



Dental-Katalog  
Dental Catalogue  
Catalogo dentale  
Catálogo dental  
Catalogue dentaire





.1

Zahnzangen  
Extracting Forceps  
Pinze per estrazione  
Pinzas de extracciòn  
Daviers

Zahnärztliche Chirurgie  
Dental surgery  
Chirurgia dentale  
Cirugia dental  
Chirurgie dentaire

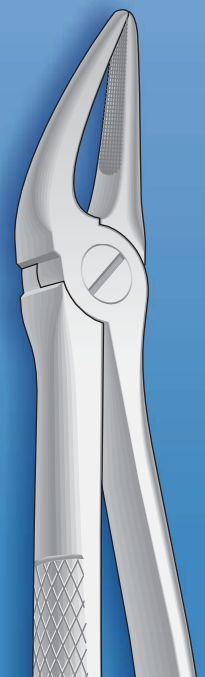





Zahnzangen, Englische Form  
 Extracting Forceps, English Pattern  
 Pinze per estrazione, Forma Inglese  
 Pinzas da extracciòn, Forma Inglesa  
 Daviers, Forme Anglaise



**B**

Obere Schneide- und Eckzähne  
 Upper Incisors and cuspids  
 Incisivi e canini superiori  
 Incisivos y caninos superiores  
 Incisives et canines supérieures

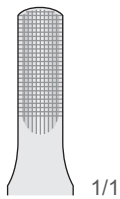

1/1

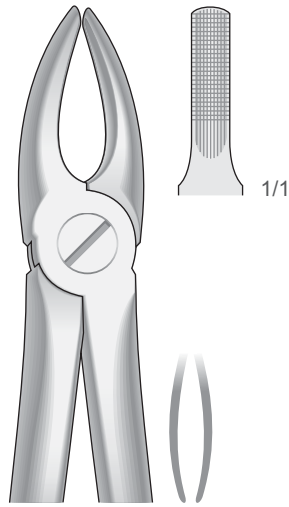

**C**

Obere Schneide- und Eckzähne  
 Upper Incisors and cuspids  
 Incisivi e canini superiori  
 Incisivos y caninos superiores  
 Incisives et canines supérieures

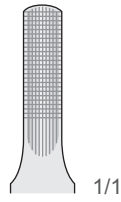

1/1

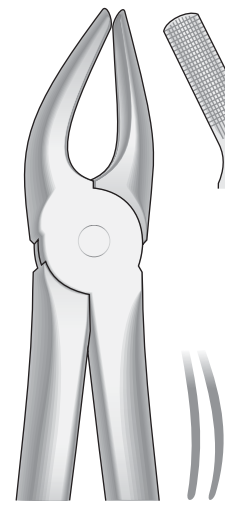

**H**

Obere Prämolaren  
 Upper premolars  
 Premolari superiori  
 Premolares superiores  
 Prémolaires supérieures

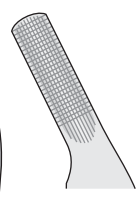

1/1

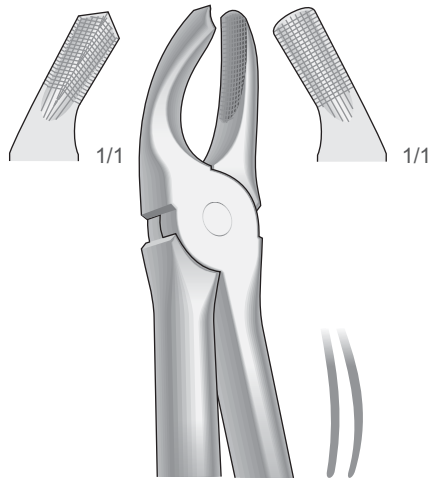

**BH**

Obere Molaren, rechts  
 Upper molars, right  
 Molari superiori, destra  
 Molares superiores, derechos  
 Molaires supérieures, droites

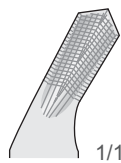

1/1

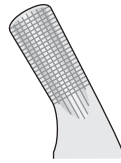

1/1

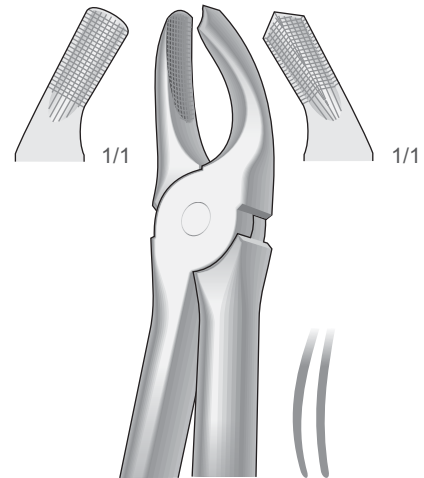

**BI**

Obere Molaren, links  
 Upper molars, left  
 Molari superiori, sinistra  
 Molares superiores, izquierdos  
 Molaires supérieures, gauches

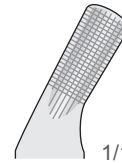

1/1

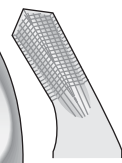

1/1



Zahnzangen, Englische Form  
Extracting Forceps, English Pattern  
Pinze per estrazione, Forma Inglese  
Pinzas da extracciòn, Forma Inglesa  
Daviers, Forme Anglaise

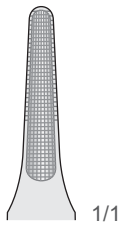
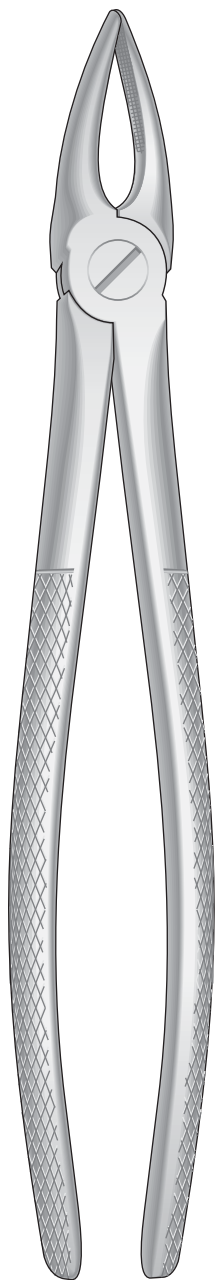

Obere Wurzeln und Schneidezähne  
Upper Roots and incisors  
Radici e incisivi superiori  
Raíces y incisivos superiores  
Racines et incisives supérieures

BL

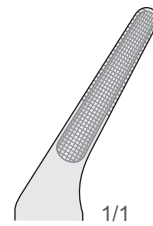

Obere Wurzeln  
Upper Roots  
Radici superiori  
Raíces superiores  
Racines supérieures

DA



Zahnzangen, Englische Form  
 Extracting Forceps, English Pattern  
 Pinze per estrazione, Forma Inglese  
 Pinzas da extracciòn, Forma Inglesa  
 Daviers, Forme Anglaise

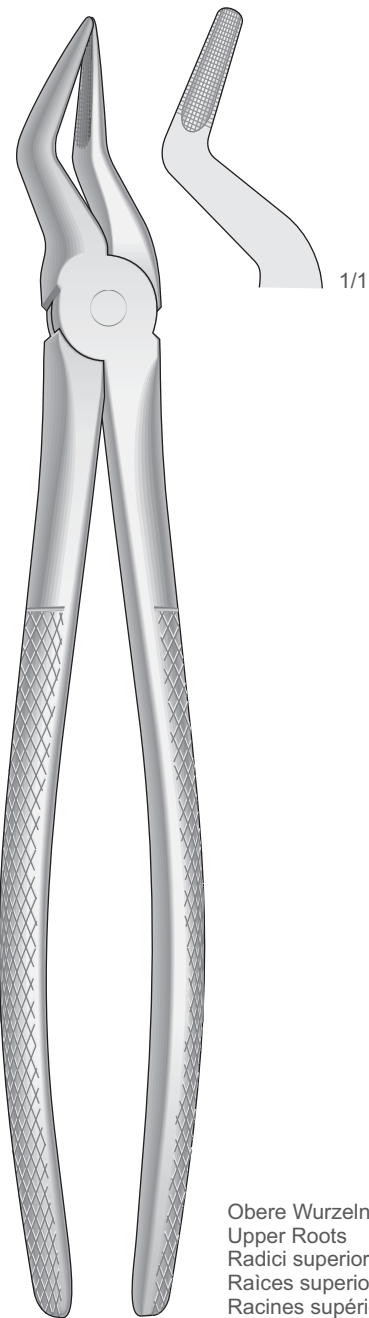

**FB**

Obere Wurzeln  
 Upper Roots  
 Radici superiori  
 Raíces superiores  
 Racines supérieures

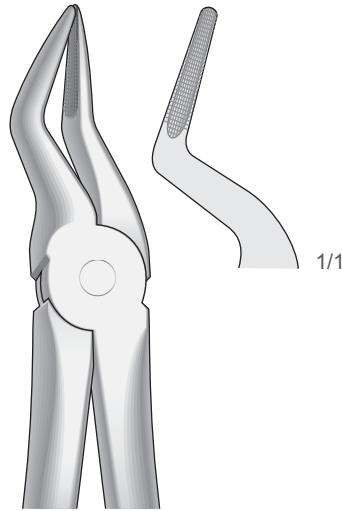

**FB-01**

Obere Wurzeln  
 Upper Roots  
 Radici superiori  
 Raíces superiores  
 Racines supérieures

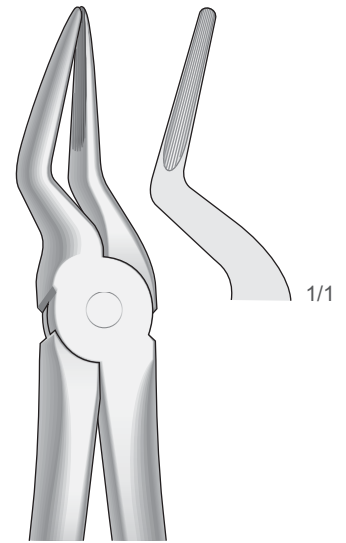

**FB-11**

Obere Wurzeln  
 Upper Roots  
 Radici superiori  
 Raíces superiores  
 Racines supérieures

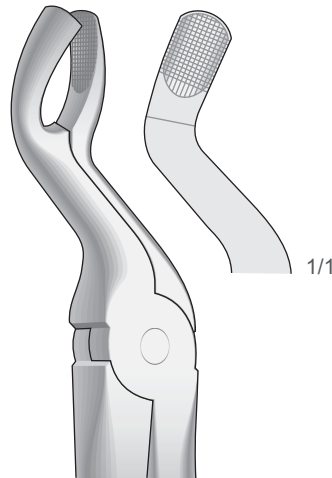

**GH-01**

Obere Dritte Molaren - Für Obere Weisheitszähne  
 Upper molars - For Upper wisdom teeth  
 Ottavi superiori - Per denti del giudizio superiori  
 Molares superiores - Para muelas del juicio superiores  
 Molaires supérieures - Pour dents de sagesse supérieures



Zahnzangen, Englische Form  
Extracting Forceps, English Pattern  
Pinze per estrazione, Forma Inglese  
Pinzas da extracciòn, Forma Inglesa  
Daviers, Forme Anglaise

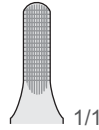
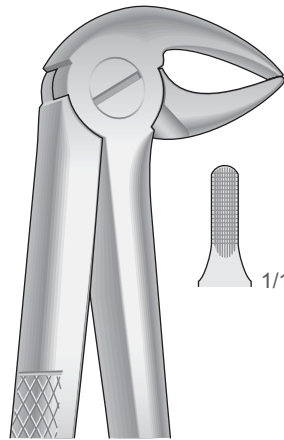

DD

Untere Prämolaren, Schneidezähne und Wurzeln  
Lower incisors, premolars and roots  
Incisivi, premolari e radici inferiori  
Incisivos, premolares y raíces inferiores  
Incisives, prémolaires et racines inférieures

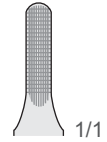
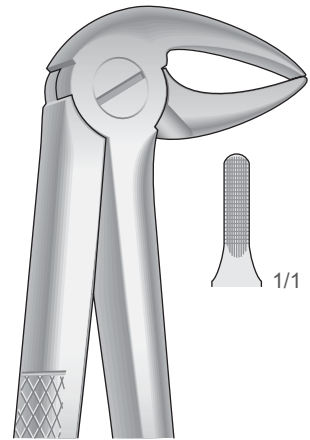

DD-01

Untere Wurzeln, schlankes Maul  
Lower roots, Slender jaw  
Radici inferiori, morso stretto  
Raíces inferiores, boca estrecha  
Racines inférieures, avec un bec très fin

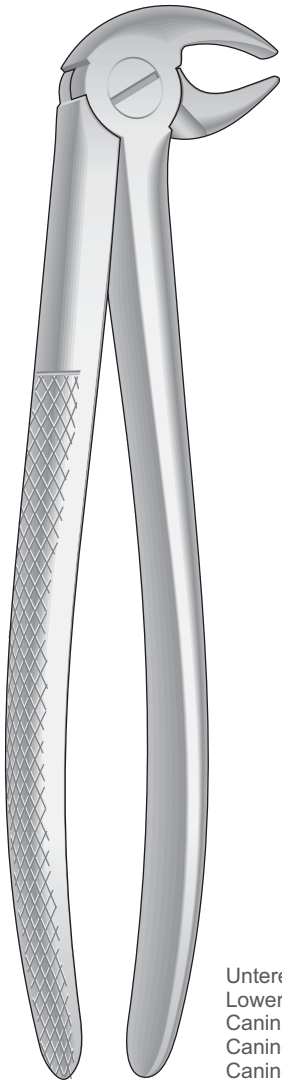

BD

Untere Eckzähne und Prämolaren  
Lower cuspids and premolars  
Canini e premolari inferiori  
Caninos y premolares inferiores  
Canines et prémolaires inférieures

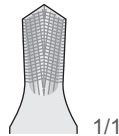
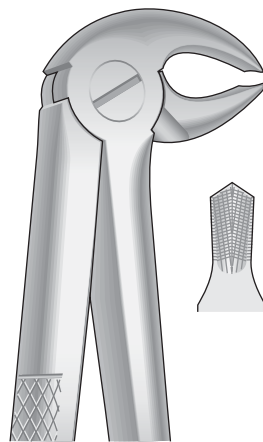

CC

Untere Molaren  
Lower molars  
Molari inferiori  
Molares inferiores  
Molaires inférieures

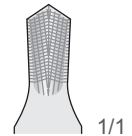
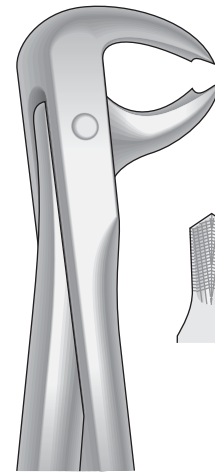

HD

Untere Molaren  
Lower molars  
Molari inferiori  
Molares inferiores  
Molaires inférieures





Zahnzangen, Englische Form  
 Extracting Forceps, English Pattern  
 Pinze per estrazione, Forma Inglese  
 Pinzas da extracciòn, Forma Inglesa  
 Daviers, Forme Anglaise

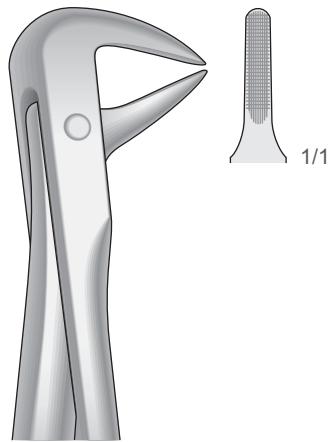

**HE-13**

Untere Wurzeln, schneide-und Eckzähne  
 Lower roots, Incisors and bicuspid  
 Radici, incisivi e canini inferiori  
 Raíces, incisivos y caninos inferiores  
 Racines, incisives et canines inférieures

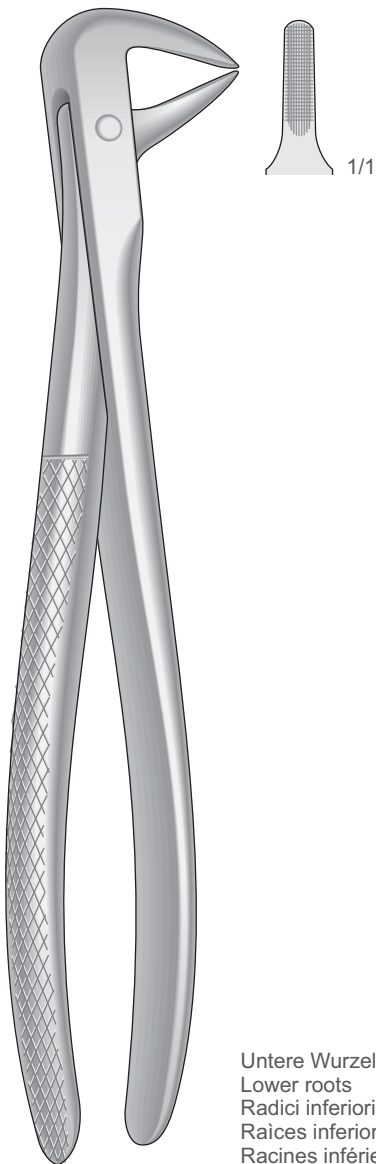

**HE**

Untere Wurzeln  
 Lower roots  
 Radici inferiori  
 Raíces inferiores  
 Racines inférieures

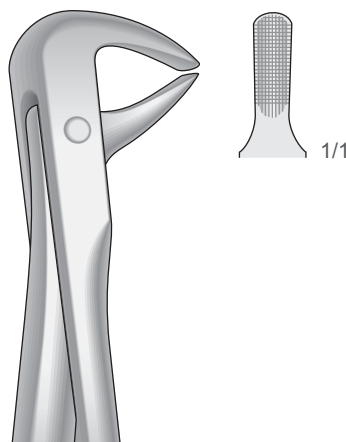

**HF**

Untere Eckzähne und Prämolaren  
 Lower Cuspids and bicuspid  
 Canini e premolari inferiori  
 Caninos y premolares inferiores  
 Canines et prémolaires inférieures

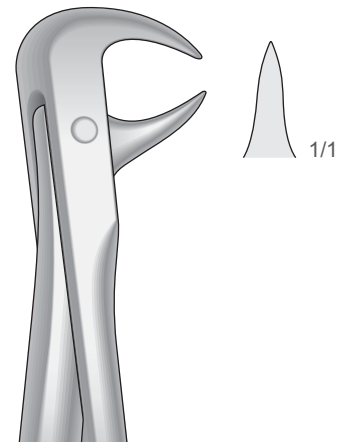

**IG-01**

Untere Molaren  
 Lower molars  
 Molari inferiori  
 Molares inferiores  
 Molaires inférieures



Zahnzangen, Englische Form  
Extracting Forceps, English Pattern  
Pinze per estrazione, Forma Inglese  
Pinzas da extracciòn, Forma Inglese  
Daviers, Forme Anglaise

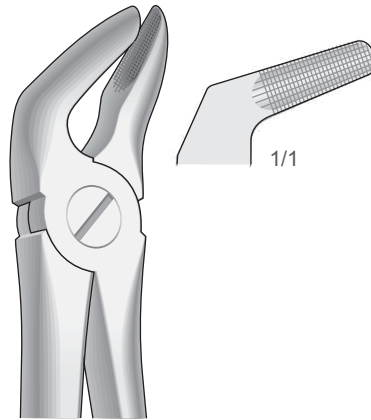

I

Untere Prämolaren  
Lower premolars  
Premolari inferiori  
Premolares inferiores  
Prémolaires inférieures

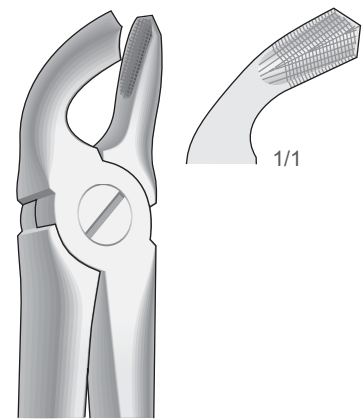

CB

Untere Weisheitszähne und Molaren  
Lower wisdom teeth and molars  
Denti del giudizio e molari inferiori  
Muelas del juicio y Molares inferiores  
Dents de sagesse et molaires inférieures

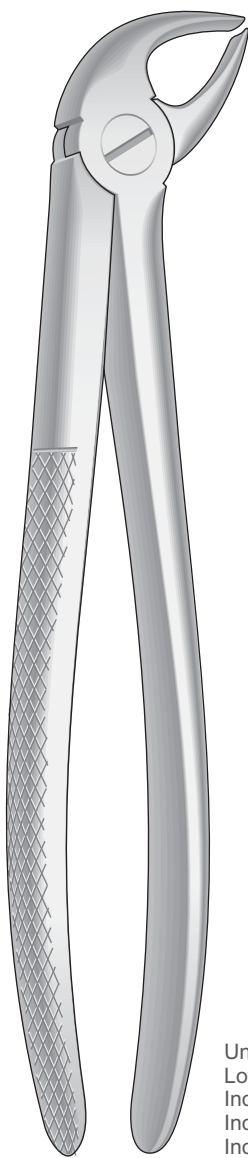

E

Untere Schneide- und Eckzähne  
Lower Incisors and cuspids  
Incisivi e canini inferiori  
Incisivos y caninos inferiores  
Incisives et canines inférieures

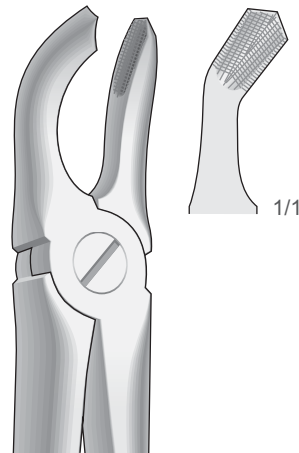
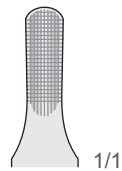

HL

Untere Weisheitszähne  
Lower wisdom teeth  
Denti del giudizio inferiori  
Muelas del juicio inferiores  
Dent de sagesse inférieures

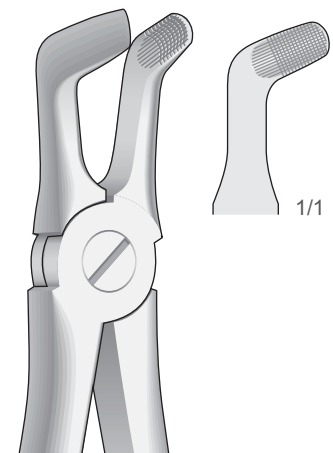

HL-01

Untere Molaren und Weisheitszähne  
Lower molars and wisdom teeth  
Molari e denti del giudizio inferiori  
Molares y muelas del juicio inferiores  
Molaires et dent de sagesse inférieures



Zahnzangen, Englische Form  
 Extracting Forceps, English Pattern  
 Pinze per estrazione, Forma Inglese  
 Pinzas da extracciòn, Forma Inglesa  
 Daviers, Forme Anglaise

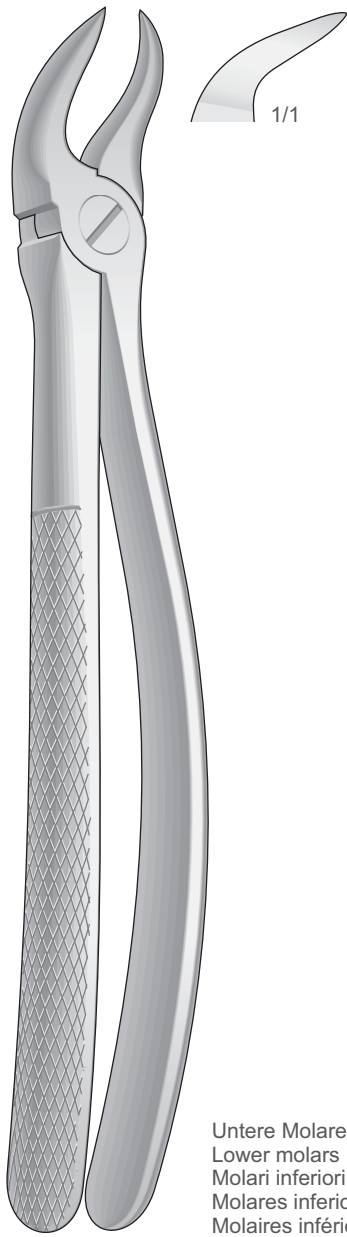

Untere Molaren  
 Lower molars  
 Molari inferiori  
 Molares inferiores  
 Molaires inférieures

IH

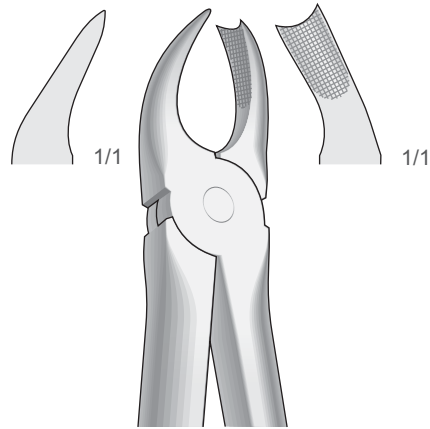

IL

Obere Molaren, rechts  
 Upper molars, right  
 Molari superiori, destra  
 Molares superiores, derechos  
 Molaires supérieures, droites

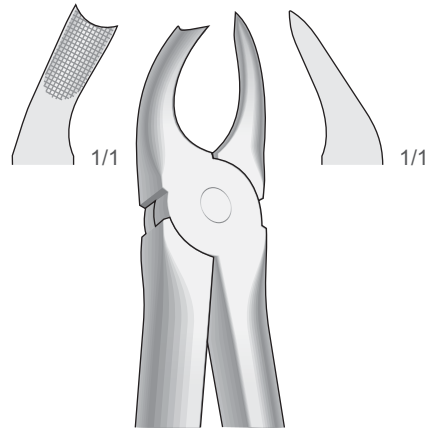

LA

Obere Molaren, links  
 Upper molars, left  
 Molari superiori, sinistra  
 Molares superiores, izquierdos  
 Molaires supérieures, gauches



Zahnzangen, Englische Form  
Extracting Forceps, English Pattern  
Pinze per estrazione, Forma Inglese  
Pinzas da extracciòn, Forma Inglesa  
Daviers, Forme Anglaise

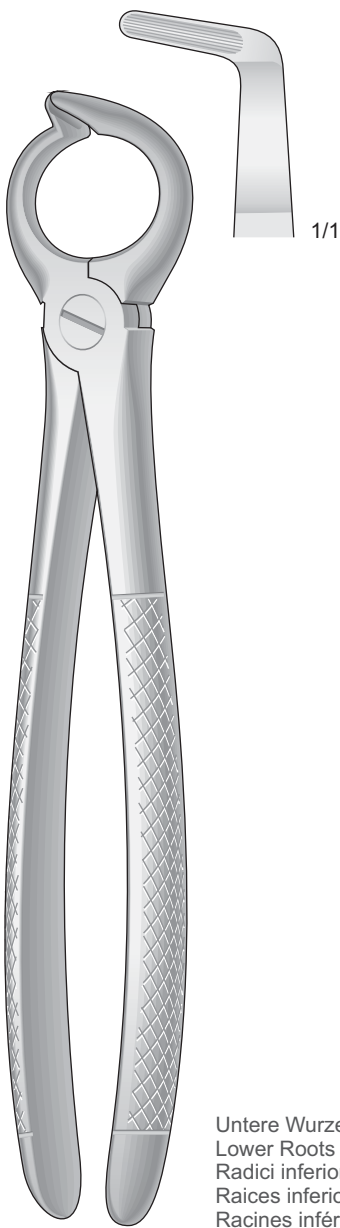

**GI**

Untere Wurzeln  
Lower Roots  
Radici inferiori  
Raices inferiores  
Racines inférieures

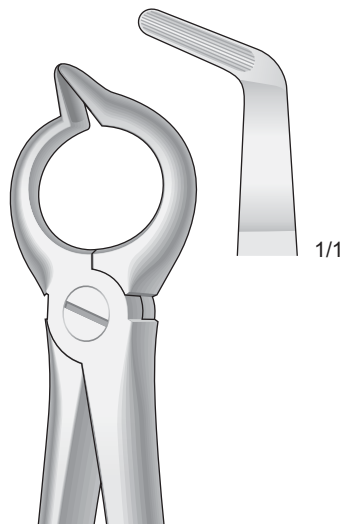

**GI01**

Untere Wurzeln  
Lower Roots  
Radici inferiori  
Raices inferiores  
Racines inférieures

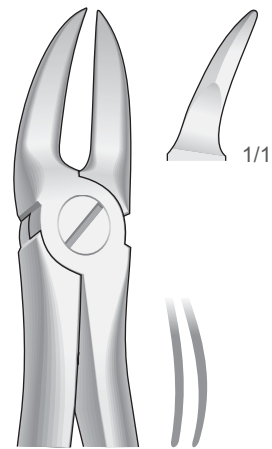

**FF**

Zum Trennen oberer Molarenwurzeln  
For separating upper molar roots  
Per radici dei molari superiori, presa in profondità  
Para partir raices de molares superiores, profundo  
Pour séparer les racines des molaires supérieures

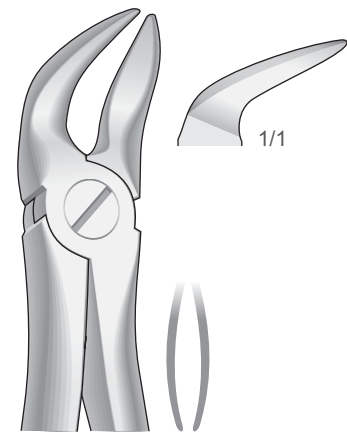

**FG**

Zum Trennen Unterer Molarenwurzeln  
For separating lower molar roots  
Per radici dei molari inferiori, presa in profondità  
Para partir raices de molares inferiores, profundo  
Pour séparer les racines des molaires inférieures



Zahnzangen, Englische Form  
 Extracting Forceps, English Pattern  
 Pinze per estrazione, Forma Inglese  
 Pinzas da extracciòn, Forma Inglesa  
 Daviers, Forme Anglaise

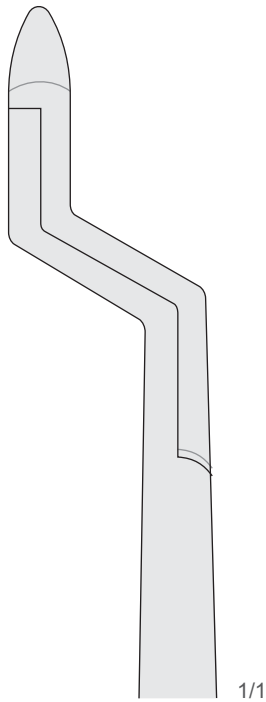
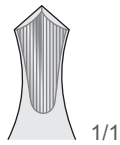
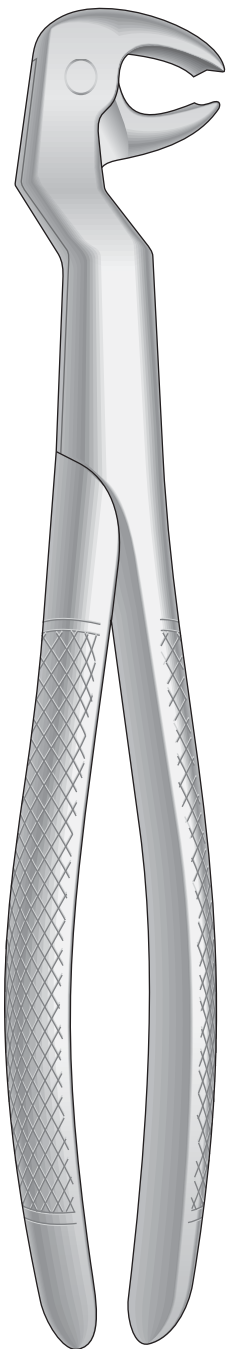

Untere Molaren und Weisheitszähne, rechts  
 Lower molars and wisdom teeth, right  
 Molari e denti del giudizio inferiori, a destra  
 Molares y muelas del juicio inferiores, derecha  
 Molaires et dent de sagesse inférieures, droites

ROUTURIER  
 CC 1/2 R

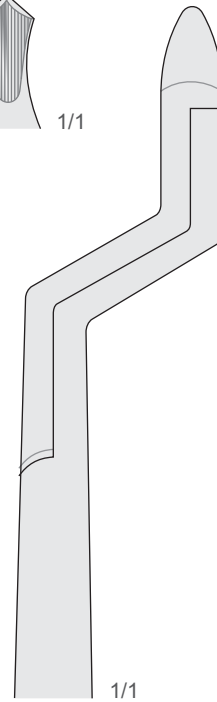
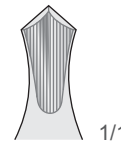
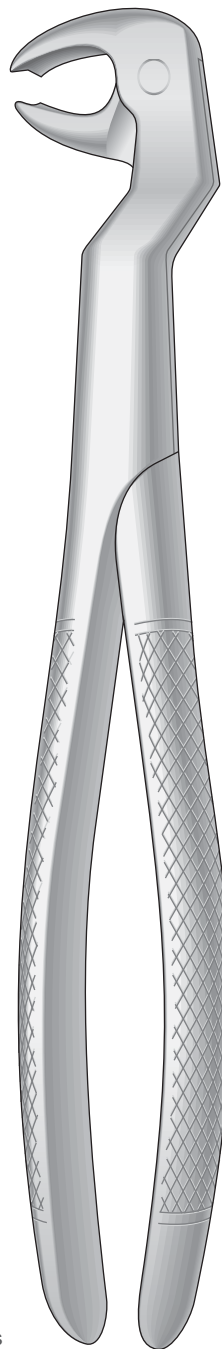

Untere Molaren und Weisheitszähne, links  
 Lower molars and wisdom teeth, left  
 Molari e denti del giudizio inferiori, a sinistra  
 Molares y muelas del juicio inferiores, izquierda  
 Molaires et dent de sagesse inférieures, gauches

ROUTURIER  
 CC 1/2 L



Zahnzangen, Englische Form  
Extracting Forceps, English Pattern  
Pinze per estrazione, Forma Inglese  
Pinzas da extracciòn, Forma Inglesa  
Daviers, Forme Anglaise

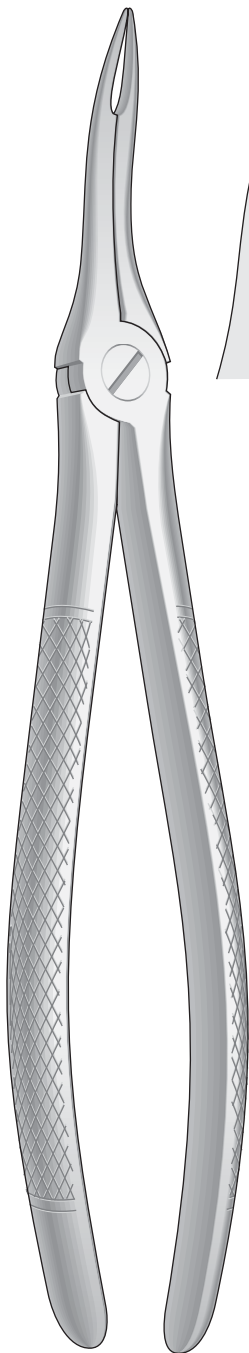

EL

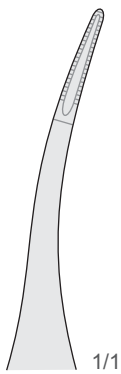

EI

Obere Wurzeln  
Upper roots  
Radici superiori  
Raíces superiores  
Racines supérieures

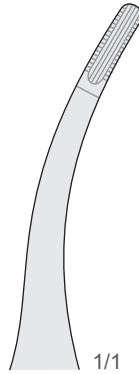

Obere Wurzeln sehr feine  
Upper very fine roots  
Radici superiori molto sottili  
Raíces superiores muy finas  
Racines supérieures très fines

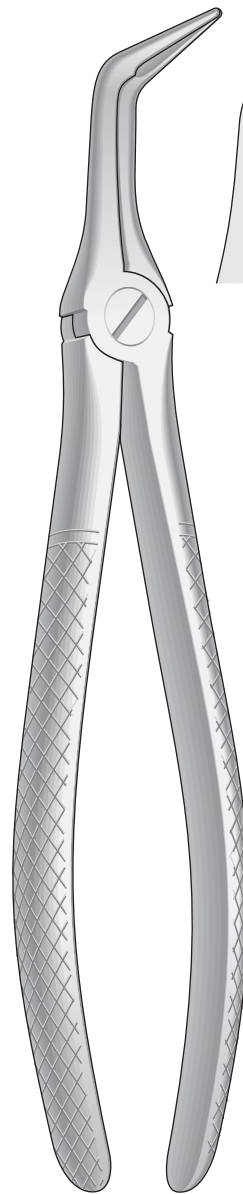

EG11

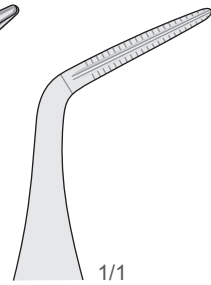

Untere Wurzeln  
Lower roots  
Radici inferiori  
Raíces inferiores  
Racines inférieures



Zahnzangen mit Paßformgriff  
 Extracting Forceps with anatomically shaped handle  
 Pinze per estrazione con manico anatomico  
 Pinzas da extracciòn con mango adaptado a la anatomìa de la mano  
 Daviers avec manche adapté à l'anatomie de la main

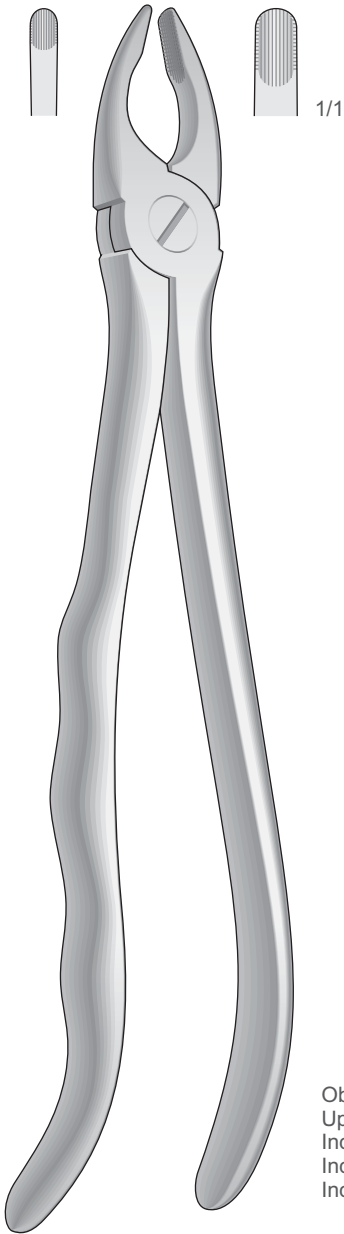

18-D0113

Obere Schneide- und Eckzähne  
 Upper incisors and cuspids  
 Incisivi e canini superiori  
 Incisivos y caninos superiores  
 Incisives et canines supérieures

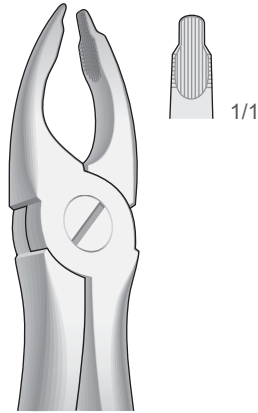

18-DE

Obere Schneide- und Eckzähne  
 Upper incisors and cuspids  
 Incisivi e canini superiori  
 Incisivos y caninos superiores  
 Incisives et canines supérieures

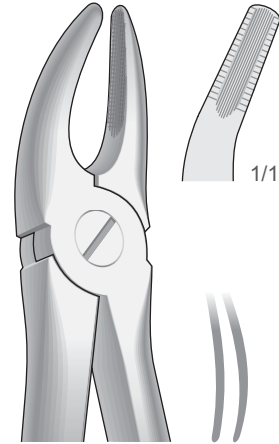

18-H

Obere Prämolaren  
 Upper premolars  
 Premolari superiori  
 Premolares superiores  
 Prémolaires supérieures

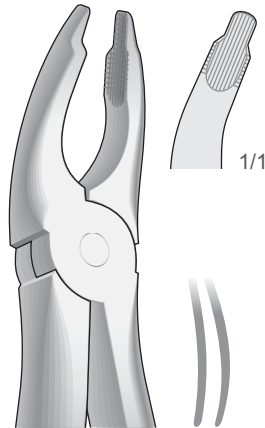

18-DF

Obere Schneidezähne und Prämolaren, tiefgreifend  
 Upper incisors and bicuspid, deep-gripping  
 Incisivi e premolari superiori, presa in profondità  
 Incisivos y premolares superiores, a gran calado  
 Incisives et prémolaires supérieures, à attaque profonde



Zahnzangen mit Paßformgriff  
Extracting Forceps with anatomically shaped handle  
Pinzas per estrazione con manico anatomico  
Pinzas da extracciòn con mango adaptado a la anatomia de la mano  
Daviers avec manche adapté à l'anatomie de la main

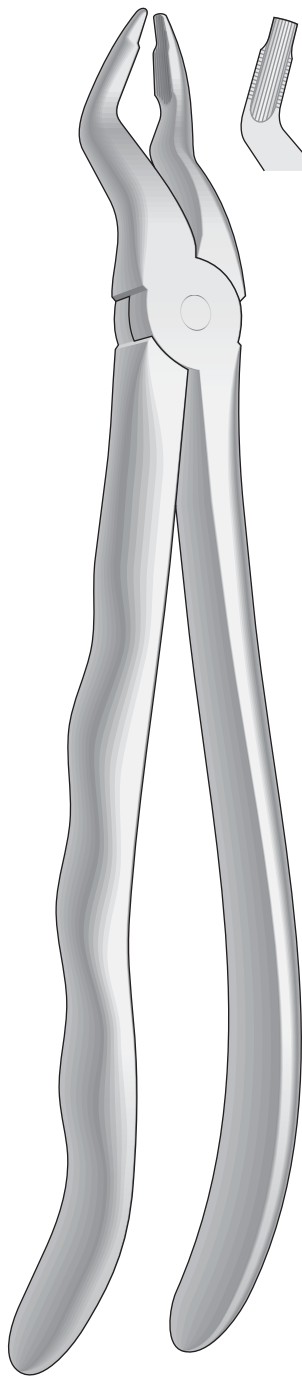

18-DB

Obere Prämolaren  
Upper premolars  
Premolari superiori  
Premolares superiores  
Prémolaires supérieures

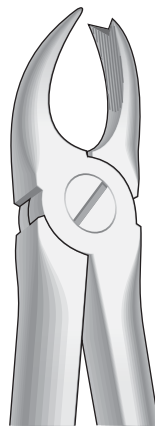
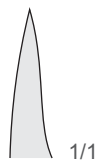
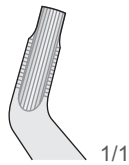

18-GG17

Obere Molaren, rechts  
Upper molars, right  
Molari superiori, destra  
Molares superiores, derechos  
Molaires supérieures, droites

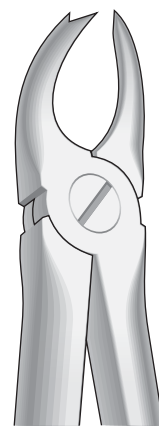
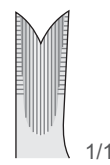
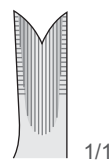

18-GG11

Obere Molaren, links  
Upper molars, left  
Molari superiori, sinistra  
Molares superiores, izquierdos  
Molaires supérieures, gauches

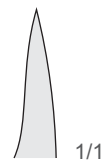





Zahnzangen mit Paßformgriff  
 Extracting Forceps with anatomically shaped handle  
 Pinze per estrazione con manico anatomico  
 Pinzas da extracciòn con mango adaptado a la anatomìa de la mano  
 Daviers avec manche adapté à l'anatomie de la main

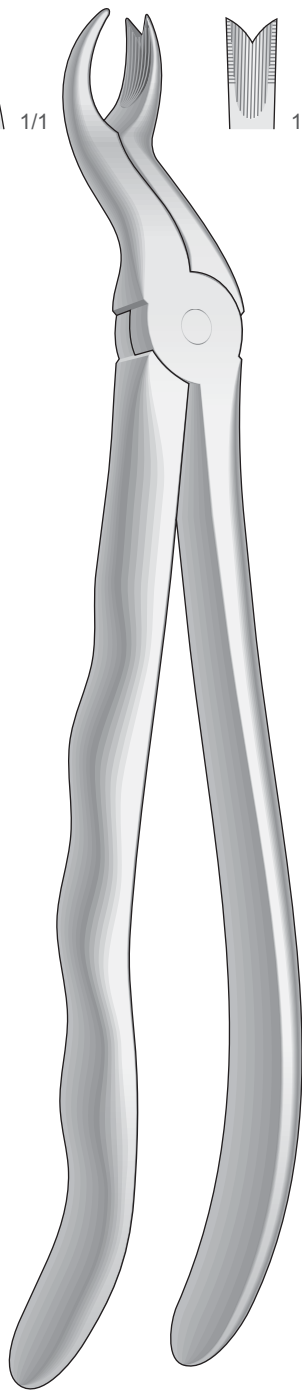
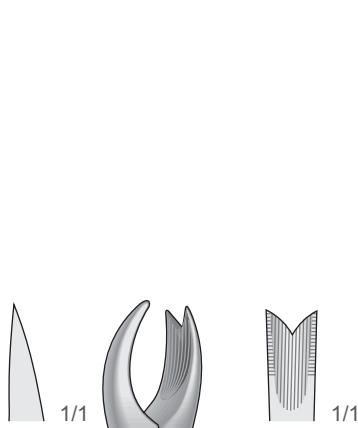

**18-GH17**

Obere Molaren, rechts  
 Upper molars, right  
 Molari superiori, destra  
 Molares superiores, derechos  
 Molaires supérieures, droites

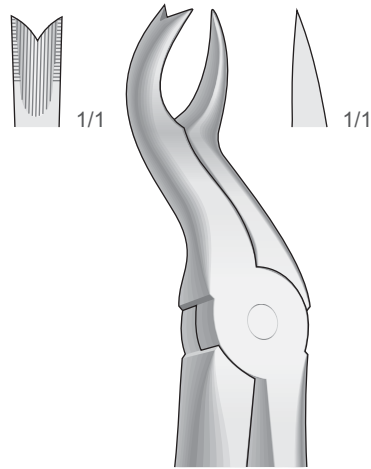

**18-GH11**

Obere Molaren, links  
 Upper molars, left  
 Molari superiori, sinistra  
 Molares superiores, izquierdos  
 Molaires supérieures, gauches

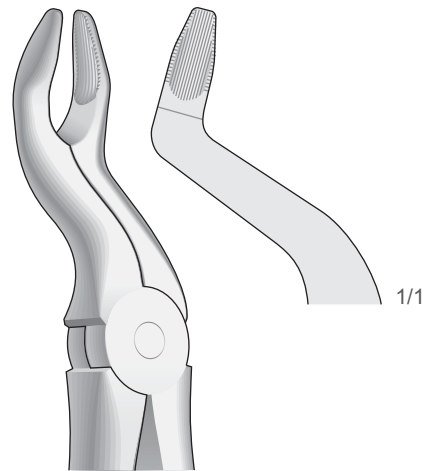

**18-GH13**

Obere Molaren  
 Upper molars  
 Molari superiori  
 Molares superiores  
 Molaires supérieures



Zahnzangen mit Paßformgriff  
Extracting Forceps with anatomically shaped handle  
Pinze per estrazione con manico anatomico  
Pinzas da extracciòn con mango adaptado a la anatomia de la mano  
Daviers avec manche adapté à l'anatomie de la main

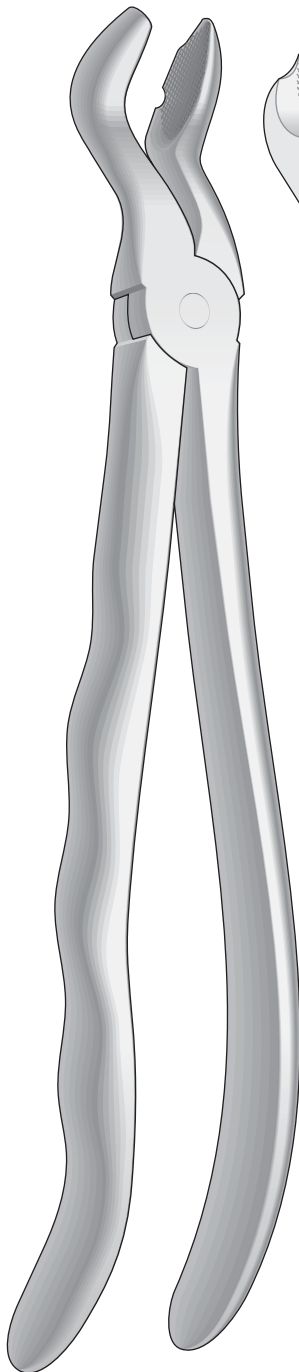

FELSCH  
18-IA

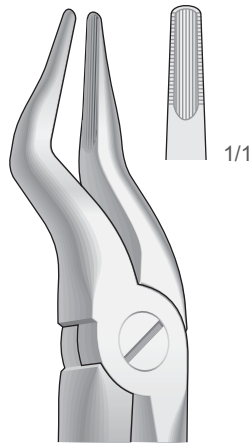
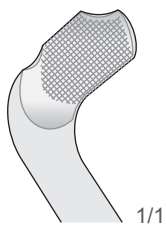

18-FB02

Obere Dritte Molaren  
Upper molars  
Ottavi superiori  
Molares superiores  
Molaires supérieures

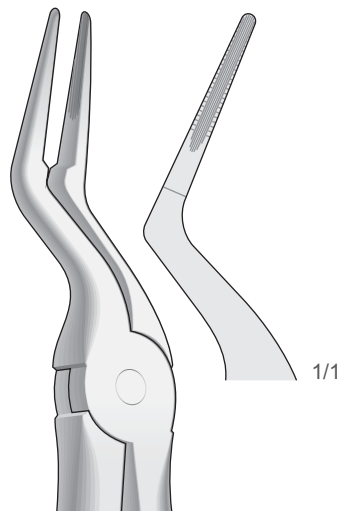

18-LH

Obere Wurzelplitterzange  
Upper Root Fragments  
Frammenti e radici superiori  
Fragmentos de raices superiores  
Fragments des racines supérieures

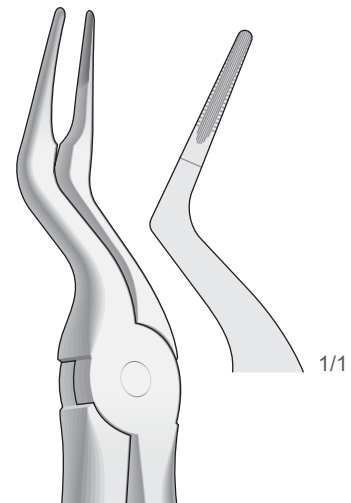

18-LH02

Obere Wurzelplitterzange  
Upper Root Fragments  
Frammenti e radici superiori  
Fragmentos de raices superiores  
Fragments des racines supérieures

Für obere Weisheitszähne, mit Fangvorrichtung  
For upper wisdom teeth, with retaining device  
Denti del giudizio superiori, con dispositivo di presa  
Muelas del juicio superiores, con dispositivo de retencion  
Pour dents de sagesse supérieures, mors conçus pour recueillir la dent



Zahnzangen mit Paßformgriff  
 Extracting Forceps with anatomically shaped handle  
 Pinze per estrazione con manico anatomico  
 Pinzas da extracciòn con mango adaptado a la anatomìa de la mano  
 Daviers avec manche adapté à l'anatomie de la main

Obere Wurzeln sehr feine  
 Upper very fine roots  
 Radici superiori molto sottili  
 Raíces superiores muy finas  
 Racines supérieures très fines

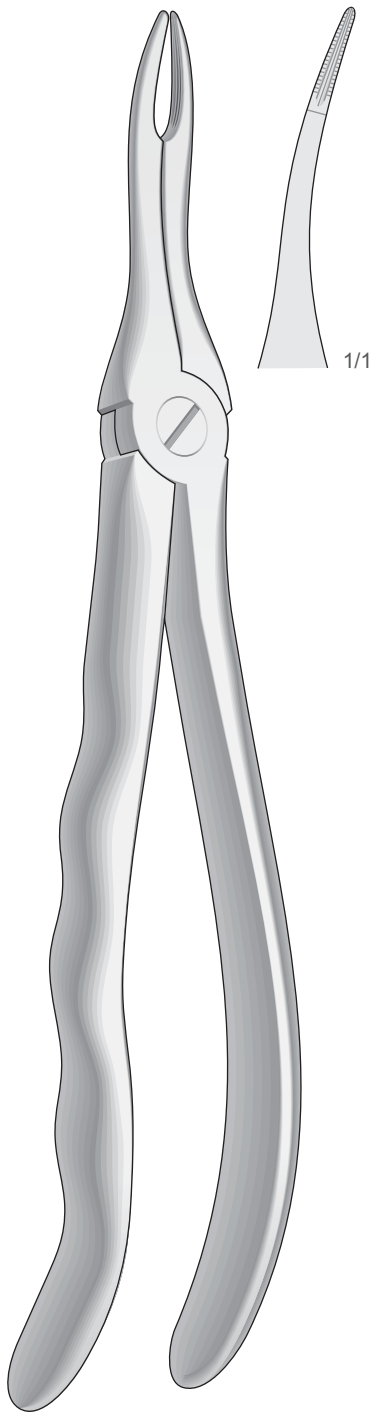

18-EL

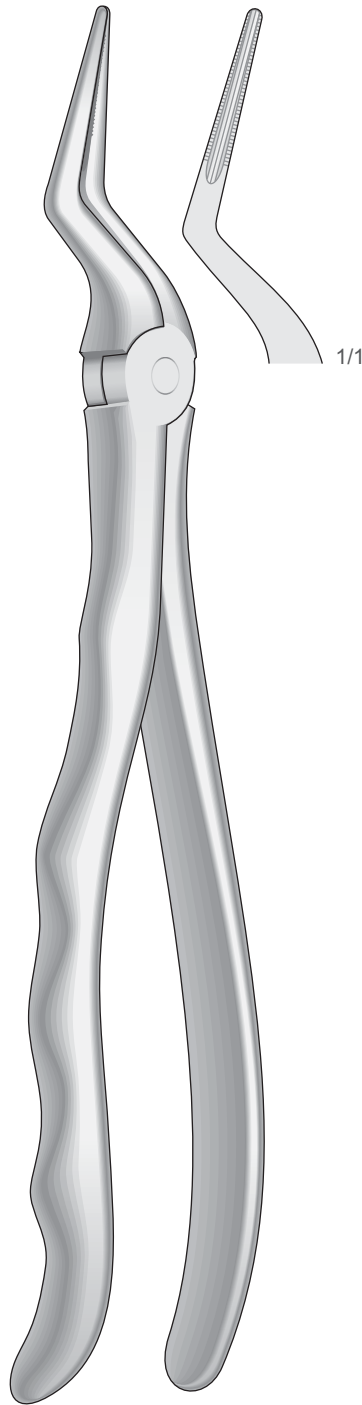

18-FB1123

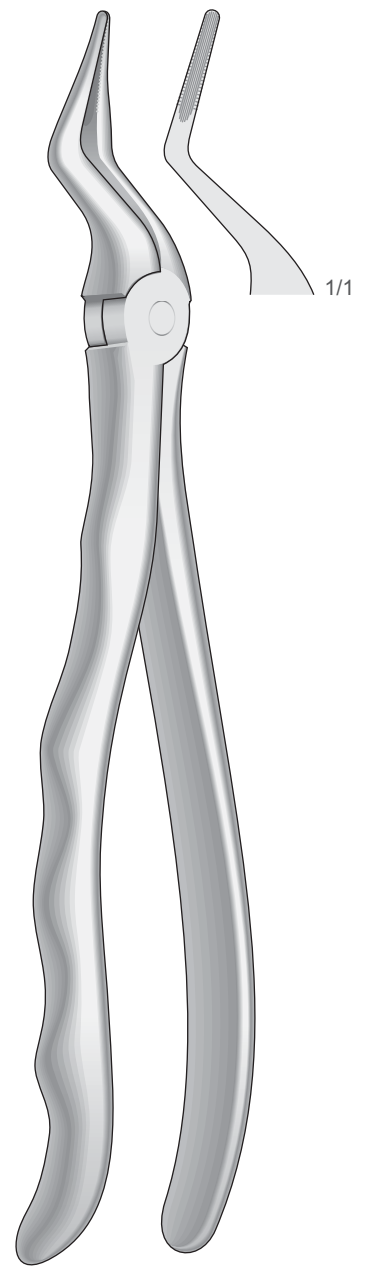

18-DFB18



Zahnzangen mit Paßformgriff  
Extracting Forceps with anatomically shaped handle  
Pinze per estrazione con manico anatomico  
Pinzas da extracciòn con mango adaptado a la anatomia de la mano  
Daviers avec manche adapté à l'anatomie de la main

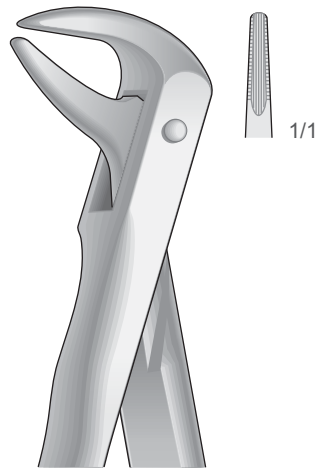

09-HE13

Untere Wurzeln Schneide- und Eckzähne  
Lower roots, incisors and cuspids  
Radici, incisivi e canini inferiori  
Raíces, incisivos y caninos inferiores  
Racines, incisives et canines inférieures

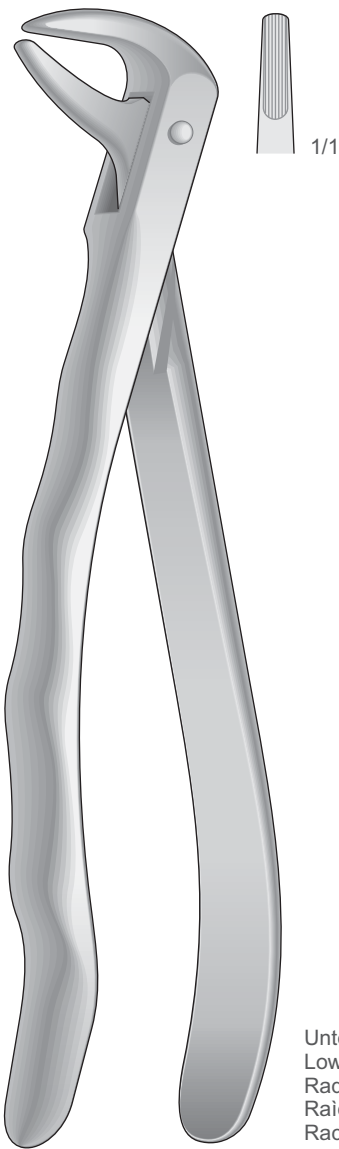

09-HE

Untere Wurzeln Schneide- und Eckzähne  
Lower roots, incisors and cuspids  
Radici, incisivi e canini inferiori  
Raíces, incisivos y caninos inferiores  
Racines, incisives et canines inférieures

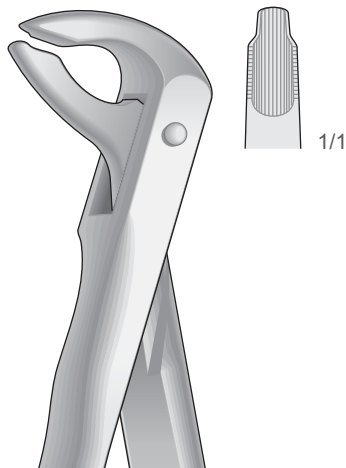

09-DG

Untere Wurzeln Schneide- und Eckzähne  
Lower roots, incisors and cuspids  
Radici, incisivi e canini inferiori  
Raíces, incisivos y caninos inferiores  
Racines, incisives et canines inférieures

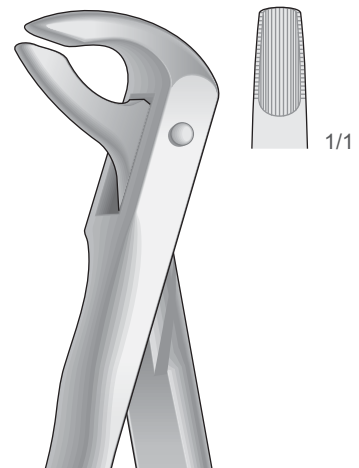

09-DG13

Untere Wurzeln Schneide- und Eckzähne  
Lower roots, incisors and cuspids  
Radici, incisivi e canini inferiori  
Raíces, incisivos y caninos inferiores  
Racines, incisives et canines inférieures



Zahnzangen mit Paßformgriff  
 Extracting Forceps with anatomically shaped handle  
 Pinze per estrazione con manico anatomico  
 Pinzas da extracciòn con mango adaptado a la anatomìa de la mano  
 Daviers avec manche adapté à l'anatomie de la main

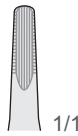

1/1

09-FL

Untere Wurzelflitterzange  
 Lower Root Fragments  
 Frammenti e radici inferiori  
 Fragmentos de raices inferiores  
 Fragments des racines inférieures

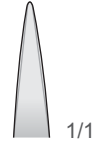

1/1

09-IG03

Untere Molaren mit kariesen oder abgebrochenen Kronen  
 Lower molars with carious or broken caps  
 Molari inferiori con corone cariate o spezzate  
 Molares inferiores con coronas rotas o cariadas  
 Molaires inférieures avec couronnes cariées ou cassées

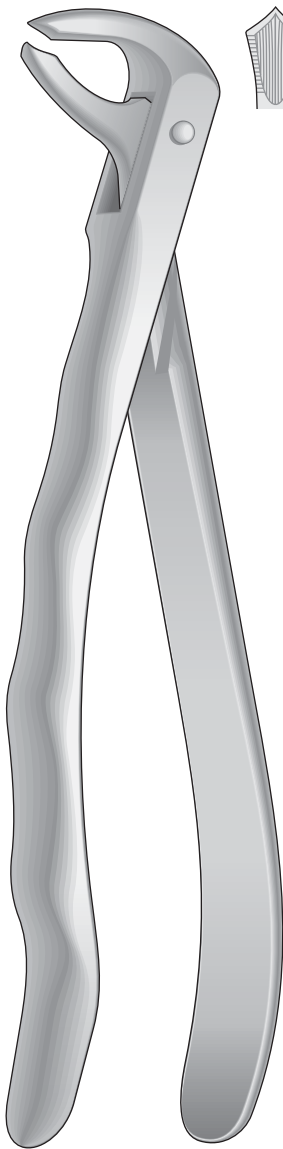

1/1

09-HD

Untere Molaren  
 Lower molars  
 Molari inferiori  
 Molares inferiores  
 Molaires inférieures

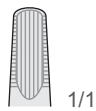
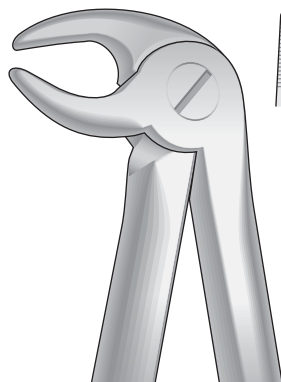

1/1

09-BD

Untere Prämolaren und Eckzähne  
 Lower premolars and cuspids  
 Canini e premolari inferiori  
 Caninos y premolares inferiores  
 Canines et prémolaires inférieures

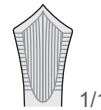

1/1

09-CC

Untere Molaren  
 Lower molars  
 Molari inferiori  
 Molares inferiores  
 Molaires inférieures



Zahnzangen mit Paßformgriff  
Extracting Forceps with anatomically shaped handle  
Pinze per estrazione con manico anatomico  
Pinzas da extracciòn con mango adaptado a la anatomia de la mano  
Daviers avec manche adapté à l'anatomie de la main

Untere Weisheitszähne  
Lower wisdom teeth  
Denti del giudizio inferiori  
Muelas del juicio inferiores  
Dent de sagesse inférieures

Untere Prämolaren  
Lower premolars  
Premolari inferiori  
Premolares inferiores  
Prémolaires inférieures

Untere Molaren  
Lower Molars  
Molari inferiori  
Molares inferiores  
Molaires inférieures

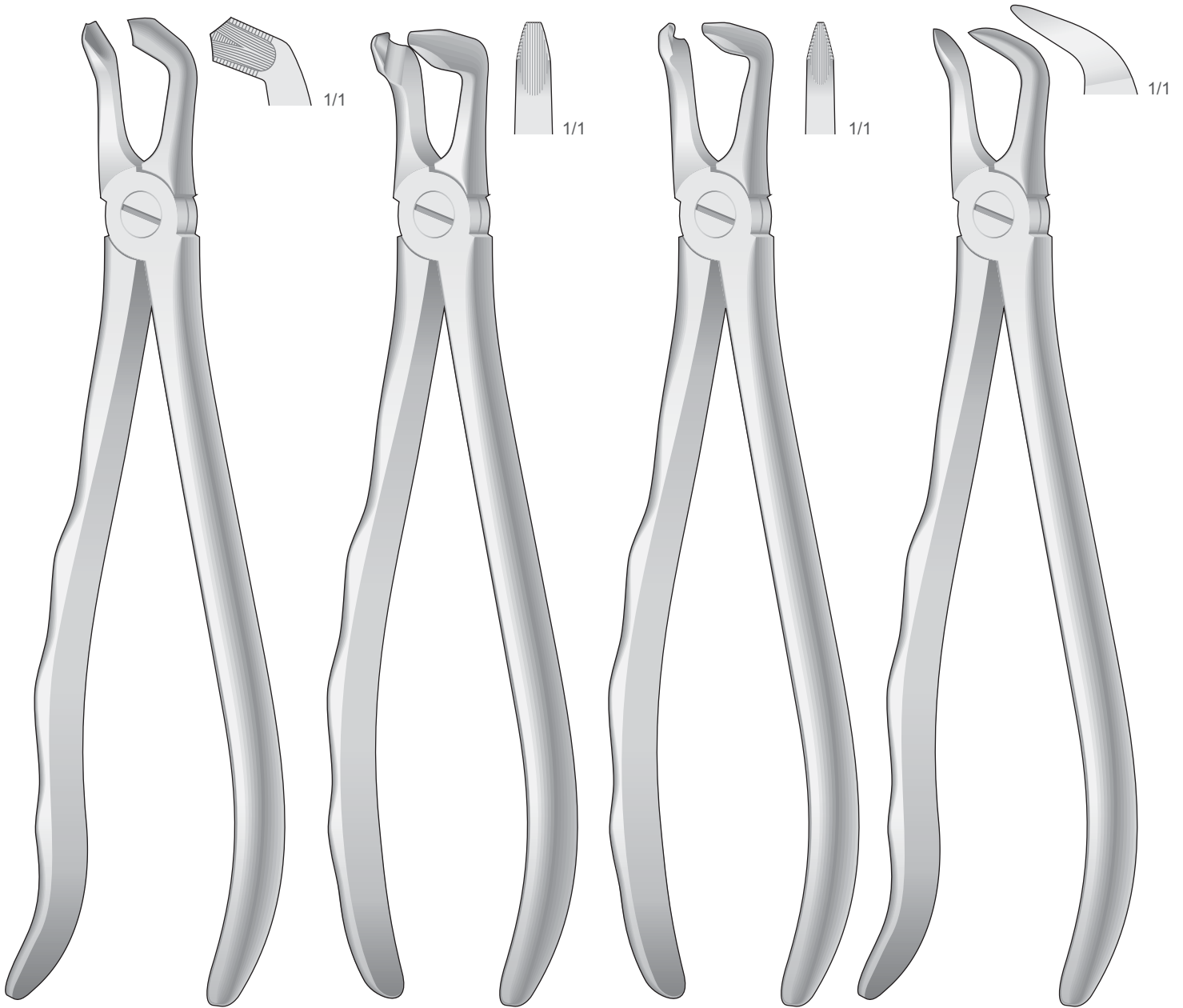

09-HL

09-HL13

09-EG13

09-IH



Zahnzangen mit Paßformgriff  
 Extracting Forceps with anatomically shaped handle  
 Pinze per estrazione con manico anatomico  
 Pinzas da extracciòn con mango adaptado a la anatomìa de la mano  
 Daviers avec manche adapté à l'anatomie de la main

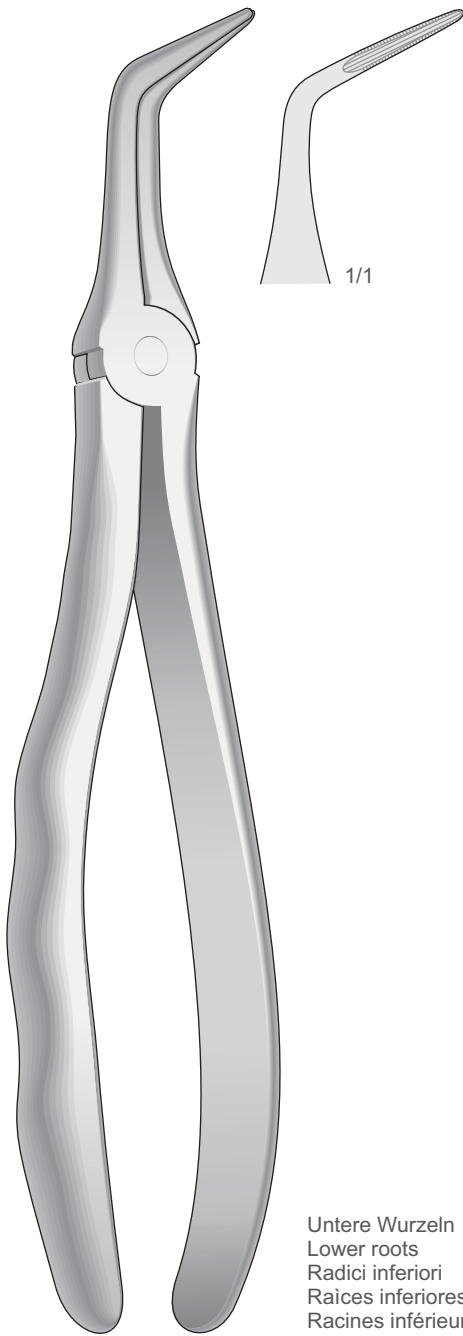

Untere Wurzeln  
 Lower roots  
 Radici inferiori  
 Raíces inferiores  
 Racines inférieures

09-EG1123



Untere Wurzeln  
 Lower roots  
 Radici inferiori  
 Raíces inferiores  
 Racines inférieures

09-EG11



Zahnzangen mit Paßformgriff  
Extracting Forceps with anatomically shaped handle  
Pinze per estrazione con manico anatomico  
Pinzas da extracciòn con mango adaptado a la anatomia de la mano  
Daviers avec manche adapté à l'anatomie de la main

Untere Molaren und Weisheitszähne  
Lower molars and wisdom teeth  
Molari e denti del giudizio inferiori  
Molares y muelas del juicio inferiores  
Molaires et dent de sagesse inférieures

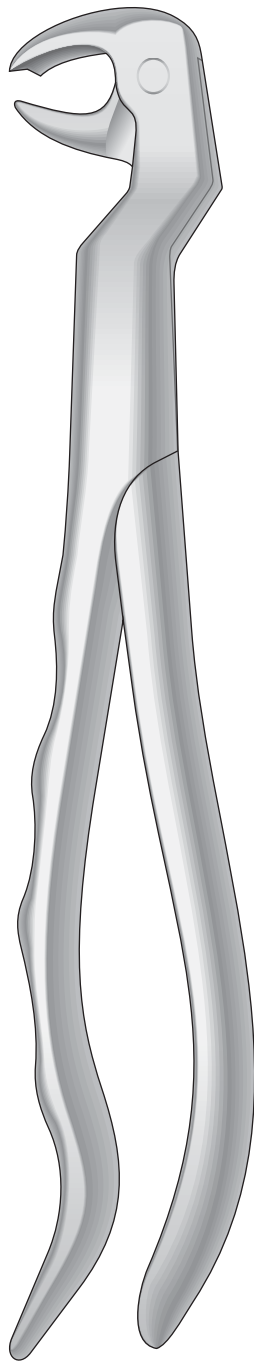

1/1

Links  
Left  
Sinistra  
Izquierdos  
Gauches

09-CC B/C 11

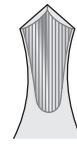
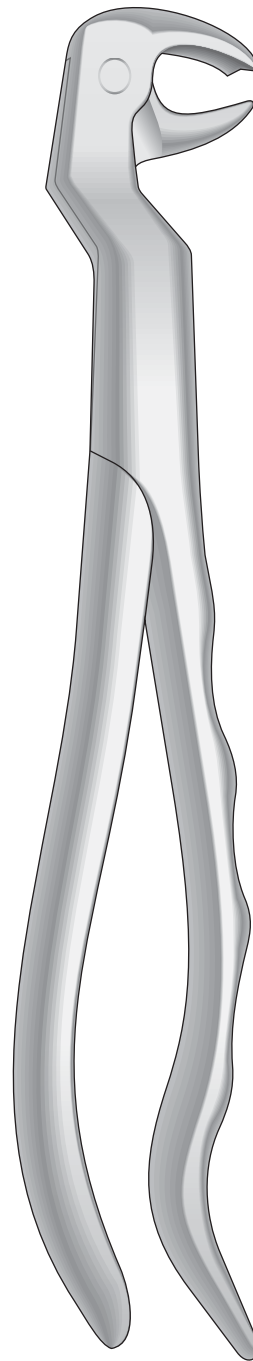

1/1

Rechts  
Right  
Destra  
Derechos  
Droites

09-CC B/C 17





Zahnzangen mit Paßformgriff  
 Extracting Forceps with anatomically shaped handle  
 Pinze per estrazione con manico anatomico  
 Pinzas da extracciòn con mango adaptado a la anatomìa de la mano  
 Daviers avec manche adapté à l'anatomie de la main

Untere Wurzeln sehr feine  
 Lower very fine roots  
 Radici inferiori molto sottili  
 Raíces inferiores muy finas  
 Racines inférieures très fines

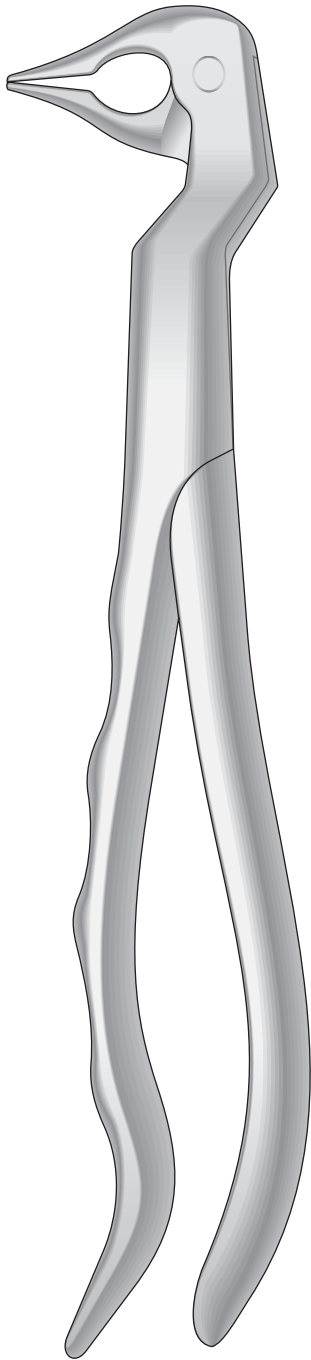

09-BDD L

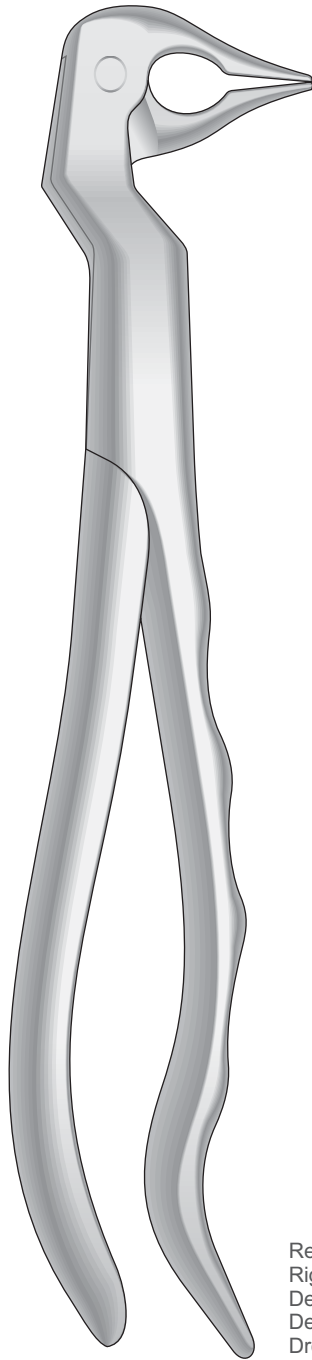

09-BDD R

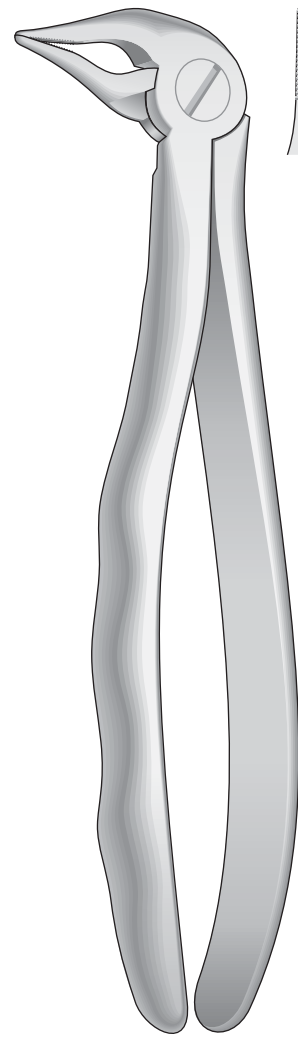

09-BDD18

Links  
 Left  
 Sinistra  
 Izquierdos  
 Gauches

Rechts  
 Right  
 Destra  
 Derechos  
 Droites



Zahnzangen, Amerikanische Form  
Extracting Forceps, American Pattern  
Pinze per estrazione, Forma Americana  
Pinzas da extracciòn, Forma Americana  
Daviers, Forme Américaine

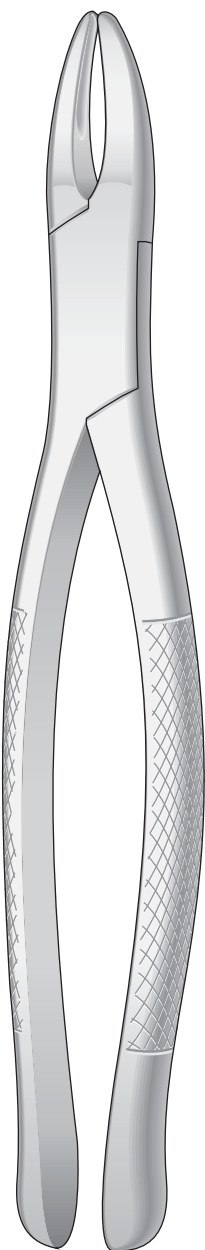

0112-B

Obere Schneide- und Eckzähne  
Upper incisors and cuspids  
Incisivi e canini superiori  
Incisivos y caninos superiores  
Incisives et canines supérieures

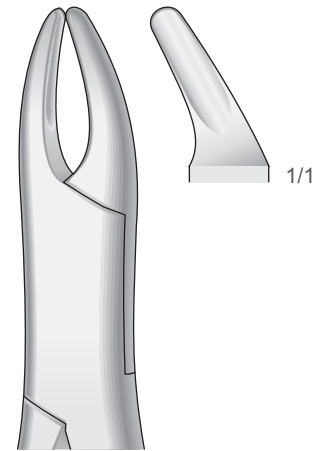
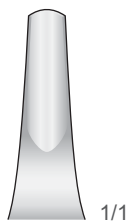

CRYER  
0112-BFA

Obere Prämolaren, Schneidezähne, Wurzeln  
Upper Bicuspid, incisors and roots  
Premolari, incisivi e radici superiori  
Premolares, incisivos y raices superiores  
Prémolaires, incisives et racines supérieures

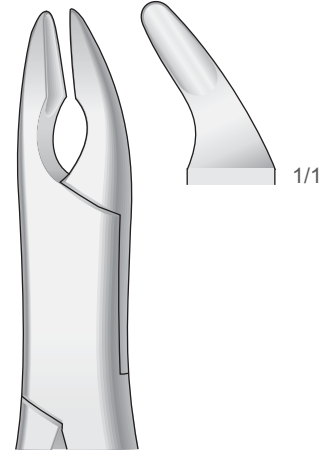

CRYER  
0112-BFA01

Obere Prämolaren, Schneidezähne, Wurzeln  
Upper Bicuspid, incisors and roots  
Premolari, incisivi e radici superiori  
Premolares, incisivos y raices superiores  
Prémolaires, incisives et racines supérieures

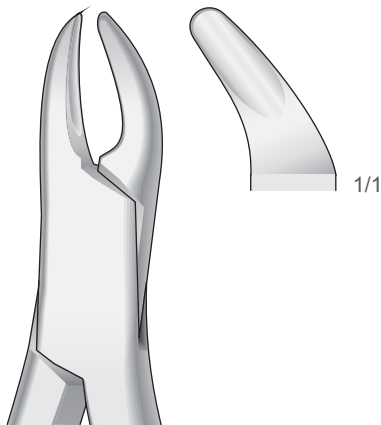

0112-GC

Schneidezähne, Prämolaren, Milchzähne  
Incisors, premolars, deciduous teeth  
Incisivi, premolari, denti da latte  
Incisivos, premolares, dientes de leche  
Incisives, prémolaires, dents de lait



Zahnzangen, Amerikanische Form  
 Extracting Forceps, American Pattern  
 Pinze per estrazione, Forma Americana  
 Pinzas da extracciòn, Forma Americana  
 Daviers, Forme Américaine

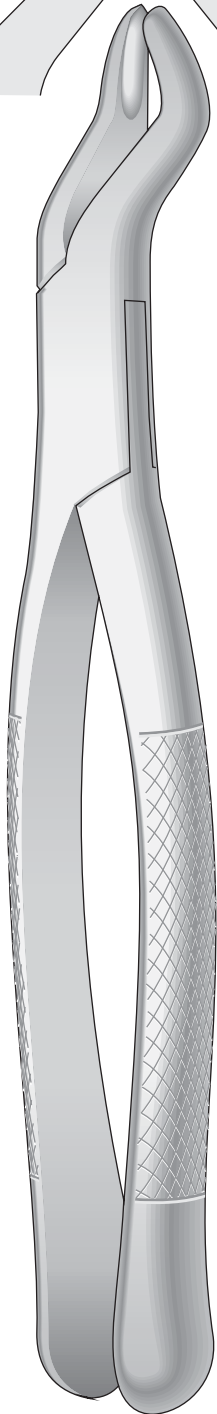
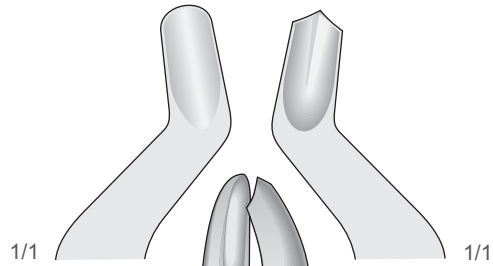
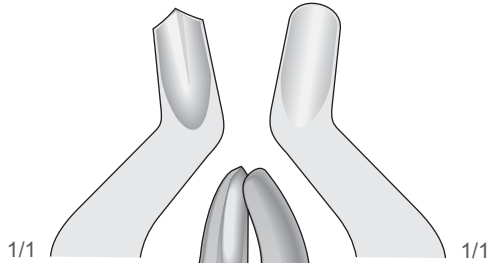

0112-FD11

Obere Molaren, Links  
 Upper Molars, Left  
 Molari superiori, Sinistra  
 Molares superiores, Izquierdos  
 Molaires supérieures, Gauches

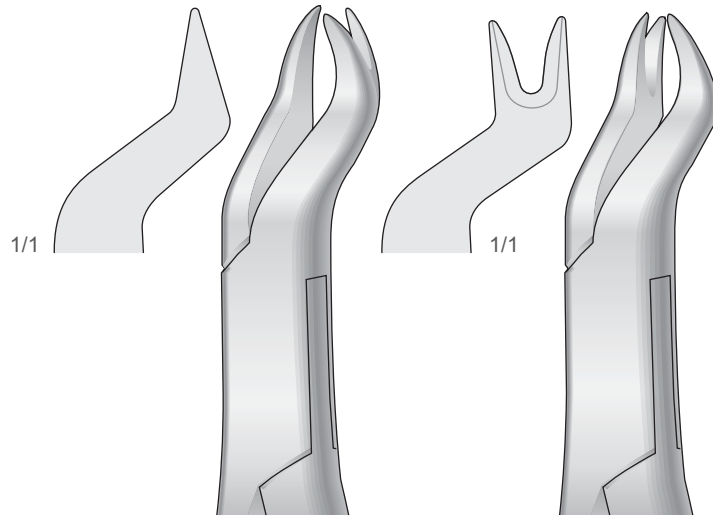

NEVIUS  
 0112-II17

Obere Molaren, Rechts  
 Upper Molars, Right  
 Molari superiori, Destra  
 Molares superiores, Derechos  
 Molaires supérieures, Droites

NEVIUS  
 0112-II11

Obere Molaren, Links  
 Upper Molars, Left  
 Molari superiori, Sinistra  
 Molares superiores, Izquierdos  
 Molaires supérieures, Gauches

0112-FD17



Zahnzangen, Amerikanische Form  
Extracting Forceps, American Pattern  
Pinze per estrazione, Forma Americana  
Pinzas da extracciòn, Forma Americana  
Daviers, Forme Américaine

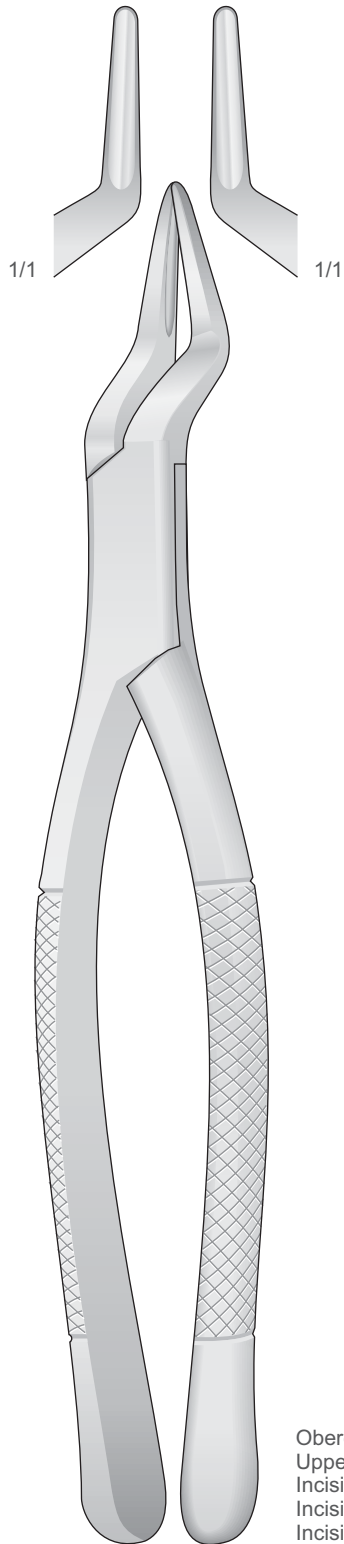

0112-GF

Obere Schneidezähne und Wurzeln  
Upper Incisors and Roots  
Incisivi e radici superiori  
Incisivos y raíces superiores  
Incisives et racines supérieures

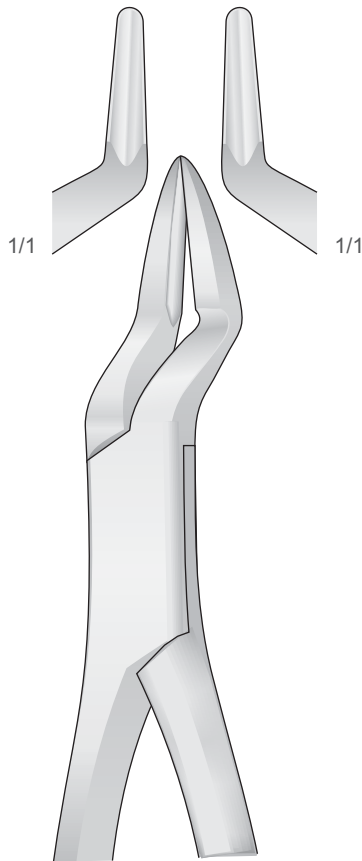

PARMLY  
0112-DC01

Obere Wurzeln und Prämolaren  
Upper Roots and Premolars  
Radici e premolari superiori  
Raices y premolares superiores  
Racines et prémolaires supérieures

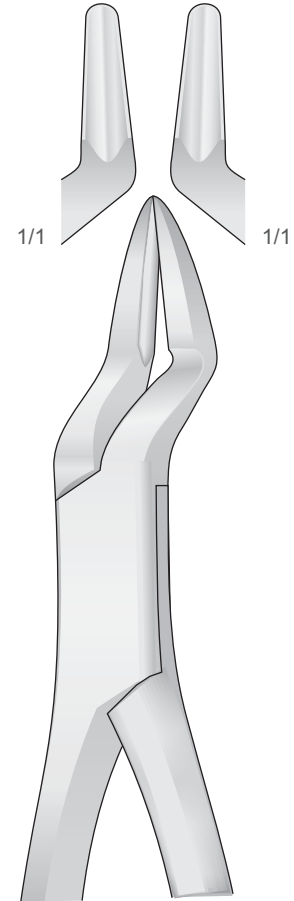

PARMLY  
0112-DC

Obere Prämolaren und Molaren  
Upper Premolars and Molars  
Premolari e molari superiori  
Premolares y Molares superiores  
Prémolaires et Molaires supérieures

Zahnzangen, Amerikanische Form  
 Extracting Forceps, American Pattern  
 Pinze per estrazione, Forma Americana  
 Pinzas da extracciòn, Forma Americana  
 Daviers, Forme Américaine

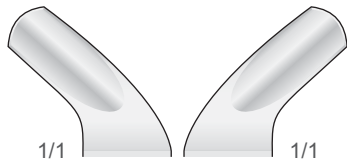

0112-CE

Obere Molaren  
 Upper Molars  
 Molari superiori  
 Molares superiores  
 Molaires supérieures

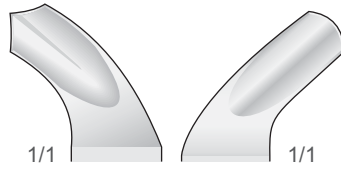

HARRIS  
 0112-BI17

Obere Molaren, Rechts  
 Upper Molars, Right  
 Molari superiori, Destra  
 Molares superiores, Derechos  
 Molaires supérieures, Droites

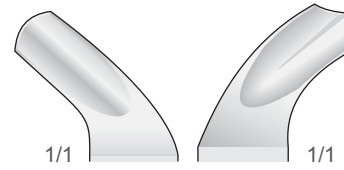

HARRIS  
 0112-BI11

Obere Molaren, Links  
 Upper Molars, Left  
 Molari superiori, Sinistra  
 Molares superiores, Isquierdos  
 Molaires supérieures, Gauches

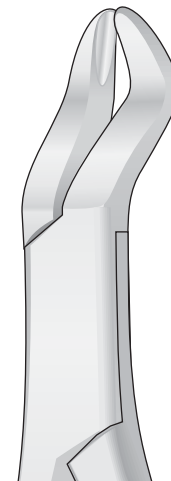
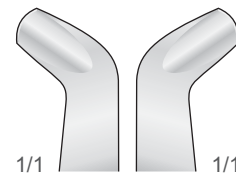

0112-CBA

Obere Molaren  
 Upper Molars  
 Molari superiori  
 Molares superiores  
 Molaires supérieures



Zahnzangen, Amerikanische Form  
Extracting Forceps, American Pattern  
Pinze per estrazione, Forma Americana  
Pinzas da extracciòn, Forma Americana  
Daviers, Forme Américaine

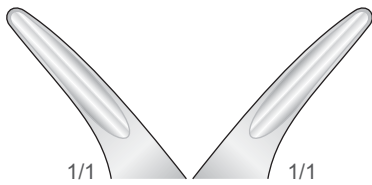

1/1 1/1

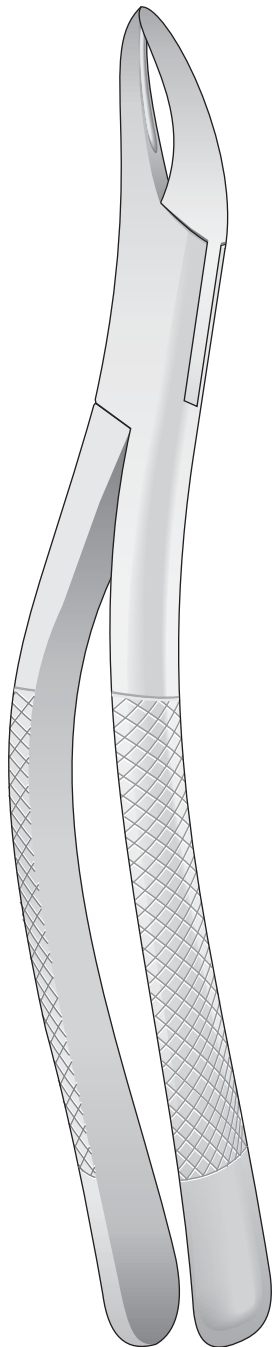

**TOMES  
0112-GL**

Obere und Untere  
Upper and lower  
Superiori e inferiori  
Superiores y inferiores  
Supérieures et inférieures

Wurzeln  
Roots  
Radici  
Raíces  
Racines

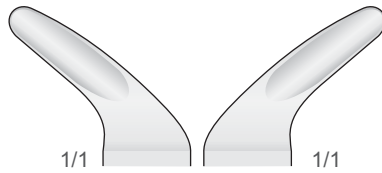

1/1 1/1

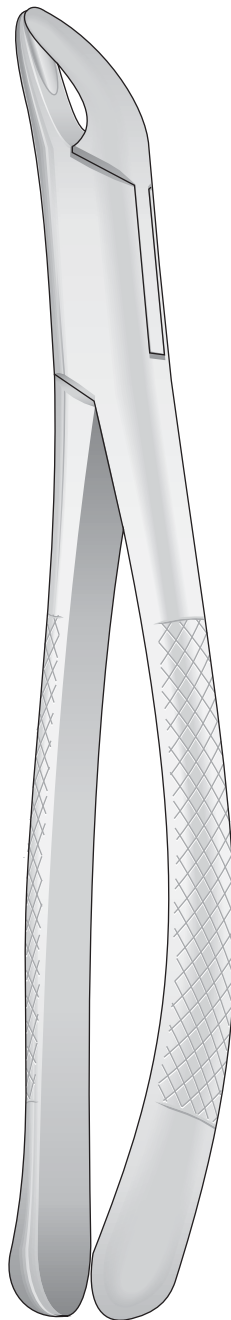

**CRYER  
0112-BFB**

Untere  
Lower  
Inferiori  
Inferiores  
Inférieures

Schneidezähne, Prämolaren, Wurzeln  
Incisors, Premolars, Roots  
Incisivi, premolari, radici  
Incisivos, premolares, raíces  
Incisives, prémolaires, racines



1/1 1/1

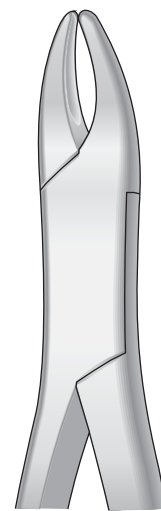

**HULL  
0112-BAB**

Für Eckzähne und Prämolaren,  
Universalzange und Kinderzange  
For canines and Premolars,  
Universal and Tooth forceps for children  
Canini e premolari,  
universale e per bambini  
Caninos y premolares,  
universal y para niños  
Canines et prémolaires,  
universel et pour enfants



Zahnzangen, Amerikanische Form  
 Extracting Forceps, American Pattern  
 Pinze per estrazione, Forma Americana  
 Pinzas da extracciòn, Forma Americana  
 Daviers, Forme Américaine

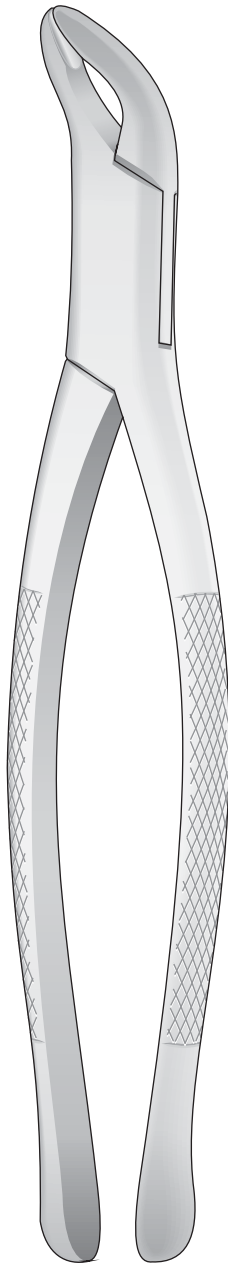
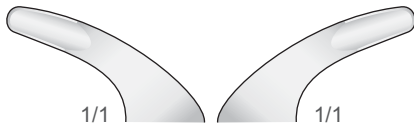

0112-CAD

Untere Schneidezähne, Prämolaren, Wurzeln  
 Lower Incisors, Premolars, Roots  
 Incisivi, premolari, radici inferiori  
 Incisivos, premolares, raíces inferiores  
 Incisives, prémolaires, racines inférieures

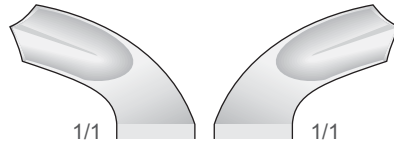

0112-BH

Untere Molaren  
 Lower Molars  
 Molari inferiori  
 Molares inferiores  
 Molaires inférieures

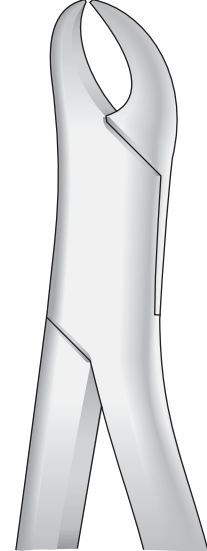
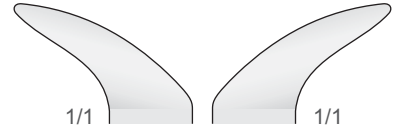

0112-CD

Untere Molaren  
 Lower Molars  
 Molari inferiori  
 Molares inferiores  
 Molaires inférieures



Zahnzangen, Amerikanische Form  
Extracting Forceps, American Pattern  
Pinze per estrazione, Forma Americana  
Pinzas da extracciòn, Forma Americana  
Daviers, Forme Américaine

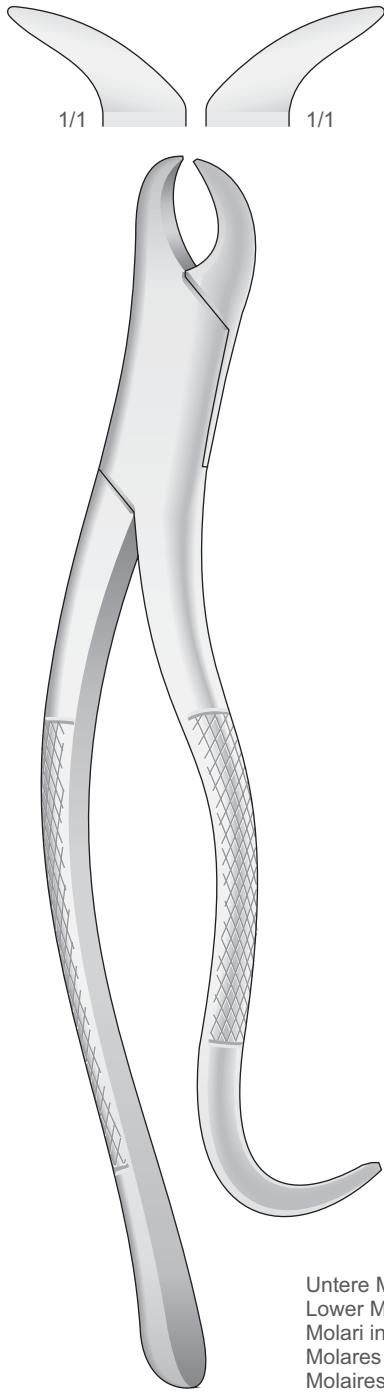

0112-BG

Untere Molaren  
Lower Molars  
Molari inferiori  
Molares inferiores  
Molaires inférieures

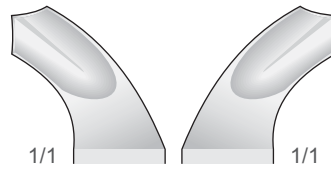

1/1 1/1

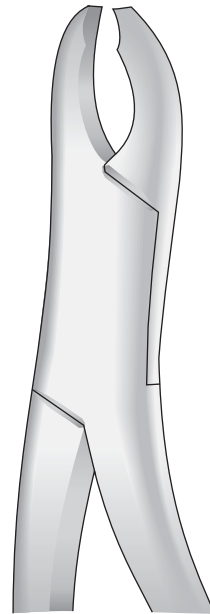

HARRIS  
0112-BF

Untere Molaren  
Lower Molars  
Molari inferiori  
Molares inferiores  
Molaires inférieures

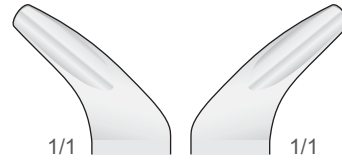

1/1 1/1

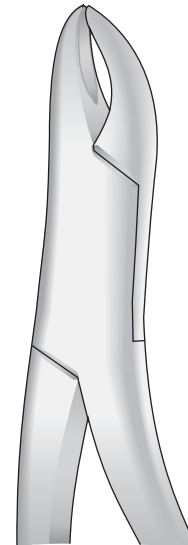

0112-BAD

Untere Schneidezähne, Prämolaren, Wurzeln  
Lower Incisors, Premolars, Roots  
Incisivi, premolari, radici inferiori  
Incisivos, premolares, raices inferiores  
Incisives, prémolaires, racines inférieures





Zahnzangen, Amerikanische Form  
 Extracting Forceps, American Pattern  
 Pinze per estrazione, Forma Americana  
 Pinzas da extracciòn, Forma Americana  
 Daviers, Forme Américaine

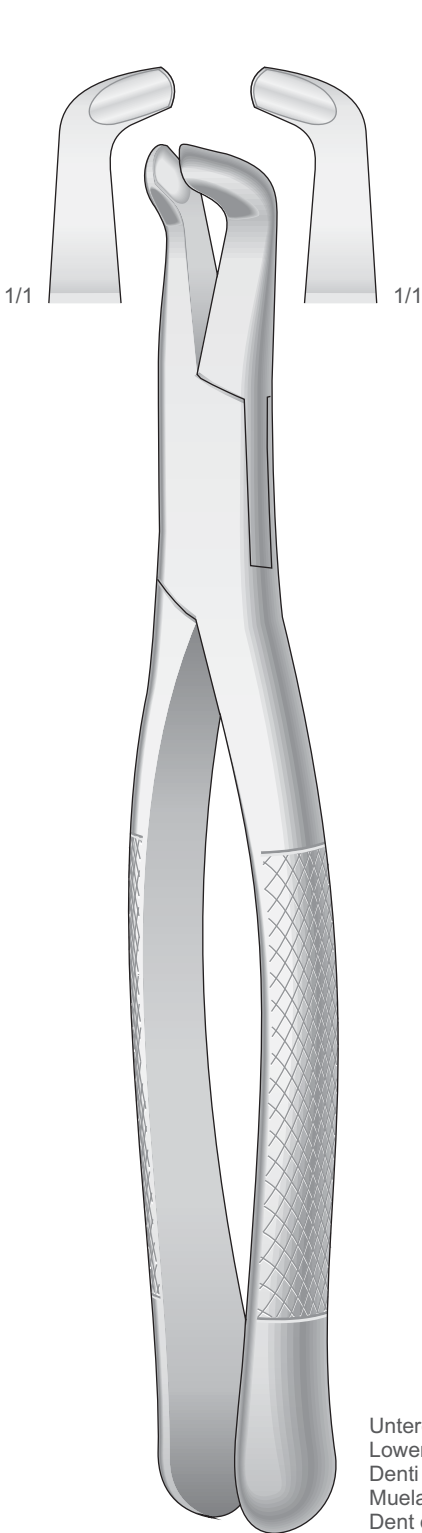

0112-CCC

Untere Weisheitszähne  
 Lower wisdom teeth  
 Denti del giudizio inferiori  
 Muelas del juicio inferiores  
 Dent de sagesse inférieures

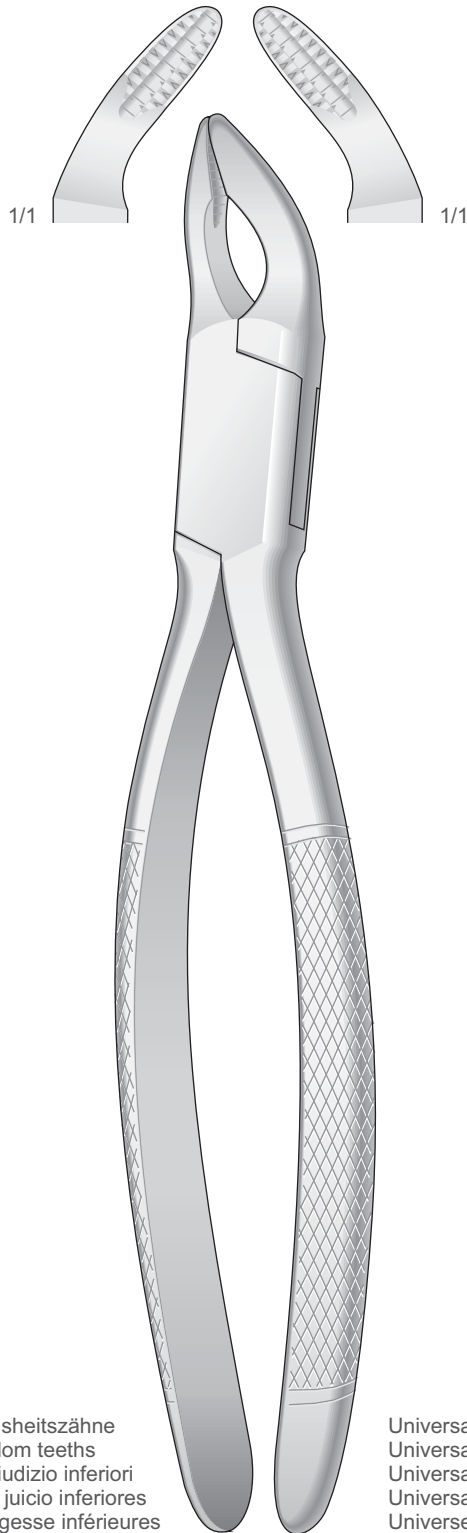

COHEN  
 0112-CFA

Universal  
 Universal  
 Universale  
 Universal  
 Universel

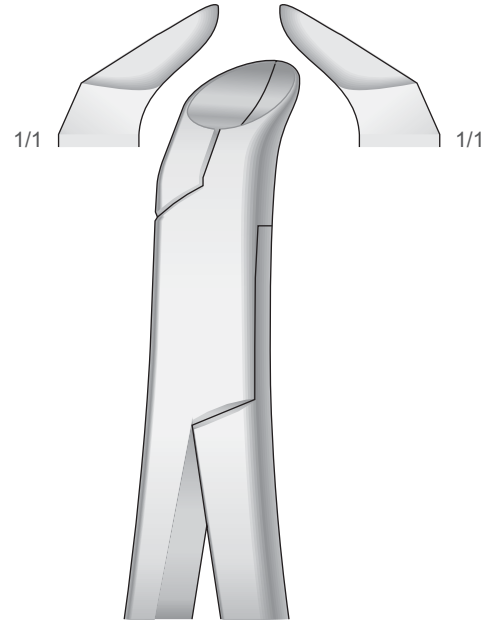

PHYSICK  
 0112-F

Untere Weisheitszähne  
 Lower wisdom teeth  
 Denti del giudizio inferiori  
 Muelas del juicio inferiores  
 Dent de sagesse inférieures



Zahnzangen, Amerikanische Form  
Extracting Forceps, American Pattern  
Pinze per estrazione, Forma Americana  
Pinzas da extracciòn, Forma Americana  
Daviers, Forme Américaine

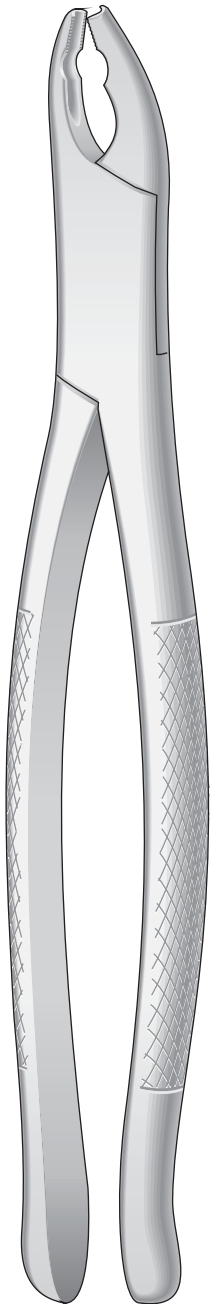
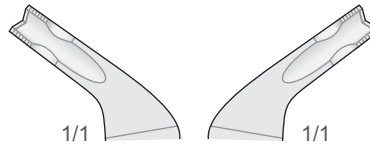
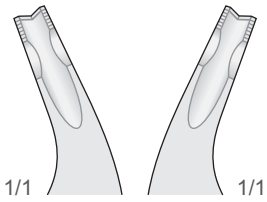

Obere  
Upper  
Superiori  
Superiores  
Supérieures

Prämolaren, Schneidezähne und Wurzeln  
Bicuspids, incisors and roots  
Premolari, incisivi e radici  
Premolares, incisivos y raíces  
Premolaires, incisives et racines

0112-BFA23



Untere  
Lower  
Inferiori  
Inferiores  
Inférieures

Prämolaren, Schneidezähne und Wurzeln  
Bicuspids, incisors and roots  
Premolari, incisivi e radici  
Premolares, incisivos y raíces  
Premolaires, incisives et racines

0112-BFB23



Zahnzangen, Amerikanische Form  
 Extracting Forceps, American Pattern  
 Pinze per estrazione, Forma Americana  
 Pinzas da extracciòn, Forma Americana  
 Daviers, Forme Américaine

Für Kinder  
 For children  
 Per bambini  
 Para niños  
 Pour enfants

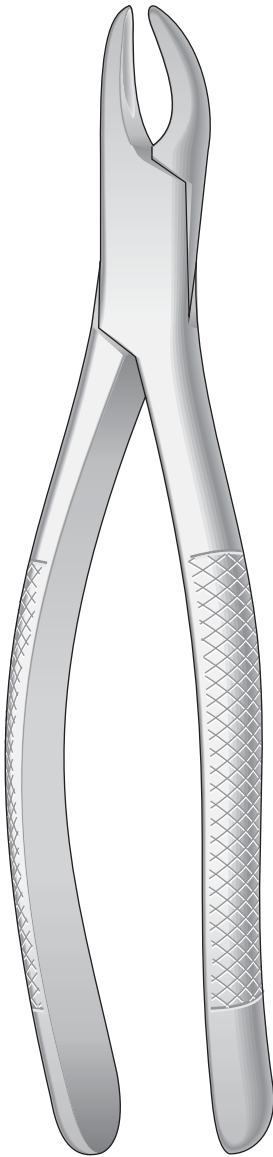
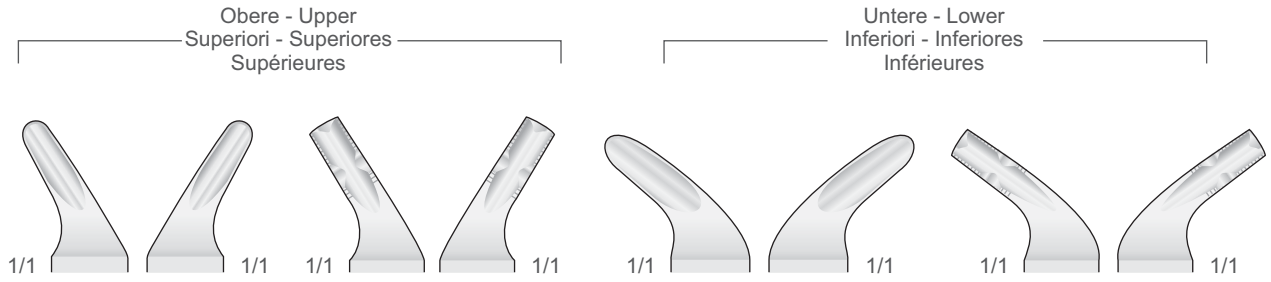

CRYER  
 0112-BFA18

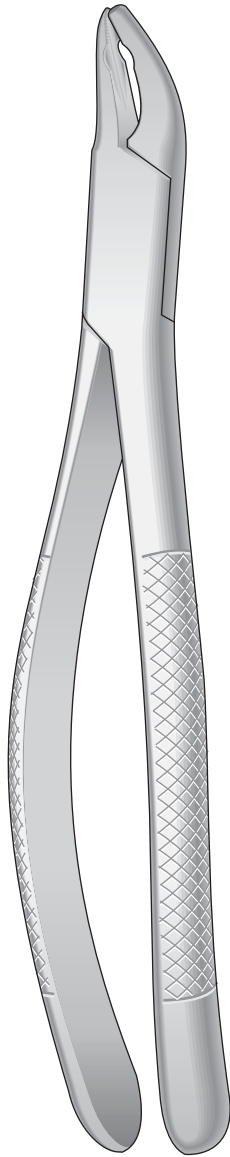

0112-BFA0118

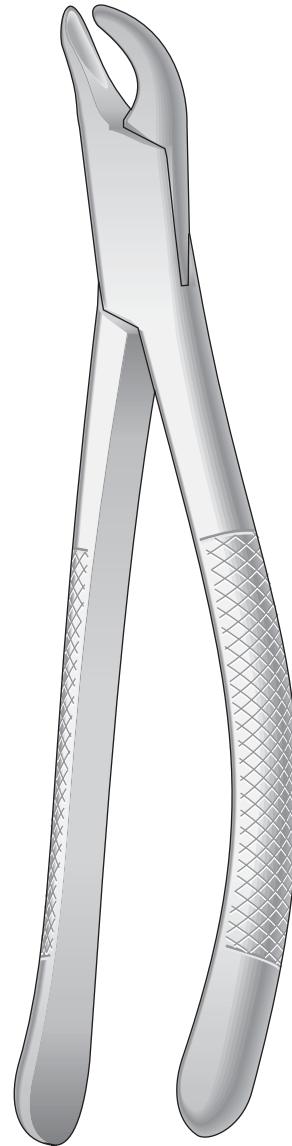

CRYER  
 0112-BFB18



0112-BFB0118



Geriefte - Serrated - Striata - Estriadas - Striées

Obere Schneidezähne, Prämolaren, Wurzeln  
Upper incisors, premolars, roots  
Incisivi, premolari e radici superiori  
Incisivos, premolares y raíces superiores  
Incisives, premolaires et racines supérieures

Untere Schneidezähne, Prämolaren, Wurzeln  
Lower incisors, premolars, roots  
Incisivi, premolari e radici inferiori  
Incisivos, premolares y raíces inferiores  
Incisives, premolaires et racines inférieures

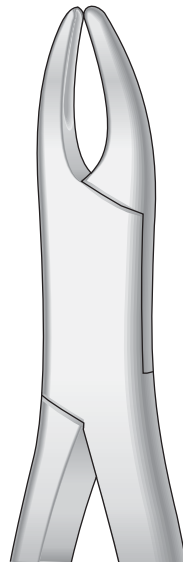
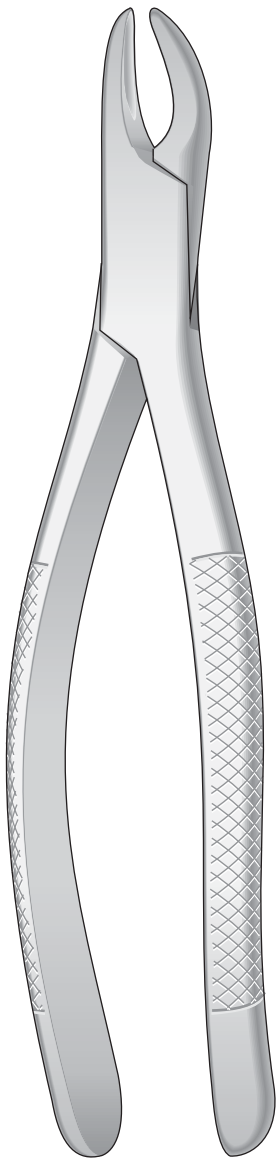
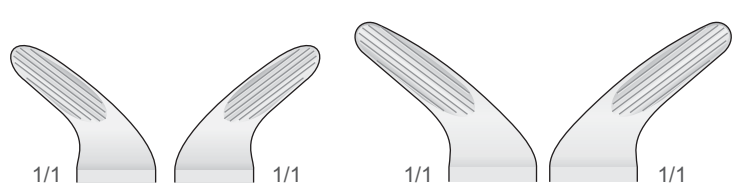
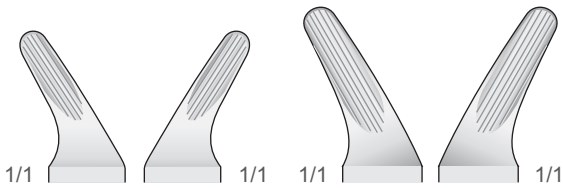

CRYER  
011207-BFA

Für Erwachsene  
For adults  
Per adulti  
Para adultos  
Pour adults

Für Kinder  
For children  
Per bambini  
Para niños  
Pour enfants

CRYER  
011207-BFA18

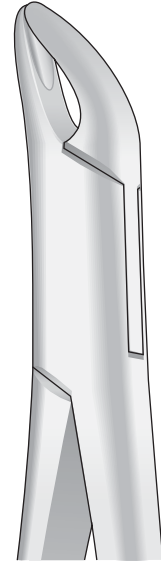
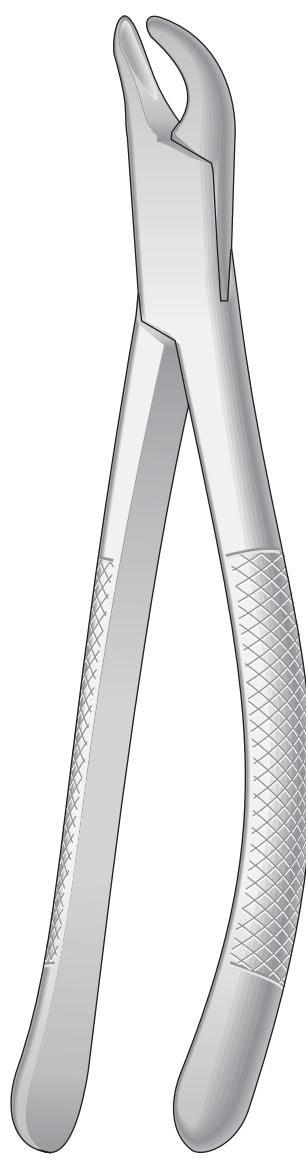

CRYER  
011207-BFB

Für Erwachsene  
For adults  
Per adulti  
Para adultos  
Pour adults

Für Kinder  
For children  
Per bambini  
Para niños  
Pour enfants

CRYER  
011207-BFB18



Zahnzangen  
 Extracting Forceps  
 Pinze per estrazione  
 Pinzas da extracciòn  
 Daviers

Schneidezähne, Eckzähne, Wurzeln  
 Incisors, bicuspid and roots  
 Incisivi, canini e radici  
 Incisivos, caninos y raices  
 Incisives, canines et racines

Molaren  
 Molars  
 Molari  
 Molares  
 Molaires

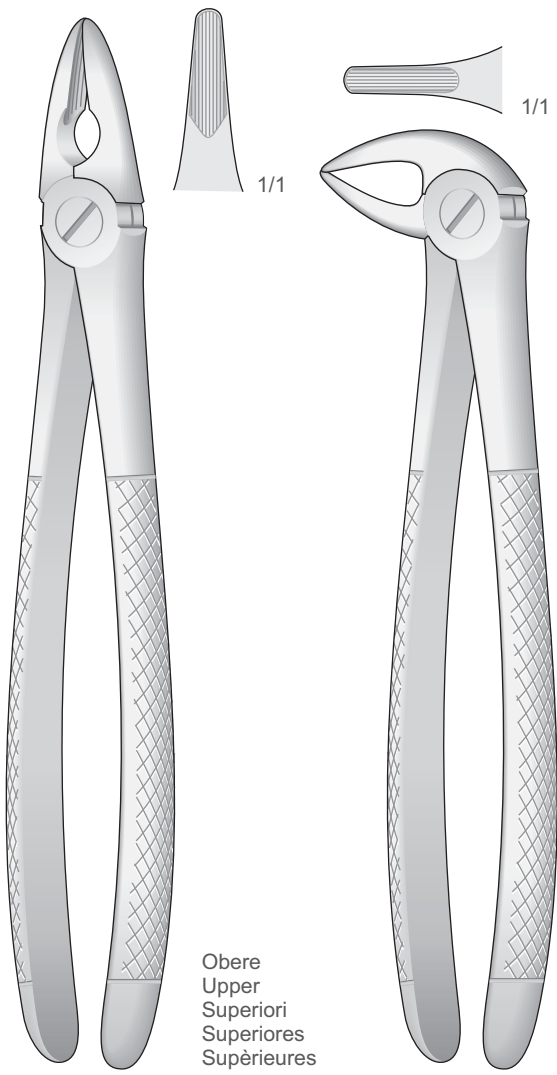

MEAD  
1204-B

MEAD  
1204-D

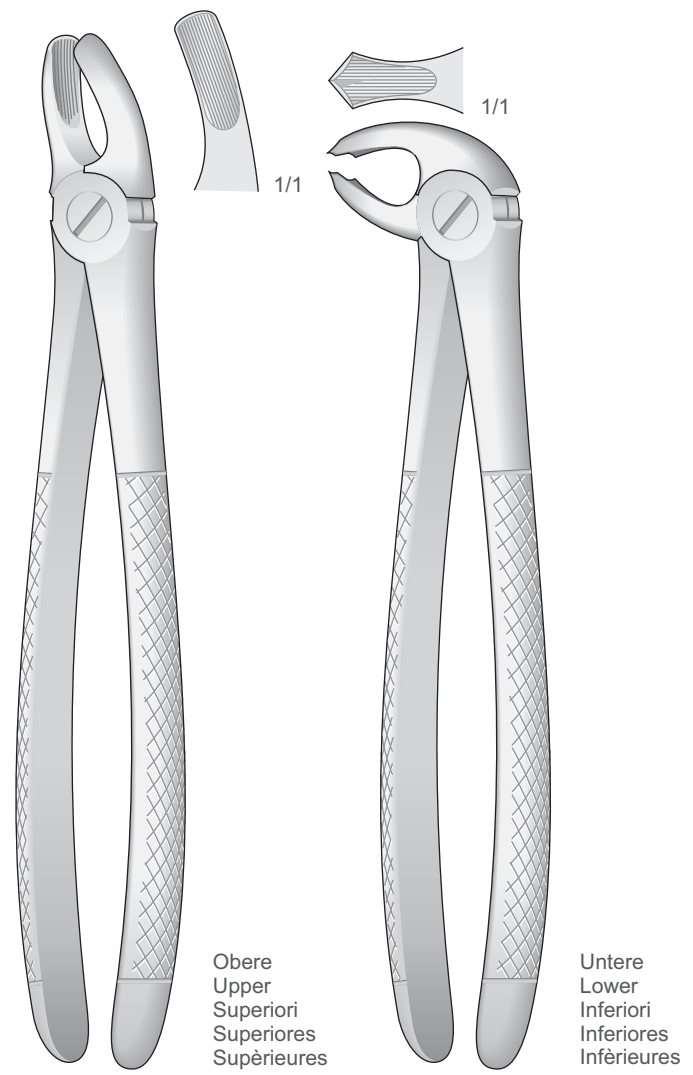

MEAD  
1204-C

MEAD  
1204-E



Kinderzahnzangen, Amerikanische Form  
Extracting Forceps for children, American Pattern  
Pinze per estrazione per bambini, Forma Americana  
Forceps dentales para niños, Forma Americana  
Daviers pour enfants, Forme Américaine

Molaren  
Pedo Lower Molars  
Molari  
Molares  
Molaires

Molaren  
Pedo Lower Molars  
Molari  
Molares  
Molaires

Zähne und wurzeln  
Pedo upper incisors  
Bicuspid and roots  
Denti e radici  
Dientes y raíces  
Dentes et racines

Zähne und wurzeln  
Pedo lower incisors  
Bicuspid and roots  
Denti e radici  
Dientes y raíces  
Dentes et racines

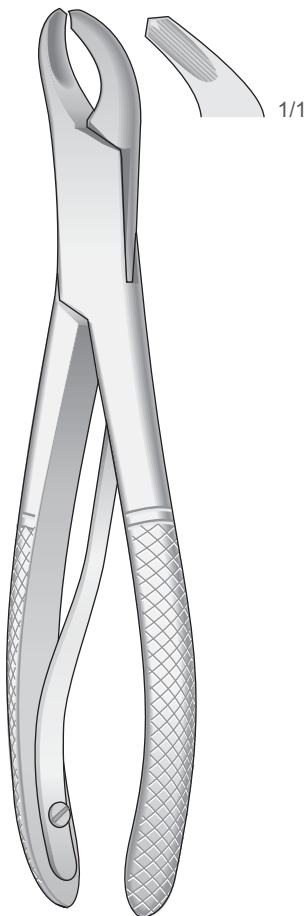

150502-BH18

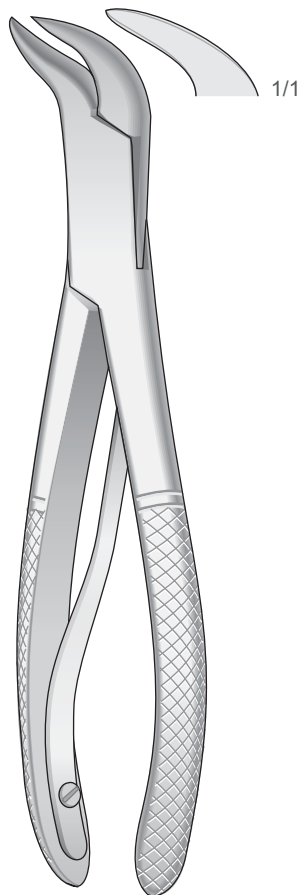

150502-CD18

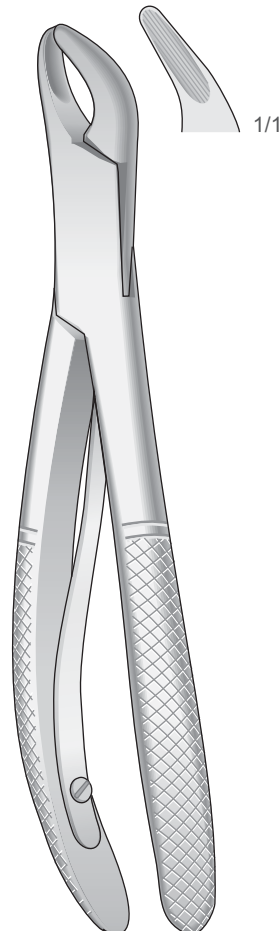

150502-BFA18

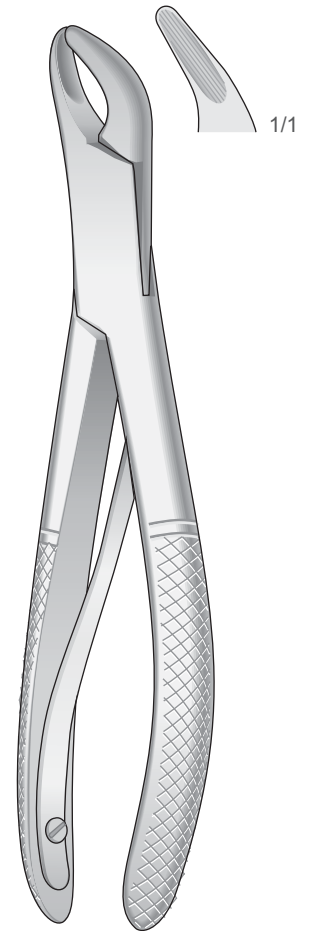

150502-BFB18



Kinderzahnzangen  
 Extracting Forceps for children  
 Pinze per estrazione per bambini  
 Forceps dentales para niños  
 Daviers pour enfants

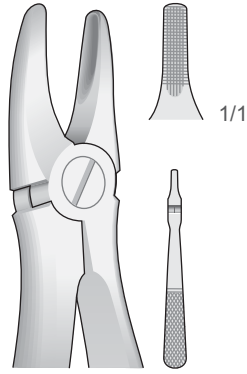

**150502-B**

Obere Schneidezähne  
 Upper Incisors  
 Incisivi superiori  
 Incisivos superiores  
 Incisives supérieures

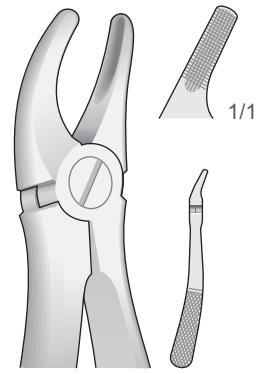

**150502-C**

Obere Prämolaren  
 Upper Premolars  
 Premolari superiori  
 Premolares superiores  
 Prémolaires supérieures

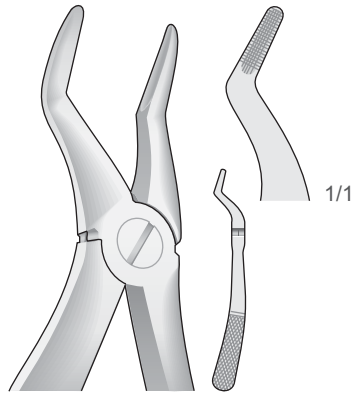

**150502-E**

Obere Wurzeln  
 Upper roots  
 Radici superiori  
 Raíces superiores  
 Racines supérieures

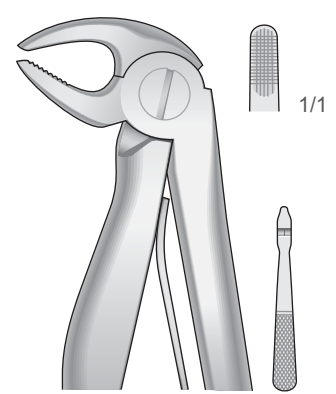

**150502-F**

Untere Schneidezähne  
 Lower incisors  
 Incisivi inferiori  
 Incisivos inferiores  
 Incisives inférieures

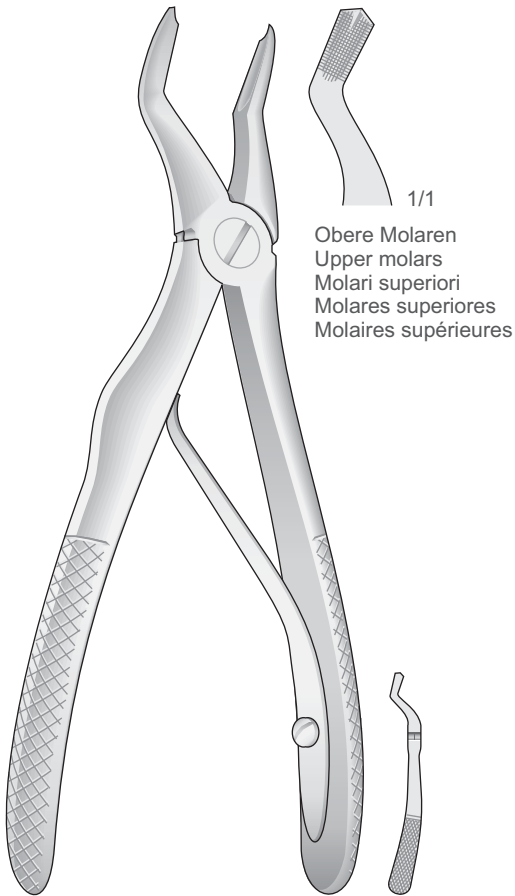

**150502-D**

Obere Molaren  
 Upper molars  
 Molari superiori  
 Molares superiores  
 Molaires supérieures

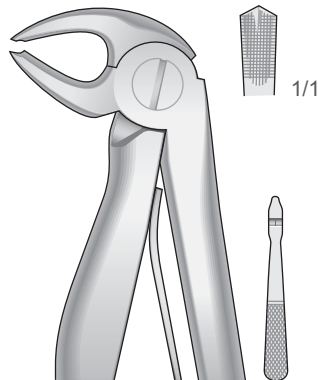

**150502-G**

Untere Molaren  
 Lower Molars  
 Molari inferiori  
 Molares inferiores  
 Molaires inférieures

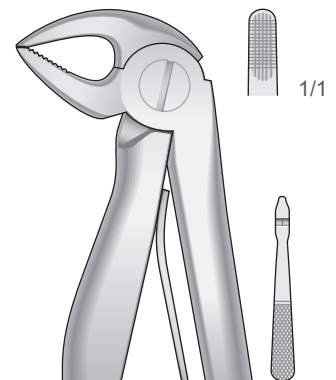

**150502-H**

Untere Wurzeln  
 Lower roots  
 Radici inferiori  
 Raíces inferiores  
 Racines inférieures

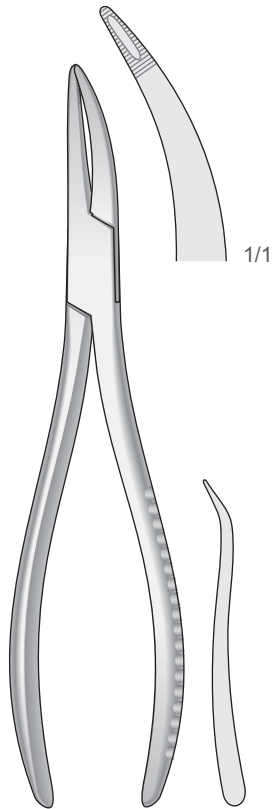

Obere Wurzeln, Universal  
Upper roots, Universal  
Radici superiori, Universale  
Raices superiores, Universal  
Racines superieures, Universel

**WITZEL  
0410-CG**  
170 mm

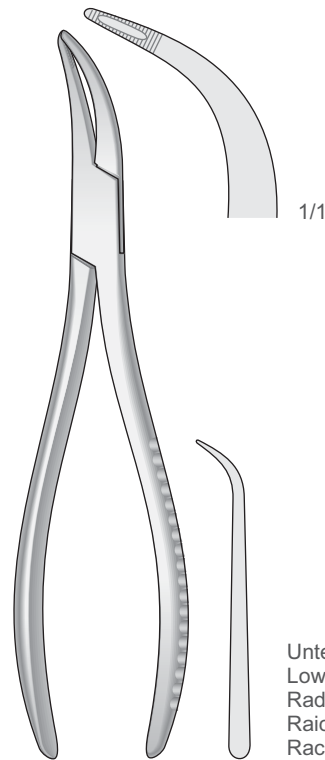

Untere Wurzeln, Universal  
Lower roots, Universal  
Radici inferiori, Universale  
Raices inferiores, Universal  
Racines inferieures, Universel

**WITZEL  
0410-CI**  
165 mm

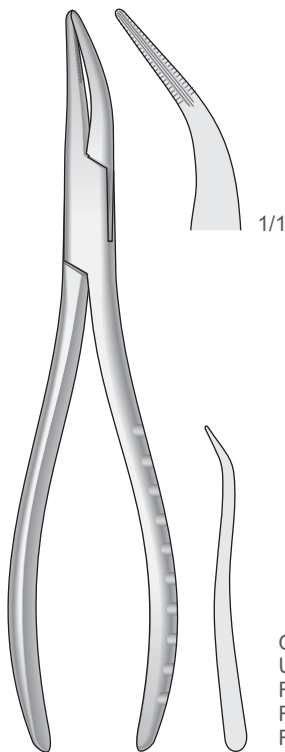

Obere Wurzeln, Universal  
Upper roots, Universal  
Radici superiori, Universale  
Raices superiores, Universal  
Racines superieures, Universel

**EAA (DAA)**  
165 mm

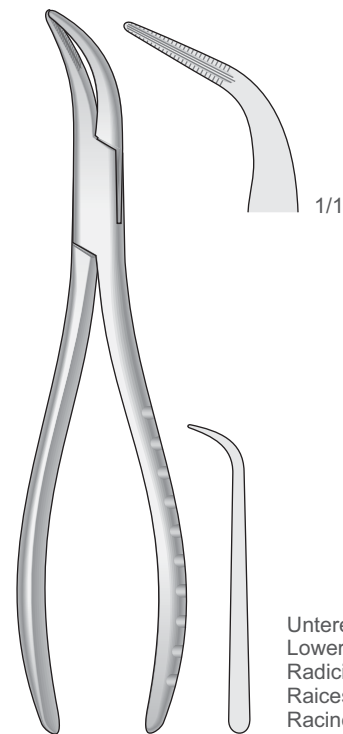

Untere Wurzeln, Universal  
Lower roots, Universal  
Radici inferiori, Universale  
Raices inferiores, Universal  
Racines inferieures, Universel

**EAB (DAB)**  
160 mm





Zahnzangen, Wurzelkanalinstrumente  
 Extracting Forceps, Nerve Instruments  
 Pinze per estrazione, strumenti per canali radicolari  
 Pinzas da extracciòn, instrumentos de canal  
 Daviers, instruments pour canaux radiculaires

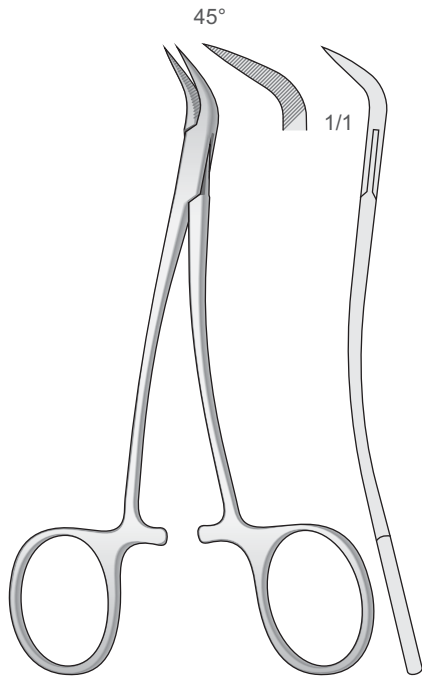

PEET  
 0417-EA  
 120 mm

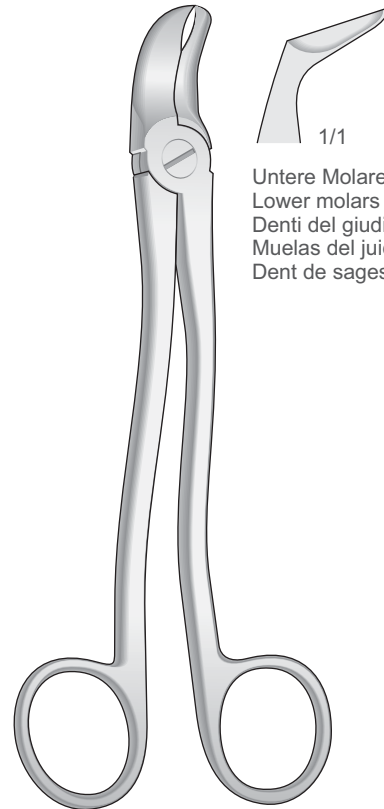

1714-B  
 175 mm

Untere Molaren und Weisheitszähne  
 Lower molars and wisdom teeth  
 Denti del giudizio e molari inferiori  
 Muelas del juicio y molares inferiores  
 Dent de sagesse et molaires inférieures

Wurzelfragmente  
 Root fragments  
 Frammenti di radici  
 Fragmentos de raíces  
 Fragments de racines

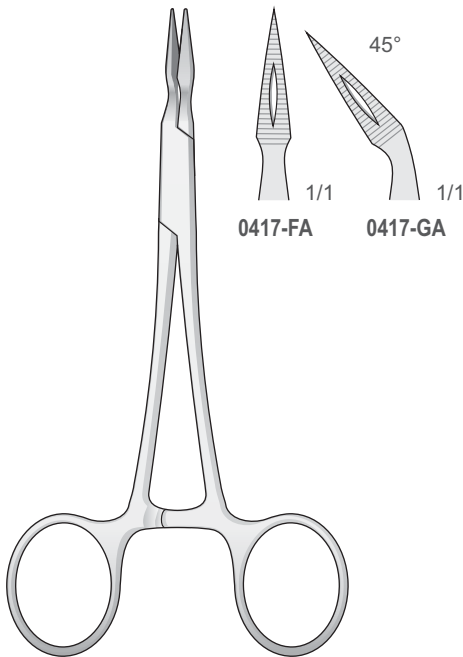

STIEGLITZ  
 0417-FA/0417-GA  
 140 mm

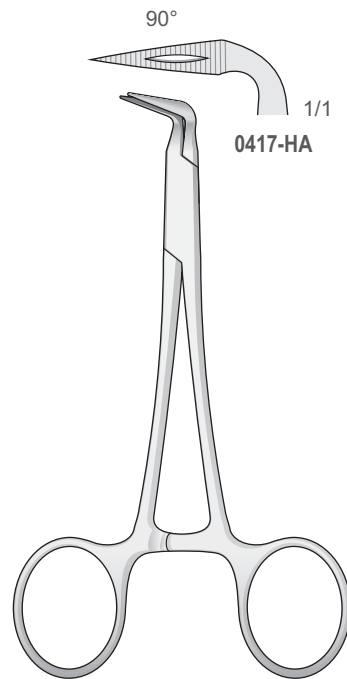

STIEGLITZ  
 0417-HA  
 120 mm



Wurzelkanalinstrumente  
Nerve Instruments  
Strumenti per canali radicolari  
Instrumentos de canal  
Instruments pour canaux radiculaires

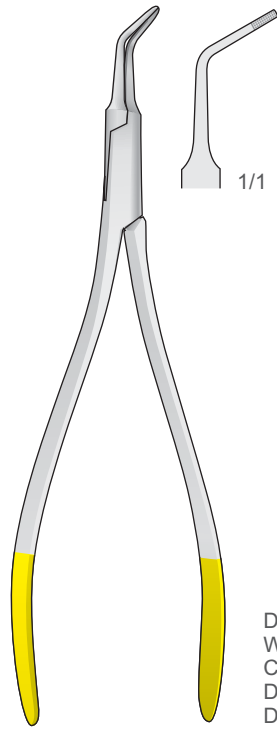

Diamantiert  
With Diamond  
Con diamante  
Diamantada  
Diamantées

0401-AB12  
130 mm

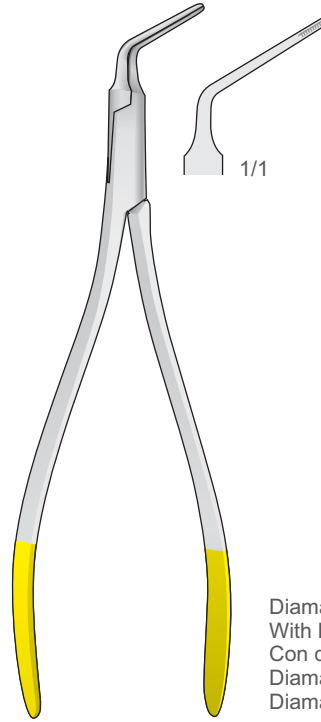

Diamantiert  
With Diamond  
Con diamante  
Diamantada  
Diamantées

0401-BA  
130 mm

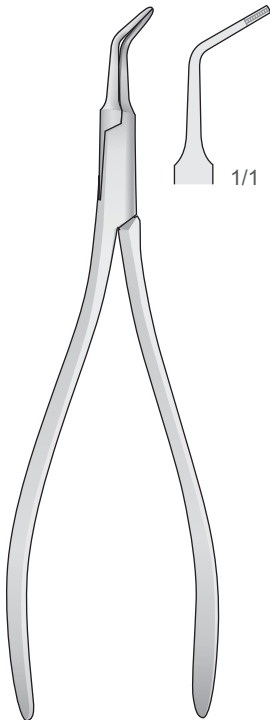

0401-AB  
130 mm

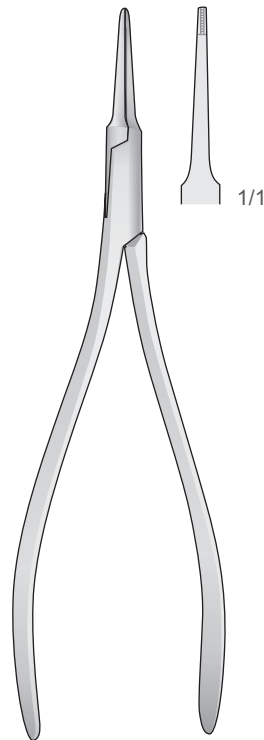

0401-AC  
130 mm

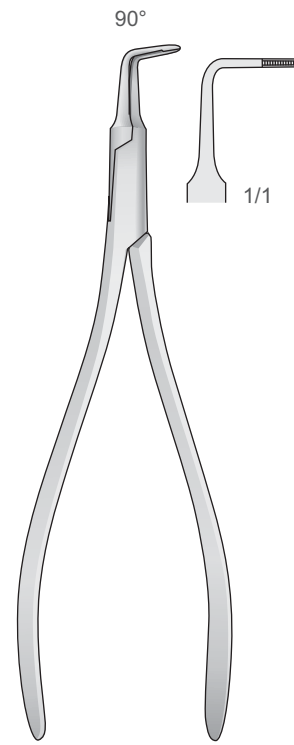

0401-AD  
125 mm

.2

Wurzelheber  
Root Elevators  
Leve per radici  
Elevadores para raíces  
Élévateurs à racines

Zahnärztliche Chirurgie  
Dental surgery  
Chirurgia dentale  
Cirugia dental  
Chirurgie dentaire

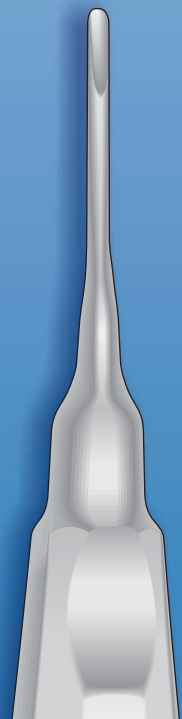



**SMALL HANDLE**

Luxatoren - Luxators  
 Lussatori - Luxadores  
 Luxateurs

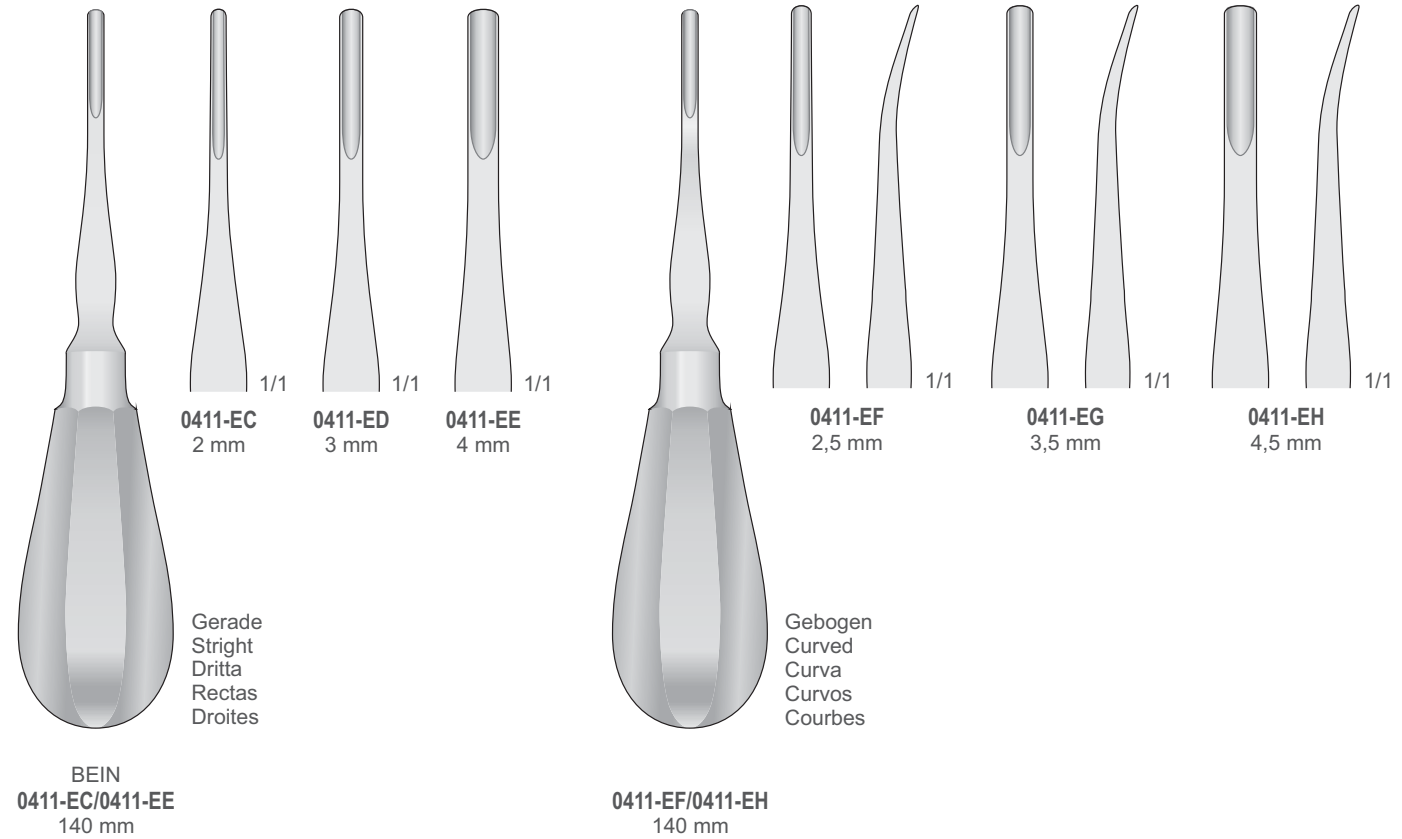
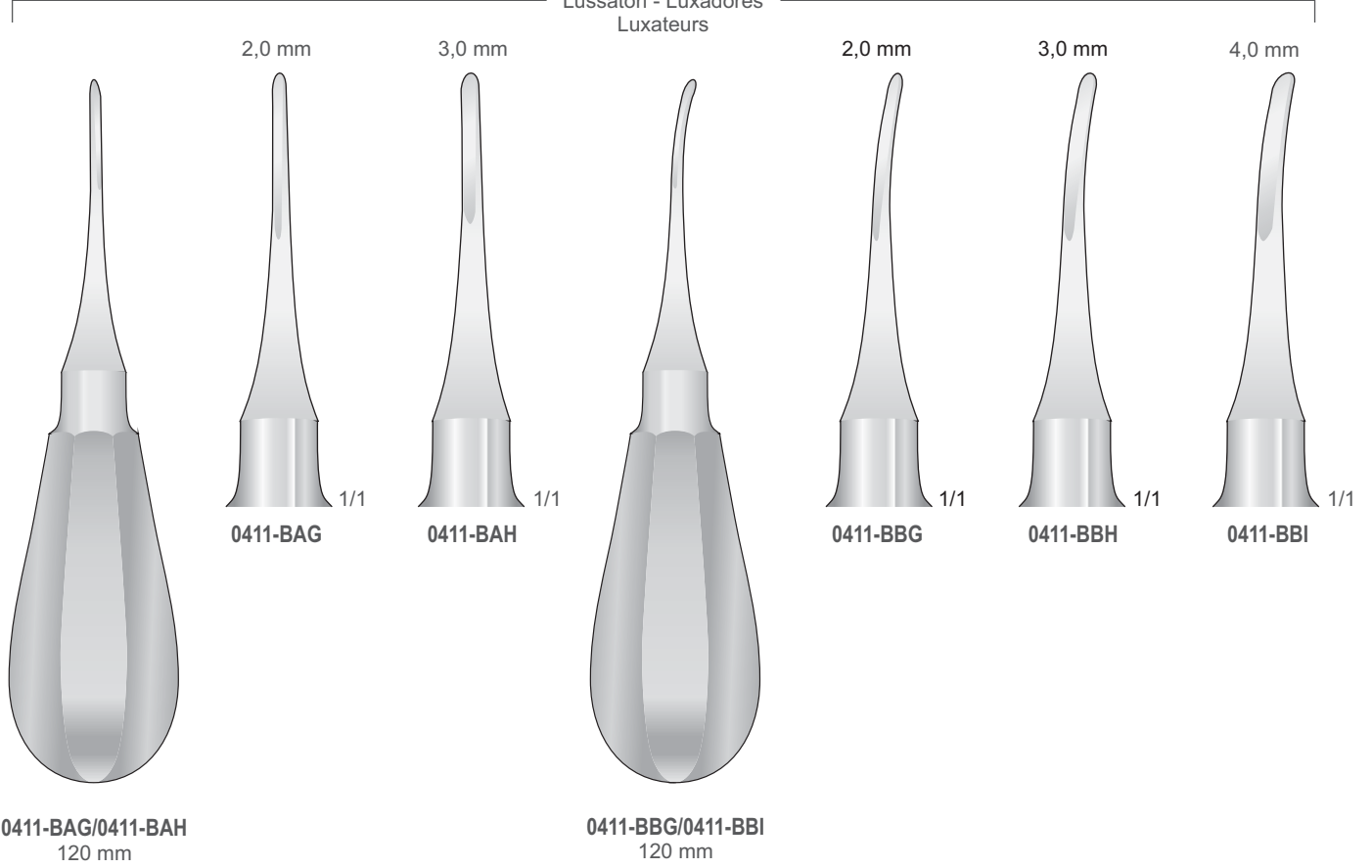

2,0 mm

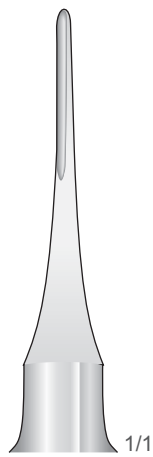

**0411-IB**  
150 mm

2,5 mm

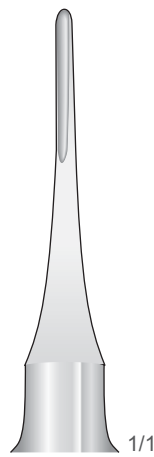

**0411-IC**  
150 mm

3,0 mm

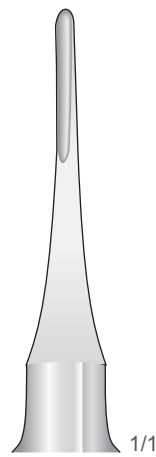

**0411-ID**  
150 mm

3,5 mm

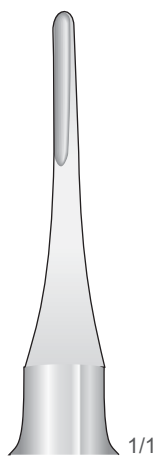

**0411-IE**  
150 mm

4,0 mm

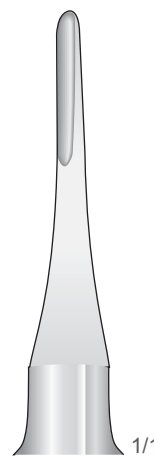

**0411-IF**  
150 mm

4,5 mm

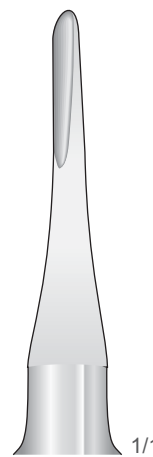

**0411-IG**  
150 mm

5,0 mm

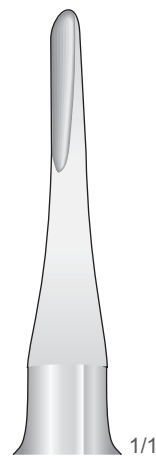

**0411-IH**  
150 mm

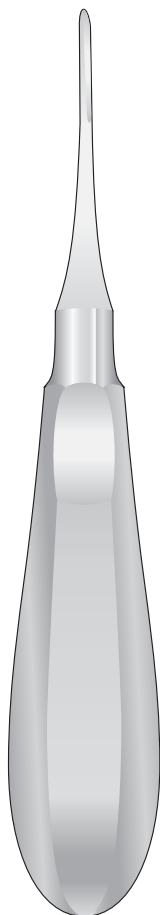

**0411-IB/0411-IH**  
150 mm

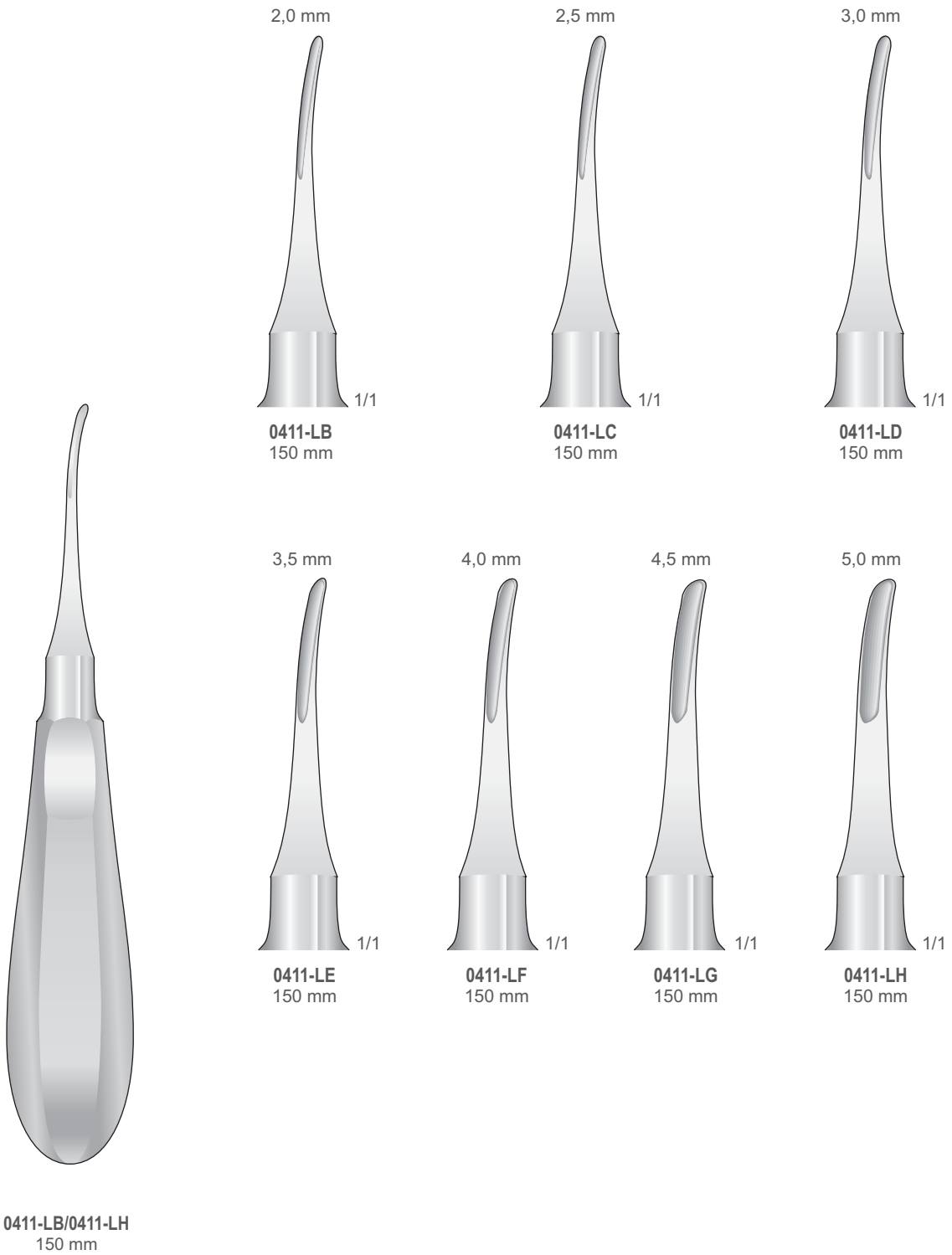

Luxatoren  
 Luxators  
 Lussatori  
 Luxadores  
 Luxateurs

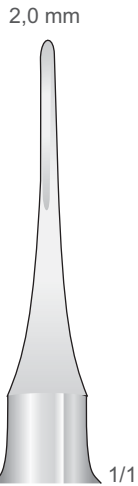

**0411-BAC**  
150 mm

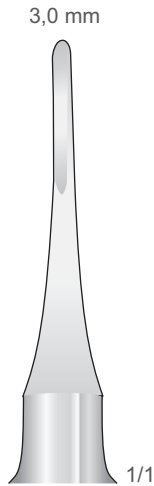

**0411-BAD**  
150 mm

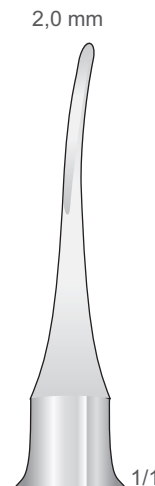

**0411-BBC**  
150 mm

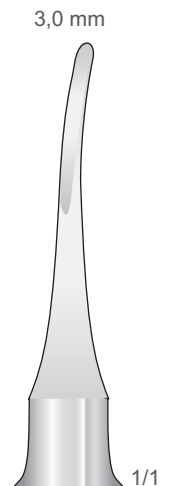

**0411-BBD**  
150 mm

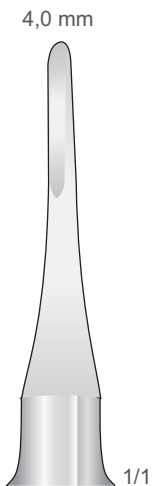

**0411-BAE**  
150 mm

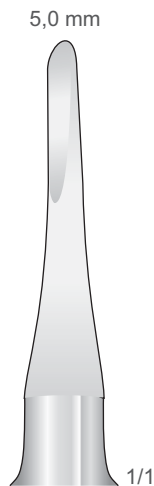

**0411-BAF**  
150 mm

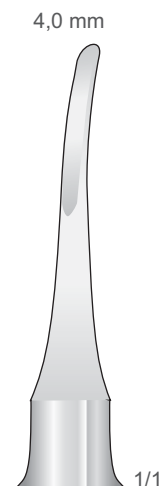

**0411-BBE**  
150 mm

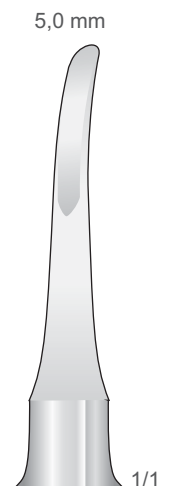

**0411-BBF**  
150 mm

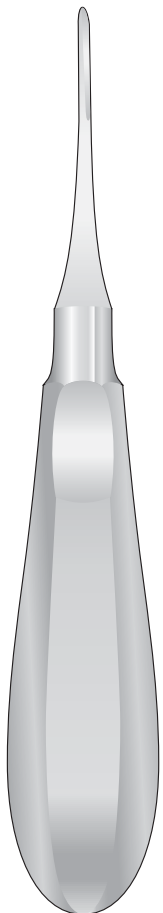

**0411-BAC/0411-BAF**  
150 mm

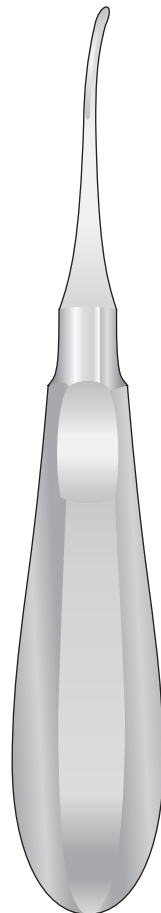

**0411-BBC/0411-BBF**  
150 mm



Wurzelheber  
 Root Elevators  
 Leve per radici  
 Elevadores para raices  
 Elevateurs à racines

Wurzelspitzenheber  
 Root fragment Elevators  
 Leve per frammenti di radice  
 Elevadores para fragmentos de raices  
 Elévateurs de fragments de racines

Gezahnt  
 Serrated  
 Dentellata  
 Dentada  
 Dentelé



**HEIDBRINK**  
**0805-B**  
 140 mm



**HEIDBRINK**  
**0805-C**  
 140 mm



**HEIDBRINK**  
**0805-D**  
 140 mm

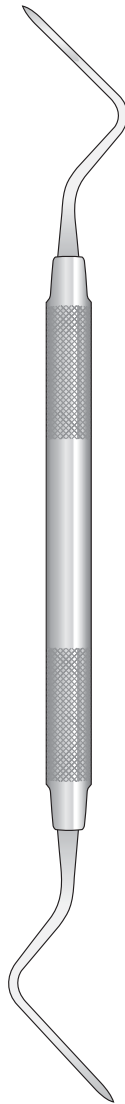

**HEIDBRINK**  
**080306-1/2**  
 195 mm

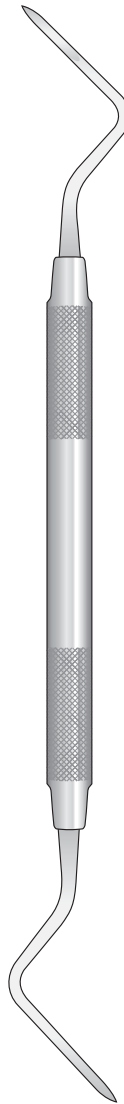

**HEIDBRINK**  
**080306-3/4**  
 195 mm

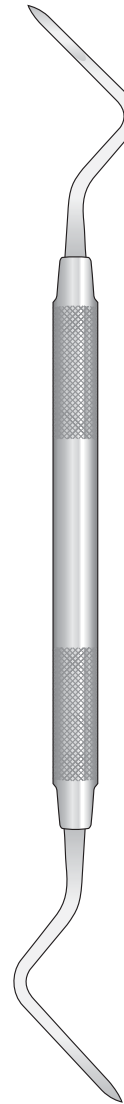

**HEIDBRINK**  
**080306-5/6**  
 195 mm

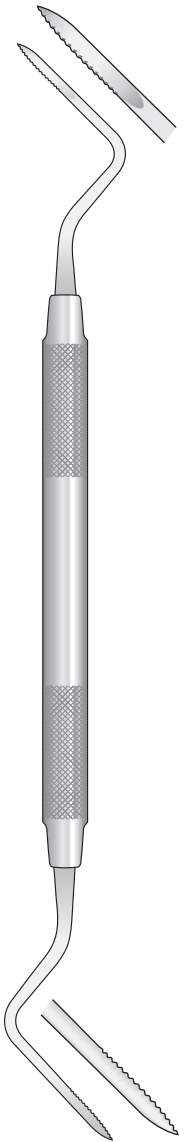

**HEIDBRINK**  
**080306-3/4BI**  
 195 mm

Extraktionshebel für obere Weisheitszähne  
 Luxator for upper wisdom teeth  
 Leva per estrazione dente del giudizio superiore  
 Elevador de extracción de muelas del juicio superiores  
 Levier d'extraction pour dent de sagesse supérieures

Wurzelheber  
 Root Elevators  
 Leve per radici  
 Elevadores para raíces  
 Elévateurs de racines

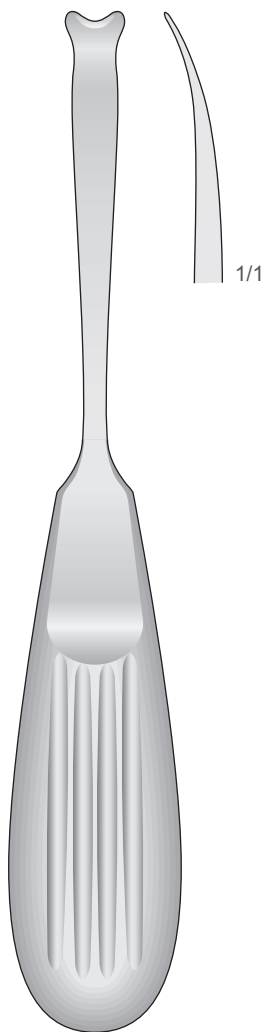

ROSIN  
 0411-FI  
 160 mm



WARWICK-JAMES  
 0411-CA  
 160 mm



WARWICK-JAMES  
 0411-CB  
 155 mm



WARWICK-JAMES  
 0411-CC  
 155 mm

Obere  
 Upper  
 Superiori  
 Superiores  
 Supérieures

Untere  
 Lower  
 Inferiori  
 Inferiores  
 Inférieures

Untere  
 Lower  
 Inferiori  
 Inferiores  
 Inférieures

Eine seite gezahnt  
 One side serrated  
 Un lato dentellato  
 Dentadura mäs lado  
 Dentelure sur un côté

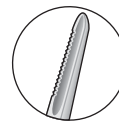
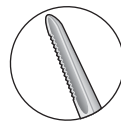

Fig. 94



0411-HG  
 155 mm

Fig. 95



0411-HH  
 155 mm

Fig. 100L



0411-HI  
 155 mm

Fig. 100R



0411-HL  
 155 mm

Gezahnt  
 Serrated  
 Dentellate  
 Dentadas  
 Dentelé

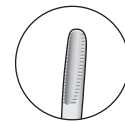
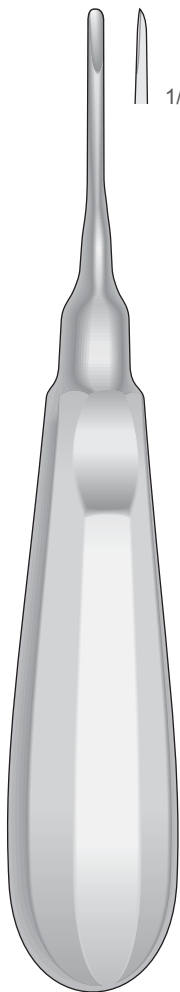
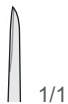
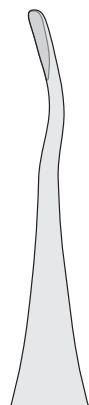

Fig. 301



APEXO  
**0411-DE**  
 160 mm

Fig. 302



**0411-DF**

Fig. 303

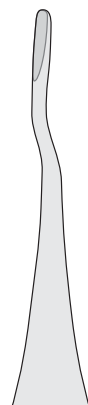

**0411-DG**

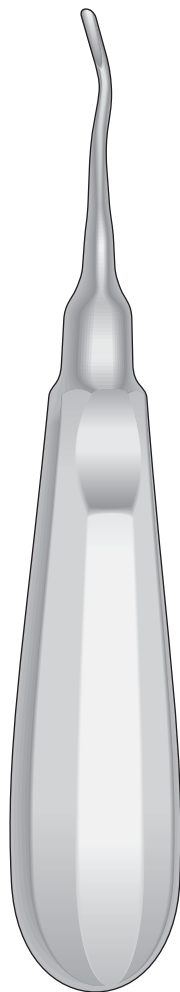

APEXO  
**0411-DF/0411-DG**  
 160 mm

Fig. 77L

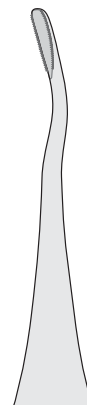

**0411-DH**

Fig. 77R

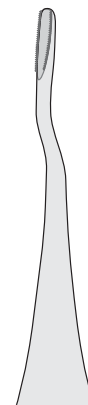

**0411-DI**

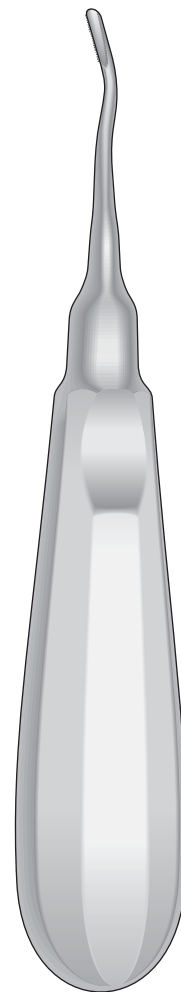

APEXO  
**0411-DH/0411-DI**  
 160 mm

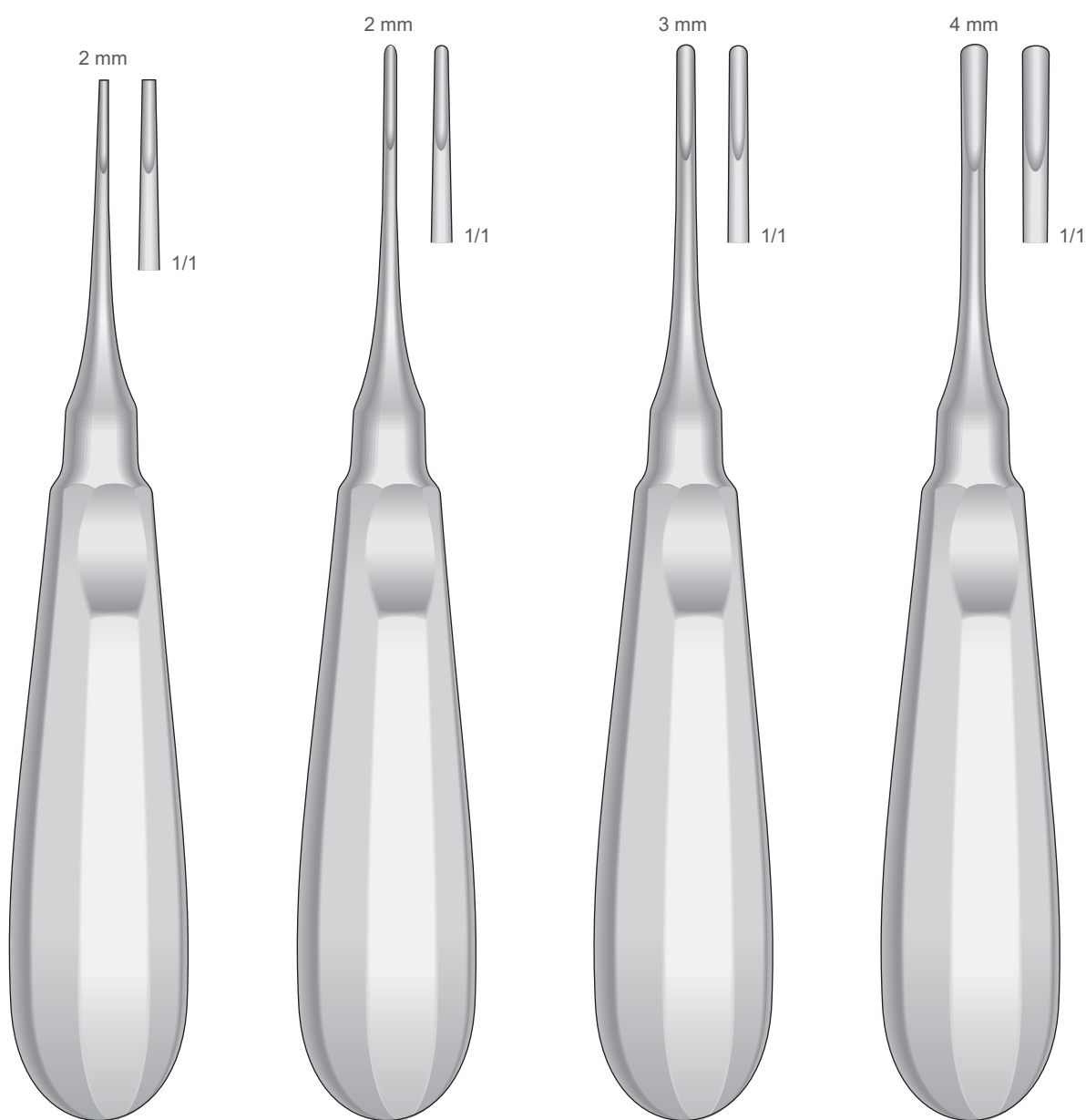

02050913-B19  
150 mm

02050913-C  
155 mm

02050913-D  
155 mm

02050913-E  
155 mm

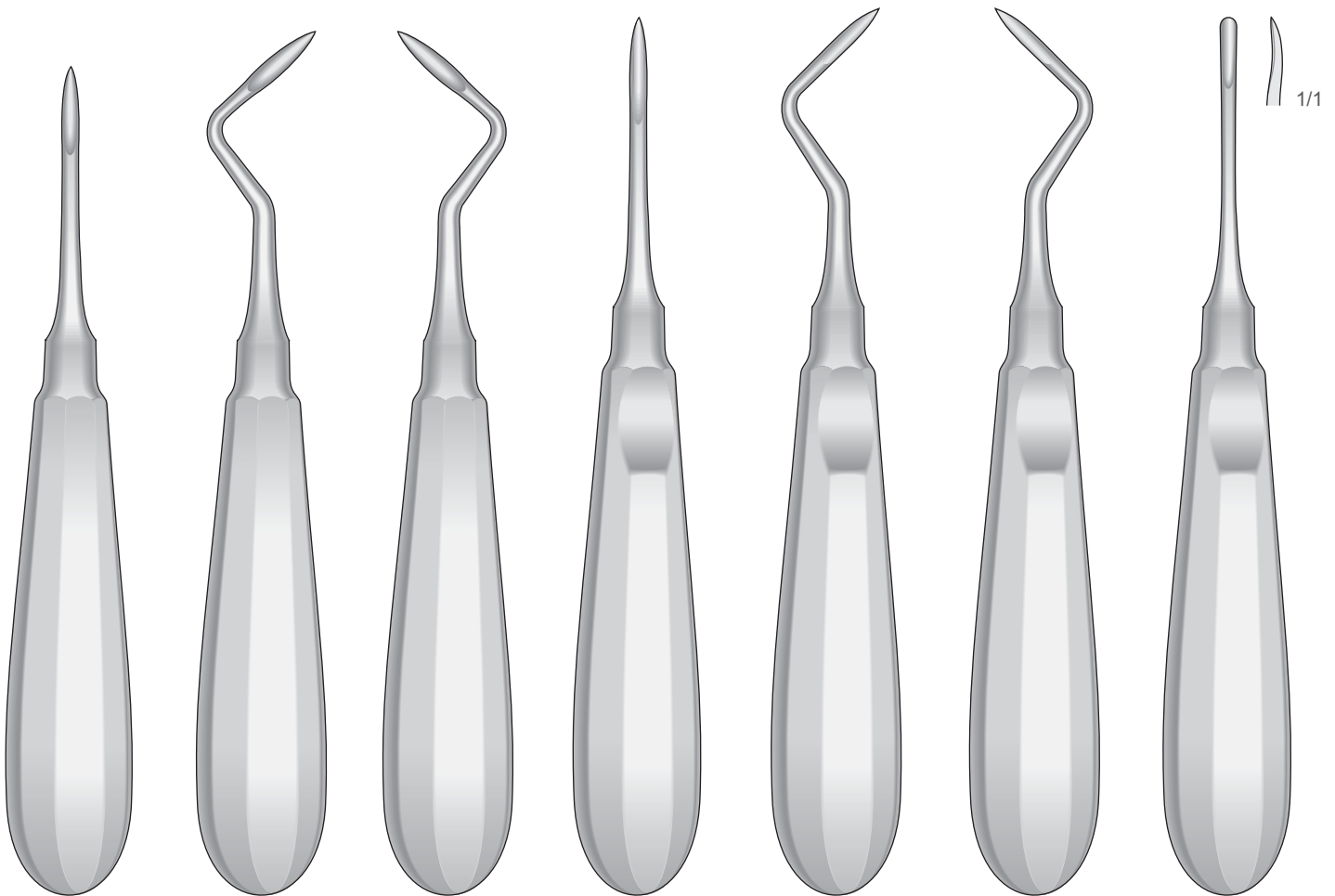

0611140817-B  
140 mm

0611140817-C  
150 mm

0611140817-D  
150 mm

011509030111-B  
155 mm

011509030111-C  
155 mm

011509030111-D  
155 mm

011509030111-E  
155 mm

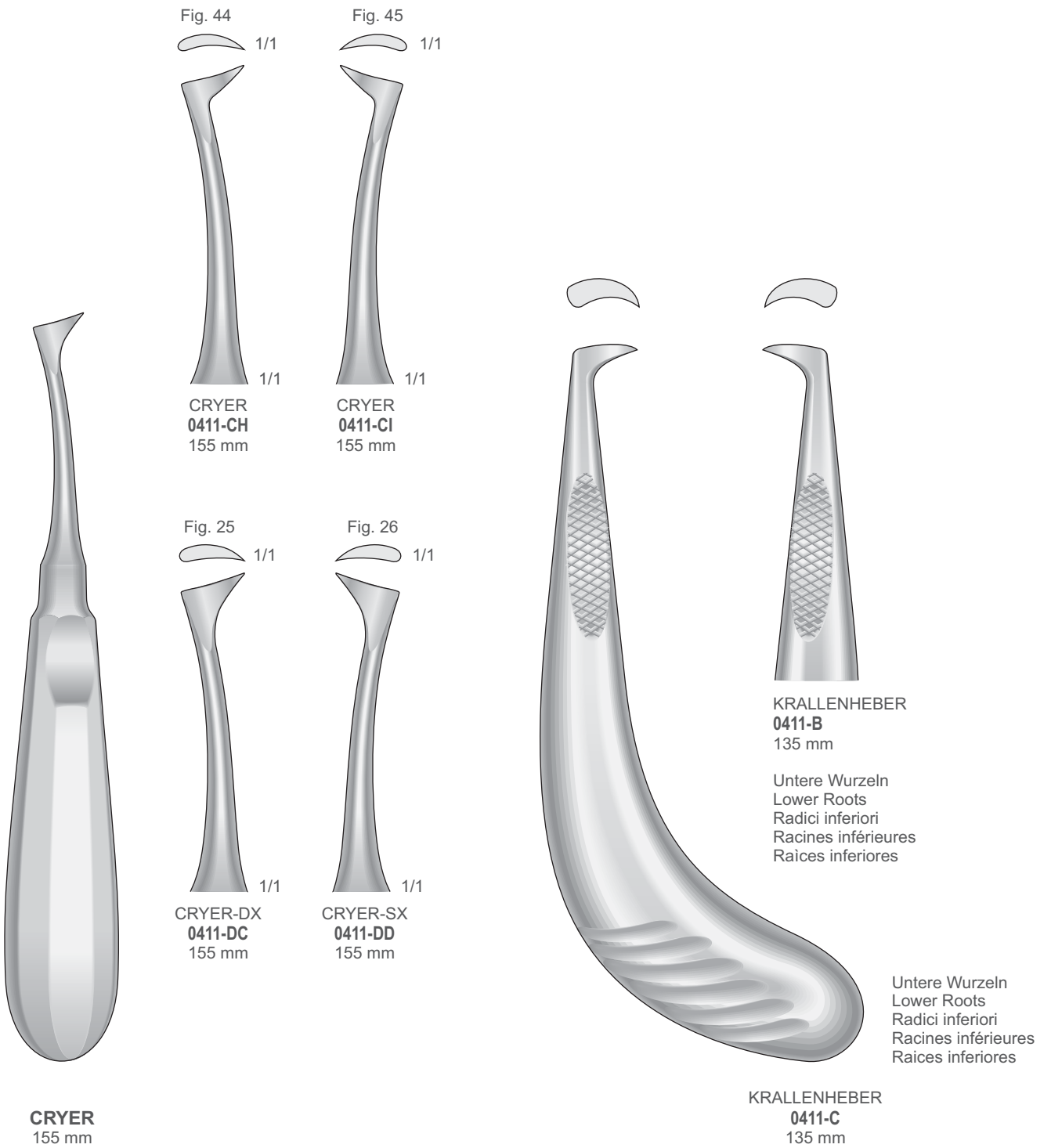

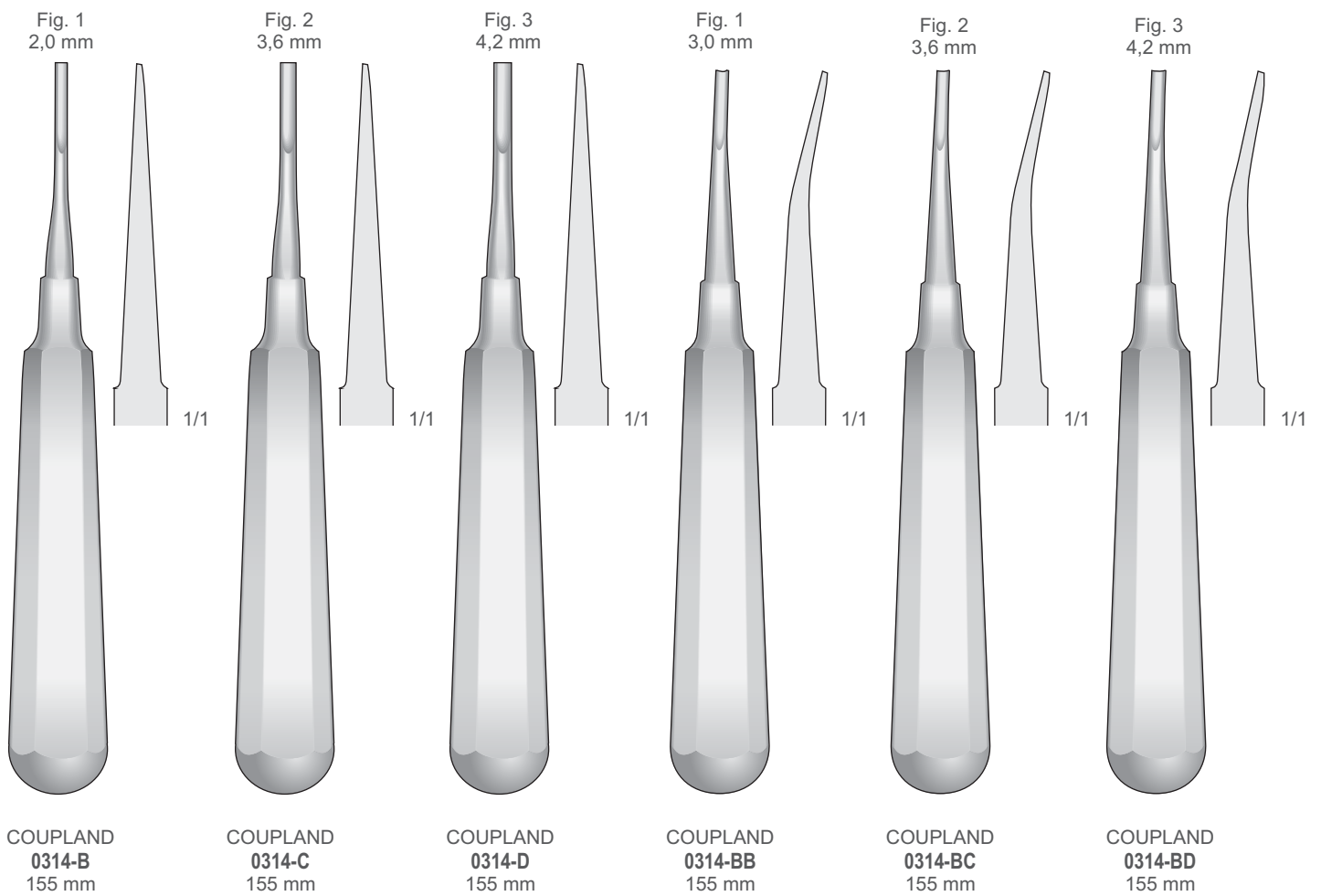



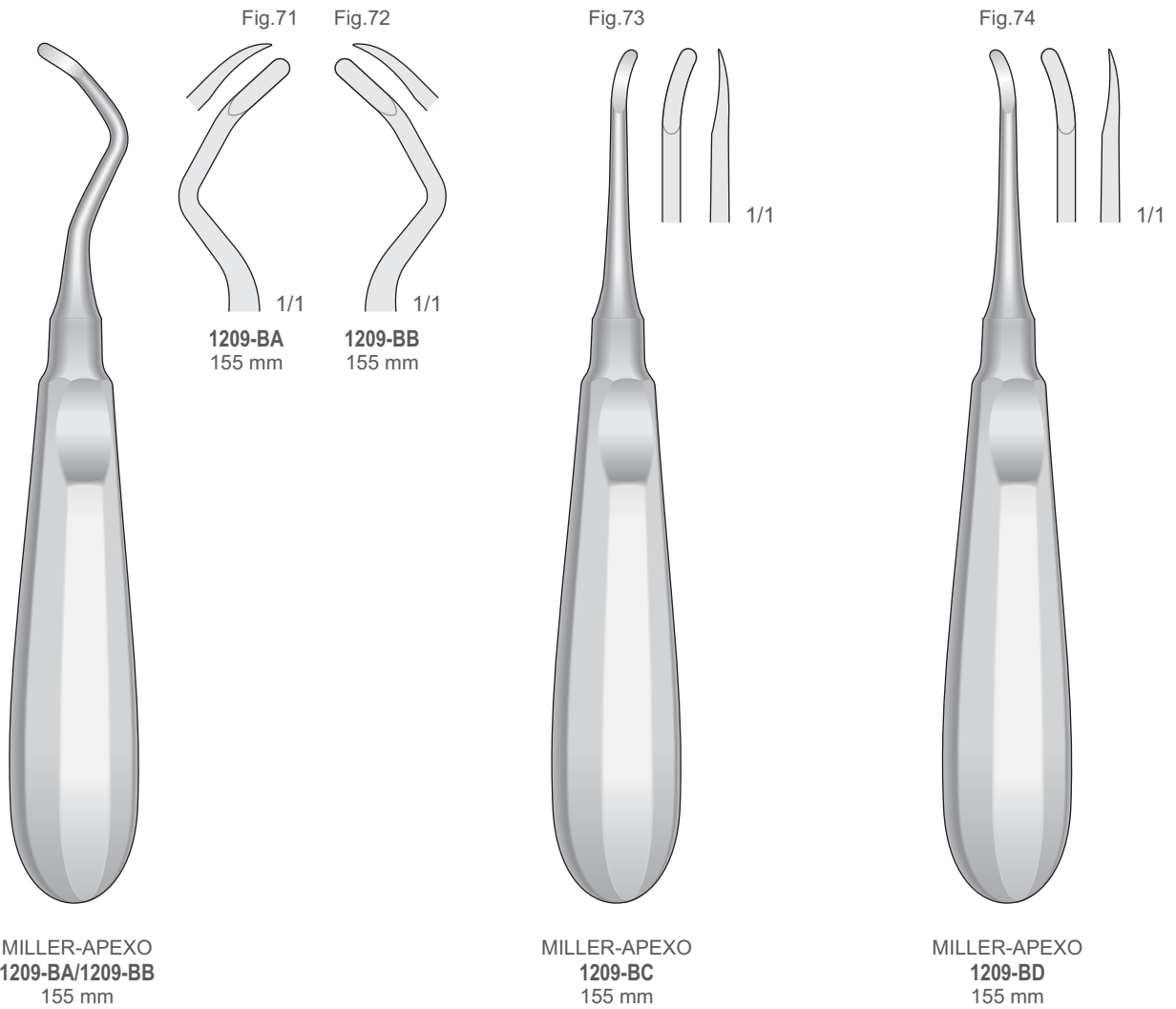

MILLER-APEXO  
**1209-BA/1209-BB**  
 155 mm

MILLER-APEXO  
**1209-BC**  
 155 mm

MILLER-APEXO  
**1209-BD**  
 155 mm

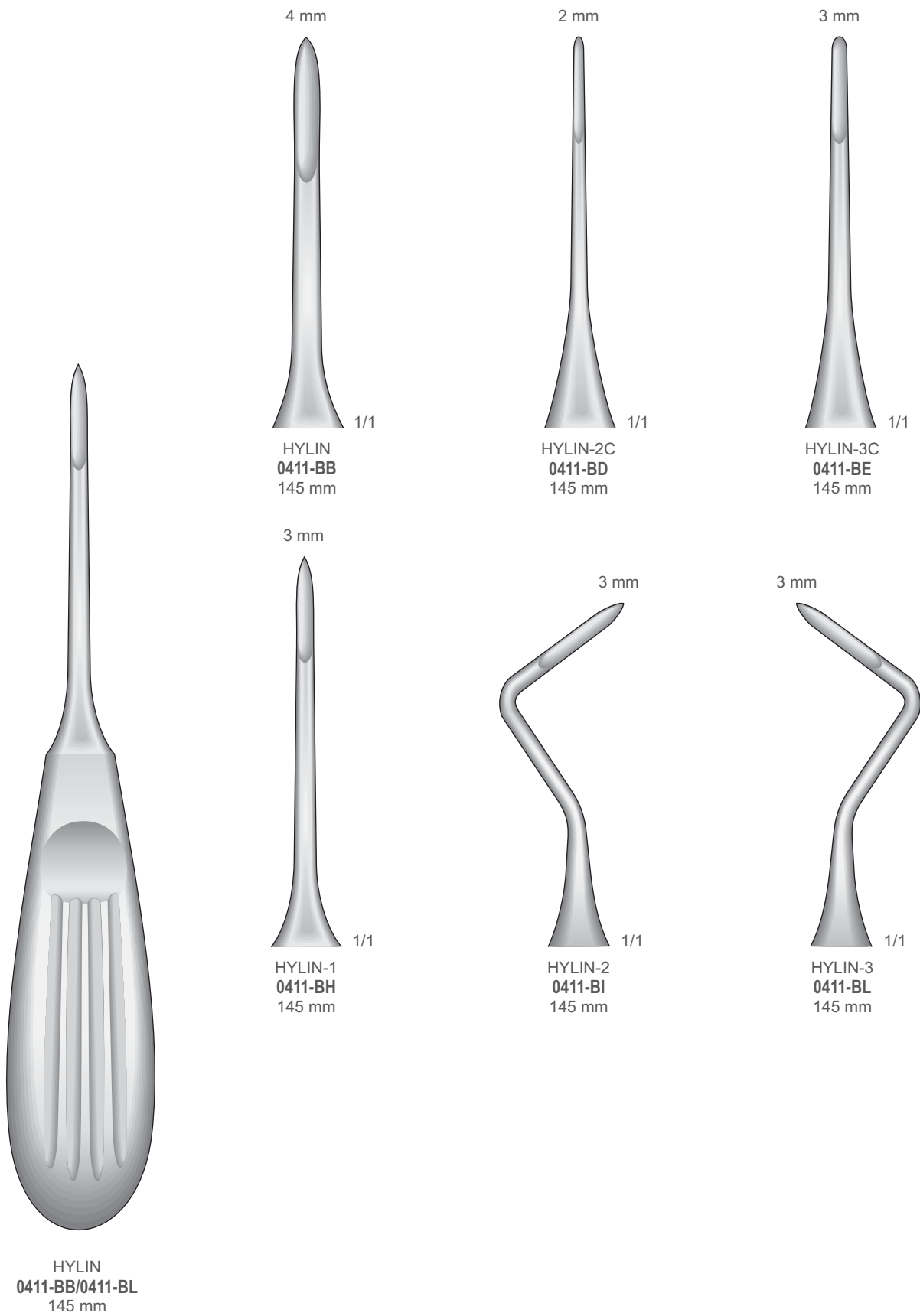

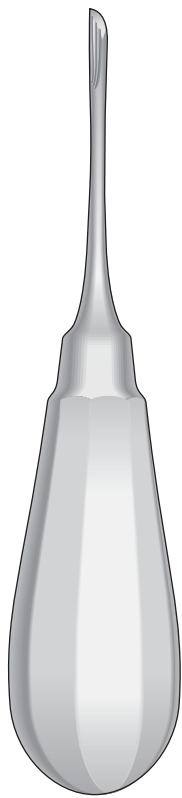

**KOPP**  
**0411-DA**  
 130 mm

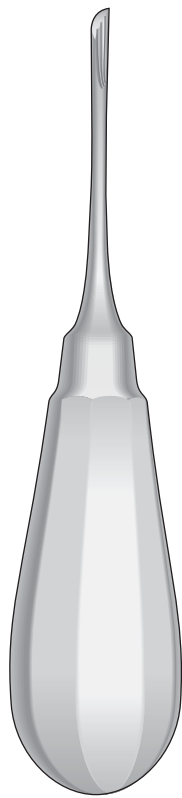

**KOPP**  
**0411-DB**  
 130 mm

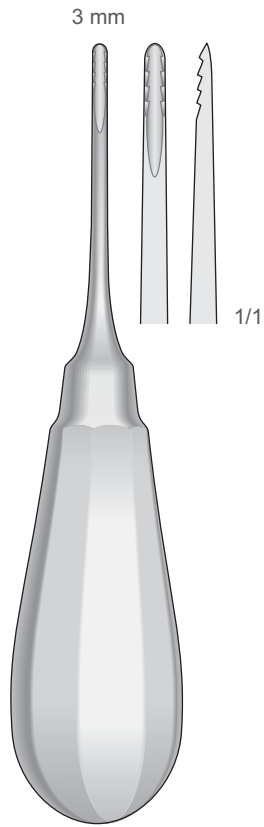

**02050913-B25**  
 130 mm

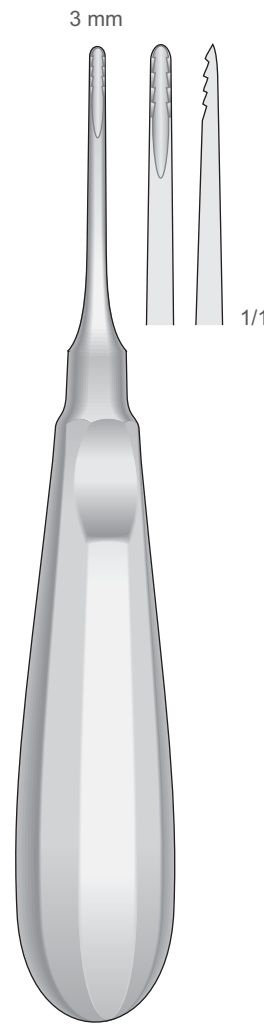

**02050913-C25**  
 155 mm

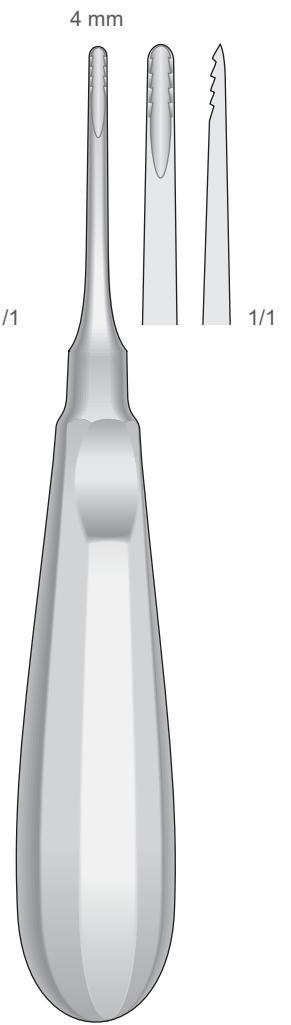

**LINDO-LEVIEN**  
**02050913-E25**  
 155 mm

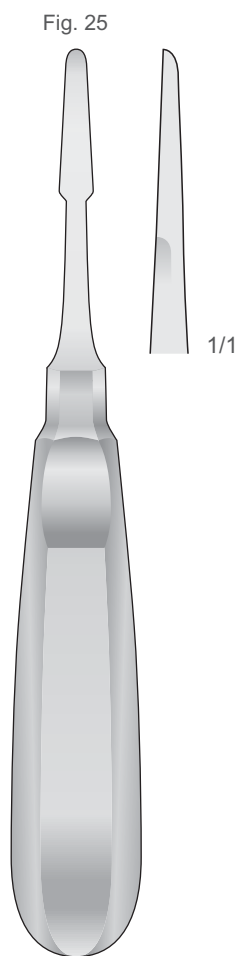

**SELDIN**  
**1805-C**  
 160 mm

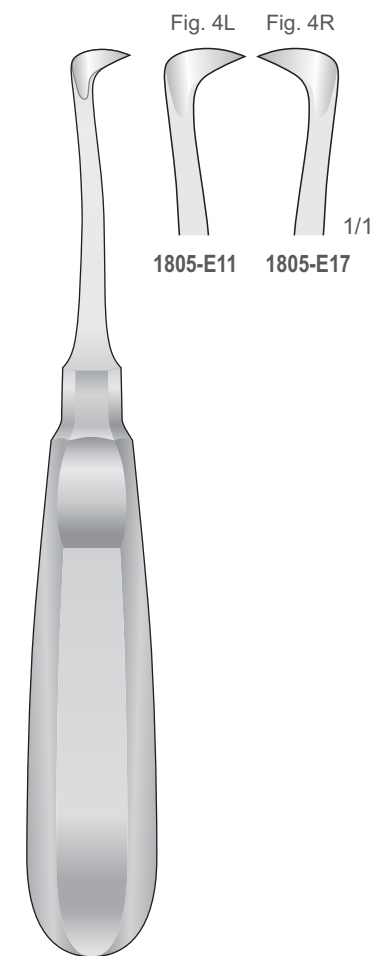

**SELDIN**  
**1805-E11/1805-E17**  
 160 mm

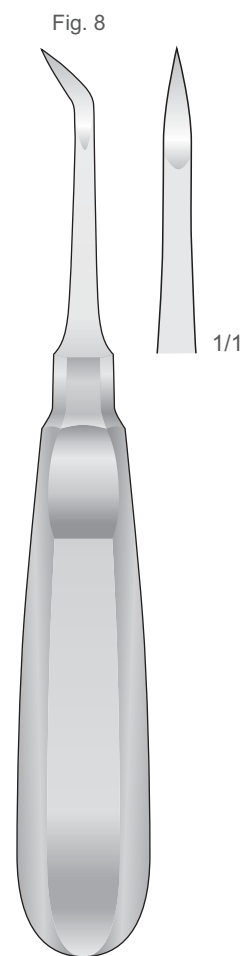

**CRANE PICK**  
**0815-G**  
 155 mm

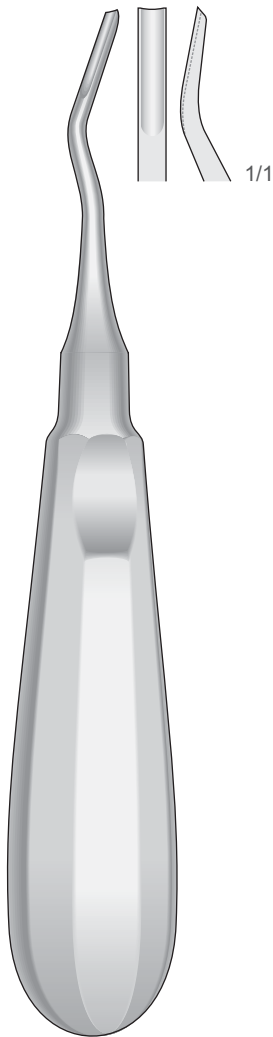

**0411-FE**  
160 mm

Fig. 304W

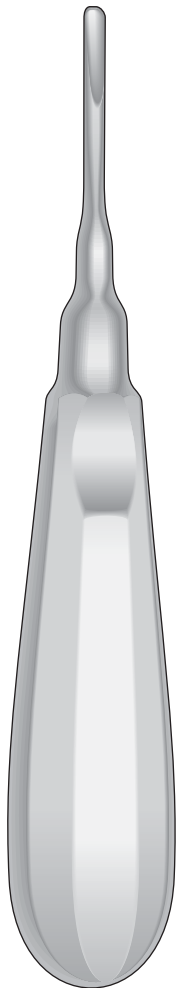

SELDIN  
**0411-EI**  
155 mm

Fig. 34S

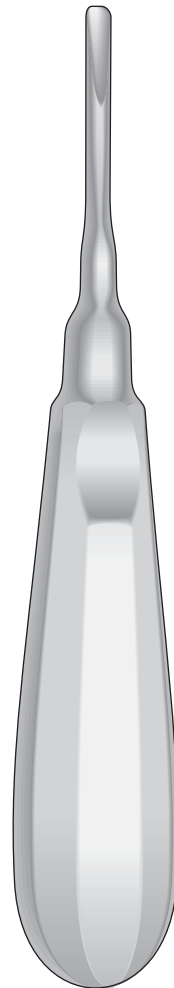

SELDIN  
**0411-EL**  
155 mm

2,2 mm

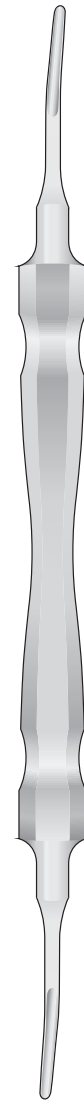

FAHRENKRUG  
**0411-AF**  
190 mm

3,0 mm

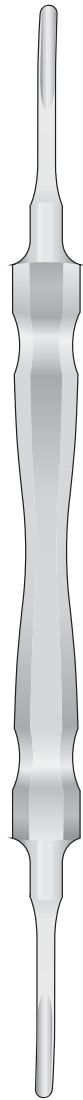

FAHRENKRUG  
**0411-AG**  
190 mm

Fig. 6

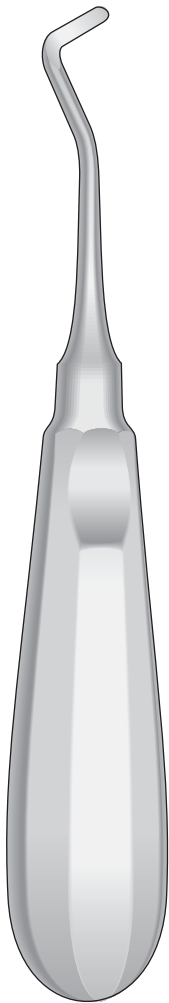

POTT  
 0411-LI  
 160 mm

Fig. 7

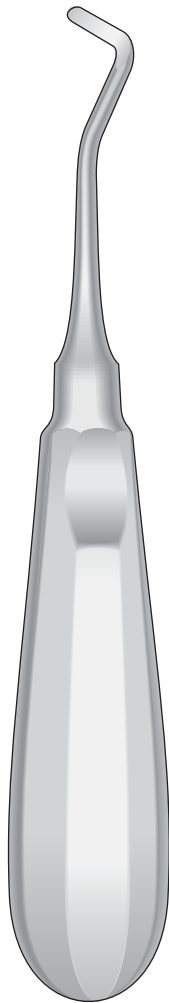

POTT  
 0411-LL  
 160 mm

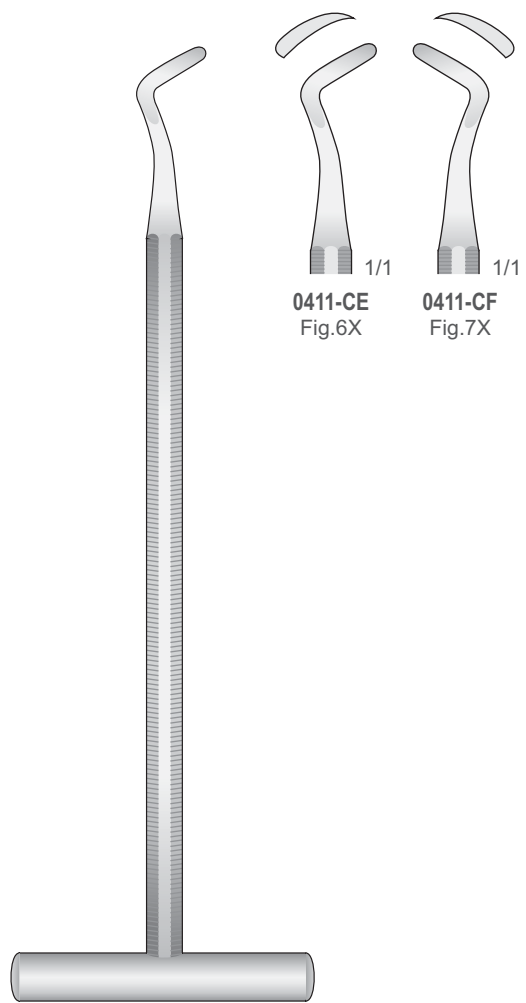

POTT  
 0411-CE/0411-CF  
 155 mm

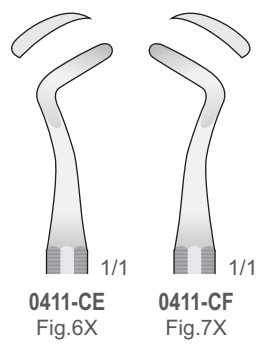



Syndesmotome  
 Syndesmotomes  
 Sindesmotomi  
 Syndesmôtomos  
 Syndesmotomes

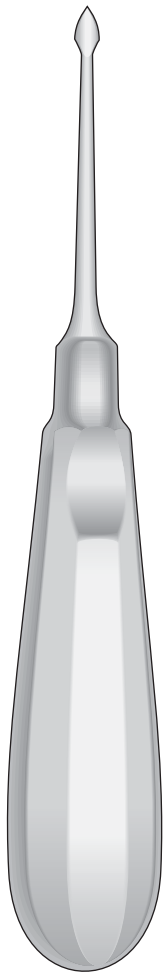

BERNARD  
 0411-HD/0411-BCE

Gerade  
 Straight  
 Diritto  
 Rectas  
 Droites



BERNARD  
 0411-HD  
 150 mm

Links  
 Left  
 Sinistra  
 A la izquierda  
 À gauche

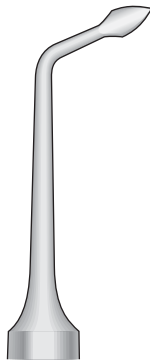

BERNARD  
 0411-HE  
 140 mm

Rechts  
 Right  
 Destro  
 A la derecha  
 À droite

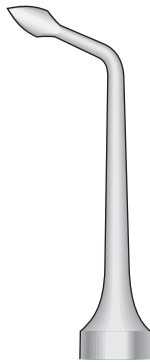

BERNARD  
 0411-HF  
 140 mm

Bajonett - Bayonet  
 Baionetta - Bayoneta  
 Baionnette

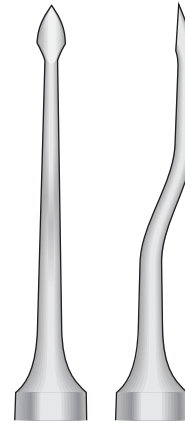

BERNARD  
 0411-BCD  
 150 mm

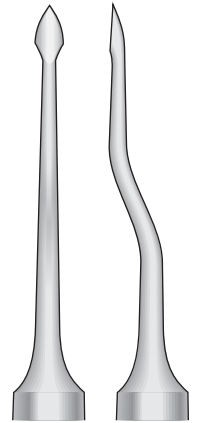

BERNARD  
 0411-BCE  
 150 mm

Wurzelheber  
Root Elevators  
Leve per radici  
Elevadores para raíces  
Elevateurs à racines

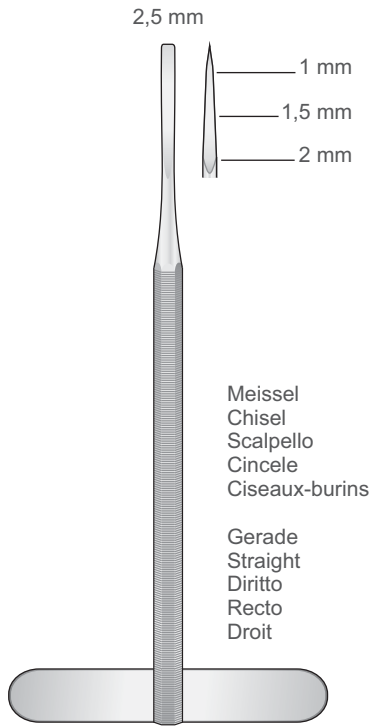

0411-II  
130 mm

Meissel  
Chisel  
Scalpello  
Cincele  
Ciseaux-burins

Gerade  
Straight  
Diritto  
Recto  
Droit

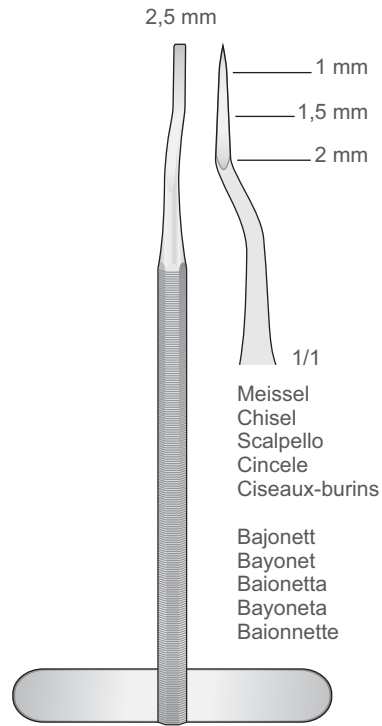

0411-IL  
130 mm

Meissel  
Chisel  
Scalpello  
Cincele  
Ciseaux-burins

Bajonett  
Bayonet  
Baionetta  
Bayoneta  
Baionnette

Syndesmotome  
Syndesmotomes  
Sindesmotomo  
Syndesmõtomas  
Syndesmotomes

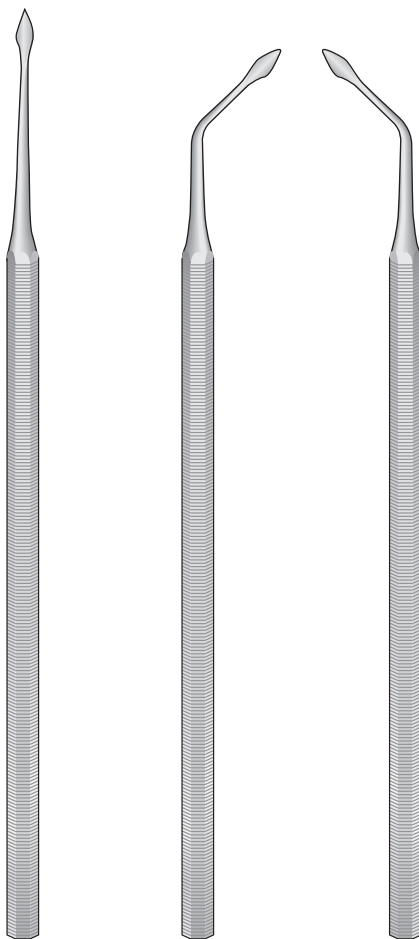

0411-GD  
158 mm

0411-GC  
152 mm

0411-GB  
152 mm

Raspatorien  
Raspatories  
Scollaperiosteo  
Legras  
Rugines

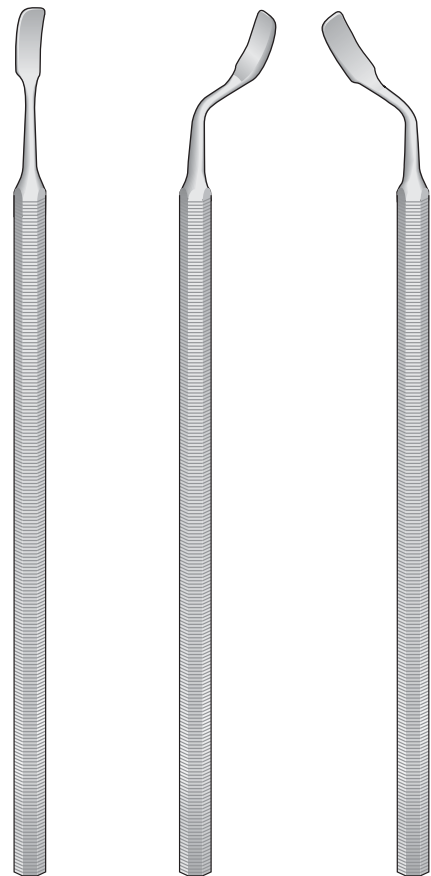

0411-FL  
150 mm

0411-GI  
150 mm

0411-GL  
150 mm



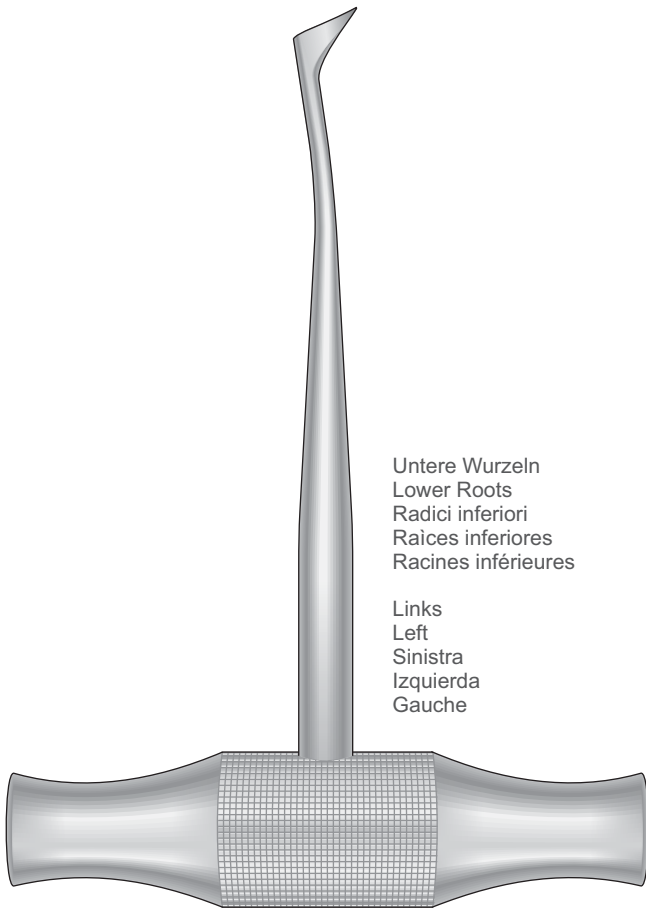

Untere Wurzeln  
Lower Roots  
Radici inferiori  
Raices inferiores  
Racines inférieures

Links  
Left  
Sinistra  
Izquierda  
Gauche

WINTER  
0411-BAA

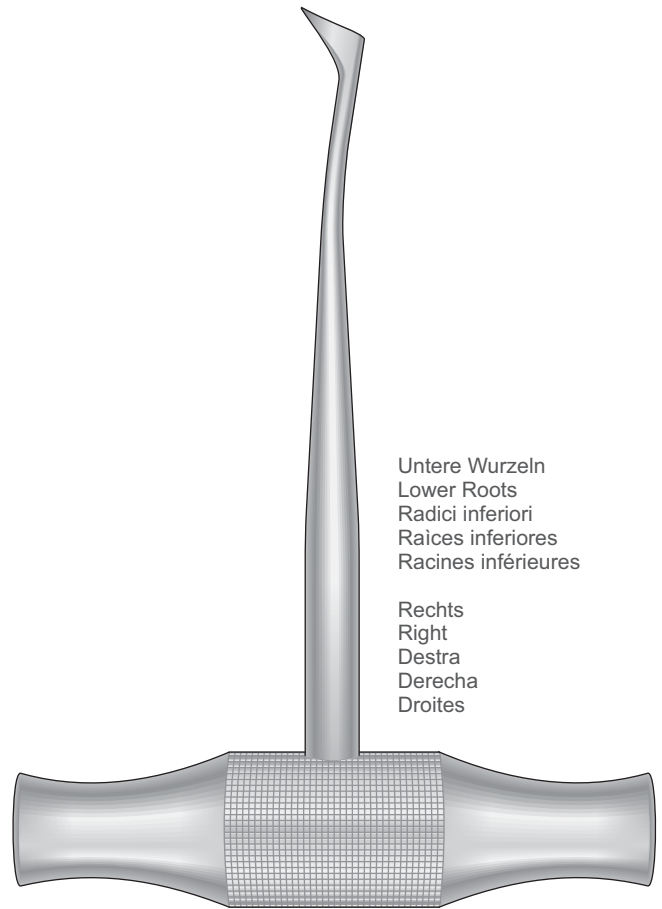

Untere Wurzeln  
Lower Roots  
Radici inferiori  
Raices inferiores  
Racines inférieures

Rechts  
Right  
Destra  
Derecha  
Droites

WINTER  
0411-BAB

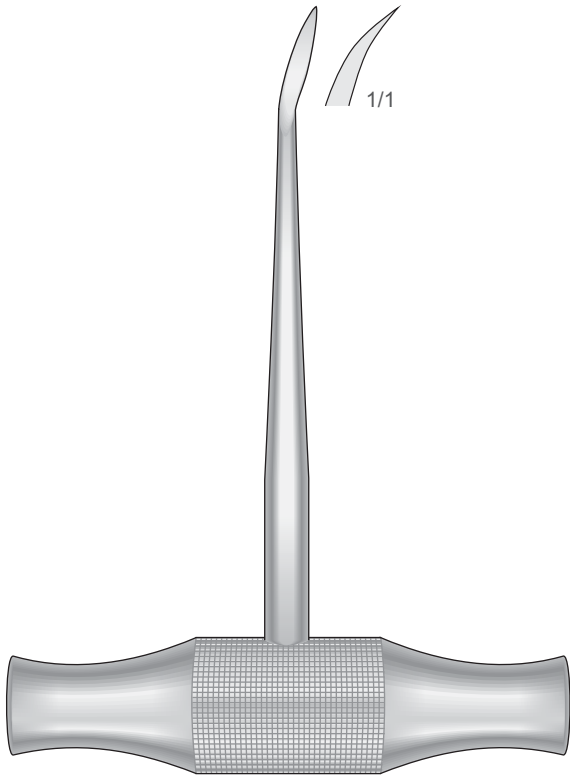

WINTER  
**0411-GE**  
 120 mm



WINTER  
**0411-GF**  
 120 mm



WINTER  
**0411-GG**  
 125 mm

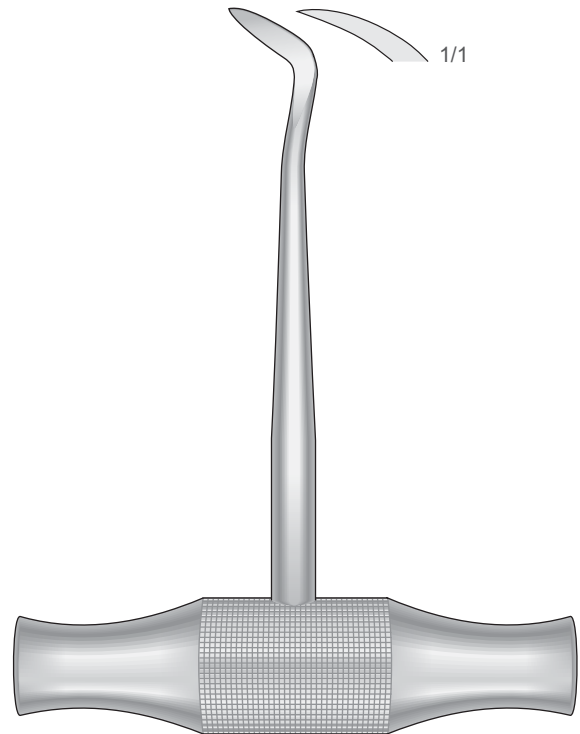

WINTER  
**0411-GH**  
 125 mm

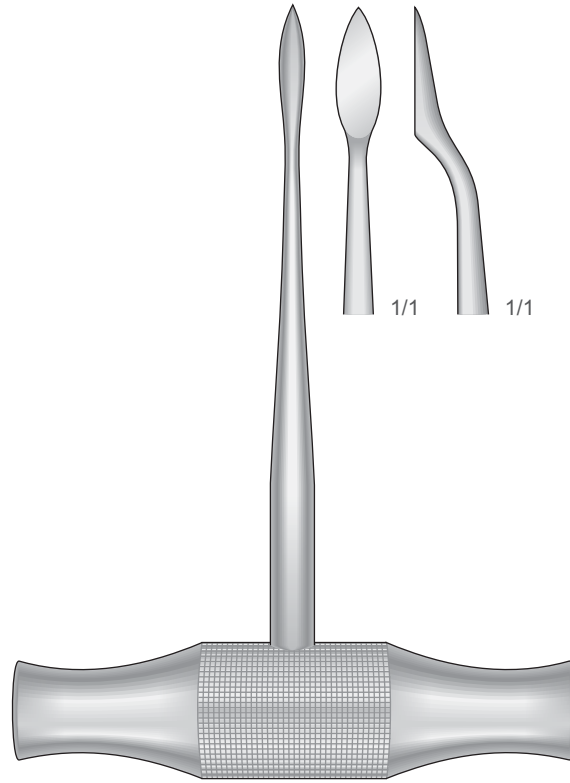

LECLUSE  
 0411-LA  
 130 mm

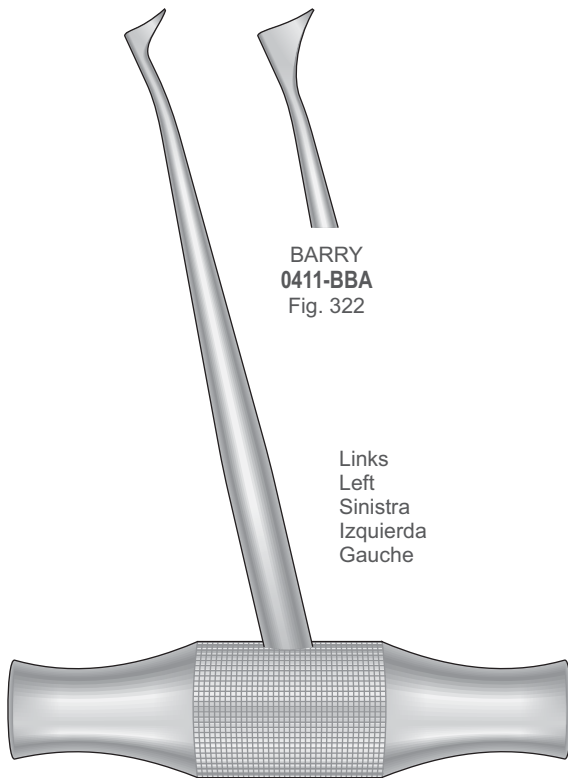

BARRY  
 0411-BAI Fig. 320  
 115 mm

Links  
 Left  
 Sinistra  
 Izquierda  
 Gauche

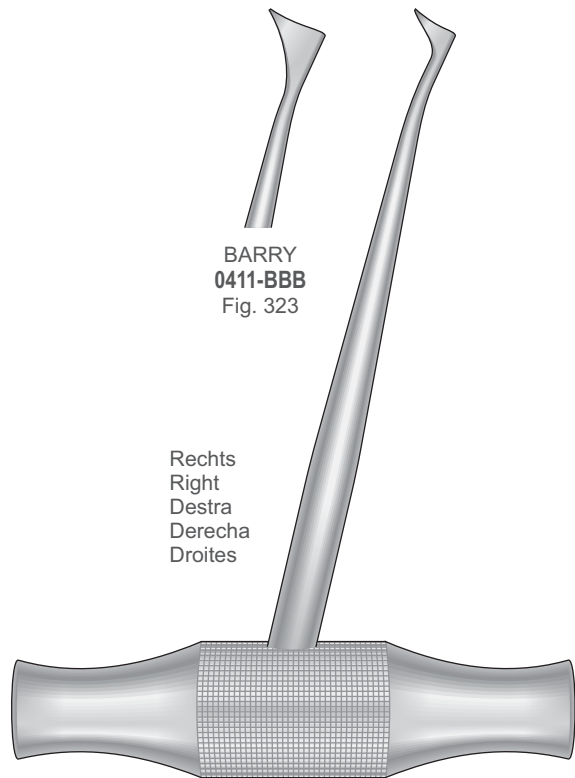

BARRY  
 0411-BAL Fig. 321  
 115 mm

Rechts  
 Right  
 Destra  
 Derecha  
 Droites

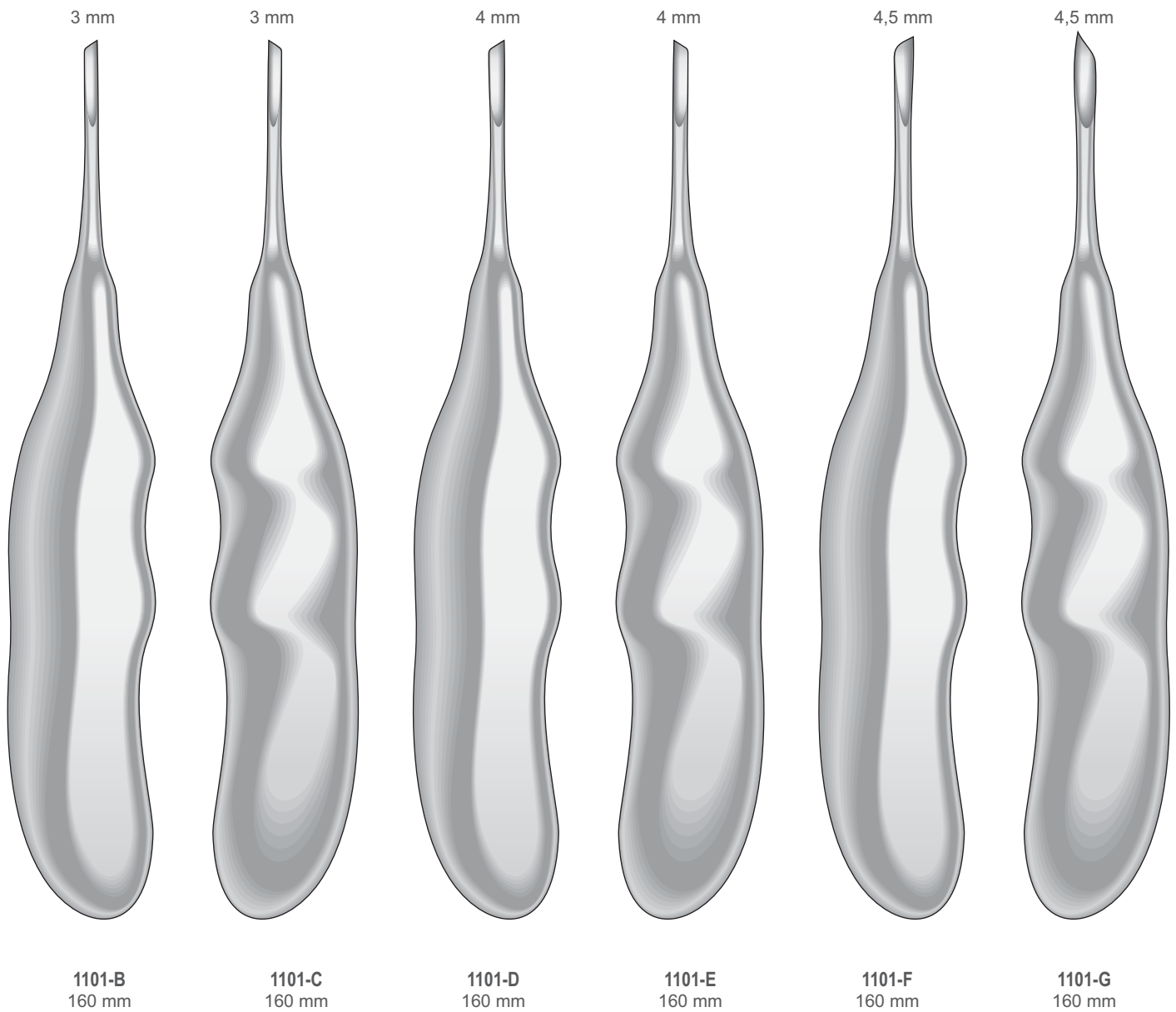



**1101-H**  
160 mm



**1101-I**  
160 mm



**1101-L**  
160 mm



**1101-BA**  
160 mm

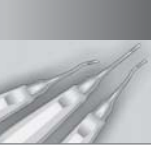

2 mm



**1101-BB**  
155 mm

3 mm



**1101-BC**  
155 mm

4 mm



**1101-BD**  
155 mm



**1101-BG**  
160 mm



**1101-BH**  
160 mm



3 mm



**1101-CA**  
160 mm

3 mm



**1101-CB**  
160 mm

4 mm



**1101-CC**  
160 mm

4 mm



**1101-CD**  
160 mm



Massiv  
 Solid  
 Manico  
 Pieno  
 Massif

CHOMPRET  
**0308-BB**  
 150 mm



Massiv  
 Solid  
 Manico  
 Pieno  
 Massif

CHOMPRET  
**0308-BC**  
 150 mm



Massiv  
 Solid  
 Manico  
 Pieno  
 Massif

CHOMPRET  
**0308-BD**  
 150 mm



Massiv  
 Solid  
 Manico  
 Pieno  
 Massif

CHOMPRET  
**0308-BE**  
 145 mm



CHOMPRET  
**0308-B**  
 165 mm



CHOMPRET  
**0308-C**  
 165 mm



CHOMPRET  
**0308-D**  
 165 mm



CHOMPRET  
**0308-E**  
 160 mm



MORSE - SCALERS

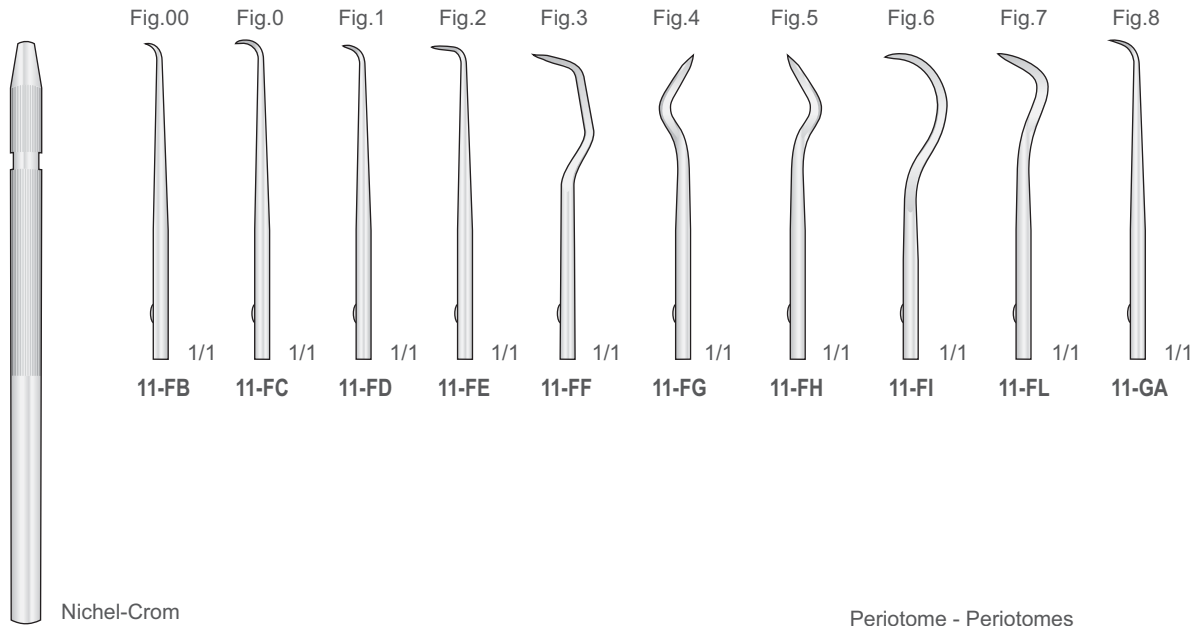

1201-I  
125 mm

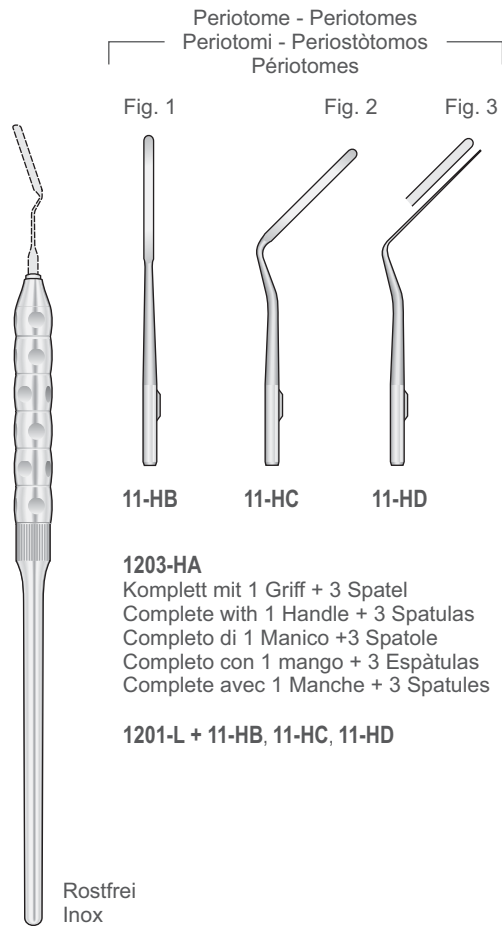

**1203-HA**  
 Komplett mit 1 Griff + 3 Spatel  
 Complete with 1 Handle + 3 Spatulas  
 Completo di 1 Manico +3 Spatole  
 Completo con 1 mango + 3 Espátulas  
 Complete avec 1 Manche + 3 Spatules

1201-L + 11-HB, 11-HC, 11-HD

Ersatz  
 Insert for replacement  
 Inserto di ricambio  
 Puntas de repuesto  
 Pointes de rechange

Für MA-9  
 For MA-9  
 Per MA-9  
 Para MA-9  
 Pour MA-9

1201-L  
140 mm

Periotome - Periotomes  
 Periotomi - Periotòmos  
 Périotomes

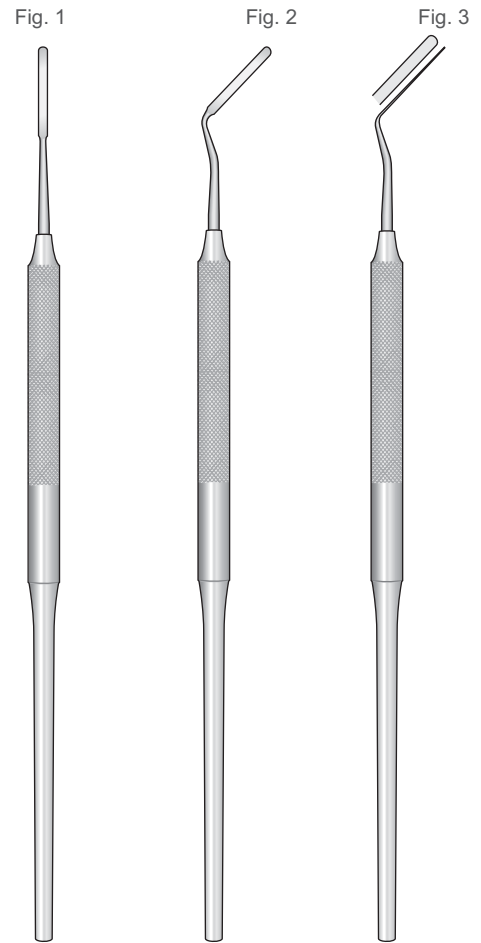

1203-BB  
160 mm

1203-BC  
160 mm

1203-BD  
160 mm

**180412-03**

Komplett mit 2 Griffe + 20 Klingen  
Complete with 2 Handles + 20 Blades  
Completo di 2 Manici + 20 lame  
Completo con 2 mangos + 20 hojas  
Complete avec 2 Manches + 20 lames

**1804-12**

Griff  
Handle  
Manico  
Mango  
Manche

**180412-L**

Komplett mit 2 Griffe + 9 Klingen APICALI  
Complete with 2 Handles + 9 Blades APICALI  
Completo di 2 Manici + 9 lame APICALI  
Completo con 2 mangos + 9 hojas APICALI  
Complete avec 2 Manches + 9 lames APICALI

**180412-BB**

Komplett mit 2 Griffe + 11 Klingen CERVICALI  
Complete with 2 Handles + 11 Blades CERVICALI  
Completo di 2 Manici + 11 lame CERVICALI  
Completo con 2 mangos + 11 hojas CERVICALI  
Complete avec 2 Manches + 11 lames CERVICALI

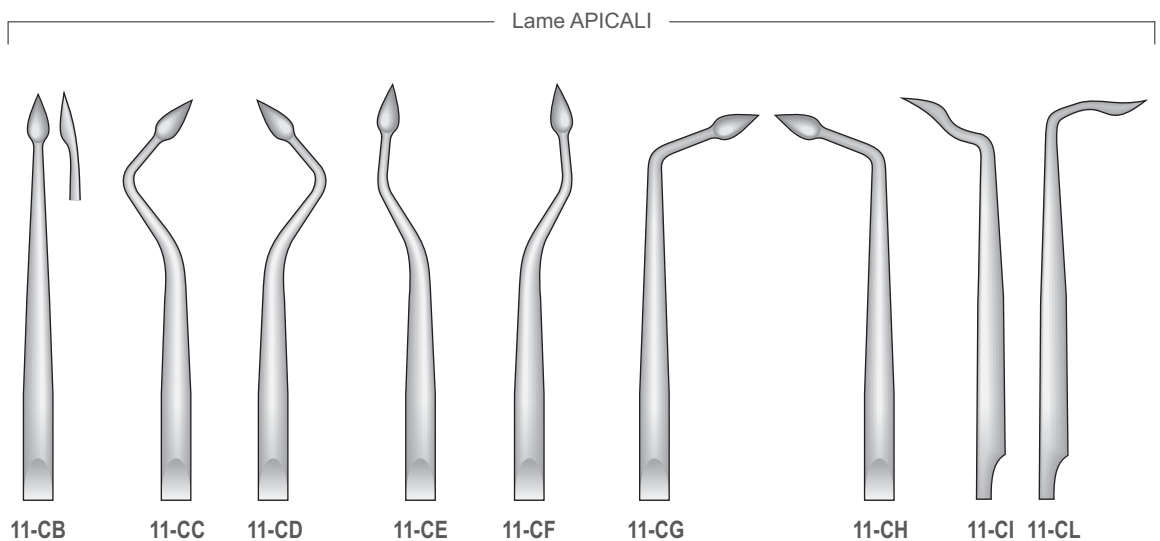
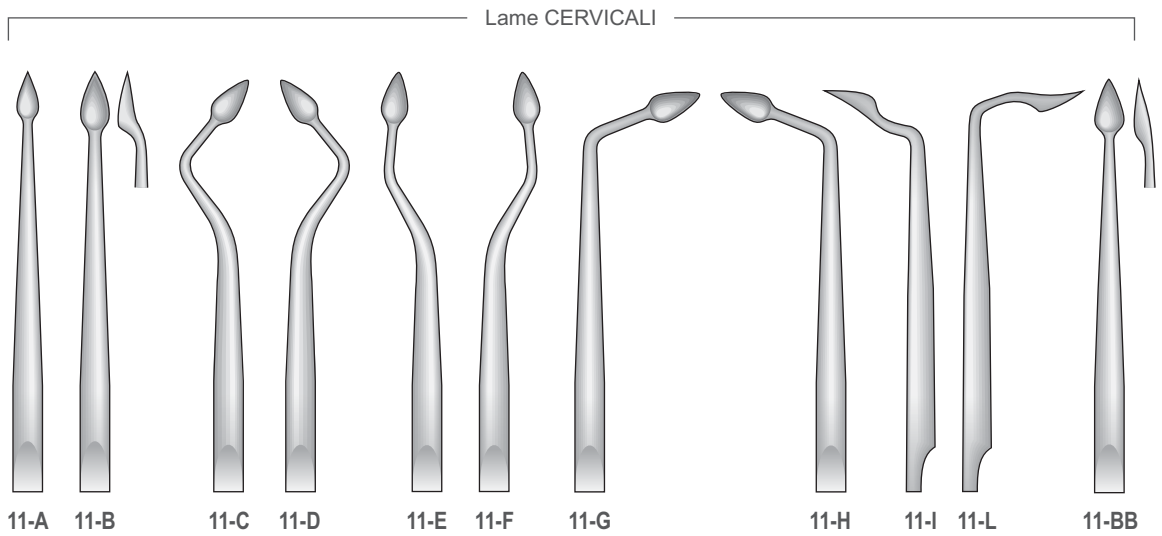

1804-12

.3

Skalpelle  
Scalpel Blades  
Lame per bisturi  
Hojas de bisturi  
Lames de bistouris

Zahnärztliche Chirurgie  
Dental surgery  
Chirurgia dentale  
Cirugia dental  
Chirurgie dentaire





Skalpellgriffe - Mikro Skalpellklingen  
 Scalpel Handles - Micro Scalpel Blades  
 Manici per bisturi - Micro lame per bisturi  
 Mangos de bisturi - Micro hojas de bisturi  
 Manches pour bistouris - Micro lames de bistouris

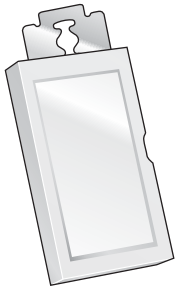

**1102-EA**  
 Packung 10 Klingen  
 Package 10 blades  
 Scatola da 10 lame  
 Cajita de 10 hojas  
 Boite de 10 lames

Skalpellgriffe für Mikro-Klingen  
 Scalpel handles for Micro blades  
 Manici per micro lame  
 Mangos de bisturi para micro hojas  
 Manches de bistouris pour micro lames

Micro-Klingen  
 Micro blades  
 Micro lame  
 Micro hojas  
 Micro lames

Rasierklingen-Brecker und halter  
 Razor blade breaker and holder  
 Manico porta lame  
 Mango para Hojas de afeitador  
 Porte lames à rasoir

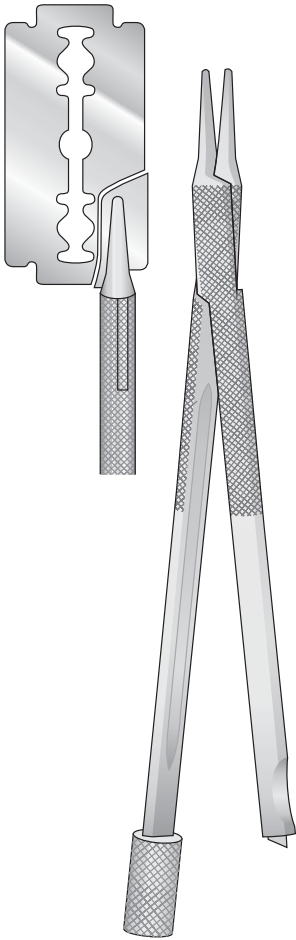

**1310-BC**  
 120 mm



**0202-EG**  
 135 mm

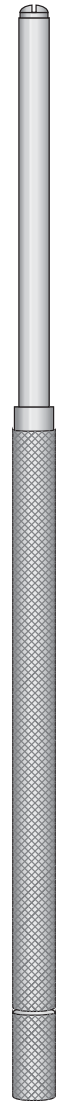

**0202-EI**  
 155 mm



**1102-DGB**  
 Pack. 10 pcs



**1102-DGC**  
 Pack. 10 pcs



**1102-DGD**  
 Pack. 10 pcs



**1102-DGE**  
 Pack. 10 pcs



**1102-DGF**  
 Pack. 10 pcs



**1102-DGG**  
 Pack. 10 pcs



**1102-DGH**  
 Pack. 10 pcs



**1102-DGI**  
 Pack. 10 pcs



**1102-DGL**  
 Pack. 10 pcs

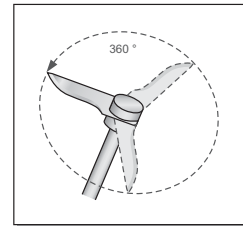

Für Mikro-Klingen  
For Micro Blades  
Per micro lame  
Para micro Hojas  
Pour Micro-Lame de bistouris



**1310-B**  
100 mm



**1310-D**  
130 mm



**1310-C**  
150 mm

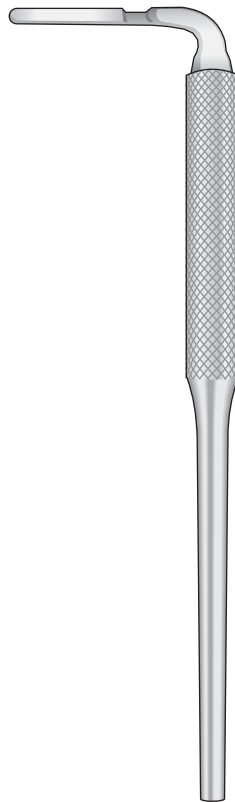

**1201-02BG**  
120 mm

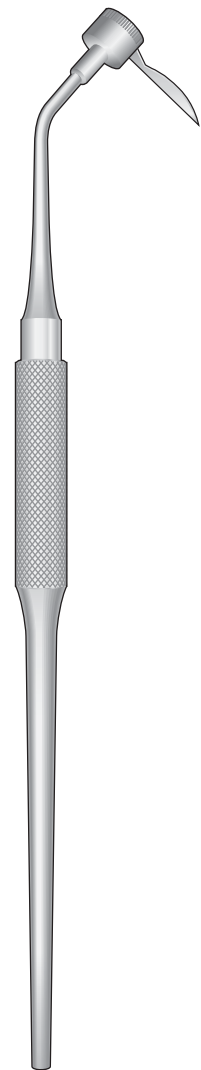

**0702-E**  
165 mm

Skalpelle und Skalpellgriffe  
 Scalpel Blades and Handle  
 Lame e manici per bisturi  
 Hojas y mangos de bisturi  
 Lames et manches de bistouris

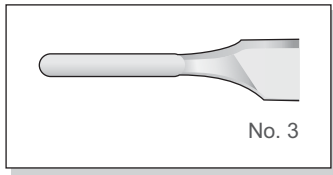

Packungen à 100  
 Packages of 100 ea  
 Scatole da 100 pezzi  
 Cajas de 100 c/u  
 Boîtes de 100 pièces



1102-BA  
Fig. 10



1102-BB  
Fig. 11

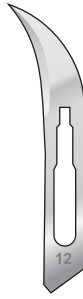

1102-BC  
Fig. 12



1102-BC04  
Fig. 12D



1102-BD  
Fig. 13



1102-BF  
Fig. 15



1102-BF01  
Fig. 15A



1102-BF03  
Fig. 15C



1201-02D



1201-02D12



1201-02H



1201-02H10



1201-02B



1201-02C



1201-02I/1201-02L  
155 mm

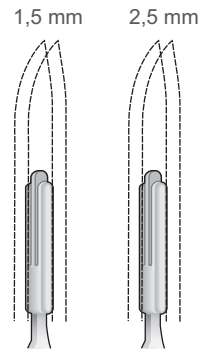

1201-02I 1201-02L

Doppelt Skalpellgriff  
 Scalpel Handle double Blade  
 Manico per bisturi a doppia lama  
 Mango de bisturi doble hojas  
 Manche pour bistouri double-lames

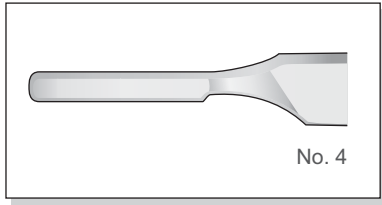

No. 4

Packungen à 100  
Packages of 100 ea  
Scatole da 100 pezzi  
Cajas de 100 c/u  
Boîtes de 100 pièces



1102-BI



1102-CA



1102-CB



1102-CD

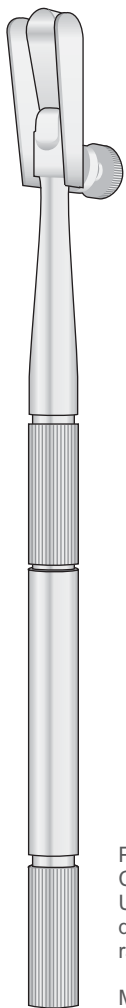

PAQUETTE  
BLADE HOLDER  
0702-C  
160 mm

Palatal, Gingival,  
Connective Tissue Grafts  
Uses standard  
double-edged  
razor blade

Mucotomo



1201-02E

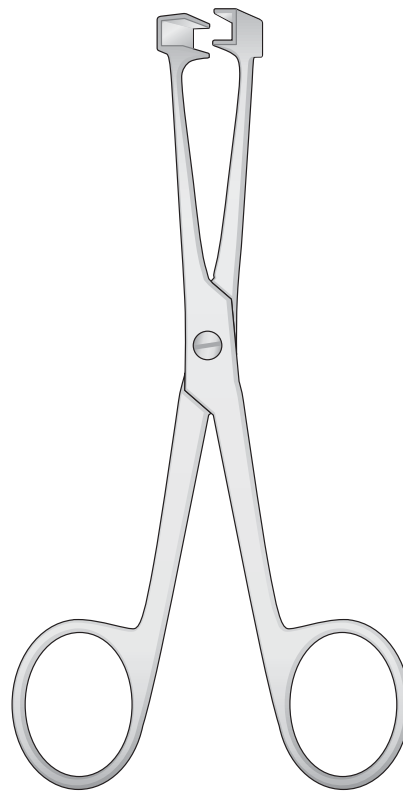

0718-BI  
135 mm

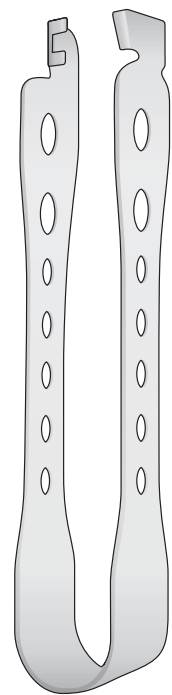

0718-BG  
115 mm

Klingenentfemer  
Scalpel blade removing forceps  
Pinze togliilama  
Pinza para quitar hojas de bisturías  
Pince pour enlever les lames de bistouris





Messer  
Knives  
Coltelli  
Bisturíes  
Couteau



**1310-AG**  
5 mm

**1310-AI**  
6 mm

**1310-BA**  
7 mm



**1310-BE**  
125 mm

**1310-BG**  
135 mm



**1310-BI**  
35 mm

**1310-CA**  
35 mm

**ZIEGLER**  
**1310-AG/1310-BA**  
115 mm

**GRAEFE**  
**1310-BE/1310-BG**

**GRAEFE**  
**1310-BI/1310-CA**  
140 mm



1/1



2 mm



1/1

2 mm



**LA FORCE**  
**1310-AH**  
120 mm

**ELLIS**  
**1310-AL**  
120 mm

**1310-BB**  
125 mm

**1310-BH**  
125 mm

**1310-DL**  
125 mm

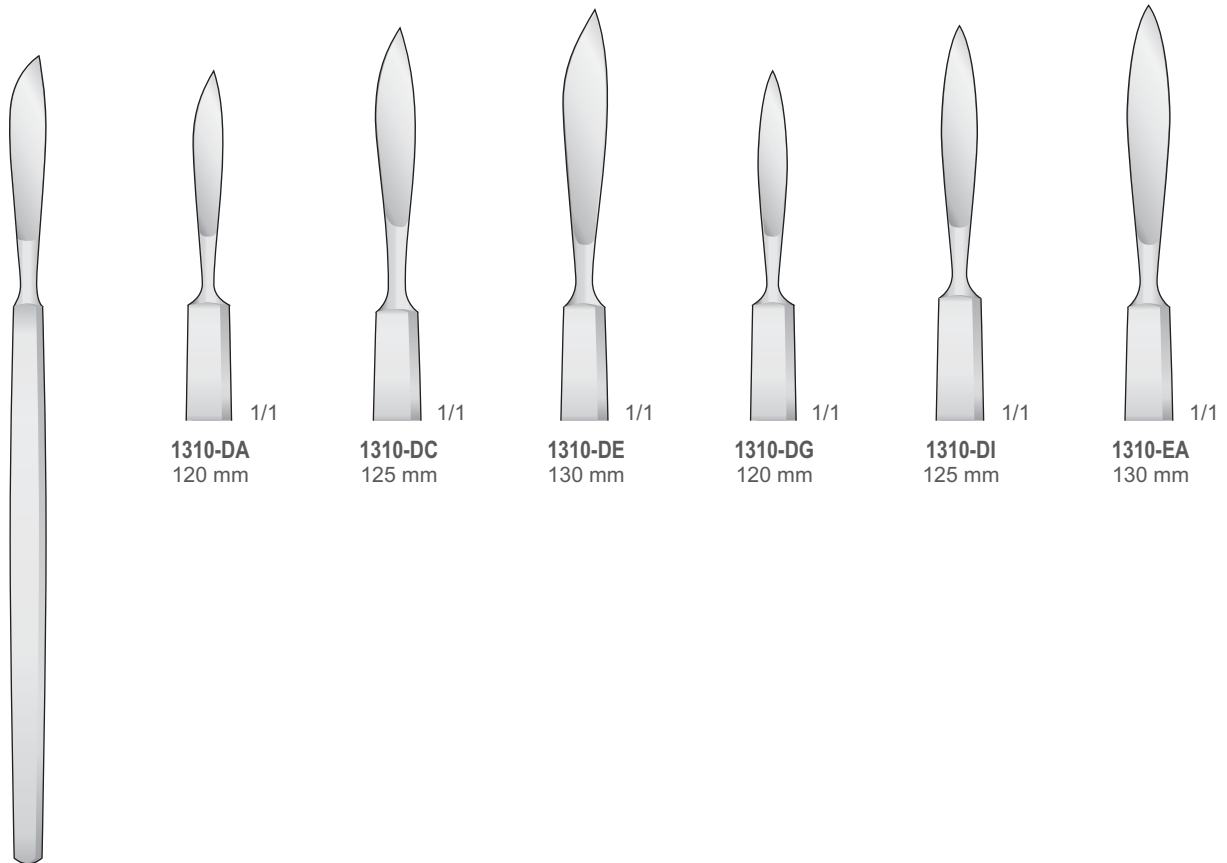

**1310-DA**  
120 mm

1/1

**1310-DC**  
125 mm

1/1

**1310-DE**  
130 mm

1/1

**1310-DG**  
120 mm

1/1

**1310-DI**  
125 mm

1/1

**1310-EA**  
130 mm

1/1

**1310-DA/1310-EA**



.4

Scheren  
Scissors  
Forbici  
Tijeras  
Ciseaux

Zahnärztliche Chirurgie  
Dental surgery  
Chirurgia dentale  
Cirugia dental  
Chirurgie dentaire







Mikro-Scheren  
Micro Scissors  
Micro Forbici  
Micro Tijeras  
Micro Ciseaux

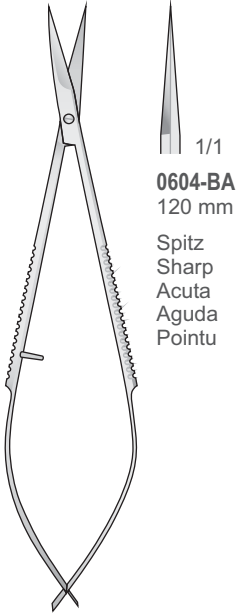

1/1  
**0604-BA**  
120 mm  
Spitz  
Sharp  
Acuta  
Aguda  
Pointu

NOYES  
**0604-BA**  
120 mm

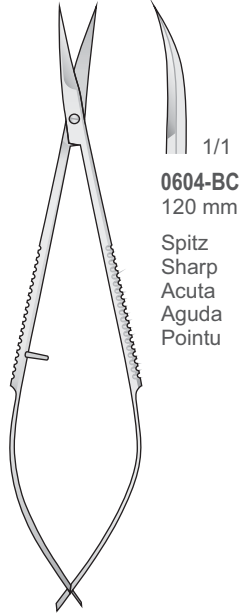

1/1  
**0604-BC**  
120 mm  
Spitz  
Sharp  
Acuta  
Aguda  
Pointu

NOYES  
**0604-BC**  
120 mm

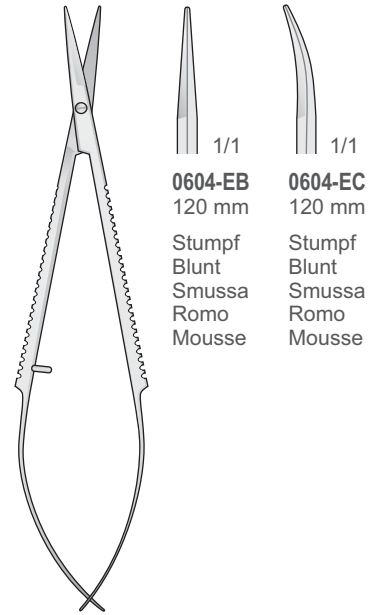

1/1 1/1  
**0604-EB** **0604-EC**  
120 mm 120 mm  
Stumpf  
Blunt  
Smussa  
Romo  
Mousse

**0604-EB/0604-EC**  
120 mm

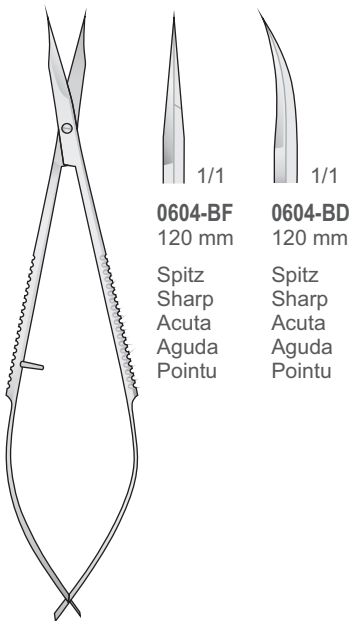

1/1 1/1  
**0604-BF** **0604-BD**  
120 mm 120 mm  
Spitz  
Sharp  
Acuta  
Aguda  
Pointu

WESTCOTT  
**0604-BD/0604-BF**  
120 mm

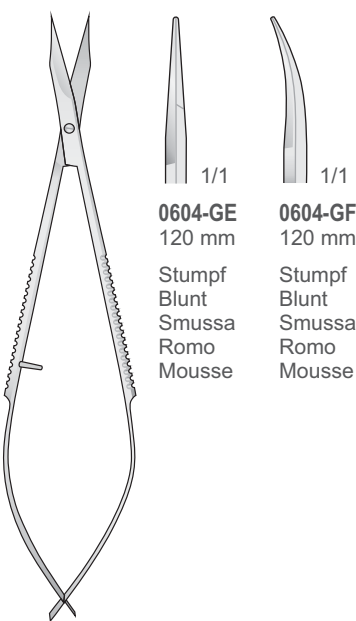

1/1 1/1  
**0604-GE** **0604-GF**  
120 mm 120 mm  
Stumpf  
Blunt  
Smussa  
Romo  
Mousse

WESTCOTT  
**0604-GE/0604-GF**  
120 mm

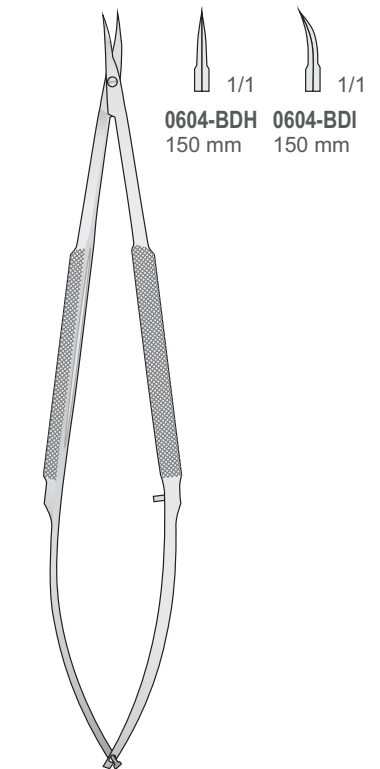

1/1 1/1  
**0604-BDH** **0604-BDI**  
150 mm 150 mm

**0604-BDH/0604-BDI**  
150 mm

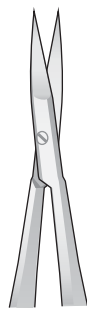
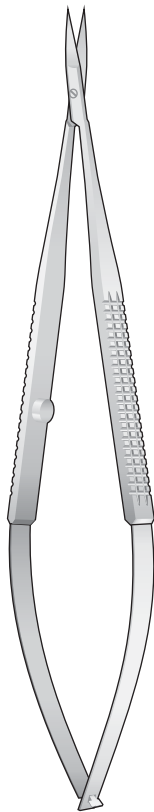

**0604-BIC**  
160 mm  
Spitz  
Sharp  
Acuta  
Aguda  
Pointu



**0604-BID**  
160 mm  
Spitz  
Sharp  
Acuta  
Aguda  
Pointu

1/1

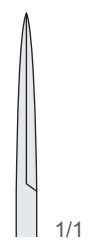
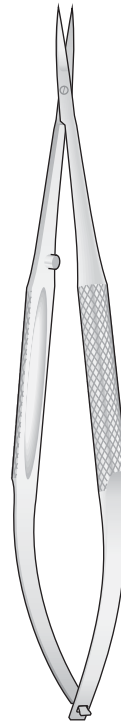

**0604-CCE**  
145 mm  
Spitz  
Sharp  
Acuta  
Aguda  
Pointu

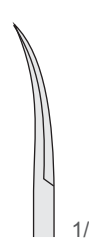

**0604-CCF**  
145 mm  
Spitz  
Sharp  
Acuta  
Aguda  
Pointu

1/1

1/1

**0604-BIC/0604-BID**  
160 mm

**0604-CCE/0604-CCF**  
145 mm

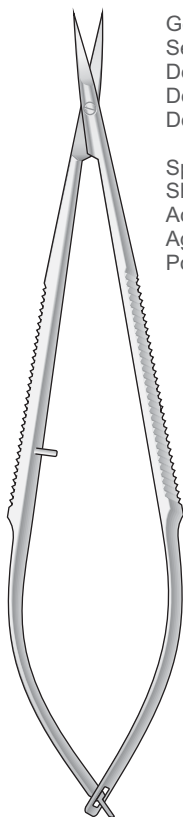

Gezahnt  
Serrated  
Dentellata  
Dentada  
Dentelé  
  
Spitz  
Sharp  
Acuta  
Aguda  
Pointu

**0604-BEF**  
160 mm

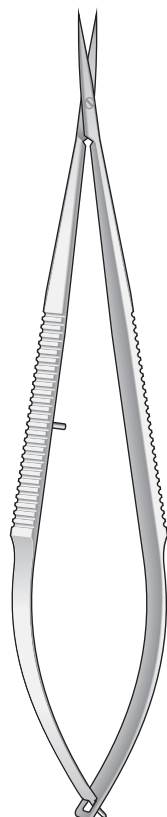

1/1  
**0604-AG**  
160 mm  
Spitz  
Sharp  
Acuta  
Aguda  
Pointu

**0604-AG**  
160 mm

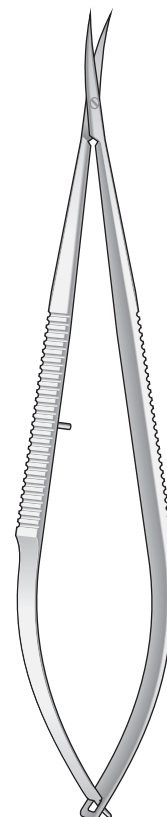

1/1  
**0604-AI**  
160 mm  
Spitz  
Sharp  
Acuta  
Aguda  
Pointu

**0604-AI**  
160 mm



Scheren  
Scissors  
Forbici  
Tijeras  
Ciseaux

Spitz - Sharp  
Acuta - Aguda  
Pointu

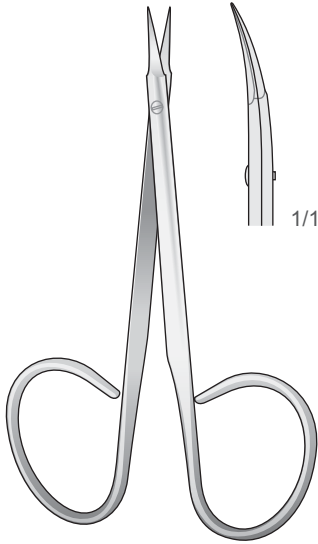

**STITCH**  
**0607-CBG**  
115 mm

Iris Scheren - Iris scissors  
Forbici Iris - Tijeras Iris  
Ciseaux Iris

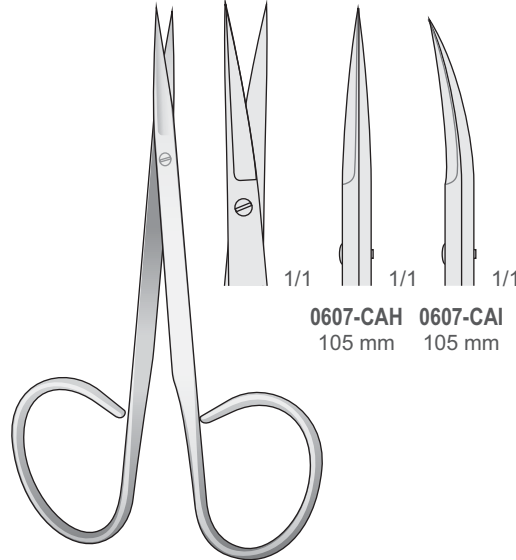

**0607-CAH** **0607-CAI**  
105 mm 105 mm

**0607-CAH/0607-CAI**  
105 mm

Stumpf - Blunt  
Smussa - Romas  
Mousse

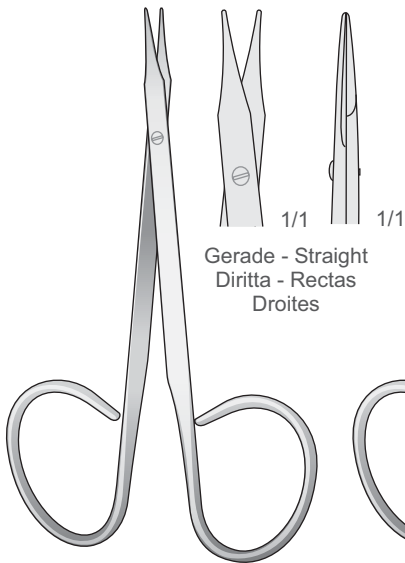

**STEVENS**  
**0607-CAL**  
100 mm

Stumpf - Blunt  
Smussa - Romas  
Mousse

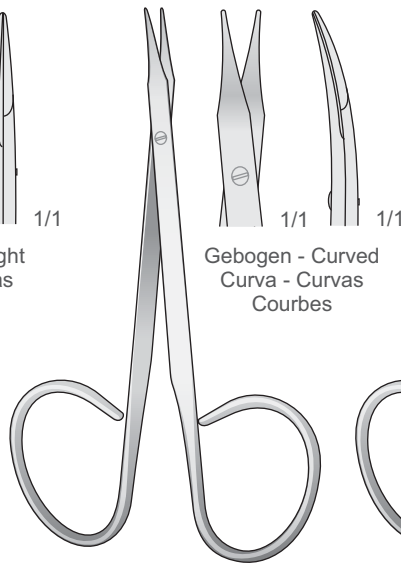

**STEVENS**  
**0607-CBA**  
100 mm

Spitz - Sharp  
Acuta - Aguda  
Pointu

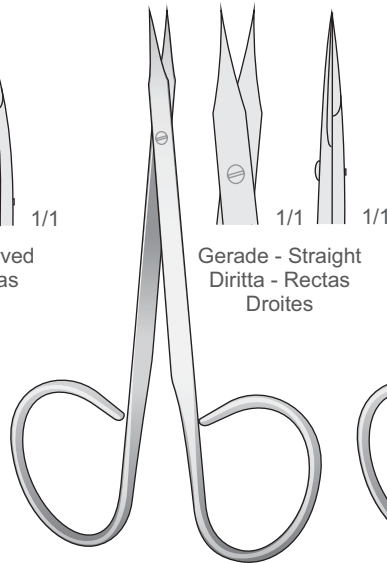

**WALTON**  
**0607-CBB**  
100 mm

Spitz - Sharp  
Acuta - Aguda  
Pointu

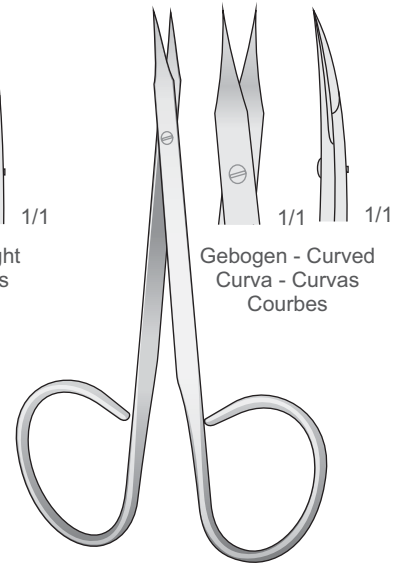

**WALTON**  
**0607-CBC**  
100 mm



L = links  
left  
mancini  
izquierdo  
gauche

**0607-BB11** 110 mm    **0607-BC11** 110 mm

Links Scheren  
Left Scissors  
Forbici per mancini  
Tijeras para zurdos  
Gauche Ciseaux

**0607-BBC** 105 mm    **0607-BBD** 105 mm

**IRIS**  
**0607-BB11/0607-BC11**  
110 mm

**COTTLE**  
**0607-FL**  
115 mm

**COTTLE-KNAPP**  
**0607-BBC/0607-BBD**  
105 mm

Spitz  
Sharp  
Acuta  
Aguda  
Pointu

Spitz  
Sharp  
Acuta  
Aguda  
Pointu

Spitz  
Sharp  
Acuta  
Aguda  
Pointu

Spitz  
Sharp  
Acuta  
Aguda  
Pointu

**0607-B** 110 mm    **0607-C** 110 mm

**0607-E** 105 mm    **0607-F** 105 mm

**IRIS**  
**0607-B/0607-C**  
110 mm

**0607-E/0607-F**  
105 mm





Scheren  
Scissors  
Forbici  
Tijeras  
Ciseaux

Gezahnt - Serrated  
Dentellata - Dentelé - Dentadas



**0607-BFG**  
110 mm

**0607-BFH**  
110 mm

Gezahnt - Serrated  
Dentellata - Dentelé - Dentadas

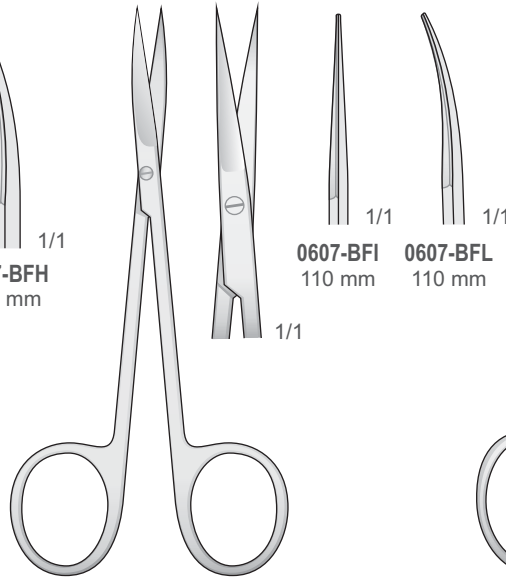

**0607-BFI**  
110 mm

**0607-BFL**  
110 mm

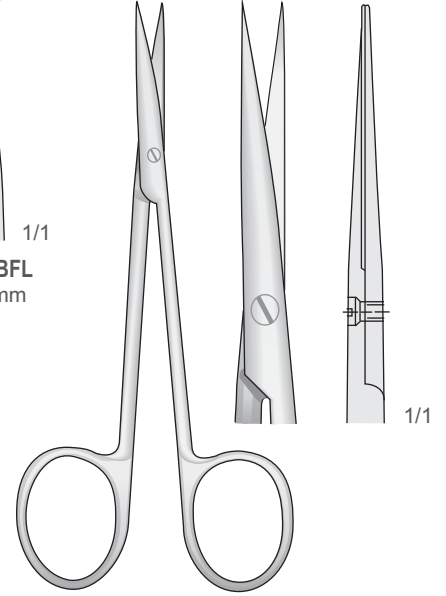

**KILNER**  
**0607-FI**  
115 mm

**0607-BFG/0607-BFH**  
110 mm

**0607-BFI/0607-BFL**  
110 mm

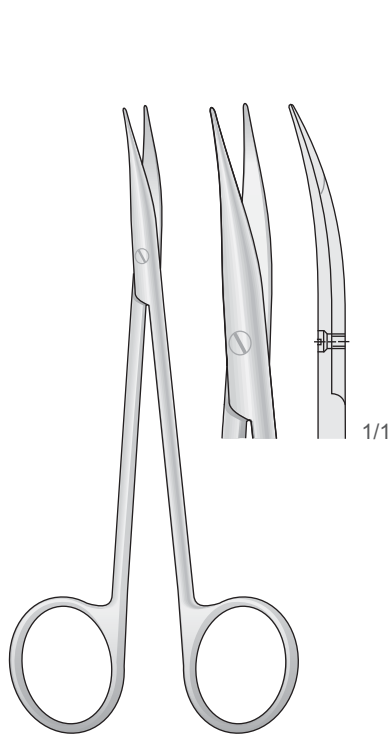

**JAMESON-WERBER**  
**0607-BCD**  
130 mm

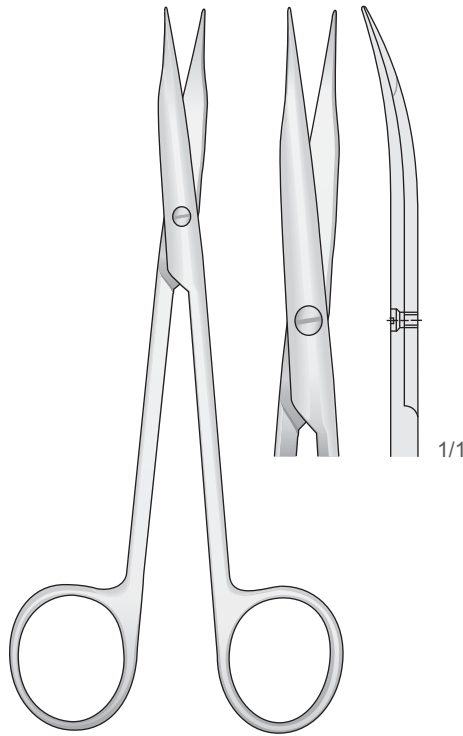

**JAMESON**  
**0607-BCE**  
145 mm

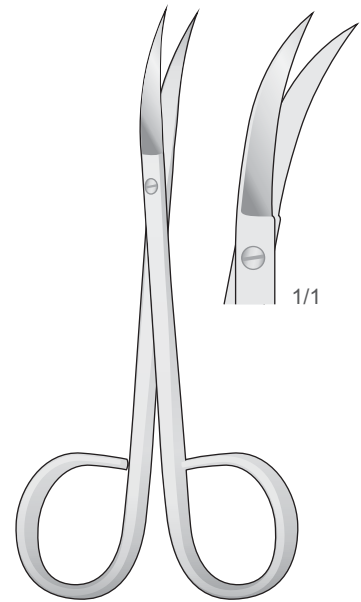

**0607-D**  
115 mm

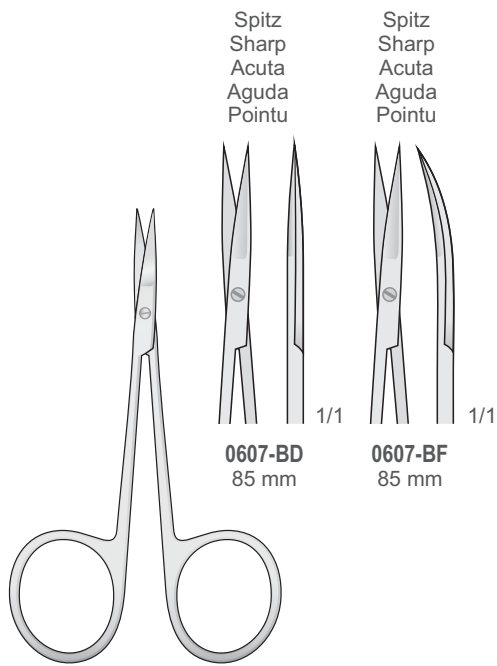

Spitz  
Sharp  
Acuta  
Aguda  
Pointu

Spitz  
Sharp  
Acuta  
Aguda  
Pointu

0607-BD  
85 mm

0607-BF  
85 mm

0607-CD

0607-CE

MICRO-IRIS  
0607-BD/0607-BF  
85 mm

0607-CD/0607-CE  
110 mm

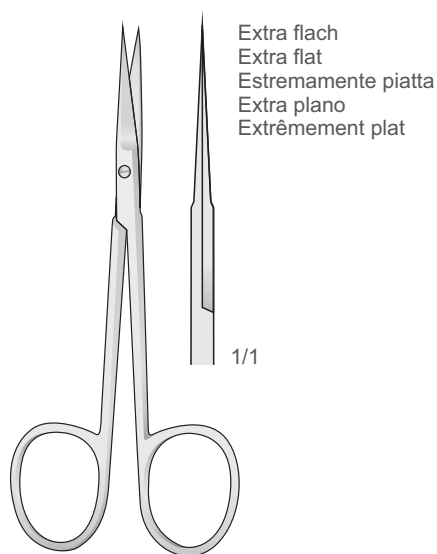

Extra flach  
Extra flat  
Estremamente piatta  
Extra plano  
Extrêmement plat

1/1

0607-BAE  
100 mm

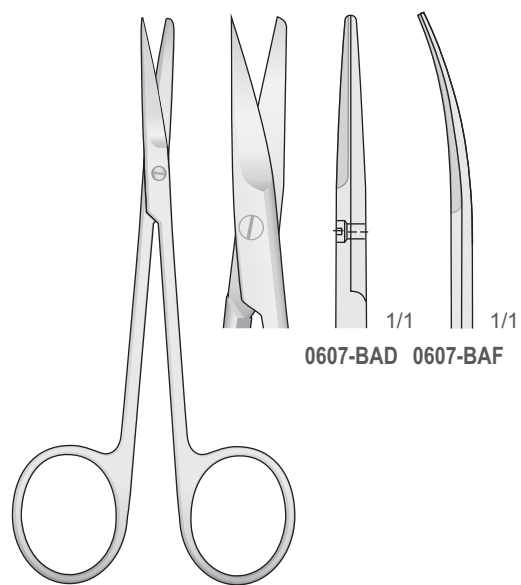

0607-BAD

0607-BAF

0607-BAD/0607-BAF  
110 mm



Scheren  
Scissors  
Forbici  
Tijeras  
Ciseaux

Spitz - Sharp  
Acuta - Agudo  
Aigu

Spitz - Sharp  
Acuta - Agudo  
Aigu



0612-BCG

0612-BCH

METZENBAUM  
0612-BCG/0612-BCH  
145 mm

0612-BC 0612-BAL

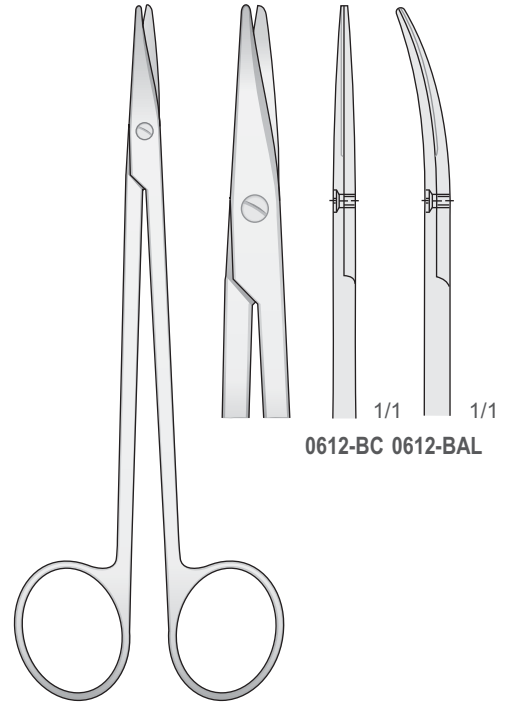

METZENBAUM  
0612-BC/0612-BAL  
150 mm

1/1  
Spitz  
Sharp  
Acuta  
Aguda  
Pointu

1/1  
Spitz  
Sharp  
Acuta  
Aguda  
Pointu

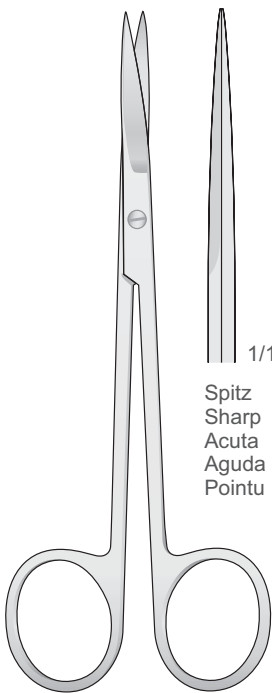

METZENBAUM  
0607-CI  
145 mm

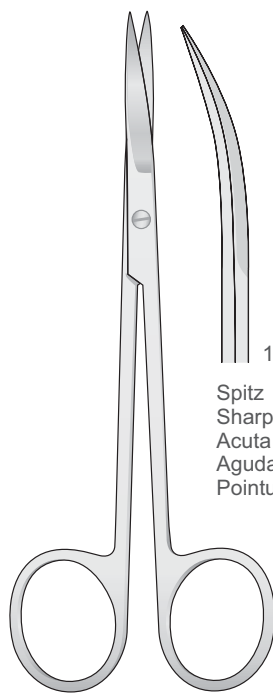

METZENBAUM  
0607-BE  
145 mm

0607-BEH  
150 mm

0607-BEI  
150 mm

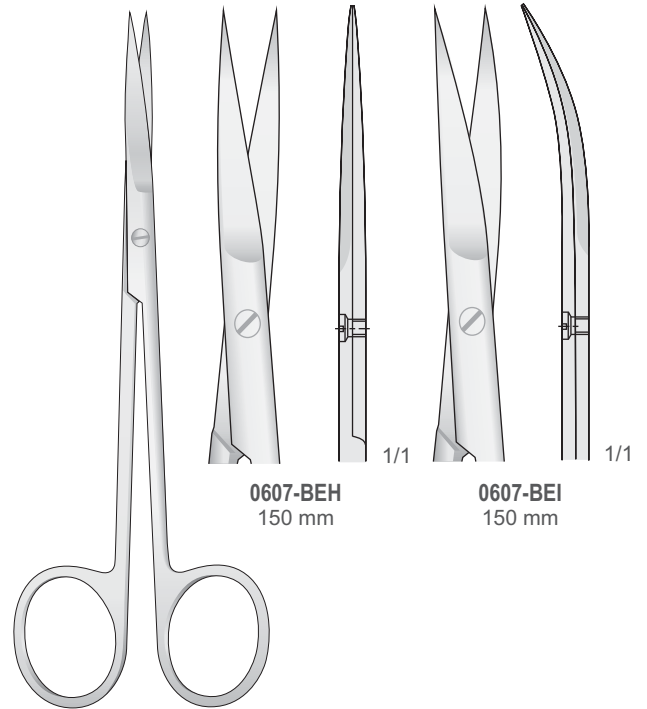

JOSEPH  
0607-BEH/0607-BEI  
150 mm



Stumpf  
Blunt  
Smussa  
Romas  
Mousse

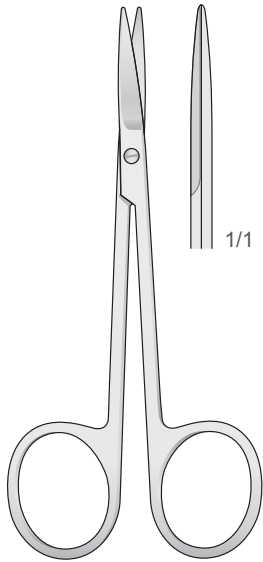

**0607-BAB**  
110 mm

Stumpf  
Blunt  
Smussa  
Romas  
Mousse

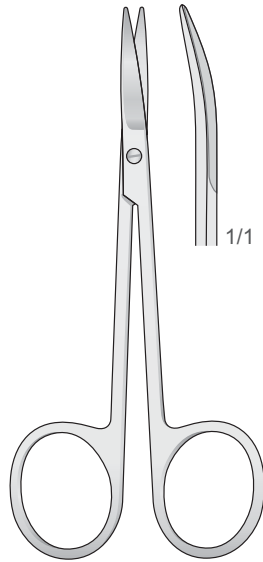

**0607-BAC**  
110 mm

Stumpf  
Blunt  
Smussa  
Romas  
Mousse

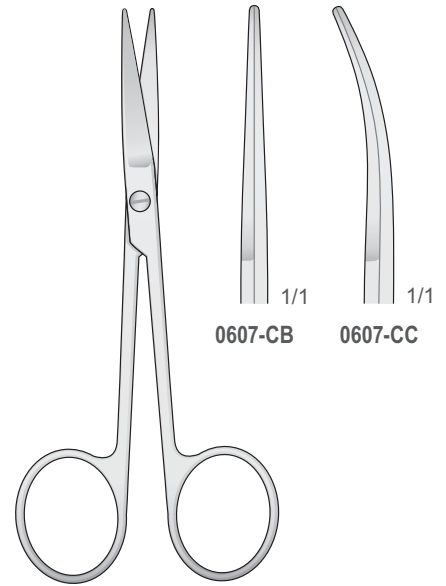

**0607-CB/0607-CC**  
115 mm

Spitz  
Sharp  
Acute  
Agudas  
Pointu

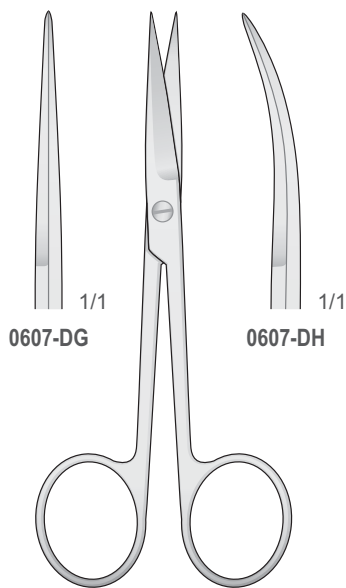

**0607-DG/0607-DH**  
115 mm

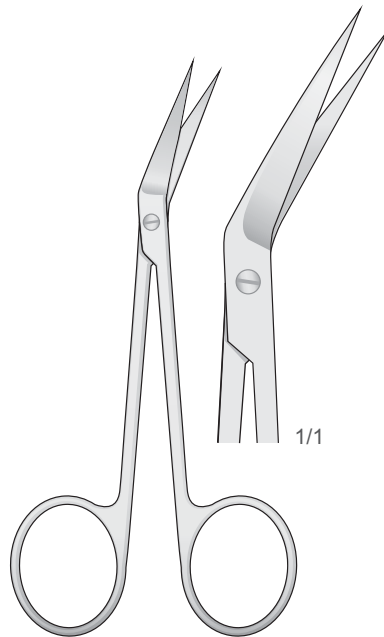

**LOCKLIN  
1110-B**  
115 mm

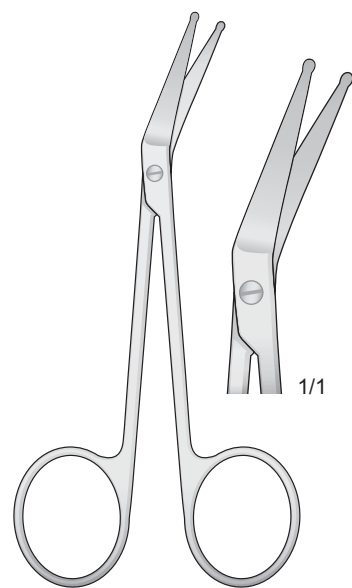

**LOCKLIN MOD.  
1110-D**  
110 mm



Mit einer Schneide gezahnt  
With one blade serrated  
Con una lama zigrinata  
Con una hoja dentada  
Avec lame dentelé

**KILNER**  
**0607-BCB**  
130 mm

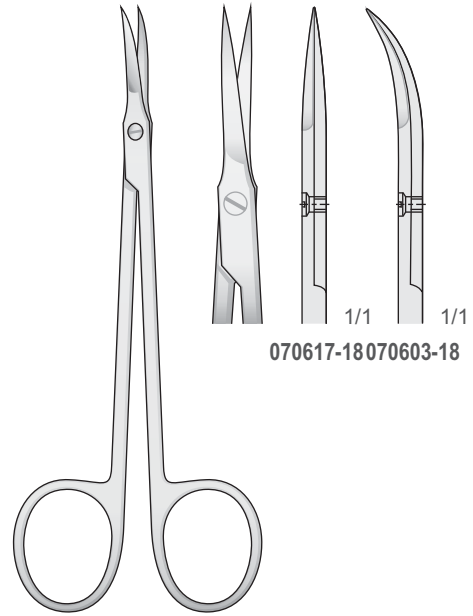

**070617-18/070603-18**

**070617-18/070603-18**  
120 mm

Gezahnt - Serrated  
Dentellata - Dentadas  
Dentelé

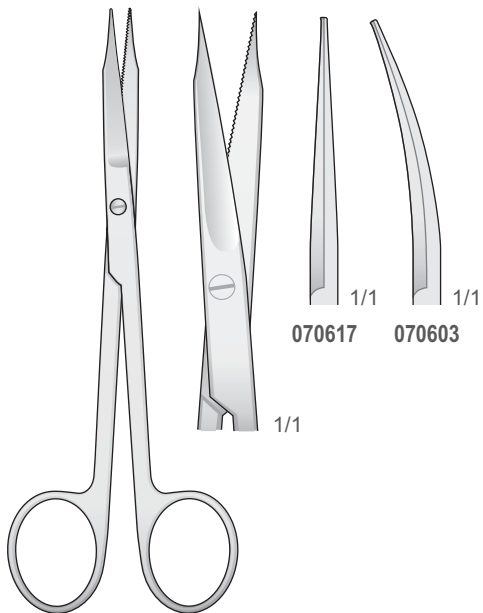

**070617**   **070603**

**GOLDMAN-FOX**  
**070617/070603**  
120 mm

Gezahnt - Serrated  
Dentellata - Dentadas  
Dentelé

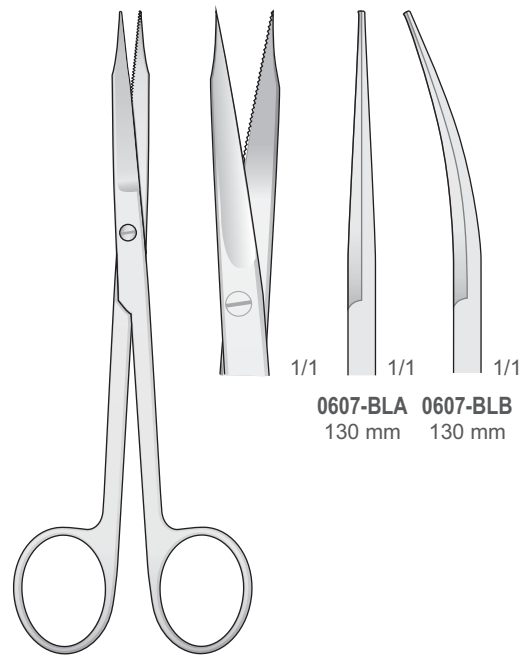

**0607-BLA**   **0607-BLB**  
130 mm   130 mm

**GOLDMAN-FOX**  
**0607-BLA/0607-BLB**  
130 mm



Gezahnt - Serrated  
Dentellata - Dentadas  
Dentelé

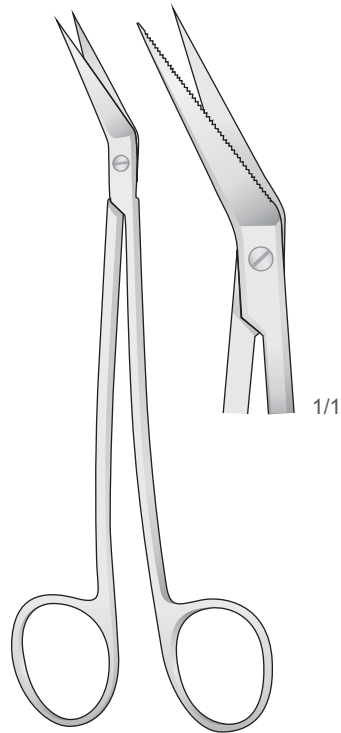

LOCKLIN  
1110-C  
160 mm

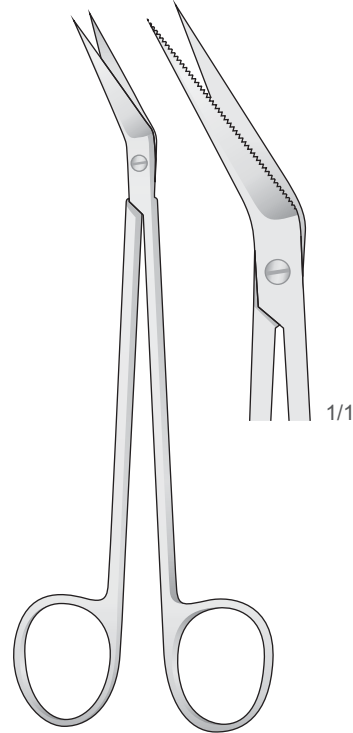

LOCKLIN  
1110-E  
160 mm

Gezahnt - Serrated  
Dentellata - Dentadas  
Dentelé

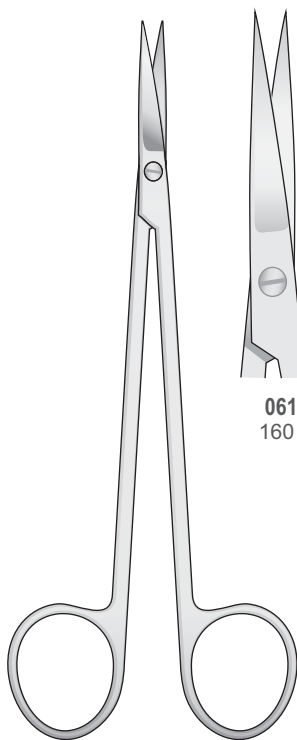

KELLY  
0610-B/0610-C  
160 mm

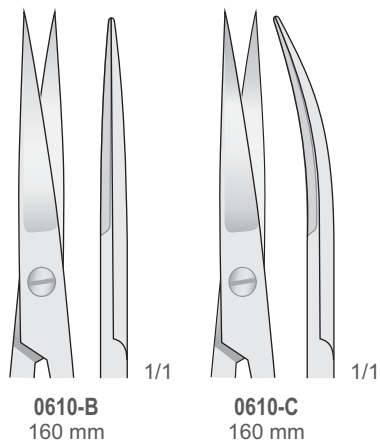

0610-B  
160 mm

0610-C  
160 mm

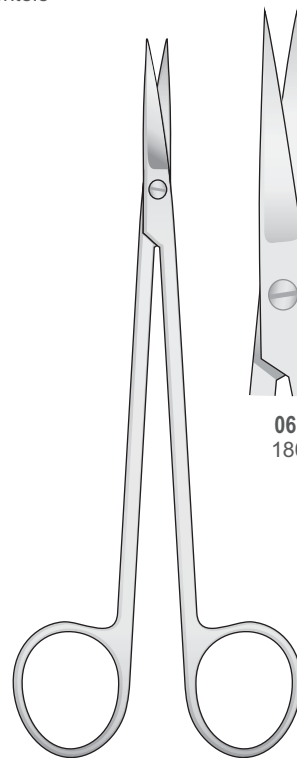

KELLY  
0610-IH/0610-II  
180 mm

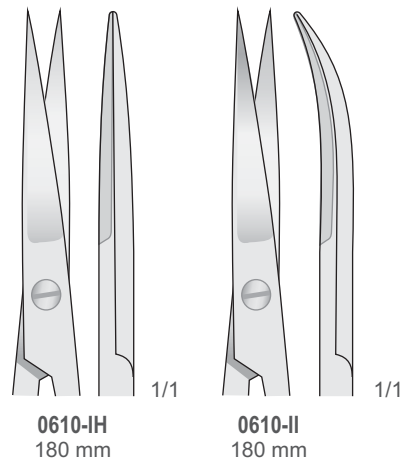

0610-IH  
180 mm

0610-II  
180 mm



Scheren  
Scissors  
Forbici  
Tijeras  
Ciseaux

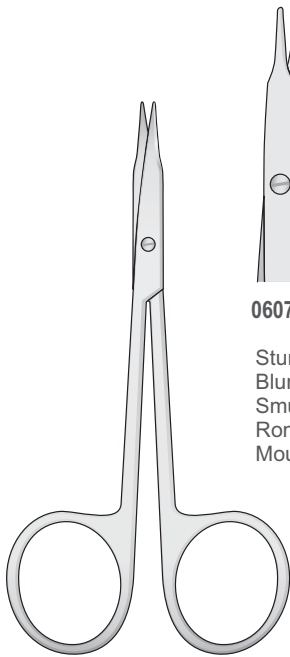

STEVENS  
0607-FA/0607-FD  
110 mm

1/1	1/1	1/1	1/1
<b>0607-FA</b>	<b>0607-FB</b>	<b>0607-FC</b>	<b>0607-FD</b>
Stumpf Blunt Smussa Romas Mousse	Gerade Straight Diritta Rectas Droites	Stumpf Blunt Smussa Romas Mousse	Gebogen Curved Curva Curvas Courbes
		Spitz Sharp Acuta Agudas Pointu	Gerade Straight Diritta Rectas Droites
			Spitz Sharp Acuta Agudas Pointu
			Gebogen Curved Curva Curvas Courbes

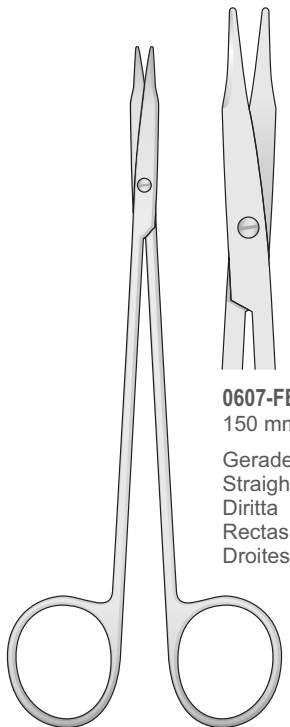

REYNOLDS  
0607-FE/0607-FF

1/1	1/1
<b>0607-FE</b>	<b>0607-FF</b>
Gerade Straight Diritta Rectas Droites	Gebogen Curved Curva Curvas Courbes

Stumpf  
Blunt  
Smussa  
Romas  
Mousse

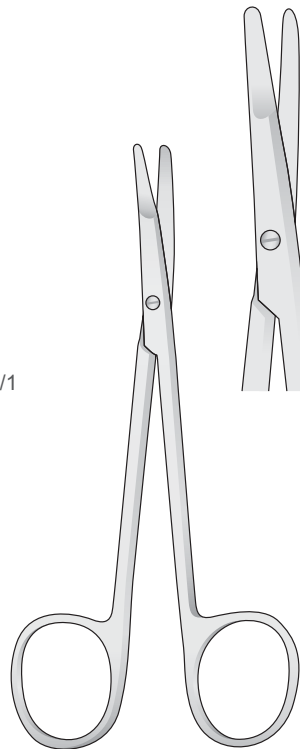

KILNER  
0607-BL03/0607-GH

1/1	1/1	1/1	1/1
<b>0607-GG</b>	<b>0607-GH</b>	<b>0607-BL/0607-BL03</b>	
Gerade Straight Diritta Rectas Droites	Gebogen Curved Curva Curvas Courbes	Gerade Straight Diritta Rectas Droites	Gebogen Curved Curva Curvas Courbes

Stumpf  
Blunt  
Smussa  
Romas  
Mousse



Gezahnt - Serrated  
Dentellata - Dentadas  
Dentelé

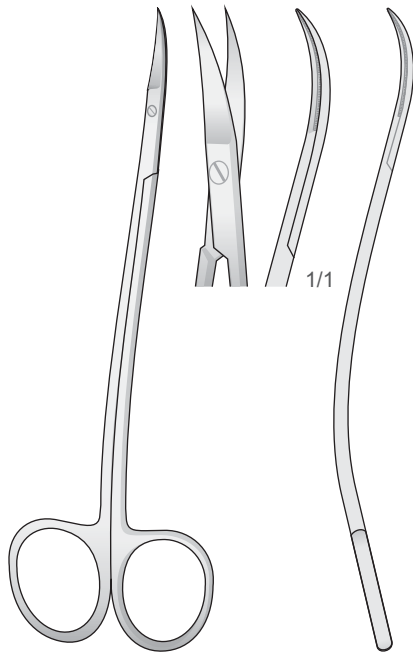

LA GRANGE  
1107-B  
115 mm

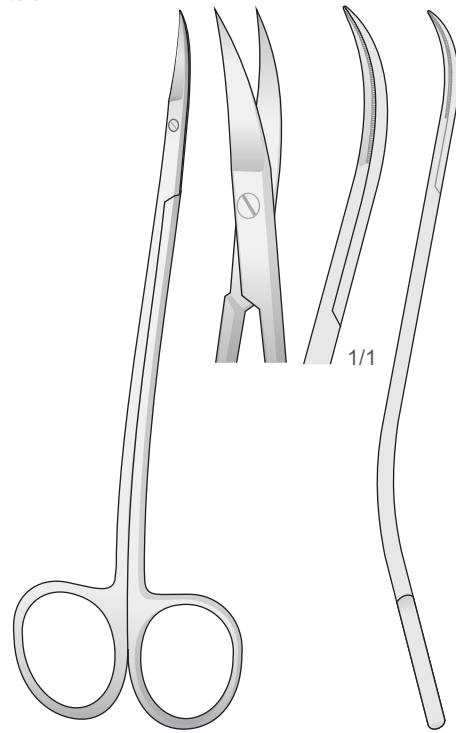

LA GRANGE  
1107-G  
155 mm

Gezahnt - Serrated  
Dentellata - Dentadas  
Dentelé

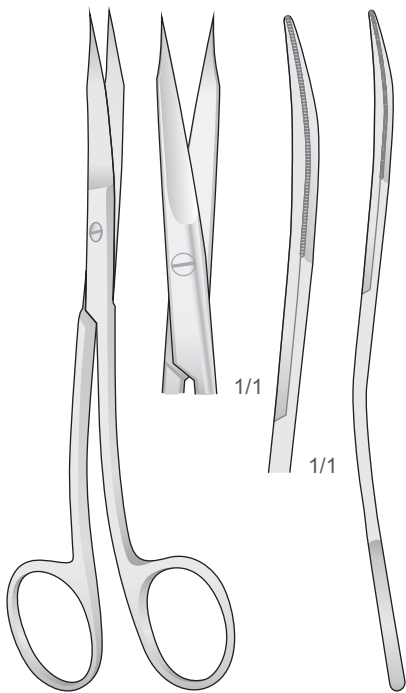

GOLDMAN-FOX S FORM  
070618  
130 mm

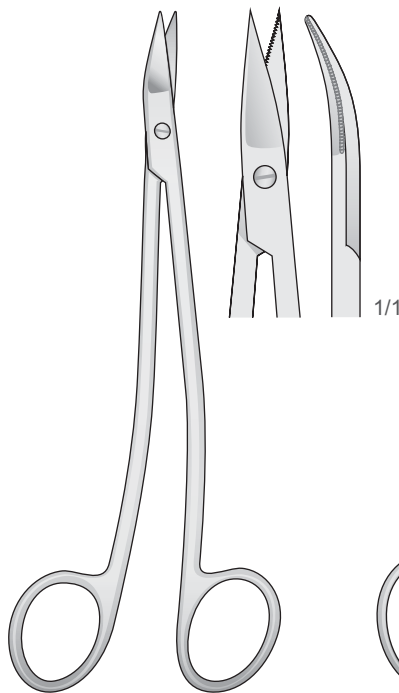

NEUMANN  
0607-CA  
130 mm

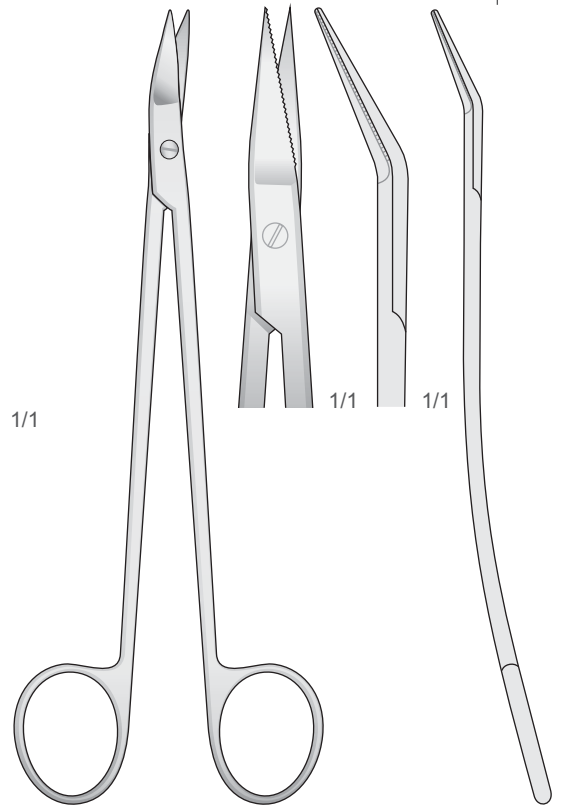

DEAN  
04050113  
180 mm





Scheren  
Scissors  
Forbici  
Tijeras  
Ciseaux

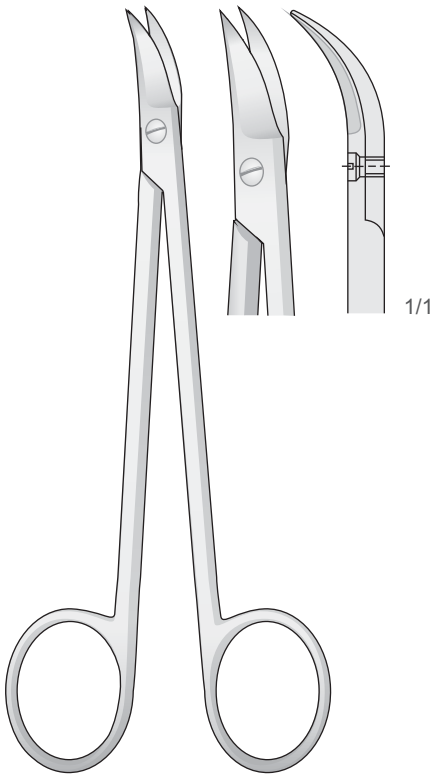

QUINBY  
0607-DI  
130 mm

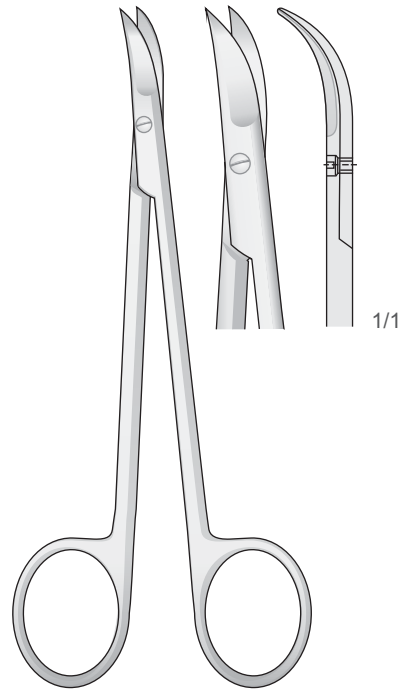

CHADWICK  
0607-DL  
115 mm

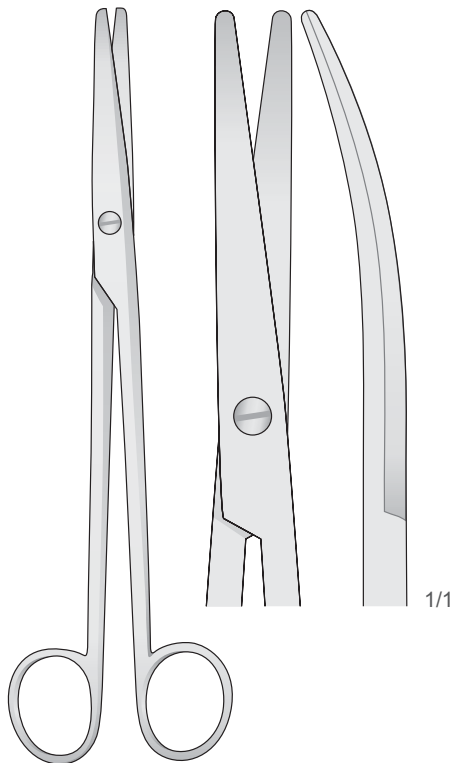

MAYO-LEXER  
0612-HL  
165 mm

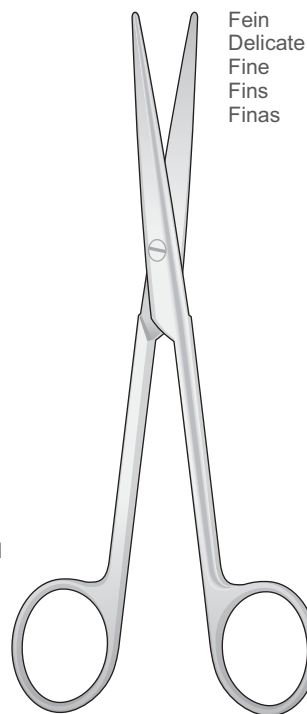

LEXER  
0612-BIA/0612-BIB  
165 mm

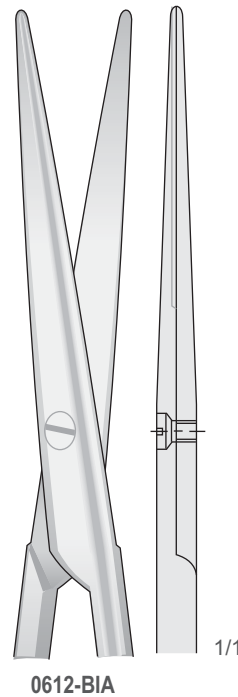

0612-BIA

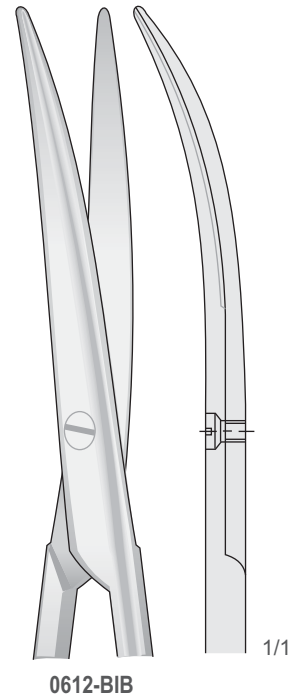

0612-BIB

Fein  
Delicate  
Fine  
Fins  
Finas



Stumpf  
Blunt  
Smusse  
Romas  
Mousses

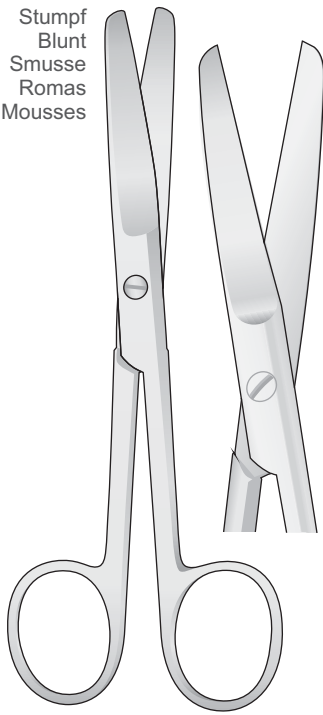

**0612-L** 145 mm  
**0612-BA** 145 mm

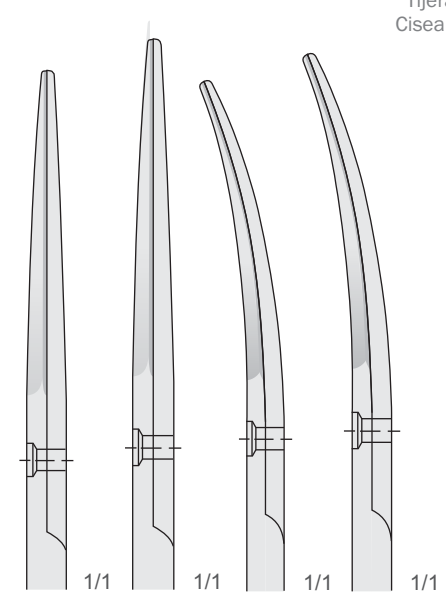
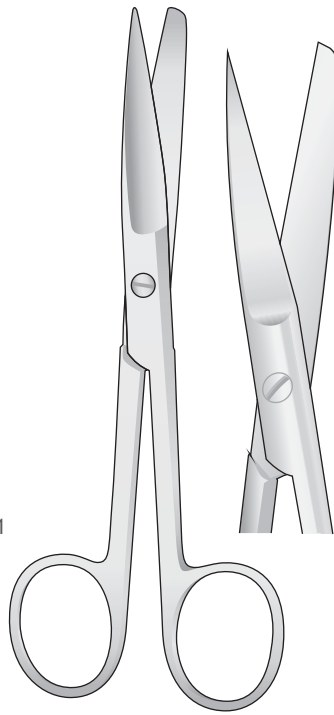

**0612-EL** 115 mm  
**0612-CH** 130 mm  
**0612-GD** 115 mm  
**0612-CI** 130 mm

**0612-L/0612-BA**  
145 mm

**0612-CH/0612-GD**

Stumpf  
Blunt  
Smusse  
Romas  
Mousses

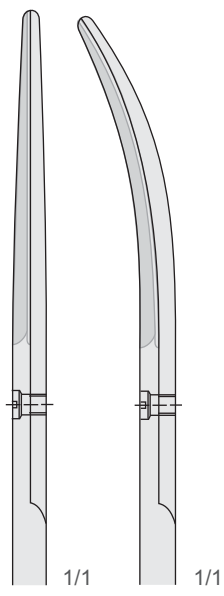
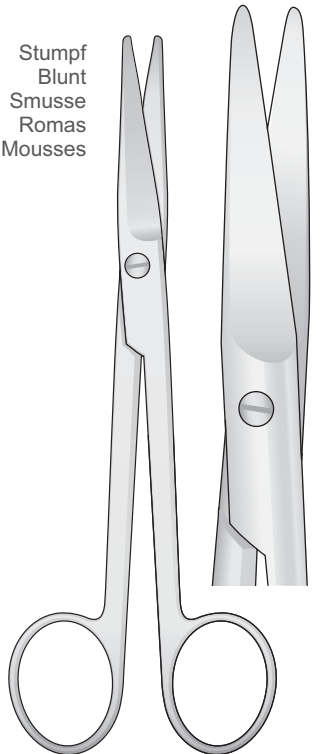

**0612-F** 140 mm  
**0612-G** 140 mm

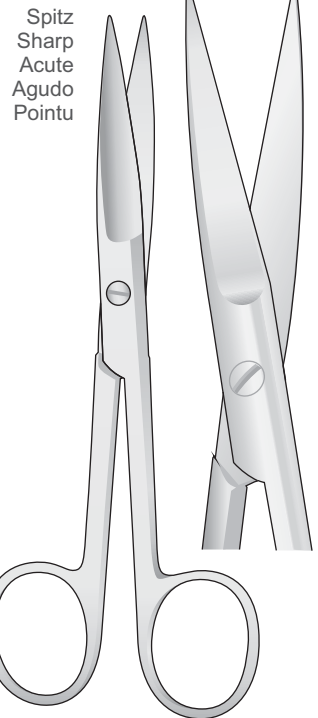

Spitz  
Sharp  
Acute  
Agudo  
Pointu

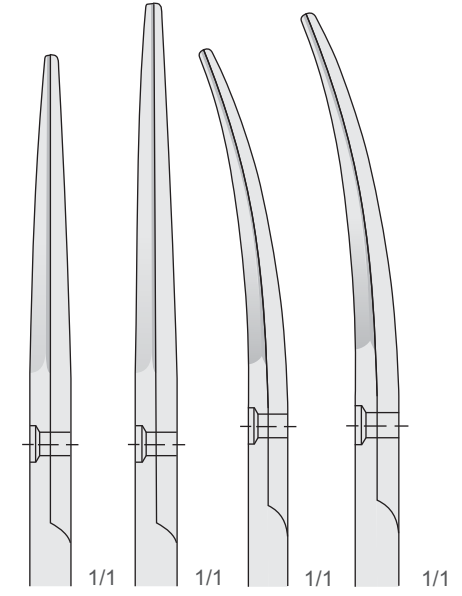

**0612-EB** 130 mm  
**0612-H** 145 mm  
**0612-EC** 130 mm  
**0612-I** 145 mm

MAYO  
**0612-F/0612-G**  
140 mm

**0612-H/0612-EC**



# SuperCut

Mit einer Schneide gezahnt  
With one blade serrated  
Con una lama dentellata  
Con una hoja dentada  
Avec une lame dentée

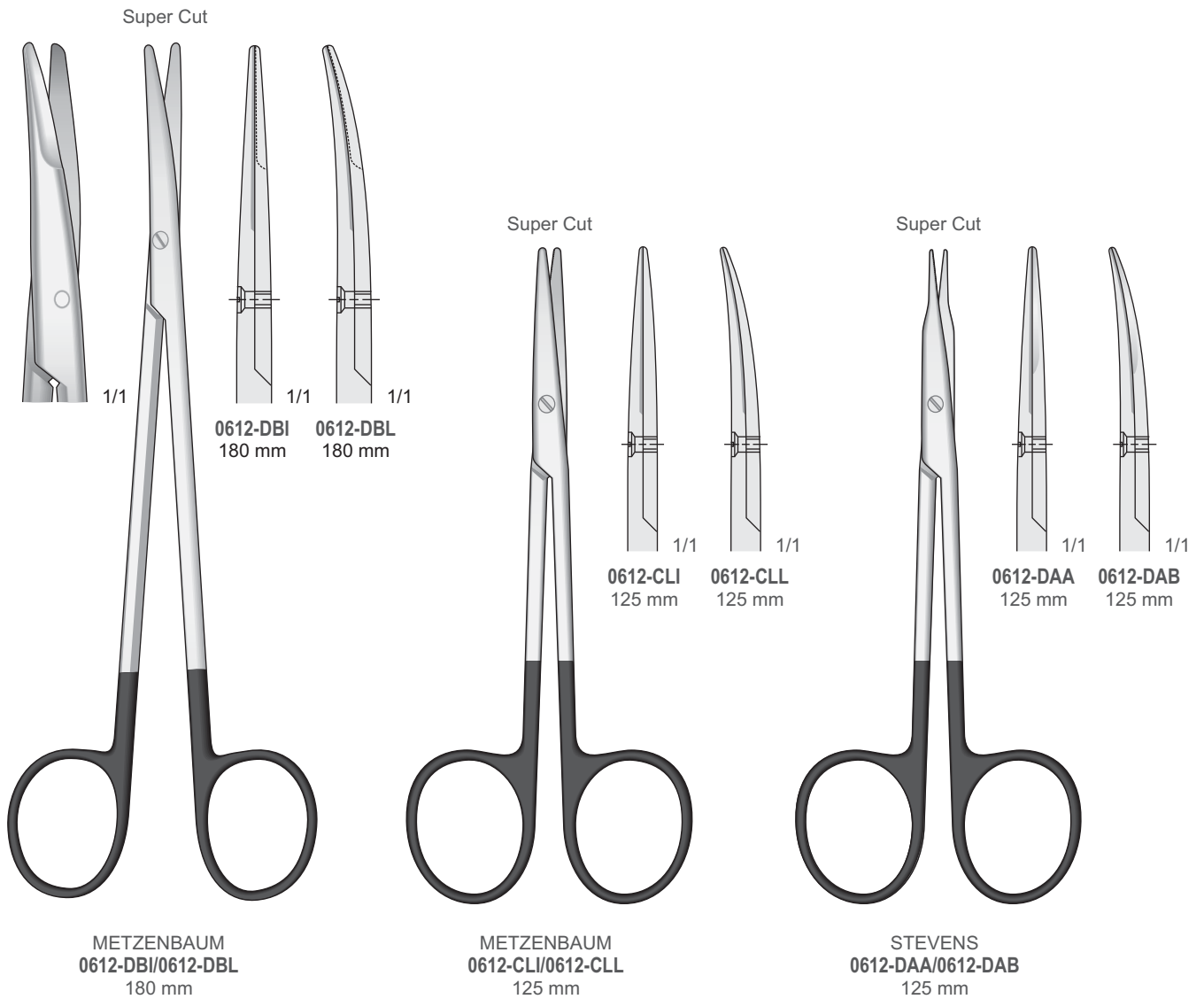



Scheren  
Scissors  
Forbici  
Tijeras  
Ciseaux

Fein  
Delicate  
Fine  
Finas  
Fins

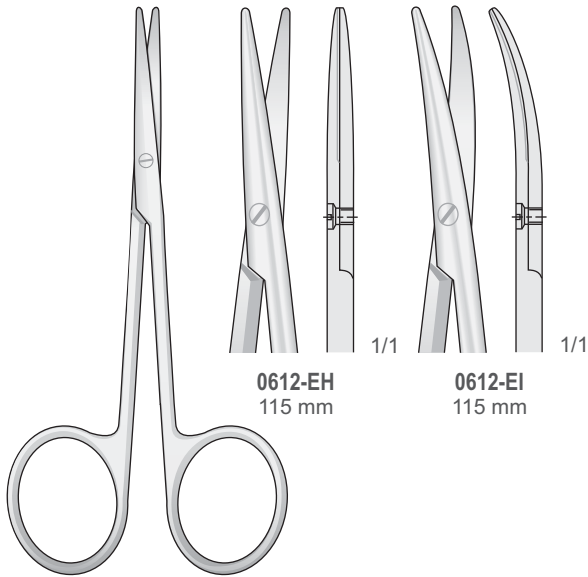

**0612-EH**  
115 mm

**0612-EI**  
115 mm

**BABY - METZENBAUM**  
**0612-EH/0612-EI**  
115 mm

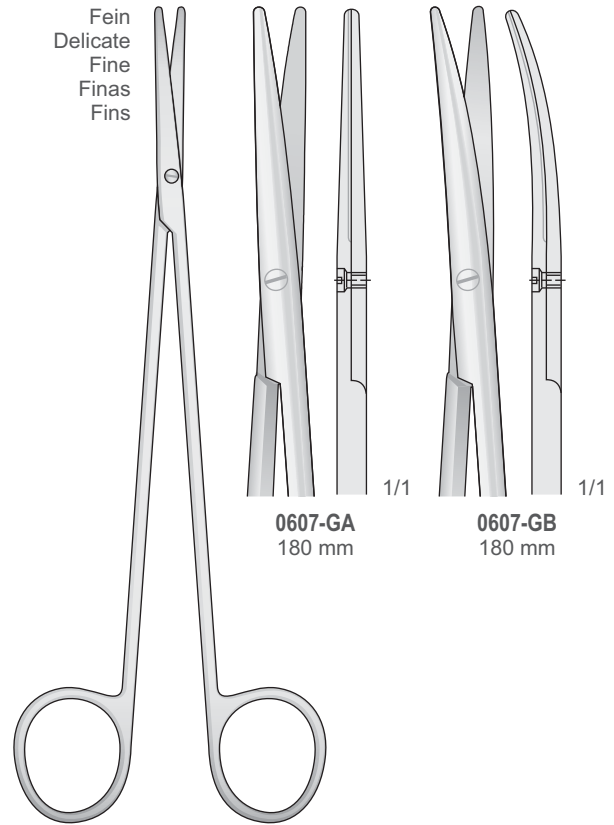

**0607-GA**  
180 mm

**0607-GB**  
180 mm

**TOENNIS-ADSON**  
**0607-GA/0607-GB**  
180 mm

Präparierscheren - Dissecting Scissors  
Forbici per dissezione - Tijeras para preparaciones - Ciseaux à dissection

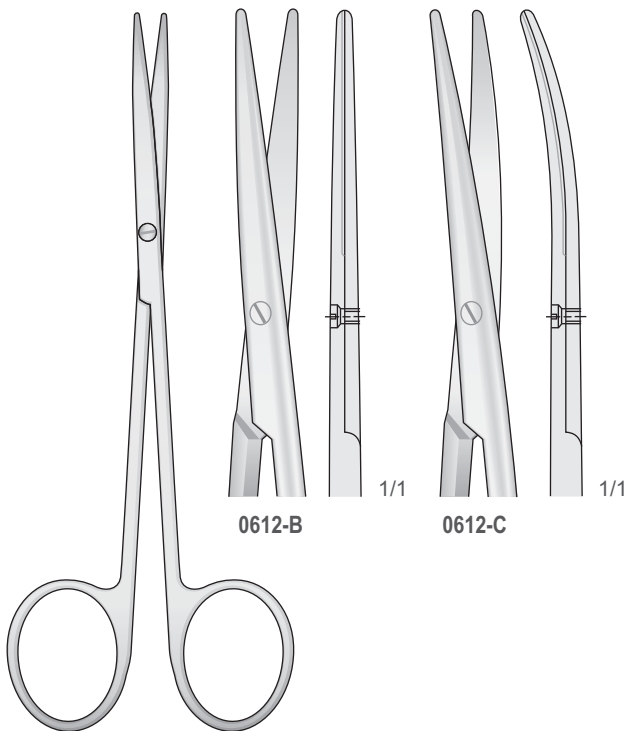

**0612-B**

**0612-C**

**METZENBAUM**  
**0612-B/0612-C**  
145 mm

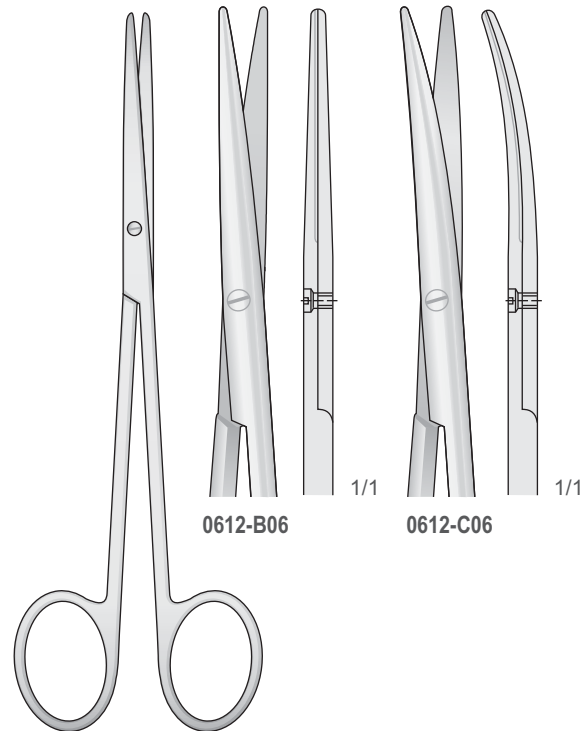

**0612-B06**

**0612-C06**

**METZENBAUM-FINO**  
**0612-B06/0612-C06**  
145 mm



Scheren  
Scissors  
Forbici  
Tijeras  
Ciseaux

Mit Hartmetalleinsätzen - Tungsten-carbide scissors  
Con punta al carburo di tungsteno - Tijeras de tungsteno - Avec plaquettes en carbure de tungstène

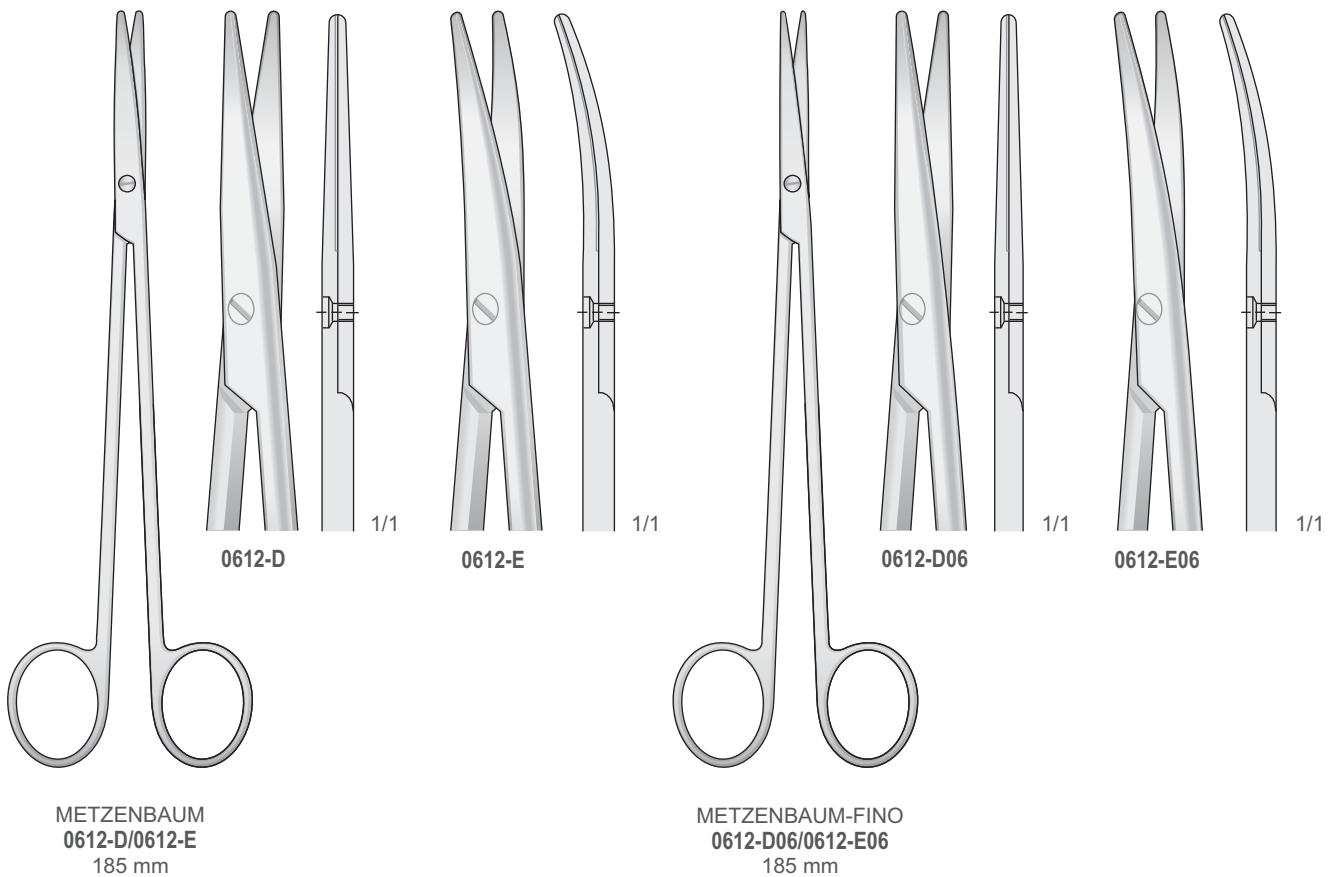
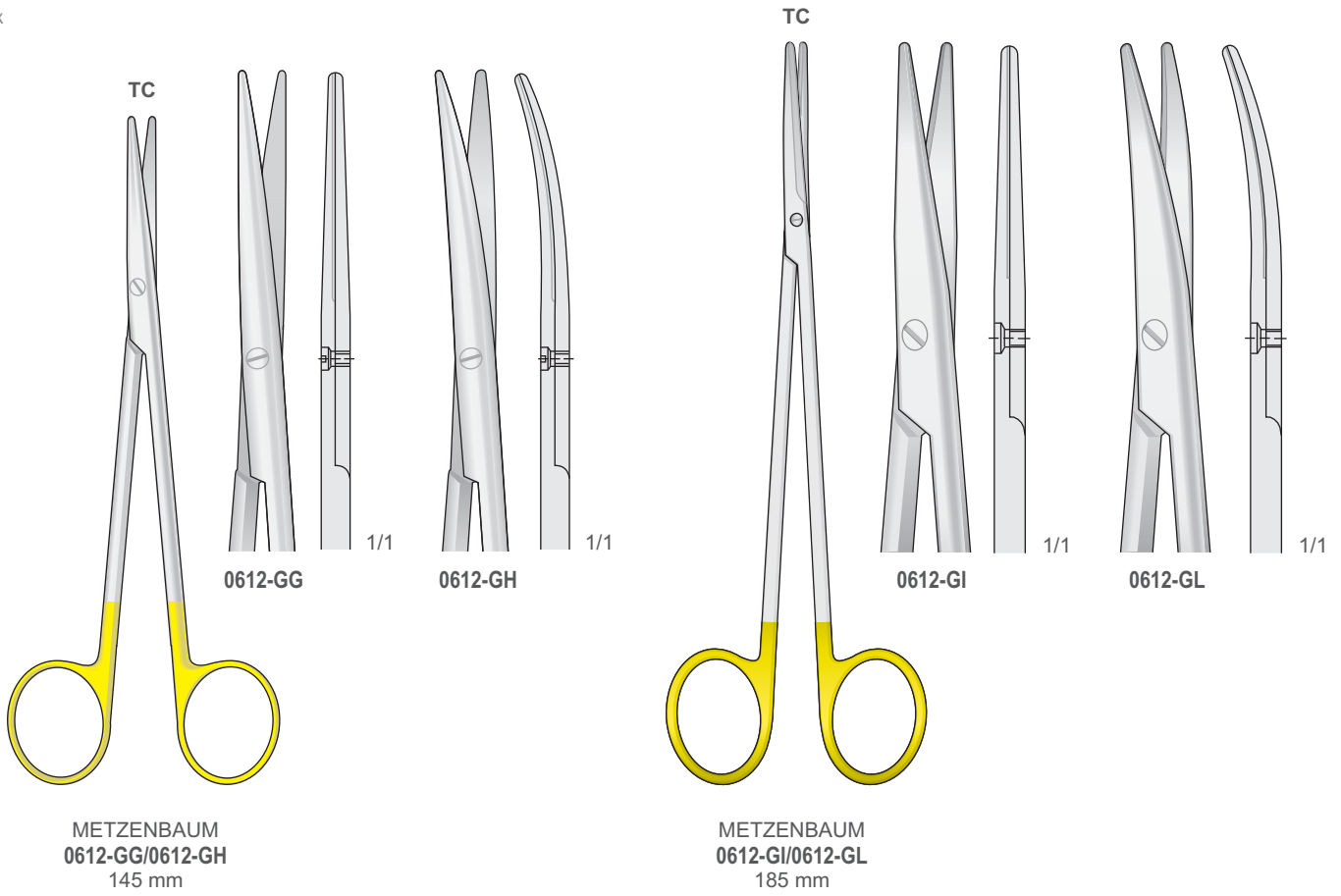



Mit Hartmetalleinsätzen - Tungsten-carbide scissors  
Con punta al carburo di tungsteno - Tijeras de tungsteno - Avec plaquettes en carbure de tungstène

TC

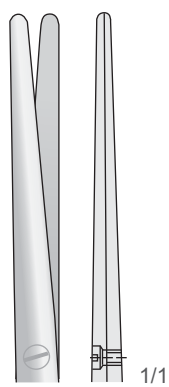
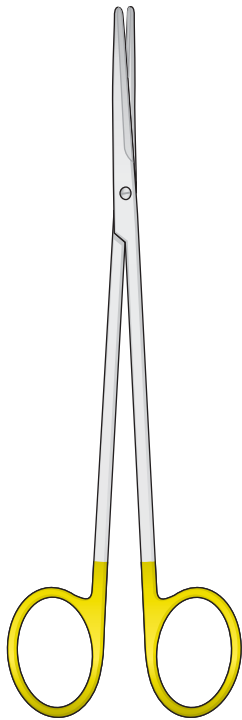

**0612-CAB**  
140 mm

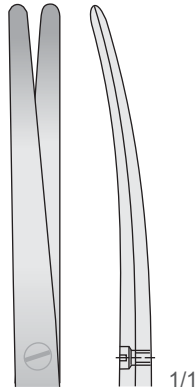

**0612-CAC**  
140 mm

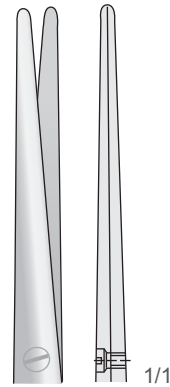

**0612-CAD**  
180 mm

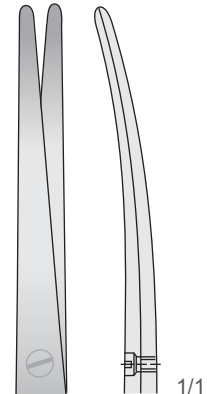

**0612-CAE**  
180 mm

METZENBAUM-FINO  
**0612-CAB/0612-CAE**

Mit Hartmetalleinsätzen - Tungsten-carbide scissors  
Con punta al carburo di tungsteno - Tijeras de tungsteno - Avec plaquettes en carbure de tungstène

TC

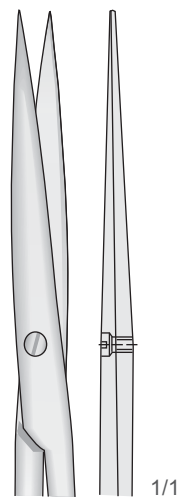
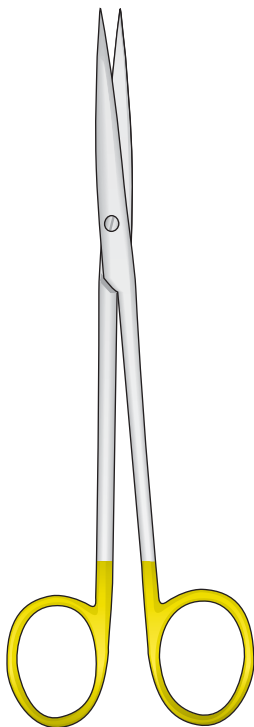

**0612-LG**  
140 mm

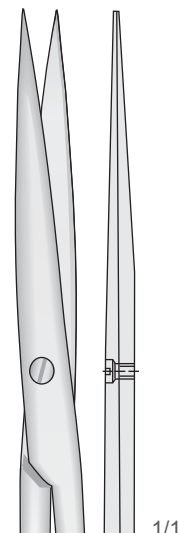

**0612-LH**  
180 mm

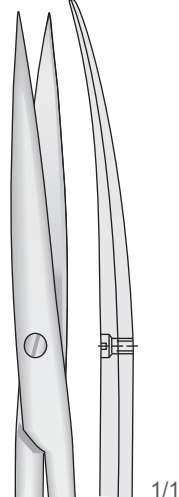

**0612-LI**  
140 mm

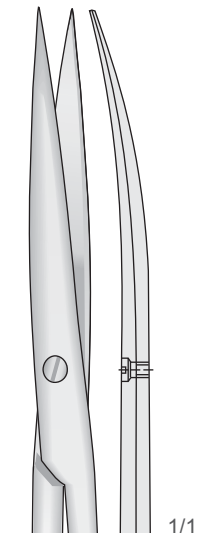

**0612-LL**  
180 mm

METZENBAUM-FINO  
**0612-LG/0612-LL**



Scheren  
Scissors  
Forbici  
Tijeras  
Ciseaux

Mit Hartmetalleinsätzen - Tungsten-carbide scissors  
Con punta al carburo di tungsteno - Tijeras de tungsteno - Avec plaquettes en carbure de tungstène

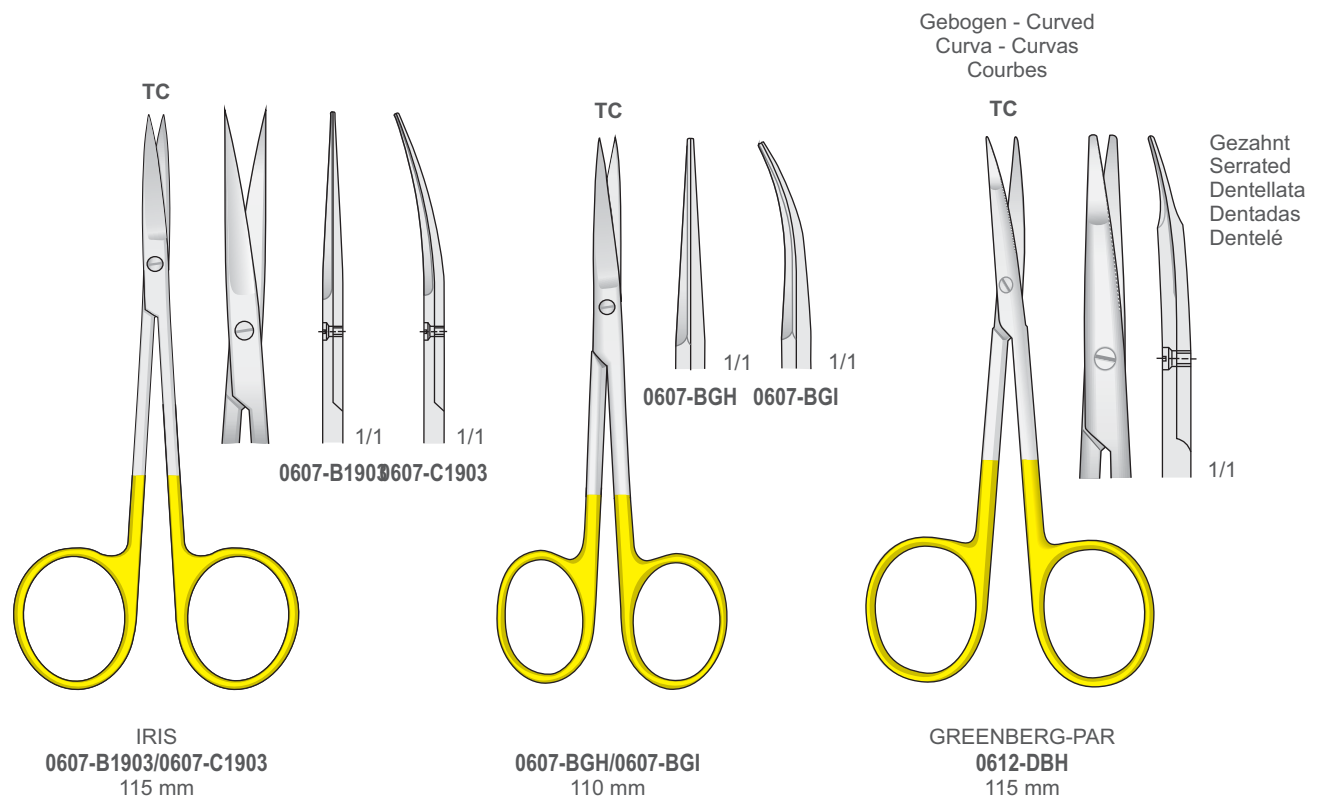
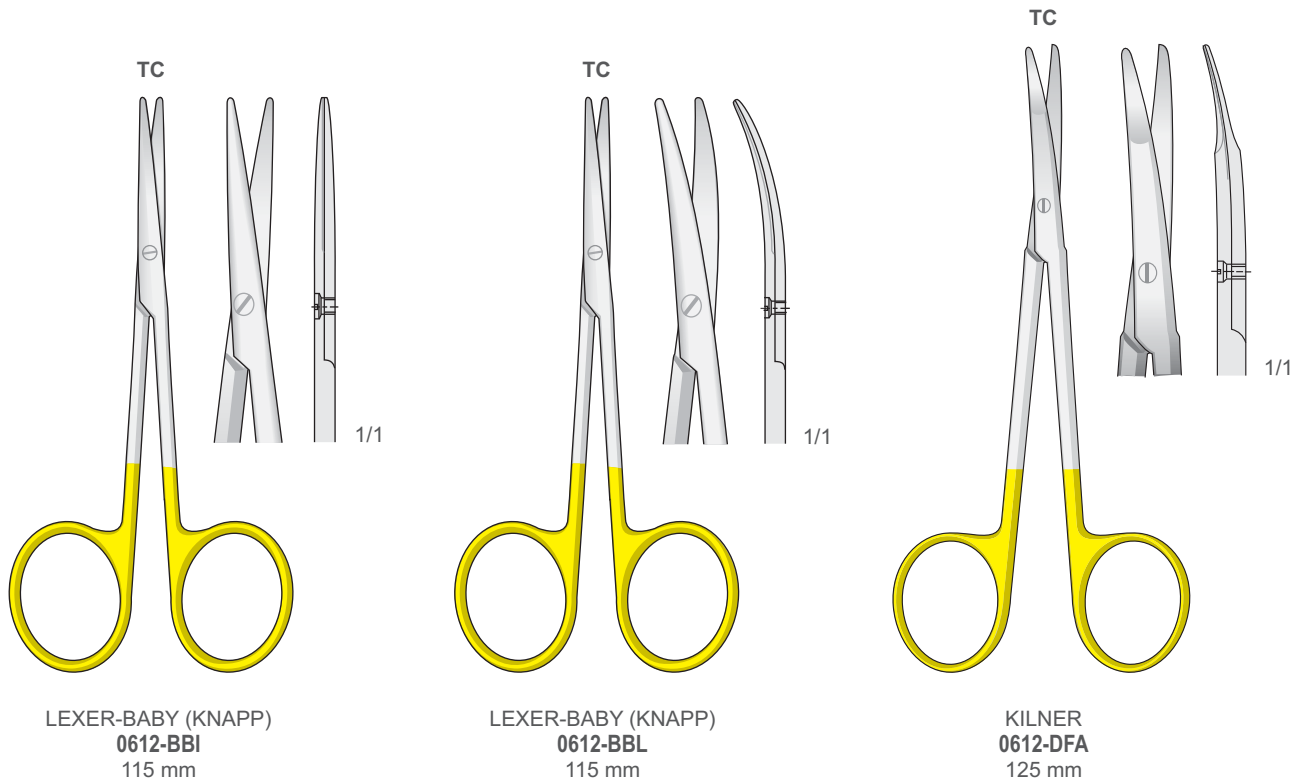

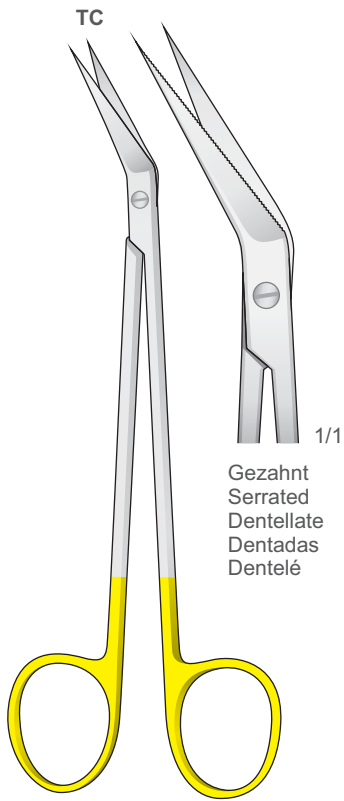

**1110-BA**  
160 mm

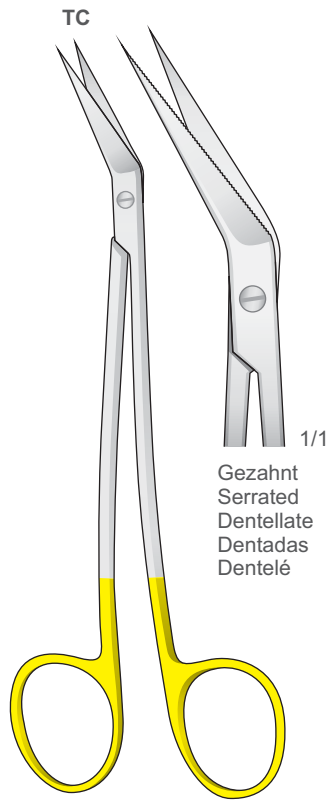

**1110-BC**  
160 mm

Mit Hartmetalleinsätzen  
Tungsten-carbide scissors  
Con punta al carburo di tungsteno  
Tijeras de tungsteno  
Avec plaquettes en carbure de tungstène

Gezahnt  
Serrated  
Dentellate  
Dentadas  
Dentelé

Gezahnt  
Serrated  
Dentellate  
Dentadas  
Dentelé

Eine Schneide gezahnt S-förmig gebogen  
One toothed cutting edge S-shaped  
Una lama dentata curva a forma S  
Una hoja dentada forma S  
Une lame dentelée courbés en S

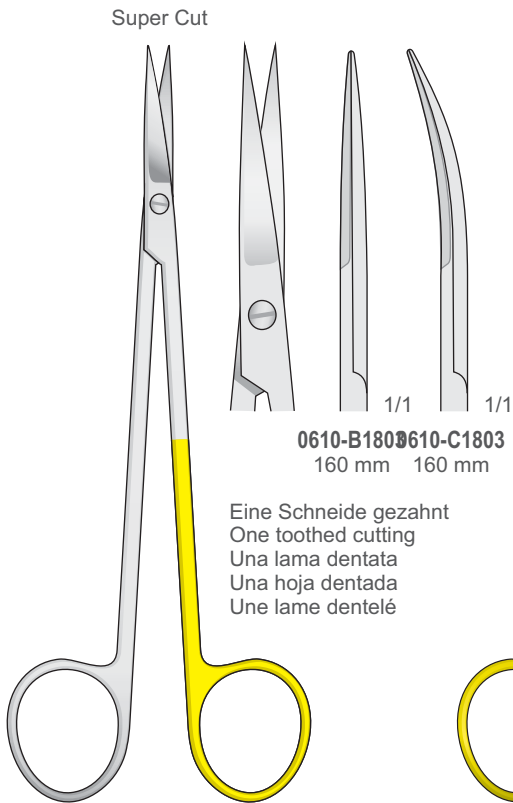

**KELLY**  
**0610-B1803/0610-C1803**  
160 mm

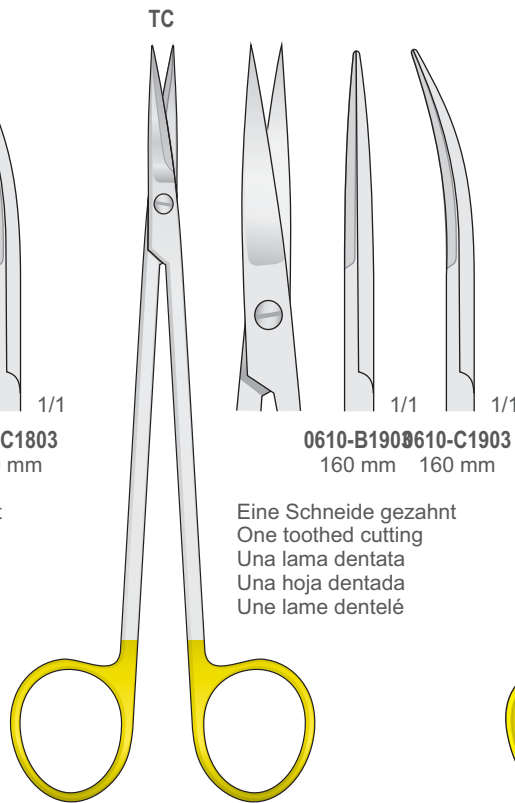

**KELLY**  
**0610-B1903/0610-C1903**  
160 mm

Eine Schneide gezahnt  
One toothed cutting  
Una lama dentata  
Una hoja dentada  
Une lame dentelé

Eine Schneide gezahnt  
One toothed cutting  
Una lama dentata  
Una hoja dentada  
Une lame dentelé

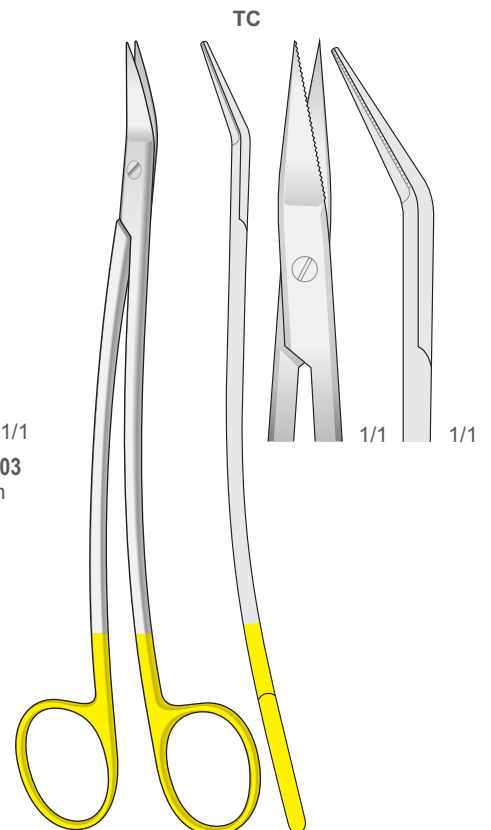

**04050113-1903**  
175 mm





Scheren  
Scissors  
Forbici  
Tijeras  
Ciseaux

Scheren mit wellenschliff auf einer Schnittfläche - Scissors cut one serrated cutting edge  
Forbici con taglio ondulato su una lama - Tijeras con onda afilados  
Ciseaux avec affutage spécial ont une lame dentée

Wellenschliff  
TC

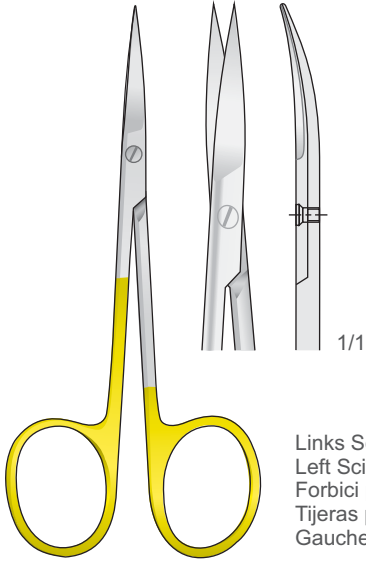

Links Scheren  
Left Scissors  
Forbici per mancini  
Tijeras para zurdos  
Gauche Ciseaux

IRIS  
0612-BAA11  
110 mm

Wellenschliff  
TC

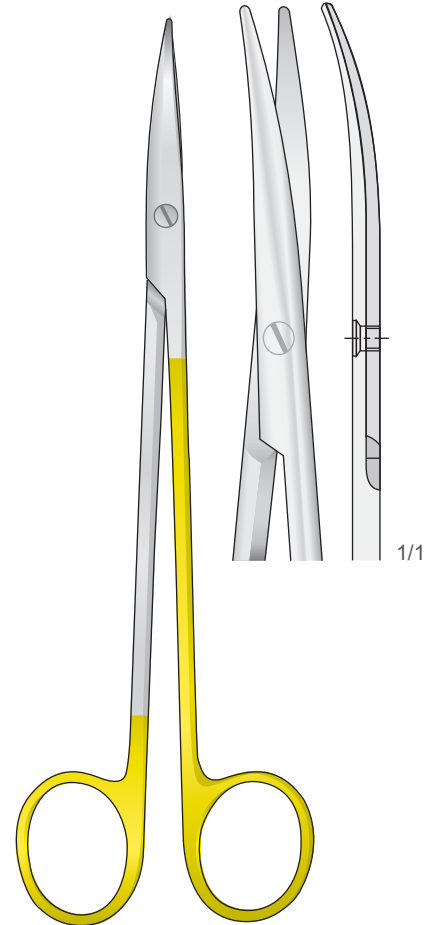

METZENBAUM  
0612-BAE  
185 mm

Wellenschliff  
TC

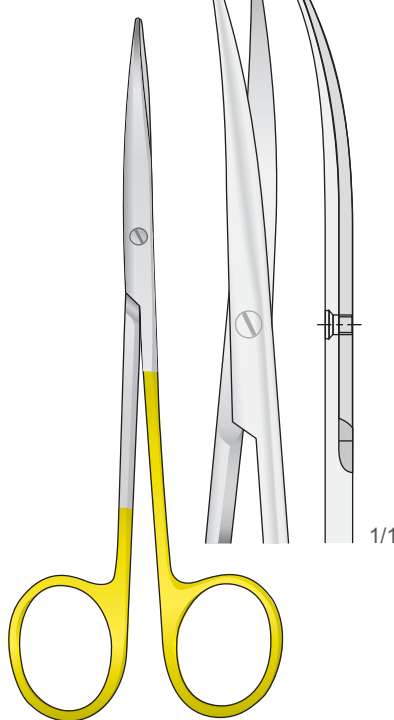

METZENBAUM  
0612-BAC  
145 mm

Wellenschliff  
TC

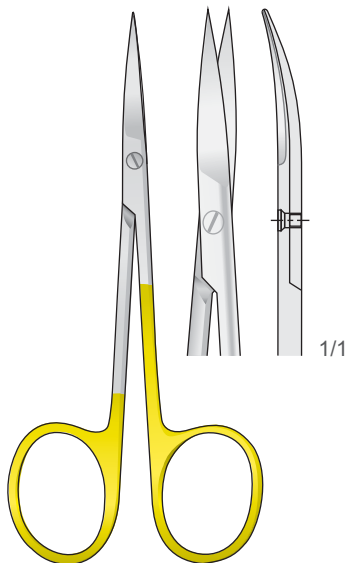

IRIS  
0612-BAA  
110 mm

“Super-cut” scheren micro-schliff für tissue atrauma  
 “Super-cut” scissors for gripping tissue and cutting interproximally  
 Forbici “Super-cut” estremamente taglienti per tessuti con riduzione del trauma  
 Tijeras “super cortes” para cortar tissue-atrauma  
 Ciseaux “super cut” coupe les tissus en reduisant les risques de traumatisme

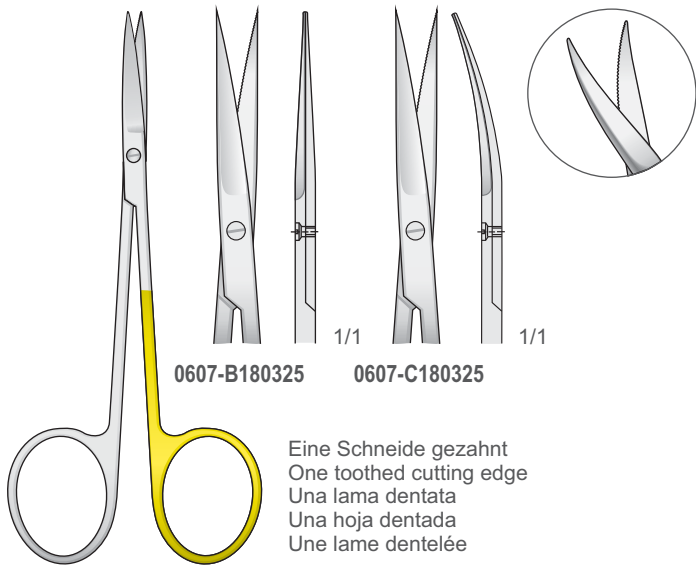

0607-B180325

0607-C180325

Eine Schneide gezahnt  
 One toothed cutting edge  
 Una lama dentata  
 Una hoja dentada  
 Une lame dentelée

0607-B180325/0607-C180325  
 110 mm

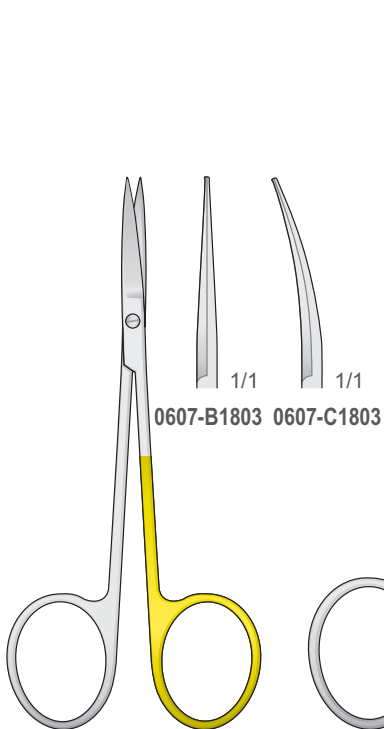

0607-B1803 0607-C1803

IRIS  
 0607-B1803/0607-C1803  
 110 mm

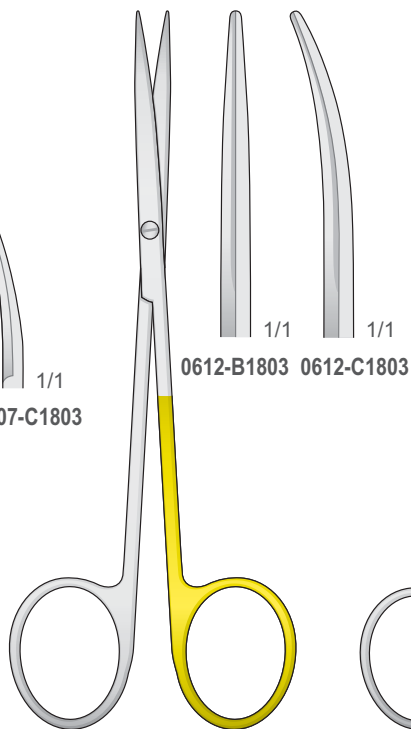

0612-B1803 0612-C1803

METZENBAUM  
 0612-B1803/0612-C1803  
 145 mm

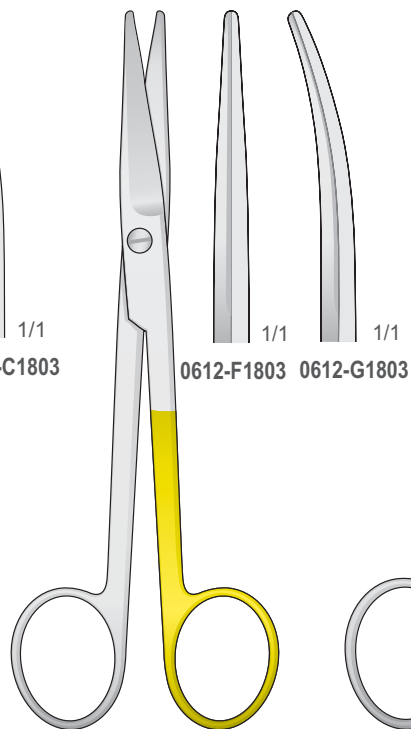

0612-F1803 0612-G1803

MAYO  
 0612-F1803/0612-G1803  
 140 mm

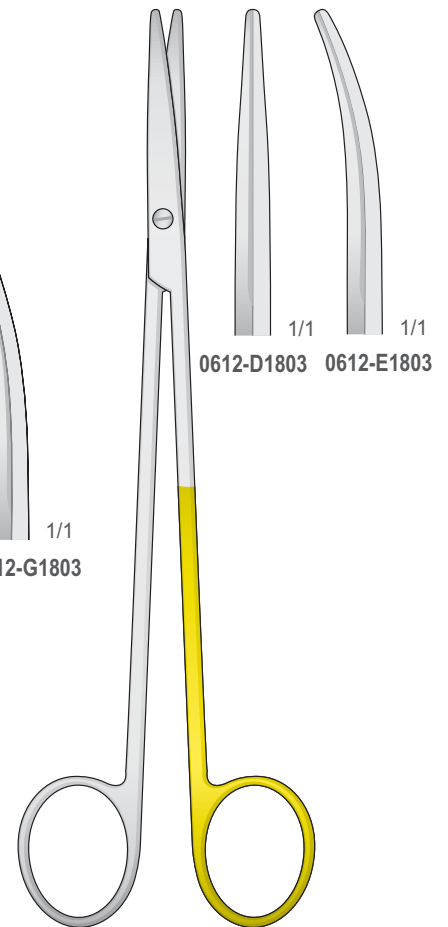

0612-D1803 0612-E1803

METZENBAUM  
 0612-D1803/0612-E1803  
 185 mm



Scheren  
Scissors  
Forbici  
Tijeras  
Ciseaux

"Super-cut" scheren micro-schliff für tissue atrauma  
 "Super-cut" scissors for gripping tissue and cutting interproximally  
 Forbici "super-cut" estremamente taglienti per tessuti con riduzione del trauma  
 Tijeras "super cortes" para cortar tissue-atrauma  
 Ciseaux "Super Cut" avec aiguisement spécial

Gezahnt - Serrated  
Dentellate - Dentada  
Dentelé

Spitz  
Sharp  
Acute  
Agudas  
Pointu

Stumpf  
Blunt  
Smusse  
Romas  
Mousse

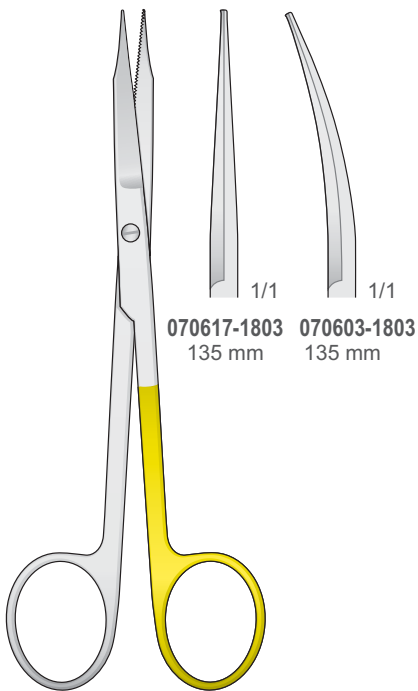

GOLDMAN-FOX  
070617-1803/070603-1803  
135 mm

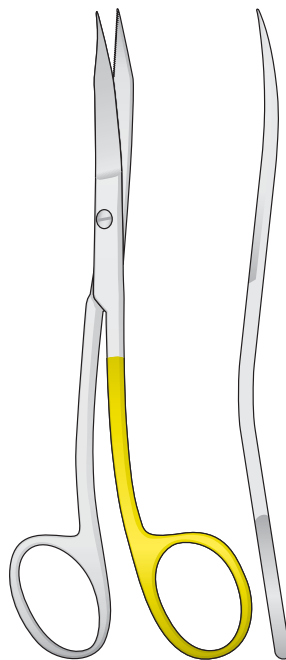

GOLDMAN-FOX S FORM  
070618-1803  
130 mm

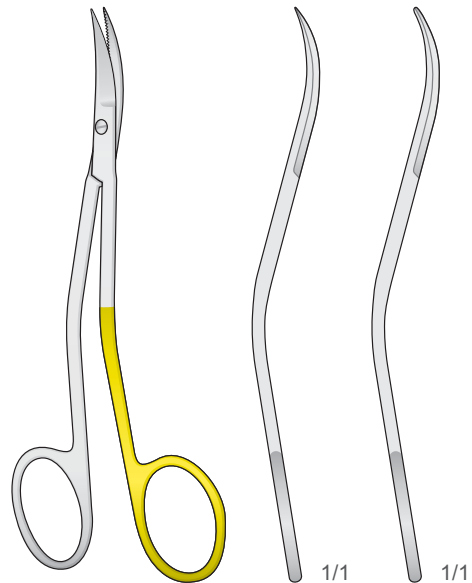

LA GRANGE LA GRANGE LA GRANGE  
1107-B1803/1107-C1803 1107-B1803 1107-C1803  
115 mm

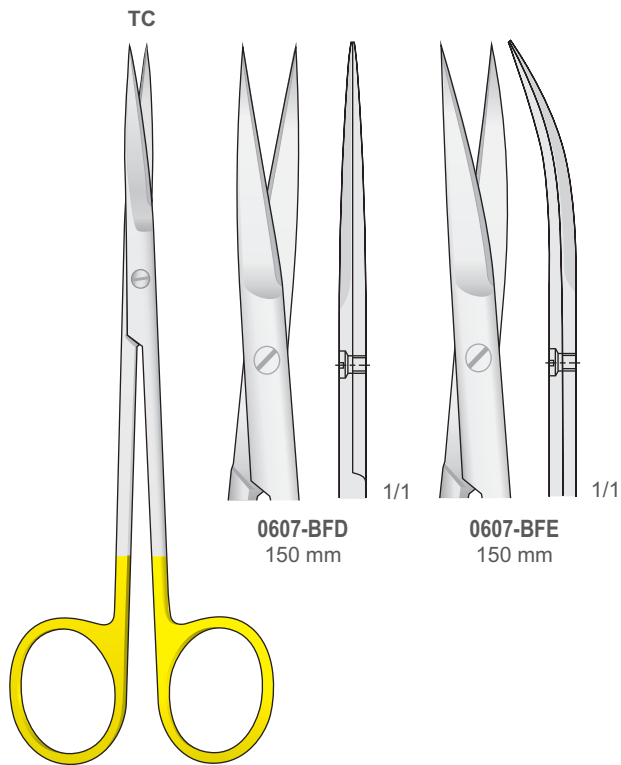

**0607-BFD**  
150 mm

**0607-BFE**  
150 mm

Mit Hartmetalleinsätzen  
Tungsten-carbide scissors  
Con punta al carburo di tungsteno  
Tijeras de tungsteno  
Avec plaquettes en carbure de tungstène

**JOSEPH**  
**0607-BFD/0607-BFE**  
150 mm

Gezahnt - Serrated  
Dentellate - Dentadas  
Dentelé

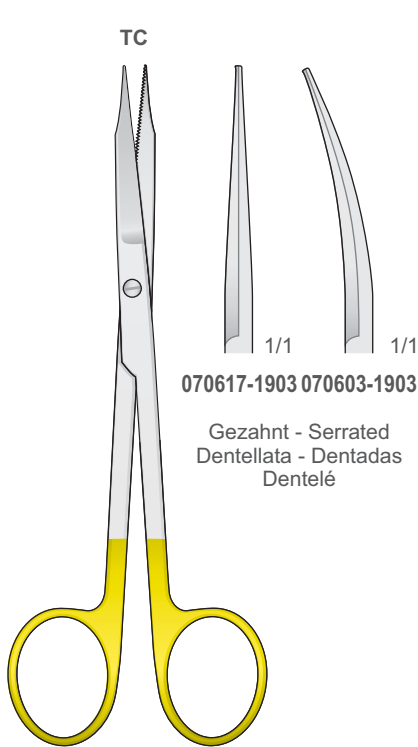

**070617-1903 070603-1903**

Gezahnt - Serrated  
Dentellate - Dentadas  
Dentelé

**GOLDMAN-FOX**  
**070603-1903/070617-1903**  
135 mm

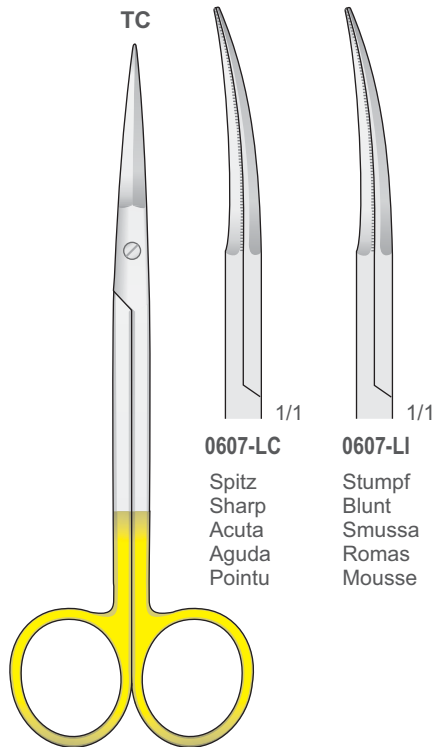

**0607-LC**  
Spitz  
Sharp  
Acuta  
Aguda  
Pointu

**0607-LI**  
Stumpf  
Blunt  
Smussa  
Romas  
Mousse

**PECK-JOSEPH**  
**0607-LC/0607-LI**  
140 mm

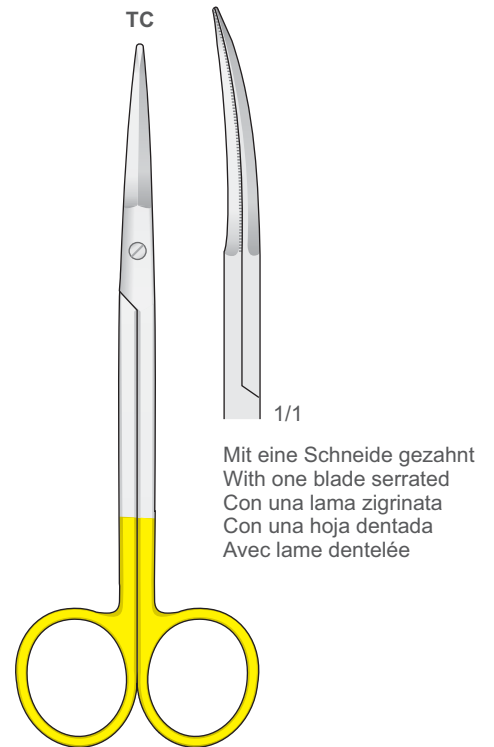

Mit eine Schneide gezahnt  
With one blade serrated  
Con una lama zigrinata  
Con una hoja dentada  
Avec lame dentelée

**GREGORY**  
**0612-DDL**  
140 mm



Scheren  
Scissors  
Forbici  
Tijeras  
Ciseaux

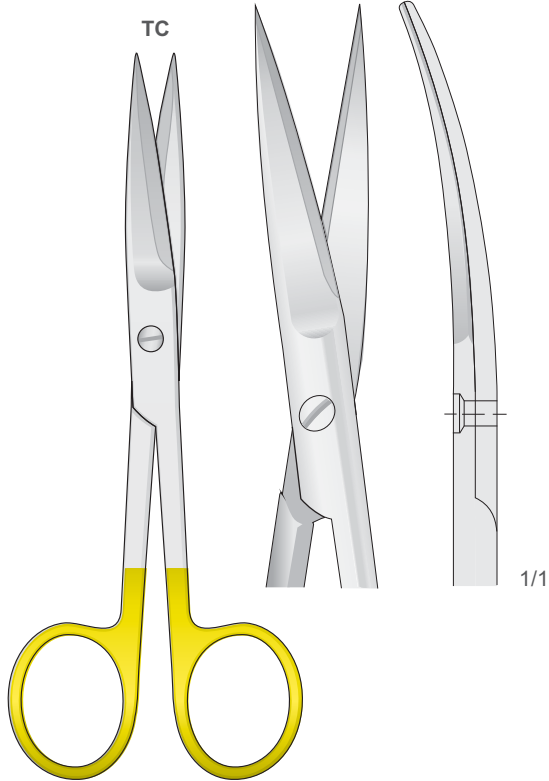

Mit Hartmetalleinsätzen  
Tungsten-carbide scissors  
Con punta al carburo di tungsteno  
Tijeras de tungsteno  
Avec plaquettes en carbure de tungstène

**0612-BEG**  
145 mm

Draht- und Blehschere gezahnt  
Wire cutting scissor serrated  
Forbice universale dentellata  
Tijeras para cortar hilo de acero dentadas  
Coupe-fils dentelés

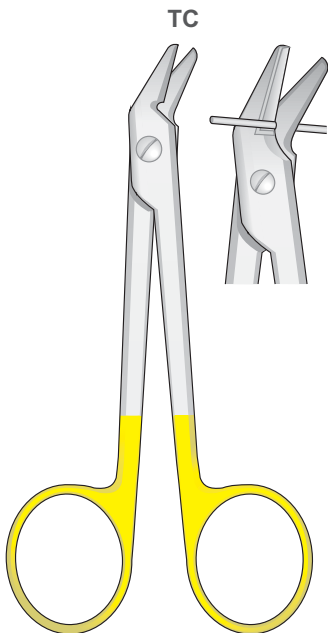

**0415-BCA**  
120 mm

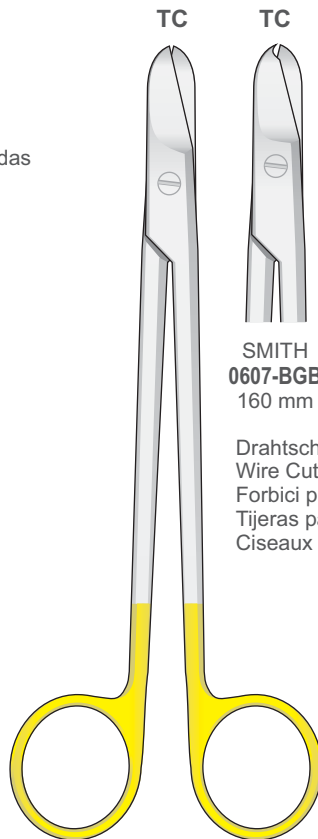

**SMITH  
0607-BGA**  
160 mm

**SMITH  
0607-BGB**  
160 mm

Drahtschere  
Wire Cutting Scissors  
Forbici per fili  
Tijeras para Alambre  
Ciseaux à fils

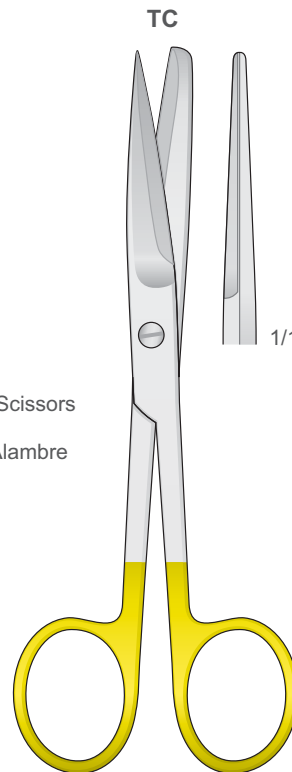

**0612-FB**  
145 mm

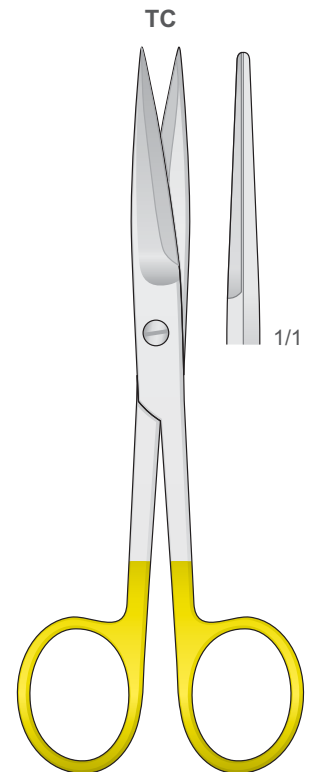

**0612-FL**  
145 mm



Ligatur Scheren  
Ligature Scissors  
Forbici per legature  
Tijeras para ligaduras  
Ciseaux à ligatures

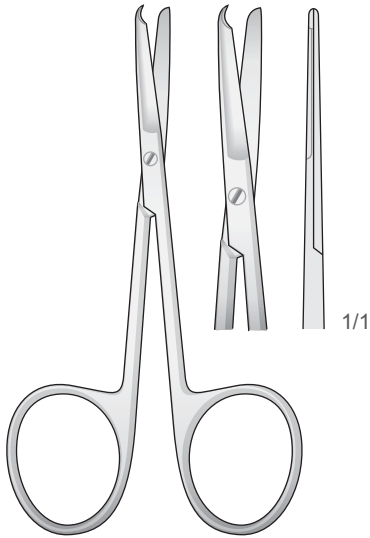

SPENCER  
1803-L  
90 mm

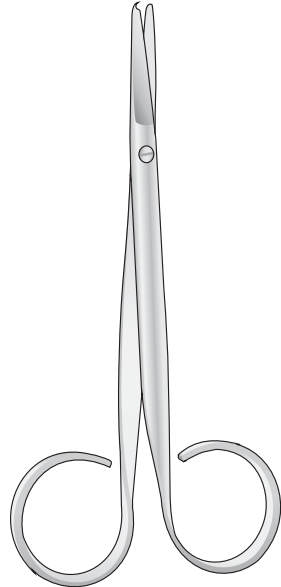

SPENCER  
1803-B  
110 mm

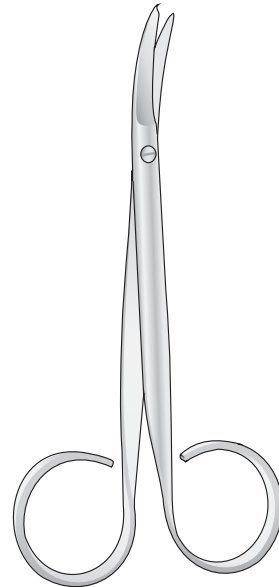

SPENCER  
1803-F  
110 mm

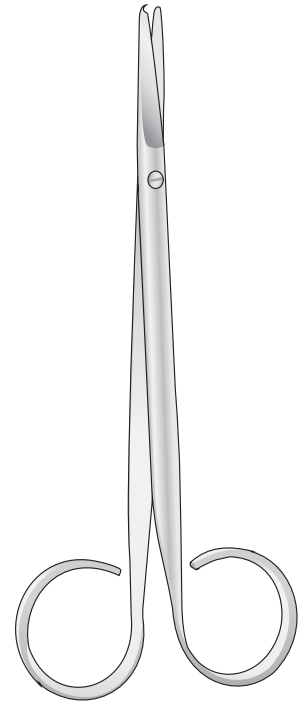

SPENCER  
1803-C  
145 mm

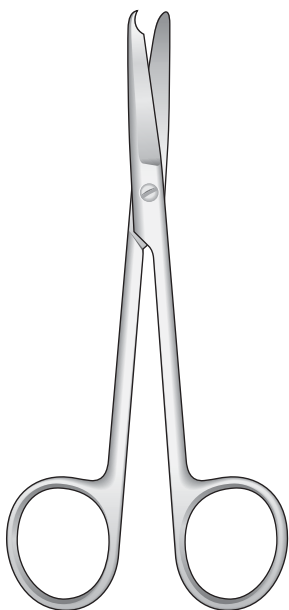

SPENCER  
1803-BE  
120 mm

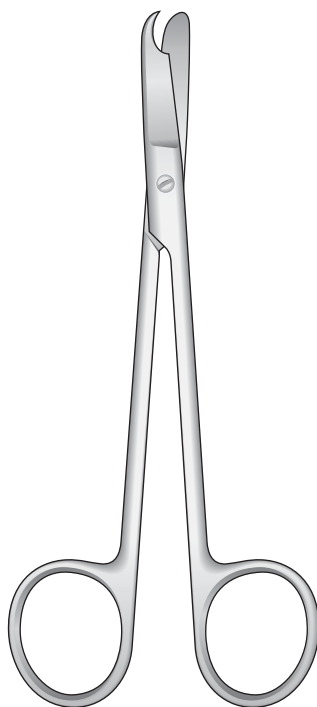

LITTAUER  
1803-BF  
140 mm

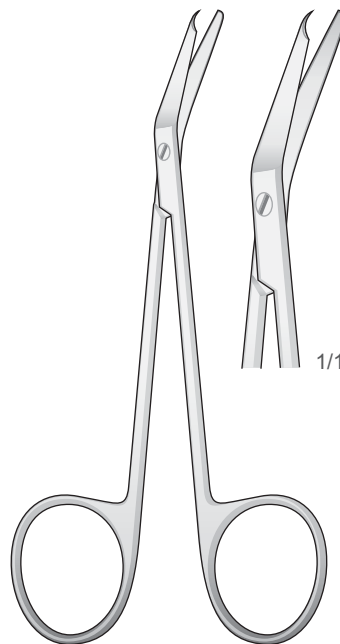

SPENCER  
1803-BD  
130 mm

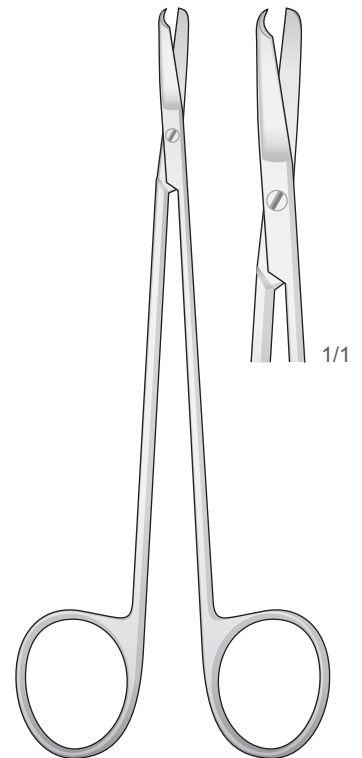

KELLY  
1803-BG  
150 mm



Draht und blechscheren  
 Wire and plate cutting scissors  
 Forbici per fili metallici  
 Tijeras para cortar alambre  
 Ciseaux coupe-fils métalliques

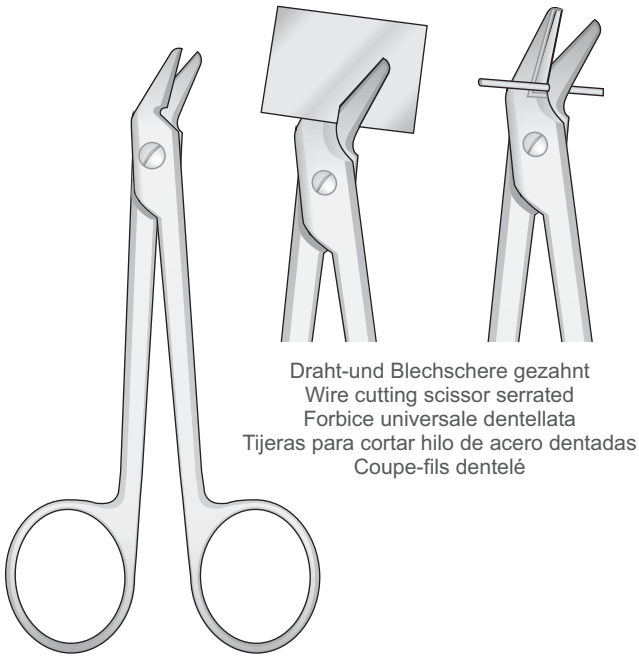

Draht-und Blechscherre gezahnt  
 Wire cutting scissor serrated  
 Forbice universale dentellata  
 Tijeras para cortar hilo de acero dentadas  
 Coupe-fils dentelé

**0415-LA**  
 120 mm

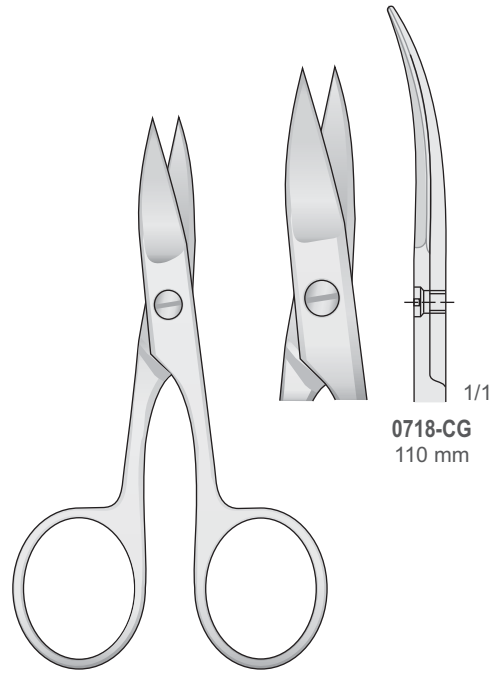

**0718-CG**  
 110 mm

**0718-CG**  
 110 mm

Spitz  
 Sharp  
 Acute  
 Agudas  
 Pointu



**0415-LB** 1/1    **0415-BAB** 1/1    **0415-LC** 1/1

**BEEBE**  
**0415-LB/0415-BAB**  
 110 mm

Stumpf  
 Blunt  
 Smusse  
 Romas  
 Mousse



**0415-BAC** 1/1    **0415-BAD** 1/1    **0415-BAE** 1/1    **0415-BAF** 1/1

**BEEBE**  
**0415-BAC/0415-BAF**  
 110 mm





.5

Pinzetten  
Tissue Pliers  
Pinzette  
Pinzas  
Pinces

Zahnärztliche Chirurgie  
Dental surgery  
Chirurgia dentale  
Cirugia dental  
Chirurgie dentaire







Mikro Pinzetten  
Delicate Forceps  
Micro Pinzette  
Pinzas finas  
Micro Pincas

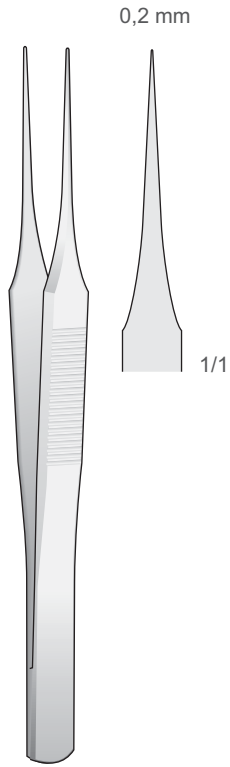

**0204-DGA**  
110 mm

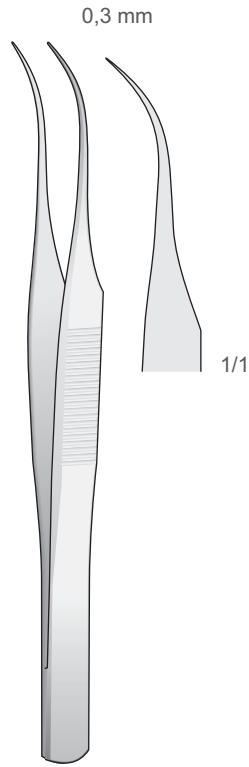

**0204-DGB**  
110 mm

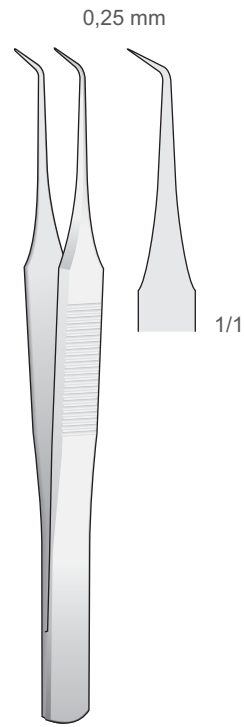

**0204-DGC**  
100 mm

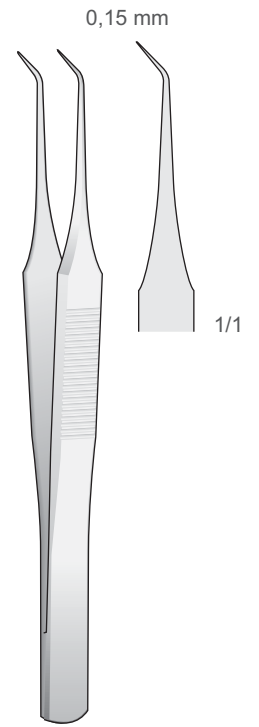

**0204-DGD**  
100 mm

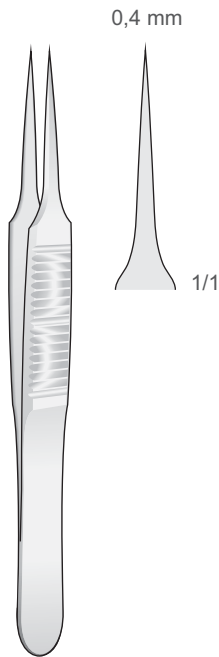

**0204-DGE**  
110 mm

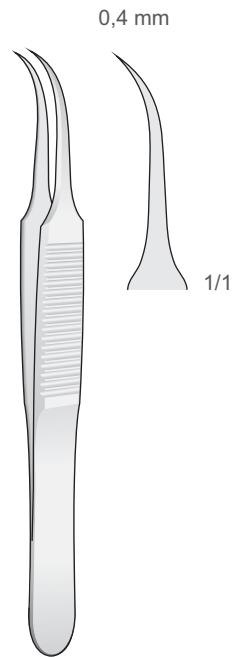

**0204-DGF**  
110 mm

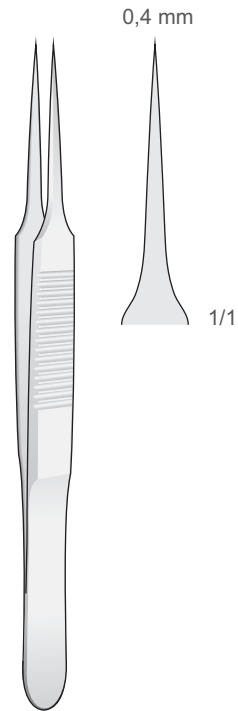

**0204-DGG**  
130 mm

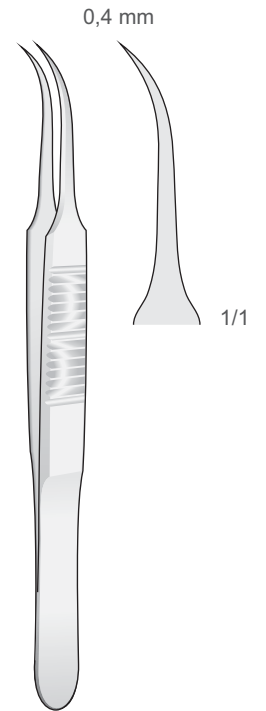

**0204-DGH**  
130 mm

Mikro diamantiertes Maul  
Micro Diamond Jaw  
Micro punta diamantata  
Micro boca diamantada  
Micro mors diamanté

Tissue Forceps  
1x2 Teeth

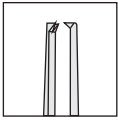

**BISHOP-HARMON**  
**1206-BHH** 1,2 mm  
85 mm

Dressing Forceps  
criss-cross serrated tips

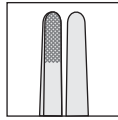

**BISHOP-HARMON**  
**1206-CEL** 1,2 mm  
85 mm



1/1  
1x2 Zähne  
1x2 Teeth  
1x2 Denti  
1x2 Dientes  
1x2 Dents



**CASTROVIEJO**  
**0204-DEI** 0,9 mm  
120 mm

1/1  
9x9 Zähne  
9x9 Teeth  
9x9 Denti  
9x9 Dientes  
9x9 Dents



**BROWN**  
**0204-DEL**  
120 mm

1,2 mm

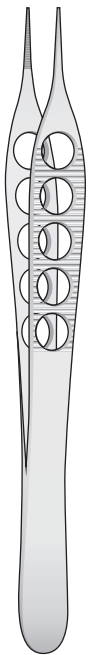

**ADSON**  
**0204-CAH**  
120 mm

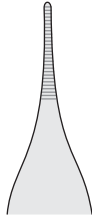

1/1

1,2 mm

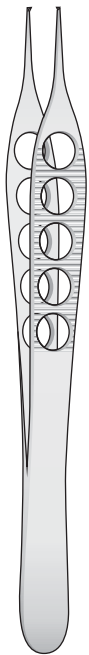

**ADSON**  
**0204-CAI**  
120 mm

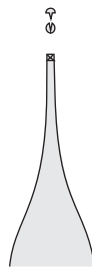

1/1



1/1

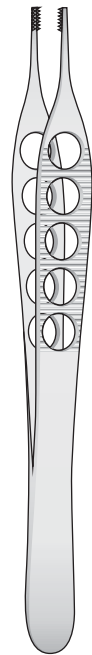

**ADSON-BROWN**  
**0204-CAL**  
120 mm

7x7 Zähne  
7x7 Teeth  
7x7 Denti  
7x7 Dientes  
7x7 Dents

TC

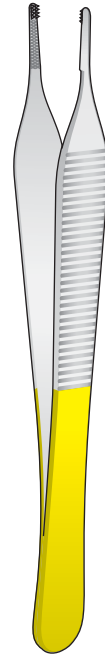

**ADSON-BROWN**  
**0204-CFD**  
120 mm

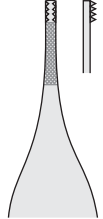

1/1



Mikro Pinzetten  
Delicate Forceps  
Micro Pinzette  
Pinzas finas  
Micro Pincers

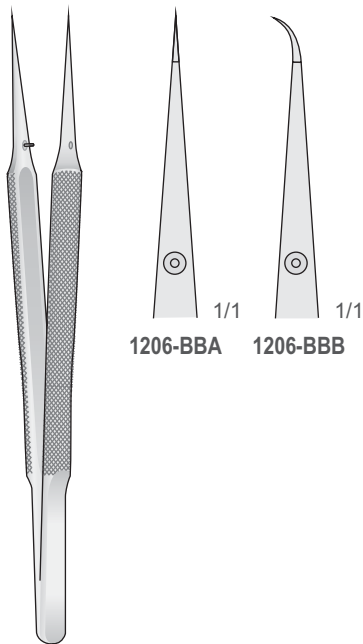
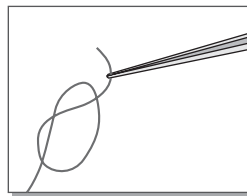

**1206-BBA/1206-BBB**  
120 mm

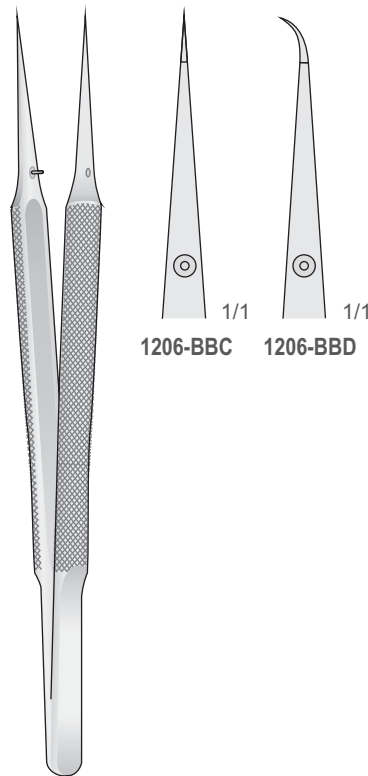

**1206-BBC/1206-BBD**  
150 mm

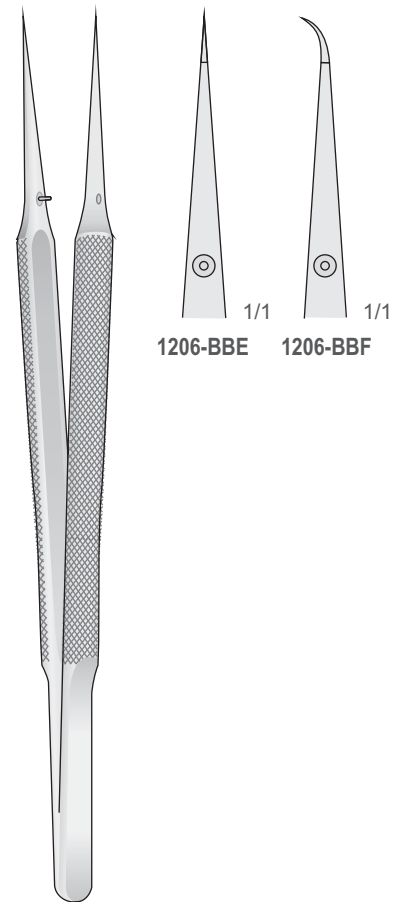

**1206-BBE/1206-BBF**  
180 mm



Mikro Pinzette - Rundgriff Ø 8 mm  
Mit Führungsstift diamantiert  
Fadenplatte 6x0,7 mm

Mikro Pinzetten  
Micro Forceps  
Micro Pinzette  
Micro Pinzas  
Micro Pincas

Diamantiert  
Diamond Coated  
Diamantate  
Diamantadas  
Diamanté

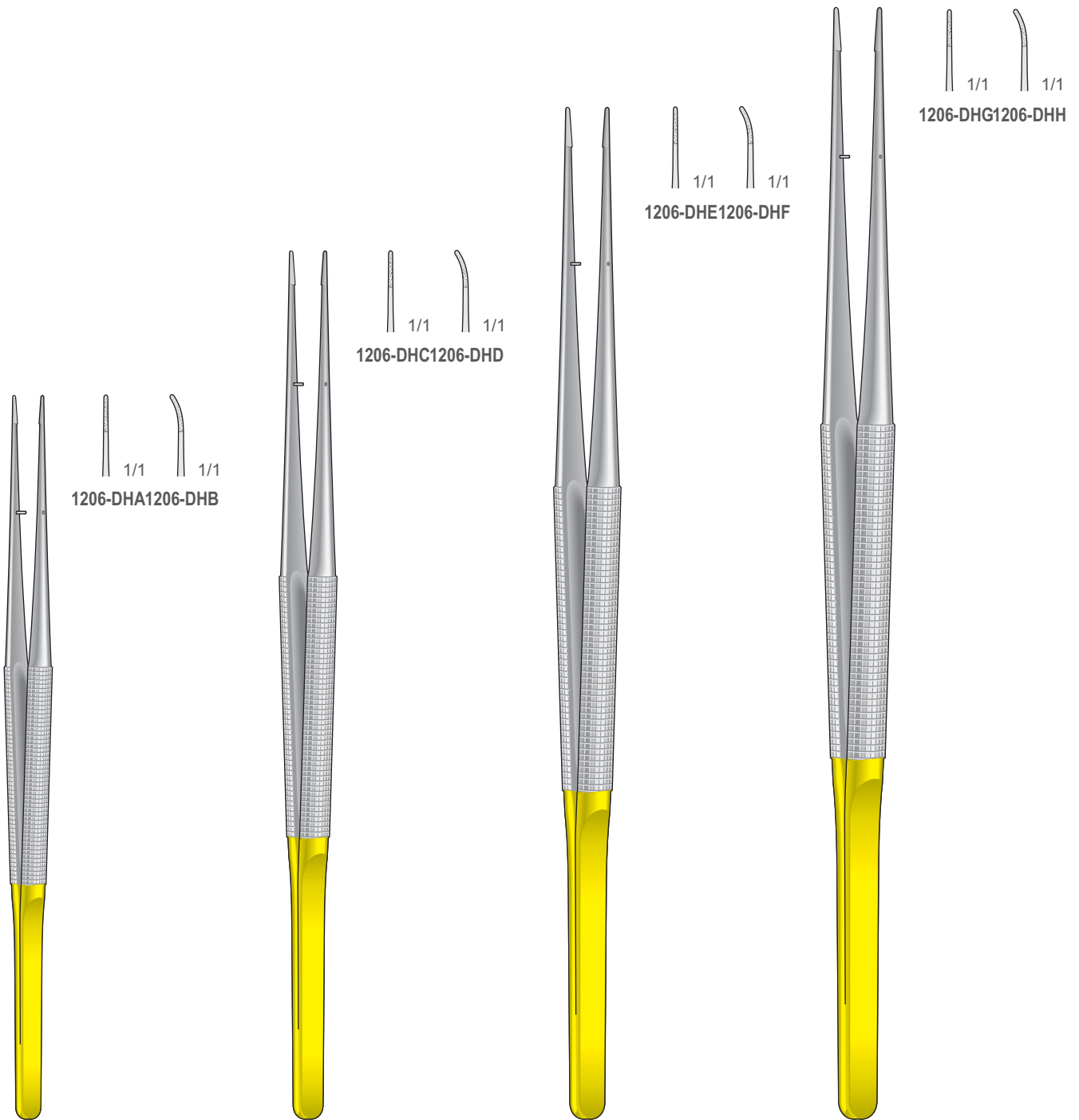

1206-DHA/1206-DHB  
150 mm

1206-DHC/1206-DHD  
180 mm

1206-DHE/1206-DHF  
210 mm

1206-DHG/1206-DHH  
230 mm



Mikro Pinzetten  
 Micro Forceps  
 Micro Pinzette  
 Micro Pinzas  
 Micro Pincas

Mikro Pinzette - Rundgriff Ø 8 mm  
 Mit Führungsstift diamantiert  
 Fadenplatte 6x0,7 mm

Diamantiert  
 Diamond Coated  
 Diamantate  
 Diamantadas  
 Diamanté

<p>1x2 Zähne          1x2 Teeths          1x2 Denti          1x2 Dientes          1x2 Dents</p>	<p>1206-DHI 1206-DHL</p>	<p>1x2 Zähne          1x2 Teeths          1x2 Denti          1x2 Dientes          1x2 Dents</p>	<p>1206-DIA 1206-DIB</p>	<p>1x2 Zähne          1x2 Teeths          1x2 Denti          1x2 Dientes          1x2 Dents</p>	<p>1206-DIC 1206-DID</p>	<p>1x2 Zähne          1x2 Teeths          1x2 Denti          1x2 Dientes          1x2 Dents</p>	<p>1206-DIE 1206-DIF</p>
<p>1206-DHI/1206-DHL          150 mm</p>	<p>1206-DIA/1206-DIB          180 mm</p>	<p>1206-DIC/1206-DID          210 mm</p>	<p>1206-DIE/1206-DIF          230 mm</p>				



Titan-Pinzetten  
Titanium Tissue Forceps  
Pinzette in titanio  
Pinzas de titanio  
Pincas en titane

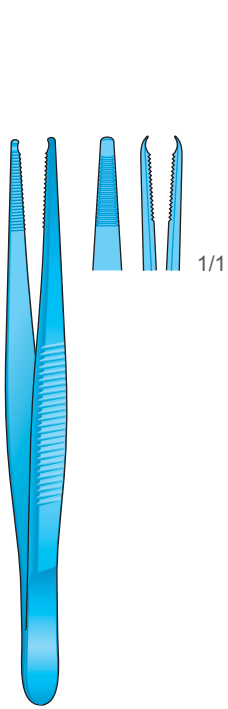

0204-CIF19  
90 mm

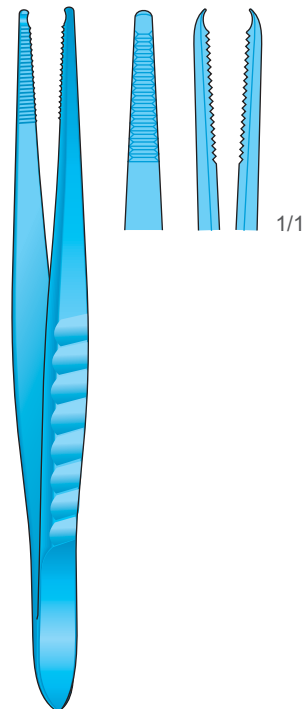

0204-CHA19  
130 mm

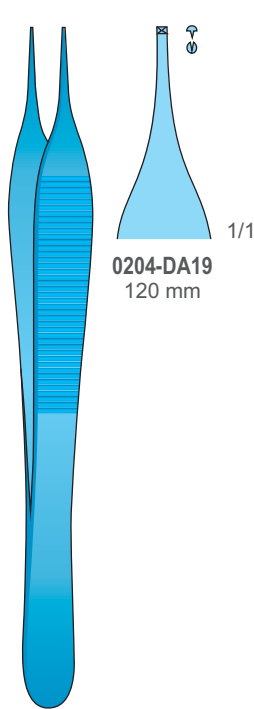

ADSON  
0204-DA19  
120 mm

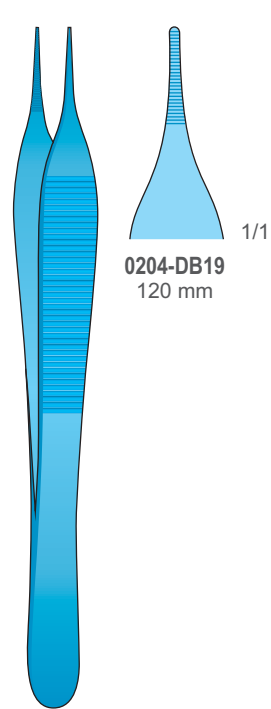

ADSON  
0204-DB19  
120 mm

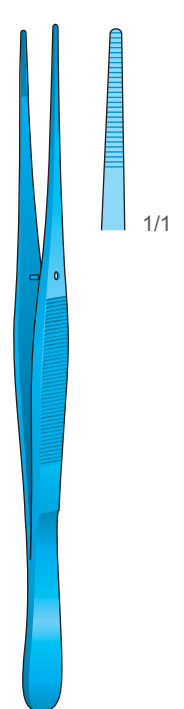

0204-AL19  
130 mm

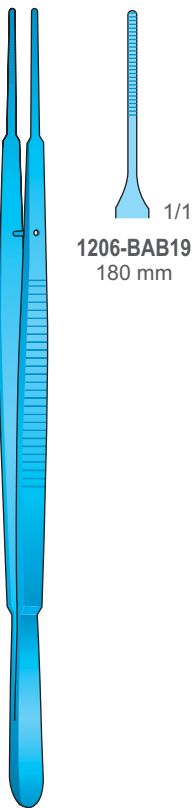

GERALD  
1206-BAB19/1206-BAC19  
180 mm

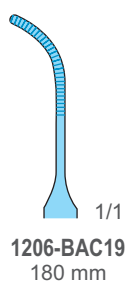

1206-BAC19  
180 mm

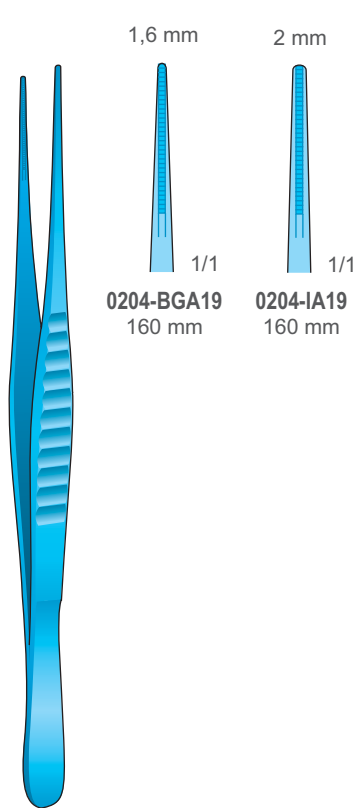

DE BAKEY  
0204-IA19/0204-BGA19

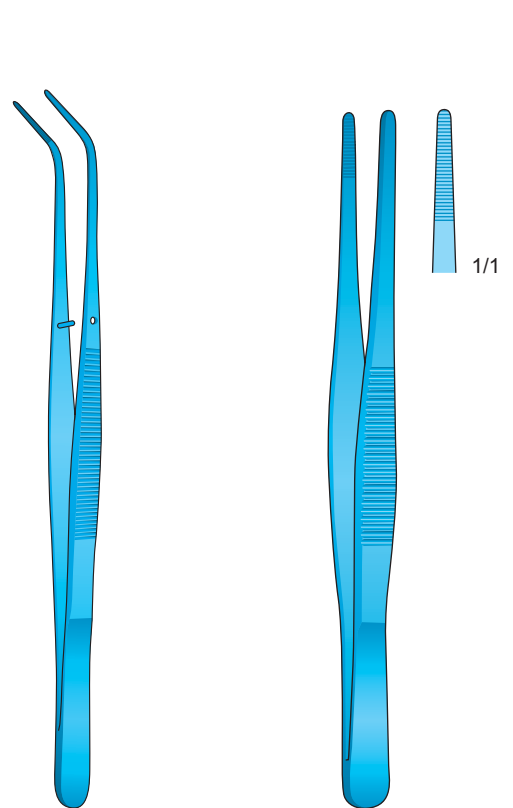

COLLEGE  
1919-AB  
150 mm

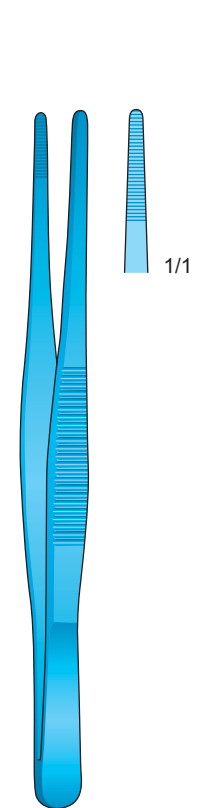

0204-HF19  
145 mm





Mikro Pinzetten  
Delicate Forceps  
Micro Pinzette  
Pinzas finas  
Micro Pincers

Rund-Griffe Ø 8 mm  
Round handle Ø 8 mm  
Manico rotondo Ø 8 mm  
Mango redondo Ø 8 mm  
Manche rond Ø 8 mm

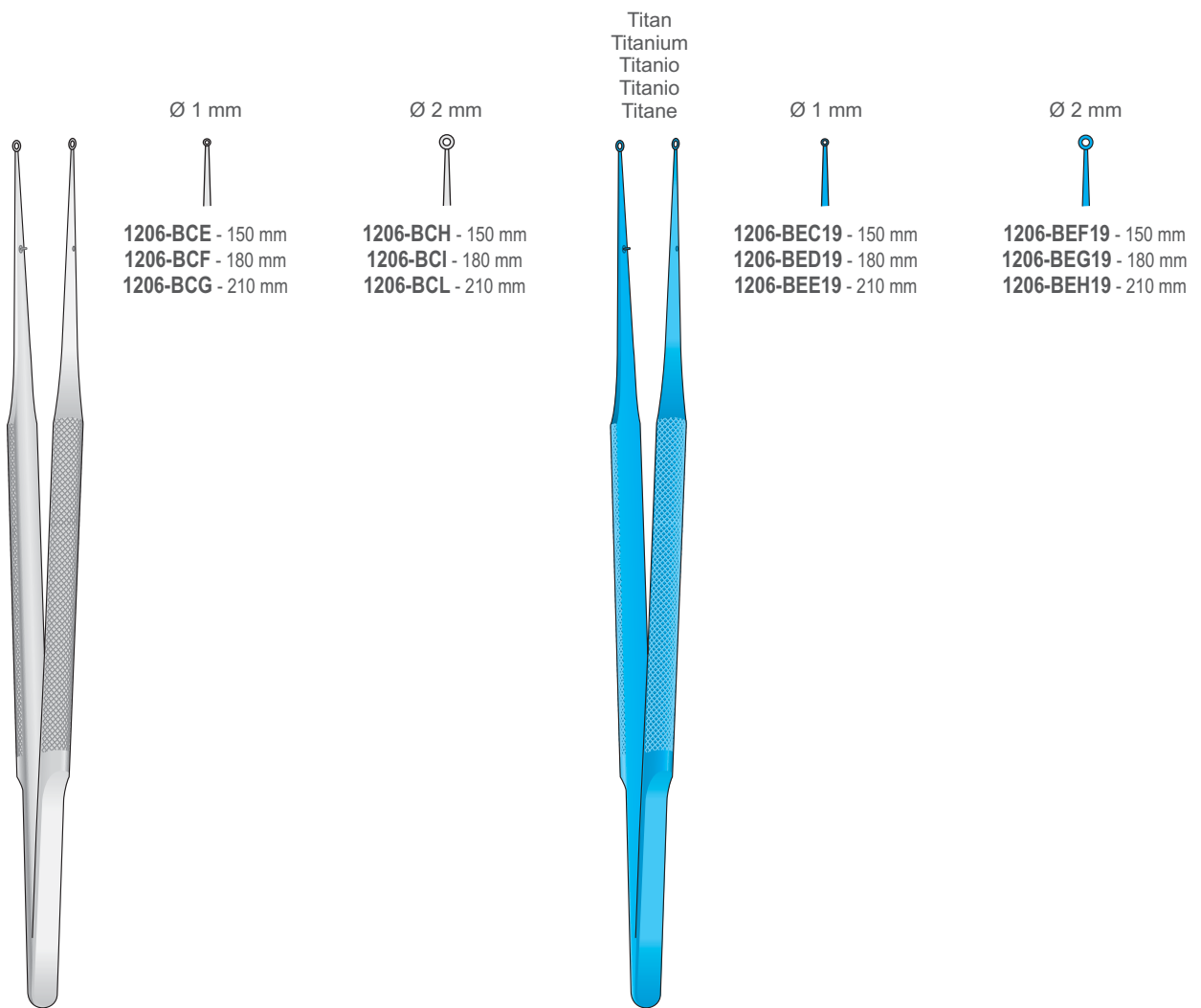

Ø 1 mm  
1206-BCE - 150 mm  
1206-BCF - 180 mm  
1206-BCG - 210 mm

Ø 2 mm  
1206-BCH - 150 mm  
1206-BCI - 180 mm  
1206-BCL - 210 mm

Titan  
Titanium  
Titanio  
Titane

Ø 1 mm  
1206-BEC19 - 150 mm  
1206-BED19 - 180 mm  
1206-BEE19 - 210 mm

Ø 2 mm  
1206-BEF19 - 150 mm  
1206-BEG19 - 180 mm  
1206-BEH19 - 210 mm

1206-BCE/1206-BCL

1206-BEC19/1206-BEH19

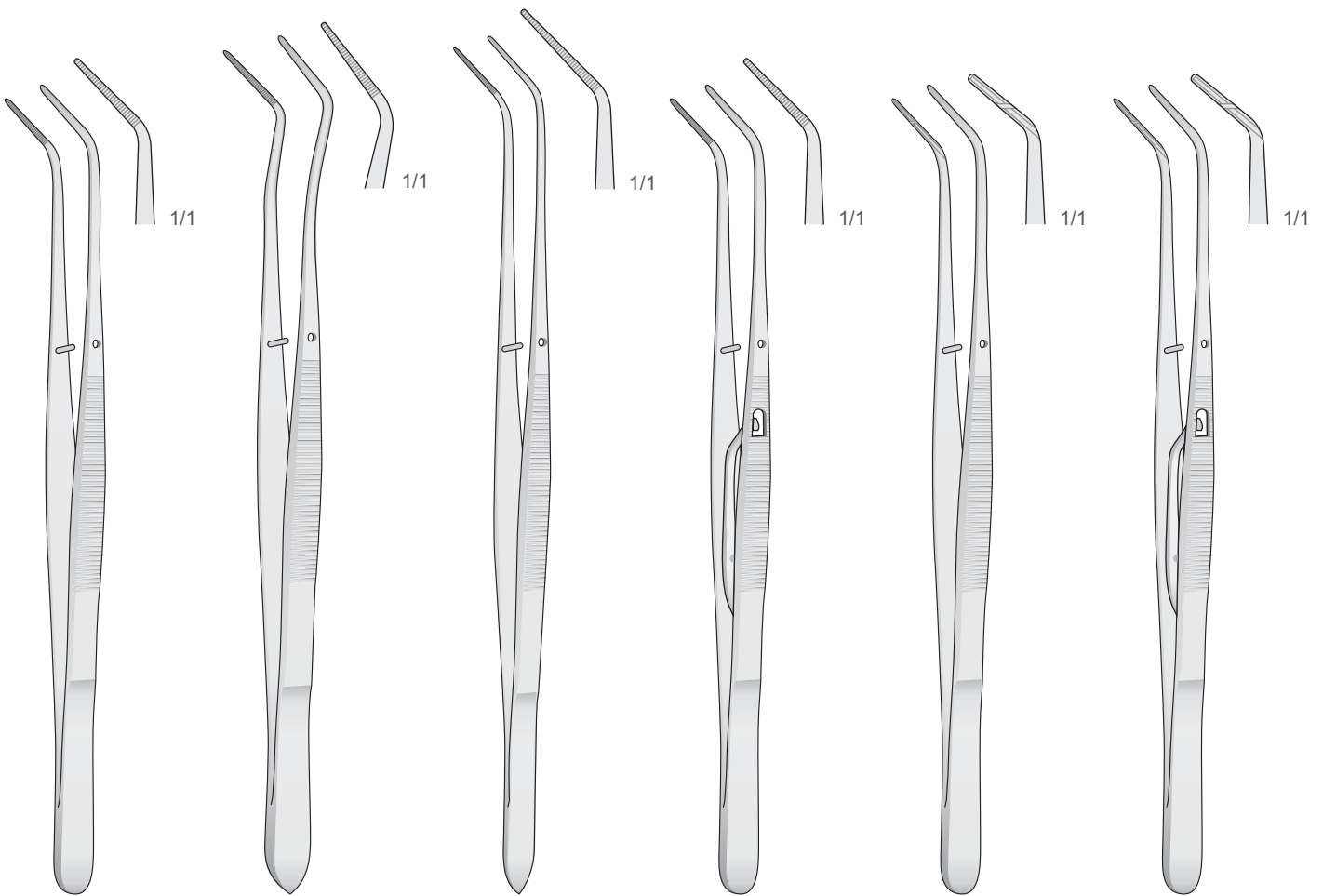

**03141111050705**  
150 mm

**120517090112**  
160 mm

**0611010707**  
160 mm

**03141111050705-18**  
150 mm

**0401-AE**  
150 mm

**0401-AF**  
150 mm



Zahnpinzetten  
 Cotton and Dressing Pliers  
 Pinzette per medicazione  
 Pinzas para vendajes  
 Précelles pour cotton

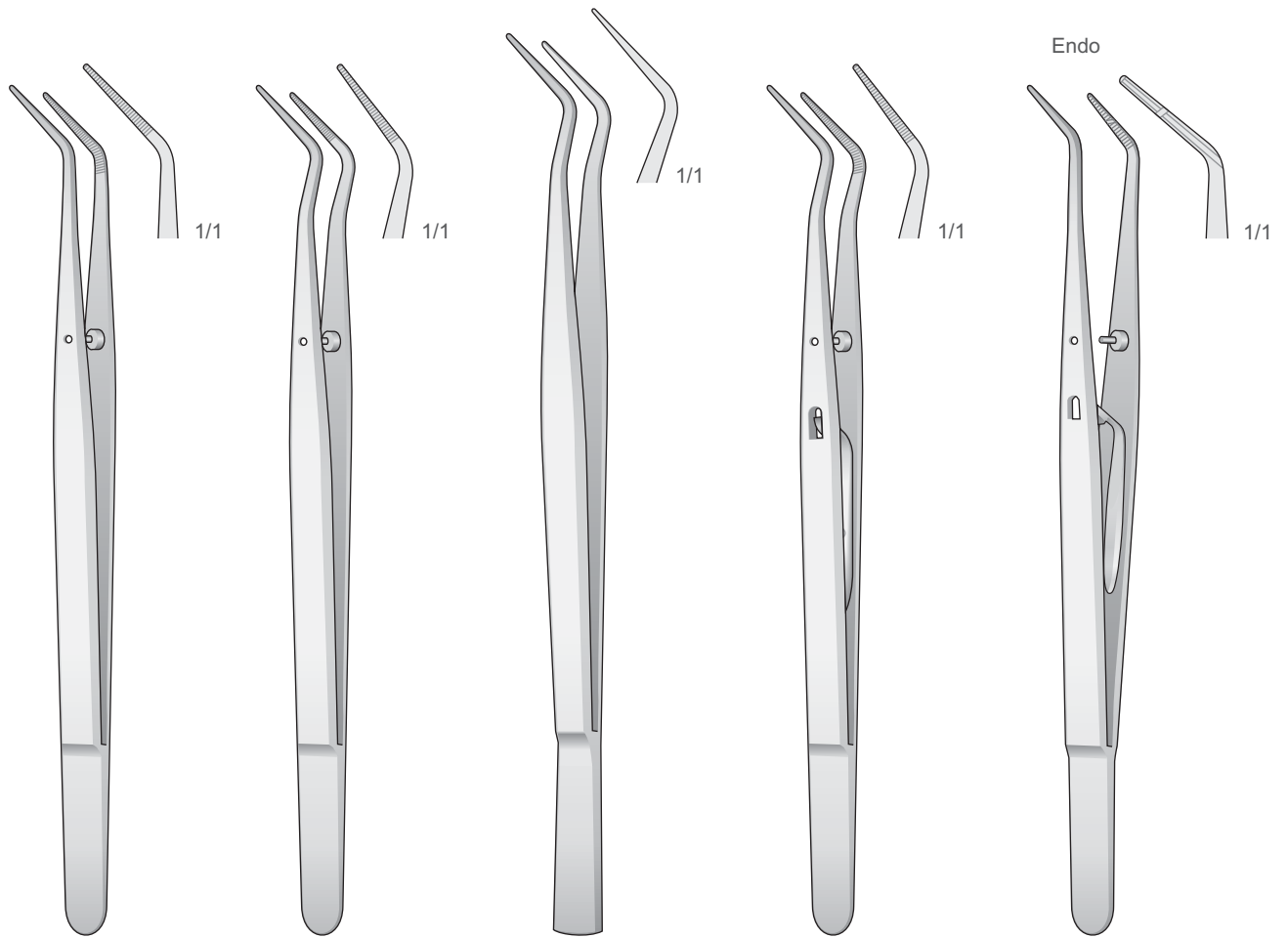

**COLLEGE**  
**0204-AB**  
 150 mm

**MERIAM**  
**0204-AC**  
 150 mm

**CAULK**  
**0204-BB**  
 160 mm

**LOCKING**  
**0204-AD**  
 150 mm

**0401-AL**  
 150 mm

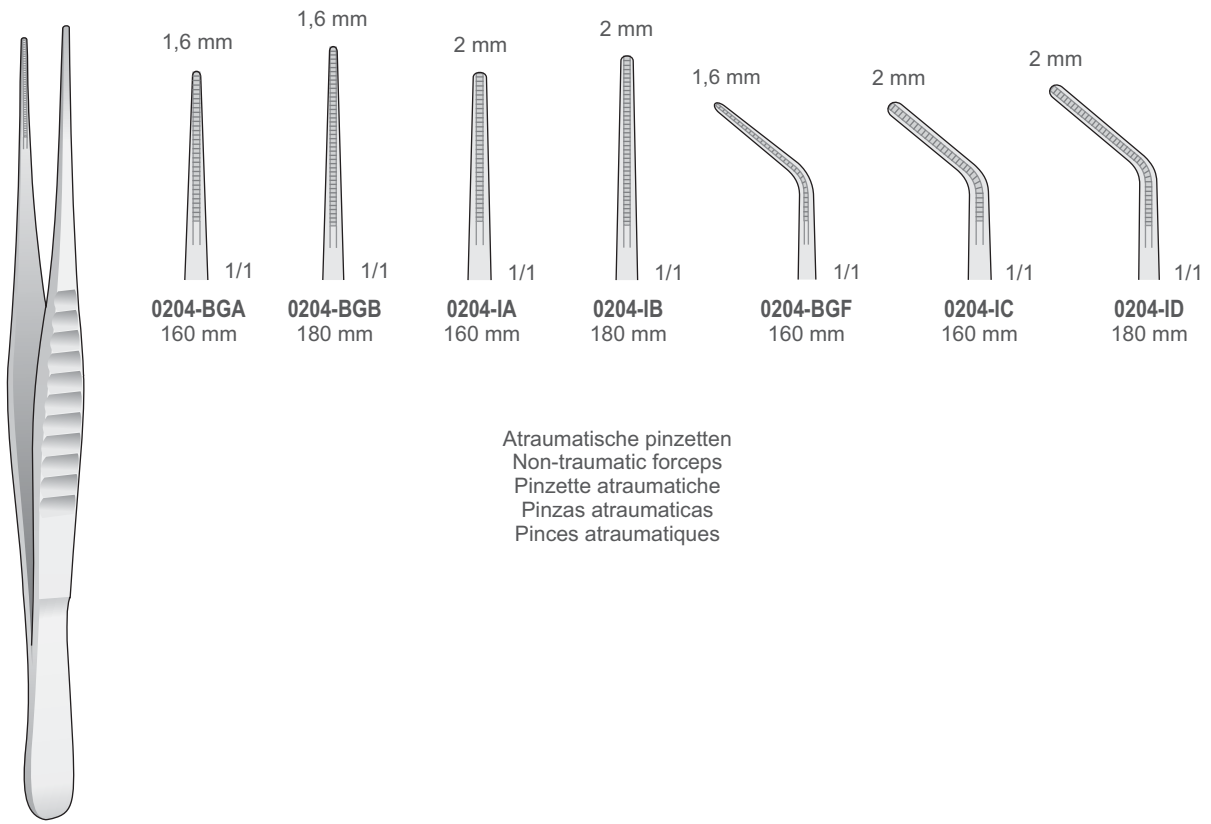

Atraumatische pinzetten  
Non-traumatic forceps  
Pinzette atraumatiche  
Pinzas atraumaticas  
Pincas atraumaticas

DE BAKEY  
0204-IA/0204-BGF

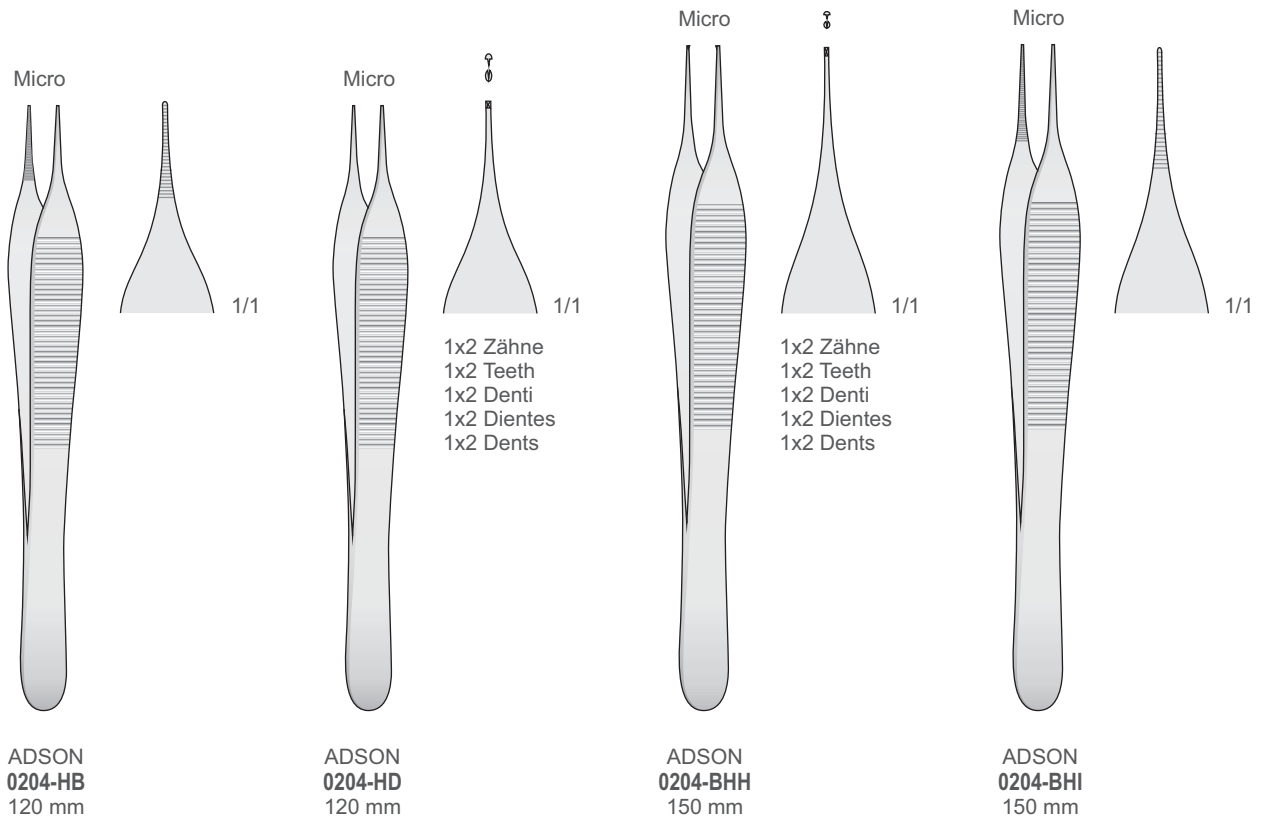

ADSON  
0204-HB  
120 mm

ADSON  
0204-HD  
120 mm

ADSON  
0204-BHH  
150 mm

ADSON  
0204-BHI  
150 mm



Chirurgische Pinzetten  
Tissue Forceps  
Pinzette chirurgiche  
Pinzas quirùrgicas  
Pincas quirùrgicas

Taschenmarkierungspinzetten  
Pocket markers  
Pinzette segnatasche  
Pinzas para marcar el sulco periodontal  
Pincas à marquer la poche

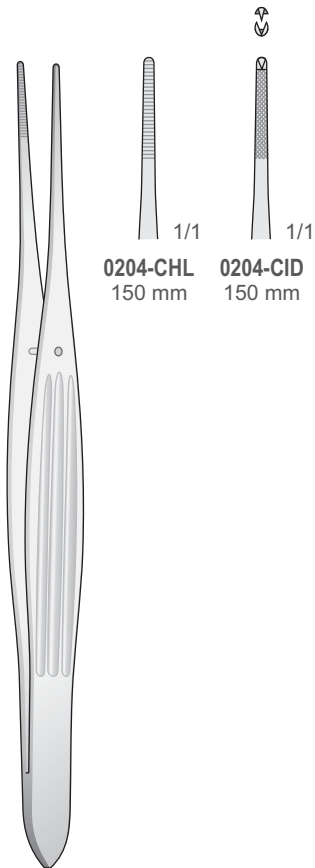

McINDOE  
0204-CHL/0204-CID  
150 mm

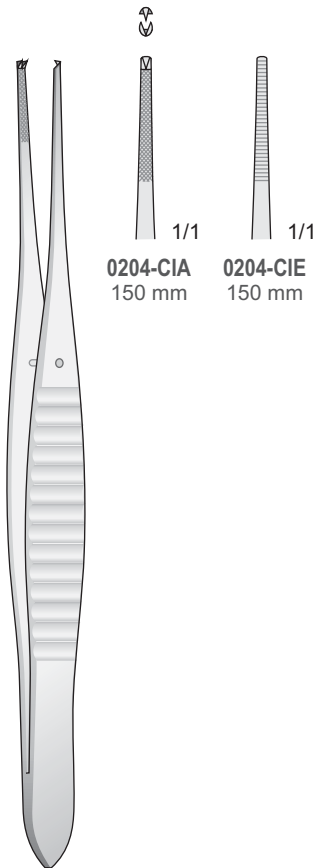

GILLIES  
0204-CIA/0204-CIE  
150 mm

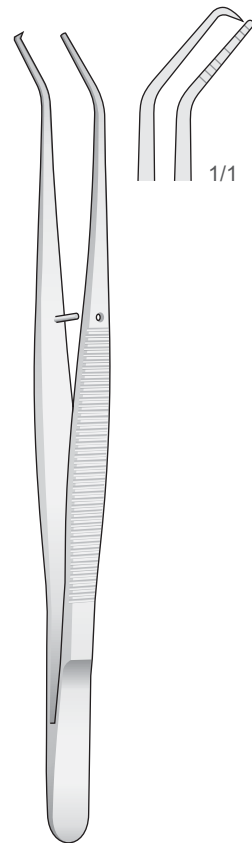

CRANE-CAPLAN  
0402-AB  
150 mm

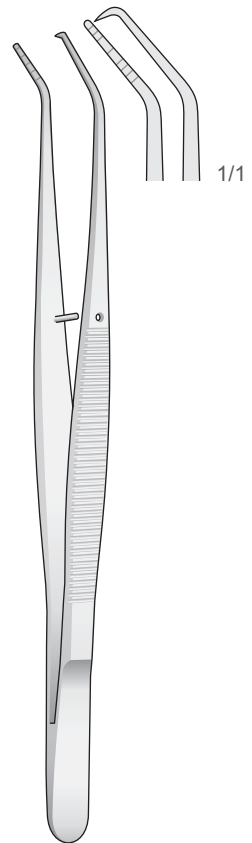

CRANE-CAPLAN  
0402-AC  
150 mm

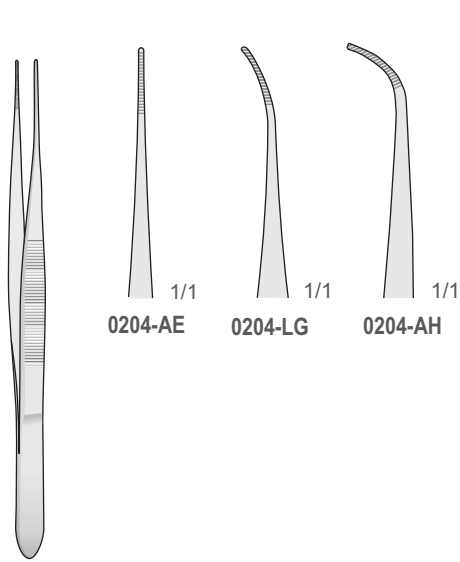

GRAEFE  
0204-AE/0204-LG  
100 mm

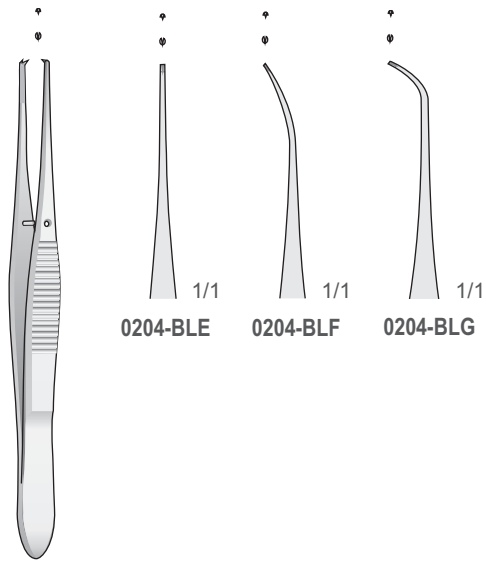

GRAEFE  
0204-BLE/0204-BLG  
100 mm

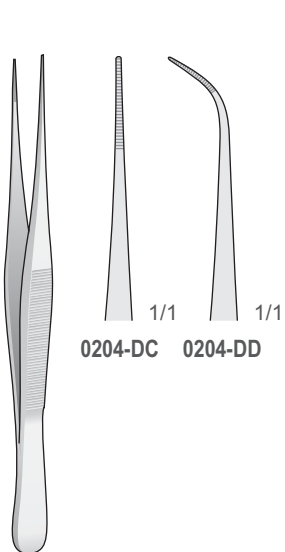

0204-DC/0204-DD  
100 mm

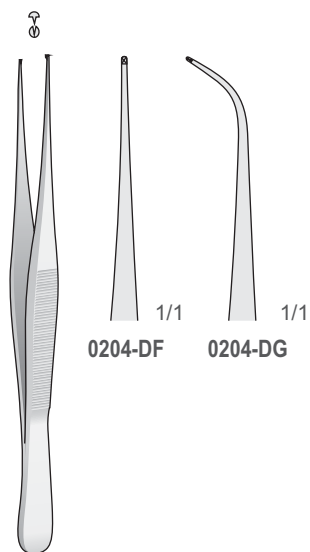

0204-DF/0204-DG  
100 mm

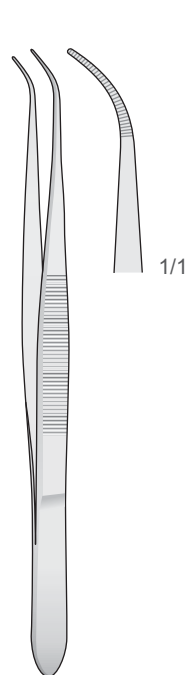

PERRY  
0204-AF  
125 mm

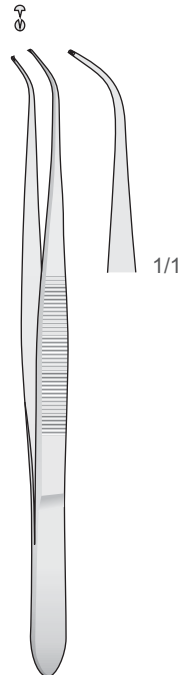

0204-AG  
125 mm



Anatomische Pinzetten  
 Dressing Forceps  
 Pinzette anatomiche  
 Pinzas de diseccion  
 Pincas anatomiques

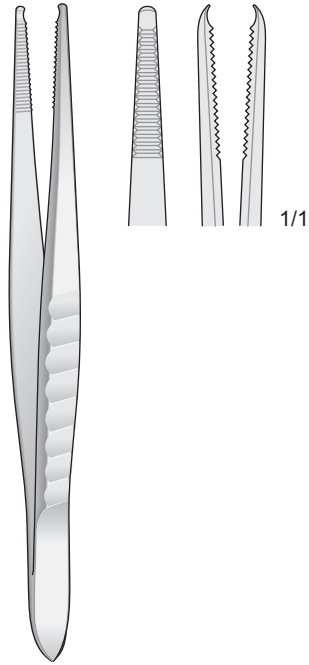

**0204-CHA**  
130 mm

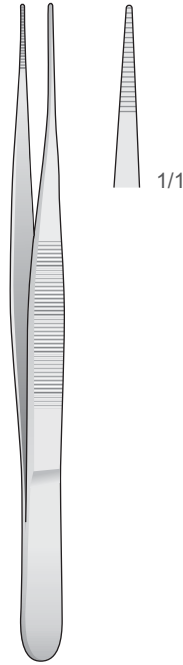

**0204-BEF**  
130 mm

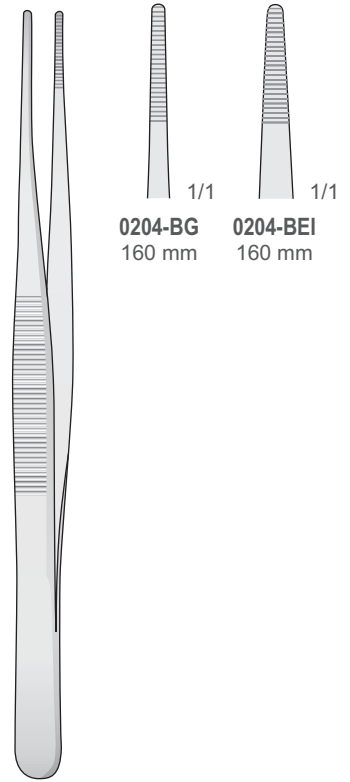

**0204-BG** 160 mm  
**0204-BEI** 160 mm

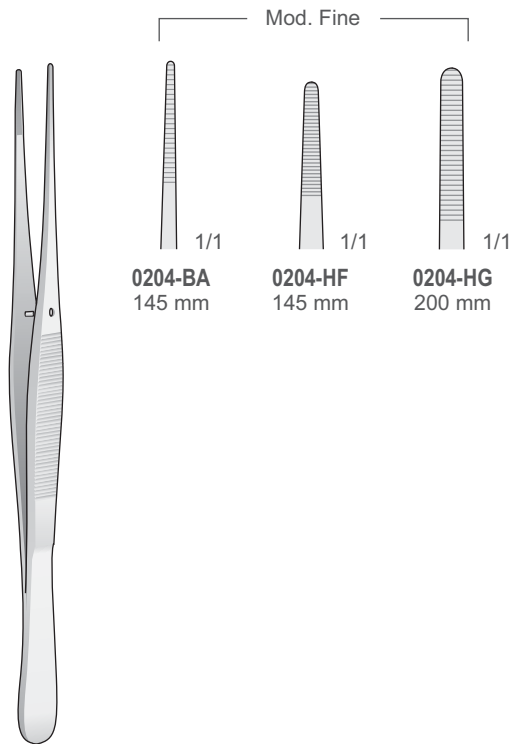

**0204-BA/0204-HG**

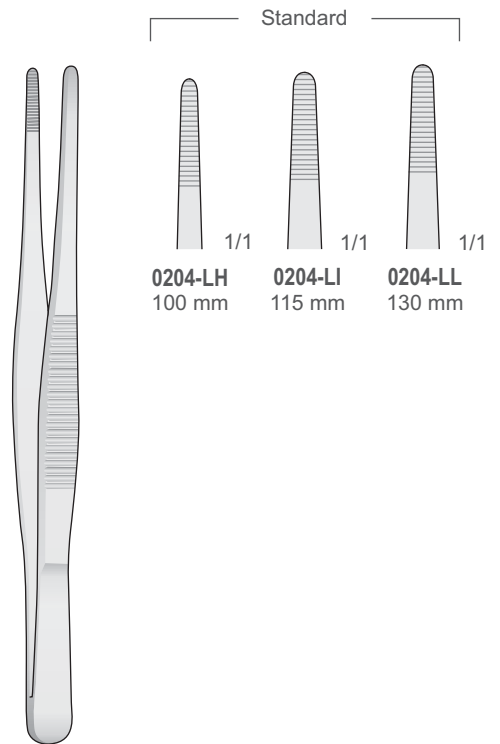

**0204-LH/0204-LL**



Chirurgische Pinzetten  
Tissue Forceps  
Pinzette chirurgiche  
Pinzas quirúrgicas  
Pincas quirúrgicas

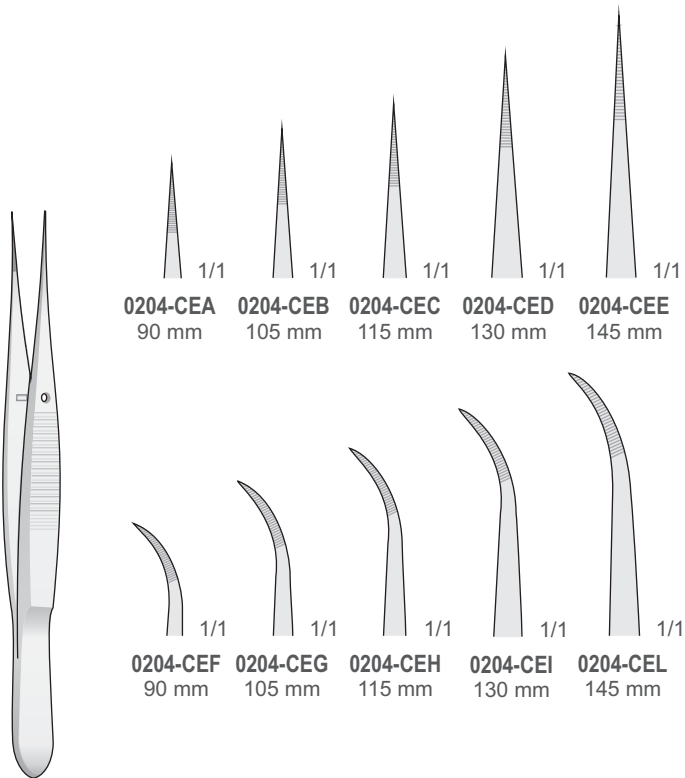

0204-CEA/0204-CEL

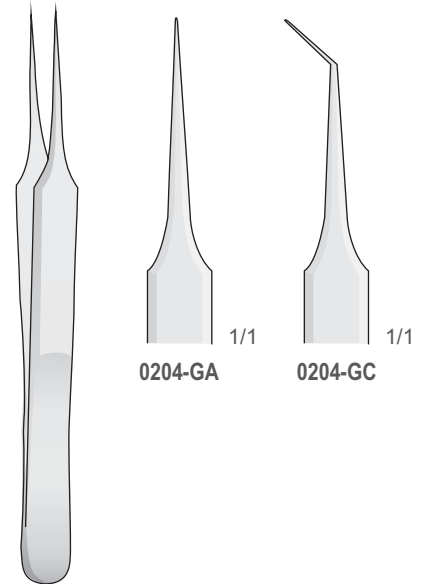

0204-GA/0204-GC  
110 mm

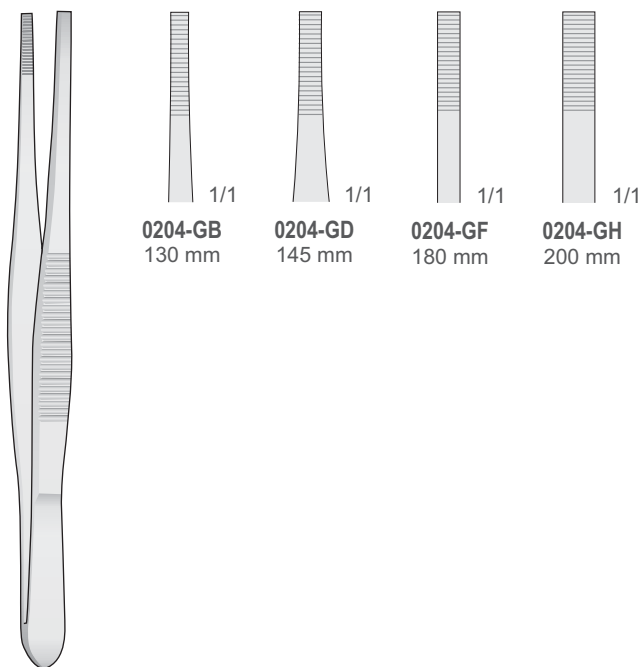

STILLE  
0204-GB/0204-GH

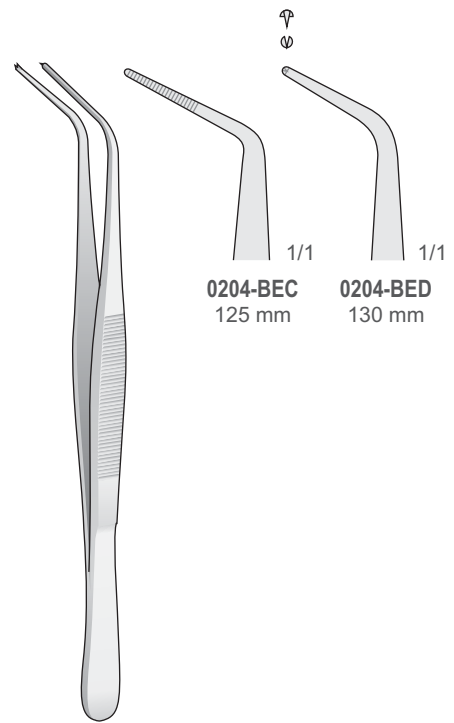

0204-BEC/0204-BED





Chirurgische Pinzetten  
Tissue Forceps  
Pinzette chirurgiche  
Pinzas chirùrgicas  
Pincas chirùrgicas

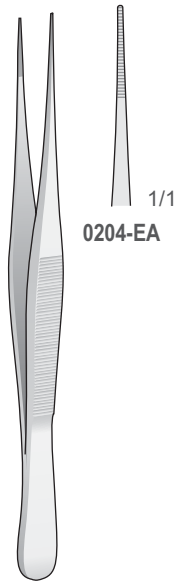

**0204-EA**  
110 mm

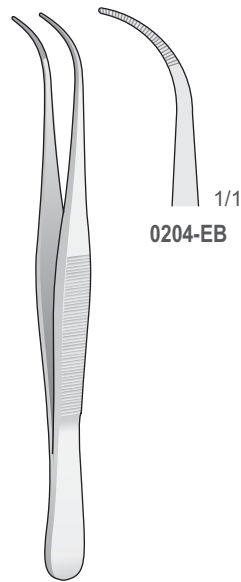

**0204-EB**  
110 mm

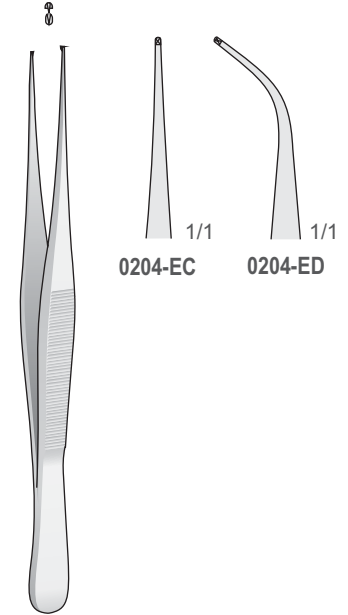

**0204-EC/0204-ED**  
110 mm

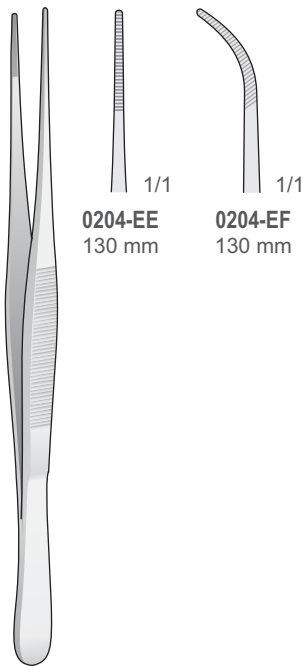

SEMKEN  
**0204-EE/0204-EF**  
130 mm

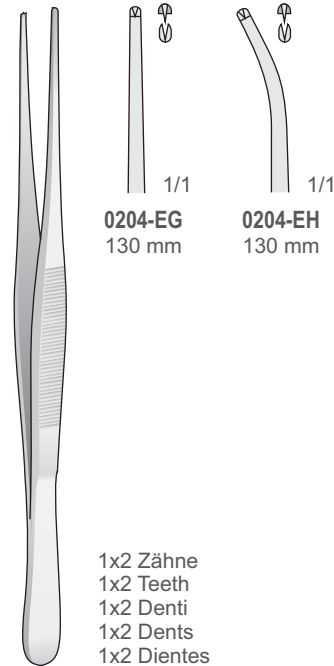

SEMKEN  
**0204-EG/0204-EH**  
130 mm

1x2 Zähne  
1x2 Teeth  
1x2 Denti  
1x2 Dents  
1x2 Dientes

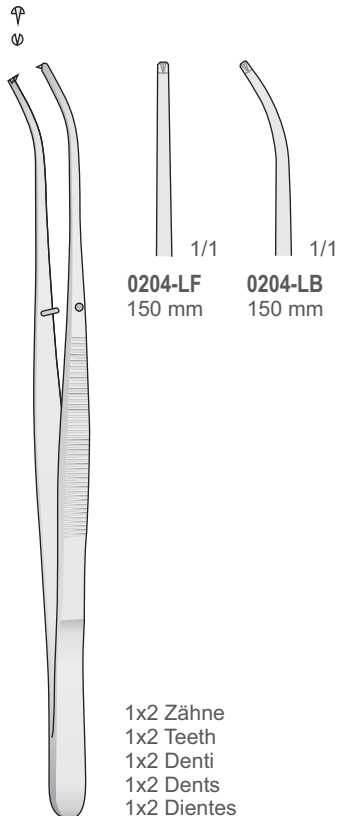

SEMKEN  
**0204-LB/0204-LF**  
150 mm

1x2 Zähne  
1x2 Teeth  
1x2 Denti  
1x2 Dents  
1x2 Dientes

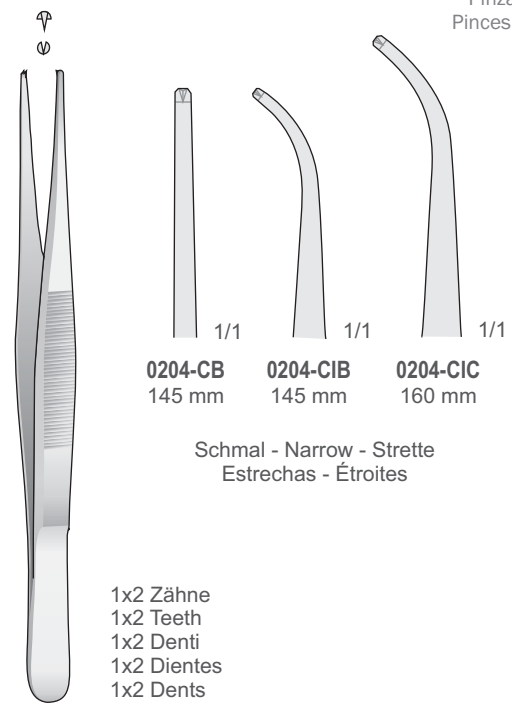
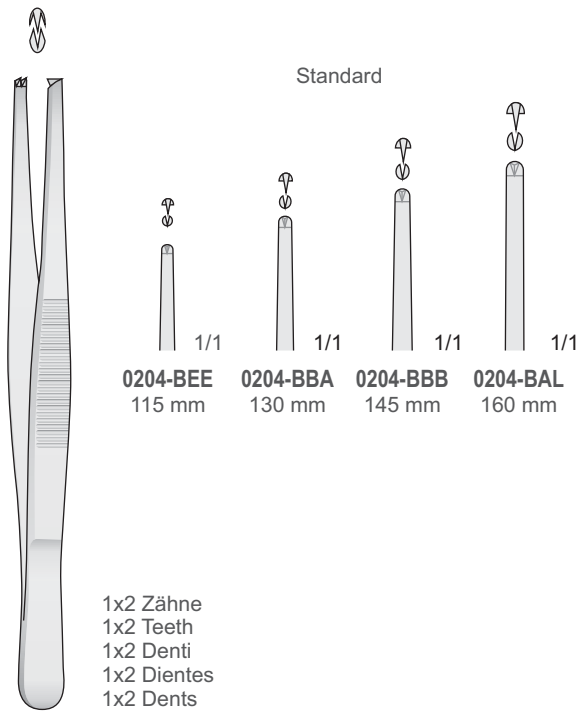

0204-BAL/0204-BEE

0204-CB/0204-CIC

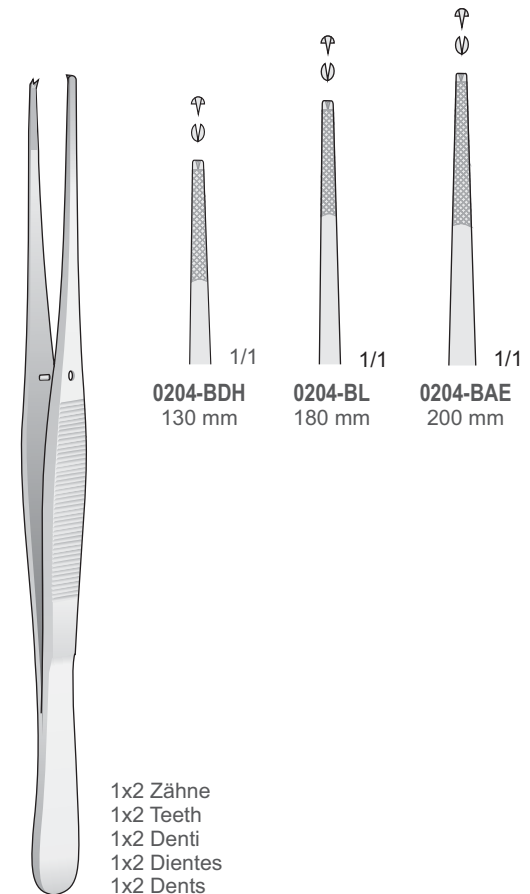
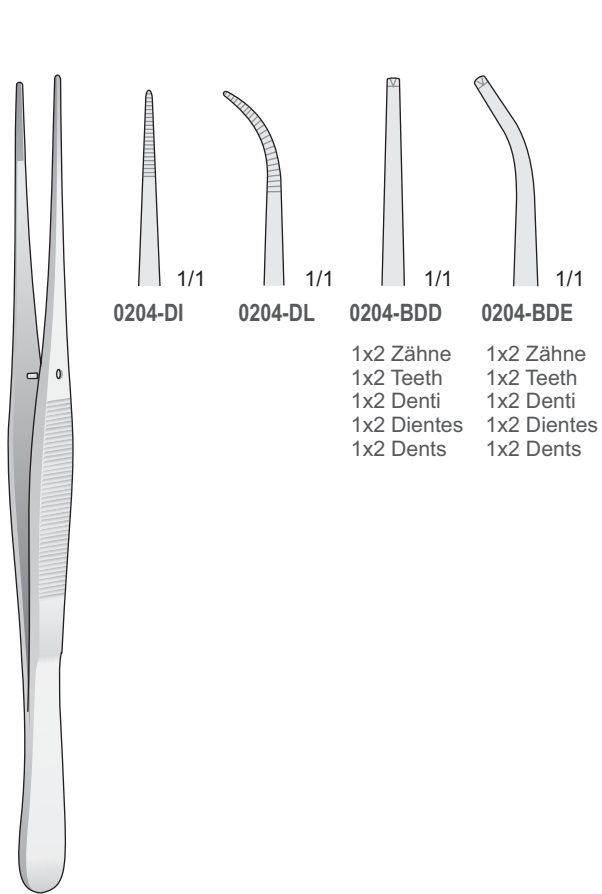

0204-DI/0204-BDE  
200 mm

0204-BL/0204-BDH



Chirurgische Pinzetten  
 Tissue Forceps  
 Pinzette chirurgiche  
 Pinzas quirúrgicas  
 Pincas quirúrgicas

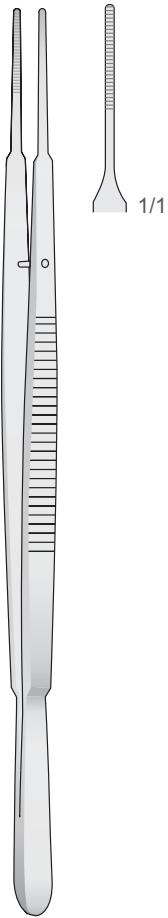

**GERALD  
 1206-BAB**  
 180 mm

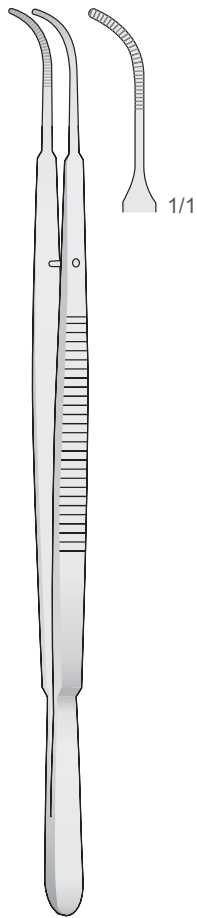

**GERALD  
 1206-BAC**  
 180 mm

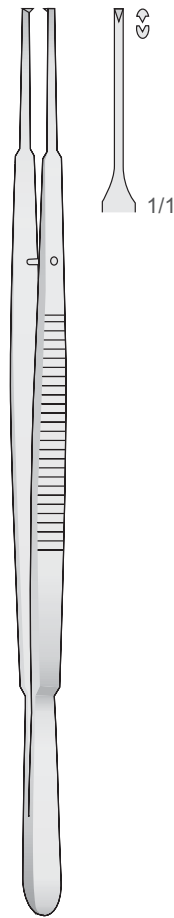

**GERALD  
 1206-BAD**  
 180 mm

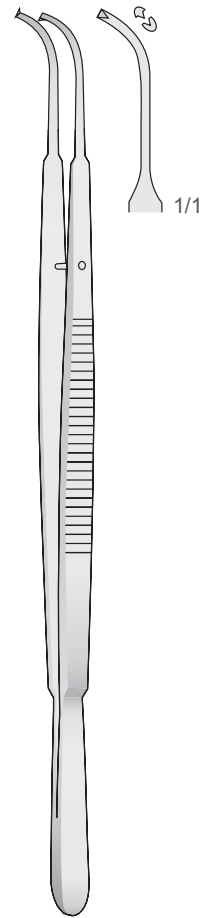

**GERALD  
 1206-BAE**  
 180 mm

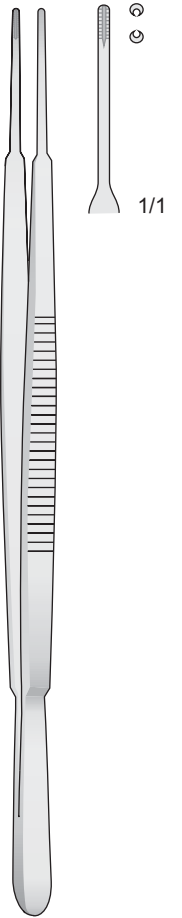

**GERALD-BROWN  
 1206-BAF**  
 180 mm

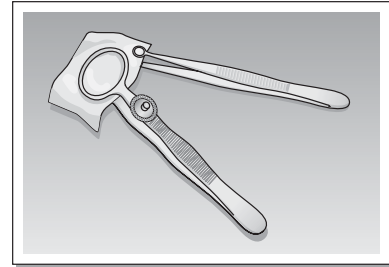
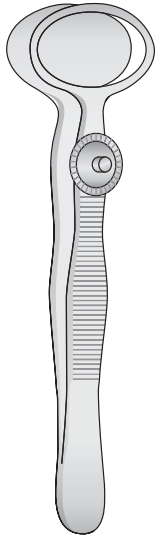

**DESMARRES**  
**0204-BDA/0204-BDB**  
90 mm

Pinzetten zum Halten Membranen  
Membrane Holding forceps  
Pinza per fissaggio membrane  
Pinza para sostener membranas  
Pince pour le maintien membranes

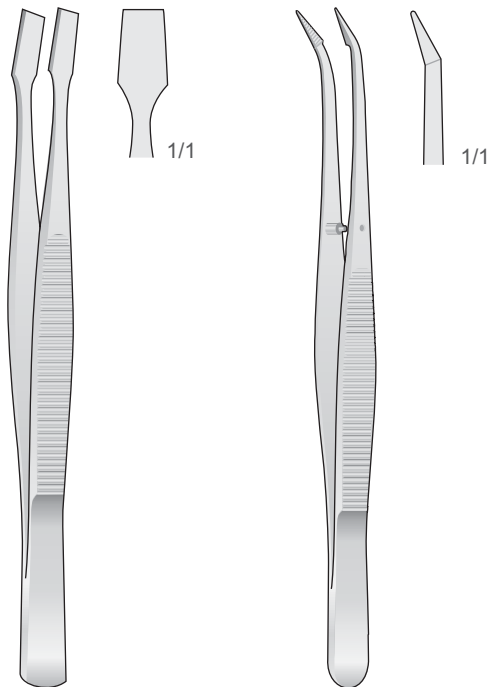

**KÜHNE**  
**0518-EE**  
105 mm

**BARRAQUER**  
**0518-GF**  
105 mm

Membrane Forceps  
with delicate Ring tip

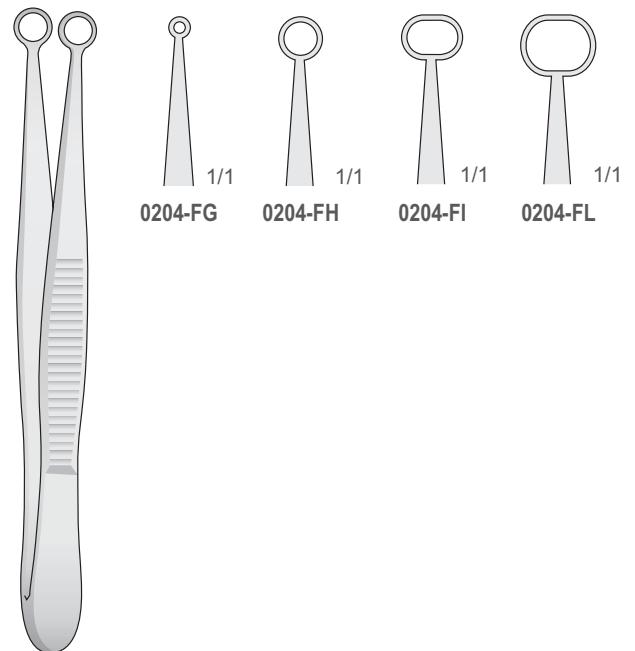

**0204-FG/0204-FL**  
100 mm



Chirurgische Pinzetten  
Tissue Forceps  
Pinzette chirurgiche  
Pinzas chirurgicalas  
Pincas chirurgicales

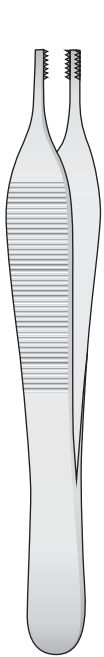

**ADSON-BROWN**  
**0204-LC/0204-BEB**  
120 mm

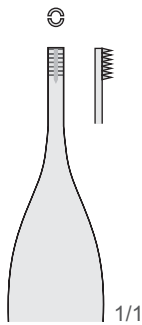

**0204-LC**  
120 mm

6x6 Zähne  
6x6 Teeth  
6x6 Denti  
6x6 Dientes  
6x6 Dents

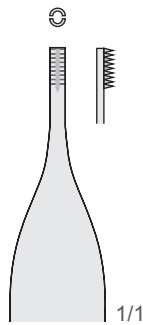

**0204-BEB**  
120 mm

9x9 Zähne  
9x9 Teeth  
9x9 Denti  
9x9 Dientes  
9x9 Dents

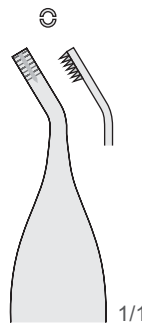

**0204-LD**  
120 mm

6x6 Zähne  
6x6 Teeth  
6x6 Denti  
6x6 Dientes  
6x6 Dents

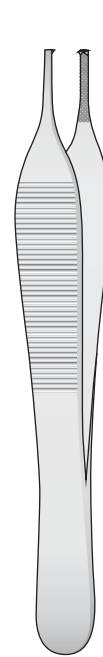

**ADSON**  
**0204-LA**  
120 mm

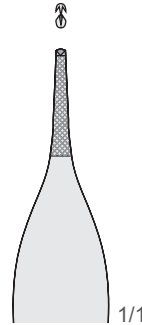

**0204-LA**  
120 mm



**BROWN**  
**0204-LE**  
150 mm

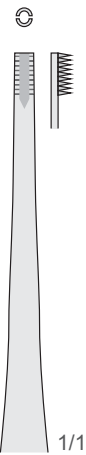

8x8 Zähne  
8x8 Teeth  
8x8 Denti  
8x8 Dientes  
8x8 Dents



**ADSON**  
**0204-DIA**  
150 mm

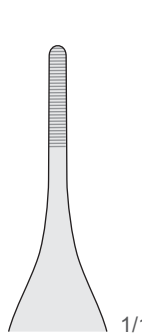

**ADSON**  
**0204-DIB**  
150 mm

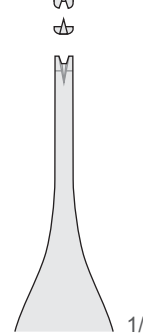

1x2 Zähne  
1x2 Teeth  
1x2 Denti  
1x2 Dientes  
1x2 Dents



**ADSON-BROWN**  
**0204-DIC**  
150 mm

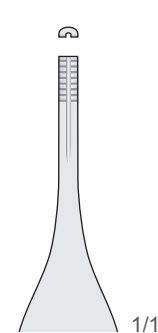

9x9 Zähne  
9x9 Teeth  
9x9 Denti  
9x9 Dientes  
9x9 Dents



1,0 mm

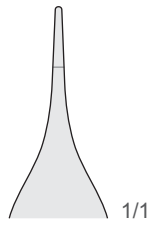

Mit Fadenplatte  
With tying platform  
Con piano prendifilo  
Con plataforma  
Avec plateaux pour monofil

ADSON  
0204-DHA  
120 mm

1,0 mm

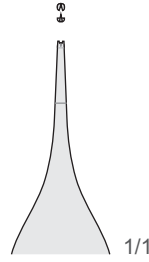

Mit Fadenplatte  
With tying platform  
Con piano prendifilo  
Con plataforma  
Avec plateaux pour monofil  
1x2 Zähne  
1x2 Teeth  
1x2 Denti  
1x2 Dientes  
1x2 Dents

ADSON  
0204-DHB  
120 mm

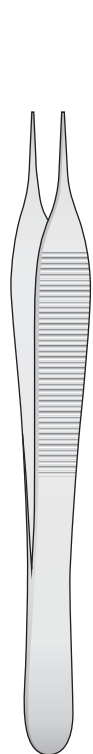

ADSON  
0204-DA/0204-HD

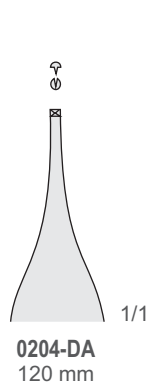

0204-DA  
120 mm

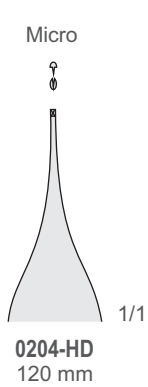

0204-HD  
120 mm

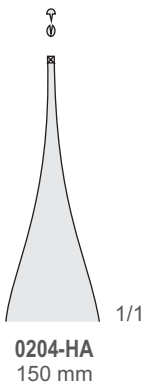

0204-HA  
150 mm



ADSON  
0204-DB/0204-HC

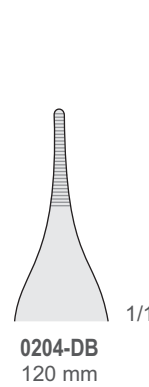

0204-DB  
120 mm

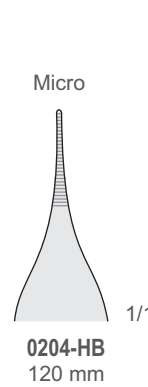

0204-HB  
120 mm

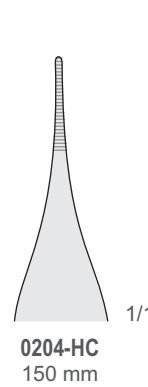

0204-HC  
150 mm



Chirurgische Pinzetten - Anatomische Pinzetten  
 Tissue Forceps - Dressing forceps  
 Pinzette chirurgiche - Pinzette anatomiche  
 Pinzas quirùrgicas - Pinzas de diseccion  
 Pincas quirùrgicas - Pincas anatomiques

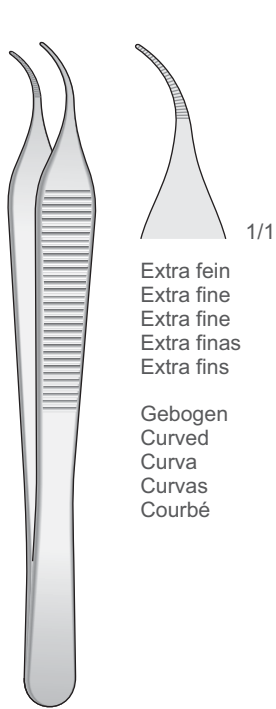

Extra fein  
 Extra fine  
 Extra fine  
 Extra finas  
 Extra fins

Gebogen  
 Curved  
 Curva  
 Curvas  
 Courbé

**MICRO-ADSON**  
**0204-DHC**  
 120 mm

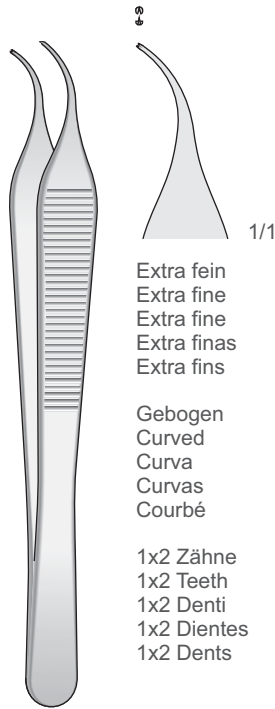

Extra fein  
 Extra fine  
 Extra fine  
 Extra finas  
 Extra fins

Gebogen  
 Curved  
 Curva  
 Curvas  
 Courbé

1x2 Zähne  
 1x2 Teeth  
 1x2 Denti  
 1x2 Dientes  
 1x2 Dents

**MICRO-ADSON**  
**0204-DHD**  
 120 mm

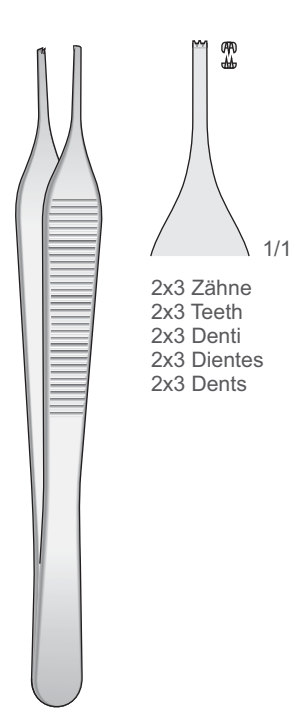

2x3 Zähne  
 2x3 Teeth  
 2x3 Denti  
 2x3 Dientes  
 2x3 Dents

**ADSON**  
**0204-DHH**  
 120 mm

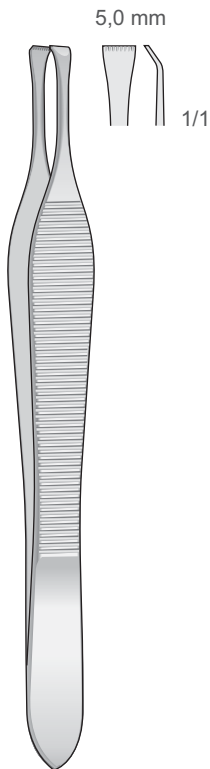

**BEASLEY-BABCOCK**  
**0204-FB**  
 120 mm

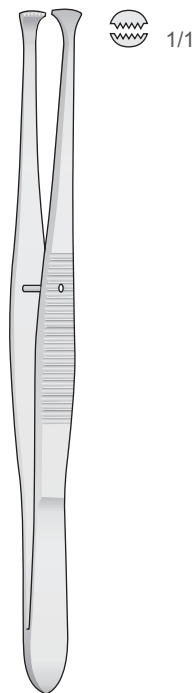

**GRAEFE**  
**0204-BDF**  
 110 mm

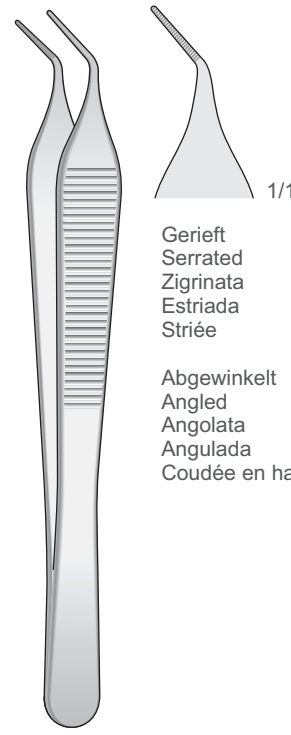

Gerieft  
 Serrated  
 Zigrinata  
 Estriada  
 Striée

Abgewinkelt  
 Angled  
 Angolata  
 Angulada  
 Coudée en haut

**ADSON**  
**0204-DHI**  
 120 mm

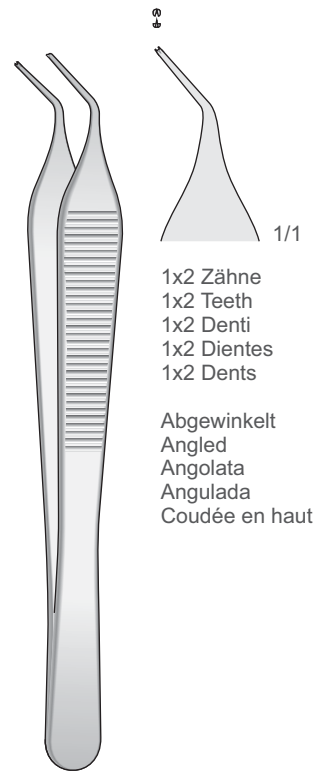

1x2 Zähne  
 1x2 Teeth  
 1x2 Denti  
 1x2 Dientes  
 1x2 Dents

Abgewinkelt  
 Angled  
 Angolata  
 Angulada  
 Coudée en haut

**ADSON**  
**0204-DHL**  
 120 mm



Chirurgische Pinzetten - Anatomische Pinzetten  
 Tissue Forceps - Dressing forceps  
 Pinzette chirurgiche - Pinzette anatomiche  
 Pinzas quirúrgicas - Pinzas de disección  
 Pinces chirurgicales - Pinces anatomiques

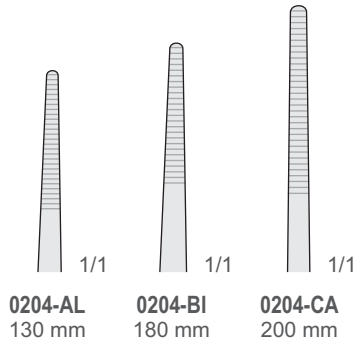

**0204-AL**  
130 mm

**0204-BI**  
180 mm

**0204-CA**  
200 mm

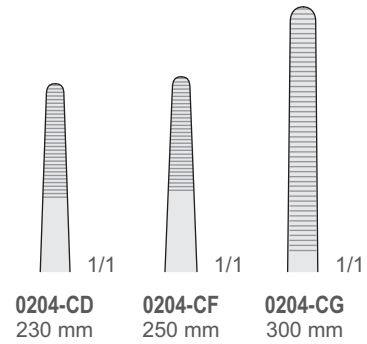

**0204-CD**  
230 mm

**0204-CF**  
250 mm

**0204-CG**  
300 mm

**0204-AL/0204-CA**

**0204-CD/0204-CG**

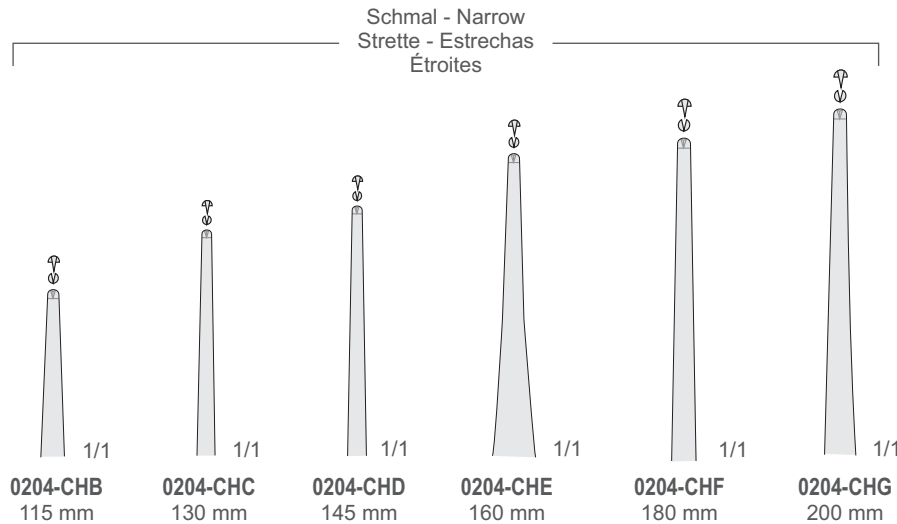

**0204-CHB**  
115 mm

**0204-CHC**  
130 mm

**0204-CHD**  
145 mm

**0204-CHE**  
160 mm

**0204-CHF**  
180 mm

**0204-CHG**  
200 mm

1x2 Zähne  
 1x2 Teeth  
 1x2 Denti  
 1x2 Dientes  
 1x2 Dents

**0204-CHB/0204-CHG**





Chirurgische Pinzetten  
Tissue Forceps  
Pinzette chirurgiche  
Pinzas chirùrgicas  
Pinces chirùrgicales

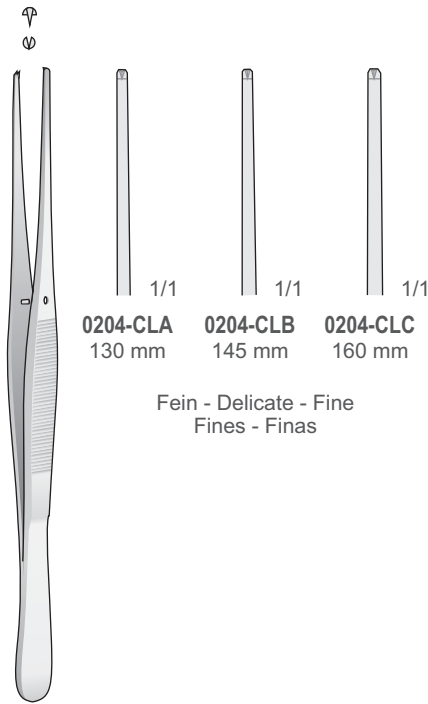

**0204-CLA** 130 mm  
**0204-CLB** 145 mm  
**0204-CLC** 160 mm

Fein - Delicate - Fine  
Fines - Finas



1,1 mm 1,3 mm 1,0 mm  
1,1 mm 1,3 mm 1,0 mm  
**0204-DFB** 125 mm  
**0204-DFC** 150 mm  
**0204-DFD** 175 mm  
**0204-DFE** 125 mm  
**0204-DFG** 150 mm  
**0204-DFG** 175 mm

**0204-CLA/0204-CLC**

**0204-DFB/0204-DFG**

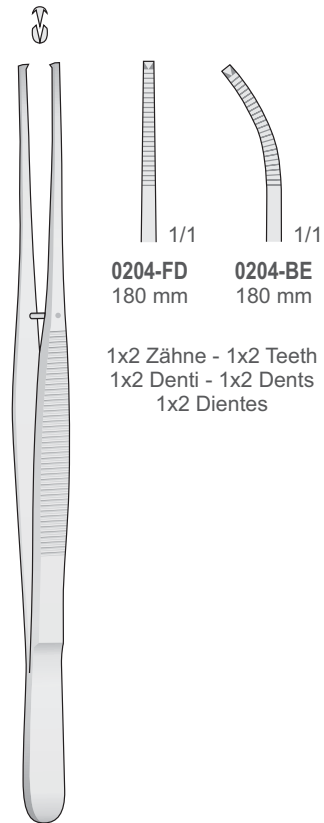

**0204-FD** 180 mm  
**0204-BE** 180 mm

1x2 Zähne - 1x2 Teeth  
1x2 Denti - 1x2 Dents  
1x2 Dientes

**POTTS-SMITH**  
**0204-BE/0204-FD**  
180 mm

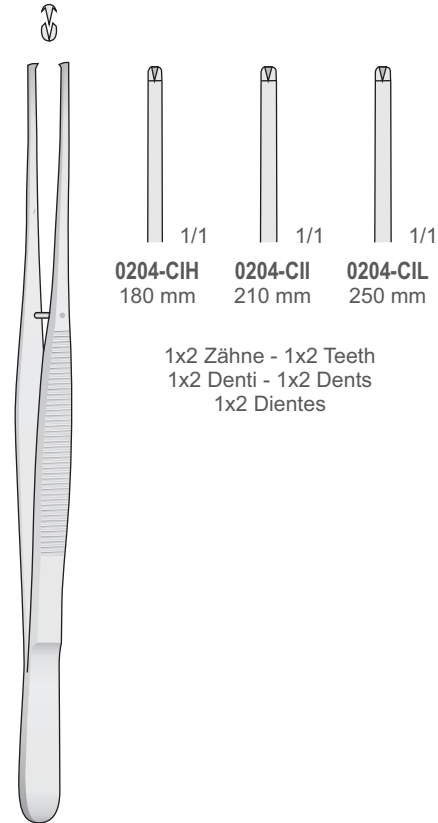

**0204-CIH** 180 mm  
**0204-CII** 210 mm  
**0204-CIL** 250 mm

1x2 Zähne - 1x2 Teeth  
1x2 Denti - 1x2 Dents  
1x2 Dientes

**POTTS-SMITH**  
**0204-CIH/0204-CIL**

Chirurgische Pinzetten, Atraumatische Pinzetten  
 Tissue Forceps, Non-traumatic Forceps  
 Pinzette chirurgiche, Pinzette atraumatiche  
 Pinzas quirurgicas, Pinzas atraumaticas  
 Pincas chirurgicales, Pincas atraumaticas

TC

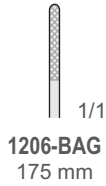

TC

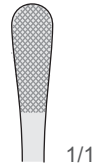

Mit Hartmetalleinlage  
 With Tungsten-carbide inserts  
 Con inserti al carburo di tungsteno  
 Pinzas con plaquetas de carburo de tungsteno  
 Avec plaquettes en carbure de tungstène

GERALD  
1206-BAG/1206-BAH  
175 mm

WANGENSTEEN  
0204-CDC  
150 mm

TC

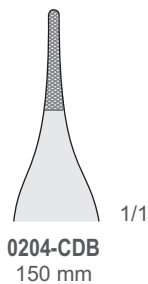
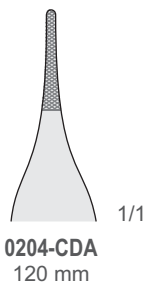
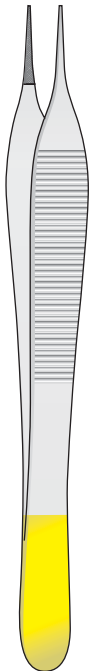

TC

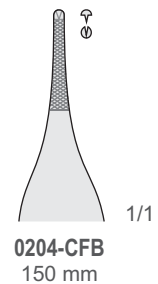
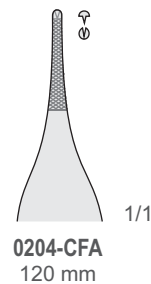
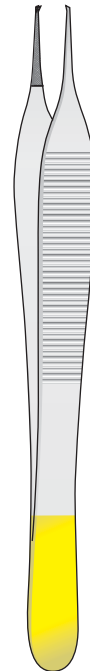

1x2 Zähne  
1x2 Teeth  
1x2 Denti  
1x2 Dientes  
1x2 Griffes

1x2 Zähne  
1x2 Teeth  
1x2 Denti  
1x2 Dientes  
1x2 Griffes

ADSON  
0204-CDA/0204-CDB

ADSON  
0204-CFA/0204-CFB



Chirurgische Pinzetten, Atraumatische Pinzetten  
 Tissue Forceps, Non-traumatic Forceps  
 Pinzette chirurgiche, Pinzette atraumatiche  
 Pinzas quirurgicas, Pinzas atraumaticas  
 Pincas chirurgicales, Pincas atraumatiques

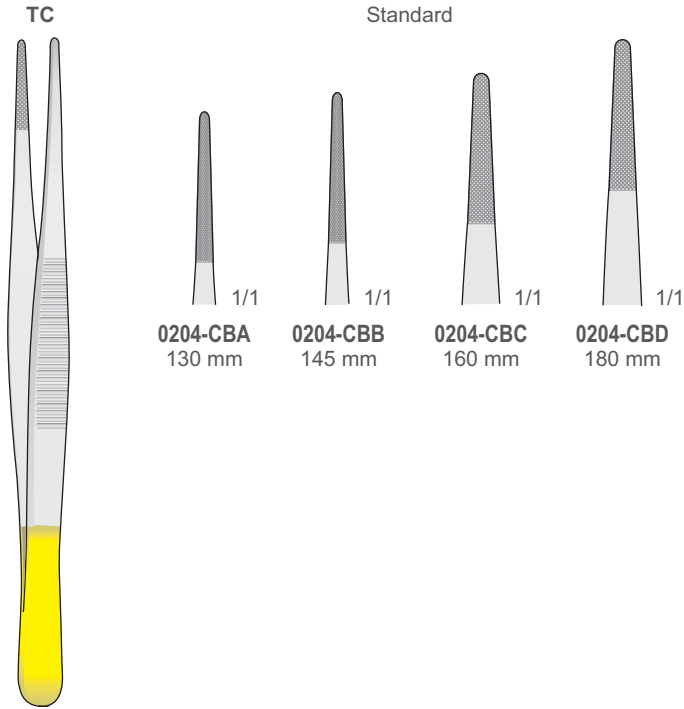

0204-CBA/0204-CBD

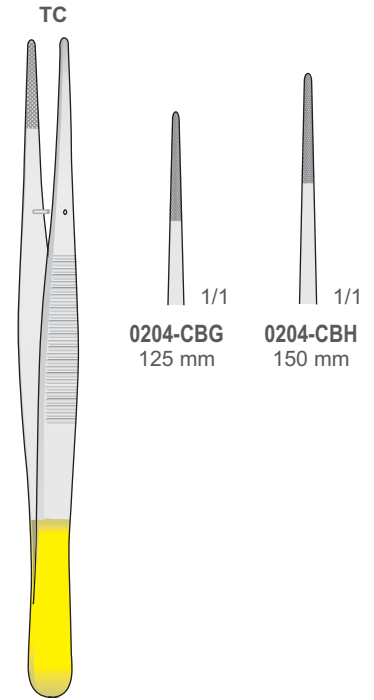

SEMKEN  
 0204-CBG/0204-CBH

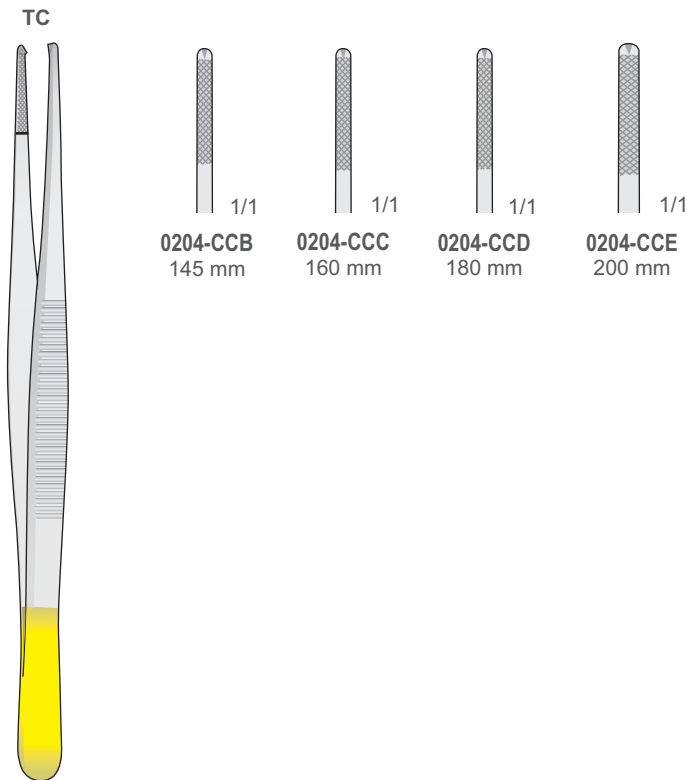

0204-CCB/0204-CCE

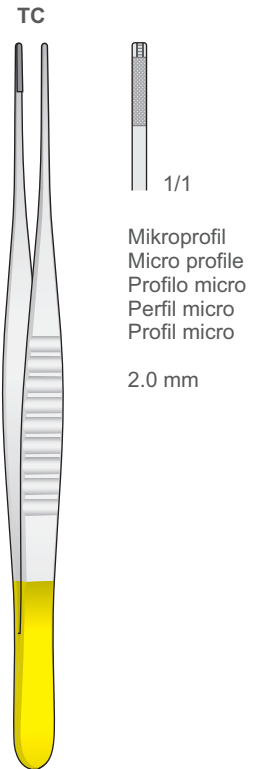

DE BAKEY  
 0204-CGH  
 160 mm

Mikroprofil  
 Micro profile  
 Profilo micro  
 Perfil micro  
 Profil micro  
 2.0 mm

Naht- und Membranpinzette - Suture and membrane Forceps  
Pinzette per suture e membrane - Pinzas para suturas y membranas  
Pincettes à suture et à membrane

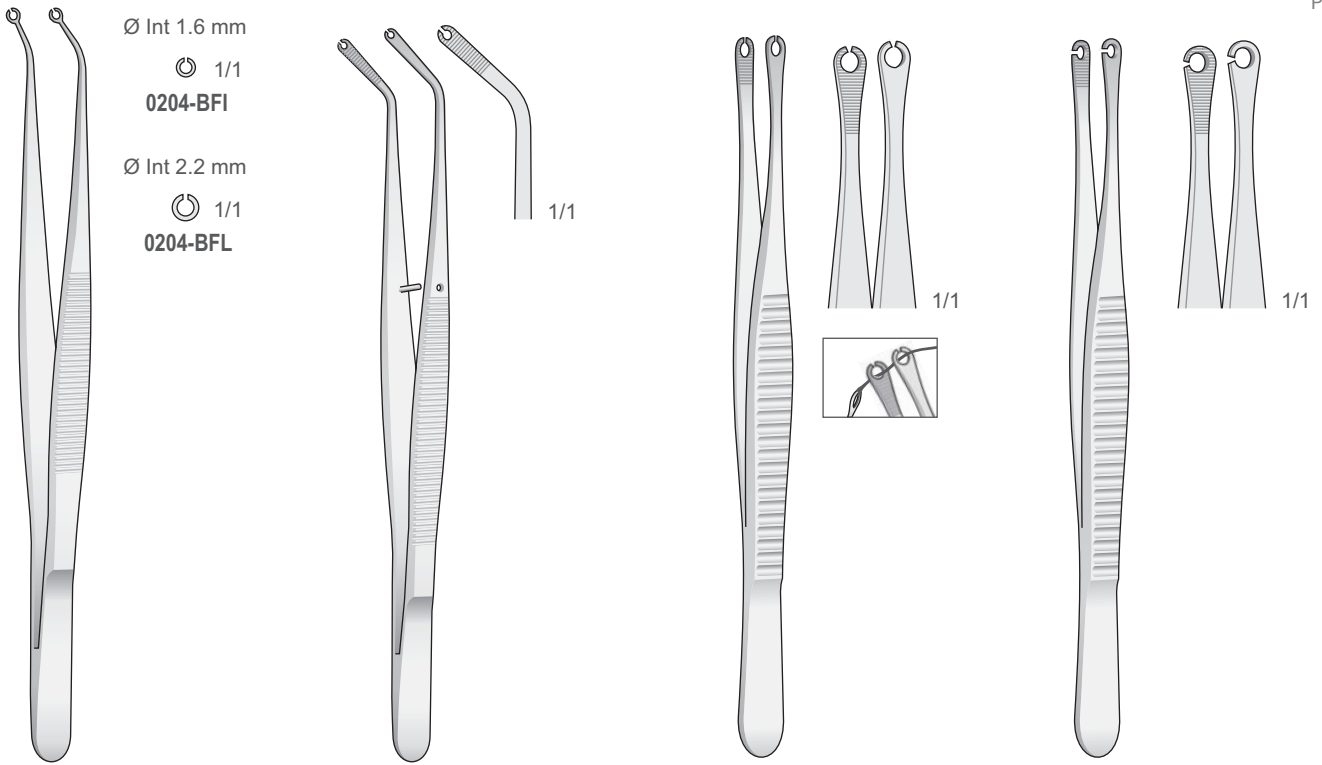

**0204-BFI/0204-BFL**  
160 mm

**CORN  
0401-AH**  
150 mm

**0401-AG**  
150 mm

**0401-AI**  
150 mm

Artikulationspapier-Pinzetten - Articulating Paper Forceps  
Pinza per carta articolazione - Pinzas para papel de articular  
Pince pour papier à articuler

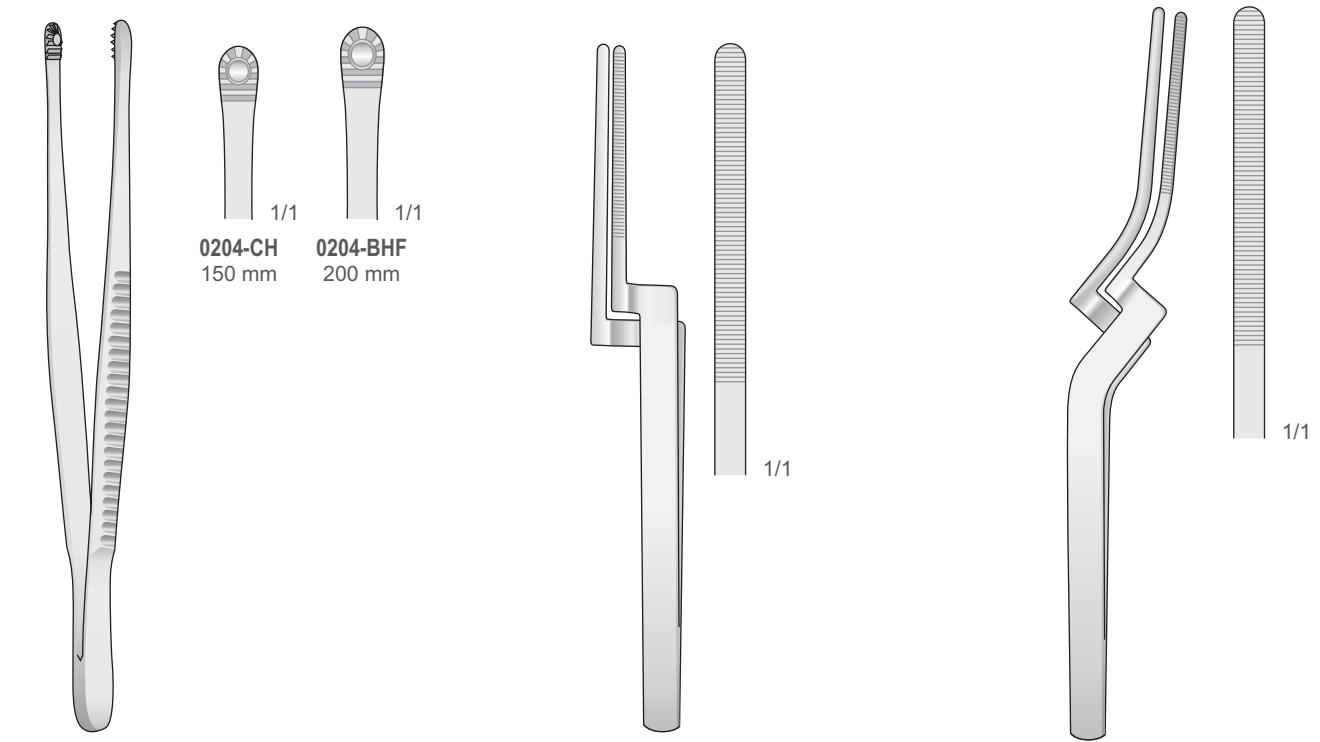

**RUSSIAN  
0204-CH/0204-BHF**

**MILLER  
0417-HI**  
145 mm

**MILLER  
0417-IA**  
160 mm

.6

Nadelhalter  
Needle Holders  
Port'aghi  
Portaagujas  
Porte aiguilles

Zahnärztliche Chirurgie  
Dental surgery  
Chirurgia dentale  
Cirugia dental  
Chirurgie dentaire

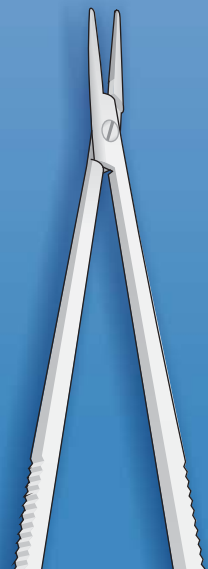



Mit Scheren  
With Scissor  
Con forbice  
Con tijeras  
Avec ciseaux

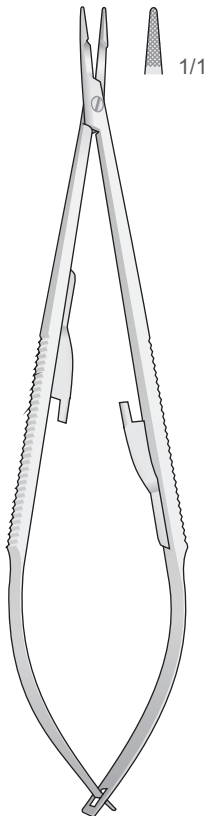

**0604-CG**  
140 mm

1/1 1/1  
**0604-BE** 140 mm  
**0604-BG** 140 mm

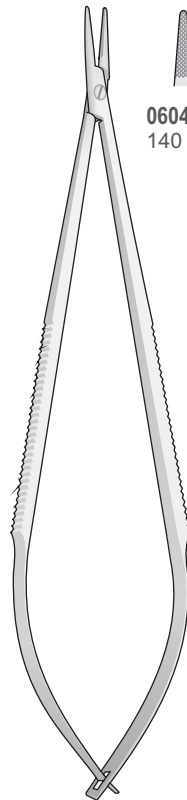

**0604-BE/0604-BG**  
140 mm

Glattes Maul  
Smooth jaws  
Con morso liscio  
Mandibula lisa  
A' mors lisse

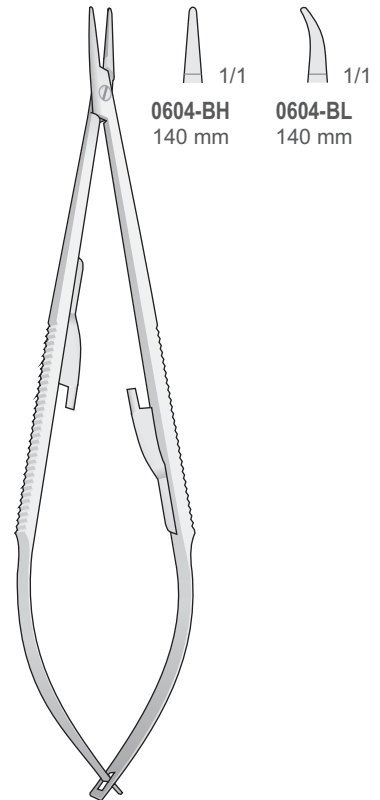

CASTROVIEJO  
**0604-BH/0604-BL**  
140 mm

Mit Sperre - With Lock  
Con arresto - Con cierre  
Avec Arrêt

Glattes Maul  
Smooth Jaw  
Morso liscio  
Boca lisa  
Mors lisse

Feingerieftes Maul  
Fine serrated jaws  
Morso zigrinato fine  
Bocas estriadas finas  
Mors stries fins

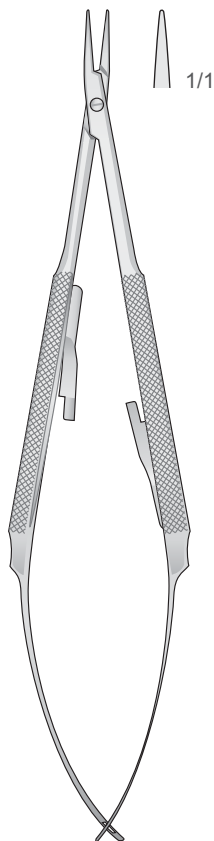

**BARRAQUER**  
**0604-CBG**  
150 mm

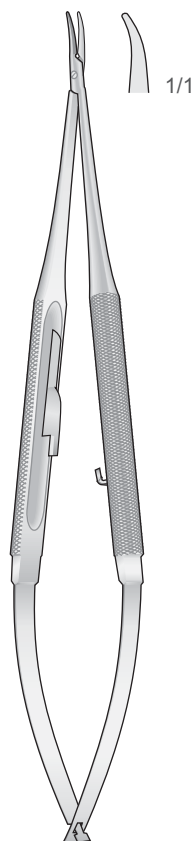

**BARRAQUER**  
**0604-CBH**  
150 mm

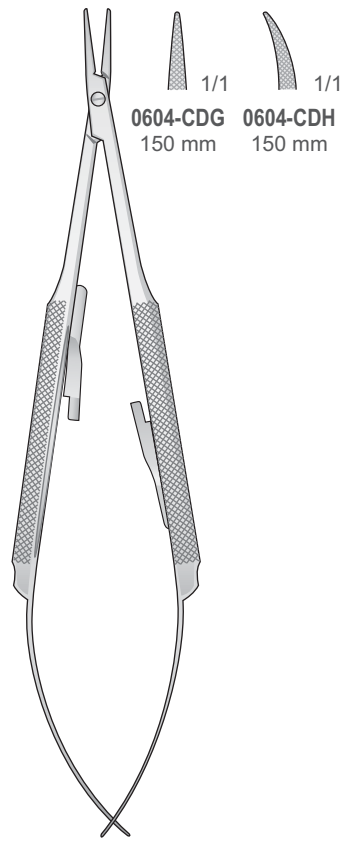

**BARRAQUER**  
**0604-CDG/0604-CDH**  
150 mm

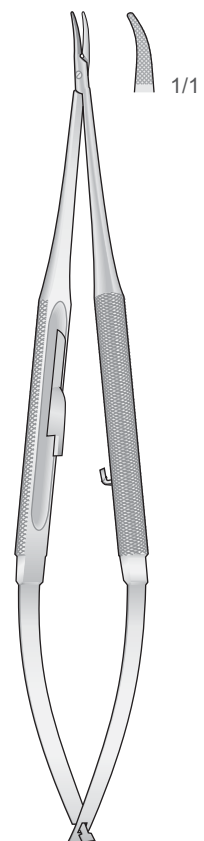

**BARRAQUER**  
**0604-CE**  
150 mm





Nadelhalter mit Hartmetalleinlagen  
Needle Holders with tungsten-carbide inserts  
Portaghi con inserti al tungsteno  
Portaagujas con plaquetas de carburo de tungsteno  
Porte aiguilles avec plaquettes en carbure de tungstène

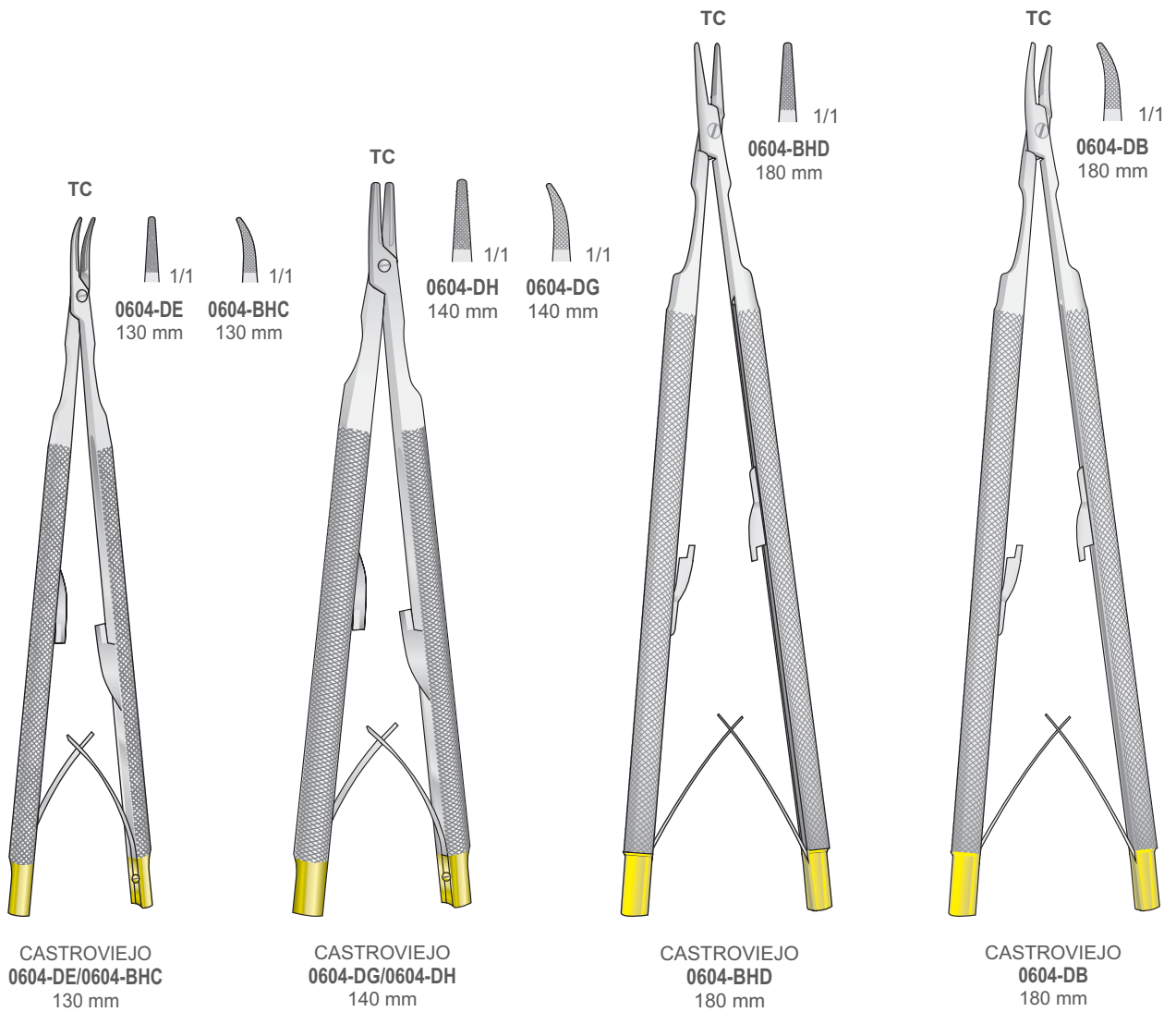

Nadelhalter mit Hartmetalleinlagen  
Needle Holders with tungsten-carbide inserts  
Portaghi con inserti al tungsteno  
Portaagujas con plaquitas de carburo de tungsteno  
Porte aiguilles avec plaquettes en carbure de tungstène

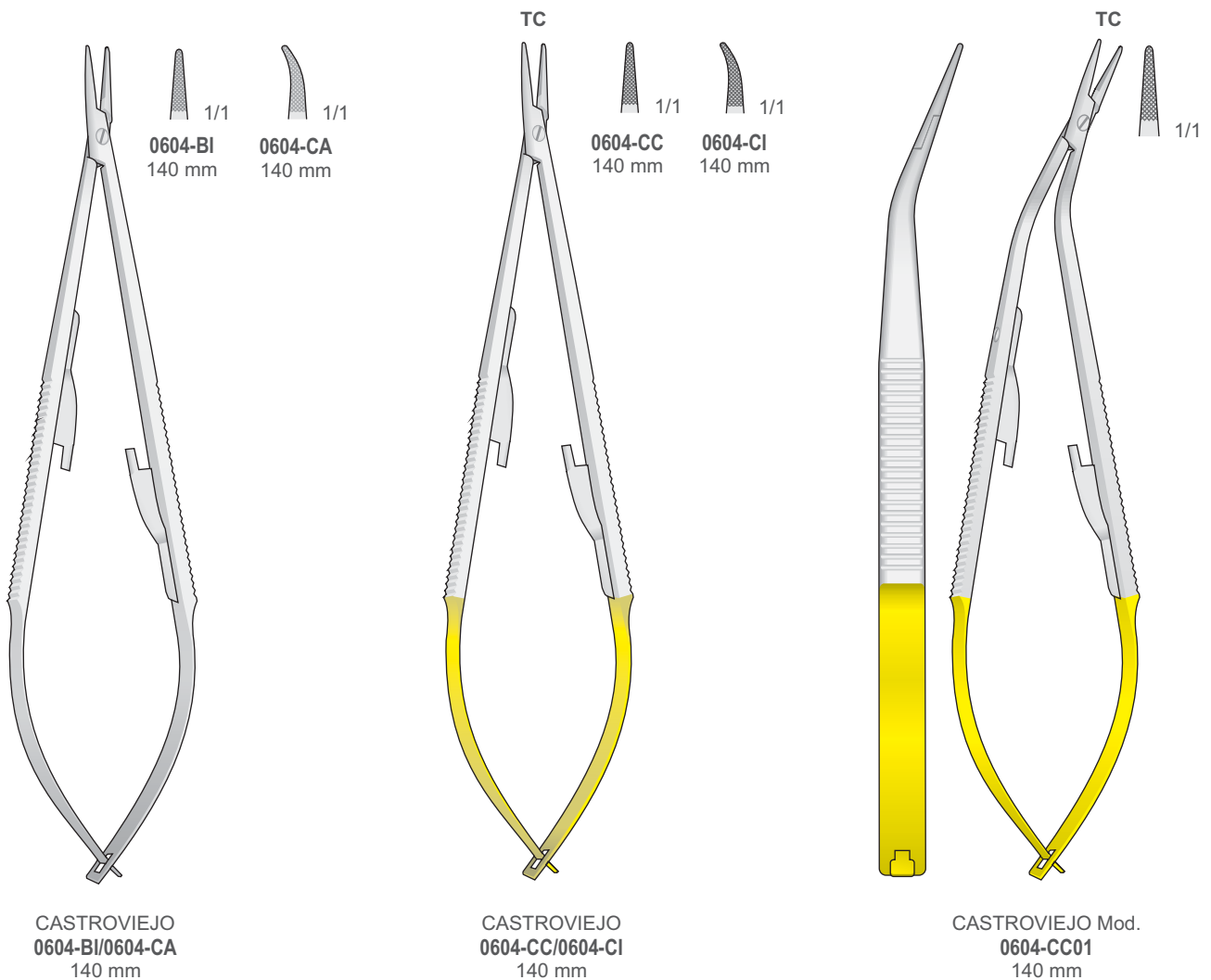



Nadelhalter mit Hartmetalleinlagen  
Needle Holders with tungsten-carbide inserts  
Portaghi con inserti al tungsteno  
Portaagujas con plaquetas de carburo de tungsteno  
Porte aiguilles avec plaquettes en tungstène

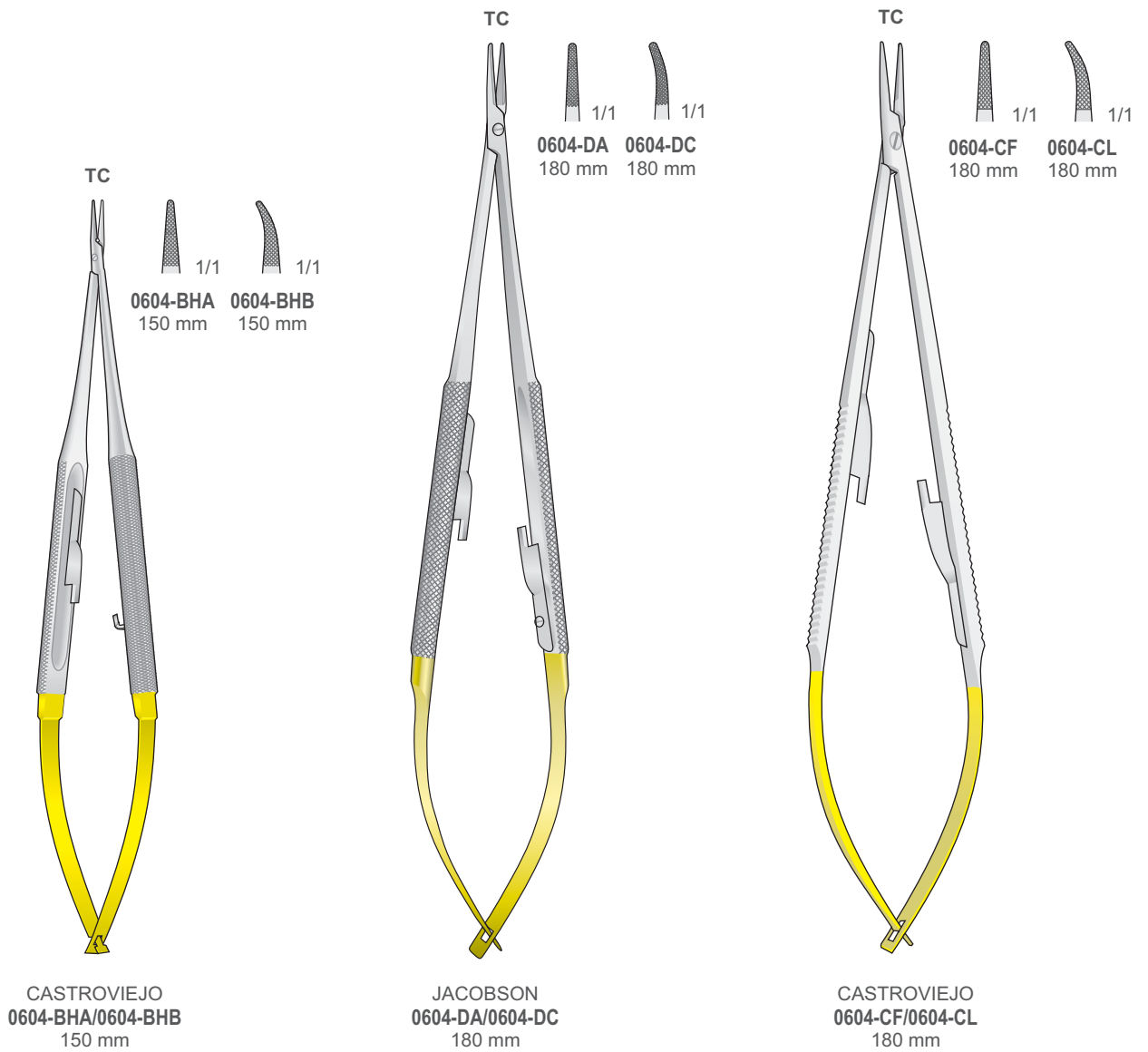

Nadelhalter mit Hartmetalleinlagen  
Needle Holders with tungsten-carbide inserts  
Portaghi con inserti al tungsteno  
Portaagujas con plaquitas de carburo de tungsteno  
Porte aiguilles avec plaquettes en carbure de tungstène

Diamantiert  
Diamond Coated  
Diamantati

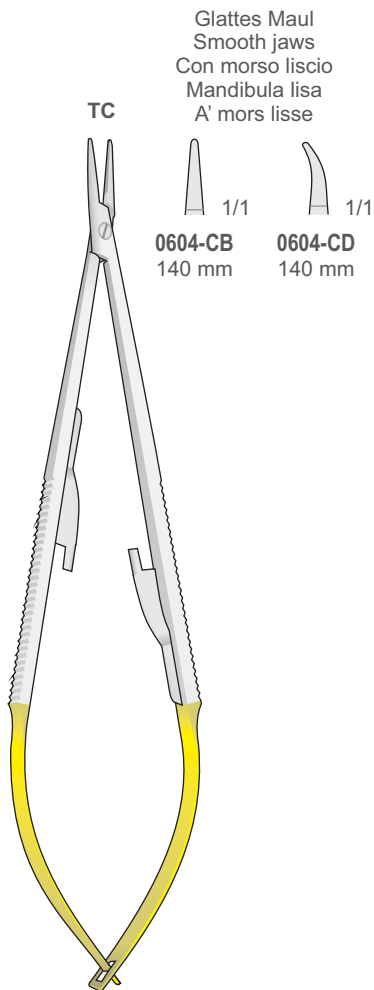

CASTROVIEJO  
**0604-CB/0604-CD**  
140 mm

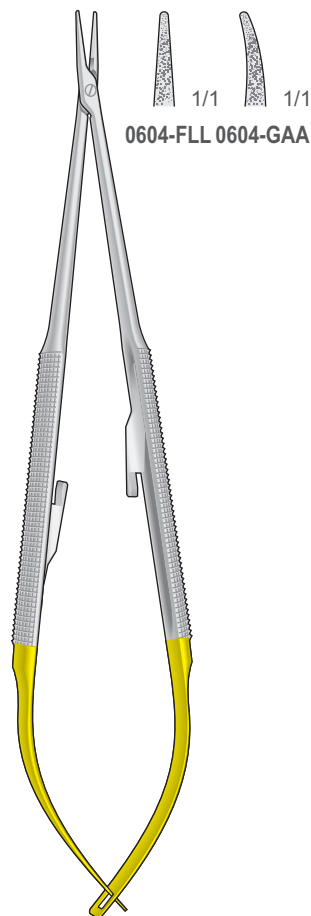

**0604-FLL/0604-GAA**  
150 mm

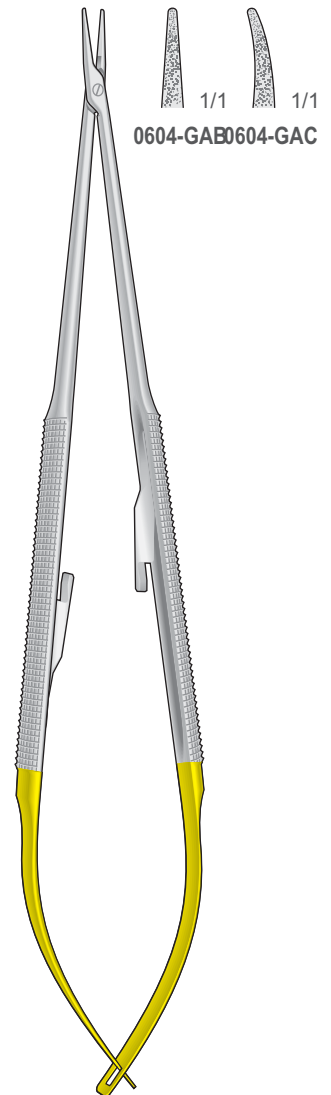

**0604-GAB/0604-GAC**  
180 mm

**Titan - Titanium - Titanio - Titane**

Rund-Griffe Ø 8 mm  
 Round handle Ø 8 mm  
 Manico rotondo Ø 8 mm  
 Mango redondo Ø 8 mm  
 Manche rond Ø 8 mm

Mikro Nadelhalter  
 Micro Needle Holders  
 Micro port'aghi  
 Micro portaagujas  
 Micro porte aiguilles

Mikro Scheren  
 Micro Scissors  
 Micro forbici  
 Micro tijeras  
 Micro ciseaux

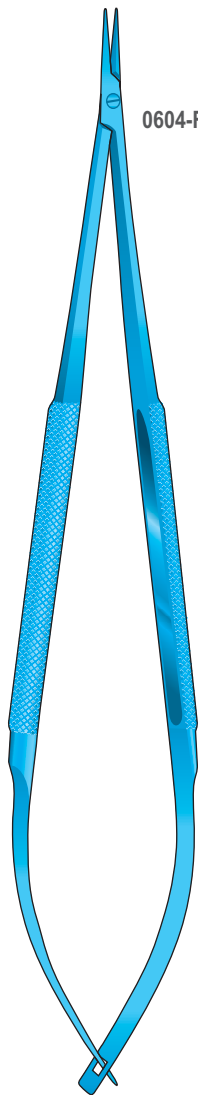

1/1 1/1  
 0604-FGC19 0604-FGD19

0604-FGC19/0604-FGD19  
 180 mm

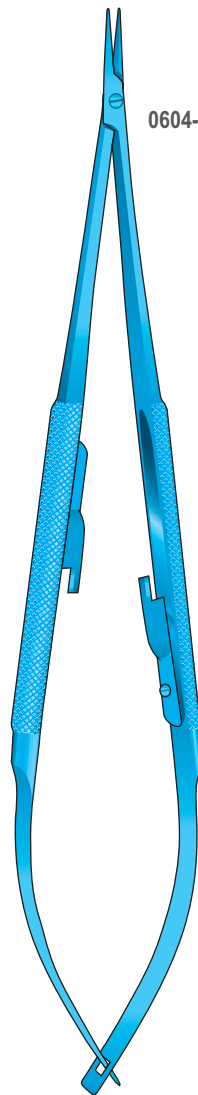

1/1 1/1  
 0604-FHE19 0604-FHF19

Mit Sperre  
 With Lock  
 Con arresto  
 Con cierre  
 Avec Arrêt

0604-FHE19/0604-FHF19  
 180 mm

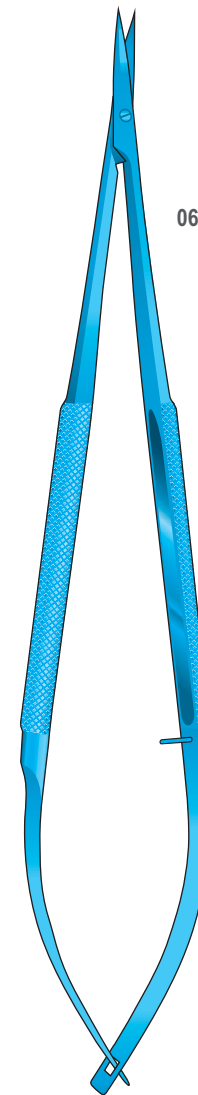

1/1 1/1  
 0604-FIH19 0604-FII19

0604-FIH19/0604-FII19  
 180 mm

Nadelhalter mit Hartmetalleinlagen  
Needle Holders with tungsten-carbide inserts  
Portaghi con inserti al tungsteno  
Portaagujas con plaquitas de carburo de tungsteno  
Porte aiguilles avec plaquettes en carbure de tungstène

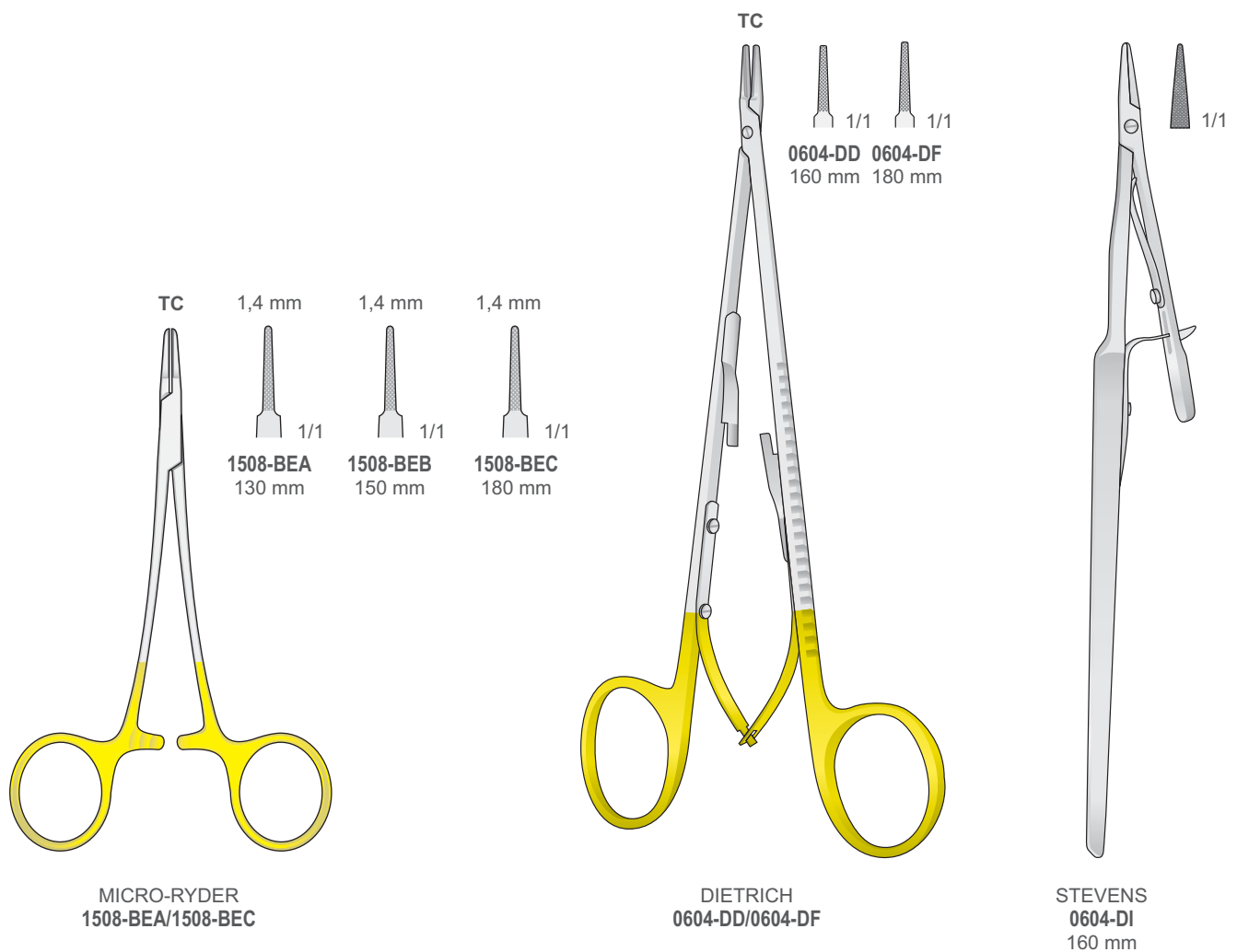

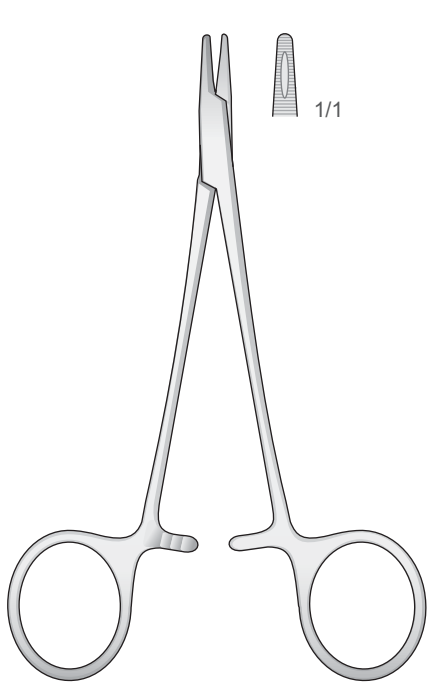

DERF  
1508-DL  
125 mm

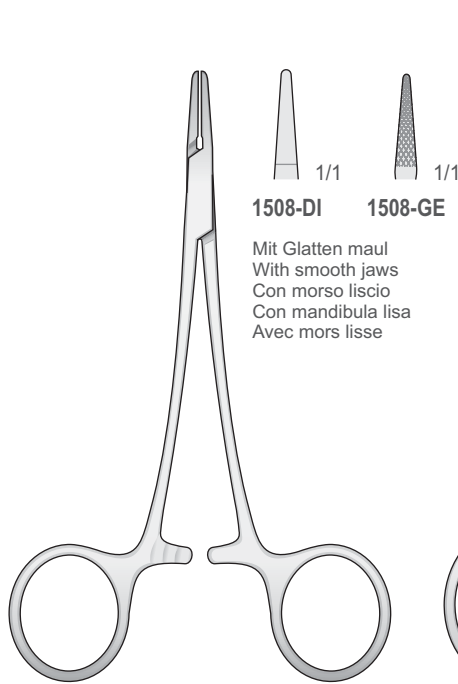

1508-DI/1508-GE  
120 mm

Mit Glatten maul  
With smooth jaws  
Con morso liscio  
Con mandibula lisa  
Avec mors lisse

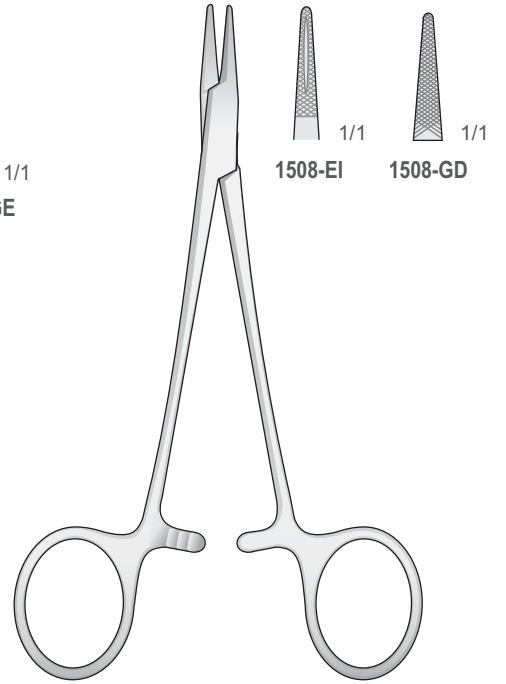

HALSEY  
1508-EI/1508-GD  
130 mm

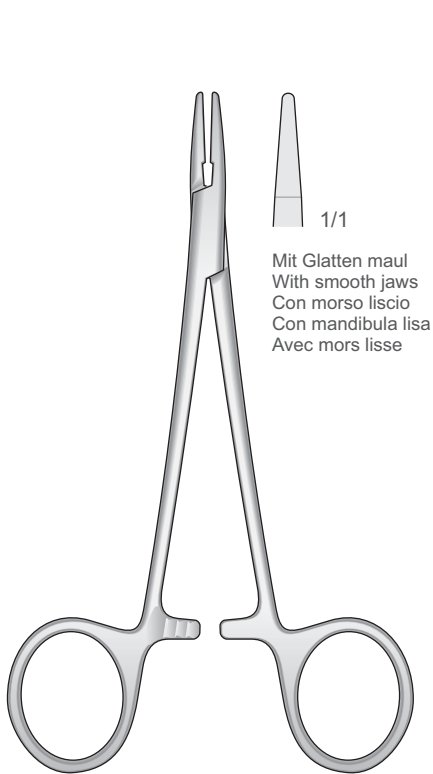

HALSEY  
1508-DH  
130 mm

Mit Glatten maul  
With smooth jaws  
Con morso liscio  
Con mandibula lisa  
Avec mors lisse

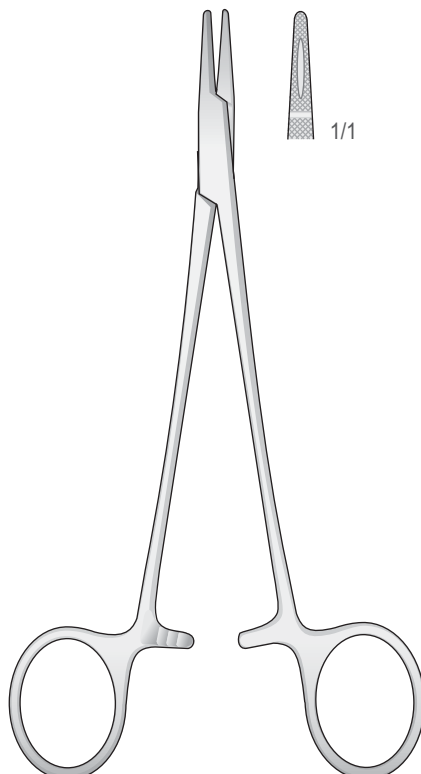

CRILE-WOOD  
1508-GB  
150 mm

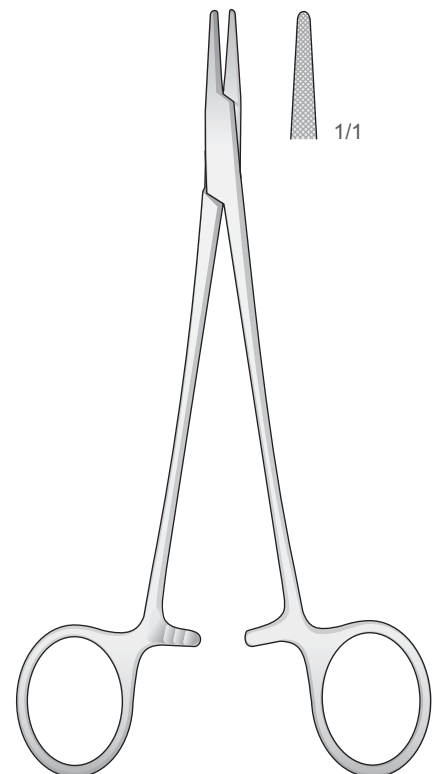

CRILE-MURRAY  
1508-GC  
150 mm

Nadelhalter mit Schere - Needle holders with scissors  
Port'aghi con forbici - Portaagujas con tijeras  
Porte aiguilles avec ciseaux

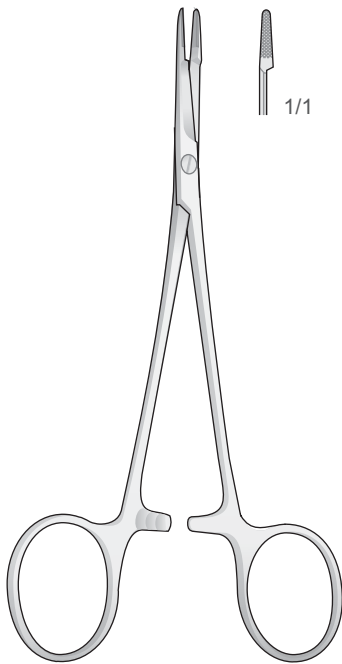

MINI-OLSEN-HEGAR  
**0212-GB**  
120 mm

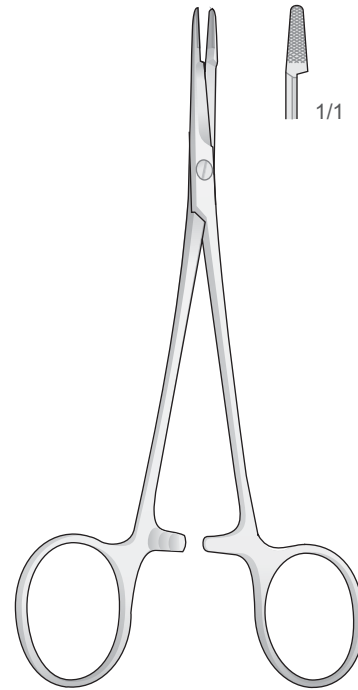

OLSEN-HEGAR  
**0212-GC**  
140 mm

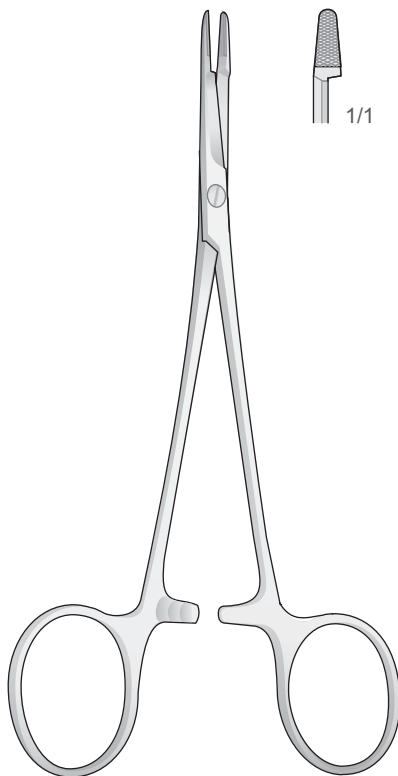

OLSEN-HEGAR  
**0212-GD**  
170 mm

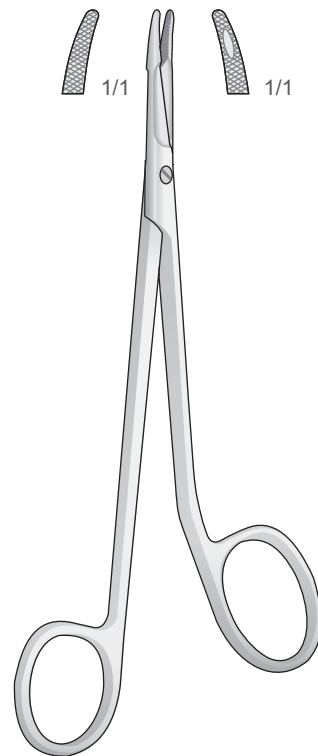

MINI-GILLIES  
**1514-FL**  
145 mm



Nadelhalter mit Hartmetalleinlagen  
Needle holders with tungste-carbide inserts  
Portaghi con inserti al tungsteno  
Portaagujas con plaquitas de carburo de tungsteno  
Porte-aiguilles avec plaquettes en carbure de tungstène

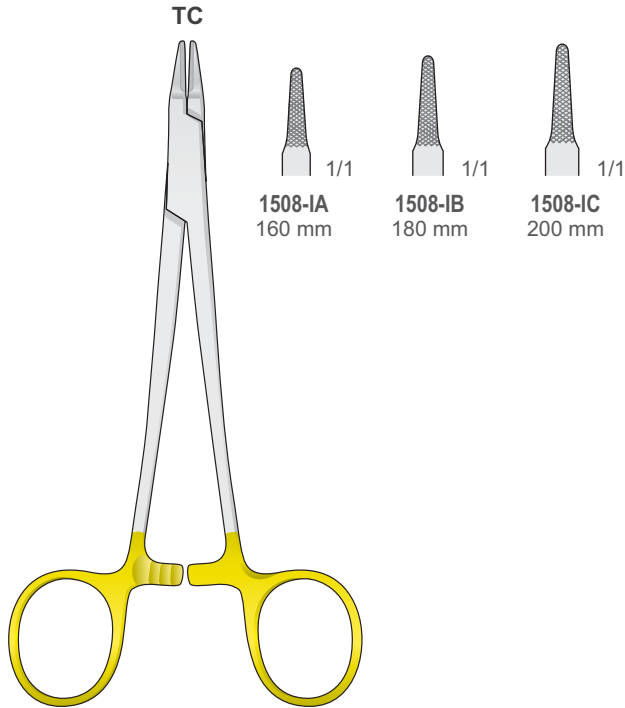

RYDER  
1508-IA/1508-IC

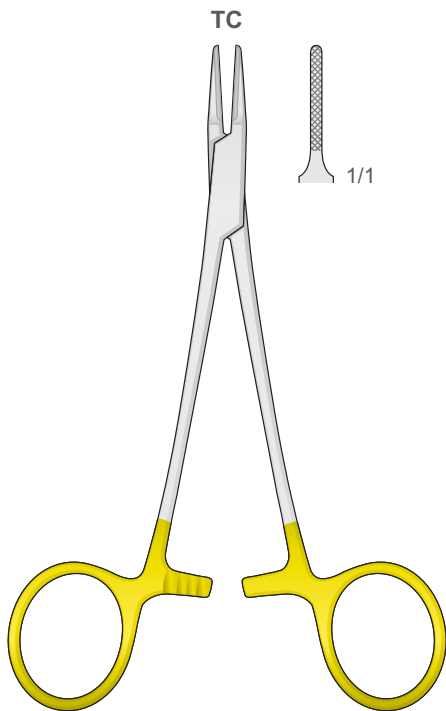

RYDER  
1508-ID  
140 mm

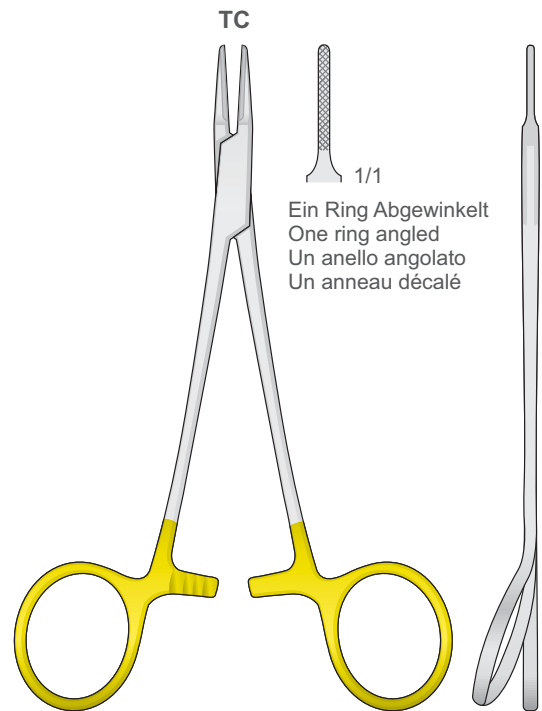

1508-IE  
140 mm

Ein Ring Abgewinkelt  
One ring angled  
Un anello angolato  
Un anneau décalé

Nadelhalter mit Hartmetalleinlagen  
Needle holders with tungste-carbide inserts  
Portaghi con inserti al tungsteno  
Portaagujas con plaquitas de carburo de tungsteno  
Porte-aiguilles avec plaquettes en carbure de tungstène

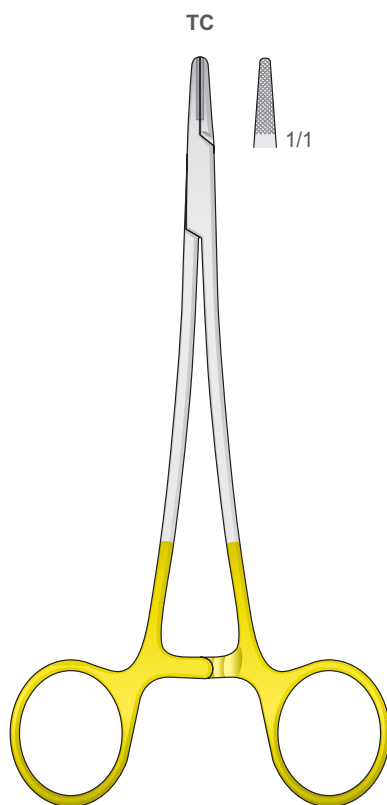

**1508-HL**  
145 mm

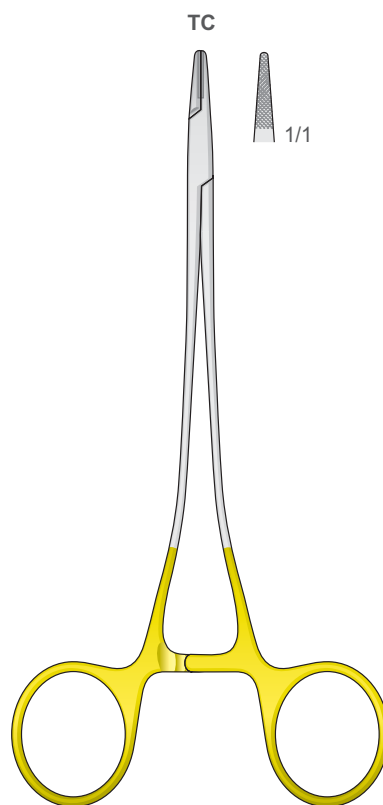

FINE SWEDISH PATTERN  
**1508-IF**  
150 mm

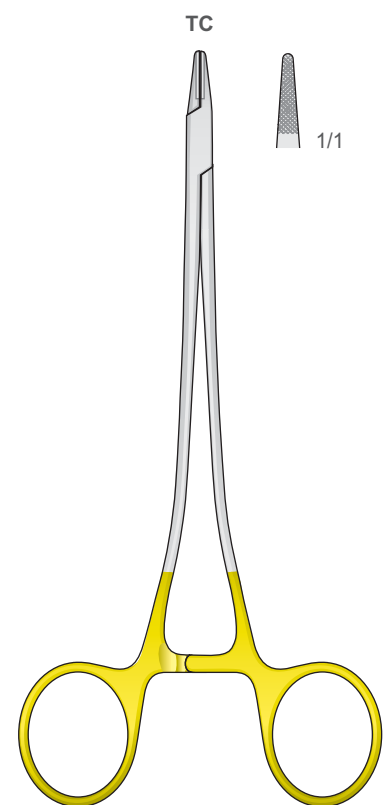

SWEDISH MOD.  
**1508-BAG**  
150 mm

Nadelhalter mit Hartmetalleinlagen - Needle Holders with tungsten-carbide inserts  
Portaghi con inserti al tungsteno - Porte aiguilles avec plaquettes en carbure de tungstène  
Portaagujas con plaquitas de carburo de tungsteno

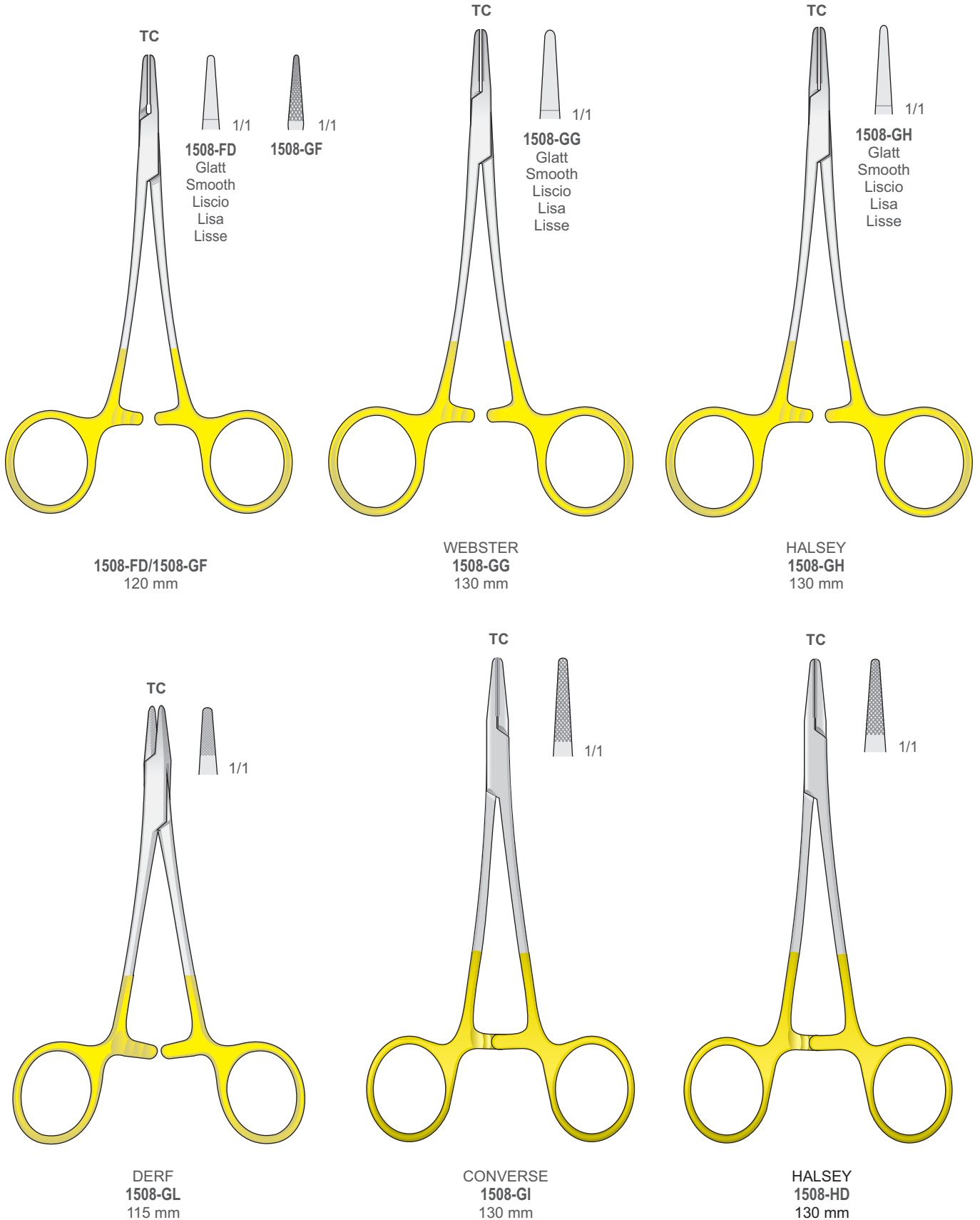

Nadelhalter mit Hartmetalleinlagen - Needle Holders with tungsten-carbide inserts  
 Portaghi con inserti al tungsteno - Porte aiguilles avec plaquettes en carbure de tungstène  
 Portaagujas con plaquitas de carburo de tungsteno

Nadelhalter  
 Needle Holders  
 Port'aghi  
 Portaagujas  
 Porte aiguilles

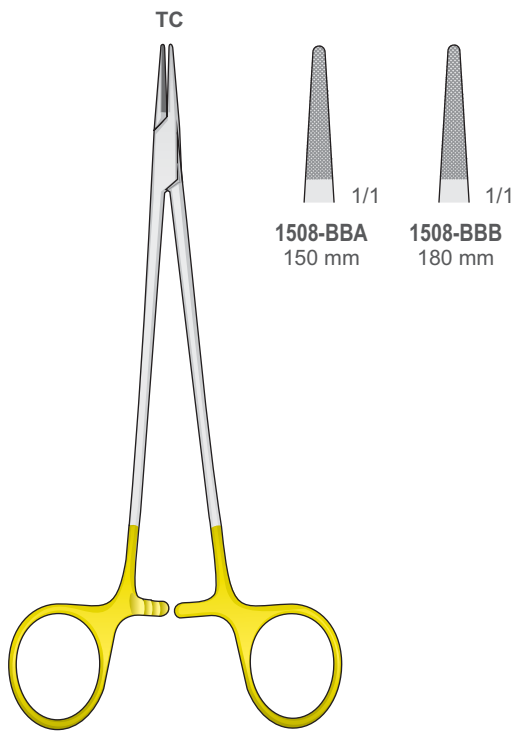

DE BAKEY  
1508-BBA/1508-BBB

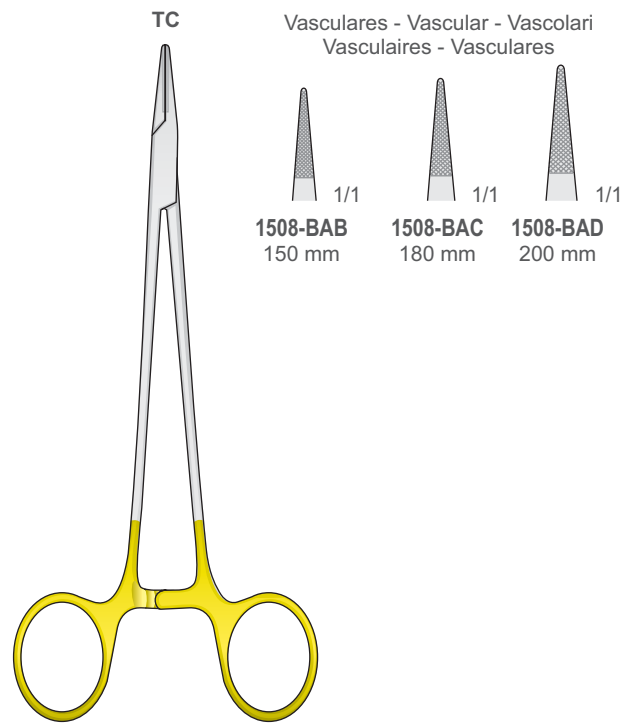

MICRO-VASCULAR  
1508-BAB/1508-BAD

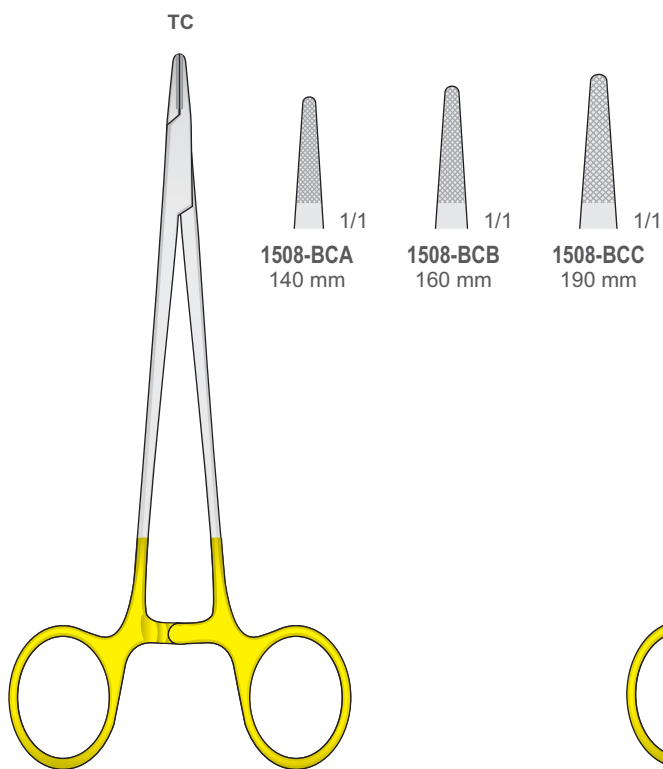

MAYO-HEGAR  
1508-BCA/1508-BCC

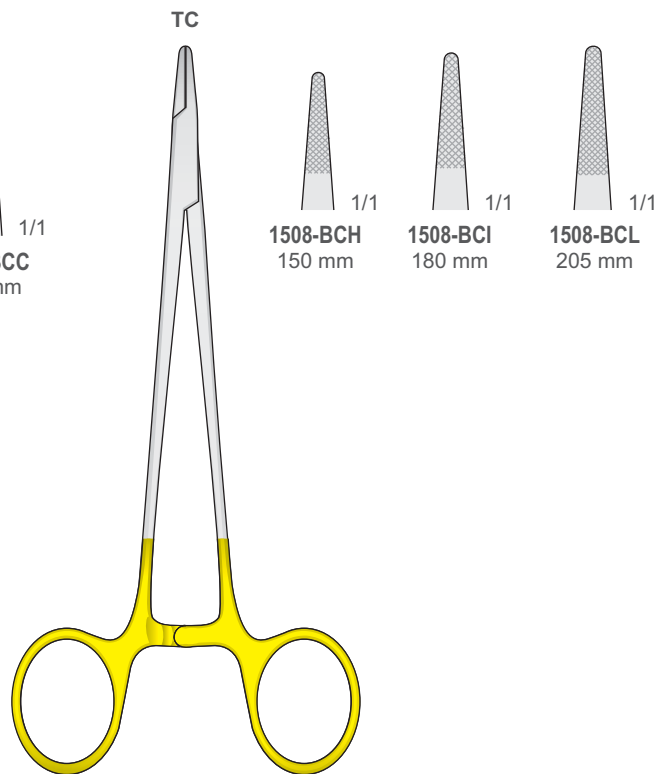

MAYO-HEGAR-FINO  
1508-BCH/1508-BCL

Nadelhalter mit Hartmetalleinlagen - Needle Holders with tungsten-carbide inserts  
Portaghi con inserti al tungsteno - Portaagujas con plaquitas de carburo de tungsteno  
Porte aiguilles avec plaquettes en carbure de tungstène

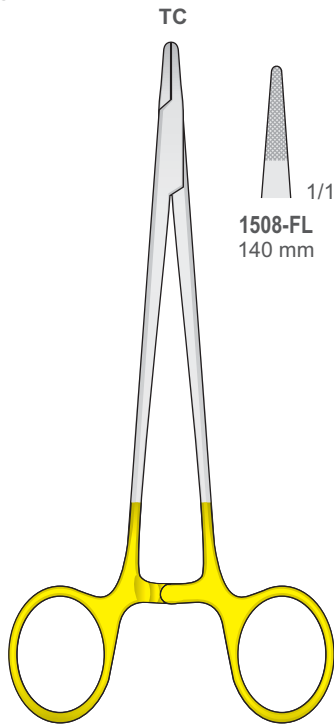

HEGAR  
1508-FL/1508-HG

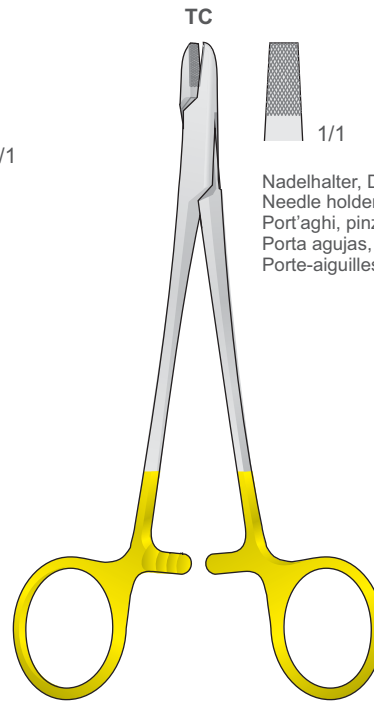
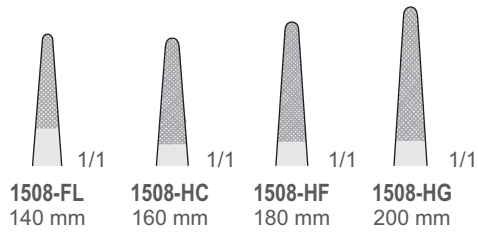

1508-FI  
150 mm

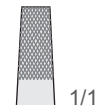

Nadelhalter, Draht-Zangen  
Needle holder, wire forceps  
Port'aghi, pinze per fili d'acciaio  
Porta agujas, pinzas para hilos  
Porte-aiguilles, pinces à saisir

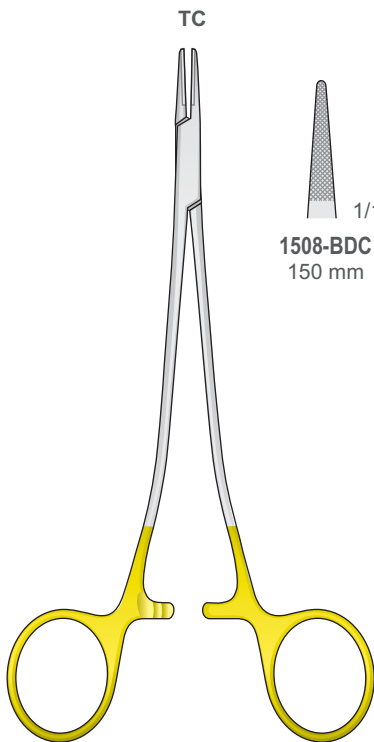

SAROT  
1508-BDC/1508-BDE

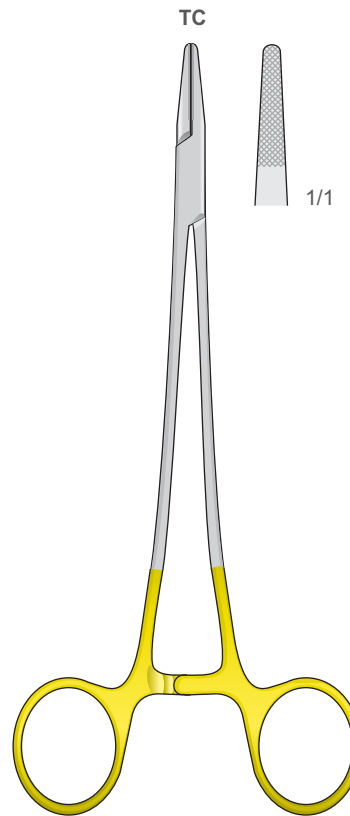
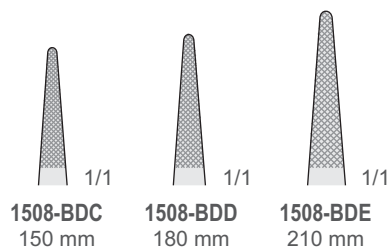

CRILE-WOOD  
1508-HH  
180 mm

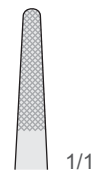

Nadelhalter mit Hartmetalleinlagen - Needle Holders with tungsten-carbide inserts  
 Portaghi con inserti al tungsteno - Portaagujas con plaquitas de carburo de tungsteno  
 Porte aiguilles avec plaquettes en carbure de tungstène

Nadelhalter  
 Needle Holders  
 Port'aghi  
 Portaagujas  
 Porte aiguilles

Ein Ring abgewinkelt  
 One ring angled  
 Un anello angolato  
 Un anneau décalé

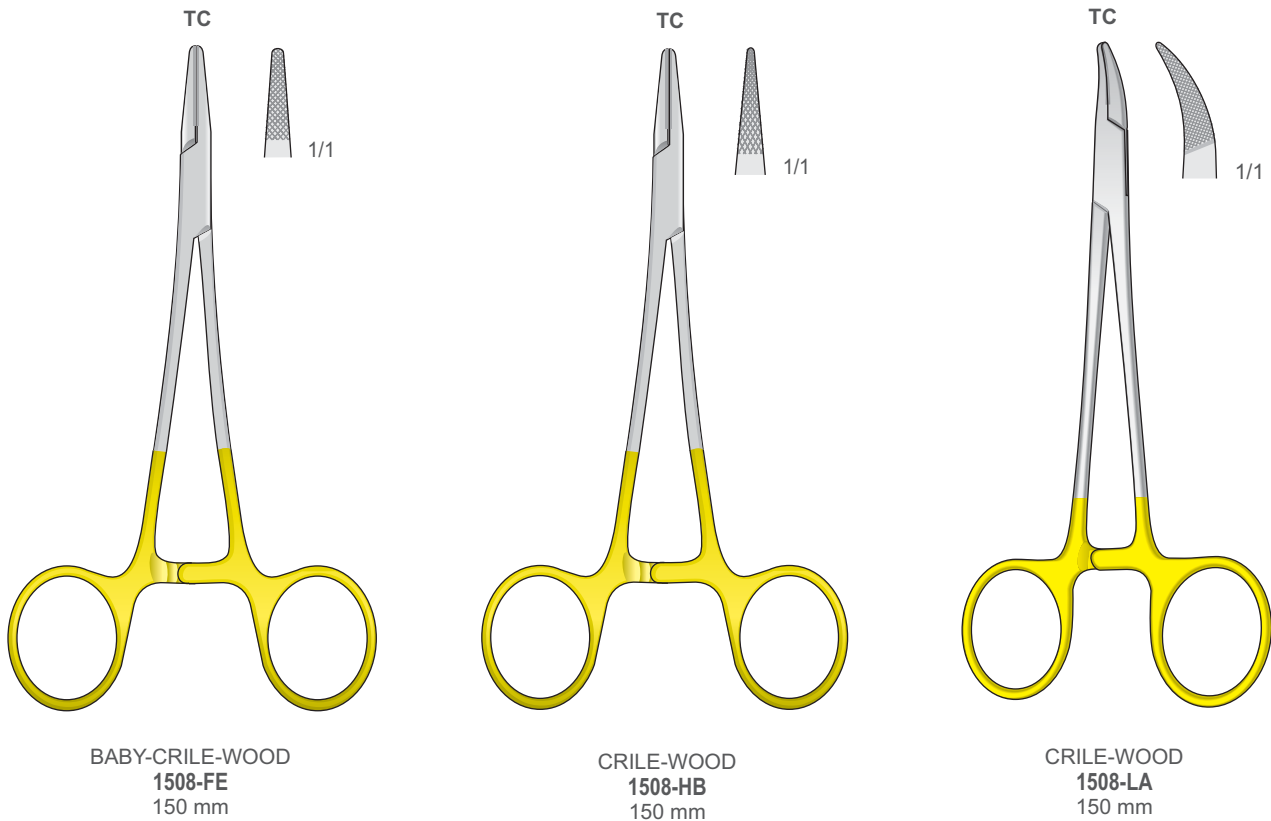
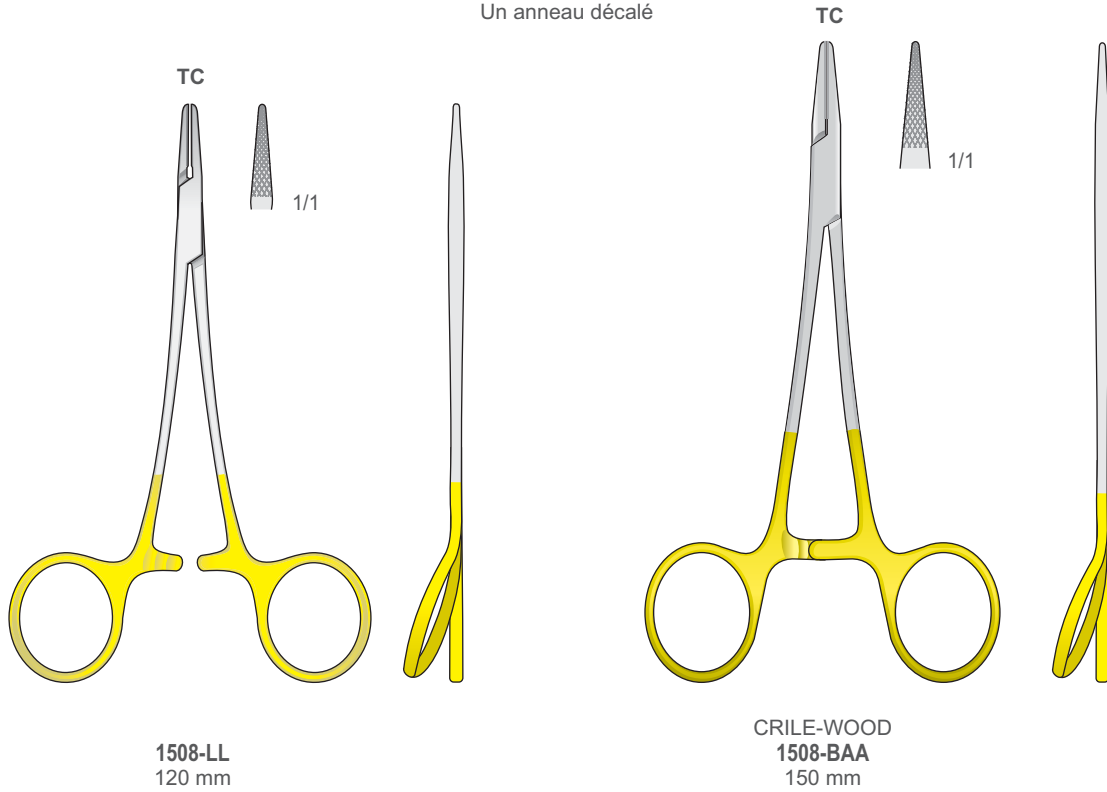

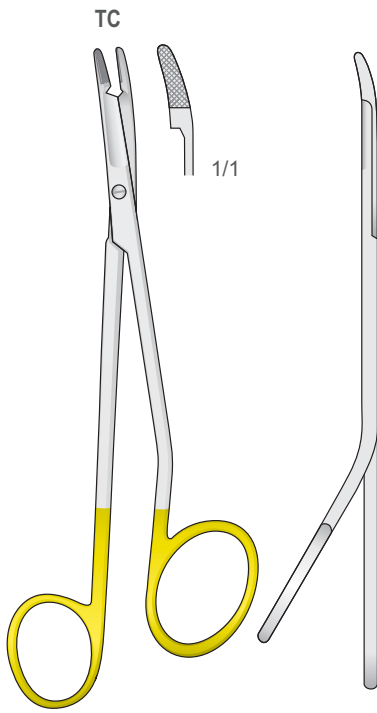

MINI-GILLIES  
1514-LL  
145 mm

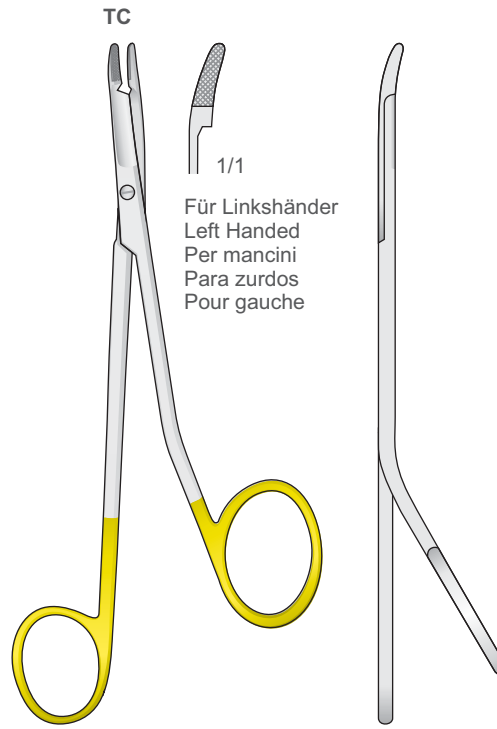

MINI-GILLIES  
1514-LL11  
145 mm

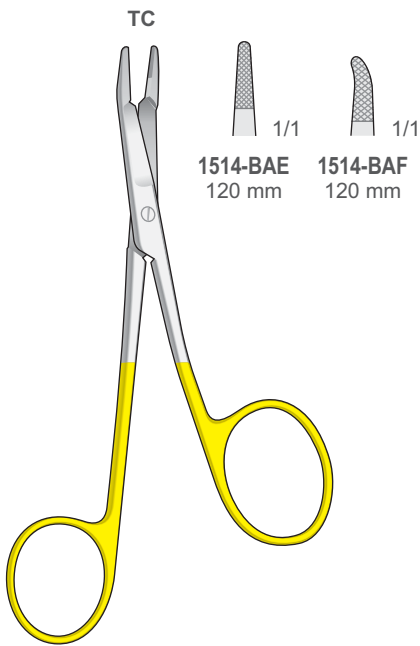

FOSTER-GILLIES  
1514-BAE/1514-BAF  
120 mm

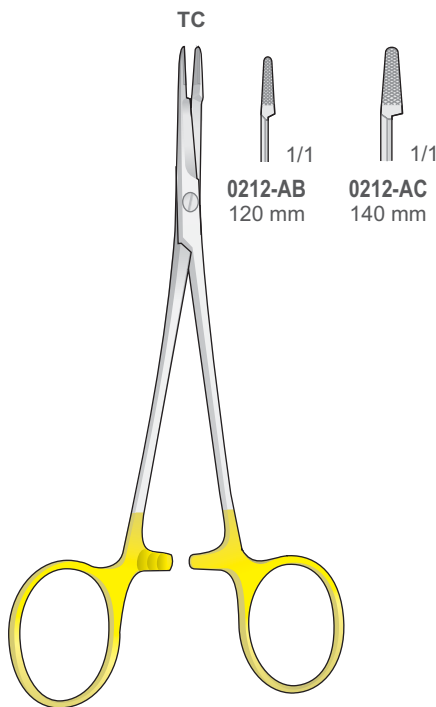

OLSEN-HEGAR  
0212-AB/0212-AC

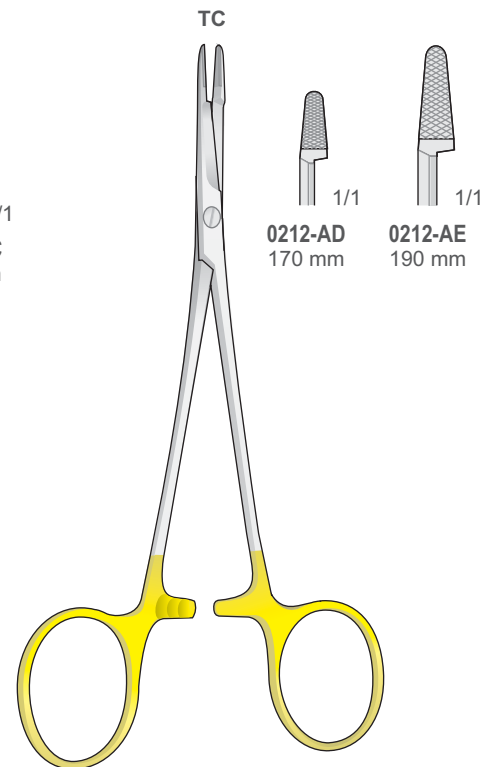

OLSEN-HEGAR  
0212-AD/0212-AE

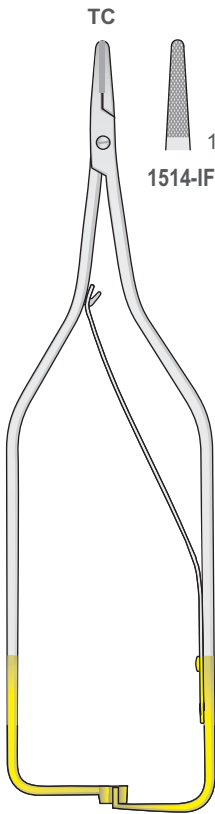

ARRUGA  
1514-IF/1514-IH  
160 mm

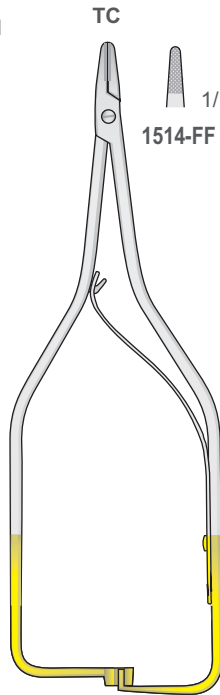

BOYNTON  
1514-FF/1514-FG  
120 mm

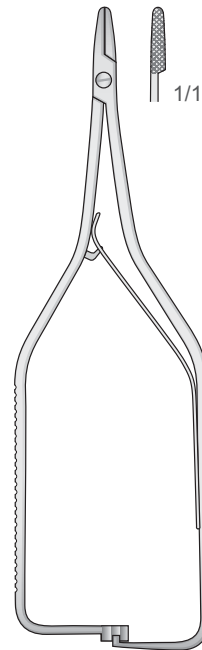

BOYNTON  
1514-II  
120 mm

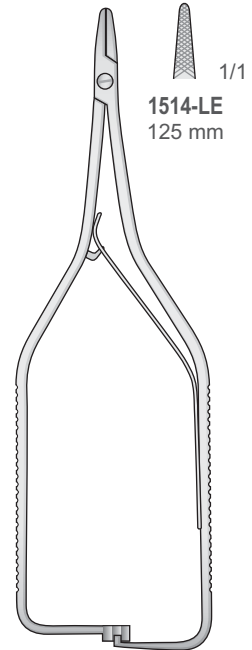

BOYNTON  
1514-LE  
125 mm

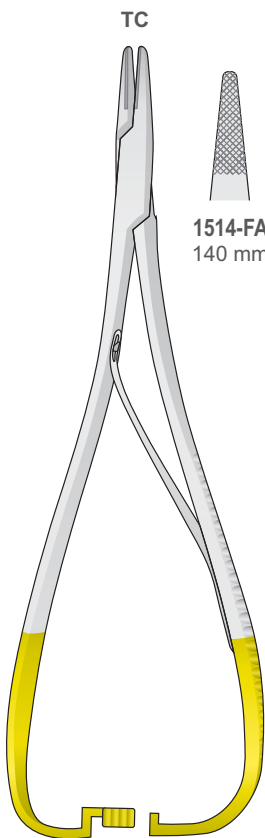

MATHIEU  
1514-FA/1514-FC

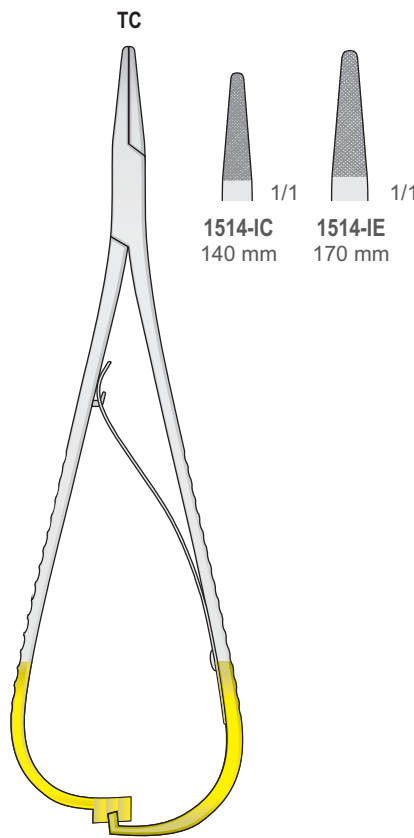

MATHIEU  
1514-IC/1514-IE

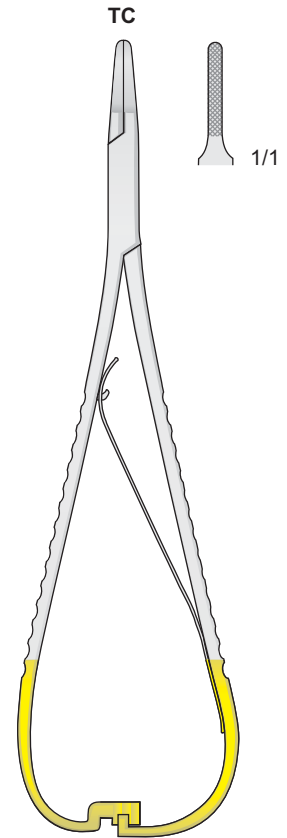

LICHTENBERG  
1514-IG  
175 mm



Nadelhalter  
Needle Holders  
Port'aghi  
Portaagujas  
Porte aiguilles

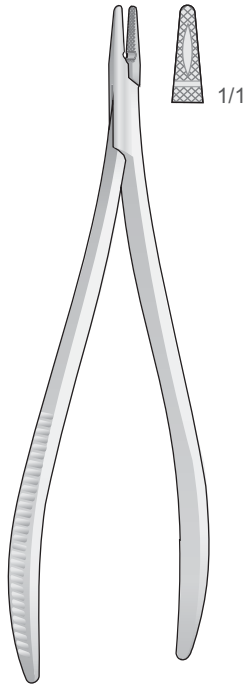

CRILE  
1514-DH  
150 mm

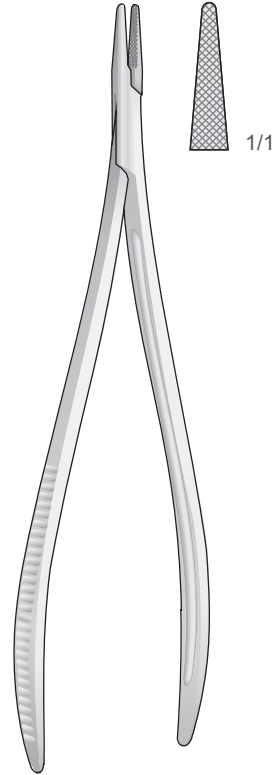

TÖNNIS  
1514-DI  
190 mm

Schlankesmodell - Delicate pattern - Modello fine  
Modelo delegado - Modèle fin

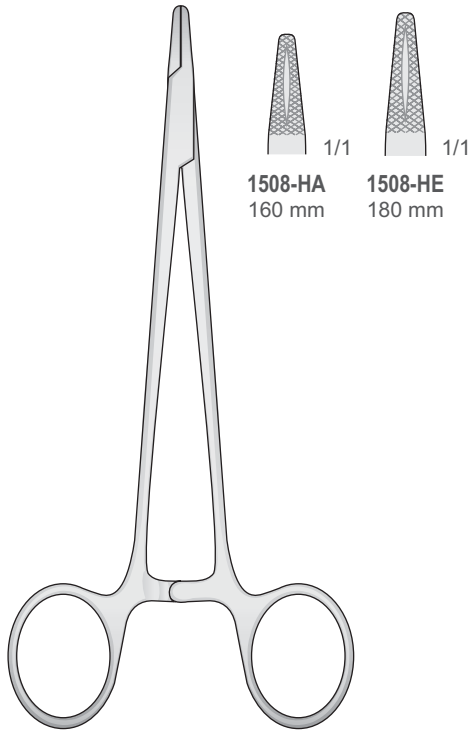

HEGAR  
1508-HA/1508-HE

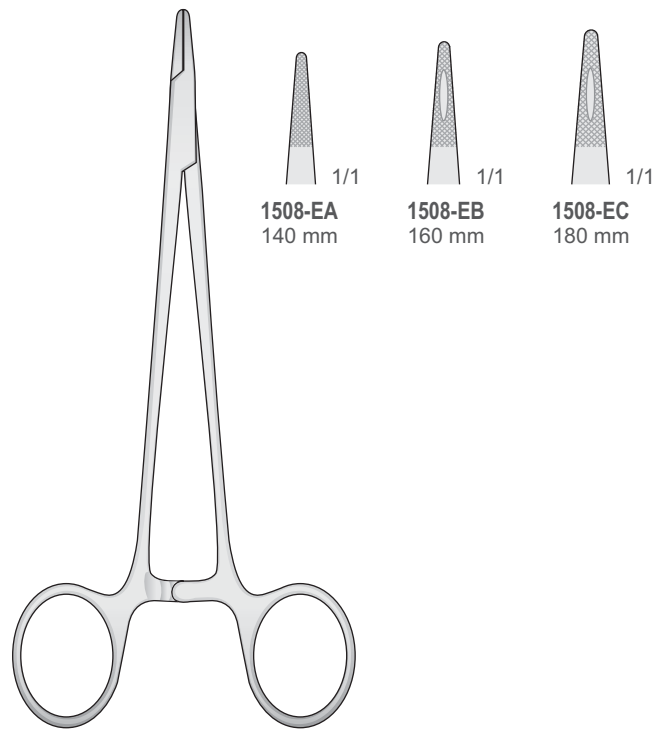

MAYO-HEGAR  
1508-EA/1508-EC

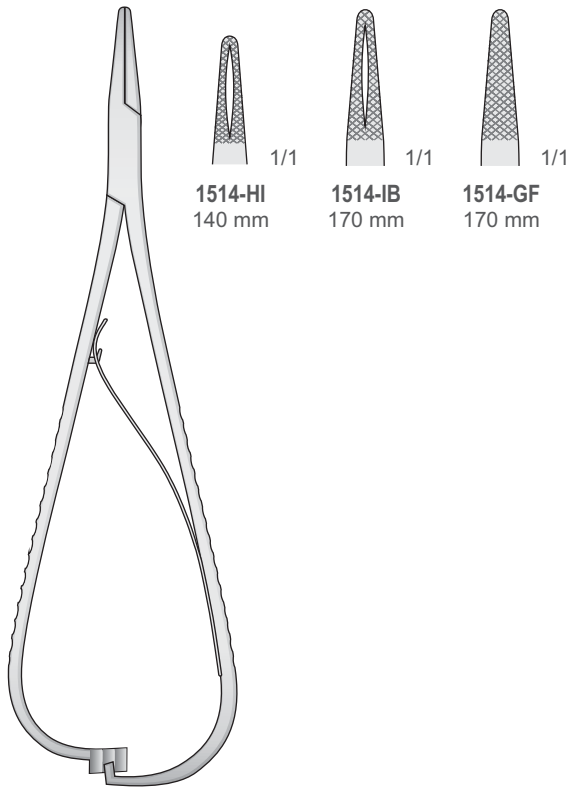

MATHIEU  
1514-GF/1514-IB

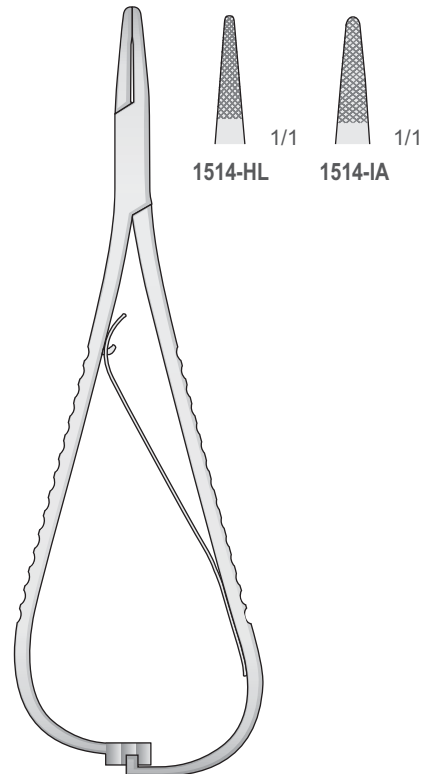

MATHIEU  
1514-HL/1514-IA  
140 mm

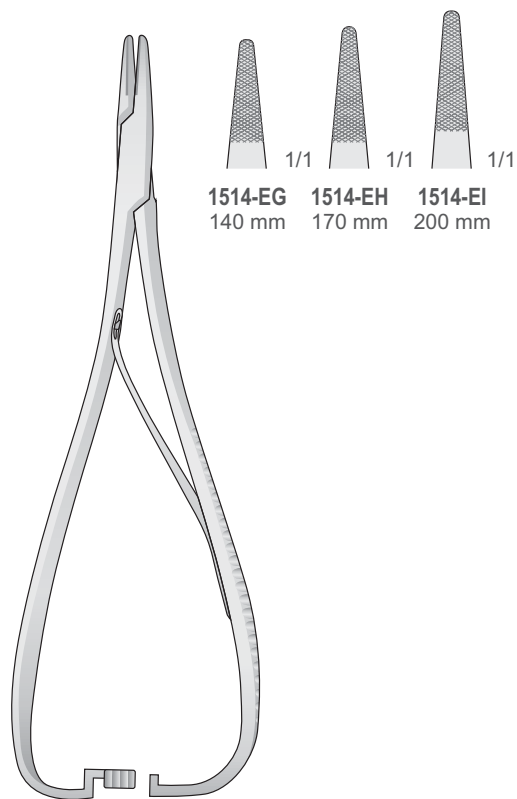

MATHIEU  
1514-EG/1514-EI

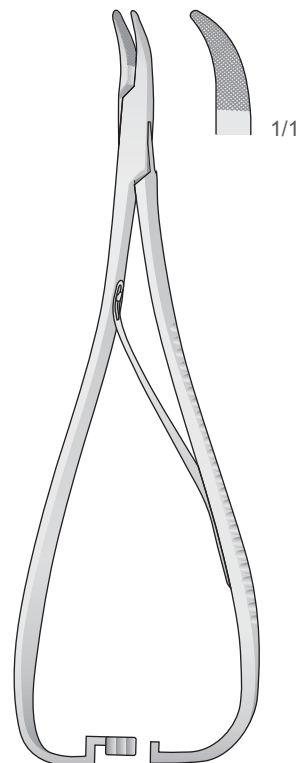

1514-EA  
140 mm

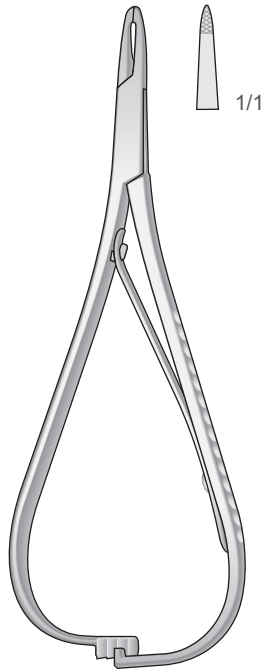

MATHIEU  
1514-EF  
125 mm

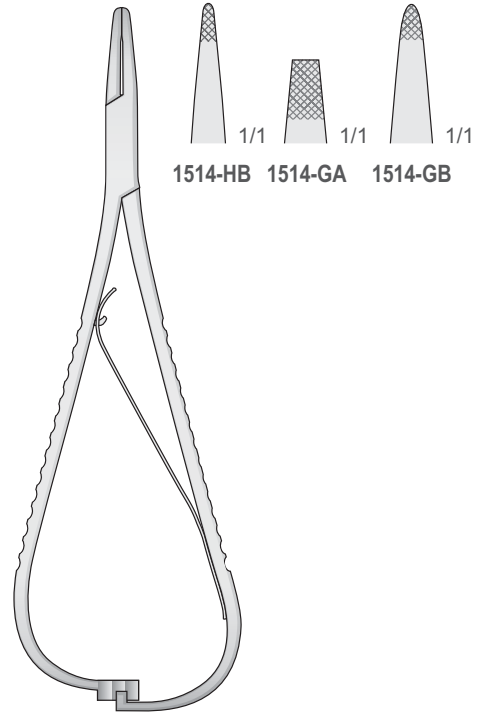

MATHIEU  
1514-GA/1514-HB  
140 mm

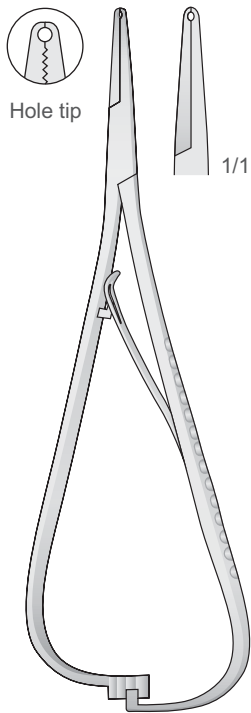

SMAHA  
1514-GI  
140 mm

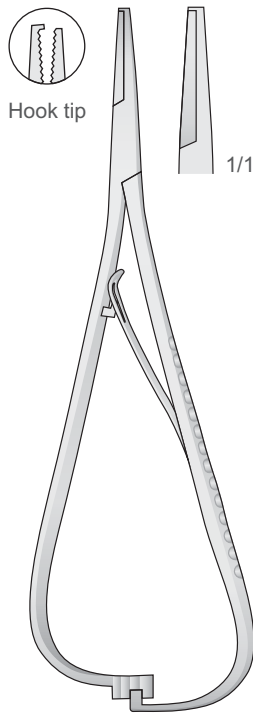

SMAHA  
1514-GL  
140 mm

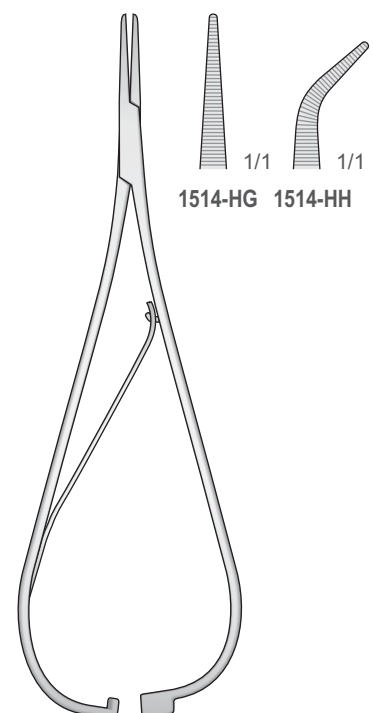

SMAHA  
1514-HG/1514-HH  
140 mm



.7

Arterienklemmen, Tuchklemmen  
Hemostatic Forceps, Towel Clamps  
Pinze emostatiche, Fissateli  
Pinzas hemostáticas, Pinzas de campo  
Pincés hémostatiques, Pincés pour fixer les compresses

Zahnärztliche Chirurgie  
Dental surgery  
Chirurgia dentale  
Cirugia dental  
Chirurgie dentaire





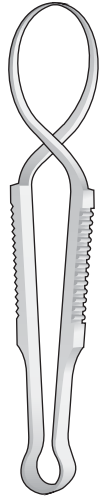

SCHAEDEL  
0206-DI  
85 mm

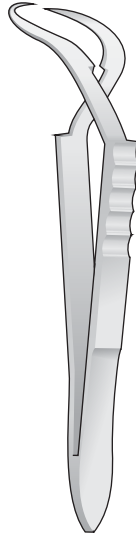

JONES  
0206-EI  
90 mm

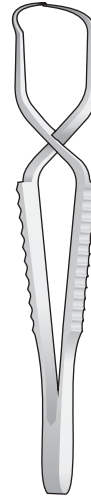

FAURE  
0206-EA  
85 mm

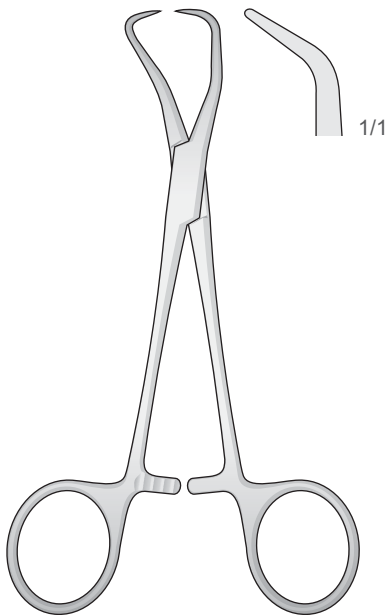

BACKHAUS  
0206-EC/0206-EG

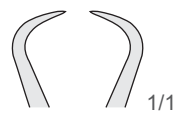

0206-EC  
90 mm

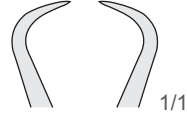

0206-EB  
100 mm

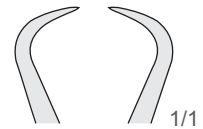

0206-EE  
110 mm

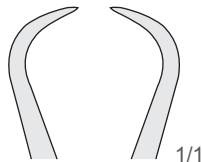

0206-EG  
130 mm

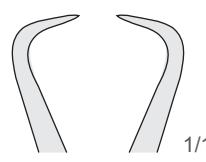

0206-ED  
135 mm

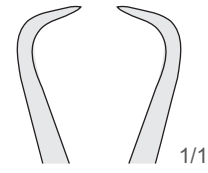

0206-EF  
140 mm

Für Papiertücher  
For paper cloths  
Per teli di carta  
Para paños  
Pour Champs en papier

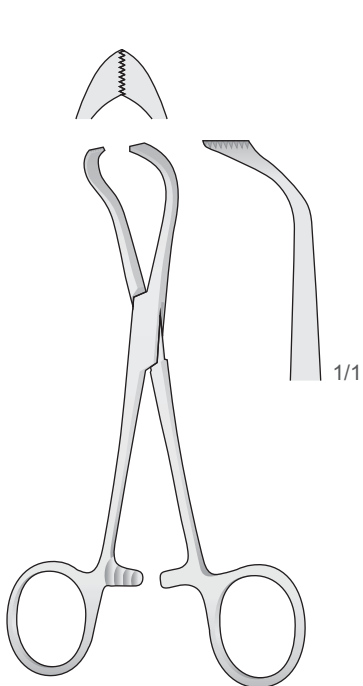

LORNA  
0206-FA  
100 mm

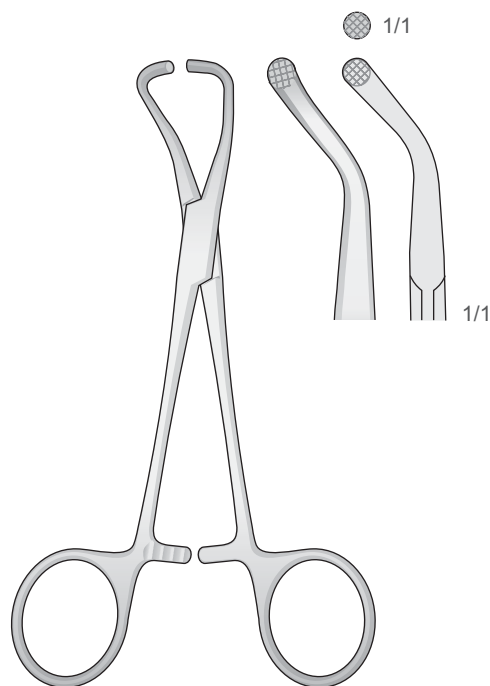

0206-FC  
130 mm

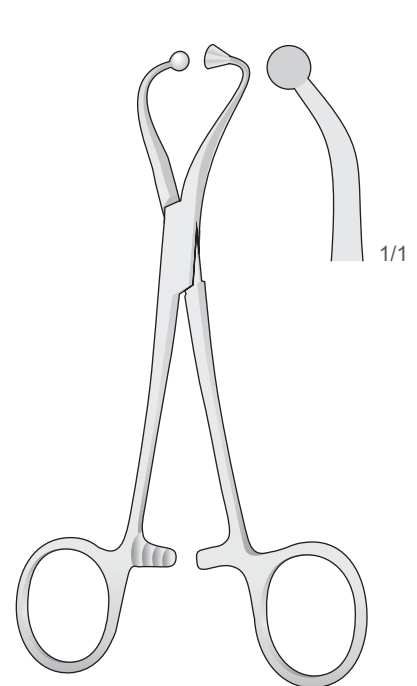

0206-HF  
140 mm



Kornzangen  
Dressing Forceps  
Pinze porta tamponi  
Pinzas porta tampones  
Pincas porte-tampons

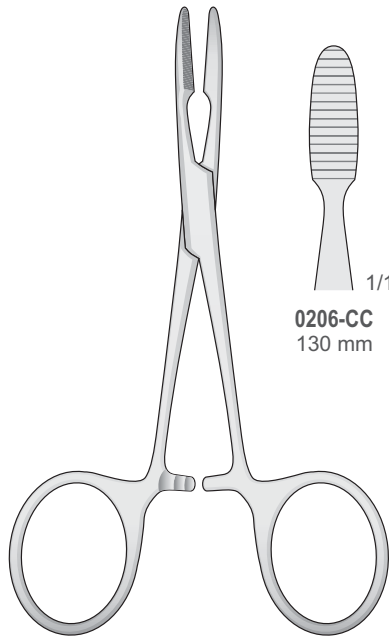

PEAN-MURPHY  
0206-CC/0206-CE

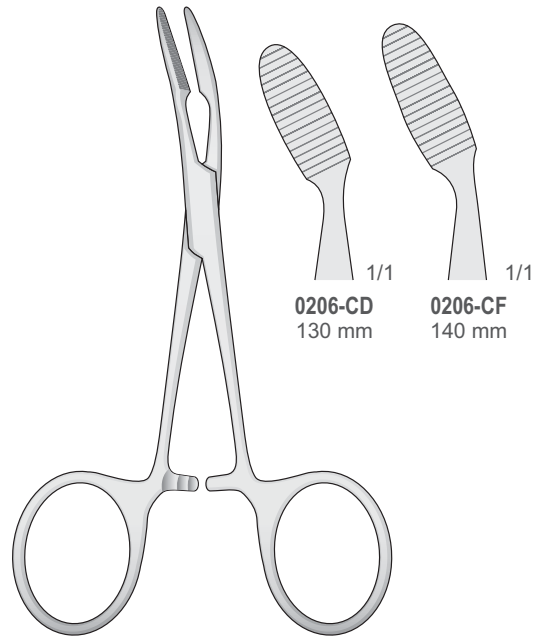

PEAN-MURPHY  
0206-CD/0206-CF

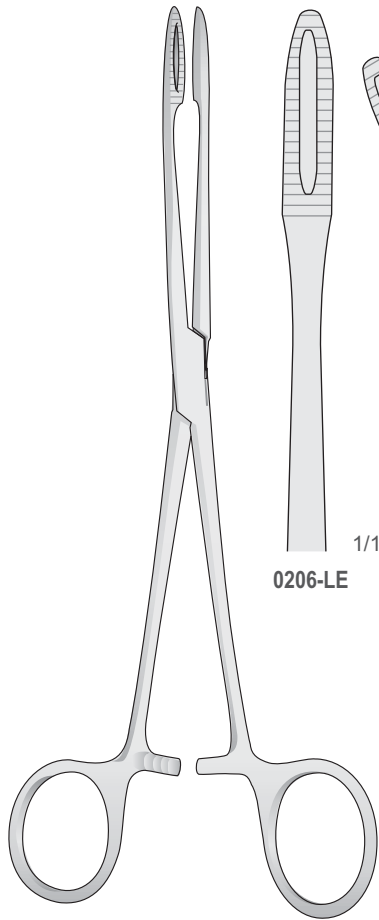

GROSS  
0206-LE/0206-LF  
200 mm

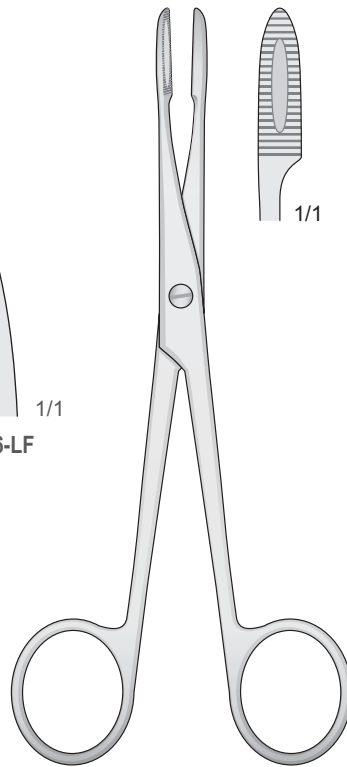

GROSS  
0206-BA 130 mm  
0206-BC 160 mm

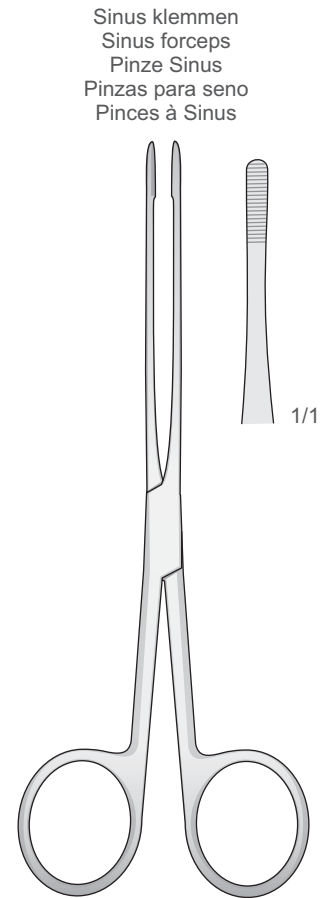

LISTER  
0206-CA  
150 mm

Sinus klemmen  
Sinus forceps  
Pinze Sinus  
Pinzas para seno  
Pincas à Sinus

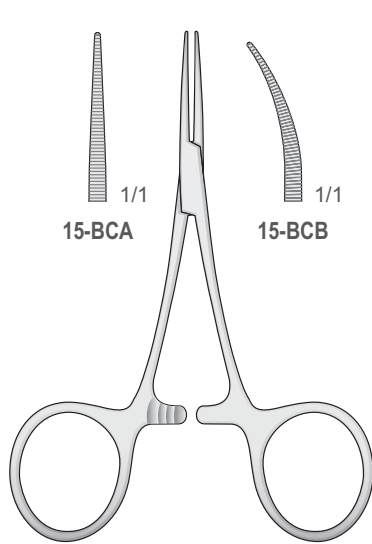

HARTMANN/BABY-MOSQUITO  
**15-BCA/15-BCB**  
 95 mm

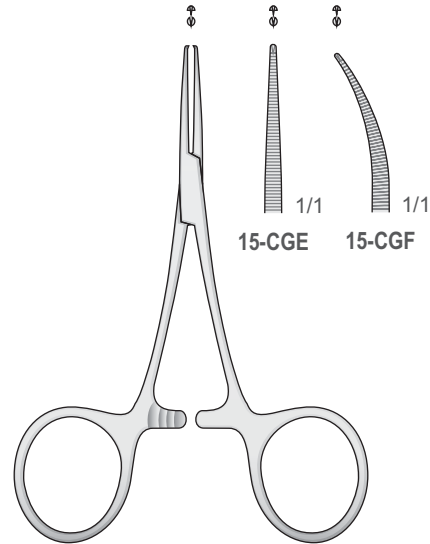

HARTMANN/BABY-MOSQUITO  
**15-CGE/15-CGF**  
 95 mm

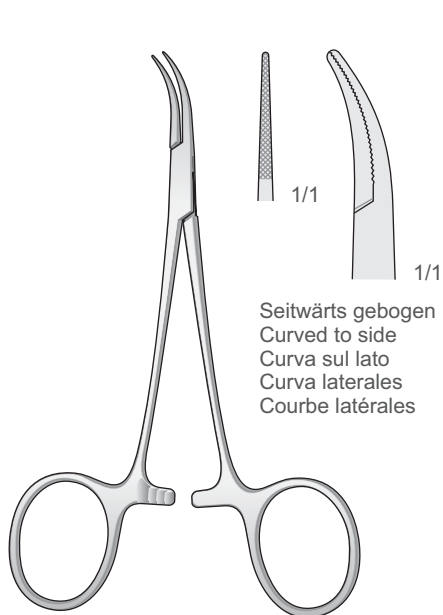

DANDY-MOSQUITO  
**15-DDC**  
 120 mm

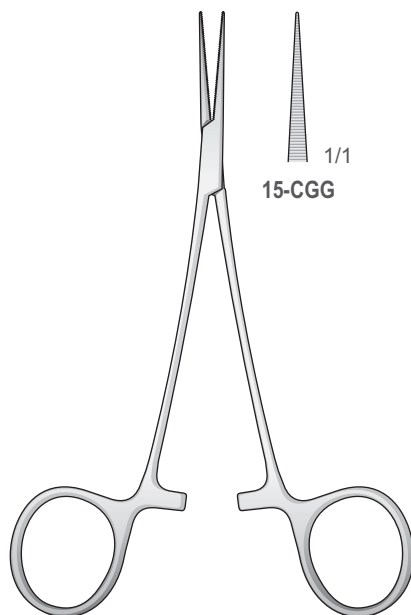

JACOBSON-MICRO  
**15-CGG**  
 130 mm

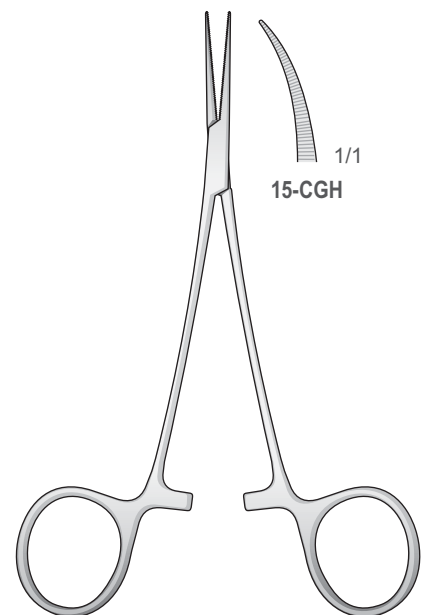

JACOBSON-MICRO  
**15-CGH**  
 130 mm

Seitwärts gebogen  
 Curved to side  
 Curva sul lato  
 Curva laterales  
 Courbe latérales

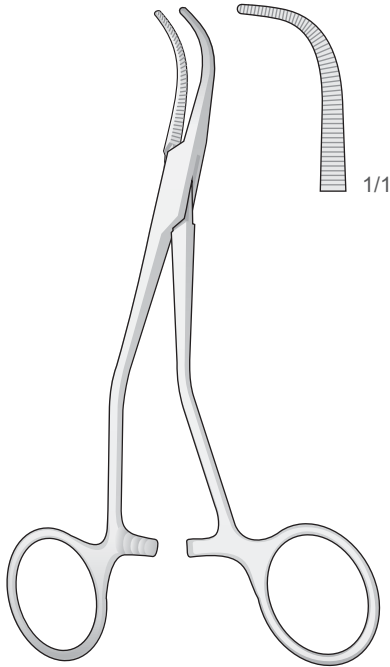

**15-BF**  
130 mm

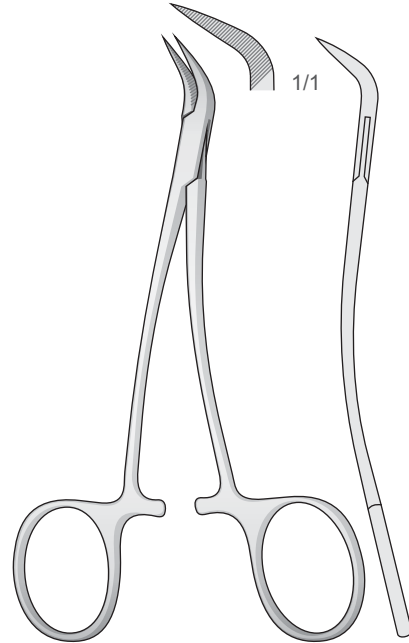

**PEET**  
**0417-EA**  
120 mm

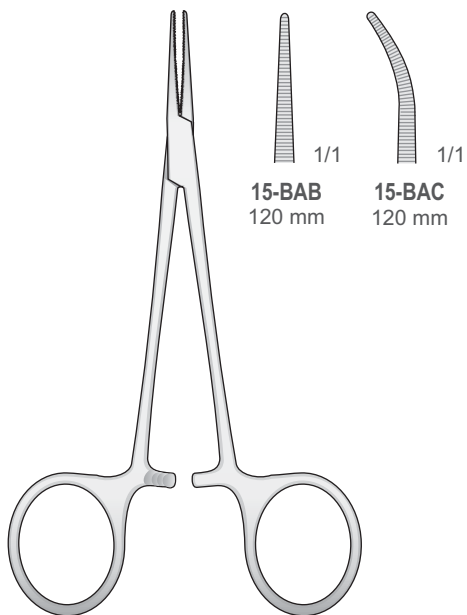

**MICRO-HALSTED**  
**15-BAB/15-BAC**

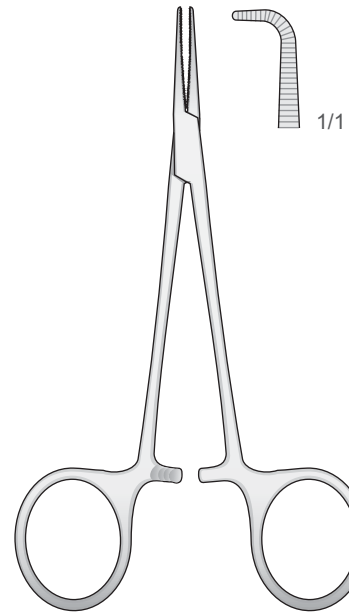

**MICRO-HALSTED**  
**15-BDF**  
115 mm



Arterienklemmen  
Hemostatic Forceps  
Pinze emostatiche  
Pinzas hemostáticas  
Pincas hémostatiques

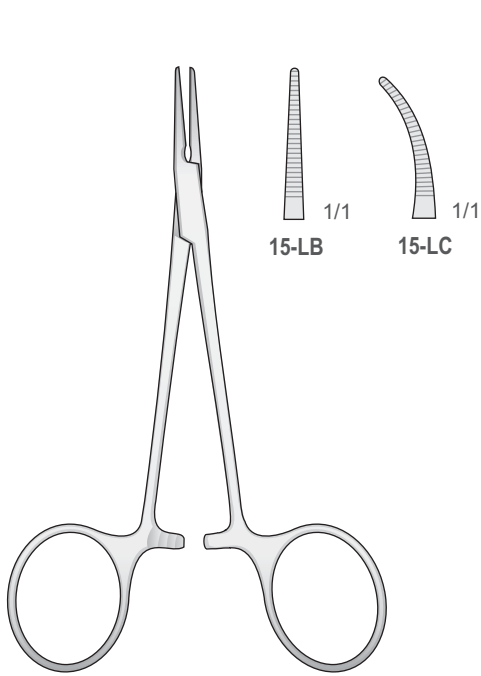

HALSTED  
15-LB/15-LC  
125 mm

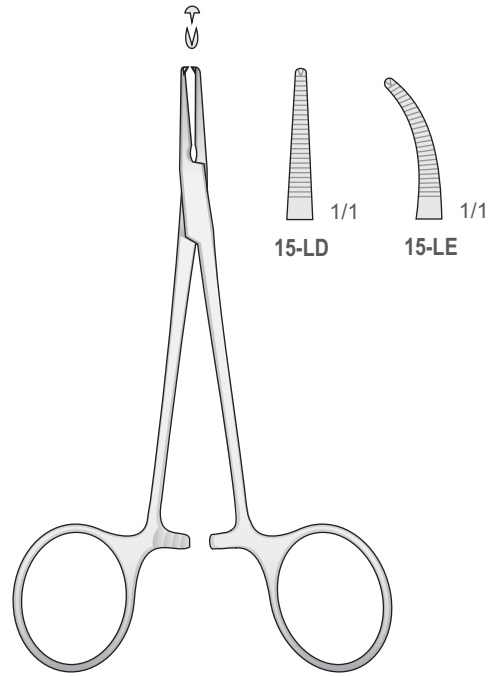

HALSTED  
15-LD/15-LE  
125 mm

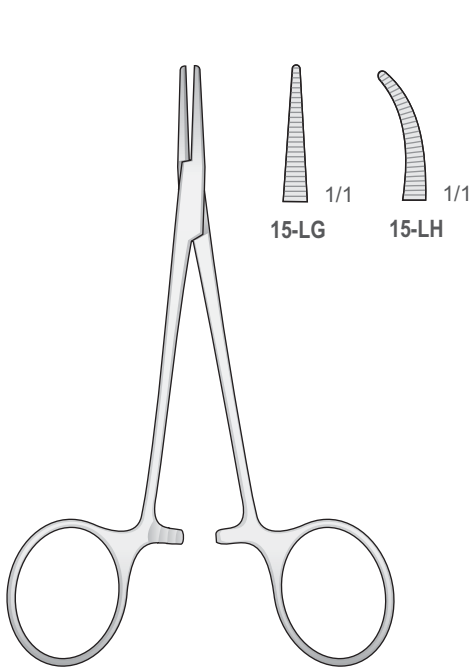

HALSTED-MOSQUITO  
15-LG/15-LH  
120 mm

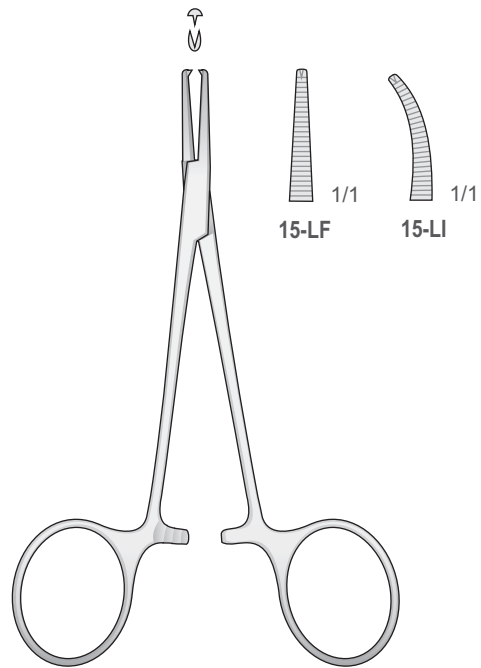

HALSTED-MOSQUITO  
15-LF/15-LI  
120 mm

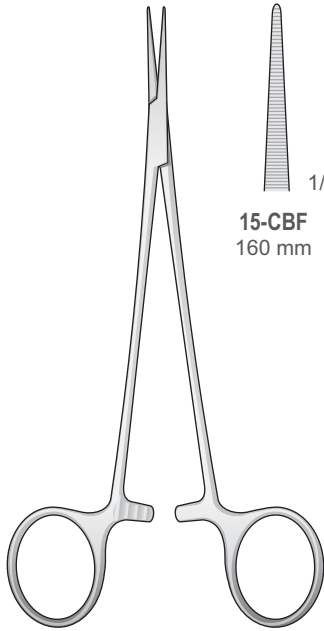

15-CBF  
160 mm

15-CBG  
160 mm

15-CBH  
160 mm

15-CBF/15-CBH  
160 mm

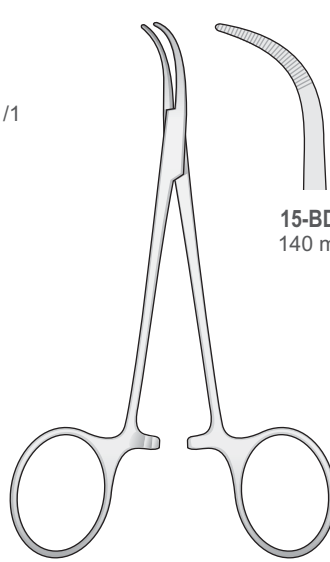

15-BDG  
140 mm

15-BDH  
180 mm

BABY-MIXTER  
15-BDG/15-BDH

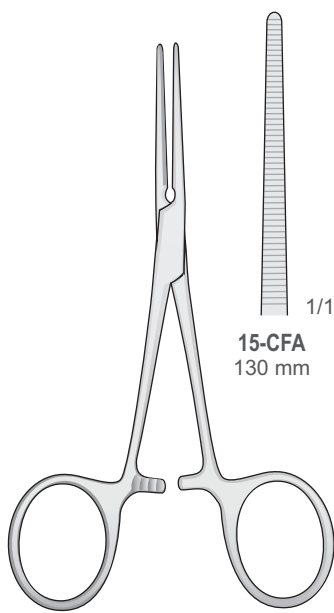

15-CFA  
130 mm

15-CFC  
140 mm

15-CFB  
130 mm

15-CFD  
140 mm

PEAN  
15-CFA/15-CFD

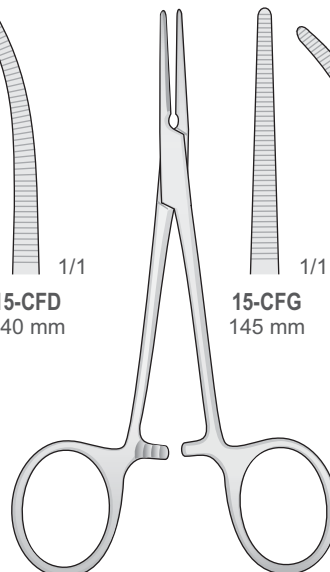

15-CFG  
145 mm

15-CFH  
145 mm

PEAN  
15-CFG/15-CFH

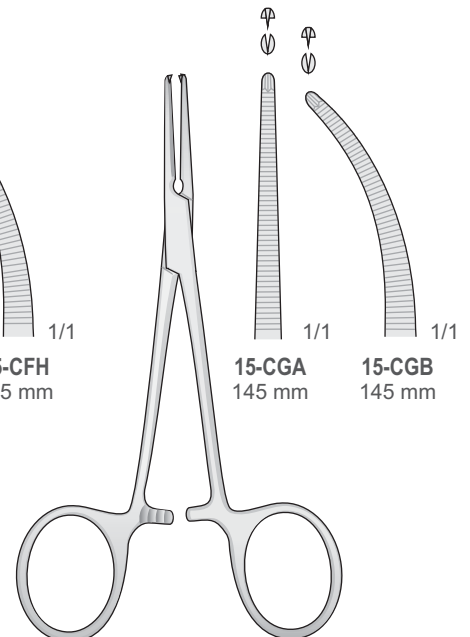

15-CGA  
145 mm

15-CGB  
145 mm

KOCHER  
15-CGA/15-CGB

Arterienklemmen  
 Hemostatic Forceps  
 Pinze emostatiche  
 Pinzas hemostáticas  
 Pincas hémostatiques

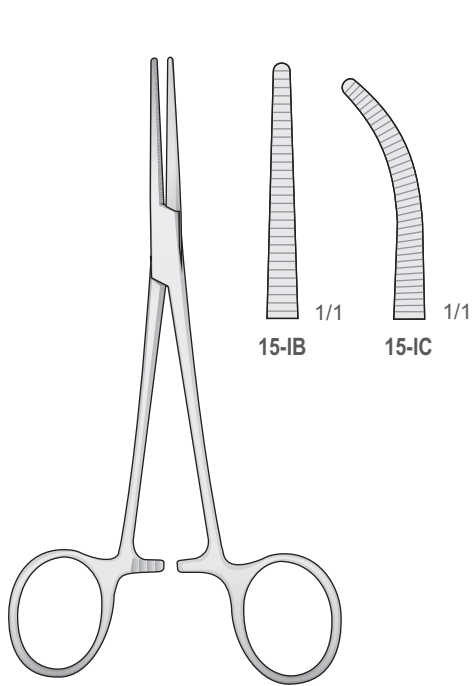

CRILE  
 15-IB/15-IC  
 140 mm

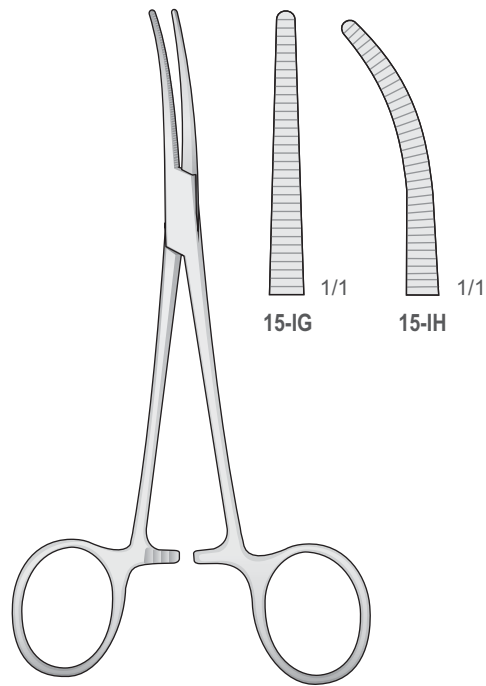

CRILE  
 15-IG/15-IH  
 160 mm

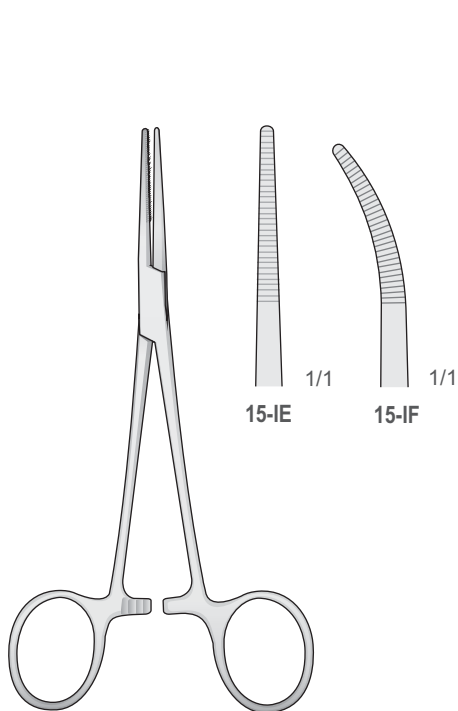

KELLY  
 15-IE/15-IF  
 140 mm

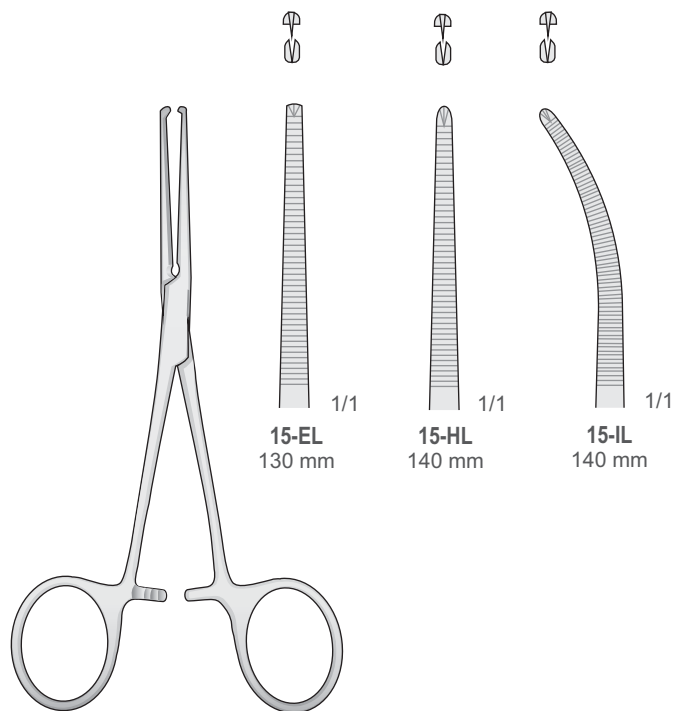

KOCHER  
 15-EL/15-IL

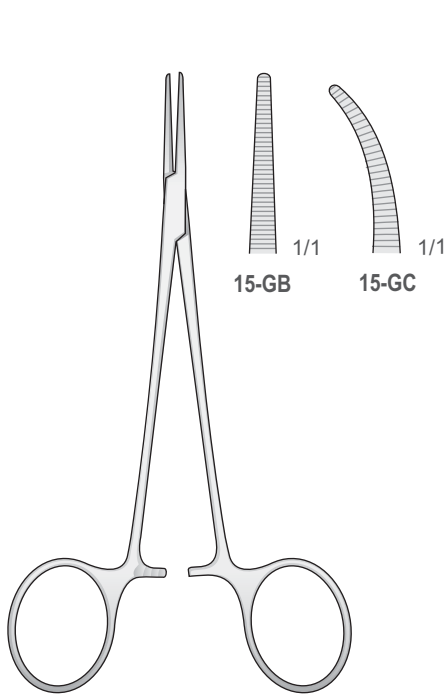

LERICHE  
 15-GB/15-GC  
 150 mm

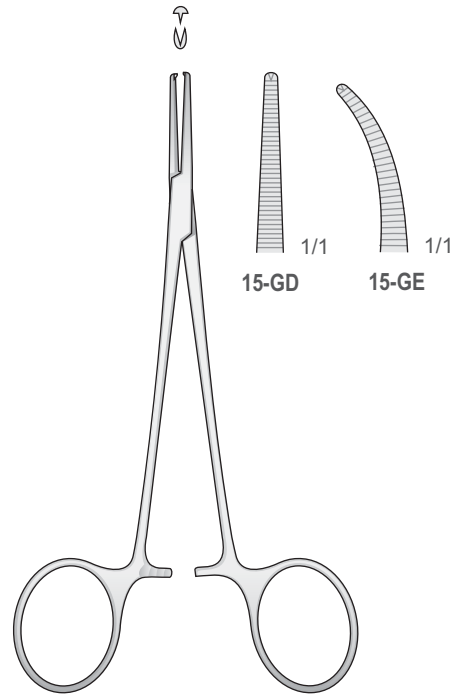

LERICHE  
 15-GD/15-GE  
 150 mm

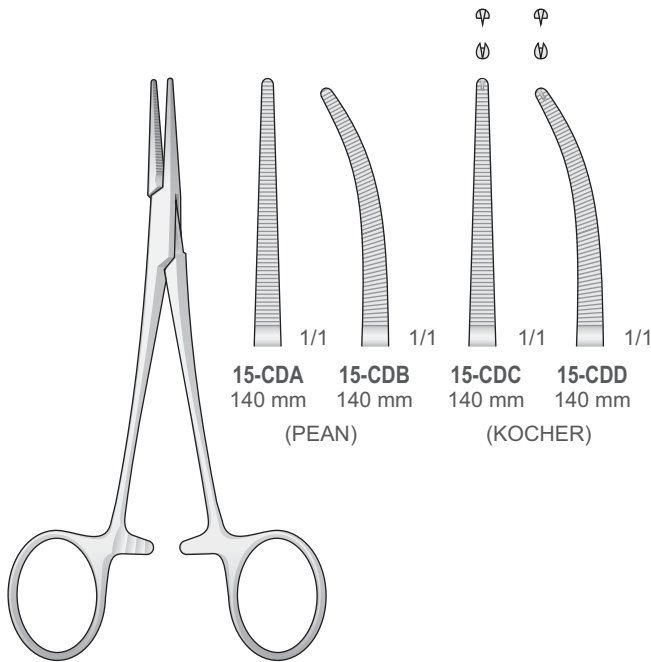

BABY-CRILE  
 15-CDA/15-CDD  
 140 mm

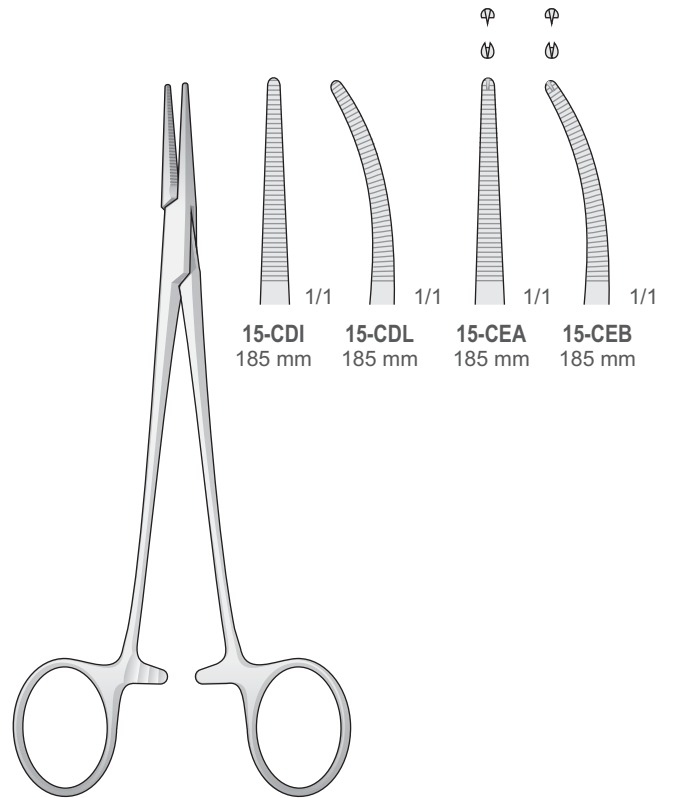

HALSTED  
 15-CDI/15-CEB  
 185 mm

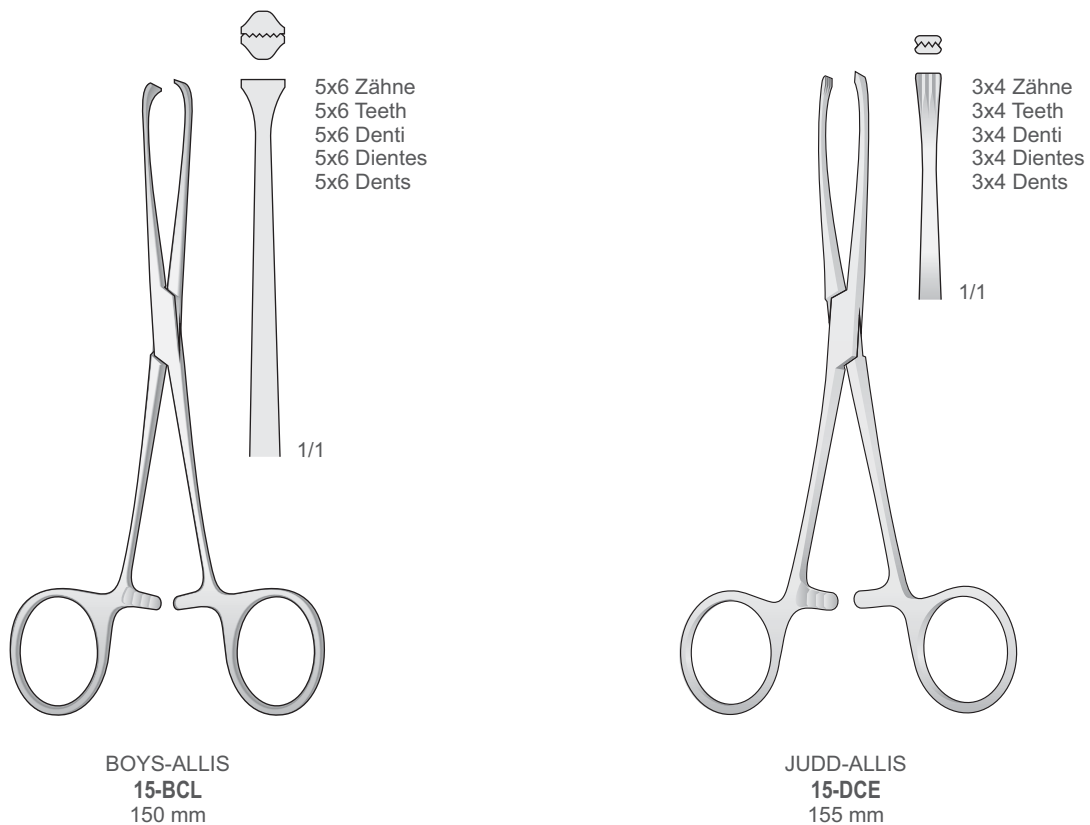
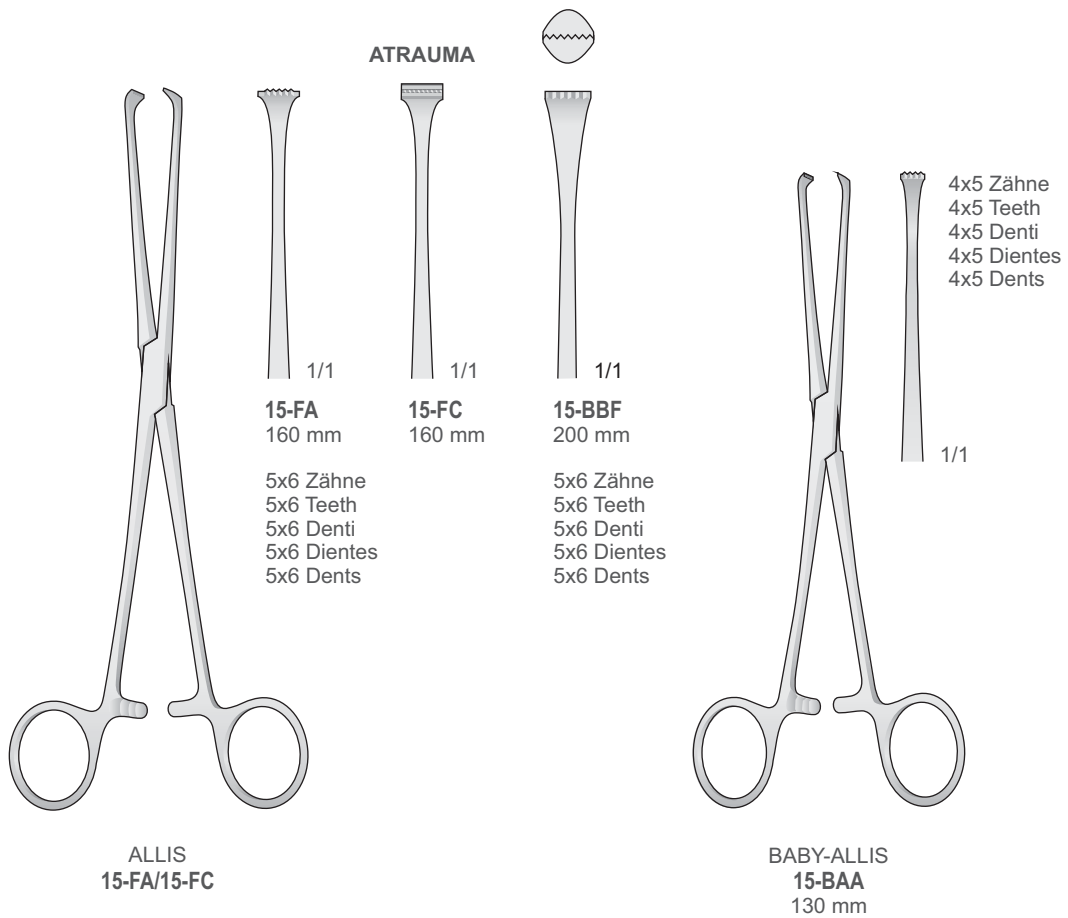



.8

Wundhaken, Mundsperrer  
Retractors, Mouth gags  
Divaricatori, Apribocca  
Separadores, Abrebocas  
Ecarteurs, Ecarteurs buccal

Zahnärztliche Chirurgie  
Dental surgery  
Chirurgia dentale  
Cirugia dental  
Chirurgie dentaire







Wundhaken  
Retractors  
Divaricatori  
Separadores  
Ecarteurs

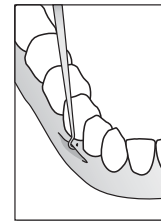
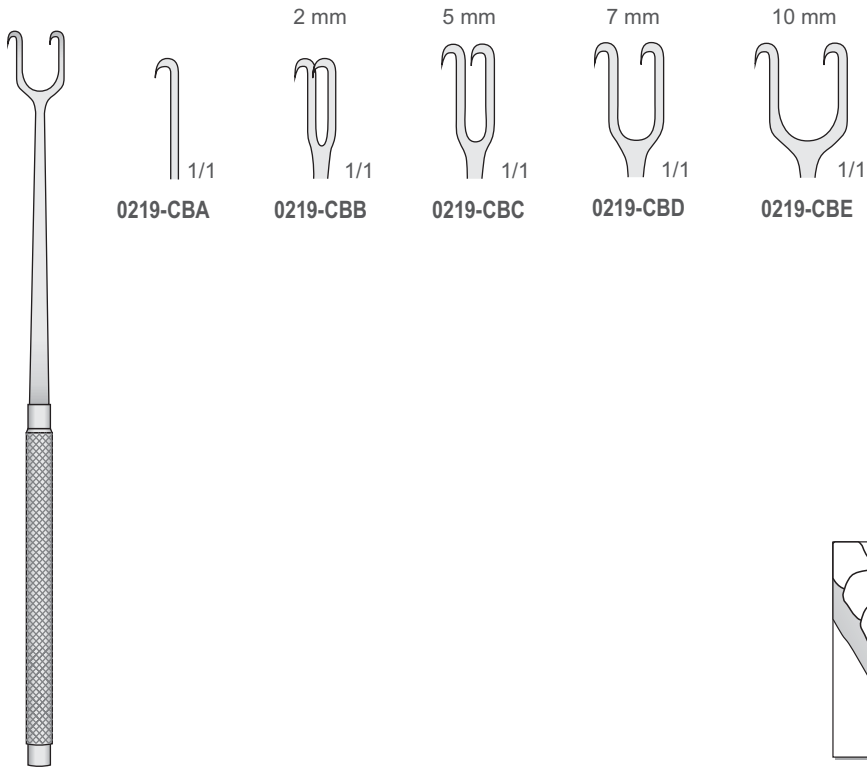

JOSEPH  
0219-CBA/0219-CBE  
160 mm

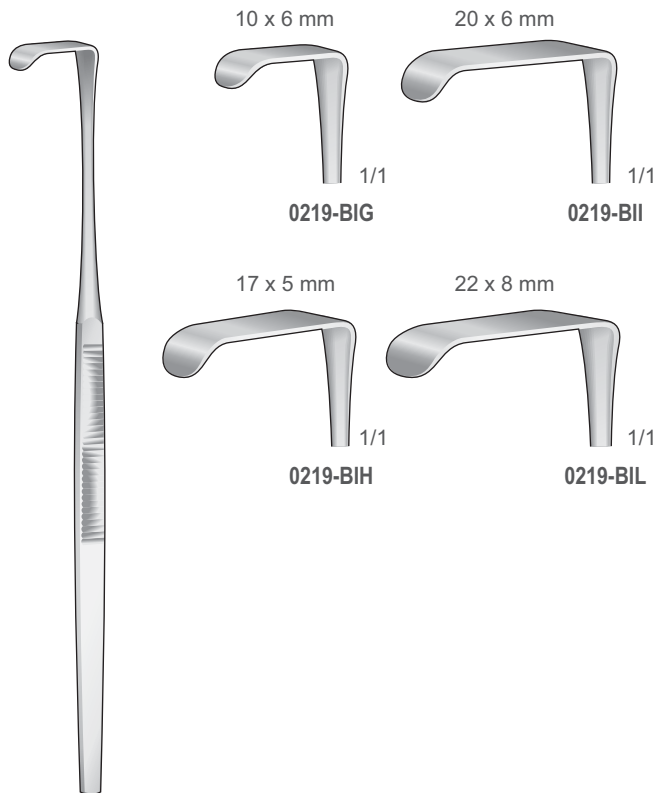

MINI-LANGENBECK  
0219-BIG/0219-BIL  
160 mm

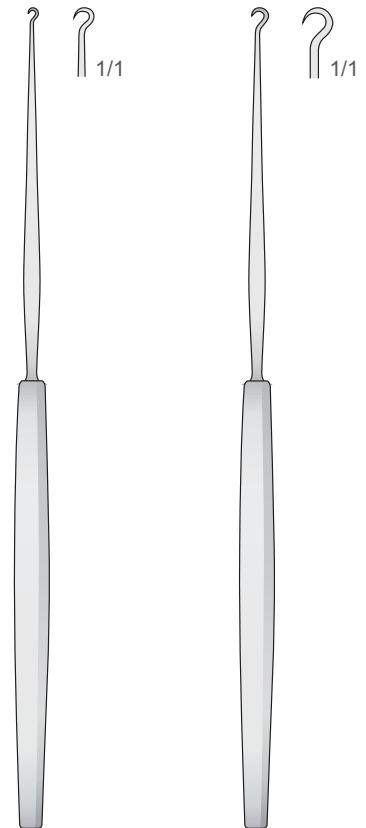

GILLIES  
0219-BF  
180 mm

GILLIES  
0219-BG  
180 mm



Wundhaken  
Retractors  
Divaricatori  
Separadores  
Ecarteurs

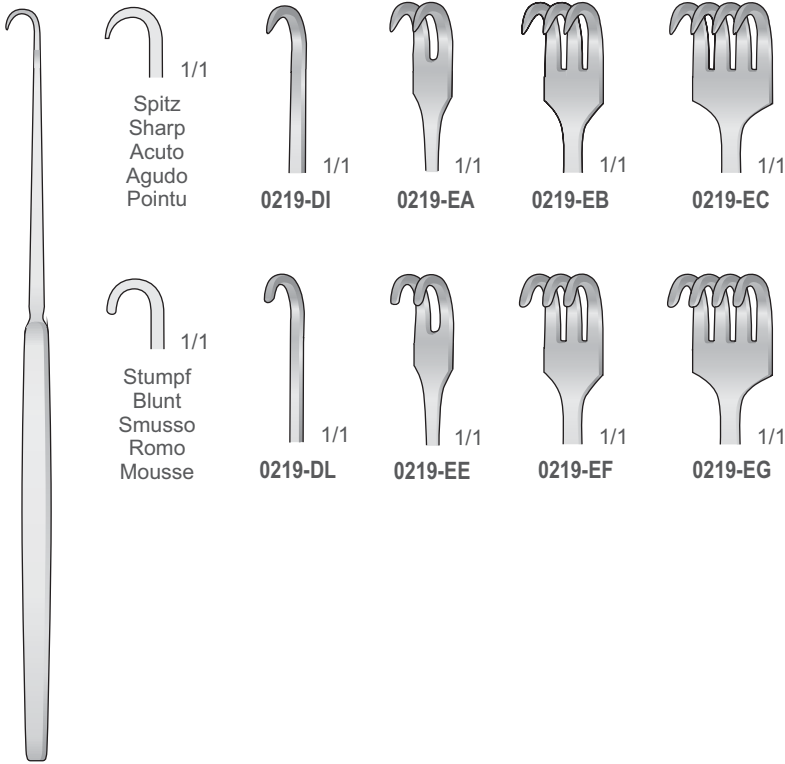

1/1  
Spitz  
Sharp  
Acuto  
Agudo  
Pointu

1/1  
0219-DI

1/1  
0219-EA

1/1  
0219-EB

1/1  
0219-EC

1/1  
Stumpf  
Blunt  
Smusso  
Romo  
Mousse

1/1  
0219-DL

1/1  
0219-EE

1/1  
0219-EF

1/1  
0219-EG

0219-DI/0219-EG  
160 mm

Feine wundhaken flexibel-spitz  
Delicate retractors flexible-sharp  
Divaricatori delicati flessibili-acuti  
Separadores finos flexibles-agudas  
Ecarteurs fins pointu flexible

Feine wundhaken flexibel-stumpf  
Delicate retractors flexible-blunt  
Divaricatori delicati flessibili-smussi  
Separadores finos flexibles-romas  
Ecarteurs fins mousse flexible

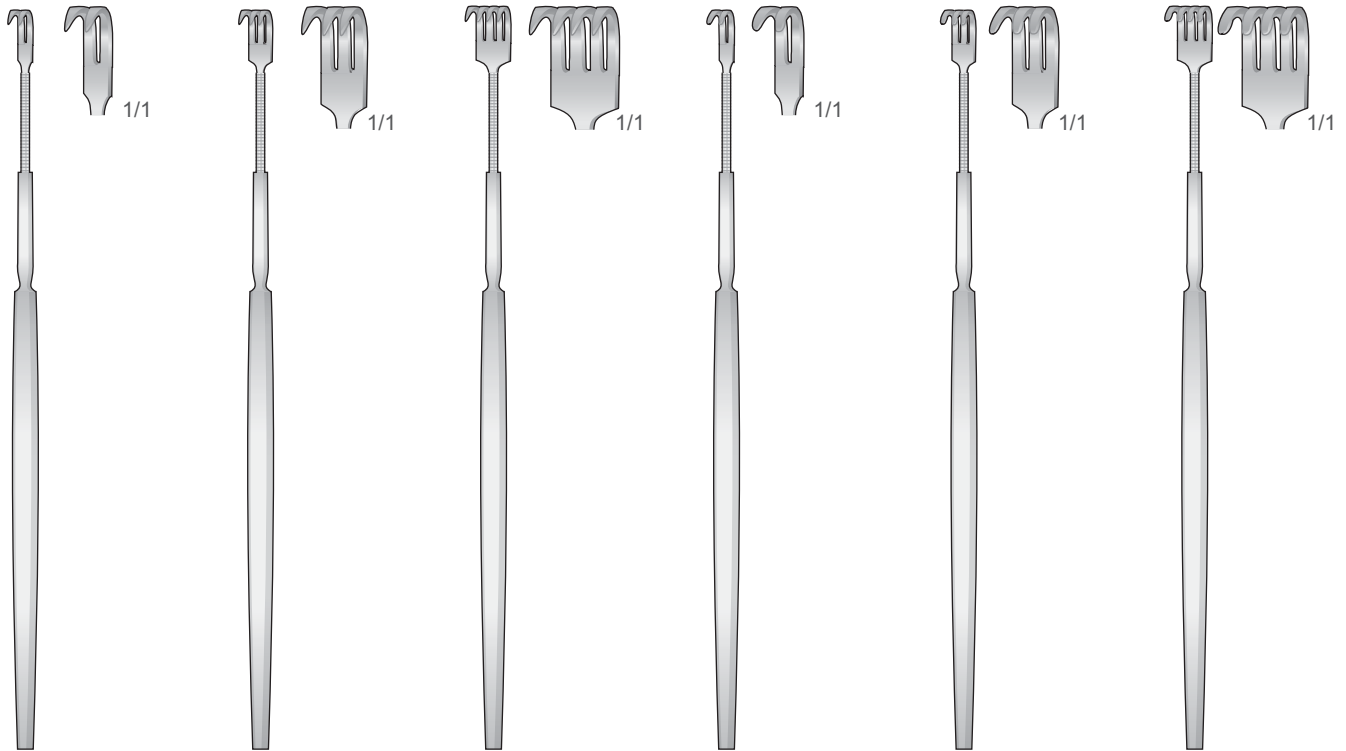

0219-FA  
150 mm

0219-FB  
150 mm

0219-FC  
150 mm

0219-FE  
150 mm

0219-FF  
150 mm

0219-FG  
150 mm



Wundhaken  
Retractors  
Divaricatori  
Separadores  
Ecarteurs

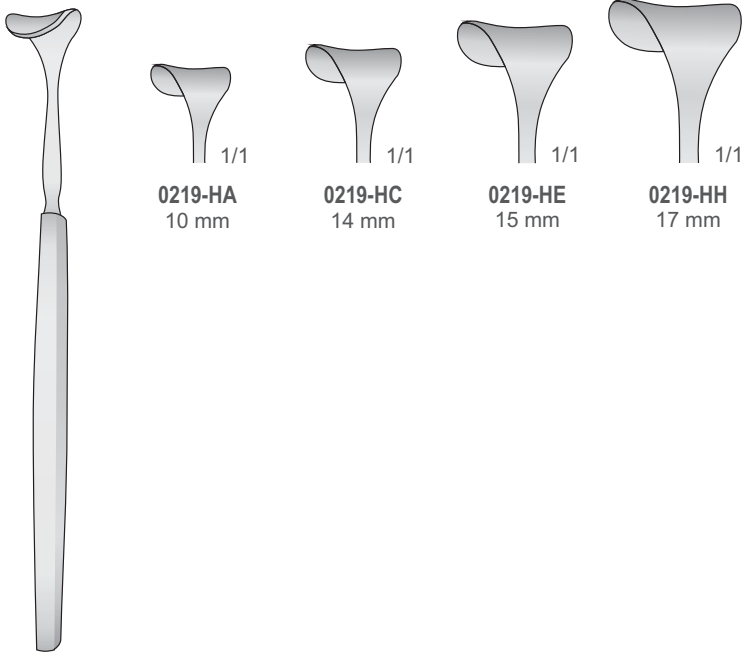

**0219-HA**  
10 mm

**0219-HC**  
14 mm

**0219-HE**  
15 mm

**0219-HH**  
17 mm

**DESMARRES**  
**0219-HA/0219-HH**  
140 mm

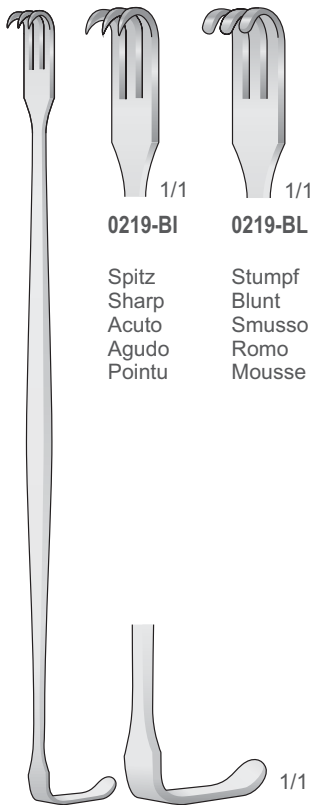

**0219-BI**

**0219-BL**

Spitz  
Sharp  
Acuto  
Agudo  
Pointu

Stumpf  
Blunt  
Smusso  
Romo  
Mousse

**SEÁN-MILLER**  
**0219-BI/0219-BL**  
160 mm

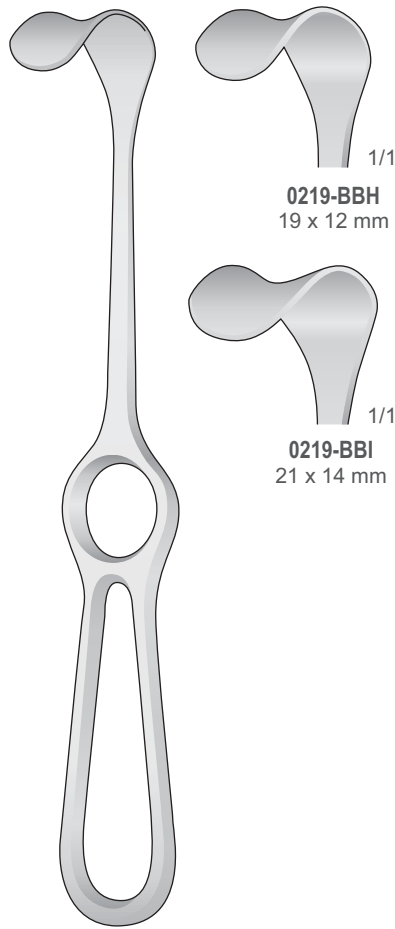

**0219-BBH**  
19 x 12 mm

**0219-BBI**  
21 x 14 mm

**KOCHER**  
**0219-BBH/0219-BBI**  
205 mm

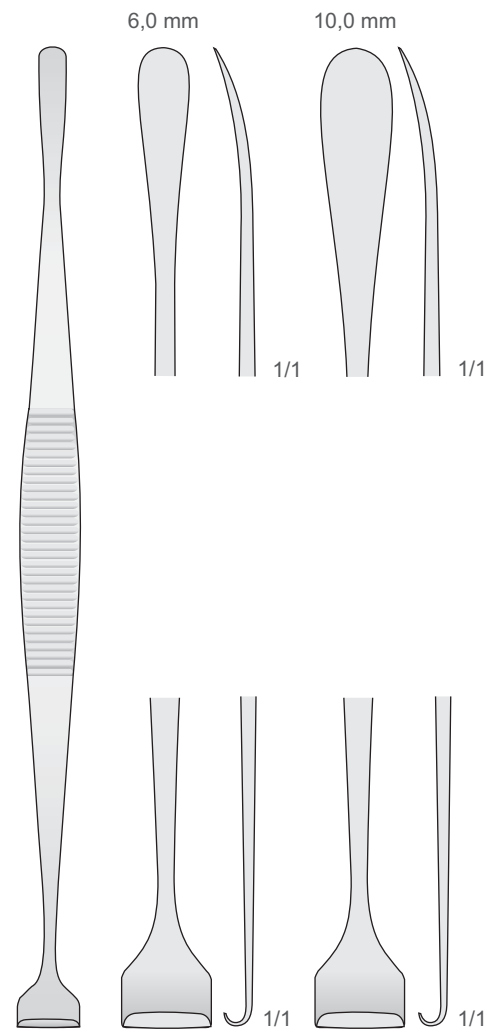

6,0 mm

10,0 mm

**HURD**  
**0219-B/0219-C**  
220 mm

12 mm

12 mm

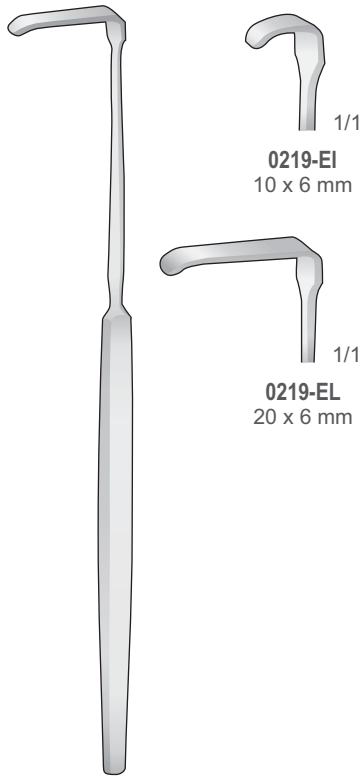

SENN GREEN  
0219-EI/0219-EL  
160 mm

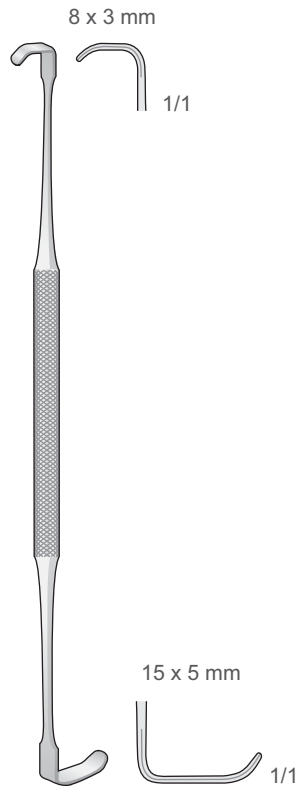

RAGNELL  
0219-CH  
140 mm

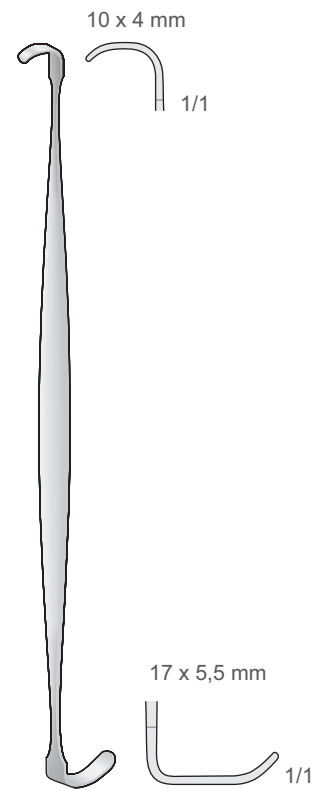

RAGNELL-DAVIS  
0219-CG  
140 mm

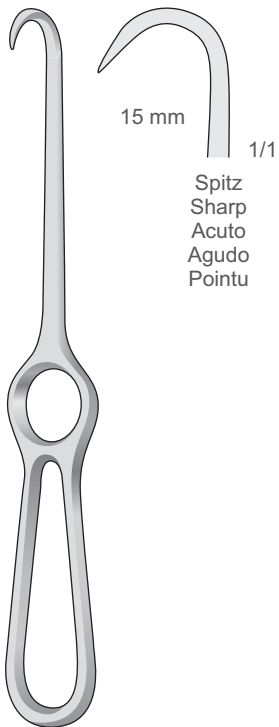

KOCHER  
0219-BDL  
205 mm

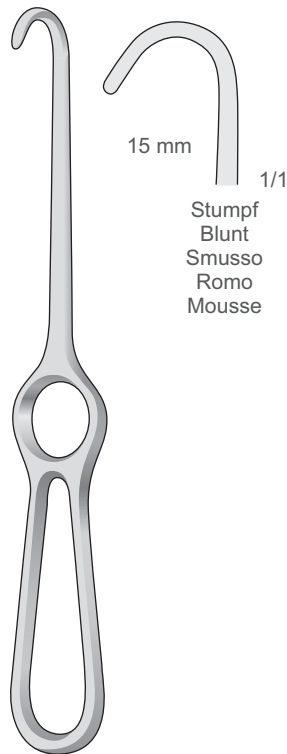

KOCHER  
0219-BEA  
220 mm



LAHEY  
0219-BAL  
195 mm

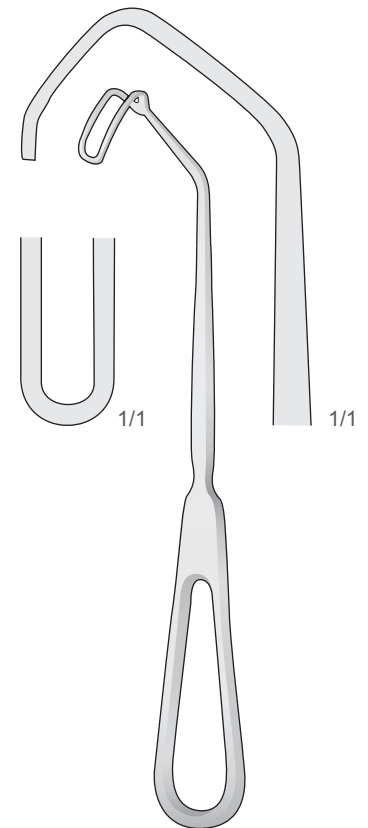

CUSHING  
0219-CL  
200 mm

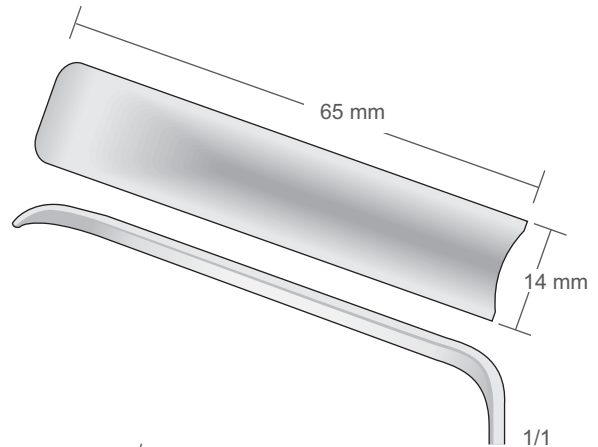

0219-CGF

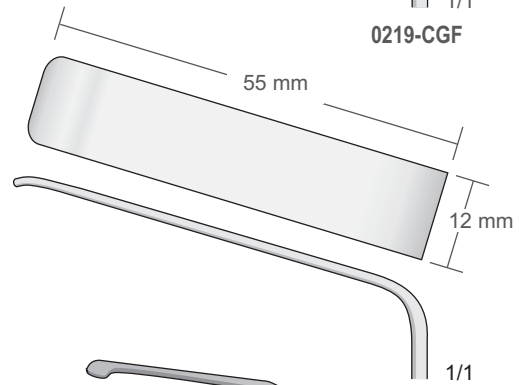

0219-CGE

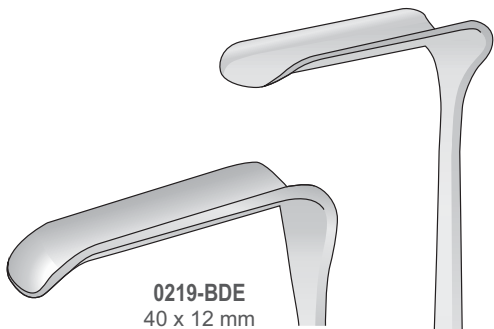

0219-BDE  
40 x 12 mm

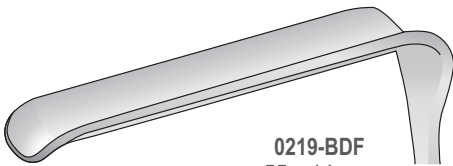

0219-BDF  
55 x 14 mm

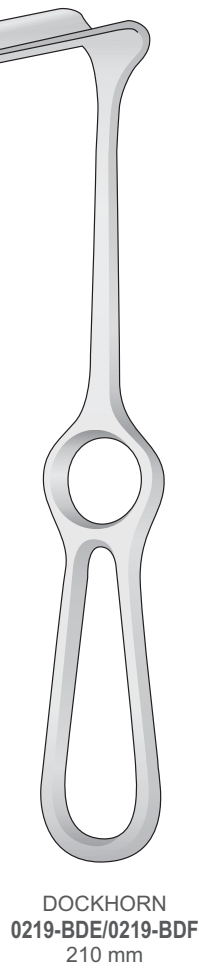

DOCKHORN  
0219-BDE/0219-BDF  
210 mm

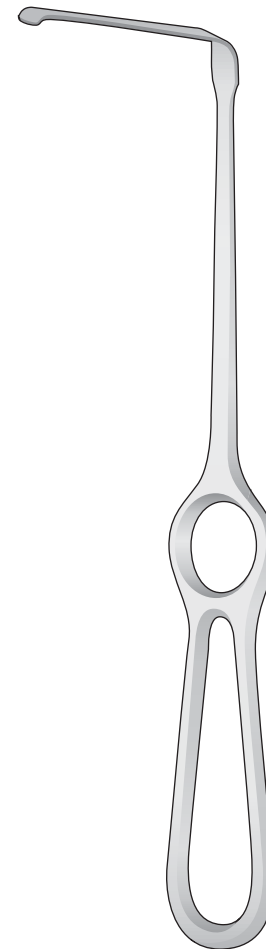

0219-CGE/0219-CGF  
235 mm

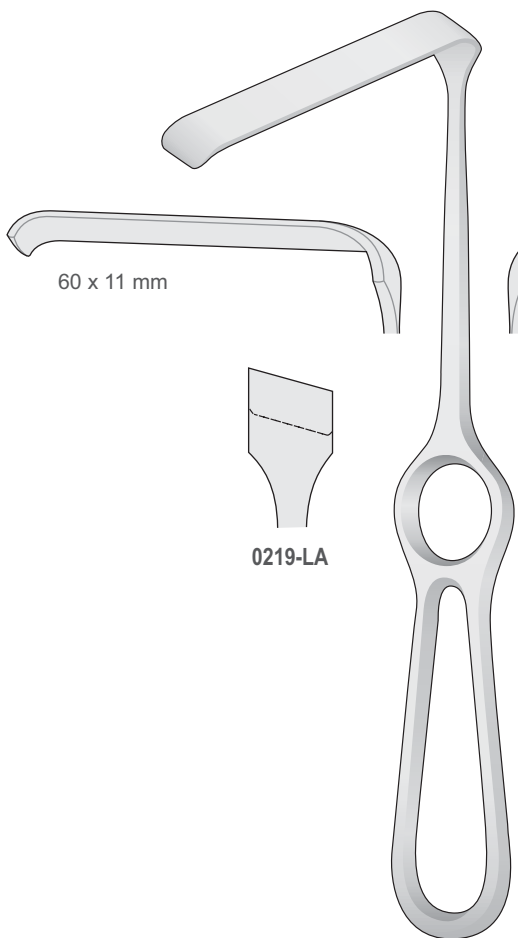

KIRSCH  
0219-LA/0219-LB  
210 mm

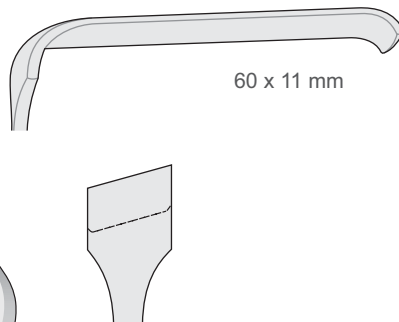

MIDDELDORPF  
0219-IA/0219-IC  
225 mm

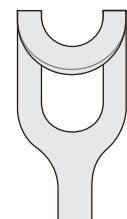

0219-IA  
15 x 15 mm

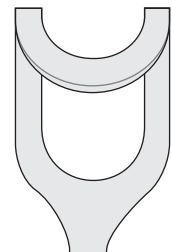

0219-IB  
20 x 22 mm

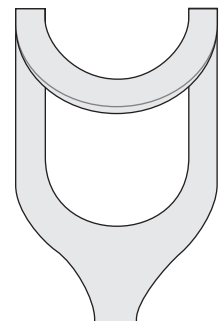

0219-IC  
28 x 28 mm





Wundhaken  
Retractors  
Divaricatori  
Separadores  
Ecarteurs

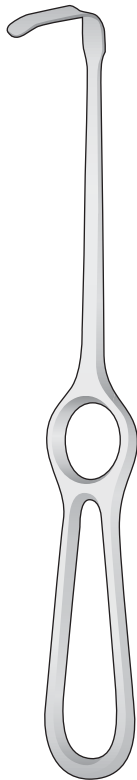

OBWEGESER  
0219-BFC/0219-BFH  
220 mm

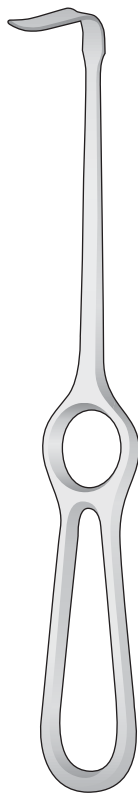

OBWEGESER  
0219-LC/0219-BAA  
220 mm

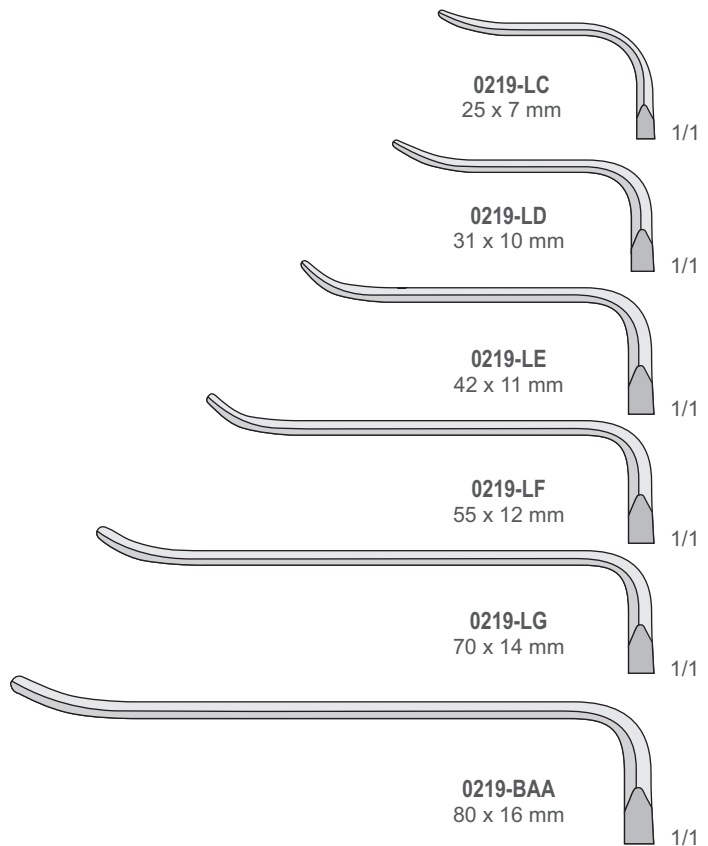
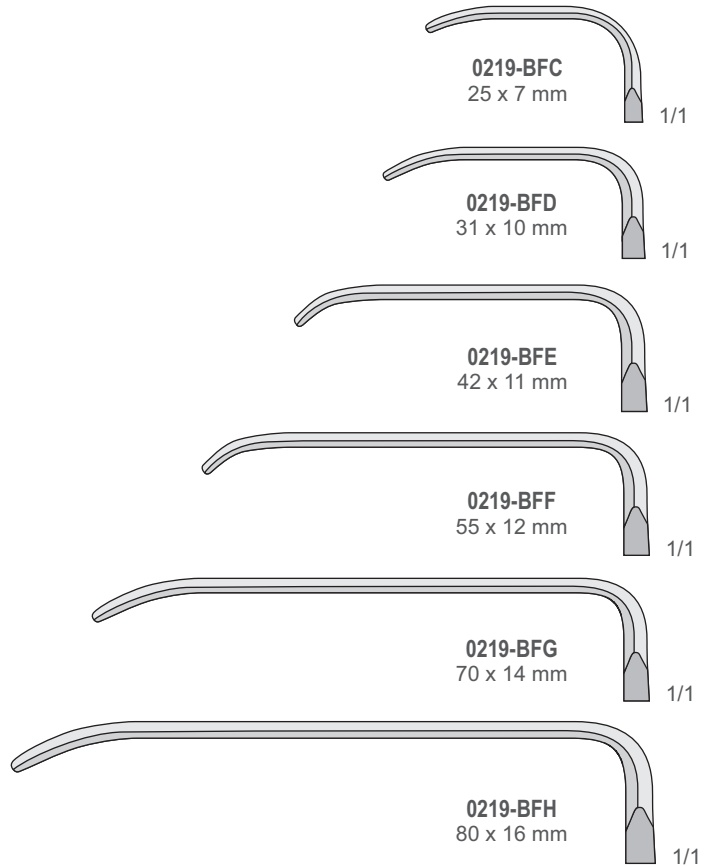

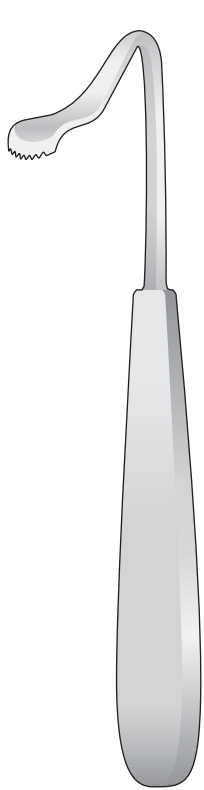

**BOWLED-HENRY**  
**0414-BHF**  
170 mm

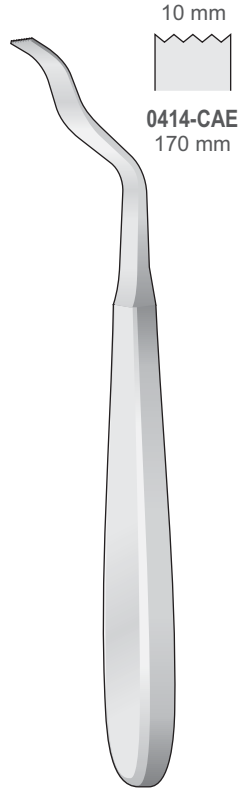

**0414-CAE/0414-CAEL**  
170 mm

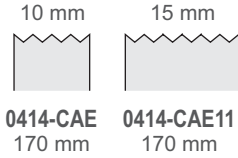

**AUSTIN**  
**0414-CBC**  
140 mm

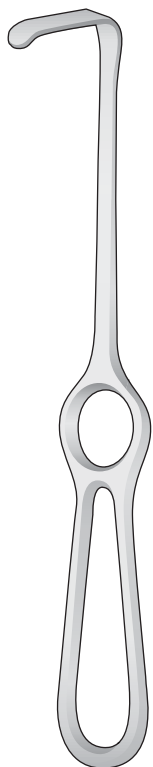
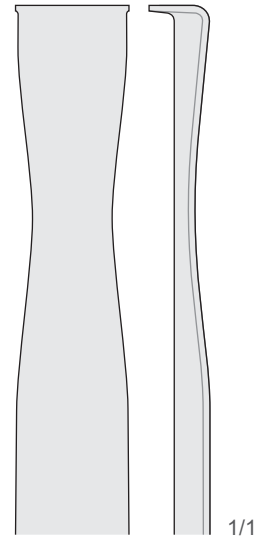

**LANGENBECK**  
**0219-DD/0219-ED**  
210 mm

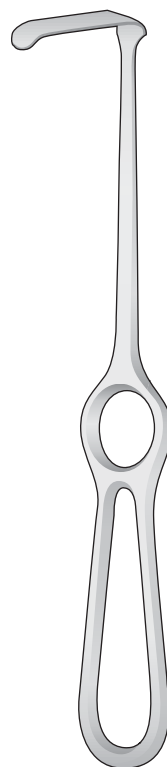
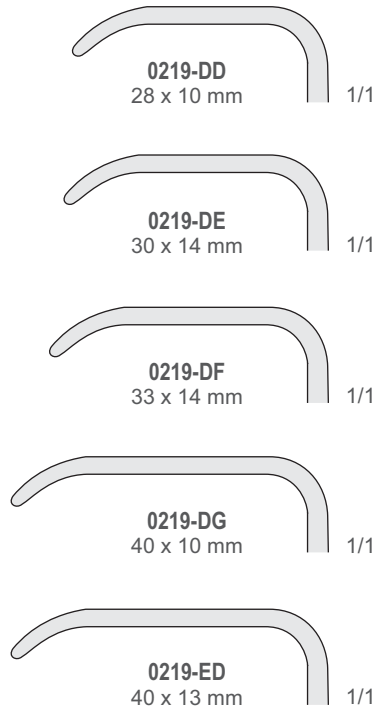

**KOCHER-LANGENBECK**  
**0219-GA/0219-CGA**  
215 mm

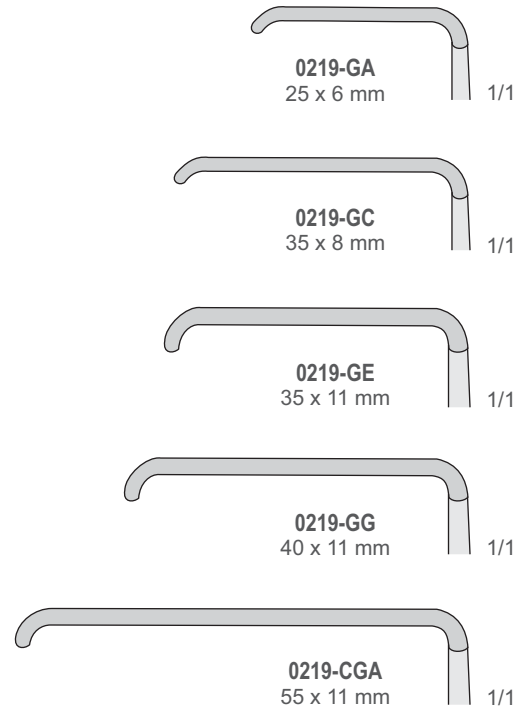



Wundhaken  
Retractors  
Divaricatori  
Separadores  
Ecarteurs

Rostfrei - Stainless Steel  
Acciaio - Acero - Acer

Biegsam - Malleable  
Malleabili - Maleables  
Souples

**1412-IF**  
Komplettsset mit 3 Spatel  
Set complete with 3 spatulas  
Set completo con 3 spatole  
Set completos con 3 espatulas  
Set complete avec 3 spatules  
**1412-IA + 1412-IB + 1412-IC**

Schwarz Verchromt  
Black anodized  
Cromato nero  
Cromado en negro  
Chromé noir

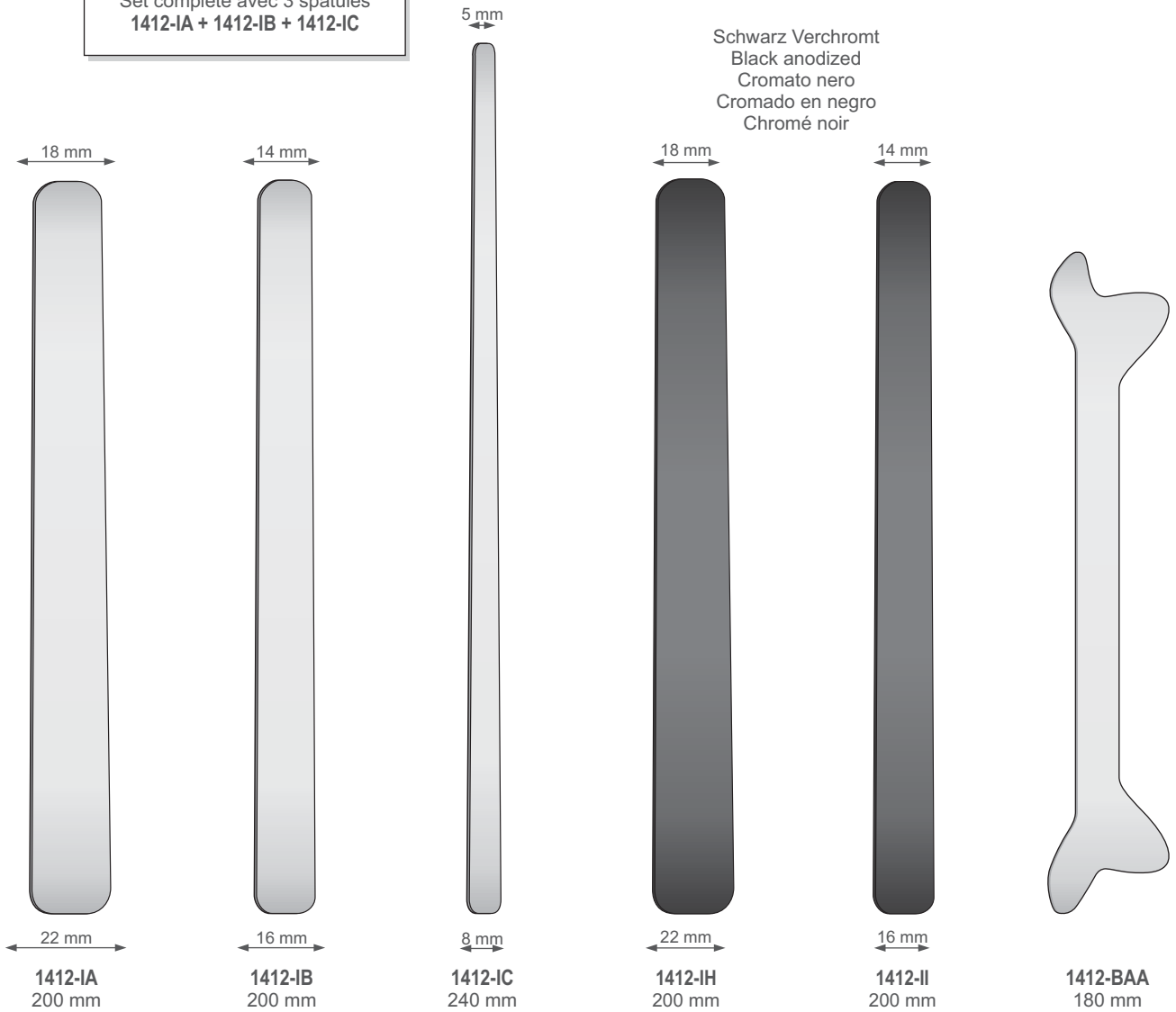



Zungendrucker  
Tongue Depressors  
Abbassalingua  
Abajalenguas  
Abaisse langue

Kinnhalter  
Chin Holder  
Divaricatore per mento  
Separador para menton  
Ecarteur pour menton

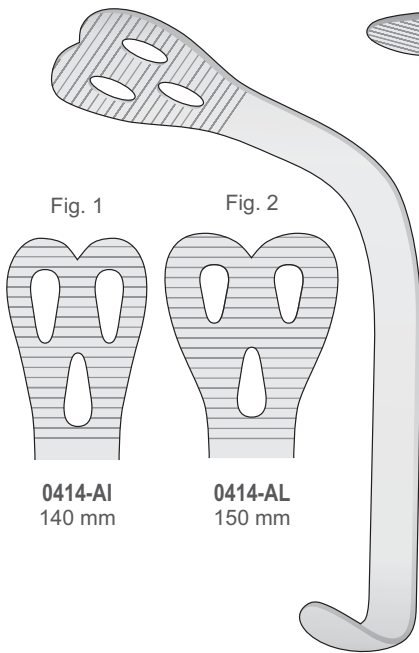
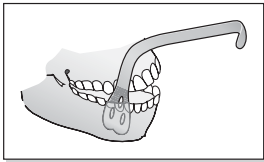

Fig. 1

Fig. 2

0414-AI  
140 mm

0414-AL  
150 mm

WIEDER  
0414-AI/0414-AL

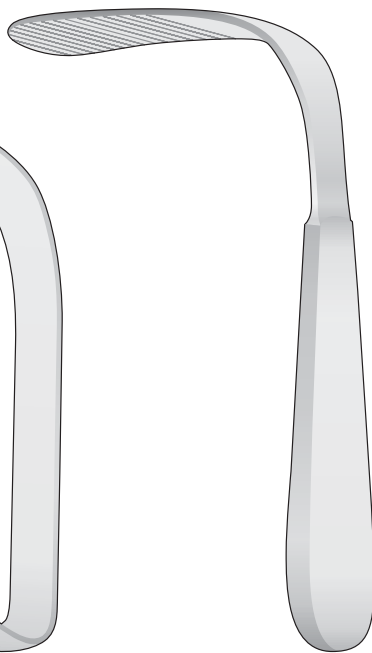

TOBOLD  
1412-AI  
145 mm

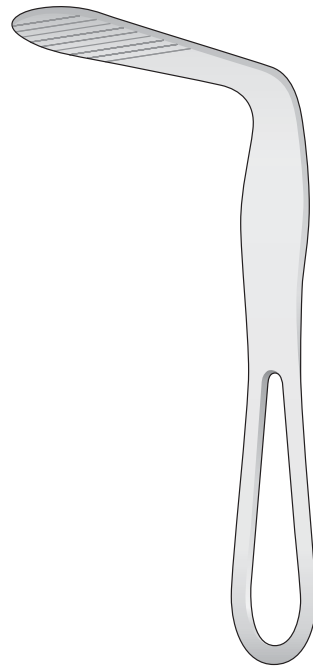

HARTMANN  
1412-AG  
150 mm

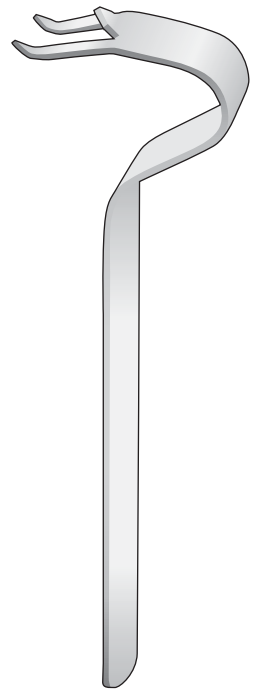

OBWEGESER  
0414-EA  
155 mm



Wundhaken  
 Retractors  
 Divaricatori  
 Separadores  
 Ecarteurs

Ramushaken für Spina Nasalis  
 Ramus Retractor for nasal spine  
 Divaricatori per spina nasalis  
 Separadores para spina nasalis  
 Ecarteurs pour spina nasalis



42 x 10 mm

1/1

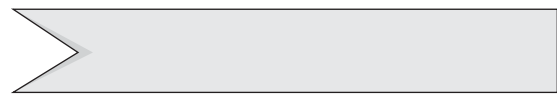

70 x 11 mm

1/1

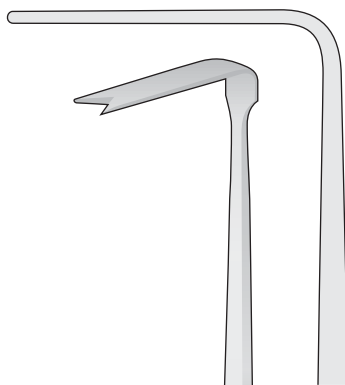

1/1

OBWEGESER  
**0219-GH**  
 220 mm

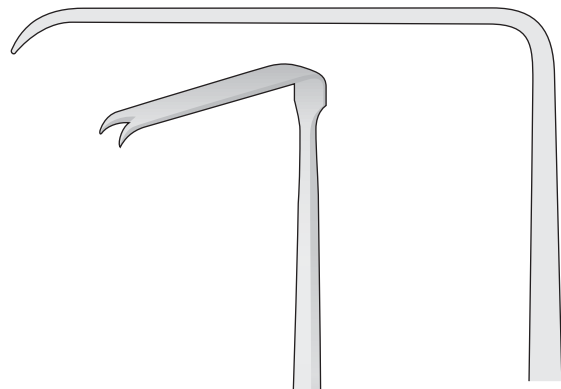

1/1

OBWEGESER  
**0219-GI**  
 220 mm



Paar Einsätze aus Silikon für:  
 Pair of silicone inserts for:  
 Coppia di inserti in silicone per:  
 Pareja de inserto de silicone para:  
 Paire de inserts en silicon pour:

**1412-EA - 1412-EB**

Ø 8 mm



**1412-EA17**  
 30 mm

Ø 11 mm



**1412-EB17**  
 30 mm

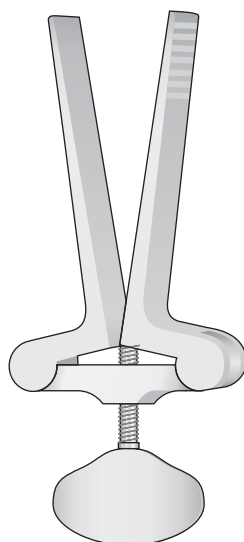

**HEISTER**  
**1412-GC**  
 135 mm

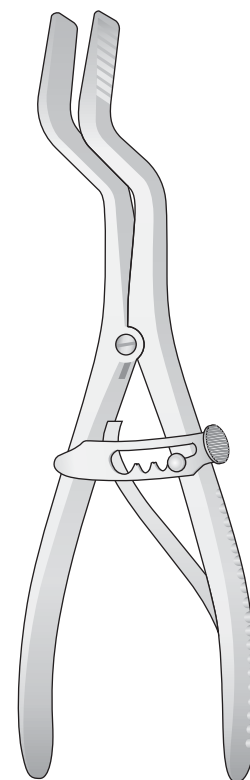

**ROSER KÖNIG**  
**1412-GA**  
 185 mm

Für Erwachsene - For adults  
 Per adulti - Para adultos  
 Pour adultes

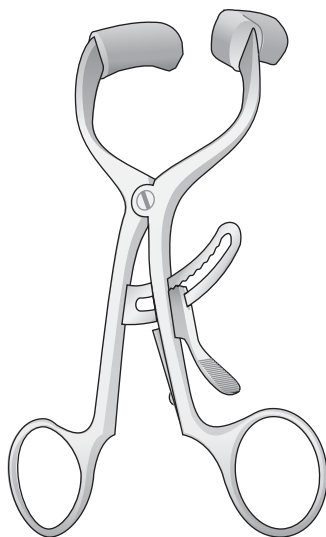

**MOLT**  
**DOYEN-JANSEN**  
**1412-EB**  
 140 mm

Für Erwachsene - For adults  
 Per adulti - Para adultos  
 Pour adultes

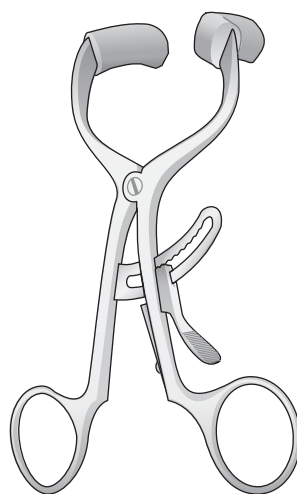

**MOLT**  
**DOYEN-COLLIN**  
**1412-EA**  
 120 mm

Für Kinder  
 For children  
 Per bambini  
 Para niños  
 Pour enfants

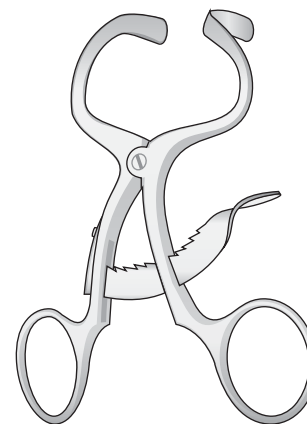

**MOLT**  
**1412-EC**  
 100 mm



Mundsperrer  
 Mouth gags  
 Apribocca  
 Abrebocas  
 Ecarteur buccal

Abhalter für gesamten Ober-bzw. Unterkiefer  
 Retractor for complete upper resp. Lower jaws  
 Retrattore per arcata superiore e inferiore intera  
 Separadores para quijadas enteras inferiores y superiores  
 Ecarteurs pour machoires complètes inférieures et supérieures

- 1412-HE Fig. 0 100 x 95 mm
- 1412-HF Fig. 1 115 x 105 mm
- 1412-HG Fig. 2 115 x 110 mm
- 1412-HH Fig. 3 125 x 115 mm

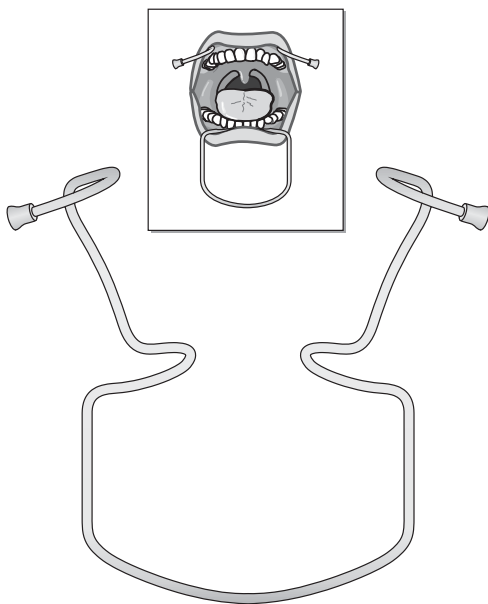

ORINGER  
 1412-HE/1412-HH

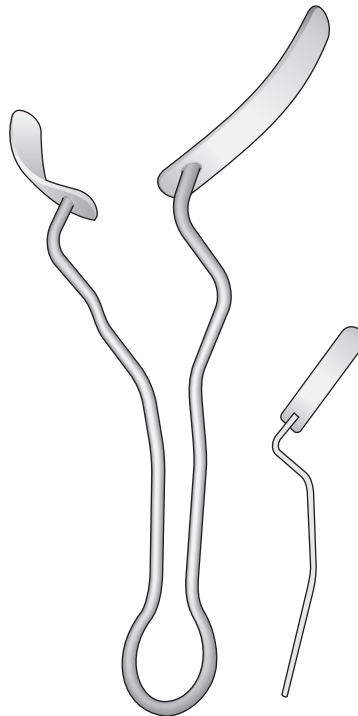

MATY  
 1412-LH  
 170 mm

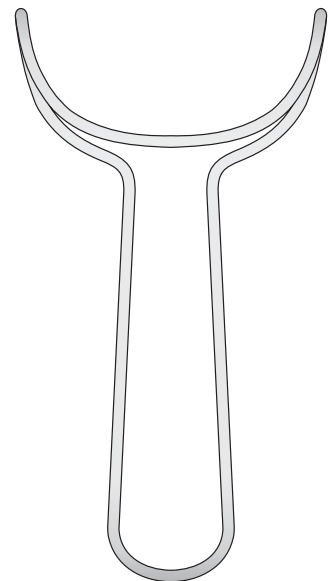

1412-LA  
 150 mm



**0219-CID**  
Set completo  
Set complete  
Komplettset  
Set complet  
Set completo  
**0219-CIE + 0219-CIF + 0219-CIG**



29 mm  
26 mm  
22 mm

28 mm  
38 mm  
44 mm

**ROUX  
0219-CID**  
165 mm

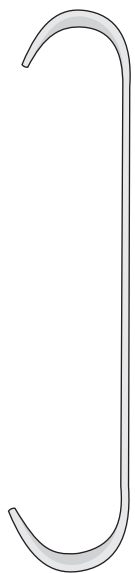

**ROUX  
0219-CIE**  
20x22 mm  
25x28 mm

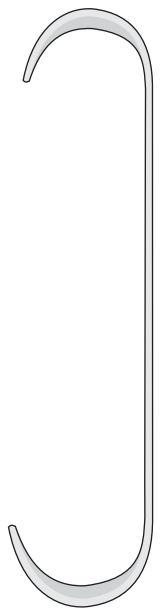

**ROUX  
0219-CIF**  
23x26 mm  
29x38 mm

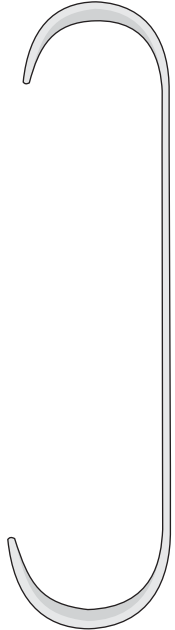

**ROUX  
0219-CIG**  
29x29 mm  
34x44 mm

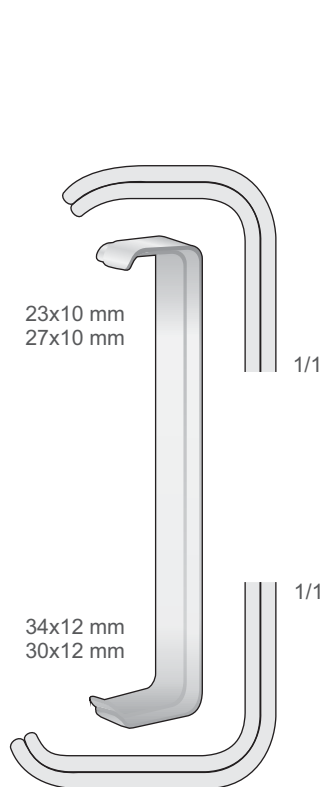

23x10 mm  
27x10 mm

1/1

34x12 mm  
30x12 mm

1/1

**FARABEUF  
0219-CA**  
120 mm

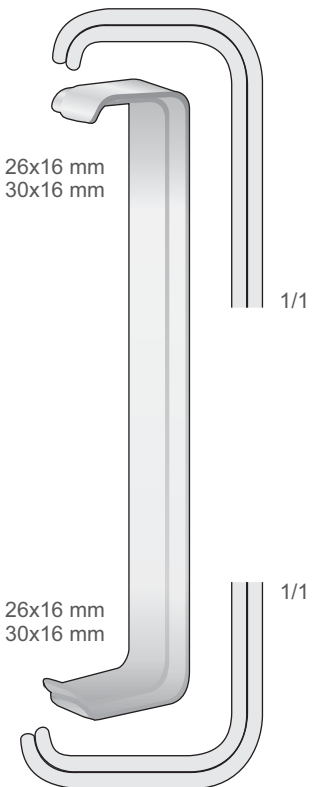

26x16 mm  
30x16 mm

1/1

26x16 mm  
30x16 mm

1/1

**FARABEUF  
0219-CF**  
150 mm



20x22 mm

**ROUX-MAGNUS  
0219-CIH**  
150 mm



23x26 mm

**ROUX-MAGNUS  
0219-CII**  
160 mm

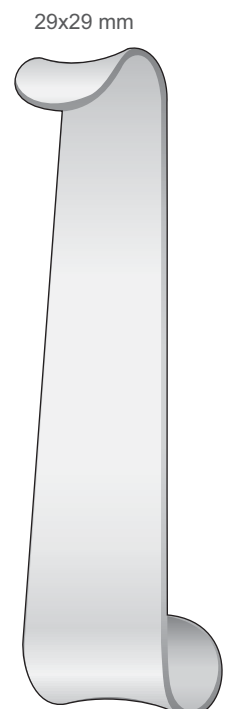

29x29 mm

**ROUX-MAGNUS  
0219-CIL**  
170 mm





Wangenhalter  
 Cheek Retractors  
 Divaricatori per guance  
 Separador para mejillas  
 Ecarteurs des joues

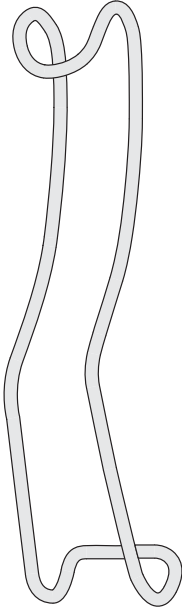

STERNBERG  
 1412-FA  
 160 mm



STERNBERG  
 1412-FC  
 160 mm

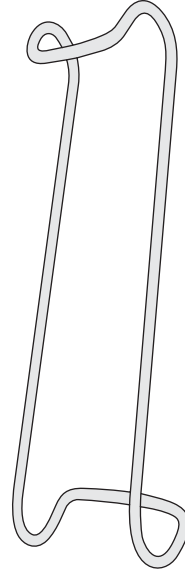

COLUMBIA  
 1412-GH  
 140 mm

Schwarz Verchromt  
 Black anodized  
 Cromato nero  
 Cromado en negro  
 Chromé noir

**NEW  
 BLACK**

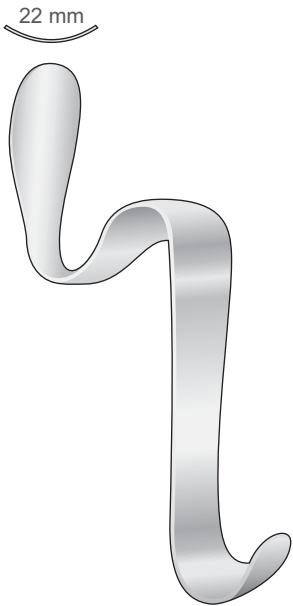

BISHOP  
 1412-GB  
 130 mm



MINNESOTA  
 1412-FF  
 140 mm

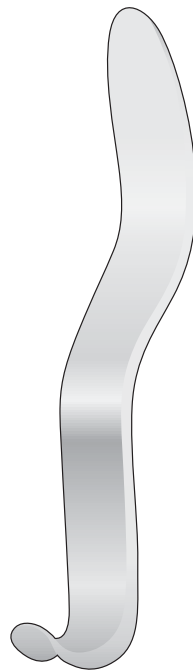

CAWOOD-MINNESOTA  
 1412-GG  
 160 mm



MINNESOTA  
 1412-EE02  
 140 mm

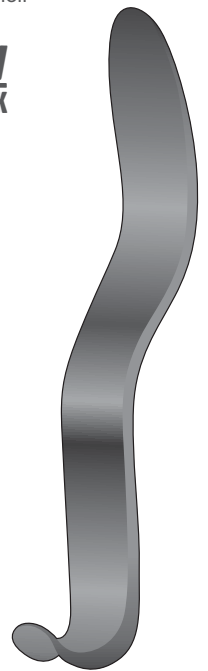

CAWOOD-MINNESOTA  
 1412-GG02  
 160 mm

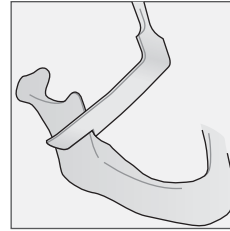

Ramus Retraktoren Recht  
Ramus Retractor Right  
Retrattore Ramus destro  
Separadores Ramus derecho  
Ecarteur Ramus droites

Ramus Retraktoren Link  
Ramus Retractor Left  
Retrattore Ramus sinistro  
Separadores Ramus izquierdo  
Ecarteur Ramus gauches

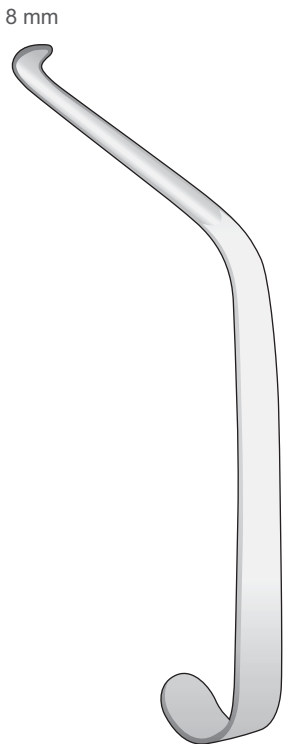

OBWEGESER  
**0414-EB**  
165 mm

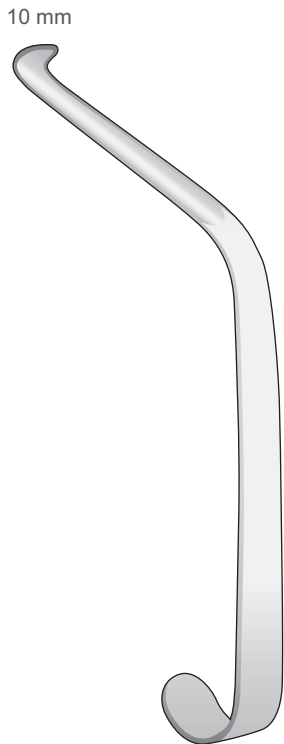

OBWEGESER  
**0414-BEC**  
165 mm



MISCH  
**0219-BFI**  
210 mm

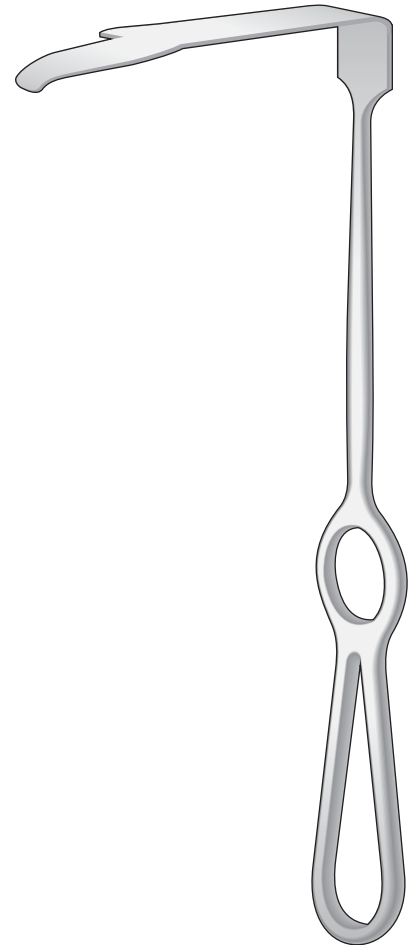

MISCH  
**0219-BFL**  
210 mm

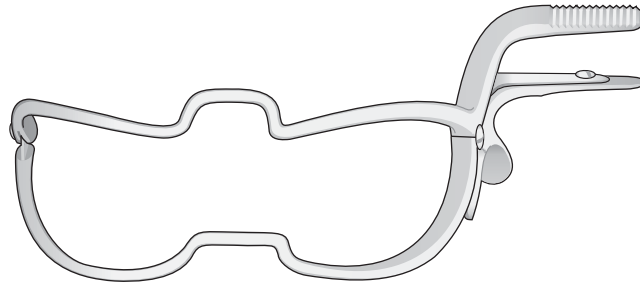

WHITEHEAD-JENNINGS

- 1412-BDG 90 mm
- 1412-BDH 110 mm
- 1412-BDI 130 mm
- 1412-BDL 150 mm

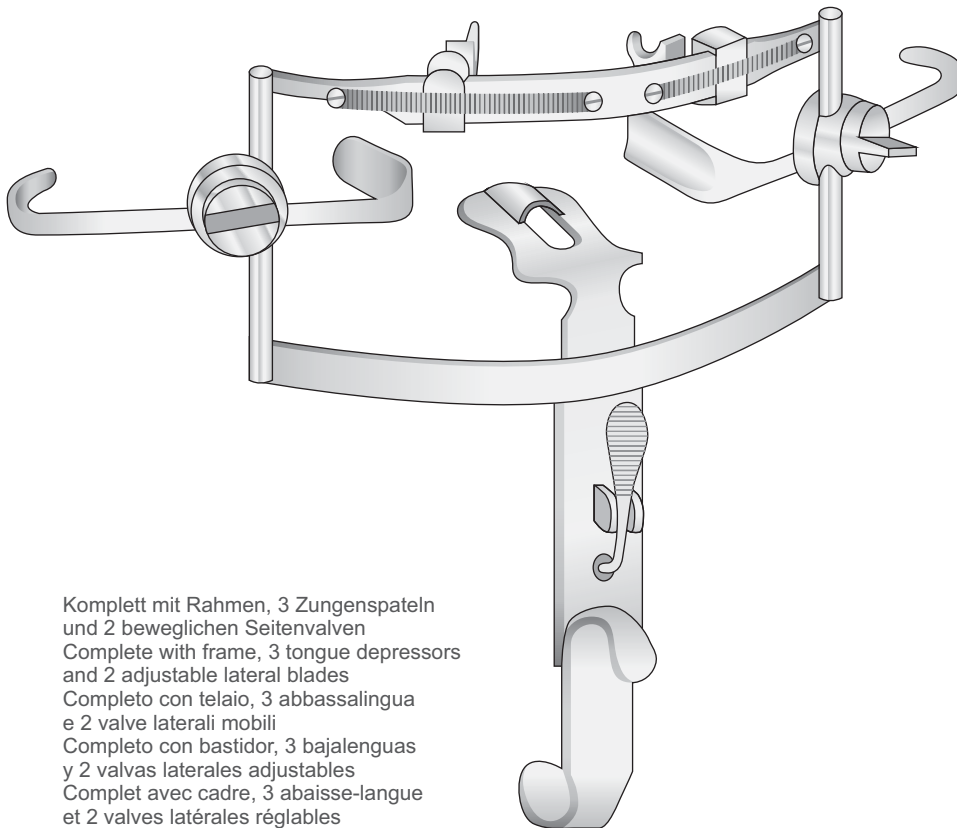

Komplett mit Rahmen, 3 Zungenspateln  
 und 2 beweglichen Seitenvälven  
 Complete with frame, 3 tongue depressors  
 and 2 adjustable lateral blades  
 Completo con telaio, 3 abbassalingua  
 e 2 valve laterali mobili  
 Completo con bastidor, 3 bajalenguas  
 y 2 valvas laterales ajustables  
 Complet avec cadre, 3 abaisse-langue  
 et 2 valves latérales réglables

DINGMANN  
 1412-BBA  
 Set completo

DINGMANN

Zungenspatel  
 Tongue depressor  
 Abbassalingua  
 Bajalengua  
 Abaisse langue

Fig. 1

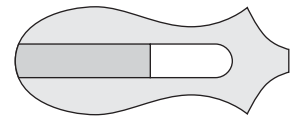

1412-BBC  
 65 x 25 mm

Fig. 2

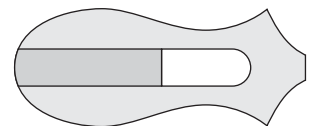

1412-BBD  
 70 x 29 mm

Fig. 3

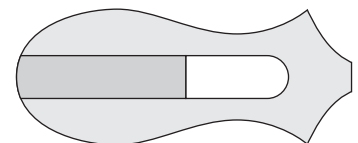

1412-BBE  
 80 x 32 mm

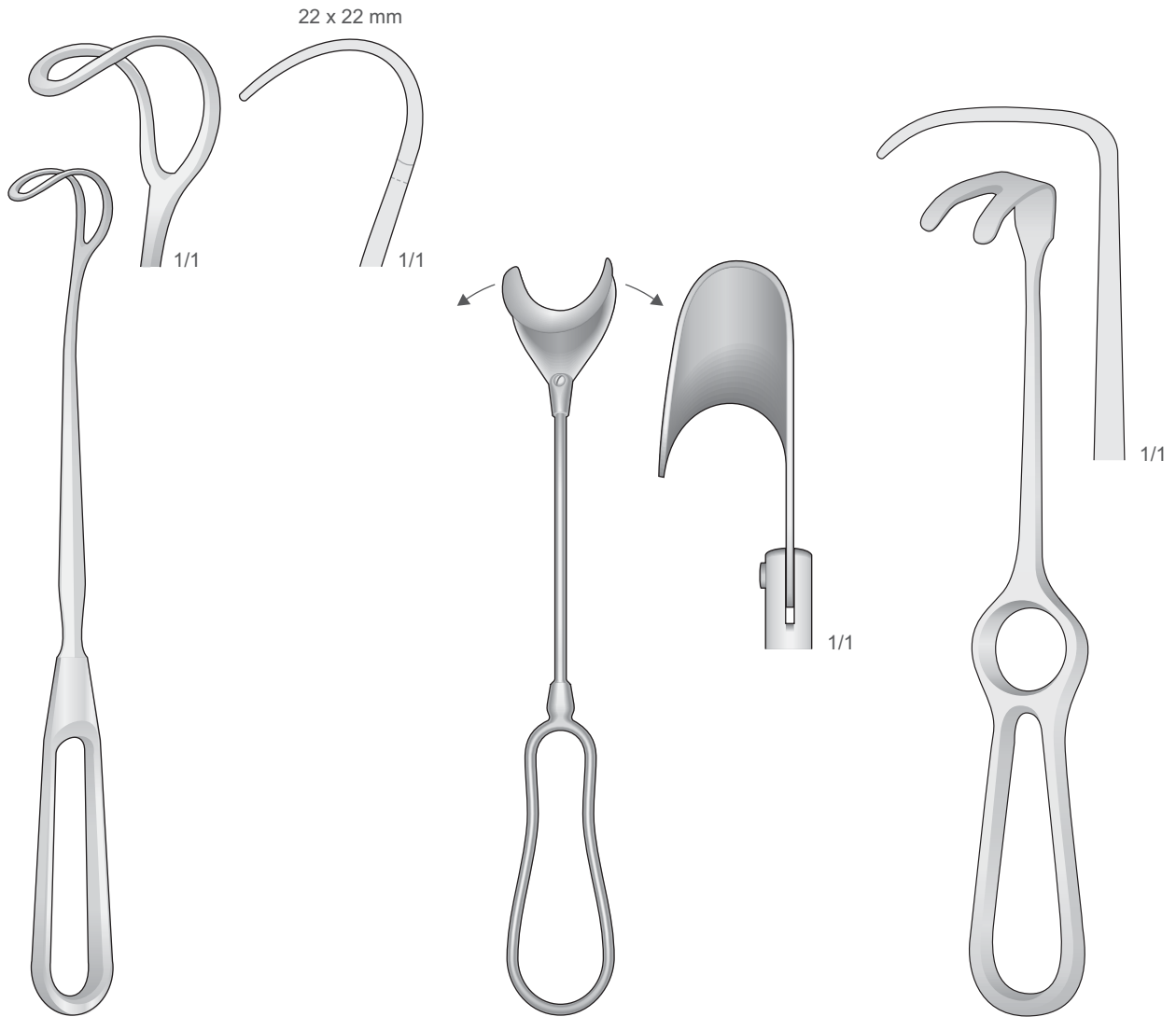

**GREENE**  
**0219-BDB**  
225 mm

**0219-BDC**  
200 mm

**WASSMUND**  
**0219-GL**  
220 mm



Zungenspatel - Zungenzangen  
 Tongue Depressors - Tongue Holding Forceps  
 Abbassalingua - Pinze tiralingua  
 Abaja lenguas - Pinzas tira-lengua  
 Abaisse langues - Pinces tire-langue

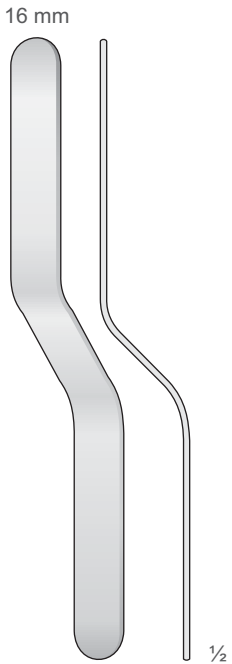

**1412-AH**  
145 mm

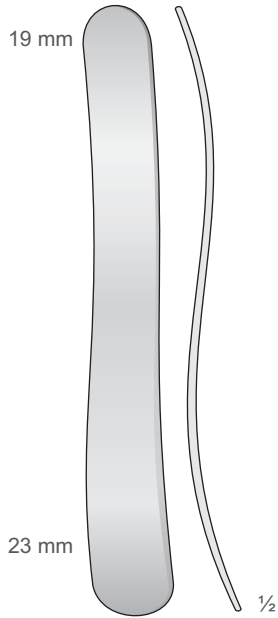

**KROENIG**  
**1412-BG**  
150 mm

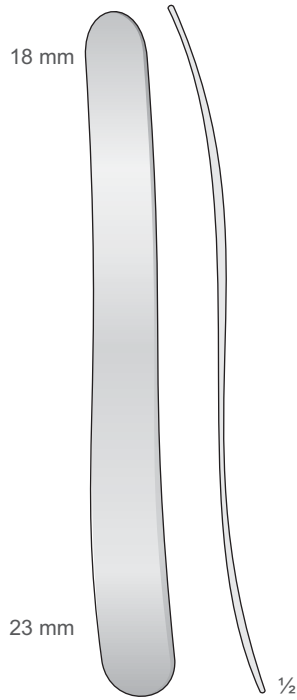

**BUCHWALD**  
**1412-BI**  
180 mm

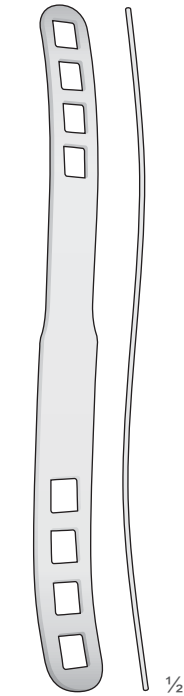

**BRUENINGS**  
**1412-AE**  
190 mm

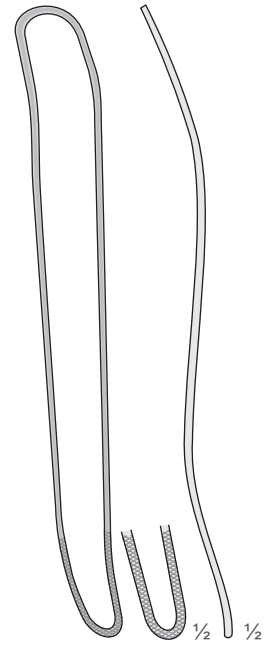

**FRENZEL**  
**1412-BL**  
165 mm

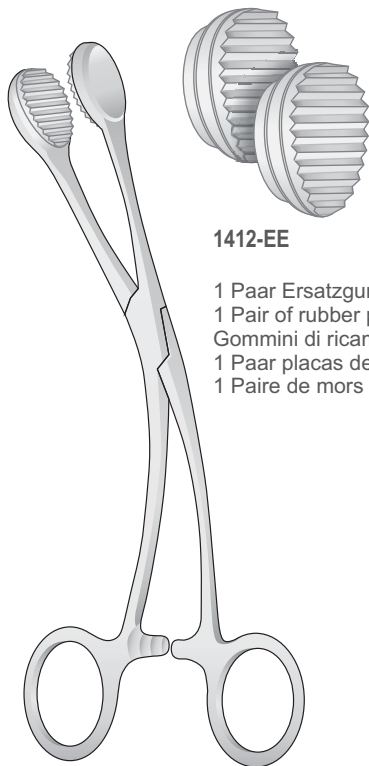

**YOUNG**  
**1412-EF**  
160 mm

**1412-EE**

1 Paar Ersatzgummi  
 1 Pair of rubber pads  
 Gommini di ricambio 2 pezzi  
 1 Paar placas de caucho  
 1 Paire de mors caoutchouc

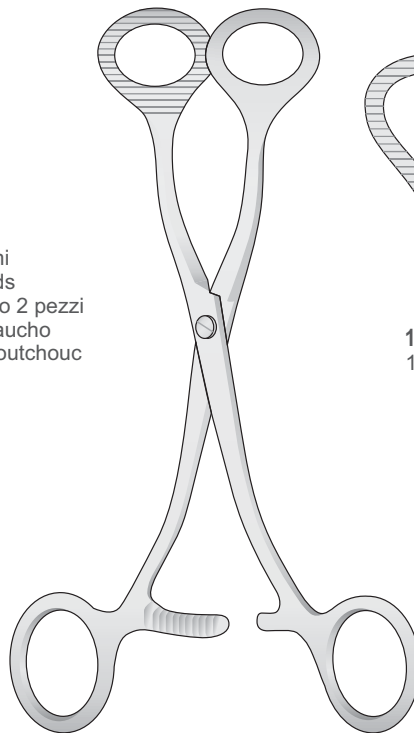

**COLLIN**  
**1412-BA/1412-DA**

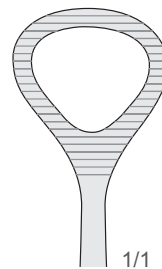

**1412-DA**  
165 mm

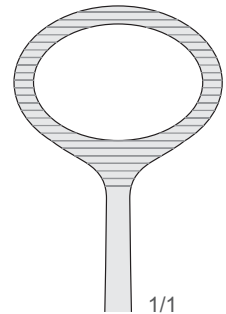

**1412-BA**  
170 mm

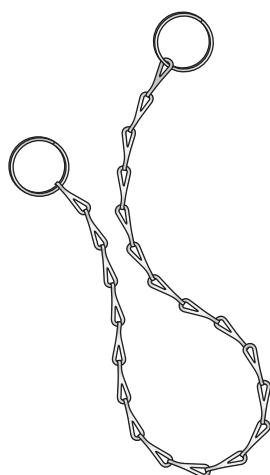

**1005-CA**  
200 mm



**1005-EA**  
400 mm

Dampfsterilisation bis 134°C  
Autoclavable to 134°C  
Autoclavabile a 134°C  
Autoclave hasta 134°C  
Autoclavable jusqu'à 134°C

Packung mit 2 Stück  
Package with 2 units  
Confezione da 2 pezzi  
Paquete con 2 unidades  
Boîte avec 2 pièces

Schwarzer Gummi  
Black Rubber  
Gomma nera  
Caucho negro  
Caoutchouc noir

Schwarzer Gummi  
Black Rubber  
Gomma nera  
Caucho negro  
Caoutchouc noir

Schwarzer Gummi  
Black Rubber  
Gomma nera  
Caucho negro  
Caoutchouc noir



**1412-HA**  
SMALL  
Klein, für Kinder  
Small, for children  
Piccolo, per bambini  
Pequeño, para niños  
Petit, pour enfants



**1412-HB**  
MEDIUM  
Normal, für Erwachsene  
Regular, for adults  
Normale, per adulti  
Regular, para adultos  
Regulier, pour adultes



**1412-HC**  
LARGE  
Groß, für Erwachsene  
Large, for adults  
Grande, per adulti  
Grande, para adultos  
Grand, pour adultes

.9

Implantologie  
Implantology  
Implantologia  
Implantologia  
Implantologie

Zahnärztliche Chirurgie  
Dental surgery  
Chirurgia dentale  
Cirugia dental  
Chirurgie dentaire









Osteotome  
Osteotomes  
Osteotomi  
Osteótomos  
Ostéotomes

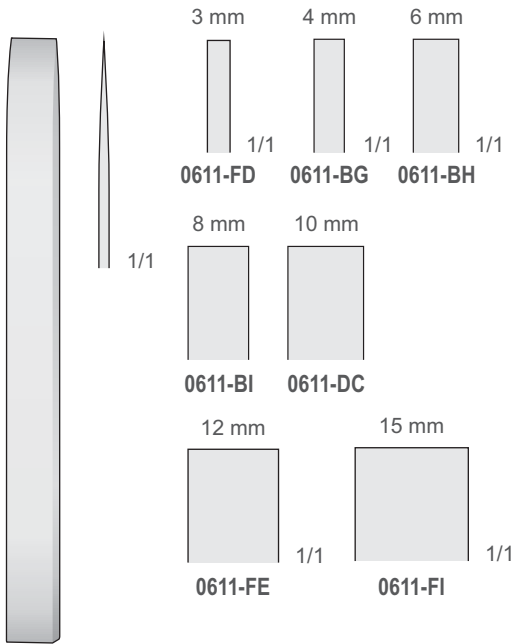

MINI-LAMBOTTE  
0611-BG/0611-FI  
125 mm

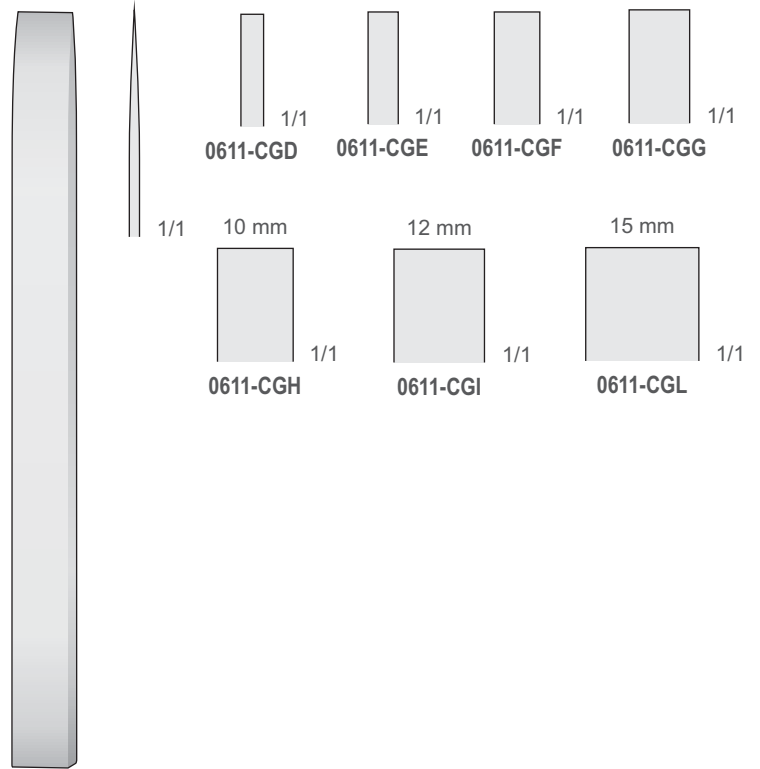

MINI-LAMBOTTE  
0611-CGD/0611-CGL  
170 mm

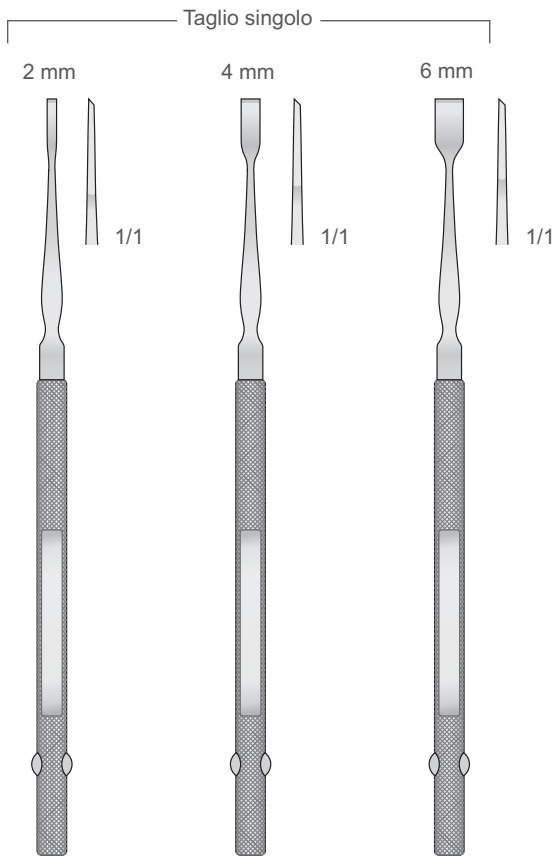

FREER  
1907-BA  
160 mm

FREER  
1907-BB  
160 mm

FREER  
1907-BC  
160 mm

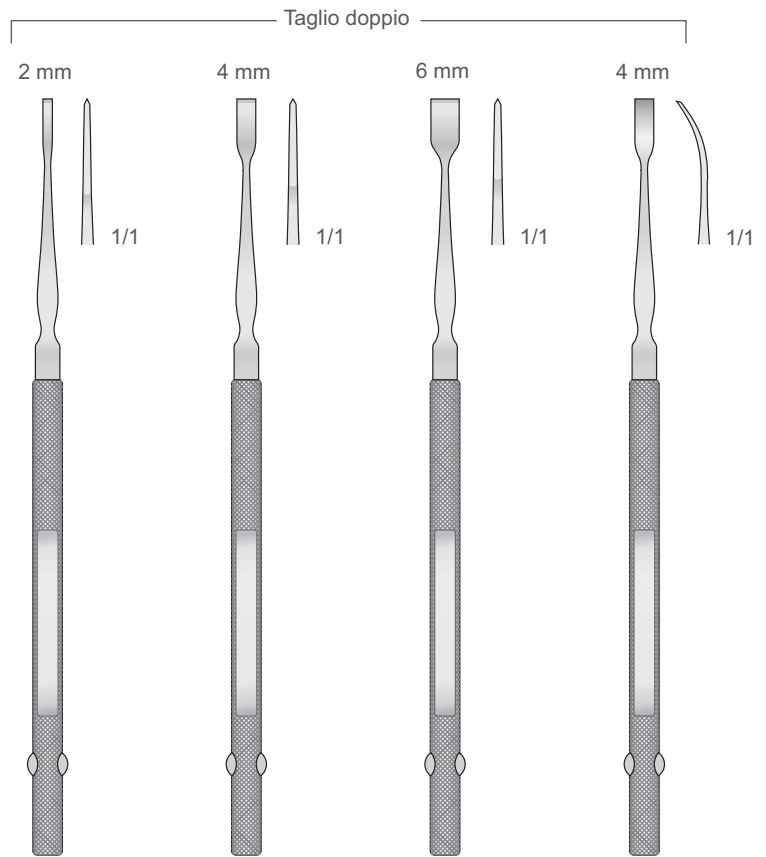

FREER  
1907-CA  
160 mm

FREER  
1907-CB  
160 mm

FREER  
1907-CC  
160 mm

FREER  
1907-CD  
160 mm



Osteotome - Hohlmeissel  
 Osteotomes - Gouges  
 Osteotomi - Scalpelli  
 Osteótomos - Cinceles  
 Ostéotomes - Scalpel

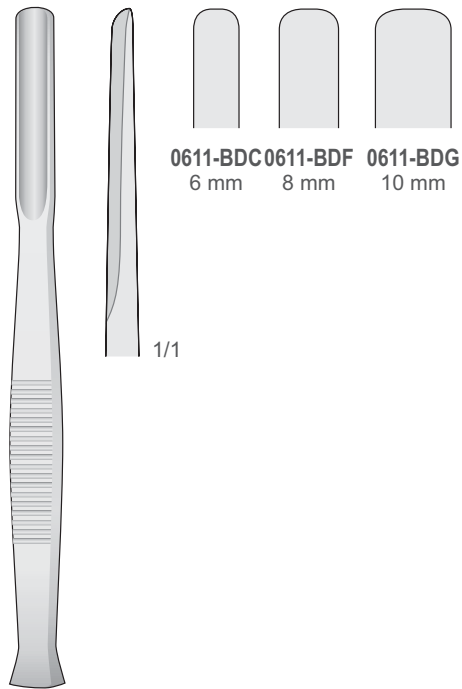
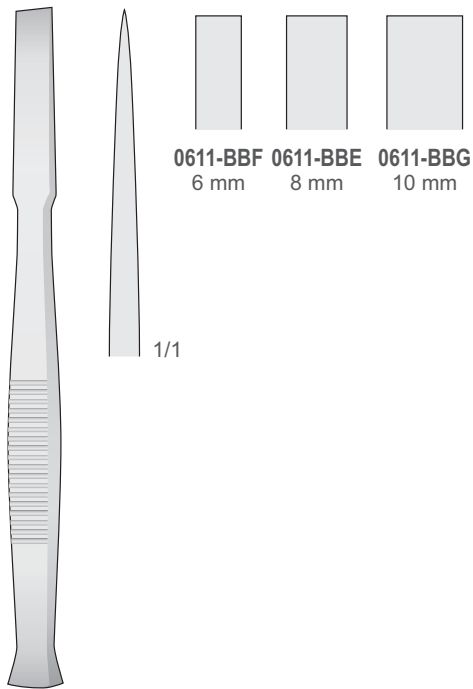

**0611-BBE/0611-BBG**  
140 mm

**0611-BDC/0611-BDG**  
140 mm

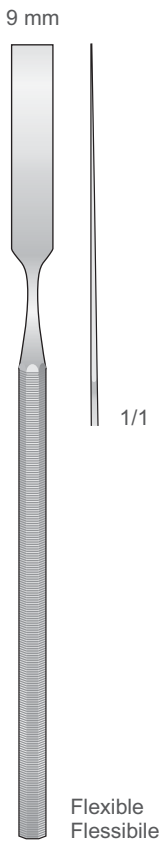

**1907-BF**  
170 mm

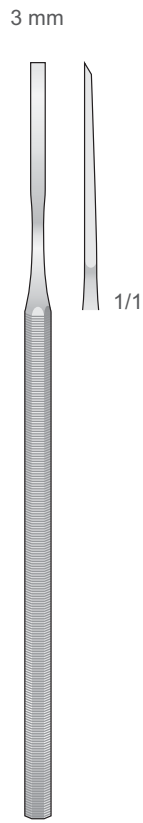

**1907-DA**  
155 mm

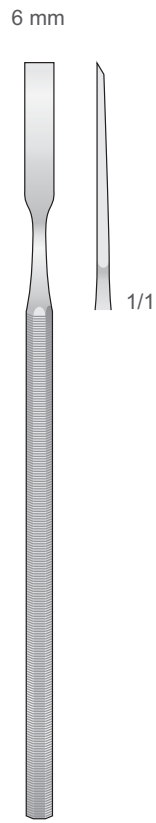

**1907-DB**  
155 mm

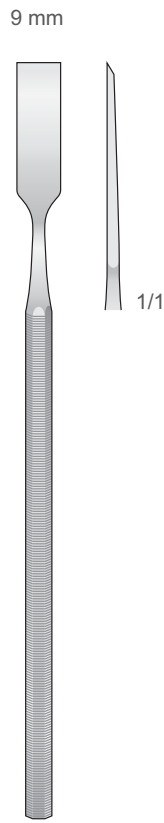

**1907-DC**  
155 mm

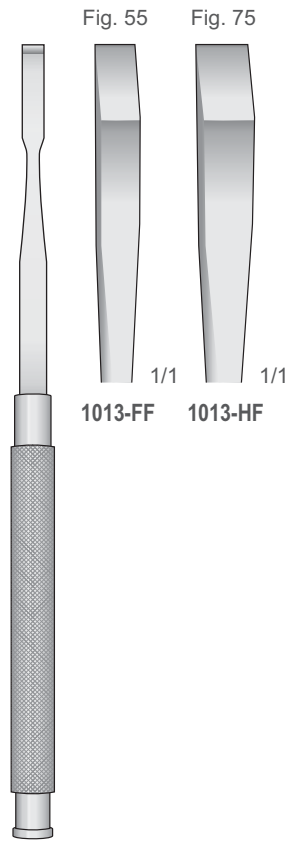

**KRAMER-NEVINS**  
**1013-FF/1013-HF**  
175 mm

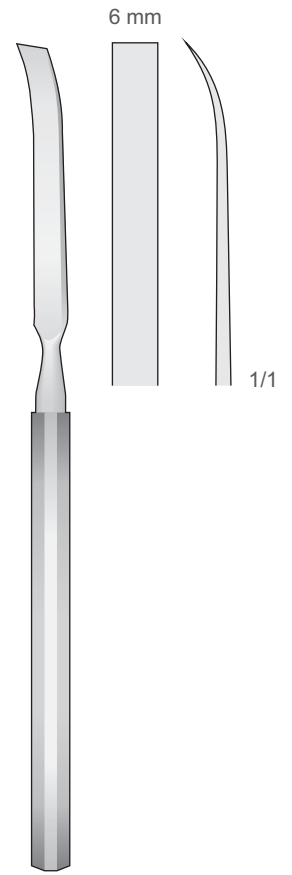

**0414-BLG**  
180 mm



Osteotome - Hohlmeissel  
 Osteotomes - Gouges  
 Osteotomi - Scalpelli  
 Osteótomos - Cinceles  
 Ostéotomes - Scalpel

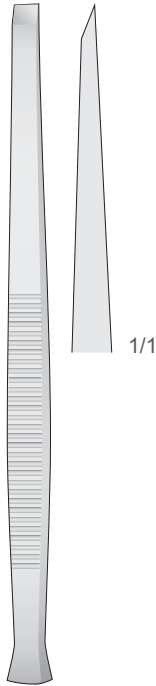

**0611-BD**  
3 mm

**0611-BE**  
4 mm

**0611-BF**  
5 mm

**PARTSCH**  
**0611-BD/0611-BF**  
140 mm

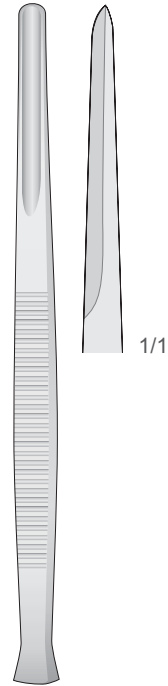

**0611-AD**  
3 mm

**0611-AE**  
4 mm

**0611-AF**  
5 mm

**PARTSCH**  
**0611-AD/0611-AF**  
140 mm

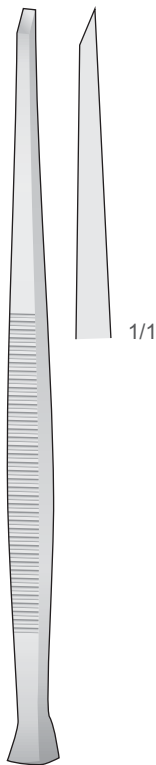

**0611-BHH**  
3 mm

**0611-BID**  
6 mm

**0611-BHL**  
4 mm

**0611-BIE**  
7 mm

**0611-BIB**  
5 mm

**PARTSCH**  
**0611-BHH/0611-BIE**  
170 mm

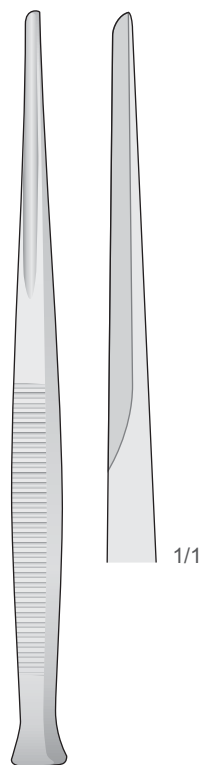

**0611-BIF**  
3 mm

**0611-BII**  
6 mm

**0611-BIG**  
4 mm

**0611-BIL**  
7 mm

**0611-BIH**  
5 mm

**PARTSCH**  
**0611-BIF/0611-BIL**  
170 mm



Osteotome - Meissel  
 Osteotomes - Chisels  
 Osteotomi - Scalpelli  
 Osteótomos - Cinceles  
 Ostéotomes - Burins

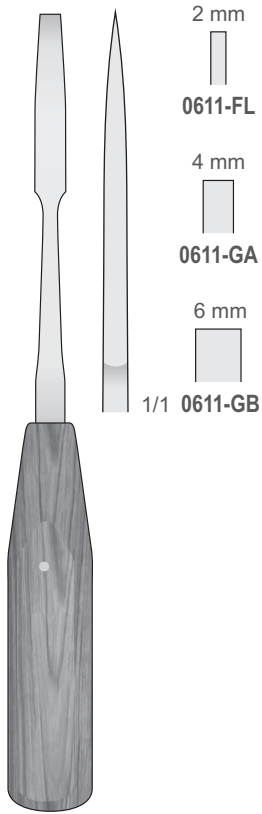

MINI-LEXER  
 0611-FL/0611-GB  
 200 mm

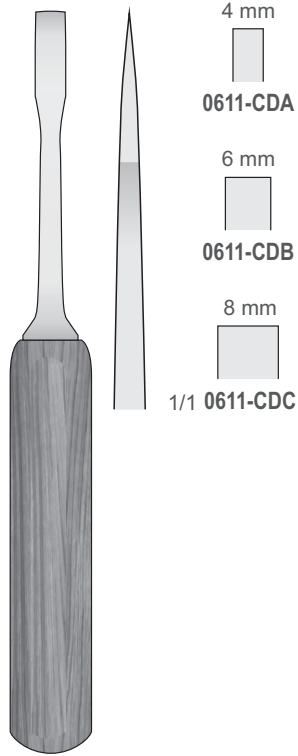

MINI-LEXER  
 0611-CDA/0611-CDC  
 180 mm

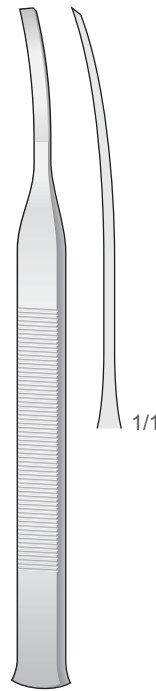

TESSIER  
 0611-EBB 5 mm  
 0611-EBC 7 mm  
 160 mm

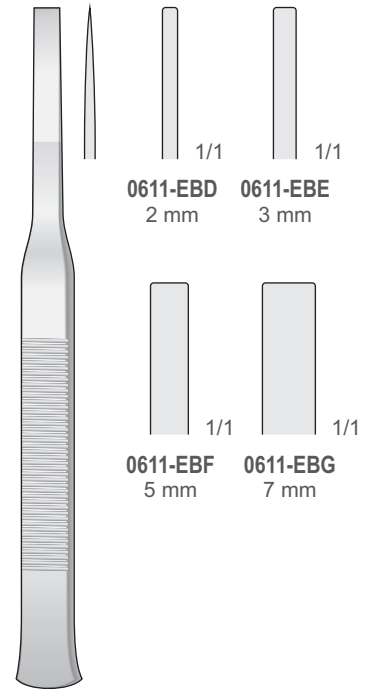

TESSIER  
 0611-EBD/0611-EBG  
 160 mm

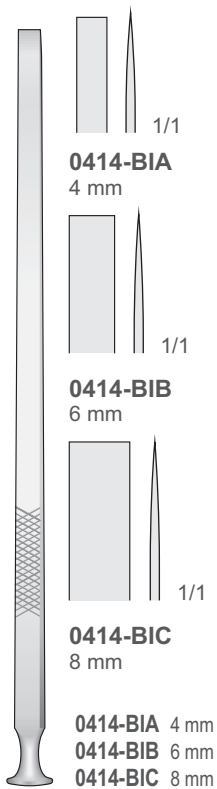

EPKER  
 0414-BIA/0414-BIC  
 180 mm

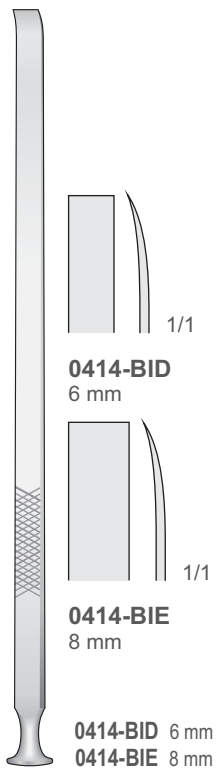

EPKER  
 0414-BID/0414-BIE  
 180 mm

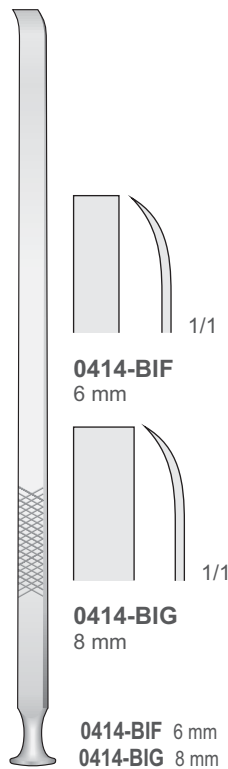

EPKER  
 0414-BIF/0414-BIG  
 180 mm

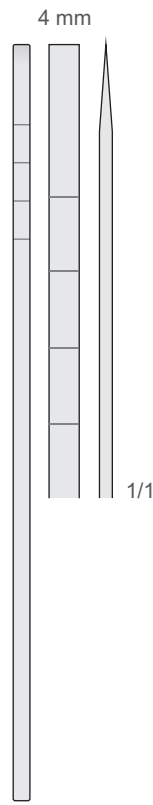

COTTLE  
 0414-BEA  
 180 mm

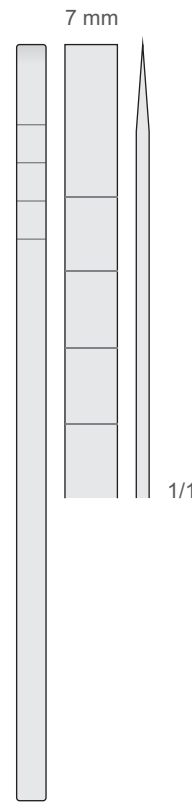

COTTLE  
 0414-BEB  
 180 mm

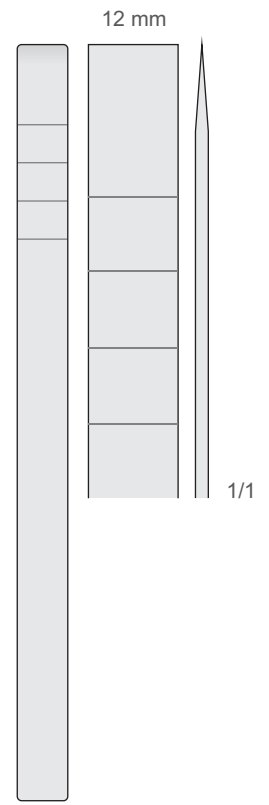

COTTLE  
 0414-BED  
 180 mm

Chirurgische Hämmer  
Surgical mallets  
Martelli chirurgici  
Martillos quirurgicos  
Maillets chirurgicaux



Ø 20 mm - 140 g



**0611-AB**  
165 mm

Ø 25 mm - 300 g

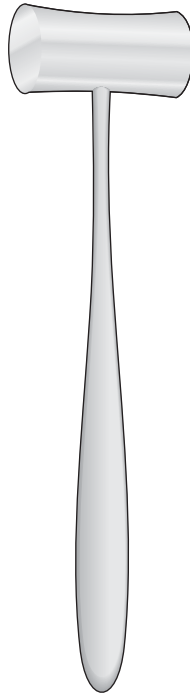

**LUCAE**  
**0611-BA12**  
190 mm

Ø 27 mm - 135 g

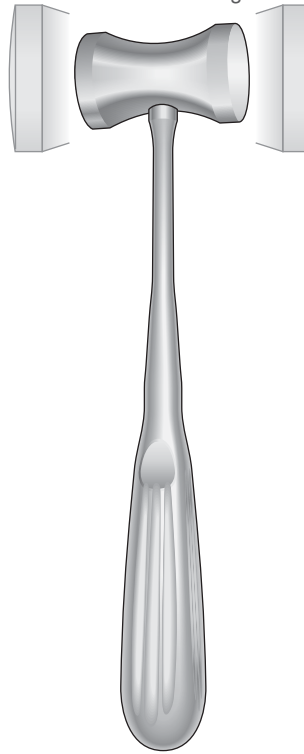

**HAJEK**  
**0611-BCI**  
200 mm

Ø 30 mm - 240 g



**COTTLE**  
**0611-BAE**  
185 mm

1 Seite flach - 1 Seite convex  
1 Side flat - 1 Side convex  
1 Lato piatto - 1 Lato convesso  
1 Parte plana - 1 Parte convexa  
1 Face plate - 1 Face convexe

Ø 20 mm - 160 g

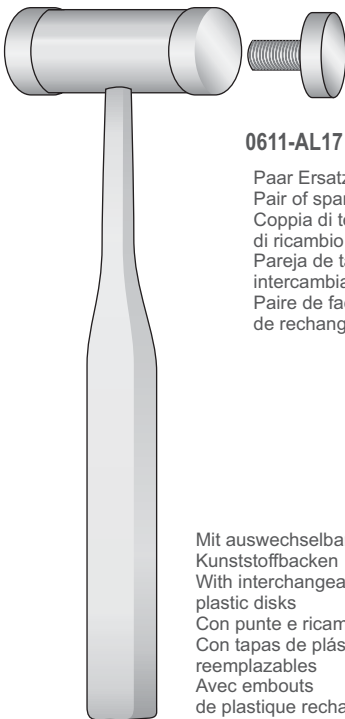

**0611-AL17**

Paar Ersatzbacken  
Pair of spare faces  
Coppia di teste  
di ricambio  
Pareja de tapas  
intercambiables  
Paire de faces  
de rechange

Mit auswechselbaren  
Kunststoffbacken  
With interchangeable  
plastic disks  
Con punte e ricambi in teflon  
Con tapas de plástico  
reemplazables  
Avec embouts  
de plastique rechangeables

**MEAD**  
**0611-AL**  
190 mm

Ø 25 mm - 200 g

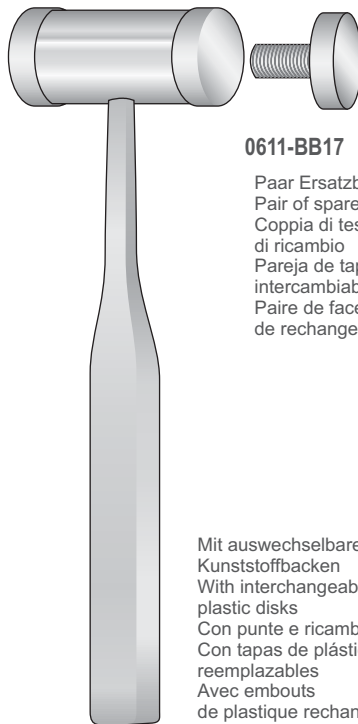

**0611-BB17**

Paar Ersatzbacken  
Pair of spare faces  
Coppia di teste  
di ricambio  
Pareja de tapas  
intercambiables  
Paire de faces  
de rechange

Mit auswechselbaren  
Kunststoffbacken  
With interchangeable  
plastic disks  
Con punte e ricambi in teflon  
Con tapas de plástico  
reemplazables  
Avec embouts  
de plastique rechangeables

**MEAD**  
**0611-BB**  
200 mm

Ø 26 mm - 320 g

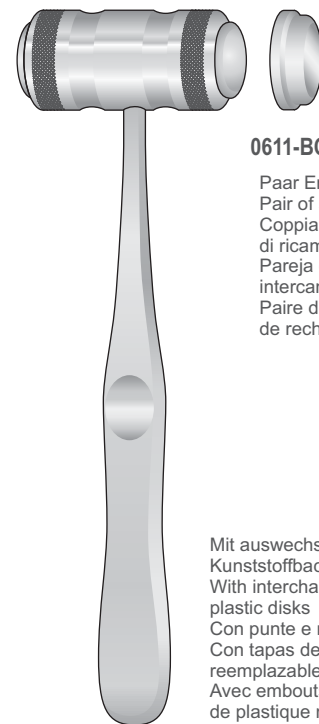

**0611-BC17**

Paar Ersatzbacken  
Pair of spare faces  
Coppia di teste  
di ricambio  
Pareja de tapas  
intercambiables  
Paire de faces  
de rechange

Mit auswechselbaren  
Kunststoffbacken  
With interchangeable  
plastic disks  
Con punte e ricambi in teflon  
Con tapas de plástico  
reemplazables  
Avec embouts  
de plastique rechangeables

**MEAD**  
**0611-BC**  
190 mm



Sinus Lift Retraktoren - Sinus Lift Retractors  
 Divaricatori per Sinus Lift - Separadores para Sinus Lift  
 Écarteurs pour Sinus Lift

Raspatorien  
 Periosteals  
 Scollaperiosteal  
 Periostotomos  
 Raspatoires

17 mm

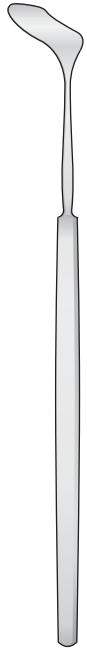

SAUTTER  
**1310-CEL**  
 145 mm

11 mm

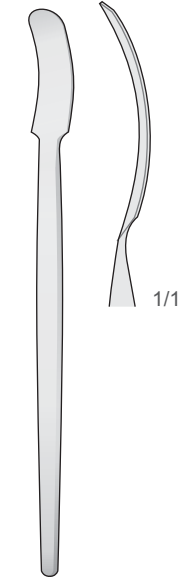

**1310-BAF**  
 125 mm

9 mm

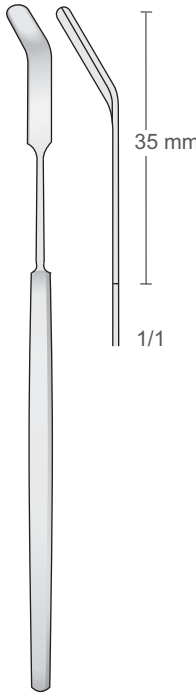

MODELL GIESSEN  
**1310-CFB**  
 160 mm

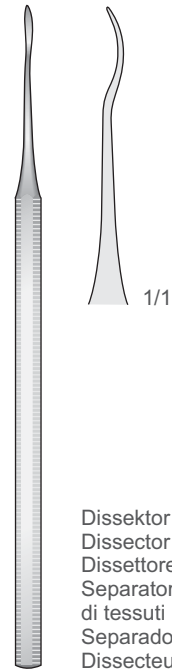

Dissektor  
 Dissector  
 Dissettore  
 Separatore  
 di tessuti  
 Separadores  
 Dissecteur

4,5 mm

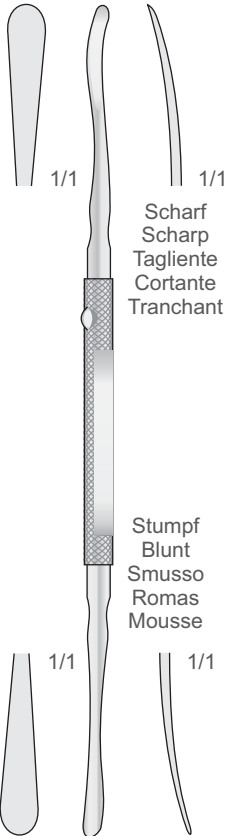

**0617050517**  
 180 mm

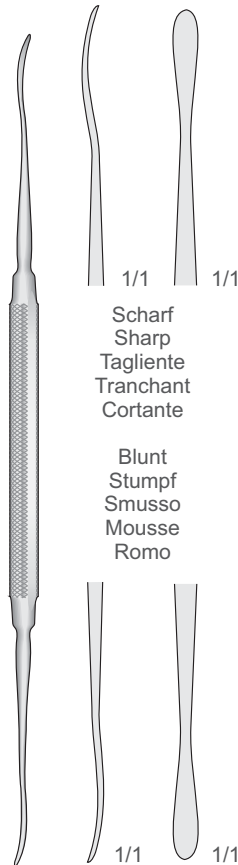

FREER  
**0617-BG**  
 185 mm

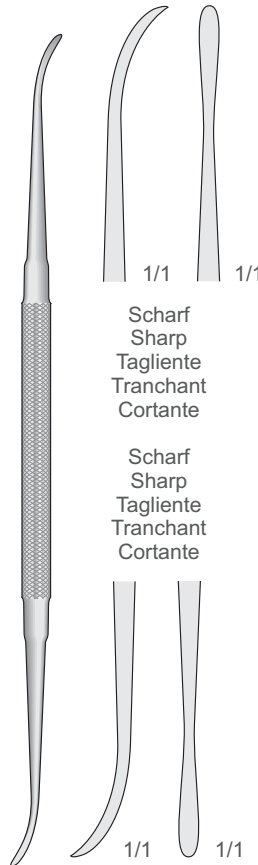

FREER-YASARGIL  
**0617-BH**  
 185 mm

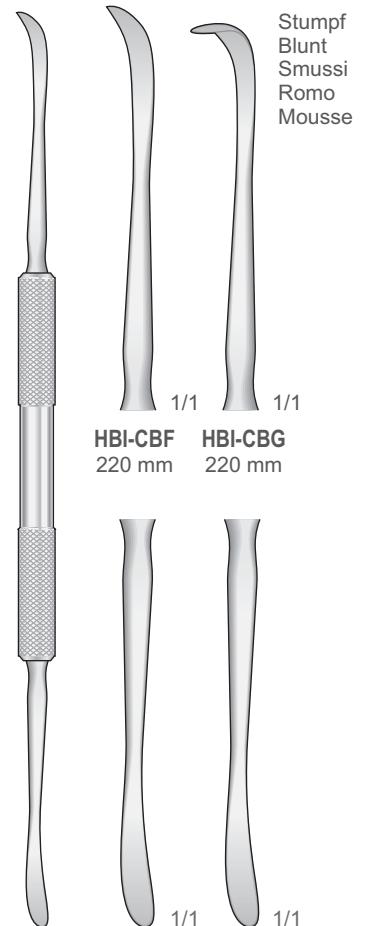

OBWEGESER-FREER  
**HBI-CBF/HBI-CBG**  
 220 mm

Stumpf  
 Blunt  
 Smussi  
 Romo  
 Mousse



Knochen-Trephine  
Bone Trephine  
Trephine per osso  
Trephine para huesos  
Trephin pour os

**Combination Trocar-Trephine Instruments**

Bestehend aus einem Trokar, einer gezahnten Trephine und einem Kolben zur Entnahme von Knochentransplantaten aus Tibia und Beckenkamm mittels eines geschlossenen Verfahrens

Consisting of trocar, a toothed trephine and a plunger for taking tibial and iliac bone grafts through a closed technique

Composto di un trequarti, una camicia dentata ed un pistone per il prelievo degli innesti ossei dalla tibia e dalla cresta iliaca tramite una tecnica chirurgica intracutanea

Compuesto por un tròcar, un trépano dentado y un émbolo para obtener injertos óseos tibiales e iliacos mediante una técnica cerrada

Composé d'un trocart, d'une tréphine dentée et d'un piston pour le prélèvement de greffes osseuses de la tibia ou de la crête iliaque par une technique fermée

**0610-BAA**

Komplettset mit 4 Teilen  
Set complete with 4 pieces  
Set completo di 4 pezzi  
Set completo con 4 piezas  
Set complet avec 4 pièces

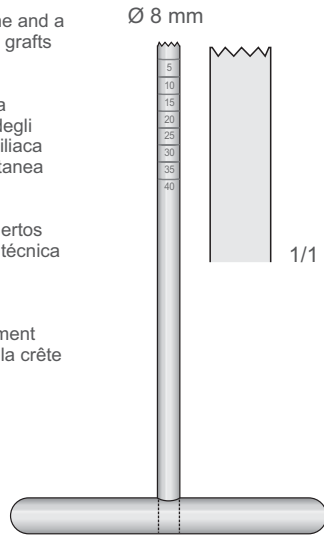

**0610-BAB**  
145 mm

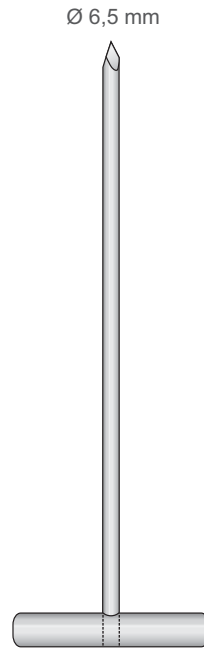

**0610-BAC**  
163 mm

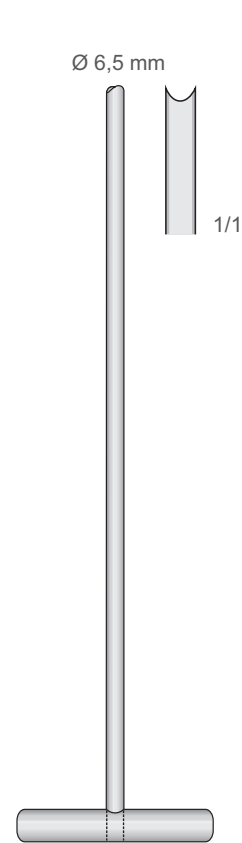

**0610-BAD**  
208 mm

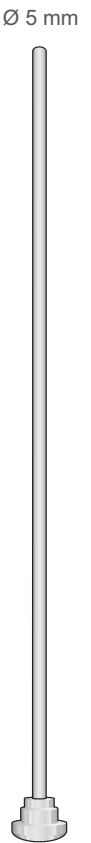

**0610-BAE**  
220 mm

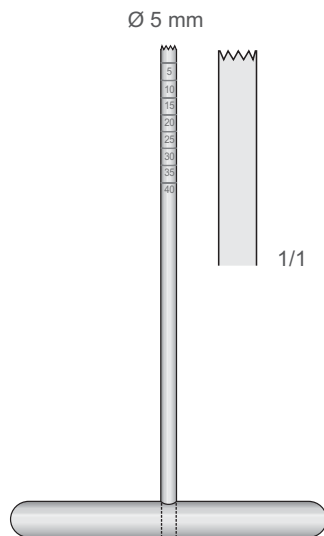

**0610-BAG**  
145 mm

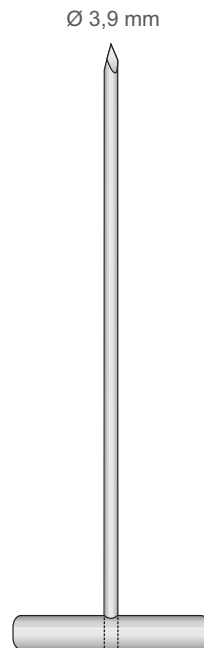

**0610-BAH**  
163 mm

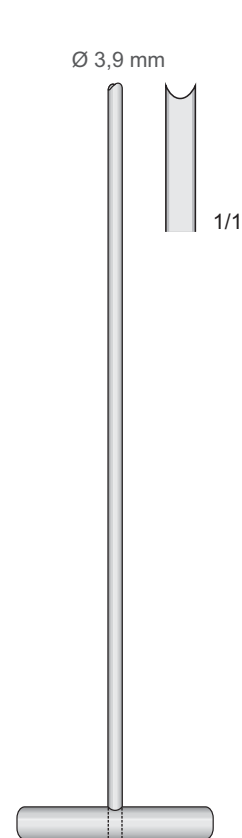

**0610-BAI**  
208 mm



**0610-BAL**  
220 mm

**0610-BAF**

Komplettset mit 4 Teilen  
Set complete with 4 pieces  
Set completo di 4 pezzi  
Set completo con 4 piezas  
Set complet avec 4 pièces



**Implant Sinus Lift Osteotomes**

**0611-EAA**  
Komplettset mit  
Set complete with  
Set completo con  
Kit completo con  
Set complete avec  
  
**0218-GA**  
**0611-DLB/0611-DLL**  
(Fig.1 - 2 - 3 - 4 - 5 - 6 - 7 - 8 - 9)

Fig. 1  
Ø 2.5 mm



**0611-DLB**  
155 mm

Fig. 2  
Ø 2.5 mm



**0611-DLC**  
155 mm

Fig. 3  
Ø 2.5 mm



**0611-DLD**  
155 mm

Fig. 4  
Ø 2.5 mm



**0611-DLE**  
155 mm

Fig. 5  
Ø 2.5 mm



**0611-DLF**  
155 mm





Osteotome  
Osteotomes  
Osteotomi  
Osteòtomos  
Ostéotomes

**Implant Sinus Lift Osteotomes**

**0611-EAA12**  
Komplettsset mit  
Set complete with  
Set completo con  
Kit completo con  
Set complete avec  
  
**0218-GA**  
**0611-DIL/0611-DLL**  
(Fig.00 - 0 - 1 - 2 - 3 - 4 - 5 - 6 - 7 - 8 - 9)

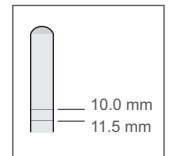
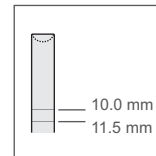

Fig. 6  
Ø 2.5 mm



**0611-DLG**  
155 mm

Fig. 7  
Ø 2.5 mm



**0611-DLH**  
155 mm

Fig. 8  
Ø 2.5 mm



**0611-DLI**  
155 mm

Fig. 9  
Ø 3.1 mm



**0611-DLL**  
155 mm

Fig. 00  
Ø 3.0 mm



**0611-DIL**  
155 mm

Fig. 0  
Ø 3.0 mm



**0611-DLA**  
155 mm



Fig. 1		Fig. 2		Fig. 3		Fig. 4		Fig. 5		Fig. 6	
Height	Diameter	Height	Diameter	Height	Diameter	Height	Diameter	Height	Diameter	Height	Diameter
0	Ø 1,60	0	Ø 1,90	0	Ø 2,80	0	Ø 3,10	0	Ø 3,90	0	Ø 5,50
7,5	Ø 1,80	7,5	Ø 2,20	7,5	Ø 3,20	7,5	Ø 3,70	10	Ø 5	10	Ø 6,20
10	Ø 2	10	Ø 2,35	10,5	Ø 3,35	10,5	Ø 3,90	13	Ø 5,20	13	Ø 6,30
13,5	Ø 2,40	13,5	Ø 3,30	13,5	Ø 3,60	15,5	Ø 4,30	20,5	Ø 6,30		
15,5	Ø 3,60	15,5	Ø 3,40	21	Ø 4,40						
		23,5	Ø 4,50								

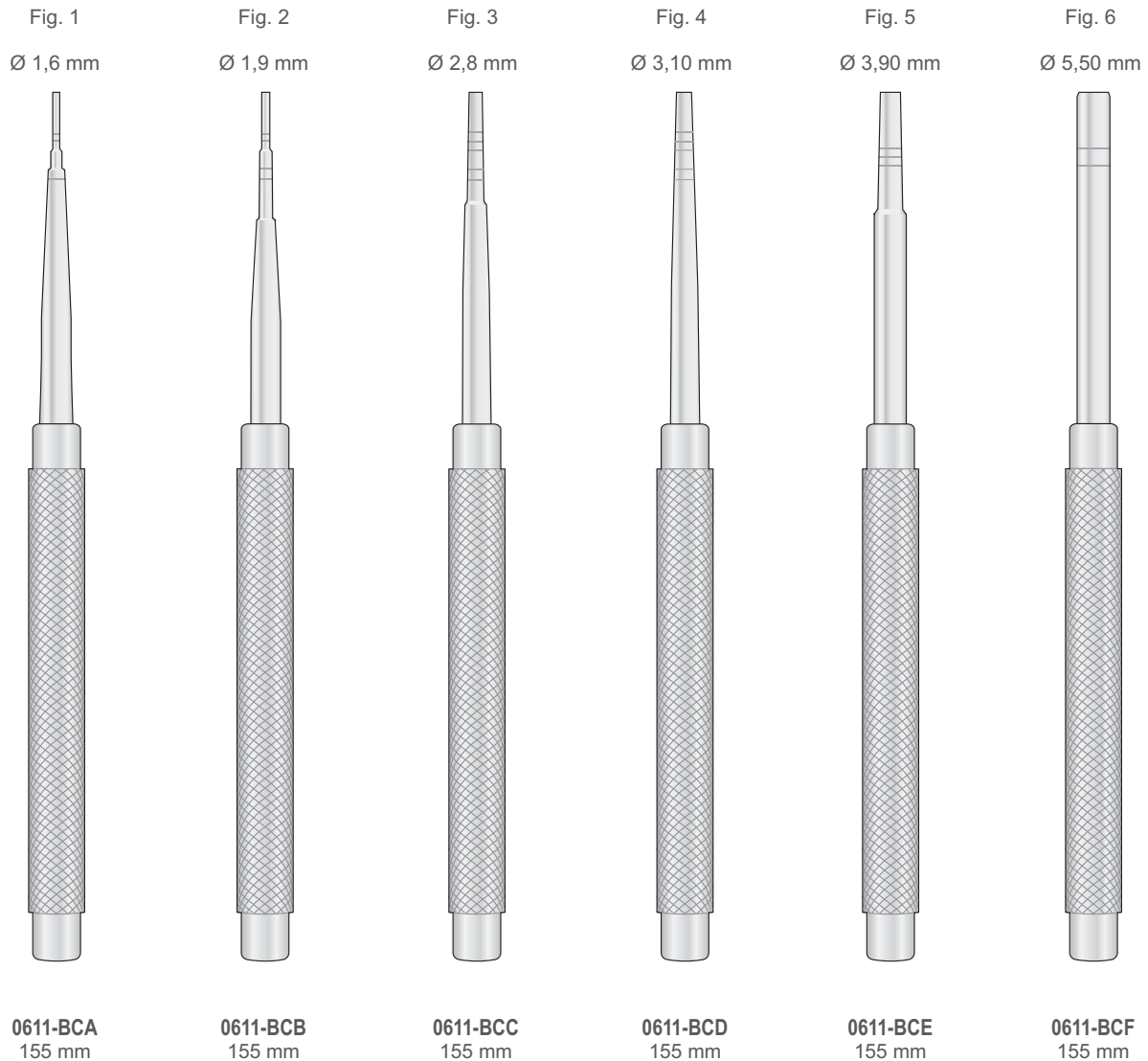



Osteotome  
Osteotomes  
Osteotomi  
Osteótomos  
Ostéotomes

L.	Ø 1° osteotome	Ø 2° osteotome	Ø 3° osteotome	Ø 4° osteotome	Ø 5° osteotome
0	1,5	2,1	2,6	3,0	3,5
5	1,9	2,6	3,0	3,5	3,9
8	2,2	2,8	3,3	3,8	4,2
10	2,4	3,0	3,5	4,0	4,4
12	2,6	3,2	3,7	4,2	4,6
14	2,8	3,4	3,9	4,4	4,8

Retificator  
Rettificatori

Fig. 1  
Ø 1,5 mm



**0611-CLC**  
155 mm

Fig. 2  
Ø 2,1 mm



**0611-CLD**  
155 mm

Fig. 3  
Ø 2,6 mm



**0611-CLE**  
155 mm

Fig. 4  
Ø 3,0 mm



**0611-CLF**  
155 mm

Fig. 5  
Ø 3,5 mm



**0611-CLG**  
155 mm

Ø 2,8 mm



**0611-CLH**  
155 mm

Ø 3,5 mm



**0611-CLI**  
155 mm

Ø 4,2 mm



**0611-CLL**  
155 mm



Knochenmeißel Graduiert  
Graduated Chisels  
Scalpelli graduati  
Osteótomos graduado  
Ostéotomes gradués

3,8 mm

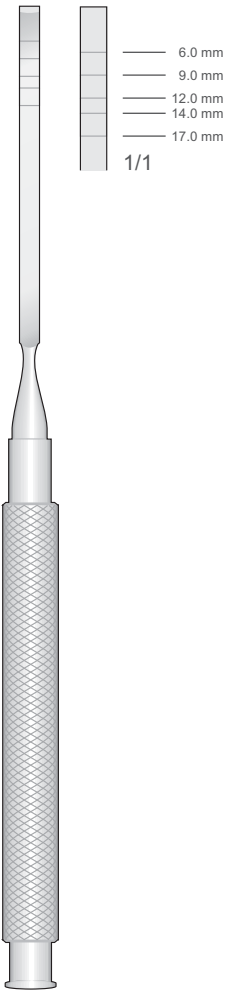

0611-BEB  
170 mm

3,8 mm

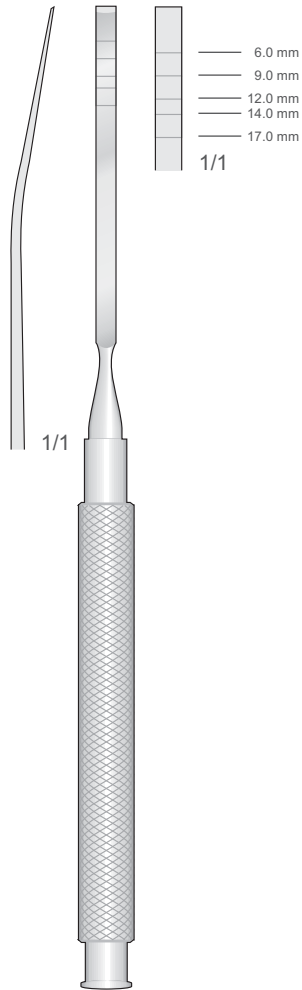

0611-BEC  
170 mm

7,5 mm

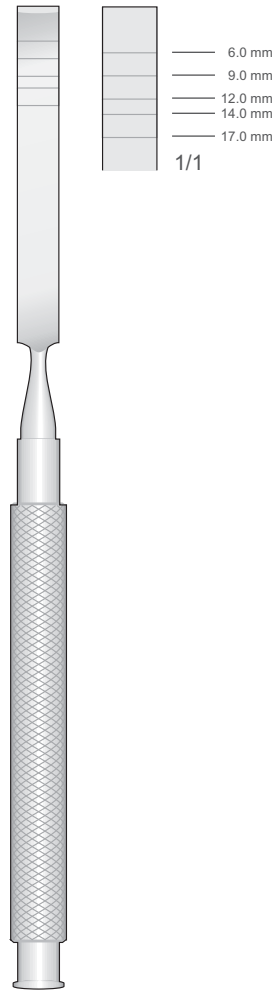

0611-BED  
170 mm

7,5 mm

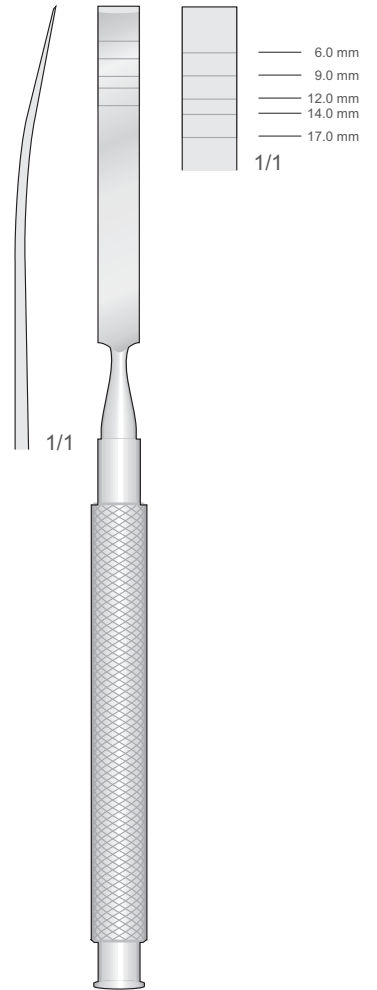

0611-BEE  
170 mm



Osteotome  
Osteotomes  
Osteotomi  
Osteótomos  
Ostéotomes

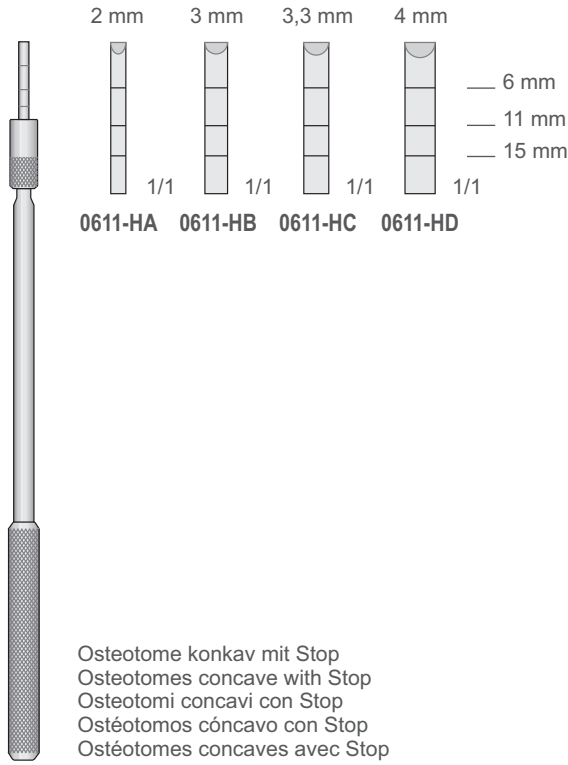

**0611-HA/0611-HD**  
165 mm

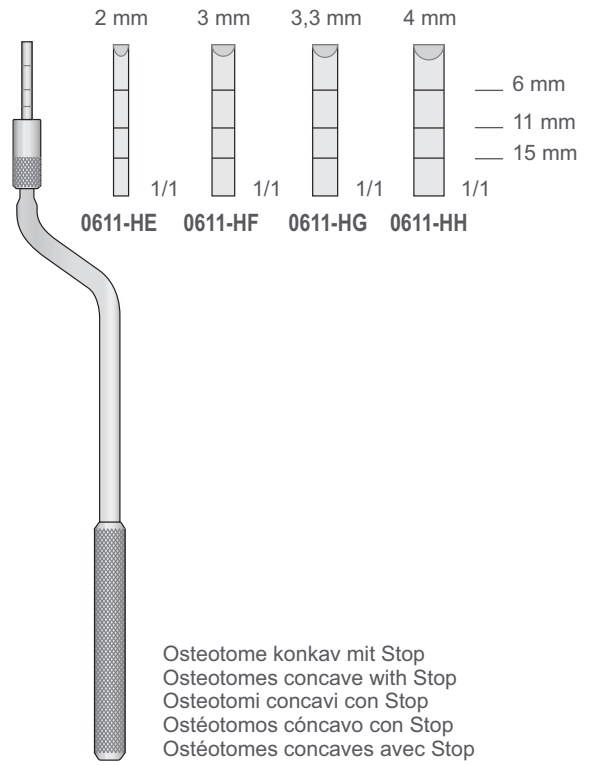

**0611-HE/0611-HH**  
165 mm

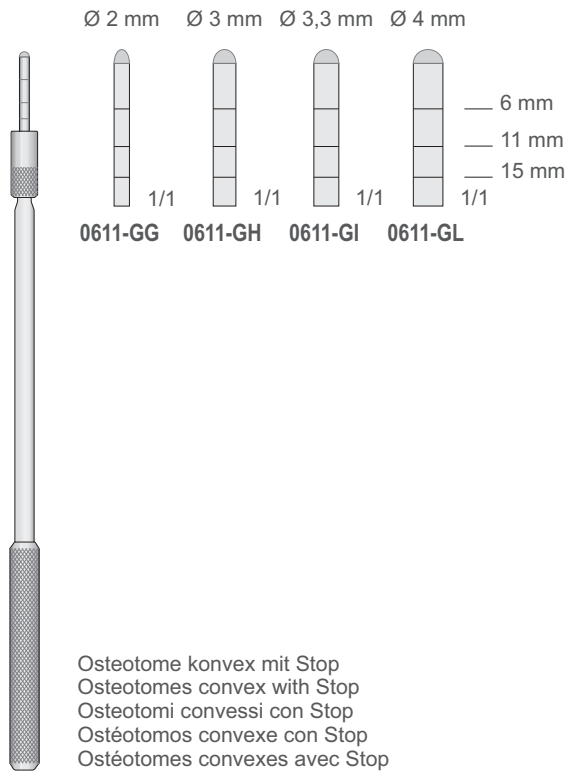

**0611-GG/0611-GL**  
165 mm

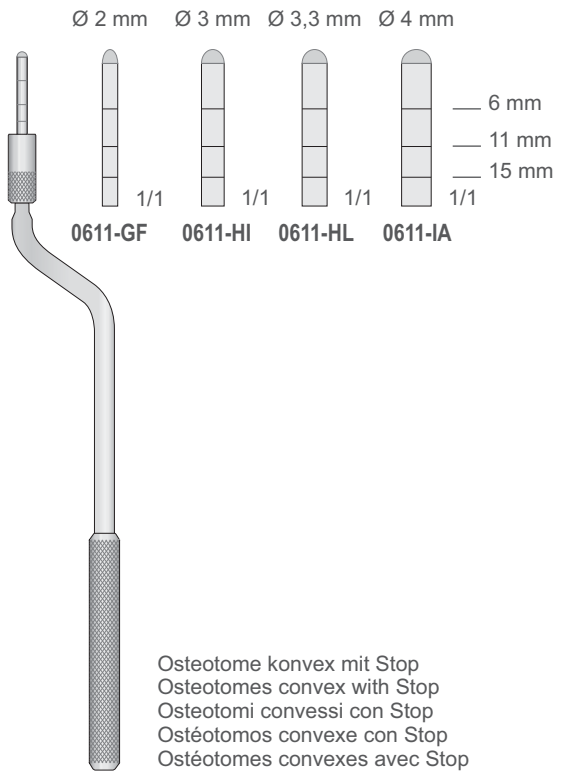

**0611-GF/0611-IA**  
160 mm

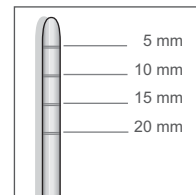
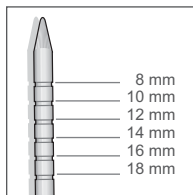

Implant Site Dilator  
Implant Site Dilators  
Dilatatori per osso  
Dilatadores oséos  
Dilatateur d'os

Expansion Osteotome  
Expansion Osteotomes  
Espansori di osso  
Expansores oséos  
Expanseurs d'os

Ø 2 mm

Ø 3 mm

Ø 3,3 mm

Ø 4 mm

Ø 3 mm

Ø 4 mm

Ø 5 mm



0611-CF  
145 mm

0611-CG  
145 mm

0611-CH  
145 mm

0611-CI  
145 mm

0611-DH  
145 mm

0611-DI  
145 mm

0611-DL  
145 mm

Trephine  
Trephine Burs  
Frese carotatrici - Trephine  
Trephine  
Trephine

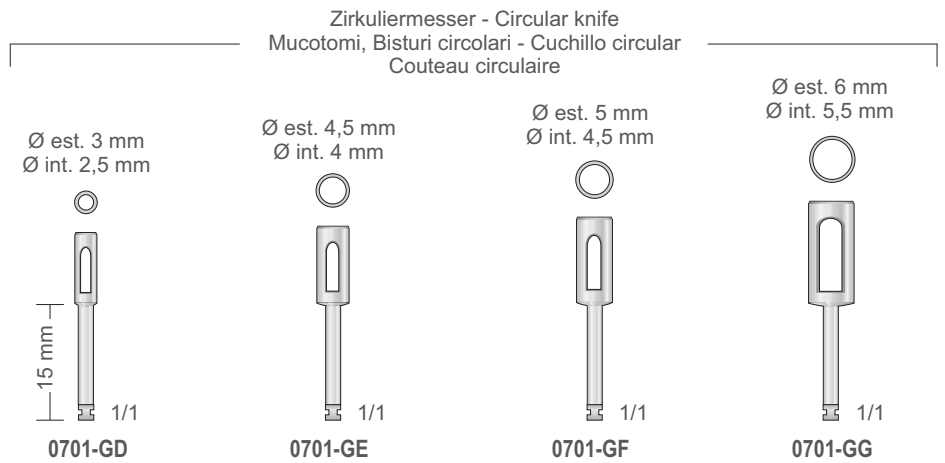
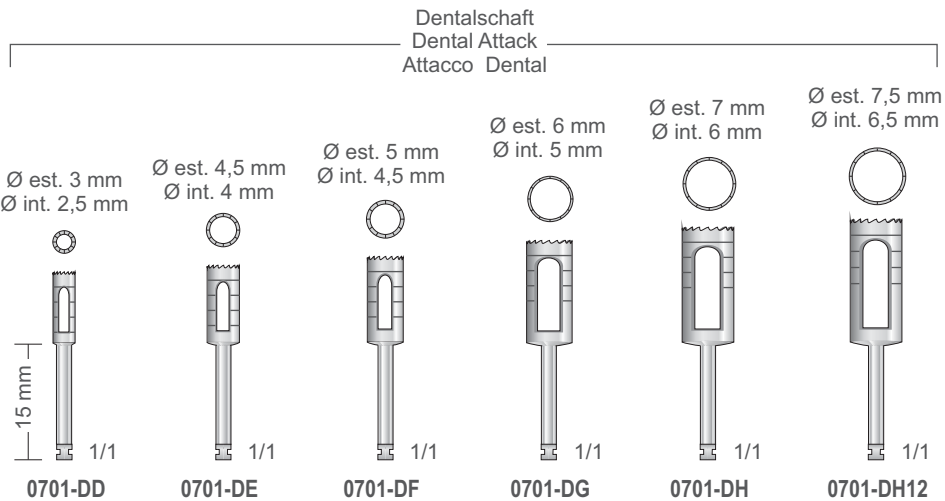

Hautstanzen - Tissue punches  
Mucotomi Punches - PUNCHES para cortar tejidos  
Punches à couper le tissu

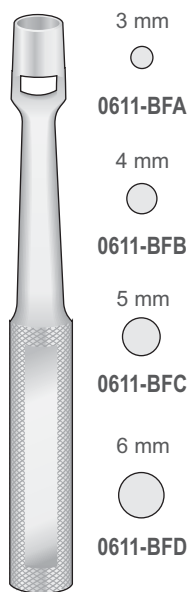

KEYES  
0611-BFA/0611-BFD  
100 mm

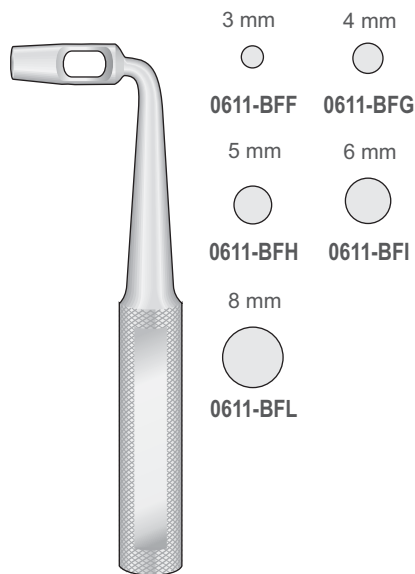

KEYES  
0611-BFF/0611-BFL  
90 mm

Implant Graduierung  
Implant depth gauge with ball end  
Sonda per controllare la profondità del sito  
Sonda para controlar la profundidad

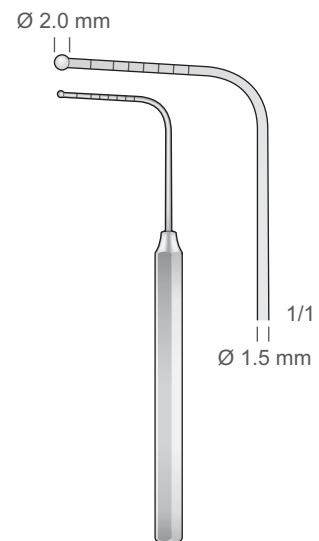

0701-GA  
100 mm



Knochenschale  
 Bone Well  
 Bacinella per osso  
 Cubeta para hueso  
 Cuvette à os



Rostfrei  
 Stainless Steel  
 Acciaio inossidabile  
 Acero inoxidable  
 Acier Inoxydable

**1818-GF**  
 35 mm

Absaugkanülen für Knochen, mit 1 Filter  
 Suction tube for bone, with 1 filter  
 Cannule d'aspiration con trattenuta osso, con 1 filtro  
 Cánulas aspiradoras para hueso, con 1 filtro  
 Canule à aspiration d'os avec 1 filtre

Membranplatzierungsinstrumente  
 Membrane Placement Instruments  
 Strumenti per posizionare membrana  
 Instrumentos para colocar membranas  
 Instruments d'application de membrane

Aufbring Instrument  
 für Knochenmaterial  
 Applicator for bone material  
 Apilicatore per materiale osseo  
 Cucharillas para huesos  
 Curettes à os

Ersatzknochenfilter  
 Bone Filter of replacement  
 Filtro di ricambio per osso  
 Filtro de repuesto para hueso  
 Filtre de rechange pour os

Rostfrei  
 Stainless Steel  
 Acciaio inossidabile  
 Acero inoxidable  
 Acier Inoxydable

Ø 10 mm int.

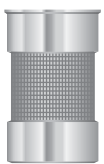

1/1

**0706-BDE**  
 20 mm

Sterilisierbar  
 Autoclavable  
 Autoclavabile

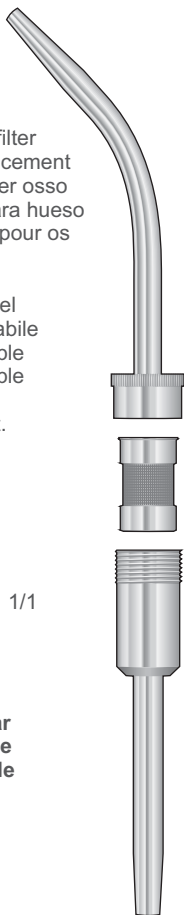

**0706-BDD**  
 180 mm



2/1



1/1

**121509-B**  
 185 mm



1/1

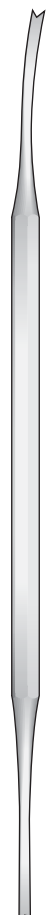

1/1

LUNIATSCHEK  
**1506-G**  
 170 mm

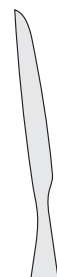

1/1



1/1

**0912-BF**  
 180 mm



Knochenspritzen  
Bone Syringes  
Siringhe per osso  
Jeringas de hueso  
Seringues à os

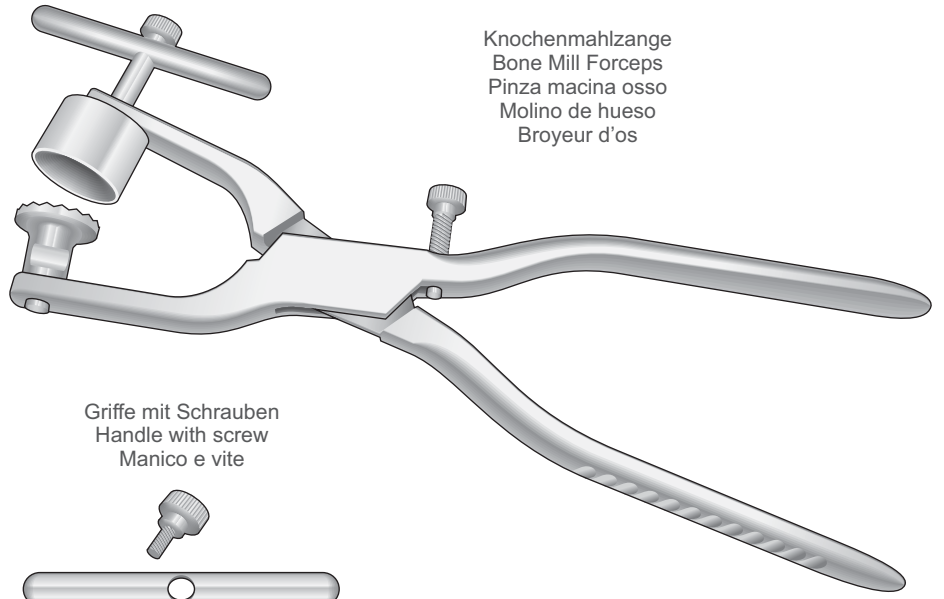

Knochenmahlzange  
Bone Mill Forceps  
Pinza macina osso  
Molino de hueso  
Broyeur d'os

Titan-Mahlwerk  
Upper Titanium  
Milling part  
Inserto superiore  
in titanio



0701-BH

Titan-Mahlwerk  
Lower Titanium  
Milling part  
Inserto inferiore  
in titanio



0701-BI

Griffe mit Schrauben  
Handle with screw  
Manico e vite

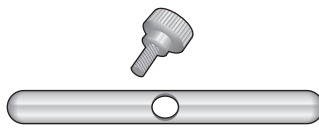

0701-BL

0701-CA

Einbringinstrument für Knochenmaterial  
Graft materials Syringes - Inserter for Bone material  
Siringhe per biomateriali

Ø Int. 2,5 mm  
Ø Est. 3,5 mm

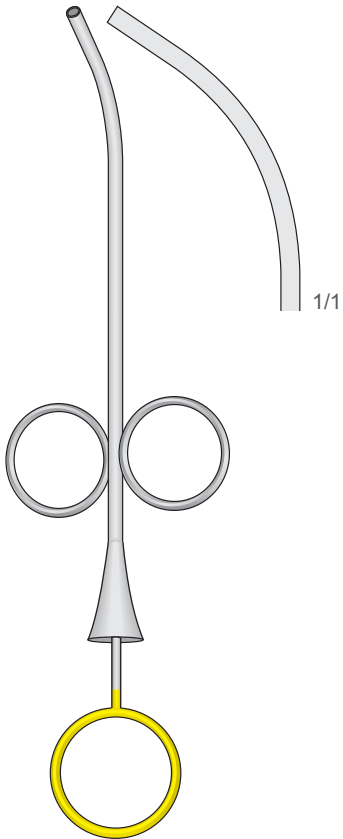

1818-GA12  
160 mm

Ø Int. 3,5 mm  
Ø Est. 4,5 mm

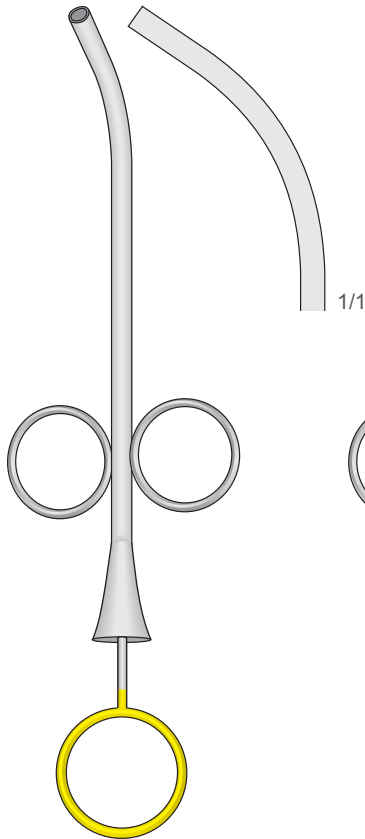

1818-GB12  
160 mm

Ø Int. 4,4 mm  
Ø Est. 5,5 mm

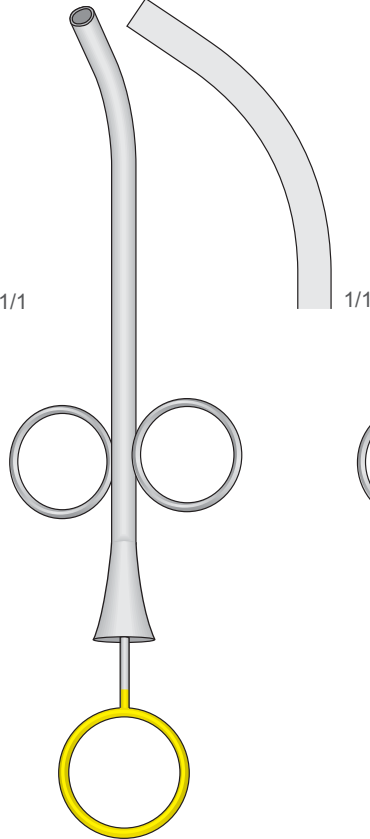

1818-GC12  
160 mm

Ø Int. 6 mm  
Ø Est. 7 mm

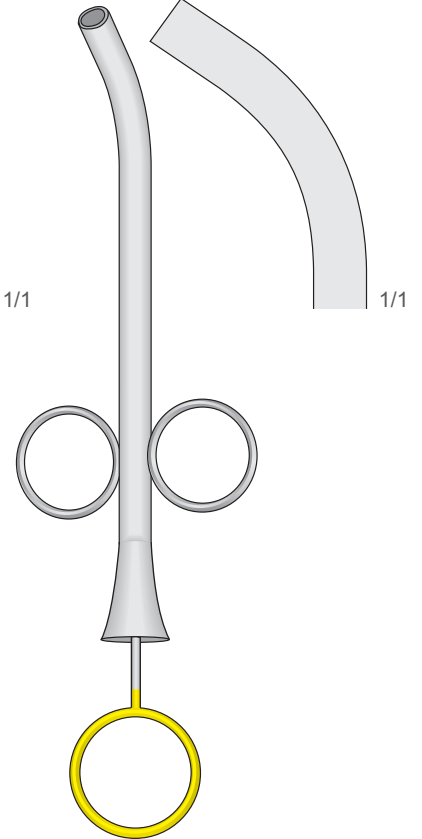

1818-GE12  
160 mm



Knochenstopfer  
 Bone tampers - Bone packers  
 Compattatore per osso  
 Compactador para huesos  
 Compacteur à os - Pilons

Knochenschaber, Rostfrei Stahl - Bone scraper, Stainless Steel  
 Grattini per osso, Inox - Raspador de hueso, Acero inoxidable  
 Râpes à os, Acier inoxydable

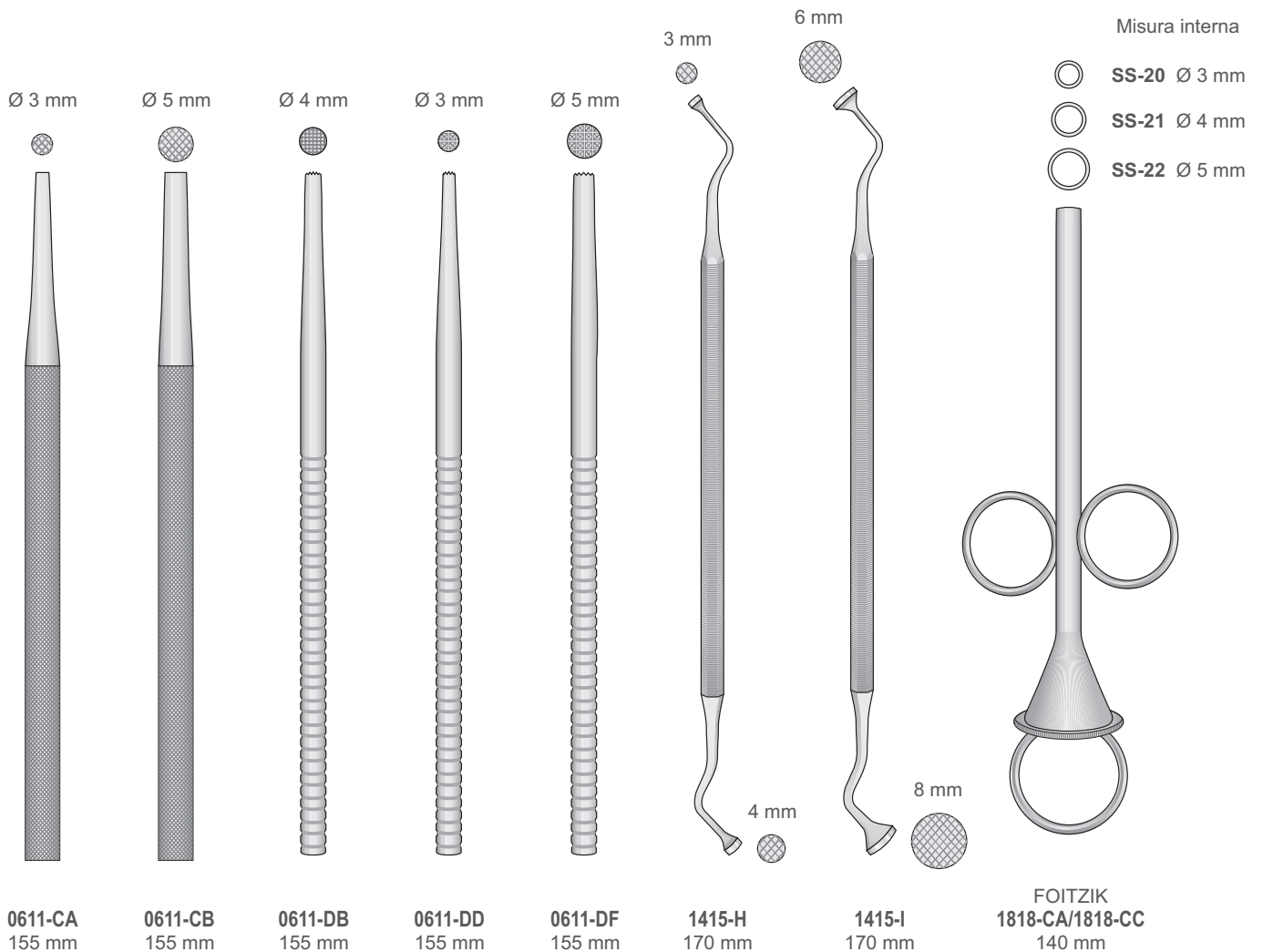
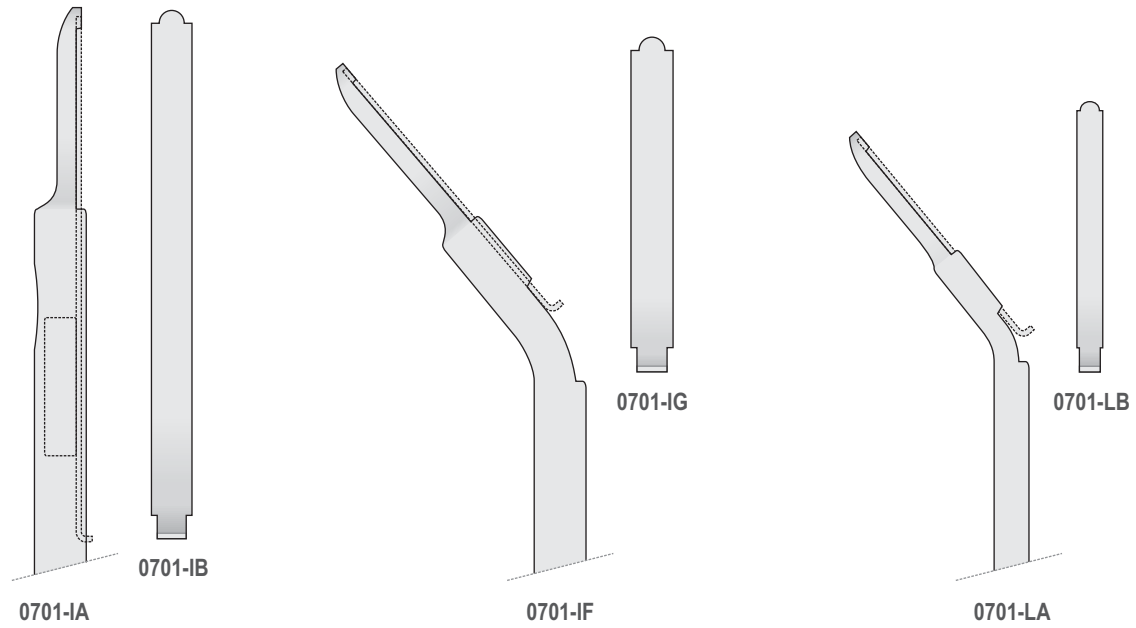



Knochenschaber, Rostfrei Stahl  
 Bone scraper, Stainless Steel  
 Grattini per osso, Inox  
 Raspador de hueso, Acero inoxidable  
 Ràpes à os, Acier inoxydable

Knochenreibeschlinge  
 Blade of change  
 Lama di ricambio  
 Hojas de recambio  
 Lâme de rechange



0701-HB  
 90 mm

Knochen-Schaben Komplett  
 mit Reibeschlinge  
 Bone-Grafts complete with blade  
 Grattino completo di lama

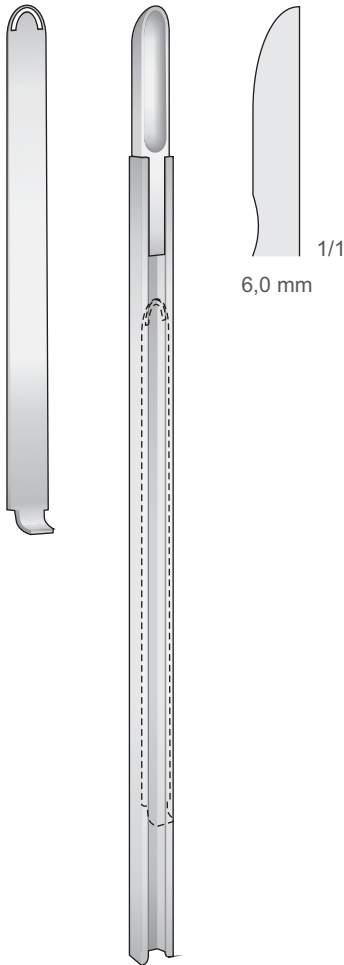

0701-HA  
 170 mm

Knochen-Schaben Komplett  
 mit Reibeschlinge  
 Bone-Grafts complete with blade  
 Grattino completo di lama

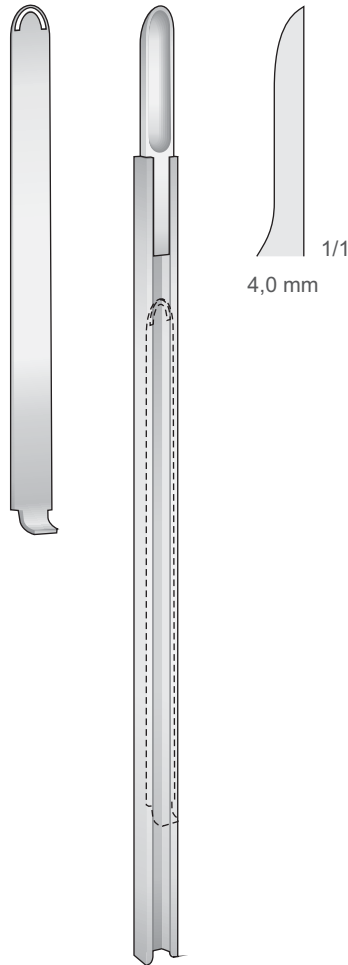

0701-HD  
 170 mm

Knochen-Schaben Komplett  
 mit Reibeschlinge  
 Bone-Grafts complete with blade  
 Grattino completo di lama

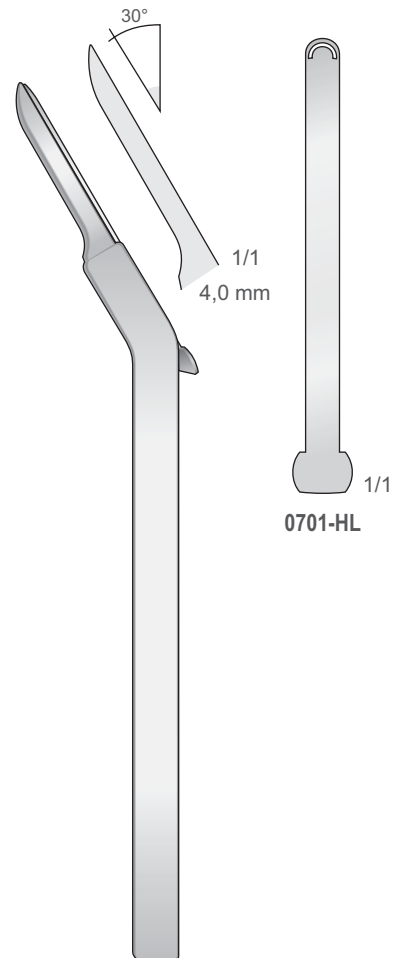

0701-HI  
 155 mm



Meßbereich: 0 - 20 mm  
Measuring range: 0 - 20 mm  
Campo di misura: 0 - 20 mm  
Alcance de medición: 0 - 20 mm  
Etendue de mesure: 0 - 20 mm

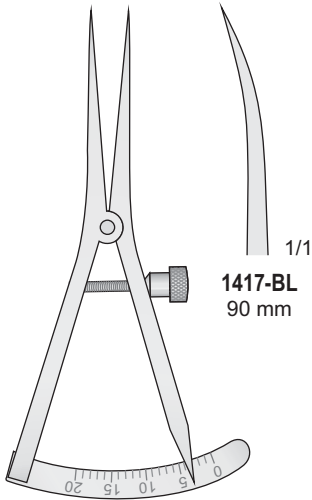

CASTROVIEJO  
1417-BL  
90 mm

0,5 mm

0,5 mm

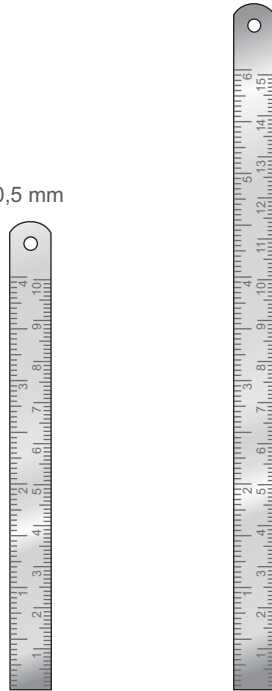

1118-AI  
100 mm

1118-AL  
200 mm

Meßbereich: 0 - 80 mm  
Measuring range: 0 - 80 mm  
Campo di misura: 0 - 80 mm  
Alcance de medición: 0 - 80 mm  
Etendue de mesure: 0 - 80 mm

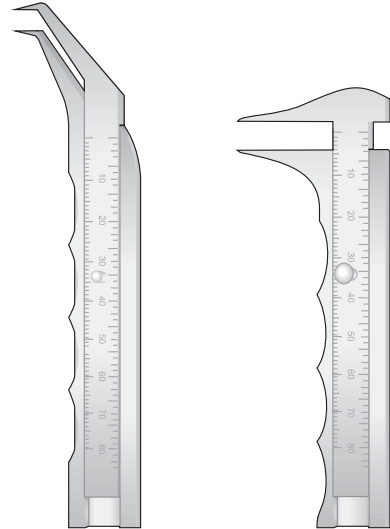

1417-EA  
125 mm

1417-EF  
95 mm

Meßbereich: 0 - 40 mm  
Measuring range: 0 - 40 mm  
Campo di misura: 0 - 40 mm  
Alcance de medición: 0 - 40 mm  
Etendue de mesure: 0 - 40 mm

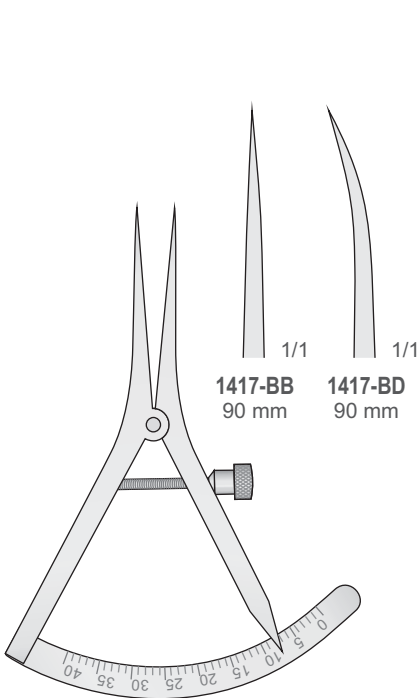

CASTROVIEJO  
1417-BB/1417-BD  
90 mm

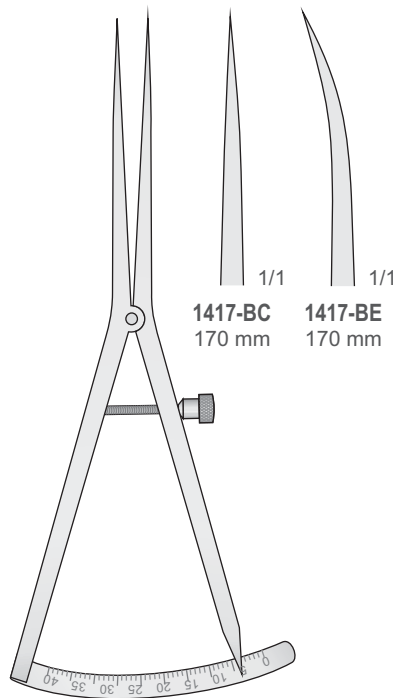

CASTROVIEJO  
1417-BC/1417-BE  
170 mm

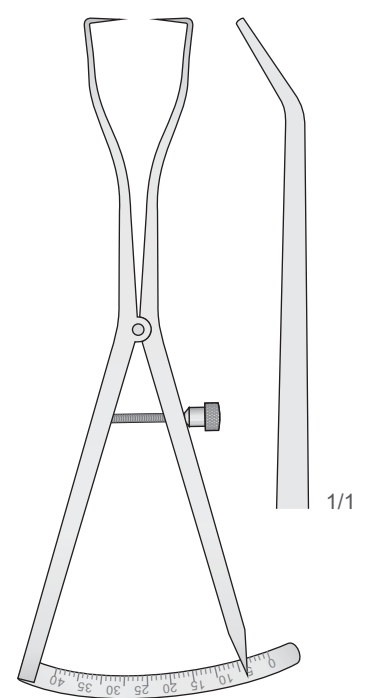

CASTROVIEJO  
1417-BI  
170 mm

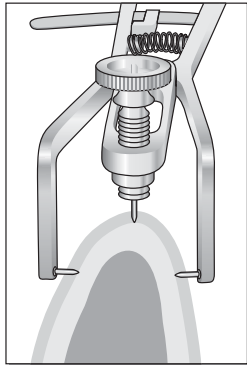

**0402-DAA**

Implantat - Messzange  
Implantology Caliper  
Misuratore per Implantologia  
Calibre de implantologia  
Compas d'implantologie

Trei-Dimensional  
Tridimensionally  
Misuratore tridimensionale  
per misurazione cresta

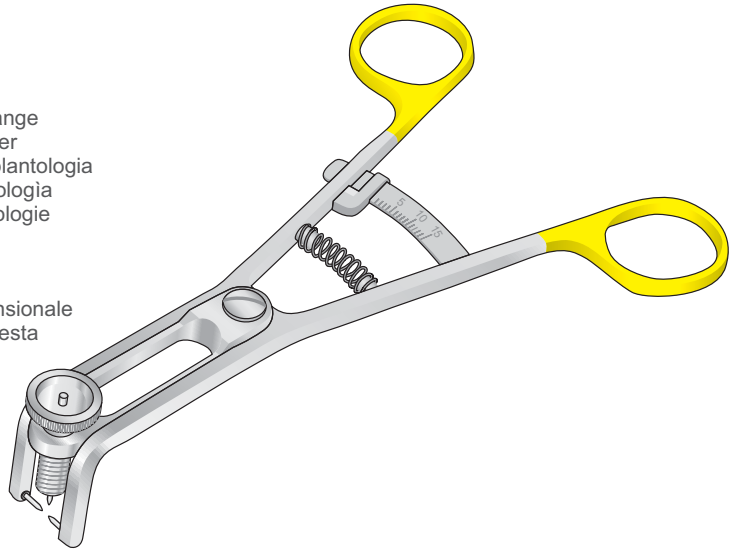

**BONE BLOCK CLAMP**

Bohrzangen für Knochen-Transplantate  
Bone graft holding and drilling forceps  
Pinza di fissaggio Graft  
Pinzas para coger y taladrar óseo

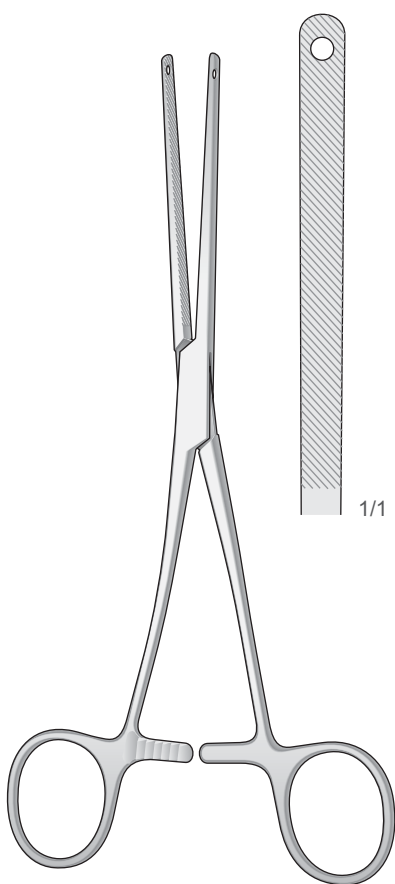

**15-DEA**  
220 mm

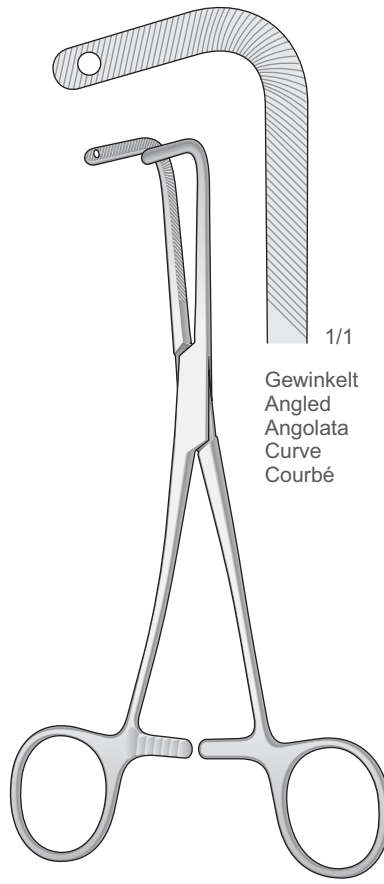

**15-DEB**  
200 mm

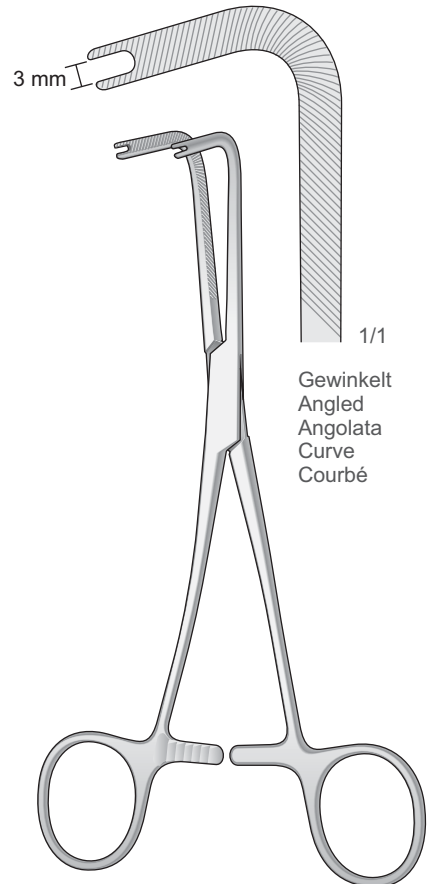

**15-DEC**  
200 mm



Wundspreizer - Knochenhaltezange  
 Retractor - Bone holding Forceps  
 Divaricatore - Pinza per fissare l'osso  
 Separador - Pinzas para coger huesos  
 Ecarteur - Pincés pour tenir l'os

Tibia Wundspreizer  
 Tibial and Iliac Retractor  
 Divaricatore per tibia e cresta iliaca  
 Separadores para tibiales y iliacos  
 Ecarteur pour tibia e crête iliaque

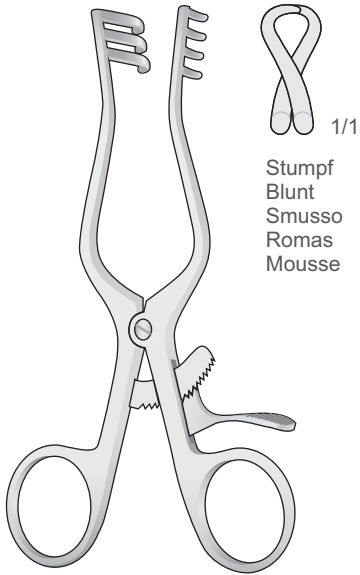

**WEITLANER**  
**0221-CD**  
 165 mm

1/1  
 Stumpf  
 Blunt  
 Smusso  
 Romas  
 Mousse

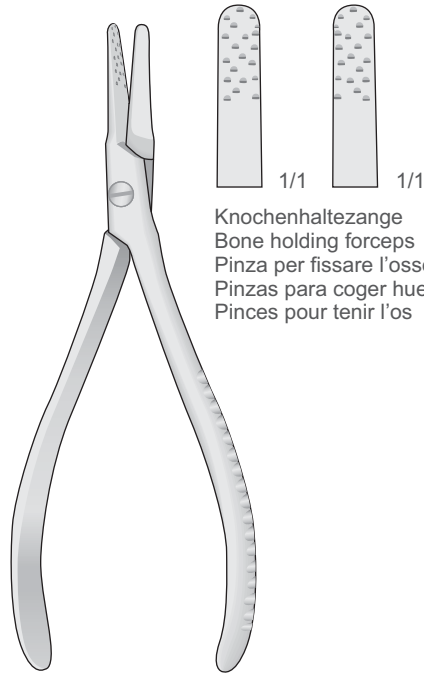

**RADOLF**  
**0614-BFL**  
 135 mm

1/1  
 Knochenhaltezange  
 Bone holding forceps  
 Pinza per fissare l'osso  
 Pinzas para coger huesos  
 Pincés pour tenir l'os

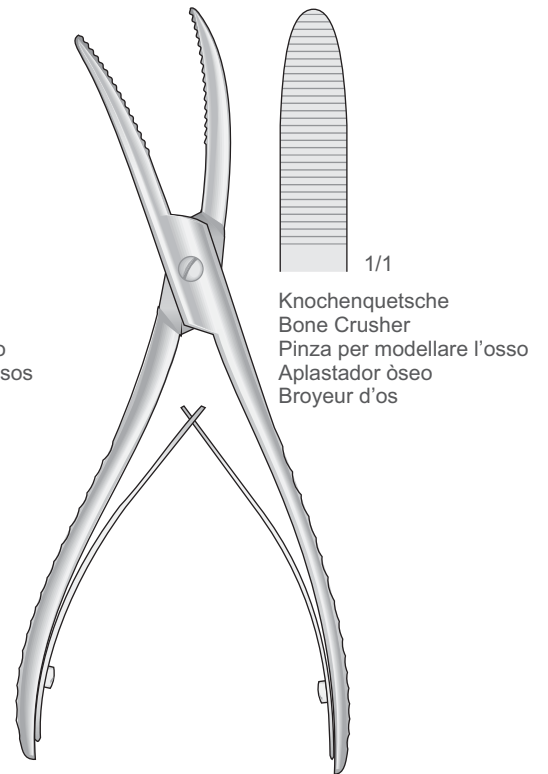

**WOLFF**  
**1123-BBD**  
 180 mm

1/1  
 Knochenquetsche  
 Bone Crusher  
 Pinza per modellare l'osso  
 Aplastador óseo  
 Broyeur d'os

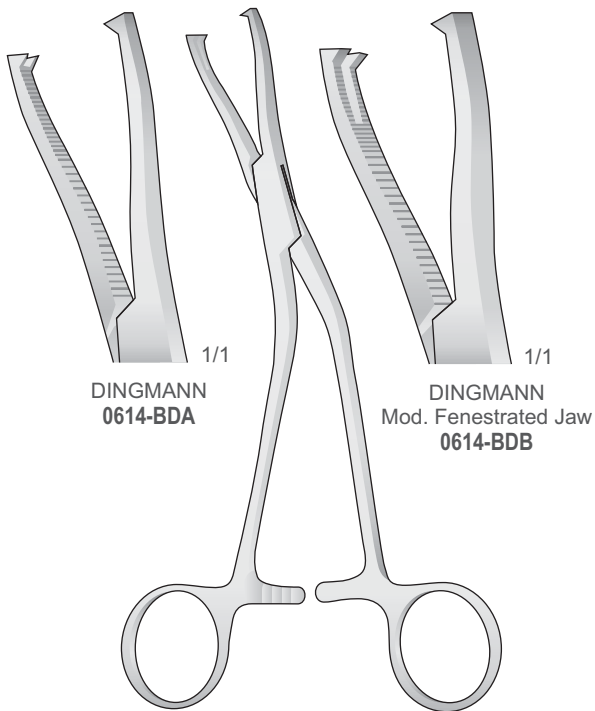

**DINGMANN**  
**0614-BDA/0614-BDB**  
 190 mm

**DINGMANN**  
**0614-BDA**

**DINGMANN**  
 Mod. Fenestrated Jaw  
**0614-BDB**

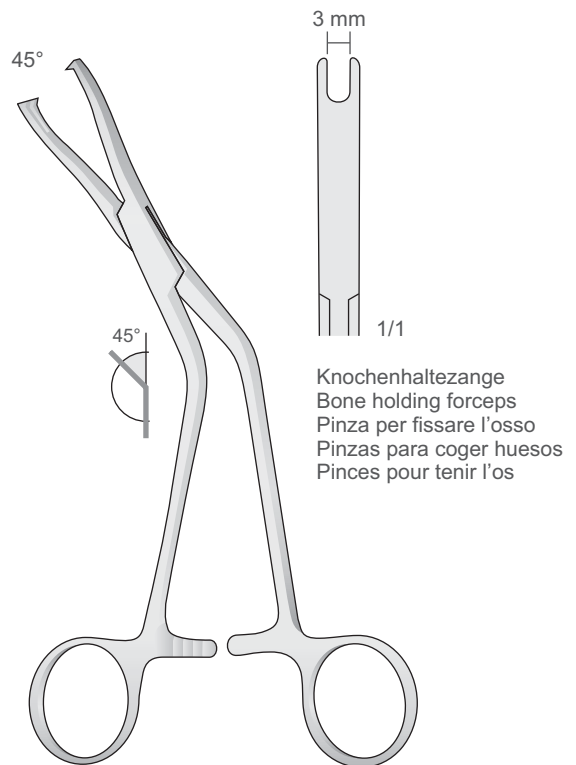

**DINGMANN - Mod. Fenestrated Jaw**  
**0614-BDB18**  
 190 mm

1/1  
 Knochenhaltezange  
 Bone holding forceps  
 Pinza per fissare l'osso  
 Pinzas para coger huesos  
 Pincés pour tenir l'os

.10

Raspatorien, Löffel, Hohlmeißelzangen  
Raspatories, Curettes, Bone rongeurs  
Scollaperiostei, Cucchiali, Pinze ossivore  
Rugines, Cucharillas, Pinzas-gubias  
Legras, Curettes, Pincas-gouges

Zahnärztliche Chirurgie  
Dental surgery  
Chirurgia dentale  
Cirugia dental  
Chirurgie dentaire







Periosteal elevators

Scharf - Sharp  
Taglienti - Cortante  
Tranchant

Raspatorien  
Periosteal Raspatories  
Periostotomi  
Legras periostotomos  
Rugines à périostomie

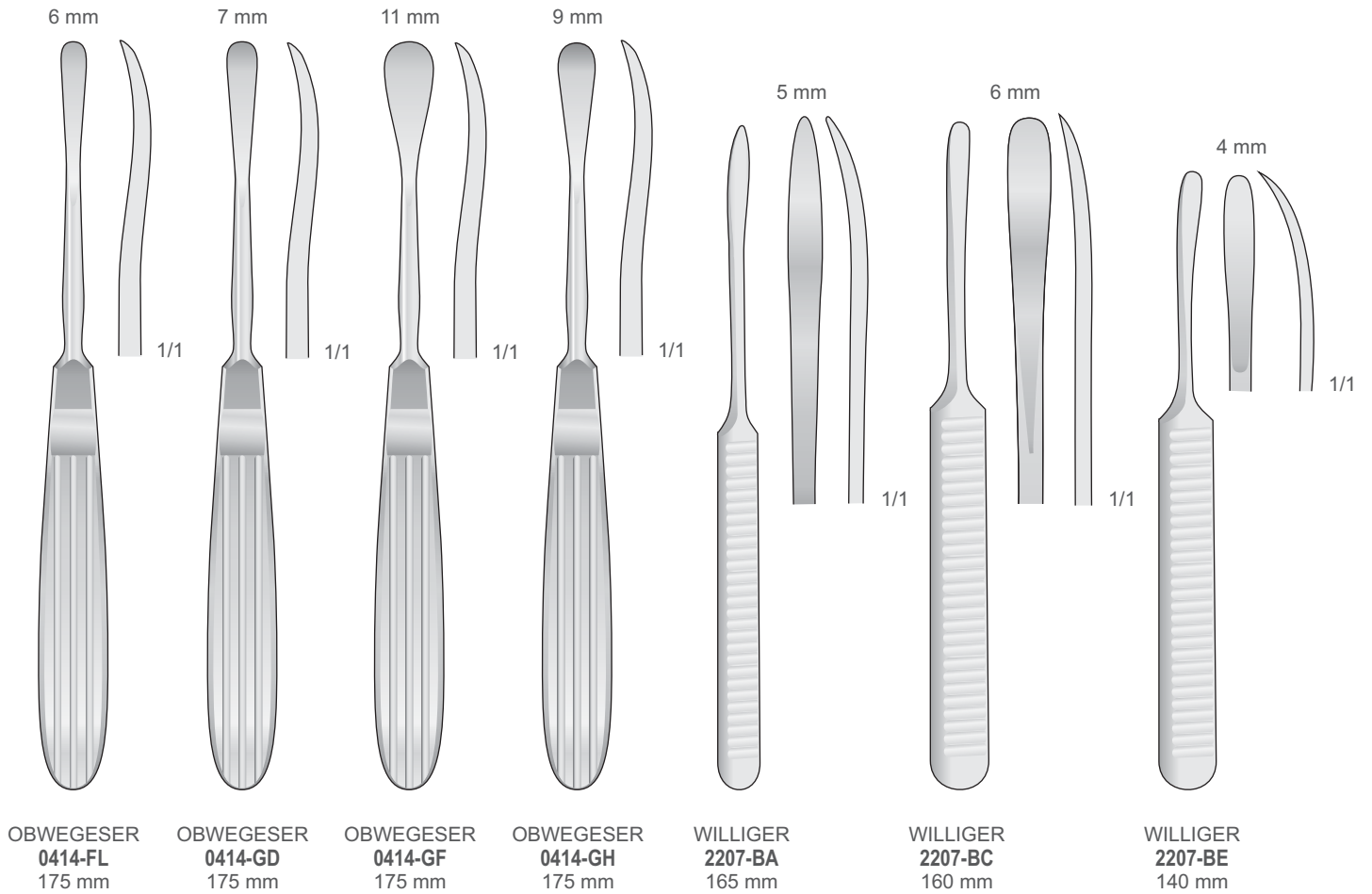

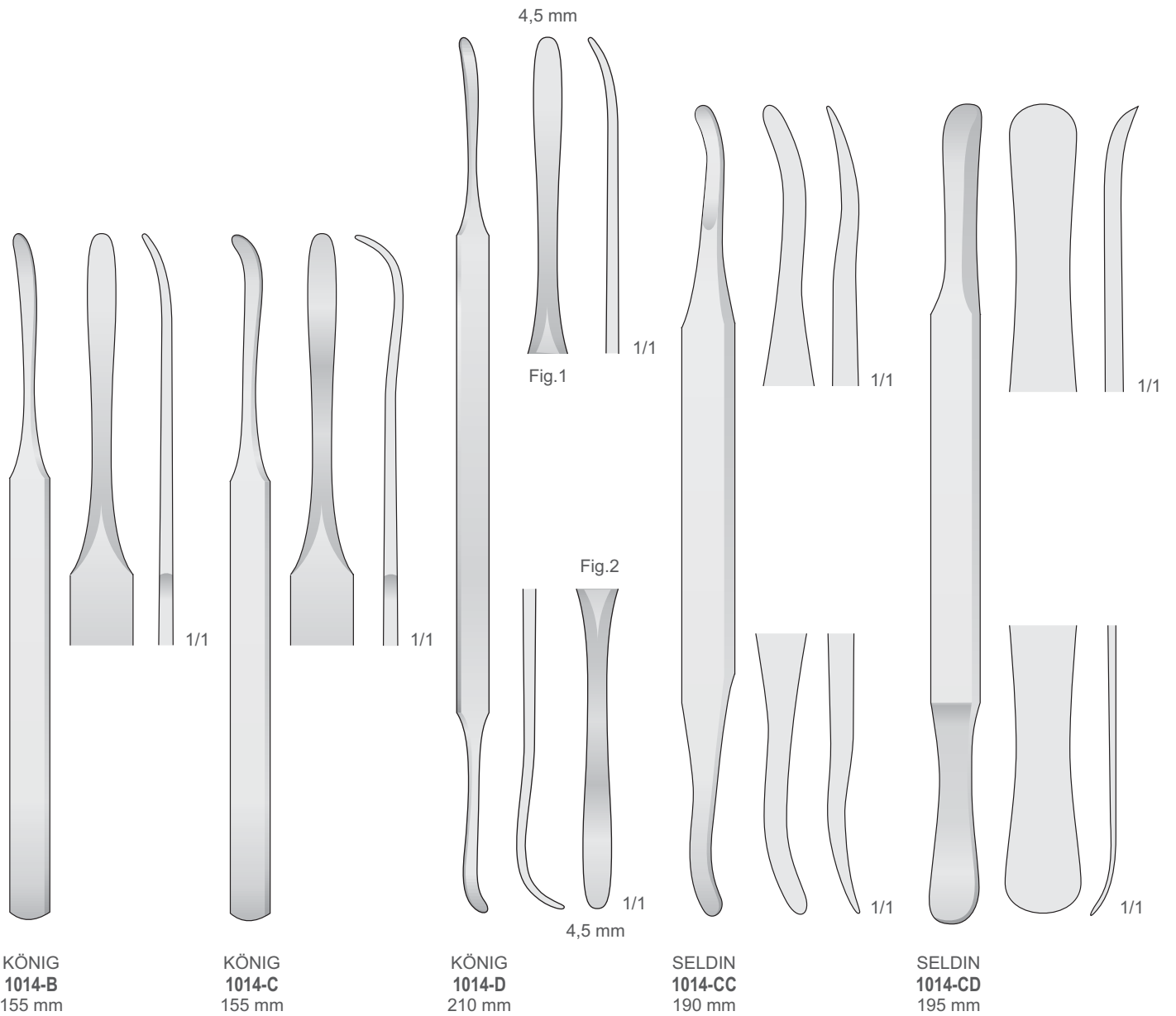

Raspatorien - Elevatorien  
 Raspatories - Elevators  
 Periostotomi - Elevatori  
 Legras - Elevadores  
 Rugines - Elevateurs

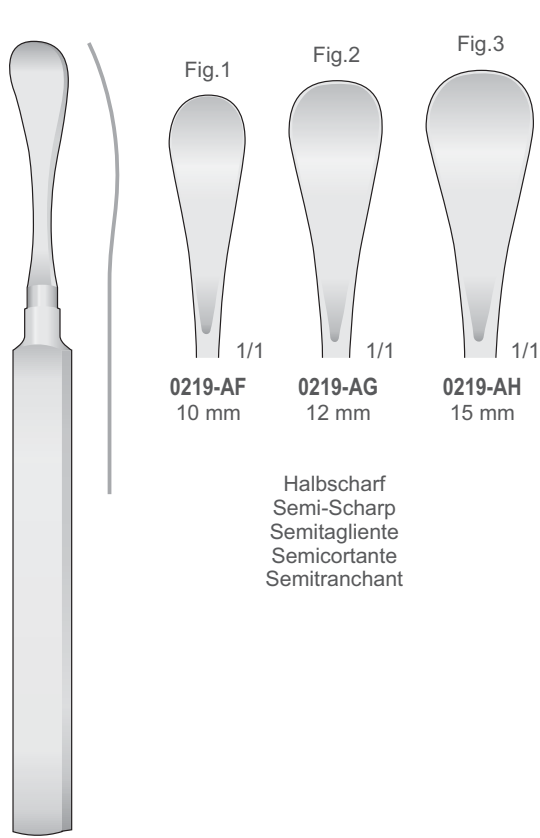

Halbscharf  
 Semi-Scharp  
 Semitagliente  
 Semicortante  
 Semitranchant

HENAHAN  
 0219-AF/0219-AH  
 175 mm

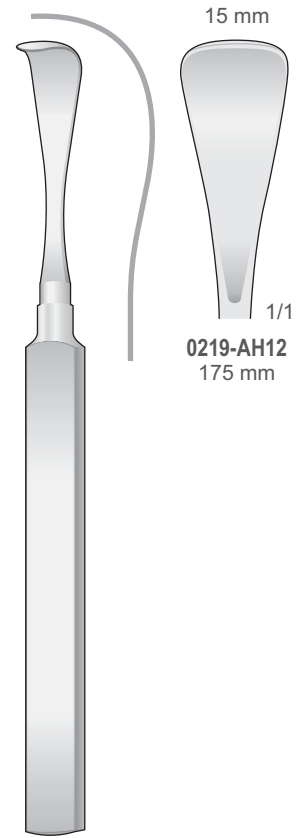

HENAHAN  
 0219-AH12  
 175 mm

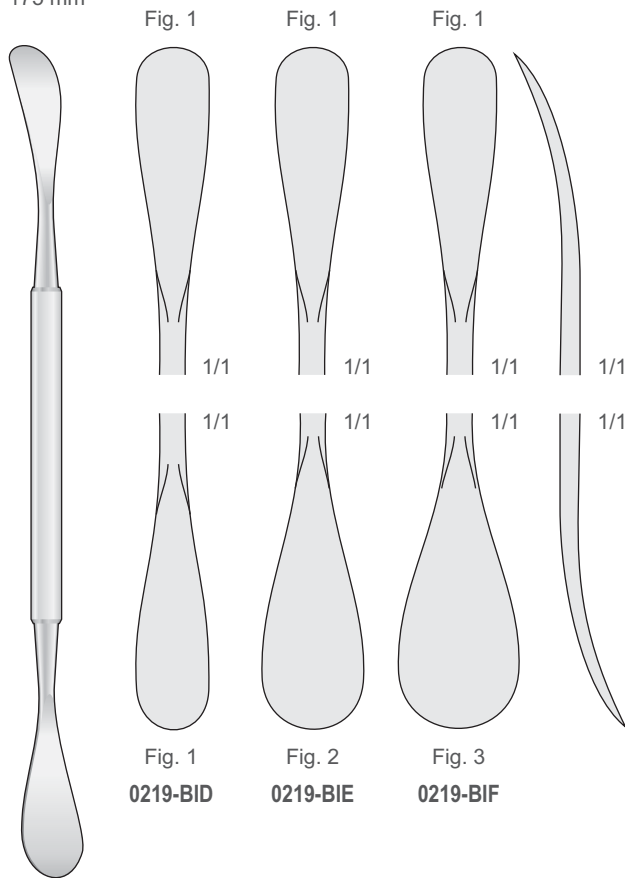

HENAHAN  
 0219-BID/0219-BIF  
 200 mm

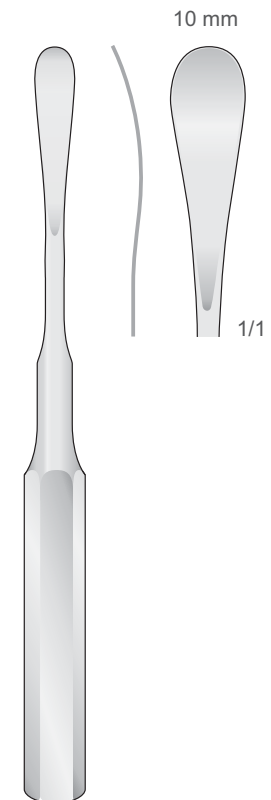

MOLT  
 1214-BF  
 160 mm

Fig. 12S

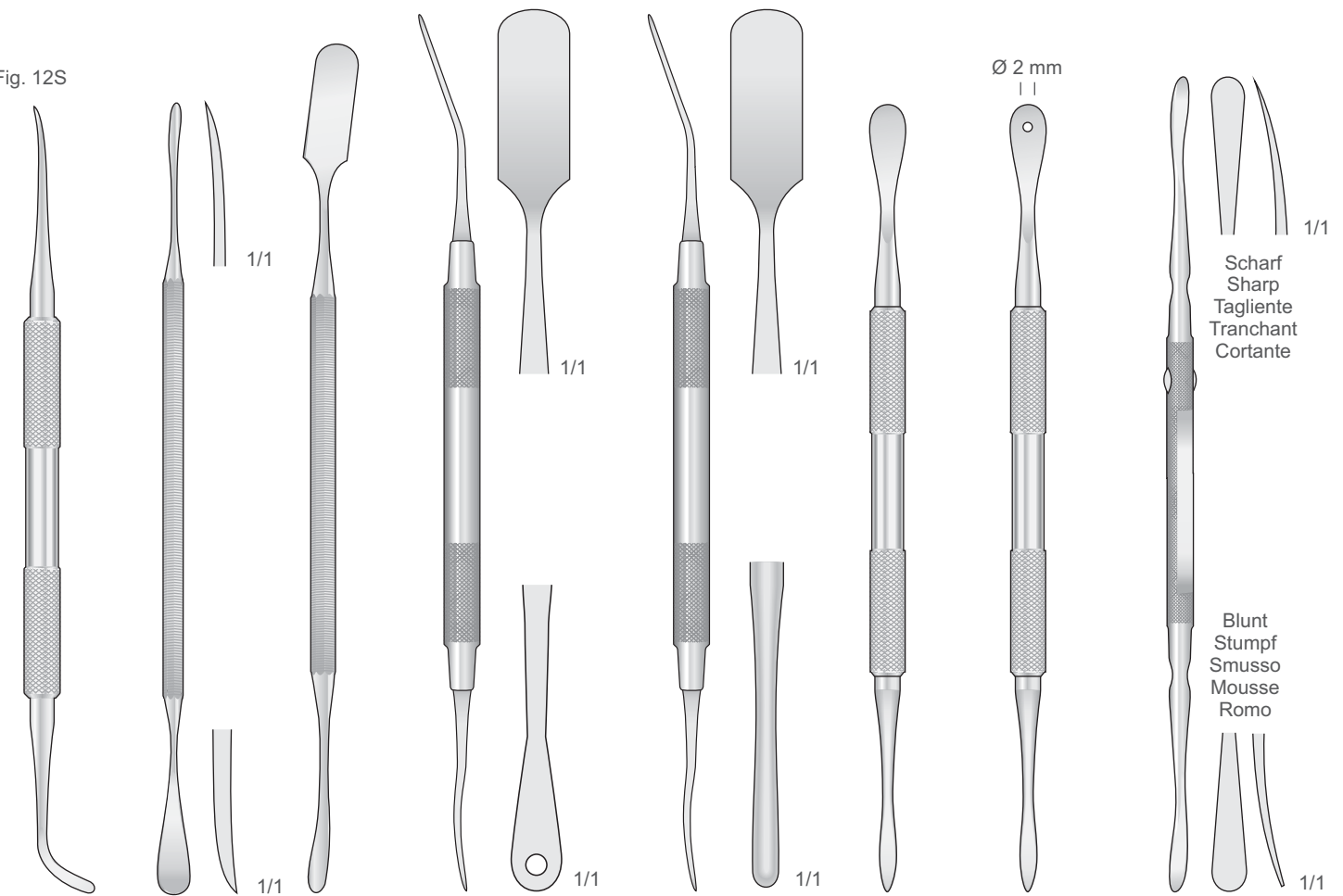

**BENNETT**  
**1014-FI**  
 175 mm

**12141119-L**  
 175 mm

**1517-D**  
 190 mm

**PRICHARD**  
**1517-D01**  
 180 mm

**PRICHARD**  
**HBI-1517D**  
 175 mm

**MOLT**  
**HBI-12L**  
 170 mm

**MOLT**  
**1214-L01**  
 170 mm

**0617050517**  
 180 mm

Scharf  
 Sharp  
 Tagliente  
 Tranchant  
 Cortante

Blunt  
 Stumpf  
 Smusso  
 Mousse  
 Romo

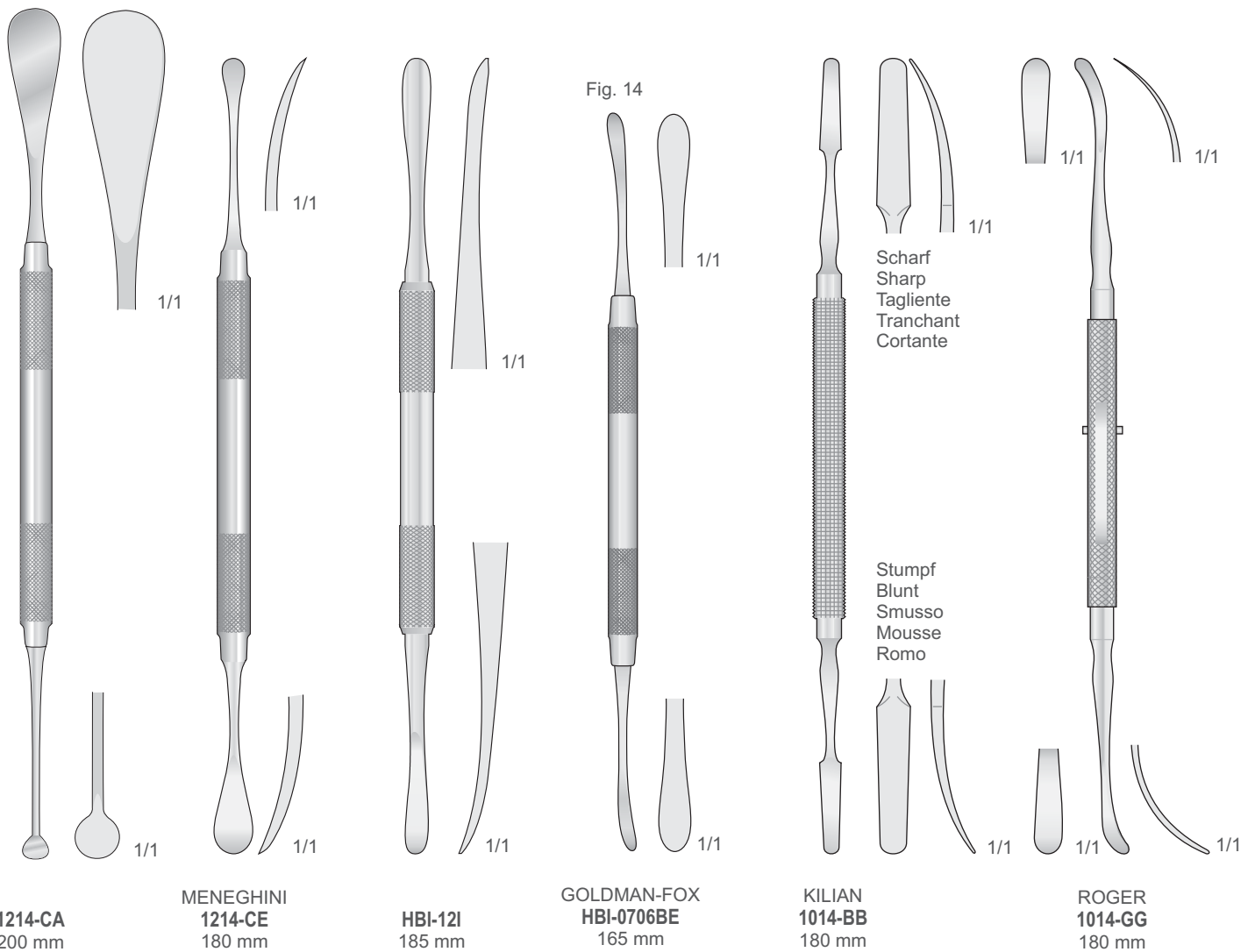

Raspatorien - Elevatorien  
 Raspatories - Elevators  
 Periotomi - Elevatori  
 Legras - Elevadores  
 Rugines - Elevateurs

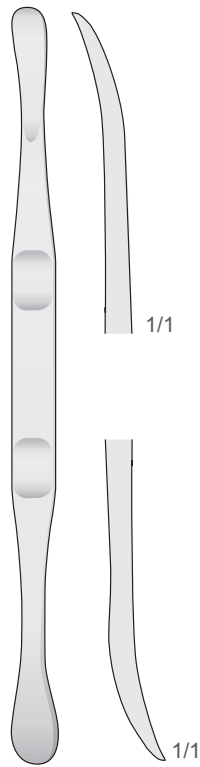

**BABBUSH**  
**1014-CA**  
 180 mm

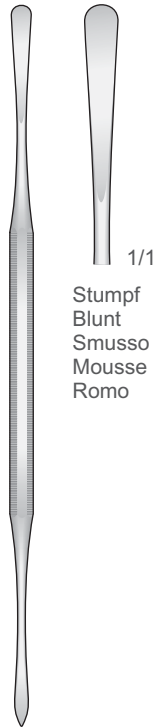

**0518-CH**  
 160 mm

1/1  
 Stumpf  
 Blunt  
 Smusso  
 Mousse  
 Romo

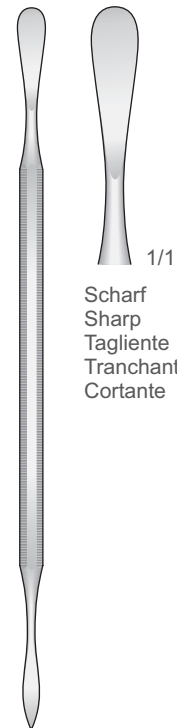

**0802**  
 160 mm

1/1  
 Scharf  
 Sharp  
 Tagliente  
 Tranchant  
 Cortante

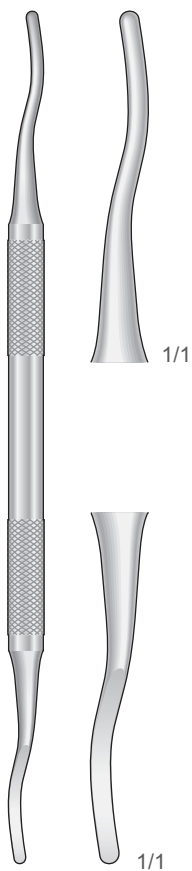

**HOPKINS**  
**HBI-BLB**  
 185 mm

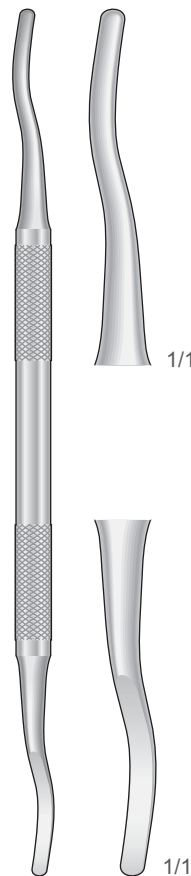

**HOPKINS**  
**HBI-BLC**  
 185 mm

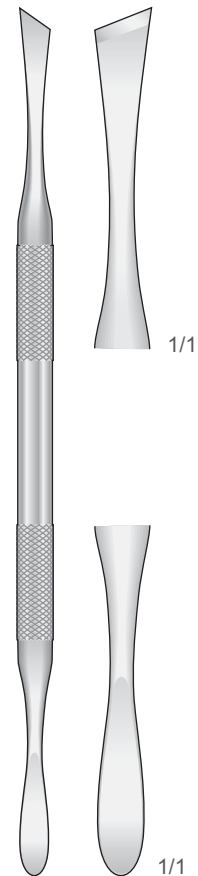

**MEAD**  
**HBI-CCD**  
 185 mm

Raspatorien - Elevatorien  
 Raspatories - Elevators  
 Periostotomi - Elevatori  
 Legras - Elevadores  
 Rugines - Elevateurs

Runder Hohlgriff 8 mm  
 Hollow Round Handle 8 mm  
 Manico tondo vuoto 8 mm  
 Mango hueco 8 mm  
 Manche rond vide 8 mm

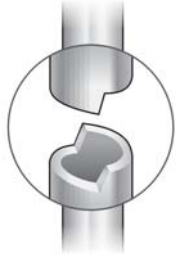

Sinus Lift Instrumente  
 Sinus Lift Instruments  
 Strumenti per rialzo del seno  
 Instrumentos para elevación de senos  
 Instruments pour les soulevés de sinus

Fig. 24G

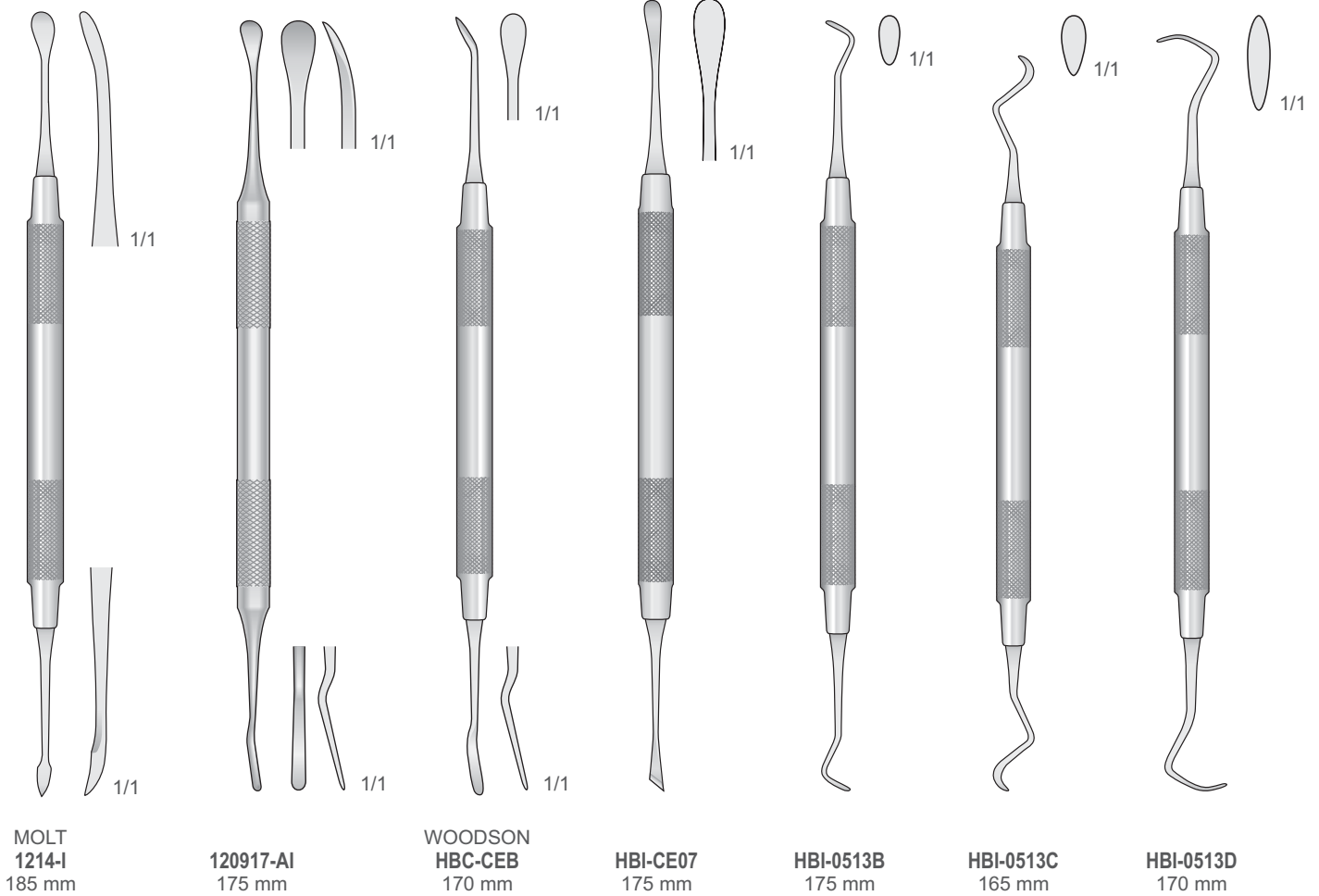

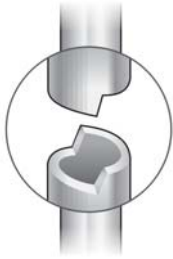

Runder Hohlgriff 8 mm  
Hollow Round Handle 8 mm  
Manico tondo vuoto 8 mm  
Mango hueco 8 mm  
Manche rond vide 8 mm

Sinus Lift Instrumente - Sinus Lift Instruments  
Strumenti per rialzo del seno - Instrumentos para elevación de senos  
Instruments pour les soulevés de sinus

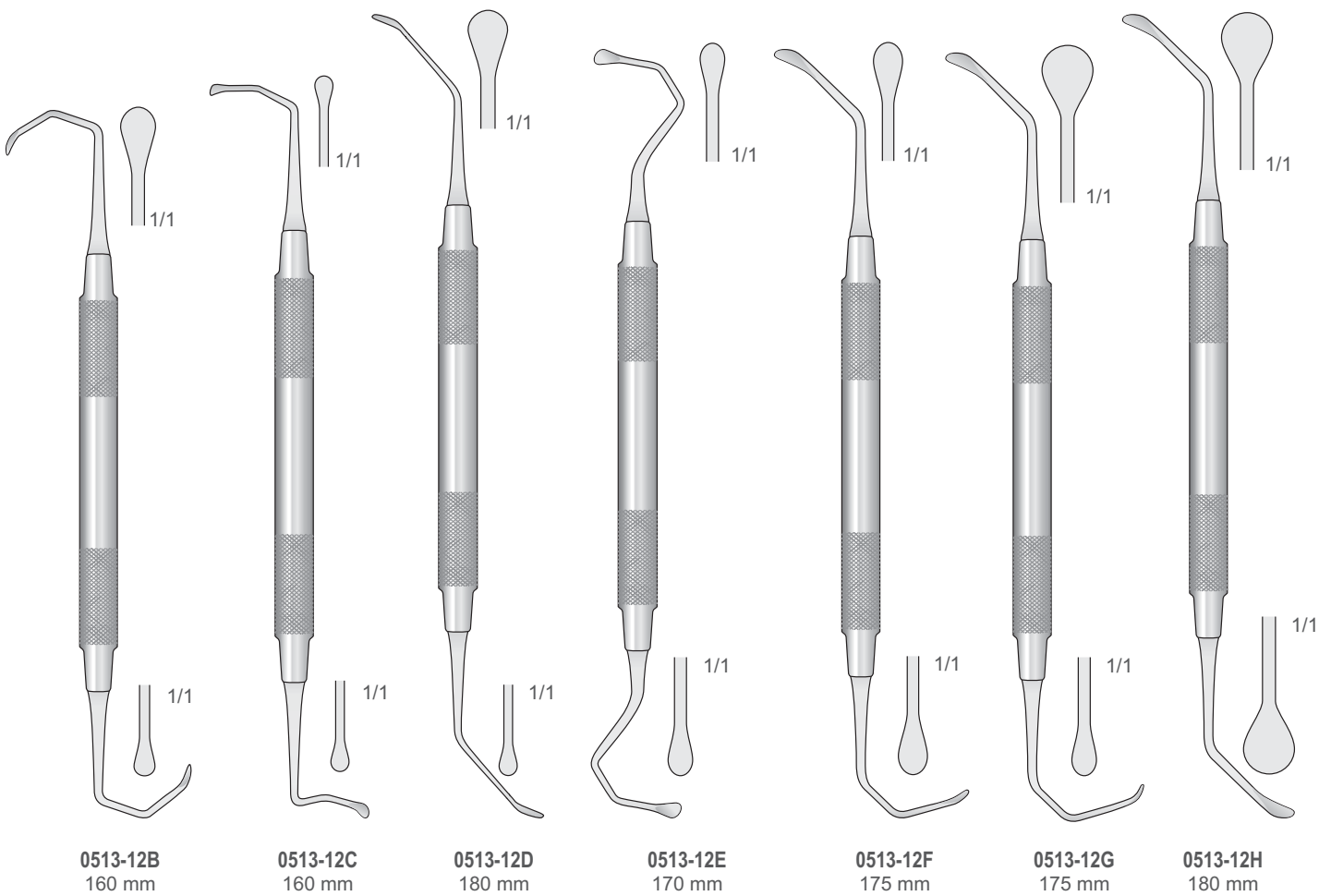



Runder Hohlgriff 8 mm  
Hollow Round Handle 8 mm  
Manico tondo vuoto 8 mm  
Mango hueco 8 mm  
Manche rond vide 8 mm

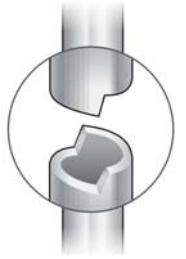

Curette

Sinus lifting

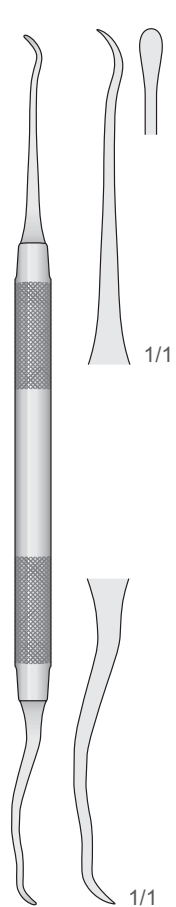

**MILLER-COLBURN**  
**0320-1203B**  
185 mm

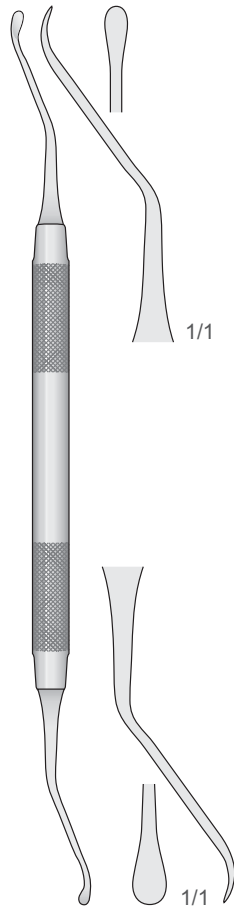

**MOLT**  
**1214-BC**  
190 mm

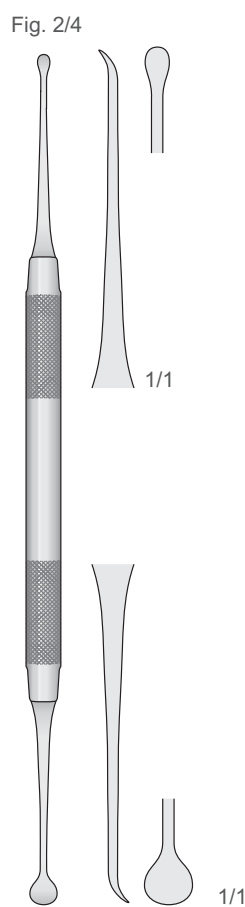

**MOLT**  
**1214-BA**  
180 mm



**1811-B**  
200 mm

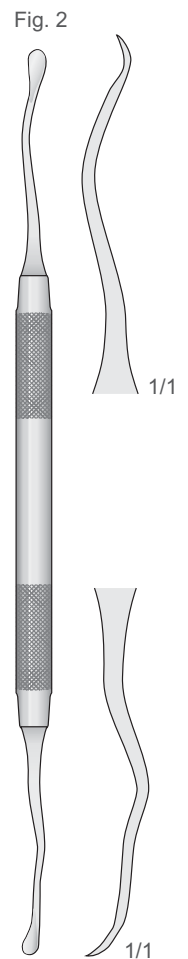

**1811-C**  
195 mm

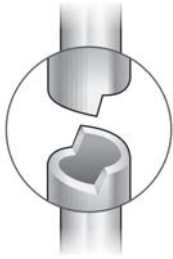

Runder Hohlgriff 8 mm  
Hollow Round Handle 8 mm  
Manico tondo vuoto 8 mm  
Mango hueco 8 mm  
Manche rond vide 8 mm

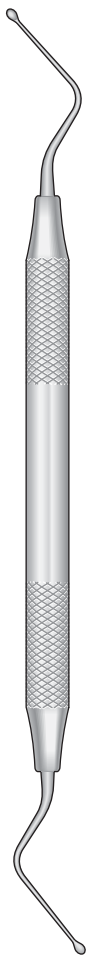

HEMINGWAY  
HCA-BAB/HCA-BAE  
180 mm

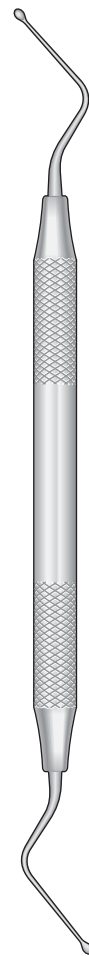
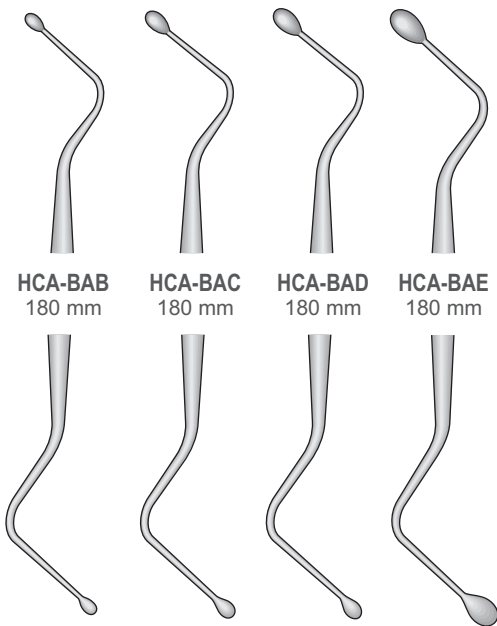

LUCAS  
HCA-IF/HCA-II  
180 mm

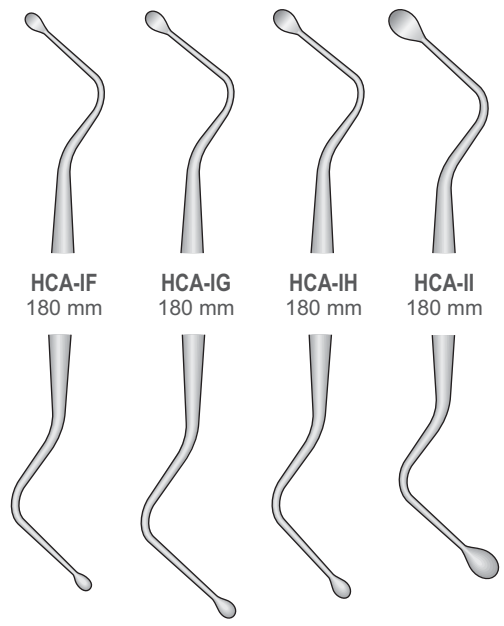

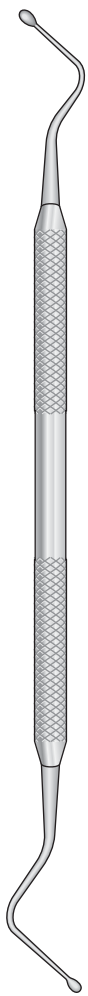

HEMINGWAY  
**03-B**  
170 mm

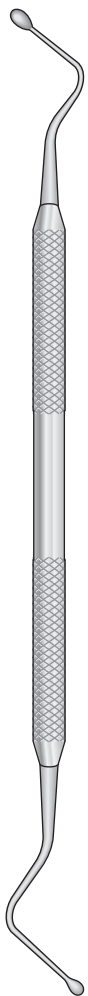

HEMINGWAY  
**03-C**  
170 mm

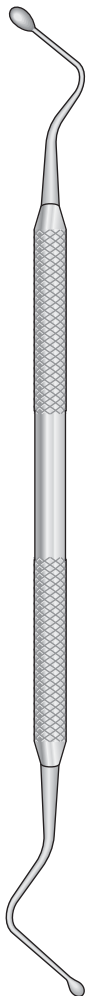

HEMINGWAY  
**03-D**  
170 mm

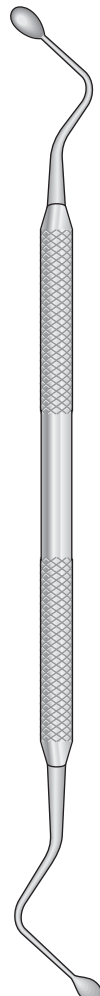

HEMINGWAY  
**03-E**  
170 mm

Wundhachen Mandibular  
Mandibular Nerve Diplace  
Per spostamento  
nervo mandibolare  
Para nero mandibular

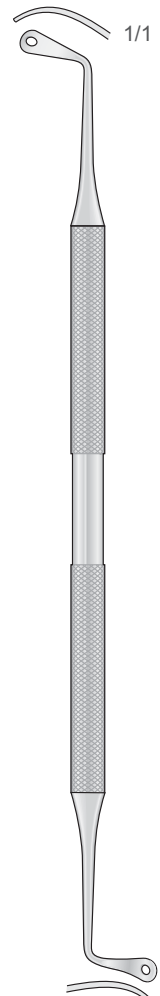

**1811-CB**  
165 mm

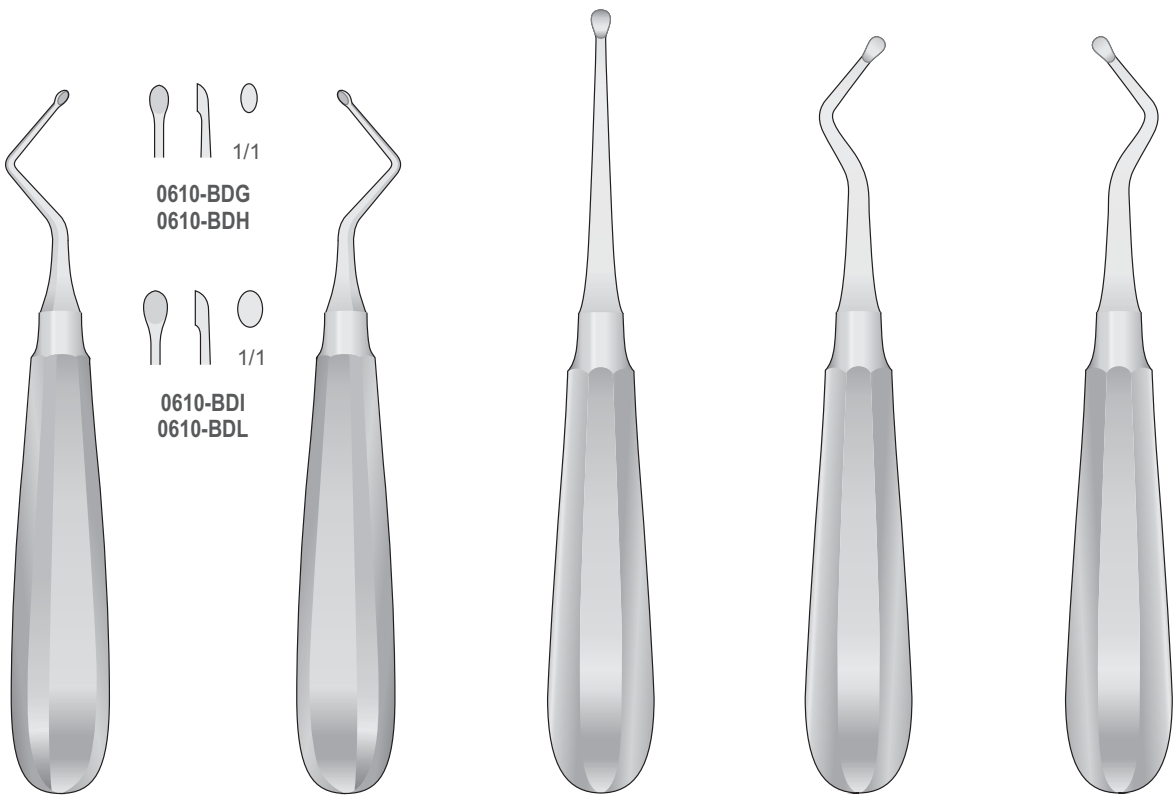

**KERPEL**  
**0610-BDG**  
**0610-BDI**  
145 mm

**KERPEL**  
**0610-BDH**  
**0610-BDL**  
145 mm

**0411-FA**  
155 mm

**0411-FB**  
150 mm

**0411-FC**  
150 mm

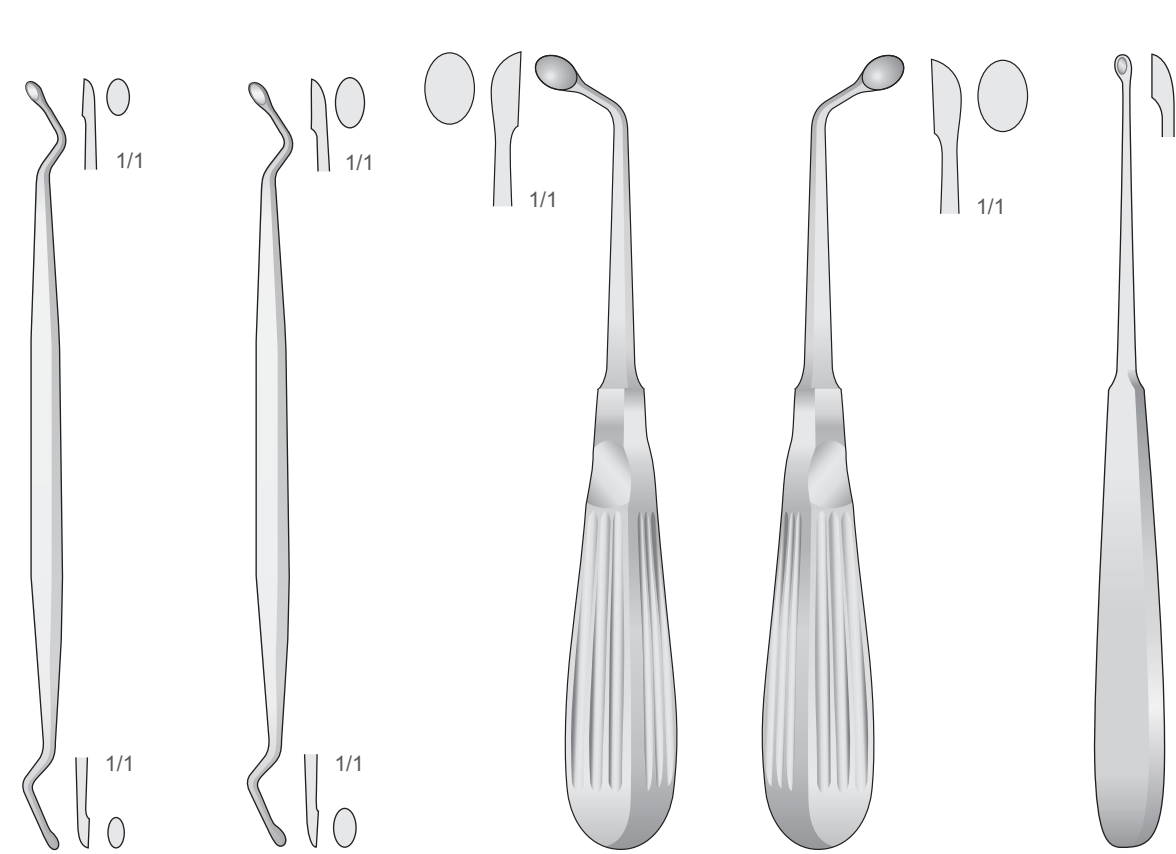

**0610-ID**  
160 mm

**JANSEN**  
**0610-IE**  
160 mm

**UFFENORDE**  
**0610-BII**  
170 mm

**UFFENORDE**  
**0610-BIL**  
170 mm

**WILLIGER**  
**0610-BLH/0610-BLI**  
170 mm

Fig. 00  
3,4 mm  
1/1  
**0610-BLH**

Fig. 1  
5,2 mm  
1/1  
**0610-BLI**

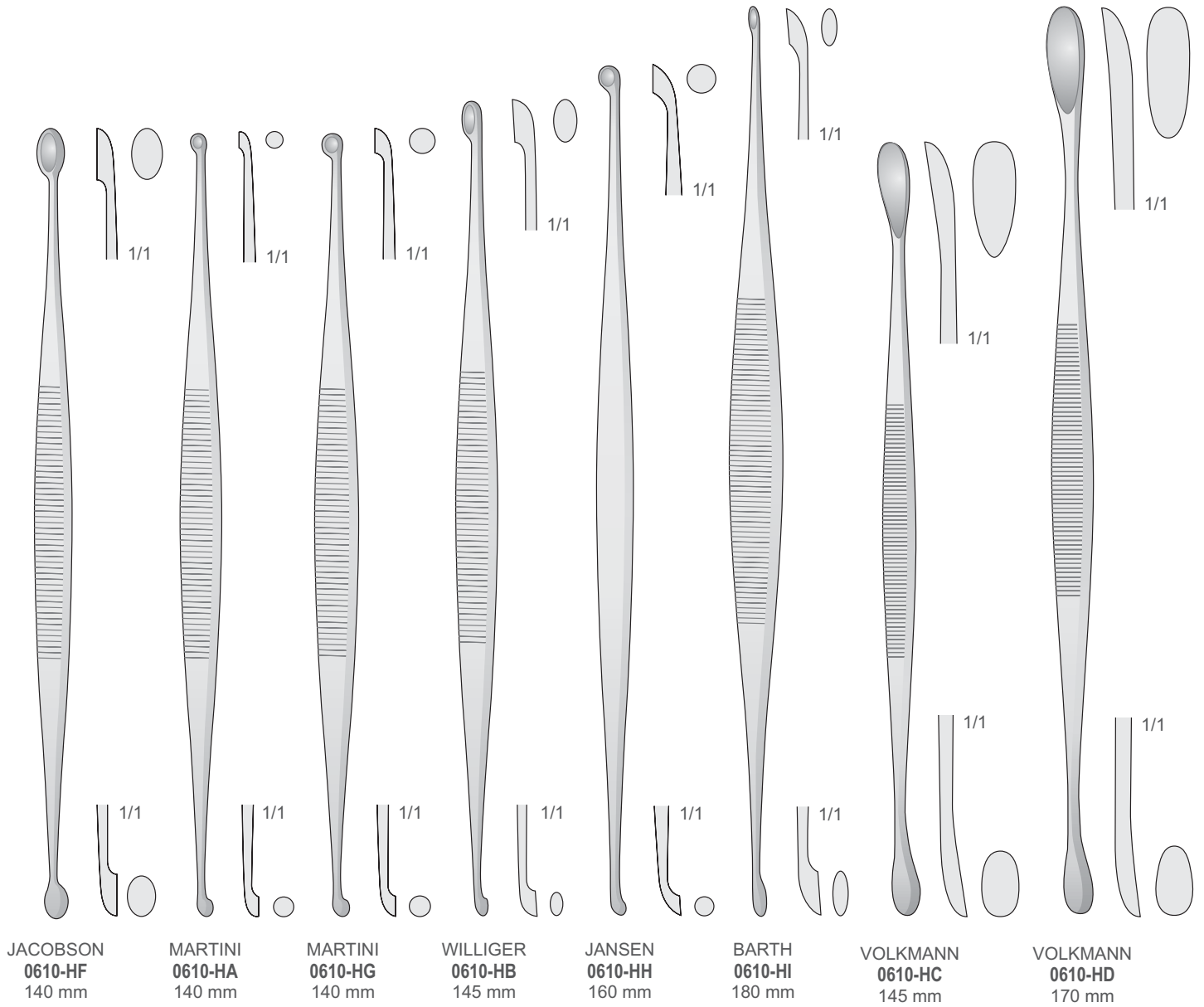

JACOBSON  
0610-HF  
140 mm

MARTINI  
0610-HA  
140 mm

MARTINI  
0610-HG  
140 mm

WILLIGER  
0610-HB  
145 mm

JANSEN  
0610-HH  
160 mm

BARTH  
0610-HI  
180 mm

VOLKMANN  
0610-HC  
145 mm

VOLKMANN  
0610-HD  
170 mm

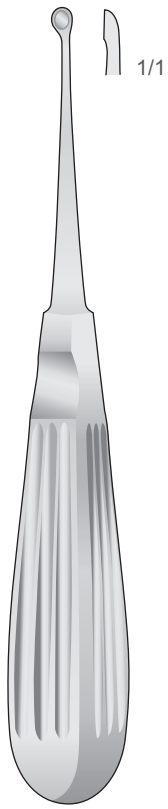

**VOLKMANN**  
**0610-GA/0610-GH**  
170 mm

- |   |  |   |   |
|---|--|---|---|
| Fig.0000<br>2,8 mm<br>○ 1/1<br><b>0610-GA</b> | Fig.000<br>3,6 mm<br>○ 1/1<br><b>0610-GB</b> | Fig.00<br>4,4 mm<br>○ 1/1<br><b>0610-GC</b> | Fig.0<br>5,2 mm<br>○ 1/1<br><b>0610-GD</b>  |
| Fig.1<br>6,8 mm<br>○ 1/1<br><b>0610-GE</b>    | Fig.2<br>8,5 mm<br>○ 1/1<br><b>0610-GF</b>   | Fig.3<br>10 mm<br>○ 1/1<br><b>0610-GG</b>   | Fig.4<br>11,5 mm<br>○ 1/1<br><b>0610-GH</b> |

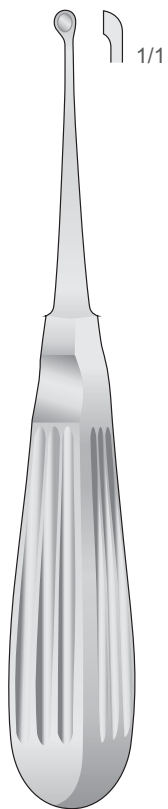

**BRUNS**  
**0610-BBA/0610-BBG**  
165 mm

- |                               |                               |                              |
|-------------------------------|-------------------------------|------------------------------|
| 3 mm<br>○<br><b>0610-BBA</b>  | 4 mm<br>○<br><b>0610-BBB</b>  | 5 mm<br>○<br><b>0610-BBC</b> |
| 6 mm<br>○<br><b>0610-BBD</b>  | 8 mm<br>○<br><b>0610-BBE</b>  |                              |
| 10 mm<br>○<br><b>0610-BBF</b> | 12 mm<br>○<br><b>0610-BBG</b> |                              |

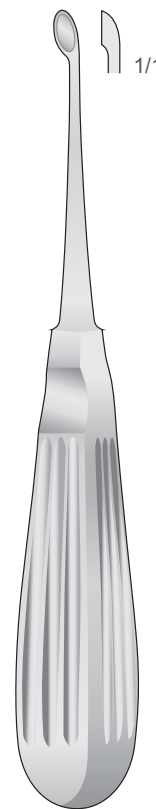

**SCHEDE**  
**0610-BCA/0610-BCG**  
170 mm

- |                                |                                |                                |
|--------------------------------|--------------------------------|--------------------------------|
| 2,5 mm<br>○<br><b>0610-BCA</b> | 3,4 mm<br>○<br><b>0610-BCB</b> | 4,2 mm<br>○<br><b>0610-BCC</b> |
| 5,2 mm<br>○<br><b>0610-BCD</b> | 6,3 mm<br>○<br><b>0610-BCE</b> |                                |
| 7,4 mm<br>○<br><b>0610-BCF</b> | 8 mm<br>○<br><b>0610-BCG</b>   |                                |

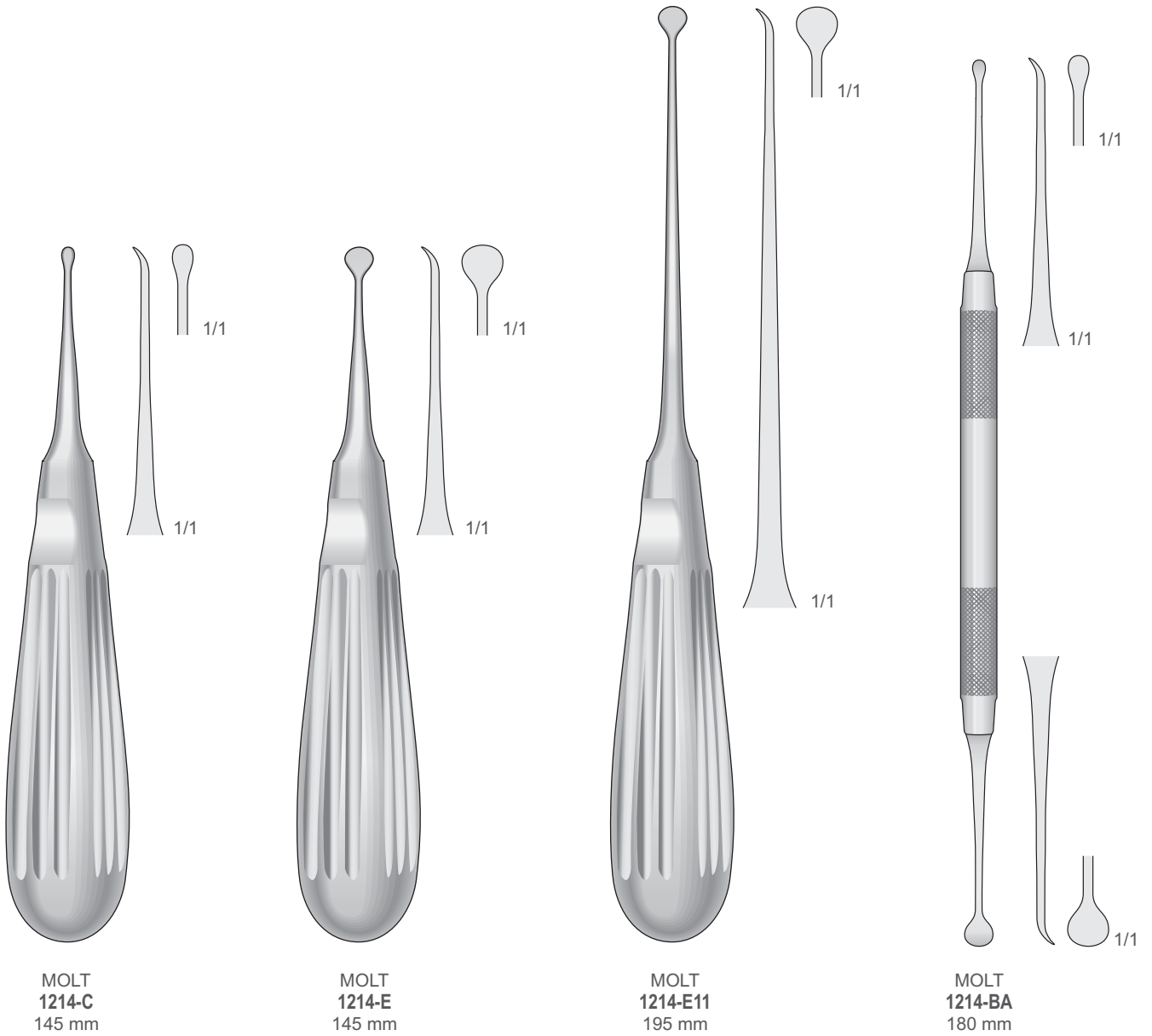

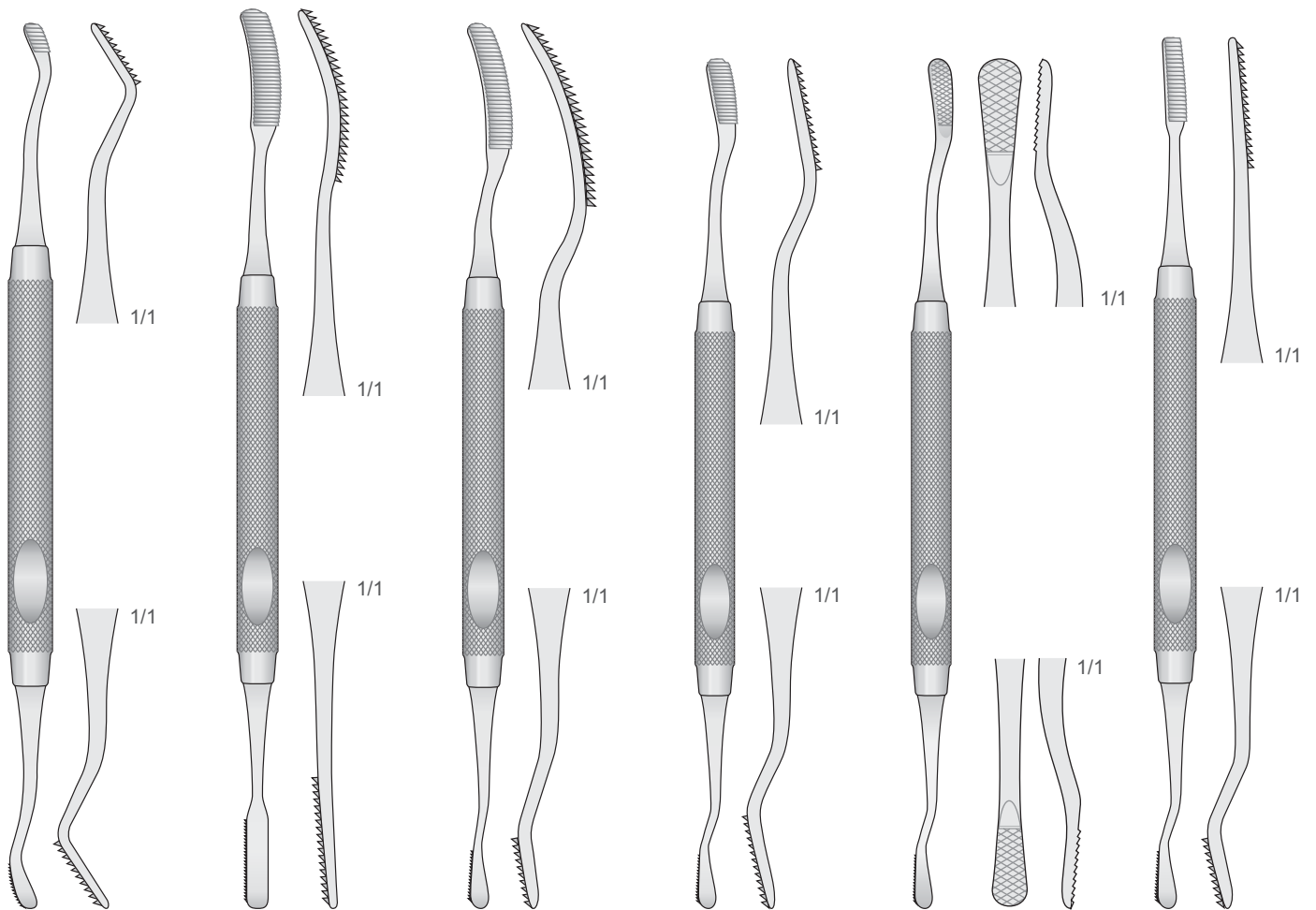

HOWARD  
**0414-B**  
 180 mm

MILLER  
**0414-C**  
 185 mm

MILLER  
**0414-D**  
 180 mm

HOWARD  
**0414-E**  
 170 mm

MILLER  
**0414-E03**  
 170 mm

MILLER  
**0414-F**  
 175 mm



Knochenfeilen  
 Bone Files  
 Lime per osso  
 Limas para huesos  
 Rapes à os

Runder Hohlgriff 8 mm  
 Hollow Round Handle 8 mm  
 Manico tondo vuoto 8 mm  
 Mango hueco 8 mm  
 Manche rond vide 8 mm

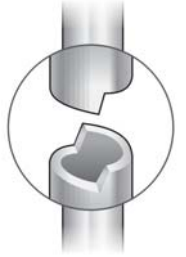

Parodontal Feilen  
 Periodontal Files  
 Lime parodontali  
 Limas periodontales  
 Limes parodontales

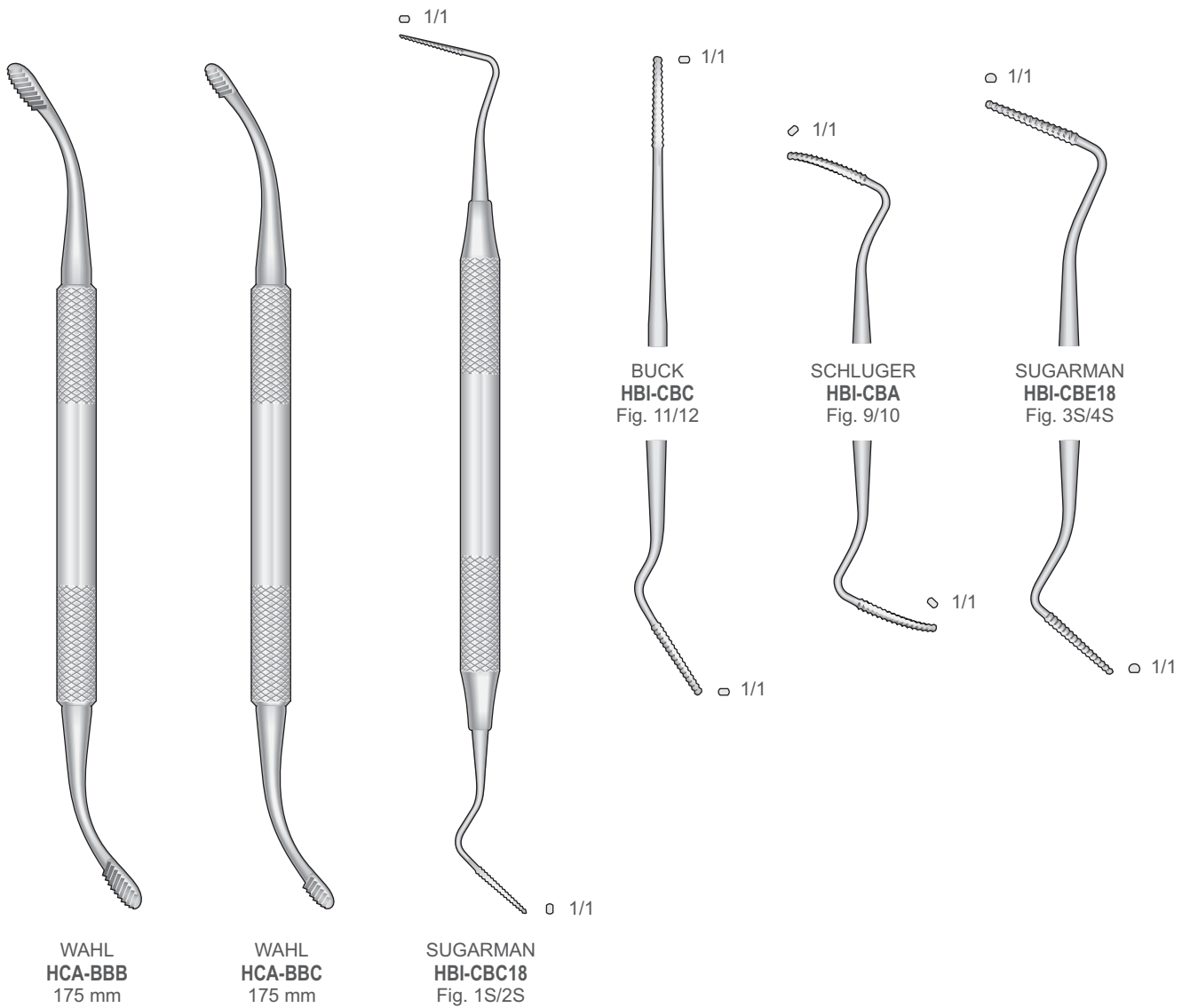

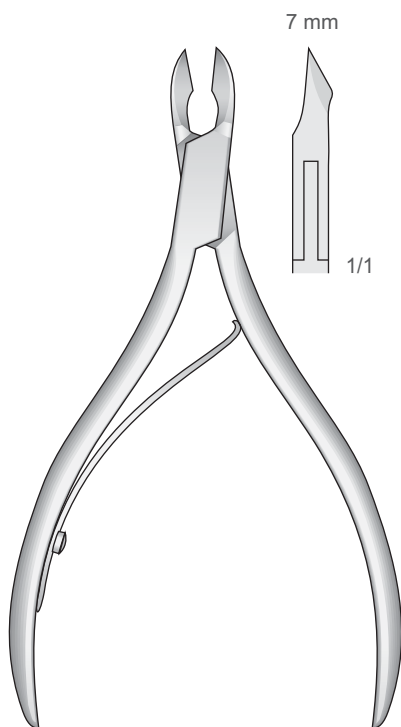

**CHOEN**  
**1123-GA**  
105 mm

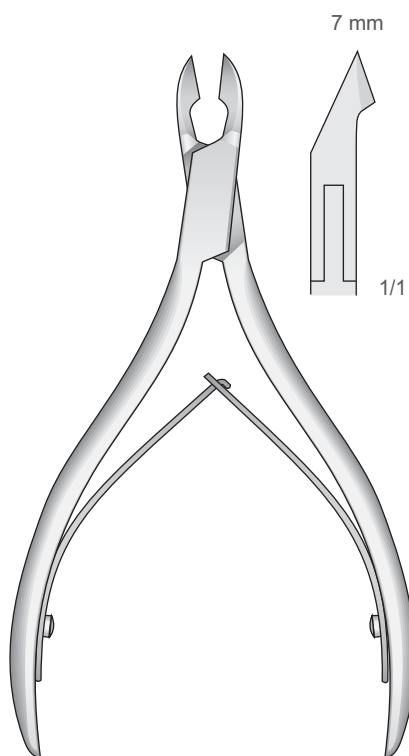

**ILIC**  
**1123-FA**  
115 mm

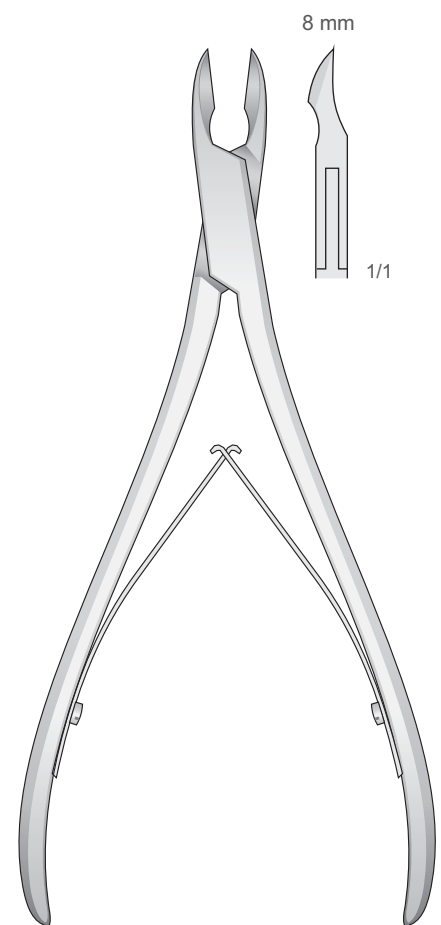

**1123-FC**  
140 mm

Hohlmeißelzangen  
 Bone rongeurs  
 Pinze ossivore  
 Pinzas-gubias  
 Pincas-gouges

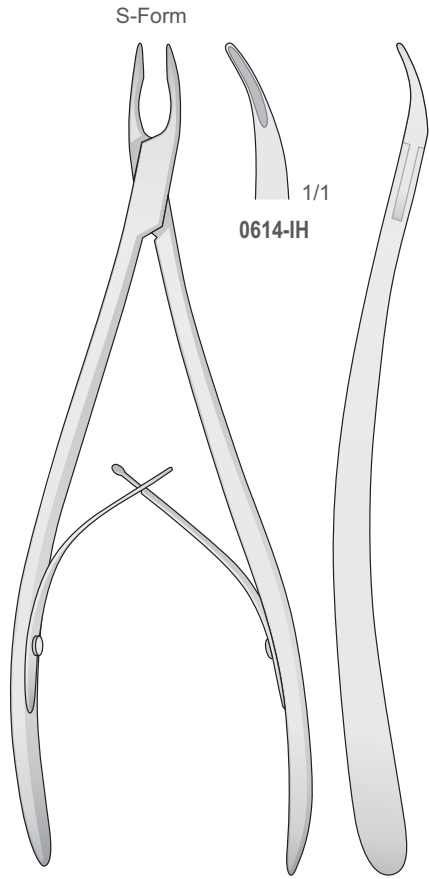

S-Form

0614-IH

STELLBRINK  
 0614-IH  
 190 mm



0614-II

0614-IL

STELLBRINK  
 0614-II/0614-IL  
 170 mm

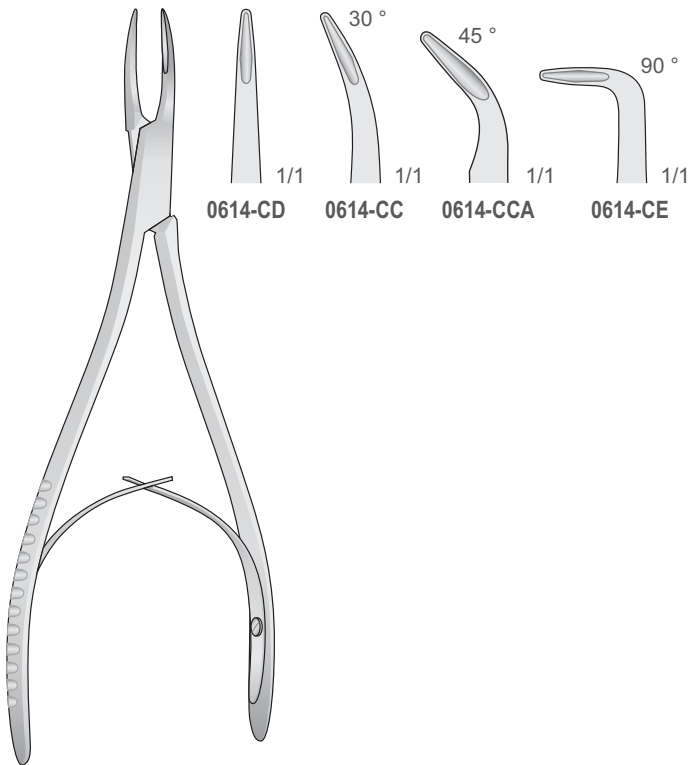

0614-CD

0614-CC

0614-CCA

0614-CE

MINI-FRIEDMANN  
 0614-CC/0614-CC0  
 150 mm

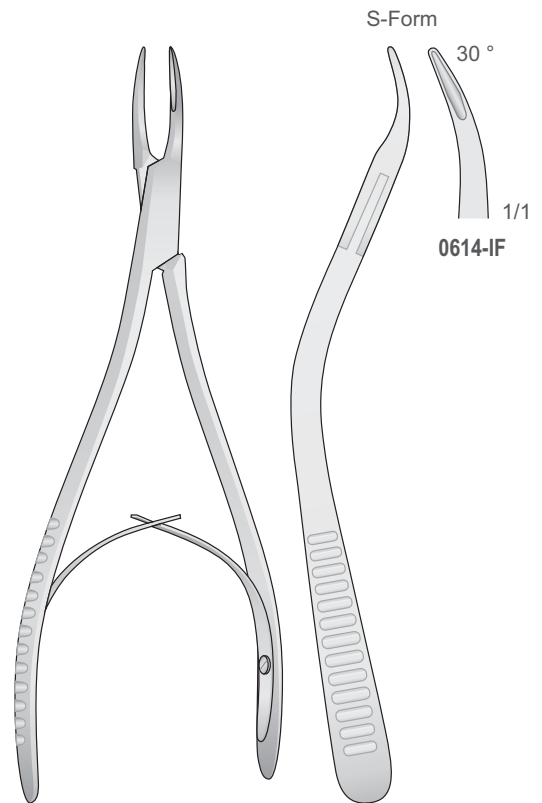

S-Form

0614-IF

MINI-FRIEDMANN  
 0614-IF  
 145 mm

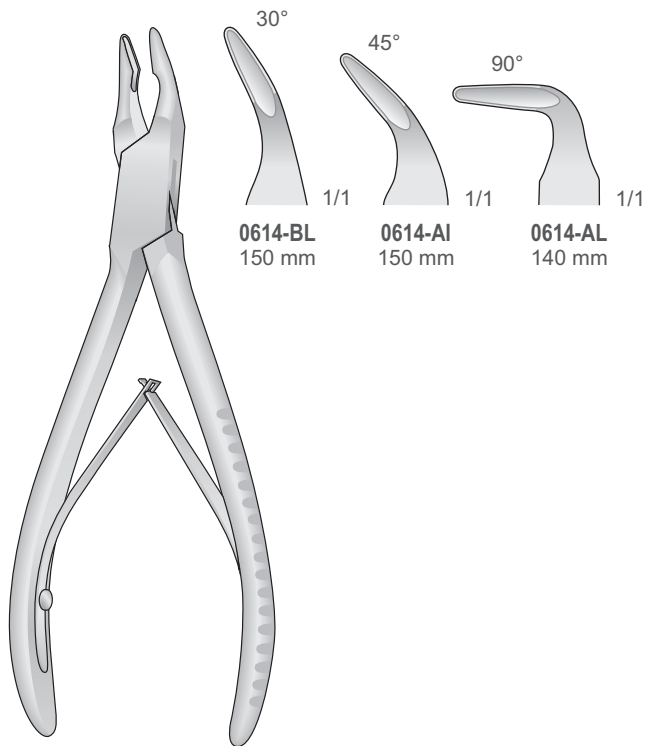

BLUMENTHAL  
 0614-AI/0614-BL

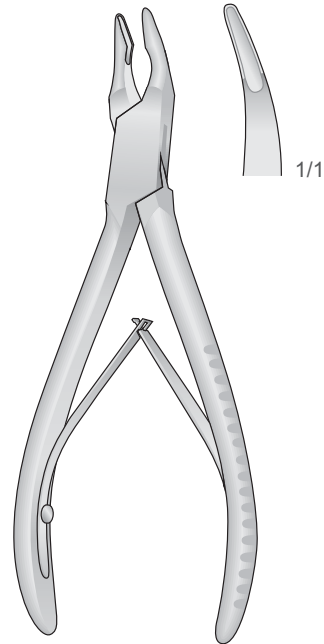

MINI FRIEDMAN  
 0614-BF  
 120 mm

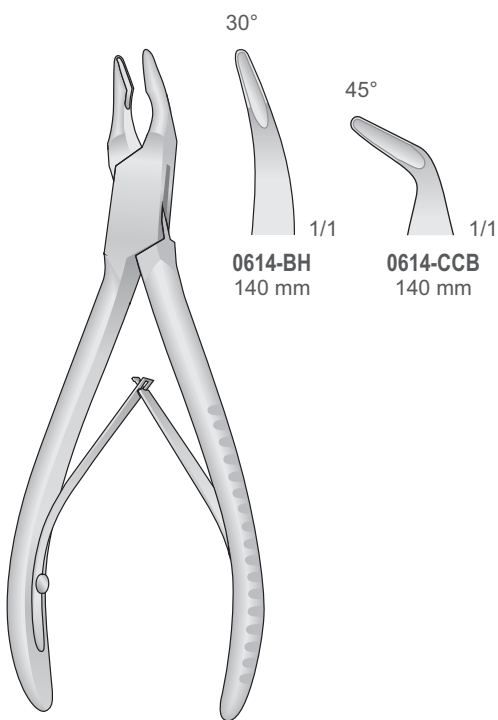

FRIEDMANN  
 0614-BH/0614-CCB  
 140 mm

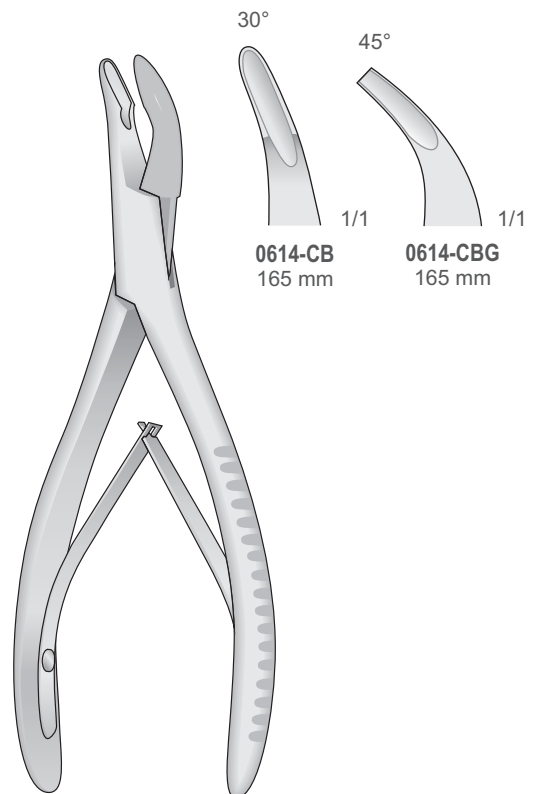

MEAD  
 0614-CB/0614-CBG  
 165 mm

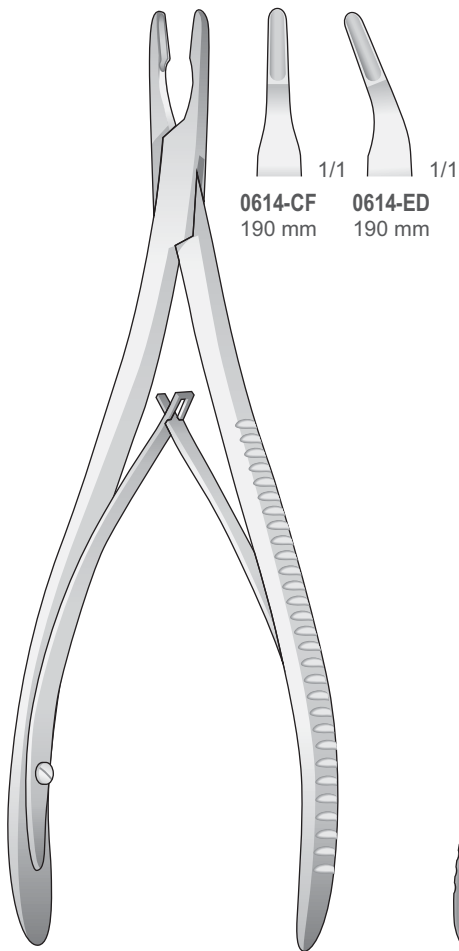

**0614-CF** 190 mm  
**0614-ED** 190 mm

LEMPERT  
**0614-CF/0614-ED**  
 190 mm

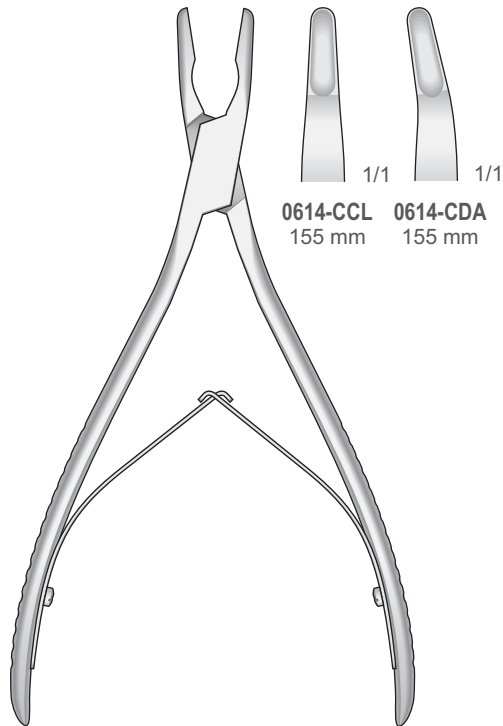

**0614-CCL** 155 mm  
**0614-CDA** 155 mm

LEMPERT  
**0614-CCL/0614-CDA**  
 155 mm

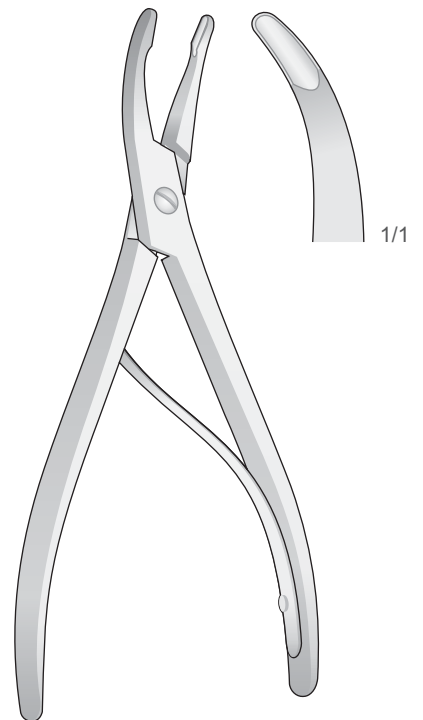

LUER  
**0614-BI**  
 155 mm

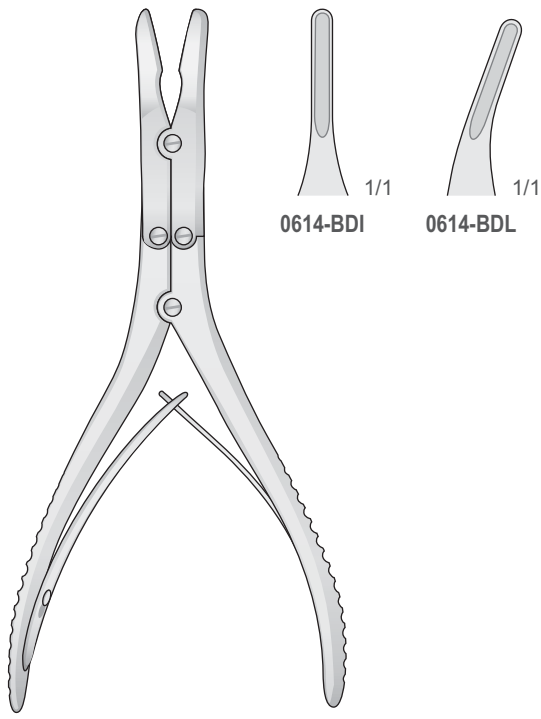

**RUSKIN**  
**0614-BDI/0614-BDL**  
 150 mm

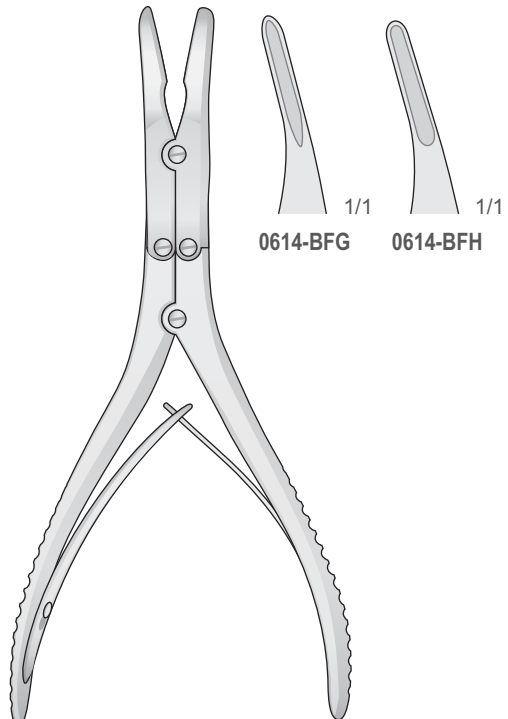

**KLEINERT-KUTZ**  
**0614-BFG/0614-BFH**  
 155 mm

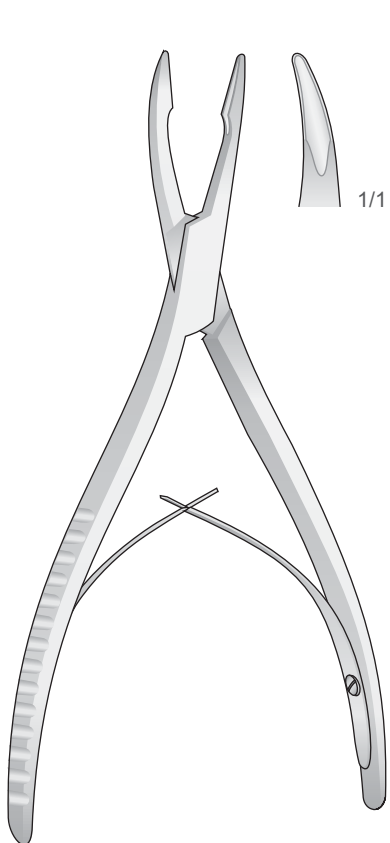

**FRIEDMANN**  
**0614-BG**  
 160 mm

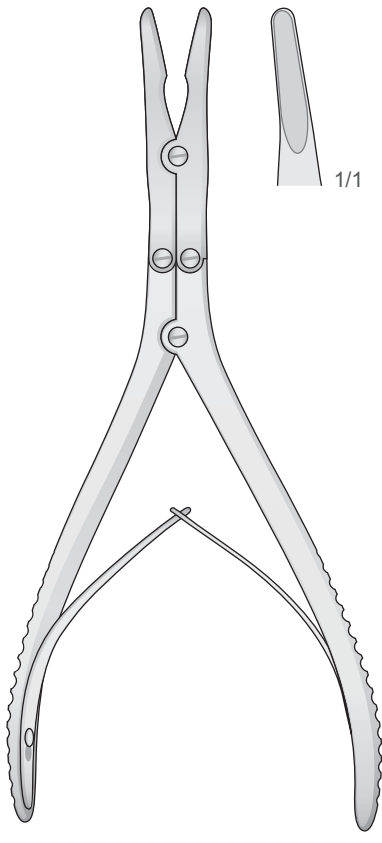

**BEYER**  
**0614-CA**  
 180 mm

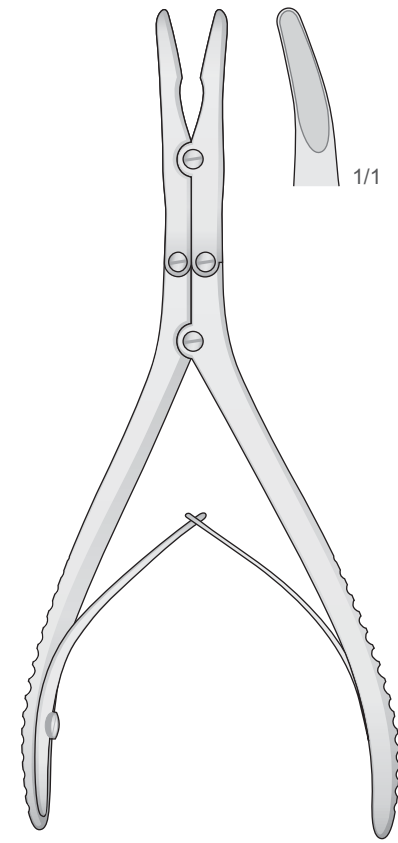

**ZAUFAL-JANSEN**  
**0614-DE**  
 180 mm

Hohlmeißelzangen  
 Bone rongeurs  
 Pinze ossivore  
 Pinzas-gubias  
 Pincas-gouges

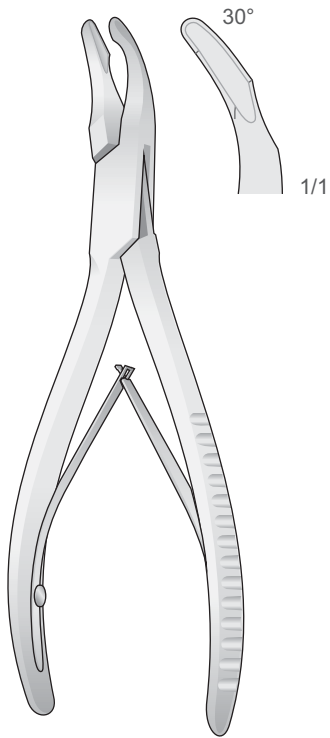

CLEVELAND  
**0614-CDB** 140 mm  
**0614-CDC** 170 mm

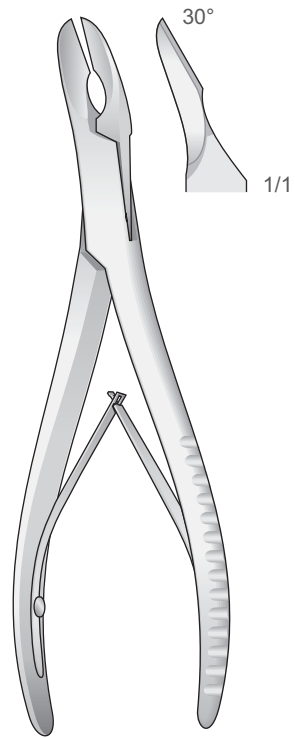

CLEVELAND  
**0614-CDD** 150 mm  
**0614-CDE** 170 mm

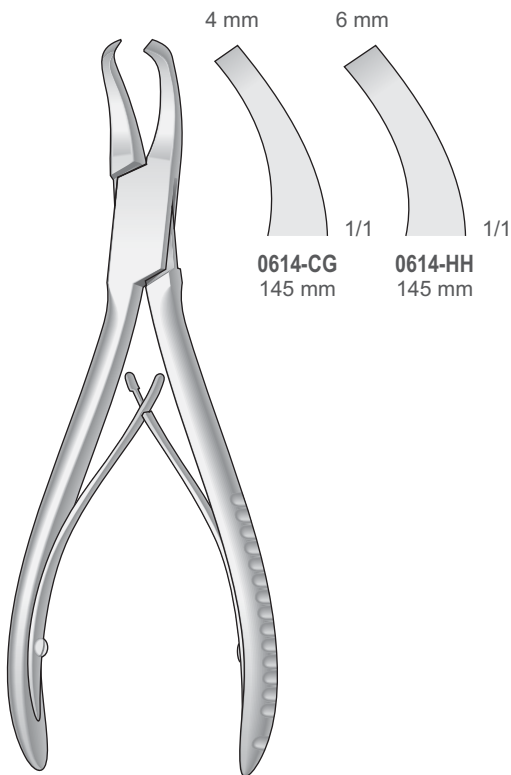

GARDNER  
**0614-CG/0614-HH**  
 145 mm

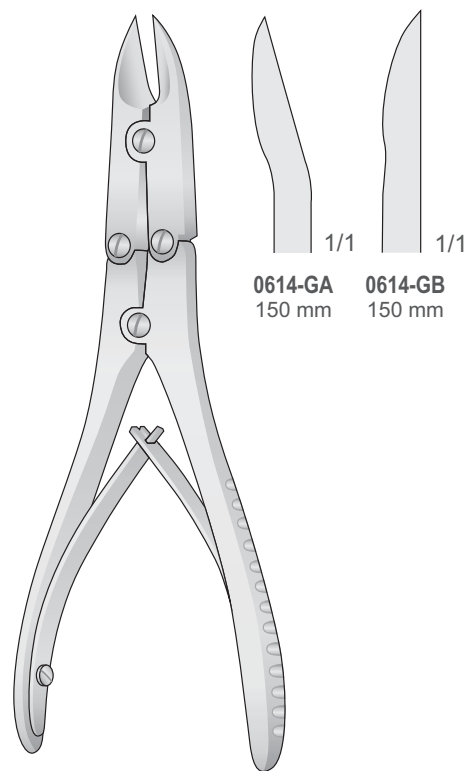

BÖHLER  
**0614-GA/0614-GB**  
 150 mm

Punches - Stanzen

Bone cutting forceps  
for opening the Sinus  
Strumento tagliente per  
aumentare il volume del seno

Knochensplitterzangen  
Bone cutting forceps  
Pinze ossivore  
Pinza cortantes para huesos  
Pincas coupantes à os

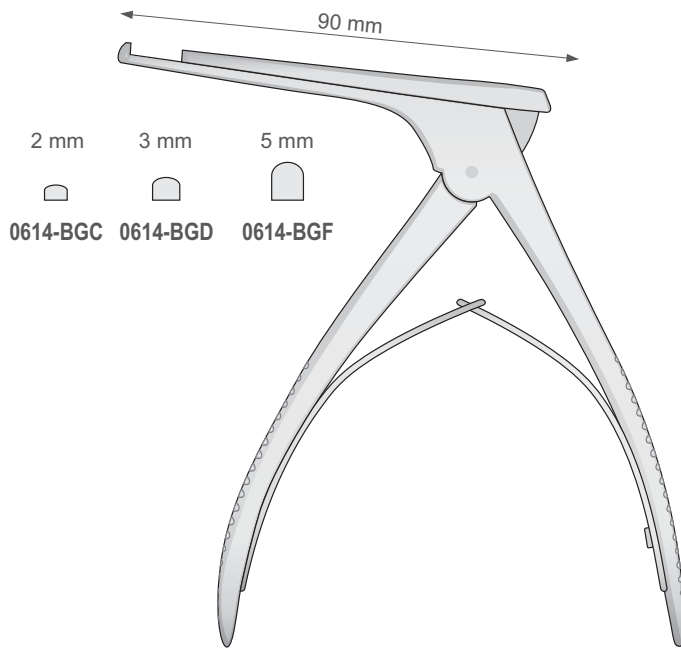

**KERRISON**  
0614-BGC 2 mm  
0614-BGD 3 mm  
0614-BGF 5 mm

Bone cutting forceps  
for opening the Sinus  
Strumento tagliente per  
aumentare il volume del seno

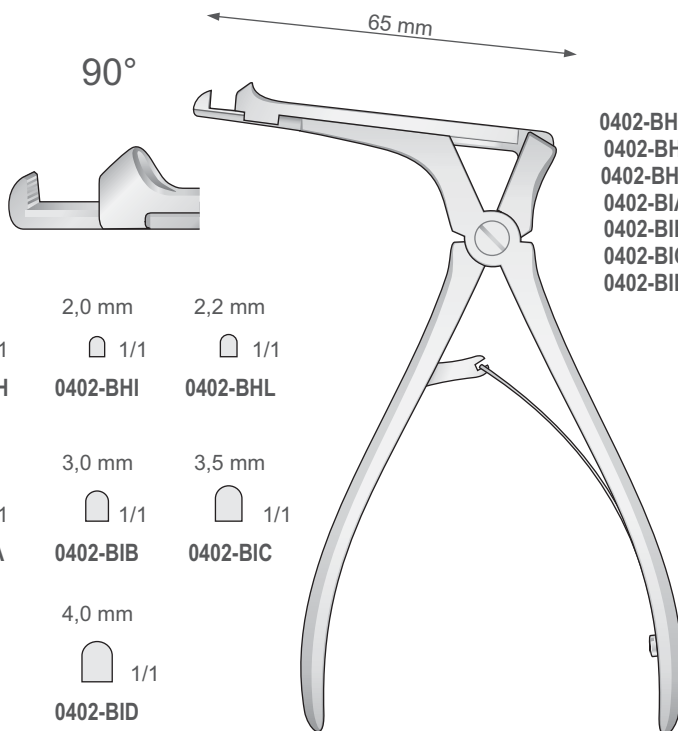

**CITELLI**  
0402-BHH/0402-BID

Fig.  
R-18

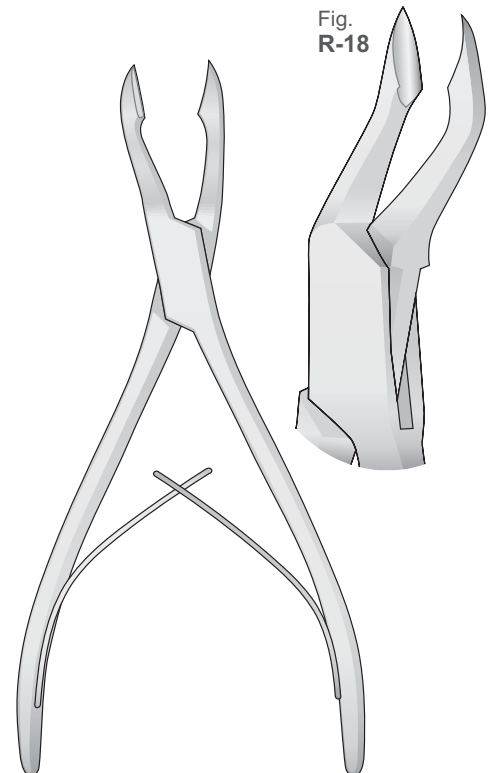

**0614-DD**  
175 mm



.11

Diagnostik, Parodontologie, Konservierung  
Diagnostic, Periodontal, Restorative  
Diagnostica, Parodontologia, Conservativa  
Diagnòstico, Parodontologia, Conservativo  
Diagnostic, Parodontologie, Conservateur

Zahnärztliche Chirurgie  
Dental surgery  
Chirurgia dentale  
Cirugia dental  
Chirurgie dentaire





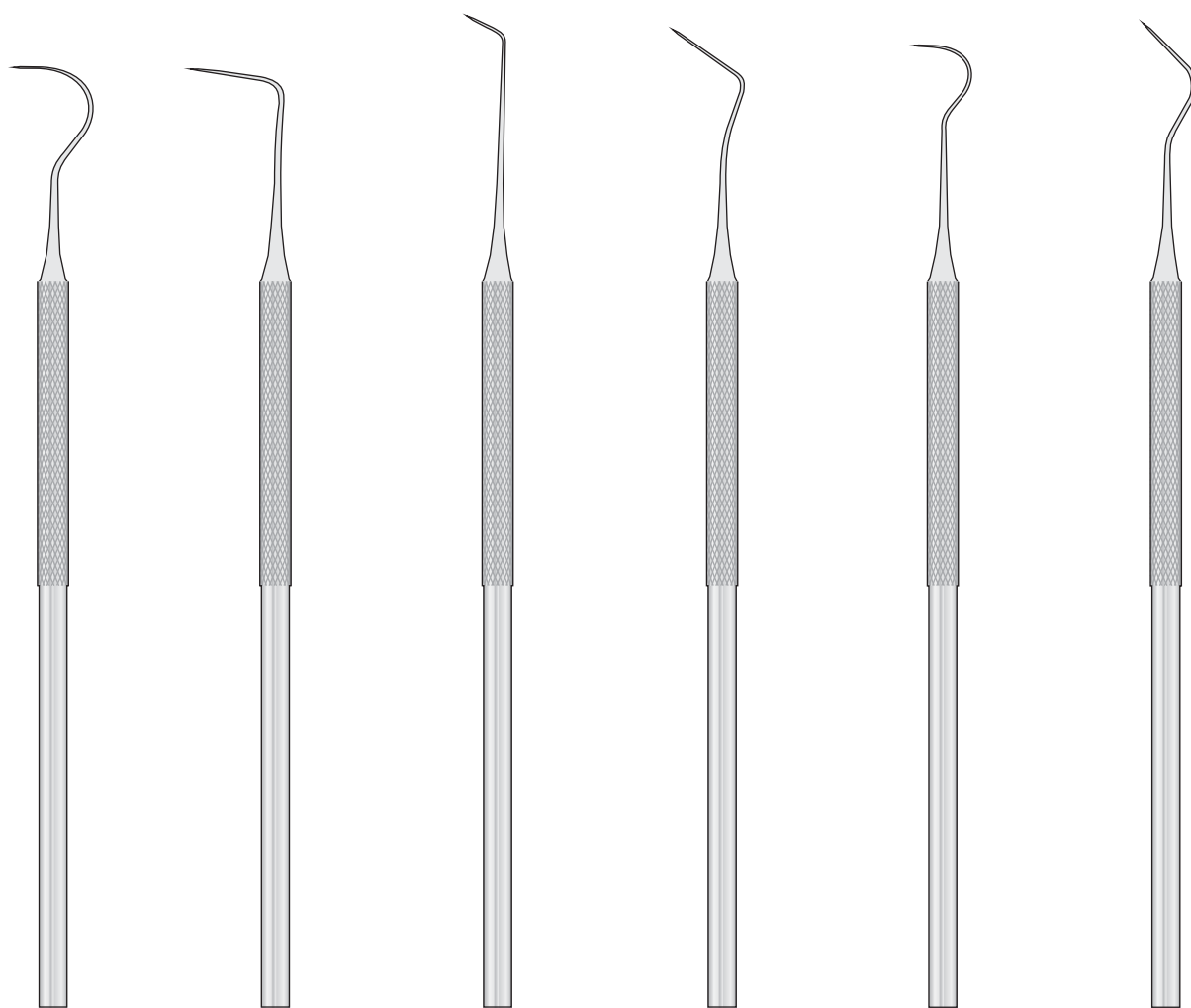

**1814-B**  
Fig. 23

**1814-C**  
Fig. 11

**1814-D**  
Fig. 6

**1814-E**  
Fig. 9

**1814-F**  
Fig. 2

**1814-G**  
Fig. 10



**1814-H**  
Fig. 12

**1814-I**  
Fig. 6A

**1814-L**  
Fig. 8A

**1814-BA**  
Fig. 17A

**1814-BB**  
Fig. 3A

**1814-BC**  
Fig. 3



Do not sterilizing with ultra sound - Not Metal brushes  
 Non sterilizzare in ultrasuoni - No spazzola metallica

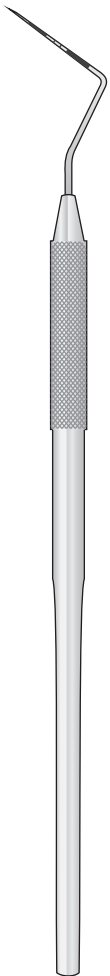
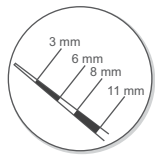

CP-11  
 1812-BB  
 160 mm

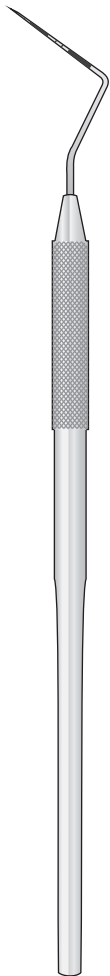
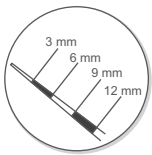

CP-12  
 1812-BC  
 160 mm

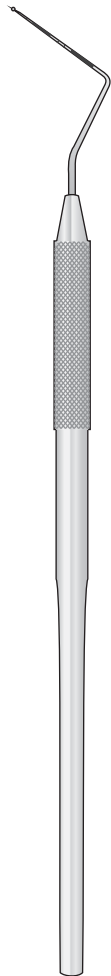
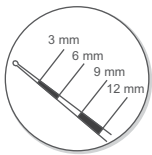

CP-12S  
 1812-BD  
 160 mm

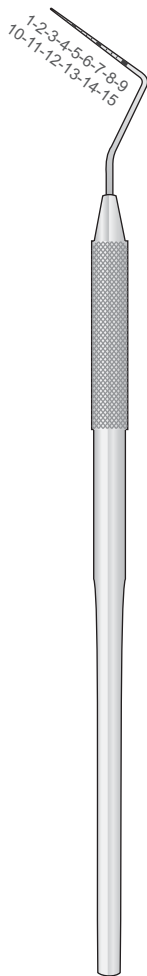
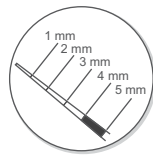

CP-15UNC  
 1812-BF  
 160 mm

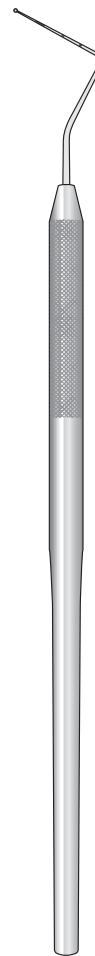
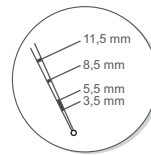

WHO  
 1812-CB  
 160 mm

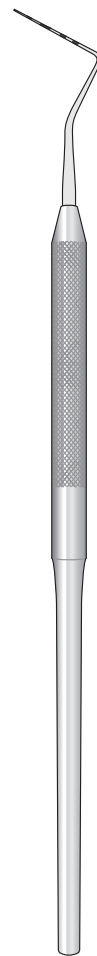
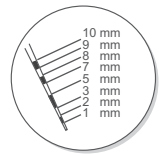

CP-10  
 1812-BL  
 160 mm

Sonden - Doppelpendig  
 Explorers - Double end  
 Sonda doppia  
 Exploradores dobles  
 Explorateurs doubles



11/12 ODU  
**1814-CA**  
 165 mm

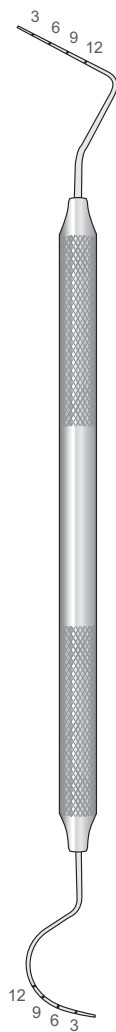

UT3/4 CATTONI  
**1812-CA**  
 165 mm

3 - 6 - 9 - 12



12 - 9 - 6 - 3

2QN NABERS  
**1812-CC**  
 175 mm

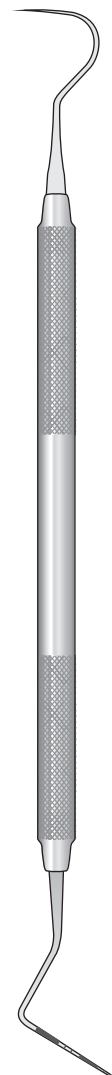
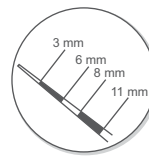

23 CP-11  
**0523-BB**

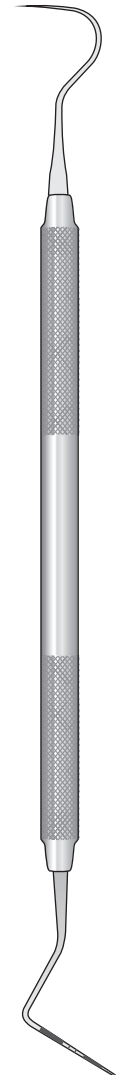
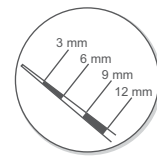

23 CP-12  
**0523-BC**



Parodontometer  
 Periodontal Probes  
 Sonde parodontali  
 Sondas parodontales  
 Sondes parodontales

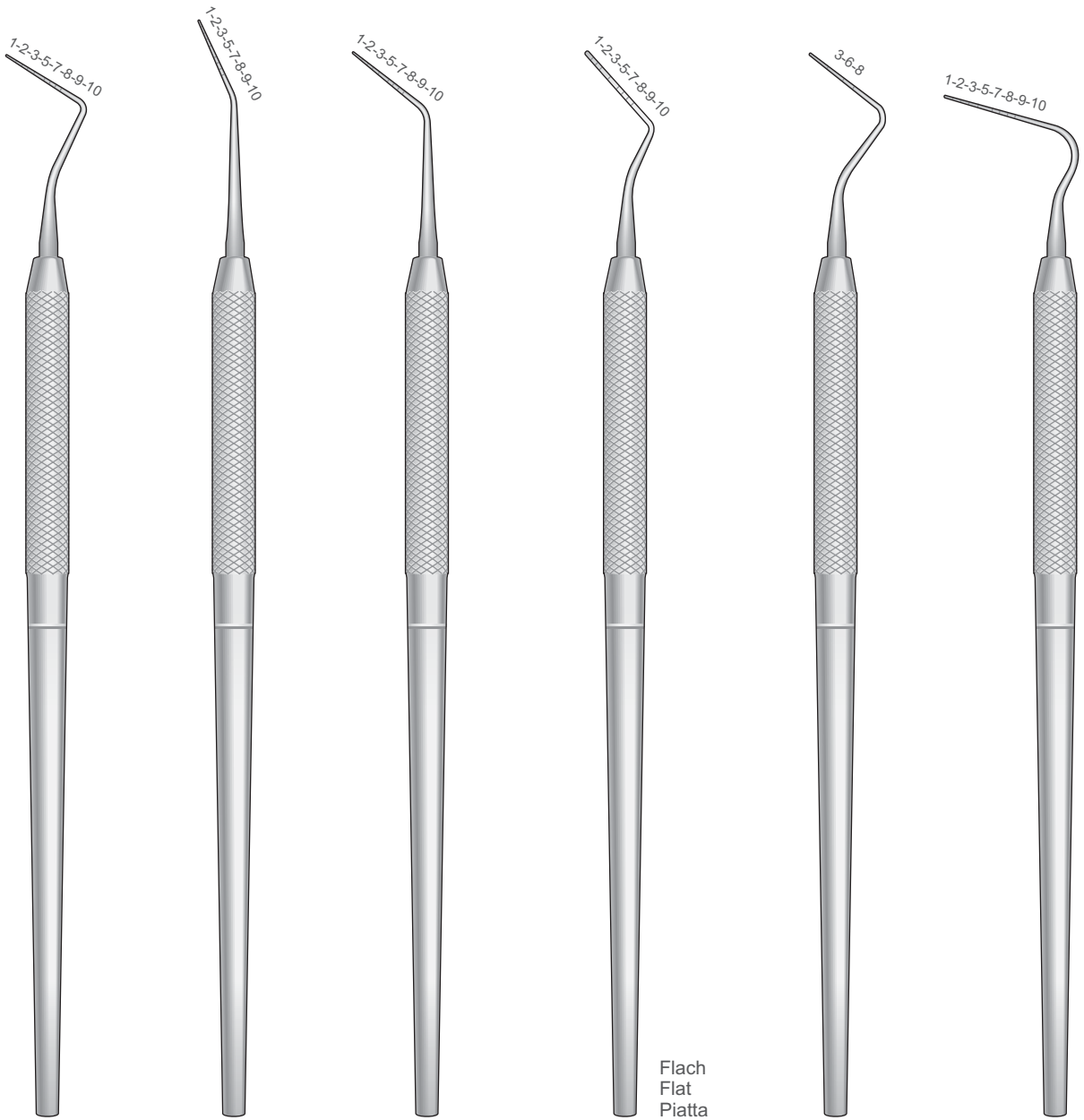

Flach  
 Flat  
 Piatta

WILLIAMS  
1812-B

MERRITT A  
1812-C

MERRITT B  
1812-D

GOLDMAN-FOX  
1812-E

UNIVERSITY  
OF MICHIGAN  
1812-F

26 G  
1812-G

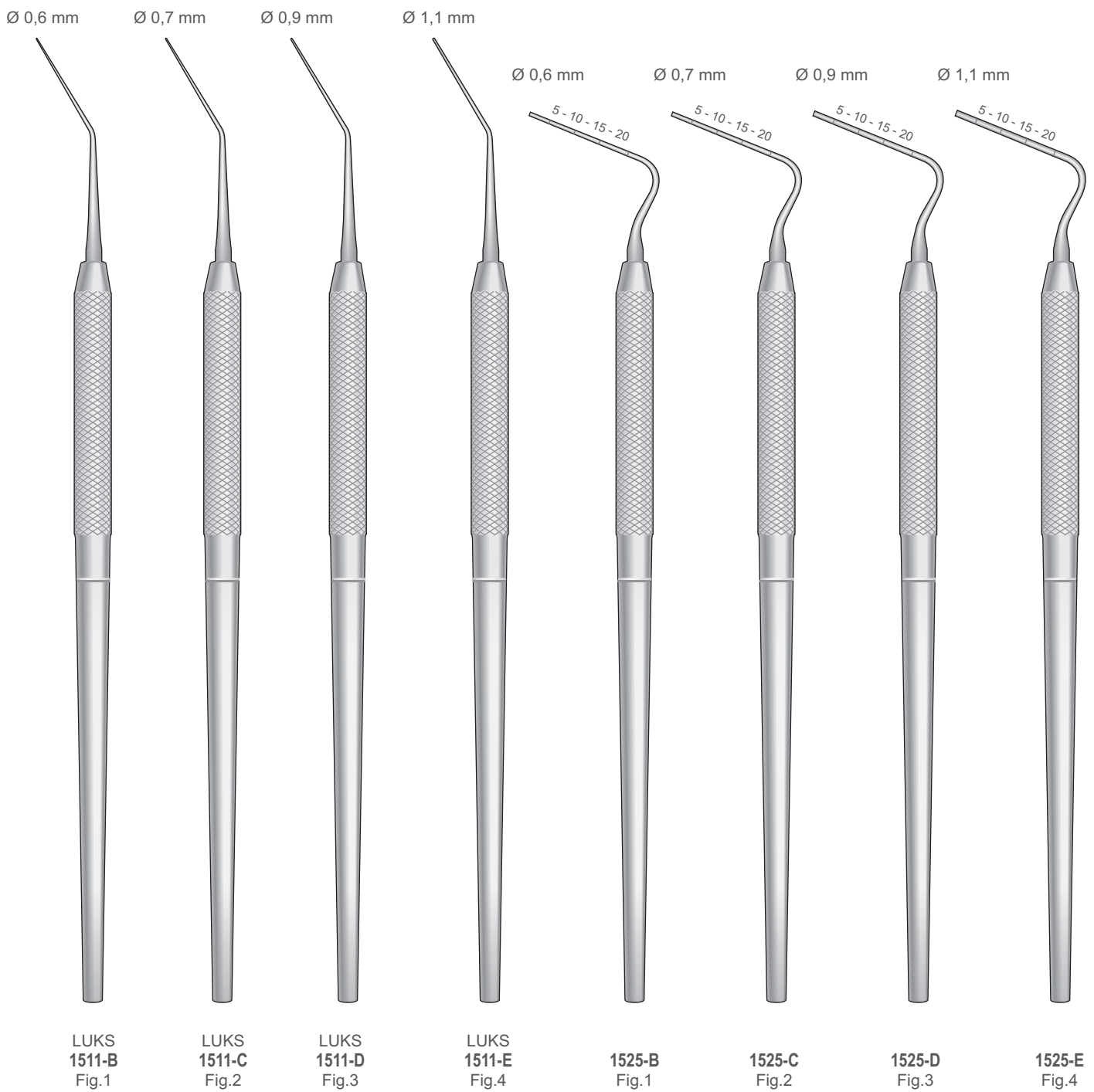





Spreaders

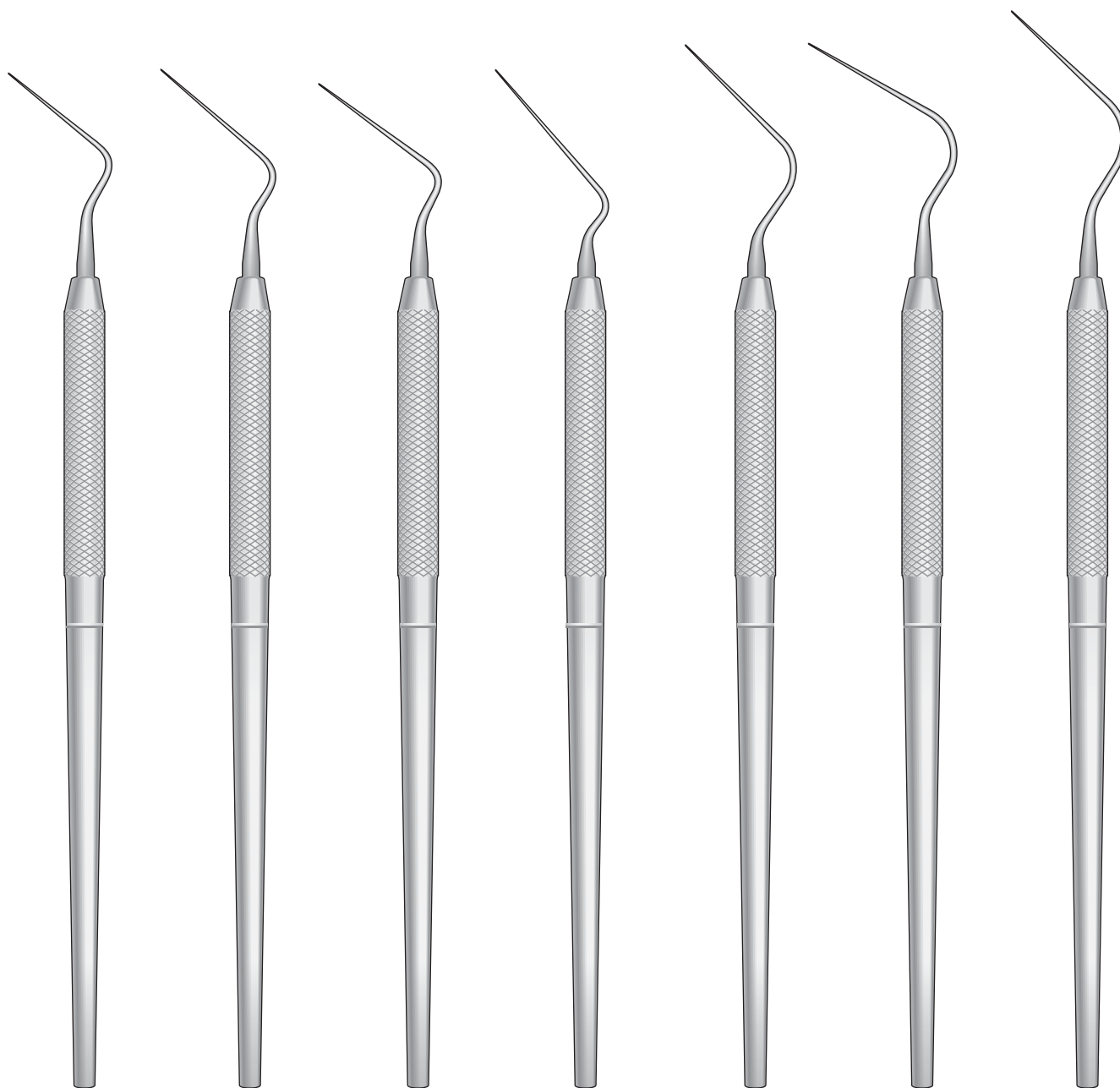

**1815-B**  
Fig.1S

**1815-C**  
Fig.2S

**1815-D**  
Fig.D11

**1815-E**  
Fig.MA57

**1815-F**  
Fig.0

**1815-G**  
Fig.00

**1815-H**  
Fig.3



Tamponstopfer  
Gauze Packers  
Porta tamponi  
Tamponeadores  
Porte tampons

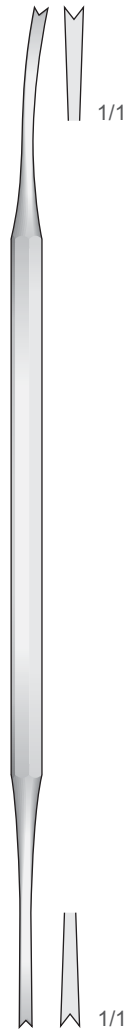

LUNIATSCHEK  
**1506-G**  
170 mm



UNIVERSAL  
**1506-EA**  
140 mm

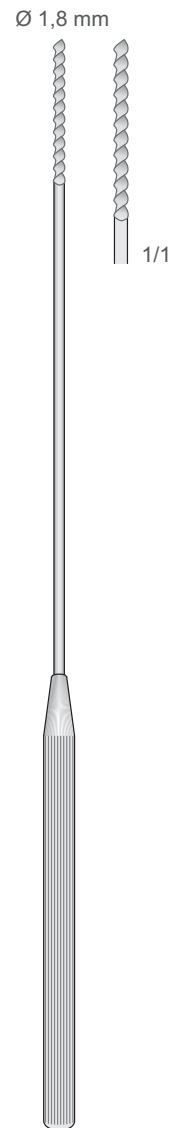

UNIVERSAL  
**1506-EB**  
180 mm

Mundspiegel und Griffe  
Mirrors and mirror handles  
Specchietti e manici  
Espejos y mango  
Miroirs et manche



Pack. 12 pcs.

15-D	18 mm
15-E	22 mm
15-F	24 mm

Plan  
Plane  
Piano  
Planos  
Plans



Pack. 12 pcs.

1708-E	22 mm
1708-F	24 mm

Rhodiumspiegel  
Rhodium Mirror  
Specchietto rodriato  
Espejo de rodio  
Miroir au rhodium



Pack. 12 pcs.

07-D	18 mm
07-E	22 mm
07-F	24 mm

Hohl-Vergrößernd  
Concave with enlarging effect  
Concavo con ingrandimento  
Còncavo con efecto de aumento  
Creux avec effect agrandissant



Pack. 6 pcs.

1708-BE	22 mm
---------	-------

**MEGA DUO**  
RHODIUM n.4

Beidseitig Rhodium Beschichtet  
Rhodium-coated, both sides  
Con rivestimento in rodio su entrambi i lati  
Ambos lados con revestimiento de rodio  
Revêtu de rhodium des deux côtés



Massiv  
Solid  
Pieno  
Sòlido  
Massif

Rostfrei  
Stainless  
Inox  
Inoxidable  
Inoxydable

**1201-B**  
120 mm



Massiv  
Solid  
Pieno  
Sòlido  
Massif

Rostfrei  
Stainless  
Inox  
Inoxidable  
Inoxydable

**1201-C**  
125 mm



Hohl  
Hollow  
Vuoto  
Hueco  
Creux

Verchromt  
Chromium  
Cromato  
Cromado  
Chromé

**1201-D**  
125 mm



Hohl  
Hollow  
Vuoto  
Hueco  
Creux

Aluminium  
Alu  
Alluminio  
Alu  
Alu

**0111-1201F**  
120 mm



Hohl  
Hollow  
Vuoto  
Hueco  
Creux

Rostfrei  
Stainless  
Inox  
Inoxidable  
Inoxydable

**1201-H**  
135 mm



1/1



1/1

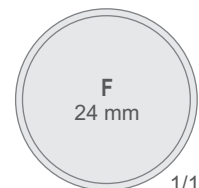

1/1

Spiegeldurchmesser - Diameter of mirrors  
Diametro dello specchio - Diamètre des miroirs  
Diámetro de los espejos

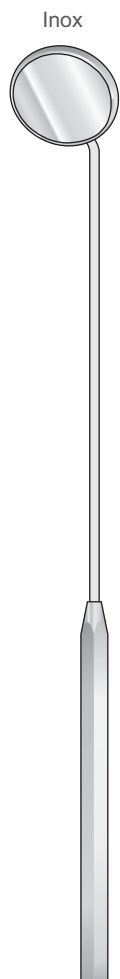
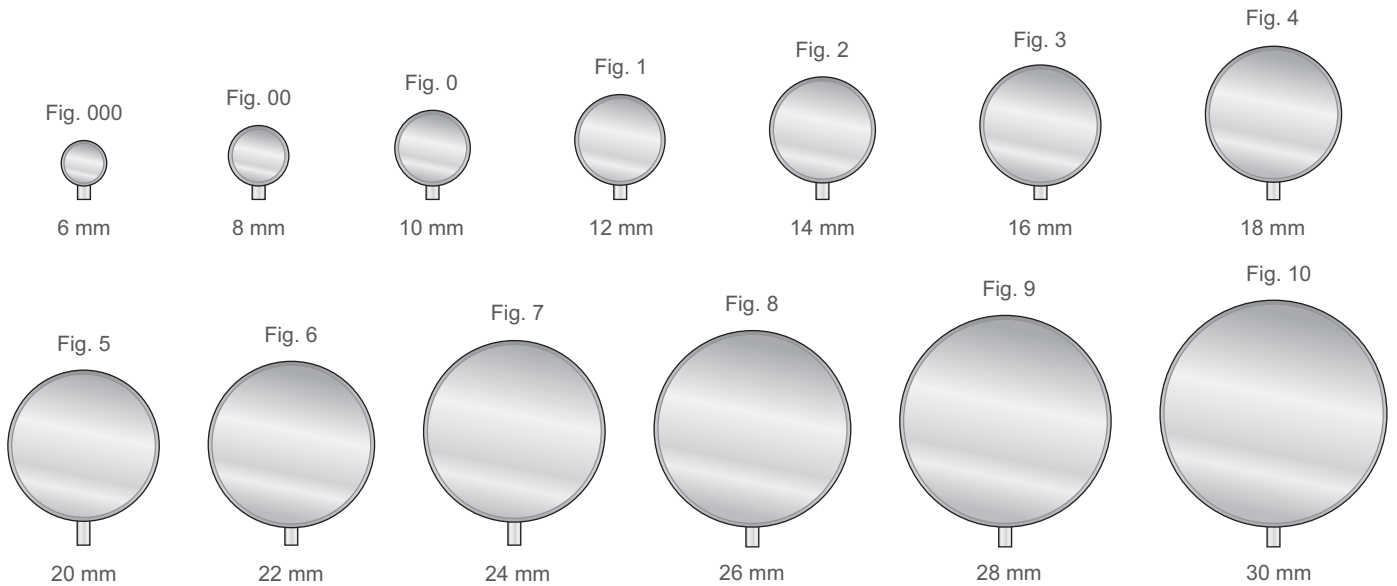

Kehlkopfspiegel mit Sechskantgriff  
Laryngeal mirrors with hexagonal handle  
Specchietto laringeo con manico esagonale  
Espejo laringeo con mango hexagonal  
Miroirs laryngiens avec manche hexagonal

- 07-I Fig. 00
- 07-BA Fig. 0
- 07-BC Fig. 1
- 07-BE Fig. 2
- 07-BG Fig. 3
- 07-BI Fig. 4
- 07-CA Fig. 5
- 07-CC Fig. 6
- 07-CE Fig. 7
- 07-CG Fig. 8
- 07-CI Fig. 9
- 07-DA Fig. 10

07-I/07-DA  
180 mm

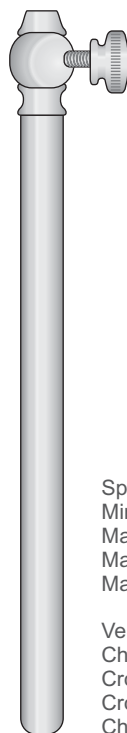

Spiegelgriff  
Mirrors handle  
Manico per specchietti  
Mango para espejos  
Manche à miroir

Verchromt  
Chromium  
Cromato  
Cromado  
Chromé

1201-G  
120 mm

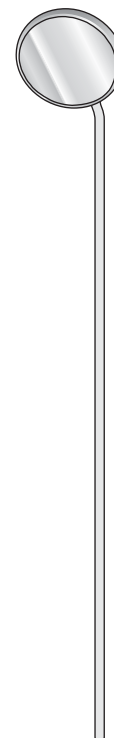

Kehlkopfspiegel  
Laryngeal mirrors  
Specchietto laringeo  
Espejos laringeos  
Miroirs laryngiens

- 15-AAA Fig. 000
- 15-AA Fig. 00
- 15-A Fig. 0
- 15-AB Fig. 1
- 15-AC Fig. 2
- 15-AD Fig. 3
- 15-AE Fig. 4
- 15-AF Fig. 5
- 15-AG Fig. 6

15-AAA/15-AG  
120 mm



Spritzen zur lokalen Interligamentär-Anästhesie  
Syringes for Intraligamental anaesthesia  
Siringa per anestesia intraligamentare  
Jeringa intraligamentaria para anestesia  
Seringues pour anesthésies locales intraligementaires

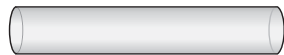
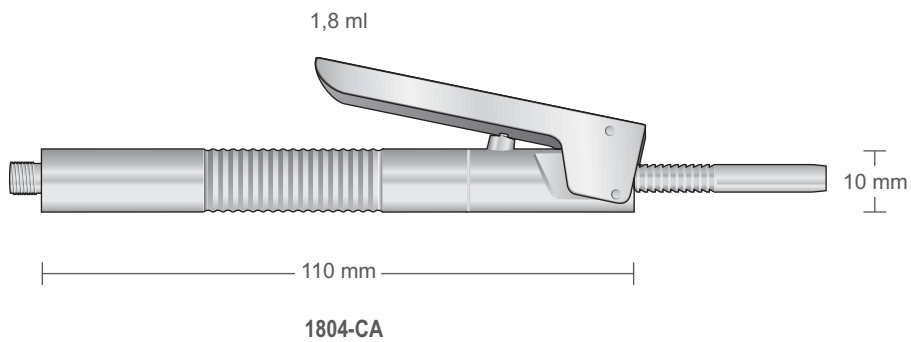

**1804-H17**  
Ersatzzylinder für SD-7  
Autoclavable plastic protection sleeve for SD-7  
Protezione in plastica autoclavabile per SD-7  
Cilindro de repuesto para SD-7  
Cylindre de rechange pour SD-7

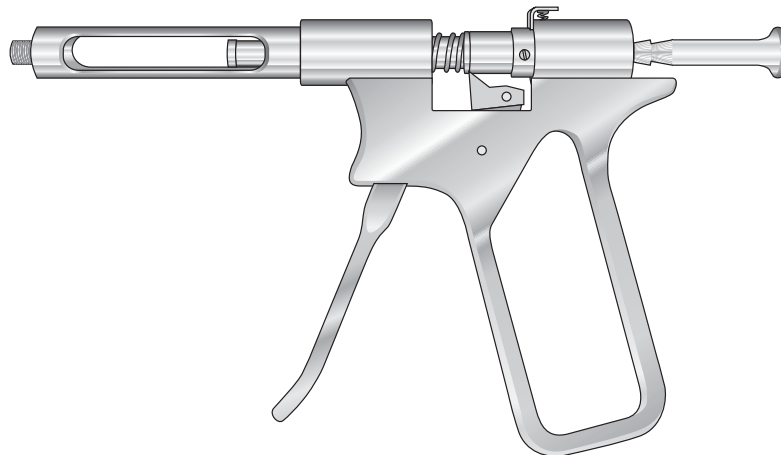

**1804-H**

Zylinder-Ampullen Spritzen  
Cartridge Syringes  
Siringhe per tubofiale  
Jeringas de ampollas  
Seringues d'ampoules

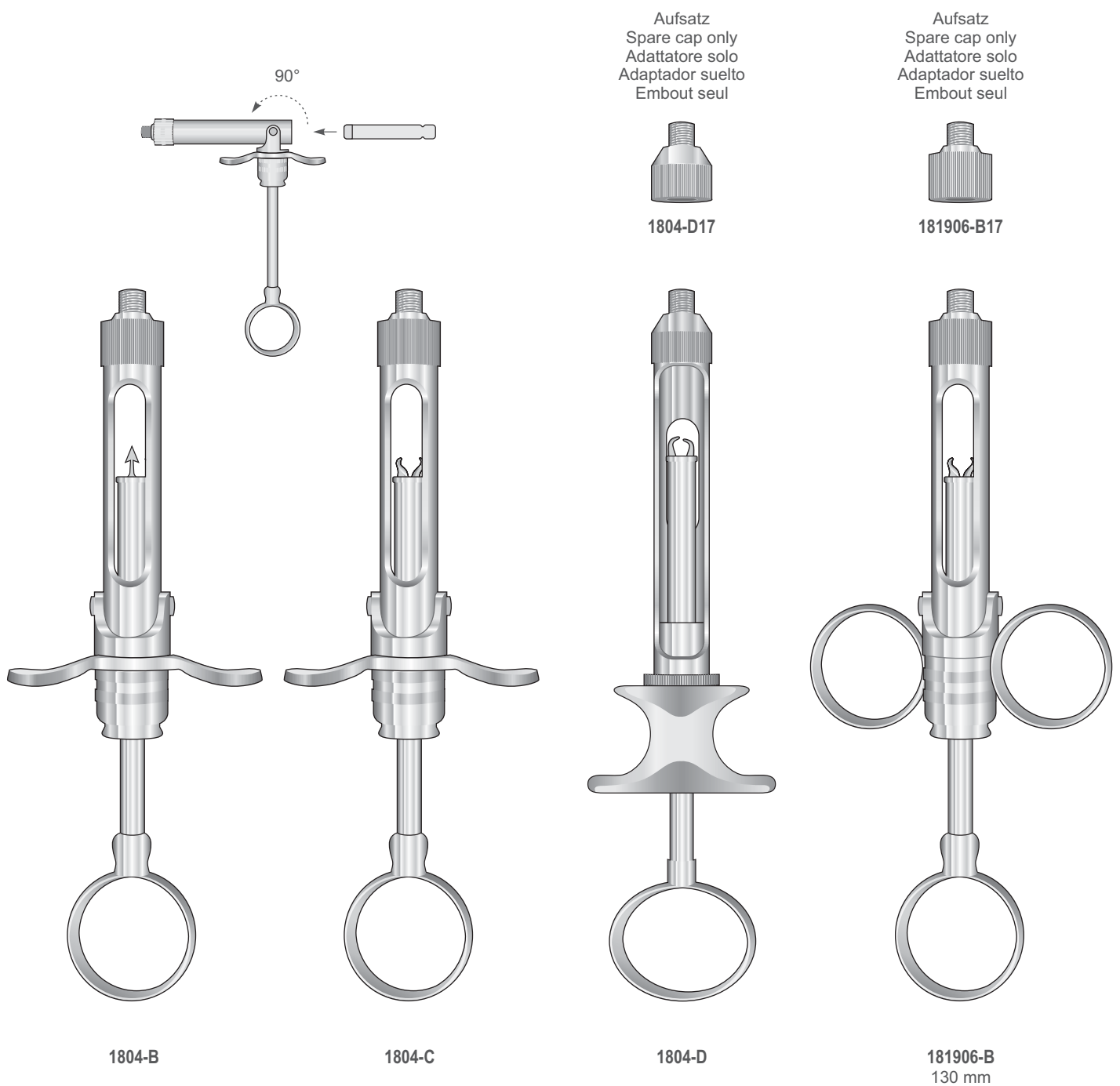



GRACEY  
0320-B/C



GRACEY  
0320-D/E



GRACEY  
0320-F/G



GRACEY  
0320-H/I



GRACEY  
0320-L/BA



GRACEY  
0320-BB/BC



GRACEY  
0320-BD/BE

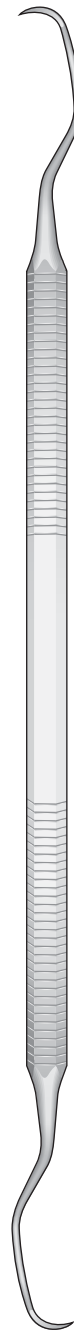

LANGER Fig. 1/2  
031411-B/03



LANGER Fig. 3/4  
031411-D/05



COLUMBIA  
031411-C1711



COLUMBIA  
031411-E1711



COLUMBIA  
031411-BD/BE

# Elite Extra Thin

American made, German approved  
 Elite Curettes  
 precision at it's best



Runder Hohlgriff 9 mm  
 Hollow Round Handle 9 mm  
 Manico tondo vuoto 9 mm  
 Mango hueco 9 mm  
 Manche rond vide 9 mm

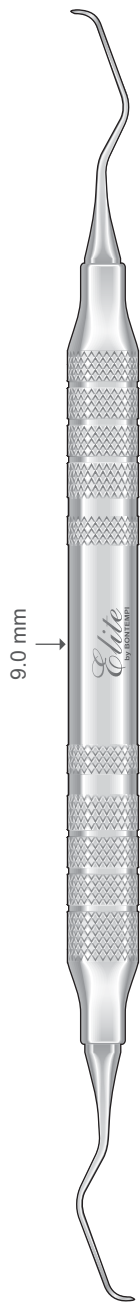

**201807-B/C0519**  
 Gracey  
 Curette 1/2ET



**201807-D/E0519**  
 Gracey  
 Curette 3/4ET



**201807-F/G0519**  
 Gracey  
 Curette 5/6ET



**201807-H/I0519**  
 Gracey  
 Curette 7/8ET



**201807-L/BA0519**  
 Gracey  
 Curette 9/10ET



**201807-BB/BC0519**  
 Gracey  
 Curette 11/12ET



**201807-BD/BE0519**  
 Gracey  
 Curette 13/14ET



**201807-BF/BG0519**  
 Gracey  
 Curette 15/16ET

## Elite Curette Extra Thin

Feather weight Extra Light handles  
 Balance and equilibrated for great tactile working ability  
 USA Stainless Steel, anticorrosion  
 Maintains long sharp edges



Küretten Elite by Bontempi  
 Curettes Elite by Bontempi  
 Curette Elite by Bontempi  
 Curetas Elite by Bontempi  
 Curettes Elite by Bontempi

Runder Hohlgriff 9 mm  
 Hollow Round Handle 9 mm  
 Manico tondo vuoto 9 mm  
 Mango hueco 9 mm  
 Manche rond vide 9 mm

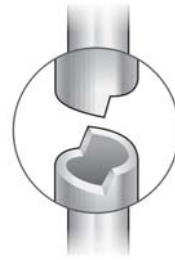

*Elite*

American made, German approved  
 Elite Scalers and Curettes  
 precision at it's best

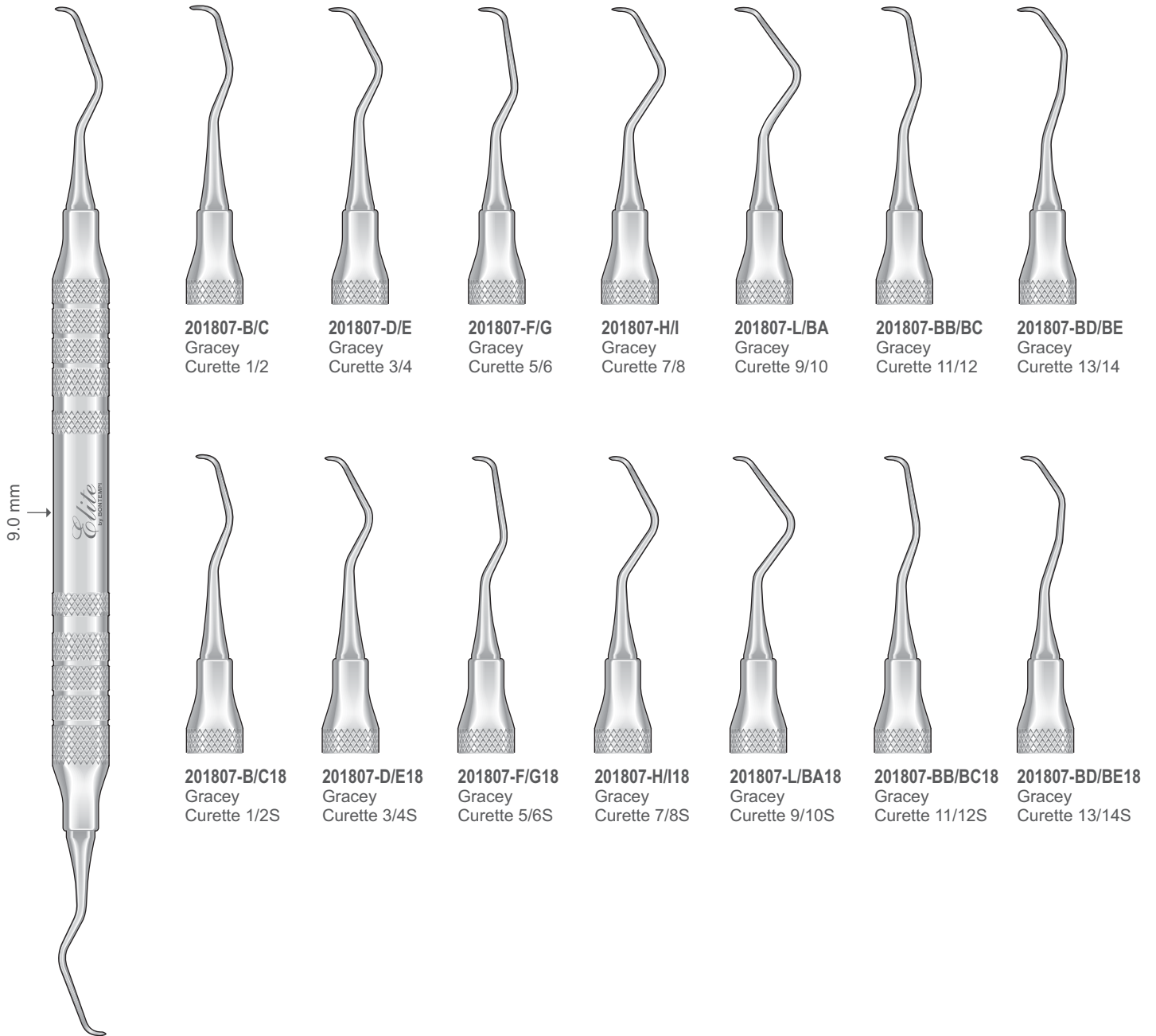

**Elite Scalers and Curette**

Feather weight Extra Light handles  
 Balance and equilibrated for great tactile working ability  
 USA Stainless Steel, anticorrosion  
 Maintains long sharp edges

# Elite

American made, German approved  
 Elite Scalers and Curettes  
 precision at it's best



Runder Hohlgriff 9 mm  
 Hollow Round Handle 9 mm  
 Manico tondo vuoto 9 mm  
 Mango hueco 9 mm  
 Manche rond vide 9 mm

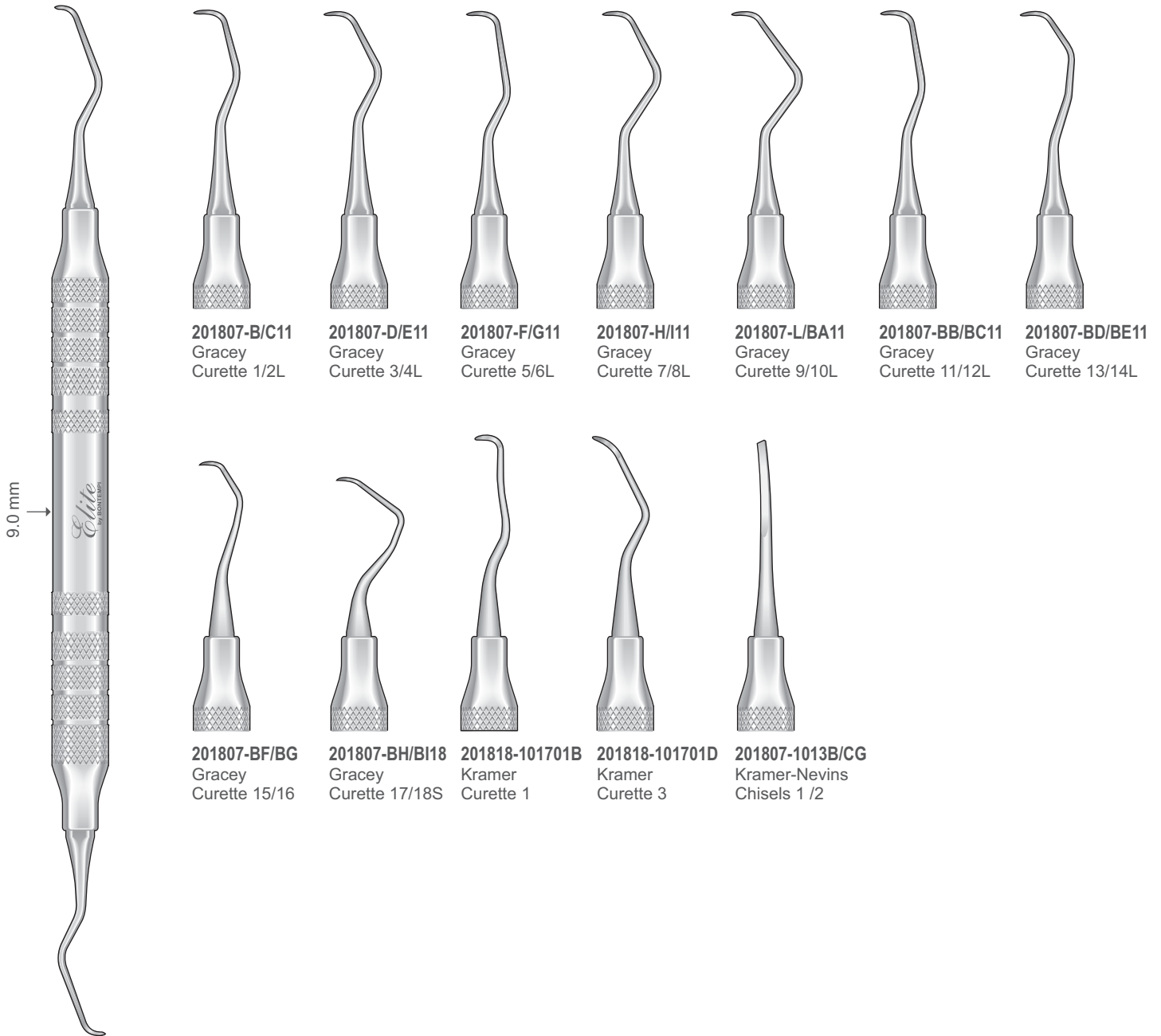

**201807-B/C11**  
 Gracey  
 Curette 1/2L

**201807-D/E11**  
 Gracey  
 Curette 3/4L

**201807-F/G11**  
 Gracey  
 Curette 5/6L

**201807-H/I11**  
 Gracey  
 Curette 7/8L

**201807-L/BA11**  
 Gracey  
 Curette 9/10L

**201807-BB/BC11**  
 Gracey  
 Curette 11/12L

**201807-BD/BE11**  
 Gracey  
 Curette 13/14L

**201807-BF/BG**  
 Gracey  
 Curette 15/16

**201807-BH/BI18**  
 Gracey  
 Curette 17/18S

**201818-101701B**  
 Kramer  
 Curette 1

**201818-101701D**  
 Kramer  
 Curette 3

**201807-1013B/CG**  
 Kramer-Nevins  
 Chisels 1 /2

## Elite Scalers and Curette

Feather weight Extra Light handles  
 Balance and equilibrated for great tactile working ability  
 USA Stainless Steel, anticorrosion  
 Maintains long sharp edges

Küretten Elite by Bontempi  
 Curettes Elite by Bontempi  
 Curette Elite by Bontempi  
 Curetas Elite by Bontempi  
 Curettes Elite by Bontempi

Runder Hohlgriff 9 mm  
 Hollow Round Handle 9 mm  
 Manico tondo vuoto 9 mm  
 Mango hueco 9 mm  
 Manche rond vide 9 mm

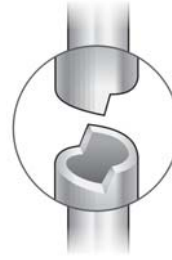

*Elite*

American made, German approved  
 Elite Scalers and Curettes  
 precision at it's best

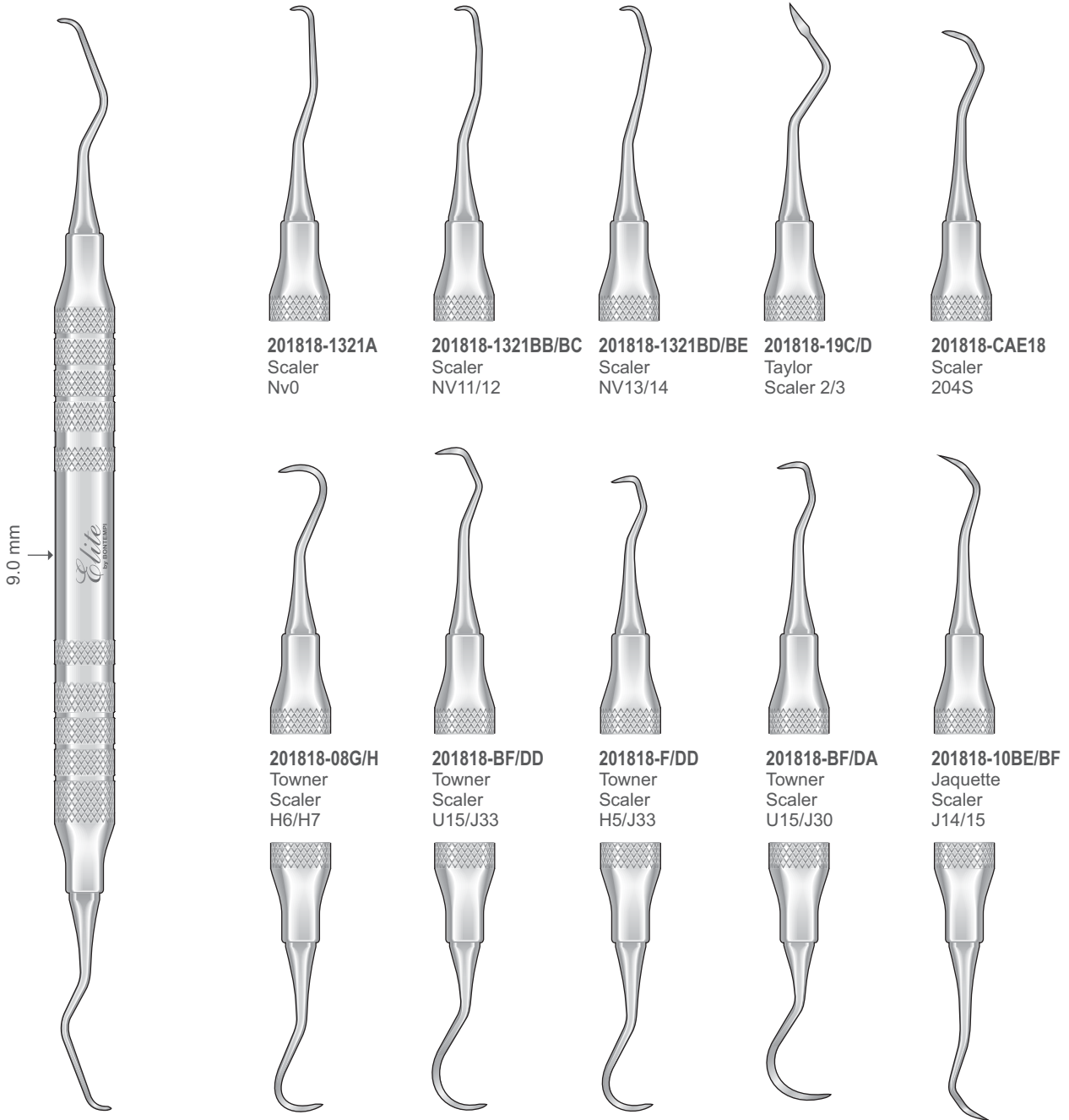

**Elite Scalers and Curette**

Feather weight Extra Light handles  
 Balance and equilibrated for great tactile working ability  
 USA Stainless Steel, anticorrosion  
 Maintains long sharp edges

# Elite

American made, German approved  
 Elite Scalers and Curettes  
 precision at it's best



Runder Hohlgriff 9 mm  
 Hollow Round Handle 9 mm  
 Manico tondo vuoto 9 mm  
 Mango hueco 9 mm  
 Manche rond vide 9 mm

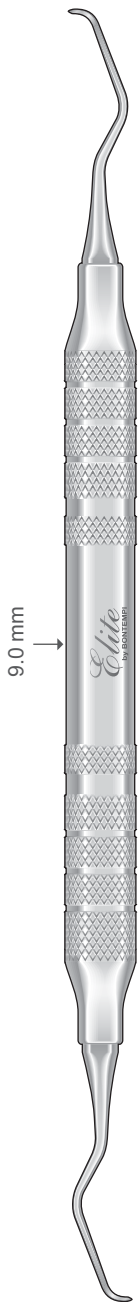

**201818-1203BB/BC**  
 McCall  
 Scaler 11/12



**201818-1203BD/BE**  
 McCall  
 Curette 13/14



**201818-1203BD/BE18**  
 McCall  
 Curette 13S/14S



**201818-1203BH/BI18**  
 McCall  
 Curette 17S/18S



**201803-C1711**  
 Columbia  
 Curette 2RL



**201803-E1711**  
 Columbia  
 Curette 4RL



**201803-BD/BE**  
 Columbia  
 Curette 13/14



**201818-F/G110113**  
 Langer  
 Curette 5/6

## Elite Scalers and Curette

Feather weight Extra Light handles  
 Balance and equilibrated for great tactile working ability  
 USA Stainless Steel, anticorrosion  
 Maintains long sharp edges



Universal Küretten  
 Universal Curettes  
 Curette universali  
 Curetas universales  
 Curettes universelles

Parodontalfeilen  
 Periodontal Files  
 Lime parodontali  
 Limas parodontales  
 Limes parodontales

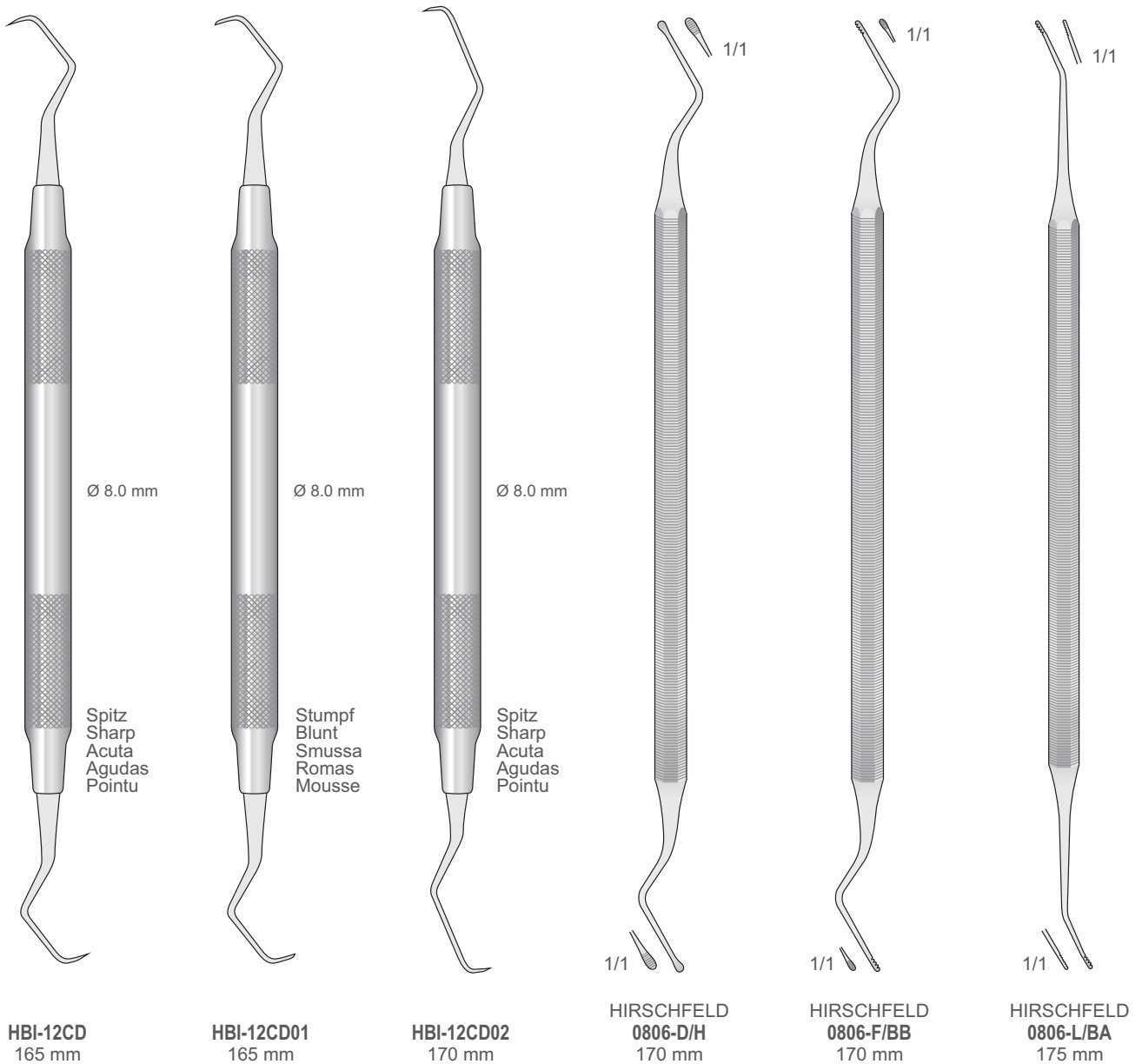



Scalers

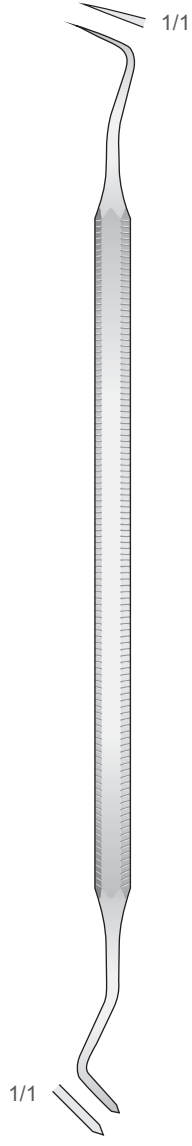

LANGE  
1506-L  
160 mm

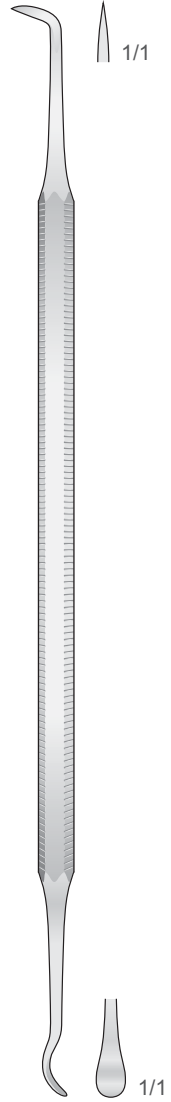

MITCHEL  
0119-BC  
170 mm



0119-B



0119-C17



0119-C11



0119-G



Amalgampistole für retrograde  
 Amalgam gun for retrograde  
 Siringhe portamalgame retrogradi  
 Portaamalgame para retrógradas  
 Porte-amalgame pour rétrogrades

Nach oben Gebogen - Curved up  
 Curva in avanti - Curvas hacia arriba  
 Courbes vers le haut  
 Ø 0,9 mm

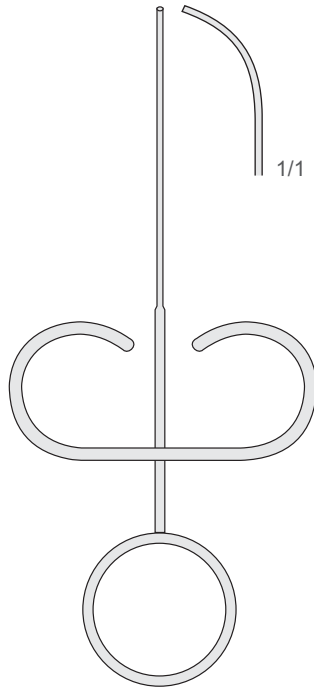

**1818-FB**  
 130 mm

Seitwärts Gebogen - Curved to side  
 Curva sul lato - Curvas laterales  
 Courbes latérales  
 Ø 0,9 mm

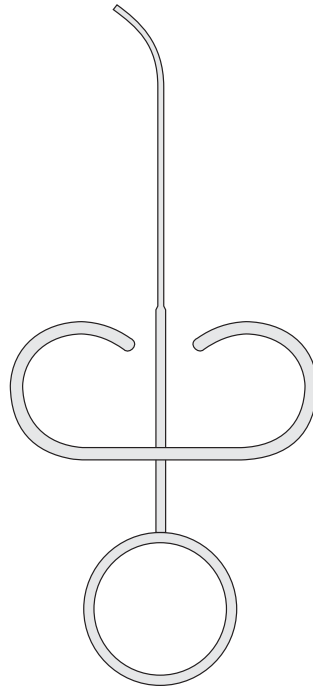

**1818-FF**  
 130 mm

Gerade - Straight  
 Diritta - Rectas  
 Droites  
 Ø 1,2 mm

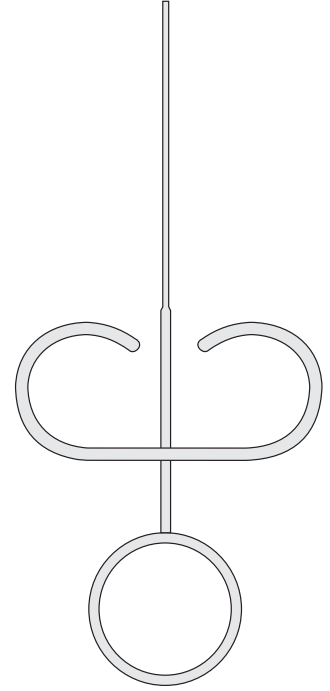

**1818-FE**  
 130 mm

Seitwärts Gebogen - Curved to side  
 Curva sul lato - Curvas laterales  
 Courbes latérales  
 Ø 1,2 mm

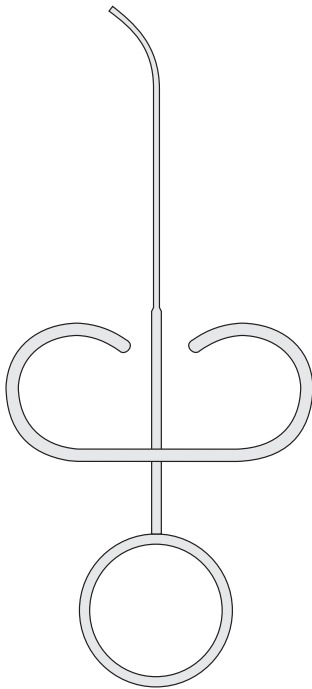

**1818-FG**  
 130 mm

Nach oben Gebogen - Curved up  
 Curva in avanti - Curvas hacia arriba  
 Courbes vers le haut  
 Ø 1,2 mm

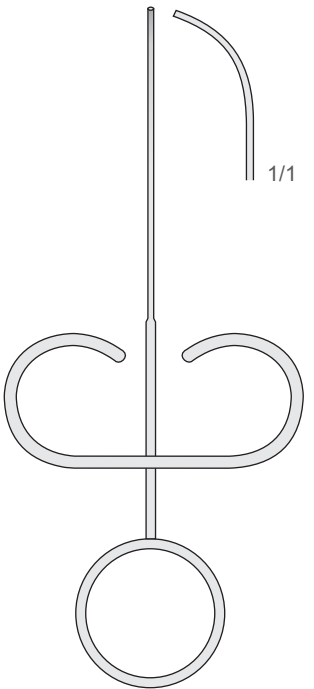

**1818-FI**  
 130 mm

Seitwärts Gebogen - Curved to side  
 Curva sul lato - Curvas laterales  
 Courbes latérales  
 Ø 1,8 mm

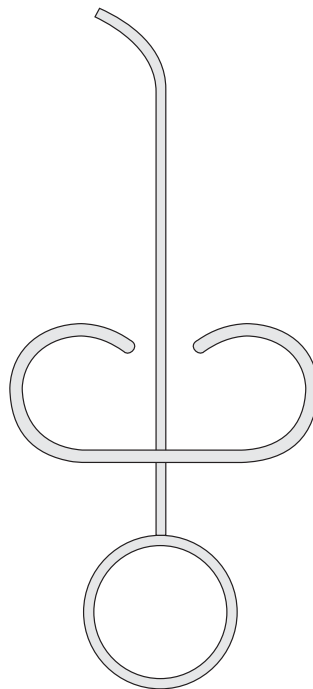

**1818-FA**  
 130 mm

Nach oben Gebogen - Curved up  
 Curva in avanti - Curvas hacia arriba  
 Courbes vers le haut  
 Ø 1,8 mm

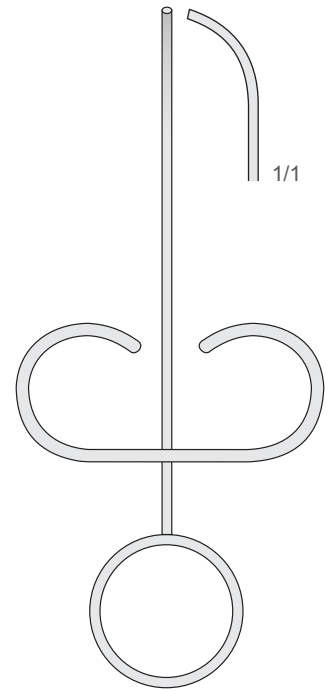

**1818-FC**  
 130 mm

Amalgambecher  
Amalgam well  
Mortajo per amalgama  
Vaso para amalgama  
Gobelet pour amalgame



Rostfrei  
Stainless Steel  
Acciaio inossidabile  
Acero inoxidable  
Acier Inoxydable

**1818-GF**  
Ø 35 mm  
h. 35 mm

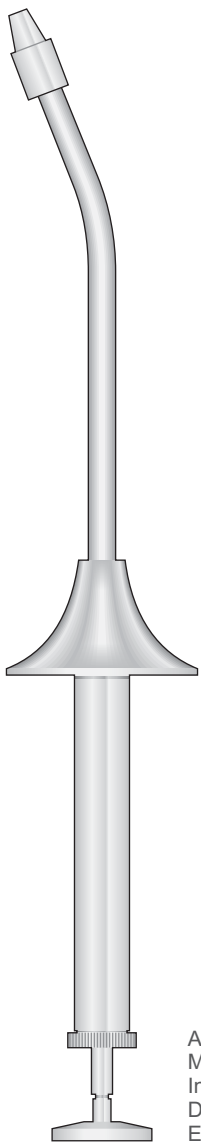

Aus Metall  
Metal tip  
In metallo  
De metal  
En métal

**1818-BF**

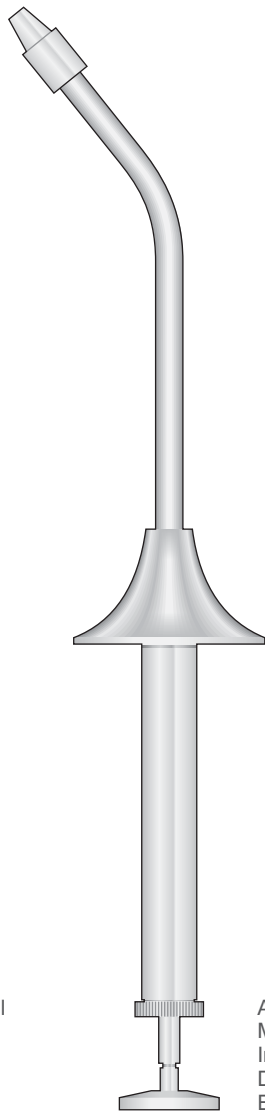

Aus Metall  
Metal tip  
In metallo  
De metal  
En métal

**1818-BG**

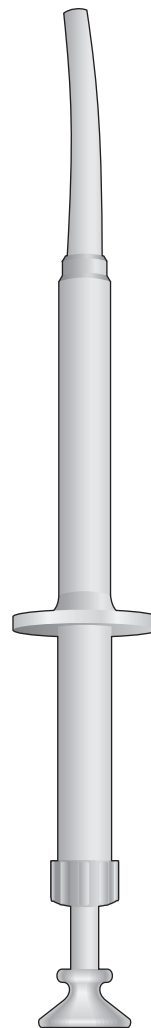

Autoclavable  
Aus Kunststoff  
Plastic tip  
In plastica  
De plàstic  
En plastique

**1818-EB**  
170 mm

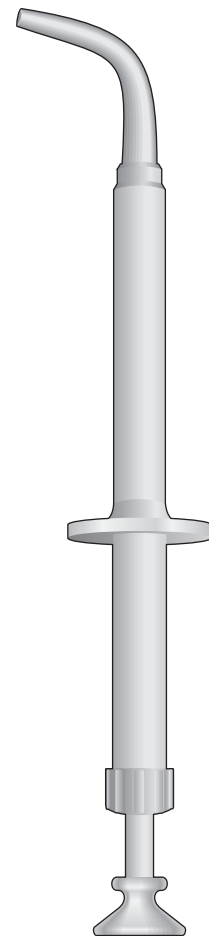

Autoclavable  
Aus Kunststoff  
Plastic tip  
In plastica  
De plàstic  
En plastique

**1818-EC**  
160 mm





Titanbeschichtet  
 Titanium-coated  
 Ricoperto in Titanio  
 Con revestimiento de titanio  
 Recouvert de Titane

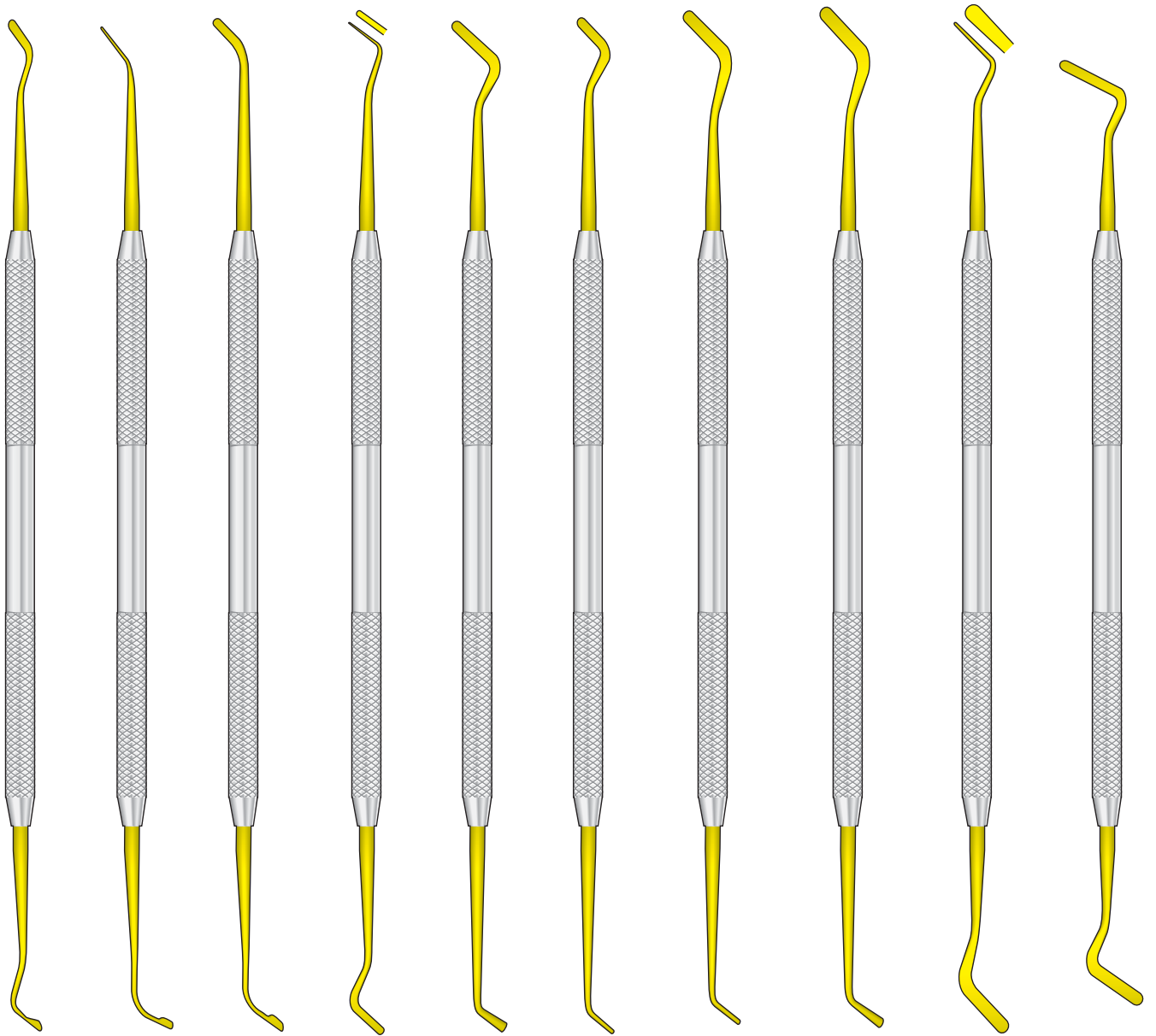

FELT  
1419-B

FELT  
1419-C

FELT  
1419-D

FELT  
1419-E

FELT  
1419-F

FELT  
1419-G

GOLDSTEIN  
1419-H

GOLDSTEIN  
1419-I

GOLDSTEIN  
1419-L

GOLDSTEIN  
1419-BA



Titanbeschichtet  
Titanium-coated  
Ricoperto in Titanio  
Con revestimiento de titanio  
Recouvert de Titane

1,5 mm



1419-BB

2,0 mm



1419-BC

2,0 mm



1419-BD

2,5 mm



1419-BE



1419-BF



1419-BG

0,7 mm

1,0 mm

2,0 mm

2,5 mm



Kompositinstrumente  
 Composite Instruments  
 Strumenti per composito  
 Instrumentos para composites  
 Instruments pour composites

Alu  
 Aluminium  
 Alluminio  
 Aluminio  
 Aluminium



FELT  
0605-B

FELT  
0605-C

FELT  
0605-D

FELT  
0605-E

FELT  
0605-F

FELT  
0605-G

FELT  
0605-E/F

GOLDSTEIN  
0714-B

GOLDSTEIN  
0714-C

GOLDSTEIN  
0714-D

GOLDSTEIN  
0714-E



Zementspatel  
Cement Spatulas  
Spatole per cemento  
Espátulas para cemento  
Spatules à ciment

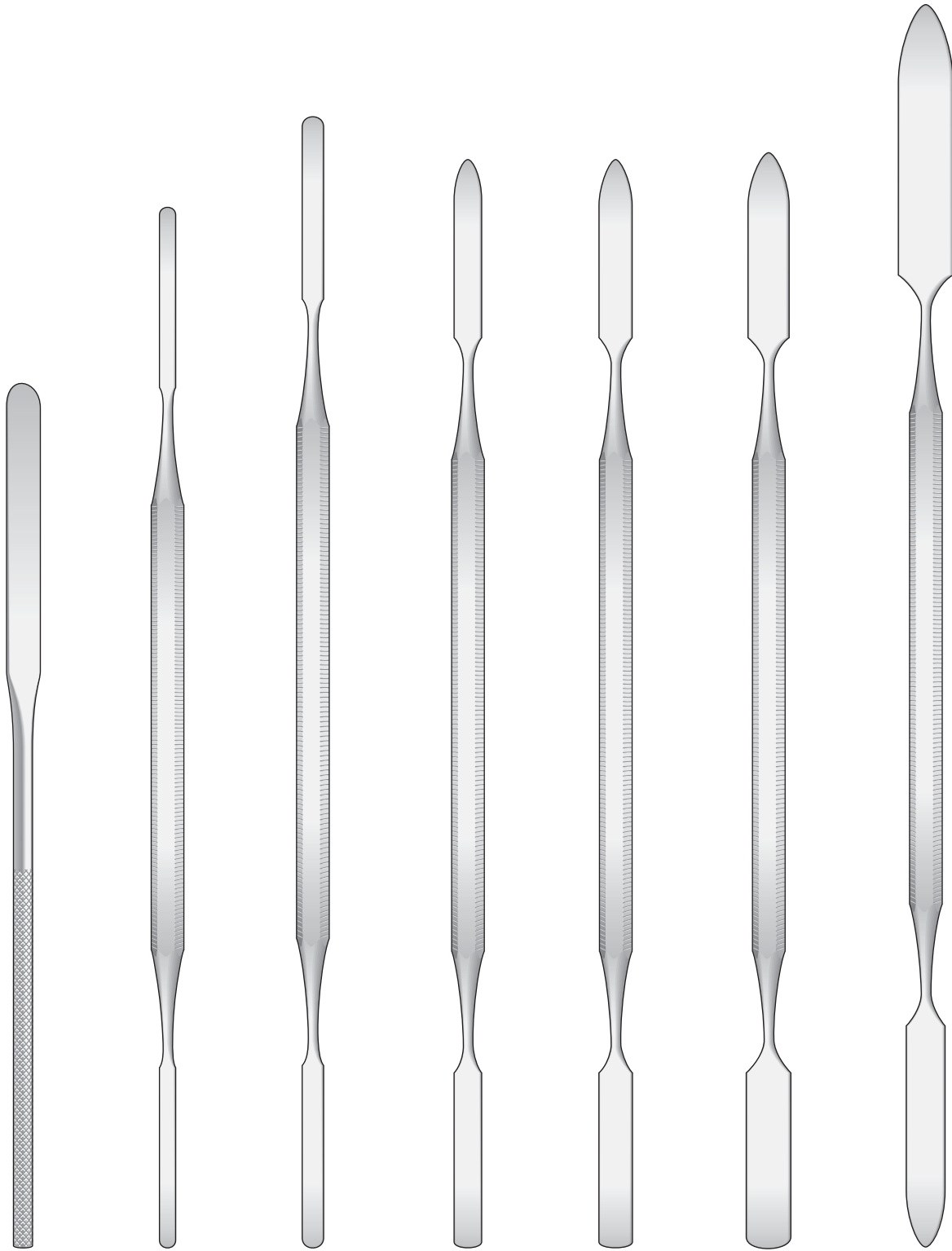

1817

18-AA

18-A

18-B

18-C

18-D

18-E



Heidemann-Spateln  
 Heidemann Spatulas  
 Spatole Heidemann  
 Espátulas Heidemann  
 Spatules Heidemann

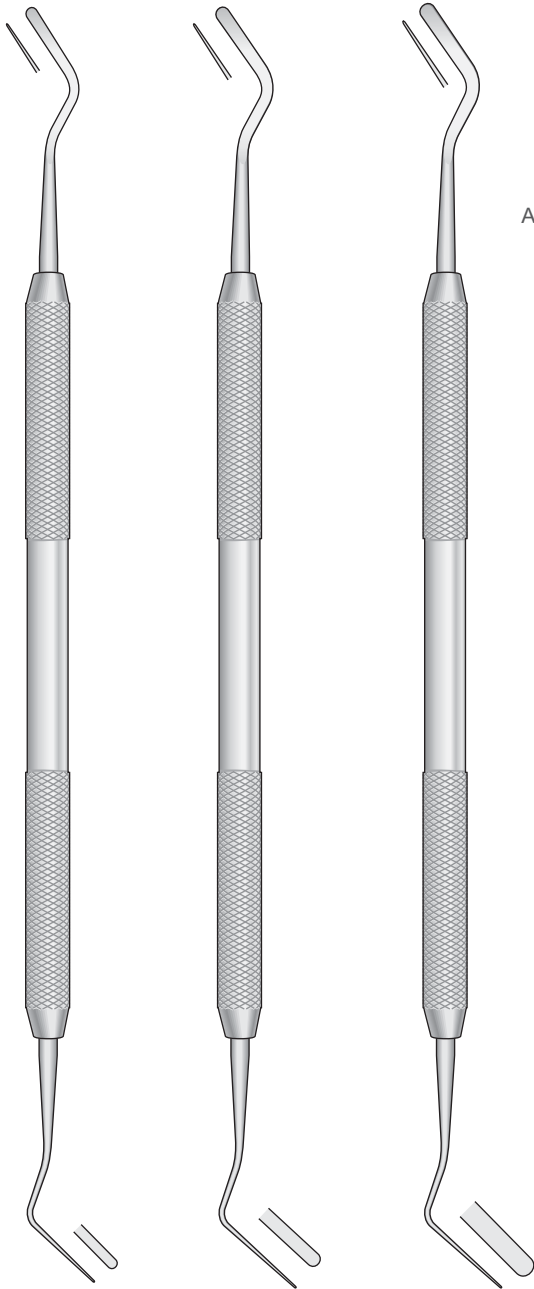

08-B

08-C

08-D

01-B

Dycal Applikator  
 Placement Instrument  
 Applicatore per sottofondo  
 Aplicadores de fondo  
 de cavidades  
 Applicateur de fond  
 de cavité

Instrumente zum modellieren von Füllungen  
 Amalgam Carvers

Strumenti per modellare e rifinire otturazioni  
 Instrumentos para modelar las obturaciones  
 Instruments à modeler les obturations

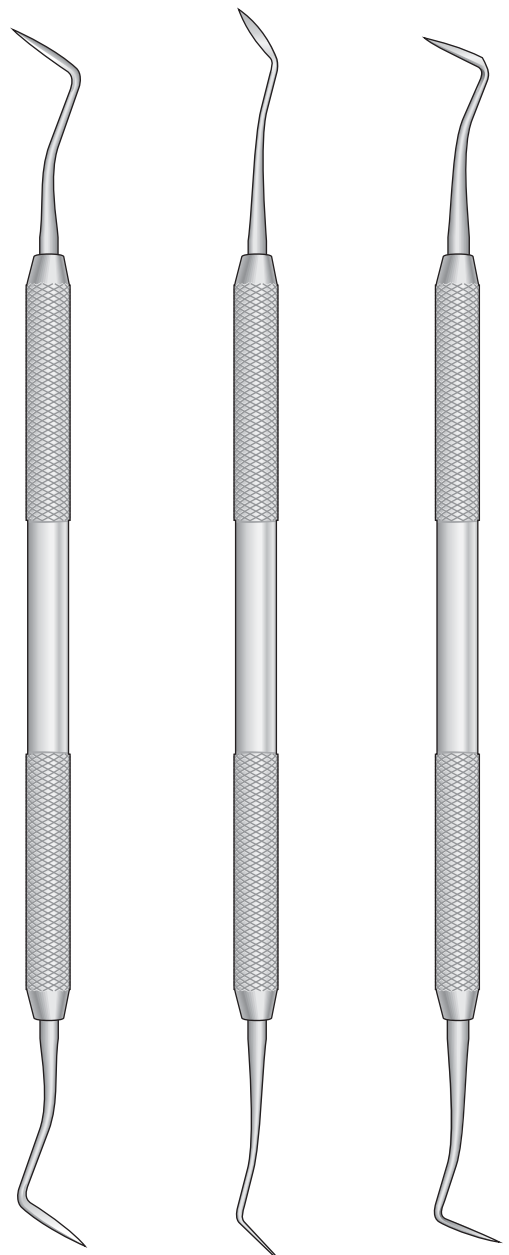

17-B

17-C

17-D

Instrumente zum Modellieren von Füllungen  
 Amalgam carvers  
 Strumenti per modellare e rifinire otturazioni  
 Instrumentos para modelar las obturaciones  
 Instruments à modeler les obturations

Instrument für Drahrückzug  
 Instrument for Retractor wire  
 Strumento per filo retrattore  
 Instrumento para hilo retractor  
 Instruments pour fil rétracteur

Cleoids - Discoids

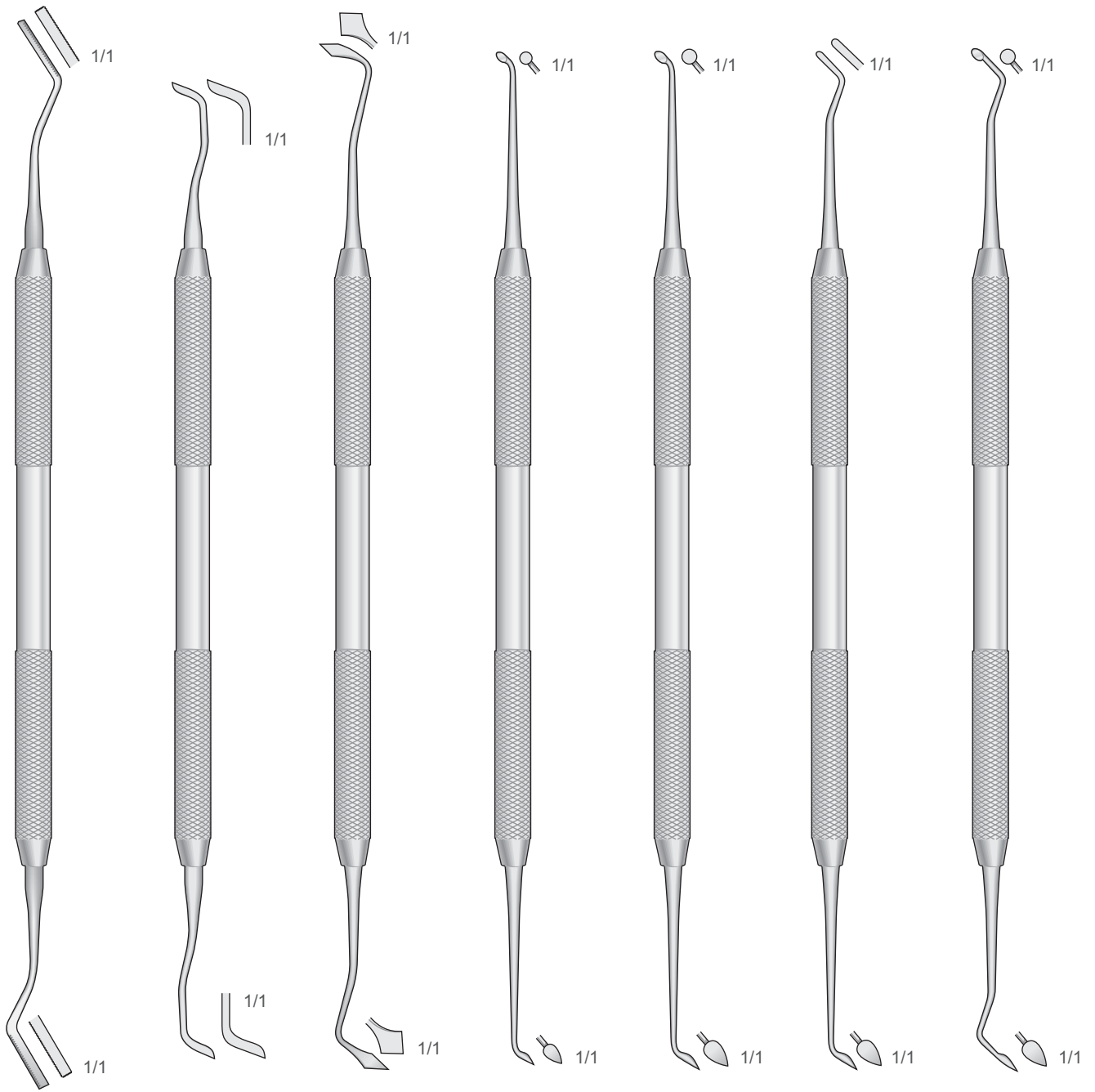

0321-BB

201803-C  
USC

06-C/D  
FRAHM

0304-B

0304-C

0304-D

0304-E

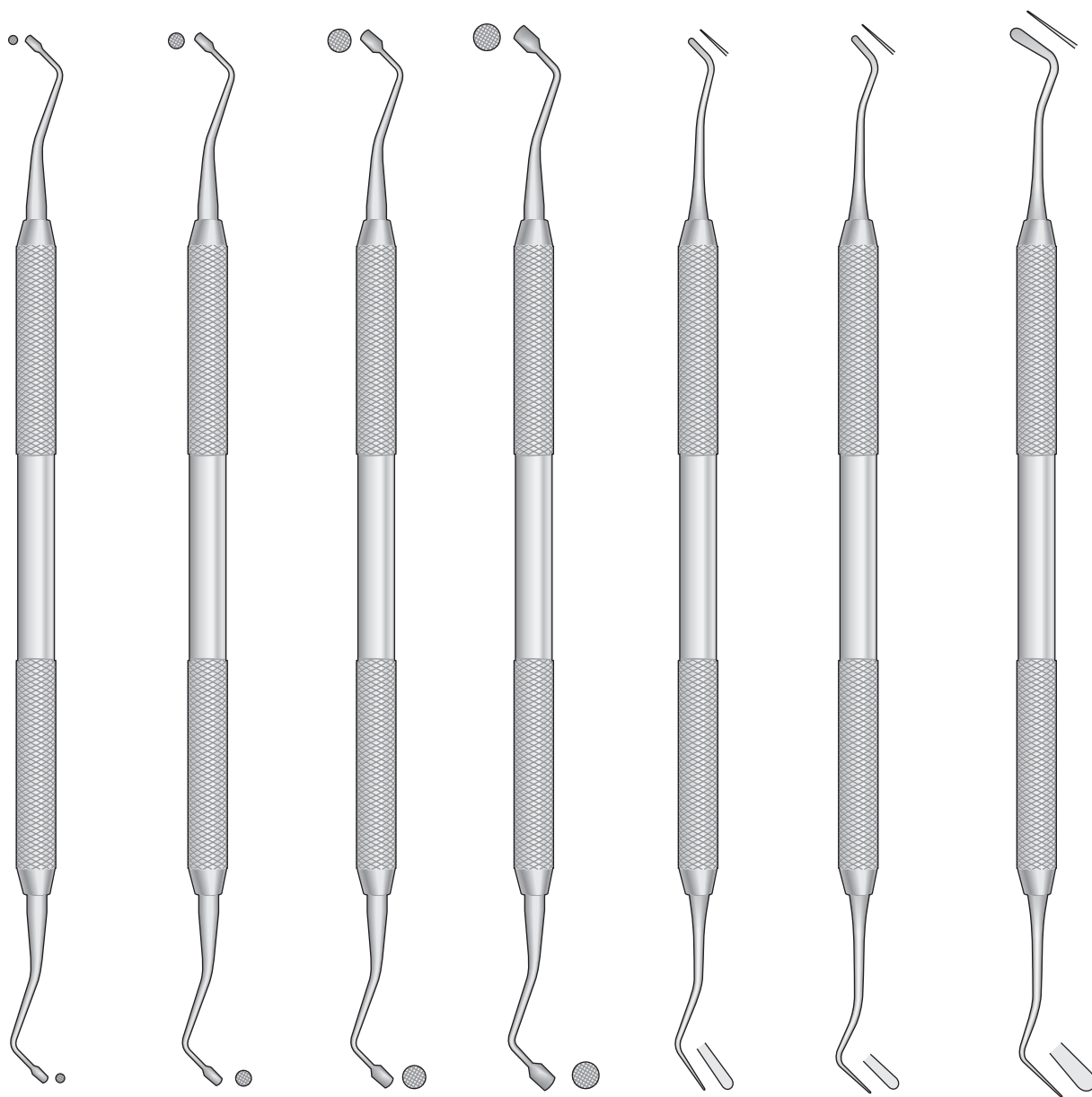

14-B

14-C

14-D

14-E

1410-B

1410-C

1410-D



Gerieft  
Serrated  
Zigrinati  
Estríados  
Striée

Glatt  
Smooth  
Lisci  
Lisos  
Lissée

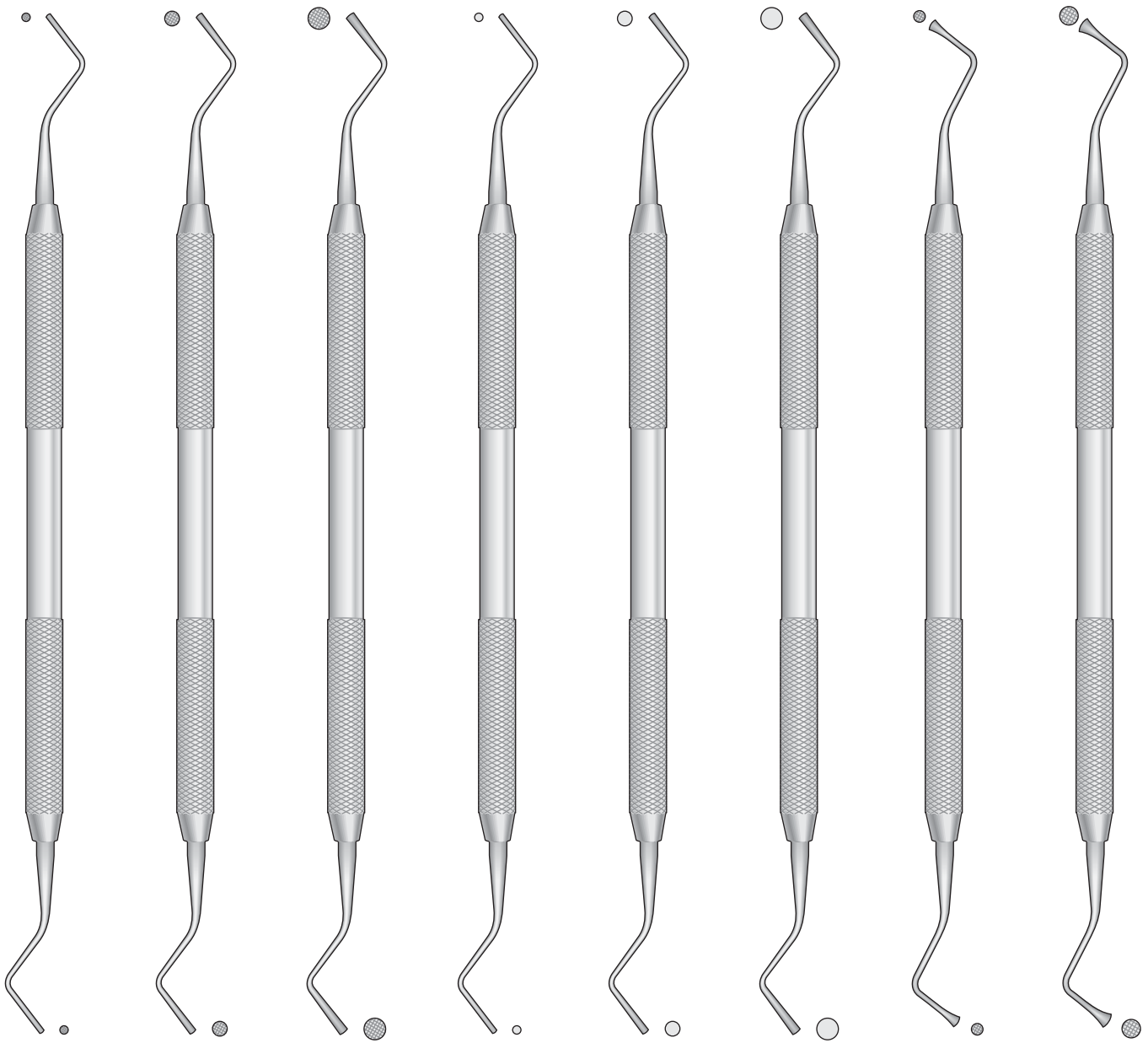

1425-B

1425-C

1425-D

1411-B

1411-C

1411-D

WARD  
1403-B

WARD  
1403-C



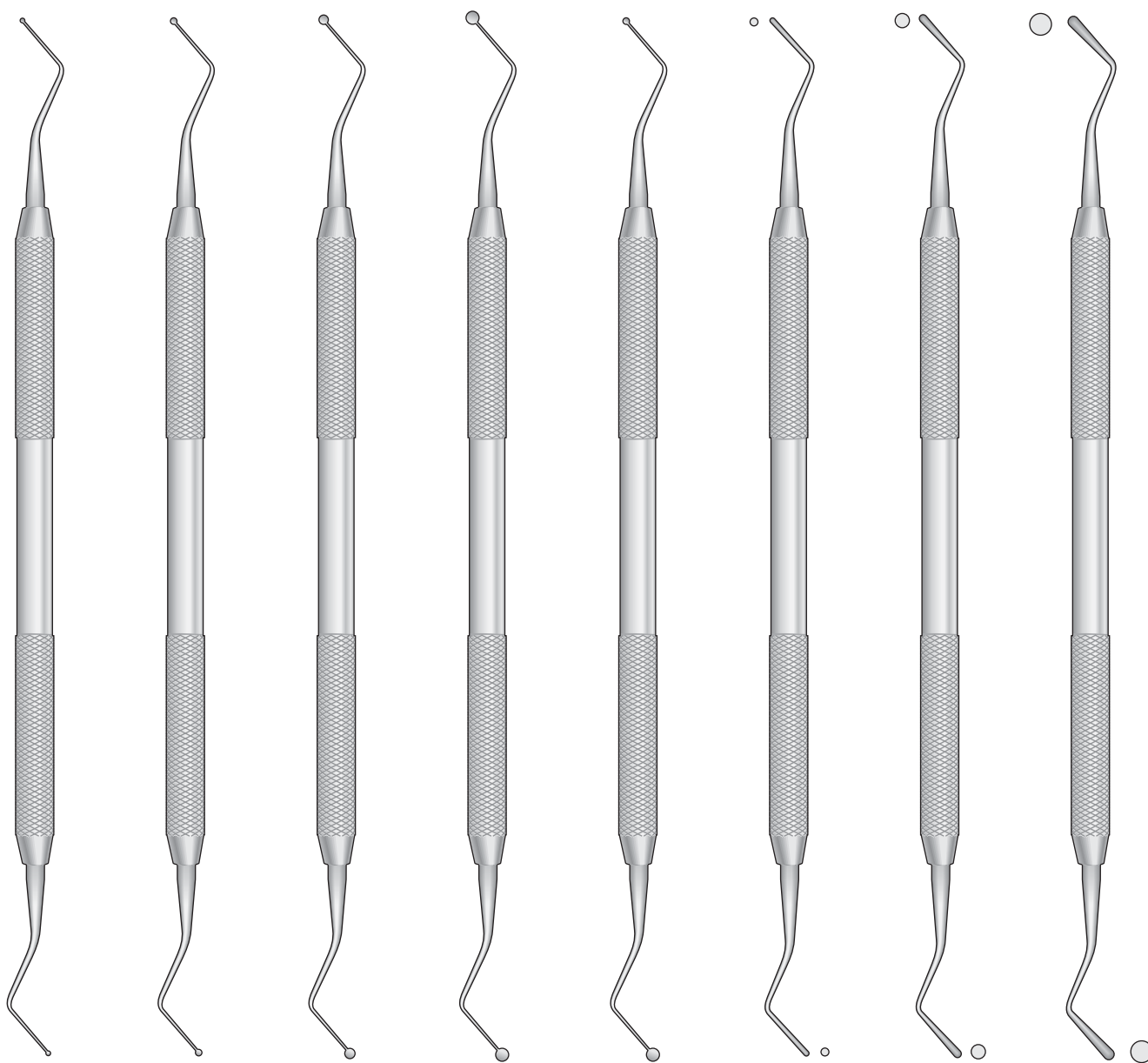

1415-B

1415-C

1415-D

1415-E

1415-F

1401-B

1401-C

1401-D

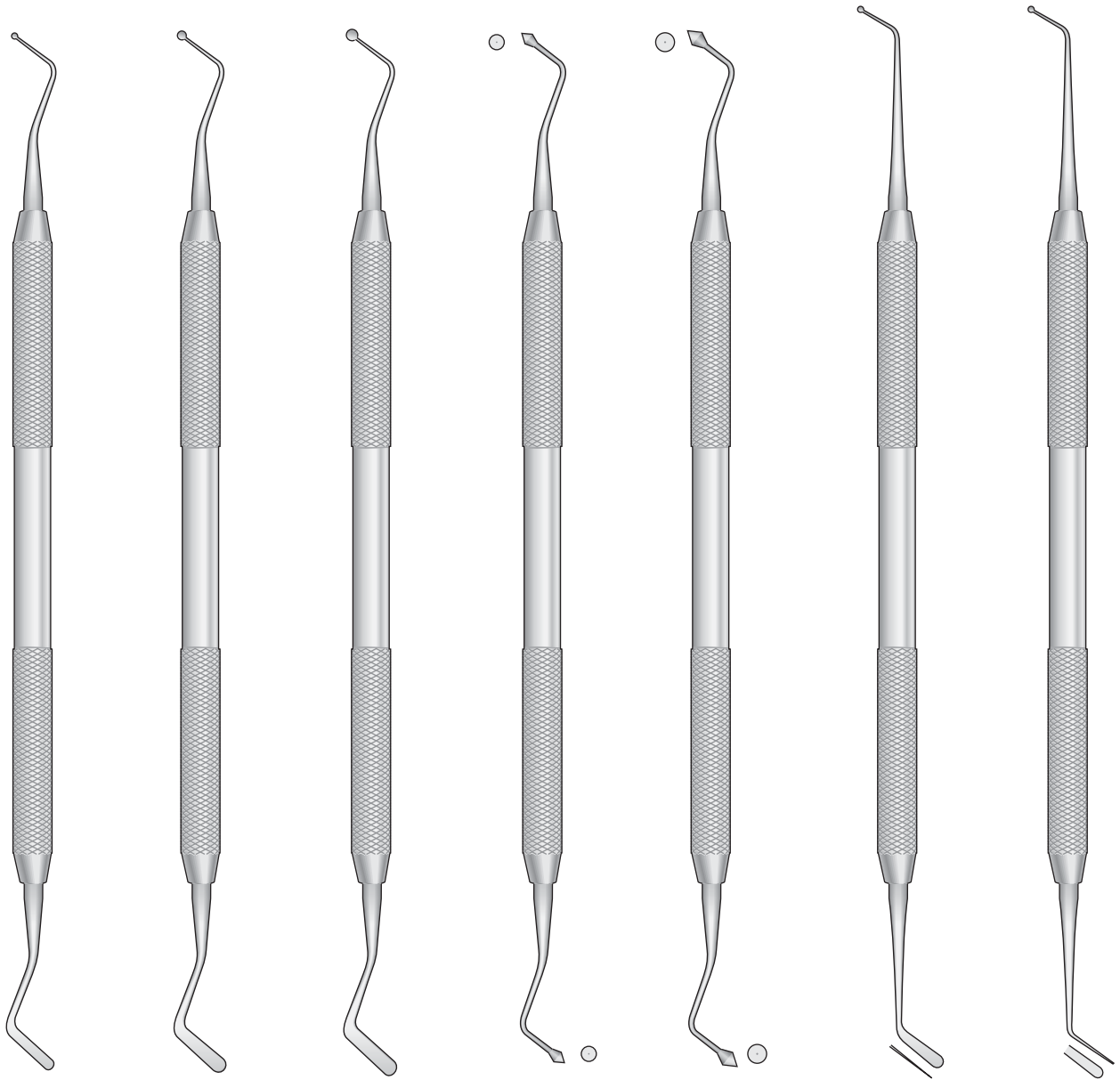

1423-B

1423-C

1423-D

WESTCOTT  
1418-B

WESTCOTT  
1418-C

1412-C

1413-B

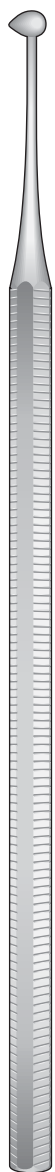

WHITE  
02-D



WHITE  
02-E

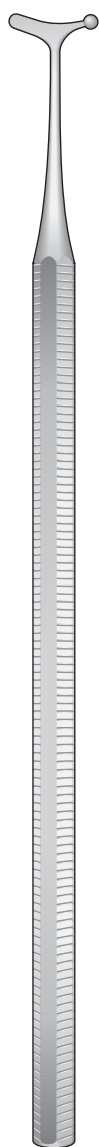

WHITE  
02-DC

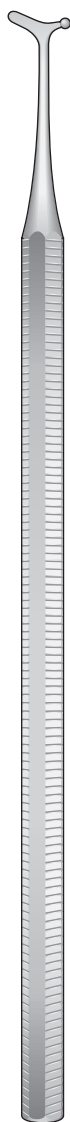

WHITE  
02-DD

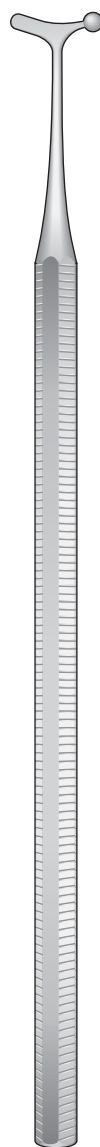

WHITE  
02-DE



WHITE  
02-CI/CL  
Double

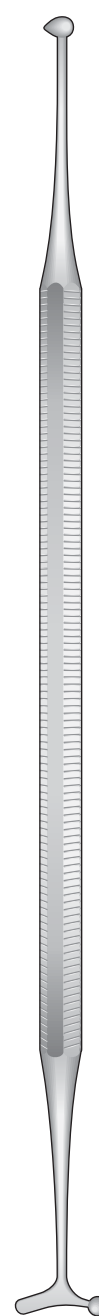

WHITE  
02-DB/DC  
Double

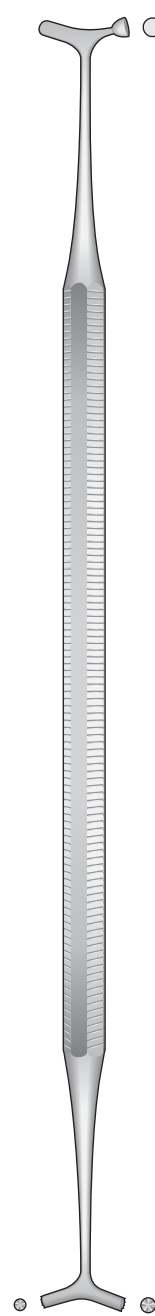

BENNET  
02-DF  
170 mm



**MARKLEY PLUGGERS**

Amalgam Instrumente  
Amalgam Instruments  
Strumenti per amalgama  
Instrumentos para amalgama  
Instruments à amalgame

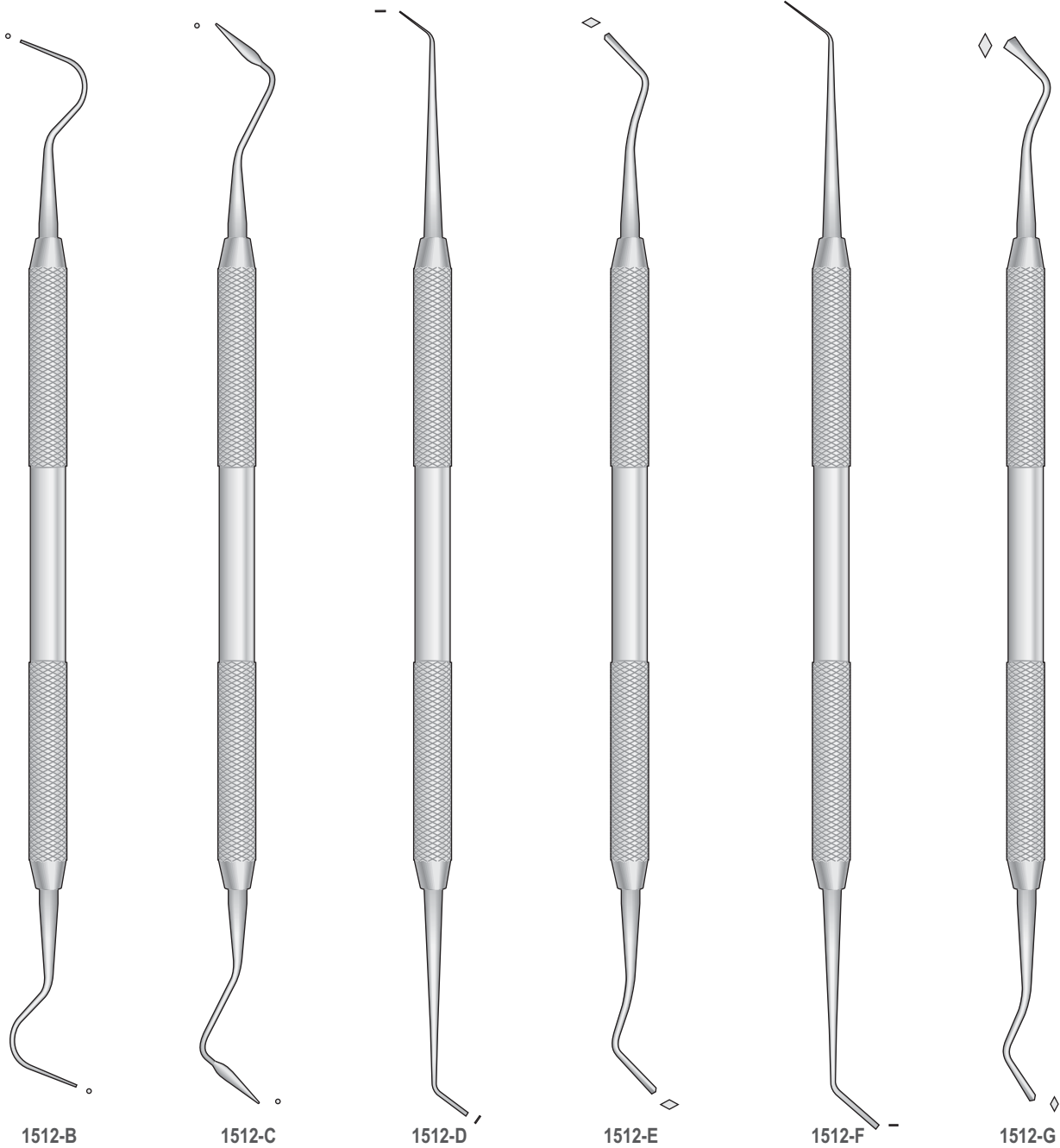

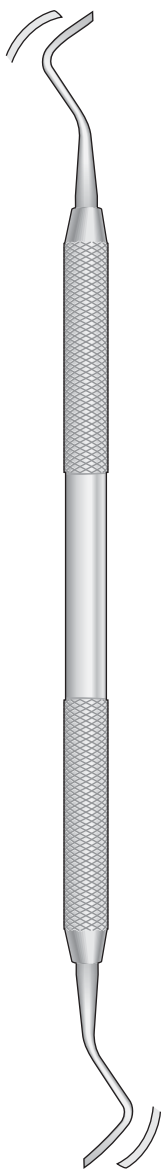

BLACK  
1918-B

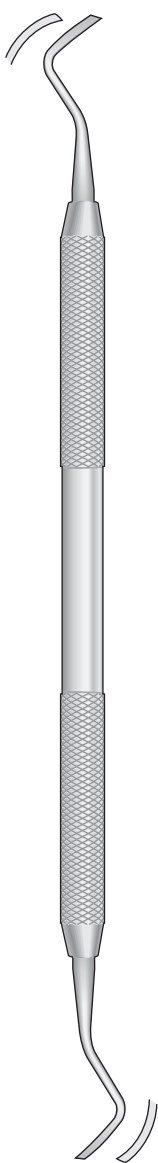

BLACK  
1918-C



BLACK  
1918-D

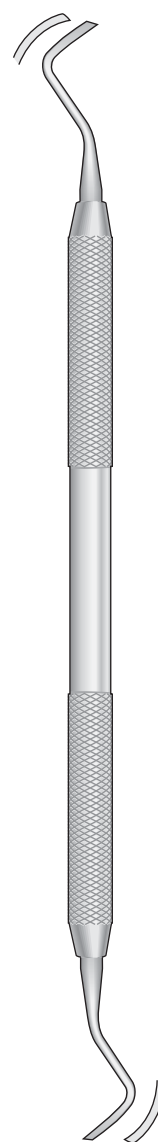

BLACK  
1918-E

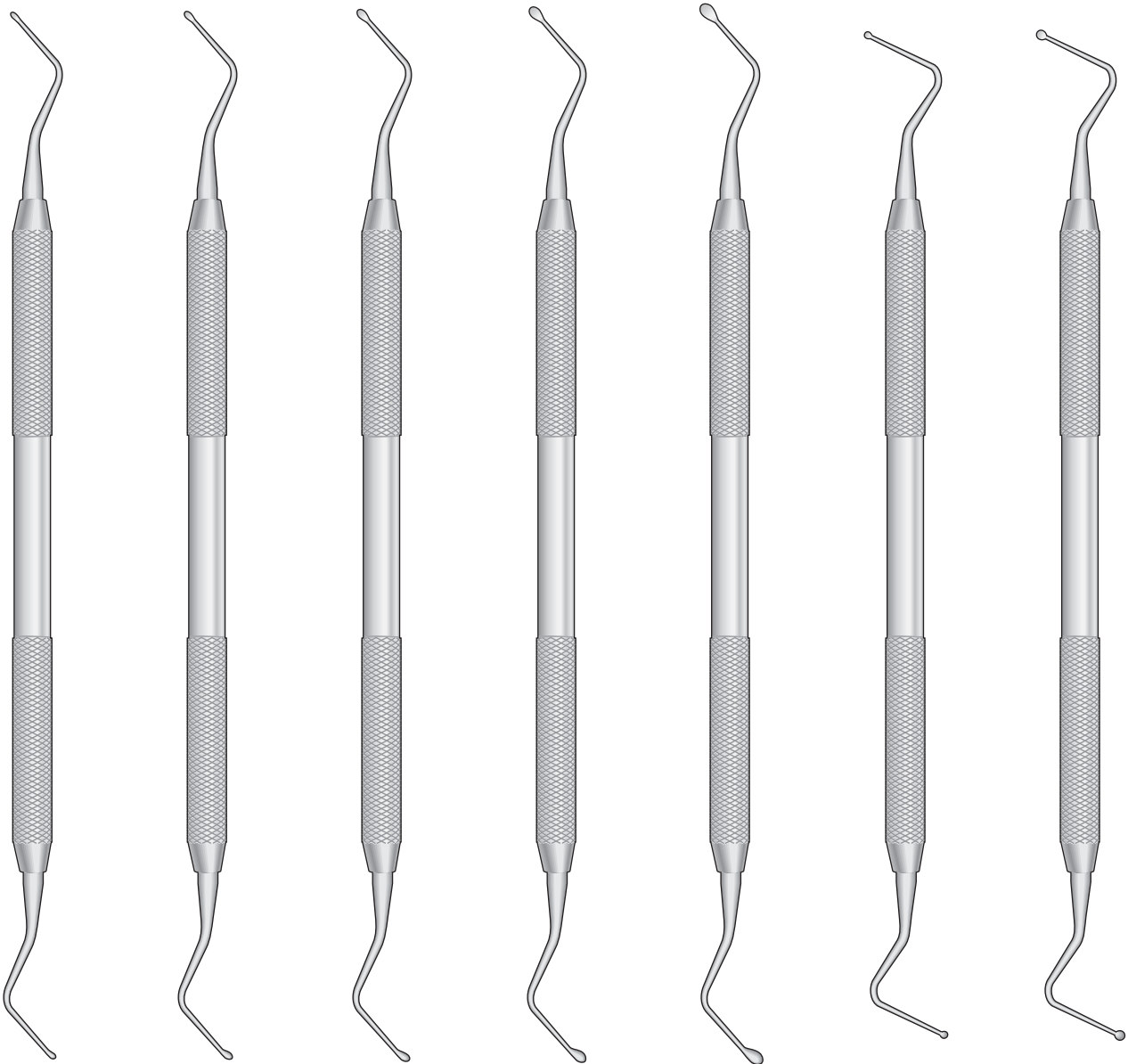

05-A

05-B

05-C

05-D

05-E

0503-B

0503-C

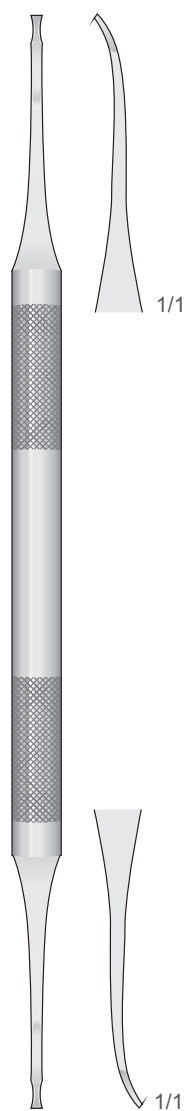

**FEDI  
1406-B**  
175 mm

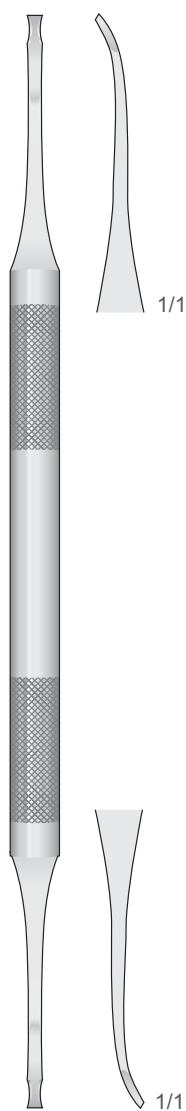

**FEDI  
1406-C**  
175 mm



**FEDI  
1406-D**  
170 mm

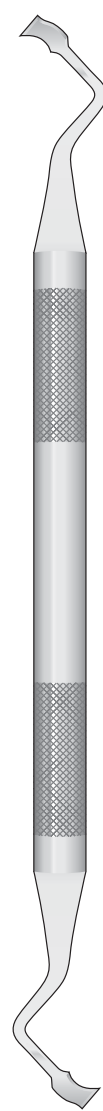

**OCHSENBEIN  
141802-E01**  
170 mm



**141802-E**  
170 mm



Bevel IN

Bevel OUT



OCHSENBEIN-3  
HBI-BAD

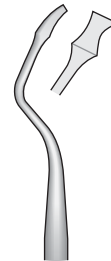

OCHSENBEIN-4  
HBI-BAE



RHODES BACK ACTION  
HBI-BAH



OCHSENBEIN-1  
141802-B  
165 mm

OCHSENBEIN-2  
141802-C  
165 mm

TG CHISELS  
HBI-BBD



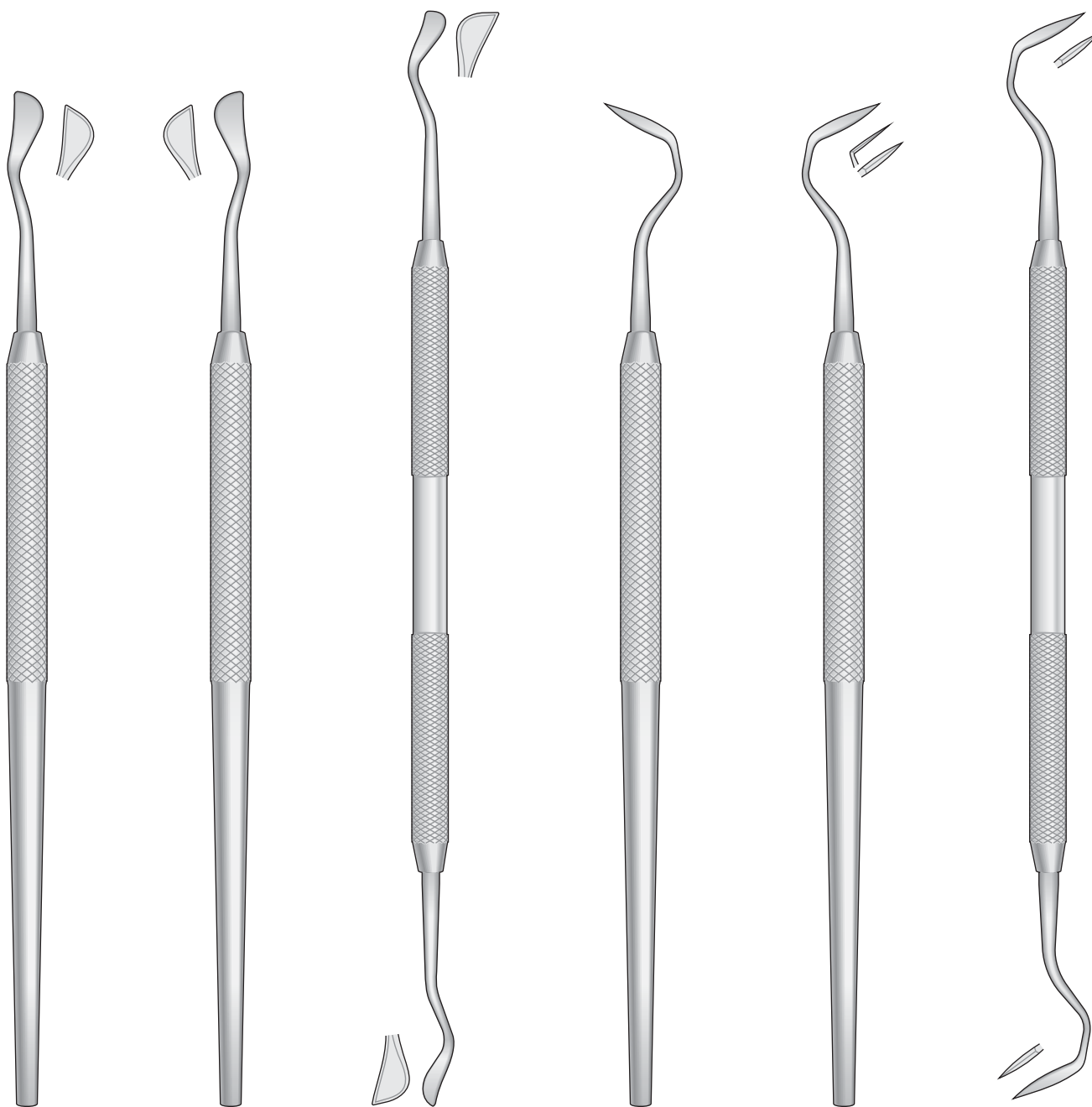

KIRKLAND  
101004-B

KIRKLAND  
101004-C

KIRKLAND  
101004-E

ORBAN  
140213-B

ORBAN  
140213-C

ORBAN  
140213-E



Runder Hohlgriff 8 mm  
 Hollow Round Handle 8 mm  
 Manico tondo vuoto 8 mm  
 Mango hueco 8 mm  
 Manche rond vide 8 mm

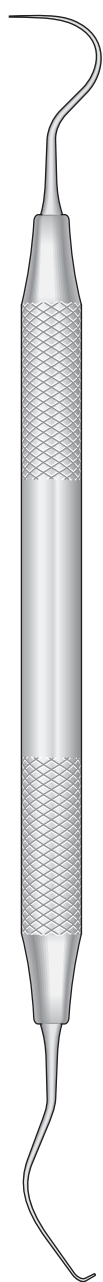

HAH-CD04B

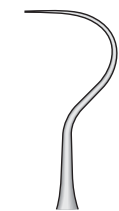

HAH-CD04C



HAH-BG04B



HAH-BG04C



HAH-2019B



HAH-CAC

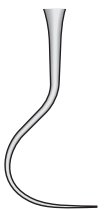

HAH-CAC01



HAH-CAD



HAH-G04B



HAH-G04C



HAH-G04D



Parodontometer Doppelseitig  
 Periodontal probes double-ended  
 Sonde parodontali doppie  
 Sondas parodontales dobles  
 Sondes parontales doubles

Runder Hohlgriff 8 mm  
 Hollow Round Handle 8 mm  
 Manico tondo vuoto 8 mm  
 Mango hueco 8 mm  
 Manche rond vide 8 mm

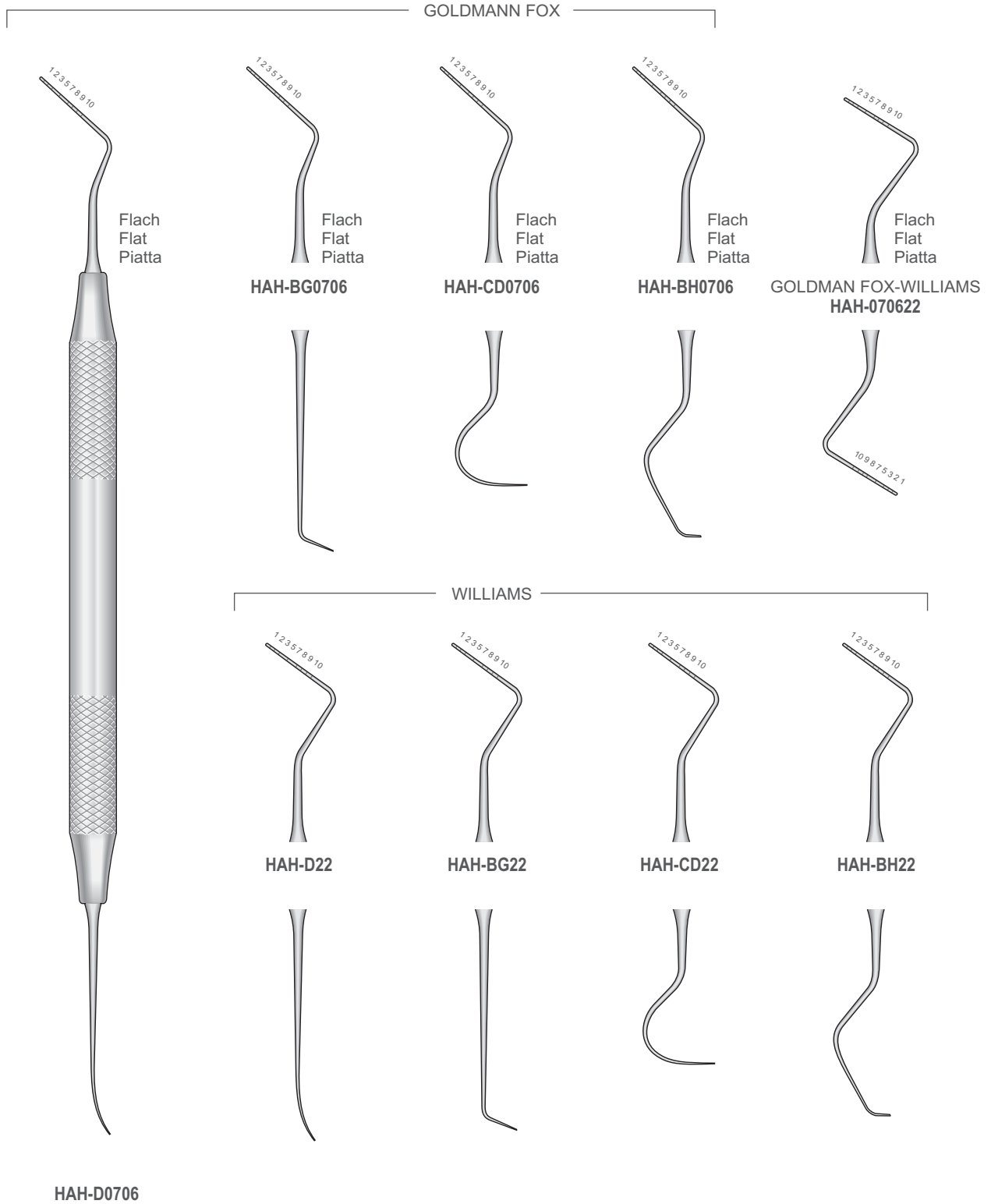
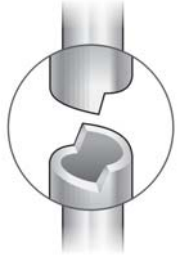



Runder Hohlgriff 8 mm  
 Hollow Round Handle 8 mm  
 Manico tondo vuoto 8 mm  
 Mango hueco 8 mm  
 Manche rond vide 8 mm

UNIVERSITY OF MICHIGAN

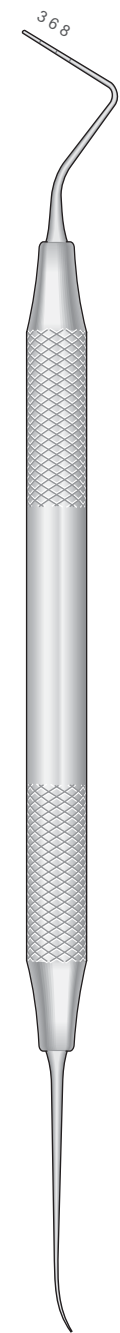

HAH-D2012

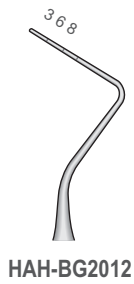

HAH-BG2012

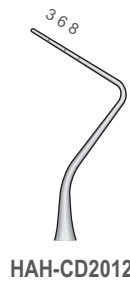

HAH-CD2012

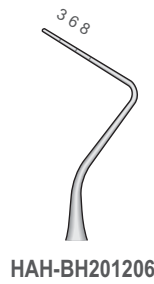

HAH-BH201206



NABERS  
HAH-B13

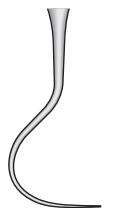

NABERS  
HAH-C13

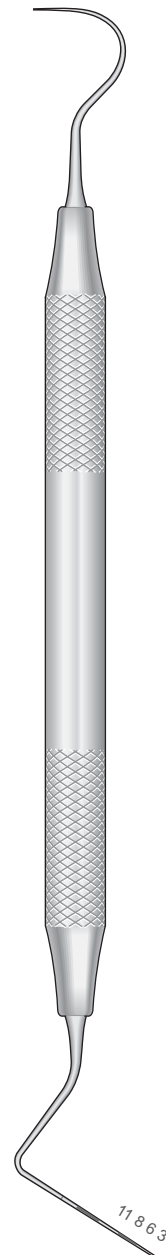

HAH-CDBB

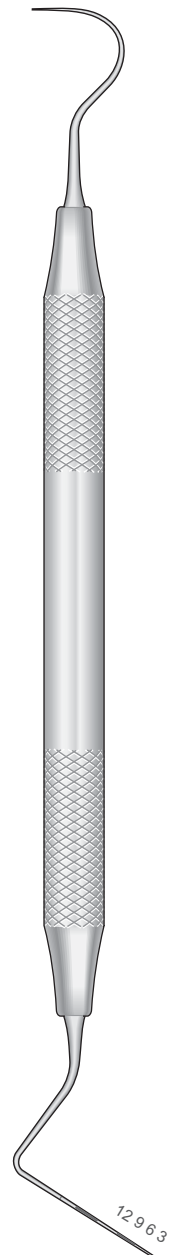

HAH-CDBC

Spateln - Füllungsinstrumente  
 Spatulas - Filling Instruments  
 Spatole - Otturatori  
 Espatulas - Instrumentos para obturaciones  
 Spatules - Instruments pour obturations

Runder Hohlgriff 8 mm  
 Hollow Round Handle 8 mm  
 Manico tondo vuoto 8 mm  
 Mango hueco 8 mm  
 Manche rond vide 8 mm

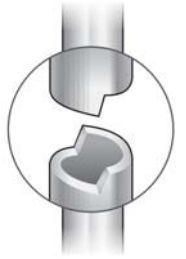

Heidemann Spateln  
 Heidemann Spatulas  
 Spatole Heidemann  
 Espatulas Heidemann  
 Spatules Heidemann

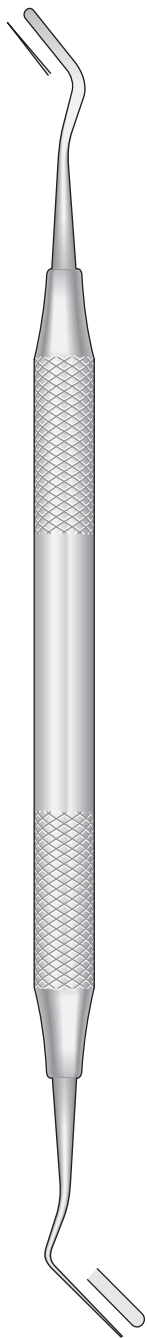

HEIDEMANN  
HBB-DAB

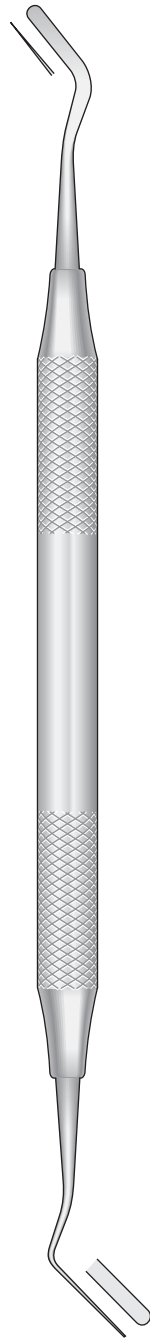

HEIDEMANN  
HBB-DAC

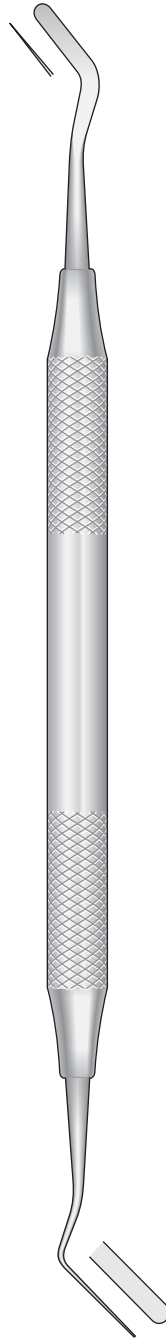

HEIDEMANN  
HBB-DAD

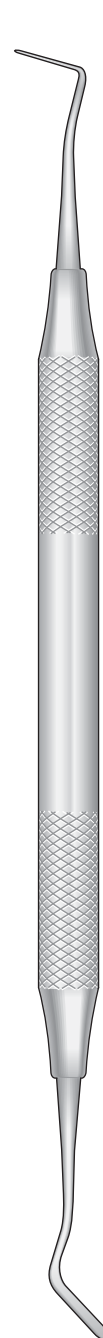

IPC  
HBF-DBB  
Interproximal

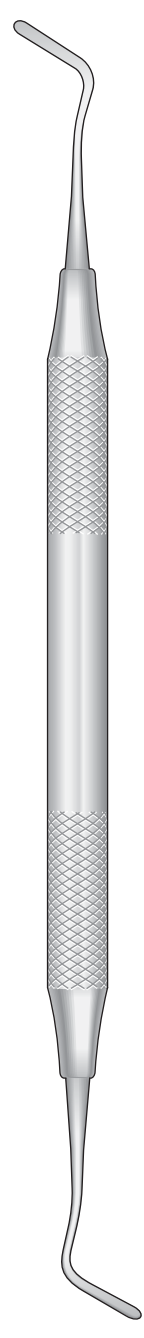

IPC/OA  
HBF-DBC  
Interproximal Off-Angle



Runder Hohlgriff 8 mm  
Hollow Round Handle 8 mm  
Manico tondo vuoto 8 mm  
Mango hueco 8 mm  
Manche rond vide 8 mm



HBC-BAB

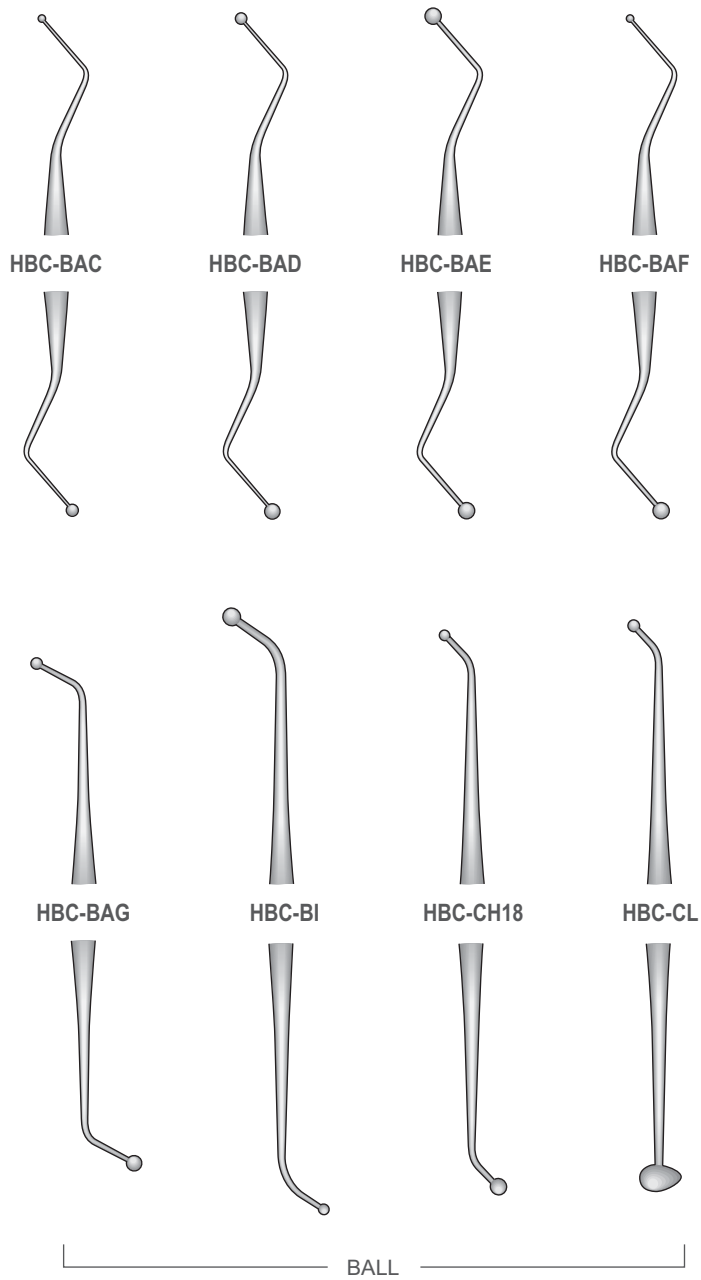



Runder Hohlgriff 8 mm  
Hollow Round Handle 8 mm  
Manico tondo vuoto 8 mm  
Mango hueco 8 mm  
Manche rond vide 8 mm

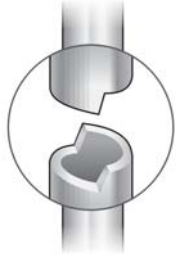

Glatt - Smooth  
Lisci - Lisos  
Lissée

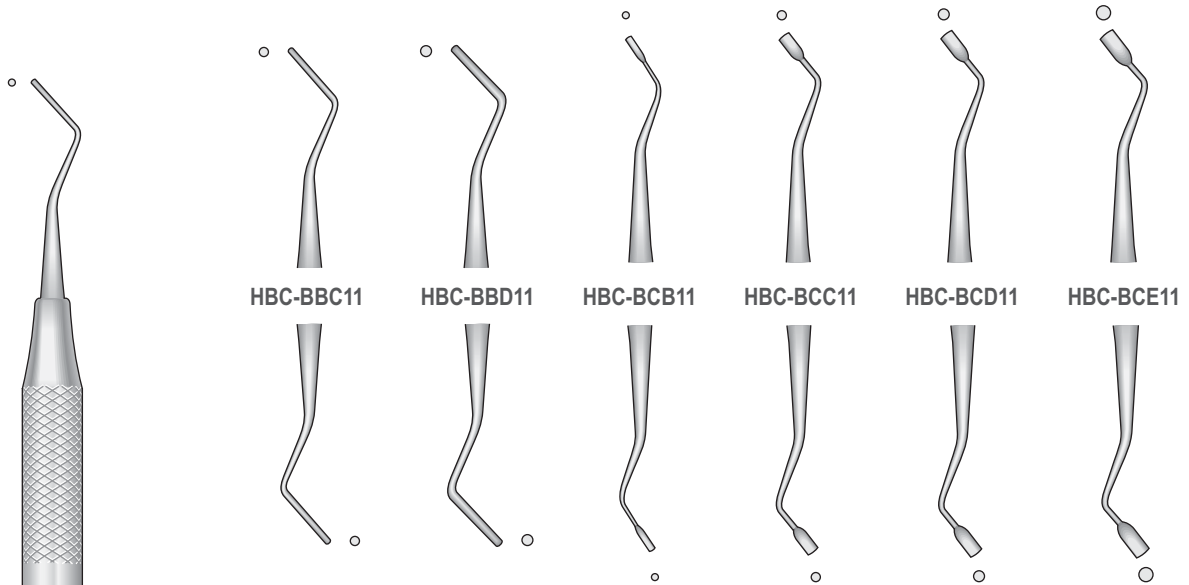

Gerieft - Serrated  
Zigrinati - Estriados  
Striés

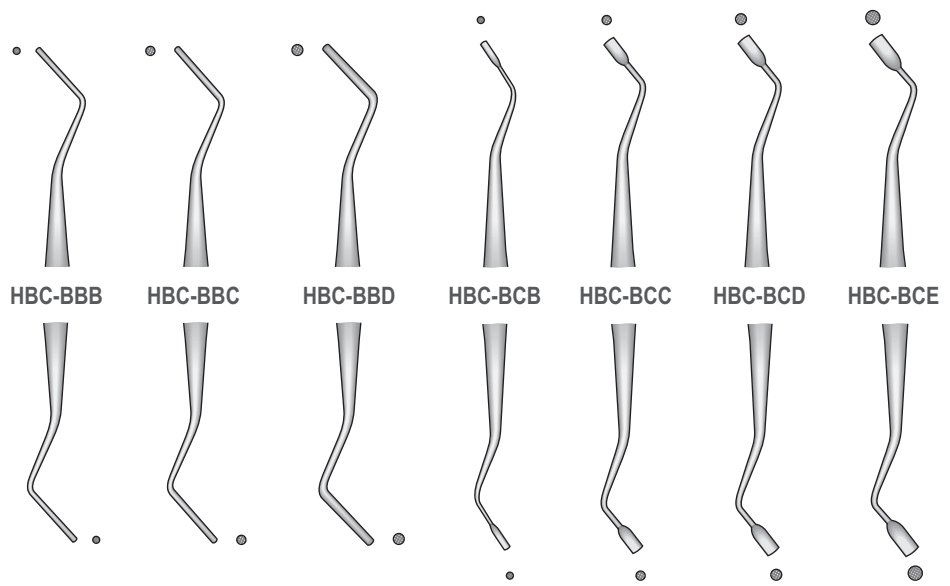

HBC-BBB11

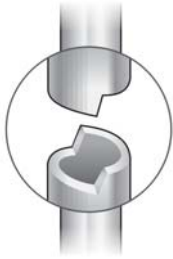

Runder Hohlgriff 8 mm  
Hollow Round Handle 8 mm  
Manico tondo vuoto 8 mm  
Mango hueco 8 mm  
Manche rond vide 8 mm



**HBC-150609**  
170 mm

HOLLENBACK

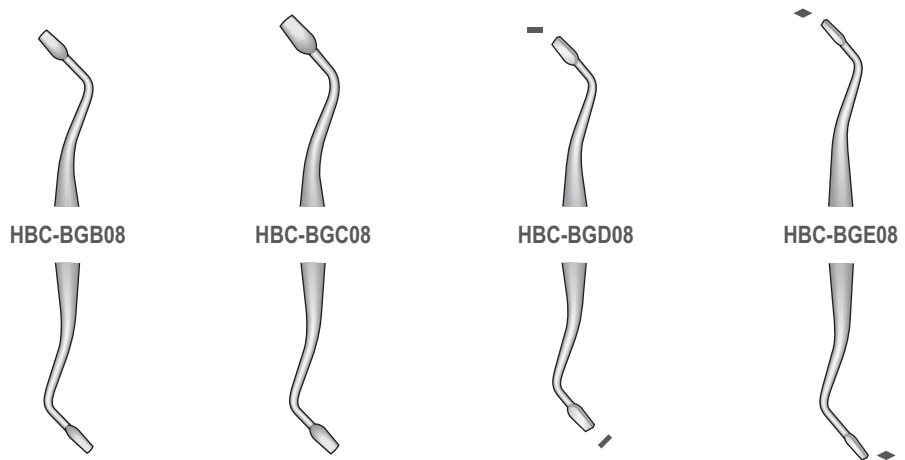

MARKLEY PLUGGERS

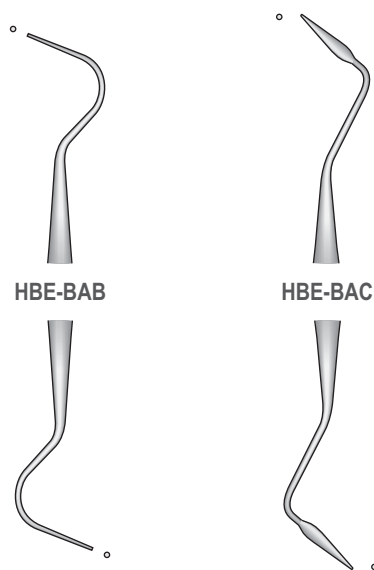



Runder Hohlgriff 8 mm  
 Hollow Round Handle 8 mm  
 Manico tondo vuoto 8 mm  
 Mango hueco 8 mm  
 Manche rond vide 8 mm

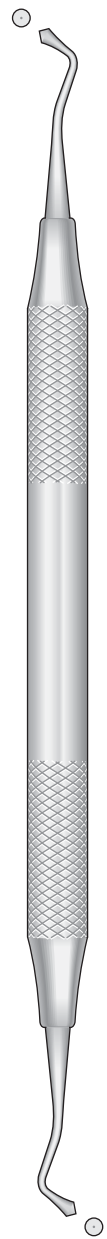
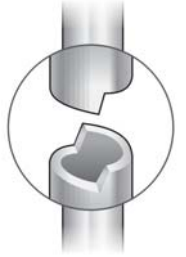

WESTCOTT  
HBC-BHB

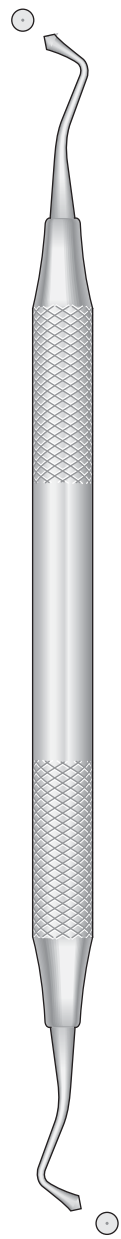

WESTCOTT  
HBC-BHC

WOODSON

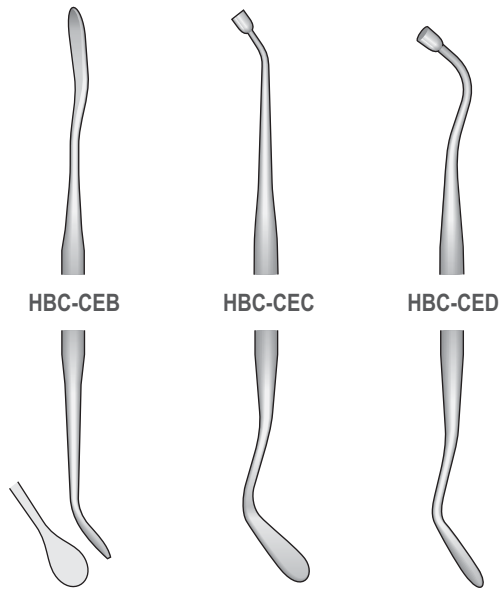

HBC-CEB

HBC-CEC

HBC-CED

LADMORE

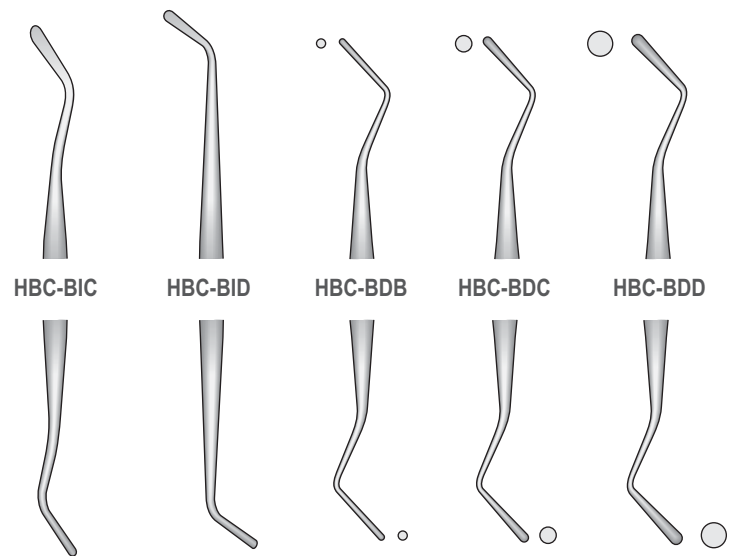

HBC-BIC

HBC-BID

HBC-BDB

HBC-BDC

HBC-BDD

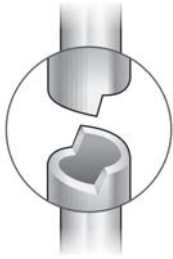

Runder Hohlgriff 8 mm  
Hollow Round Handle 8 mm  
Manico tondo vuoto 8 mm  
Mango hueco 8 mm  
Manche rond vide 8 mm



HBC-CFB

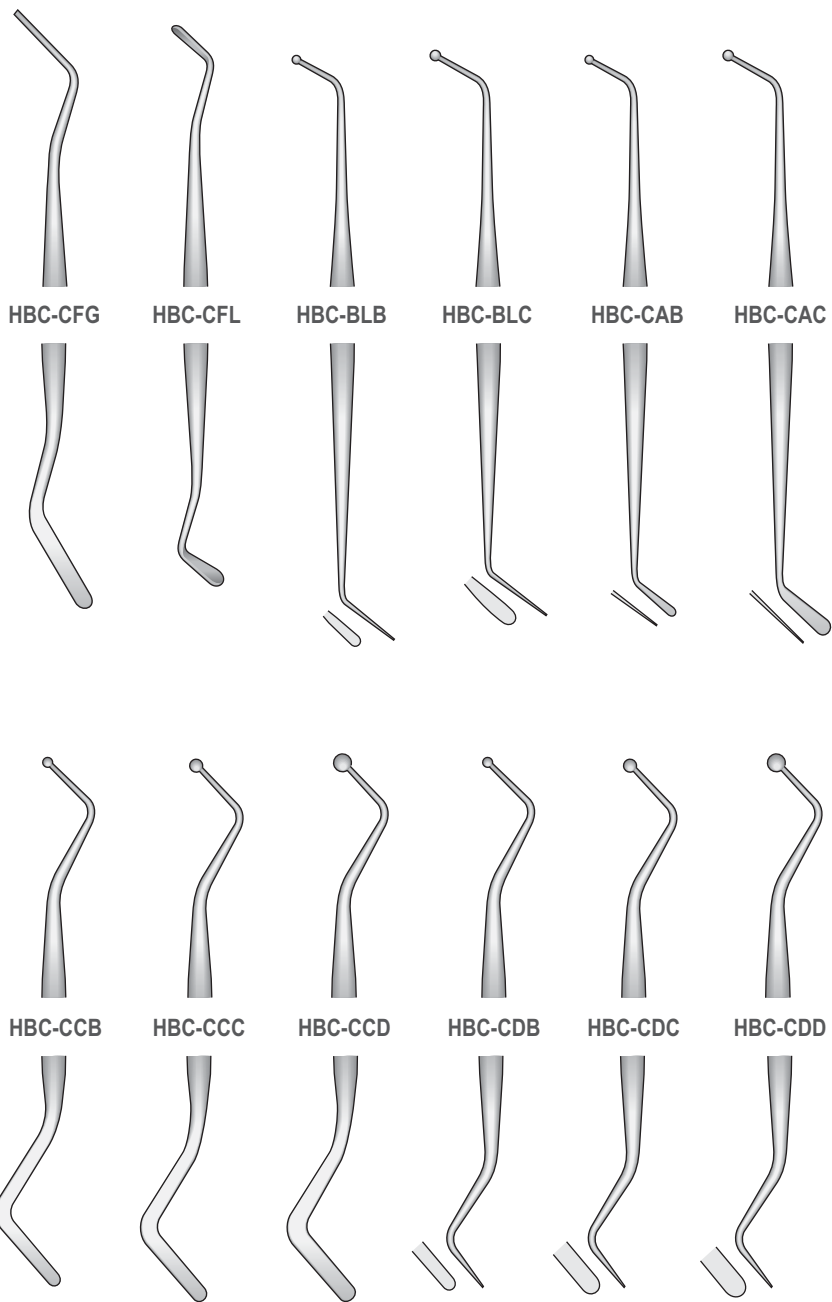

HBC-CFG

HBC-CFL

HBC-BLB

HBC-BLC

HBC-CAB

HBC-CAC

HBC-CCB

HBC-CCC

HBC-CCD

HBC-CDB

HBC-CDC

HBC-CDD

Instrumente zum Modellieren von Füllungen  
 Amalgam carvers  
 Strumenti per modellare e rifinire otturazioni  
 Instrumentos para modelar las obturaciones  
 Instruments à modeler les obturations

Runder Hohlgriff 8 mm  
 Hollow Round Handle 8 mm  
 Manico tondo vuoto 8 mm  
 Mango hueco 8 mm  
 Manche rond vide 8 mm

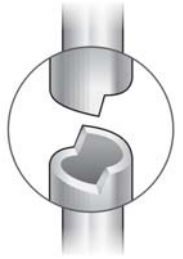

HOLLENBACK



HOLLENBACK  
 HBF-BAB



HBF-BAC



HBF-BAD



HBF-BAD18



CARVER 104  
 HBF-EAE



WILAND  
 HBF-EAI



Runder Hohlgriff 8 mm  
Hollow Round Handle 8 mm  
Manico tondo vuoto 8 mm  
Mango hueco 8 mm  
Manche rond vide 8 mm

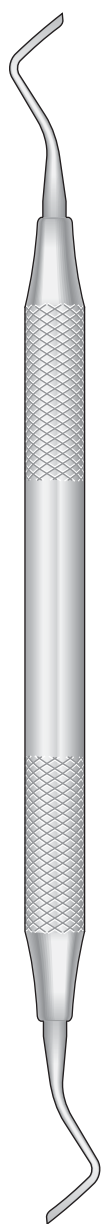

BLACK 26  
HBG-CAB

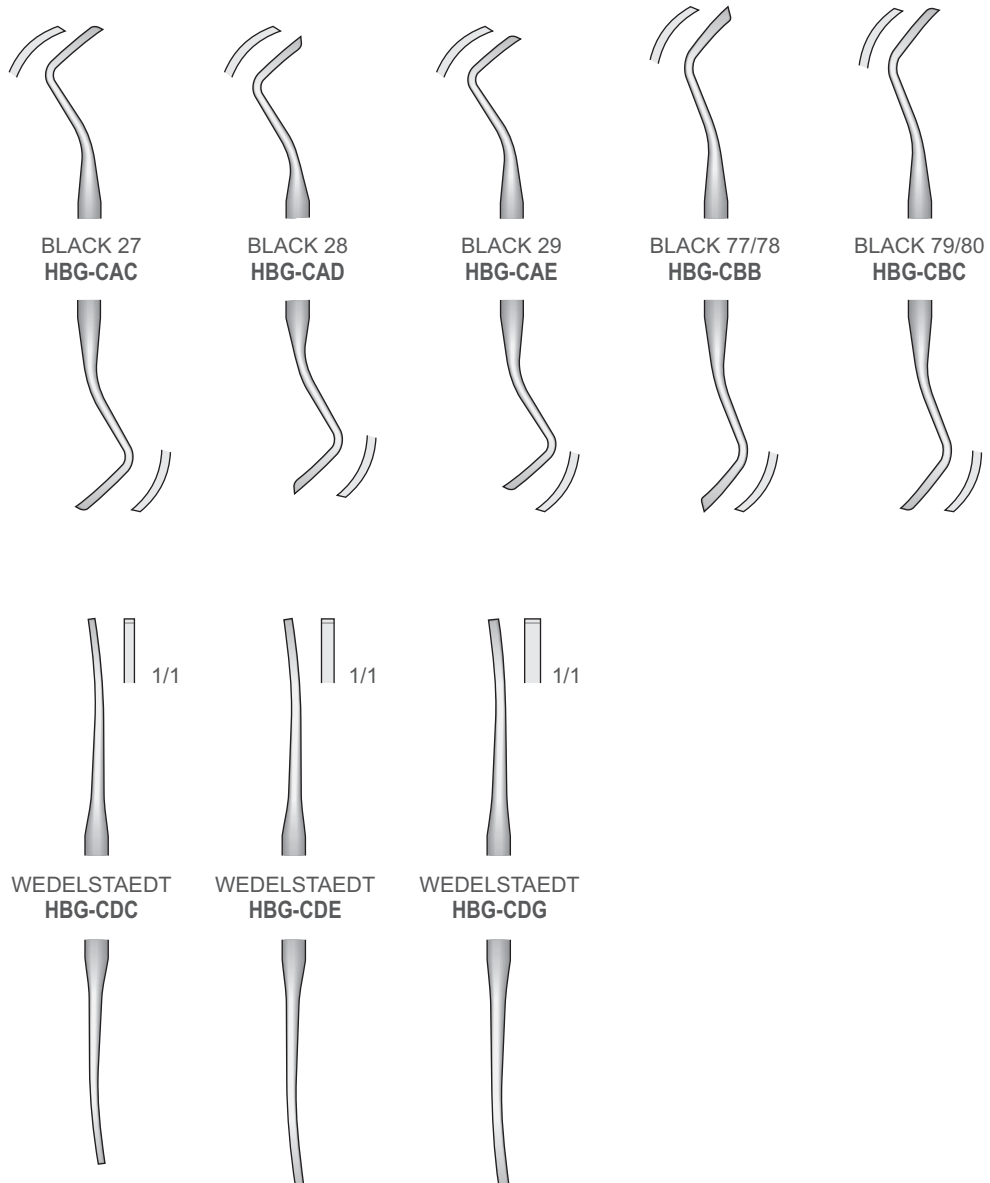

Instrumente für die Konservierende Behandlung  
 Operative Instruments  
 Strumenti per trattamento conservativo  
 Instrumentos para operatoria  
 Instruments pour D.O.



Runder Hohlgriff 8 mm  
 Hollow Round Handle 8 mm  
 Manico tondo vuoto 8 mm  
 Mango hueco 8 mm  
 Manche rond vide 8 mm

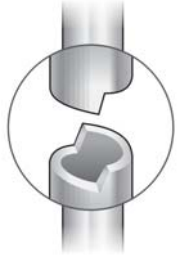

Instrument für Drahrückzug  
 Instrument for Retractor wire  
 Strumento per filo retrattore  
 Instrumento para hilo retractor  
 Instruments pour fil rtracteur

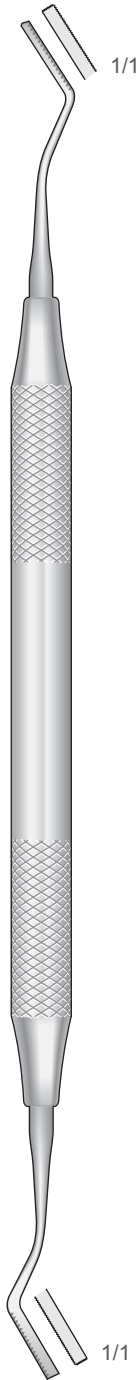

HBE-0321BB

Cleoids - Discoids

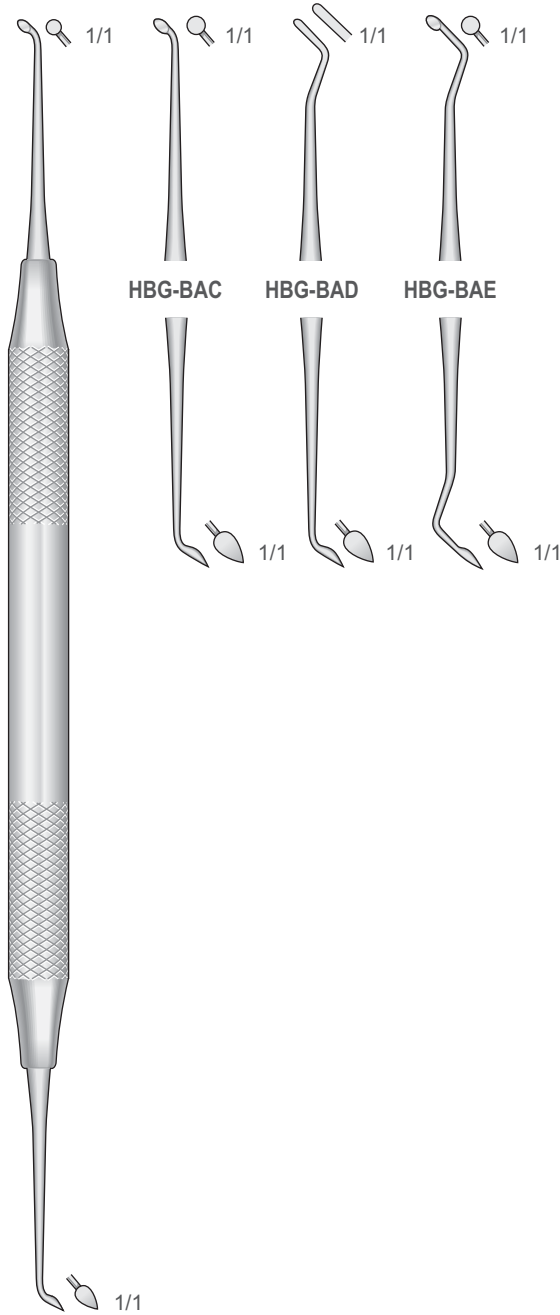

HBG-BAB

Dykal Applikator  
 Placement Instruments  
 Applicatori per sottofondo  
 Aplicadores de fondo de cavidades  
 Applicateurs de fond de cavité

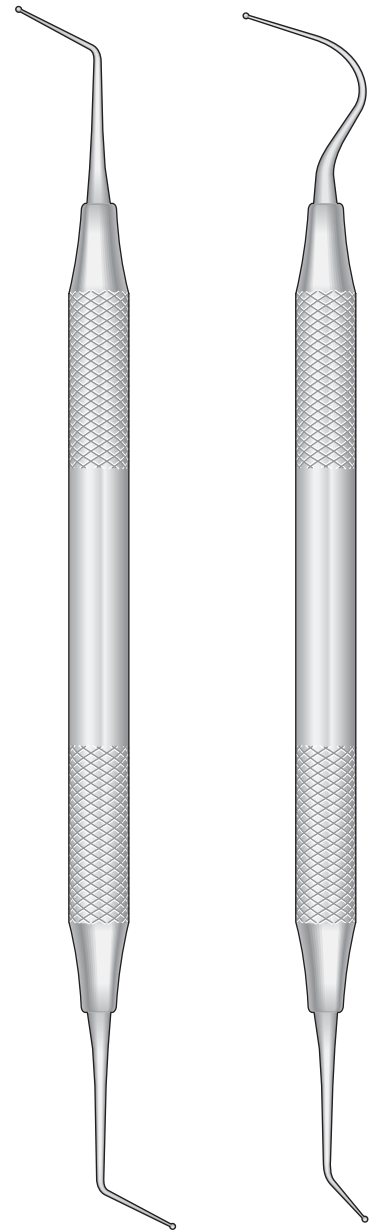

HBD-BAB

HBD-BAC

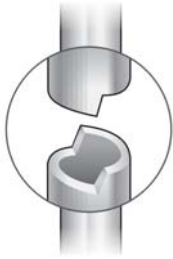

Runder Hohlgriff 8 mm  
Hollow Round Handle 8 mm  
Manico tondo vuoto 8 mm  
Mango hueco 8 mm  
Manche rond vide 8 mm



HBH-BAA

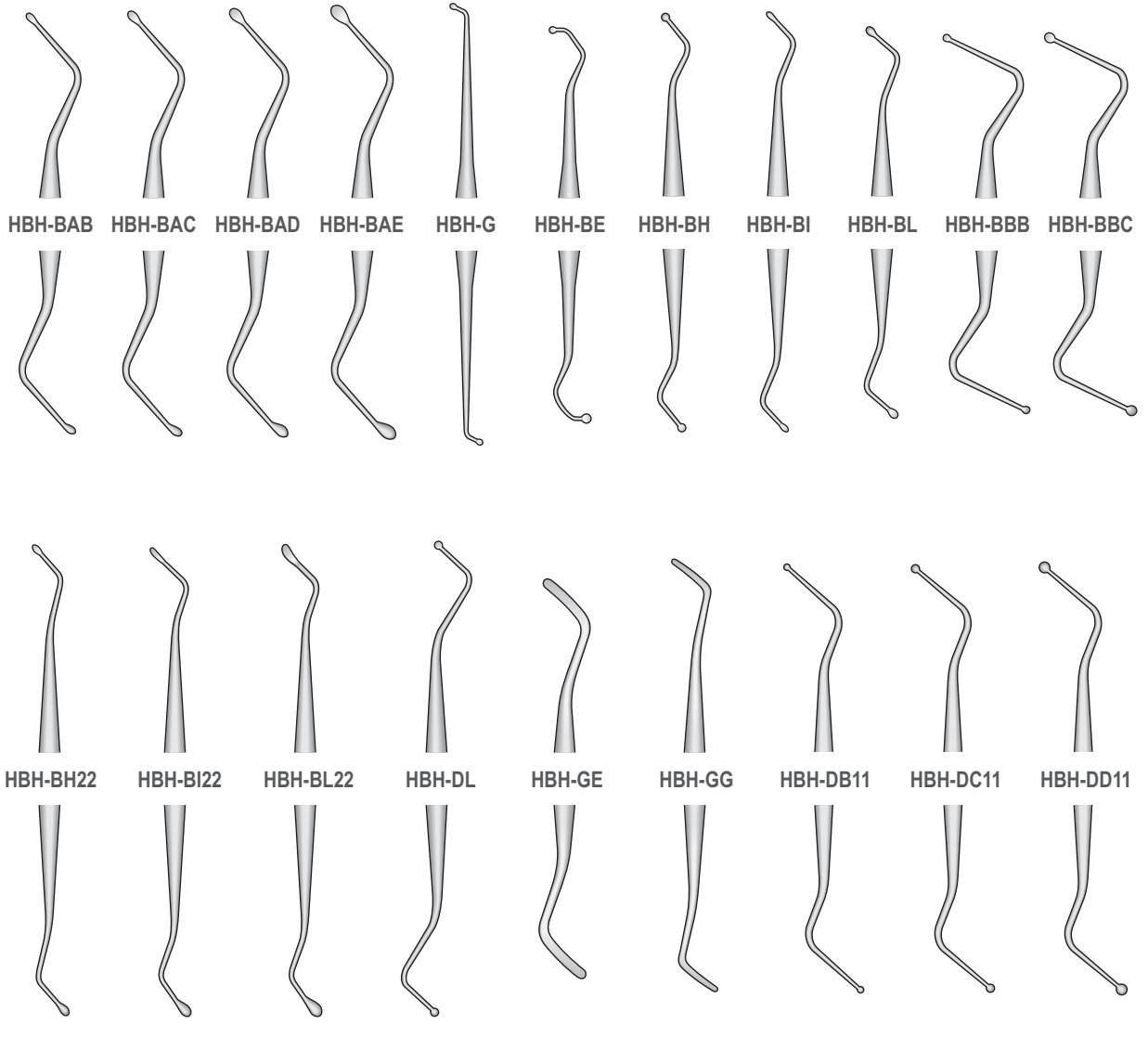

Parodontalmesser  
 Gingivectomy knives  
 Bisturi per gengivectomia  
 Bisturis para la gingivectomia  
 Bistouris pour la gingivectomie

Runder Hohgriff 8 mm  
 Hollow Round Handle 8 mm  
 Manico tondo vuoto 8 mm  
 Mango hueco 8 mm  
 Manche rond vide 8 mm

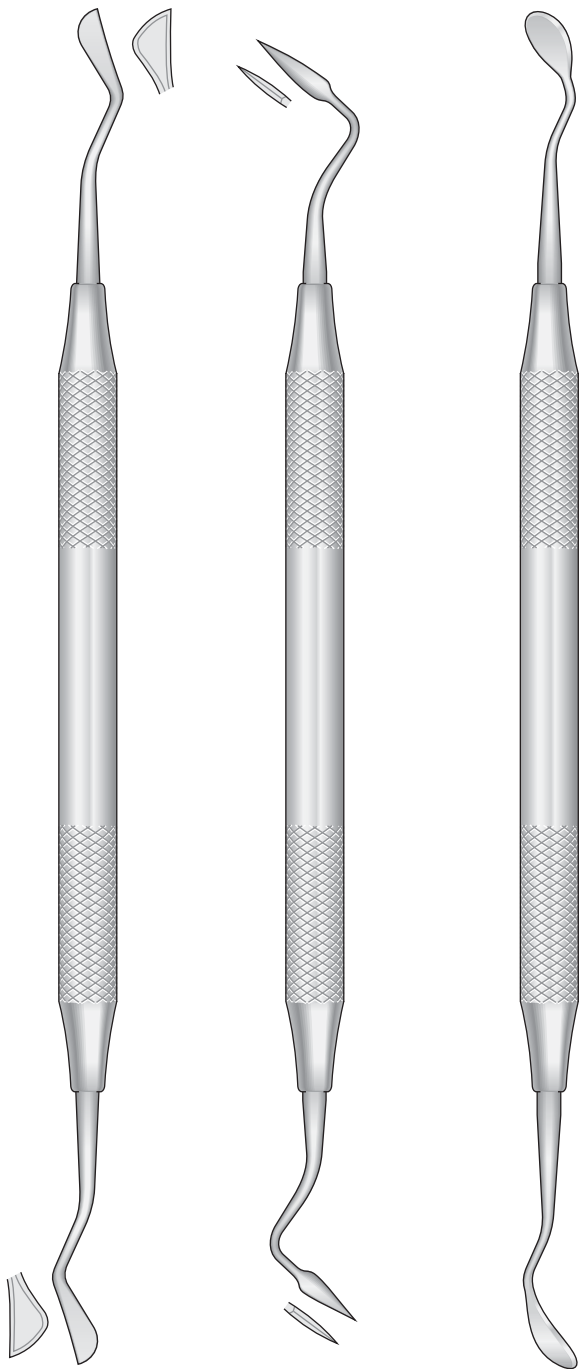
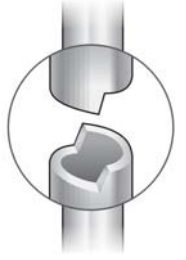

KIRKLAND  
HBI-BCD

ORBAN  
HBI-BDD

GOLDMAN-FOX  
HBI-BEH

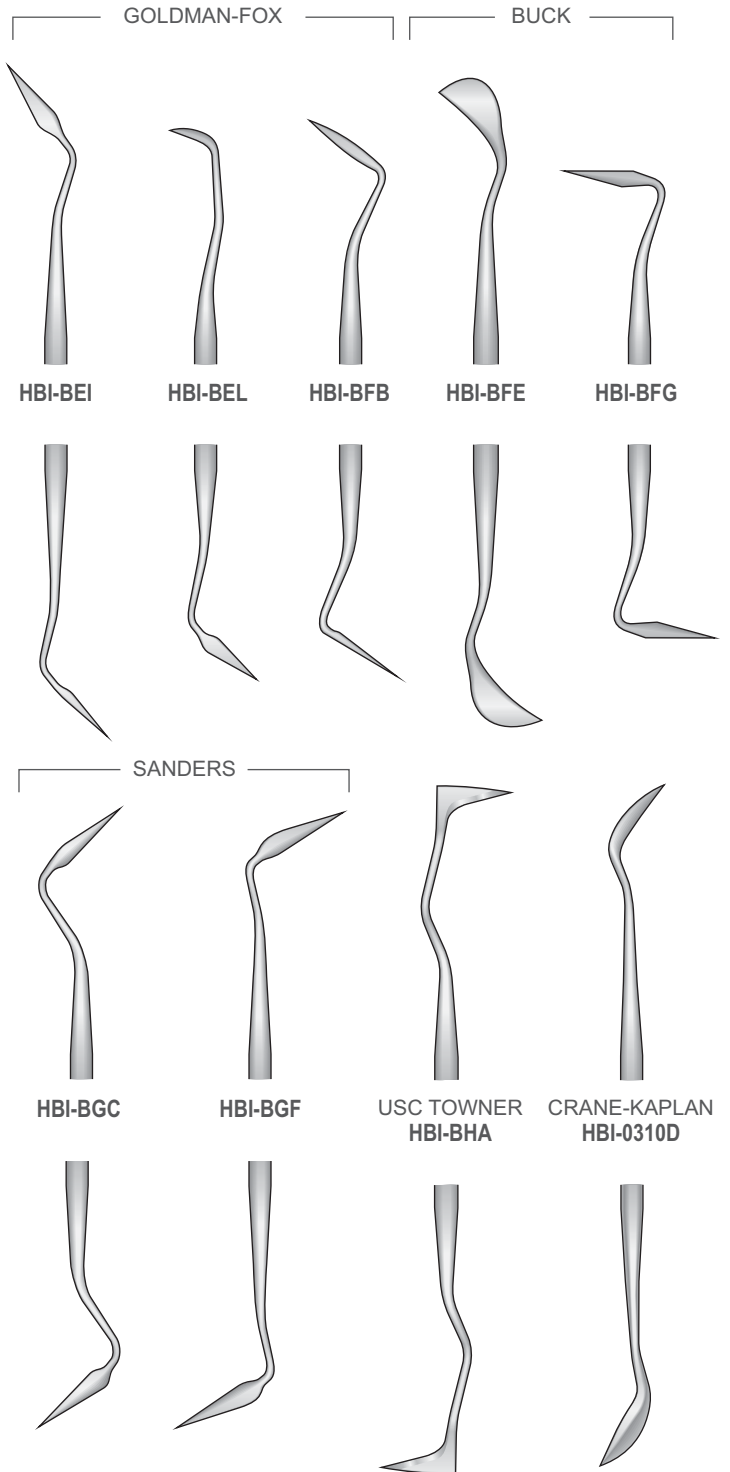

GOLDMAN-FOX

BUCK

HBI-BEI

HBI-BEL

HBI-BFB

HBI-BFE

HBI-BFG

HBI-BGC

HBI-BGF

USC TOWNER  
HBI-BHA

CRANE-KAPLAN  
HBI-0310D

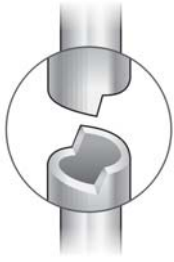

Runder Hohlgriff 8 mm  
Hollow Round Handle 8 mm  
Manico tondo vuoto 8 mm  
Mango hueco 8 mm  
Manche rond vide 8 mm

GRACEY

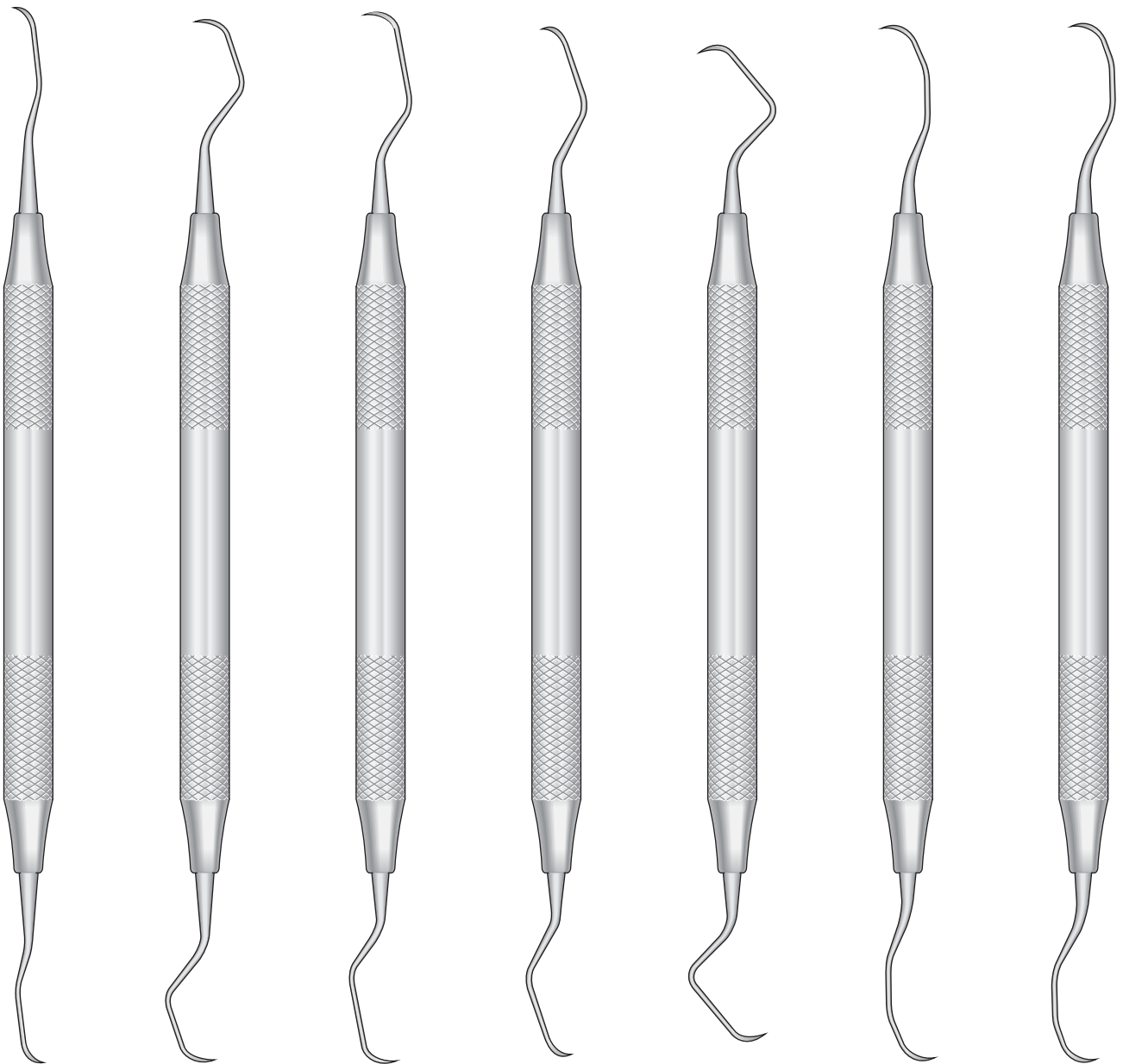

GRACEY  
HBI-B/C

GRACEY  
HBI-D/E

GRACEY  
HBI-F/G

GRACEY  
HBI-H/I

GRACEY  
HBI-L/BA

GRACEY  
HBI-BB/BC

GRACEY  
HBI-BD/BE



Runder Hohlgriff 8 mm  
Hollow Round Handle 8 mm  
Manico tondo vuoto 8 mm  
Mango hueco 8 mm  
Manche rond vide 8 mm

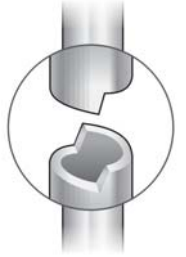

Mesial - Distal



GRACEY  
HBI-BB1204



GRACEY  
HBI-BD1204



DE MARCO  
HBI-CFB



DE MARCO  
HBI-CFC



COLUMBIA  
HBI-C1711



COLUMBIA  
HBI-E1711



COLUMBIA  
HBI-BE



LANGER  
HBI-CDC



LANGER  
HBI-CDE



Runder Hohlgriff 8 mm  
Hollow Round Handle 8 mm  
Manico tondo vuoto 8 mm  
Mango hueco 8 mm  
Manche rond vide 8 mm

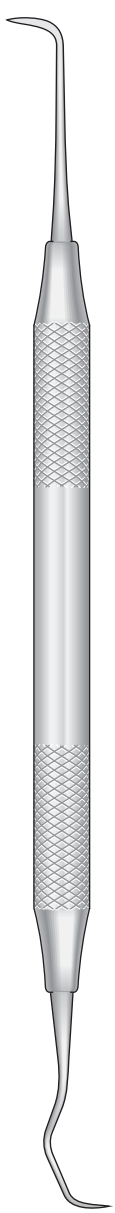

GOLDMAN-FOX  
HBI-CHB



GOLDMAN-FOX  
HBI-CHC



GOLDMAN-FOX  
HBI-CHD



GOLDMAN-FOX  
HBI-CHE



GOLDMAN-FOX  
HBI-CHF



GOLDMAN-FOX  
HBI-CHH

Runder Hohlgriff 8 mm  
 Hollow Round Handle 8 mm  
 Manico tondo vuoto 8 mm  
 Mango hueco 8 mm  
 Manche rond vide 8 mm

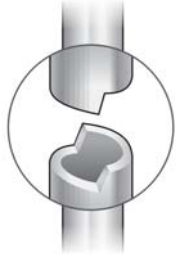

MC CALL  
HBI-CIC



MC CALL  
HBI-CIC01

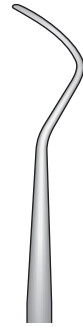

MC CALL  
HBI-CIE

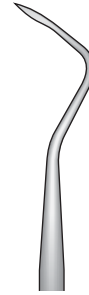

MC CALL  
HBI-CIE18



MC CALL  
HBI-CII18



JAQUETTE  
HBI-DDD



JAQUETTE  
HBI-DDC



JAQUETTE  
HBI-DDF





Runder Hohlgriff 8 mm  
 Hollow Round Handle 8 mm  
 Manico tondo vuoto 8 mm  
 Mango hueco 8 mm  
 Manche rond vide 8 mm



TAYLOR  
HBI-1914D

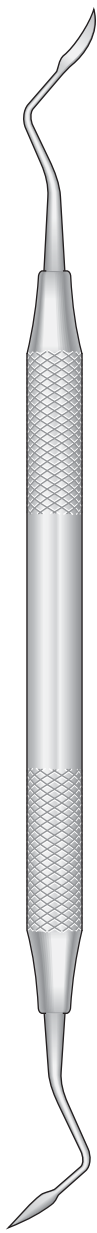

HBI-CAE



HBI-CAE18

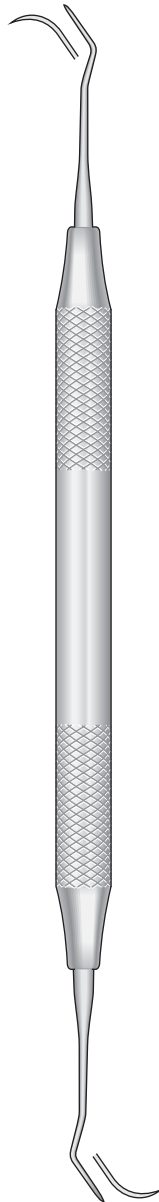

HBI-CAE1804



HBI-030914D

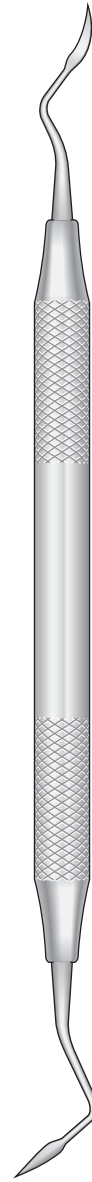

CRANE-CAPLAN  
HBI-0310G

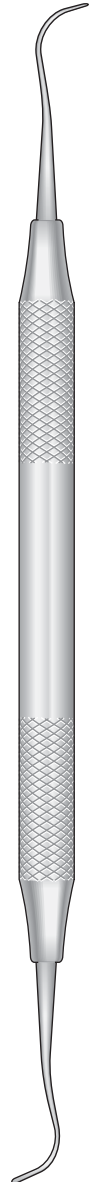

YOUNGER-GOOD  
HBI-240714I

Runder Hohlgriff 8 mm  
 Hollow Round Handle 8 mm  
 Manico tondo vuoto 8 mm  
 Mango hueco 8 mm  
 Manche rond vide 8 mm

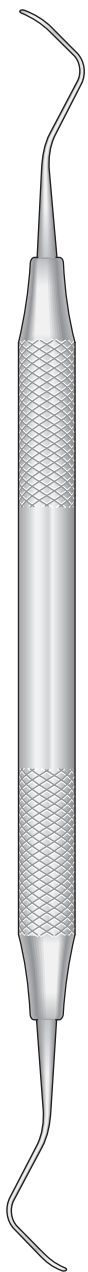
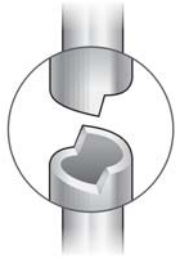

RULE 23/24  
 HBI-1714E



I. UNIVERSITY  
 HBI-CGI



TOWNER-JAQUETTE  
 HBL-BBB



TOWNER-JAQUETTE  
 HBL-BCF

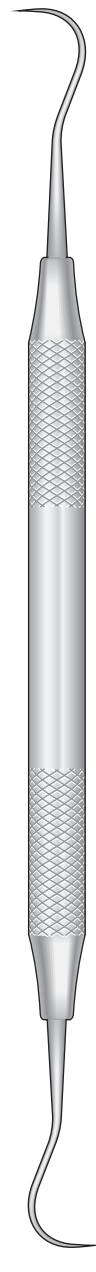

TOWNER-JAQUETTE  
 HBL-BCG

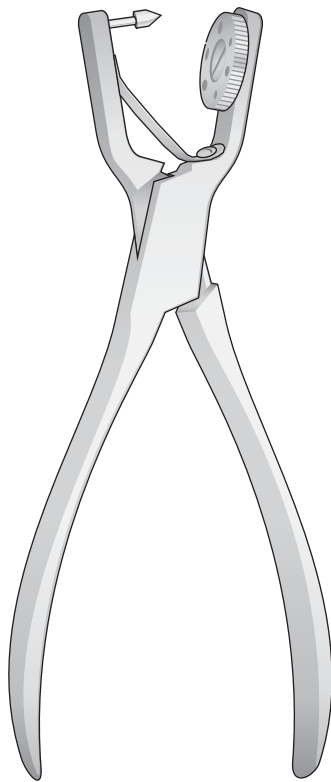

AINS WORTH  
**0406-AC**  
 160 mm

Lochzangen  
 Punch Forceps  
 Pinze foradiga  
 Perforadores  
 Pincés à perforer

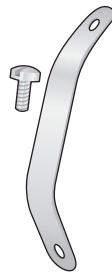

**0406-AC12**  
 Feder mit Schraube  
 Spring with screw  
 Molla con vite  
 Muelle con tornillo  
 Ressort avec vis



**0406-AC17**  
 Lochscheibe  
 Punch Disk  
 Disco divisore  
 Disco agujereado  
 Disque perforé



**0406-AC15**  
 Stift, mit Schraube  
 Pin, with screw  
 Perno con vite  
 Punzón con perno  
 Broche

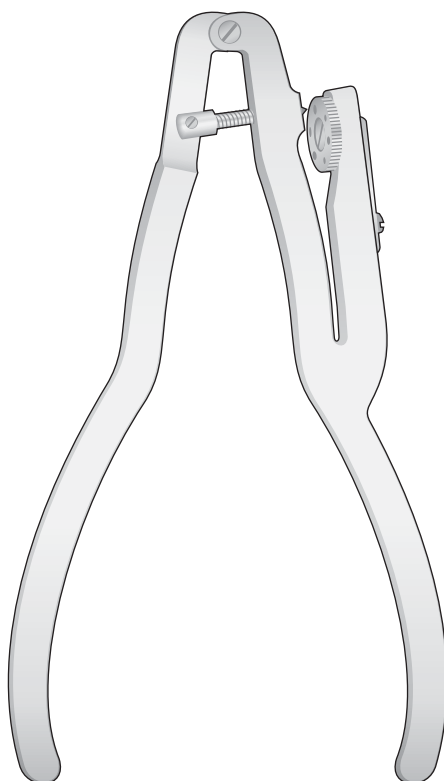

IVORY  
**0406-AA**  
 160 mm

Lochzangen  
 Punch Forceps  
 Pinze foradiga  
 Perforadores  
 Pincés à perforer



**0406-AA12**  
 Spiralfeder  
 Spiral Spring  
 Molla a spirale  
 Muelle espiral  
 Ressort en spirale



**0406-AA11 + 0406-AA21**  
 Feder mit Schraube  
 Spring with screw  
 Molla con vite  
 Muelle con tornillo  
 Ressort avec vis



**0406-AA17**  
 Lochscheibe  
 Punch Disk  
 Disco divisore  
 Disco agujereado  
 Disque perforé



**0406-AA15 + 0406-AA13**  
 Stift, mit Schraube  
 Pin, with screw  
 Perno con vite  
 Punzón con perno  
 Broche avec vis



Klammerzangen  
 Clamps forceps  
 Pinze per ganci  
 Pinzas para ganchos  
 Pincés à crampons

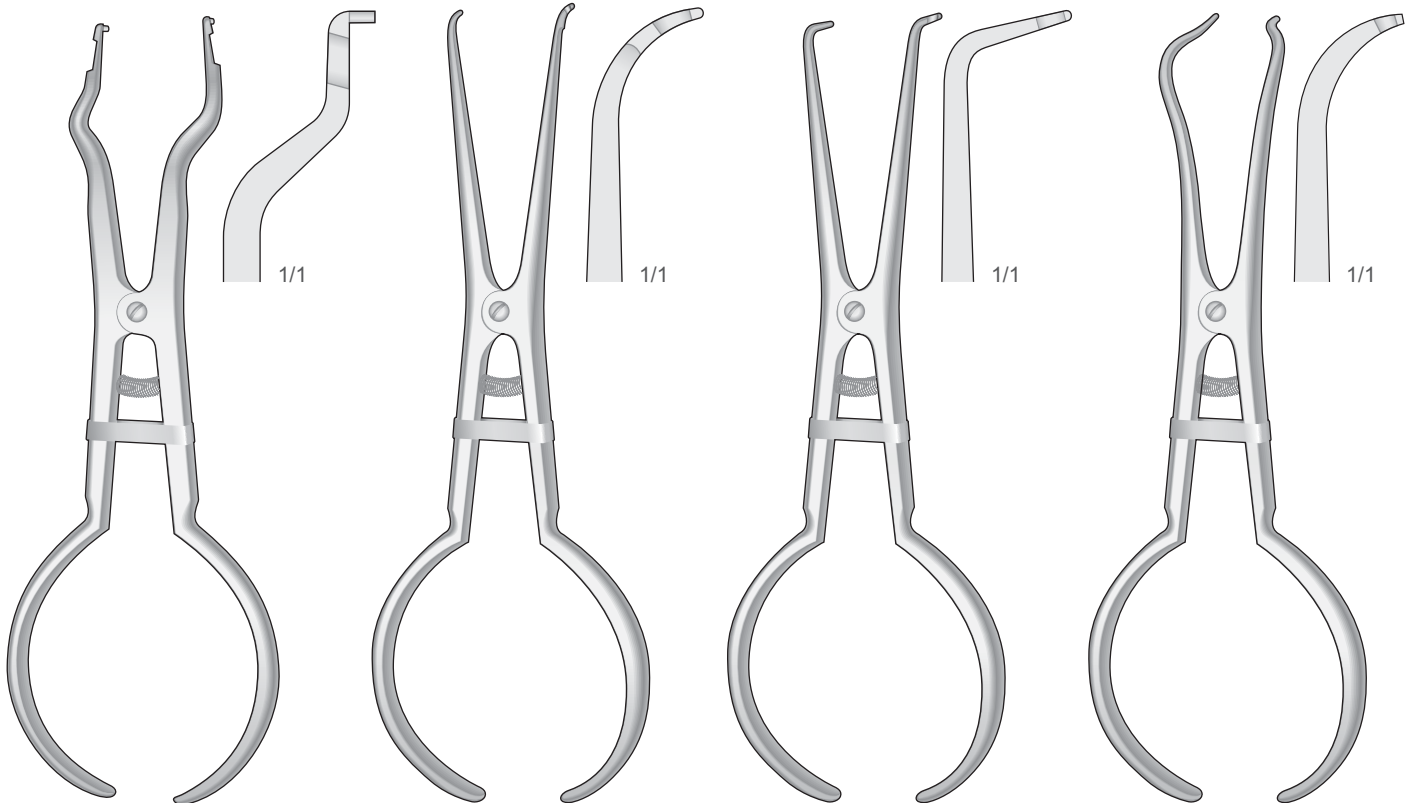

**BREWER**  
**0406-BA**  
 170 mm

**PALMER**  
**0406-BF**  
 170 mm

**STOKE**  
**0406-BG**  
 170 mm

**0406-BI**  
 170 mm

Molaren, 12 Stück  
 Molars, 12 pieces  
 Molari, 12 pezzi  
 Molares, 12 piezas  
 Molaies, 12 Pièces

Premolaren, 12 Stück  
 Premolars, 12 pieces  
 Premolari, 12 pezzi  
 Premolares, 12 piezas  
 Prémolaires, 12 Pièces



0406-EA/B



0406-EB/E



0406-EA/C



0406-EB/F



0406-EA/D



0406-EB/G

Klammerzangen - Clamp Forceps  
 Pinze per uncini - Porta Clamps  
 Pincas porte-crampons

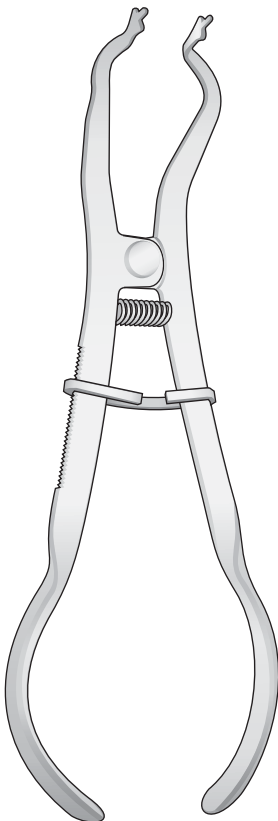

IVORY  
 0406-BC  
 170 mm

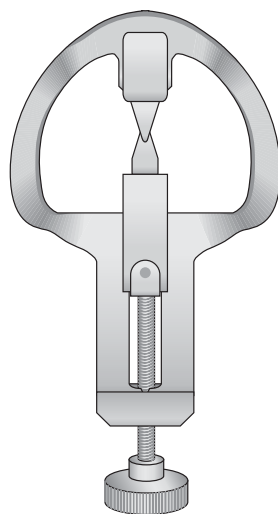

IVORY  
 0406-ED

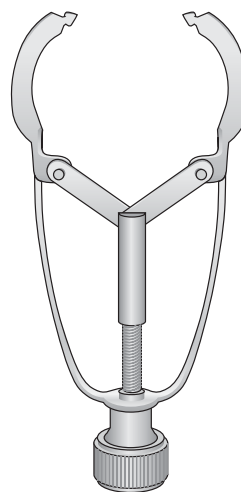

IVORY  
 0406-EA

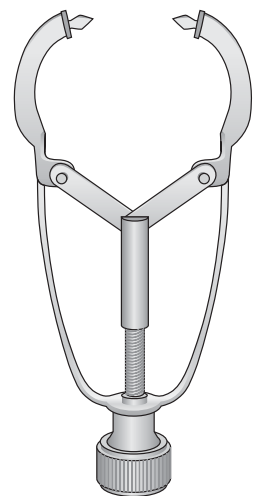

IVORY  
 0406-EB



Kofferdam-Klammern  
 Rubber-Dam Clamps  
 Uncini per diga  
 Clamps para diques  
 Crampons pour digue



IVORY  
**0406-BCG**



IVORY  
**0406-BCH**



IVORY  
**0406-BCI**



IVORY  
**0406-BCL**



IVORY  
**0406-BDA**



IVORY  
**0406-BDB**



IVORY  
**0406-BFB**



IVORY  
**0406-BGA**

Kofferdam-Rahmen - Edelstahl  
 Rubber-Dam Frames - Stainless Steel  
 Telaio per diga - Inox  
 Guadro para diques - Inoxidable  
 Cadre à digue - Inoxidable

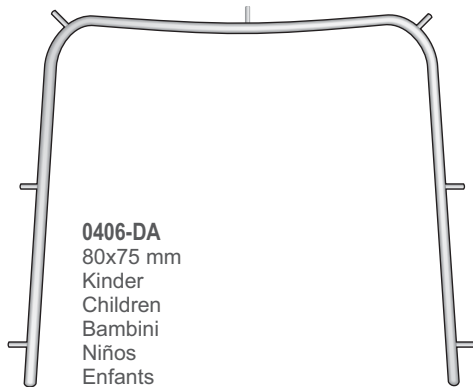

**0406-DA**  
 80x75 mm  
 Kinder  
 Children  
 Bambini  
 Niños  
 Enfants

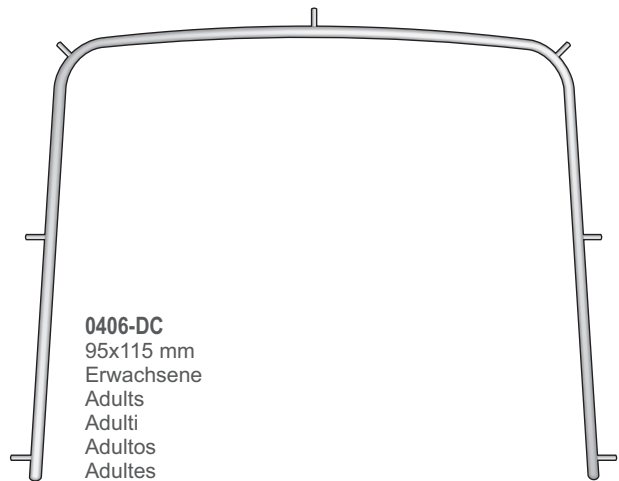

**0406-DC**  
 95x115 mm  
 Erwachsene  
 Adults  
 Adulti  
 Adultos  
 Adultes

Molaren, 12 Stück  
 Molars, 12 pieces  
 Molari, 12 pezzi  
 Molares, 12 piezas  
 Molaires, 12 Pièces

Premolaren, 12 Stück  
 Premolars, 12 pieces  
 Premolari, 12 pezzi  
 Premolares, 12 piezas  
 Prémolaires, 12 Pièces

TOFFLEMIRE  
 Universal



0406-AD/H



0406-AD/BB



0406-AD/B



0406-AD/I



0406-AD/BC



0406-AD/C



0406-AD/L



0406-AD/BD



0406-AD/D



0406-AD/BA

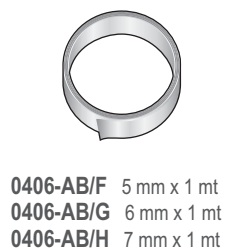

0406-AB/F 5 mm x 1 mt  
 0406-AB/G 6 mm x 1 mt  
 0406-AB/H 7 mm x 1 mt



0406-AF/F 5 mm x 5 mt  
 0406-AF/G 6 mm x 5 mt  
 0406-AF/H 7 mm x 5 mt

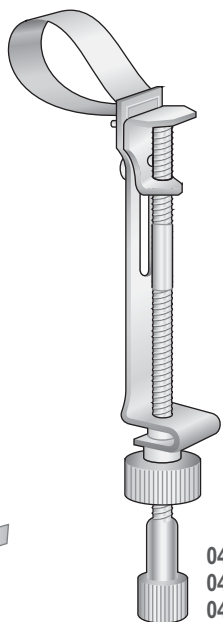

IVORY  
 0406-AG/0406-AL

0406-AG 5 mm  
 0406-AI 6 mm  
 0406-AL 7 mm

Paar - Pair  
 Coppia - Par  
 Paire

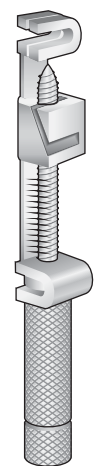

Fig.1  
 Rechts  
 Right  
 Destra  
 Derecha  
 Droit

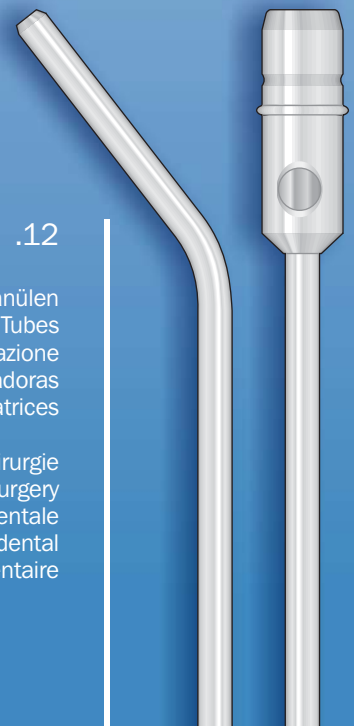

Fig.2  
 Links  
 Left  
 Sinistra  
 Izquierda  
 Gauche

NYSTRÖM  
 0406-AE  
 Fig.1 + Fig.2



TOFFLEMIRE  
 0406-AH  
 Universal



.12

Absaugkanülen  
Suction Tubes  
Cannule per aspirazione  
Cánulas aspiradoras  
Canule aspiratrices

Zahnärztliche Chirurgie  
Dental surgery  
Chirurgia dentale  
Cirugia dental  
Chirurgie dentaire



Absaugkanülen  
Suction Tubes  
Cannule per aspirazione  
Cànulas aspiradoras  
Canules aspiratrices

Rostfrei  
Stainless Steel  
Acciaio chirurgico  
Acero  
Acier

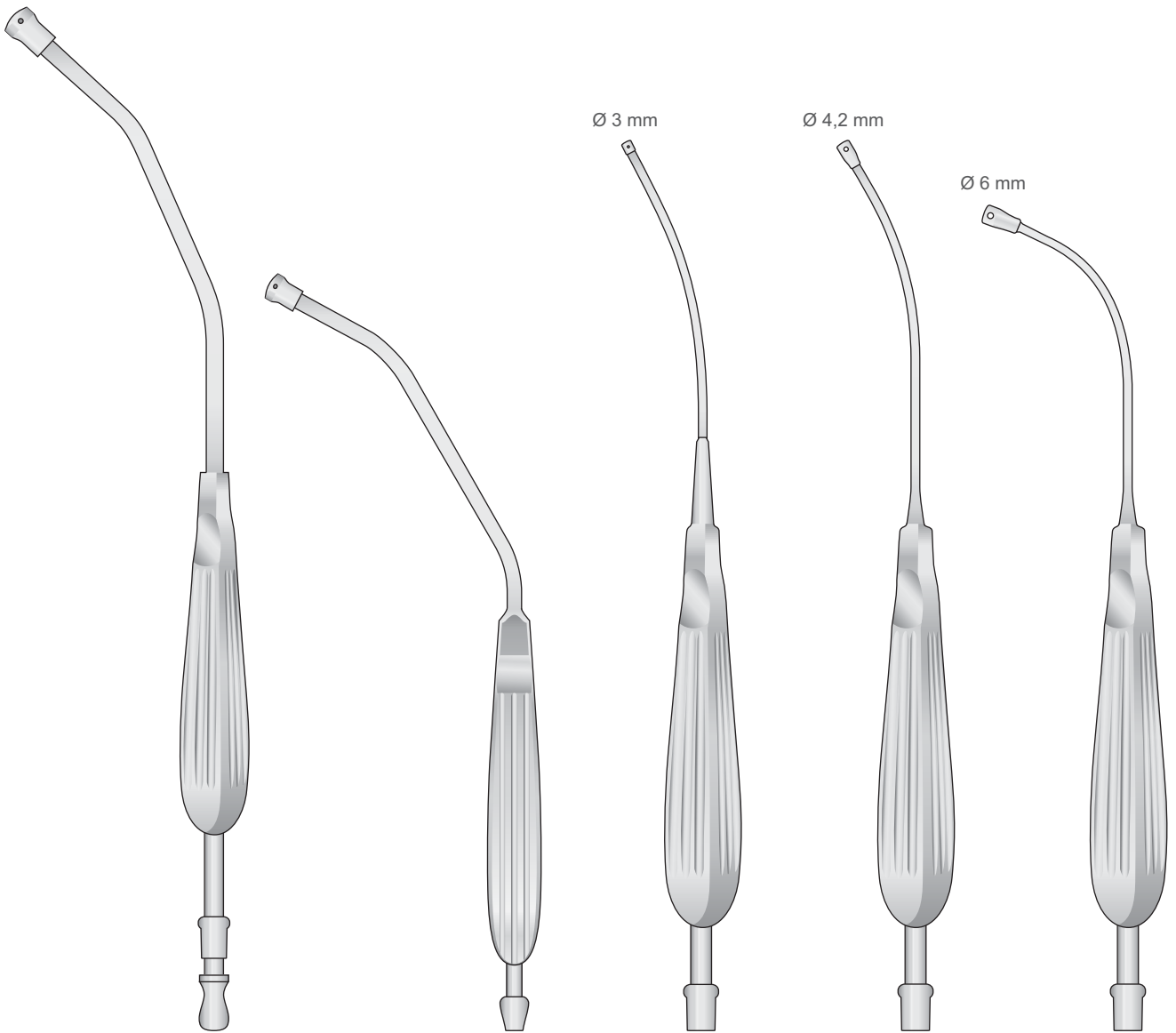

**YANKAUER**  
**0706-BC**  
310 mm

**BABY-YANKAUER**  
**0706-BA**  
200 mm

**ANDREWS-PYNCHON**  
**0706-AG**  
250 mm

**ANDREWS-PYNCHON**  
**0706-AH**  
250 mm

**ANDREWS-PYNCHON**  
**0706-FE**  
230 mm

Absaugkanülen  
Suction Tubes  
Cannule per aspirazione  
Cánulas aspiradoras  
Canules aspiratrices

Rostfrei  
Stainless Steel  
Acciaio chirurgico  
Acero  
Acier

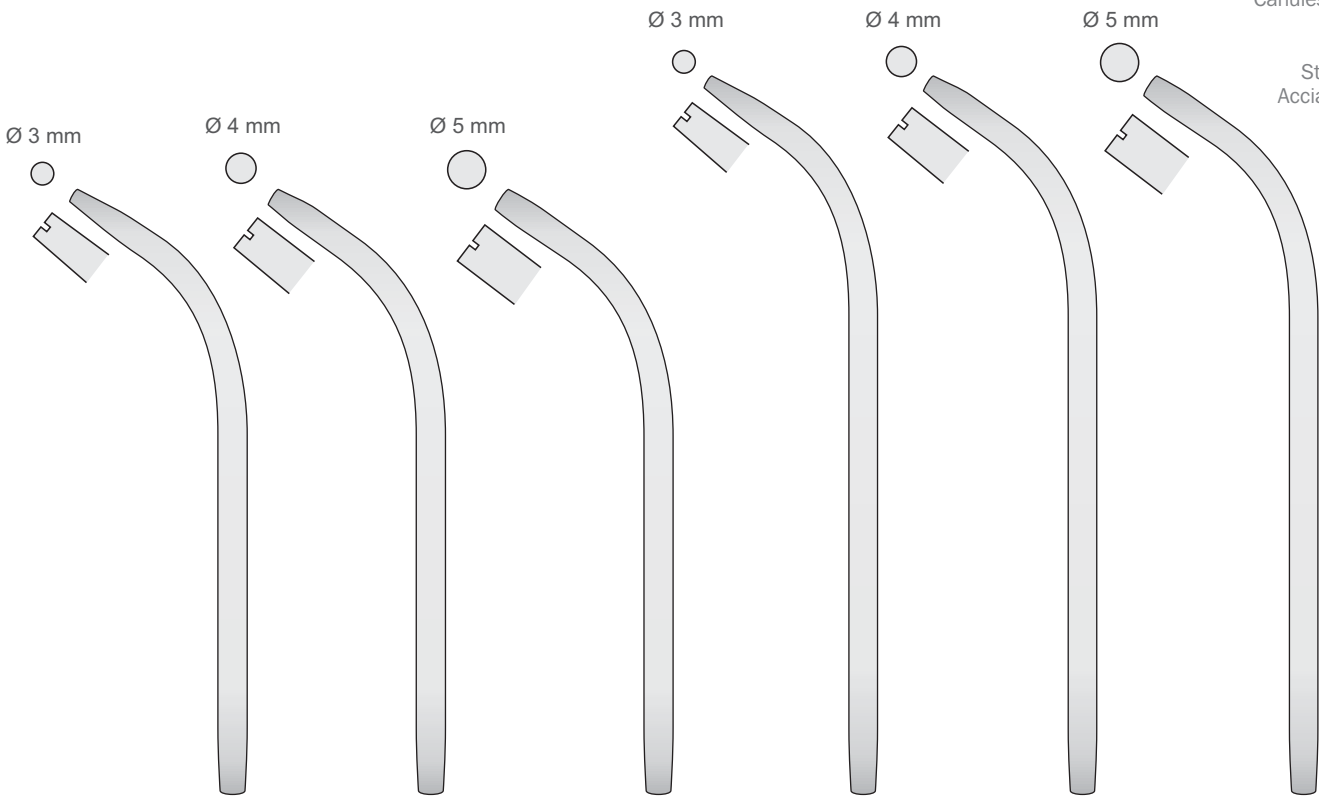

**0706-DA**  
140 mm

**0706-DB**  
140 mm

**0706-DC**  
140 mm

**0706-DD**  
170 mm

**0706-DE**  
170 mm

**0706-DF**  
170 mm

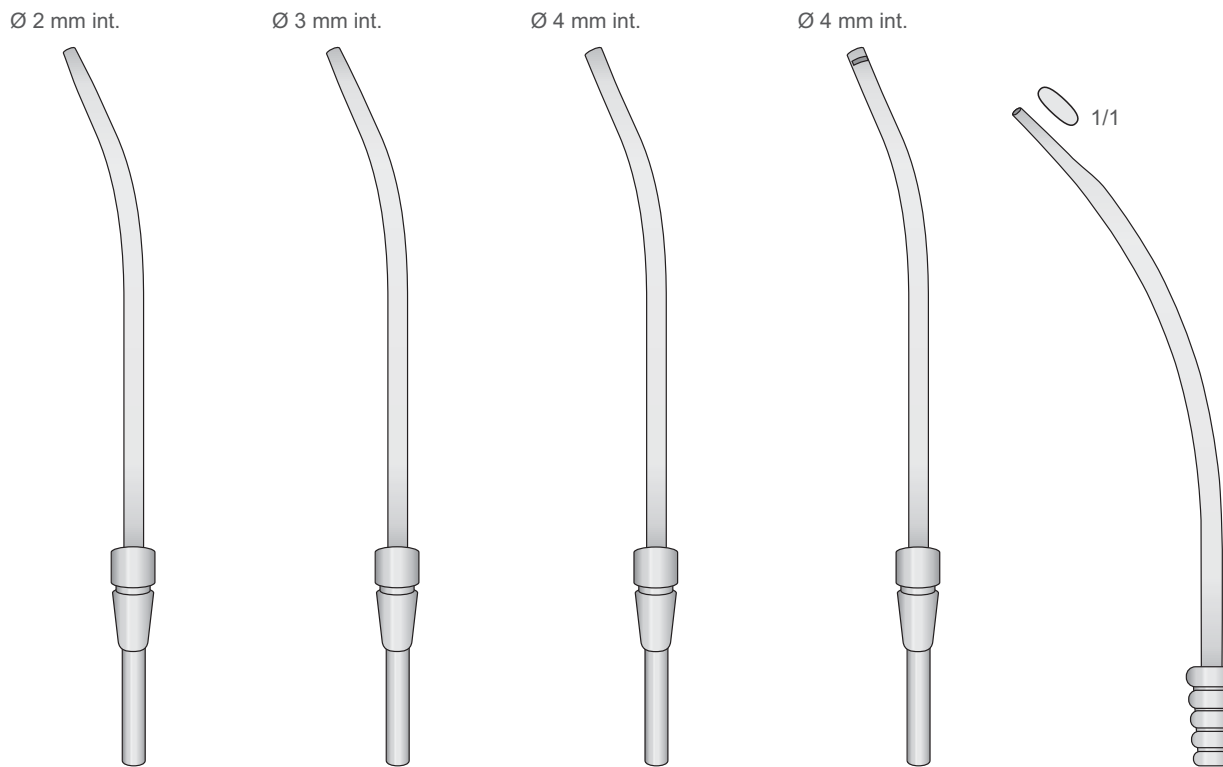

MC. KESSON  
**0706-BD**  
180 mm

MC. KESSON  
**0706-BE**  
180 mm

MC. KESSON  
**0706-BF**  
180 mm

MC. KESSON  
**0706-BG**  
180 mm

**0706-CA**  
160 mm

Absaugkanülen  
Suction Tubes  
Cannule per aspirazione  
Cànulas aspiradoras  
Canules aspiratrices

Rostfrei  
Stainless Steel  
Acciaio chirurgico  
Acero  
Acier

Adaptor  
Adapter  
Adattatore  
Adaptador  
Adaptateur

Ø Est. 6,0 mm  
Ø Int. 4,5 mm

**Autoclavable Tubing**

Schlauch - Silikon  
Flexible Tube - Silicone  
Raccordo in silicone per cannule  
Autoclavabile  
Tubo flexible de silicona  
Tuyau - Silicone  
2 mt.



**1918-EA**  
75 mm



**0706-CHB**  
56 mm

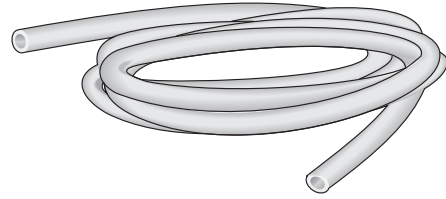

**1918-FA**  
2 mt.

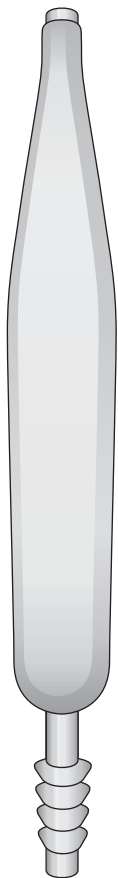

**COUPLAND**  
**0706-AB**  
150 mm

Ø 1 mm

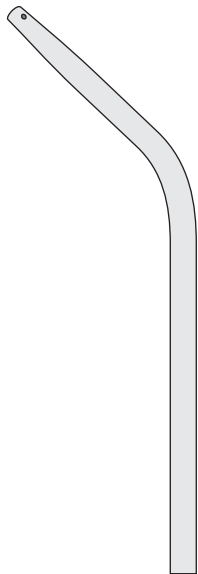

**0706-AF**  
95 mm

Ø 1,5 mm

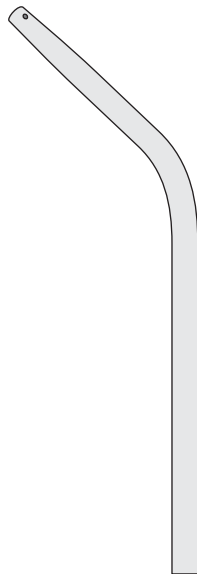

**0706-AE**  
95 mm

Ø 2,5 mm

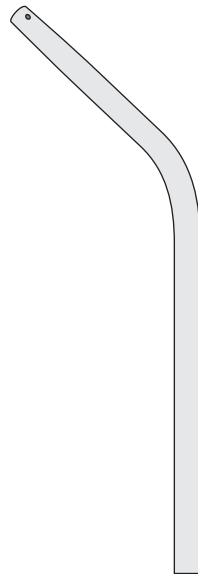

**0706-AD**  
95 mm

Ø 3,5 mm int.

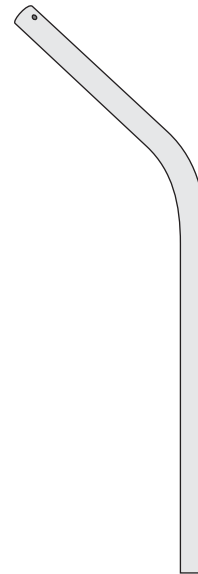

**0706-AC**  
95 mm

**0706-BB**

Set komplett mit Griff + 4 Kanülen  
Set complete with handle + 4 tubes  
Set completo di manico + 4 cannule  
Set completo con mango + 4 cànulas  
Set complet avec poignée + 4 canules

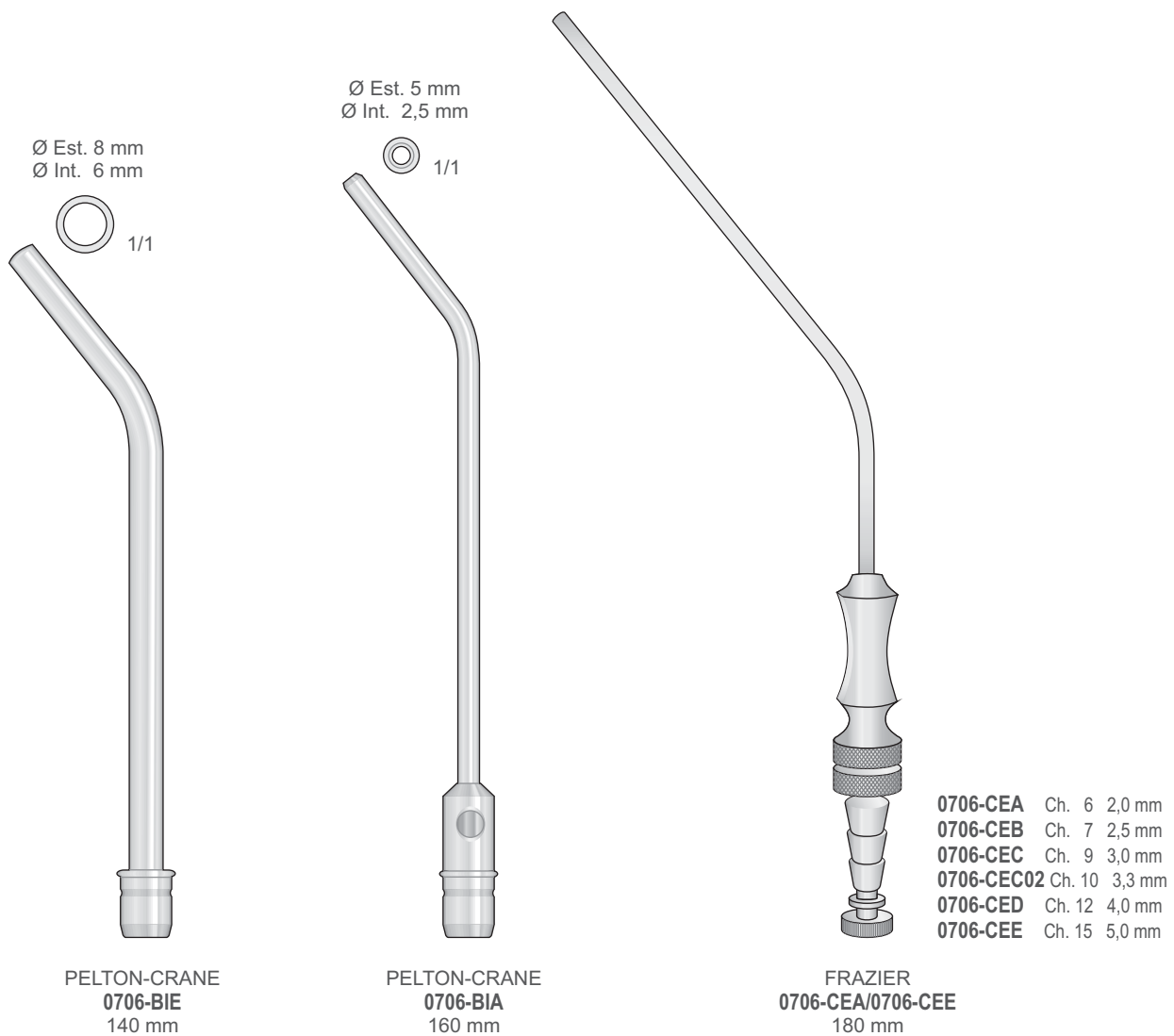

PELTON-CRANE  
**0706-BIE**  
140 mm

PELTON-CRANE  
**0706-BIA**  
160 mm

FRAZIER  
**0706-CEA/0706-CEE**  
180 mm



Absaugkanülen  
Suction Tubes  
Cannule per aspirazione  
Cànulas aspiradoras  
Canules aspiratrices

Rostfrei  
Stainless Steel  
Acciaio chirurgico  
Acero  
Acier

Biegsam  
Malleable  
Malleabile  
Flexible  
Flexible

Ø 3 mm

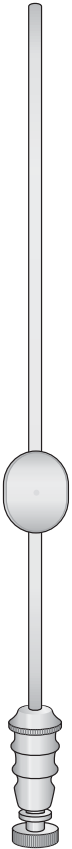

WERTHEIMER  
0706-GL  
160 mm

Biegsam  
Malleable  
Malleabile  
Flexible  
Flexible

Ø 3 mm

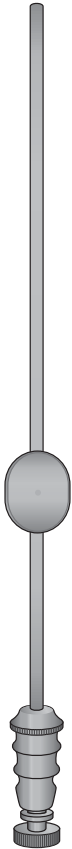

FRAZIER  
0706-HA  
160 mm

Verchromt Schwarz  
Chromium Black  
Cromata nera  
Cromado negro  
Chromé noir

Biegsam  
Malleable  
Malleabile  
Flexible  
Flexible

Ø 3 mm

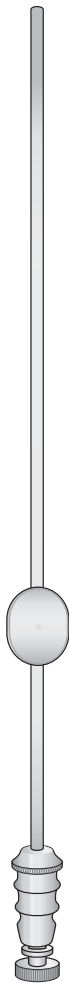

WERTHEIMER  
0706-GA  
200 mm

Biegsam  
Malleable  
Malleabile  
Flexible  
Flexible

Ø 3 mm

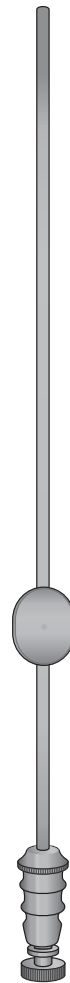

FRAZIER  
0706-GB  
200 mm

Verchromt Schwarz  
Chromium Black  
Cromata nera  
Cromado negro  
Chromé noir

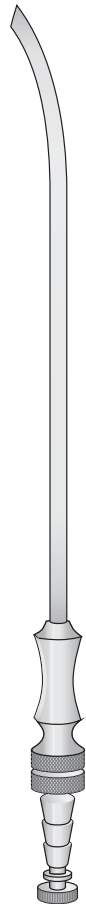

ADSON  
0706-EB ch. 12 Ø 4 mm  
0706-EC ch. 15 Ø 5 mm  
210 mm

Kanülenreinigungs-Bürsten  
 Cleaning brush for Tubes  
 Scovolini per pulizia cannule  
 Cepillos para limpiar cànulas  
 Brosse de nettoyage pour canules



Handwaschbürste  
 Nail brushes  
 Spazzola per unghie  
 Cepillos de uñas  
 Brosse à ongles

Sterilisier bar  
 Autoclavable  
 Autoclavabile  
 Esterilizable  
 Stérilisable

**0706-CAA**  
 4 x 11 cm

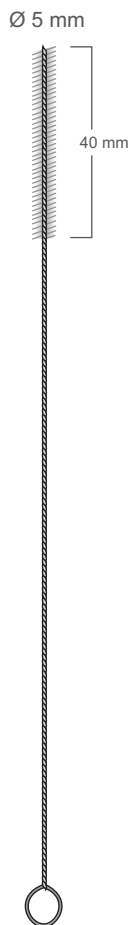

**0706-EA**  
 235 mm

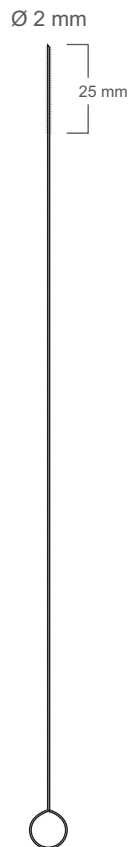

**0706-BIC**  
 215 mm

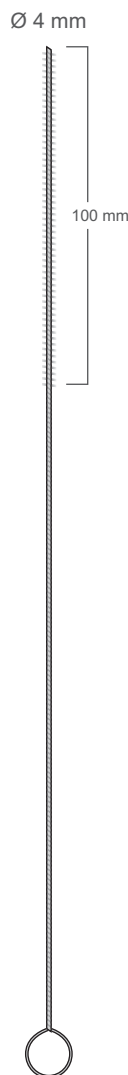

**0706-BID**  
 300 mm

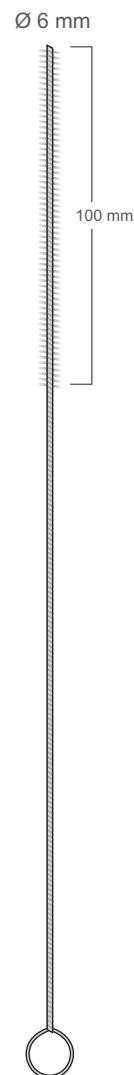

**0706-BIF**  
 300 mm

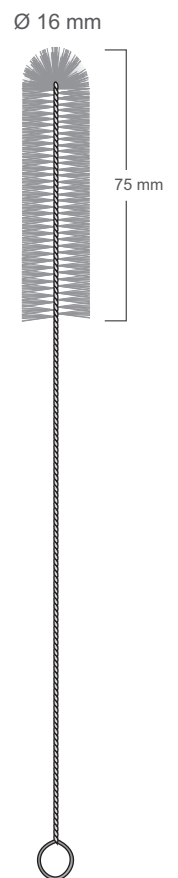

**0706-BII**  
 220 mm

.13

Kieferorthopädie  
Orthodontics  
Ortodonzia  
Ortodoncia  
Orthodontie

Zahnärztliche Chirurgie  
Dental surgery  
Chirurgia dentale  
Cirugia dental  
Chirurgie dentaire

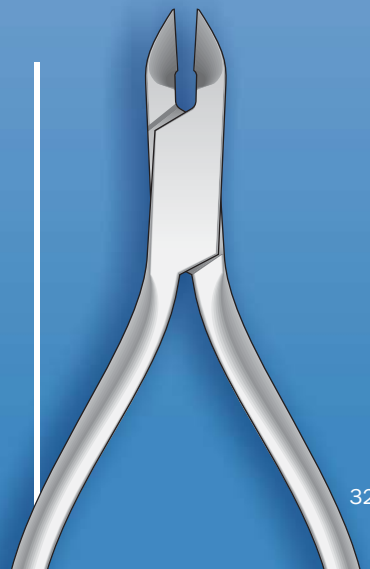



Drahtbiegezaugen  
 Wire bending Pliers  
 Pinze per piegare fili  
 Alicates para doblar alambres  
 Pincès à plier les fils

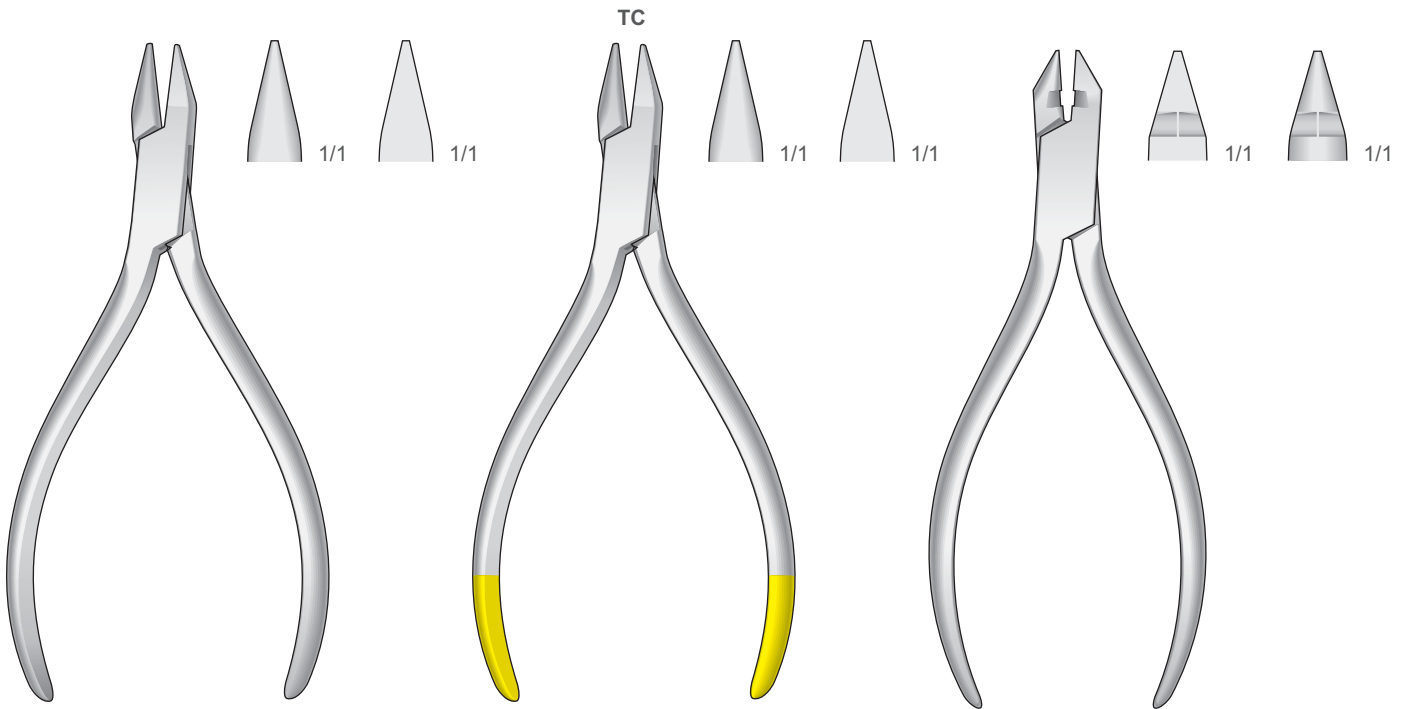

**0415-BBI**  
130 mm

**0415-BBL**  
130 mm

**0415-BCB**  
130 mm

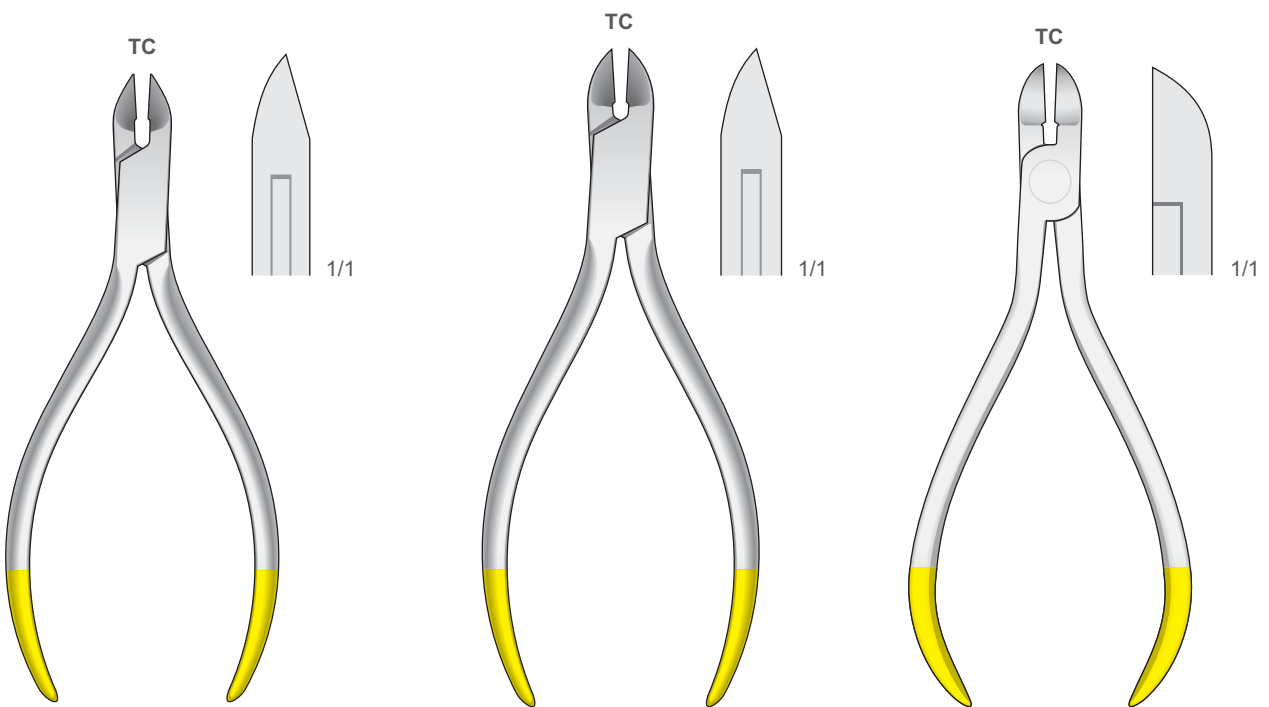

**1123-IE**  
125 mm

**1123-IF**  
130 mm

**1123-IH**  
125 mm

Drahtbiegezaugen  
Wire bending Pliers  
Pinze per piegare fili  
Alicates para doblar alambres  
Pincers à pliers les fils

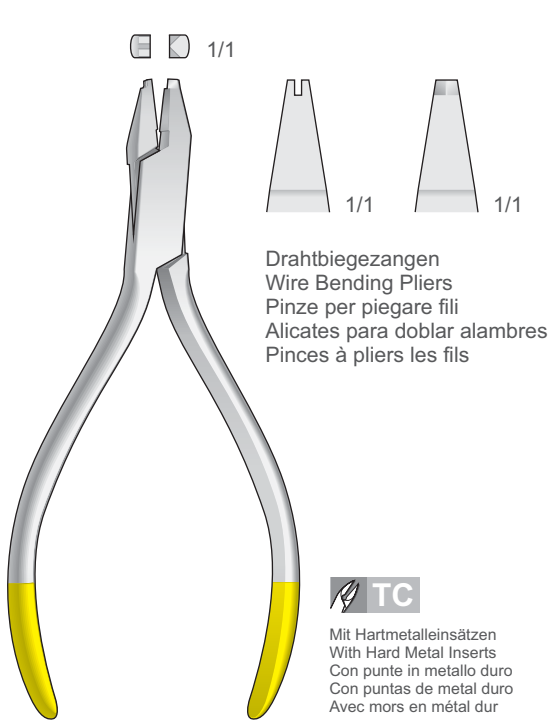

**0415-BBE**  
130 mm

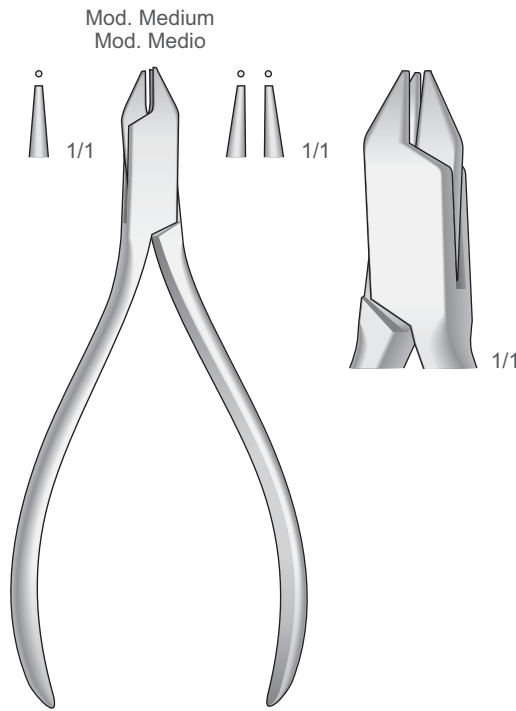

**ADERER**  
**0415-BBG**  
125 mm

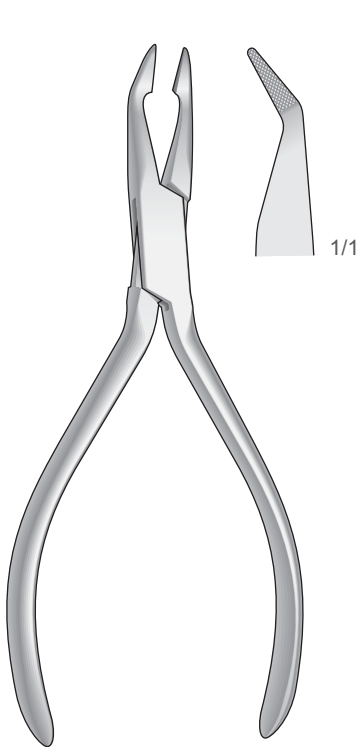

**WEINGART**  
**0415-BDE**  
140 mm

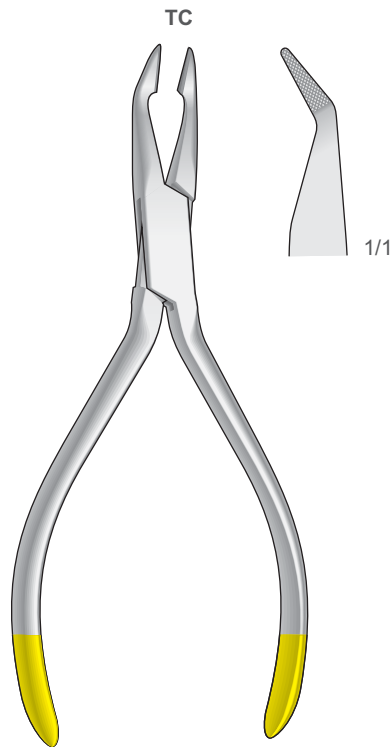

**WEINGART**  
**0415-BDF**  
140 mm

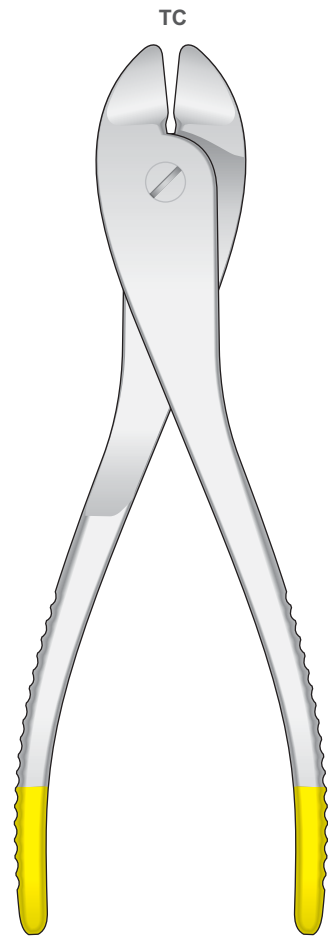

**1123-BAB**  
185 mm

Drahtschneidezangen  
Wire cutting pliers  
Tronchesi per fili metallici  
Alicates para cortar alambre  
Pinces à couper les fils

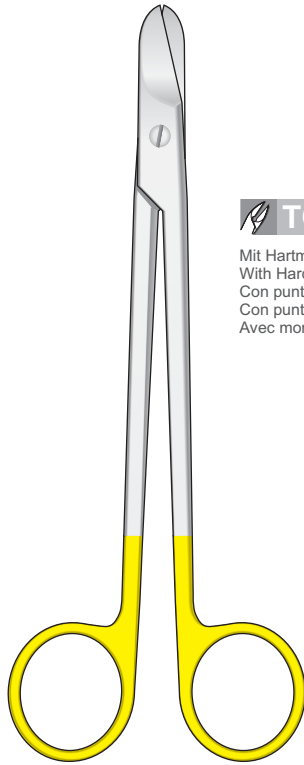

Mit Hartmetalleinsätzen  
With Hard Metal Inserts  
Con punte in metallo duro  
Con puntas de metal duro  
Avec mors en métal dur

SMITH  
0607-BGA  
160 mm

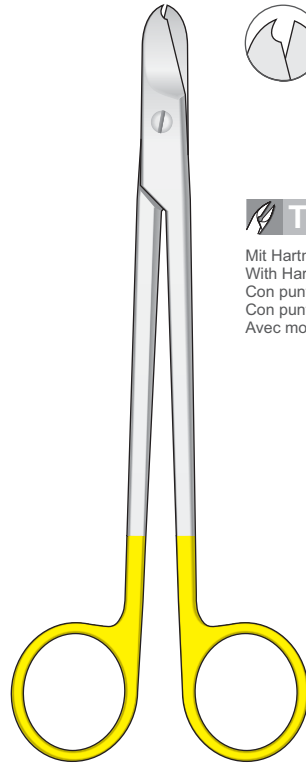

Mit Hartmetalleinsätzen  
With Hard Metal Inserts  
Con punte in metallo duro  
Con puntas de metal duro  
Avec mors en métal dur

SMITH  
0607-BGB  
160 mm

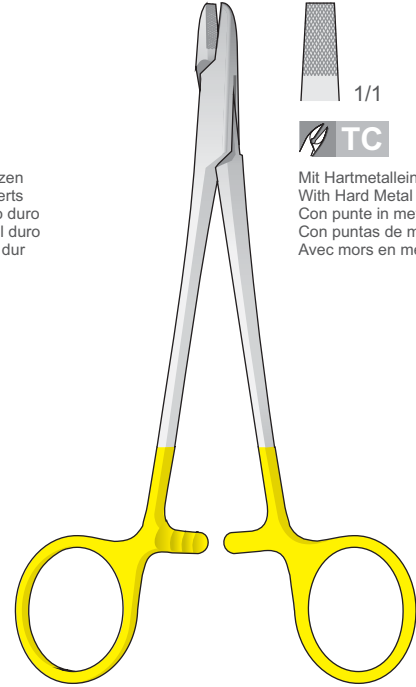

1/1



Mit Hartmetalleinsätzen  
With Hard Metal Inserts  
Con punte in metallo duro  
Con puntas de metal duro  
Avec mors en métal dur

1508-FI  
150 mm

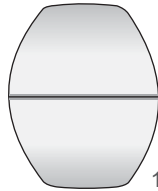
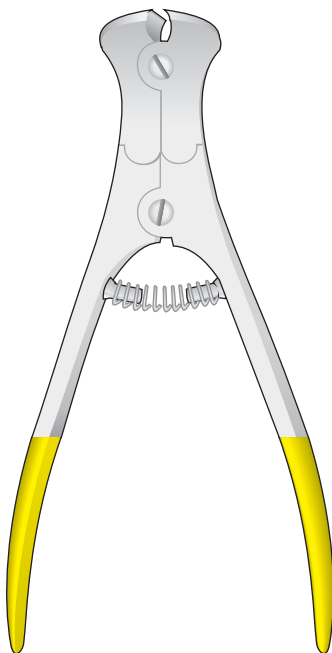

1/1



Mit Hartmetalleinsätzen  
With Hard Metal Inserts  
Con punte in metallo duro  
Con puntas de metal duro  
Avec mors en métal dur

○ Max Ø 2.0 mm (.078")

Für weichen Draht  
For soft Wire  
Per filo leggero  
Para alambre blando  
Pour fil léger

○ Max Ø 1.5 mm (.059")

Für harten Draht  
For hard Wire  
Per filo duro  
Para alambre duro  
Pour fil dur

1123-BAC  
145 mm

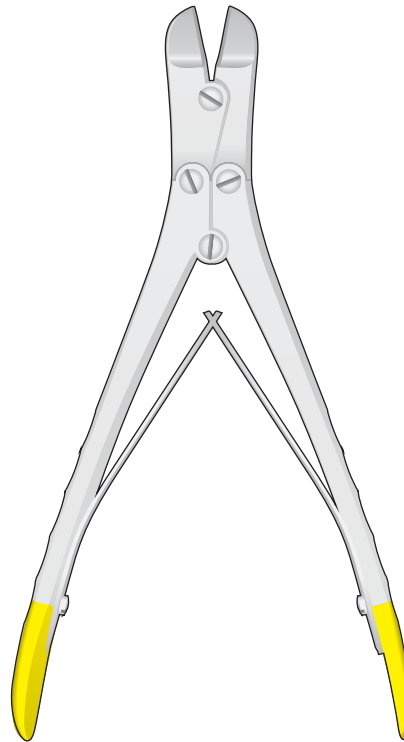

1/1



Mit Hartmetalleinsätzen  
With Hard Metal Inserts  
Con punte in metallo duro  
Con puntas de metal duro  
Avec mors en métal dur

○ Max Ø 2.0 mm (.078")

Für weichen Draht  
For soft Wire  
Per filo leggero  
Para alambre blando  
Pour fil léger

○ Max Ø 1.5 mm (.059")

Für harten Draht  
For hard Wire  
Per filo duro  
Para alambre duro  
Pour fil dur

1123-BAD  
170 mm

Scheren für dünne Stahl-und Edelmetallbleche - Scissors for thin steel and precious metal sheets  
Forbici per lamine sottili di acciaio e metalli preziosi - Tijeras para láminas delgadas de acero y metales preciosos  
Ciseaux pour couper les feuilles de métaux



Scheren für dünne Stahl-und Edelmetallbleche - Scissors for thin steel and precious metal sheets  
Forbici per lamine sottili di acciaio e metalli preziosi - Tijeras para láminas delgadas de acero y metales preciosos  
Ciseaux pour couper les feuilles de métaux

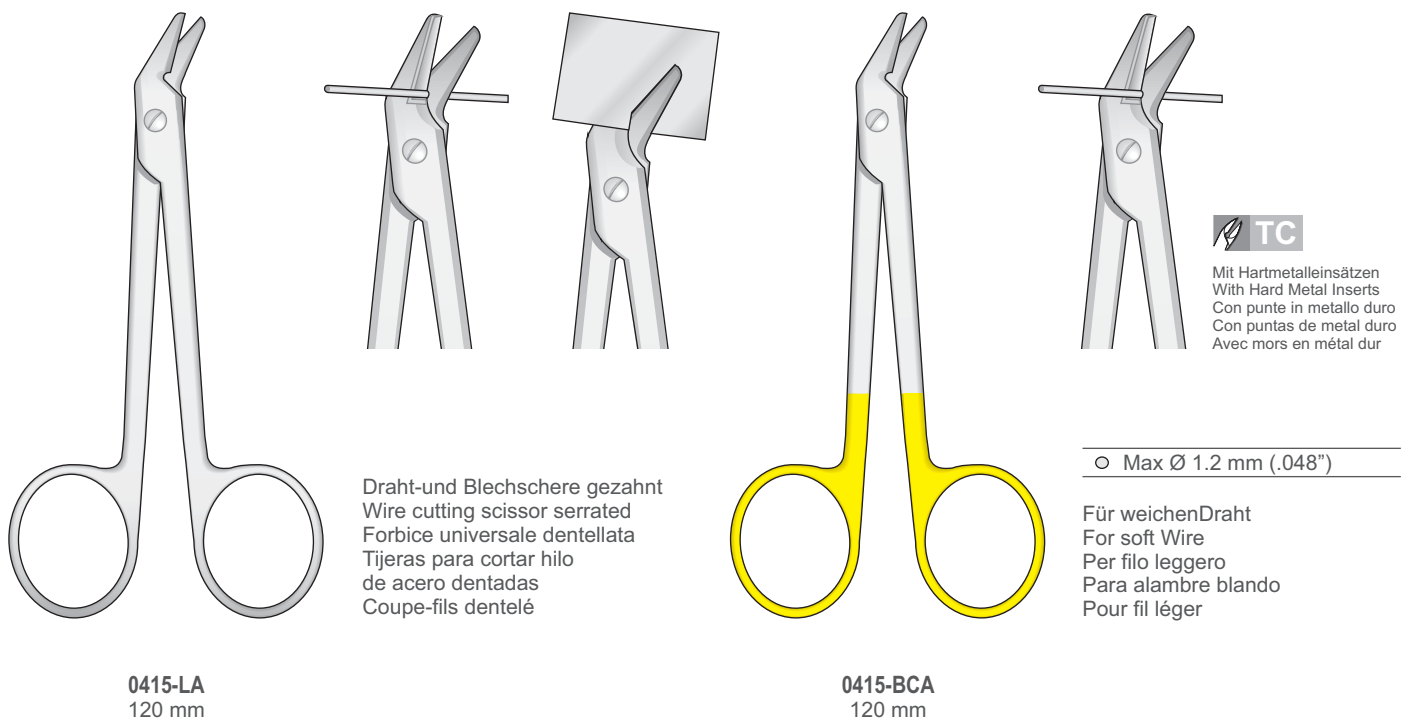



Separierzangen  
Separating Pliers  
Pinze tendielastici  
Pinza estira-elásticos  
Pince à separer

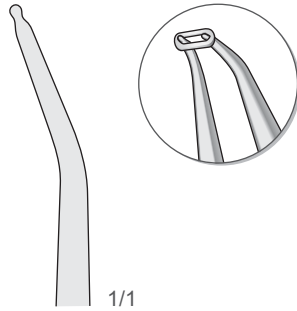
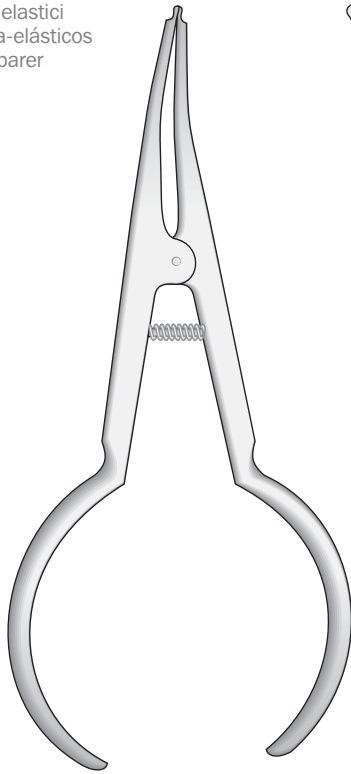

Separierzange, zum Einbringen von Gummi-Separierligaturen  
Separating forceps, for inserting elastic separators  
Pinze per legature per separatori elastci  
Pinza para ligaduras estira elásticos  
Pince à serrer les ligatures

**0406-CA**  
155 mm



2,5 x 1,0 mm

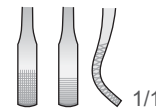

**SHURE**  
**0415-BCE**  
175 mm

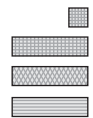

**0415-FE**  
175 mm

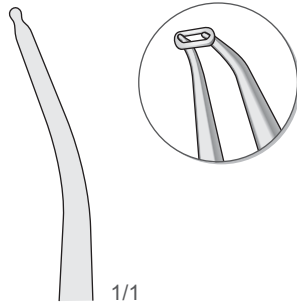
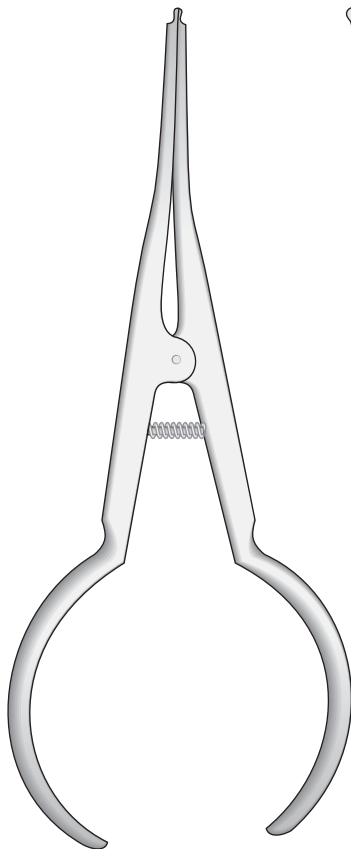

Separierzange, zum Einbringen von Gummi-Separierligaturen  
Separating forceps, for inserting elastic separators  
Pinze per legature per separatori elastci  
Pinza para ligaduras estira elásticos  
Pince à serrer les ligatures

**0406-CB**  
170 mm

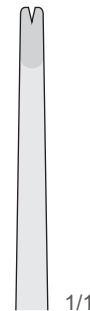
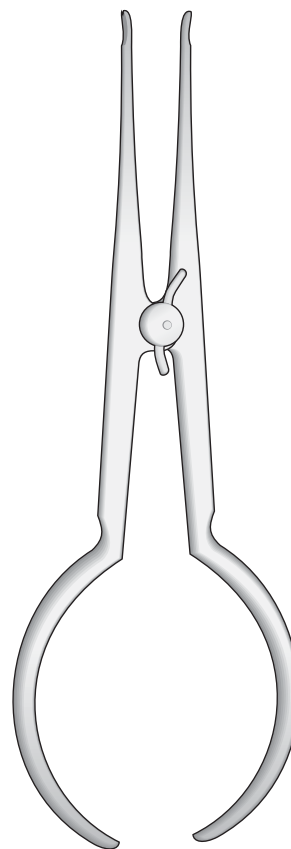

Ligaturenspannzange  
Ligature Tying Plier  
Pinza per legature  
Pinza para ligaduras  
Pince à serrer les ligatures

**0406-FA**  
170 mm

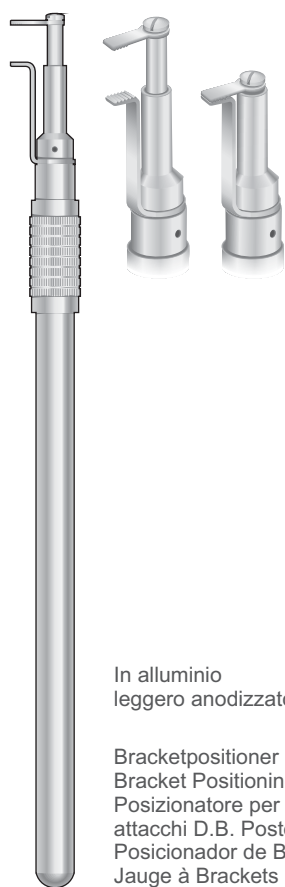

Bandandrücker  
Band Pusher  
Spingibande  
in acciaio inox  
Empujador de bandas  
Instruments pour  
poser les bagues

Con punta dentellata

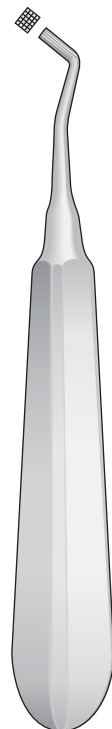

In alluminio  
leggero anodizzato

Bracketpositioner  
Bracket Positioning Gauge  
Posizionatore per  
attacchi D.B. Posteriori  
Posicionador de Brackets  
Jauge à Brackets

0415-BAA  
170 mm

MERSHON  
0415-FA  
140 mm

Direzionatori  
di legature

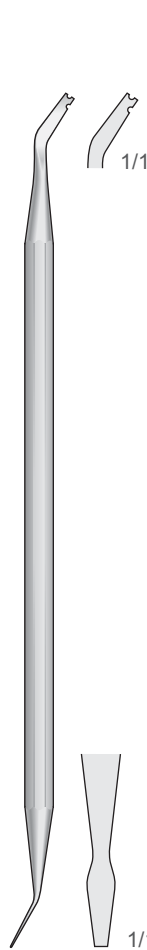

0415-BCF  
155 mm

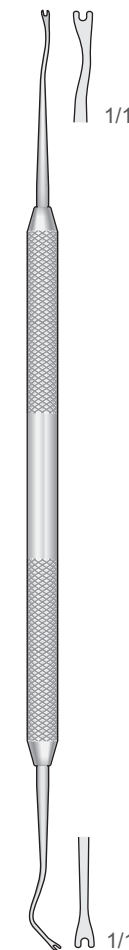

1506-B  
170 mm



1506-C  
170 mm



1506-D  
160 mm

Ligaturen-Setzer  
Twirl on instrument  
Applicatore per  
legature elastiche  
Instrumentos para  
aplicar las ligaduras  
Instrument pour  
appliquer  
les ligatures

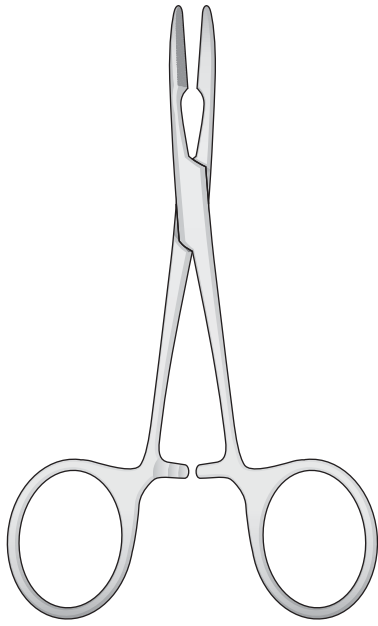

PEAN-MURPHY  
0206-CC  
130 mm

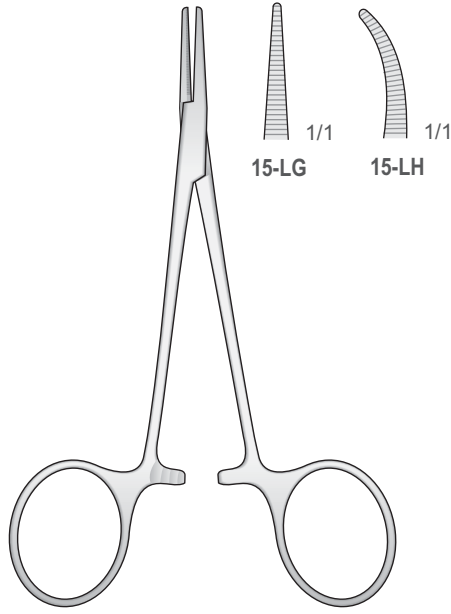

HALSTED-MOSQUITO  
15-LG/15-LH  
120 mm



03141111050705  
150 mm

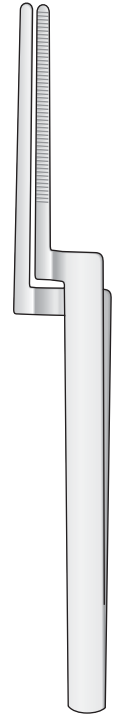

MILLER  
0417-HI  
145 mm

Bracketset Pinzette - Forceps for positioning Brackets  
Pinzette per riposizionare gli attacchi diretti  
(posizionamento dei Bracket)  
Pinza para colocar Brackets - Précelle pour positionner les Brackets

Bracket Gauge  
Rostfrei - Inox  
Acciaio temperato  
Acero temperado  
Acer



0415-BDC  
130 mm



0415-BDD  
130 mm



0415-FC  
130 mm



0415-BCG  
110 mm

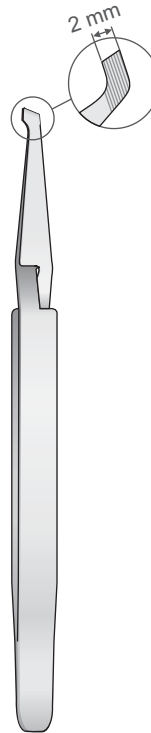

0415-BCH  
125 mm



0415-BCI  
145 mm

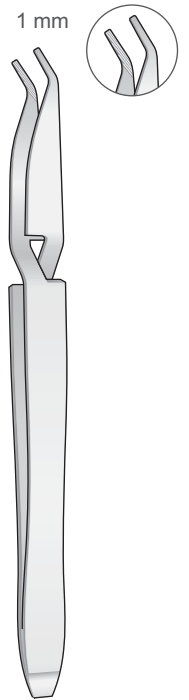

0415-BCL  
130 mm

Dental-Schieblehre für Praxis und Labor  
Gauge Caliper for practice and laboratory  
Calibri dentali per studio e laboratorio  
Calibrador dental para el gabinete y el laboratorio  
Gauge calibreur pour cabinet et laboratoire

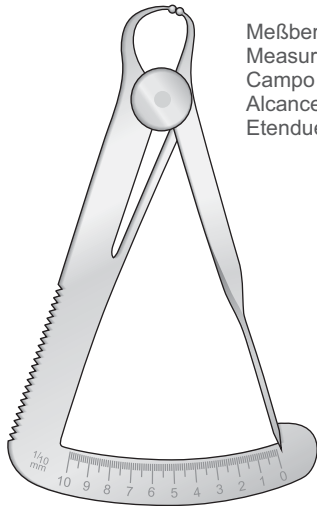

Meßbereich: 0 - 10 mm  
Measuring range: 0 - 10 mm  
Campo di misura: 0 - 10 mm  
Alcance de medición: 0 - 10 mm  
Etendue de mesure: 0 - 10 mm

IWANSON  
**0415-HCB**  
100 mm

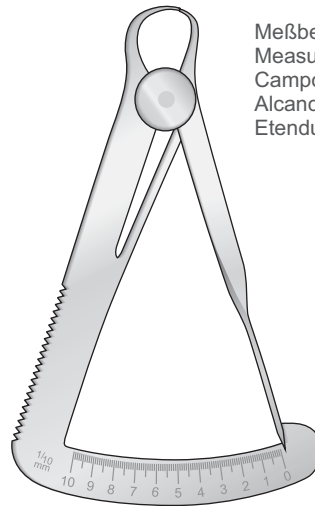

Meßbereich: 0 - 10 mm  
Measuring range: 0 - 10 mm  
Campo di misura: 0 - 10 mm  
Alcance de medición: 0 - 10 mm  
Etendue de mesure: 0 - 10 mm

IWANSON  
**0415-HCA**  
100 mm

Meßbereich: 0 - 100 mm  
Measuring range: 0 - 100 mm  
Campo di misura: 0 - 100 mm  
Alcance de medición: 0 - 100 mm  
Etendue de mesure: 0 - 100 mm

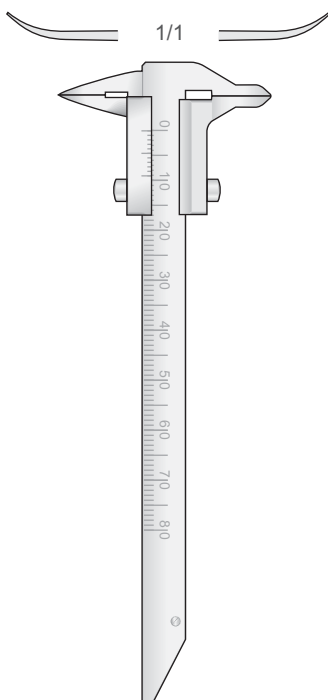

**0415-HCD**  
80 mm

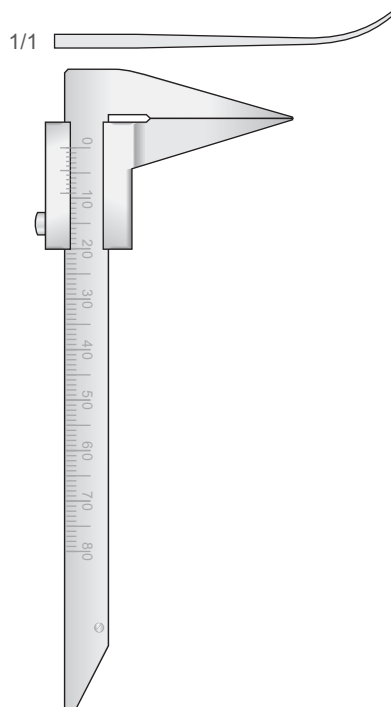

**0415-HCE**  
80 mm

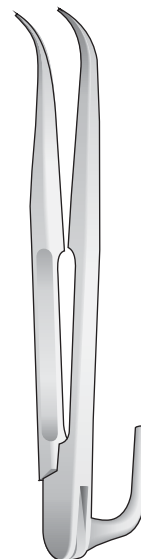

ZIELINSKY  
**0415-HCF**  
110 mm

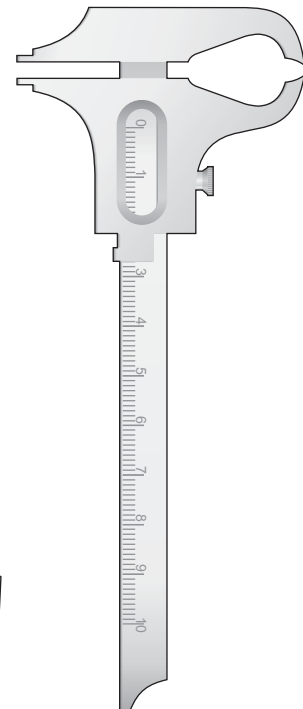

BOLEY  
**0415-HDA**  
140 mm

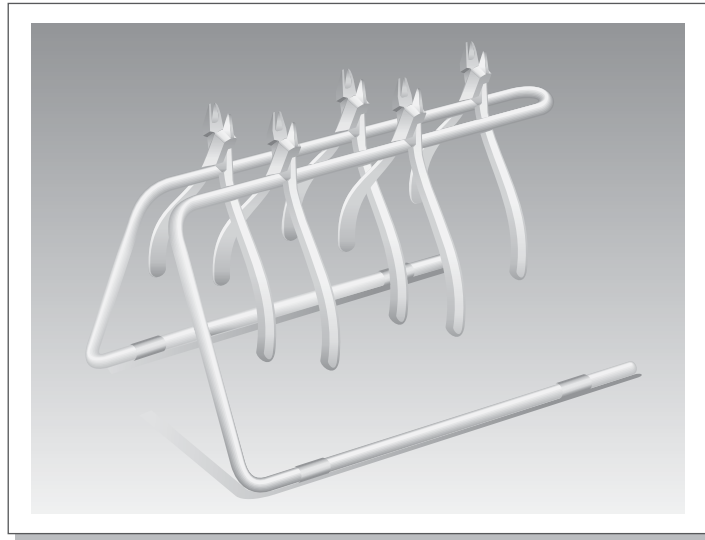

Zangenständer  
Plier Stand  
Supporto per pinze  
Soportes para alicates  
Supports de pinces

Rostfrei - Stainless Steel  
Acciaio Inox - Acero - Acier

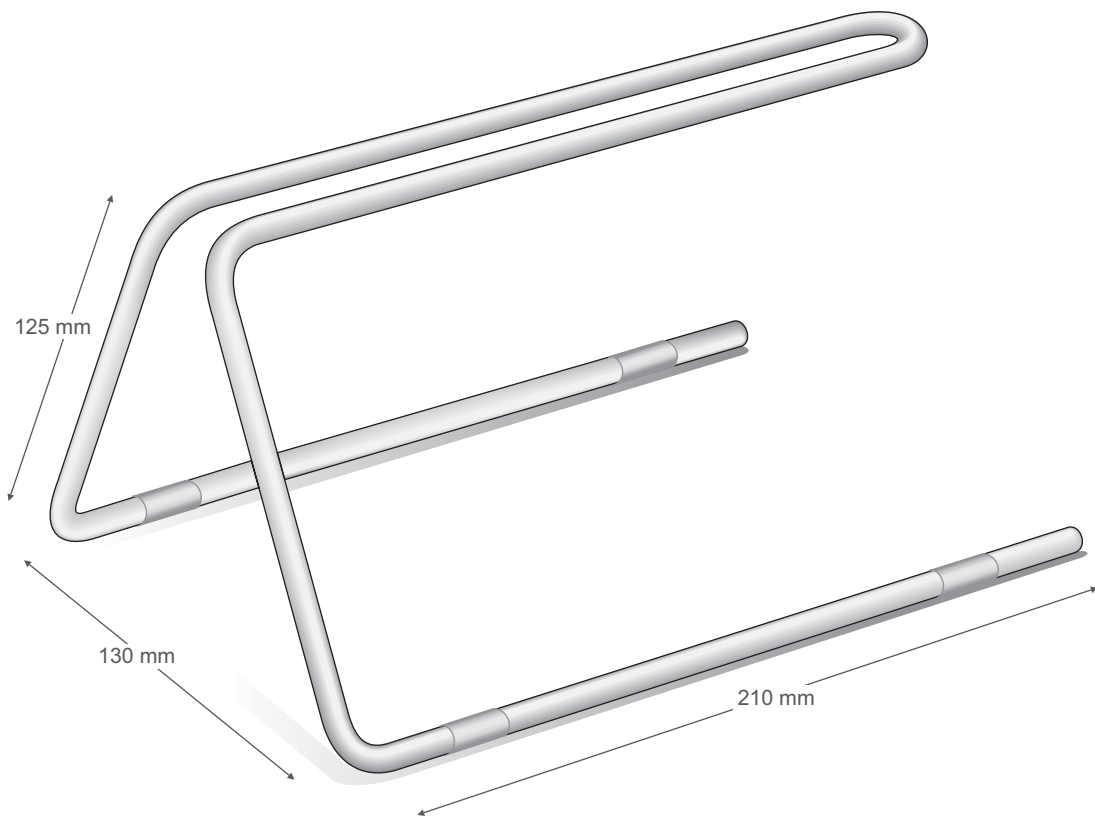

0415-BEA



.14

Kroneninstrumente und Labor  
Crown Instruments and Laboratory  
Strumenti per corone e laboratorio  
Instrumentos para coronas y laboratorio  
Instruments à couronnes et laboratoire

Zahnärztliche Chirurgie  
Dental surgery  
Chirurgia dentale  
Cirugia dental  
Chirurgie dentaire







Kroneninstrumente  
 Crown Instruments  
 Pinze per corone  
 Alicates para coronas  
 Pincas à couronnes

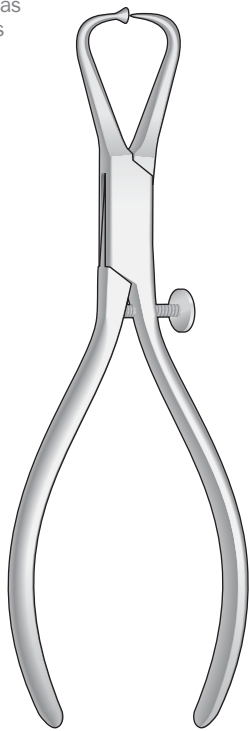

**KERLING**  
**0415-DI01**  
 145 mm

Kupferringabnehmezange  
 Copper ring removing Pliers  
 Pinza per togliere anelli di rame  
 Pinza para sacar anillos de cobre  
 Pince à enlever les bagues en cuivre

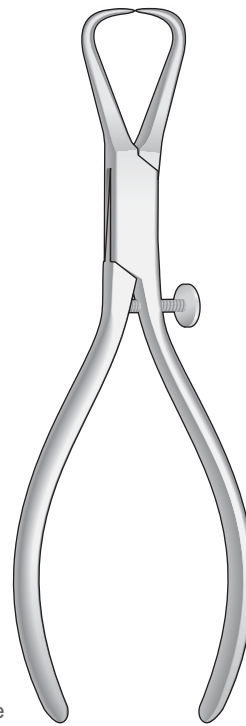

**FURRER**  
**0415-DI**  
 145 mm

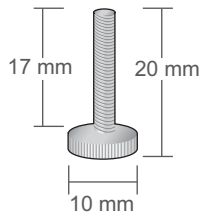

**0415-DI17**  
 Schraube  
 Replacement Scraw  
 Vite di ricambio  
 Tornillos de recambio  
 Rechange

Kupferringabnehmezange  
 Copper ring removing Pliers  
 Pinza per togliere anelli di rame  
 Pinza para sacar anillos de cobre  
 Pince à enlever les bagues en cuivre

Teleskopkronenzangen - Pliers for telescope crowns  
 Pinze per corone telescopiche - Alicates para coronas telescópicas  
 Pincas pour couronnes telesopes

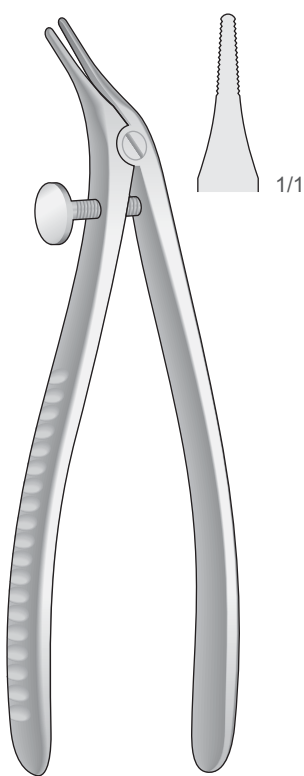

**BÖHM**  
**0415-CI**  
 150 mm

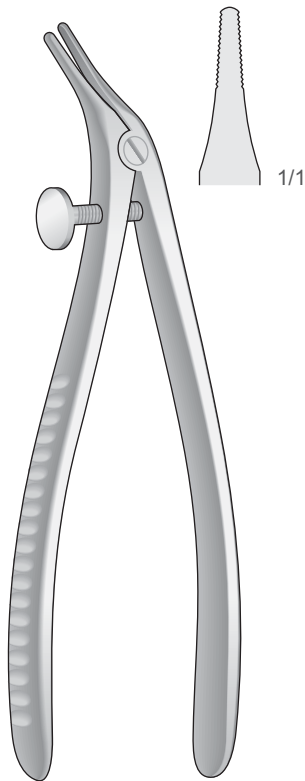

**BÖHM**  
**0415-CL**  
 150 mm

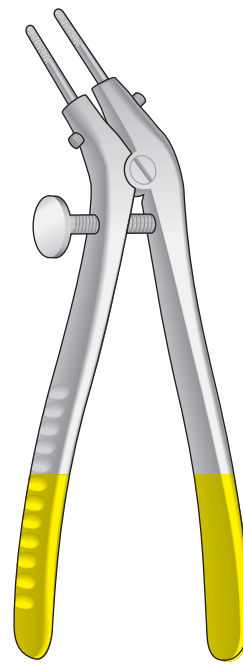

**0415-CE**  
 120 mm

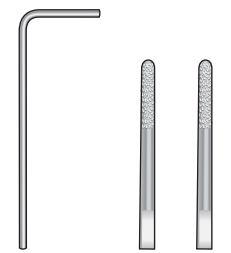

**0415-CE03** **0415-CE17**  
 Schlüssel  
 Key  
 Chiavetta  
 Llave  
 Clé  
 Diamantierte Einsätze, paarweise  
 Diamond inserts, in pairs  
 Coppia di punte diamantate  
 Puntas diamantadas, a pares  
 Pointes diamantées, par paires

121719/03H

Bridge - Extractor complete set  
 consisting of:  
**MRT-7, C-71, C-72, C-73, C-74**

Martelletto togliiponti completo di:  
**MRT-7, C-71, C-72, C-73, C-74**

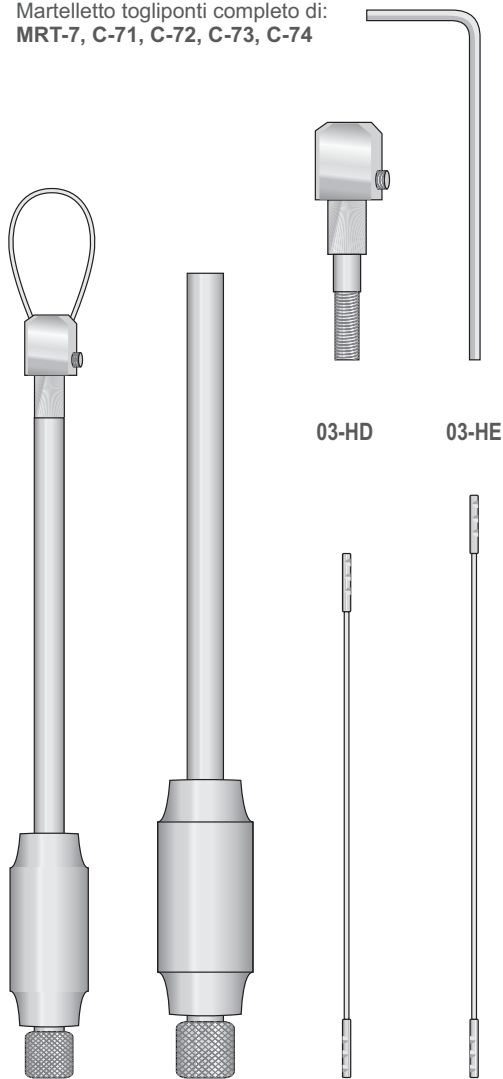

121719/03H

121719-H

03-HB  
70 mm

03-HC  
80 mm

03-HD

03-HE

Kronenabnehmer  
 Removing pliers  
 for temporary  
 bridges and crowns  
 Levacorone  
 Scador de coronas  
 Arrache couronne

TC

Mit Silikon  
 With silicone insert  
 Con inserto in silicone  
 Con inserto de silicon  
 Avec insert en silicon

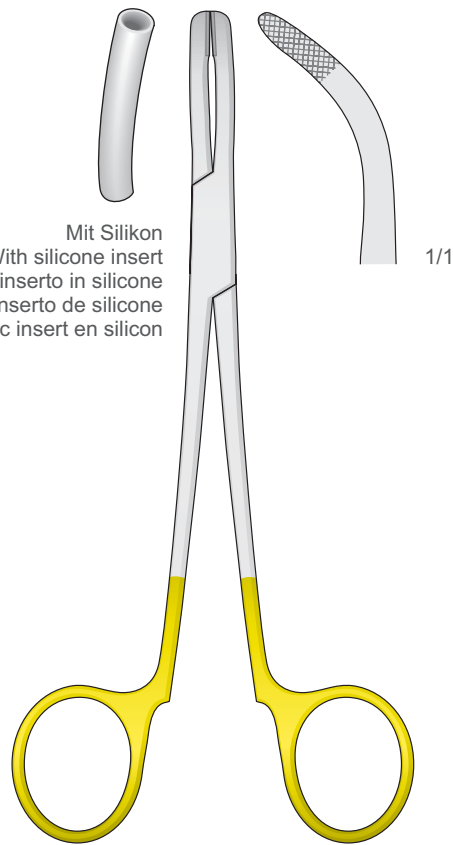

1508-GA  
170 mm

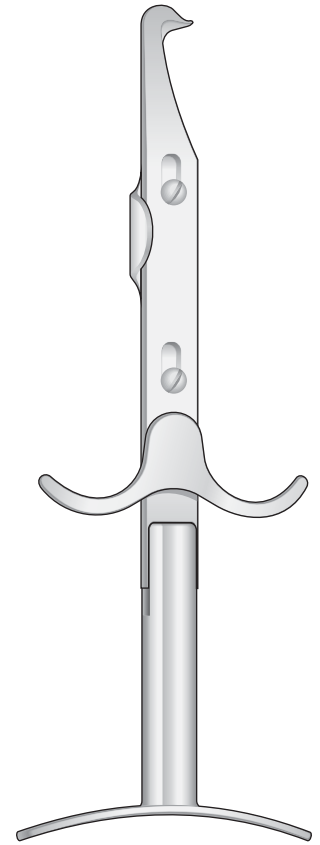

121719-G  
170 mm

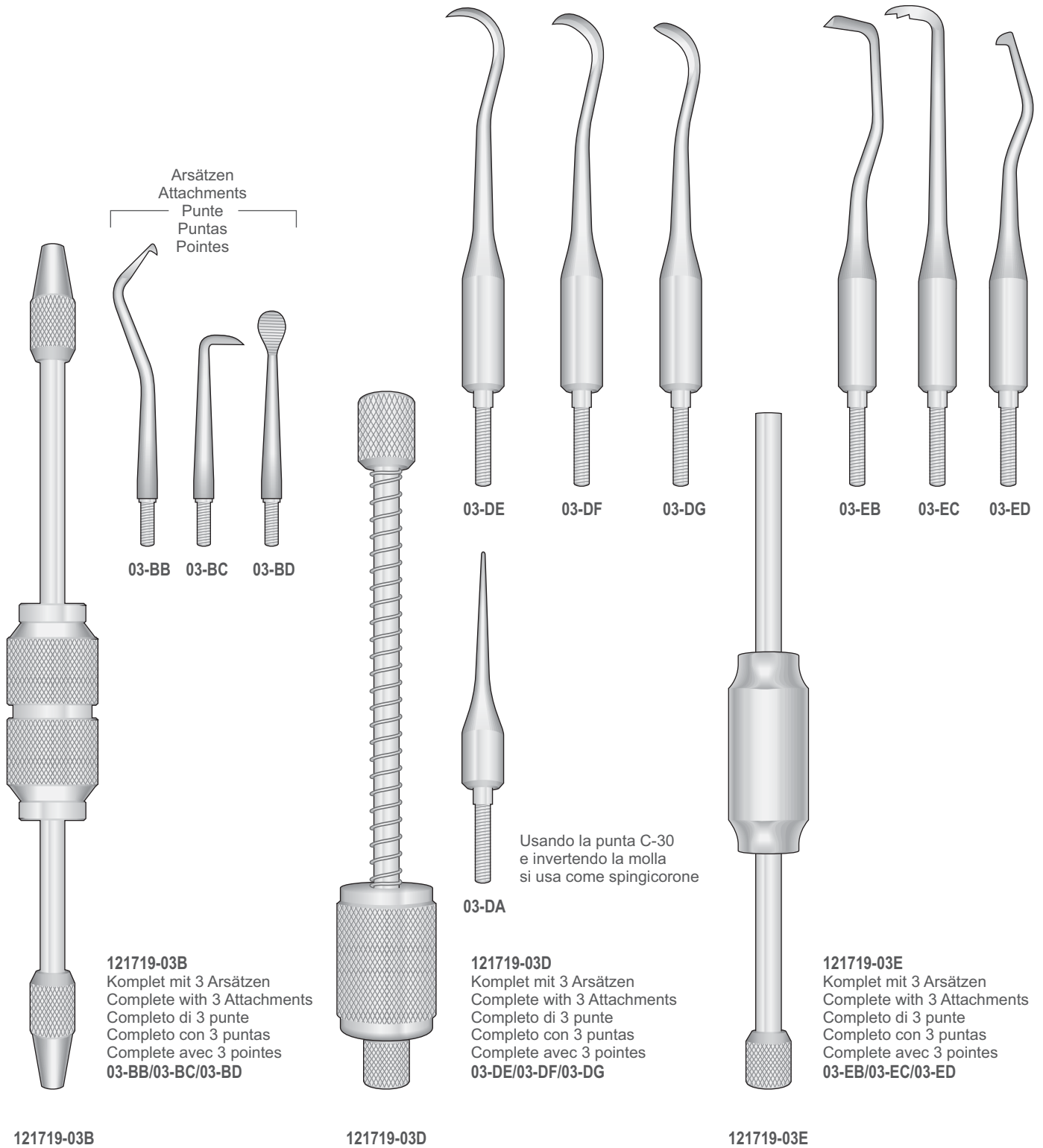

Arsätzen  
Attachments  
Punte  
Puntas  
Pointes

03-BB 03-BC 03-BD

03-DE 03-DF 03-DG 03-EB 03-EC 03-ED

03-DA

Usando la punta C-30  
e invertendo la molla  
si usa come spingicorone

**121719-03B**  
Komplet mit 3 Arsätzen  
Complete with 3 Attachments  
Completo di 3 punte  
Completo con 3 puntas  
Complete avec 3 pointes  
**03-BB/03-BC/03-BD**

**121719-03D**  
Komplet mit 3 Arsätzen  
Complete with 3 Attachments  
Completo di 3 punte  
Completo con 3 puntas  
Complete avec 3 pointes  
**03-DE/03-DF/03-DG**

**121719-03E**  
Komplet mit 3 Arsätzen  
Complete with 3 Attachments  
Completo di 3 punte  
Completo con 3 puntas  
Complete avec 3 pointes  
**03-EB/03-EC/03-ED**

121719-03B

121719-03D

121719-03E



Kronenabnehmer  
Crown removers  
Levacorone  
Instrumentos para quitar coronas  
Instruments à détacher les couronnes

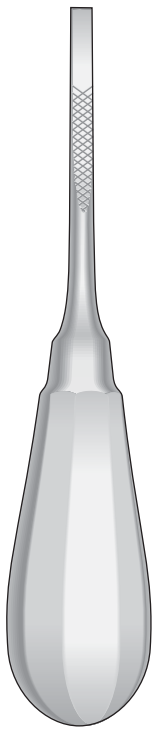

0411-03  
140 mm



0411-21  
130 mm

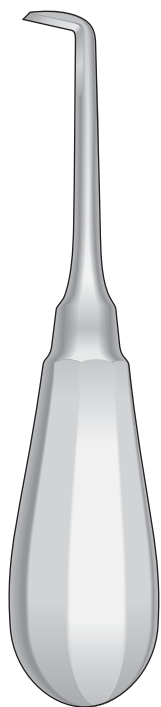

0411-A  
130 mm



UNIVERSAL  
0411-GA  
150 mm

Replacement Kit Consisting of 10 couples  
Plastic-Polymer Tips and 10 g. Powder Adhesive  
Kit di ricambio con 10 coppie di inserti  
in plastica e 10 gr. di polvere adesiva

Powder adhesive  
Polvere adesiva  
10 gr.

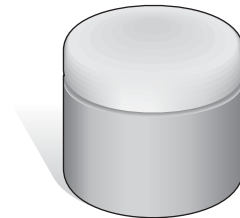

10 Couples  
10 Coppie



0415-BDH

Kronenaufweitzange  
Crown extraction pliers with  
interchangeable plastic tips  
Pinza per corone

**0415-BDG**  
Set consisting of 1 ea. Crown-tractor  
and 10 Plastic-Polymer tips, and 10g. Powder Adhesive  
Set completo di pinza per corone,  
10 coppie di inserti in plastica e 10 gr. di polvere adesiva

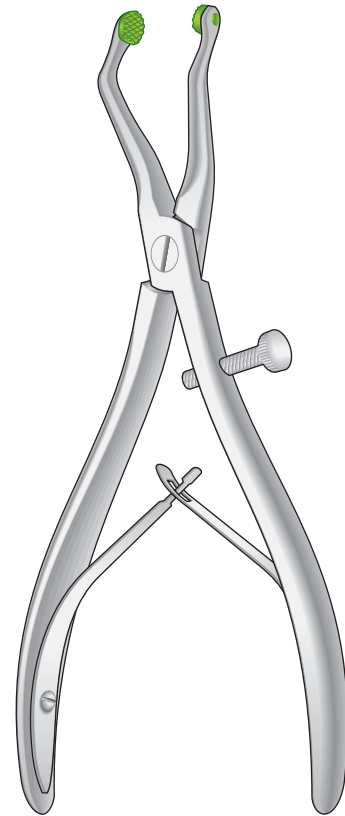

0415-BDG  
140 mm

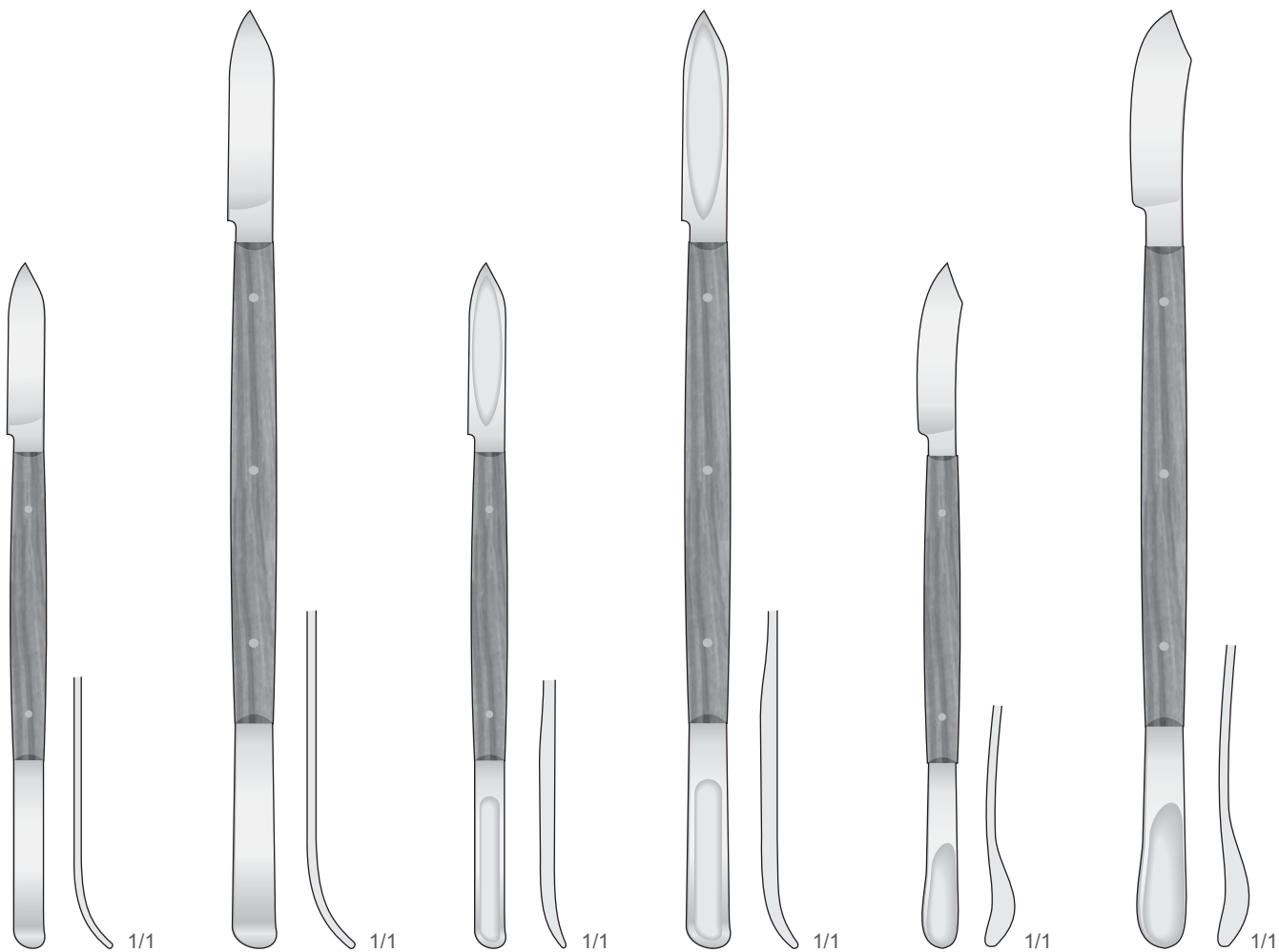

FAHNENSTOCK  
0315

FAHNENSTOCK  
0307

LESSMANN  
031511

LESSMANN  
030711

031518

030718

Biegsam  
Flexible  
Flessibili  
Flexibles  
Flexibles

Spatel Inox  
Spatulas Inox - Rigid  
Spatola Inox - Rigida



**GRITMAN**  
**0312**  
175 mm

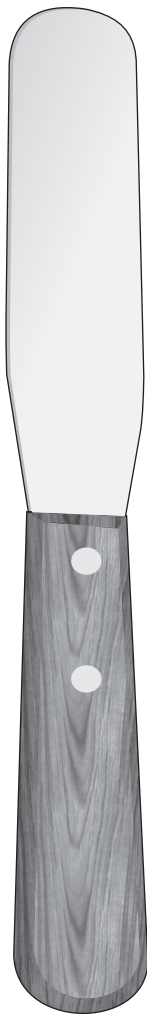

**1801-B**  
200 mm



**1801-C**  
200 mm



**1801-D**  
200 mm

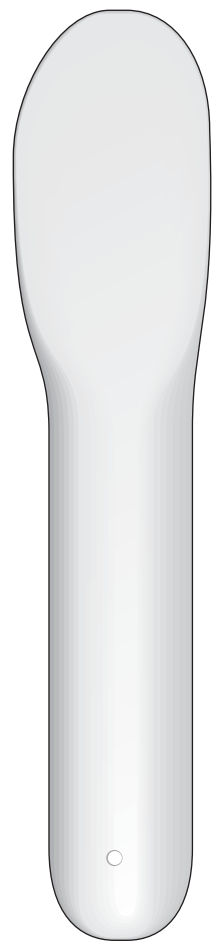

**18BI-I**  
185 mm

Runder Hohlgriff 8 mm  
 Hollow Round Handle 8 mm  
 Manico tondo vuoto 8 mm  
 Mango hueco 8 mm  
 Manche rond vide 8 mm

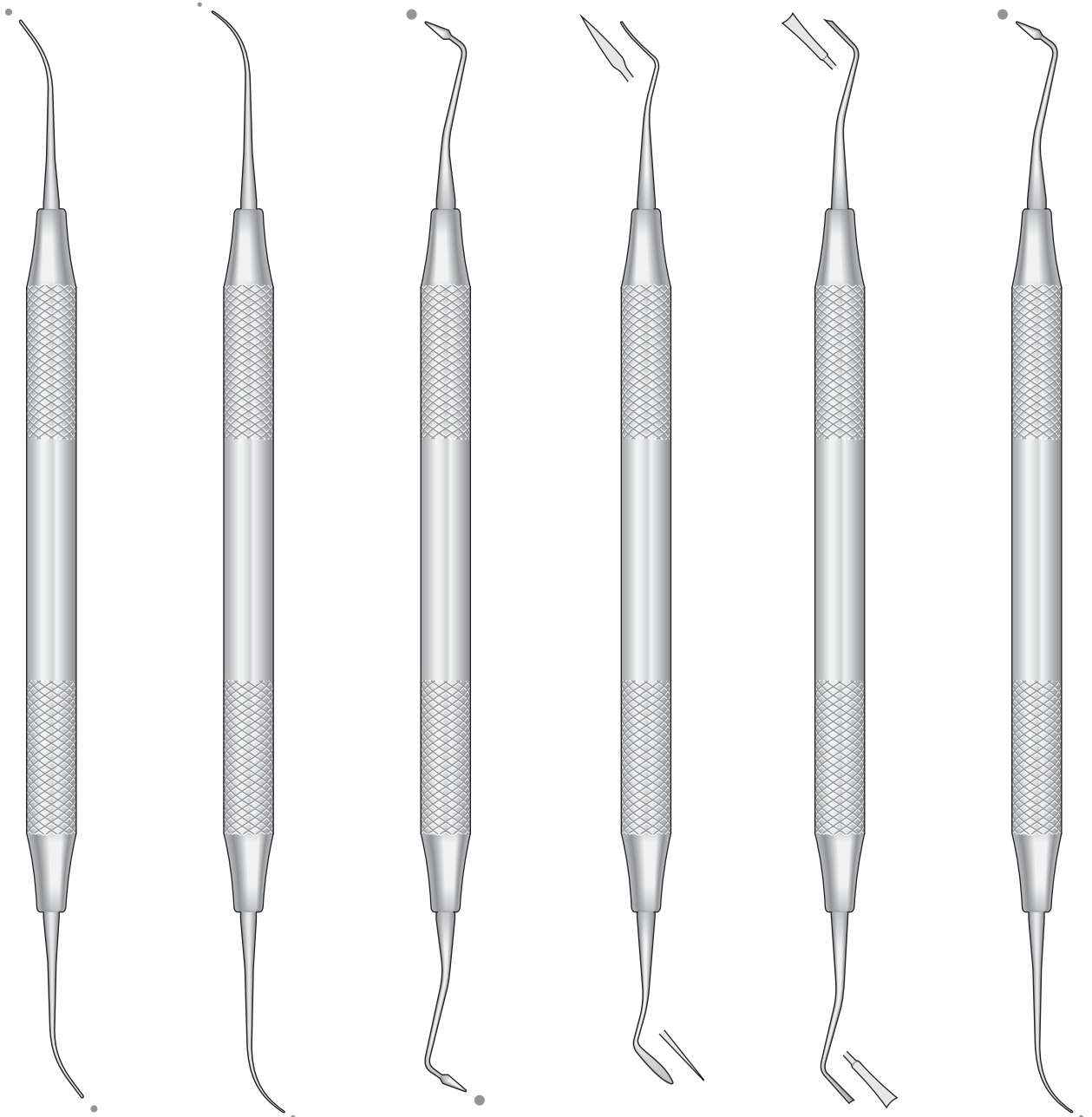
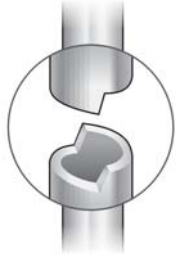

P.K. THOMAS  
**HFB-BCB**  
 165 mm

P.K. THOMAS  
**HFB-BCC**  
 165 mm

P.K. THOMAS  
**HFB-BCD**  
 165 mm

P.K. THOMAS  
**HFB-BCE**  
 165 mm

P.K. THOMAS  
**HFB-BCF**  
 165 mm

P.K. THOMAS  
**HFB-C/D**  
 165 mm

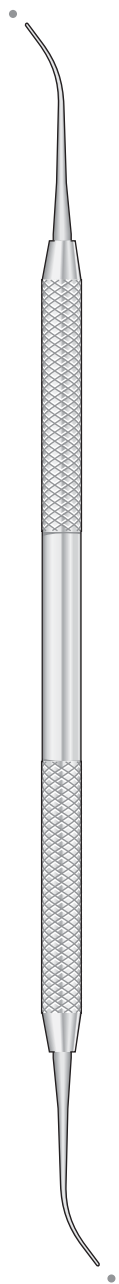

P.K. THOMAS  
**1519-B**  
 165 mm

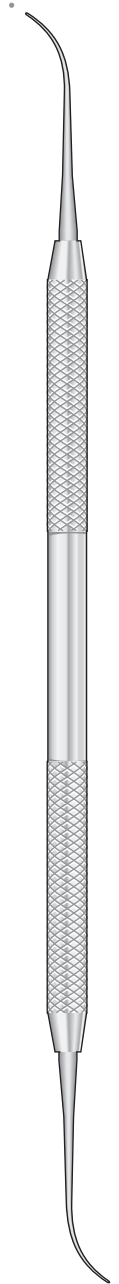

P.K. THOMAS  
**1519-C**  
 165 mm

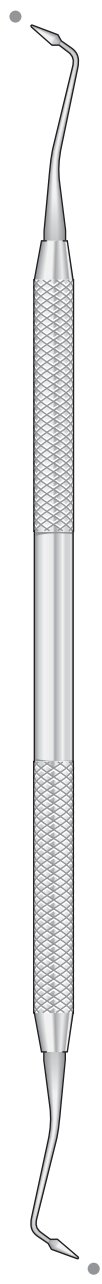

P.K. THOMAS  
**1519-D**  
 165 mm

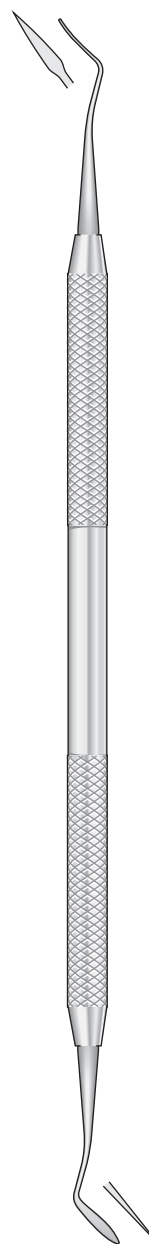

P.K. THOMAS  
**1519-E**  
 165 mm

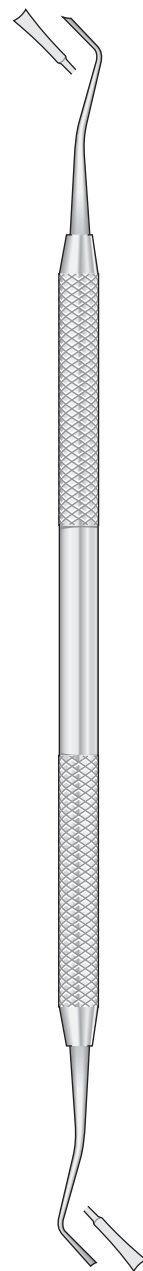

P.K. THOMAS  
**1519-F**  
 165 mm



Instrumente für Labor  
 Instruments for laboratory  
 Strumenti da laboratorio  
 Instrumentos para laboratorio  
 Instruments pour laboratoire

Alu  
 Aluminium  
 Alluminio  
 Aluminium  
 Aluminio

Runder Hohlgriff 8 mm  
 Hollow Round Handle 8 mm  
 Manico tondo vuoto 8 mm  
 Mango hueco 8 mm  
 Manche rond vide 8 mm

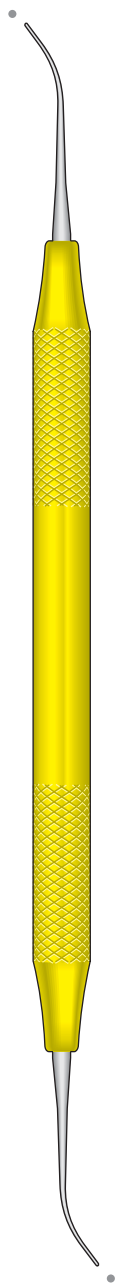
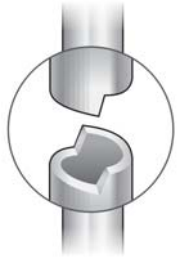

P.K. THOMAS  
**0111-1519B**  
 165 mm

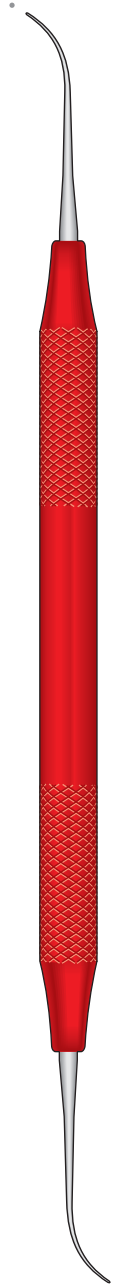

P.K. THOMAS  
**0111-1519C**  
 165 mm

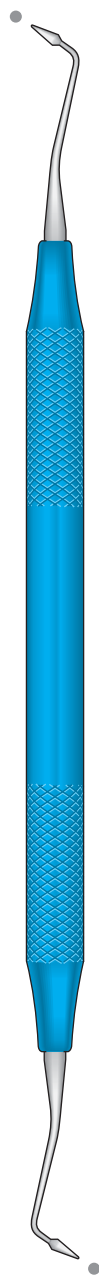

P.K. THOMAS  
**0111-1519D**  
 165 mm

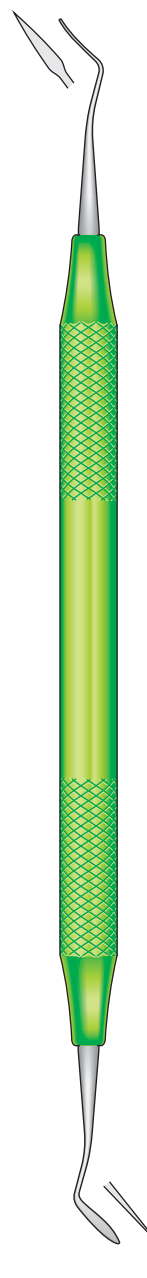

P.K. THOMAS  
**0111-1519E**  
 165 mm

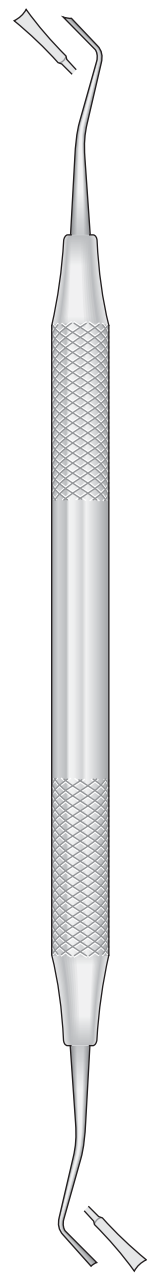

P.K. THOMAS  
**0111-1519F**  
 165 mm

Modellierinstrumente für Keramik  
 Ceramic sculpturing instruments  
 Strumenti per ceramica  
 Instrumentos para modelar la ceramica  
 Instruments à modeler la céramique

Alu  
 Aluminium  
 Alluminio  
 Aluminium  
 Alumínio

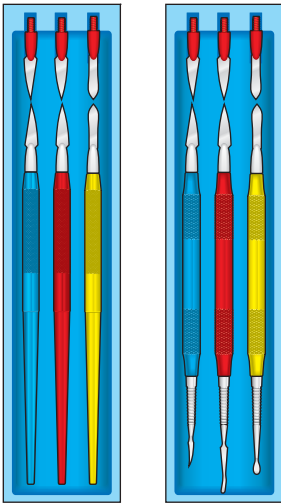

Biegsam - Flexible  
 Flessibili - Flexibles  
 Flexibles

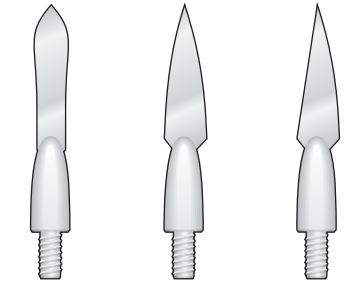

0311-B02    0311-C02    0311-D02

Superbiegsam - Superflexible  
 Superflessibili - Superflexibles  
 Superflexibles

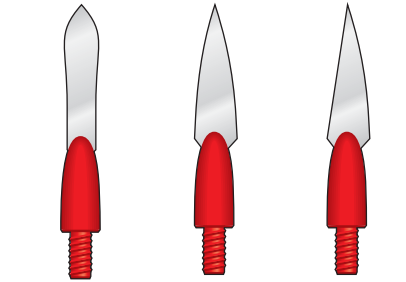

0311-B17    0311-C17    0311-D17

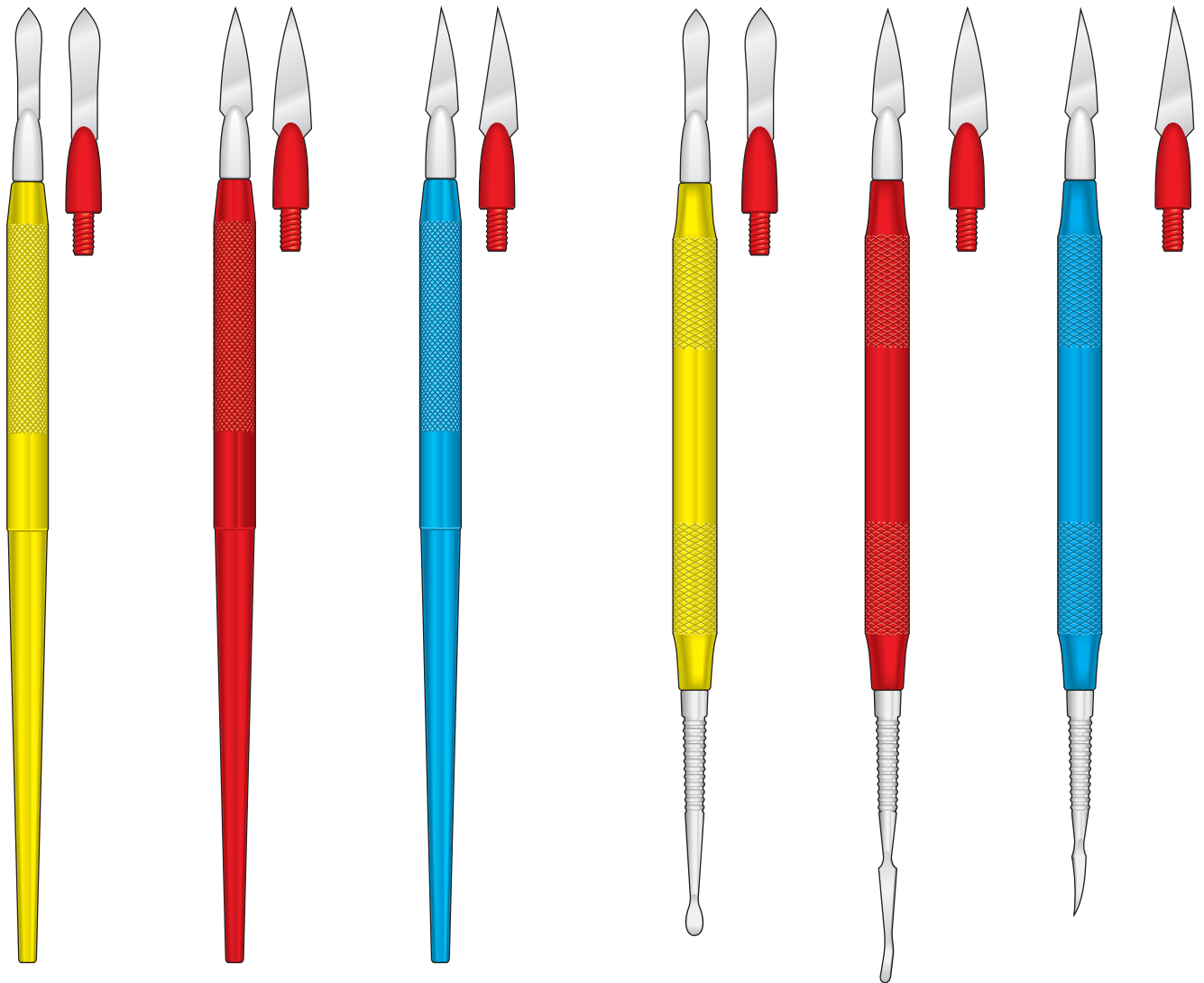

0111-180519/03B

0111-180519/03C

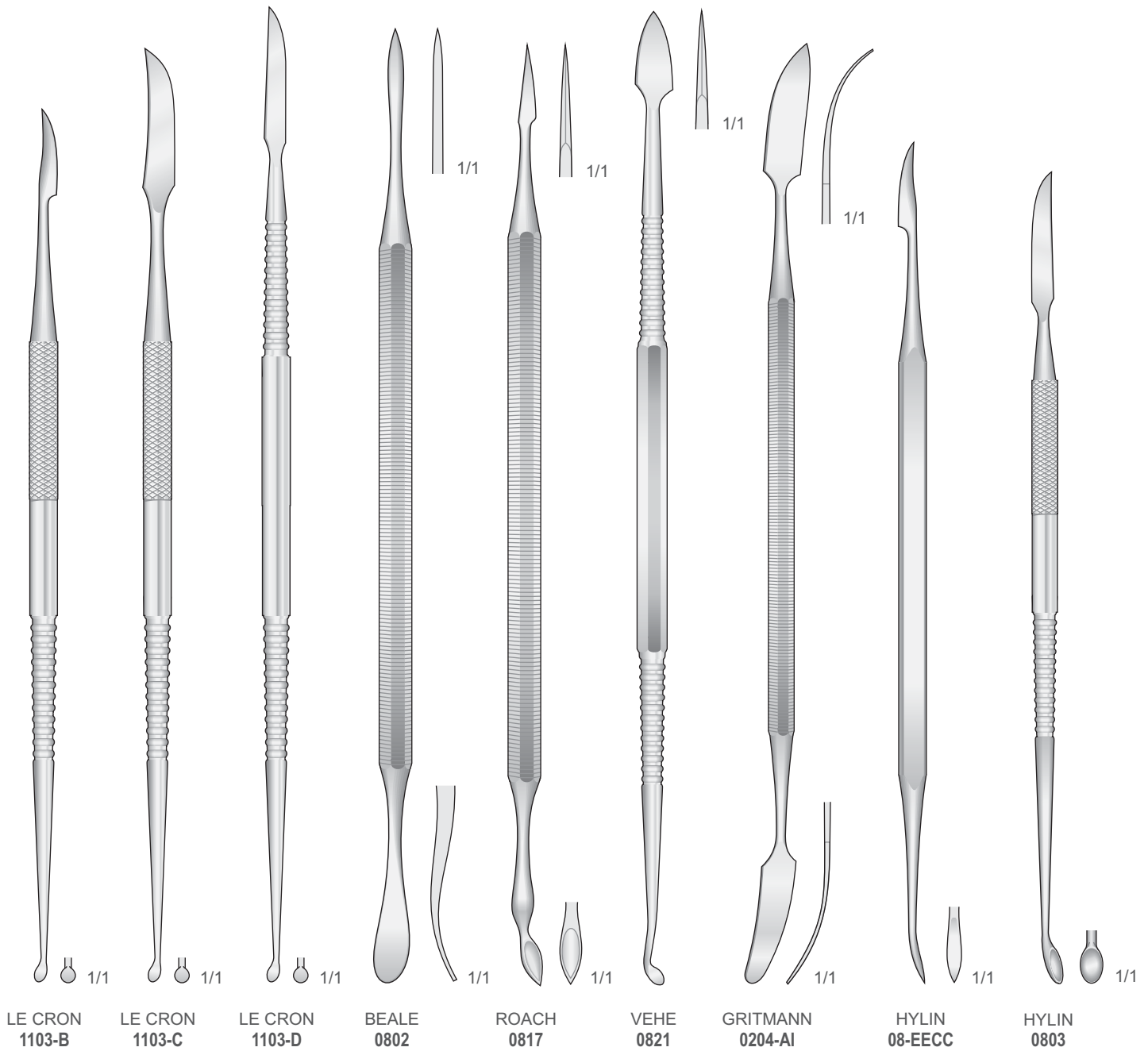

**LE CRON**  
1103-B

**LE CRON**  
1103-C

**LE CRON**  
1103-D

**BEALE**  
0802

**ROACH**  
0817

**VEHE**  
0821

**GRITMANN**  
0204-AI

**HYLIN**  
08-EECC

**HYLIN**  
0803

Gipsschneidezange  
 Plaster cutting pliers  
 Cesioia taglia gesso  
 Alicates para cortar yeso  
 Pince à couper le piâtre

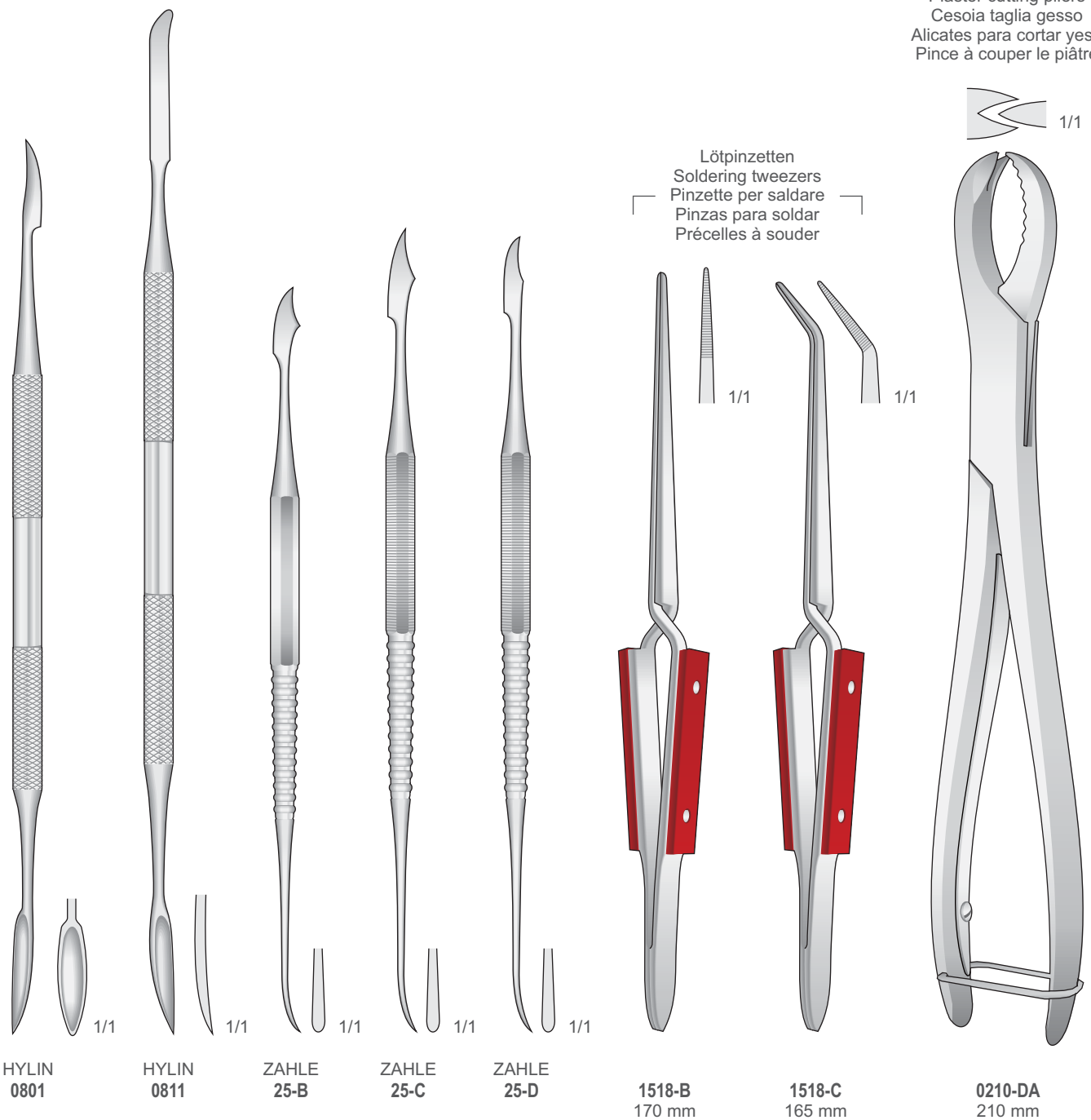

HYLIN  
0801

HYLIN  
0811

ZAHLE  
25-B

ZAHLE  
25-C

ZAHLE  
25-D

1518-B  
170 mm

1518-C  
165 mm

0210-DA  
210 mm

Lötpinzetten  
 Soldering tweezers  
 Pinzette per saldare  
 Pinzas para soldar  
 Précelles à souder

.15

Erhaltung für instrumente, Sterilisieretuis  
Maintening of instruments, Sterilizing Boxes  
Mantenimento strumenti, Scatole per sterilizzazione  
Mantenimiento del instrumental, Estuches de asterilización  
Nettoyage d'instruments, Etais de stérilisation

Zahnärztliche Chirurgie  
Dental surgery  
Chirurgia dentale  
Cirugia dental  
Chirurgie dentaire







Gefäße aus Edelstahl  
Stainless Steel Receptacles  
Recipienti in acciaio inossidabile  
Recipientes de acero inoxidable  
Réceptientes en acier inoxydable

Nadeldose  
Needle case  
Scatola per aghi  
Caja para agujas  
Boite à aiguilles



**0218-B**  
Ø 78 mm h 15 mm

Verbandstofftrommeln  
Dressing sterilizing drums  
Cestelli cilindrici  
Cajas para esterilizacion  
Boites à stérilisation



**0318-BC** 125x125 mm  
**0318-BF** 150x150 mm  
**0318-BL** 190x145 mm

Nierenschalen  
Kidney bowls  
Bacinelle reniformi  
Riñoneras  
Bassins réniformes



**0217-CA** 200 mm  
**0217-CF** 250 mm  
**0217-CI** 280 mm

Runder Sterilbehälter mit Ausguss  
Lotion bowis capsules  
Capsule inox con fondo piano e becco  
Cubetas de acero inoxidable  
Cuvettes de acier inoxydable

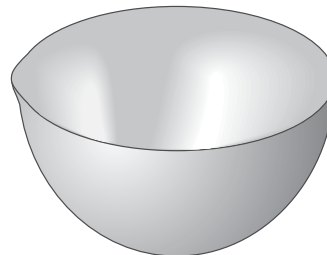

**0318-AB** Ø 40 mm 15 cc  
**0318-AC** Ø 60 mm 75 cc  
**0318-AD** Ø 80 mm 225 cc  
**0318-AE** Ø 100 mm 325 cc  
**0318-AF** Ø 120 mm 500 cc

Gefäße  
Receptacles  
Recipiente  
Recipientes  
Réceptientes



**0218-DC**  
180 x 85 x 20 mm

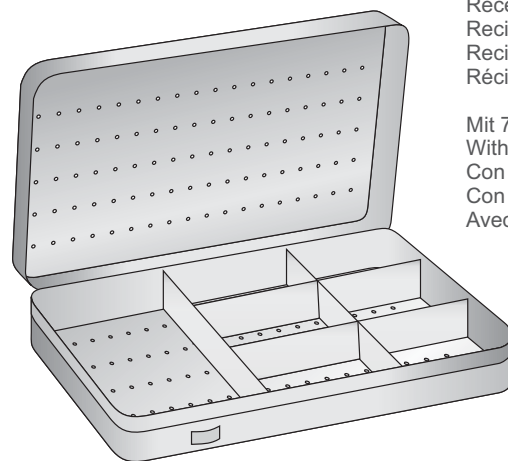

**0218-CH**  
150 x 90 x 20 mm

Mit 7 box  
With 7 box  
Con 7 box  
Con 7 box  
Avec 7 box

Schalen  
Trays  
Vassoi porta-strumenti  
Bandejas  
Bassins



**2118-CA** 210 x 110 x 25 mm  
**2118-CG** 250 x 180 x 30 mm  
**2118-DA** 300 x 220 x 30 mm

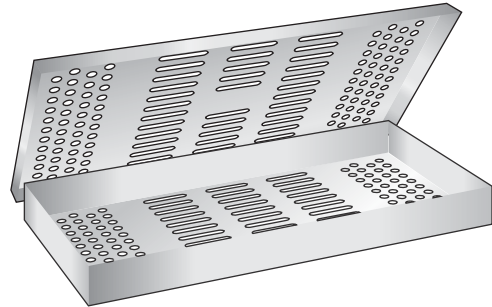

**0218-EB**  
275 x 130 x 25 mm

Mit Instrumentehalter und box  
With Insert frames and box  
Con griglia e scomparti  
Con porta instrumentos y box  
Avec Porte instruments et box

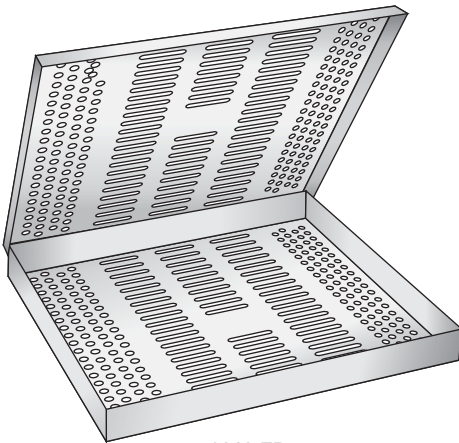

**0218-ED**  
285 x 190 x 25 mm

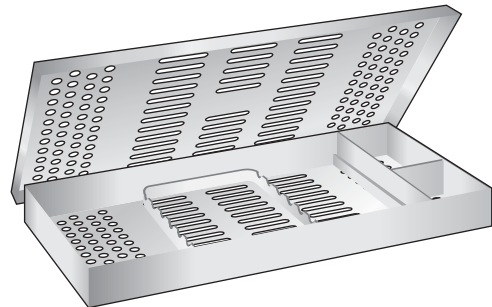

**0218-EA** 275x130x25mm  
**0218-EC** 285x190x25mm

Silikonmatte  
Matte en silicone  
Tappeti in aghi di silicone  
Tapete en agujas de silicona  
Tapis en Silicone

Sterilisierbar  
Autoclavable  
Autoclavabili

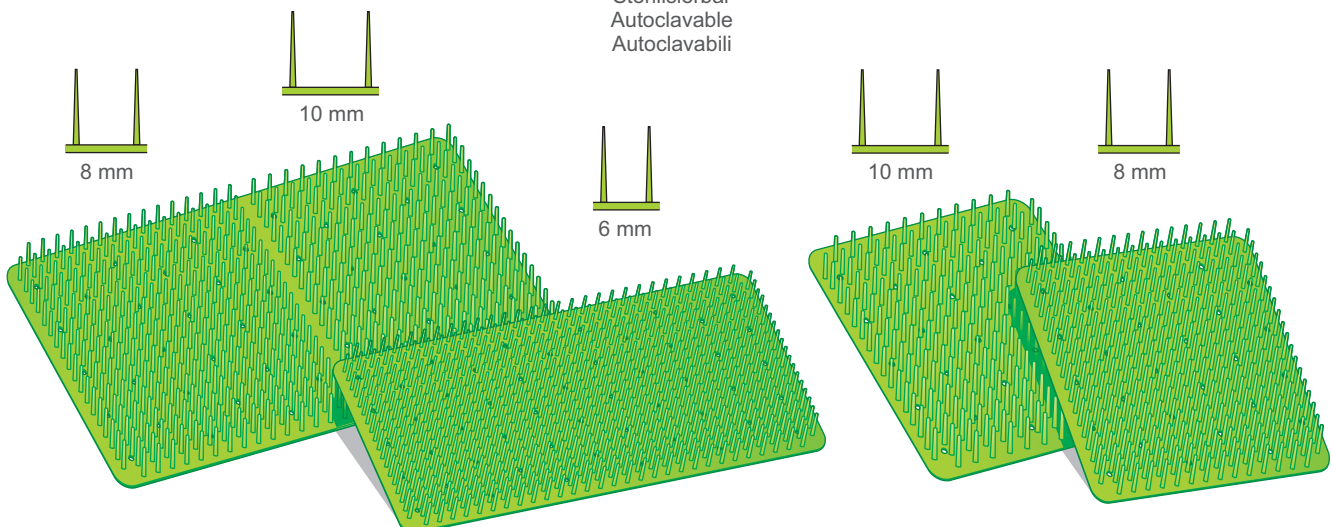

**1918-BAE**  
270 x 180 mm

**1918-BAD**  
260 x 120 mm

**1918-BAC**  
135 x 180 mm

**1918-BAB**  
135 x 180 mm





Dental Trays Container  
 Dental Trays Containers  
 Trays Contenitori per sterilizzare  
 Trays Contenedores para esterilización  
 Trays Containers pour stérilizer

Tray Inox mit Silikoneinrichtung - Stainless Steel Cassettes with Silicone Racks  
 Tray Inox con griglia in silicone - Recipientes de acero con equipo de silicona  
 Cassettes en acier avec aménagement en silicone

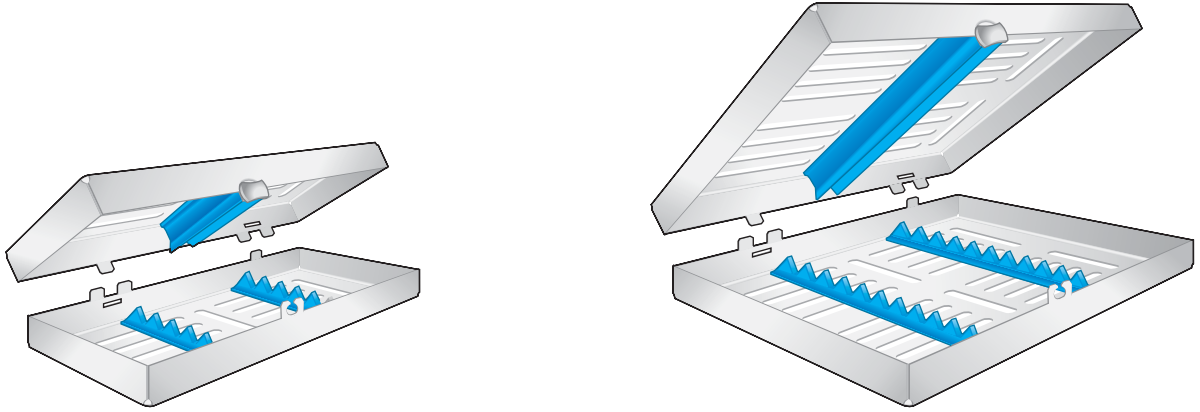

**0218-FL** Für 5 Instrumente  
 For 5 Instruments  
 Per 5 strumenti  
 Para 5 instrumentos  
 Pour 5 instruments  
 185 x 75 x 35 mm

**0218-GA** Für 10 Instrumente  
 For 10 Instruments  
 Per 10 strumenti  
 Para 10 instrumentos  
 Pour 10 instruments  
 185 x 135 x 35 mm

**0218-GB** Für 20 Instrumente  
 For 20 Instruments  
 Per 20 strumenti  
 Para 20 instrumentos  
 Pour 20 instruments  
 290 x 185 x 35 mm

**0319-FFF**  
**0319-FGA**  
**0319-FGF**



**0319-GFB**  
**0319-GFC**  
**0319-GFD**



**Sterilcontainer,**  
 mit Deckel- und Bodenperforation,  
 passend in gängige Praxisautoklaven  
**Containers for sterilization,**  
 with perforation in lid and bottom,  
 suitable for common practice autoclaves  
**Contenitori dentali,**  
 con coperchio e fondo perforato,  
 adatti a tutte le autoclavi comuni  
**Contenedores dentales,**  
 con tapa perforada y fondo perforado,  
 aptos para autoclaves habituales  
**Containers stérile,**  
 avec perforation du couvercle et du fond,  
 convenant aux autoclaves courants  
 pour cabinets médicaux

Silikoneinrichtung für Tray  
 Silicone Racks for Tray  
 Griglia in Silicone per Tray  
 Equipo de silicona para Tray  
 Aménagement en silicone pour Tray



**0319-FFF**  
 300 x 140 x 40 mm  
**0319-GFB**  
 310 x 190 x 40 mm

**0319-FGA**  
 300 x 140 x 70 mm  
**0319-GFC**  
 310 x 190 x 65 mm

**0319-FGF**  
 300 x 140 x 100 mm  
**0319-GFD**  
 310 x 190 x 130 mm

Alu  
 Aluminium  
 Alluminio  
 Aluminio  
 Aluminium

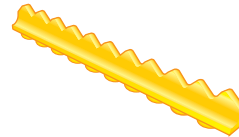

**TRANSLUCENT YELLOW**  
**180911-AB**  
 130 mm

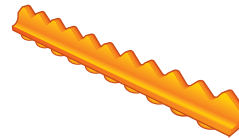

**ORANGE**  
**180911-AC**  
 130 mm

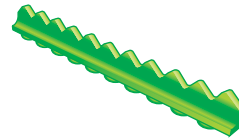

**TRANSLUCENT GREEN**  
**180911-AD**  
 130 mm

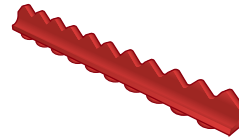

**RUST RED**  
**180911-AE**  
 130 mm

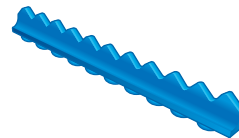

**BLUE**  
**180911-AF**  
 130 mm

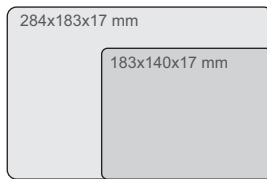

Farbcodiert-Tray-Unterteile für 17 instrumente  
Color-Coded bases for 17 instruments  
Vassoio colorati per 17 strumenti  
Bandejas en colores para 17 instrumentos  
Plateaux colorés pour 17 instruments

Für 17 instrumente  
For 17 instruments  
Per 17 strumenti  
Para 17 instrumentos  
Pour 17 instruments

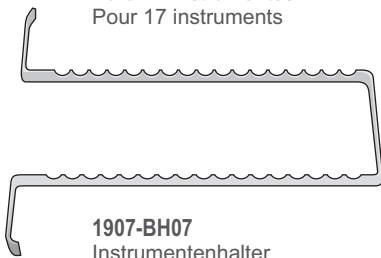

**1907-BH07**  
Instrumentenhalter  
Insert frames  
Griglia Portastrumenti  
Porta instrumentos  
Porte instruments



**1907-BH01**  
284x183x17 mm  
Unterteile allein  
Only base  
Vassoio solo  
Bandeja suelta  
Plateau seul

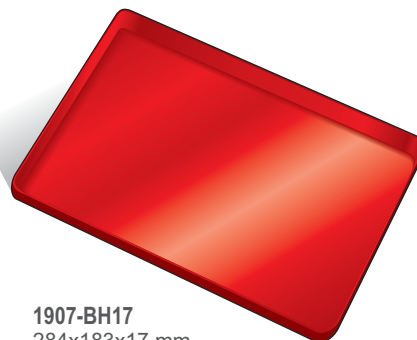

**1907-BH17**  
284x183x17 mm  
Unterteile allein  
Only base  
Vassoio solo  
Bandeja suelta  
Plateau seul



**1907-BH21**  
284x183x17 mm  
Unterteile allein  
Only base  
Vassoio solo  
Bandeja suelta  
Plateau seul

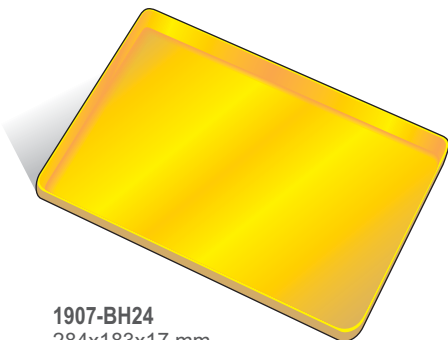

**1907-BH24**  
284x183x17 mm  
Unterteile allein  
Only base  
Vassoio solo  
Bandeja suelta  
Plateau seul

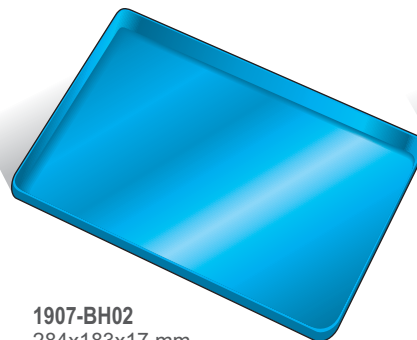

**1907-BH02**  
284x183x17 mm  
Unterteile allein  
Only base  
Vassoio solo  
Bandeja suelta  
Plateau seul



**1907-BH03**  
288x187x29 mm  
Tray-Deckel, grau  
Lid - Grey only  
Coperchio - Solo argento  
Tapa en color gris  
Couvercle - seulement en gris



Alu- MIDI Tray  
 Aluminium MIDI Trays  
 Tray in alluminio, misura MIDI  
 Bandejas de aluminio, tamaño MIDI  
 Boîtes en aluminium, format MIDI

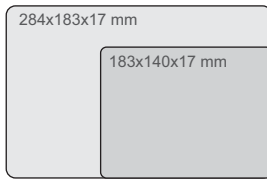

Farbcodiert-Tray-Unterteile für 8 instrumente  
 Color-Coded bases for 8 instruments  
 Vassoi colorati per 8 strumenti  
 Bandejas en colores para 8 instrumentos  
 Plateaux colorés pour 8 instruments

Für 8 instrumente  
 For 8 instruments  
 Per 8 strumenti  
 Para 8 instrumentos  
 Pour 8 instruments

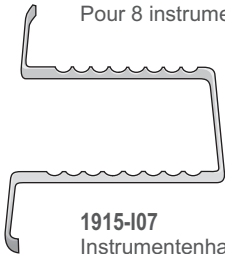

**1915-I07**  
 Instrumentenhalter  
 Insert frames  
 Griglia Portastrumenti  
 Porta instrumentos  
 Porte instruments

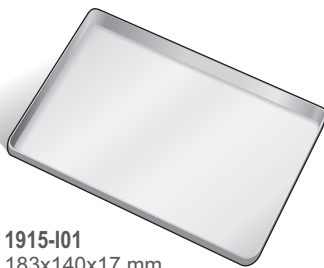

**1915-I01**  
 183x140x17 mm  
 Unterteile allein  
 Only base  
 Vassoio solo  
 Bandeja suelta  
 Plateau seul



**1915-I17**  
 183x140x17 mm  
 Unterteile allein  
 Only base  
 Vassoio solo  
 Bandeja suelta  
 Plateau seul

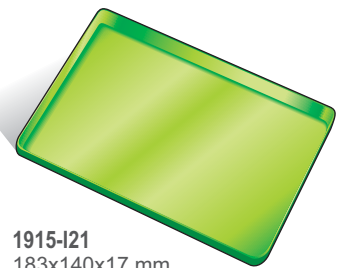

**1915-I21**  
 183x140x17 mm  
 Unterteile allein  
 Only base  
 Vassoio solo  
 Bandeja suelta  
 Plateau seul

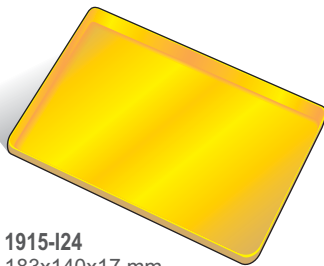

**1915-I24**  
 183x140x17 mm  
 Unterteile allein  
 Only base  
 Vassoio solo  
 Bandeja suelta  
 Plateau seul

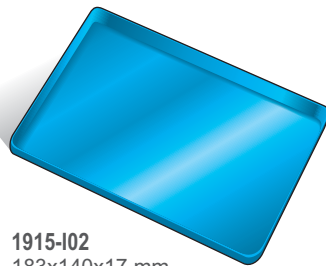

**1915-I02**  
 183x140x17 mm  
 Unterteile allein  
 Only base  
 Vassoio solo  
 Bandeja suelta  
 Plateau seul

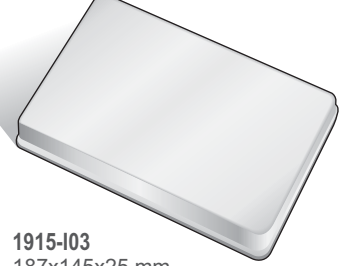

**1915-I03**  
 187x145x25 mm  
 Tray-Deckel, grau  
 Lid - Grey only  
 Coperchio - Solo argento  
 Tapa en color gris  
 Couvercle - seulement en gris

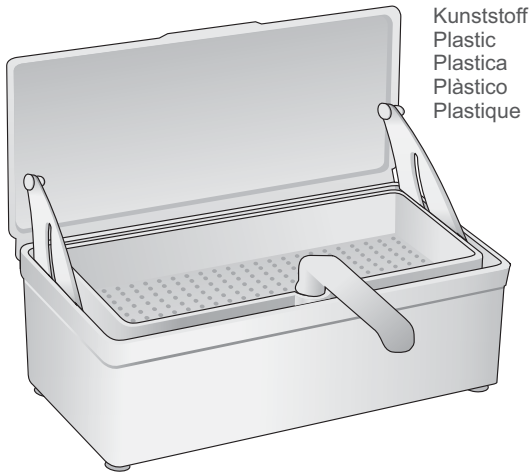

Kunststoff  
 Plastic  
 Plastica  
 Plàstico  
 Plastique

**0218-BAA**  
 255 x 105 x 85 mm

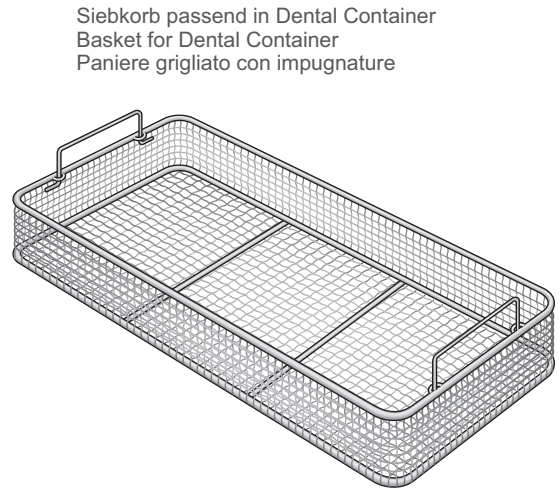

Siebkorb passend in Dental Container  
 Basket for Dental Container  
 Paniere grigliato con impugnature

**0319-GFA**  
 265 x 120 x 45 mm

**Rostfrei - Stainless steel - Inox - Inoxidable - Inoxydable**

Norm-tray complet mit tray-unterteile, deckel und instrumentenhalter für 23 instrumente  
 Instrument tray complete with base, lid and insert frame for 23 instruments  
 Portastrumenti completo di vassoio, coperchio e griglia per 23 strumenti  
 Bandeja completa de tapa y porta instrumentos para 23 instrumentos  
 Boite complete avec plateau et couvercle pour 23 instruments

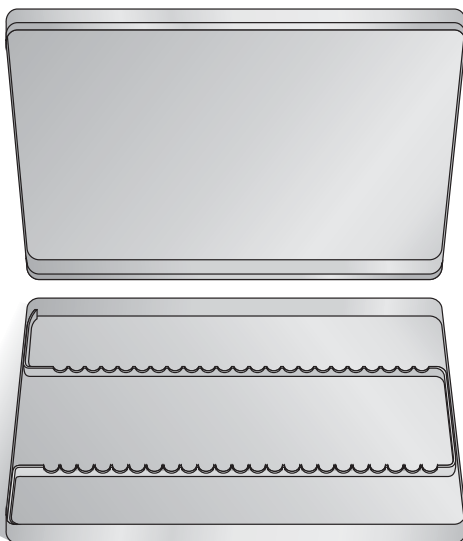

**TRAY INOX**  
**19-09**  
 284 x 183 x 17 mm

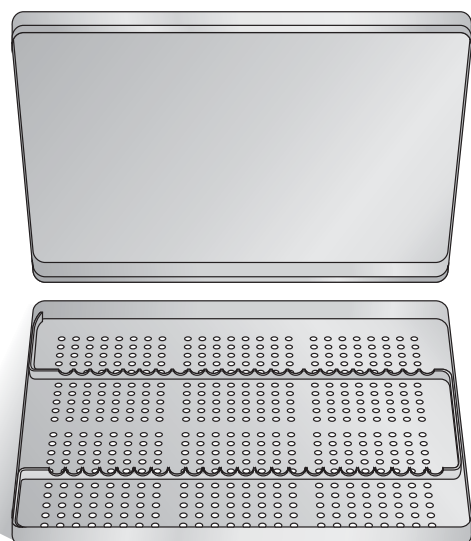

**TRAY INOX**  
**19-0906**  
 284 x 183 x 17 mm



RODHOIL  
0402-141117  
50 cc

Olio lubrificante per  
strumenti chirurgici

**RODHOIL**

Schmiermittel mit hoher Dichte. Es sichert den perfekten Gebrauch und die Leichtgängigkeit aller chirurgischen Instrumente. Man gibt es auf die Verbindungen und Gelenke und in alle beweglichen Teile, die Reibungen unterworfen sind.

**RODHOIL**

Lubricant to high density. It assures the perfect utility and fluency of all the surgical instruments. For apply in to loosens, join and in all the parts in subject movement subject to attrition.

**RODHOIL**

Lubrificante ad alta densità. Assicura la perfetta funzionalità e scorrevolezza di tutti gli strumenti chirurgici. Da applicare negli snodi, giunture e in tutte le parti in movimento soggette ad attrito.

Das wasserlösliche Schmiermittel verlängert die Lebensdauer von chirurgischen Instrumenten

Soluble lubricant extends useful life of surgical instruments

Lubrificante anticorrosivo e detergente per strumenti chirurgici

Lubrificante soluble en agua, so uso prolonga la duración de los instrumentos quirúrgicos

Lubrifiant soluble dans l'eau prolonge la vie des instruments chirurgicaux

**CLEANLACT**

Reinigungskonzentrat für chirurgische Instrumente. Es wirkt antibakteriell, nicht-ätzend und schmierig. Es garantiert die perfekte Erhaltung aller Instrumente aus Stahl, entfernt eventuelle Flecken, Ränder, und Bräunungen von Sterilisationen, Desinfektionen und Reinigungen mit hartem Wasser. Es sollte regelmäßig verwendet werden.

**CLEANLACT**

Product concentrated for surgical instruments. It explains an action anti-corrosive, antibacterium and lubricant. It guarantees the perfect maintenance of all the instruments in steel eliminating eventual stains and burnishes to sterilization, disinfection and to washings with hard waters. It used periodically.

**CLEANLACT**

Prodotto concentrato per strumenti chirurgici. Esplica un azione anticorrosiva batteriostatica e lubrificante. Garantisce il perfetto mantenimento di tutti gli strumenti in acciaio eliminando eventuali macchie, aloni e bruntiture dovute a sterilizzazioni, disinfezioni e a lavaggi con acque dure. Va usato periodicamente.



CLEANLACT  
0402-FA12  
500 cc

CLEANLACT  
0402-B11  
1000 cc

Schleifsteine  
Sharpening stones  
Pietre di Arkansas per affilatura strumenti  
Materiales para afilar  
Pierres d'affutage

Original Arkansas



Teflon-Stäbchen  
Teflon stick for tasting  
Bastoncino di Teflon  
per prova affilatura  
Bastoncito de teflon  
Petit bâton en teflon



**0402-BF**  
100 mm



**0402-CLL**  
ARKANSAS  
conica n° 299  
90 mm

**0402-LG**  
ARKANSAS n°8  
100 x 50 x 13 mm

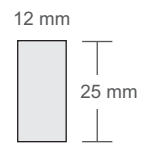

**0402-E**  
ARKANSAS n°4  
100 mm

Special Gummi für Metal  
Special Rubber for Metal  
Gomme speciali per metalli

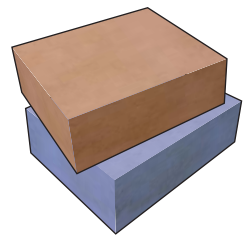

<b>0402-AH</b> 50 x 40 x 20 mm Fein - Fine Grana Fine Finas - Fin	<b>0402-AI</b> 50 x 40 x 20 mm Größ - Large Grana grossa Grande - Large
---	---

Instrumente-Reinigungsbürste  
Brush for instruments  
Spazzolino per pulizia strumenti  
Cepillo para instrumentos  
Brosse pour instruments



**SCHARPENOil**  
**0402-1411**  
30 cc



**0402-G01**  
ARKANSAS n°6A  
100 mm



**0402-D**  
INDIA n°6  
100 mm

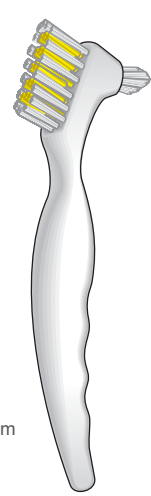

**0402-BB**  
155 mm

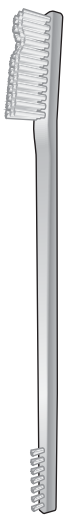

**0402-BC**  
175 mm



Vorbereitung - Nagel scheren  
 Preparation - Nail scissors  
 Preparazione - Forbici per unghie  
 Preparacion - Tijeras para uñas  
 Préparation - Ciseaux à ongles

Handwaschbürste  
 Nail brushes  
 Spazzola per unghie  
 Cepillos de uñas  
 Brosse à ongles

Sterilisier bar  
 Autoclavable  
 Autoclavabile  
 Esterilizable  
 Stérilisable



**0706-CAA**  
 4 x 11 cm

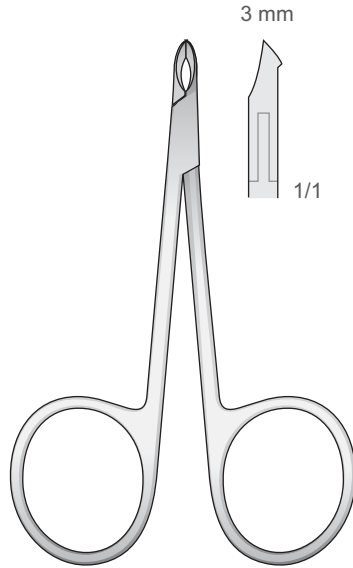

**0718-EA**  
 85 mm

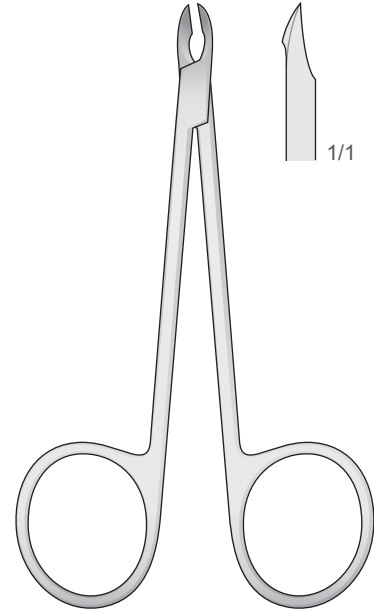

**0718-FC**  
 100 mm

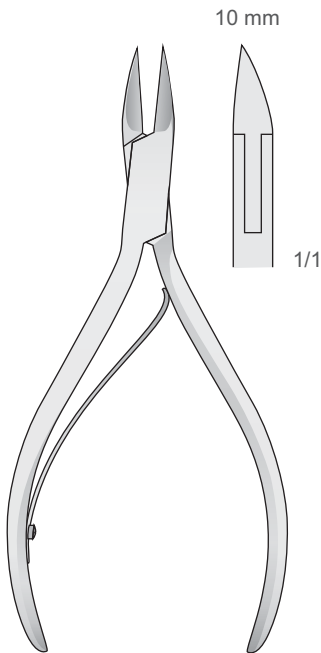

**0718-EC**  
 100 mm

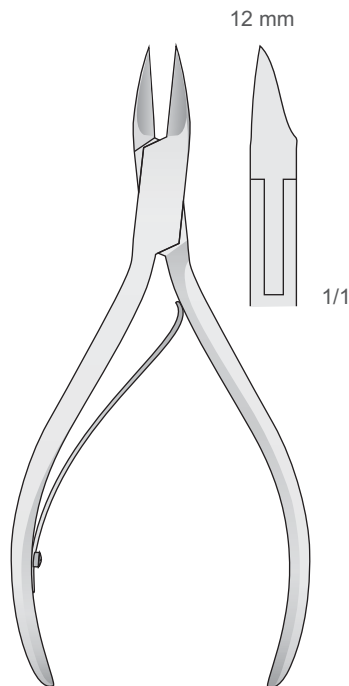

**0718-EE**  
 110 mm

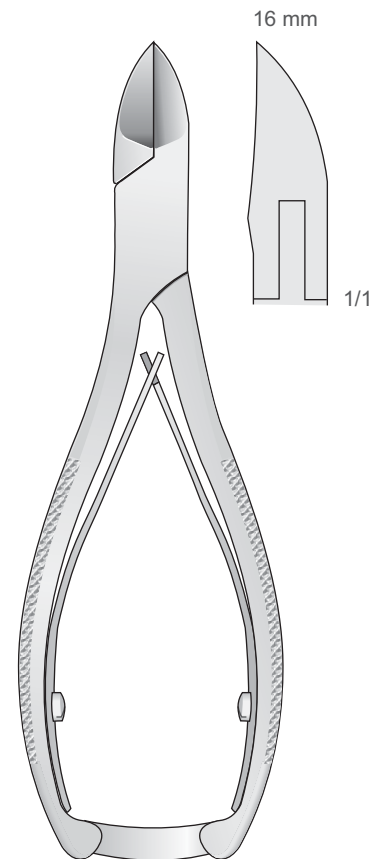

**0718-EI**  
 140 mm



Sterilisierzangen zum Fassen und Halten Steriler Instrumente  
Sterilizing forceps for picking up and holding of sterile instruments  
Pinze per prelevare strumenti sterilizzati  
Pinzas para esterilización  
Pincas pour saisir les objets stérilisés



**0718-AC**  
145 mm



DAVIS  
**0718-AD**  
160 mm



DAVIS  
**0718-AE**  
200 mm

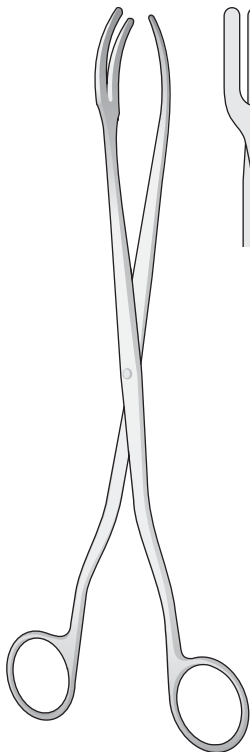

**0718-BA**  
200 mm

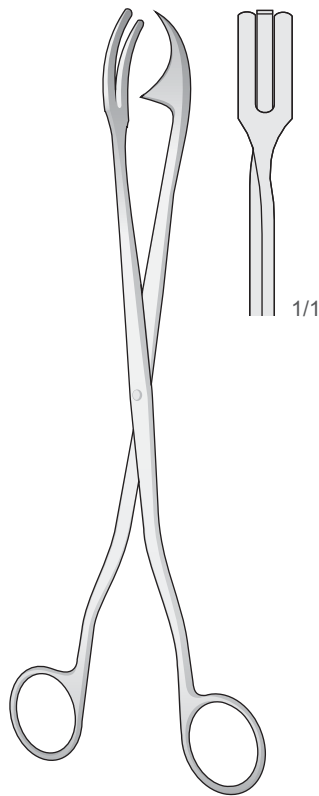

ROGGE  
**0718-AG**  
230 mm

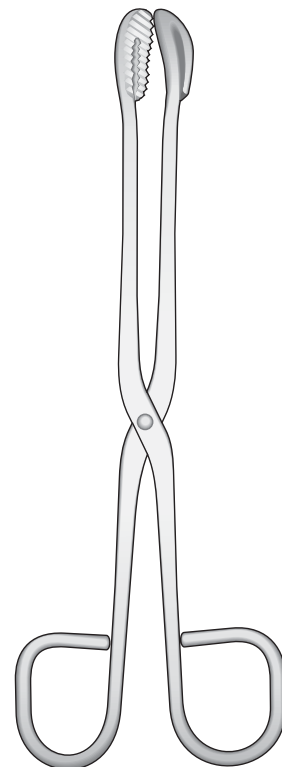

**0718-BD**  
200 mm



.16

Alfabetisches Inhaltsverzeichnis  
Alphabetical Index  
Indice alfabetico  
Indice alfabetico  
Index alphabétique

Zahnärztliche Chirurgie  
Dental surgery  
Chirurgia dentale  
Cirugia dental  
Chirurgie dentaire





**A**

<b>ADERER</b> , Drahtbiegezange	324
<b>ADSON</b> , Absaugkanülen	319
- Mikro Pinzetten	114
- Chirurgischen Pinzetten	122, 131, 132, 133, 136
- Titan Pinzetten	118
<b>ADSON-BROWN</b> , Mikro Pinzetten	114
- Chirurgischen Pinzetten	131
<b>AINSWORTH</b> , Kofferdam Instrumente	308
<b>ALLIS</b> , Gewebefasszange	174
<b>ANDREWS-PYNCHON</b> , Absaugkanülen	315
<b>APEXO</b> , Wurzelheber	50
<b>ARKANSAS</b> , Schleifsteine	356
<b>ARRUGA</b> , Nadelhalter	158
<b>AUSTIN</b> , Wundhaken	184

**B**

<b>BABY-ALLIS</b> , Gewebefasszange	174
<b>BABY-CRILE</b> , Arterienklemmen	173
<b>BABY-CRILEWOOD</b> , Nadelhalter	156
<b>BABY-METZENBAUM</b> , Scheren	98
<b>BABY-MIXTER</b> , Arterienklemmen	171
<b>BABY-YANKAUER</b> , Absaugkanülen	315
<b>BACKHAUS</b> , Tuchklemmen	165
<b>BALL</b> , Füllungsinstrumente	292
<b>BARRAQUER</b> , Chirurgische Pinzetten	130
- Nadelhalter	142
<b>BARRY</b> , Wurzelheber	65
<b>BARTH</b> , Löffel	235
<b>BEALE</b> , Instrumente für Labor	345
<b>BEASLEY-BABCOCK</b> , Chirurgische Pinzetten	133
<b>BEEBE</b> , Scheren	326
- Drahtschneidezange	109
<b>BEIN</b> , Wurzelheber	43
<b>BENNETT</b> , Raspatorien	226
<b>BERNARD</b> , Wurzelheber	61
<b>BEYER</b> , Hohlmeißelzangen	244
<b>BISHOP</b> , Wangenhalter	191
<b>BISHOP-HARMON</b> , Mikro Pinzetten	114
<b>BLACK</b> , Schmelzinstrumente	283, 298
<b>BLUMENTHAL</b> , Hohlmeißelzangen	242
<b>BÖHLER</b> , Hohlmeißelzangen	245
<b>BÖHM</b> , Teleskopkronenzangen	335
<b>BOLEY</b> , Meßinstrumente	330
<b>BOWLED-HENRY</b> , Wundhaken	184
<b>BOYNTON</b> , Nadelhalter	158
<b>BOYS-ALLIS</b> , Gewebefasszange	174
<b>BREWER</b> , Klammerzange	309
<b>BROWN</b> , Mikro Pinzetten	114
- Chirurgische Pinzetten	131
<b>BRUENINGS</b> , Zungenspatel	195
<b>BRUNS</b> , Löffel	236
<b>BUCHWALD</b> , Zungenspatel	195
<b>BUCK</b> , Parodontalmesser	301
- Knochenfeilen	239

**C**

<b>CARVER</b> , Instrumente zum Modellieren von Füllungen	297
<b>CASTROVIEJO</b> , Mikro Pinzetten	114
- Nadelhalter	141, 143, 144, 145, 146
- Meßinstrumente	218
<b>CAWOOD-MINNESOTA</b> , Wangenhalter	191
<b>CHADWICK</b> , Scheren	97
<b>CHOEN</b> , Gewebezängchen	240
<b>CHOMPRET</b> , Syndesmotome	70
<b>CITELLI</b> , Hohlmeißelzangen	246
<b>CLEVELAND</b> , Hohlmeißelzangen	245
<b>COHEN</b> , Zahnzangen	31
<b>COLLEGE</b> , Titan Pinzetten	118
- Zahnpinzetten	120, 121
<b>COLLIN</b> , Zungenzangen	195
<b>COLUMBIA</b> , Küretten	262, 266
- Wundhaken	191
<b>CONVERSE</b> , Nadelhalter	153
<b>CORN</b> , Pinzetten	138
<b>COTTLE</b> , Scheren	86
- Chirurgische Hämmer	203
- Meißel	202

<b>COTTLE-KNAPP</b> , Scheren	86
<b>COUPLAND</b> , Absaugkanülen	317
- Wurzelheber	54
<b>CRANE-CAPLAN</b> , Küretten	306
- Chirurgische Pinzetten	123
<b>CRANE-KAPLAN</b> , Parodontalmesser	301
<b>CRANEPICK</b> , Wurzelheber	58
<b>CRILE</b> , Arterienklemmen	172
- Nadelhalter	159
<b>CRILE-MURRAY</b> , Nadelhalter	149
<b>CRILE-WOOD</b> , Nadelhalter	149, 155, 156
<b>CRYER</b> , Wurzelheber	53
- Zahnzangen	24, 28, 33, 34
<b>CUSHING</b> , Wundhaken	180

**D**

<b>DANDY-MOSQUITO</b> , Arterienklemmen	168
<b>DAVIS</b> , Sterilisierzangen zum Steriler Instrumente	358
<b>DE BAKEY</b> , Chirurgische Pinzetten	122, 137
- Titan Pinzetten	118
- Nadelhalter	154
<b>DE MARCO</b> , Küretten	303
<b>DEAN</b> , Scheren	94
<b>DERF</b> , Nadelhalter	149, 153
<b>DESMARRES</b> , Wundhaken	179
- Chirurgische Pinzetten	130
<b>DIETRICH</b> , Nadelhalter	148
<b>DINGMANN</b> , Mundsperrler	193
- Knochenhaltezange	220
<b>DOCKHORN</b> , Wundhaken	180

**E**

<b>ELLIS</b> , Messer	79
<b>EPKER</b> , Osteotome	202

**F**

<b>FAHNENSTOCK</b> , Wachsmesser	339
<b>FAHRENKRUG</b> , Wurzelheber	59
<b>FARABEUF</b> , Wundhaken	190
<b>FAURE</b> , Tuchklemmen	165
<b>FEDI</b> , Meißel für Parodontologie	285
<b>FELSCH</b> , Zahnzange	16
<b>FELT</b> , Kompositinstrumente	271, 273
<b>FOITZIK</b> , Knochestopfer	216
<b>FOSTER-GILLIES</b> , Nadelhalter	157
<b>FRAZIER</b> , Absaugkanülen	318, 319
<b>FREER</b> , Osteotome	199
- Raspatorien	204
<b>FREER-YASARGIL</b> , Raspatorien	204
<b>FRENZEL</b> , Zungenspatel	195
<b>FRIEDMANN</b> , Hohlmeißelzange	242, 244
<b>FURRER</b> , Kupferingabnehmzange	335

**G**

<b>GARDNER</b> , Hohlmeißelzange	245
<b>GERALD</b> , Chirurgische Pinzetten	129, 136
- Titan Pinzetten	118
<b>GERALD-BROWN</b> , Chirurgische Pinzetten	129
<b>GIESSEN</b> , Raspatorien	204
<b>GILLIES</b> , Wundhaken	177
- Chirurgische Pinzetten	123
<b>GOLDMAN-FOX</b> , Parodontalmesser	301
- Küretten	304
- Elevatorien	229
- Scheren	91, 94, 105, 106
- Parodontometer	253
<b>GOLDMAN-FOX-WILLIAMS</b> , Parodontometer	289
<b>GOLDSTEIN</b> , Kompositinstrumente	271, 273
<b>GRACEY</b> , Küretten	261, 263, 264, 302, 303
<b>GRAEFE</b> , Messer	79
- Chirurgische Pinzetten	123, 133
<b>GREENBERG-PAR</b> , Scheren	101
<b>GREENE</b> , Wundhaken	194
<b>GREGORY</b> , Scheren	106
<b>GRITMAN</b> , Spatel	340
- Instrumente für Labor	345
<b>GROSS</b> , Kornzangen	167

**H**

<b>HAJEK</b> , Chirurgische Hämmer	203
<b>HALSEY</b> , Nadelhalter	149, 153
<b>HALSTED</b> , Arterienklemmen	170, 173
<b>HALSTED-MOSQUITO</b> , Arterienklemmen	170
- Ligature Instrumente	329
<b>HARRIS</b> , Zahnzange	27, 30
<b>HARTMANN</b> , Wundhaken	186
<b>HARTMANN-BABY-MOSQUITO</b> , Arterienklemmen	168
<b>HEGAR</b> , Nadelhalter	155, 159
<b>HEIDBRINK</b> , Wurzelheber	47
<b>HEIDEMANN</b> , Spatel	291
<b>HEISTER</b> , Mund sperrer	188
<b>HEMINGWAY</b> , Löffel	232, 233
<b>HENAHAN</b> , Raspatorien	225
<b>HIRSCHFELD</b> , Knochenfeilen	267
<b>HOLLENBACK</b> , Füllungsinstrumente	294, 297
<b>HOPKINS</b> , Raspatorien	228
<b>HOWARD</b> , Knochenfeilen	238
<b>HULL</b> , Zahnzange	28
<b>HYLIN</b> , Wurzelheber	56
- Instrumente für Labor	345, 346

**I**

<b>ILIC</b> , Gewebezängchen	240
<b>INDIA</b> , Schleifsteine	356
<b>IRIS</b> , Scheren	86, 88, 101, 103, 104
<b>IVORY</b> , Kofferdam Instrumente	308, 310, 311, 312
<b>IWANSON</b> , Meßinstrumente	330

**J**

<b>JACOBSON</b> , Löffel	235
- Nadelhalter	145
<b>JACOBSON-MICRO</b> , Arterienklemmen	168
<b>JAMESON</b> , Scheren	87
<b>JAMESON-WERBER</b> , Scheren	87
<b>JANSEN</b> , Löffel	235
<b>JAQUETTE</b> , Küretten	265, 305
<b>JONES</b> , Tuchklemmen	165
<b>JOSEPH</b> , Wundhaken	177
- Scheren	89, 106
<b>JUDD-ALLIS</b> , Tuchklemmen	174

**K**

<b>KELLY</b> , Scheren	92, 102, 103
- Arterienklemmen	172
<b>KERLING</b> , Kupferringabnehmzange	335
<b>KERPEL</b> , Löffel	234
<b>KERRISON</b> , Hohlmeißelzange	246
<b>KEYES</b> , Hautstanzen	213
<b>KILIAN</b> , Raspatorien	227
<b>KILNER</b> , Scheren	87, 91, 93, 101
<b>KIRKLAND</b> , Gewebezängchen	287, 301
<b>KIRSCH</b> , Wundhaken	182
<b>KLEINER-KUTZ</b> , Hohlmeißelzange	244
<b>KOCHER</b> , Wundhaken	179, 180
- Arterienklemmen	171, 172
<b>KOCHER-LANGENBECK</b> , Wundhaken	184
<b>KÖNIG</b> , Raspatorien	224
<b>KOPP</b> , Wurzelheber	57
<b>KRALLENHEBER</b> , Wurzelheber	53
<b>KRAMER</b> , Küretten	264
<b>KRAMER-NEVINS</b> , Küretten	264
- Meißel	200
<b>KROENIG</b> , Zungenspatel	195

**L**

<b>LA FORCE</b> , Messer	79
<b>LA GRANGE</b> , Scheren	94, 105
<b>LADMORE</b> , Füllungsinstrumente	295
<b>LAHEY</b> , Wundhaken	180
<b>LANG</b> , Scaler	268
<b>LANGENBECK</b> , Wundhaken	184
<b>LANGER</b> , Küretten	266
<b>LE CLUSE</b> , Wurzelheber	65
<b>LE CRON</b> , Instrumente für Labor	345

<b>LEMPERT</b> , Hohlmeißelzange	243
<b>LERICHE</b> , Arterienklemmen	173
<b>LESSMANN</b> , Wachsmesser	339
<b>LEXER</b> , Scheren	95
<b>LEXER-BABY (KNAPP)</b> , Scheren	101
<b>LICHTENBERG</b> , Nadelhalter	158
<b>LINDO-LEVIEN</b> , Wurzelheber	57
<b>LISTER</b> , Sinus klemmen	167
<b>LITTAUER</b> , Scheren	108
<b>LOCKING</b> , Zahnpinzetten	121
<b>LOCKLIN</b> , Scheren	90, 92
<b>LORNA</b> , Tuchklemmen	166
<b>LUCAE</b> , Chirurgische Hämmer	203
<b>LUCAS</b> , Löffel	232
<b>LUER</b> , Hohlmeißelzange	243
<b>LUKS</b> , Nervinstrumente	254
<b>LUNIATSCHEK</b> , Watteträger	256
- Membranplatzierungsinstrumente	214

**M**

<b>MARKLEY PLUGGERS</b> , Füllungsinstrumente	294
<b>MARTINI</b> , Löffel	235
<b>MATHIEU</b> , Nadelhalter	158, 160, 161
<b>MATY</b> , Mundsperrer	189
<b>MAYO</b> , Scheren	96, 104
<b>MAYO-HEGAR</b> , Nadelhalter	154, 159
<b>MAYO-LEXER</b> , Scheren	95
<b>MAYO-STILLE</b> , Scheren	95
<b>McCALL</b> , Küretten	266, 305
<b>McINDOE</b> , Chirurgische Pinzetten	123
<b>McKESSON</b> , Absaugkanülen	316
<b>MEAD</b> , Chirurgische Hämmer	203
- Raspatorien	228
- Zahnzangen	35
- Hohlmeißelzange	242
<b>MENEGHINI</b> , Raspatorien	227
<b>MERIAM</b> , Zahnpinzetten	120, 121
<b>MERRIT</b> , Parodontometer	253
<b>MERSHON</b> , Bandandrücker	328
<b>METZENBAUM</b> , Scheren	89, 97, 98, 99, 103, 104
<b>METZENBAUM-FINO</b> , Scheren	98, 99, 100
<b>MICRO-ADSON</b> , Chirurgische Pinzetten	133
<b>MICRO-HALSTED</b> , Arterienklemmen	169
<b>MICRO-RYDER</b> , Nadelhalter	148
<b>MICRO-VASCULAR</b> , Nadelhalter	154
<b>MIDDELDORPF</b> , Wundhaken	182
<b>MILLER</b> , Knochenfeilen	238
- Pinzetten	138
- Ligature Instrumente	329
<b>MILLER-APEXO</b> , Wurzelheber	55
<b>MILLER-COLBURN</b> , Raspatorien	231
<b>MINI-FRIEDMANN</b> , Hohlmeißelzange	241, 242
<b>MINI-GILLIES</b> , Nadelhalter	150, 157
<b>MINI-LAMBOTTE</b> , Osteotome	199
<b>MINI-LANGENBECK</b> , Wundhaken	177
<b>MINI-LEXER</b> , Osteotome	202
<b>MINI-OLSEN-HEGAR</b> , Nadelhalter	150
<b>MINNESOTA</b> , Wundhaken	191
<b>MISCH</b> , Wundhaken	192
<b>MITCHEL</b> , Scaler	268
<b>MOLT</b> , Mundsperrer	188
- Löffel	237
- Raspatorien	225, 226, 229, 231
<b>MOLT-DOYEN-COLLIN</b> , Mundsperrer	188
<b>MOLT-DOYEN-JANSEN</b> , Mundsperrer	188

**N**

<b>NABERS</b> , Parodontometer	290
<b>NEUMANN</b> , Scheren	94
<b>NEVIUS</b> , Zahnzangen	25
<b>NOYES</b> , MiKro Scheren	83
<b>NYSTRÖM</b> , Kofferdam Instrumente	312

**O**

<b>OBWEGESER</b> , Wundhaken	183, 186, 187, 192
- Raspatorien	223
<b>OBWEGESER-FREER</b> , Raspatorien	204
<b>OCHSENBEIN</b> , Meißel für Parodontologie	285, 286



**OLSEN-HEGAR**, Nadelhalter 150, 157  
**ORBAN**, Parodontalmesser 287, 301  
**ORINGER**, Mundsperrer 189

**P**

**P.K.THOMAS**, Instrumente für Labor 341, 342, 343  
**PALMER**, Klammerzange 309  
**PAQUETTE**, Hautstanze 78  
**PARMLY**, Zahnzangen 26  
**PARTSCH**, Osteotome 201  
 - Meissel 201  
**PEAN**, Arterienklemmen 171  
**PEAN-MURPHY**, Kornzangen 167  
 - Ligature Instrumente 329  
**PECK-JOSEPH**, Scheren 106  
**PEET**, Wurzelkanalinstrumente 39  
 - Arterienklemmen 169  
**PELTON-CRANE**, Absaugkanülen 318  
**PERRY**, Chirurgische Pinzetten 124  
**PHYSICK**, Zahnzange 31  
**POTT**, Wurzelheber 60  
**POTTS-SMITH**, Chirurgischen Pinzetten 135  
**PRICHARD**, Periostotome 226

**Q**

**QUINBY**, Scheren 97

**R**

**RAGNELL**, Wundhaken 180  
**RAGNELL-DAVIS**, Wundhaken 180  
**REYNOLDS**, Scheren 93  
**ROACH**, Instrumente für Labor 345  
**ROGER**, Raspatorien 227  
**ROGGE**, Sterilisierzangen zum Steriler Instrumente 358  
**ROSER-KÖNIG**, Mundsperrer 188  
**ROSIN**, Wurzelheber 48  
**ROUTURIER**, Zahnzangen 11  
**ROUX**, Wundhaken 190  
**ROUX-MAGNUS**, Wundhaken 190  
**RULE**, Küretten 307  
**RUSKIN**, Hohlmeisselzange 244  
**RUSSIAN**, Pinzetten 138  
**RYDER**, Nadelhalter 151

**S**

**SANDERS**, Parodontalmesser 301  
**SAROT**, Nadelhalter 155  
**SAUTTER**, Raspatorien 204  
**SCHAEDEL**, Tuchklemmen 165  
**SCHEDE**, Löffel 236  
**SCHLUGER**, Knochenfeilen 239  
**SEAN-MILLER**, Wundhaken 179  
**SELDIN**, Wurzelheber 58, 59  
 - Raspatorien 224  
**SEMKEN**, Chirurgische Pinzetten 127, 137  
**SENN-GREEN**, Wundhaken 180  
**SHURE**, Separierzangen 327  
**SMAHA**, Nadelhalter 161  
**SMITH**, Scheren 107  
 - Drahtschneidezange 325  
**SPENCER**, Scheren 108  
**STELLBRINK**, Hohlmeisselzangen 241  
**STERNBERG**, Wundhaken 191  
**STEVENS**, Scheren 85, 93, 97  
 - Nadelhalter 148  
**STIEGLITZ**, Zahnzangen 39  
**STILLE**, Chirurgische Pinzetten 126  
**STITCH**, Scheren 85  
**STOKE**, Klammerzange 309  
**SUGARMAN**, Knochenfeilen 239  
**SWEDISH**, Nadelhalter 152

**T**

**TAYLOR**, Küretten 265, 306  
**TG CHISELS**, Meissel für Parodontologie 286  
**TOBOLD**, Wundhaken 186

**TOFFLEMIRE**, Kofferdam Instrumente 312  
**TOMES**, Zahnzangen 28  
**TÖNNIS**, Nadelhalter 159  
**TÖNNIS-ADSON**, Scheren 98  
**TOWNER**, Parodontalmesser 301  
 - Küretten 165  
**TOWNER-JAQUETTE**, Küretten 307

**U**

**UFFENORDE**, Löffel 234  
**UNIVERSAL**, Kronenabnehmer 338  
 - Watteträger 256  
**UNIVERSITY OF MICHIGAN**, Parodontometer 253, 290

**V**

**VEHE**, Instrumente für Labor 345  
**VOLKMANN**, Löffel 235, 236

**W**

**WAHL**, Knochenfeilen 239  
**WALTON**, Scheren 85  
**WANGENSTEEN**, Chirurgischen Pinzetten 136  
**WARD**, Füllungsinstrumente 278  
**WARWICK-JAMES**, Wurzelheber 48  
**WASSMUND**, Wundhaken 194  
**WEBSTER**, Nadelhalter 153  
**WEDELSTAEDT**, Schmelzinstrumente 298  
**WEINGART**, Drahtbiegezange 324  
**WEITLANER**, Wundhaken 220  
**WERTHEIMER**, Absaugkanülen 319  
**WESTCOTT**, Mikro Scheren 83  
 - Füllungsinstrumente 280, 295  
**WHITE**, Füllungsinstrumente 281  
**WHITEHEAD-JENNINGS**, Mundsperrer 193  
**WIEDER**, Wundhaken 186  
**WILAND**, Instrumente zum Modellieren von Füllungen 297  
**WILLIAMS**, Parodontometer 253  
**WILLIGER**, Löffel 234, 235  
 - Raspatorien 223  
**WINTER**, Wurzelheber 63, 64  
**WITZEL**, Zahnzange 38  
**WOODSON**, Füllungsinstrumente 295

**Y**

**YANKAUER**, Absaugkanülen 315  
**YOUNG**, Zungenzangen 195  
**YOUNGER-GOOD**, Küretten 306

**Z**

**ZAHLE**, Instrumente für Labor 346  
**ZAUFAL-JANSEN**, Hohlmeisselzangen 244  
**ZIEGLER**, Messer 79  
**ZIELINSKY**, Meßinstrumente 330





## A

<b>ADERER</b> , Wire bending Pliers	324
<b>ADSON</b> , Suction tubes	319
- Delicate forceps	114
- Tissue forceps	122, 131, 132, 133, 136
- Titanium Tissue Forceps	118
<b>ADSON-BROWN</b> , Delicate forceps	114
- Tissue forceps	131
<b>AINSWORTH</b> , Rubber-Dam instrumente	308
<b>ALLIS</b> , Tissue Grasping forceps	174
<b>ANDREWS-PYNCHON</b> , Suction tubes	315
<b>APEXO</b> , Root elevators	50
<b>ARKANSAS</b> , Sharpening Stones	356
<b>ARRUGA</b> , Needle Holders	158
<b>AUSTIN</b> , Retractors	184

## B

<b>BABY-ALLIS</b> , Tissue Grasping forceps	174
<b>BABY-CRILE</b> , Hemostatic Forceps	173
<b>BABY-CRILEWOOD</b> , Needle Holders	156
<b>BABY-METZENBAUM</b> , Scissors	98
<b>BABY-MIXTER</b> , Hemostatic Forceps	171
<b>BABY-YANKAUER</b> , Suction tubes	315
<b>BACKHAUS</b> , Towl Clamps	165
<b>BALL</b> , Filling Instruments	292
<b>BARRAQUER</b> , Tissue forceps	130
- Needle Holders	142
<b>BARRY</b> , Root elevators	65
<b>BARTH</b> , Curettes	235
<b>BEALE</b> , Instruments for laboratory	345
<b>BEASLEY-BABCOCK</b> , Tissue forceps	133
<b>BEEBE</b> , Scissors	326
- Wire and Plate cutting Scissors	109
<b>BEIN</b> , Root elevators	43
<b>BENNETT</b> , Raspatories	226
<b>BERNARD</b> , Root elevators	61
<b>BEYER</b> , Bone rongeurs	244
<b>BISHOP</b> , Cheek Retractor	191
<b>BISHOP-HARMON</b> , Delicate forceps	114
<b>BLACK</b> , Cavity preparation Instruments	283, 298
<b>BLUMENTHAL</b> , Bone rongeurs	242
<b>BÖHLER</b> , Bone rongeurs	245
<b>BÖHM</b> , Pliers for telescope crowns	335
<b>BOLEY</b> , Measuring Instruments	330
<b>BOWLED-HENRY</b> , Retractors	184
<b>BOYNTON</b> , Needle Holders	158
<b>BOYS-ALLIS</b> , Tissue Grasping Forceps	174
<b>BREWER</b> , Clamps forceps	309
<b>BROWN</b> , Delicate forceps	114
- Tissue forceps	131
<b>BRUENINGS</b> , Tongue depressors	195
<b>BRUNS</b> , Curettes	236
<b>BUCHWALD</b> , Tongue depressors	195
<b>BUCK</b> , Gingivectomy knives	301
- Bone files	239

## C

<b>CARVER</b> , Amalgam carvers	297
<b>CASTROVIEJO</b> , Delicate forceps	114
- Needle Holders	141, 143, 144, 145, 146
- Measuring Instruments	218
<b>CAWOOD-MINNESOTA</b> , Cheek Retractors	191
<b>CHADWICK</b> , Scissors	97
<b>CHOEN</b> , Tissue Nippers	240
<b>CHOMPRET</b> , Syndesmotomes	70
<b>CITELLI</b> , Bone cutting forceps	246
<b>CLEVELAND</b> , Bone rongeurs	245
<b>COHEN</b> , Extracting forceps	31
<b>COLLEGE</b> , Titanium tissue forceps	118
- Cotton and Dressing pliers	120, 121
<b>COLLIN</b> , Tongue holding forceps	195
<b>COLUMBIA</b> , Curettes	262, 266
- Retractors	191
<b>CONVERSE</b> , Needle Holders	153
<b>CORN</b> , Forceps	138
<b>COTTLE</b> , Scissors	86
- Surgical Mallets	203
- Chisels	202

<b>COTTLE-KNAPP</b> , Scissors	86
<b>COUPLAND</b> , Suction tubes	317
- Root elevators	54
<b>CRANE-CAPLAN</b> , Curettes	306
- Tissue forceps	123
<b>CRANE-KAPLAN</b> , Gingivectomy knives	301
<b>CRANEPICK</b> , Root levators	58
<b>CRILE</b> , Hemostatic Forceps	172
- Needle Holders	159
<b>CRILE-MURRAY</b> , Needle Holders	149
<b>CRILE-WOOD</b> , Needle Holders	149, 155, 156
<b>CRYER</b> , Root levators	53
- Extracting Forceps	24, 28, 33, 34
<b>CUSHING</b> , Retractors	180

## D

<b>DANDY-MOSQUITO</b> , Hemostatic forceps	168
<b>DAVIS</b> , Forceps for sterile instruments	358
<b>DE BAKEY</b> , Tissue forceps	122, 137
- Titanium Tissue forceps	118
- Needle holders	154
<b>DE MARCO</b> , Curettes	303
<b>DEAN</b> , Scissors	94
<b>DERF</b> , Needle Holders	149, 153
<b>DESMARRES</b> , Retractors	179
- Tissue Forceps	130
<b>DIETRICH</b> , Needle Holders	148
<b>DINGMANN</b> , Mouth gags	193
- Bone Holding Forceps	220
<b>DOCKHORN</b> , Retractors	180

## E

<b>ELLIS</b> , Knives	79
<b>EPKER</b> , Osteotomes	202

## F

<b>FAHNENSTOCK</b> , Wax knives	339
<b>FAHRENKRUG</b> , Root elevators	59
<b>FARABEUF</b> , Retractors	190
<b>FAURE</b> , Towel Clamps	165
<b>FEDI</b> , Periodontal chisels	285
<b>FELSCH</b> , Extracting forceps	16
<b>FELT</b> , Composite Instruments	271, 273
<b>FOITZIK</b> , Bone Syringes	216
<b>FOSTER-GILLIES</b> , Needle Holders	157
<b>FRAZIER</b> , Suction tubes	318, 319
<b>FREER</b> , Osteotomes	199
- Periosteals	204
<b>FREER-YASARGIL</b> , Periosteals	204
<b>FRENZEL</b> , Tongue depressors	195
<b>FRIEDMANN</b> , Bone rongeurs	242, 244
<b>FURRER</b> , Copper ring removing Pliers	335

## G

<b>GARDNER</b> , Bone rongeurs	245
<b>GERALD</b> , Tissue forceps	129, 136
- Titanium Tissue Forceps	118
<b>GERALD-BROWN</b> , Tissue Forceps	129
<b>GIESSEN</b> , Periosteals	204
<b>GILLIES</b> , Retractors	177
- Tissue Forceps	123
<b>GOLDMAN-FOX</b> , Gingivectomy knives	301
- Curettes	304
- Elevators	229
- Scissors	91, 94, 105, 106
- Periodontal Probes	253
<b>GOLDMAN-FOX-WILLIAMS</b> , Periodontal Probes	289
<b>GOLDSTEIN</b> , Composite Instruments	271, 273
<b>GRACEY</b> , Curettes	261, 263, 264, 302, 303
<b>GRAEFE</b> , Knives	79
- Tissue Forceps	123, 133
<b>GREENBERG-PAR</b> , Scissors	101
<b>GREENE</b> , Retractors	194
<b>GREGORY</b> , Scissors	106
<b>GRITMAN</b> , Spatulas	340
- Instruments for Laboratory	345
<b>GROSS</b> , Dressing Forceps	167

## H

<b>HAJEK</b> , Surgical Mallets	203
<b>HALSEY</b> , Needle Holders	149, 153
<b>HALSTED</b> , Hemostatic Forceps	170, 173
<b>HALSTED-MOSQUITO</b> , Hemostatic Forceps	170
- Ligating Instruments	329
<b>HARRIS</b> , Extracting Forceps	27, 30
<b>HARTMANN</b> , Retractors	186
<b>HARTMANN-BABY-MOSQUITO</b> , Hemostatic Forceps	168
<b>HEGAR</b> , Needle Holders	155, 159
<b>HEIDBRINK</b> , Root elevators	47
<b>HEIDEMANN</b> , Spatulas	291
<b>HEISTER</b> , Mouth Gags	188
<b>HEMINGWAY</b> , Curettes	232, 233
<b>HENAHAN</b> , Raspatories	225
<b>HIRSCHFELD</b> , Periodontal Files	267
<b>HOLLENBACK</b> , Filling Instruments	294, 297
<b>HOPKINS</b> , Raspatories	228
<b>HOWARD</b> , Bone Files	238
<b>HULL</b> , Extracting Forceps	28
<b>HYLIN</b> , Root elevators	56
- Instruments for laboratory	345, 346

## I

<b>ILIC</b> , Tissue Nippers	240
<b>INDIA</b> , Sharpening Stones	356
<b>IRIS</b> , Scissors	86, 88, 101, 103, 104
<b>IVORY</b> , Rubber-Dam Instruments	308, 310, 311, 312
<b>IWANSON</b> , Measuring Instruments	330

## J

<b>JACOBSON</b> , Curettes	235
- Needle Holders	145
<b>JACOBSON-MICRO</b> , Hemostatic Forceps	168
<b>JAMESON</b> , Scissors	87
<b>JAMESON-WERBER</b> , Scissors	87
<b>JANSEN</b> , Curettes	235
<b>JAQUETTE</b> , Curettes	265, 305
<b>JONES</b> , Towl Clamps	165
<b>JOSEPH</b> , Retractors	177
- Scissors	89, 106
<b>JUDD-ALLIS</b> , Tissue Grasping Forceps	174

## K

<b>KELLY</b> , Scissors	92, 102, 103
- Hemostatic Forceps	172
<b>KERLING</b> , Copper ring removing Pliers	335
<b>KERPEL</b> , Curettes	234
<b>KERRISON</b> , Bone rongeurs	246
<b>KEYES</b> , Tissue Punches	213
<b>KILIAN</b> , Raspatories	227
<b>KILNER</b> , Scissors	87, 91, 93, 101
<b>KIRKLAND</b> , Gingivectomy knives	287, 301
<b>KIRSCH</b> , Retractors	182
<b>KLEINER-KUTZ</b> , Bone rongeurs	244
<b>KOCHER</b> , Retractors	179, 180
- Hemostatic Forceps	171, 172
<b>KOCHER-LANGENBECK</b> , Retractors	184
<b>KÖNIG</b> , Raspatories	224
<b>KOPP</b> , Root elevators	57
<b>KRALLENHEBER</b> , Root elevators	53
<b>KRAMER</b> , Curettes	264
<b>KRAMER-NEVINS</b> , Curettes	264
- Gouges	200
<b>KROENIG</b> , Tongue Holding Forceps	195

## L

<b>LA FORCE</b> , Knives	79
<b>LA GRANGE</b> , Scissors	94, 105
<b>LADMORE</b> , Filling Instruments	295
<b>LAHEY</b> , Retractors	180
<b>LANGE</b> , Scalers	268
<b>LANGENBECK</b> , Retractors	184
<b>LANGER</b> , Curettes	266
<b>LE CLUSE</b> , Root elevators	65
<b>LE CRON</b> , Instruments for Laboratory	345

<b>LEMPERT</b> , Bone rongeurs	243
<b>LERICHE</b> , Hemostatic Forceps	173
<b>LESSMANN</b> , Wax knives	339
<b>LEXER</b> , Scissors	95
<b>LEXER-BABY (KNAPP)</b> , Scissors	101
<b>LICHTENBERG</b> , Needle Holders	158
<b>LINDO-LEVIEN</b> , Root elevators	57
<b>LISTER</b> , Sinus Forceps	167
<b>LITTAUER</b> , Scissors	108
<b>LOCKING</b> , Cotton and Dressind Pliers	121
<b>LOCKLIN</b> , Scissors	90, 92
<b>LORNA</b> , Towl Clamps	166
<b>LUCAE</b> , Surgical Mallets	203
<b>LUCAS</b> , Curettes	232
<b>LUER</b> , Bone rongeurs	243
<b>LUKS</b> , Endodontic Instruments	254
<b>LUNIATSCHEK</b> , Cotton Applicators	256
- Membrane Placement Instruments	214

## M

<b>MARKLEY PLUGGERS</b> , Filling Instruments	294
<b>MARTINI</b> , Curettes	235
<b>MATHIEU</b> , Needle Holders	158, 160, 161
<b>MATY</b> , Mouth Gags	189
<b>MAYO</b> , Scissors	96, 104
<b>MAYO-HEGAR</b> , Needle Holders	154, 159
<b>MAYO-LEXER</b> , Scissors	95
<b>MAYO-STILLE</b> , Scissors	95
<b>McCALL</b> , Curettes	266, 305
<b>McINDOE</b> , Tissue Forceps	123
<b>McKESSON</b> , Suction Tubes	316
<b>MEAD</b> , Surgical Mallets	203
- Raspatories	228
- Extracting Forceps	35
- Bone rongeurs	242
<b>MENEGHINI</b> , Raspatories	227
<b>MERIAM</b> , Cotton and Dressing Pliers	120, 121
<b>MERRIT</b> , Periodontal Probes	253
<b>MERSHON</b> , Band Pusher	328
<b>METZENBAUM</b> , Scissors	89, 97, 98, 99, 103, 104
<b>METZENBAUM-FINO</b> , Scissors	98, 99, 100
<b>MICRO-ADSON</b> , Tissue Forceps	133
<b>MICRO-HALSTED</b> , Hemostatic Forceps	169
<b>MICRO-RYDER</b> , Needle Holders	148
<b>MICRO-VASCULAR</b> , Needle Holders	154
<b>MIDDELDORPF</b> , Retractors	182
<b>MILLER</b> , Bone Files	238
- Forceps	138
- Ligating Instruments	329
<b>MILLER-APEXO</b> , Root elevators	55
<b>MILLER-COLBURN</b> , Raspatories	231
<b>MINI-FRIEDMANN</b> , Bone rongeurs	241, 242
<b>MINI-GILLIES</b> , Needle Holders	150, 157
<b>MINI-LAMBOTTE</b> , Osteotomes	199
<b>MINI-LANGENBECK</b> , Retractors	177
<b>MINI-LEXER</b> , Osteotomes	202
<b>MINI-OLSEN-HEGAR</b> , Needle Holders	150
<b>MINNESOTA</b> , Retractors	191
<b>MISCH</b> , Retractors	192
<b>MITCHEL</b> , Scalers	268
<b>MOLT</b> , Mouth Gags	188
- Curettes	237
- Raspatories	225, 226, 229, 231
<b>MOLT-DOYEN-COLLIN</b> , Mouth Gags	188
<b>MOLT-DOYEN-JANSEN</b> , Mouth Gags	188

## N

<b>NABERS</b> , Periodontal Probes	290
<b>NEUMANN</b> , Scissors	94
<b>NEVIUS</b> , Extracting Forceps	25
<b>NOYES</b> , Micro Scissors	83
<b>NYSTRÖM</b> , Matrix Retainers	312

## O

<b>OBWEGESER</b> , Retractors	183, 186, 187, 192
- Raspatories	223
<b>OBWEGESER-FREER</b> , Periosteal	204
<b>OCHSENBEIN</b> , Periodontal Chisels	285, 286





<b>OLSEN-HEGAR</b> , Needle Holders	150, 157
<b>ORBAN</b> , Gingivectomy Knives	287, 301
<b>ORINGER</b> , Mouth Gags	189

**P**

<b>P.K.THOMAS</b> , Instruments for Laboratory	341, 342, 343
<b>PALMER</b> , Rubber Dam Clamp Forceps	309
<b>PAQUETTE</b> , Palatal Gingival razor blade	78
<b>PARMLY</b> , Extracting Forceps	26
<b>PARTSCH</b> , Osteotomes	201
- Chisel	201
<b>PEAN</b> , Hemostatic Forceps	171
<b>PEAN-MURPHY</b> , Dressing Forceps	167
- Ligating Instruments	329
<b>PECK-JOSEPH</b> , Scissors	106
<b>PEET</b> , Nerve Instruments	39
- Hemostatic Forceps	169
<b>PELTON-CRANE</b> , Suction Tubes	318
<b>PERRY</b> , Tissue Forceps	124
<b>PHYSICK</b> , Extracting Forceps	31
<b>POTT</b> , Root elevators	60
<b>POTTS-SMITH</b> , Tissue Forceps	135
<b>PRICHARD</b> , Raspatories	226

**Q**

<b>QUINBY</b> , Scissors	97
--------------------------	----

**R**

<b>RAGNELL</b> , Retractors	180
<b>RAGNELL-DAVIS</b> , Retractors	180
<b>REYNOLDS</b> , Scissors	93
<b>ROACH</b> , Instruments for Laboratory	345
<b>ROGER</b> , Raspatories	227
<b>ROGGE</b> , Forceps for sterile instruments	358
<b>ROSER-KÖNIG</b> , Mouth Gags	188
<b>ROSIN</b> , Root elevators	48
<b>ROUTURIER</b> , Extracting Forceps	11
<b>ROUX</b> , Retractors	190
<b>ROUX-MAGNUS</b> , Retractors	190
<b>RULE</b> , Curettes	307
<b>RUSKIN</b> , Bone rongeurs	244
<b>RUSSIAN</b> , Forceps	138
<b>RYDER</b> , Needle Holders	151

**S**

<b>SANDERS</b> , Gingivectomy Knives	301
<b>SAROT</b> , Needle Holders	155
<b>SAUTTER</b> , Periosteal	204
<b>SCHAEDEL</b> , Towl Clamps	165
<b>SCHEDE</b> , Curettes	236
<b>SCHLUGER</b> , Bone Files	239
<b>SEAN-MILLER</b> , Retractors	179
<b>SELDIN</b> , Root elevators	58, 59
- Raspatories	224
<b>SEMKEN</b> , Tissue Forceps	127, 137
<b>SENN-GREEN</b> , Retractors	180
<b>SHURE</b> , Separating Pliers	327
<b>SMAHA</b> , Needle Holders	161
<b>SMITH</b> , Scissors	107
- Wire cutting Pliers	325
<b>SPENCER</b> , Scissors	108
<b>STELLBRINK</b> , Bone rongeurs	241
<b>STERNBERG</b> , Retractors	191
<b>STEVENS</b> , Scissors	85, 93, 97
- Needle Holders	148
<b>STIEGLITZ</b> , Extracting Forceps	39
<b>STILLE</b> , Tissue Forceps	126
<b>STITCH</b> , Scissors	85
<b>STOKE</b> , Rubber Dam Clamp forceps	309
<b>SUGARMAN</b> , Bone Files	239
<b>SWEDISH</b> , Needle Holders	152

**T**

<b>TAYLOR</b> , Curettes	265, 306
<b>TG CHISELS</b> , Periodontal Chisels	286
<b>TOBOLD</b> , Retractors	186

<b>TOFFLEMIRE</b> , Matrix Retainers	312
<b>TOMES</b> , Extracting Forceps	28



**A**

<b>ADERER</b> , Pinze per piegare fili	324
<b>ADSON</b> , Cannule per aspirazione	319
- Micro Pinzette	114
- Pinzette chirurgiche	122, 131, 132, 133, 136
- Pinzette in titanio	118
<b>ADSON-BROWN</b> , Micro Pinzette	114
- Pinzette chirurgiche	131
<b>AINSWORTH</b> , Strumenti per diga	308
<b>ALLIS</b> , Pinze per tessuti	174
<b>ANDREWS-PYNCHON</b> , Cannule per aspirazione	315
<b>APEXO</b> , Leve per radici	50
<b>ARKANSAS</b> , Pietre per affilatura strumenti	356
<b>ARRUGA</b> , Port'aghi	158
<b>AUSTIN</b> , Divaricatori	184

**B**

<b>BABY-ALLIS</b> , Pinze per tessuti	174
<b>BABY-CRILE</b> , Pinze emostatiche	173
<b>BABY-CRILEWOOD</b> , Port'aghi	156
<b>BABY-METZENBAUM</b> , Forbici	98
<b>BABY-MIXTER</b> , Pinze emostatiche	171
<b>BABY-YANKAUER</b> , Cannula per aspirazione	315
<b>BACKHAUS</b> , Fissateli	165
<b>BALL</b> , Otturatori	292
<b>BARRAQUER</b> , Pinzette chirurgiche	130
- Port'aghi	142
<b>BARRY</b> , Leve per radici	65
<b>BARTH</b> , Cucchiari	235
<b>BEALE</b> , Strumenti da laboratorio	345
<b>BEASLEY-BABCOCK</b> , Pinzette chirurgiche	133
<b>BEEBE</b> , Forbici	326
- Forbici per fili metallici	109
<b>BEIN</b> , Leve per radici	43
<b>BENNETT</b> , Periostotomi	226
<b>BERNARD</b> , Leve per radici	61
<b>BEYER</b> , Pinze ossivore	244
<b>BISHOP</b> , Divaricatori	191
<b>BISHOP-HARMON</b> , Micro Pinzette	114
<b>BLACK</b> , Strumenti da smalto	283, 298
<b>BLUMENTHAL</b> , Pinze ossivore	242
<b>BÖHLER</b> , Pinze ossivore	245
<b>BÖHM</b> , Pinze per corone telescopiche	335
<b>BOLEY</b> , Strumenti per misura	330
<b>BOWLED-HENRY</b> , Divaricatori	184
<b>BOYNTON</b> , Port'aghi	158
<b>BOYS-ALLIS</b> , Pinze per tessuti	174
<b>BREWER</b> , Pinze per ganci	309
<b>BROWN</b> , Micro Pinzette	114
- Pinzette chirurgiche	131
<b>BRUENINGS</b> , Abbassalingua	195
<b>BRUNS</b> , Cucchiari	236
<b>BUCHWALD</b> , Abbassalingua	195
<b>BUCK</b> , Bisturi per gengivectomia	301
- Lime per osso	239

**C**

<b>CARVER</b> , Strumenti per modellare e rifinire otturazioni	297
<b>CASTROVIEJO</b> , Micro Pinzette	114
- Port'aghi	141, 143, 144, 145, 146
- Strumenti per misura	218
<b>CAWOOD-MINNESOTA</b> , Divaricatori	191
<b>CHADWICK</b> , Forbici	97
<b>CHOEN</b> , Tronchesi per gengive e tessuti	240
<b>CHOMPRET</b> , Sindesmotomi	70
<b>CITELLI</b> , Pinze ossivore	246
<b>CLEVELAND</b> , Pinze ossivore	245
<b>COHEN</b> , Pinze da estrazione	31
<b>COLLEGE</b> , Pinzette in titanio	118
- Pinzette per medicazione	120, 121
<b>COLLIN</b> , Pinze tiralingua	195
<b>COLUMBIA</b> , Curette	262, 266
- Divaricatori	191
<b>CONVERSE</b> , Port'aghi	153
<b>CORN</b> , Pinzette	138
<b>COTTLE</b> , Forbici	86
- Martelli chirurgici	203
- Scalpelli	202

<b>COTTLE-KNAPP</b> , Forbici	86
<b>COUPLAND</b> , Cannule per aspirazione	317
- Leve per radici	54
<b>CRANE-CAPLAN</b> , Curette	306
- Pinzette chirurgiche	123
<b>CRANE-KAPLAN</b> , Bisturi per gengivectomia	301
<b>CRANEPICK</b> , Leve per radici	58
<b>CRILE</b> , Pinze emostatiche	172
- Port'aghi	159
<b>CRILE-MURRAY</b> , Port'aghi	149
<b>CRILE-WOOD</b> , Port'aghi	149, 155, 156
<b>CRYER</b> , Leve per radici	53
- Pinze da estrazione	24, 28, 33, 34
<b>CUSHING</b> , Divaricatori	180

**D**

<b>DANDY-MOSQUITO</b> , Pinze emostatiche	168
<b>DAVIS</b> , Pinze per prelevare strumenti sterilizzati	358
<b>DE BAKEY</b> , Pinzette chirurgiche	122, 137
- Pinzette in titanio	118
- Port'aghi	154
<b>DE MARCO</b> , Curette	303
<b>DEAN</b> , Forbici	94
<b>DERF</b> , Port'aghi	149, 153
<b>DESMARRES</b> , Divaricatori	179
- Pinzette chirurgiche	130
<b>DIETRICH</b> , Port'aghi	148
<b>DINGMANN</b> , Apribocca	193
- Pinza per fissare l'osso	220
<b>DOCKHORN</b> , Divaricatori	180

**E**

<b>ELLIS</b> , Coltelli	79
<b>EPKER</b> , Osteotomi	202

**F**

<b>FAHNENSTOCK</b> , Coltelli per cera	339
<b>FAHRENKRUG</b> , Leve per radici	59
<b>FARABEUF</b> , Divaricatori	190
<b>FAURE</b> , Fissateli	165
<b>FEDI</b> , Scalpelli per parodontologia	285
<b>FELSCH</b> , Pinze da estrazione	16
<b>FELT</b> , Strumenti per composito	271, 273
<b>FOITZIK</b> , Siringa per osso	216
<b>FOSTER-GILLIES</b> , Port'aghi	157
<b>FRAZIER</b> , Cannule per aspirazione	318, 319
<b>FREER</b> , Osteotomi	199
- Scollaperiostei	204
<b>FREER-YASARGIL</b> , Scollaperiostei	204
<b>FRENZEL</b> , Abbassalingua	195
<b>FRIEDMANN</b> , Pinze ossivore	242, 244
<b>FURRER</b> , Pinze per togliere anelli di rame	335

**G**

<b>GARDNER</b> , Pinze ossivore	245
<b>GERALD</b> , Pinzette chirurgiche	129, 136
- Pinzette in titanio	118
<b>GERALD-BROWN</b> , Pinzette chirurgiche	129
<b>GIESSEN</b> , Scollaperiostei	204
<b>GILLIES</b> , Divaricatori	177
- Pinzette chirurgiche	123
<b>GOLDMAN-FOX</b> , Bisturi per gengivectomia	301
- Curette	304
- Elevatori	229
- Forbici	91, 94, 105, 106
- Sonde parodontali	253
<b>GOLDMAN-FOX-WILLIAMS</b> , Sonde parodontali	289
<b>GOLDSTEIN</b> , Strumenti per composito	271, 273
<b>GRACEY</b> , Curette	261, 263, 264, 302, 303
<b>GRAEFE</b> , Coltelli	79
- Pinzette chirurgiche	123, 133
<b>GREENBERG-PAR</b> , Forbici	101
<b>GREENE</b> , Divaricatori	194
<b>GREGORY</b> , Forbici	106
<b>GRITMAN</b> , Spatole	340
- Strumenti da laboratorio	345
<b>GROSS</b> , Pinza porta tamponi	167

**H**

<b>HAJEK</b> , Martelli chirurgici	203
<b>HALSEY</b> , Port'aghi	149, 153
<b>HALSTED</b> , Pinze emostatiche	170, 173
<b>HALSTED-MOSQUITO</b> , Pinze emostatiche	170
- Strumenti per legature	329
<b>HARRIS</b> , Pinze da estrazione	27, 30
<b>HARTMANN</b> , Divaricatori	186
<b>HARTMANN-BABY-MOSQUITO</b> , Pinze emostatiche	168
<b>HEGAR</b> , Port'aghi	155, 159
<b>HEIDBRINK</b> , Leve per radici	47
<b>HEIDEMANN</b> , Spatole	291
<b>HEISTER</b> , Apribocca	188
<b>HEMINGWAY</b> , Cucchiari	232, 233
<b>HENAHAN</b> , Periostotomi	225
<b>HIRSCHFELD</b> , Lime parodontali	267
<b>HOLLENBACK</b> , Otturatori	294, 297
<b>HOPKINS</b> , Periostotomi	228
<b>HOWARD</b> , Lime per osso	238
<b>HULL</b> , Pinze da estrazione	28
<b>HYLIN</b> , Leve per radici	56
- Strumenti per laboratorio	345, 346

**I**

<b>ILIC</b> , Tronchesi per gengive e tessuti	240
<b>INDIA</b> , Pietre per affilatura strumenti	356
<b>IRIS</b> , Forbici	86, 88, 101, 103, 104
<b>IVORY</b> , Strumenti per diga	308, 310, 311, 312
<b>IWANSON</b> , Strumenti per misura	330

**J**

<b>JACOBSON</b> , Cucchiari	235
- Port'aghi	145
<b>JACOBSON-MICRO</b> , Pinze emostatiche	168
<b>JAMESON</b> , Forbici	87
<b>JAMESON-WERBER</b> , Forbici	87
<b>JANSEN</b> , Cucchiari	235
<b>JAQUETTE</b> , Curette	265, 305
<b>JONES</b> , Fissateli	165
<b>JOSEPH</b> , Divaricatori	177
- Forbici	89, 106
<b>JUDD-ALLIS</b> , Pinze per tessuti	174

**K**

<b>KELLY</b> , Forbici	92, 102, 103
- Pinze emostatiche	172
<b>KERLING</b> , Pinze per togliere anelli di rame	335
<b>KERPEL</b> , Cucchiari	234
<b>KERRISON</b> , Pinze ossivore	246
<b>KEYES</b> , Mucotomi punches	213
<b>KILIAN</b> , Periostotomi	227
<b>KILNER</b> , Forbici	87, 91, 93, 101
<b>KIRKLAND</b> , Bisturi per gengivectomia	287, 301
<b>KIRSCH</b> , Divaricatori	182
<b>KLEINER-KUTZ</b> , Pinze ossivore	244
<b>KOCHER</b> , Divaricatori	179, 180
- Pinze emostatiche	171, 172
<b>KOCHER-LANGENBECK</b> , Divaricatori	184
<b>KÖNIG</b> , Periostotomi	224
<b>KOPP</b> , Leve per radici	57
<b>KRALLENHEBER</b> , Leve per radici	53
<b>KRAMER</b> , Curette	264
<b>KRAMER-NEVINS</b> , Curette	264
- Scalpello	200
<b>KROENIG</b> , Abbassalingua	195

**L**

<b>LA FORCE</b> , Coltello	79
<b>LA GRANGE</b> , Forbici	94, 105
<b>LADMORE</b> , Otturatori	295
<b>LAHEY</b> , Divaricatori	180
<b>LANGE</b> , Ablatori tartaro	268
<b>LANGENBECK</b> , Divaricatori	184
<b>LANGER</b> , Curette	266
<b>LE CLUSE</b> , Leve per radici	65
<b>LE CRON</b> , Strumenti da laboratorio	345

<b>LEMPERT</b> , Pinze ossivore	243
<b>LERICHE</b> , Pinze emostatiche	173
<b>LESSMANN</b> , Coltelli per cera	339
<b>LEXER</b> , Forbici	95
<b>LEXER-BABY (KNAPP)</b> , Forbici	101
<b>LICHTENBERG</b> , Port'aghi	158
<b>LINDO-LEVIEN</b> , Leve per radici	57
<b>LISTER</b> , Pinze Sinus	167
<b>LITTAUER</b> , Forbici	108
<b>LOCKING</b> , Pinzette per medicazione	121
<b>LOCKLIN</b> , Forbici	90, 92
<b>LORNA</b> , Fissateli	166
<b>LUCAE</b> , Martelli chirurgici	203
<b>LUCAS</b> , Cucchiari	232
<b>LUER</b> , Pinze ossivore	243
<b>LUKS</b> , Strumenti per trattamenti canalari	254
<b>LUNIATSCHEK</b> , Portacotone	256
- Strumenti per posizionare membrana	214

**M**

<b>MARKLEY PLUGGERS</b> , Otturatori	294
<b>MARTINI</b> , Cucchiari	235
<b>MATHIEU</b> , Port'aghi	158, 160, 161
<b>MATY</b> , Apribocca	189
<b>MAYO</b> , Forbici	96, 104
<b>MAYO-HEGAR</b> , Port'aghi	154, 159
<b>MAYO-LEXER</b> , Forbici	95
<b>MAYO-STILLE</b> , Forbici	95
<b>McCALL</b> , Curette	266, 305
<b>McINDOE</b> , Pinzette chirurgiche	123
<b>McKESSON</b> , Cannule per aspirazione	316
<b>MEAD</b> , Martelli chirurgici	203
- Periostotomi	228
- Pinze da estrazione	35
- Pinze ossivore	242
<b>MENEGHINI</b> , Periostotomi	227
<b>MERIAM</b> , Pinzette per medicazione	120, 121
<b>MERRIT</b> , Sonde parodontali	253
<b>MERSHON</b> , Spingibande	328
<b>METZENBAUM</b> , Forbici	89, 97, 98, 99, 103, 104
<b>METZENBAUM-FINO</b> , Forbici	98, 99, 100
<b>MICRO-ADSON</b> , Pinzette chirurgiche	133
<b>MICRO-HALSTED</b> , Pinzette emostatiche	169
<b>MICRO-RYDER</b> , Port'aghi	148
<b>MICRO-VASCULAR</b> , Port'aghi	154
<b>MIDDELDORPF</b> , Divaricatori	182
<b>MILLER</b> , Lima per osso	238
- Pinzette	138
- Strumenti per legature	329
<b>MILLER-APEXO</b> , Leve per radici	55
<b>MILLER-COLBURN</b> , Periostotomi	231
<b>MINI-FRIEDMANN</b> , Pinze ossivore	241, 242
<b>MINI-GILLIES</b> , Port'aghi	150, 157
<b>MINI-LAMBOTTE</b> , Osteotomi	199
<b>MINI-LANGENBECK</b> , Divaricatori	177
<b>MINI-LEXER</b> , Osteotomi	202
<b>MINI-OLSEN-HEGAR</b> , Port'aghi	150
<b>MINNESOTA</b> , Divaricatori	191
<b>MISCH</b> , Divaricatori	192
<b>MITCHEL</b> , Ablatori di tartaro	268
<b>MOLT</b> , Apribocca	188
- Cucchiari	237
- Periostotomi	225, 226, 229, 231
<b>MOLT-DOYEN-COLLIN</b> , Apribocca	188
<b>MOLT-DOYEN-JANSEN</b> , Apribocca	188

**N**

<b>NABERS</b> , Sonde parodontali	290
<b>NEUMANN</b> , Forbici	94
<b>NEVIUS</b> , Pinze da estrazione	25
<b>NOYES</b> , Micro Forbici	83
<b>NYSTRÖM</b> , Porta matrici	312

**O**

<b>OBWEGESER</b> , Divaricatori	183, 186, 187, 192
- Periostotomi	223
<b>OBWEGESER-FREER</b> , Scollaperiostei	204
<b>OCHSENBEIN</b> , Scalpelli per parodontologia	285, 286



<b>OLSEN-HEGAR</b> , Port'aghi	150, 157
<b>ORBAN</b> , Bisturi per gengivectomia	287, 301
<b>ORINGER</b> , Apribocca	189

## P

<b>P.K.THOMAS</b> , Strumenti per laboratorio	341, 342, 343
<b>PALMER</b> , Pinze per ganci	309
<b>PAQUETTE</b> , Mucotomo	78
<b>PARMLY</b> , Pinze da estrazione	26
<b>PARTSCH</b> , Osteotomi	201
- Scalpelli	201
<b>PEAN</b> , Pinze emostatiche	171
<b>PEAN-MURPHY</b> , Pinze porta tamponi	167
- Strumenti per legature	329
<b>PECK-JOSEPH</b> , Forbici	106
<b>PEET</b> , Strumenti per canali radicolari	39
- Pinze emostatiche	169
<b>PELTON-CRANE</b> , Cannule per aspirazione	318
<b>PERRY</b> , Pinzette chirurgiche	124
<b>PHYSICK</b> , Pinze da estrazione	31
<b>POTT</b> , Leve per radici	60
<b>POTTS-SMITH</b> , Pinzette chirurgiche	135
<b>PRICHARD</b> , Periostotomi	226

## Q

<b>QUINBY</b> , Forbici	97
-------------------------	----

## R

<b>RAGNELL</b> , Divaricatori	180
<b>RAGNELL-DAVIS</b> , Divaricatori	180
<b>REYNOLDS</b> , Forbici	93
<b>ROACH</b> , Strumenti per laboratorio	345
<b>ROGER</b> , Periostotomi	227
<b>ROGGE</b> , Pinze per prelevare strumenti sterilizzati	358
<b>ROSER-KÖNIG</b> , Apribocca	188
<b>ROSIN</b> , Leve per radici	48
<b>ROUTURIER</b> , Pinze da estrazione	11
<b>ROUX</b> , Divaricatori	190
<b>ROUX-MAGNUS</b> , Divaricatori	190
<b>RULE</b> , Curette	307
<b>RUSKIN</b> , Pinze ossivore	244
<b>RUSSIAN</b> , Pinzette	138
<b>RYDER</b> , Port'aghi	151

## S

<b>SANDERS</b> , Bisturi per gengivectomia	301
<b>SAROT</b> , Port'aghi	155
<b>SAUTTER</b> , Scollaperiosteali	204
<b>SCHAEDEL</b> , Fissateli	165
<b>SCHEDE</b> , Cucchiari	236
<b>SCHLUGER</b> , Lime per osso	239
<b>SEAN-MILLER</b> , Divaricatori	179
<b>SELDIN</b> , Leve per radici	58, 59
- Periostotomi	224
<b>SEMKEN</b> , Pinzette chirurgiche	127, 137
<b>SENN-GREEN</b> , Divaricatori	180
<b>SHURE</b> , Pinze tendielastici	327
<b>SMAHA</b> , Port'aghi	161
<b>SMITH</b> , Forbici	107
- Tronchesi per fili metallici	325
<b>SPENCER</b> , Forbici	108
<b>STELLBRINK</b> , Pinze ossivore	241
<b>STERNBERG</b> , Divaricatori	191
<b>STEVENS</b> , Forbici	85, 93, 97
- Port'aghi	148
<b>STIEGLITZ</b> , Pinze per estrazione	39
<b>STILLE</b> , Pinzette chirurgiche	126
<b>STITCH</b> , Forbici	85
<b>STOKE</b> , Pinze per ganci	309
<b>SUGARMAN</b> , Lime per osso	239
<b>SWEDISH</b> , Port'aghi	152

## T

<b>TAYLOR</b> , Curette	265, 306
<b>TG CHISELS</b> , Scalpelli per parodontologia	286
<b>TOBOLD</b> , Divaricatori	186

<b>TOFFLEMIRE</b> , Porta matrice	312
<b>TOMES</b> , Pinze da estrazione	28
<b>TÖNNIS</b> , Port'aghi	159
<b>TÖNNIS-ADSON</b> , Forbici	98
<b>TOWNER</b> , Bisturi per gengivectomia	301
- Curette	165
<b>TOWNER-JAQUETTE</b> , Curette	307

## U

<b>UFFENORDE</b> , Cucchiari	234
<b>UNIVERSAL</b> , Levacorone	338
- Portacotone	256
<b>UNIVERSITY OF MICHIGAN</b> , Sonde parodontali	253, 290

## V

<b>VEHE</b> , Strumenti per laboratorio	345
<b>VOLKMANN</b> , Cucchiari	235, 236

## W

<b>WAHL</b> , Lime per osso	239
<b>WALTON</b> , Forbici	85
<b>WANGENSTEEN</b> , Pinzette chirurgiche	136
<b>WARD</b> , Strumenti per otturazione	278
<b>WARWICK-JAMES</b> , Leve per radici	48
<b>WASSMUND</b> , Divaricatori	194
<b>WEBSTER</b> , Port'aghi	153
<b>WEDELSTAEDT</b> , Strumenti da smalto	298
<b>WEINGART</b> , Pinze per piegare fili	324
<b>WEITLANER</b> , Divaricatori	220
<b>WERTHEIMER</b> , Cannule per aspirazione	319
<b>WESTCOTT</b> , Micro Forbici	83
- Strumenti per otturazione	280, 295
<b>WHITE</b> , Strumenti per otturazione	281
<b>WHITEHEAD-JENNINGS</b> , Apribocca	193
<b>WIEDER</b> , Divaricatori	186
<b>WILAND</b> , Strumenti per modellare e rifinire otturazioni	297
<b>WILLIAMS</b> , Sonde parodontali	253
<b>WILLIGER</b> , Cucchiari	234, 235
- Periostotomi	223
<b>WINTER</b> , Leve per radici	63, 64
<b>WITZEL</b> , Pinze da estrazione	38
<b>WOODSON</b> , Strumenti per otturazione	295

## Y

<b>YANKAUER</b> , Cannule per aspirazione	315
<b>YOUNG</b> , Pinza tiralingua	195
<b>YOUNGER-GOOD</b> , Curette	306

## Z

<b>ZAHLE</b> , Strumenti da laboratorio	346
<b>ZAUFAL-JANSEN</b> , Pinze ossivore	244
<b>ZIEGLER</b> , Coltelli	79
<b>ZIELINSKY</b> , Strumenti per misura	330



**A**

<b>ADERER</b> , Alicates para doblar alambre	324
<b>ADSON</b> , Cànulas aspiradoras	319
- Pinzas finas	114
- Pinzas quirùrgicas	122, 131, 132, 133, 136
- Pinzas de titanio	118
<b>ADSON-BROWN</b> , Pinzas finas	114
- Pinzas quirùrgicas	131
<b>AINSWORTH</b> , Instrumentos para dique de goma	308
<b>ALLIS</b> , Pinzas para tejidos	174
<b>ANDREWS-PYNCHON</b> , Cànulas aspiradoras	315
<b>APEXO</b> , Elevadores para raices	50
<b>ARKANSAS</b> , Materiales para afilar	356
<b>ARRUGA</b> , Portaagujas	158
<b>AUSTIN</b> , Separadores	184

**B**

<b>BABY-ALLIS</b> , Pinzas para tejidos	174
<b>BABY-CRILE</b> , Pinzas hemostàticas	173
<b>BABY-CRILEWOOD</b> , Portaagujas	156
<b>BABY-METZENBAUM</b> , Tijeras	98
<b>BABY-MIXTER</b> , Pinzas hemostàticas	171
<b>BABY-YANKAUER</b> , Cànulas aspiradoras	315
<b>BACKHAUS</b> , Pinzas de campo	165
<b>BALL</b> , Instrumentos para obturaciones	292
<b>BARRAQUER</b> , Pinzas quirùrgicas	130
- Portaagujas	142
<b>BARRY</b> , Elevadores para raices	65
<b>BARTH</b> , Cucharillas	235
<b>BEALE</b> , Instrumentos para laboratorio	345
<b>BEASLEY-BABCOCK</b> , Pinzas quirùrgicas	133
<b>BEEBE</b> , Tijeras	326
- Tijeras para cortar alambre	109
<b>BEIN</b> , Elevadores para raices	43
<b>BENNETT</b> , Rugines	226
<b>BERNARD</b> , Elevadores para raices	61
<b>BEYER</b> , Pinzas para huesos	244
<b>BISHOP</b> , Separadores	191
<b>BISHOP-HARMON</b> , Pinzas finas	114
<b>BLACK</b> , Instrumentos para esmalte	283, 298
<b>BLUMENTHAL</b> , Pinzas para huesos	242
<b>BÖHLER</b> , Pinzas para huesos	245
<b>BÖHM</b> , Alicates para coronas telescòpicas	335
<b>BOLEY</b> , Instrumentos para medir	330
<b>BOWLED-HENRY</b> , Separadores	184
<b>BOYNTON</b> , Portaagujas	158
<b>BOYS-ALLIS</b> , Pinzas para tejidos	174
<b>BREWER</b> , Pinzas para ganchos	309
<b>BROWN</b> , Pinzas finas	114
- Pinzas quirùrgicas	131
<b>BRUENINGS</b> , Abaja lenguas	195
<b>BRUNS</b> , Cucharillas	236
<b>BUCHWALD</b> , Abaja lenguas	195
<b>BUCK</b> , Bisturis para la gingivectomia	301
- Limas para huesos	239

**C**

<b>CARVER</b> , Instrumentos para modelar las obturaciones	297
<b>CASTROVIEJO</b> , Pinzas finas	114
- Portaagujas	141, 143, 144, 145, 146
- Instrumentos para medir	218
<b>CAWOOD-MINNESOTA</b> , Separadores	191
<b>CHADWICK</b> , Tijeras	97
<b>CHOEN</b> , Pinzas para cortar tejidos	240
<b>CHOMPRET</b> , Syndesmòtomos	70
<b>CITELLI</b> , Pinzas para huesos	246
<b>CLEVELAND</b> , Pinzas para huesos	245
<b>COHEN</b> , Pinzas da extracciòn	31
<b>COLLEGE</b> , Pinzas de titanio	118
- Pinzas para vendajes	120, 121
<b>COLLIN</b> , Pinzas tira-lengua	195
<b>COLUMBIA</b> , Curetas	262, 266
- Separadores	191
<b>CONVERSE</b> , Portaagujas	153
<b>CORN</b> , Pinzas	138
<b>COTTLE</b> , Tijeras	86
- Martillos quirùrgicos	203
- Cinceles	202

<b>COTTLE-KNAPP</b> , Tijeras	86
<b>COUPLAND</b> , Cànulas aspiradoras	317
- Elevadores para raices	54
<b>CRANE-CAPLAN</b> , Curetas	306
- Pinzas quirùrgicas	123
<b>CRANE-KAPLAN</b> , Bisturis para la gingivectomia	301
<b>CRANEPICK</b> , Elevadores para raices	58
<b>CRILE</b> , Pinzas hemostàticas	172
- Portaagujas	159
<b>CRILE-MURRAY</b> , Portaagujas	149
<b>CRILE-WOOD</b> , Portaagujas	149, 155, 156
<b>CRYER</b> , Elevadores para raices	53
- Pinzas da extracciòn	24, 28, 33, 34
<b>CUSHING</b> , Separadores	180

**D**

<b>DANDY-MOSQUITO</b> , Pinzas hemostàticas	168
<b>DAVIS</b> , Pinzas para esterilizaciòn	358
<b>DE BAKEY</b> , Pinzas quirùrgicas	122, 137
- Pinzas de titanio	118
- Portaagujas	154
<b>DE MARCO</b> , Curetas	303
<b>DEAN</b> , Tijeras	94
<b>DERF</b> , Portaagujas	149, 153
<b>DESMARRES</b> , Separadores	179
- Pinzas quirùrgicas	130
<b>DIETRICH</b> , Portaagujas	148
<b>DINGMANN</b> , Abrebocas	193
- Pinzas para coger huesos	220
<b>DOCKHORN</b> , Separadores	180

**E**

<b>ELLIS</b> , Bisturios	79
<b>EPKER</b> , Osteòtomos	202

**F**

<b>FAHNENSTOCK</b> , Cuchillos para cera	339
<b>FAHRENKRUG</b> , Elevadores para raices	59
<b>FARABEUF</b> , Separadores	190
<b>FAURE</b> , Pinzas de campo	165
<b>FEDI</b> , Cinceles para la cirugia periodontal	285
<b>FELSCH</b> , Pinzas da extracciòn	16
<b>FELT</b> , Instrumentos para composites	271, 273
<b>FOITZIK</b> , Instrumentos para huesos	216
<b>FOSTER-GILLIES</b> , Portaagujas	157
<b>FRAZIER</b> , Cànulas aspiradoras	318, 319
<b>FREER</b> , Osteòtomos	199
- Periostòtomos	204
<b>FREER-YASARGIL</b> , Periostòtomos	204
<b>FRENZEL</b> , Abaja lenguas	195
<b>FRIEDMANN</b> , Pinzas para huesos	242, 244
<b>FURRER</b> , Pinzas para sacar anillos de cobre	335

**G**

<b>GARDNER</b> , Pinzas para huesos	245
<b>GERALD</b> , Pinzas quirùrgicas	129, 136
- Pinzas de titanio	118
<b>GERALD-BROWN</b> , Pinzas quirùrgicas	129
<b>GIESSEN</b> , Periostòtomos	204
<b>GILLIES</b> , Separadores	177
- Pinzas quirùrgicas	123
<b>GOLDMAN-FOX</b> , Bisturis para la gingivectomia	301
- Curetas	304
- Elevadores	229
- Tijeras	91, 94, 105, 106
- Sondas parodontales	253
<b>GOLDMAN-FOX-WILLIAMS</b> , Sondas parodontales	289
<b>GOLDSTEIN</b> , Instrumentos para composites	271, 273
<b>GRACEY</b> , Curetas	261, 263, 264, 302, 303
<b>GRAEFE</b> , Bisturios	79
- Pinzas quirùrgicas	123, 133
<b>GREENBERG-PAR</b> , Tijeras	101
<b>GREENE</b> , Separadores	194
<b>GREGORY</b> , Tijeras	106
<b>GRITMAN</b> , Espàtulas	340
- Instrumentos para laboratorio	345
<b>GROSS</b> , Pinzas porta tampones	167

**H**

<b>HAJEK</b> , Martillos quirurgicos	203
<b>HALSEY</b> , Portaagujas	149, 153
<b>HALSTED</b> , Pinzas hemostáticas	170, 173
<b>HALSTED-MOSQUITO</b> , Pinzas hemostáticas	170
- Instrumentos para ligaduras	329
<b>HARRIS</b> , Pinzas da extracciòn	27, 30
<b>HARTMANN</b> , Separadores	186
<b>HARTMANN-BABY-MOSQUITO</b> , Pinzas hemostáticas	168
<b>HEGAR</b> , Portaagujas	155, 159
<b>HEIDBRINK</b> , Elevadores para raices	47
<b>HEIDEMANN</b> , Espátulas	291
<b>HEISTER</b> , Abrebocas	188
<b>HEMINGWAY</b> , Cucharillas	232, 233
<b>HENAHAN</b> , Rugines	225
<b>HIRSCHFELD</b> , Limas parodontales	267
<b>HOLLENBACK</b> , Instrumentos para obturaciones	294, 297
<b>HOPKINS</b> , Rugines	228
<b>HOWARD</b> , Limas para huesos	238
<b>HULL</b> , Pinzas da extracciòn	28
<b>HYLIN</b> , Elevadores para raices	56
- Instrumentos para laboratorio	345, 346

**I**

<b>ILIC</b> , Pinzas para cortar tejidos	240
<b>INDIA</b> , Materiales para afilar	356
<b>IRIS</b> , Tijeras	86, 88, 101, 103, 104
<b>IVORY</b> , Instrumentos para dique	308, 310, 311, 312
<b>IWANSON</b> , Instrumentos para medir	330

**J**

<b>JACOBSON</b> , Cucharillas	235
- Portaagujas	145
<b>JACOBSON-MICRO</b> , Pinzas hemostáticas	168
<b>JAMESON</b> , Tijeras	87
<b>JAMESON-WERBER</b> , Tijeras	87
<b>JANSEN</b> , Cucharillas	235
<b>JAQUETTE</b> , Curetas	265, 305
<b>JONES</b> , Pinzas de campo	165
<b>JOSEPH</b> , Separadores	177
- Tijeras	89, 106
<b>JUDD-ALLIS</b> , Pinzas para tejidos	174

**K**

<b>KELLY</b> , Tijeras	92, 102, 103
- Pinzas hemostáticas	172
<b>KERLING</b> , Pinzas para sacar anillos de cobre	335
<b>KERPEL</b> , Cucharillas	234
<b>KERRISON</b> , Pinzas para huesos	246
<b>KEYES</b> , Punches para cortar tejidos	213
<b>KILIAN</b> , Rugines	227
<b>KILNER</b> , Tijeras	87, 91, 93, 101
<b>KIRKLAND</b> , Bisturis para la gingivectomia	287, 301
<b>KIRSCH</b> , Separadores	182
<b>KLEINER-KUTZ</b> , Pinzas para huesos	244
<b>KOCHER</b> , Separadores	179, 180
- Pinzas hemostáticas	171, 172
<b>KOCHER-LANGENBECK</b> , Separadores	184
<b>KÖNIG</b> , Rugines	224
<b>KOPP</b> , Elevadores para raices	57
<b>KRALLENHEBER</b> , Elevadores para raices	53
<b>KRAMER</b> , Curetas	264
<b>KRAMER-NEVINS</b> , Curetas	264
- Cinceles	200
<b>KROENIG</b> , Abaja lenguas	195

**L**

<b>LA FORCE</b> , Bisturios	79
<b>LA GRANGE</b> , Tijeras	94, 105
<b>LADMORE</b> , Instrumentos para obturacion	295
<b>LAHEY</b> , Separadores	180
<b>LANGE</b> , Limpiadores	268
<b>LANGENBECK</b> , Separadores	184
<b>LANGER</b> , Curetas	266
<b>LE CLUSE</b> , Elevadores para raices	65
<b>LE CRON</b> , Instrumentos para laboratorio	345

<b>LEMPERT</b> , Pinzas para huesos	243
<b>LERICHE</b> , Pinzas hemostáticas	173
<b>LESSMANN</b> , Cuchillos para cera	339
<b>LEXER</b> , Tijeras	95
<b>LEXER-BABY (KNAPP)</b> , Tijeras	101
<b>LICHTENBERG</b> , Portaagujas	158
<b>LINDO-LEVIEN</b> , Elevadores para raices	57
<b>LISTER</b> , Pinzas porta tampones	167
<b>LITTAUER</b> , Tijeras	108
<b>LOCKING</b> , Pinzas para vendajes	121
<b>LOCKLIN</b> , Tijeras	90, 92
<b>LORNA</b> , Pinzas de campo	166
<b>LUCAE</b> , Martillos quirurgicos	203
<b>LUCAS</b> , Cucharillas	232
<b>LUER</b> , Pinzas para huesos	243
<b>LUKS</b> , Instrumentos para nervios	254
<b>LUNIATSCHEK</b> , Porta algodones	256
- Instrumentos para colocar membranas	214

**M**

<b>MARKLEY PLUGGERS</b> , Instrumentos para obturacion	294
<b>MARTINI</b> , Cucharillas	235
<b>MATHIEU</b> , Portaagujas	158, 160, 161
<b>MATY</b> , Abrebocas	189
<b>MAYO</b> , Tijeras	96, 104
<b>MAYO-HEGAR</b> , Portaagujas	154, 159
<b>MAYO-LEXER</b> , Tijeras	95
<b>MAYO-STILLE</b> , Tijeras	95
<b>McCALL</b> , Curetas	266, 305
<b>McINDOE</b> , Pinzas quirùrgicas	123
<b>McKESSON</b> , Cànulas aspiradoras	316
<b>MEAD</b> , Martillos quirurgicos	203
- Rugines	228
- Pinzas da extracciòn	35
- Pinzas para huesos	242
<b>MENEGHINI</b> , Rugines	227
<b>MERIAM</b> , Pinzas para vendajes	120, 121
<b>MERRIT</b> , Sondas parodontales	253
<b>MERSHON</b> , Empujador de bandas	328
<b>METZENBAUM</b> , Tijeras	89, 97, 98, 99, 103, 104
<b>METZENBAUM-FINO</b> , Tijeras	98, 99, 100
<b>MICRO-ADSON</b> , Pinzas quirùrgicas	133
<b>MICRO-HALSTED</b> , Pinzas hemostáticas	169
<b>MICRO-RYDER</b> , Portaagujas	148
<b>MICRO-VASCULAR</b> , Portaagujas	154
<b>MIDDELDORPF</b> , Separadores	182
<b>MILLER</b> , Lima para huesos	238
- Pinzas	138
- Instrumentos para ligadura	329
<b>MILLER-APEXO</b> , Elevadores para raices	55
<b>MILLER-COLBURN</b> , Rugines	231
<b>MINI-FRIEDMANN</b> , Pinzas para huesos	241, 242
<b>MINI-GILLIES</b> , Portaagujas	150, 157
<b>MINI-LAMBOTTE</b> , Osteòtomos	199
<b>MINI-LANGENBECK</b> , Separadores	177
<b>MINI-LEXER</b> , Osteòtomos	202
<b>MINI-OLSEN-HEGAR</b> , Portaagujas	150
<b>MINNESOTA</b> , Separadores	191
<b>MISCH</b> , Separadores	192
<b>MITCHEL</b> , Limpiador	268
<b>MOLT</b> , Abrebocas	188
- Cucharillas	237
- Rugines	225, 226, 229, 231
<b>MOLT-DOYEN-COLLIN</b> , Abrebocas	188
<b>MOLT-DOYEN-JANSEN</b> , Abrebocas	188

**N**

<b>NABERS</b> , Sondas parodontales	290
<b>NEUMANN</b> , Tijeras	94
<b>NEVIUS</b> , Pinzas da extracciòn	25
<b>NOYES</b> , Micro Tijeras	83
<b>NYSTRÖM</b> , Instrumentos para dique	312

**O**

<b>OBWEGESER</b> , Separadores	183, 186, 187, 192
- Rugines	223
<b>OBWEGESER-FREER</b> , Periostòtomos	204
<b>OCHSENBEIN</b> , Cinceles para la cirugia periodontal	285, 286





<b>OLSEN-HEGAR</b> , Portaagujas	150, 157
<b>ORBAN</b> , Bisturis para la gingivectomia	287, 301
<b>ORINGER</b> , Abrebocas	189

## P

<b>P.K.THOMAS</b> , Instrumentos para laboratorio	341, 342, 343
<b>PALMER</b> , Pinzas para ganchos	309
<b>PAQUETTE</b> , Punches para cortar tejidos	78
<b>PARMLY</b> , Pinzas da extracciòn	26
<b>PARTSCH</b> , Osteòtomos	201
- Cinceles	201
<b>PEAN</b> , Pinzas hemostàticas	171
<b>PEAN-MURPHY</b> , Pinzas para tampones	167
- Instrumentos para ligaduras	329
<b>PECK-JOSEPH</b> , Tijeras	106
<b>PEET</b> , Instrumentos de canal	39
- Pinzas hemostàticas	169
<b>PELTON-CRANE</b> , Cànulas aspiradoras	318
<b>PERRY</b> , Pinzas quirùrgicas	124
<b>PHYSICK</b> , Pinzas da extracciòn	31
<b>POTT</b> , Elevadore para raices	60
<b>POTTS-SMITH</b> , Pinzas quirùrgicas	135
<b>PRICHARD</b> , Rugines	226

## Q

<b>QUINBY</b> , Tijeras	97
-------------------------	----

## R

<b>RAGNELL</b> , Separadores	180
<b>RAGNELL-DAVIS</b> , Separadores	180
<b>REYNOLDS</b> , Tijeras	93
<b>ROACH</b> , Instrumentos para laboratorio	345
<b>ROGER</b> , Rugines	227
<b>ROGGE</b> , Pinzas para esterilizaciòn	358
<b>ROSER-KÖNIG</b> , Abrebocas	188
<b>ROSIN</b> , Elevadores para raices	48
<b>ROUTURIER</b> , Pinzas da extracciòn	11
<b>ROUX</b> , Separadores	190
<b>ROUX-MAGNUS</b> , Separadores	190
<b>RULE</b> , Curetas	307
<b>RUSKIN</b> , Pinzas para huesos	244
<b>RUSSIAN</b> , Pinzas	138
<b>RYDER</b> , Portaagujas	151

## S

<b>SANDERS</b> , Bisturis para gingivectomia	301
<b>SAROT</b> , Portaagujas	155
<b>SAUTTER</b> , Rugines	204
<b>SCHAEDEL</b> , Pinzas de campo	165
<b>SCHEDE</b> , Cucharillas	236
<b>SCHLUGER</b> , Limas para huesos	239
<b>SEAN-MILLER</b> , Separadores	179
<b>SELDIN</b> , Elevadores para raices	58, 59
- Rugines	224
<b>SEMKEN</b> , Pinzas quirùrgicas	127, 137
<b>SENN-GREEN</b> , Separadores	180
<b>SHURE</b> , Pinza estira-elàsticos	327
<b>SMAHA</b> , Portaagujas	161
<b>SMITH</b> , Tijeras	107
- Alicates para cortar alambre	325
<b>SPENCER</b> , Tijeras	108
<b>STELLBRINK</b> , Pinzas para huesos	241
<b>STERNBERG</b> , Separadores	191
<b>STEVENS</b> , Tijeras	85, 93, 97
- Portaagujas	148
<b>STIEGLITZ</b> , Pinzas da extracciòn	39
<b>STILLE</b> , Pinzas quirùrgicas	126
<b>STITCH</b> , Tijeras	85
<b>STOKE</b> , Pinzas para ganchos	309
<b>SUGARMAN</b> , Lima para huesos	239
<b>SWEDISH</b> , Portaagujas	152

## T

<b>TAYLOR</b> , Curetas	265, 306
<b>TG CHISELS</b> , Cinceles para cirugia periodontal	286
<b>TOBOLD</b> , Separadores	186

<b>TOFFLEMIRE</b> , Instrumentos para dique	312
<b>TOMES</b> , Pinzas da extracciòn	28
<b>TÖNNIS</b> , Portaagujas	159
<b>TÖNNIS-ADSON</b> , Tijeras	98
<b>TOWNER</b> , Bisturis para gingivectomia	301
- Curetas	165
<b>TOWNER-JAQUETTE</b> , Curetas	307

## U

<b>UFFENORDE</b> , Cucharillas	234
<b>UNIVERSAL</b> , Instrumentos para quitar coronas	338
- Porta algodones	256
<b>UNIVERSITY OF MICHIGAN</b> , Sondas parodontales	253, 290

## V

<b>VEHE</b> , Instrumentos para laboratorio	345
<b>VOLKMANN</b> , Cucharillas	235, 236

## W

<b>WAHL</b> , Limas para huesos	239
<b>WALTON</b> , Tijeras	85
<b>WANGENSTEEN</b> , Pinzas quirùrgicas	136
<b>WARD</b> , Instrumentos para obturaciones	278
<b>WARWICK-JAMES</b> , Elevadores para raices	48
<b>WASSMUND</b> , Separadores	194
<b>WEBSTER</b> , Portaagujas	153
<b>WEDELSTAEDT</b> , Instrumentos para esmalte	298
<b>WEINGART</b> , Pinzas para doblar alambre	324
<b>WEITLANER</b> , Separadores	220
<b>WERTHEIMER</b> , Cànulas aspiradoras	319
<b>WESTCOTT</b> , Micro Tijeras	83
- Instrumentos para obturaciones	280, 295
<b>WHITE</b> , Instrumentos para obturaciones	281
<b>WHITEHEAD-JENNINGS</b> , Abrebocas	193
<b>WIEDER</b> , Separadores	186
<b>WILAND</b> , Instrumentos para modelar obturaciones	297
<b>WILLIAMS</b> , Sondas parodontales	253
<b>WILLIGER</b> , Cucharillas	234, 235
- Rugines	223
<b>WINTER</b> , Elevadores para raices	63, 64
<b>WITZEL</b> , Pinzas da extracciòn	38
<b>WOODSON</b> , Instrumentos para obturaciones	295

## Y

<b>YANKAUER</b> , Cànulas aspiradoras	315
<b>YOUNG</b> , Pinzas tira-lengua	195
<b>YOUNGER-GOOD</b> , Curetas	306

## Z

<b>ZAHLE</b> , Instrumentos para laboratorio	346
<b>ZAUFAL-JANSEN</b> , Pinzas para huesos	244
<b>ZIEGLER</b> , Bisturies	79
<b>ZIELINSKY</b> , Instrumentos para medir	330





**A**

<b>ADERER</b> , Pincés à pliers les fils	324
<b>ADSON</b> , Canules aspiratrices	319
- Micro Pincés	114
- Pincés chirurgicales	122, 131, 132, 133, 136
- Pincés en titane	118
<b>ADSON-BROWN</b> , Micro Pincés	114
- Pincés chirurgicales	131
<b>AINSWORTH</b> , Instruments pour digue	308
<b>ALLIS</b> , Pincés pour tissu	174
<b>ANDREWS-PYNCHON</b> , Canules aspiratrices	315
<b>APEXO</b> , Elevateurs à racines	50
<b>ARKANSAS</b> , Pierres d'affutage	356
<b>ARRUGA</b> , Porte aiguilles	158
<b>AUSTIN</b> , Ecarteurs	184

**B**

<b>BABY-ALLIS</b> , Pincés pour tissu	174
<b>BABY-CRILE</b> , Pincés hémostatiques	173
<b>BABY-CRILEWOOD</b> , Porte aiguilles	156
<b>BABY-METZENBAUM</b> , Ciseaux	98
<b>BABY-MIXTER</b> , Pincés hémostatiques	171
<b>BABY-YANKAUER</b> , Canules aspiratrices	315
<b>BACKHAUS</b> , Pincés à champs	165
<b>BALL</b> , Instruments pour obturations	292
<b>BARRAQUER</b> , Pincés chirurgicales	130
- Porte aiguilles	142
<b>BARRY</b> , Elevateurs à racines	65
<b>BARTH</b> , Curettes	235
<b>BEALE</b> , Instruments pour laboratoire	345
<b>BEASLEY-BABCOCK</b> , Pincés chirurgicales	133
<b>BEEBE</b> , Ciseaux	326
- Ciseaux coupe-fils métalliques	109
<b>BEIN</b> , Elevateurs à racines	43
<b>BENNETT</b> , Rugines	226
<b>BERNARD</b> , Elevateurs à racines	61
<b>BEYER</b> , Pincés gouges	244
<b>BISHOP</b> , Ecarteurs	191
<b>BISHOP-HARMON</b> , Micro Pincés	114
<b>BLACK</b> , Instruments à émail	283, 298
<b>BLUMENTHAL</b> , Pincés gouges	242
<b>BÖHLER</b> , Pincés gouges	245
<b>BÖHM</b> , Pincés pour couronnes télescopes	335
<b>BOLEY</b> , Instruments à mesurer	330
<b>BOWLED-HENRY</b> , Ecarteurs	184
<b>BOYNTON</b> , Porte aiguilles	158
<b>BOYS-ALLIS</b> , Pincés pour tissu	174
<b>BREWER</b> , Pincés à crampons	309
<b>BROWN</b> , Micro Pincés	114
- Pincés chirurgicales	131
<b>BRUENINGS</b> , Abaisse langues	195
<b>BRUNS</b> , Curettes	236
<b>BUCHWALD</b> , Abaisse langues	195
<b>BUCK</b> , Bistouris pour la gengivectomie	301
- Rapes à os	239

**C**

<b>CARVER</b> , Instruments à modeler les obturations	297
<b>CASTROVIEJO</b> , Micro Pincés	114
- Porte aiguilles	141, 143, 144, 145, 146
- Instruments à mesurer	218
<b>CAWOOD-MINNESOTA</b> , Ecarteurs	191
<b>CHADWICK</b> , Ciseaux	97
<b>CHOEN</b> , Pincés pour couper le tissu	240
<b>CHOMPRET</b> , Syndesmotomes	70
<b>CITELLI</b> , Pincés coupantes à os	246
<b>CLEVELAND</b> , Pincés gouges	245
<b>COHEN</b> , Daviers	31
<b>COLLEGE</b> , Pincés en titane	118
- Prélèvements pour coton	120, 121
<b>COLLIN</b> , Pincés tire-langue	195
<b>COLUMBIA</b> , Curettes	262, 266
- Ecarteurs	191
<b>CONVERSE</b> , Porte aiguilles	153
<b>CORN</b> , Pincés	138
<b>COTTLE</b> , Ciseaux	86
- Maillets chirurgicaux	203
- Scalpel	202

<b>COTTLE-KNAPP</b> , Ciseaux	86
<b>COUPLAND</b> , Canules aspiratrices	317
- Elevateurs à racines	54
<b>CRANE-CAPLAN</b> , Curettes	306
- Pincés chirurgicales	123
<b>CRANE-KAPLAN</b> , Bistouris pour la gengivectomie	301
<b>CRANEPICK</b> , Elevateurs à racines	58
<b>CRILE</b> , Pincés hémostatiques	172
- Porte aiguilles	159
<b>CRILE-MURRAY</b> , Porte aiguilles	149
<b>CRILE-WOOD</b> , Porte aiguilles	149, 155, 156
<b>CRYER</b> , Elevateurs à racines	53
- Daviers	24, 28, 33, 34
<b>CUSHING</b> , Ecarteurs	180

**D**

<b>DANDY-MOSQUITO</b> , Pincés hémostatiques	168
<b>DAVIS</b> , Pincés pour saisir les objets stérilisés	358
<b>DE BAKEY</b> , Pincés chirurgicales	122, 137
- Pincés en titane	118
- Porte aiguilles	154
<b>DE MARCO</b> , Curettes	303
<b>DEAN</b> , Ciseaux	94
<b>DERF</b> , Porte aiguilles	149, 153
<b>DESMARRES</b> , Ecarteurs	179
- Pincés chirurgicales	130
<b>DIETRICH</b> , Porte aiguilles	148
<b>DINGMANN</b> , Ecarteurs buccal	193
- Pincés pour tenir l'os	220
<b>DOCKHORN</b> , Ecarteurs	180

**E**

<b>ELLIS</b> , Couteau	79
<b>EPKER</b> , Ostéotomes	202

**F**

<b>FAHNENSTOCK</b> , Couteaux à cire	339
<b>FAHRENKRUG</b> , Elevateurs à racines	59
<b>FARABEUF</b> , Ecarteurs	190
<b>FAURE</b> , Pincés à champs	165
<b>FEDI</b> , Ciseaux de chirurgie	285
<b>FELSCH</b> , Daviers	16
<b>FELT</b> , Instruments pour composite	271, 273
<b>FOITZIK</b> , Compacteur à os pilons	216
<b>FOSTER-GILLIES</b> , Porte aiguilles	157
<b>FRAZIER</b> , Canules aspiratrices	318, 319
<b>FREER</b> , Ostéotomes	199
- Raspatoires	204
<b>FREER-YASARGIL</b> , Rugines	204
<b>FRENZEL</b> , Abaisse langues	195
<b>FRIEDMANN</b> , Pincés gouges	242, 244
<b>FURRER</b> , Pince à enlever les bagues en cuivre	335

**G**

<b>GARDNER</b> , Pincés gouges	245
<b>GERALD</b> , Pincés chirurgicales	129, 136
- Pincés en titane	118
<b>GERALD-BROWN</b> , Pincés chirurgicales	129
<b>GIESSEN</b> , Raspatoires	204
<b>GILLIES</b> , Ecarteurs	177
- Pincés chirurgicales	123
<b>GOLDMAN-FOX</b> , Bistouris pour la gengivectomie	301
- Curettes	304
- Elevateurs	229
- Ciseaux	91, 94, 105, 106
- Sondes parodontales	253
<b>GOLDMAN-FOX-WILLIAMS</b> , Sonde parodontales	289
<b>GOLDSTEIN</b> , Instruments pour composite	271, 273
<b>GRACEY</b> , Curettes	261, 263, 264, 302, 303
<b>GRAEFE</b> , Couteau	79
- Pincés chirurgicales	123, 133
<b>GREENBERG-PAR</b> , Ciseaux	101
<b>GREENE</b> , Ecarteurs	194
<b>GREGORY</b> , Ciseaux	106
<b>GRITMAN</b> , Spatules	340
- Instruments pour laboratoire	345
<b>GROSS</b> , Pincés porte-tampons	167

## H

<b>HAJEK</b> , Maillets chirurgicaux	203
<b>HALSEY</b> , Porte aiguilles	149, 153
<b>HALSTED</b> , Pincés hémostatiques	170, 173
<b>HALSTED-MOSQUITO</b> , Pincés hémostatiques	170
- Instruments à ligature	329
<b>HARRIS</b> , Daviers	27, 30
<b>HARTMANN</b> , Ecarteurs	186
<b>HARTMANN-BABY-MOSQUITO</b> , Pincés hémostatiques	168
<b>HEGAR</b> , Porte aiguilles	155, 159
<b>HEIDBRINK</b> , Elevateurs à racines	47
<b>HEIDEMANN</b> , Spatules	291
<b>HEISTER</b> , Ecarteurs buccal	188
<b>HEMINGWAY</b> , Curettes	232, 233
<b>HENAHAN</b> , Rugines	225
<b>HIRSCHFELD</b> , Limes parodontales	267
<b>HOLLENBACK</b> , Instruments pour obturations	294, 297
<b>HOPKINS</b> , Rugines	228
<b>HOWARD</b> , Curettes	238
<b>HULL</b> , Daviers	28
<b>HYLIN</b> , Elevateurs à racines	56
- Instruments pour laboratoire	345, 346

## I

<b>ILIC</b> , Pincés pour couper le tissu	240
<b>INDIA</b> , Pierres d'affutage	356
<b>IRIS</b> , Ciseaux	86, 88, 101, 103, 104
<b>IVORY</b> , Instruments pour digue	308, 310, 311, 312
<b>IWANSON</b> , Instruments à mesurer	330

## J

<b>JACOBSON</b> , Curettes	235
- Porte aiguilles	145
<b>JACOBSON-MICRO</b> , Pincés hémostatiques	168
<b>JAMESON</b> , Ciseaux	87
<b>JAMESON-WERBER</b> , Ciseaux	87
<b>JANSEN</b> , Curettes	235
<b>JAQUETTE</b> , Curettes	265, 305
<b>JONES</b> , Pincés à champs	165
<b>JOSEPH</b> , Ecarteurs	177
- Ciseaux	89, 106
<b>JUDD-ALLIS</b> , Pincés pour tissus	174

## K

<b>KELLY</b> , Ciseaux	92, 102, 103
- Pincés hémostatiques	172
<b>KERLING</b> , Pincés à enlever les bagues en cuivre	335
<b>KERPEL</b> , Curettes	234
<b>KERRISON</b> , Pincés coupantes à os	246
<b>KEYES</b> , Puncés à couper le tissu	213
<b>KILIAN</b> , Rugines	227
<b>KILNER</b> , Ciseaux	87, 91, 93, 101
<b>KIRKLAND</b> , Bistouris pour la gengivectomie	287, 301
<b>KIRSCH</b> , Ecarteurs	182
<b>KLEINER-KUTZ</b> , Pincés gouges	244
<b>KOCHER</b> , Ecarteurs	179, 180
- Pincés hémostatiques	171, 172
<b>KOCHER-LANGENBECK</b> , Ecarteurs	184
<b>KÖNIG</b> , Rugines	224
<b>KOPP</b> , Elevateurs à racines	57
<b>KRALLENHEBER</b> , Elevateurs à racines	53
<b>KRAMER</b> , Curettes	264
<b>KRAMER-NEVINS</b> , Curettes	264
- Scalpel	200
<b>KROENIG</b> , Abaisse langues	195

## L

<b>LA FORCE</b> , Couteau	79
<b>LA GRANGE</b> , Ciseaux	94, 105
<b>LADMORE</b> , Instruments pour obturations	295
<b>LAHEY</b> , Ecarteurs	180
<b>LANGÉ</b> , Détartreurs	268
<b>LANGENBECK</b> , Ecarteurs	184
<b>LANGER</b> , Curettes	266
<b>LE CLUSE</b> , Elevateurs à racines	65
<b>LE CRON</b> , Instruments pour laboratoire	345

<b>LEMPERT</b> , Pincés gouges	243
<b>LERICHE</b> , Pincés hémostatiques	173
<b>LESSMANN</b> , Couteaux à cire	339
<b>LEXER</b> , Ciseaux	95
<b>LEXER-BABY (KNAPP)</b> , Ciseaux	101
<b>LICHTENBERG</b> , Porte aiguilles	158
<b>LINDO-LEVIEN</b> , Elevateurs à racines	57
<b>LISTER</b> , Pincés porte-tampons	167
<b>LITTAUER</b> , Ciseaux	108
<b>LOCKING</b> , Précelles pour coton	121
<b>LOCKLIN</b> , Ciseaux	90, 92
<b>LORNA</b> , Pincés à champs	166
<b>LUCAE</b> , Maillets chirurgicaux	203
<b>LUCAS</b> , Curettes	232
<b>LUER</b> , Pincés gouges	243
<b>LUKS</b> , Instruments à nerfs	254
<b>LUNIATSCHEK</b> , Porte cotons	256
- Instruments d'application de membrane	214

## M

<b>MARKLEY PLUGGERS</b> , Instruments pour obturations	294
<b>MARTINI</b> , Curettes	235
<b>MATHIEU</b> , Porte aiguilles	158, 160, 161
<b>MATY</b> , Ecarteurs buccal	189
<b>MAYO</b> , Ciseaux	96, 104
<b>MAYO-HEGAR</b> , Porte aiguilles	154, 159
<b>MAYO-LEXER</b> , Ciseaux	95
<b>MAYO-STILLE</b> , Ciseaux	95
<b>McCALL</b> , Curettes	266, 305
<b>McINDOE</b> , Pincés chirurgicales	123
<b>McKESSON</b> , Canules aspiratrices	316
<b>MEAD</b> , Maillets chirurgicaux	203
- Rugines	228
- Daviers	35
- Pincés-gouges	242
<b>MENEGHINI</b> , Rugines	227
<b>MERIAM</b> , Précelles pour coton	120, 121
<b>MERRIT</b> , Sondes parodontales	253
<b>MERSHON</b> , Instruments pour poser les bagues	328
<b>METZENBAUM</b> , Ciseaux	89, 97, 98, 99, 103, 104
<b>METZENBAUM-FINO</b> , Ciseaux	98, 99, 100
<b>MICRO-ADSON</b> , Pincés chirurgicales	133
<b>MICRO-HALSTED</b> , Pincés hémostatiques	169
<b>MICRO-RYDER</b> , Porte aiguilles	148
<b>MICRO-VASCULAR</b> , Porte aiguilles	154
<b>MIDDELDORPF</b> , Ecarteurs	182
<b>MILLER</b> , Limes à os	238
- Pincés	138
- Instruments pour ligature	329
<b>MILLER-APEXO</b> , Elevateurs à racines	55
<b>MILLER-COLBURN</b> , Rugines	231
<b>MINI-FRIEDMANN</b> , Pincés-gouges	241, 242
<b>MINI-GILLIES</b> , Porte aiguilles	150, 157
<b>MINI-LAMBOTTE</b> , Ostéotomes	199
<b>MINI-LANGENBECK</b> , Ecarteurs	177
<b>MINI-LEXER</b> , Ostéotomes	202
<b>MINI-OLSEN-HEGAR</b> , Porte aiguilles	150
<b>MINNESOTA</b> , Ecarteurs	191
<b>MISCH</b> , Ecarteurs	192
<b>MITCHEL</b> , Détartreurs	268
<b>MOLT</b> , Ecarteur buccal	188
- Curettes	237
- Rugines	225, 226, 229, 231
<b>MOLT-DOYEN-COLLIN</b> , Ecarteur buccal	188
<b>MOLT-DOYEN-JANSEN</b> , Ecarteur buccal	188

## N

<b>NABERS</b> , Sondes parodontales	290
<b>NEUMANN</b> , Ciseaux	94
<b>NEVIUS</b> , Daviers	25
<b>NOYES</b> , Micro Ciseaux	83
<b>NYSTRÖM</b> , Instruments pour digue	312

## O

<b>OBWEGESER</b> , Ecarteurs	183, 186, 187, 192
- Rugines	223
<b>OBWEGESER-FREER</b> , Raspatoires	204
<b>OCHSENBEIN</b> , Ciseaux de chirurgie	285, 286



<b>OLSEN-HEGAR</b> , Porte aiguilles	150, 157
<b>ORBAN</b> , Bistouris pour la gengivectomie	287, 301
<b>ORINGER</b> , Ecarteur buccal	189

## P

<b>P.K.THOMAS</b> , Instruments pour laboratoire	341, 342, 343
<b>PALMER</b> , Pincés à crampons	309
<b>PAQUETTE</b> , Punches	78
<b>PARMLY</b> , Daviers	26
<b>PARTSCH</b> , Ostéotomes	201
- Scalpel	201
<b>PEAN</b> , Pincés hémostatiques	171
<b>PEAN-MURPHY</b> , Pincés porte-tampons	167
- Instruments à ligature	329
<b>PECK-JOSEPH</b> , Ciseaux	106
<b>PEET</b> , Instruments pour canaux radiculaires	39
- Pincés hémostatiques	169
<b>PELTON-CRANE</b> , Canules aspiratrices	318
<b>PERRY</b> , Pincés chirurgicales	124
<b>PHYSICK</b> , Daviers	31
<b>POTT</b> , Elevateurs à racines	60
<b>POTTS-SMITH</b> , Pincés chirurgicales	135
<b>PRICHARD</b> , Rugines	226

## Q

<b>QUINBY</b> , Ciseaux	97
-------------------------	----

## R

<b>RAGNELL</b> , Ecarteurs	180
<b>RAGNELL-DAVIS</b> , Ecarteurs	180
<b>REYNOLDS</b> , Ciseaux	93
<b>ROACH</b> , Instruments pour laboratoire	345
<b>ROGER</b> , Rugines	227
<b>ROGGE</b> , Pincés pour saisir les objets stérilisés	358
<b>ROSER-KÖNIG</b> , Ecarteur buccal	188
<b>ROSIN</b> , Elevateurs à racines	48
<b>ROUTURIER</b> , Daviers	11
<b>ROUX</b> , Ecarteurs	190
<b>ROUX-MAGNUS</b> , Ecarteurs	190
<b>RULE</b> , Curettes	307
<b>RUSKIN</b> , Pincés-gouges	244
<b>RUSSIAN</b> , Pincés	138
<b>RYDER</b> , Porte aiguilles	151

## S

<b>SANDERS</b> , Bistouris pour la gengivectomie	301
<b>SAROT</b> , Porte aiguilles	155
<b>SAUTTER</b> , Raspatoirs	204
<b>SCHAEDEL</b> , Pincés à tampons	165
<b>SCHAEDEL</b> , Curettes	236
<b>SCHLUGER</b> , Rapes à os	239
<b>SEAN-MILLER</b> , Ecarteurs	179
<b>SELDIN</b> , Elevateurs à racines	58, 59
- Rugines	224
<b>SEMKEN</b> , Pincés chirurgicales	127, 137
<b>SENN-GREEN</b> , Ecarteurs	180
<b>SHURE</b> , Pincés à séparer	327
<b>SMAHA</b> , Porte aiguilles	161
<b>SMITH</b> , Ciseaux	107
- Pincés à couper les fils	325
<b>SPENCER</b> , Ciseaux	108
<b>STELLBRINK</b> , Pincés-gouges	241
<b>STERNBERG</b> , Ecarteurs	191
<b>STEVENS</b> , Ciseaux	85, 93, 97
- Porte aiguilles	148
<b>STIEGLITZ</b> , Daviers	39
<b>STILLE</b> , Pincés chirurgicales	126
<b>STITCH</b> , Ciseaux	85
<b>STOKE</b> , Pincés à crampons	309
<b>SUGARMAN</b> , Rapes à os	239
<b>SWEDISH</b> , Porte aiguilles	152

## T

<b>TAYLOR</b> , Curettes	265, 306
<b>TG CHISELS</b> , Ciseaux de chirurgie	286
<b>TOBOLD</b> , Ecarteurs	186

<b>TOFFLEMIRE</b> , Porte matrices	312
<b>TOMES</b> , Daviers	28
<b>TÖNNIS</b> , Porte aiguilles	159
<b>TÖNNIS-ADSON</b> , Ciseaux	98
<b>TOWNER</b> , Bistouris pour la gengivectomie	301
- Curettes	165
<b>TOWNER-JAQUETTE</b> , Curettes	307

## U

<b>UFFENORDE</b> , Curettes	234
<b>UNIVERSAL</b> , Instruments à détacher les couronnes	338
- Porte cotons	256
<b>UNIVERSITY OF MICHIGAN</b> , Sondes parodontales	253, 290

## V

<b>VEHE</b> , Instruments pour laboratoire	345
<b>VOLKMANN</b> , Curettes	235, 236

## W

<b>WAHL</b> , Rapes à os	239
<b>WALTON</b> , Ciseaux	85
<b>WANGENSTEEN</b> , Pincés chirurgicales	136
<b>WARD</b> , Instruments pour obturations	278
<b>WARWICK-JAMES</b> , Elevateurs à racines	48
<b>WASSMUND</b> , Ecarteurs	194
<b>WEBSTER</b> , Porte aiguilles	153
<b>WEDELSTAEDT</b> , Instruments à émail	298
<b>WEINGART</b> , Pincés à pliers les fils	324
<b>WEITLANER</b> , Ecarteurs	220
<b>WERTHEIMER</b> , Canules aspiratrices	319
<b>WESTCOTT</b> , Micro Ciseaux	83
- Instruments pour obturations	280, 295
<b>WHITE</b> , Instruments pour obturations	281
<b>WHITEHEAD-JENNINGS</b> , Ecarteur buccal	193
<b>WIEDER</b> , Ecarteurs	186
<b>WILAND</b> , Instruments à modeler les obturations	297
<b>WILLIAMS</b> , Sondes parodontales	253
<b>WILLIGER</b> , Curettes	234, 235
- Rugines	223
<b>WINTER</b> , Elevateurs à racines	63, 64
<b>WITZEL</b> , Daviers	38
<b>WOODSON</b> , Instruments pour obturations	295

## Y

<b>YANKAUER</b> , Canules aspiratrices	315
<b>YOUNG</b> , Pincés tire-langue	195
<b>YOUNGER-GOOD</b> , Curettes	306

## Z

<b>ZAHLE</b> , Instruments pour laboratoire	346
<b>ZAUFAL-JANSEN</b> , Pincés-gouges	244
<b>ZIEGLER</b> , Couteau	79
<b>ZIELINSKY</b> , Instruments à mesurer	330



.17

Nummernverzeichnis  
Alphanumerical Index  
Indice alfanumerico  
Indice alfanumerico  
Index alphanumerique

Zahnärztliche Chirurgie  
Dental surgery  
Chirurgia dentale  
Cirugia dental  
Chirurgie dentaire









B	3	HBC-CH18	292	HBG-CAE	298	HBI-CHB	304	0112-BI11	27
C	3	HBC-CL	292	HBG-CBB	298	HBI-CHC	304	0112-BI17	27
E	8	HBC-BAB	292	HBG-CBC	298	HBI-CHD	304	0112-CD	29
H	3	HBC-BAC	292	HBG-CDC	298	HBI-CHE	304	0112-CE	27
I	8	HBC-BAD	292	HBG-CDE	298	HBI-CHF	304	0112-DC	26
BD	6	HBC-BAE	292	HBG-CDG	298	HBI-CHH	304	0112-DC01	26
BH	3	HBC-BAF	292			HBI-CIC	305	0112-FD11	25
BI	3	HBC-BAG	292	HBH-G	300	HBI-CIC01	305	0112-FD17	25
CB	8	HBC-BBB	293	HBH-BE	300	HBI-CIE	305	0112-GC	24
CC B/C11	11	HBC-BBB11	293	HBH-BH	300	HBI-CIE18	305	0112-GF	26
CC B/C17	11	HBC-BBC	293	HBH-BH22	300	HBI-CII18	305	0112-GL	28
CC	6	HBC-BBC11	293	HBH-BI	300	HBI-DDC	305	0112-II11	25
CL	4	HBC-BBD	293	HBH-BI22	300	HBI-DDD	305	0112-II17	25
DA	4	HBC-BBD11	293	HBH-BL	300	HBI-DDF	305	0112-BAB	28
DD	6	HBC-BCB	293	HBH-BL22	300	HBI-030914D	306	0112-BAD	30
Dd01	6	HBC-BCB11	293	HBH-DB11	300	HBI-0310D	301	0112-BFA	24
Eg11	12	HBC-BCC	293	HBH-DC11	300	HBI-0310G	306	0112-BFA01	24
EI	12	HBC-BCC11	293	HBH-DD11	300	HBI-0513B	229	0112-BFA0118	33
EL	12	HBC-BCD	293	HBH-DL	300	HBI-0513C	229	0112-BFA18	33
FB	5	HBC-BCD11	293	HBH-GE	300	HBI-0513D	229	0112-BFA23	32
Fb01	5	HBC-BCE	293	HBH-GG	300	HBI-0706BE	227	0112-BFB	28
Fb11	5	HBC-BCE11	293	HBH-BAA	300	HBI-12CD	267	0112-BFB0118	33
FF	10	HBC-BDB	295	HBH-BAB	300	HBI-12CD01	267	0112-BFB18	33
FG	10	HBC-BDC	295	HBH-BAC	300	HBI-12CD02	267	0112-BFB23	32
Gh01	5	HBC-BDD	295	HBH-BAD	300	HBI-12I	227	0112-CAD	29
GI	10	HBC-BGB08	294	HBH-BAE	300	HBI-12L	226	0112-CBA	27
Gi01	10	HBC-BGC08	294	HBH-BBB	300	HBI-1517D	226	0112-CCC	31
HD	6	HBC-BGD08	294	HBH-BBC	300	HBI-1714-E	307	0112-CFA	31
HE	7	HBC-BGE08	294			HBI-1914D	306		
He13	7	HBC-BHB	295	HBI-B/C	302	HBI-240714I	306	011207-BFA	34
HF	7	HBC-BHC	295	HBI-C17	303			011207-BFA18	34
HL	8	HBC-BIC	295	HBI-D/E	302	HBL-BBB	307	011207-BFB	34
HI01	8	HBC-BID	295	HBI-E17	303	HBL-BCF	307	011207-BFB18	34
Ig01	7	HBC-BLB	296	HBI-F/G	302	HBL-BCG	307		
IH	9	HBC-BLC	296	HBI-H/I	302			011509030111-B	52
IL	9	HBC-CAB	296	HBI-L/BA	302	HCA-IF	232	011509030111-C	52
LA	9	HBC-CAC	296	HBI-BB1204	303	HCA-IG	232	011509030111-D	52
EAA	38	HBC-CCB	296	HBI-BB/BC	302	HCA-IH	232	011509030111-E	52
EAB	38	HBC-CCC	296	HBI-BD1204	303	HCA-II	232		
		HBC-CCD	296	HBI-BD/BE	302	HCA-BAB	232	0119-B	268
HAH-B13	290	HBC-CDB	296	HBI-BE	303	HCA-BAC	232	0119-C11	268
HAH-C13	290	HBC-CDC	296	HBI-CE07	229	HCA-BAD	232	0119-C17	268
HAH-D0706	289	HBC-CDD	296	HBI-BAD	286	HCA-BAE	232	0119-G	268
HAH-D2012	290	HBC-CEB	229, 295	HBI-BAE	286	HCA-BBB	239	0119-BC	268
HAH-D22	289	HBC-CEC	295	HBI-BAH	286	HCA-BBC	239		
HAH-G04B	288	HBC-CED	295	HBI-BBD	286			02-D	281
HAH-G04C	288	HBC-CFB	296	HBI-BCD	301	HCF-B/C	47	02-E	281
HAH-G04D	288	HBC-CFG	296	HBI-BDD	301	HCF-D/E	47	02-CI/CL	281
HAH-BG04B	288	HBC-CFL	296	HBI-BEH	301	HCF-D/E18	47	02-DB/DC	281
HAH-BG04C	288	HBC-150609	294	HBI-BEI	301	HCF-F/G	47	02-DC	281
HAH-BG0706	289			HBI-BEL	301			02-DD	281
HAH-BG2012	290	HBD-BAB	299	HBI-BFB	301	HFB-C/D	341	02-DE	281
HAH-BG22	289	HBD-BAC	299	HBI-BFE	301	HFB-BCB	341	02-DF	281
HAH-BH0706	289			HBI-BFG	301	HFB-BCC	341		
HAH-BH2012	290	HBE-BAB	294	HBI-BGC	301	HFB-BCD	341	0202-EG	75
HAH-BH22	289	HBE-BAC	294	HBI-BGF	301	HFB-BCE	341	0202-EI	75
HAH-CD04B	288	HBE-0321BB	299	HBI-BHA	301	HFB-BCF	341		
HAH-CD04C	288			HBI-BLB	228			0204-AB	121
HAH-CD0706	289	HBF-BAB	297	HBI-BLC	228	01-B	275	0204-AC	121
HAH-CD2012	290	HBF-BAC	297	HBI-CAE	306			0204-AD	121
HAH-CD22	289	HBF-BAD	297	HBI-CAE18	306	0111-1201F	257	0204-AE	124
HAH-CAC	288	HBF-BAD18	297	HBI-CAE1804	306	0111-1519B	343	0204-AF	124
HAH-CAC01	288	HBF-DBB	291	HBI-CBA	239	0111-1519C	343	0204-AG	124
HAH-CAD	288	HBF-DBC	291	HBI-CBC	239	0111-1519D	343	0204-AH	124
HAH-CDBB	290	HBF-EAE	297	HBI-CBC18	239	0111-1519E	343	0204-AI	345
HAH-CDBC	290	HBF-EAI	297	HBI-CBE18	239	0111-1519F	343	0204-AL	134
HAH-070622	289			HBI-CBF	204	0111-18051903/B	344	0204-AL19	118
HAH-2019B	288	HBG-BAB	299	HBI-CBG	204	0111-18051903/C	344	0204-BA	125
		HBG-BAC	299	HBI-CCD	228			0204-BB	121
HBB-DAB	291	HBG-BAD	299	HBI-CDC	303	0112-B	24	0204-BE	135
HBB-DAC	291	HBG-BAE	299	HBI-CDE	303	0112-F	31	0204-BG	125
HBB-DAD	291	HBG-CAB	298	HBI-CFE	303	0112-BF	30	0204-BI	134
		HBG-CAC	298	HBI-CFC	303	0112-BG	30	0204-BL	128
HBC-BI	292	HBG-CAD	298	HBI-CGI	307	0112-BH	29	0204-CA	134

0204-CB	128	0204-BFL	138	0204-DGE	113	0219-AG	225	0219-BIF	225
0204-CD	134	0204-BGA	122	0204-DGF	113	0219-AH	225	0219-BIG	177
0204-CF	134	0204-BGA19	118	0204-DGG	113	0219-AH12	225	0219-BIH	177
0204-CG	134	0204-BGB	122	0204-DGH	113	0219-BF	177	0219-BII	177
0204-CH	138	0204-BGF	122	0204-DHA	132	0219-BG	177	0219-BIL	177
0204-DA	132	0204-BHF	138	0204-DHB	132	0219-BI	179	0219-CBA	177
0204-DA19	118	0204-BHH	122	0204-DHC	133	0219-BL	179	0219-CBB	177
0204-DB	132	0204-BHI	122	0204-DHD	133	0219-CA	190	0219-CBC	177
0204-DB19	118	0204-BLE	124	0204-DHH	133	0219-CF	190	0219-CBD	177
0204-DC	124	0204-BLF	124	0204-DHI	133	0219-CG	180	0219-CBE	177
0204-DD	124	0204-BLG	124	0204-DHL	133	0219-CH	180	0219-CGA	184
0204-DF	124	0204-CAH	114	0204-DIA	131	0219-CL	180	0219-CGE	181
0204-DG	124	0204-CAI	114	0204-DIB	131	0219-DD	184	0219-CGF	181
0204-DI	128	0204-CAL	114	0204-DIC	131	0219-DE	184	0219-CID	190
0204-DL	128	0204-CBA	137			0219-DF	184	0219-CIE	190
0204-EA	127	0204-CBB	137	02050913-B19	51	0219-DG	184	0219-CIF	190
0204-EB	127	0204-CBC	137	02050913-B25	57	0219-DI	178	0219-CIG	190
0204-EC	127	0204-CBD	137	02050913-C	51	0219-DL	178	0219-CIH	190
0204-ED	127	0204-CBG	137	02050913-C25	57	0219-EA	178	0219-CII	190
0204-EE	127	0204-CBH	137	02050913-D	51	0219-EB	178	0219-CIL	190
0204-EF	127	0204-CCB	137	02050913-E	51	0219-EC	178		
0204-EG	127	0204-CCC	137	02050913-E25	57	0219-ED	184	0221-CD	220
0204-EH	127	0204-CCD	137			0219-EE	178	03-B	233
0204-FB	133	0204-CCE	137	0206-BA	167	0219-EF	178	03-C	233
0204-FD	135	0204-CDA	136	0206-BC	167	0219-EG	178	03-D	233
0204-FG	130	0204-CDB	136	0206-CA	167	0219-EI	180	03-E	233
0204-FH	130	0204-CDC	136	0206-CC	167, 329	0219-EL	180	03-BB	337
0204-FI	130	0204-CEA	126	0206-CD	167	0219-FA	178	03-BC	337
0204-FL	130	0204-CEB	126	0206-CE	167	0219-FB	178	03-BD	337
0204-GA	126	0204-CEC	126	0206-CF	167	0219-FC	178	03-DA	337
0204-GB	126	0204-CED	126	0206-DI	165	0219-FE	178	03-DE	337
0204-GC	126	0204-CEE	126	0206-EA	165	0219-FF	178	03-DF	337
0204-GD	126	0204-CEF	126	0206-EB	165	0219-FG	178	03-DG	337
0204-GF	126	0204-CEG	126	0206-EC	165	0219-GA	184	03-EB	337
0204-GH	126	0204-CEH	126	0206-ED	165	0219-GC	184	03-EC	337
0204-HA	132	0204-CEI	126	0206-EE	165	0219-GE	184	03-ED	337
0204-HB	122, 132	0204-CEL	126	0206-EF	165	0219-GG	184	03-HB	336
0204-HC	132	0204-CFA	136	0206-EG	165	0219-GH	187	03-HC	336
0204-HD	122, 132	0204-CFB	136	0206-EI	165	0219-GI	187	03-HD	336
0204-HF	125	0204-CFD	114	0206-FA	166	0219-GL	194	03-HE	336
0204-HF19	118	0204-CGH	137	0206-FC	166	0219-HA	179		
0204-HG	125	0204-CHA	125	0206-HF	166	0219-HC	179	0304-B	276
0204-IA	122	0204-CHA19	118	0206-LE	167	0219-HE	179	0304-C	276
0204-IA19	118	0204-CHB	134	0206-LF	167	0219-HH	179	0304-D	276
0204-IB	122	0204-CHC	134			0219-IA	182	0304-E	276
0204-IC	122	0204-CHD	134	0210-DA	346	0219-IB	182		
0204-ID	122	0204-CHE	134			0219-IC	182	0307	339
0204-LA	131	0204-CHF	134	0212-AB	157	0219-LA	182	030711	339
0204-LB	127	0204-CHG	134	0212-AC	157	0219-LB	182	030718	339
0204-LC	131	0204-CHL	123	0212-AD	157	0219-LC	183		
0204-LD	131	0204-CIA	123	0212-AE	157	0219-LD	183	0308-B	70
0204-LE	131	0204-CIB	128	0212-GB	150	0219-LE	183	0308-C	70
0204-LF	127	0204-CIC	128	0212-GC	150	0219-LF	183	0308-D	70
0204-LG	124	0204-CID	123	0212-GD	150	0219-LG	183	0308-E	70
0204-LH	125	0204-CIE	123			0219-BAA	183	0308-BB	70
0204-LI	125	0204-CIF19	118	0217-CA	349	0219-BAL	180	0308-BC	70
0204-LL	125	0204-CIH	135	0217-CF	349	0219-BBH	179	0308-BD	70
0204-BAE	128	0204-CII	135	0217-CI	349	0219-BBI	179	0308-BE	70
0204-BAL	128	0204-CIL	135			0219-BDB	194		
0204-BBA	128	0204-CLA	135	0218-B	349	0219-BDC	194	0311-B02	344
0204-BBB	128	0204-CLB	135	0218-CH	349	0219-BDE	181	0311-B17	344
0204-BDA	130	0204-CLC	135	0218-DC	349	0219-BDF	181	0311-C02	344
0204-BDB	130	0204-DEI	114	0218-DA	350	0219-BDL	180	0311-C17	344
0204-BDD	128	0204-DEL	114	0218-EB	350	0219-BEA	180	0311-D02	344
0204-BDE	128	0204-DFB	135	0218-EC	350	0219-BFC	183	0311-D17	344
0204-BDF	133	0204-DFC	135	0218-ED	350	0219-BFD	183		
0204-BDH	128	0204-DFD	135	0218-FL	351	0219-BFE	183		
0204-BEB	131	0204-DFE	135	0218-GA	206, 207, 351	0219-BFF	183	0312	340
0204-BEC	126	0204-DFG	135	0218-GB	351	0219-BFG	183		
0204-BED	126	0204-DFH	135	0218-BAA	354	0219-BFH	183	0314-B	54
0204-BEE	128	0204-DGA	113			0219-BFI	192	0314-C	54
0204-BEF	125	0204-DGB	113	0219-B	179	0219-BFL	192	0314-D	54
0204-BEI	125	0204-DGC	113	0219-C	179	0219-BID	225	0314-BB	54
0204-BFI	138	0204-DGD	113	0219-AF	225	0219-BIE	225	0314-BC	54



0314-BD	54	0402-BID	246	0411-C	53	0411-LL	60	0415-BAE	109
031411-B/C	261	0402-CLL	356	0411-AF	59	0411-BAA	63	0415-BAF	109
031411-C1711	261	0402-DAA	219	0411-AG	59	0411-BAB	63	0415-BBE	324
031411-D/E	261	0402-1411	356	0411-BB	56	0411-BAC	46	0415-BBG	324
031411-E1711	261	0402-141117	355	0411-BD	56	0411-BAD	46	0415-BBI	323
031411-BD/BE	261	04050113	94	0411-BE	56	0411-BAE	46	0415-BBL	323
03141111050705 120, 329		04050113-1903	102	0411-BH	56	0411-BAF	46	0415-BCA	107, 326
03141111050705-18 120		0406-AA	308	0411-BI	56	0411-BAG	43	0415-BCB	323
0315	339	0406-AA11	308	0411-BL	56	0411-BAH	43	0415-BCE	327
031511	339	0406-AA12	308	0411-CA	48	0411-BAI	65	0415-BCF	328
031518	339	0406-AA13	308	0411-CB	48	0411-BAL	65	0415-BCG	329
0318-AB	349	0406-AA15	308	0411-CC	48	0411-BBA	65	0415-BCH	329
0318-AC	349	0406-AA17	308	0411-CE	60	0411-BBB	65	0415-BCI	329
0318-AD	349	0406-AA21	308	0411-CF	60	0411-BBC	46	0415-BCL	329
0318-AE	349	0406-AB/F	312	0411-CH	53	0411-BBD	46	0415-BDC	329
0318-AF	349	0406-AB/G	312	0411-CI	53	0411-BBE	46	0415-BDD	329
0318-BC	349	0406-AB/H	312	0411-DA	57	0411-BBF	46	0415-BDE	324
0318-BF	349	0406-AC	308	0411-DB	57	0411-BBG	43	0415-BDF	324
0318-BL	349	0406-AC12	308	0411-DC	53	0411-BBH	43	0415-BDG	338
0319-FFF	351	0406-AC15	308	0411-DD	53	0411-BBI	43	0415-BDH	338
0319-FGA	351	0406-AC17	308	0411-DE	50	0411-BCD	61	0415-BEA	331
0319-FGF	351	0406-AD/B	312	0411-DF	50	0411-BCE	61	0415-HCA	330
0319-FGA	351	0406-AD/C	312	0411-DG	50	0411-03	338	0415-HCB	330
0319-GFA	354	0406-AD/D	312	0411-DH	50	0411-21	338	0415-HCD	330
0319-GFB	351	0406-AD/H	312	0411-DI	50	0414-B	238	0415-HCE	330
0319-GFC	351	0406-AD/I	312	0411-EC	43	0414-C	238	0415-HCF	330
0319-GFD	351	0406-AD/L	312	0411-ED	43	0414-D	238	0415-HDA	330
0320-B/C	261	0406-AD/BA	312	0411-EE	43	0414-E	238	0417-EA	39, 169
0320-D/E	261	0406-AD/BB	312	0411-EF	43	0414-E03	238	0417-FA	39
0320-F/G	261	0406-AD/BC	312	0411-EG	43	0414-F	238	0417-GA	39
0320-H/I	261	0406-AD/BD	312	0411-EH	43	0414-AI	186	0417-HA	39
0320-L/BA	261	0406-AE	312	0411-EI	59	0414-AL	186	0417-HI	138, 329
0320-BB/BC	261	0406-AE/F	312	0411-EL	59	0414-EA	186	0417-IA	138
0320-BD/BE	261	0406-AF/F	312	0411-FA	234	0414-EB	192	05-A	284
0320-1203B	231	0406-AF/G	312	0411-FB	234	0414-FL	223	05-B	284
0321-BB	276	0406-AF/H	312	0411-FC	234	0414-GD	223	05-C	284
0401-AB	40	0406-AG	312	0411-FE	59	0414-GF	223	05-D	284
0401-AB12	40	0406-AH	312	0411-FI	48	0414-GH	223	05-E	284
0401-AC	40	0406-AI	312	0411-FL	62	0414-BEA	202	0503-B	284
0401-AD	40	0406-AL	312	0411-GA	338	0414-BEB	202	0503-C	284
0401-AE	120	0406-BA	309	0411-GB	62	0414-BEC	192	0513-12B	230
0401-AF	120	0406-BC	310	0411-GC	62	0414-BED	202	0513-12C	230
0401-AG	138	0406-BF	309	0411-GD	62	0414-BHF	184	0513-12D	230
0401-AG	138	0406-BG	309	0411-GE	64	0414-BIA	202	0513-12E	230
0401-AH	138	0406-BI	309	0411-GF	64	0414-BIB	202	0513-12F	230
0401-AI	138	0406-CA	327	0411-GG	64	0414-BIC	202	0513-12G	230
0401-AL	121	0406-CB	327	0411-GH	64	0414-BID	202	0513-12H	230
0401-BA	40	0406-DA	311	0411-GI	62	0414-BIE	202	0518-BD	204
0402-AB	123	0406-DC	311	0411-GL	62	0414-BIF	202	0518-CH	228
0402-B11	355	0406-DC	311	0411-HD	61	0414-BIG	202	0518-EE	130
0402-AC	123	0406-EA	310	0411-HD	61	0414-BIG	202	0518-GF	130
0402-D	356	0406-EA/B	310	0411-HE	61	0414-BLG	200	0523-BB	252
0402-E	356	0406-EA/C	310	0411-HF	61	0414-CAE	184	0523-BC	252
0402-G01	356	0406-EA/D	310	0411-HG	49	0414-CAE11	184	06-C/D	276
0402-AH	356	0406-EB	310	0411-HH	49	0414-CBC	184	0604-AG	84
0402-AI	356	0406-EB/E	310	0411-HI	49	0415-CE	335	0604-AI	84
0402-BB	356	0406-EB/F	310	0411-HL	49	0415-CE03	335	0604-BA	83
0402-BC	356	0406-EB/G	310	0411-IB	44	0415-CE17	335	0604-BC	83
0402-BF	356	0406-ED	310	0411-IC	44	0415-CI	335	0604-BD	83
0402-FA12	355	0406-ED	310	0411-ID	44	0415-CL	335	0604-BE	141
0402-LG	356	0406-FA	327	0411-IE	44	0415-DI	335	0604-BF	83
0402-BHH	246	0406-BCG	311	0411-IF	44	0415-DI01	335	0604-BG	141
0402-BHI	246	0406-BCH	311	0411-IG	44	0415-DI17	335	0604-BH	141
0402-BHL	246	0406-BCI	311	0411-IH	44	0415-FA	328	0604-BI	144
0402-BIA	246	0406-BCL	311	0411-II	62	0415-FC	329	0604-BL	141
0402-BIB	246	0406-BDA	311	0411-IL	62	0415-FE	327	0604-CA	144
0402-BIC	246	0406-BDB	311	0411-LA	65	0415-LA	109, 326		
		0406-BFB	311	0411-LB	45	0415-LB	109, 326		
		0406-BGA	311	0411-LC	45	0415-LC	109, 326		
		0410-CG	38	0411-LD	45	0415-BAA	328		
		0410-CH	38	0411-LE	45	0415-BAB	109, 326		
		0411-A	338	0411-LF	45	0415-BAC	109, 326		
		0411-B	53	0411-LG	45	0415-BAD	109, 326		
				0411-LI	60				

0604-CB	146	0607-CA	94	0610-HF	235	0611-FL	202	0611-DIL	207
0604-CC	144	0607-CB	90	0610-HG	235	0611-GA	202	0611-DLA	207
0604-CC01	144	0607-CC	90	0610-HH	235	0611-GB	202	0611-DLB	206
0604-CD	146	0607-CD	88	0610-HI	235	0611-GF	211	0611-DLC	206
0604-CE	142	0607-CE	88	0610-ID	234	0611-GG	211	0611-DLD	206
0604-CF	145	0607-CI	89	0610-IE	234	0611-GH	211	0611-DLE	206
0604-CG	141	0607-DG	90	0610-IH	92	0611-GI	211	0611-DLF	206
0604-CI	144	0607-DH	90	0610-II	92	0611-GL	211	0611-DLG	207
0604-CL	145	0607-DI	95	0610-BAA	205	0611-HA	211	0611-DLH	207
0604-DA	145	0607-DL	95	0610-BAB	205	0611-HB	211	0611-DLI	207
0604-DB	143	0607-FA	93	0610-BAC	205	0611-HC	211	0611-DLL	207
0604-DC	145	0607-FB	93	0610-BAD	205	0611-HD	211	0611-EAA	206
0604-DD	148	0607-FC	93	0610-BAE	205	0611-HE	211	0611-EAA12	207
0604-DE	143	0607-FD	93	0610-BAF	205	0611-HF	211	0611-EBB	202
0604-DF	148	0607-FE	93	0610-BAG	205	0611-HG	211	0611-EBC	202
0604-DG	143	0607-FF	93	0610-BAH	205	0611-HH	211	0611-EBD	202
0604-DH	143	0607-FI	87	0610-BAI	205	0611-HI	211	0611-EBE	202
0604-DI	148	0607-FL	86	0610-BAL	205	0611-HL	211	0611-EBF	202
0604-EB	83	0607-GA	98	0610-BBA	236	0611-IA	211	0611-EBG	202
0604-EC	83	0607-GB	98	0610-BBB	236	0611-BAE	203		
0604-GE	83	0607-GG	93	0610-BBC	236	0611-BBE	200	0611010707	120
0604-GF	83	0607-GH	93	0610-BBD	236	0611-BBF	200		
0604-BDH	83	0607-LC	106	0610-BBE	236	0611-BBG	200	0611140817-B	52
0604-BDI	83	0607-LI	106	0610-BBF	236	0611-BCA	208	0611140817-C	52
0604-BEF	84	0607-BAB	90	0610-BBG	236	0611-BCB	208	0611140817-D	52
0604-BHA	145	0607-BAC	90	0610-BCA	236	0611-BCC	208		
0604-BHB	145	0607-BAD	88	0610-BCB	236	0611-BCD	208	0612-B	98
0604-BHC	143	0607-BAE	88	0610-BCC	236	0611-BCE	208	0612-B06	98
0604-BHD	143	0607-BAF	88	0610-BCD	236	0611-BCF	208	0612-B1803	104
0604-BIC	84	0607-BBC	86	0610-BCE	236	0611-BCI	203	0612-C	98
0604-BID	84	0607-BBD	86	0610-BCF	236	0611-BDC	200	0612-C06	98
0604-CBG	142	0607-BCB	91	0610-BCG	236	0611-BDF	200	0612-C1803	104
0604-CBH	142	0607-BCD	87	0610-BDG	234	0611-BDG	200	0612-D	99
0604-CCE	84	0607-BCE	87	0610-BDH	234	0611-BEB	210	0612-D06	99
0604-CCF	84	0607-BEH	89	0610-BDI	234	0611-BEC	210	0612-D1803	104
0604-CDG	142	0607-BEI	89	0610-BDL	234	0611-BED	210	0612-E	99
0604-CDH	142	0607-BFD	106	0610-BII	234	0611-BEE	210	0612-E06	99
0604-FGC19	147	0607-BFE	106	0610-BIL	234	0611-BFA	213	0612-E1803	104
0604-FGD19	147	0607-BFG	87	0610-BLH	234	0611-BFB	213	0612-F	96
0604-FHE19	147	0607-BFH	87	0610-BLI	234	0611-BFC	213	0612-F1803	104
0604-FHF19	147	0607-BFI	87			0611-BFD	213	0612-G	96
0604-FIH19	147	0607-BFL	87	0611-AB	203	0611-BFF	213	0612-G1803	104
0604-FI19	147	0607-BGA	107, 325	0611-AD	201	0611-BFG	213	0612-H	96
0604-FLL	146	0607-BGB	325	0611-AE	201	0611-BFH	213	0612-I	96
0604-GAA	146	0607-BGH	101	0611-AF	201	0611-BFI	213	0612-L	96
0604-GAB	146	0607-BGI	101	0611-AL	203	0611-BFL	213	0612-BA	96
0604-GAC	146	0607-BLA	91	0611-AL17	203	0611-BHH	201	0612-BC	89
		0607-BLB	91	0611-BA12	203	0611-BHL	201	0612-CH	96
0605-B	273	0607-CAH	85	0611-BB	203	0611-BIB	201	0612-CI	96
0605-C	273	0607-CAI	85	0611-BB17	203	0611-BID	201	0612-EB	96
0605-D	273	0607-CAL	85	0611-BC	203	0611-BIE	201	0612-EC	96
0605-E	273	0607-CBA	85	0611-BC17	203	0611-BIF	201	0612-EH	98
0605-E/F	273	0607-CBB	85	0611-BD	201	0611-BIG	201	0612-EI	98
0605-F	273	0607-CBC	85	0611-BE	201	0611-BIH	201	0612-EL	96
0605-G	273	0607-CBG	85	0611-BF	201	0611-BII	201	0612-FB	107
				0611-BG	199	0611-BIL	201	0612-FL	107
0607-B	86	0610-B	92	0611-BH	199	0611-CDA	202	0612-GD	96
0607-B1803	104	0610-B1803	102	0611-BI	199	0611-CDB	202	0612-GG	99
0607-B180325	104	0610-B1903	102	0611-CA	216	0611-CDC	202	0612-GH	99
0607-B1903	101	0610-C	92	0611-CB	216	0611-CGD	199	0612-GI	99
0607-C	86	0610-C1803	102	0611-CF	212	0611-CGE	199	0612-GL	99
0607-C1803	104	0610-C1903	102	0611-CG	212	0611-CGF	199	0612-HL	95
0607-C180325	104	0610-GA	236	0611-CH	212	0611-CGG	199	0612-LG	100
0607-C1903	101	0610-GB	236	0611-CI	212	0611-CGH	199	0612-LH	100
0607-D	87	0610-GC	236	0611-DB	216	0611-CGI	199	0612-LI	100
0607-E	86	0610-GD	236	0611-DC	199	0611-CGL	199	0612-LL	100
0607-F	86	0610-GE	236	0611-DD	216	0611-CLC	209	0612-BAA	103
0607-BB11	86	0610-GF	236	0611-DF	216	0611-CLD	209	0612-BAA11	103
0607-BC11	86	0610-GG	236	0611-DH	212	0611-CLE	209	0612-BAC	103
0607-BD	88	0610-GH	236	0611-DI	212	0611-CLF	209	0612-BAE	103
0607-BE	89	0610-HA	235	0611-DL	212	0611-CLG	209	0612-BAL	89
0607-BF	88	0610-HB	235	0611-FD	199	0611-CLH	209	0612-BBI	101
0607-BL03	93	0610-HC	235	0611-FE	199	0611-CLI	209	0612-BBL	101
0607-BL17	93	0610-HD	235	0611-FI	199	0611-CLL	209	0612-BCG	89



0612-BCH	89	07-BE	258	0706-BIF	320	09-HD	19	1101-I	67
0612-BEG	107	07-BG	258	0706-BII	320	09-HE	18	1101-L	67
0612-BIA	95	07-BI	258	0706-CAA	320, 357	09-HE13	18	1101-BA	67
0612-BIB	95	07-CA	258	0706-CEA	318	09-HL	20	1101-BB	68
0612-CAB	100	07-CC	258	0706-CEB	318	09-HL13	20	1101-BC	68
0612-CAC	100	07-CE	258	0706-CEC	318	09-IG03	19	1101-BD	68
0612-CAD	100	07-CG	258	0706-CEC02	318	09-IH	20	1101-BG	68
0612-CAE	100	07-CI	258	0706-CED	318	09-BDD11	23	1101-BH	68
0612-CLI	97	07-DA	258	0706-CEE	318	09-BDD17	23	1101-CA	69
0612-CLL	97			0706-CHB	317	09-DDD18	23	1101-CB	69
0612-DAA	97	0701-BH	215					1101-CC	69
0612-DAB	97	0701-BI	215	070603	91	0912-BF	214	1101-CD	69
0612-DBH	101	0701-BL	215	070603-18	91				
0612-DBI	97	0701-CA	215	070603-1803	105	1005-CA	196	1102-BA	77
0612-DBL	97	0701-DD	213	070603-1903	106	1005-EA	196	1102-BB	77
0612-DDL	106	0701-DE	213					1102-BC	77
0612-DFA	101	0701-DF	213	070617	91	101004-B	287	1102-BC04	77
		0701-DG	213	070617-18	91	101004-C	287	1102-BD	77
0614-AI	242	0701-DH	213	070617-1803	105	101004-E	287	1102-BF	77
0614-AL	242	0701-GA	213	070617-1903	106			1102-BF01	77
0614-BF	242	0701-GD	213			1013-FF	200	1102-BF03	77
0614-BG	244	0701-GE	213	070618	94	1013-HF	200	1102-BI	78
0614-BH	242	0701-GF	213	070618-1803	105			1102-CA	78
0614-BI	243	0701-GG	213					1102-CB	78
0614-BL	242	0701-HA	216	0714-B	273	1014-B	224	1102-CD	78
0614-CA	244	0701-HB	217	0714-C	273	1014-C	224	1102-CD	78
0614-CB	242	0701-HD	217	0714-D	273	1014-D	224	1102-EA	75
0614-CC	241	0701-HI	217	0714-E	273	1014-BB	227	1102-DGB	75
0614-CD	241	0701-HL	217			1014-CA	228	1102-DGC	75
0614-CE	241	0701-IA	216	0718-AC	358	1014-CC	224	1102-DGD	75
0614-CF	243	0701-IB	216	0718-AD	358	1014-CD	224	1102-DGE	75
0614-CG	245	0701-IF	216	0718-AE	358	1014-FI	226	1102-DGF	75
0614-DD	246	0701-IG	216	0718-AG	358	1014-GG	227	1102-DGG	75
0614-DE	244	0701-LA	216	0718-BA	358			1102-DGH	75
0614-ED	243	0701-LB	216	0718-BD	358	11-A	72	1102-DGI	75
0614-GA	245			0718-BG	78	11-B	72	1102-DGL	75
0614-GB	245	0702-C	78	0718-BI	78	11-C	72		
0614-HH	245	0702-E	76	0718-CG	109	11-D	72	1103-B	345
0614-IF	241			0718-EA	357	11-E	72	1103-C	345
0614-IH	241	0706-AB	317	0718-EC	357	11-F	72	1103-D	345
0614-II	241	0706-AC	317	0718-EE	357	11-G	72		
0614-IL	241	0706-AD	317	0718-EE	357	11-H	72	1107-B	94
0614-BDA	220	0706-AE	317	0718-EI	357	11-I	72	1107-B1803	105
0614-BDB	220	0706-AF	317	0718-FC	357	11-L	72	1107-C1803	105
0614-BDB18	220	0706-AG	315	08EECC	345	11-BB	72	1107-G	94
0614-BDI	244	0706-AH	315			11-CB	72		
0614-BDL	244	0706-BA	315	08-B	275	11-CC	72	1110-B	90
0614-BFG	244	0706-BB	317	08-C	275	11-CD	72	1110-C	92
0614-BFH	244	0706-BC	315	08-D	275	11-CE	72	1110-D	90
0614-BFL	220	0706-BD	316			11-CF	72	1110-E	92
0614-BGC	246	0706-BE	316	0801	346	11-CG	72	1110-BA	102
0614-BGD	246	0706-BF	316	0802	228, 345	11-CH	72	1110-BC	102
0614-BGF	246	0706-BG	316	0803	345	11-CI	72		
0614-CBG	242	0706-CA	316	0805-B	47	11-CL	72	1118-AI	218
0614-CCA	241	0706-DA	316	0805-C	47	11-FB	71	1118-AL	218
0614-CCB	242	0706-DB	316	0805-D	47	11-FC	71		
0614-CCL	243	0706-DC	316	0806-D/H	267	11-FD	71	1123-FA	240
0614-CDA	243	0706-DD	316	0806-F/BB	267	11-FE	71	1123-FC	240
0614-CDB	245	0706-DE	316	0806-L/BA	267	11-FF	71	1123-GA	240
0614-CDC	245	0706-DF	316	0811	346	11-FG	71	1123-IE	323
0614-CDD	245	0706-EA	320	0815-G	58	11-FH	71	1123-IF	323
0614-CDE	245	0706-EB	319	0817	345	11-FI	71	1123-IH	323
		0706-EC	319	0821	345	11-FL	71	1123-BAB	324
0617-BG	204	0706-FE	315			11-GA	71	1123-BAC	325
0617-BH	204	0706-FG	319	09-BD	19	11-HB	71	1123-BAD	325
		0706-GA	319	09-CC B/C11	22	11-HC	71	1123-BBD	220
0617050517	204, 226	0706-GB	319	09-CC B/C17	22	11-HD	71		
		0706-HA	319	09-CC	19			1201-B	257
07-D	257	0706-BDD	214	09-DG	18	1101-B	66	1201-C	257
07-E	257	0706-BDE	214	09-DG13	18	1101-C	66	1201-D	257
07-F	257	0706-BIA	318	09-EG11	21	1101-D	66	1201-G	258
07-I	258	0706-BIC	320	09-EG123	21	1101-E	66	1201-H	257
07-BA	258	0706-BID	320	09-EG13	20	1101-F	66	1201-I	71
07-BC	258	0706-BIE	318	09-FL	19	1101-G	66	1201-L	71
						1101-H	67	1201-L17	71

1201-02B	77	120917-AI	229	1411-B	278			15-BCA	168
1201-02C	77			1411-C	278	1418-B	280	15-BCB	168
1201-02D	77	1214-C	237	1411-D	278	1418-C	280	15-BCL	174
1201-02D12	77	1214-E	237	1412-C	280	141802-B	286	15-BDF	169
1201-02E	78	1214-E11	237	1412-AE	195	141802-C	286	15-BDG	171
1201-02H	77	1214-I	229	1412-AG	186	141802-E	285	15-BDH	171
1201-02H10	77	1214-L01	226	1412-AH	195	141802-E01	285	15-CBF	171
1201-02I	77	1214-BA	231, 237	1412-AI	186			15-CBG	171
1201-02L	77	1214-BC	231	1412-BA	195	1419-B	271	15-CBH	171
1201-02BG	76	1214-BF	225	1412-BG	195	1419-C	271	15-CDA	173
		1214-CA	227	1412-BI	195	1419-D	271	15-CDB	173
		1214-CE	227	1412-BL	195	1419-E	271	15-CDC	173
1203-BB	71			1412-DA	195	1419-F	271	15-CDD	173
1203-BC	71	12141119-L	226	1412-EA	188	1419-G	271	15-CDI	173
1203-BD	71			1412-EA17	188	1419-H	271	15-CDL	173
1203-HA	71	121509-B	214	1412-EB	188	1419-I	271	15-CEA	173
				1412-EB17	188	1419-L	271	15-CEB	173
1204-B	35	121719/03H	336	1412-EC	188	1419-BA	271	15-CFA	171
1204-C	35	121719-G	336	1412-EC	188	1419-BB	272	15-CFB	171
1204-D	35	121719-H	336	1412-EE	195	1419-BC	272	15-CFC	171
1204-E	35	121719-03B	337	1412-EF	195	1419-BD	272	15-CFD	171
		121719-03D	337	1412-FA	191	1419-BE	272	15-CFG	171
120517090112	120	121719-03E	337	1412-FC	191	1419-BF	272	15-CFH	171
				1412-FF	191	1419-BG	272	15-CGA	171
1206-BAB	129			1412-FF02	191			15-CGB	171
1206-BAB19	118	1310-B	76	1412-GA	188	1423-B	280	15-CGE	168
1206-BAC	129	1310-C	76	1412-GB	191	1423-C	280	15-CGF	168
1206-BAC19	118	1310-D	76	1412-GC	188	1423-D	280	15-CGG	168
1206-BAD	129	1310-AG	79	1412-GG	191			15-CGH	168
1206-BAE	129	1310-AH	79	1412-GG02	191	1425-B	278	15-DCE	174
1206-BAF	129	1310-AI	79	1412-GH	191	1425-C	278	15-DDC	168
1206-BAG	136	1310-AL	79	1412-HA	196	1425-D	278	15-DEA	219
1206-BAH	136	1310-BA	79	1412-HB	196			15-DEB	219
1206-BBA	115	1310-BB	79	1412-HC	196	15-A	258	15-DEC	219
1206-BBB	115	1310-BC	75	1412-HE	189	15-AA	258		
1206-BBC	115	1310-BE	79	1412-HE	189	15-AA	258	150502-B	37
1206-BBD	115	1310-BG	79	1412-HF	189	15-AAA	258	150502-C	37
1206-BBE	115	1310-BH	79	1412-HG	189	15-AB	258	150502-D	37
1206-BBF	115	1310-BI	79	1412-HH	189	15-AC	258	150502-E	37
1206-BCE	119	1310-CA	79	1412-IA	185	15-AD	258	150502-F	37
1206-BCF	119	1310-DA	80	1412-IB	185	15-D	257	150502-G	37
1206-BCG	119	1310-DC	80	1412-IC	185	15-AE	258	150502-H	37
1206-BCH	119	1310-DE	80	1412-IF	185	15-E	257	150502-BH18	36
1206-BCI	119	1310-DG	80	1412-IH	185	15-AF	258	150502-CD18	36
1206-BCL	119	1310-DI	80	1412-II	185	15-F	257	150502-CF18	36
1206-BEC19	119	1310-DL	79	1412-LA	189	15-AG	258	150502-BFA18	36
1206-BED19	119	1310-EA	80	1412-LH	189	15-BF	169	150502-BFB18	36
1206-BEE19	119	1310-BAF	204	1412-BAA	185	15-EL	172		
1206-BEF19	119	1310-CEL	204	1412-BBA	193	15-FA	174	1506-B	328
1206-BEG19	119	1310-CFB	204	1412-BBC	193	15-FC	174	1506-C	328
1206-BEH19	119			1412-BBD	193	15-GA	173	1506-D	328
1206-BHH	114	14-B	277	1412-BBE	193	15-GB	173	1506-G	214, 256
1206-CEL	114	14-C	277	1412-BDG	193	15-GC	173	1506-L	268
1206-DHA	116	14-D	277	1412-BDH	193	15-GD	173	1506-EA	256
1206-DHB	116	14-E	277	1412-BDI	193	15-GE	173	1506-EB	256
1206-DHC	116			1412-BDL	193	15-HL	172		
1206-DHD	116	1401-B	279			15-IB	172	1508-DH	149
1206-DHE	116	1401-C	279	1413-B	280	15-IC	172	1508-DI	149
1206-DHF	116	1401-D	279			15-IE	172	1508-DL	149
1206-DHG	116			1415-B	279	15-IF	172	1508-EA	159
1206-DHH	116	140213-B	287	1415-C	279	15-IG	172	1508-EB	159
1206-DHI	117	140213-C	287	1415-D	279	15-IH	172	1508-EC	159
1206-DHL	117	140213-E	287	1415-E	279	15-IL	172	1508-EI	149
1206-DIA	117			1415-F	279	15-LB	170	1508-FD	153
1206-DIB	117	1403-B	278	1415-H	216	15-LC	170	1508-FE	156
1206-DIC	117	1403-C	278	1415-I	216	15-LD	170	1508-FI	155, 325
1206-DID	117					15-LE	170	1508-FL	155
1206-DIE	117	1406-B	285	1417-BB	218	15-LF	170	1508-GA	336
1206-DIF	117	1406-C	285	1417-BC	218	15-LG	170, 329	1508-GB	149
		1406-D	285	1417-BD	218	15-LH	170, 329	1508-GC	149
1209-BA	55			1417-BE	218	15-LI	170	1508-GD	149
1209-BB	55	1410-B	277	1417-BI	218	15-BAA	174	1508-GE	149
1209-BC	55	1410-C	277	1417-BL	218	15-BAB	169	1508-GF	153
1209-BD	55	1410-D	277	1417-EA	218	15-BAC	169	1508-GG	153
				1417-EF	218	15-BBF	174	1508-GH	153



1508-GI	153	1514-IA	160	1803-BD	108	1818-FA	269	201807-F/G11	264
1508-GL	153	1514-IB	160	1803-BE	108	1818-FB	269	201807-F/G18	263
1508-HA	159	1514-IC	158	1803-BF	108	1818-FC	269	201807-H/I	263
1508-HB	156	1514-IE	158	1803-BG	108	1818-FE	269	201807-H/I0519	262
1508-HC	155	1514-IF	158			1818-FF	269	201807-H/I11	264
1508-HD	153	1514-IG	158	1804-B	260	1818-FG	269	201807-H/I18	263
1508-HE	159	1514-IH	158	1804-C	260	1818-FI	269	201807-L/BA	263
1508-HF	155	1514-II	158	1804-D	260	1818-GA12	215	201807-L/BA0519	262
1508-HG	155	1514-LE	158	1804-D17	260	1818-GB12	215	201807-L/BA11	264
1508-HH	155	1514-LL	157	1804-H	259	1818-GC12	215	201807-L/BA18	263
1508-HL	152	1514-LL11	157	1804-H17	259	1818-GE12	215	201807-BB/BC	263
1508-IA	151	1514-BAE	157	1804-CA	259	1818-GF	214, 270	201807-BB/BC0519	262
1508-IB	151	1514-BAF	157	1804-12	72			201807-BB/BC11	264
1508-IC	151					181906-B	260	201807-BB/BC18	263
1508-ID	151	1517-D	226	1805-C	58	181906-B17	260	201807-BD/BE	263
1508-IE	151	1517-D01	226	1805-E11	58			201807-BD/BE0519	262
1508-IF	152			1805-E17	58	1907-BA	199	201807-BD/BE11	264
1508-LA	156	1518-B	346			1907-BB	199	201807-BD/BE18	263
1508-LL	156	1518-C	346	180911-AB	351	1907-BC	199	201807-BF/BG	264
1508-BAA	156			180911-AC	351	1907-BF	200	201807-BF/BG0519	262
1508-BAB	154	1519-B	342	180911-AD	351	1907-BH01	352	201807-BH/BI18	264
1508-BAC	154	1519-C	342	180911-AE	351	1907-BH02	352	201807-1013B/CG	264
1508-BAD	154	1519-D	342	180911-AF	351	1907-BH03	352		
1508-BAG	152	1519-E	342			1907-BH07	352	201818-F/G110113	266
1508-BBA	154	1519-F	342	1811-B	231	1907-BH17	352	201818-F/DD	265
1508-BBB	154			1811-C	231	1907-BH21	352	201818-BF/DA	265
1508-BCA	154	1525-B	254	1811-CB	233	1907-BH24	352	201818-BF/DD	265
1508-BCB	154	1525-C	254			1907-CA	199	201818-CAE18	265
1508-BCC	154	1525-D	254	1812-B	253	1907-CB	199	201818-08G/H	265
1508-BCH	154	1525-E	254	1812-C	253	1907-CC	199	201818-26BE/BF	265
1508-BCI	154			1812-D	253	1907-CD	199	201818-101701B	264
1508-BCL	154	17-B	275	1812-E	253	1907-DA	200	201818-101701D	264
1508-BDC	155	17-C	275	1812-F	253	1907-DB	200	201818-1203BB/BC	266
1508-BDD	155	17-D	275	1812-G	253	1907-DC	200	201818-1203BD/BE	266
1508-BDE	155			1812-BB	251			201818-1203BD/BE18	266
1508-BEA	148	1708-E	257	1812-BC	251	19-09	354 355	201818-1203BH/BI18	266
1508-BEB	148	1708-F	257	1812-BD	251	19-0906	354 355	201818-1321A	265
1508-BEC	148	1708-BE	257	1812-BF	251			201818-1321BB/BC	265
				1812-BL	251	1915-I01	353	201818-1321BD/BE	265
1511-B	254	1714-B	39	1812-CA	252	1915-I02	353	201818-19C/D	265
1511-C	254			1812-CB	251	1915-I03	353		
1511-D	254	18BI-I	340	1812-CC	252	1915-I07	353	2118-CA	350
1511-E	254	18-A	274			1915-I17	353	2118-CG	350
		18-AA	274	1814-B	249	1915-I21	353	2118-DA	350
1512-B	282	18-B	274	1814-C	249	1915-I24	353		
1512-C	282	18-C	274	1814-D	249			2207-BA	223
1512-D	282	18-D	274	1814-E	249	1918-B	283	2207-BC	223
1512-E	282	18-D0113	13	1814-F	249	1918-C	283	2207-BE	223
1512-F	282	18-E	274	1814-G	249	1918-D	283		
1512-G	282	18-H	13	1814-H	250	1918-E	283	25-B	346
		18-DB	14	1814-I	250	1918-EA	317	25-C	346
1514-DH	159	18-DE	13	1814-L	250	1918-FA	317	25-D	346
1514-DI	159	18-DF	13	1814-BA	250	1918-BAB	350		
1514-EA	160	18-EL	17	1814-BB	250	1918-BAC	350		
1514-EF	161	18-FB02	16	1814-BC	250	1918-BAD	350		
1514-EG	160	18-FB1123	17	1814-CA	252	1918-BAE	350		
1514-EH	160	18-GG11	14						
1514-EI	160	18-GG17	14	1815-B	255	1919-AB	118		
1514-FA	158	18-GH11	15	1815-C	255			201803-C	276
1514-FB	158	18-GH13	15	1815-D	255	201803-C1711	266		
1514-FC	158	18-GH17	15	1815-E	255	201803-E1711	266		
1514-FF	158	18-IA	16	1815-F	255	201803-BD/BE	266		
1514-FG	158	18-LH	16	1815-G	255			201807-B/C	263
1514-FL	150	18-LH02	16	1815-H	255			201807-B/C0519	262
1514-GA	161	18-DFB18	17					201807-B/C11	264
1514-GB	161			1817	274			201807-B/C18	263
1514-GF	160	1801-B	340					201807-D/E	263
1514-GI	161	1801-C	340	1818-BF	270	201803-C	276	201807-D/E0519	262
1514-GL	161	1801-D	340	1818-BG	270	201803-C1711	266	201807-D/E11	264
1514-HB	161			1818-CA	216	201803-E1711	266	201807-D/E18	263
1514-HG	161	1803-B	108	1818-CB	216			201807-F/G	263
1514-HH	161	1803-C	108	1818-CC	216	201807-F/G0519	262		
1514-HI	160	1803-F	108	1818-EB	270				
1514-HL	160	1803-L	108	1818-EC	270				









ideal-tek  
manufacturer & supplier of precision instruments 

**Ideal-tek SA**  
via Motta 4  
6828 Balerna  
Switzerland

Phone: +41 91 683 32 29  
Fax: +41 91 683 03 71  
E-mail: [info@ideal-tek.com](mailto:info@ideal-tek.com)