

HNO-Katalog

ENT-Catalogue

Instrumente

HNO - ENT - ORL

HNO-Katalog
ENT-Catalogue
ORL-Catalogo

ORL-Catálogo
ORL-Catalogue

1.1



**Ohr Instrumente
Ear Instruments
Strumenti per orecchio
Instrumentos auriculares
Instruments auriculaires**

Otologie
Otology
Otologia
Otología
Otologie

Diagnostik-Bestecke
Ohr Spekula

Diagnostic - Sets
Ear Specula

Diagnostica - Set
Specoli auricolari

Diagnóstico - Set
Espéculos auriculares

Trousse à Diagnostic
Spéculum auriculaires

Halogenlampe - Halogen lamp
Lampada alogene - Lâmpara Houlógeno
Lampe halogène



0101-BDA
640 mA

Set komplett Diagnostik-Otoskop in Hartschalenetui
Set complete Diagnostic Otoloscope in solid Case
Otoscopio completo con custodia
Juego para otoscopia completo en estuche
Trousse à otoscopie complète

Halogen - Alogeno



0102-EL

Oto-Ophthalmoskop-Nasenspekulum
und 2 Kehlkopfspiegel
Oto-Ophthalmoscope-Nasal specula
and 2 Laryngeal mirror
Set oto-oftalmoscopio-speculum nasale
e 2 specchietti laringei
Juego de Diagnóstico, Oto-Oftalmoscopio-Espéculo Nasal
con 2 Espejos laringeos
Trousse à Oto-Ophthalmoscopie-spéculum nasal
avec 2 miroirs laryngiens

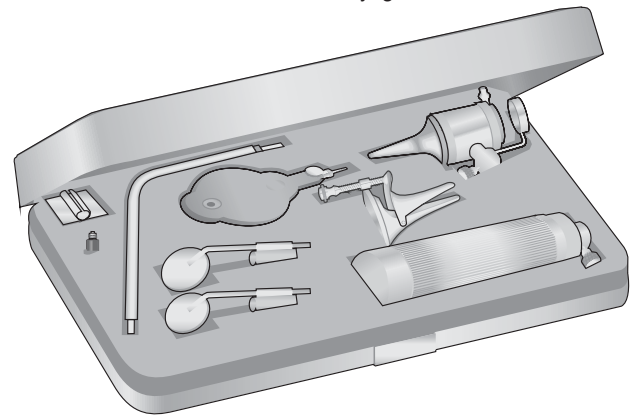

0102-EB

Speculum in Nylon
Schwarz - Black - Nero
Negro - Noir

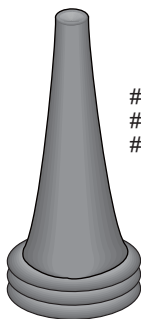

1 - Ø 3,0 mm
2 - Ø 4,5 mm
3 - Ø 5,5 mm

0102-DC17
Satz zu 3
Set of 3
Set 3 pezzi
Juego de 3
Jeu de 3
Fig. 1-3

Spekulum für kinder
Specula for children
Speculum per bambini
Espectula para niños
Spéculum pour enfants

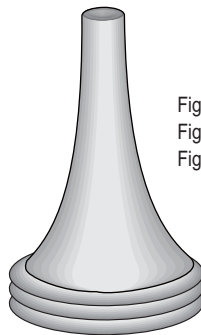
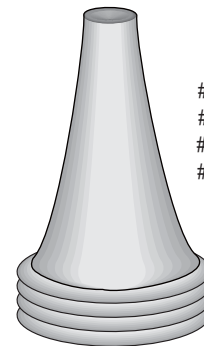

Fig. 1 - 0102-AB - Ø 1,8 mm
Fig. 2 - 0102-AC - Ø 3,2 mm
Fig. 3 - 0102-AD - Ø 4,6 mm

HARTMANN
0102-AI
Satz zu 3
Set of 3
Set 3 pezzi
Juego de 3
Jeu de 3
Fig. 1-3

Spekulum für Erwachsene
Specula for adults
Speculum per adulti
Espectula para adultos
Spéculum pour adultes



1 - 0102-AE - Ø 4,5 mm
2 - 0102-AF - Ø 5,5 mm
3 - 0102-AG - Ø 6,5 mm
4 - 0102-AH - Ø 7,5 mm

HARTMANN
0102-AL
Satz zu 4
Set of 4
Set 4 pezzi
Juego de 4
Jeu de 4
Fig. 1-4

Stimmgabeln

Tuning Forks

Diapason

Diapasones

Diapasons

C 64 / C 128

Lagerungsgestell für 15 Stück Nadeln
 Rack for 15 needles
 Piastra per 15 aghi oftalmici

150 x 100 x 2 mm

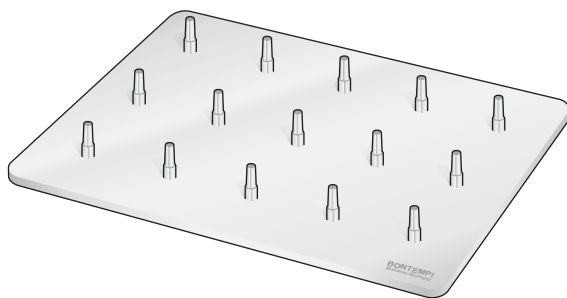

0218-CA

Ohrspekulaständer
 Ear specula storage rack
 Supporto per specoli auricolari
 Soporte para espejuelos auriculares
 Support pour spéculums auriculaires

150 x 100 x 2 mm

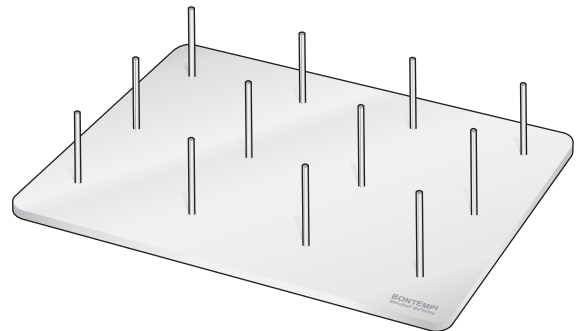

0218-CB

a¹ 440



0103-CA

C 128

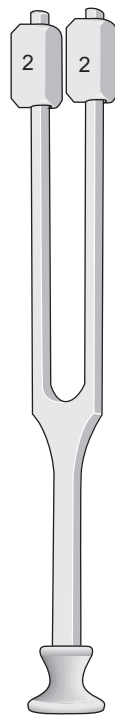

LUCAE
 0103-DA

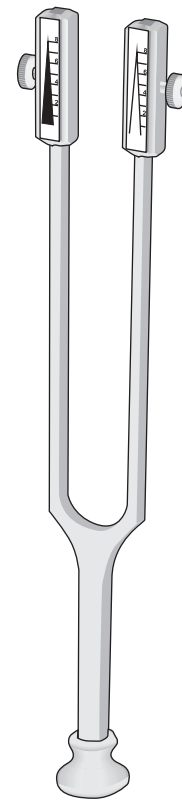
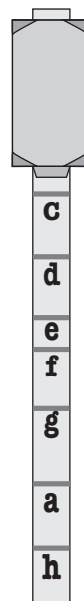

RYDEL-SEIFFERT
 0103-EA

Stimmgabeln

Tuning Forks

Diapason

Diapasones

Diapasons

Stimmgabelbesteck zu 5 Stück, in Etui, bestehend aus:
 Set of 5 Tuning Forks, in case, consisting of:
 Serie di 5 Diapason, in astuccio, composto di:
 Juego de 5 Diapasones, en estuche, compuesto de:
 Jeu de 5 Diapasons, en étui, comprenant:

- 0103-BB = c 128
- 0103-BC = c1 256
- 0103-BD = c2 512
- 0103-BE = c3 1024
- 0103-BF = c4 2048

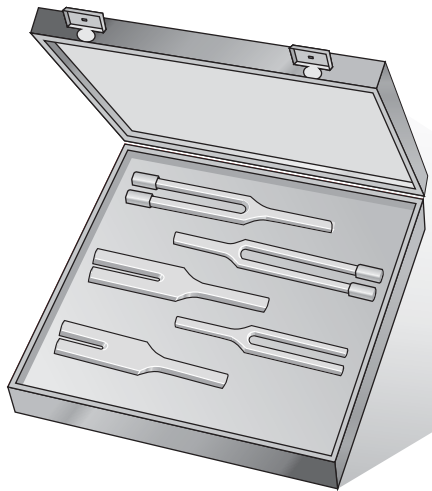

HARTMANN
0103-BI

Stimmgabelbesteck zu 6 Stück, in Etui, bestehend aus:
 Set of 6 Tuning Forks, in case, consisting of:
 Serie di 6 Diapason, in astuccio, composto di:
 Juego de 6 Diapasones, en estuche, compuesto de:
 Jeu de 6 Diapasons, en étui, comprenant:

- 0103-BB = c 128
- 0103-BC = c1 256
- 0103-BD = c2 512
- 0103-BE = c3 1024
- 0103-BF = c4 2048
- 0103-BG = c5 4096

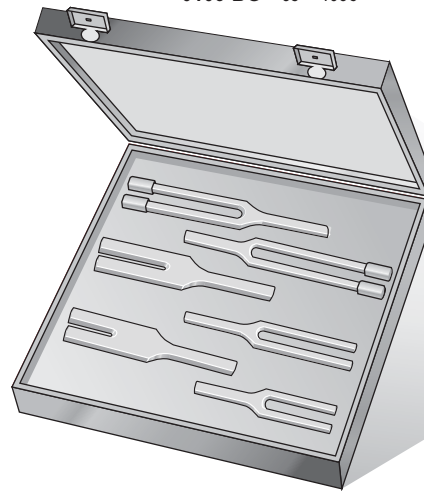

HARTMANN
0103-BL

C 128

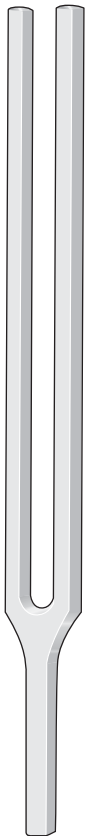

HARTMANN
0103-BB

C¹ 256



HARTMANN
0103-BC

C² 512



HARTMANN
0103-BD

C³ 1024



HARTMANN
0103-BE

C⁴ 2048



HARTMANN
0103-BF

C⁵ 4096



HARTMANN
0103-BG

C 64
 Mit Dämpfer - With clamps
 Con smorzatore - Con sordina
 Avec curseurs
 C 128
 Ohne Dämpfer - Without clamps
 Senza smorzatore - Sin sordina
 Sans curseurs

Ohrspritzen Ganzmetallausführung
 Ear syringes all metal
 Siringhe auricolari in metallo
 Jeringas auriculares
 Seringues auriculaires



SYRINGE
1804-BF
 200 ml

Ø 4 mm

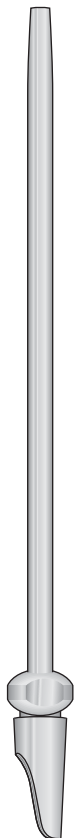

0706-LE
 160 mm

Ø 4 mm

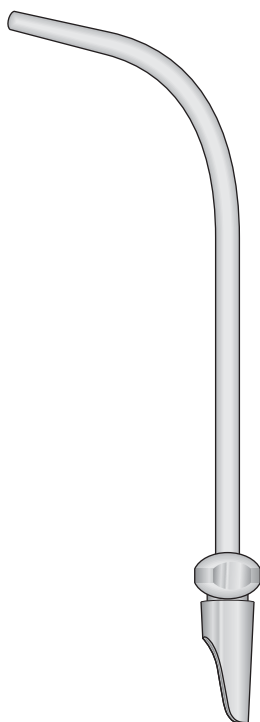

0706-LD
 145 mm

Gummiball - Rubber bulb
 Pompetta in gomma - Pera de goma
 Poire en caoutchouc

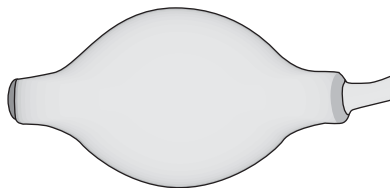

0706-LG

0706-LH
 Komplettsset mit:
 Set complete with:
 Set completo con:
 Set completos con:
 Set complet avec:

0706-LC - 0706-LD
0706-LE - 0706-LG

Schlauch - Silikon
 Flexible tube - Silicone
 Raccordo in silicone per cannule
 Autoclavabile
 Tubo flexible de silicona
 Tuyau - Silicone

2 mt.

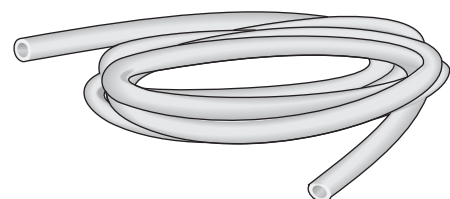

1918-FA
 2 mt.

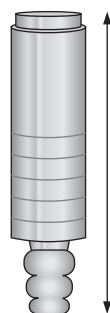

65 mm

0706-LC
 65 mm

Ohrküretten

Ear Curettes

Curette auricolari

Curetas auriculares

Curettes auriculaires

Gerade
Straight
Diritta
Rectas
Droites

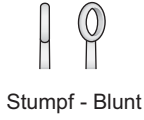

Stumpf - Blunt

Fig. 000	Fig. 00	Fig. 0	Fig. 1	Fig. 2	Fig. 3	Fig. 4	Fig. 5
1/1	1/1	1/1	1/1	1/1	1/1	1/1	1/1
0617-GI	0617-GL	0617-HA	0617-HB	0617-HC	0617-HD	0617-HE	0617-HF



Scharf - Sharp

Fig. 000	Fig. 00	Fig. 0	Fig. 1	Fig. 2	Fig. 3	Fig. 4	Fig. 5
1/1	1/1	1/1	1/1	1/1	1/1	1/1	1/1
0617-HG	0617-HH	0617-HI	0617-HL	0617-IA	0617-IB	0617-IC	0617-ID

BUCK
0617-GI/0617-IC
150 mm

Gebogen
Curved
Curva
Curvas
Courbes



Stumpf - Blunt

Fig. 000	Fig. 00	Fig. 0	Fig. 1	Fig. 2	Fig. 3	Fig. 4	Fig. 5
1/1	1/1	1/1	1/1	1/1	1/1	1/1	1/1
0617-IE	0617-IF	0617-IG	0617-IH	0617-II	0617-IL	0617-LA	0617-LB



Scharf - Sharp

Fig. 000	Fig. 00	Fig. 0	Fig. 1	Fig. 2	Fig. 3	Fig. 4	Fig. 5
1/1	1/1	1/1	1/1	1/1	1/1	1/1	1/1
0617-LC	0617-LD	0617-LE	0617-LF	0617-LG	0617-LH	0617-LI	0617-LL

BUCK
0617-IE/0617-LI
150 mm

Ohrschlingen

Ear Loops

Lacci auricolari

Microlazos auriculares

Anses auriculaires

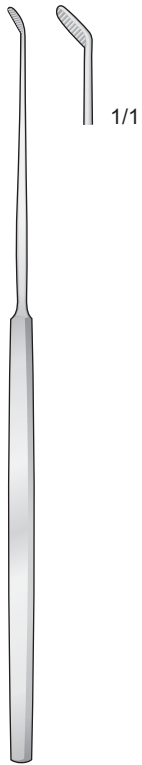

MOLDENHAUER
0402-CG
160 mm

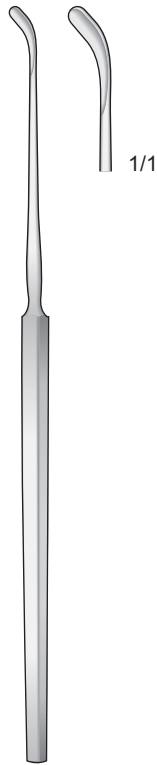

ZAUFAL
0402-CH 160 mm
0402-CI 200 mm

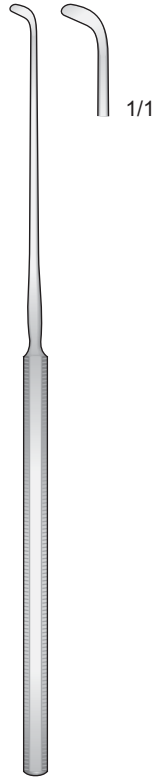

JANSEN-NEWHART
0402-EA
170 mm

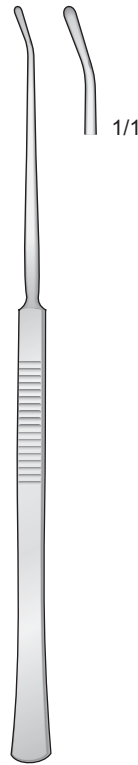

YANKAUER
0402-EB
160 mm

Ohrlöffel und -Häkchen
Ear Spoon and Hook
Cucchiao e uncinetto
Cucharilla y Gancho auriculares
Cuiller et Crochet

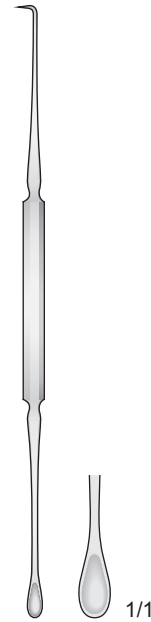

GROSS
0402-FF
120 mm

Ohrkürette und -Häkchen
Ear Curette and Hook
Curetta e uncinetto
Cureta y Gancho auriculares
Curette et Crochet

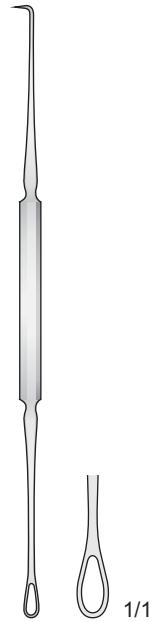

GROSS
0402-FG
120 mm

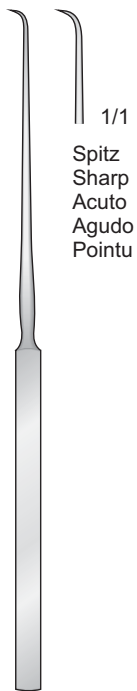

WAGENER
0402-EH
140 mm

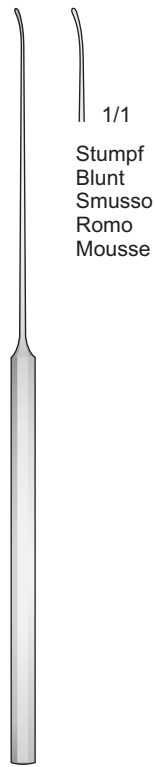

WAGENER
0402-EI
160 mm

Küretten - Curettes - Curette
Curetas - Curettes



SHAPLEIGH
0402-DG/0402-DL
130 mm



0402-DG
130 mm



0402-DH
130 mm



0402-DI
130 mm



0402-DL
130 mm

1/1
Stumpf
Blunt
Smusso
Romo
Mousse

1/1
Spitz
Sharp
Acuto
Agudo
Pointu

Ohrschlingen - Ear Loops - Anse auricolari
Ansas auriculares - Anses auriculaires



BILLEAU
0402-DA/0402-DC
160 mm

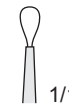

0402-DA
1/1

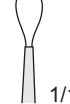

0402-DB
1/1

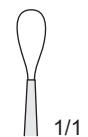

0402-DC
1/1

Ohrhäkchen

Ear Hooks

Uncini auricolari

Ganchitos auriculares

Crochets auriculaires

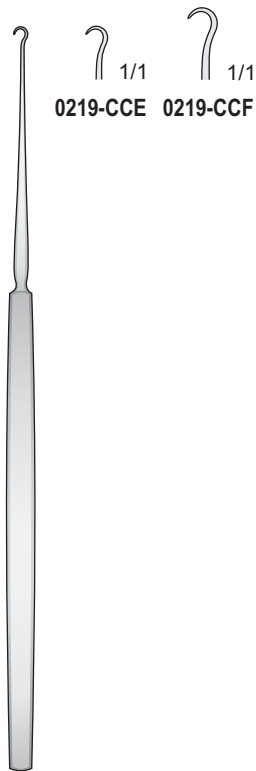

HARTMANN
0219-CCE/0219-CCF
160 mm

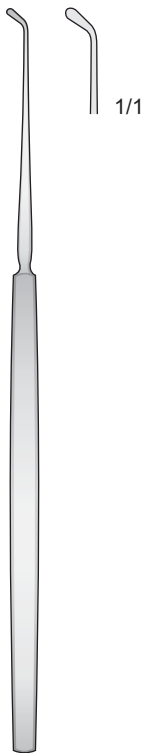

YANKAUER
0402-CL
150 mm

Ohrhebel - Ear hooks - Uncini
Ganchitos - Crochets

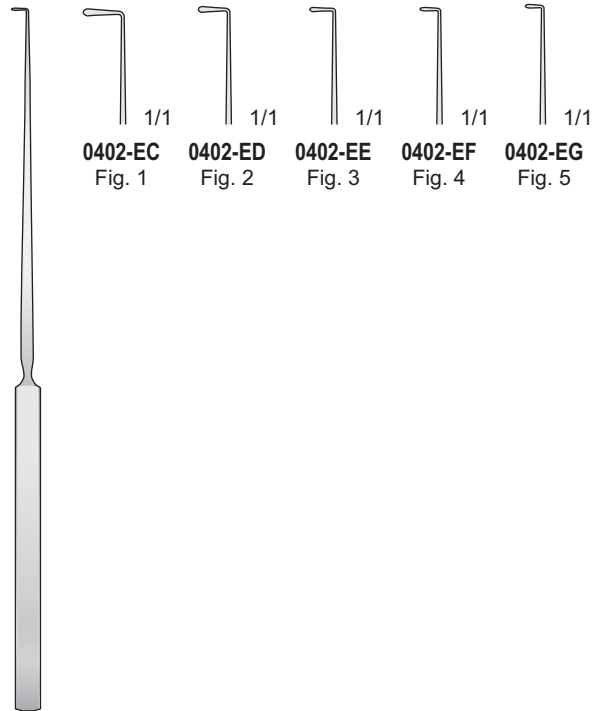

WAGENER
0402-EC/0402-EG
140 mm

Ohrhebel - Ear hooks - Uncini
Ganchitos - Crochets

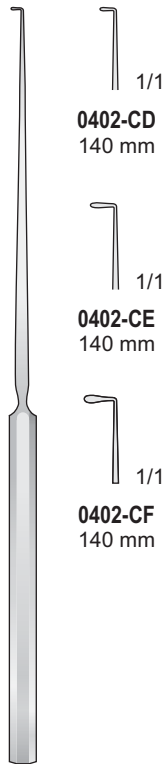

LUCAE
0402-CD/0402-CF
140 mm

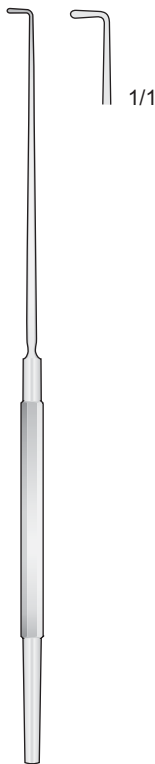

ALLPORT
0402-BH
160 mm

Ohrhebel - Ear hooks - Uncini
Ganchitos - Crochets

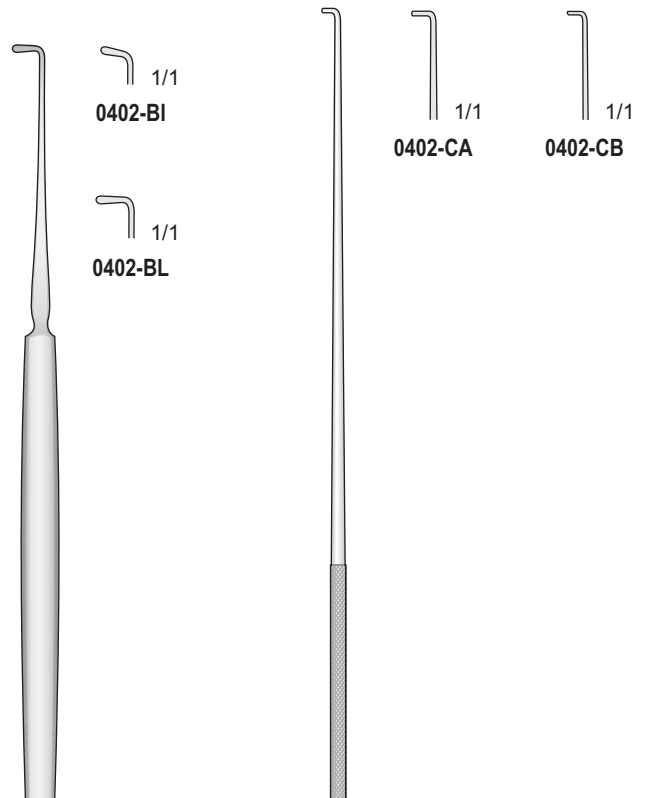

JACOBSON
0402-BI/0402-BL
150 mm

DAY
0402-CA/0402-CB
160 mm

Sichelmesser
Lanzetten

Sickle Shaped Knives
Lancets

Bisturi falciformi
Lancette

Cuchillos falciformes
Lancetas

Bistouris auriculaires croissant
Lancettes



MUCK
0617-AB
135 mm



POLITZER
0617-AC
135 mm



BRÜHL
0617-AD
150 mm



BRÜHL
0617-AE
150 mm



POLITZER
0617-AF
160 mm



LEMPERT
0617-BD
150 mm



LEMPERT
0617-BE
150 mm



Gerade
Straight
Diritta
Rectas
Droites



JACOBSON
0617-AG
155 mm



BUCK
0617-AH
150 mm

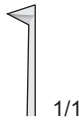

SEXTON
0617-FA/0617-FB
180 mm



0617-FA



0617-FB



SEXTON
0617-FC/0617-FD
180 mm



0617-FC



0617-FD

Sichelmesser
Lanzetten

Sickle Shaped Knives
Lancets

Bisturi falciformi
Lancette

Cuchillos falciformes
Lancetas

Bistouris auriculaires croissant
Lancettes

Ohrmesser, Ohrnadeln
Ear Knives, Tympanum Knifes and Retractors

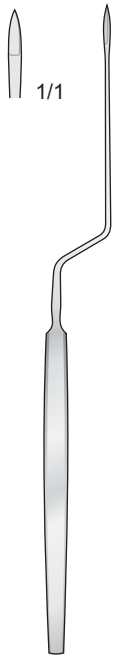

GERZOG-SEXTON
0617-FE
170 mm



0617-FF/0617-FH
160 mm

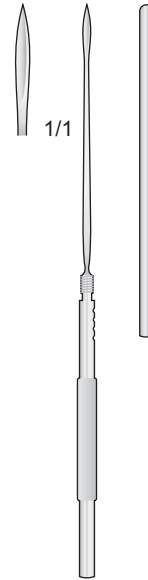
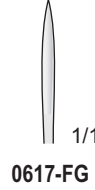

FRIESNER
0617-FI
160 mm

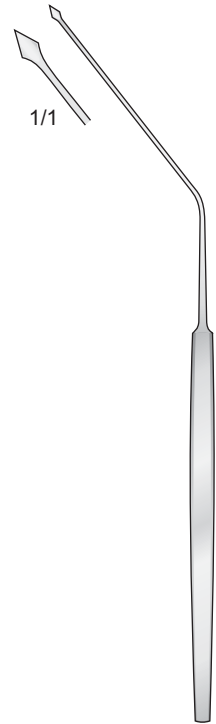

AGNEW
0617-FL
160 mm

Nadel senkrecht
Needle vertical



POLITZER
0617-GA
160 mm

Nadel waagrecht
Needle horizontal



POLITZER
0617-GB
160 mm

Nadel senkrecht
Needle vertical

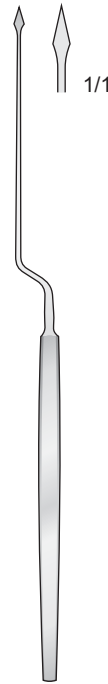

LUCAE
0617-GC
180 mm

Nadel waagrecht
Needle horizontal

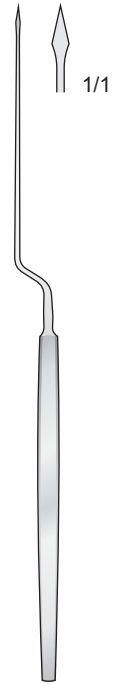

LUCAE
0617-GD
180 mm

Knorpelschaber
Cartilage abraders
Raschiatore per cartilagine
Rascador de cartilago
Grattoir à cartilages

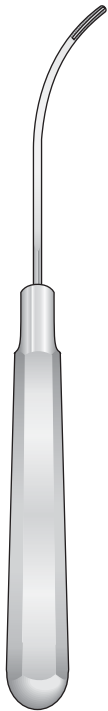

DINGMANN
0414-CEF
160 mm
1-L

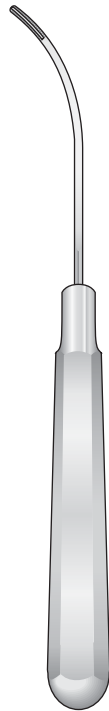

DINGMANN
0414-CEG
160 mm
2-R



DINGMANN
0414-CGF
155 mm
1-L

Raspatorien, Dissektoren
Raspatories, Dissector
Raschiatori, Dissettori
Sepradores
Rugines

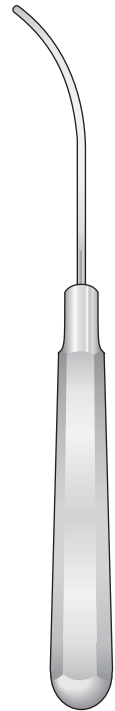

DINGMANN
0414-CGG
155 mm
2-R

Meißelschützer
Protector and Guide
Protettore facciale
Protector facial
Protecteur facial

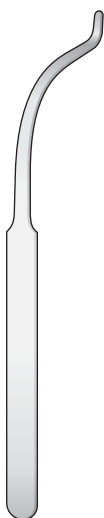

STACKE
0610-CEC
125 mm

Stumpf
Blunt
Smussa
Romo
Mousse



LANGENBECK
0402-FB
130 mm

Stumpf doppelt
Blunt double ended
Smussa
Romo
Mousse



COXETER
0402-FC
150 mm

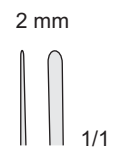

1014-HD

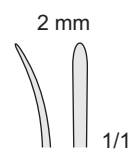

1014-HE

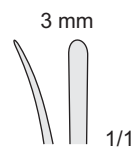

1014-HF



LEMPERT
1014-HD/1014-HF
190 mm

Ohrzàngchen
Ear Forceps
Pinze auricolari
Pinzas auriculares
Pincès auriculaires

Ohrzàngchen für Fremdkörper
Foreign body lever
Pinza per corpi estranei
Pinzas para cuerpo extràños
Pince pour corps étrangers

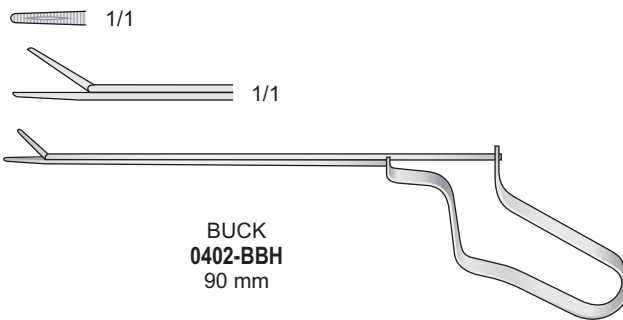

Ohrhebel für Fremdkörper
Foreign body lever
Leva per corpi estranei
Elevador para cuerpos extràños
Levier pour corps étrangers

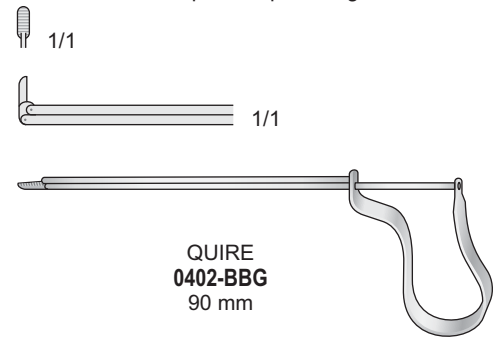

Ohrtamponzàngchen
Ear Dressing Forceps
Pinze auricolari per tamponamento
Pinzas auricular fina para tamponamiento
Pincès à pansements auriculaires

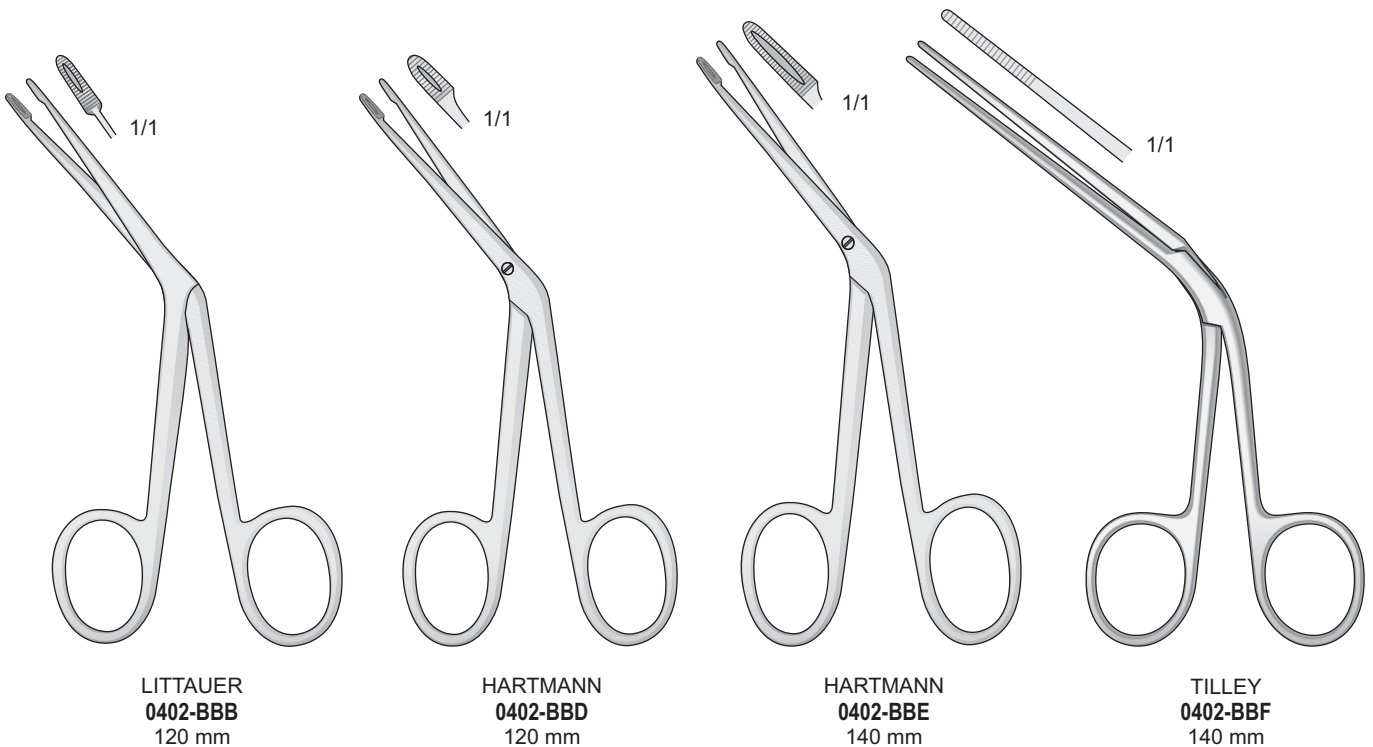

Ohr-Polypenzangen
 Ear Forceps
 Pinze auricolari
 Pinzas auricolàres
 Pincès pour polypes auriculaires

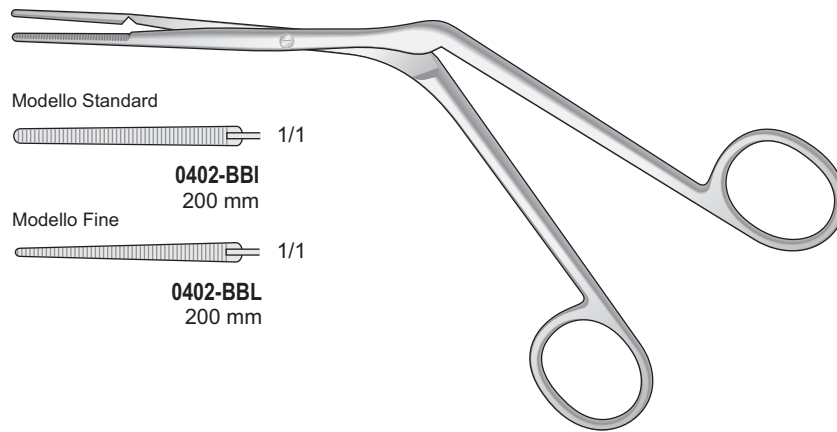

Modello Standard



0402-BBI
 200 mm

Modello Fine



0402-BBL
 200 mm

WESTMACOTT
0402-BBI/0402-BBL
 200 mm

1x2 Zähne - 1x2 Teeths
 1x2 Denti - 1x2 Dientes
 1x2 Dents

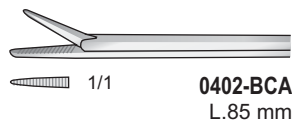

0402-BCA
 L.85 mm

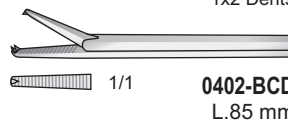

0402-BCD
 L.85 mm

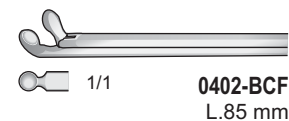

0402-BCF
 L.85 mm

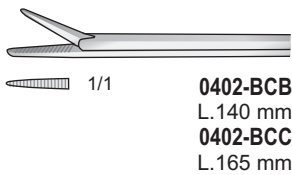

0402-BCB
 L.140 mm
0402-BCC
 L.165 mm

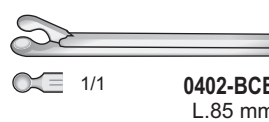

0402-BCE
 L.85 mm

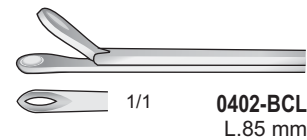

0402-BCL
 L.85 mm

85 mm

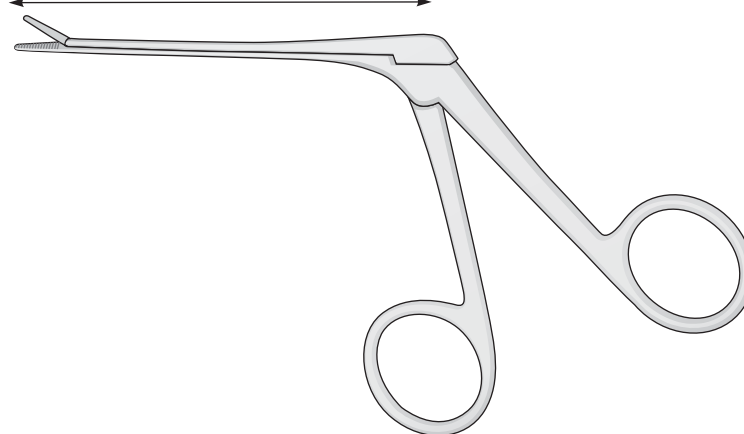

HARTMANN
0402-BCA/0402-BCL
 L. 85 mm

Ø 20 mm - 140 g



0611-AB
165 mm

Ø 25 mm - 200 g

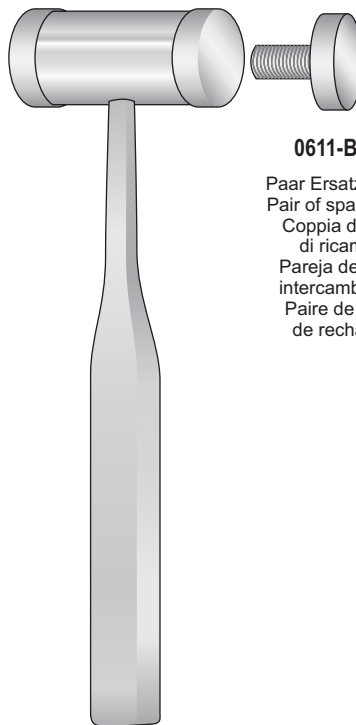

MEAD
0611-BB
200 mm

Ø 26 mm - 320 g

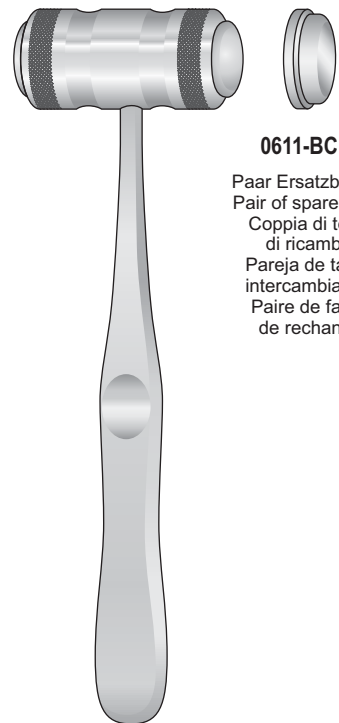

MEAD
0611-BC
190 mm

0611-BB17

Paar Ersatzbacken
Pair of spare faces
Coppia di teste
di ricambio
Pareja de tapas
intercambiables
Paire de faces
de rechange

0611-BC17

Paar Ersatzbacken
Pair of spare faces
Coppia di teste
di ricambio
Pareja de tapas
intercambiables
Paire de faces
de rechange

Ferrozell-Hämmer
Hammer in Ferrozell
Martello in Ferrozell
Martillo en Ferrozell
Marteau dans Ferrozell

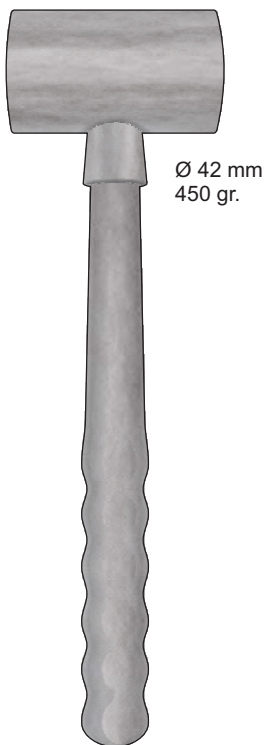

0611-BCL
260 mm

Ø 27 mm

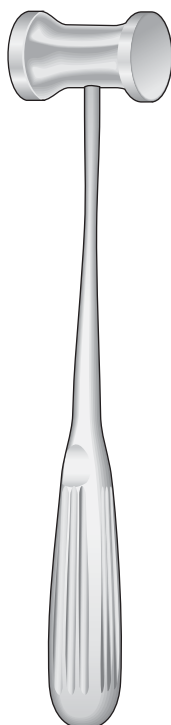

HAJEK
0611-BCI
220 mm

Ø 25 mm - 300 g

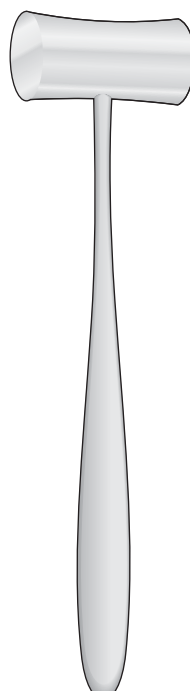

LUCAS
0611-BA12
190 mm

1 Seite flach - 1 Seite convex
1 Side flat - 1 Side convex
1 Lato piatto - 1 Lato convesso
1 Parte plana - 1 Parte convexe
1 Face plate - 1 Face convexe

Ø 30 mm - 240 g



COTTLE
0611-BAE
185 mm

Intranasal Brecher
Intranasal Hammer
Martello intranasale



QUISLING
0611-BDH
175 mm

Stossel - Osteotome

Tampers - Osteotomes

Battitori - Osteotomi

Batidor - Osteotomos

Pilons - Osteotomes

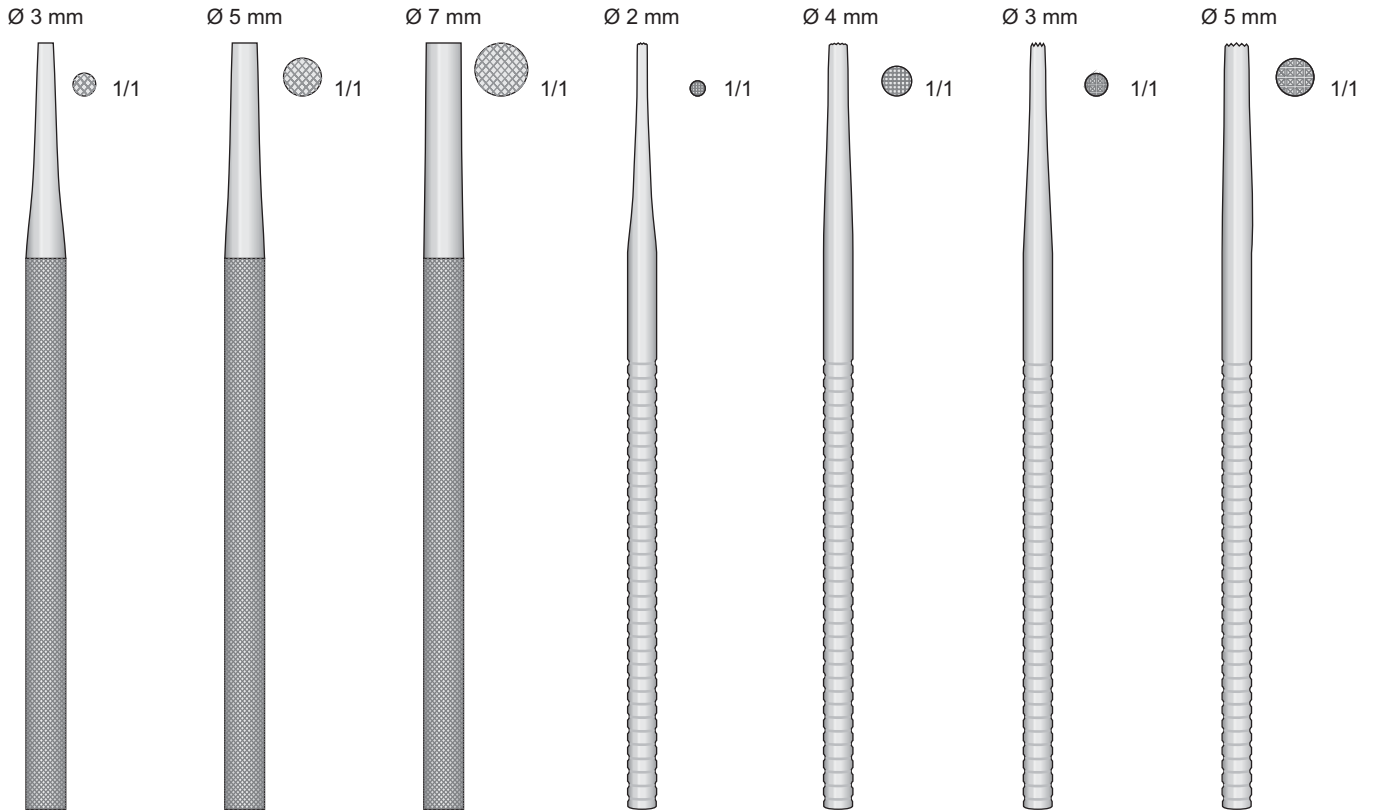

0611-CA
155 mm

0611-CB
155 mm

0611-CC
155 mm

0611-DA
155 mm

0611-DB
155 mm

0611-DD
155 mm

0611-DF
155 mm

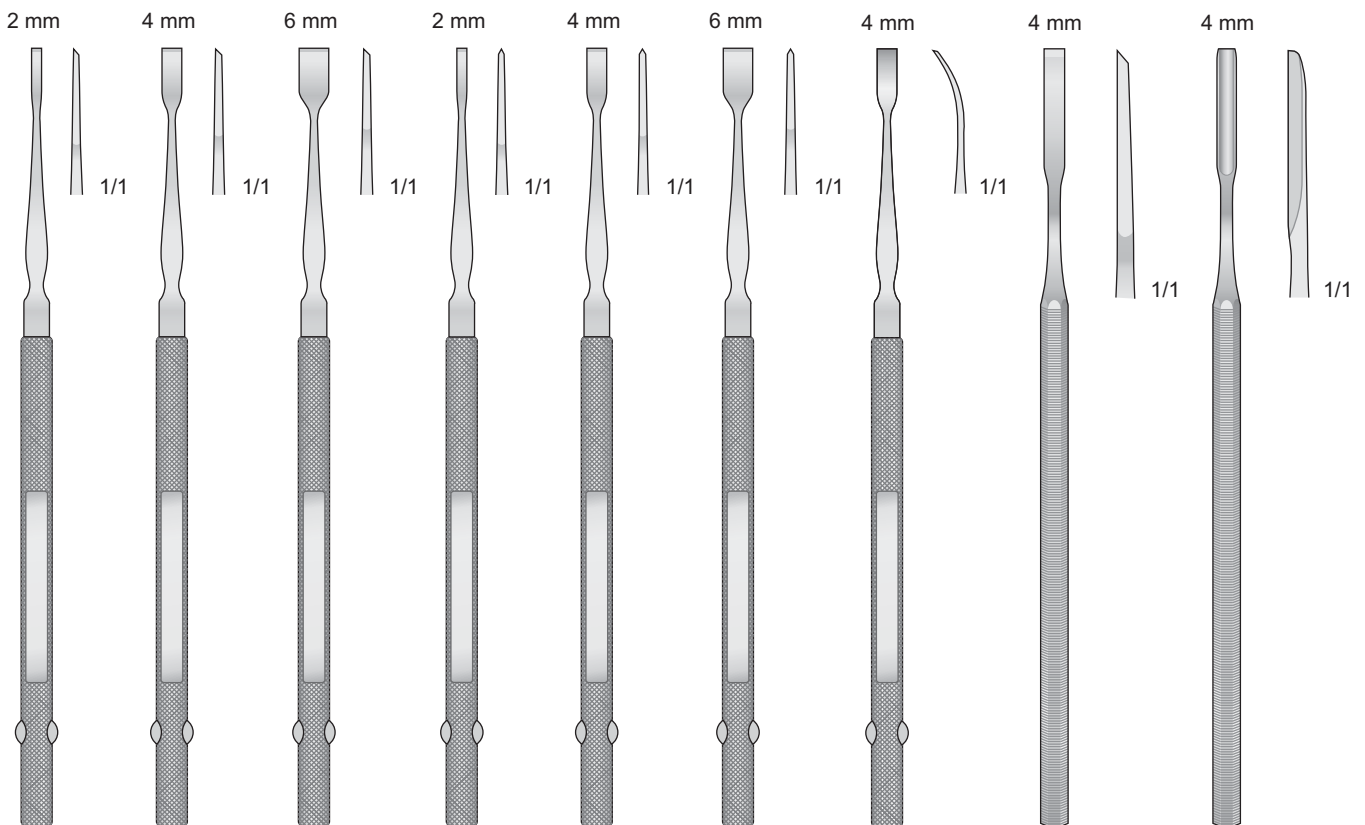

1907-BA
160 mm

1907-BB
160 mm

1907-BC
160 mm

1907-CA
160 mm

1907-CB
160 mm

1907-CC
160 mm

FREER
1907-CD
160 mm

BUCKLEY
1907-EA
160 mm

BUCKLEY
1907-EB
160 mm

Osteotome - Osteotomes
Osteotomi - Osteótomos - Ostéotomes

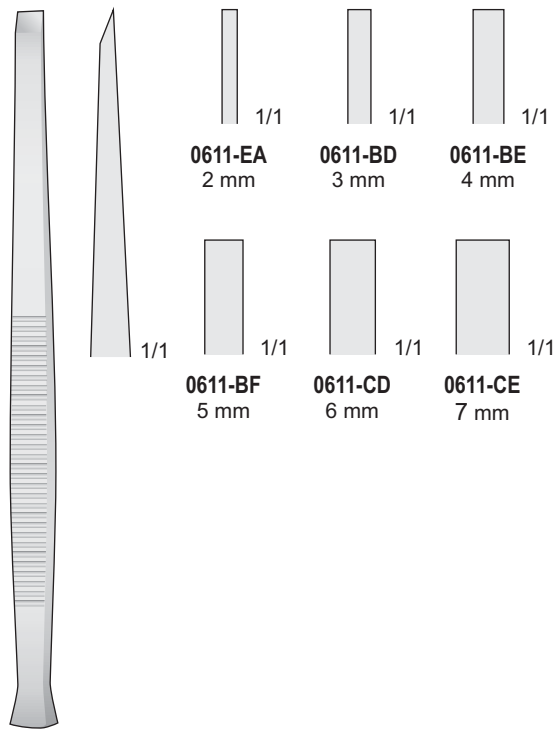

PARTSCH
0611-BD/0611-EA
140 mm

Hohlmeissel - Gouges
Sgorbie - Gubias - Gouges

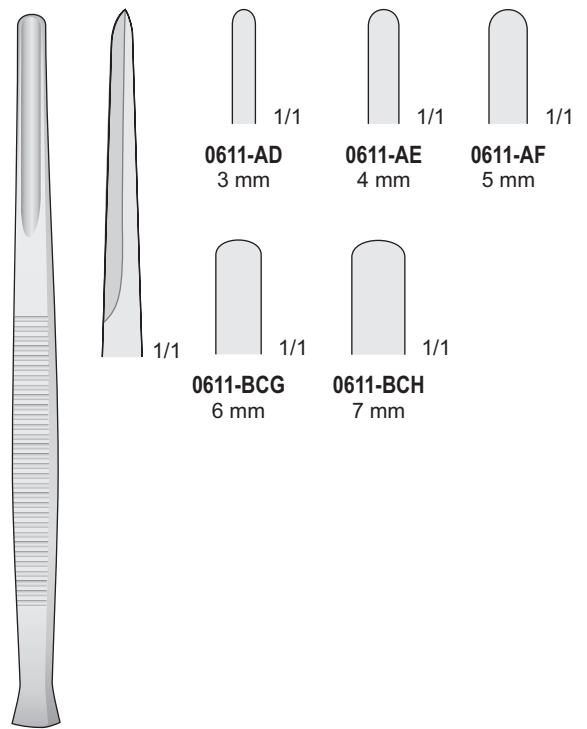

PARTSCH
0611-AD/0611-BCH
140 mm

Osteotome - Osteotomes
Osteotomi - Osteótomos - Ostéotomes

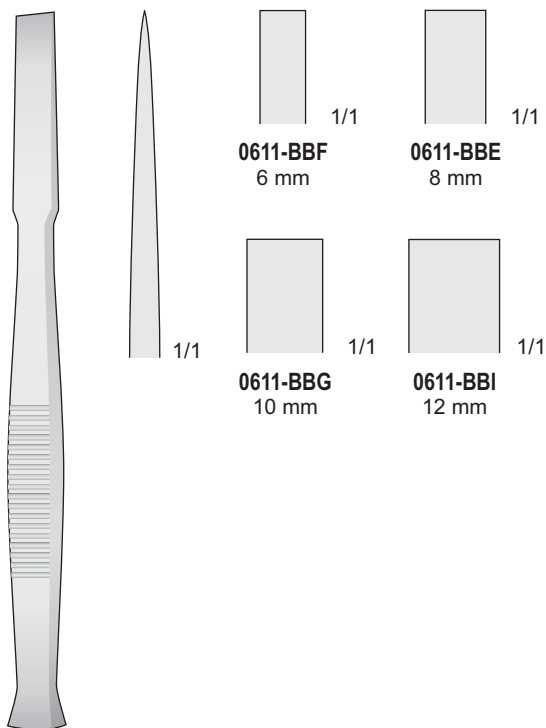

0611-BBE/FL-118
140 mm

Hohlmeissel - Gouges
Sgorbie - Gubias - Gouges

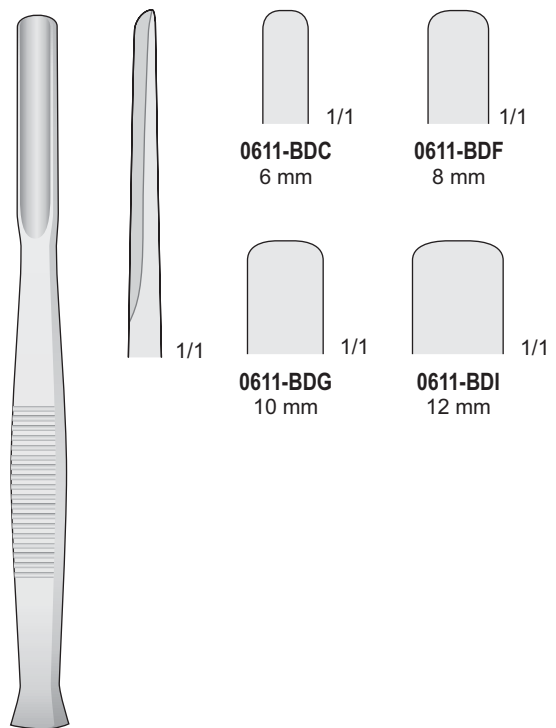

0611-BDC/0611-BDI
140 mm

Hohlmeissel
Raspatorien

Gouges
Periosteal Raspatories

Scalpelli
Periostotomi - Raspatori

Cinceles
Periostotomos - Legras

Scalpel
Rugines à périostomie

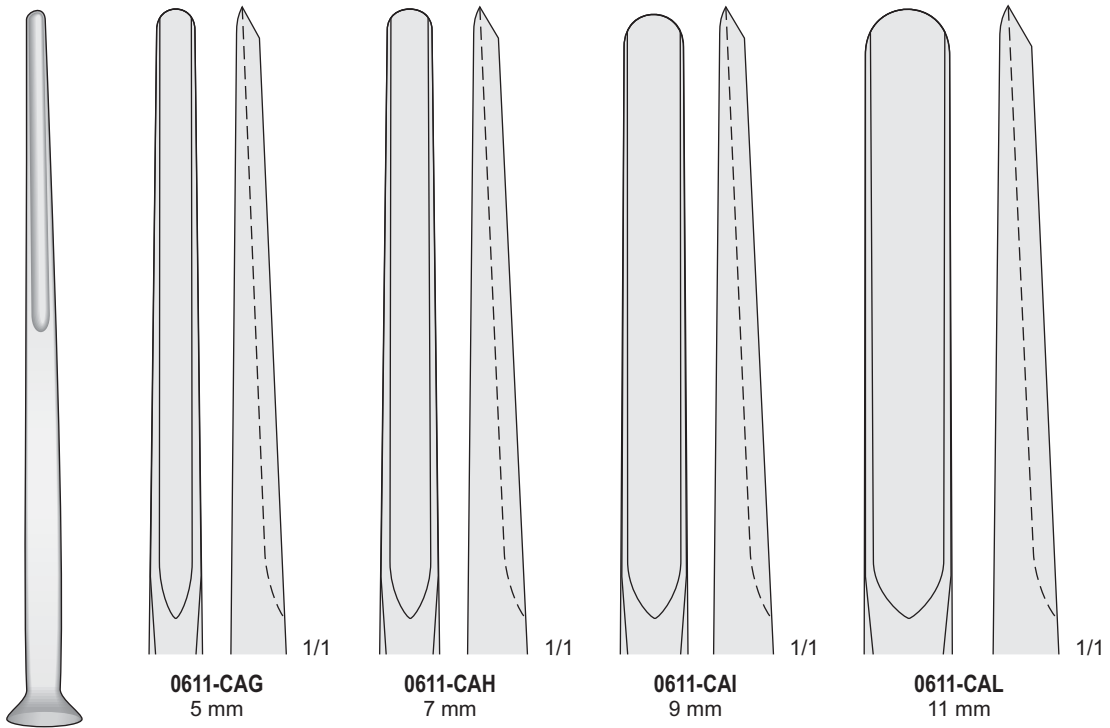

ALEXANDER
0611-CAG/0611-CAL
170 mm

Mit Ferrozellgriff - With Ferrozell handle - Con manico Ferrozell - Con mango de Ferrozell - Avec poignée en Ferrozell

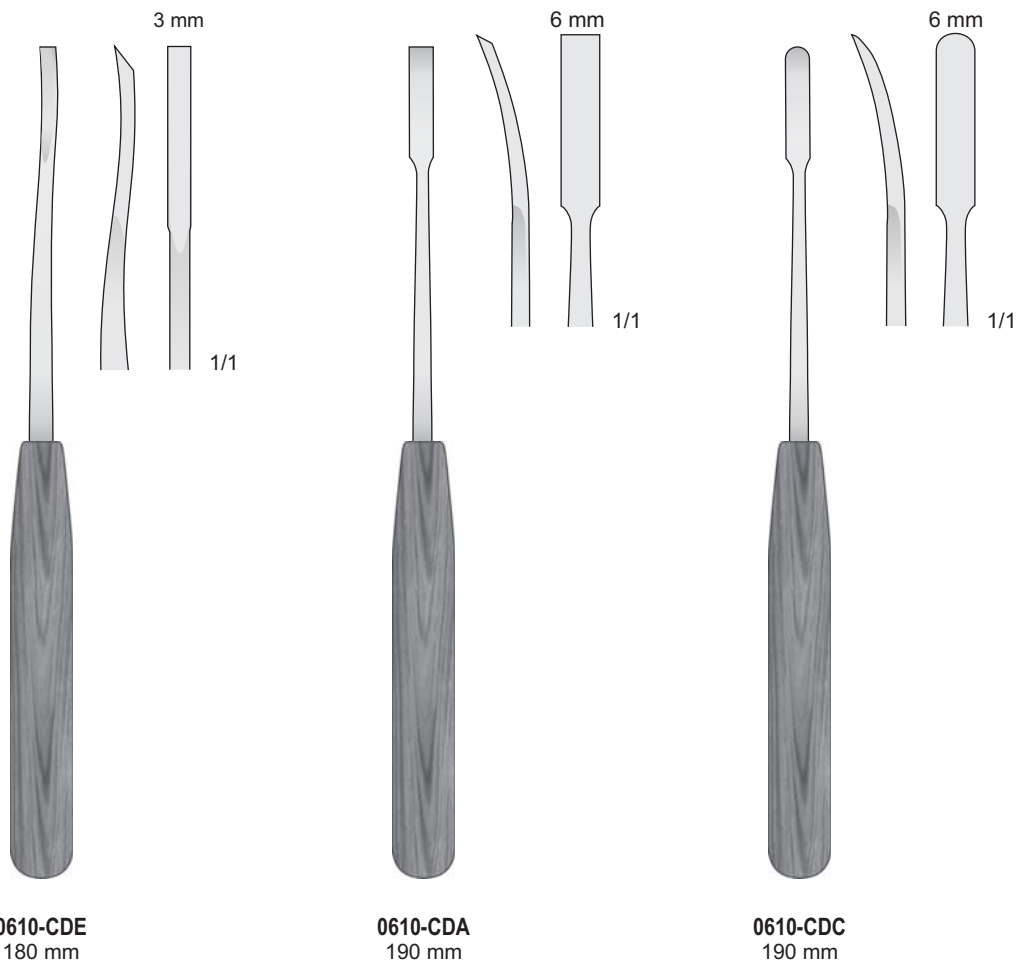

**Elevatorien
Raspatorien**

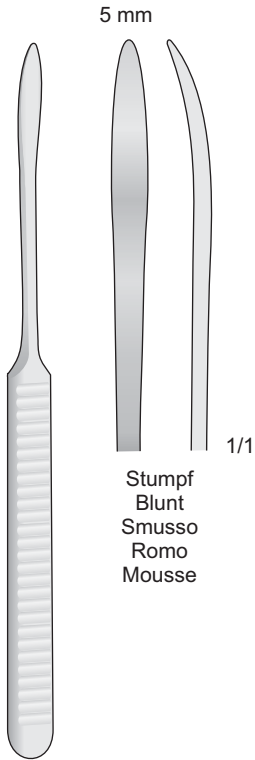

Stumpf
Blunt
Smusso
Romo
Mousse

**WILLIGER
2207-BA
165 mm**

**Elevators
Raspatories**

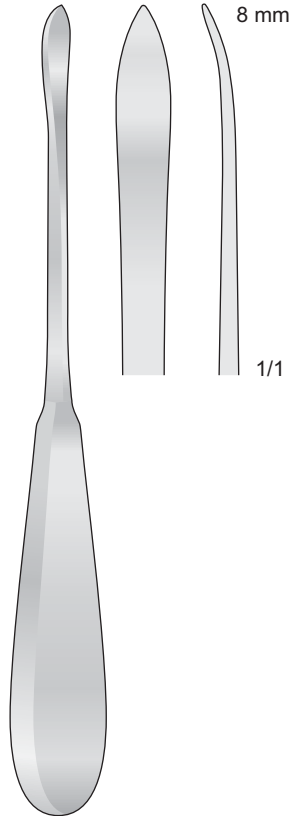

**LANGENBECK
0610-BC
200 mm**

**Elevatori
Raspatori**

**Elevadores
Legras**

**Elevateurs
Rugines**

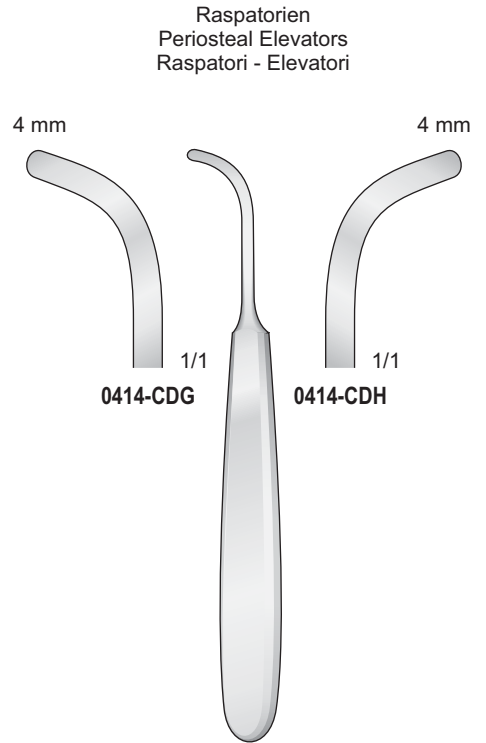

Raspatorien
Periosteal Elevators
Raspatori - Elevatori

0414-CDG

0414-CDH

**0414-CDG/0414-CDH
140 mm**

Raspatorien - Periosteal Raspatories - Periostotomi - Legras periostotomos - Rugines à périostomie

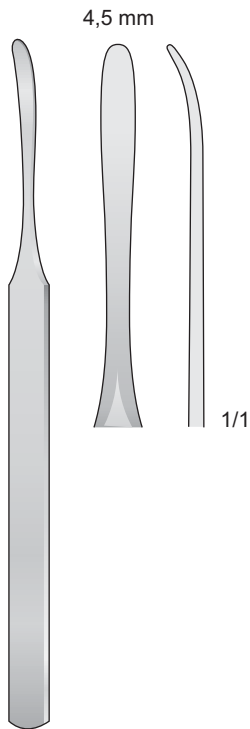

**KÖNIG
1014-B
155 mm**

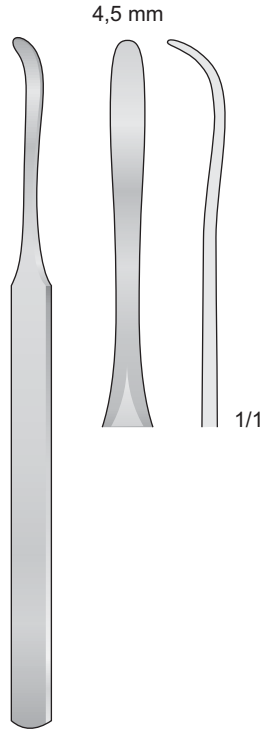

**KÖNIG
1014-C
155 mm**

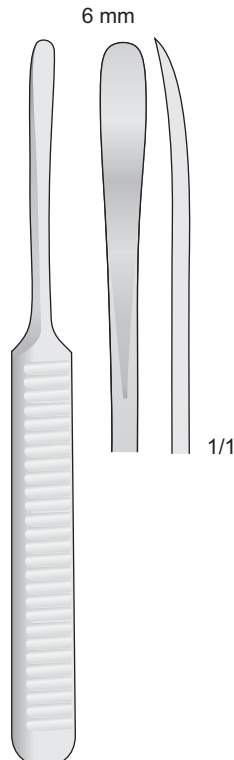

**WILLIGER
2207-BC
160 mm**

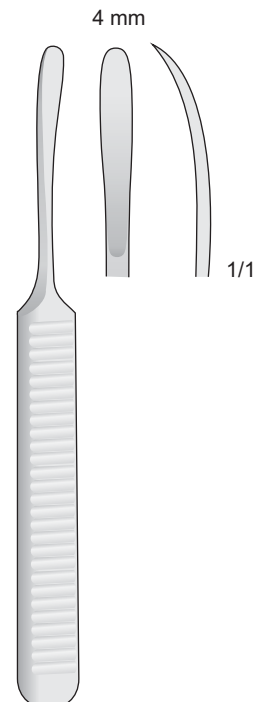

**WILLIGER
2207-BE
140 mm**

Raspatorien

Periosteal Raspatories

Periostotomi

Legras periostotomos

Rugines à periostomie

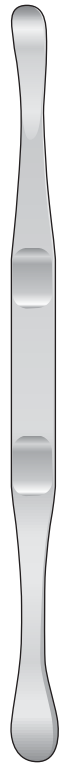

**BABBUSH
1014-CA
180 mm**

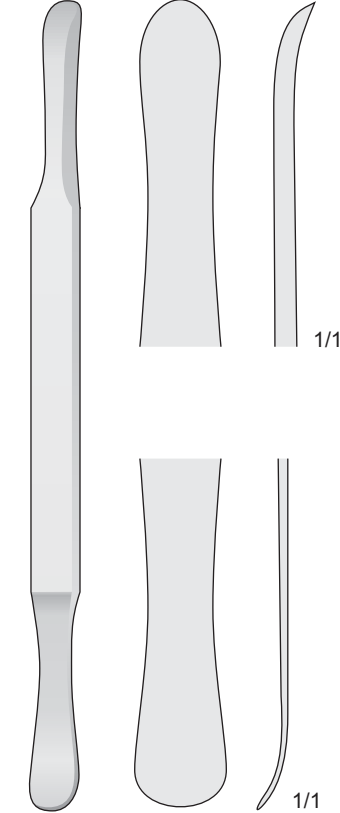
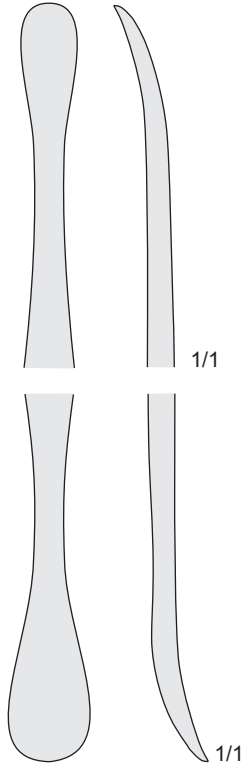

**SELDIN
1014-CD
195 mm**

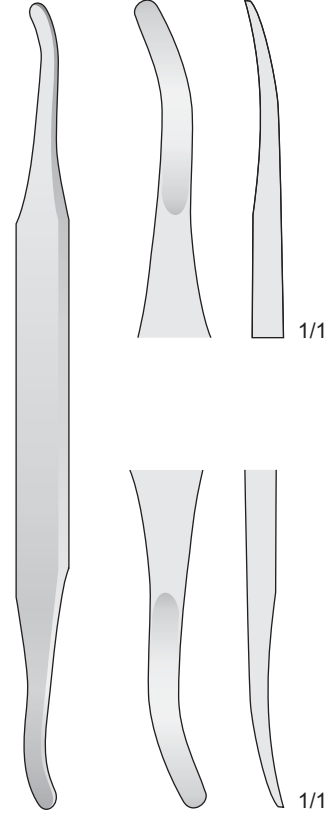

**SELDIN
1014-CC
190 mm**



**22051819
185 mm**

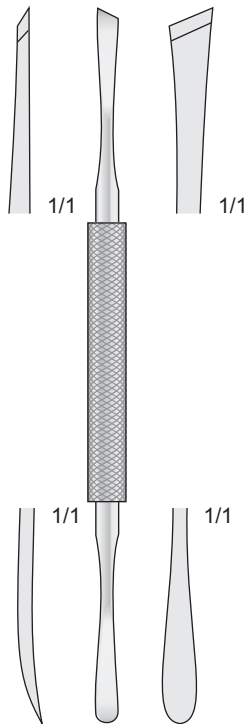

**MEAD
1014-DI
165 mm**



**MC DONALD
1014-DL
190 mm**



**ALDERDYCE
1014-DL
210 mm**

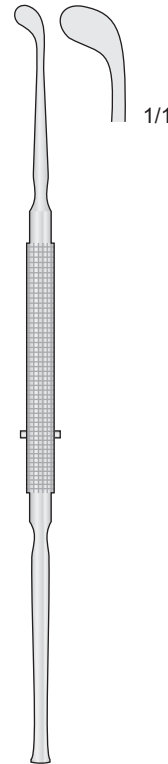

**FREER
0617-BF
190 mm**

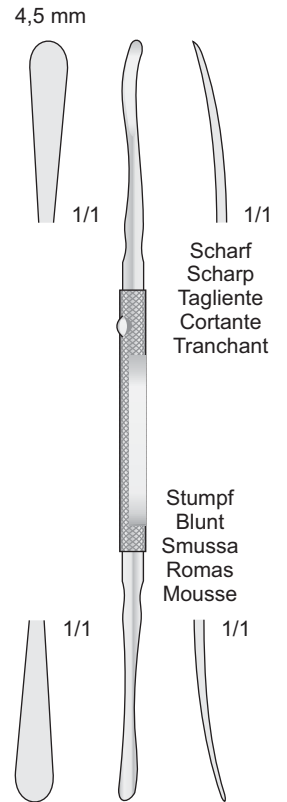

**0617050517
180 mm**

Scharf
Scharp
Tagliente
Cortante
Tranchant

Stumpf
Blunt
Smussa
Romas
Mousse

Raspatorien

Periosteal Raspatories

Periostotomi

Legras periostotomos

Rugines à periostomie

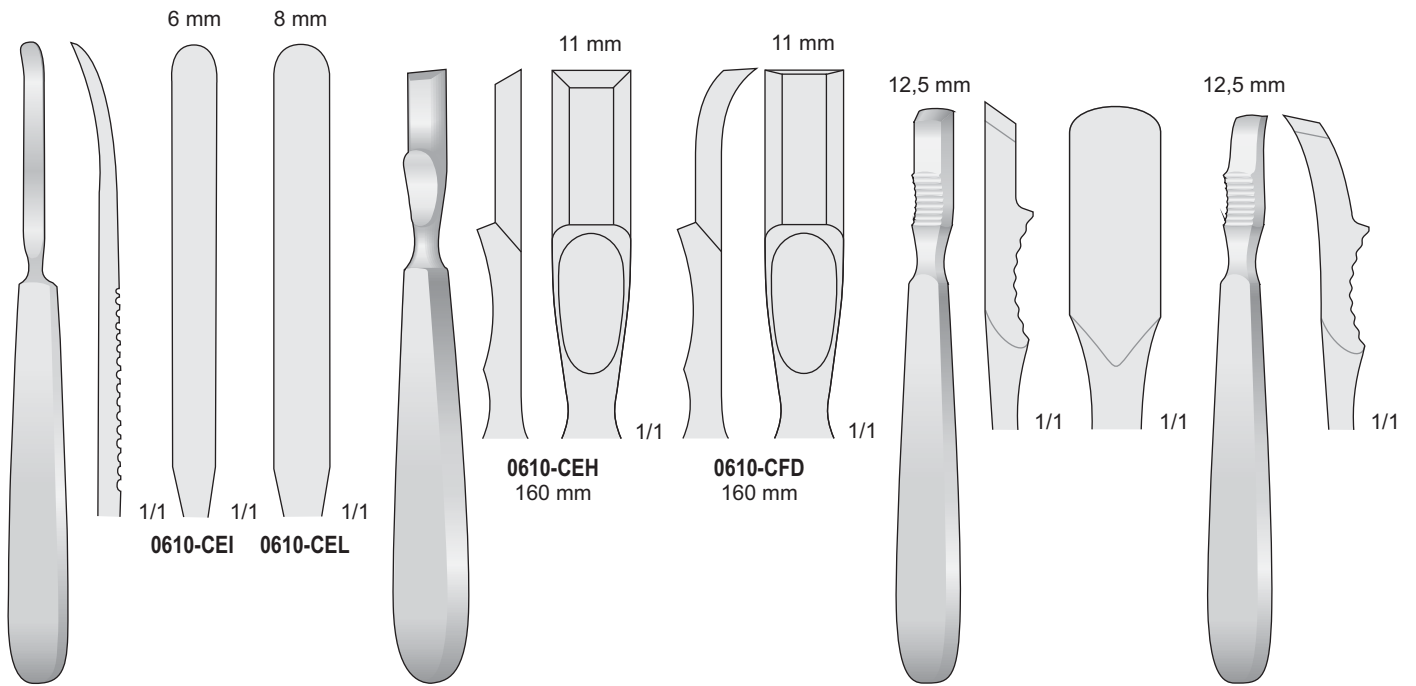

0610-CEI/0610-CEL
170 mm

FARABEUF-COLLIN
0610-CEH/0610-CFD
160 mm

FARABEUF
0610-CFA
150 mm

FARABEUF
0610-CFB
150 mm

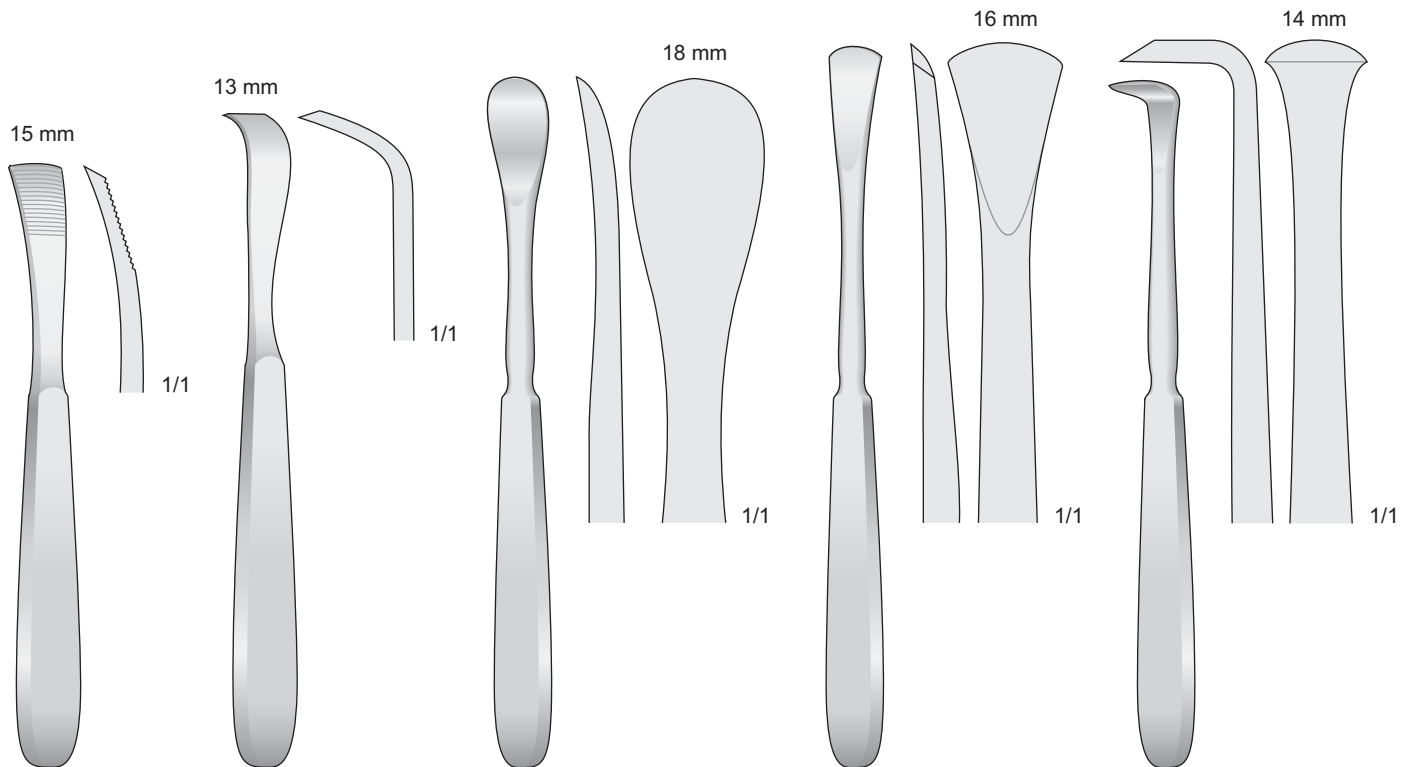

JANSEN
0610-CFF
165 mm

SCHNEIDER
0610-CFI
175 mm

SEDILLOT
0610-CFE
185 mm

LANGENBECK
0610-CFG
190 mm

LANGENBECK
0610-CFH
180 mm

Raspatorien

Raspatories

Periostotomi

Legras

Rugines

Periosteal elevators
Scharf
Sharp
Taglienti
Cortante
Tranchant

6 mm

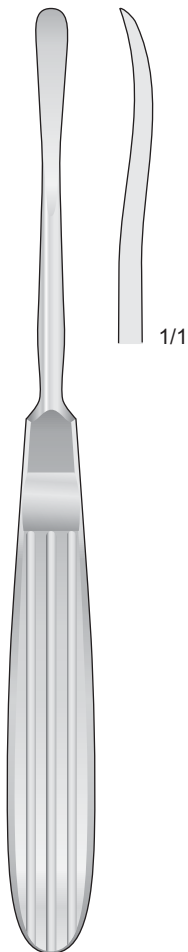

OBWEGESER
0414-FL
175 mm

7 mm

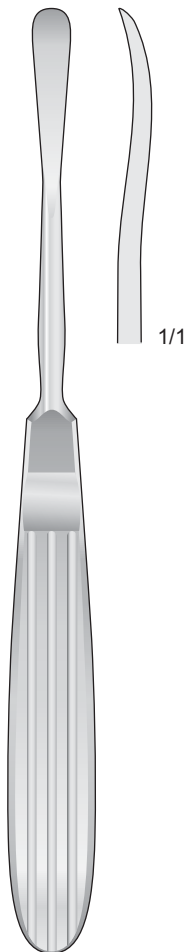

OBWEGESER
0414-GD
175 mm

9 mm

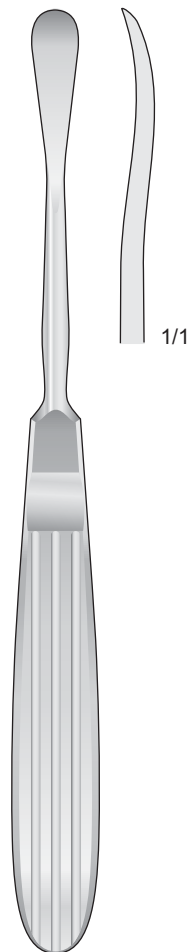

OBWEGESER
0414-GH
175 mm

11 mm

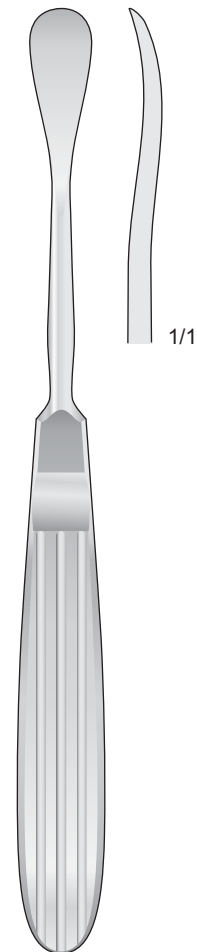

OBWEGESER
0414-GF
175 mm

Scharfe Löffel

Sharp curettes

Curette, Cucchiai taglienti

Cucharillas cortantes

Curettes tranchantes



MARTINI
0610-HA
140 mm

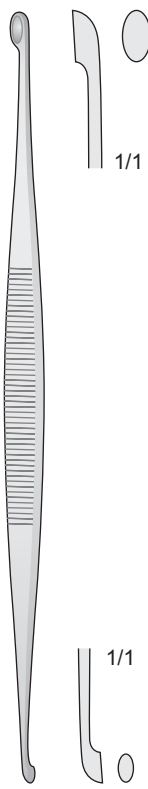

WILLIGER
0610-HB
145 mm

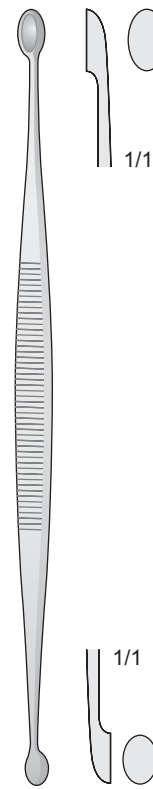

JACOBSON
0610-HF
140 mm

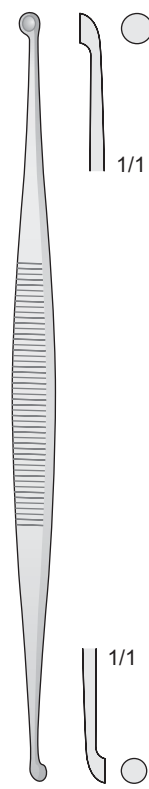

MARTINI
0610-HG
140 mm

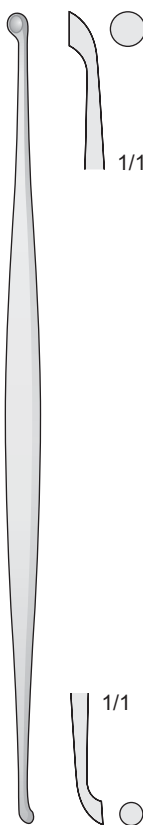

JANSEN
0610-HH
160 mm

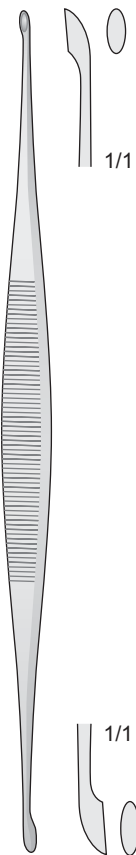

BARTH
0610-HI
180 mm

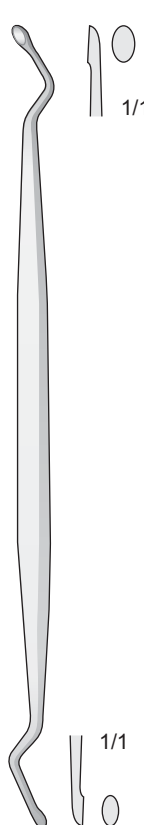

0610-ID
160 mm

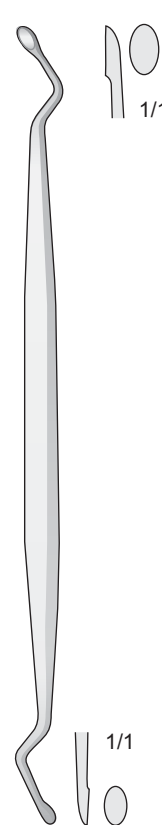

JANSEN
0610-IE
160 mm

Scharfe Löffel

Sharp currettes

Curette, Cucchiali taglienti

Cucharillas cortantes

Currettes tranchantes

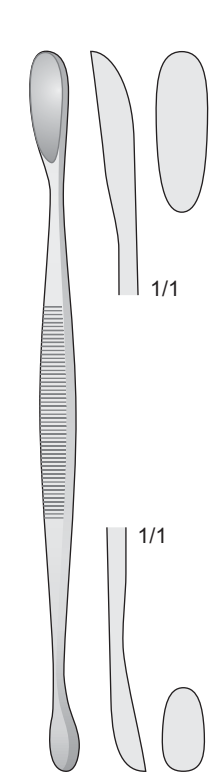

VOLKMANN
0610-HL
130 mm

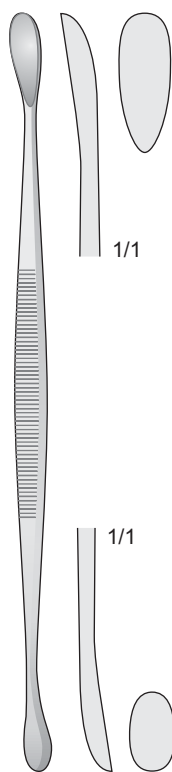

VOLKMANN
0610-HC
145 mm

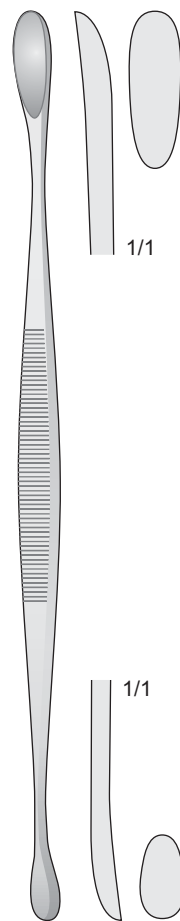

VOLKMANN
0610-HD
170 mm

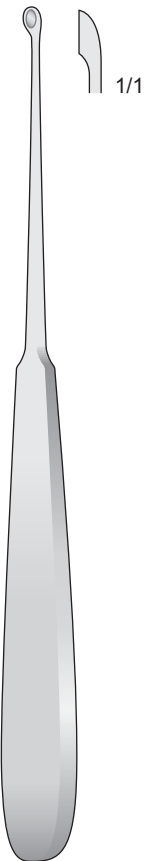

WILLIGER
0610-BLH/0610-BLI
170 mm

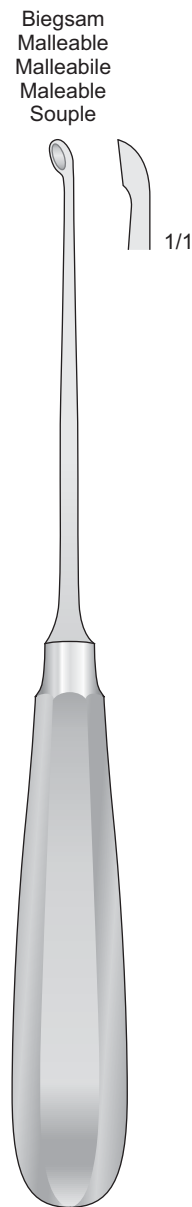

HALLE
0610-BDA/0610-BDC
215 mm

Fig. 00
3,4 mm
1/1
0610-BLH

Fig. 1
5,2 mm
1/1
0610-BLI

Biegsam
Malleable
Malleabile
Maleable
Souple

Fig.00
4,4 mm
1/1
0610-BDA

Fig.0
5,2 mm
1/1
0610-BDB

Fig.1
6,8 mm
1/1
0610-BDC

Scharfe Löffel

Sharp cures

Curette, Cucchiari taglienti

Cucharillas cortantes

Curettes tranchantes

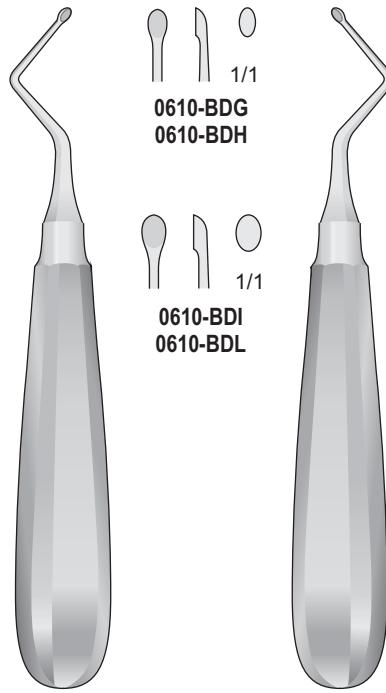

KERPEL
0610-BDG/0610-BDI
145 mm

KERPEL
0610-BDH/0610-BDL
145 mm

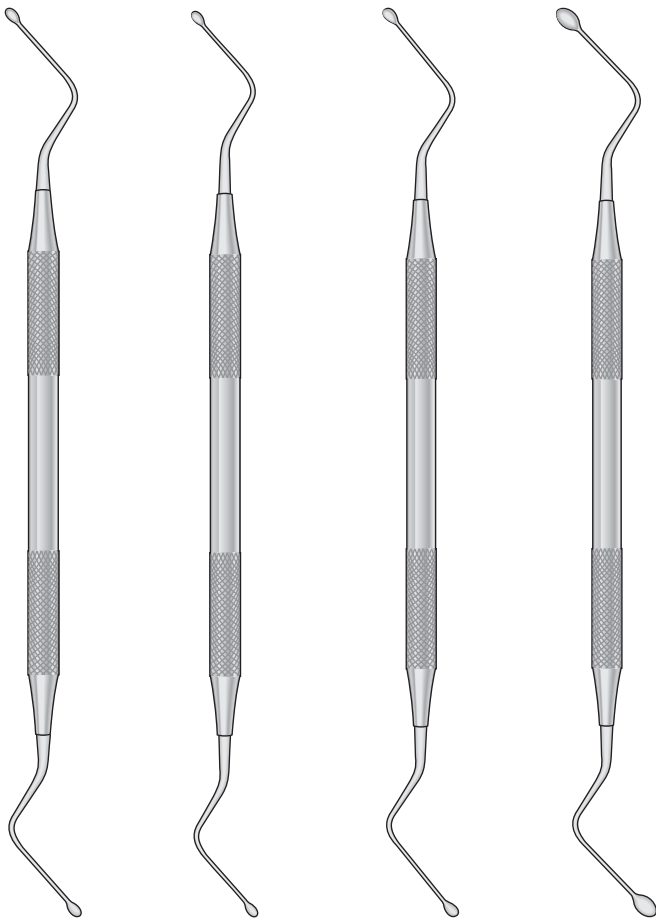

HEMINGWAY
03-B
175 mm

HEMINGWAY
03-C
175 mm

HEMINGWAY
03-D
175 mm

HEMINGWAY
03-E
175 mm

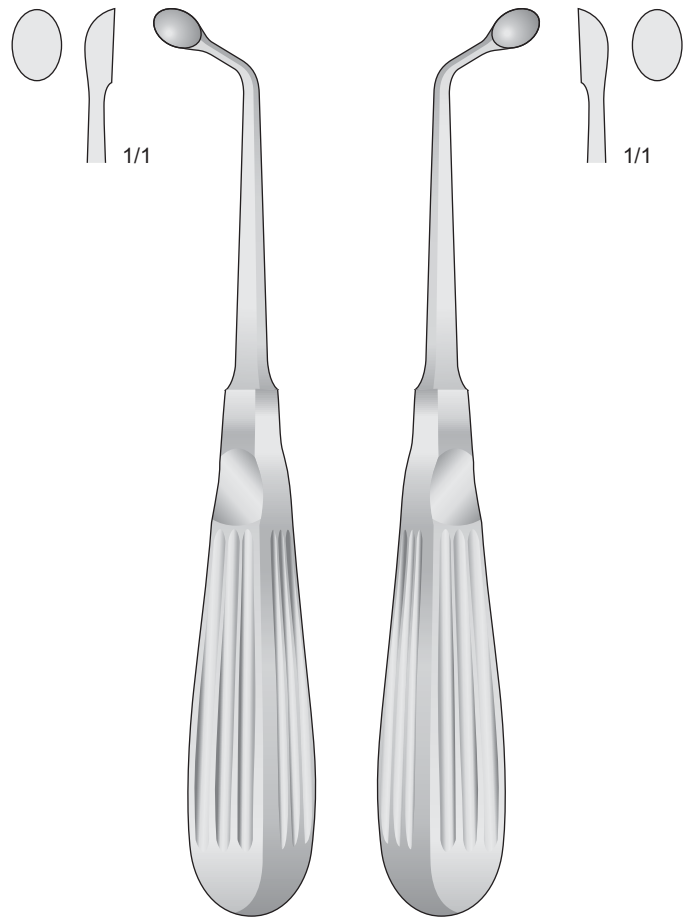

UFFENORDE
0610-BII
170 mm

UFFENORDE
0610-BIL
170 mm

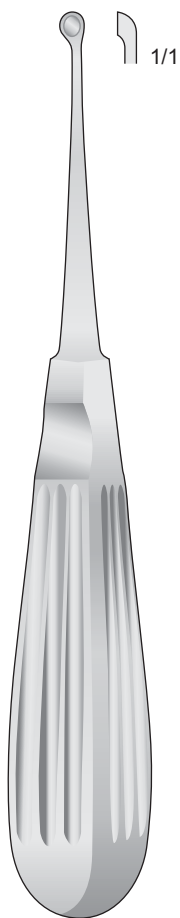

BRUNS
0610-BBA/0610-BBG
165 mm

Fig.000 3 mm	Fig.00 4 mm	Fig.0 5 mm
0610-BBA	0610-BBB	0610-BBC
Fig.1 6 mm	Fig.2 8 mm	
0610-BBD	0610-BBE	
Fig.3 10 mm	Fig.4 12 mm	
0610-BBF	0610-BBG	

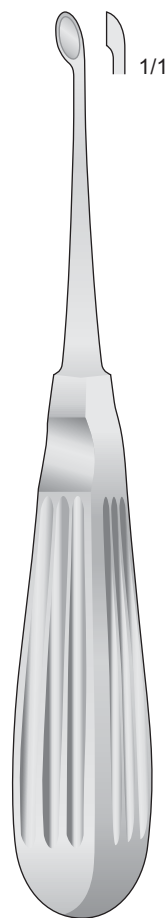

SCHEDE
0610-BCA/0610-BCG
170 mm

Fig.000 2,5 mm	Fig.00 3,4 mm	Fig.0 4,2 mm
0610-BCA	0610-BCB	0610-BCC
Fig.1 5,2 mm	Fig.2 6,3 mm	
0610-BCD	0610-BCE	
Fig.3 7,4 mm	Fig.4 8 mm	
0610-BCF	0610-BCG	

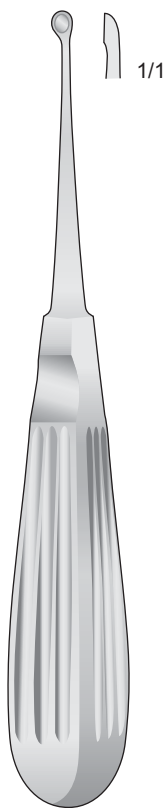

VOLKMANN
0610-GA/0610-GL
170 mm

Fig.0000
2,8 mm
1/1
0610-GA

Fig.000
3,6 mm
1/1
0610-GB

Fig.00
4,4 mm
1/1
0610-GC

,Fig.0
5,2 mm
1/1
0610-GD

Fig.1
6,8 mm
1/1
0610-GE

Fig.2
8,5 mm
1/1
0610-GF

Fig.3
10 mm
1/1
0610-GG

Fig.4
11,5 mm
1/1
0610-GH

Fig.5
13 mm
1/1
0610-GI

Fig.6
14,5 mm
1/1
0610-GL

Hohlmeißelzangen

Bone rongeurs

Pinze ossivore

Pinza-gubias

Pinces-gouges

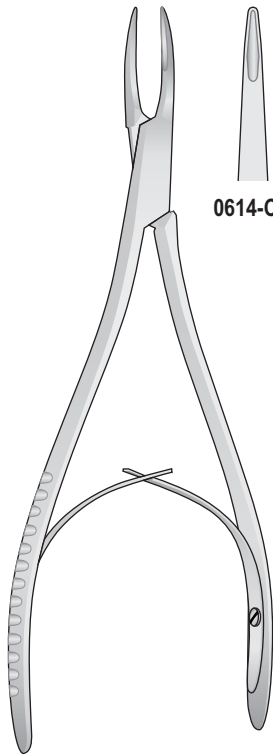

MINI-FRIEDMANN
0614-CC/0614-CC0
150 mm

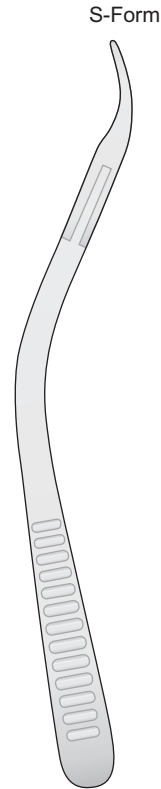
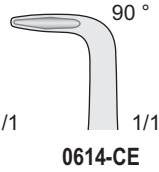
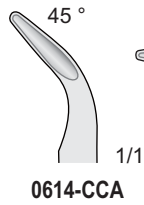
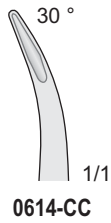
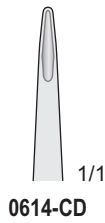

MINI-FRIEDMANN
0614-IF
145 mm

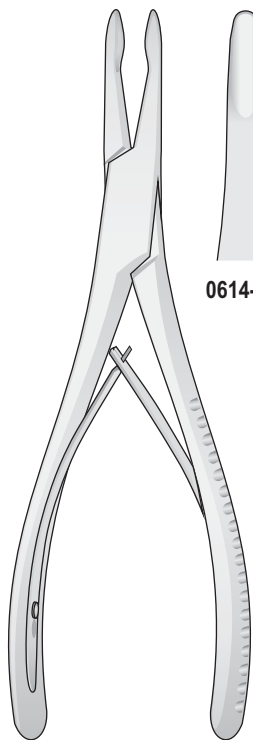
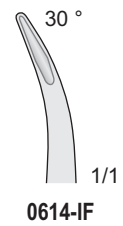

JANSEN
0614-DH/0614-DL
170 mm

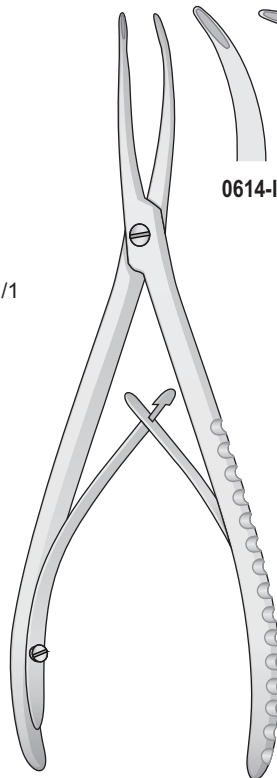
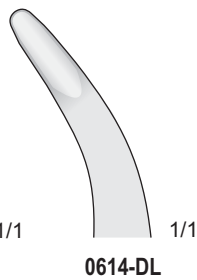
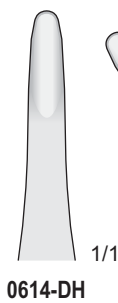

STELLBRINK
0614-II/0614-IL
170 mm

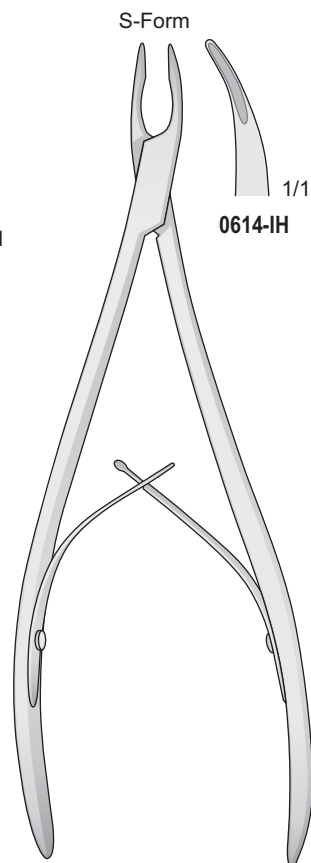
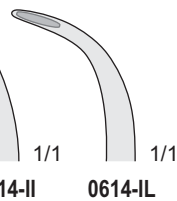

STELLBRINK
0614-IH
190 mm

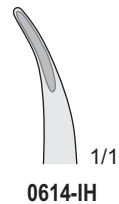

Hohlmeißelzangen

Bone rongeurs

Pinze ossivore

Pinza-gubias

Pinces-gouges

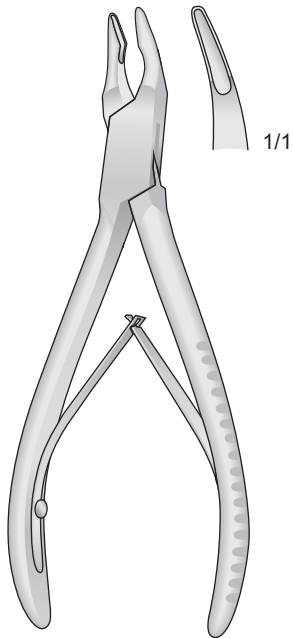

MINI FRIEDMANN
0614-BF
120 mm

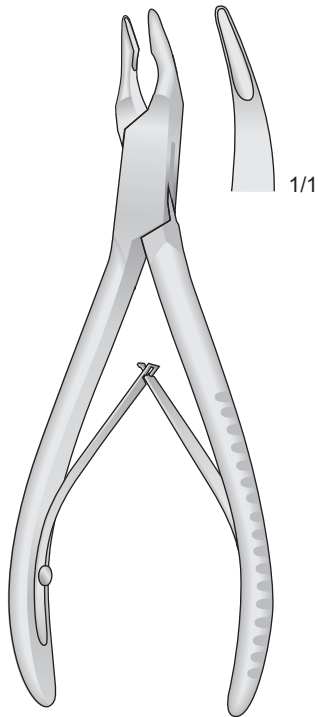

FRIEDMANN
0614-BH
140 mm

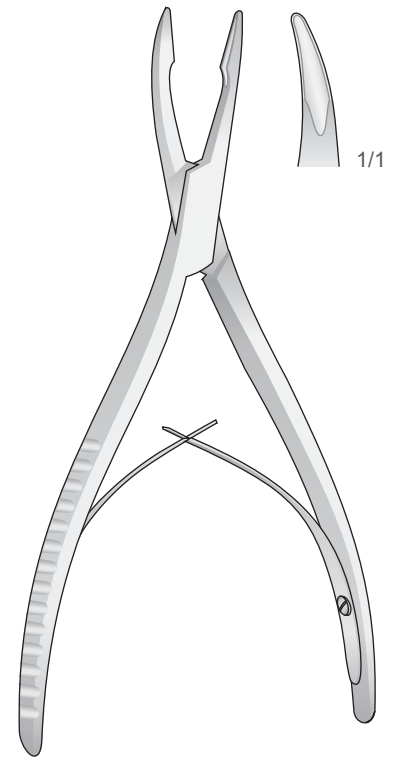

FRIEDMANN
0614-BG
160 mm

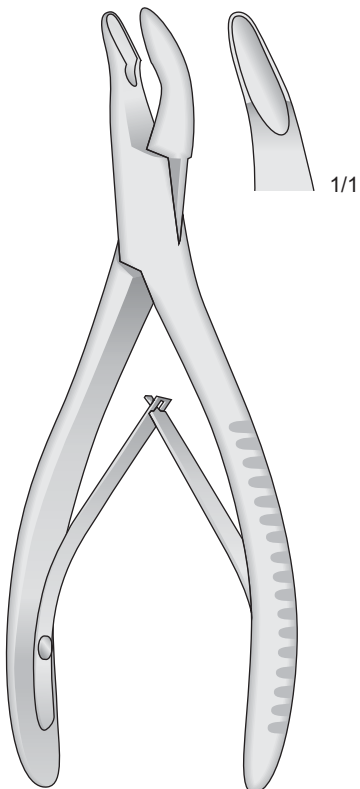

MEAD
0614-CB
165 mm

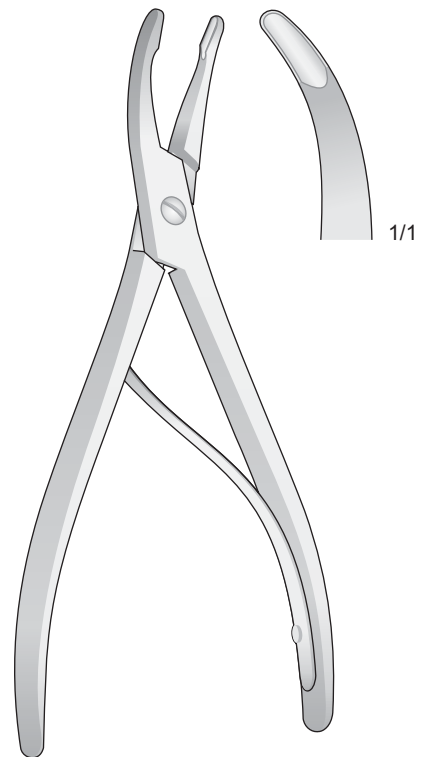

LUER
0614-BI
155 mm

Hohlmeißelzangen

Bone rongeurs

Pinze ossivore

Pinza-gubias

Pinces-gouges

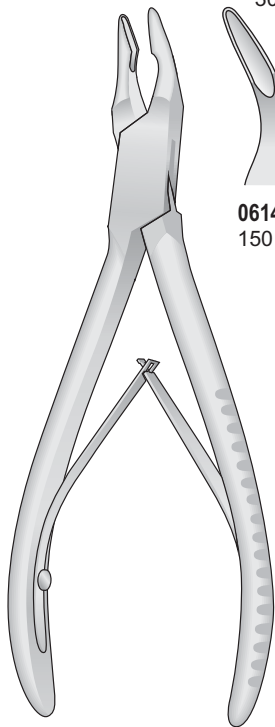

BLUMENTHAL
0614-AI/0614-BL

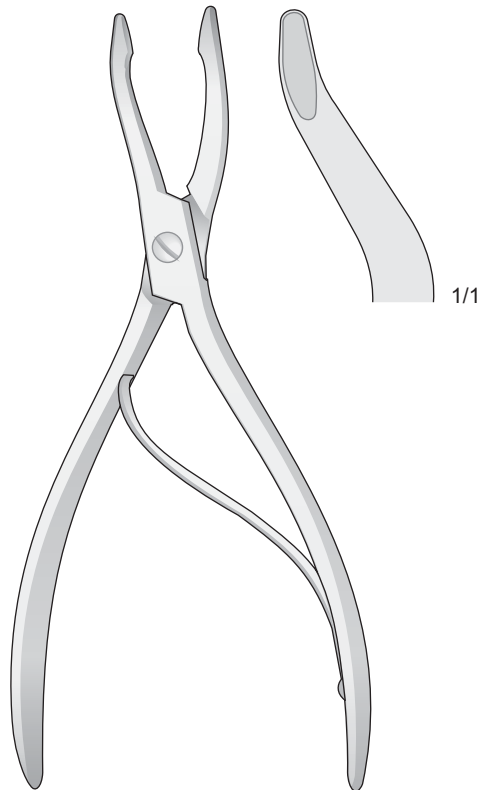
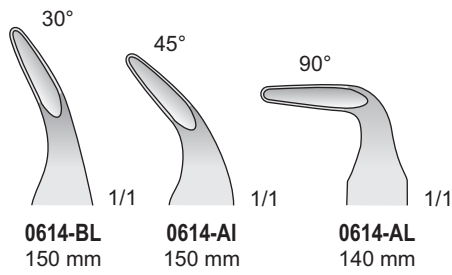

JANSEN-LEUER
0614-BA
180 mm

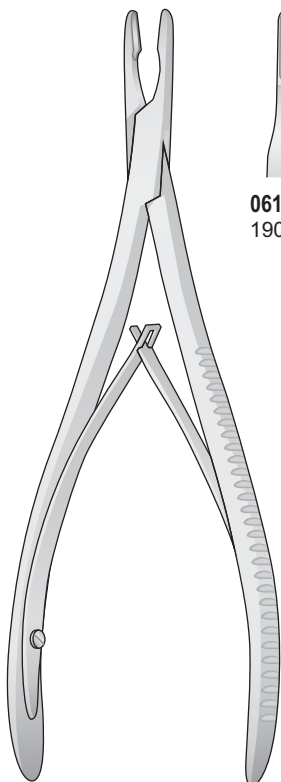

LEMPERT
0614-CF/0614-ED
190 mm

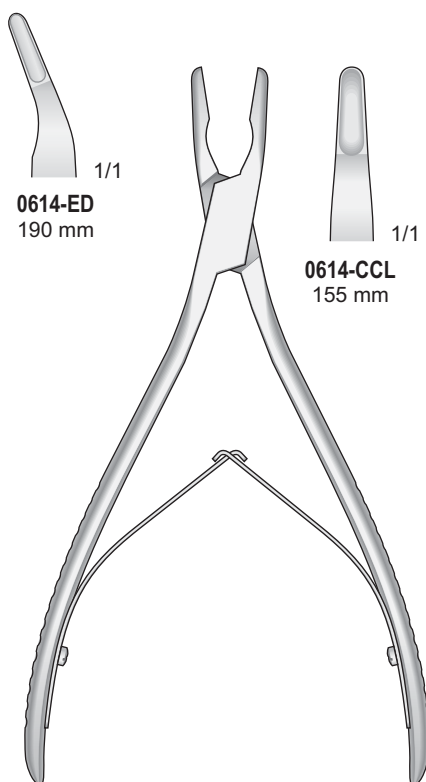
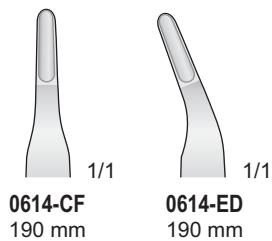

LEMPERT
0614-CCL/0614-CDA
155 mm

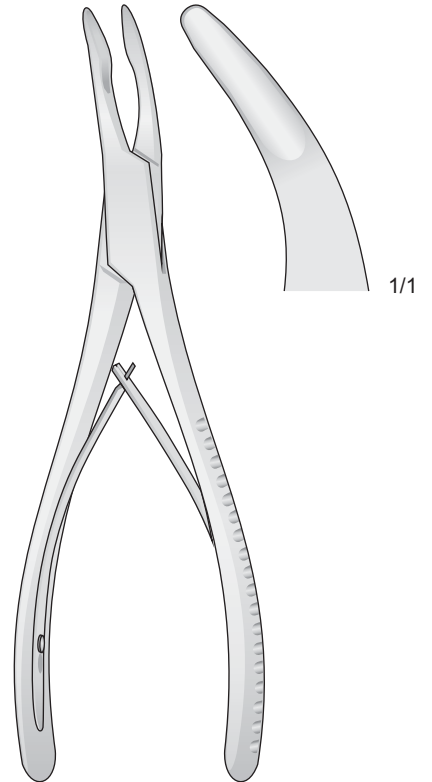
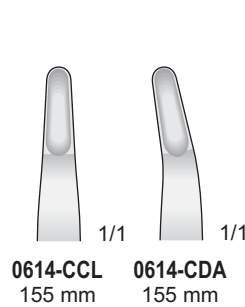

OLIVECRONA
0614-EF
190 mm

Hohlmeißelzangen

Bone rongeurs

Pinze ossivore

Pinza-gubias

Pinces-gouges

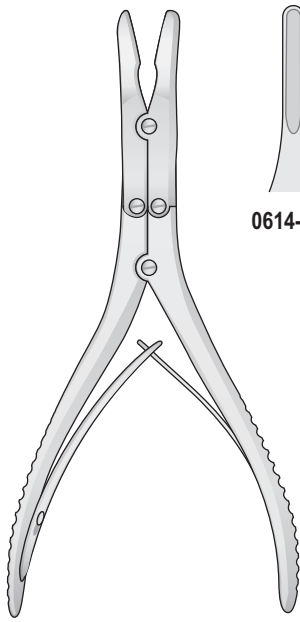

RUSKIN
0614-BDI/0614-BDL
150 mm

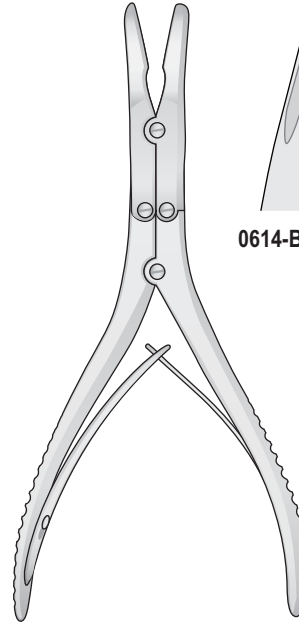
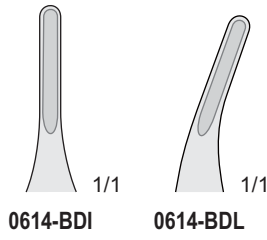

KLEINERT-KUTZ
0614-BFG/0614-BFH
155 mm

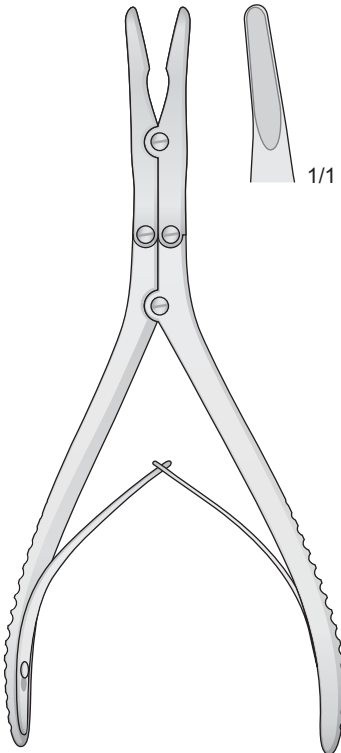
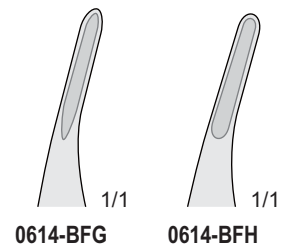

BEYER
0614-CA
180 mm

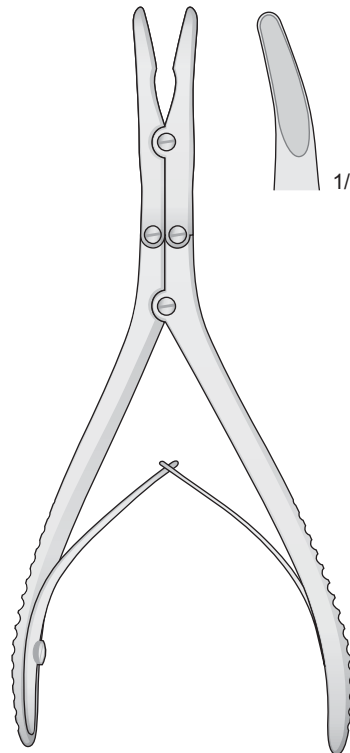
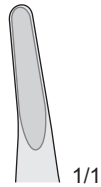

ZAUFAL-JANSEN
0614-DE
180 mm

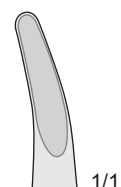

Knochensplitterzangen

Bone cutting Forceps

Pinze ossivore

Pinza cortantes para huesos

Pinces à os

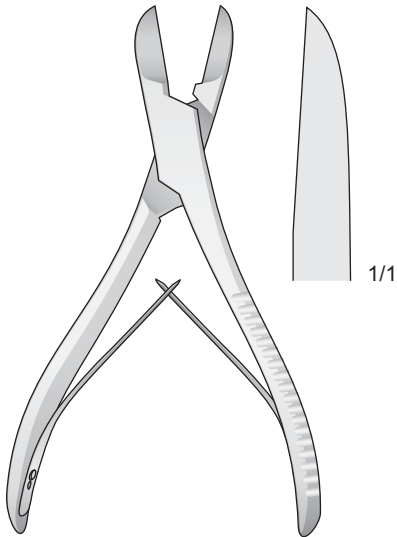

LISTON
1123-BBB
140 mm

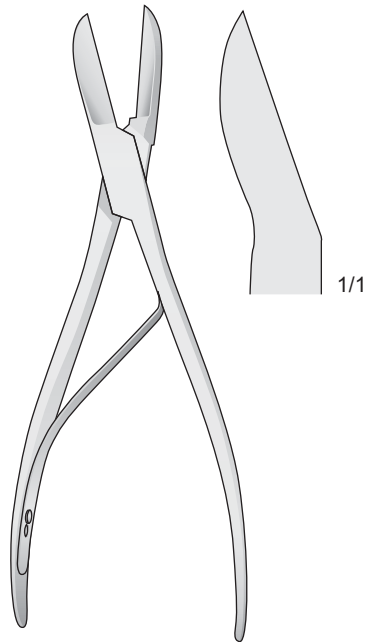

LISTON
1123-BAL
170 mm

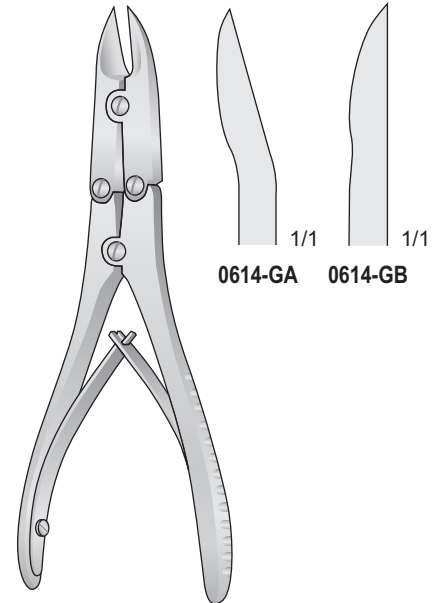

BÖHLER
0614-GA/0614-GB
150 mm

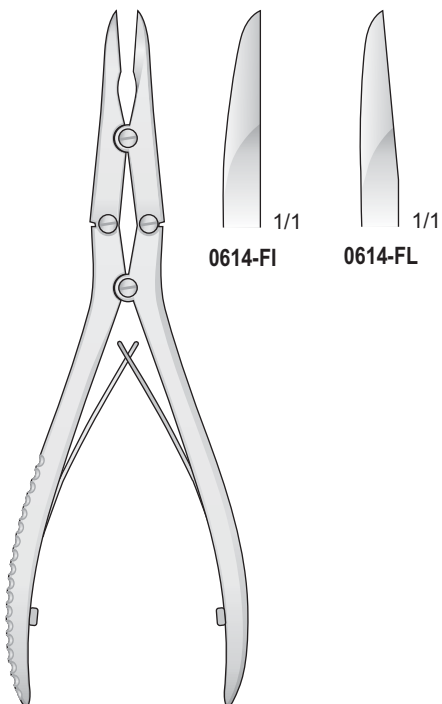

0614-FI/0614-FL
180 mm

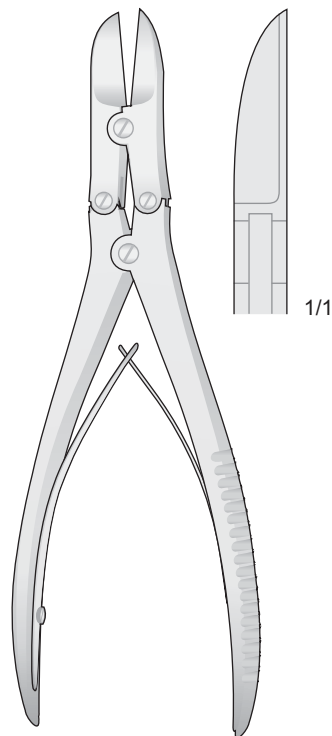

RUSKIN-LISTON
0614-BAI
190 mm

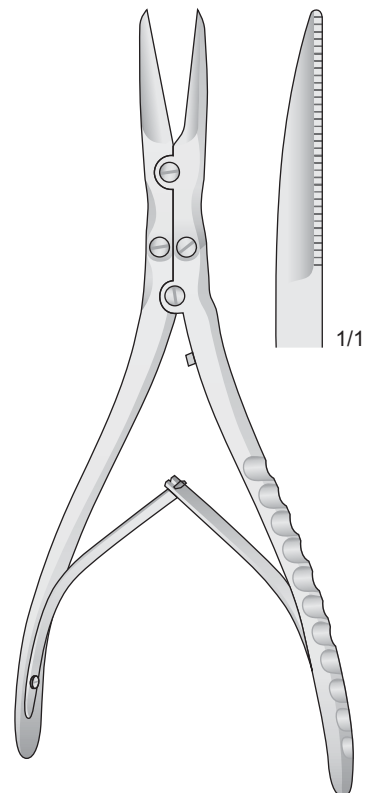

0614-BEG
215 mm

Punches - Stanzen

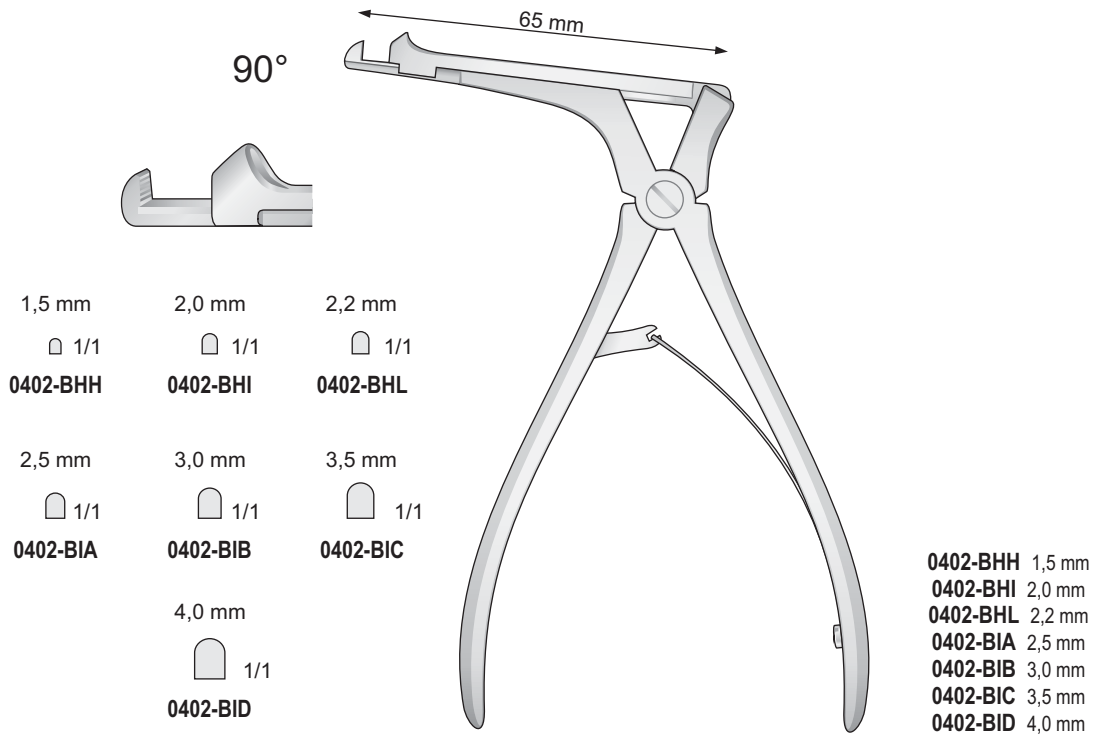

CITELLI
0402-BHH/0402-BID

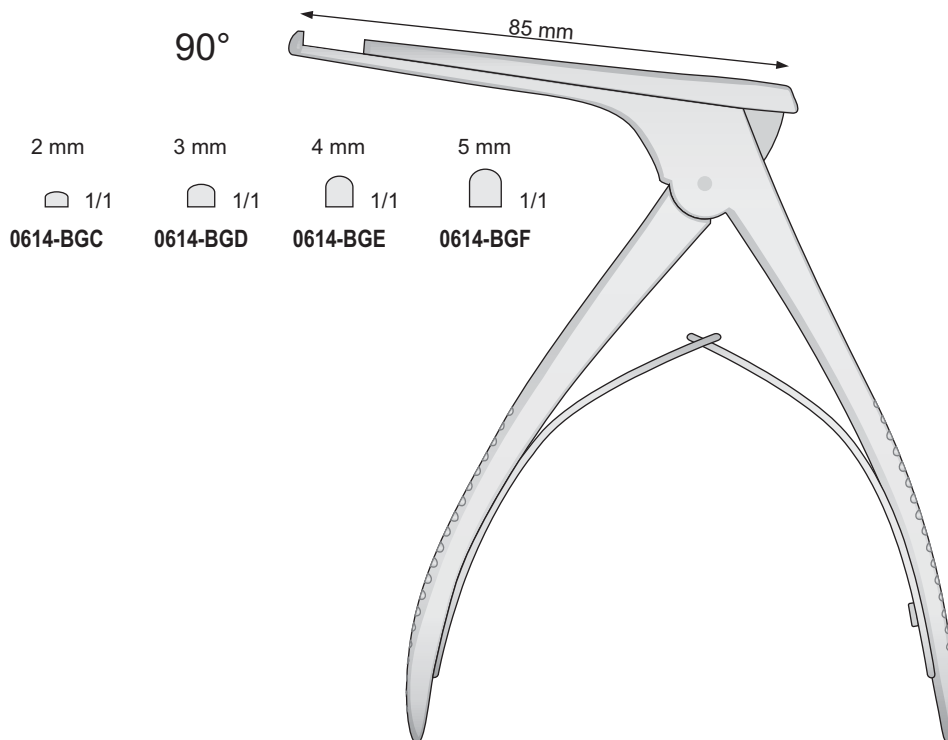

KERRISON
0614-BGC 2 mm
0614-BGD 3 mm
0614-BGE 4 mm
0614-BGF 5 mm

1.2



Ohr Instrumente
Ear Instruments
Strumenti per orecchio
Instrumentos auriculares
Instruments auriculaires

Mikro Otologie
Micro Otology
Micro Otologia
Micro Otología
Micro Otologie

Mikro-Ohrhäkchen
Mikro-Ohrnadeln

Micro Ear Hooks
Micro Ear Needles

Micro Uncini auricolari
Micro Aghi auricolari

Micro ganchitos auriculares
Micro agujas auriculares

Micro Crochets auriculaires
Micro Aiguilles auriculaires

Nadeln und Häkchen mit abgewinkeltem Schaft
Needles and Hook Shaft angled

Mikro-Häkchen
Schaft abgewinkelt
nach oben gebogen
Micro Hook
Shaft angled curved up



0617-BAB = 90° 0,3 mm
0617-BAC = 90° 0,6 mm
0617-BAD = 90° 1,0 mm

Mikro-Häkchen
Schaft abgewinkelt
nach unten gebogen
Micro Hook
Shaft angled curved down



0617-BAE = 90° 0,3 mm
0617-BAF = 90° 0,6 mm
0617-BAG = 90° 1,0 mm

Mikro-Häkchen Rund geb.
Schaft abgewinkelt
nach oben gebogen
Micro Hook round
Shaft angled curved up



0617-BAH
0617-BAI

Mikro-Häkchen Rund geb.
Schaft abgewinkelt
nach unten gebogen
Micro Hook round
Shaft angled curved down



0617-BAL
0617-BBA

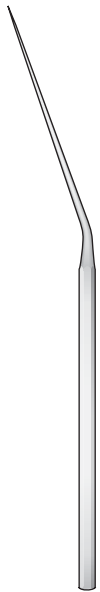

Nadel mit abgewinkeltem
Schaft
Pick with angled Shaft



BARBARA
0617-BBB

Nadel mit abgewinkeltem
Schaft
Pick with angled Shaft
Slightly curved



ROSEN
0617-BBC

0617-BAB/0617-BCE
160 mm

Mikro-Häkchen
Schaft abgewinkelt
nach oben gebogen
Micro Hook
Shaft angled curved up



0617-BBD = 25° 0,3 mm
0617-BBE = 25° 0,6 mm
0617-BBF = 25° 1,0 mm

Mikro-Häkchen
Schaft abgewinkelt
nach unten gebogen
Micro Hook
Shaft angled curved down



0617-BBG = 25° 0,3 mm
0617-BBH = 25° 0,6 mm
0617-BBI = 25° 1,0 mm

Mikro-Häkchen
Schaft abgewinkelt
nach oben gebogen
Micro Hook
Shaft angled curved up



0617-BBL = 45° 0,3 mm
0617-BCA = 45° 0,6 mm
0617-BCB = 45° 1,0 mm

Mikro-Häkchen
Schaft abgewinkelt
nach unten gebogen
Micro Hook
Shaft angled curved down



0617-BCC = 45° 0,3 mm
0617-BCD = 45° 0,6 mm
0617-BCE = 45° 1,0 mm

Mikro-Ohrhäkchen
Mikro-Ohrnadeln

Micro Ear Hooks
Micro Ear Needles

Micro Uncini auricolari
Micro Aghi auricolari

Micro ganchitos auriculares
Micro agujas auriculares

Micro Crochets auriculaires
Micro Aiguilles auriculaires

Nadeln und Häkchen
Needles and Hook

Mikro-Nadel, gerade, spitz
Needle, straight, sharp point



1/1
0617-BCF

Mikro-Nadel, leicht gebogen, spitz
Needle, slightly curved, sharp point

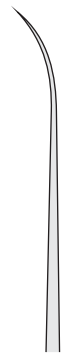

1/1
0617-BCG

Mikro-Nadel, stark gebogen, spitz
Needle, strong curved, sharp point

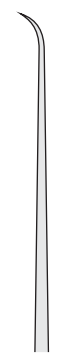

1/1
0617-BCH

45° Abgewinkelt
Hook angled 45°

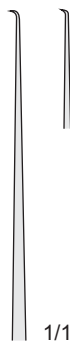

SHAMBAUGH
0617-BCI 0,4 mm
0617-BCL 0,6 mm
0617-BDA 0,8 mm
0617-BDB 1,0 mm

90° Abgewinkelt
Hook angled 90°



SHAMBAUGH
0617-BDC 0,4 mm
0617-BDD 0,6 mm
0617-BDE 0,8 mm
0617-BDF 1,0 mm

Mikro-Häkchen Retrograd gebogen
Micro Hook retrograd

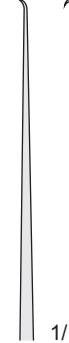

0617-BDG 1,0 mm
0617-BDH 2,5 mm

Häkchen retrograd 0,6 mm
Hook retrograd

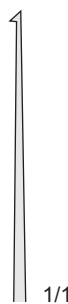

1/1
0617-BDI 0,6 mm

Fußplattenhäkchen
90° abgewinkelt 0,4 mm Stumpf
Foot plate Hook
angled 90° 0,4 mm Blunt

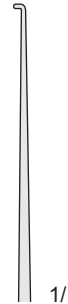

1/1
PLESTER
0617-BDL 0,4 mm

Antrum Häkchen
45° gebogen
Antrum Hook, 45° Blunt

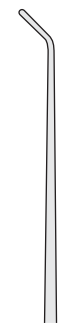

1/1
PLESTER
0617-BEA

0617-BCF/0617-BEA
160 mm



0617-BEB/0617-BFC
160 mm

Plester Führungsgabel
Leading-fork

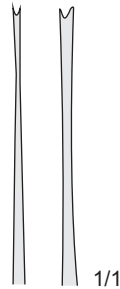

0617-BEB

Raspatorium 2 mm breit
Raspatory 2 mm width

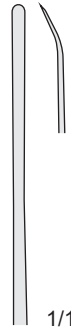

0617-BEC

Elevatorium 1 mm breit
Elevator 1 mm width



0617-BED

Raspatorium 1,8 mm breit gebogen
Raspatory 1,8 mm width

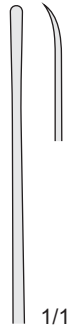

0617-BEE

Raspatorium 1 mm breit gebogen
Raspatory 1 mm width

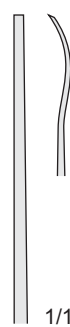

0617-BEF

Dissektor doppelt gebogen links
Dissector double curved left

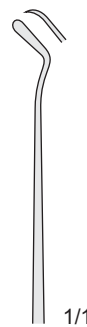

0617-BEG

Dissektor doppelt gebogen rechts
Dissector double curved right



0617-BEH

Meßsonden
Measuring Rod



HOUSE
0617-BEI 3,5 mm
0617-BEL 4,0 mm
0617-BFA 4,5 mm
0617-BFB 5,0 mm

Handinstrument zum Andrücken
von Drahtprothesen
Instrument for placing
wire protesese

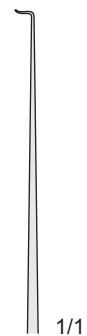

0617-BFC

Mikro-Ohrmesser

Micro Ear Knives

Micro Coltelli

Micro cuchillos auriculares

Micro couteaux auriculaires

Diszisionmesser
Discisiones-Knife

Gerade
Straight

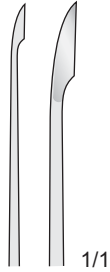

0617-DB

Sichelmesser
Sichle Knife

Leicht Gebogen
Slightly curved

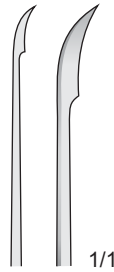

0617-DC

Lappenmesser
Flap Knife

Gerade
Straight

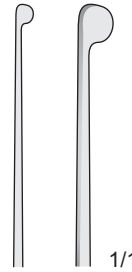

0617-DD

Raspatorium
Raspatory

1,0 mm



ZÖLLNER
0617-DF

Lanzettmesser
Lancet Knife

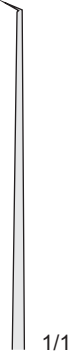

ROSEN
0617-DG

Rundschnittmesser
Flap Knife



0617-DH 1,0 mm
0617-DI 1,5 mm
0617-DL 2,0 mm
0617-EA 2,6 mm
0617-EB 3,0 mm

Rollermesser
Rechtwinklig zum Schaft
Roller Knife
blade right angled to shaft

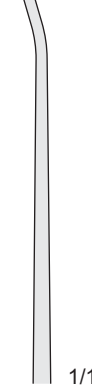

Rollermesser
Parallel zum Schaft
Roller Knife
blade parallel to shaft

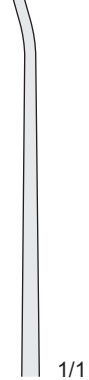

SCHUHKNECHT
0617-EC Right angled
0617-ED Parallel



0617-DB/0617-EH
160 mm

Raspatorium
Raspatory

1,0 mm



0617-EE

Rundschnittmesser 90°
Flap Knife 90°

1,5 mm



0617-EF

Trommelfellmesser
Tympanum Knife



0617-EG

Lanzentmesser
Lancet Knife



0617-EH

Mikro
Ohrraspatorien

Micro Ear
Periosteal Elevator

Micro Raspatori
auricolari

Micro Legras
auriculares

Micro Rugines-Raspatoires
auriculaires

Raspatorien
Raspatories

Gerade
Straight

Leicht Gebogen
Slightly Curved

1/1

1/1

0617-BFD

0617-BFE

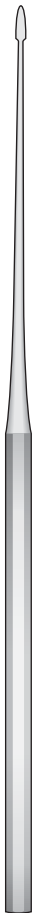

Raspatorium bajonett gebogen
Raspatory bayonet curved

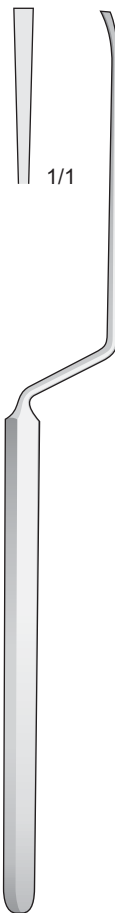

Raspatorium bajonett gebogen
Raspatory bayonet curved

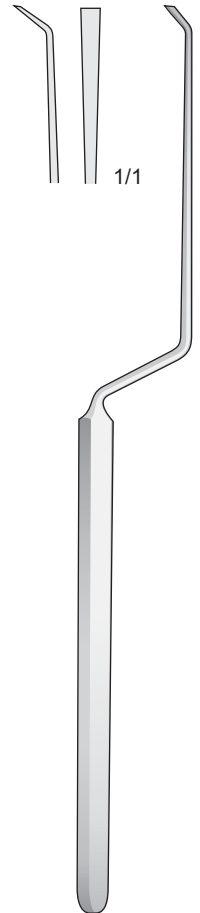

WULLSTEIN
0617-BFD/0617-BFE
160 mm

LEMPERT
0617-BFF
160 mm

ROSEN
0617-BFG
160 mm

ROSEN
0617-BFH
160 mm

Mikro-Küretten

Micro Curettes

Micro Cucchai

Micro Cucharillas

Micro Curettes

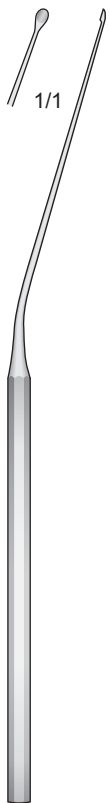

SHEA
0617-BFI
160 mm



SHEA
0617-BFL
160 mm

0617-BGA
Leicht gebogen
1,0 mm/1,2 mm
0617-BGB
Leicht gebogen
1,5 mm/1,8 mm

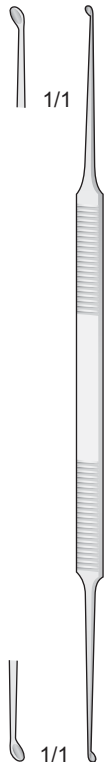

HOUSE
0617-BGA/0617-BGB
150 mm

0617-BGC
Stark gebogen
1,0 mm/1,2 mm
0617-BGD
Stark gebogen
1,5 mm/1,8 mm



HOUSE
0617-BGC/0617-BGD
150 mm

0617-BGE
Stark gebogen
Strong curved
0617-BGF
Leicht gebogen
Slightly curved



HOUSE
0617-BGE/0617-BGF
180 mm

Endolaryngeale
Mikrochirurgie

Endolaryngeal
Microsurgery

Microchirurgia
endolaringea

Microcirurgia
endolaringea

Microchirurgie
endolaryngienne

HEERMANN
Meißel und Hämmer
Chisel and Hammers
Scalpelli e martelli



0611-DHA
Flachmeißel 0,7 mm
Flat Chisel 0,7 mm
110 mm



0611-DHB
Hohlmeißel 0,7 mm
Gouge 0,7 mm
110 mm



0611-DHC
Hohlmeißel 1,0 mm
Gouge 1,0 mm
110 mm



0611-DHD
Hohlmeißel 1,5 mm
Gouge 1,5 mm
110 mm



0611-DHE
Hohlmeißel 3,0 mm
Gouge 3,0 mm
110 mm

Handgriff für Meißel
Handle for Chisel
Manico per scalpelli
0611-DHA/0611-DHE



1201-BA
90 mm



0611-DHA/0611-DHE
110 mm

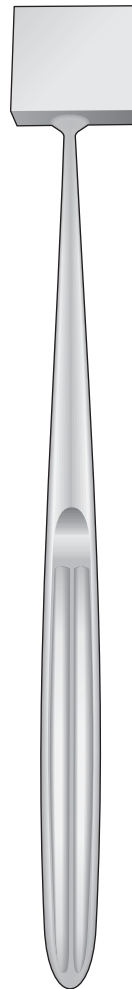

HEERMANN
0611-DHF
195 mm

1 Seite flach - 1 Seite convex
1 Side flat - 1 Side convex
1 Lato piatto - 1 Lato convesso
1 Parte plana - 1 Parte convessa
1 Face plate - 1 Face convexe

Ø 30 mm - 240 g

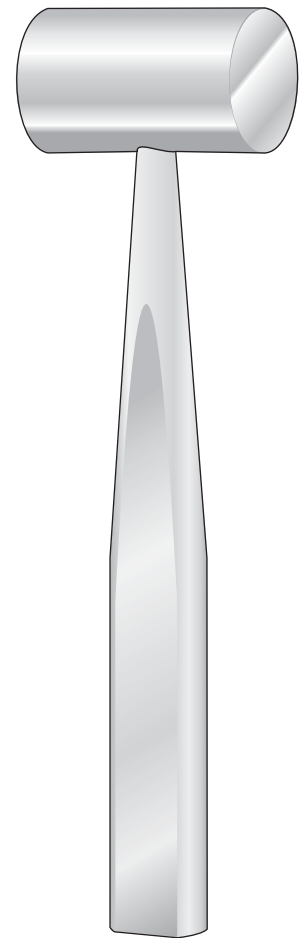

COTTLE
0611-BAE
185 mm

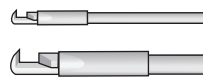

DIETER
0402-BAI
Nach Oben Schneiden
Upwards Cutting
Tagliente in alto

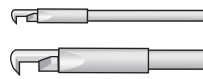

DIETER
0402-BAL
Nach Unten Schneiden
Downwards Cutting
Tagliente in basso

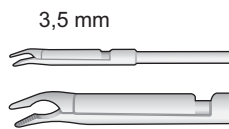

McGEE
0402-CBA
Nach Unten Gebogen
Curved down
Curvo in basso

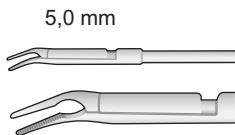

McGEE
0402-CBB
Nach Unten Gebogen
Curved down
Curvo in basso

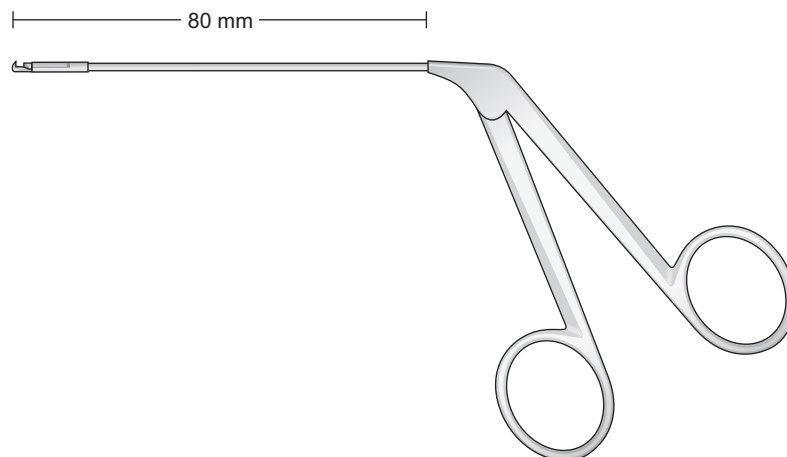

DIETER
0402-BAI/0402-CBB
80 mm

Rohrschaft. Mikro-Fazangchen - Micro ear forceps with tubular shaft

Mikro-Loffelzangchen
Micro cup shaped forceps
Micro pinze a cucchiaio

Mikro-Scheren
Micro scissors
Micro forbici

0,9 x 1,0 mm

○
Oval
Ovale
Ovales



0402-IG
Gerade - Straight
Diritta - Recta
Droit



BELLUCCI
0402-BAG
Gerade
Straight
Diritta
Recta
Droit

0,9 x 1,0 mm

○
Oval
Ovale
Ovales



0402-IH
Nach Oben Gebogen
Curved up
Curva in alto



BELLUCCI
0402-LC
Nach Oben Gebogen
Curved up
Curva in alto

0,8 x 1,3 mm

○
Oval
Ovale
Ovales



WULLSTEIN
0402-II
Gerade - Straight
Diritta - Recta
Droit



BELLUCCI
0402-LD
Links Gebogen
Curved to left
Curva a sinistra
Curvas a la izquierda
Courbes  gauche

0,8 x 1,3 mm

○
Oval
Ovale
Ovales



WULLSTEIN
0402-IL
Links Gebogen - Curved to left
Curva a sinistra - Curvas a la izquierda
Courbes  gauche



BELLUCCI
0402-LE
Rechts Gebogen
Curved to right
Curva a destra
Curvas a la derecha
Courbes  droite

0,8 x 1,3 mm

○
Oval
Ovale
Ovales



WULLSTEIN
0402-LA
Rechts Gebogen - Curved to right
Curva a destra - Curvas a la derecha
Courbes  droite



BELLUCCI
0402-LF
Horizontal
Horizontal
Orizzontale

1,0 mm

○
Rund
Round
Tonda



WULLSTEIN
0402-LB
Gerade - Straight
Diritta - Recta
Droit

1,7 x 2,5 mm

○
Oval
Ovale
Ovales



WULLSTEIN
0402-BAH
Gerade - Straight
Diritta - Recta
Droit

80 mm

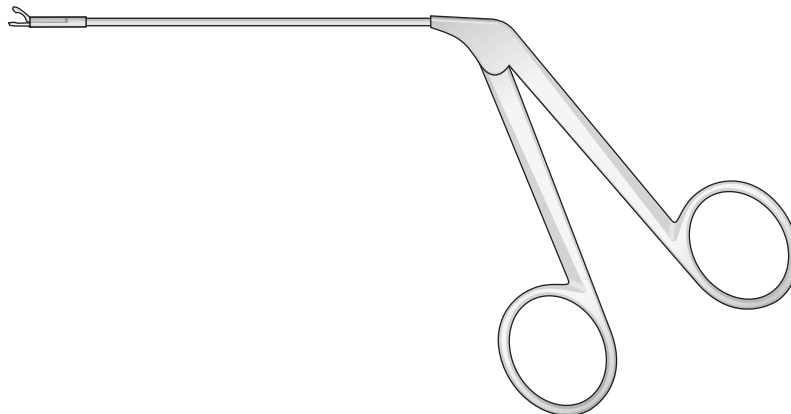

0402-IG/0402-BAH
80 mm

Rohrschaft. Mikro-Fazangchen
Micro ear forceps with tubular shaft

0,8 x 3,5 mm



0402-CCA
 Gerade
 Straight
 Diritta
 Recta
 Droit

0,8 x 3,5 mm



0402-CCD
 65° Nach Oben Gebogen
 Curved up 65°
 Curva in alto 65°

1,0 x 5,0 mm



0402-CCB
 Gerade
 Straight
 Diritta
 Recta
 Droit

0,8 x 3,5 mm



0402-CCE
 45° Nach Unter Gebogen
 Curved down 45°
 Curva in basso 45°

1,5 x 6,0 mm



0402-CCC
 Gerade
 Straight
 Diritta
 Recta
 Droit

1,0 x 5,0 mm



0402-CCF
 Links Gebogen
 Curved to left
 Curva a sinistra
 Curvas a la izquierda
 Courbes  gauche

1,0 x 5,0 mm



0402-CCG
 Rechts Gebogen
 Curved to right
 Curva a destra
 Curvas a la derecha
 Courbes  droite

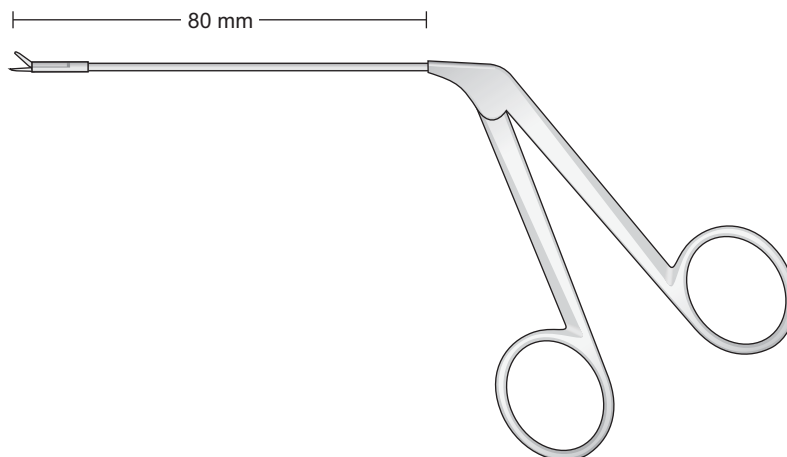

0402-CCA/0402-CCG
 80 mm

0,6 x 0,5 mm



0402-CAB
Gerade
Straight
Diritta
Recta
Droit

0,9 x 1,1 mm



0402-CAF
Gerade
Straight
Diritta
Recta
Droit

0,6 x 0,5 mm



0402-CAC
Links Gebogen
Curved to left
Curva a sinistra
Curvas a la izquierda
Courbes  gauche

0,9 x 1,1 mm



0402-CAG
Links Gebogen
Curved to left
Curva a sinistra
Curvas a la izquierda
Courbes  gauche

0,6 x 0,5 mm



0402-CAD
Rechts Gebogen
Curved to right
Curva a destra
Curvas a la derecha
Courbes  droite

0,9 x 1,1 mm



0402-CAH
Rechts Gebogen
Curved to right
Curva a destra
Curvas a la derecha
Courbes  droite

0,6 x 0,5 mm



0402-CAE
Nach Oben Gebogen
Curved up
Curva in alto
Curvas en alto
Courbes  haut

0,9 x 1,1 mm



0402-CAI
Nach Oben Gebogen
Curved up
Curva in alto
Curvas en alto
Courbes  haut

0,9 x 1,1 mm



0402-CAL
Nach Unten Gebogen
Curved down
Curva in basso
Curvas a bajo
Courbes  bas

Schaft zerlegbar
Dismantable shaft
Asta smontabile
Vstago desmontable
Tige dmontable

80 mm

Superfein
Extremely delicate
Modello super fine
Superfina
Modle superfin

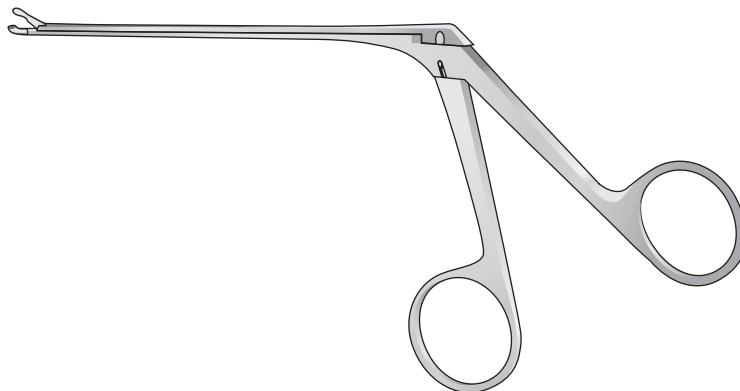

0402-CAB/0402-CAL
80 mm

6,0 x 0,8 mm



SCHUKNECHT
0402-CBD
Gerade
Straight
Diritta
Recta
Droit

4,0 x 0,5 mm



0402-CBG
Rechts Gebogen
Curved to right
Curva a destra
Curvas a la derecha
Courbes  droite

5,0 x 0,8 mm



GREVEN
0402-CBE
Gerade
Straight
Diritta
Recta
Droit

4,0 x 0,5 mm

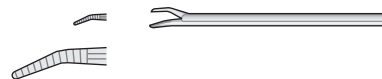

0402-CBH
Links Gebogen
Curved to left
Curva a sinistra
Curvas a la izquierda
Courbes  gauche

4,0 x 0,5 mm

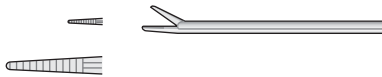

0402-CBF
Gerade
Straight
Diritta
Recta
Droit

4,0 x 0,5 mm



0402-CBI
Nach Oben Gebogen
Curved up
Curva in alto

4,0 x 0,5 mm

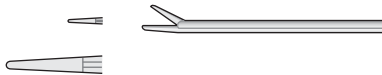

0402-BAA
Glattes Maul
Smooth jaws
Morso liscio
Mandibula lisa
Mors lisses

4,0 x 0,5 mm

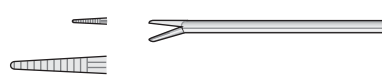

0402-CBL
Nach Unten Gebogen
Curved down
Curva in basso

Schaft zerlegbar
Dismantable shaft
Asta smontabile
Vstago desmontable
Tige dmontable

Superfein
Extremely delicate
Modello super fine
Superfina
Modle superfin

80 mm

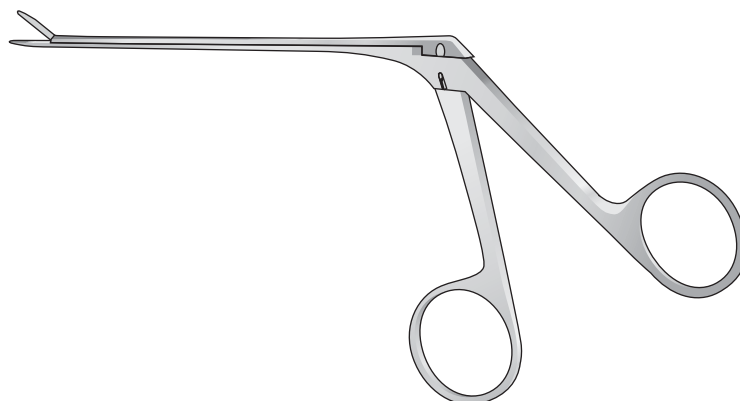

0402-CBD/0402-CBL
80 mm

2.1



**Nasen Instrumente
Nasal Instruments
Strumenti per naso
Instrumentos nasales
Instruments nasaux**

Rhinologie
Rhinology
Rinologia
Rinología
Rhinologie

Nasal Specula

Nasenspekula

Speculum nasali

Espéculos nasales

Spéculum nasaux

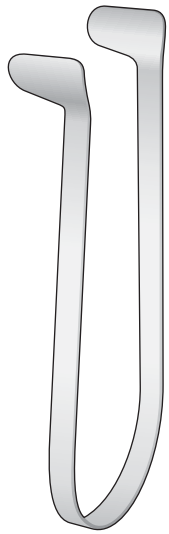

THUDICUM
1412-BIB/1412-BIH

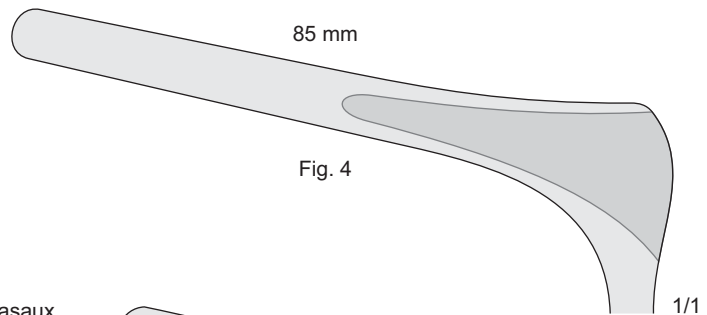
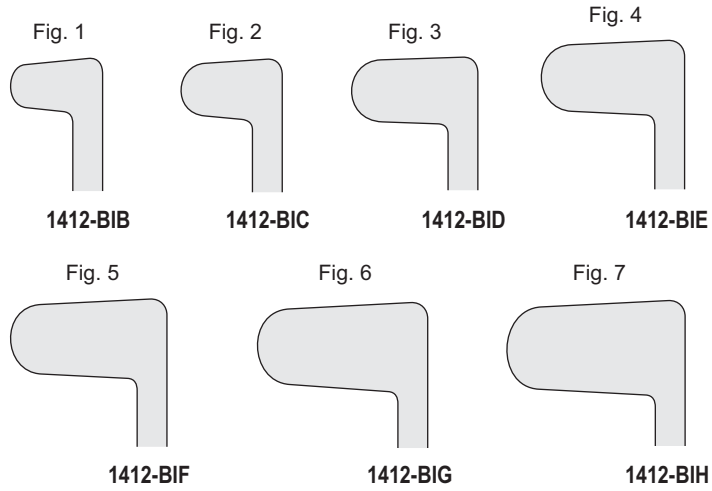

1412-DB
130 mm

Nasen Spekula - Nasal specula
Speculum nasali - Espéculos nasales - Spéculum nasaux

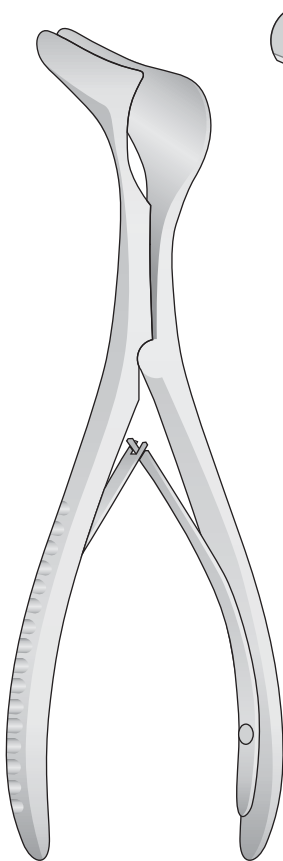

HARTMANN
1412-CA/1412-CD

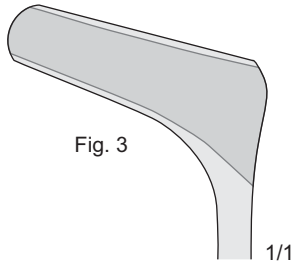

1412-CD
160 mm

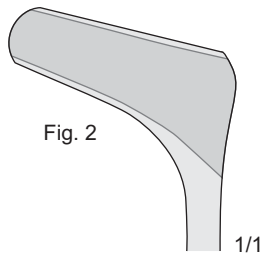

1412-CC
160 mm

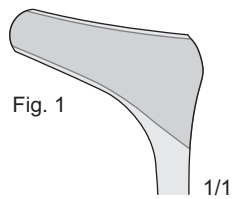

1412-CA
155 mm

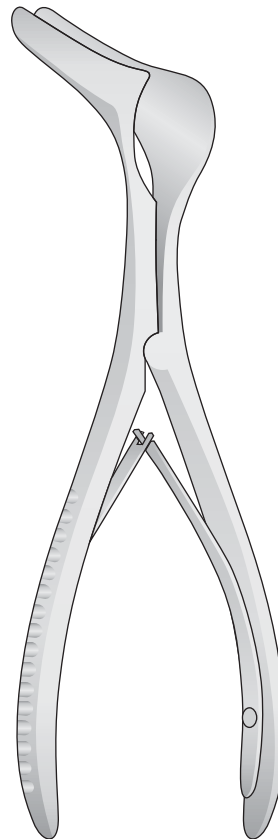

KILLIAN
1412-CE/1412-CG

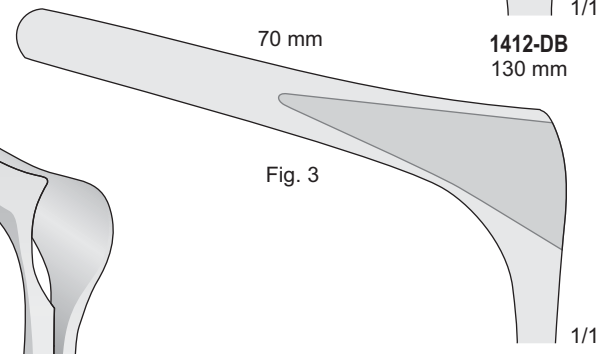

1412-CG
150 mm

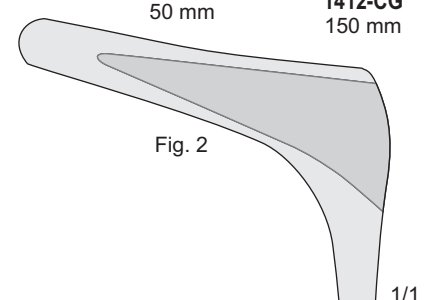

1412-CE
140 mm

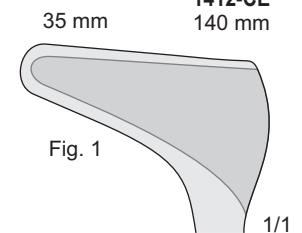

1412-CB
130 mm

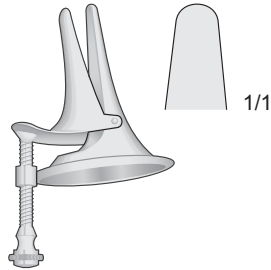

DUPLAY
0102-EB17
 Nasen Spekula
 Nasal specula
 Specolo nasale
 Espéculo nasal
 Spéculum nasal

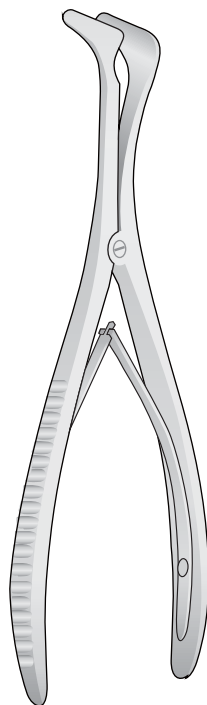

TIECK-HALLE
1412-EI/1412-EL
 135 mm

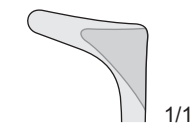

1412-EI
 Fig. 1

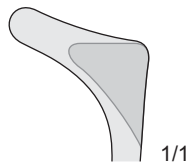

1412-EL
 Fig. 2

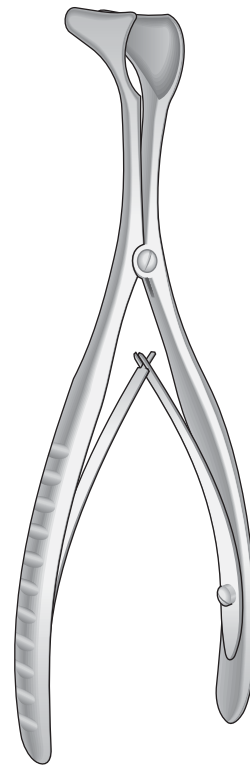

HARTMANN-HALLE
1412-BAH/1412-BAL
 150 mm

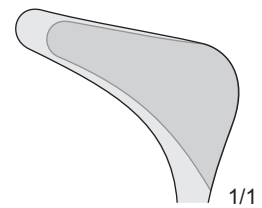

1412-BAH
 27 mm
 Fig. 1

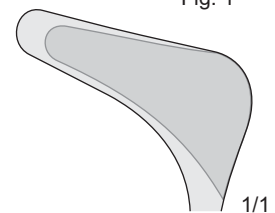

1412-BAI
 31 mm
 Fig. 2

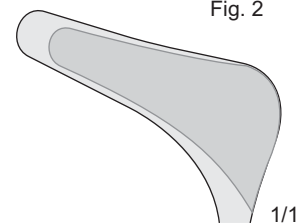

1412-BAL
 35 mm
 Fig. 3

Nasal Specula

Nasenspekula

Speculum nasali

Espéculos nasales

Spéculum nasaux

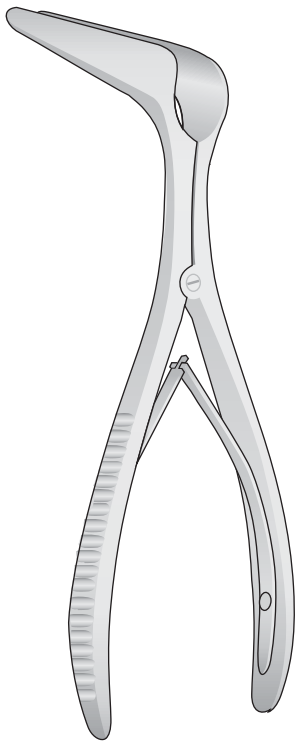

COTTLE
1412-CF/1412-CL
150 mm

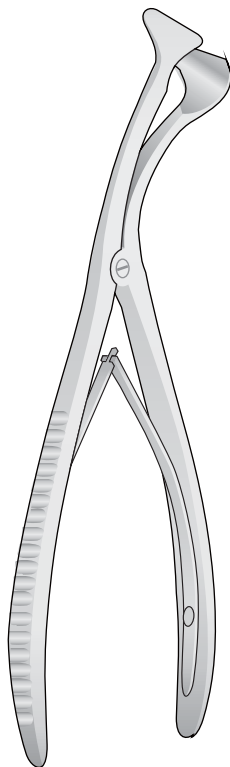
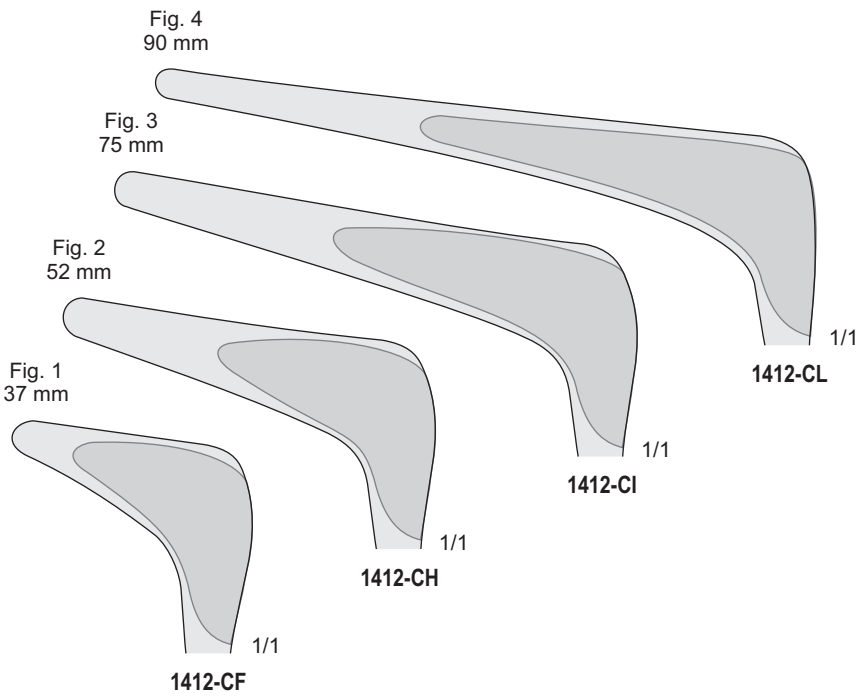

BECKMANN
1412-FB/1412-FE
150 mm

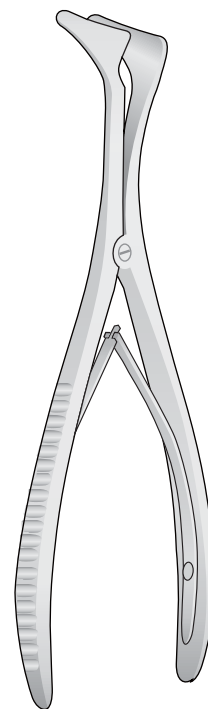
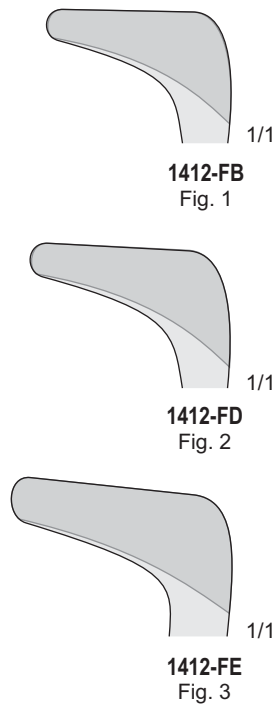

MODELL WIEN
1412-FG/1412-FL
140 mm

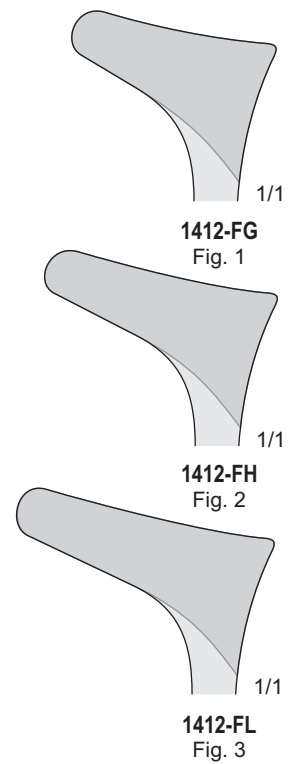

Nasen Spekula

Nasal specula

Speculum nasali

Espéculos nasales

Spéculums nasaux

Schwarz Verchromt
Black Finish
Cromato nero

Extrem dünnes Blatt
Very thin valve
Valve estremamente piatte

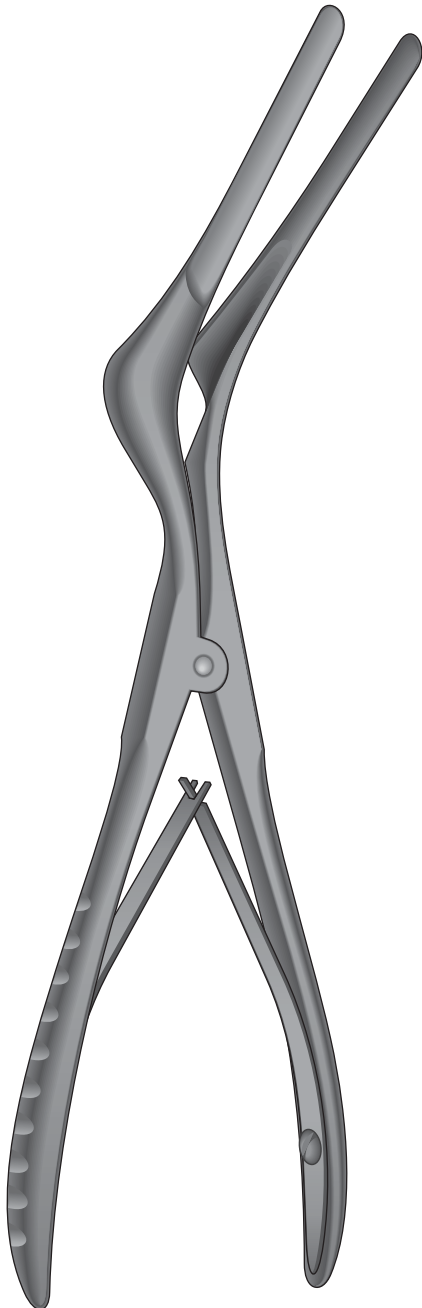

COTTLE
1412-BLG/1412-BLI

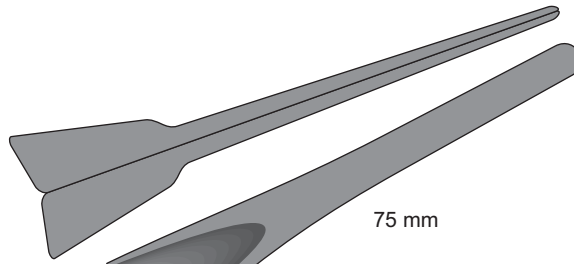

75 mm

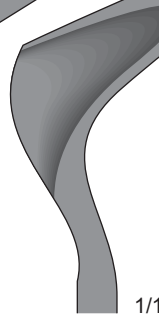

1412-BLI
160 mm

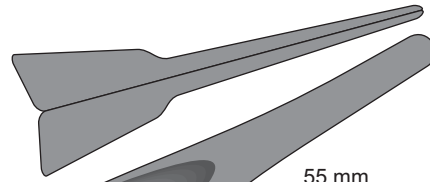

55 mm

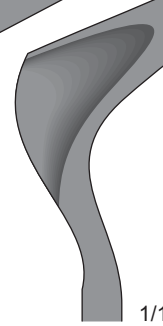

1412-BLH
150 mm

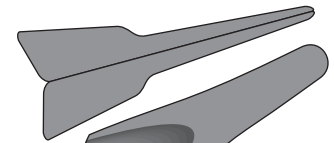

40 mm



1412-BLG
140 mm

Nasal Specula

Nasenspekula

Speculum nasali

Espéculos nasales

Spéculum nasaux

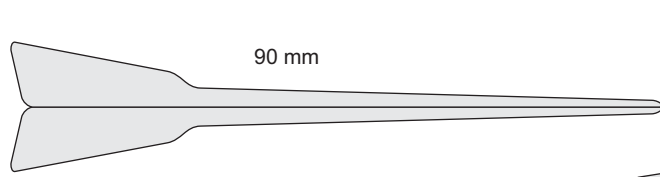

1412-BLC11
150 mm

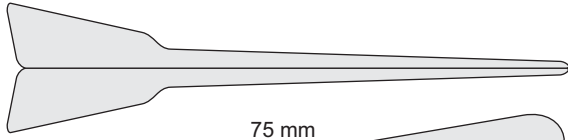

1412-BLC
150 mm

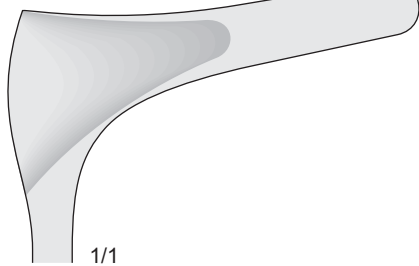
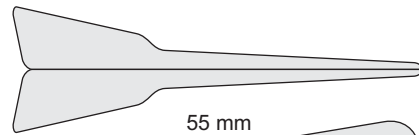

1412-BLB
140 mm

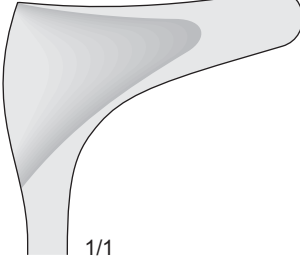
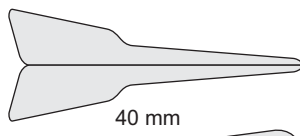

1412-BLA
130 mm

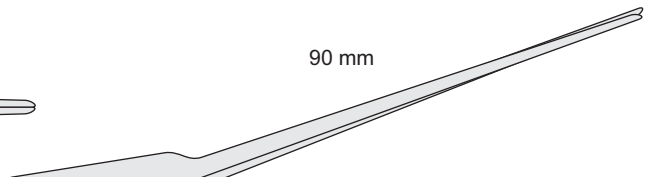

1412-BLF11
160 mm

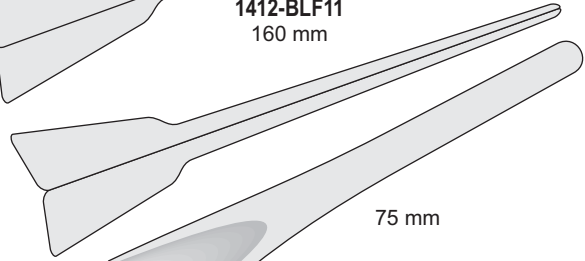

1412-BLF
160 mm

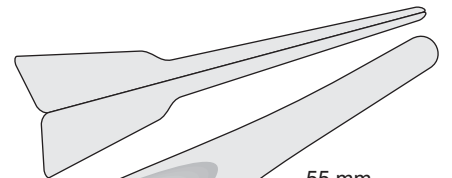

1412-BLE
150 mm

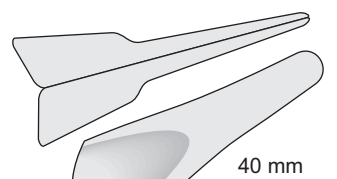

1412-BLD
140 mm

Extrem dünnes Blatt
Very thin valve

Dünnes Blatt
Thin valve

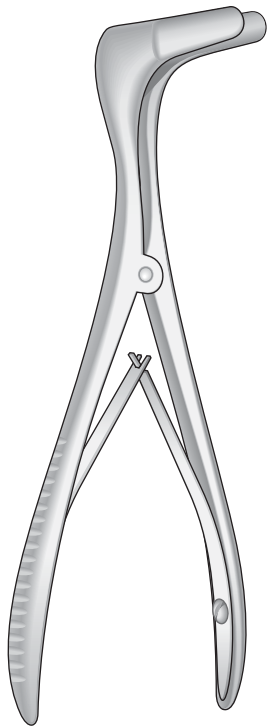

KILLIAN
1412-BLA/1412-BLC

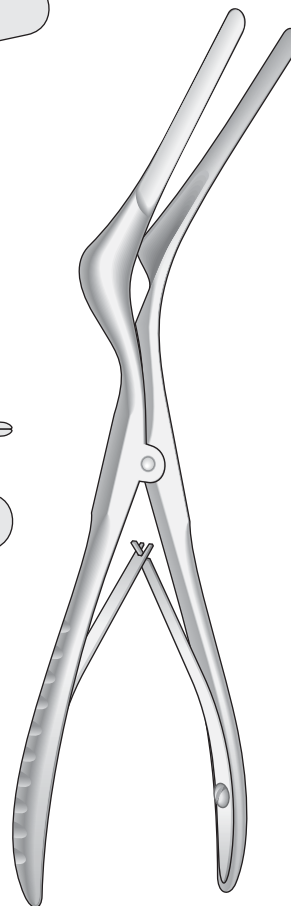

COTTLE
1412-BLD/1412-BLF

Nasen Spekula
Nasenplastik

Nasal specula
Rhinoplastic

Speculum nasali
Rinoplastica

Espéculos nasales
Rhinoplasty

Spéculums nasaux
Rinoplastic

Nasen Spekula - Nasal specula - Speculum nasali - Espéculos nasales - Spéculums nasaux

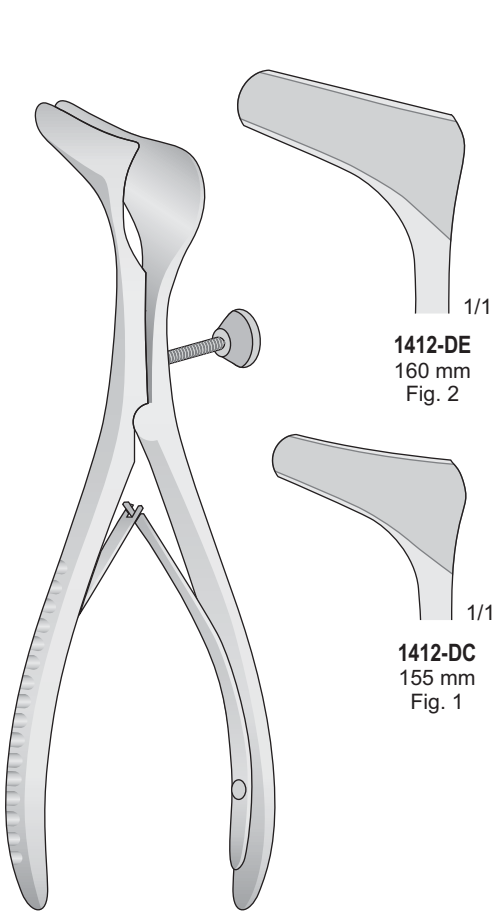

HARTMANN
1412-DC/1412-DE

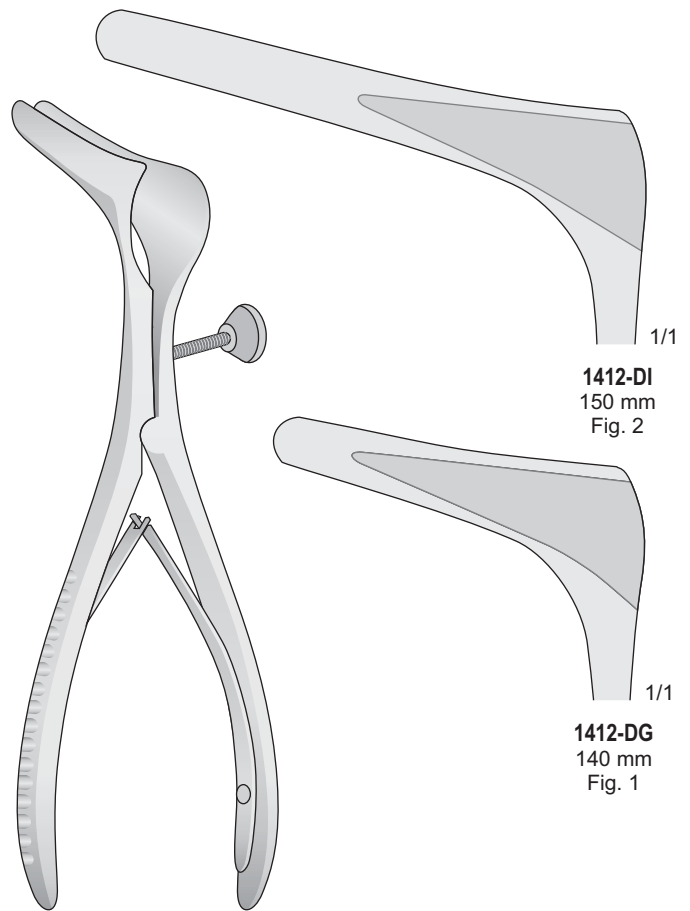

KILLIAN
1412-DG/1412-DI

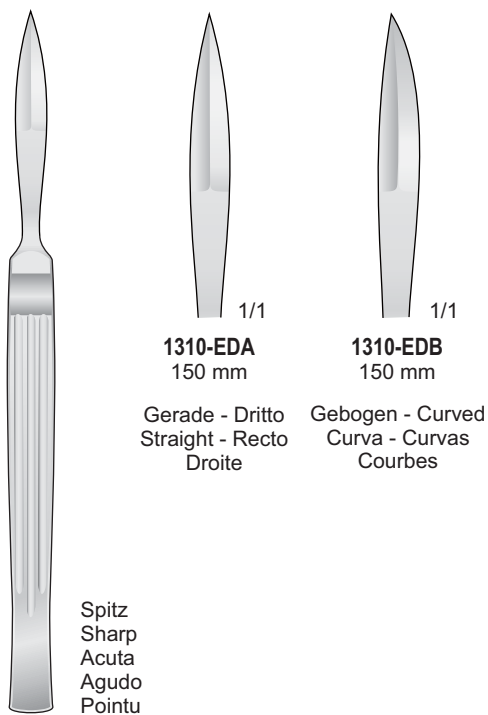

JOSEPH
1310-EDA/1310-EDB

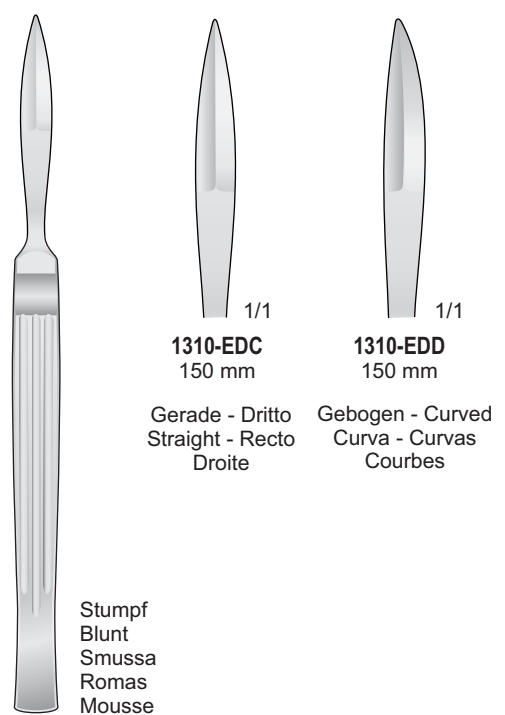

JOSEPH
1310-EDC/1310-EDD

Skalpelle

Knives

Bisturi

Bisturies

Bistouris



JOSEPH
0617-DE
150 mm



JOSEPH
1310-BAA
150 mm

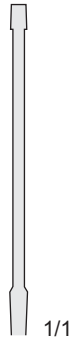

1/1



CONVERSE
1310-BAB
160 mm

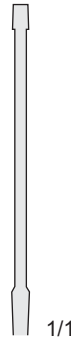

1/1



COTTLE
0617-BC
150 mm



COTTLE
0617-EI
150 mm



MASING
0617-BGI
130 mm

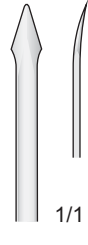

1/1



1/1

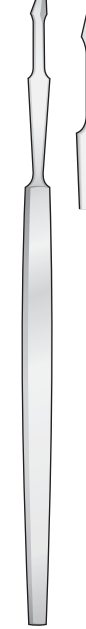

MASING
FR-169
140 mm



1/1



FOMON
1310-BAC
160 mm



FOMON
0617-BHG
160 mm



1/1



BALLENGER
0617-BHF
140 mm



1/1



BRÜNINGS
FR-177
165 mm



BRÜNINGS
0617-BHI
165 mm

Griffe Allein
Handle only
Solo manico
Mango solo
Manche seul

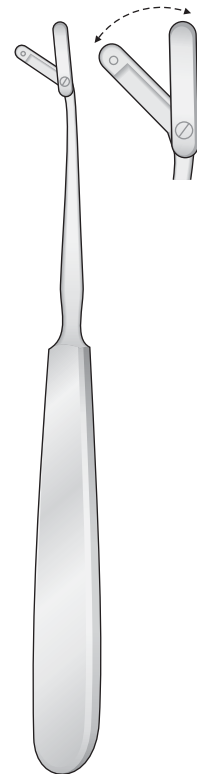

MALTZ
0617-BL
160 mm



JOSEPH
0617-EL
160 mm

1/1

1/1

Rhinologie

Rhinology

Rinologia

Rinologia

Rhinologie

Raspatorien, Elevatorien, Flachmeißel
Raspatories, Elevators, Chisels

Mukosamesser
Mucous knife
Bisturi per mucosa
Cuchillo para mucosa
Septotome

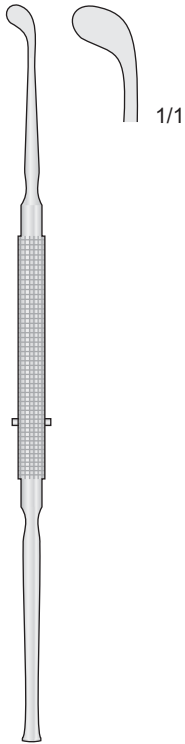

FREER
0617-BF
190 mm

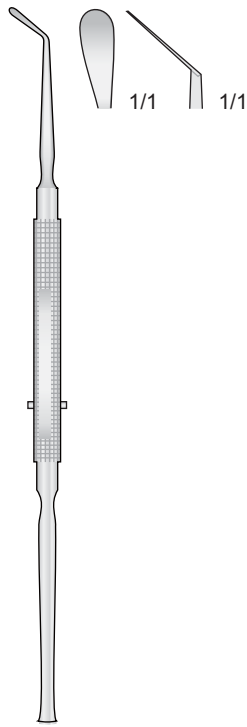

FREER
0617-BAA
190 mm

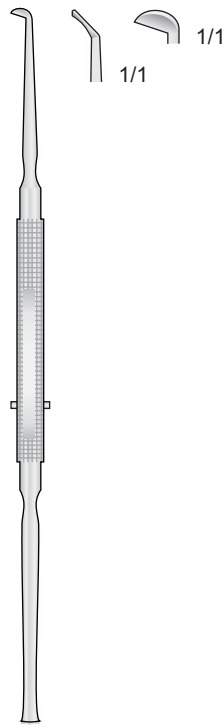

FREER
0617-BGG
190 mm

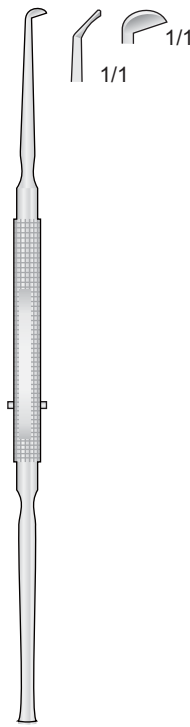

FREER
0617-BGH
190 mm



FREER
0617-BB
175 mm



FREER
0617-BI
165 mm



BALLENGER
0414-FA/0414-FC
200 mm

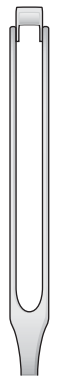

0414-FA
3 mm

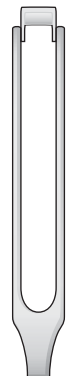

0414-FB
4 mm



0414-FC
5 mm



BALLENGER
0414-FD/0414-FF
200 mm

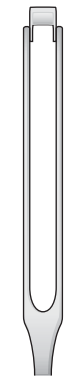

0414-FD
3 mm



0414-FE
4 mm

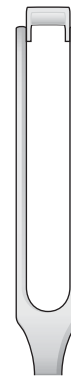

0414-FF
5 mm

Rhinologie

Rhinology

Rinologia

Rinologia

Rhinologie

Septum Elevatorien, Raspatorien
Septum elevators, Raspatories

Stumpf - Blunt
Smussa - Romo
Mousse
3,3 mm

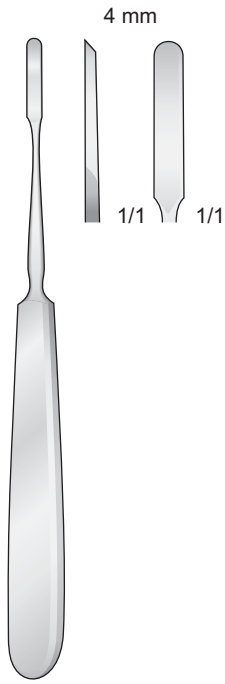

FOMON
0610-CGE
170 mm

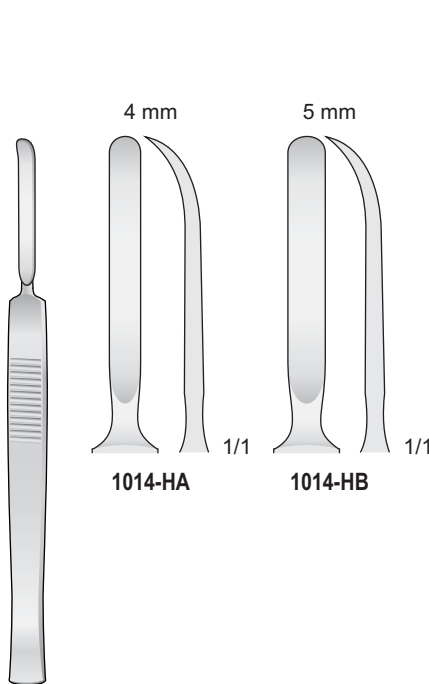

Mc KENTY
1014-HA/1014-HB
160 mm

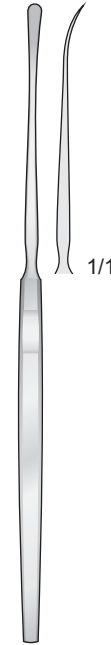

HALLE
1014-HC
180 mm



WALTON
0414-CLC/0414-CLG
160 mm

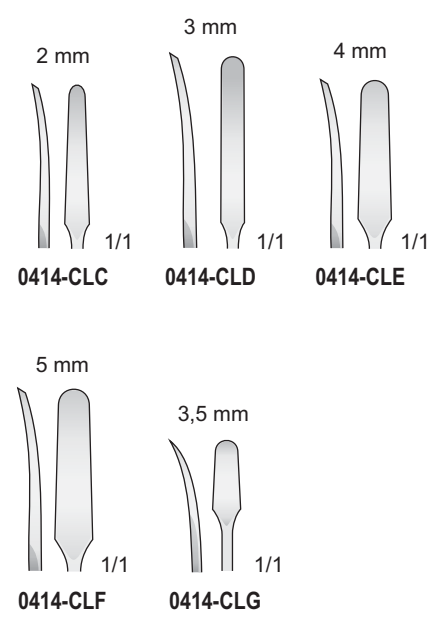

Spitz - Sharp
Acuta - Aguda
Pointu

Spitz - Sharp
Acuta - Aguda
Pointu

Spitz - Sharp
Acuta - Aguda
Pointu

Stumpf - Blunt
Smussa - Romo
Mousse

4,5 mm

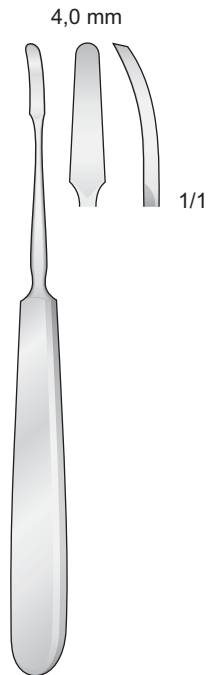

JOSEPH
0610-CGF
160 mm

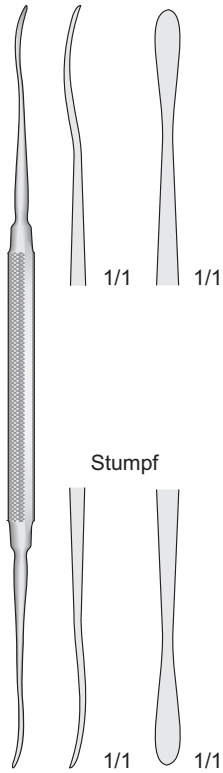

FREER
0617-BG
185 mm

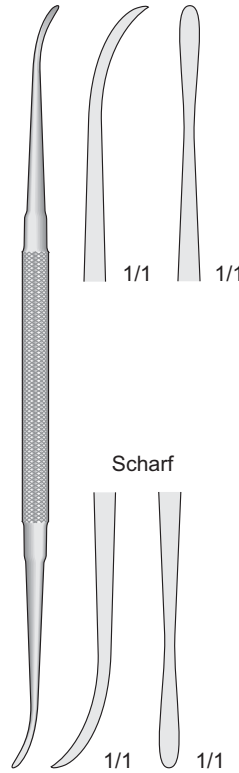

FREER-YASARGIL
0617-BH
185 mm

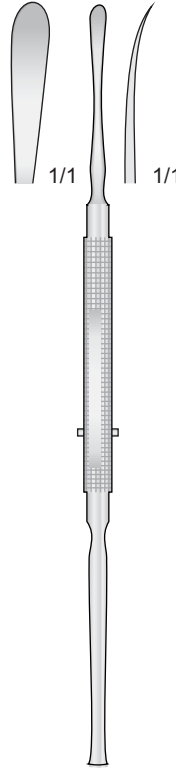

FREER
0617-GE
190 mm

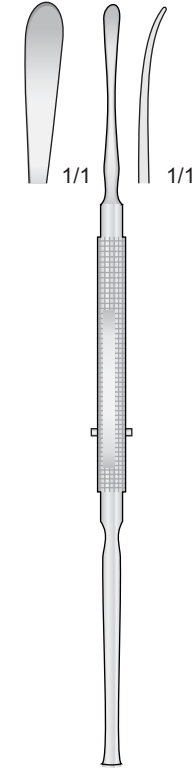

FREER
0617-GF
190 mm

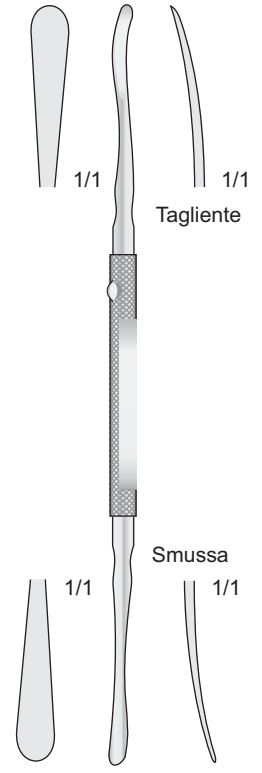

FREER
0617050517
180 mm

Rhinologie

Rhinology

Rinologia

Rinologia

Rhinologie

Septum Elevatori, Raspatori
Septum elevators, Raspatories

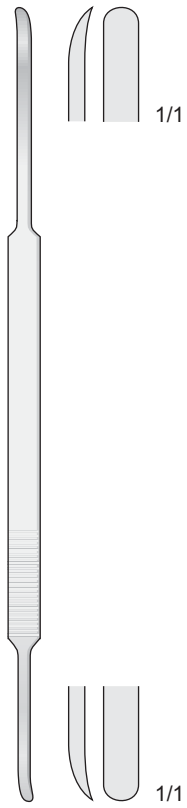

MCKENTY
1014-EG
220 mm

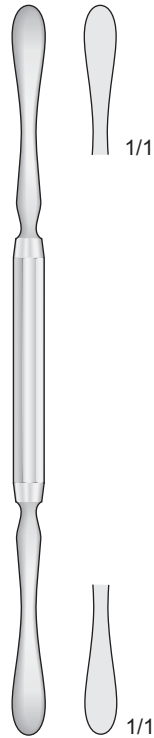

BALLENGER-HAYEK
1014-GB 190 mm
1014-GC 220 mm

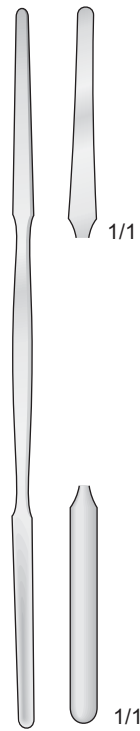

KILLIAN
1014-GD
180 mm

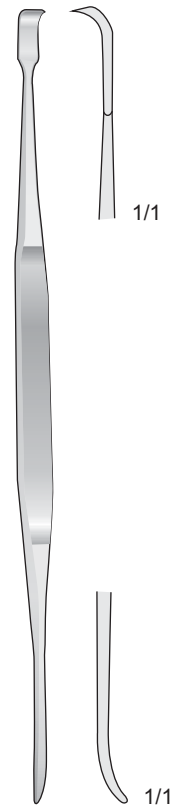

HOWARTH
1014-DA
210 mm

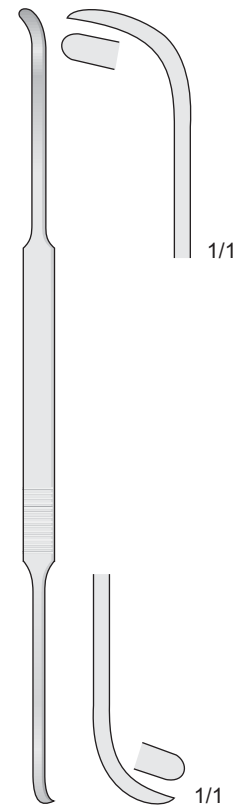

COTTLE
1014-BC
230 mm

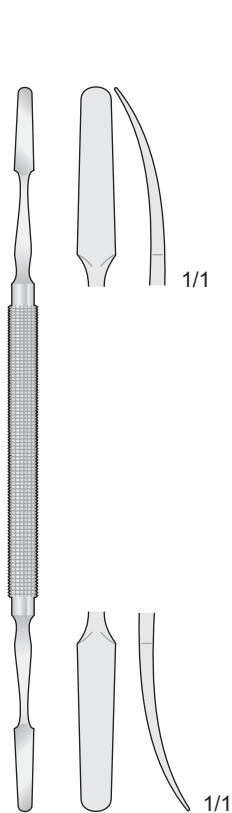

KILIAN
1014-BB
180 mm

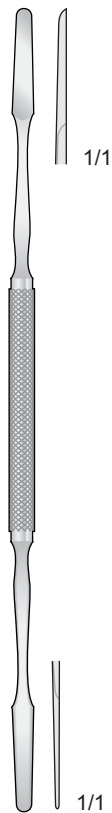

KILLIAN
1014-BD
220 mm

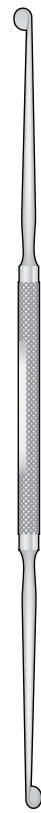

PIERCE
1014-GE
210 mm

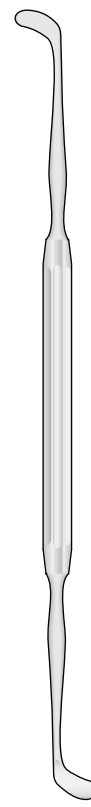

PENNINGTON
1014-GF
210 mm

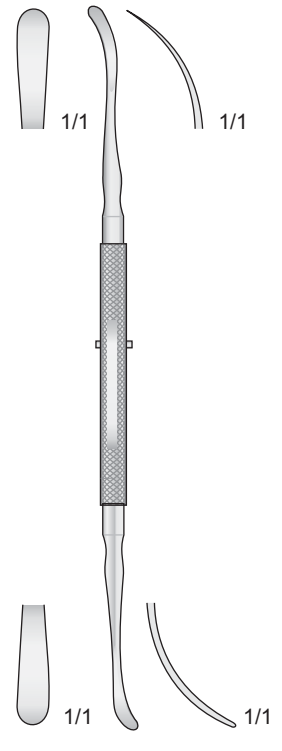

ROGER
1014-GG
180 mm

Rhinologie

Rhinology

Rinologia

Rinologia

Rhinologie

Raspatorien, Elevatorien, Flachmeißel
Raspatories, Elevators, Chisels

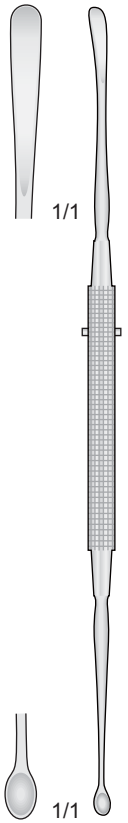

**CARTER
1014-GH**
210 mm



HBC-BI
180 mm

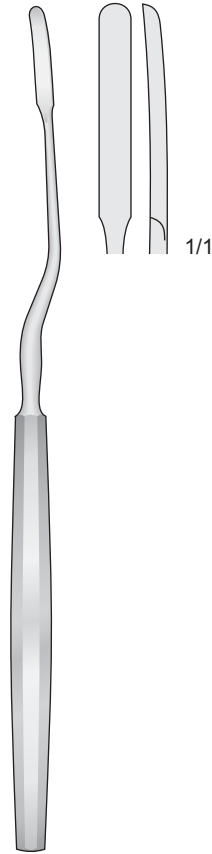

**MASING
1014-GI**
220 mm

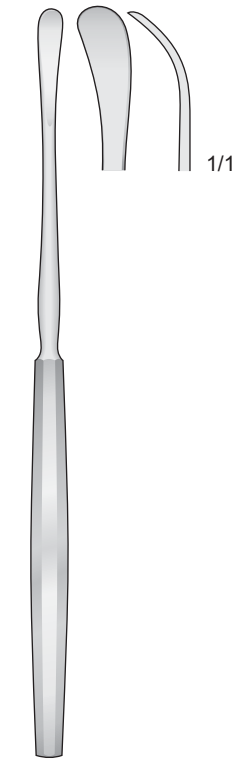

**SEWALL
1014-GL**
200 mm

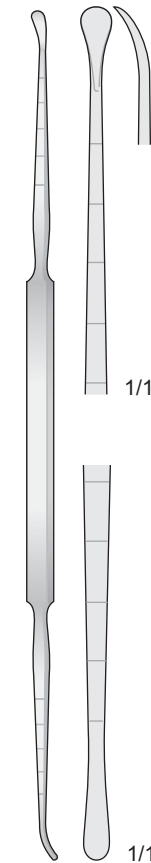

**MASING
0414-GA**
220 mm

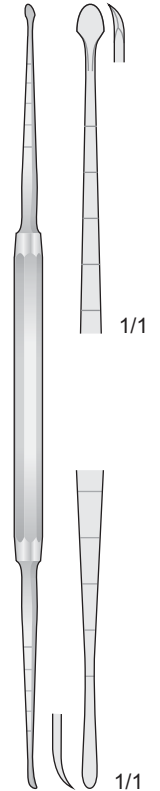

**COTTLE
0414-EH**
200 mm

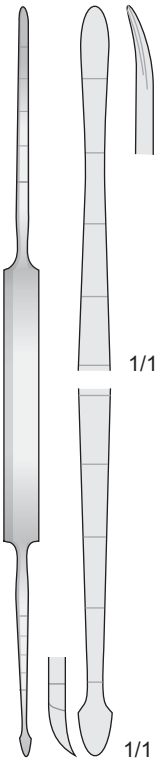

**COTTLE
0414-BBB**
210 mm

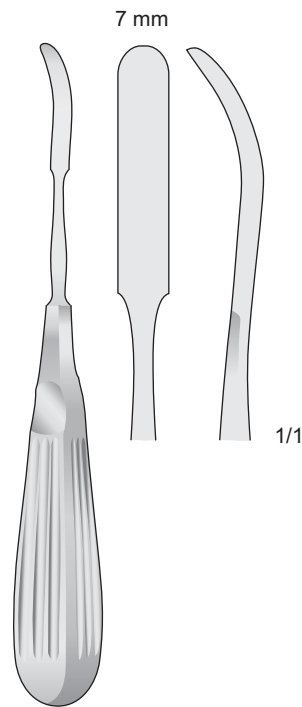

**JOSEPH
0610-IC**
180 mm



**COTTLE
0414-CBB**
195 mm

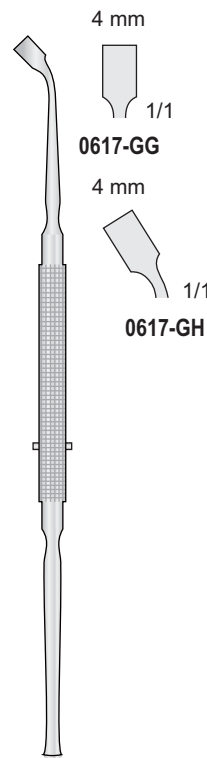

**FREER
0617-GG/0617-GH**
190 mm

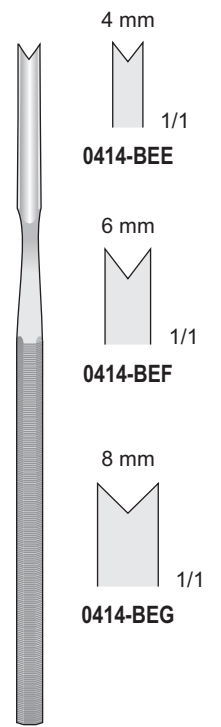

**BALLENGER
0414-BEE/0414-BEG**
150 mm

Rhinologie

Rhinology

Rinologia

Rinologia

Rhinologie

Nasenflügelhaken
Alar Retractor
Divaricatore per alette nasali
Separador para las alas nasales
Ecarteur pour les ailes du nez

22 x 13 mm

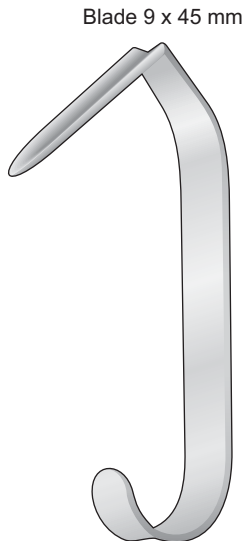

Blade 9 x 45 mm

**MALINIAC
0414-CAA**
100 mm

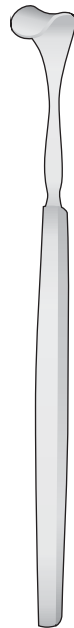

**COTTLE
0219-CEF**
150 mm

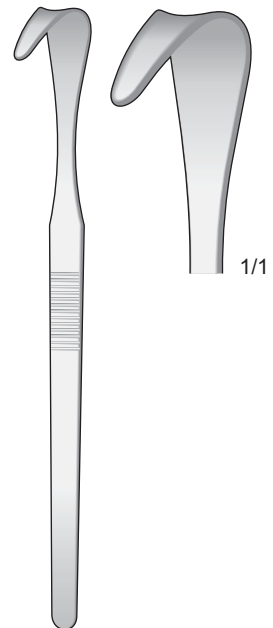

**COTTLE
0219-BDI**
150 mm

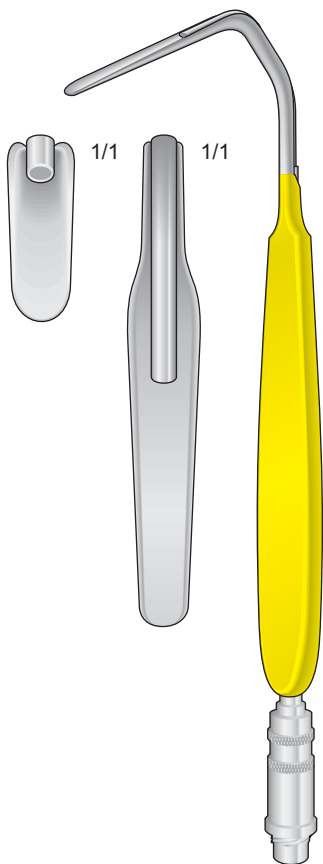

0414-EAB
185 mm

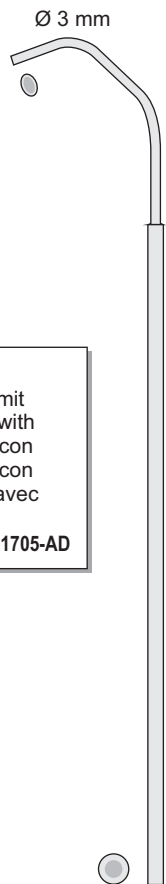

0414-EAB17
182 mm

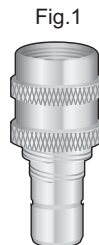

1705-AB



1705-AC



1705-AD

1705-BA
Komplettset mit
Set complete with
Set completo con
Set complete avec
1705-AB 1705-AC 1705-AD

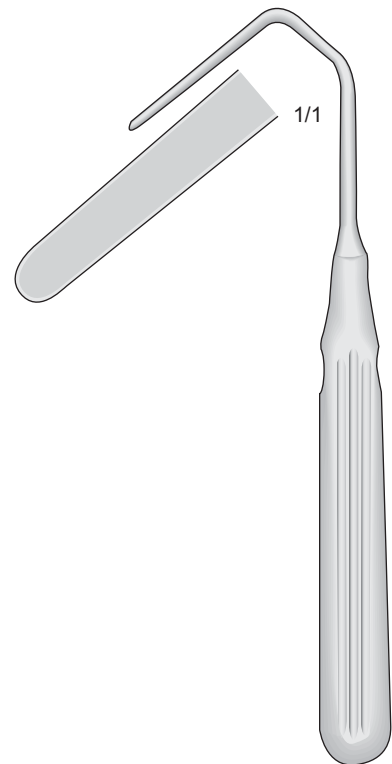

**AUFRICHT
0414-EI**
175 mm

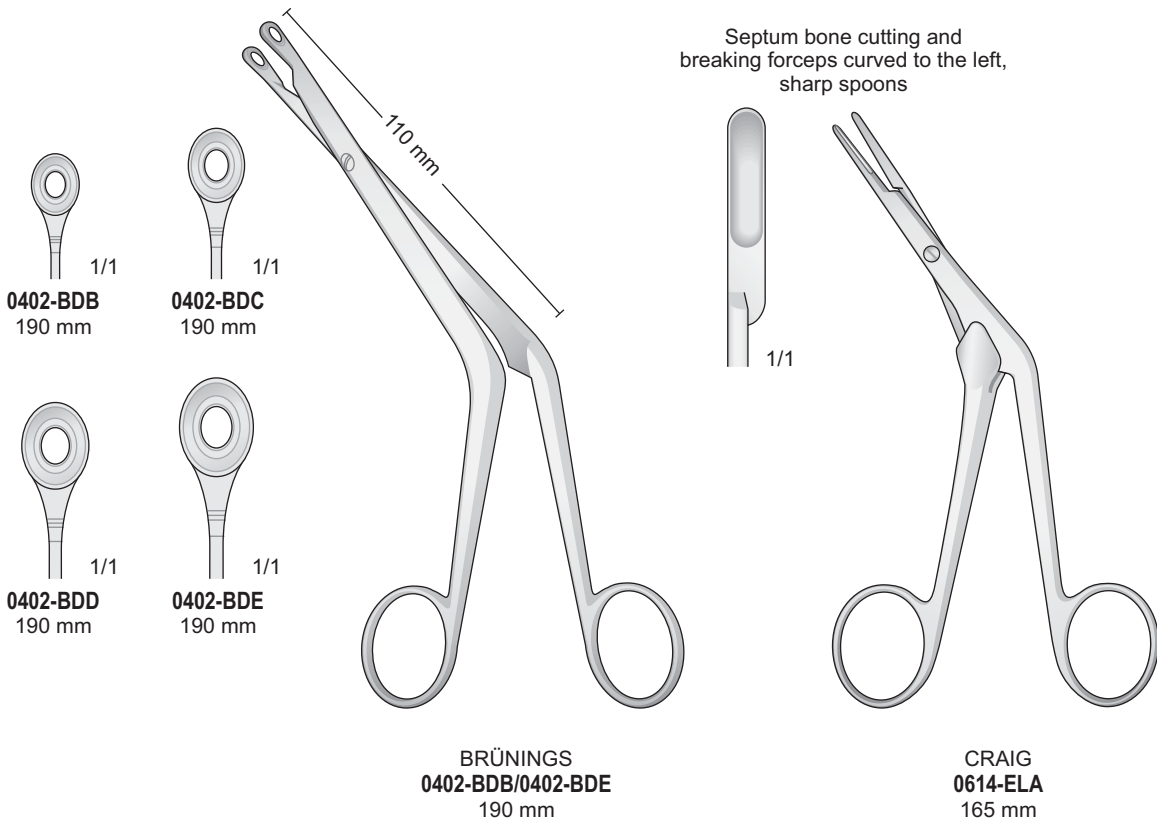

Nasenrachenzange
Adenoid Cutting Forceps

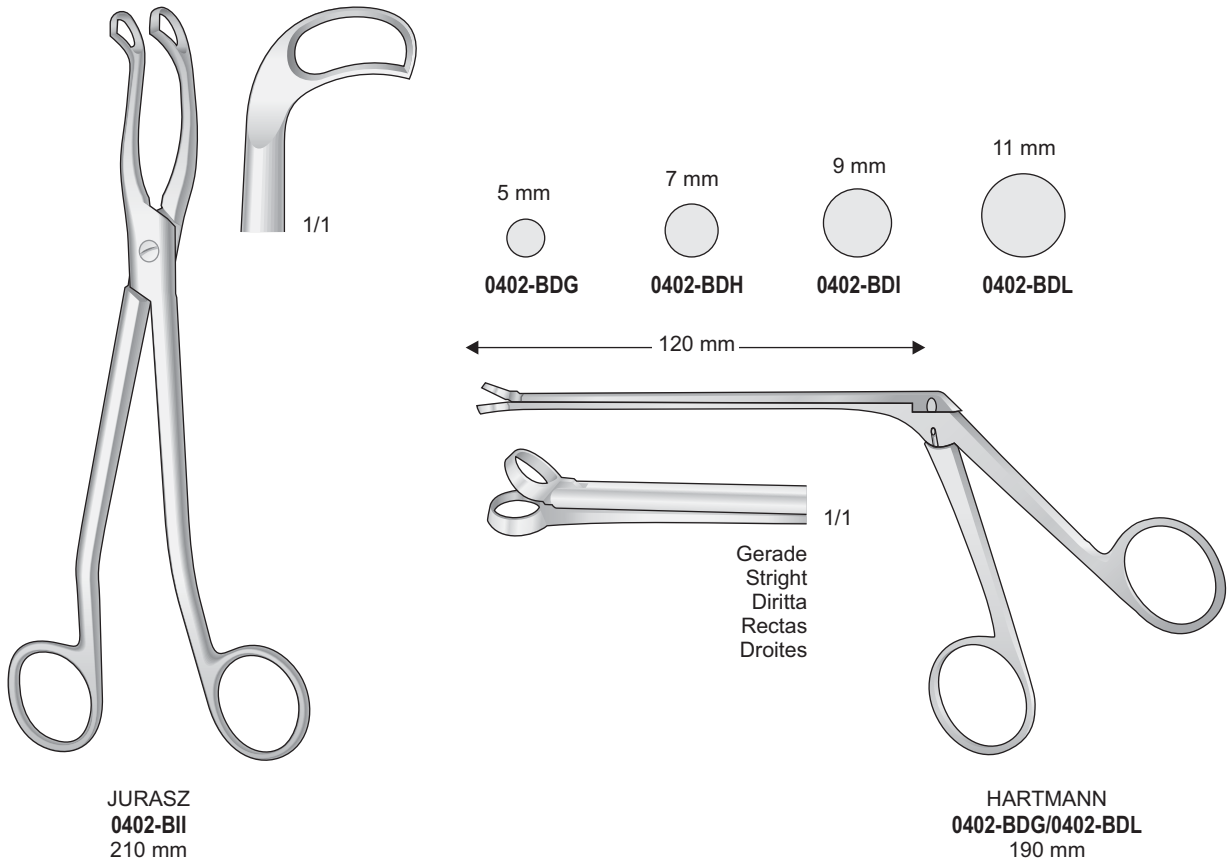

Rhinologie

Rhinology

Rinologia

Rinologia

Rhinologie

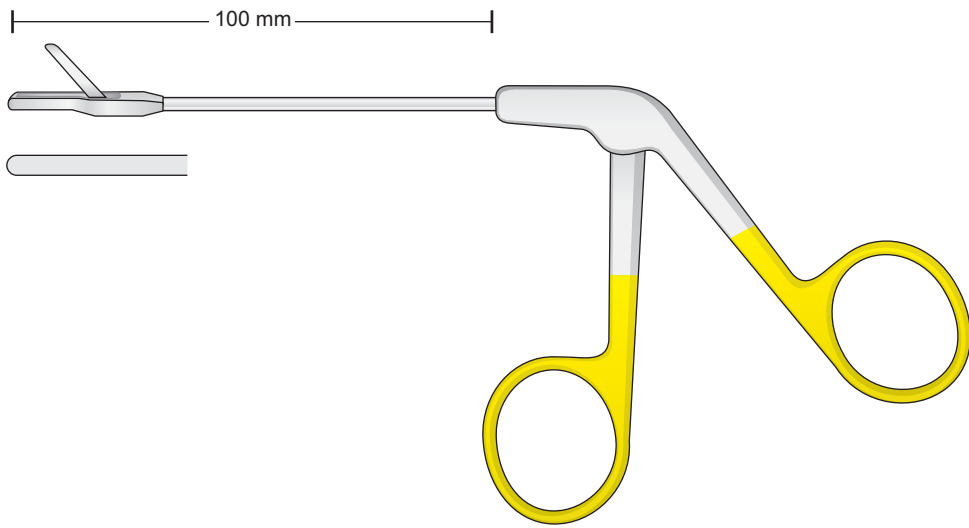

STRUYCKEN
0606-BH



STRUYCKEN
0402-BFB



HENKE
0402-BFC



HAJEK-GRUENWALD
0402-BFE



HAJEK-GRUENWALD
0402-BFD



HAJEK-GRUENWALD
0402-BFF

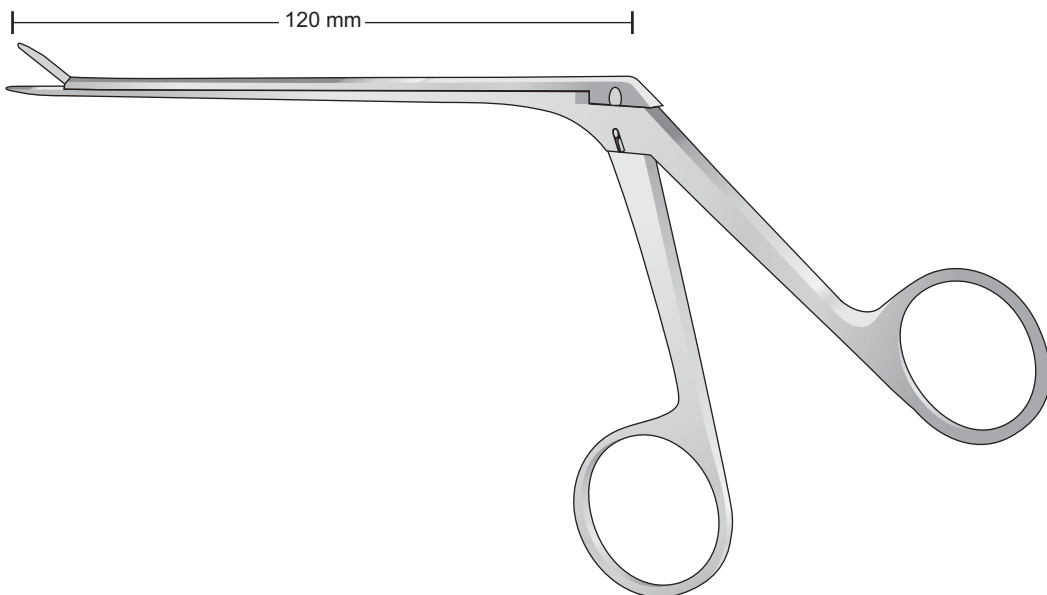

0402-BFB/0402-BFF
120 mm

Laminectomy
Rongeur

Laminectomy
rongeurs

Pinze
per biopsia

Pinzas cortantes
para laminectomía

Pinces a
laminectomía

Rongeurs - Rongeur

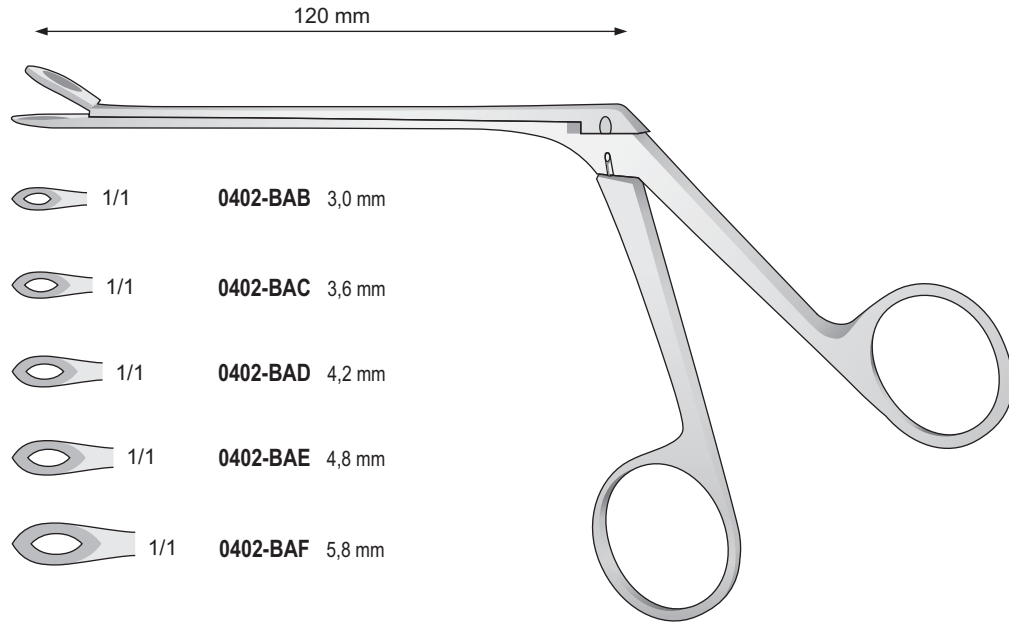

WEIL-BLAKESLEY
0402-BAB/0402-BAF
190 mm

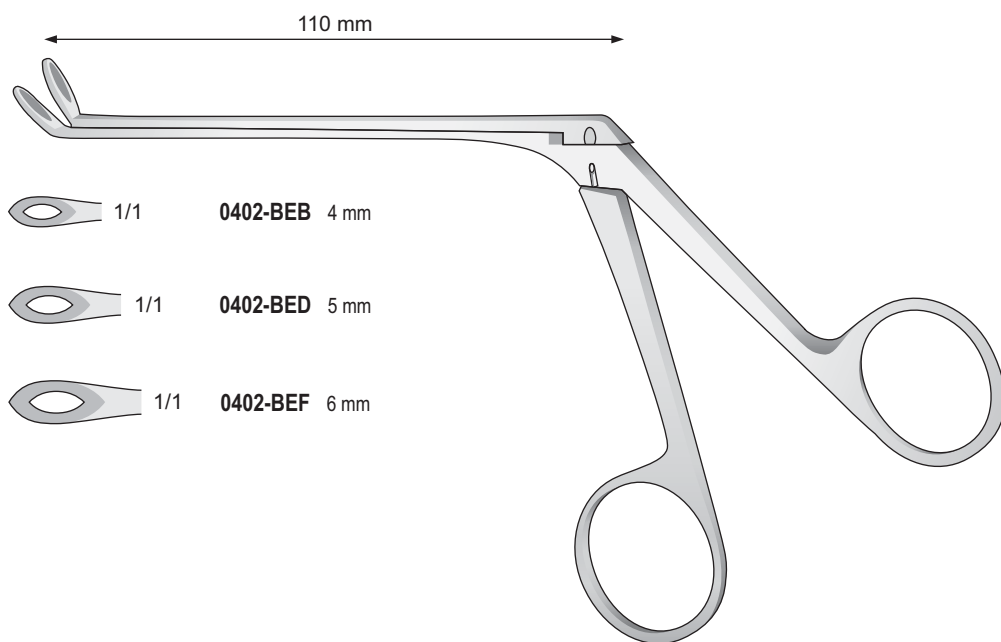

WEIL-BLAKESLEY
0402-BEB/0402-BEF
190 mm

Laminectomy
Rongeur

Laminectomy
rongeurs

Pinze
per biopsia

Pinzas cortantes
para laminectomía

Pincas a
laminectomía

Rongeurs - Rongeur

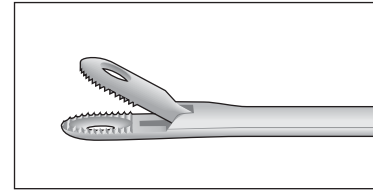
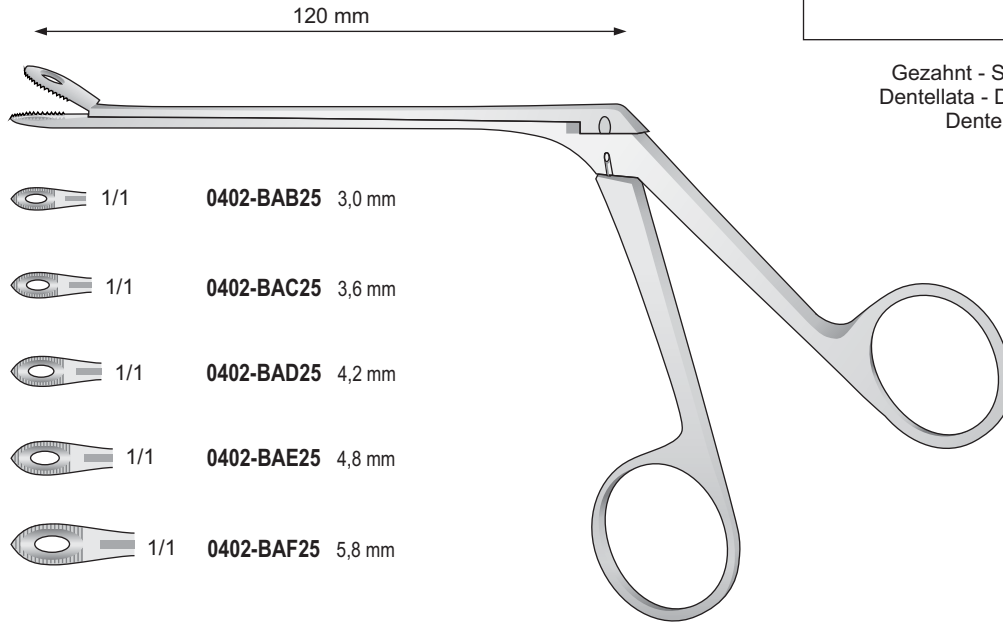

Gezahn - Serrated
Dentellata - Dentadas
Dentelé

WEIL-BLAKESLEY
0402-BAB25/0402-BAF25
190 mm

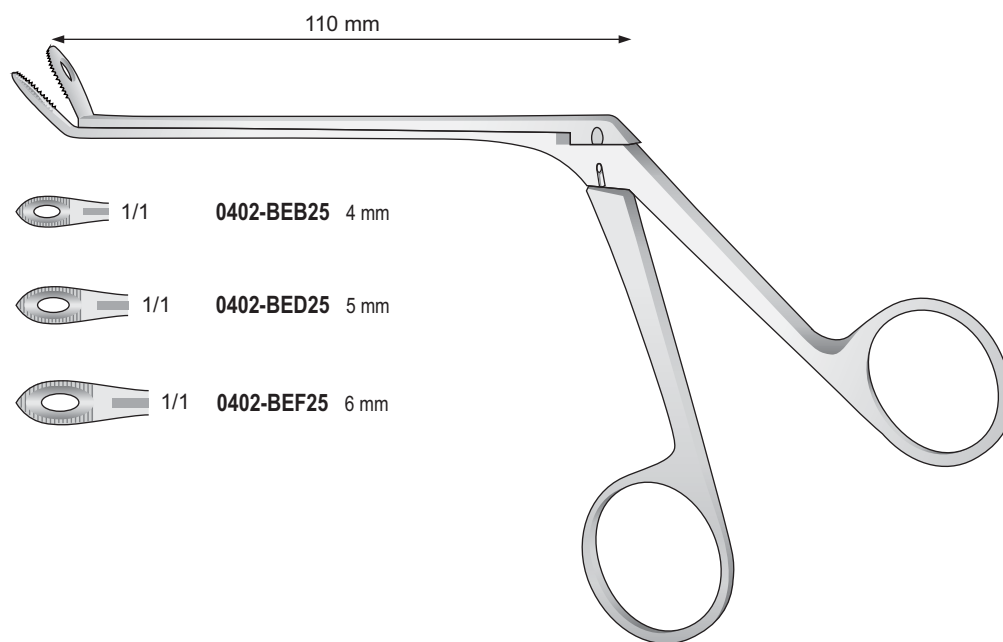

WEIL-BLAKESLEY
0402-BEB25/0402-BEF25
190 mm

Rhinologie

Rhinology

Rinologia

Rinologia

Rhinologie

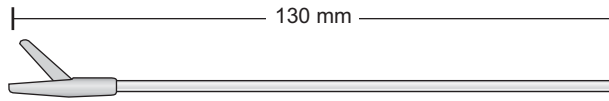

Gerade
Straight
Diritta
Rectas
Droites

0606-BA

Rechts Gebogen
Right curved
Curva a destra
Curvas a la derecha
Courbes à droite

0606-BB

Links Gebogen
Left curved
Curva a sinistra
Curvas a la izquierda
Courbes à gauche

0606-BC

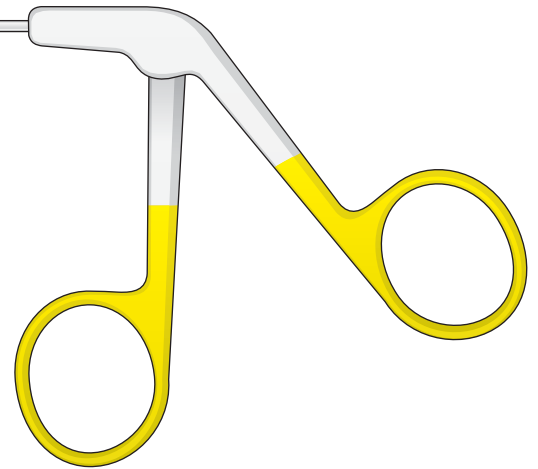

0606-BA/0606-BC

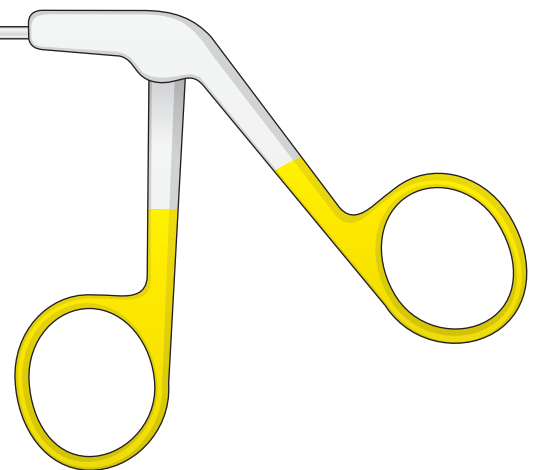
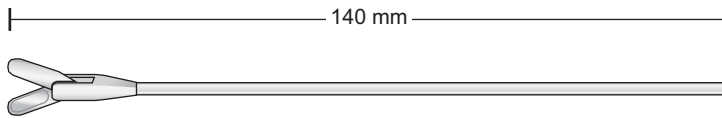

Antrumstanze, rückwärts schneidend
Antrum Punch, retrograde cutting
Pinza per antro, taglio retrogrado
Pinza saca-bocado para seno maxilar, retrógrado
Pince emporte-pièce, coupe retrograde

0606-BD

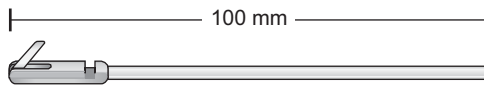

Schnitt oben
Up cutting
Tagliente in alto
Cortante en la parte superior
Coupant en haut

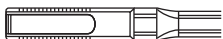

0606-BE
2mm

Schnitt rechts
Right cutting
Tagliente a destra
Cortante a la derecha
Coupant à droite

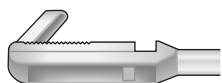

0606-BF
2mm

Schnitt links
Left cutting
Tagliente a sinistra
Cortante a la izquierda
Coupant à gauche

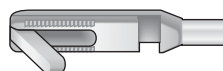

0606-BG
2mm

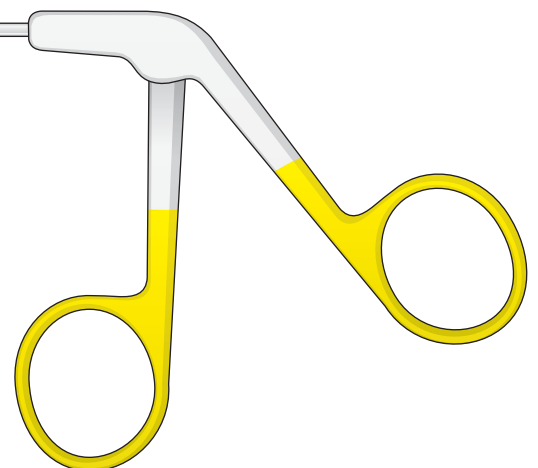

STAMMBERGER
0606-BE/0606-BG

Rhinologie

Rhinology

Rinologia

Rinologia

Rhinologie

Diritta
Stright
Gerade
Droites
Rectas

120 mm

1/1
3 mm

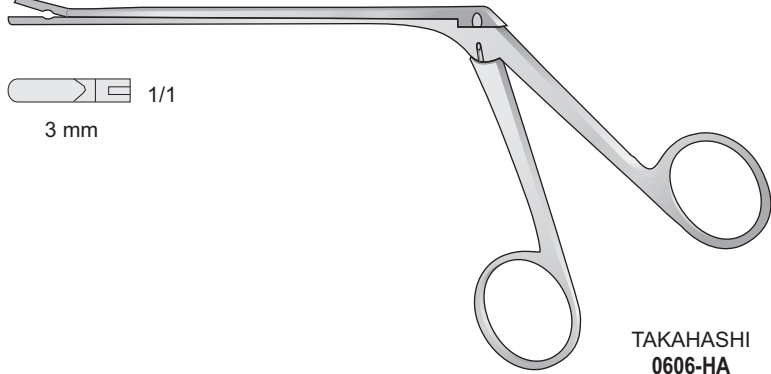

TAKAHASHI
0606-HA

Curva verso l'alto
Top curved
Aufwärtsgebogen
Courbe vers le haut
Curvos

120 mm

1/1
3 mm

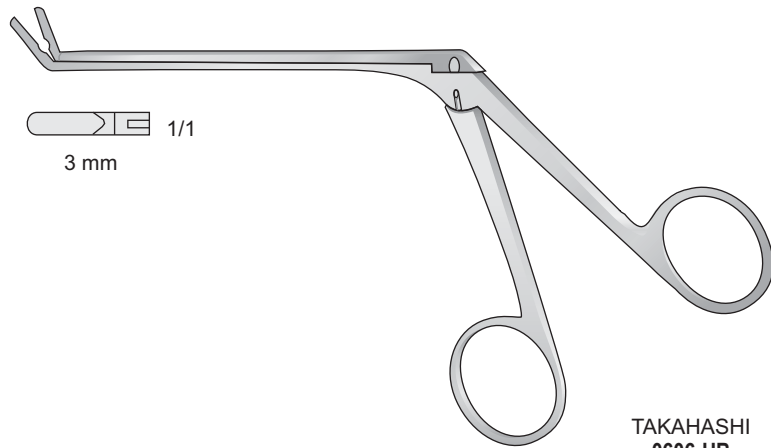

TAKAHASHI
0606-HB

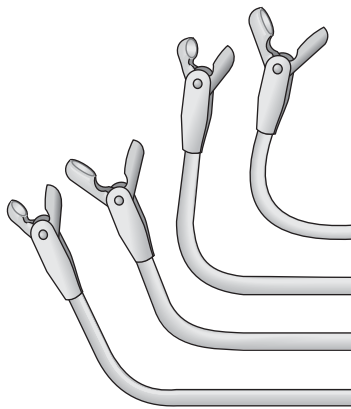

0606-BIA
4 mm
0606-BIB
3 mm
0606-BIC
4 mm
0606-BID
3 mm

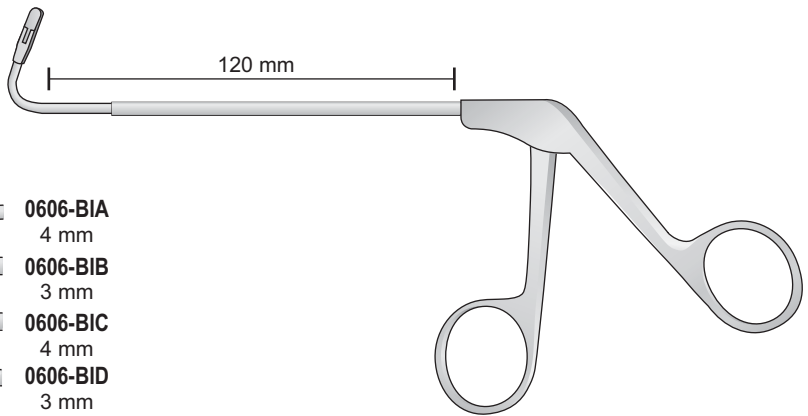

LÖFFEL
0606-BIA/0606-BIH

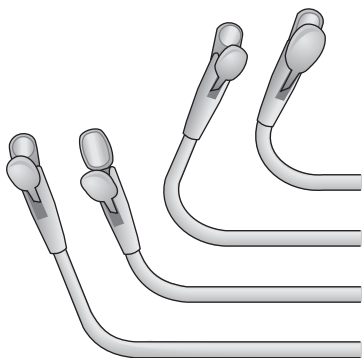

0606-BIE
4 mm
0606-BIF
3 mm
0606-BIG
4 mm
0606-BIH
3 mm

2.2



Nasen Instrumente
Nasal Instruments
Strumenti per naso
Instrumentos nasales
Instruments nasaux

Septum- und Rhinoplastik
Plastic Surgery
Settoplastica e Rinoplastcia
Rinoplastía
Septum et Rhinoplastie

Osteotome

Osteotomes

Osteotomi

Osteotomos

Ostéotomes

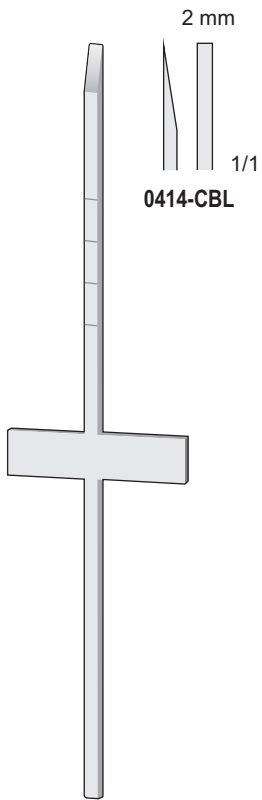

COTTLE
0414-CBL
180 mm

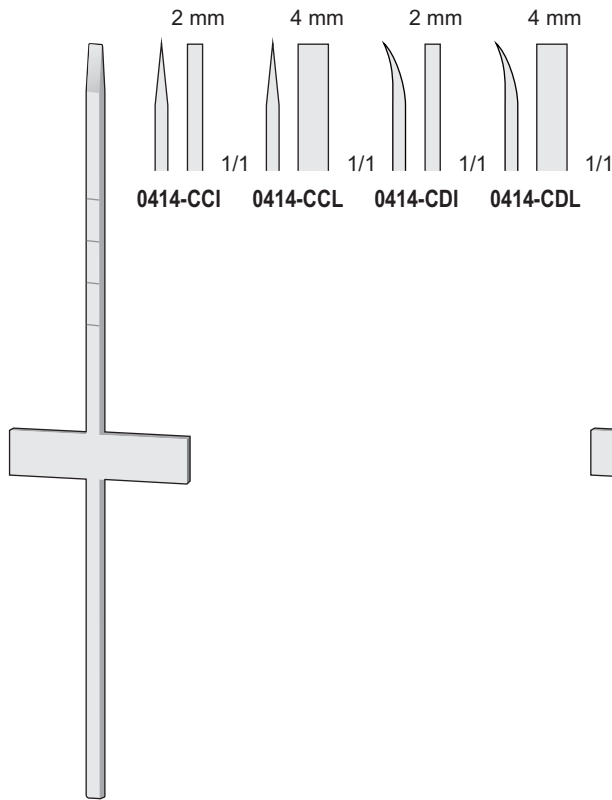

COTTLE
0414-CCI/0414-CDL
180 mm

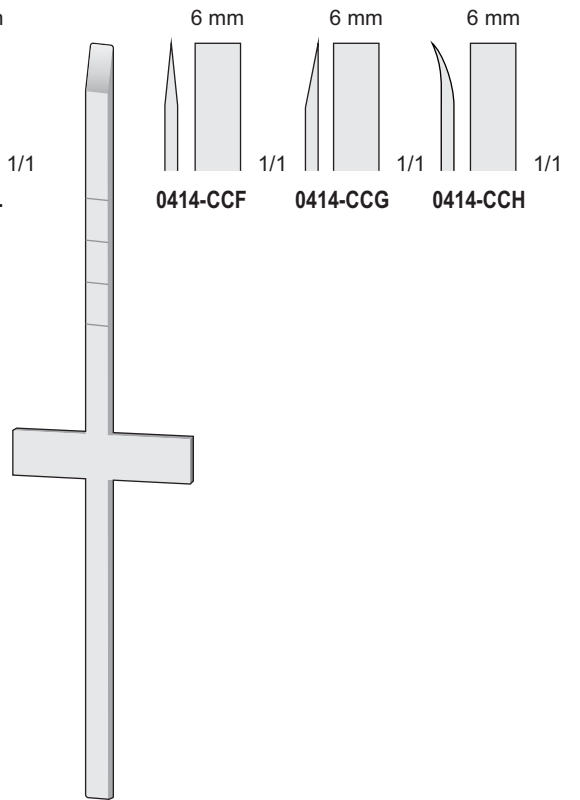

COTTLE
0414-CCF/0414-CCH
180 mm

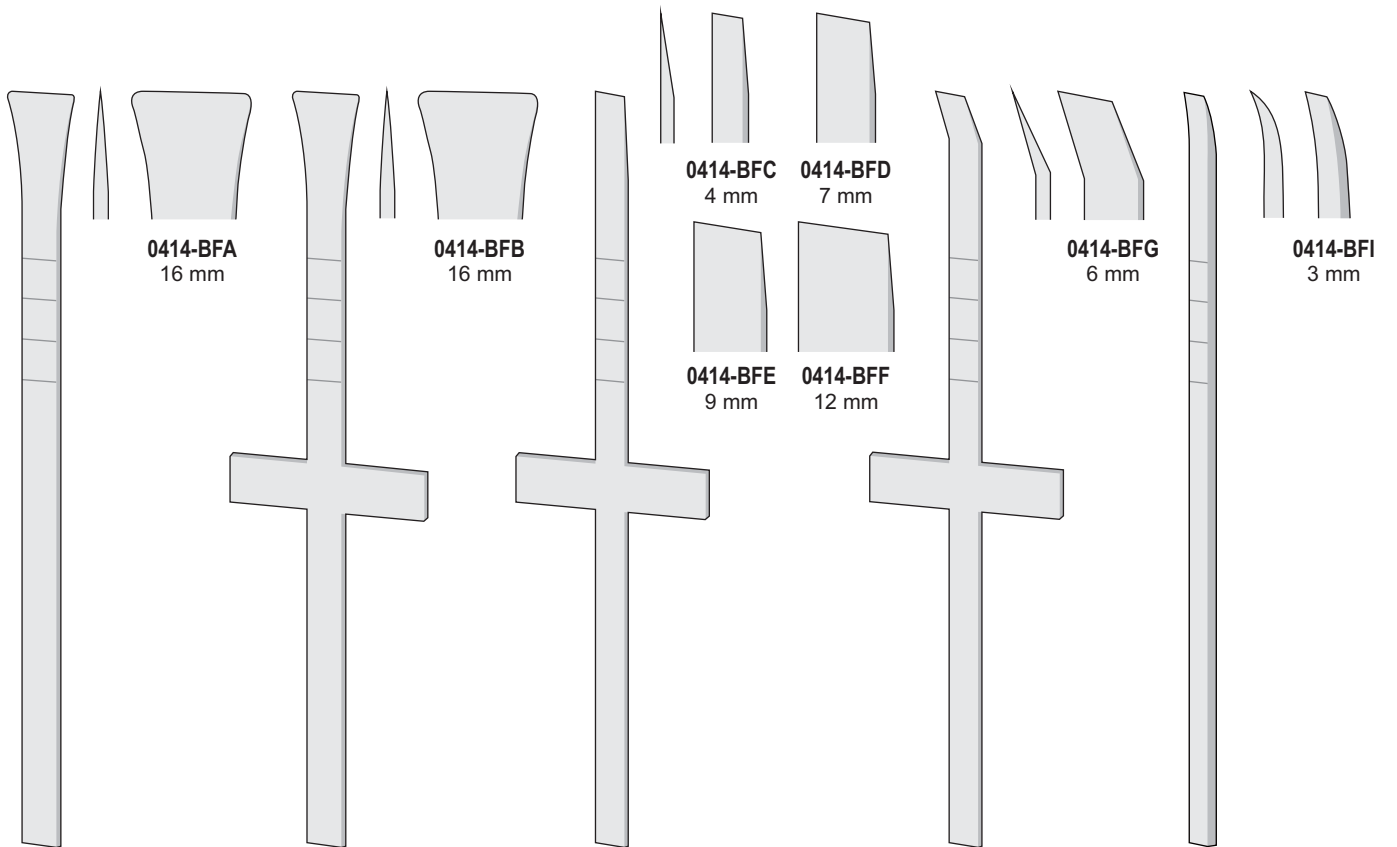

COTTLE
0414-BFA
180 mm

COTTLE
0414-BFB
180 mm

COTTLE
0414-BFC/0414-BFF
180 mm

COTTLE
0414-BFG
180 mm

COTTLE
0414-BFI
180 mm

Osteotome

6,5 mm



PARKES
0414-DCA
180 mm

Osteotomes

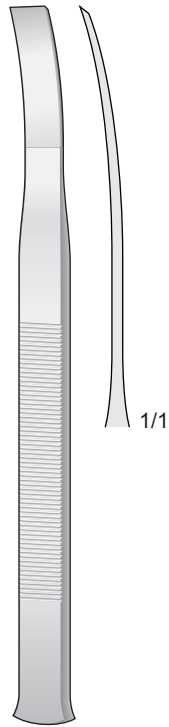

TESSIER
0611-EAE 10 mm
160 mm

Osteotomi

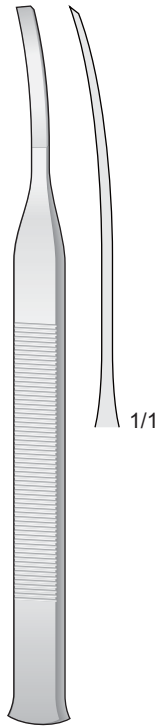

TESSIER
0611-EBB 5 mm
0611-EBC 7 mm
160 mm

Osteótomos



TESSIER
0611-EBD/0611-EBG
160 mm

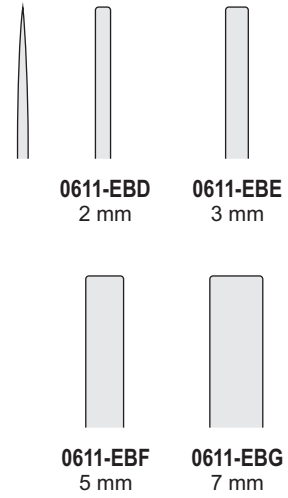

2 mm

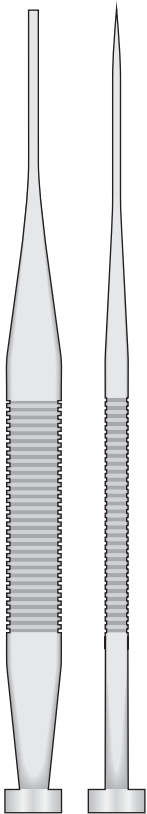

0414-BBD
170 mm

3 mm

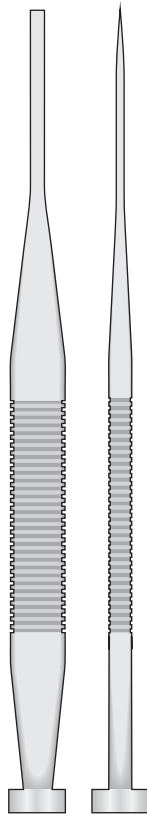

0414-BBE
170 mm

4 mm

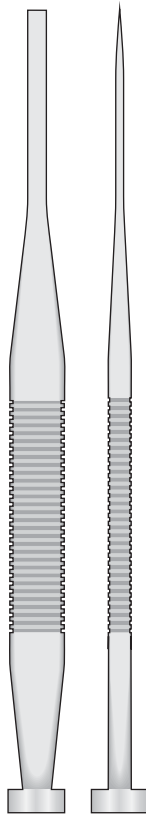

0414-BBF
170 mm

4 mm

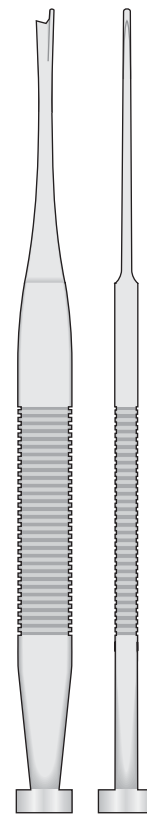

0414-BBG
170 mm



0414-BDF
185 mm

Rhinologie

Rhinology

Rinologia

Rinologia

Rhinologie

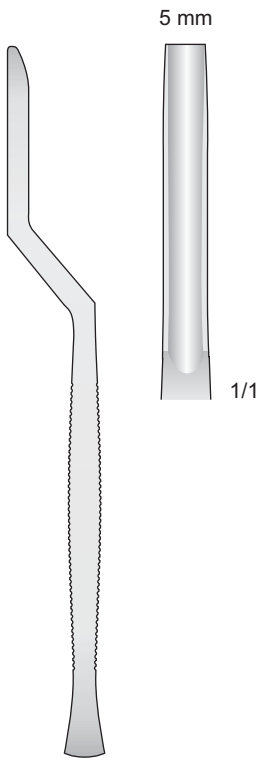

**KILIAN
0414-LB**
160 mm

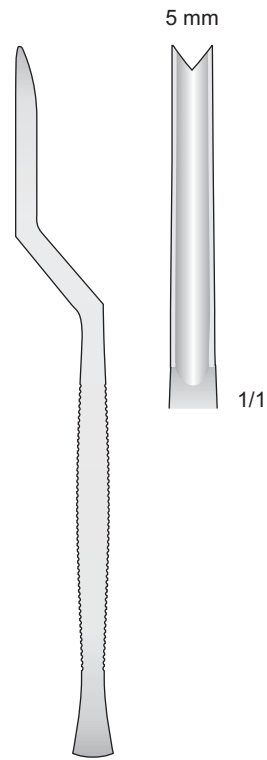

**KILIAN-KLAUS
0414-LC**
160 mm



**McINDOE
0414-CBG/0414-CBI**
145 mm

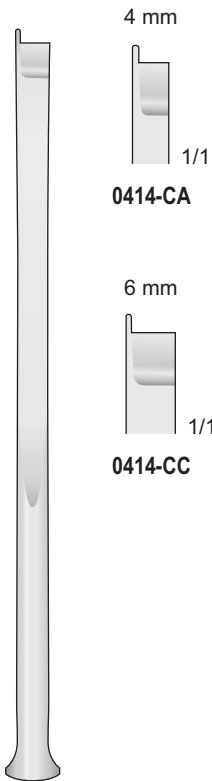
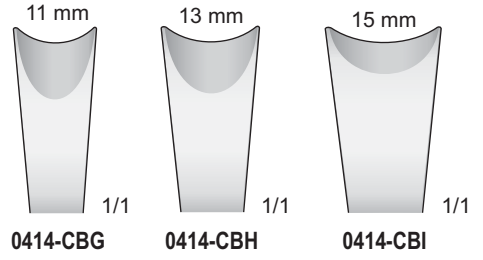

**FOMON
0414-CA/0414-CD**
165 mm

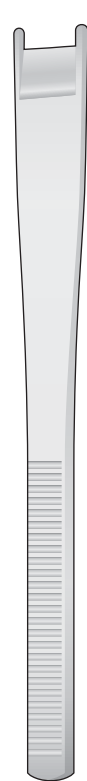
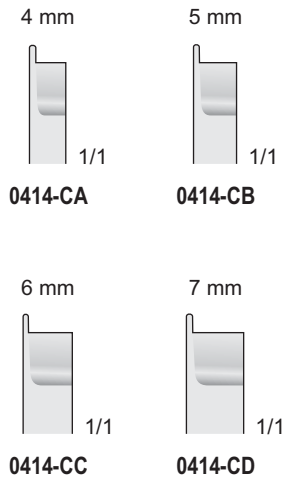

**CINELLI
0414-CE/0414-CH**
165 mm

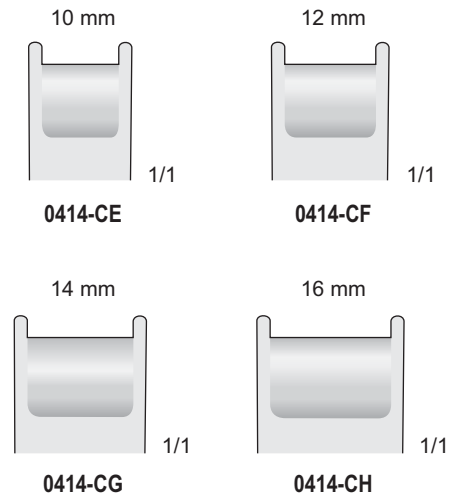

Osteotome

Osteotomes

Osteotomi

Osteótomos

Ostéotomes

Double guarded



MASING
0414-BFL
160 mm



NEIVERT-ANDERSON
0414-CHG/0414-CHI
205 mm

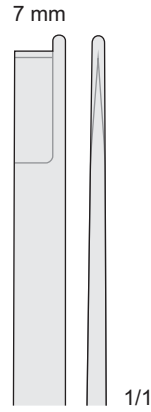

0414-CHG
205 mm

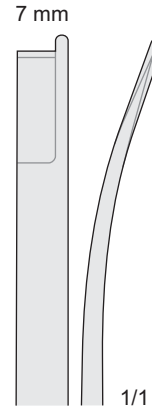

0414-CHH
205 mm

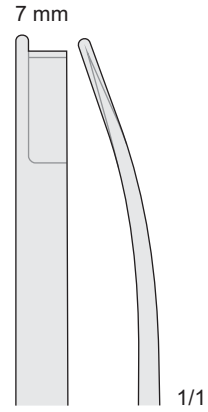

0414-CHI
205 mm

Gerade - Straight
Diritto - Rectas - Droites

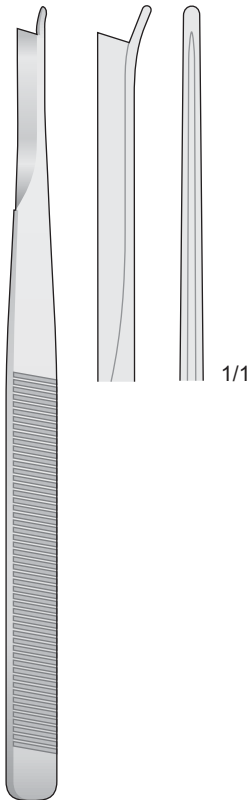

SILVER
0414-DE
180 mm

Links - Left
Sinistra - Izquierda - Gauche

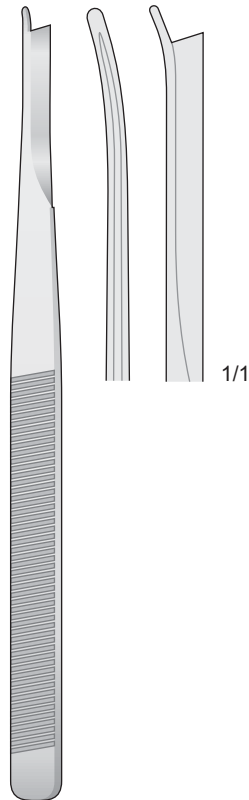

SILVER
0414-DF
180 mm

Rechts - Right
Destra - Derecha - Droite

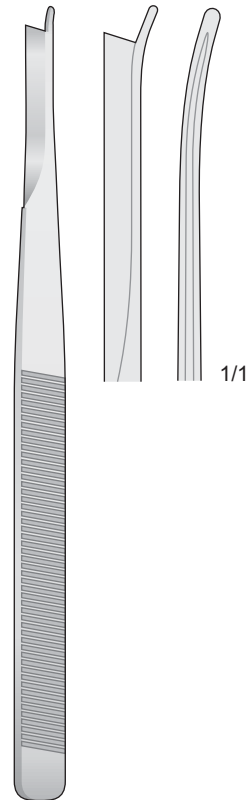

SILVER
0414-DG
180 mm

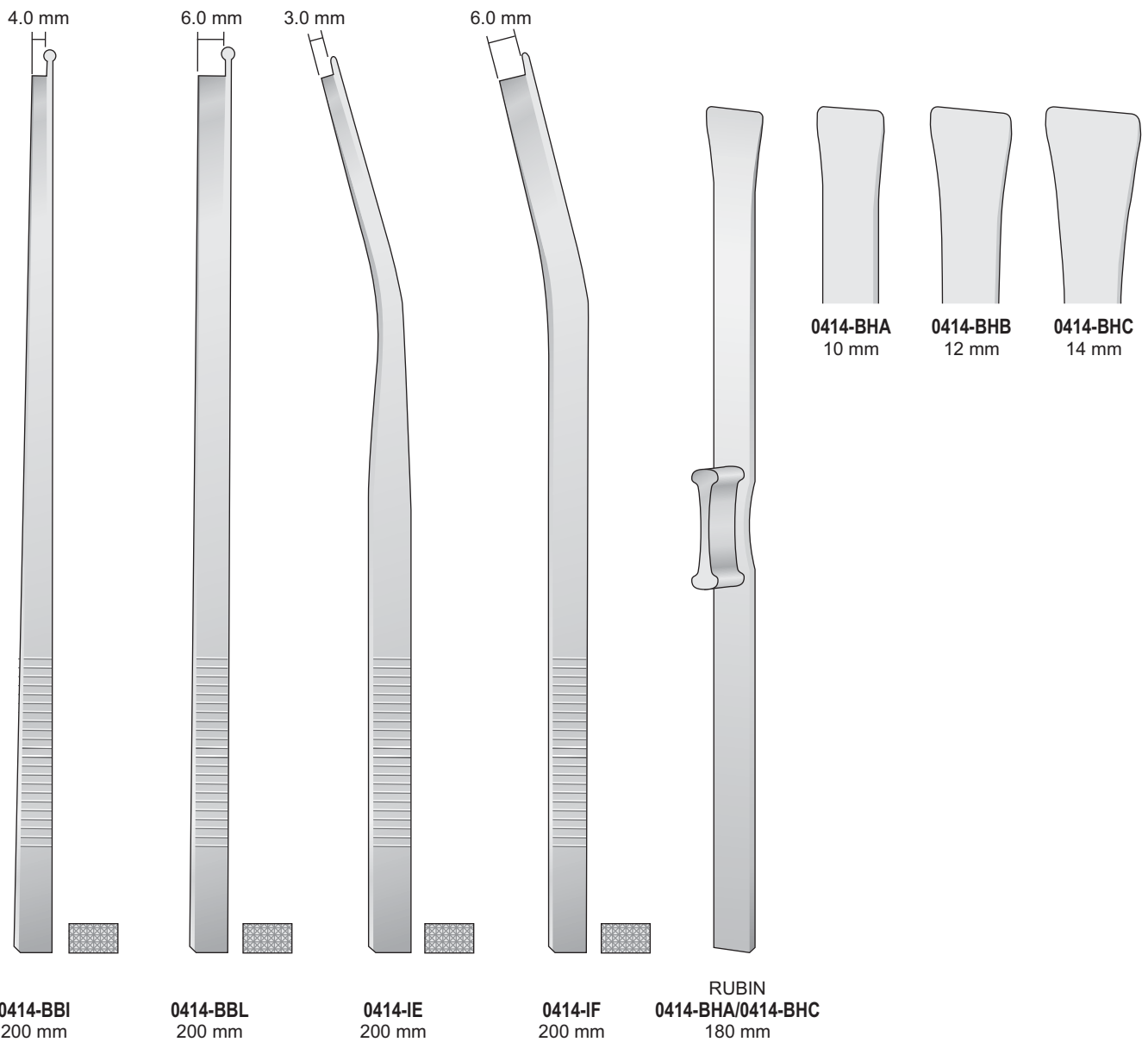

Osteotome

Osteotomes

Osteotomi

Ostéotomes

Osteótomos

Strumenti utilizzati
per Graft inferiori

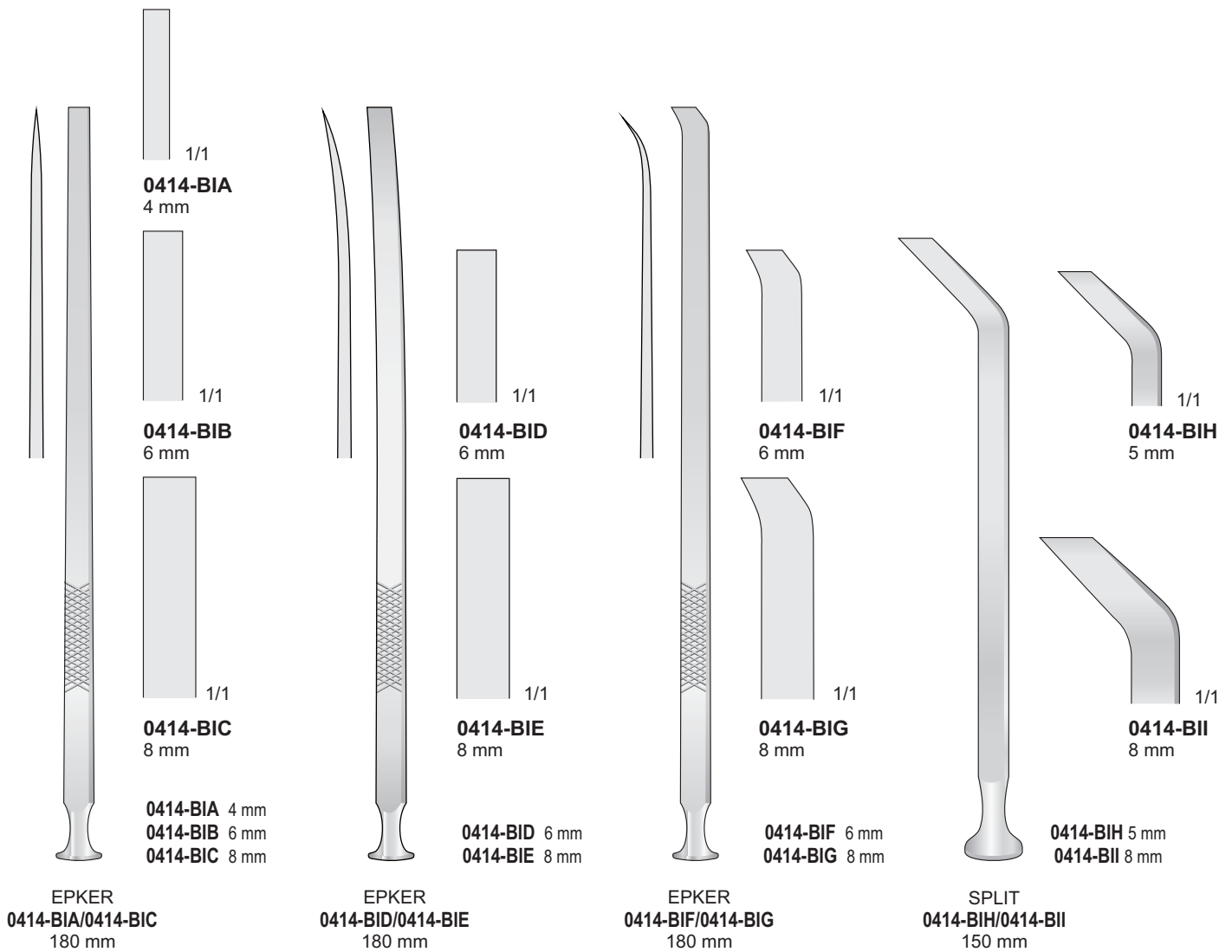

Osteotome mit
Doppelt Protezion

Osteotome with
Double Guarded

Osteotomi con
doppia protezione

Osteotom con
doble protezion

Osteotome avec
double protection

10 mm

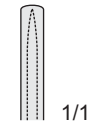

1/1



1/1

0414-CAI
160 mm

12 mm

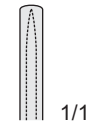

1/1



1/1

0414-CAL
160 mm

14 mm

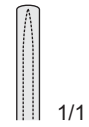

1/1



1/1

0414-CBA
160 mm

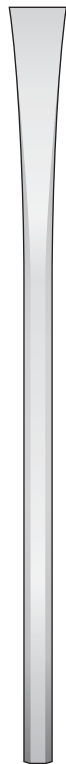

0611-DIA
2 mm



0611-DIB
4 mm



0611-DIC
6 mm



0611-DID
8 mm



0611-DIE
10 mm



0611-DIF
12 mm



0611-DIG
15 mm



0611-DIH
18 mm

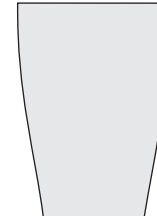

0611-DII
20 mm

SHEEHAN
0611-DIA/0611-DII
160 mm

Osteotome

Osteotomes

Osteotomi

Osteótomos

Ostéotomes

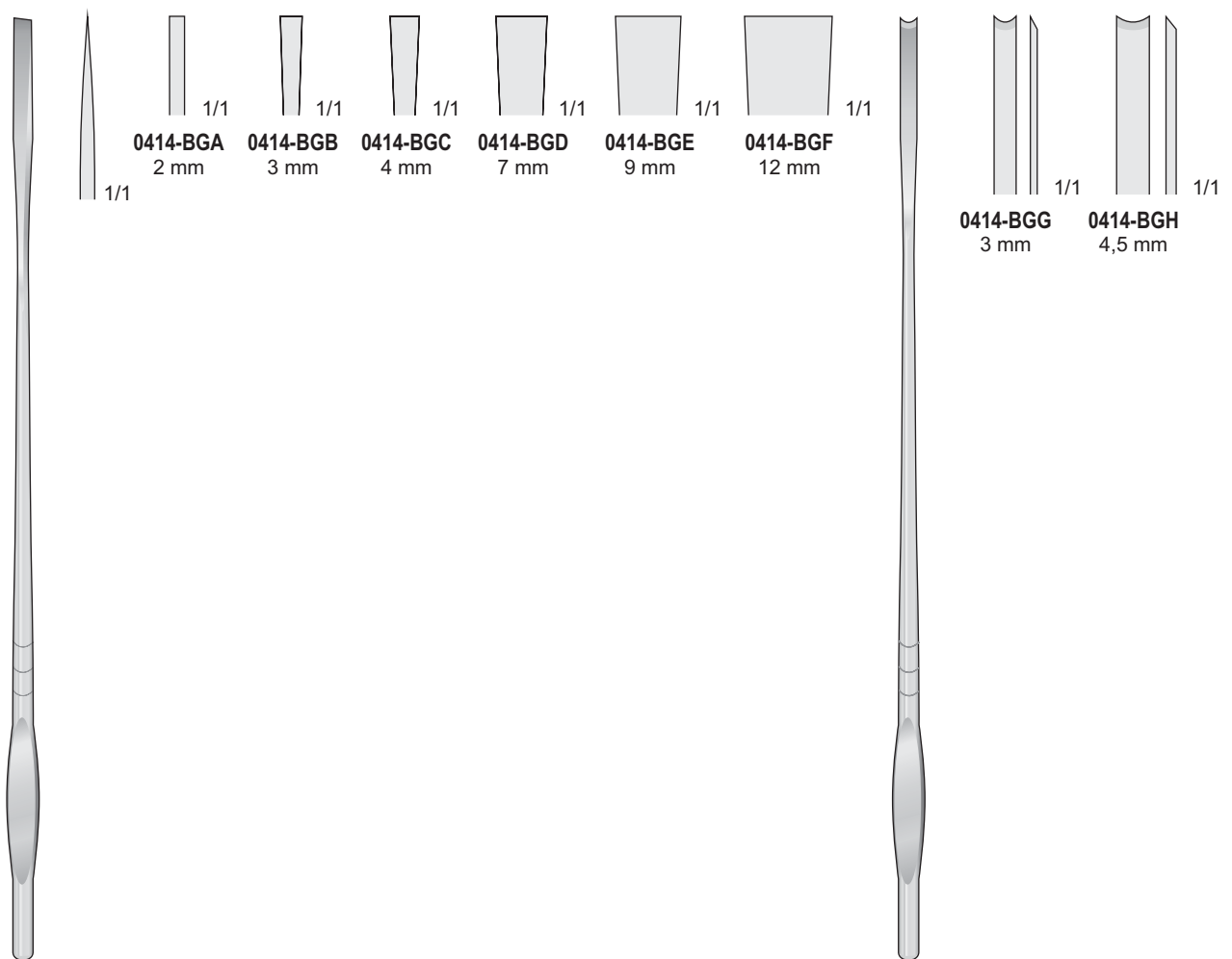

WALTER
0414-BGA/0414-BGF
190 mm

WALTER
0414-BGG/0414-BGH
190 mm

Osteotome

Osteotomes

Osteotomi

Osteotomos

Ostéotomes

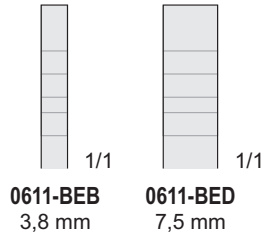

0611-BEB/0611-BED
170 mm

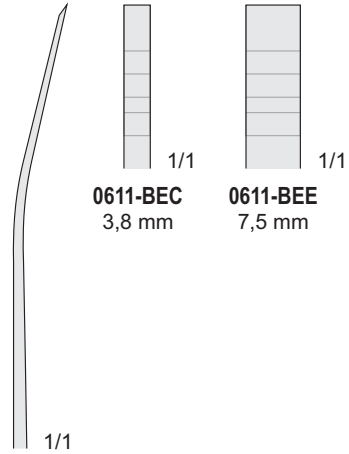

0611-BEC/0611-BEE
170 mm

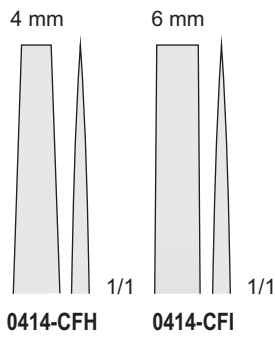
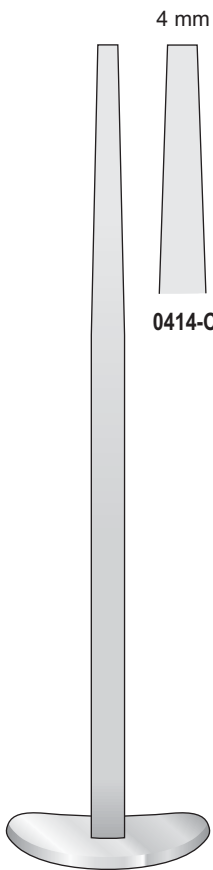

0414-CFH/0414-CFI
165 mm

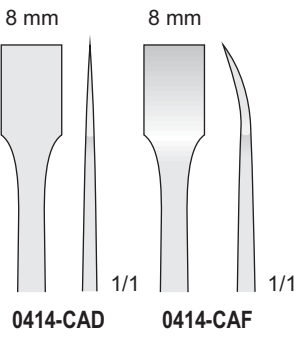
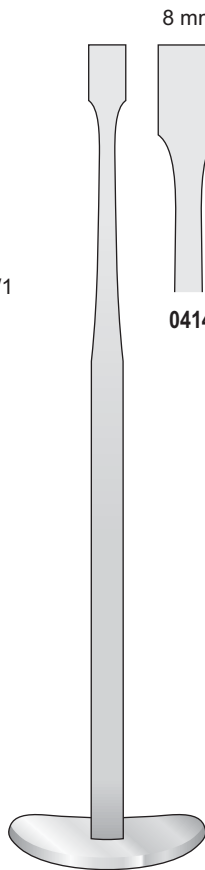

0414-CAD/0414-CAF
165 mm

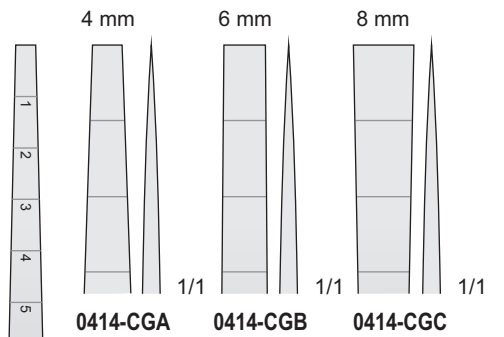
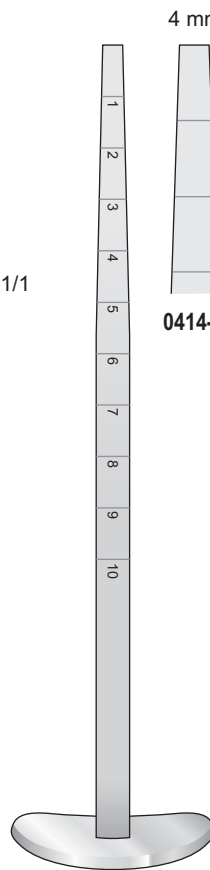

0414-CGA/0414-CGC
160 mm

Osteotome

4 mm

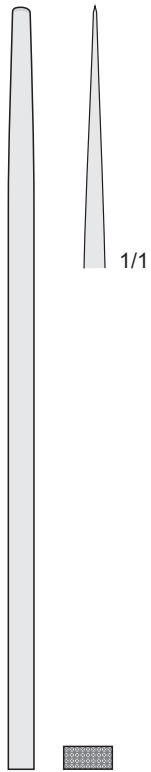

COTTLE
0414-DH
190 mm

Osteotomes

7 mm

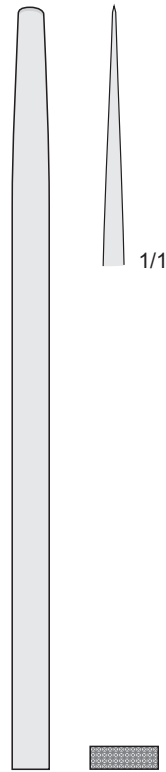

COTTLE
0414-DI
190 mm

Osteotomi

12 mm

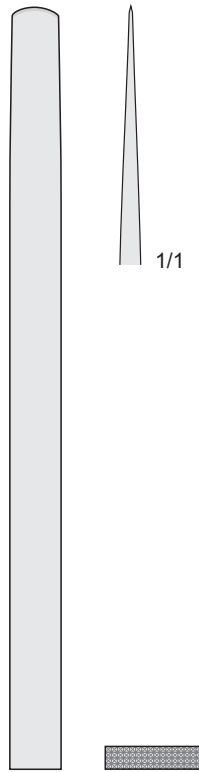

COTTLE
0414-DL
190 mm

Osteótomos



WEST
0611-BDD
160 mm

Osteótomes



WEST
0611-BDE
160 mm

4 mm

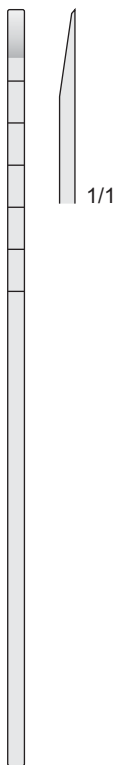

COTTLE
0414-BDA
180 mm

7 mm

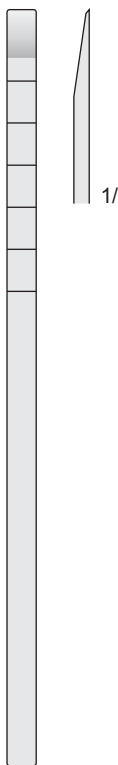

COTTLE
0414-BDB
180 mm

9 mm

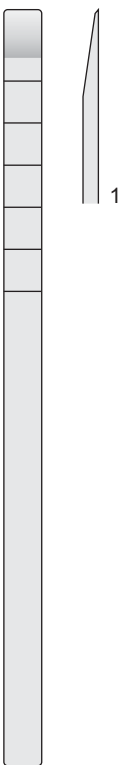

COTTLE
0414-BDC
180 mm

12 mm



COTTLE
0414-BDD
180 mm

4 mm



COTTLE
0414-BEA
180 mm

7 mm

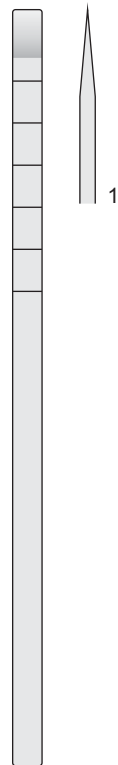

COTTLE
0414-BEB
180 mm

12 mm

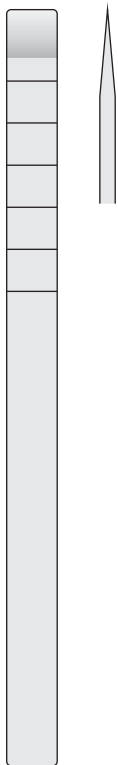

COTTLE
0414-BED
180 mm

Osteotome

Osteotomes

Osteotomi

Osteótomos

Ostéotomes

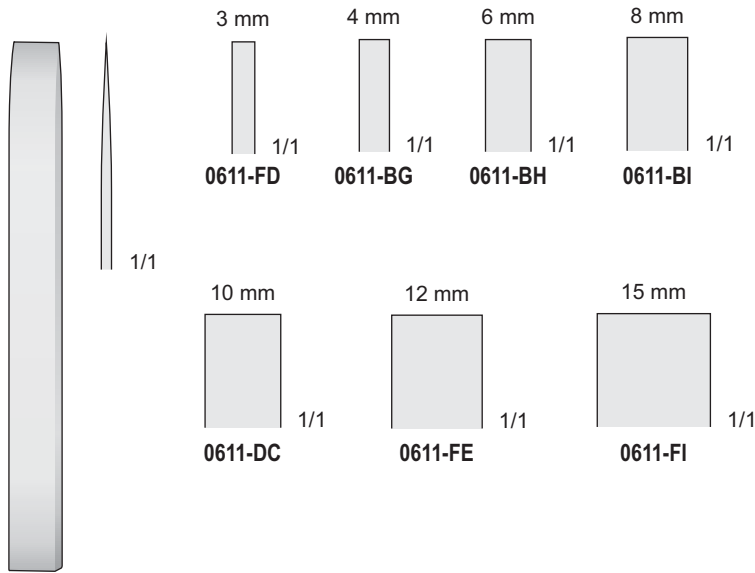

MINI-LAMBOTTE
0611-BG/0611-FI
125 mm

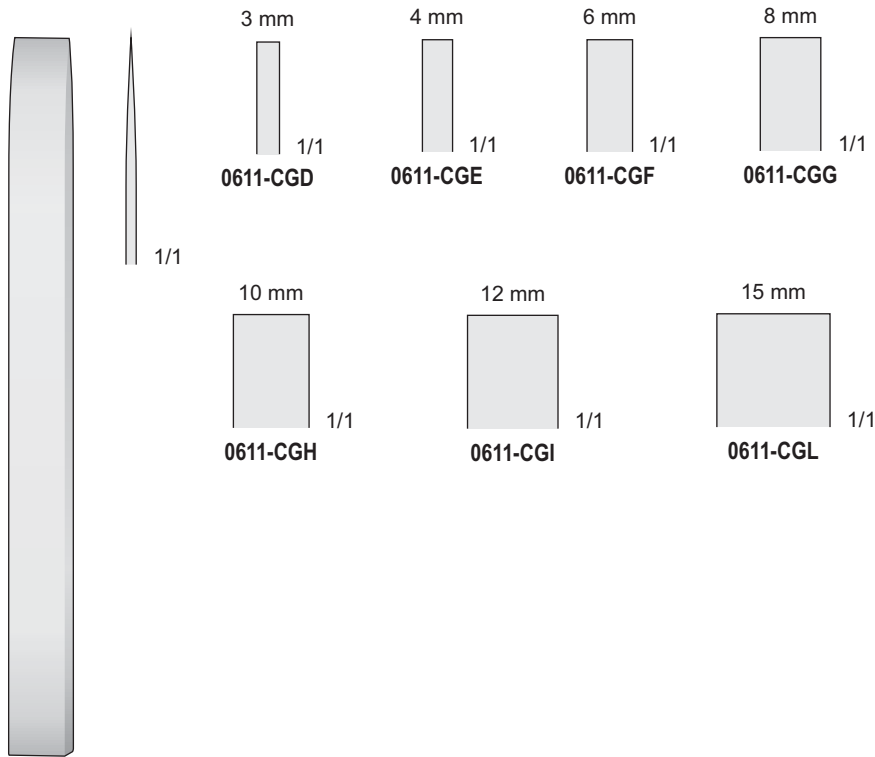

MINI-LAMBOTTE
0611-CGD/0611-CGL
170 mm

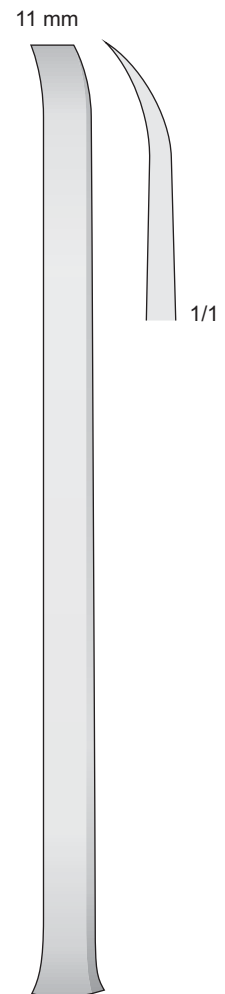

OBWEGESER
0414-BI
235 mm

Osteotome

Osteotomes

Osteotomi

Osteótomos

Ostéotomes

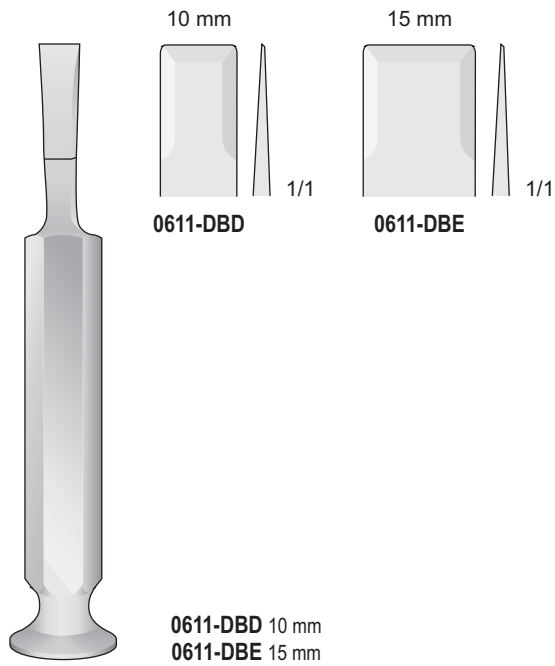

TESSIER
0611-DBD/0611-DBE
160 mm

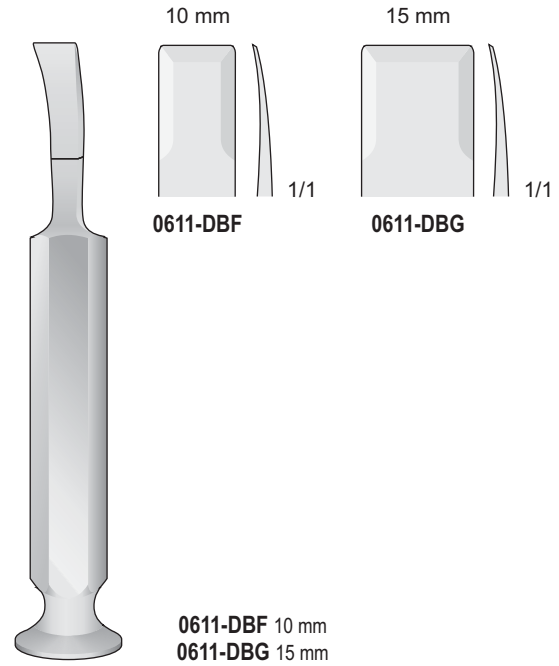

TESSIER
0611-DBF/0611-DBG
160 mm

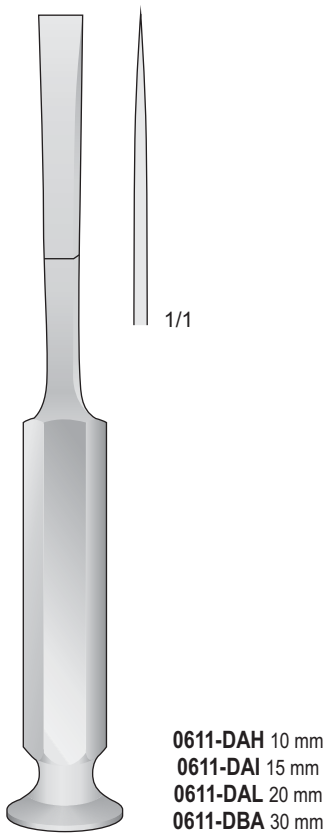

TESSIER
0611-DAH/0611-DBA
200 mm

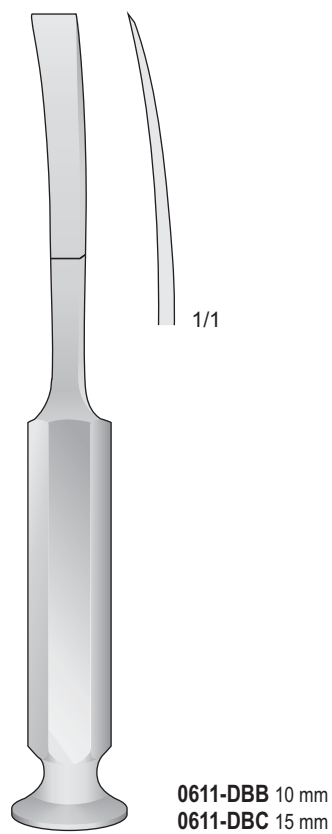

TESSIER
0611-DBB/0611-DBC
200 mm

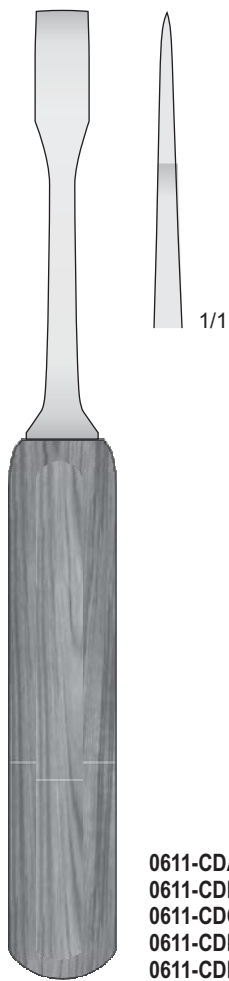

- 0611-CDA 4 mm
- 0611-CDB 6 mm
- 0611-CDC 8 mm
- 0611-CDD 10 mm
- 0611-CDE 12 mm

MINI-LEXER
0611-CDA/0611-CDE
180 mm

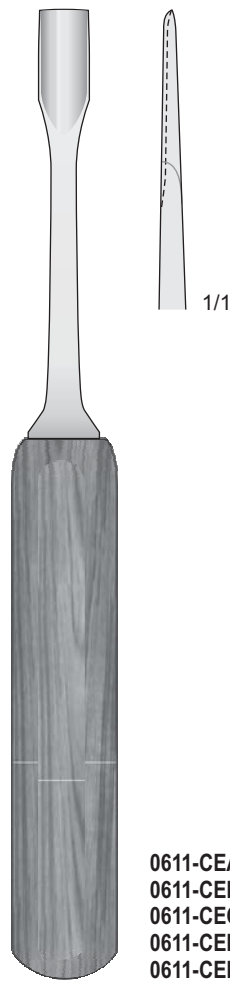

- 0611-CEA 4 mm
- 0611-CEB 6 mm
- 0611-CEC 8 mm
- 0611-CED 10 mm
- 0611-CEE 12 mm

MINI-LEXER
0611-CEA/0611-CEE
180 mm



- 0611-BLA 4 mm
- 0611-BLB 6 mm
- 0611-BLC 8 mm
- 0611-BLD 10 mm
- 0611-BLE 12 mm

LEXER
0611-BLA/0611-BLE
180 mm

Rhinologie

Rhinology

Rinologia

Rinologia

Rhinologie

Nasal septum
Osteotomes, graduated

U form

V form

4 mm

6 mm

8 mm

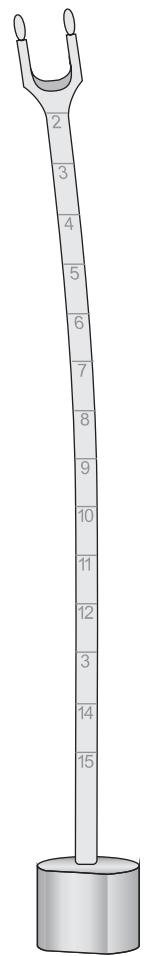
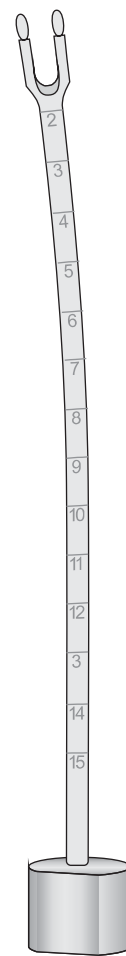
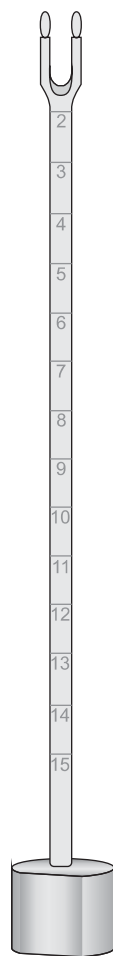
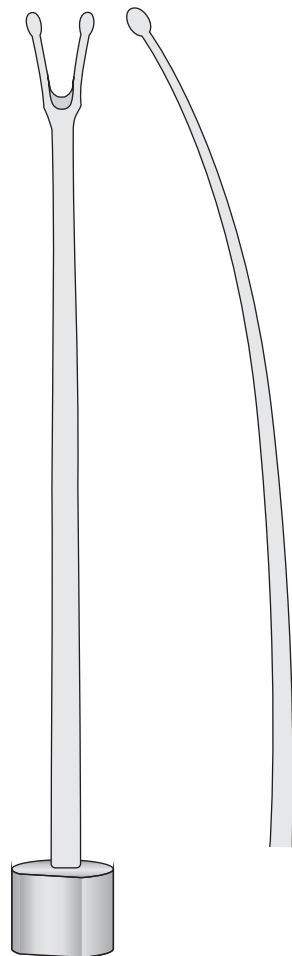
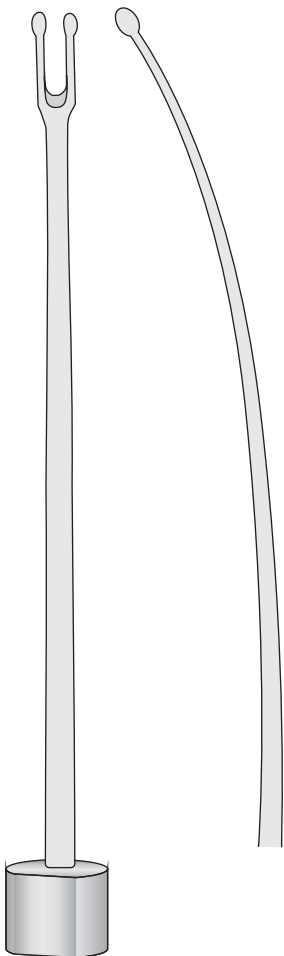

OBWEGESER
0414-BBA
185 mm

OBWEGESER
0414-BBC
185mm

OBWEGESER
0414-BCA
185 mm

OBWEGESER
0414-BCB
185 mm

OBWEGESER
0414-BCC
185 mm

Knochenfeilen

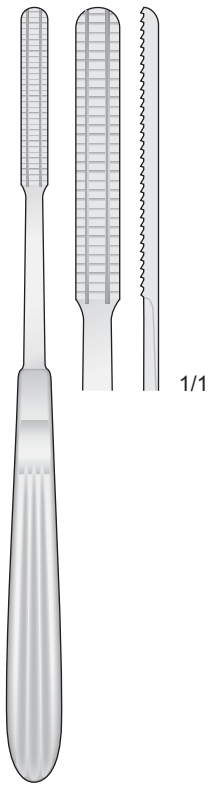

MINI-MALTZ
0414-BHH
170 mm

Bone files

Fig. 67

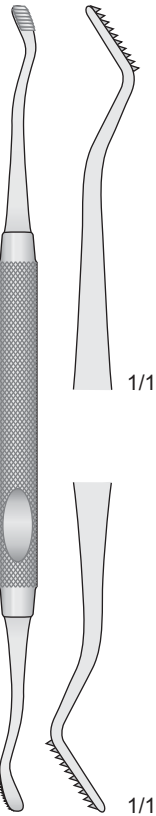

HOWARD
0414-B
180 mm

Lime per osso

Fig. 45

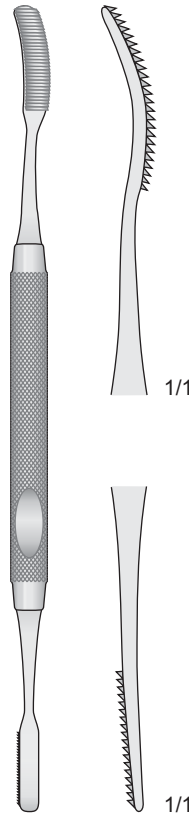

MILLER
0414-C
185 mm

Limas para huesos

Fig. 52

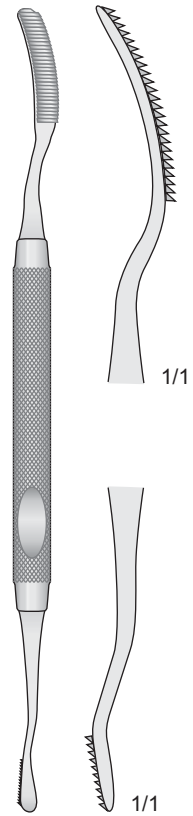

MILLER
0414-D
180 mm

Limes à os

9.0 mm

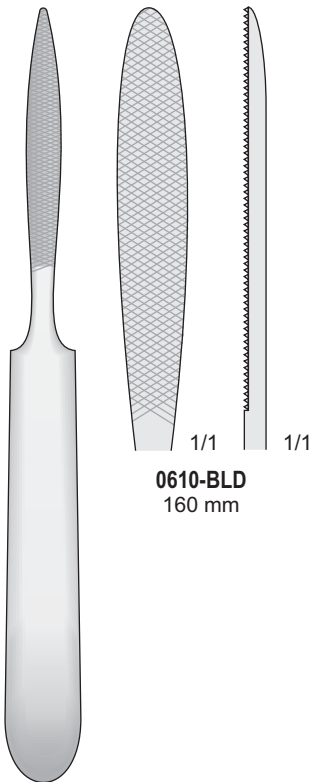

JOSEPH
0610-BLD
160 mm

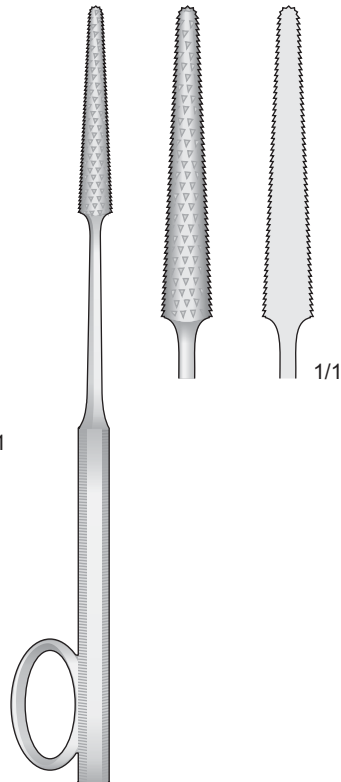

GOOD
0610-BLL
160 mm

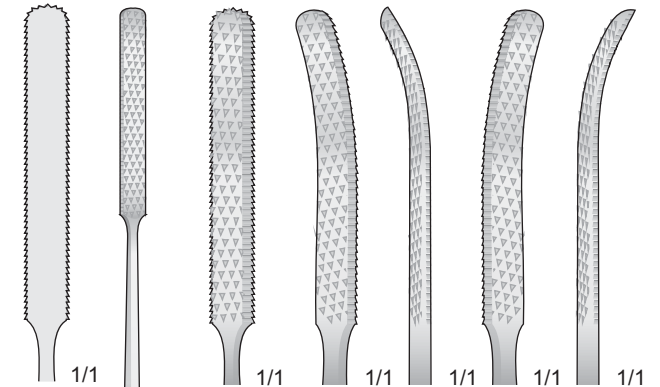

GALLAHER
0610-BLE/0610-BLG
160 mm

0610-BLE
160 mm

0610-BLF
160 mm

0610-BLG
160 mm

Knochenfeilen

Bone files

Lime per osso

Limas para huesos

Limes à os

Nasenfeilen
Nasal Files
Lime nasali
Limas nasales
Limes nasales

Nasenraspel
Nasal Rasp
Raspe nasali
Raspador nasal
Râpe nasales

8 mm



8 mm

0610-LG
210 mm

2 mm



5 mm

0610-LH
210 mm



1/1



1/1

8 mm



8 mm

0610-LI
210 mm

8 mm



8 mm

0610-LL
210 mm

Knochenfeilen

Bone files

Lime per osso

Limas para huesos

Limes à os

Nasenfeilen
Nasal File
Lima nasale
Lima nasales
Lime nasales

Nasenraspel
Nasal Rasp
Raspa nasale
Raspador nasal
Râpe nasale

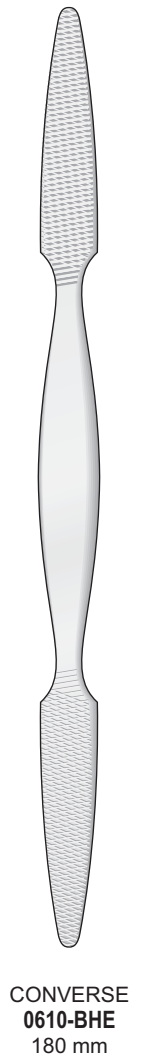
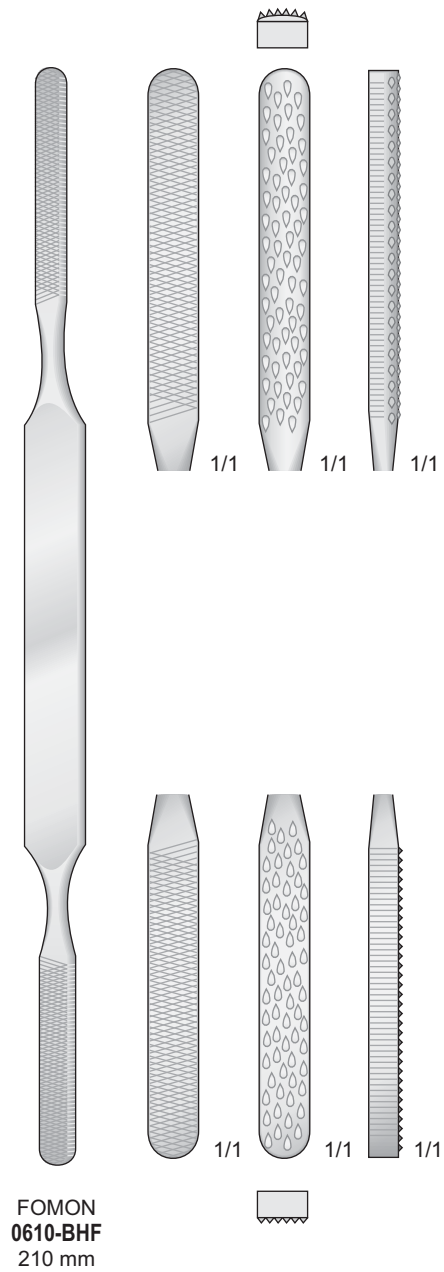
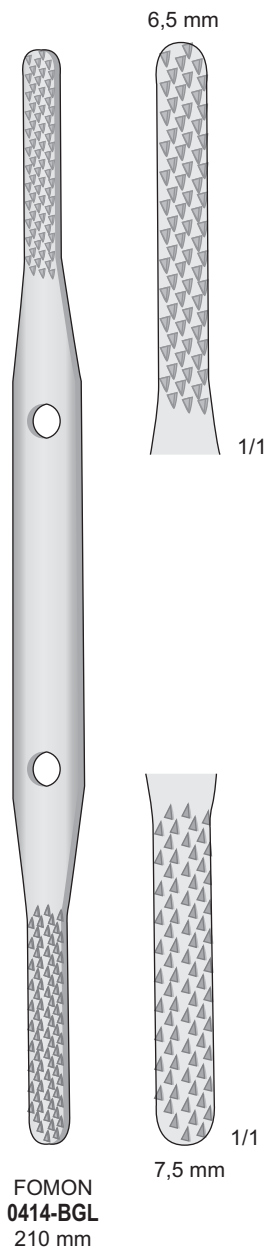
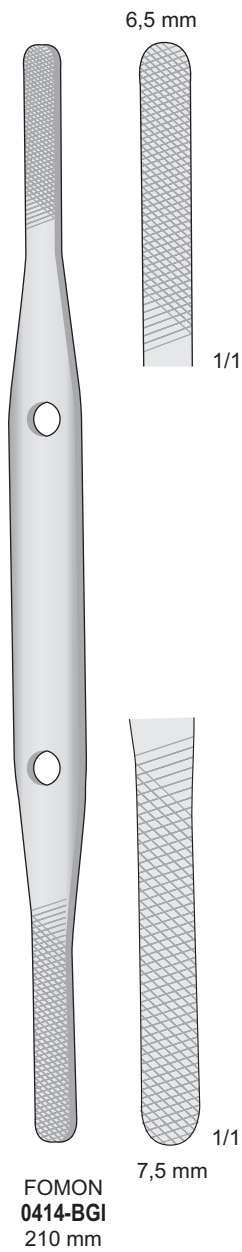

Nasenraspeln

Nasal Rasps

Raspe nasali

Raspadores nasales

Rapes nasales

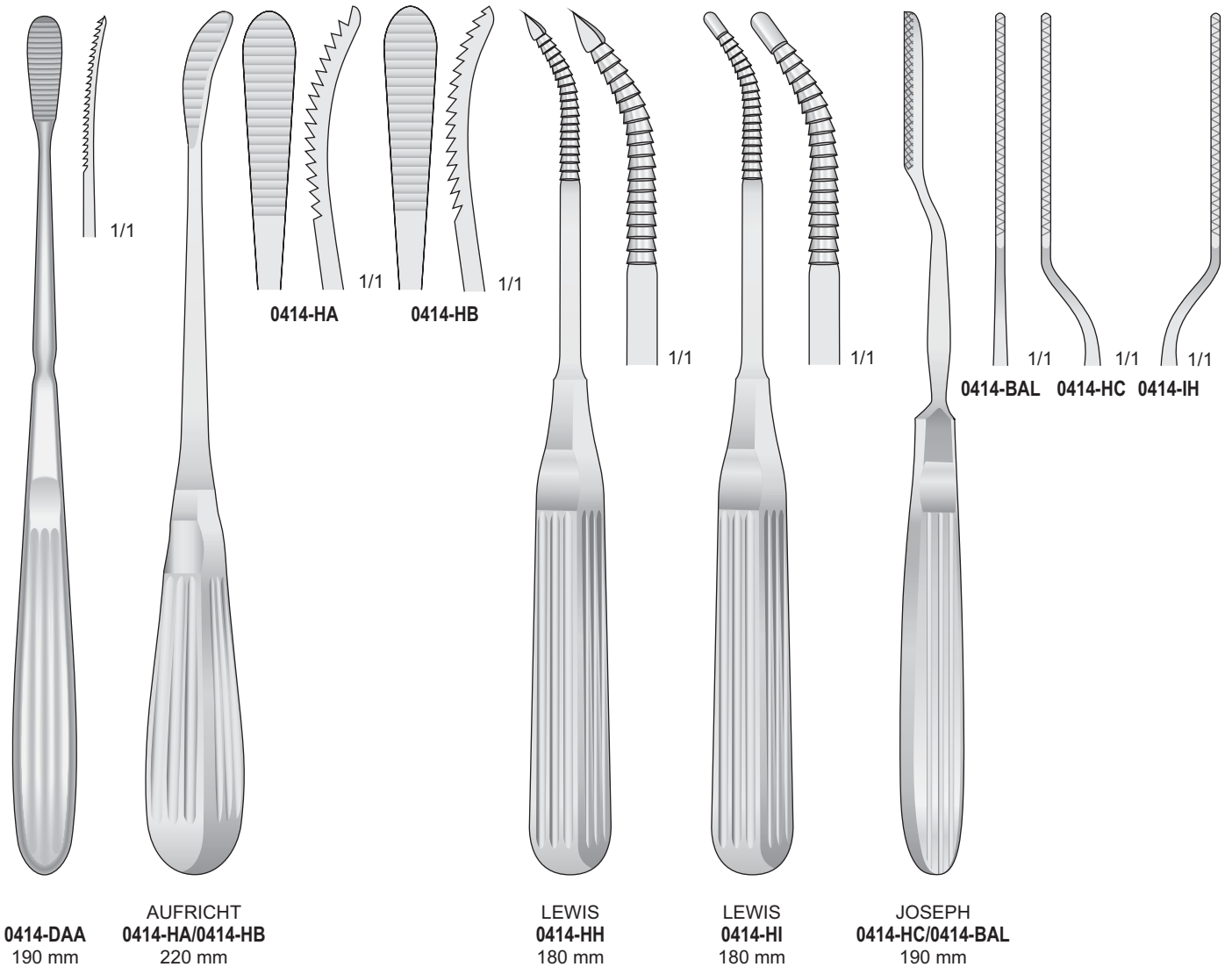

Rhinologie

Rhinology

Rinologia

Rinologia

Rhinologie

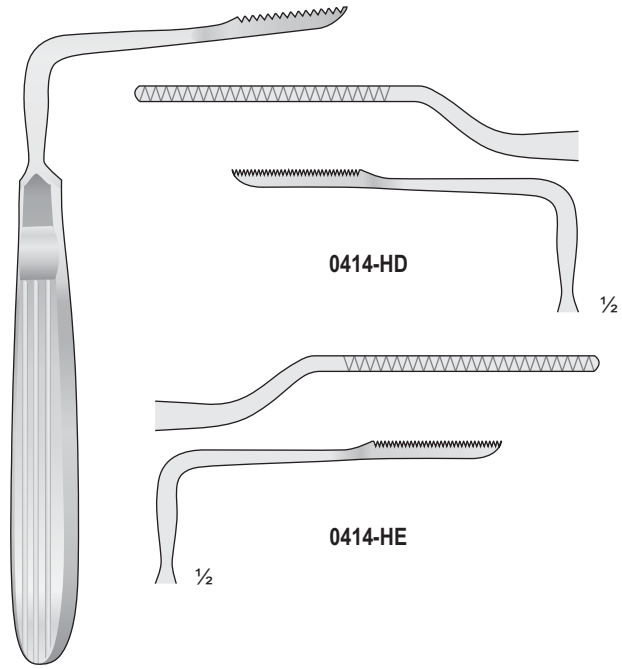

JOSEPH
0414-HD/0414-HE
135 mm

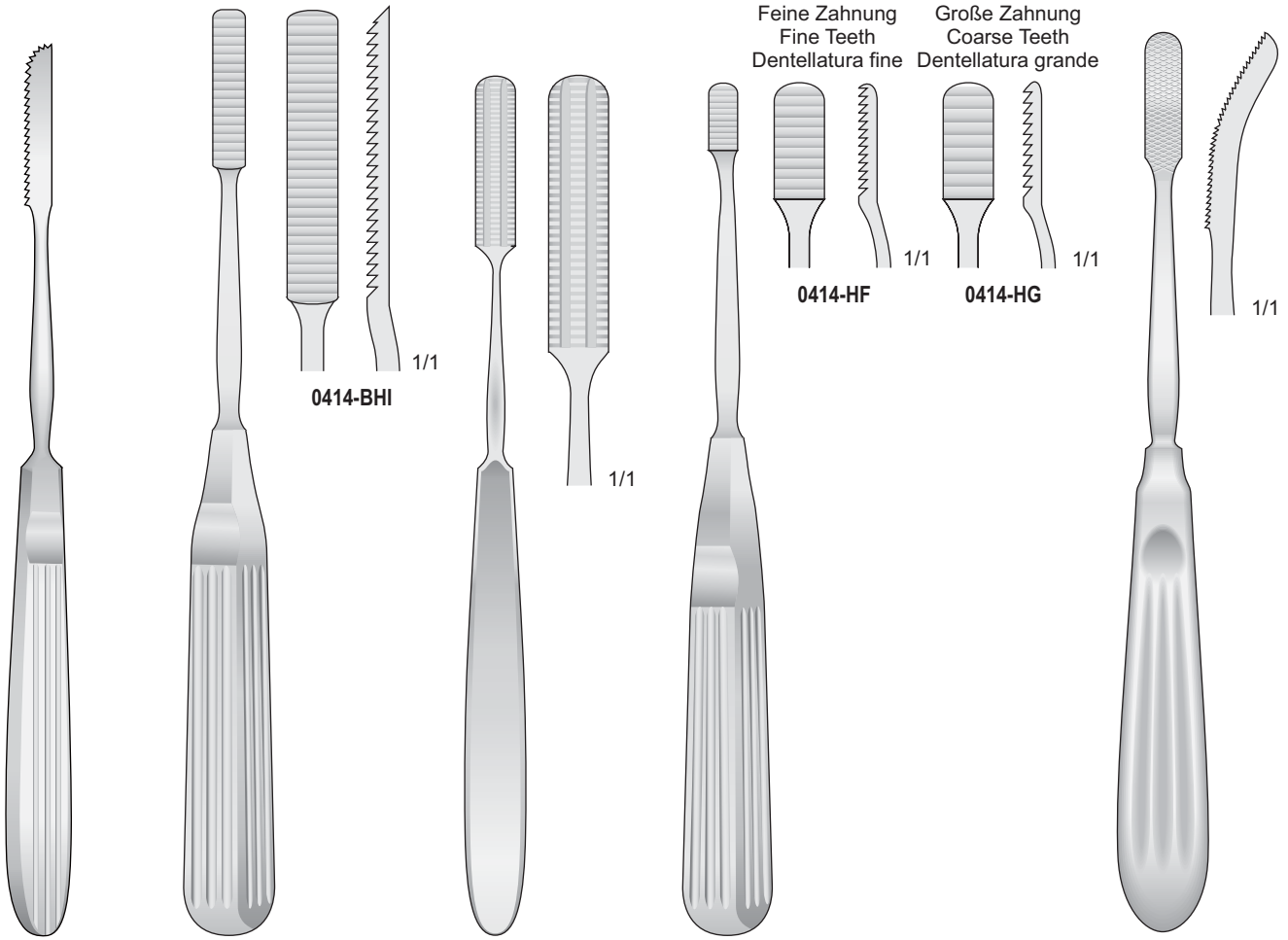

0414-CGH
190 mm

COTTLE
0414-BHI
210 mm

MALTZ
0414-BHL
180 mm

LEWIS
0414-HF/0414-HG
180 mm

0414-BIL
195 mm

Nasenraspeln
Knochenfeilen

Nasal Rasps
Bone files

Raspe nasali
Lime per osso

Raspadores nasales
Limas para huesos

Rapes nasales
Limes à os

Mit hartmetalleinsätzen - Tungsten-carbide inserts
Con punta al carburo di tungsteno - Con placas de carburo tungsteno
Avec plaquettes en carbure de tungstène

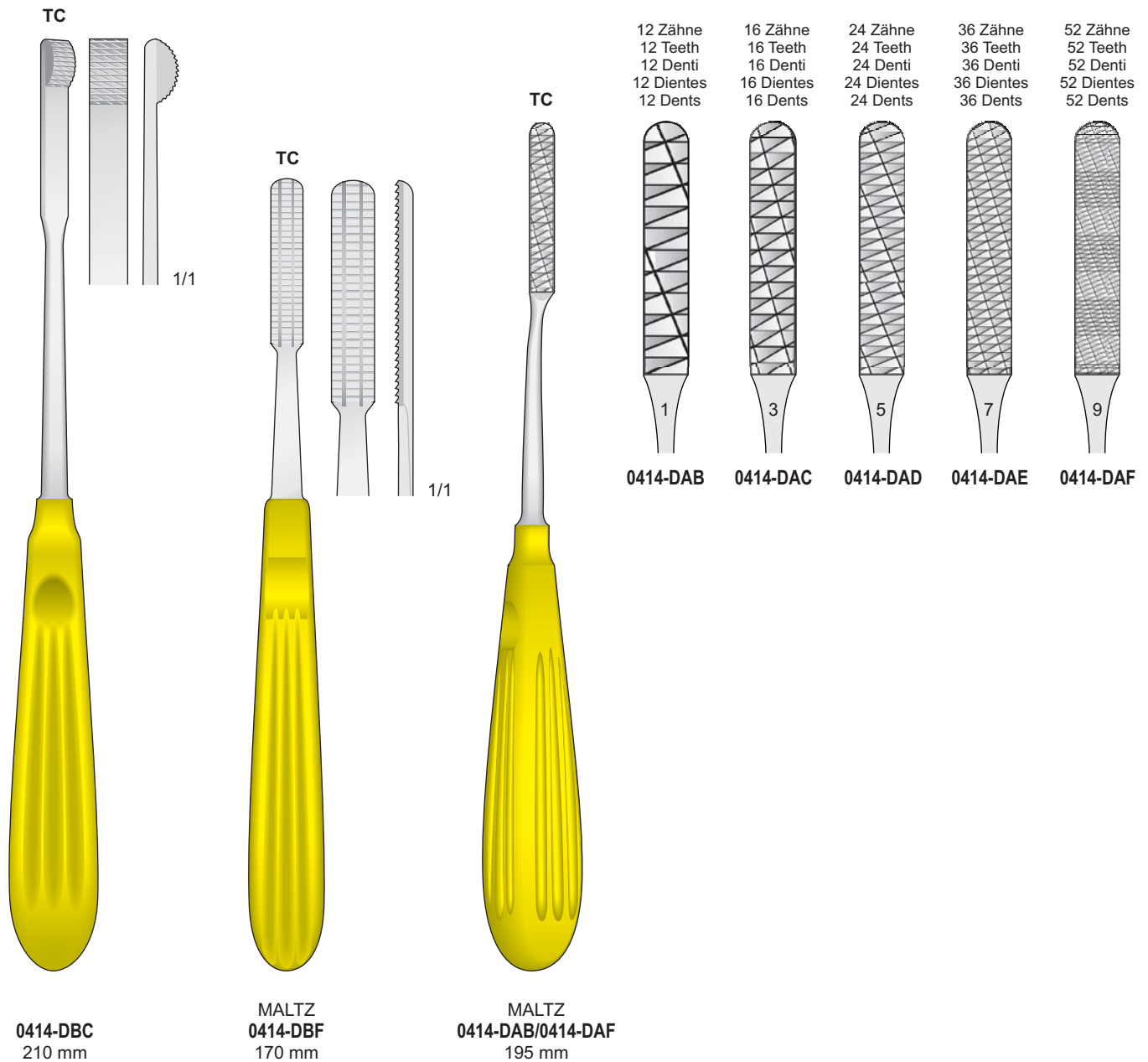

Nasenraspeln
Knochenfeilen

Nasal Rasps
Bone files

Raspe nasali
Lime per osso

Raspadores nasales
Limas para huesos

Rapes nasales
Limes à os

Mit hartmetalleinsätzen - Tungsten-carbide inserts
Con punta al carburo di tungsteno - Con placas de carburo tungsteno
Avec plaquettes en carbure de tungstène

Diamantaufilage
Diamond Jaw
Punte diamantate
Con punta diamantadas
Avec Embout diamantées

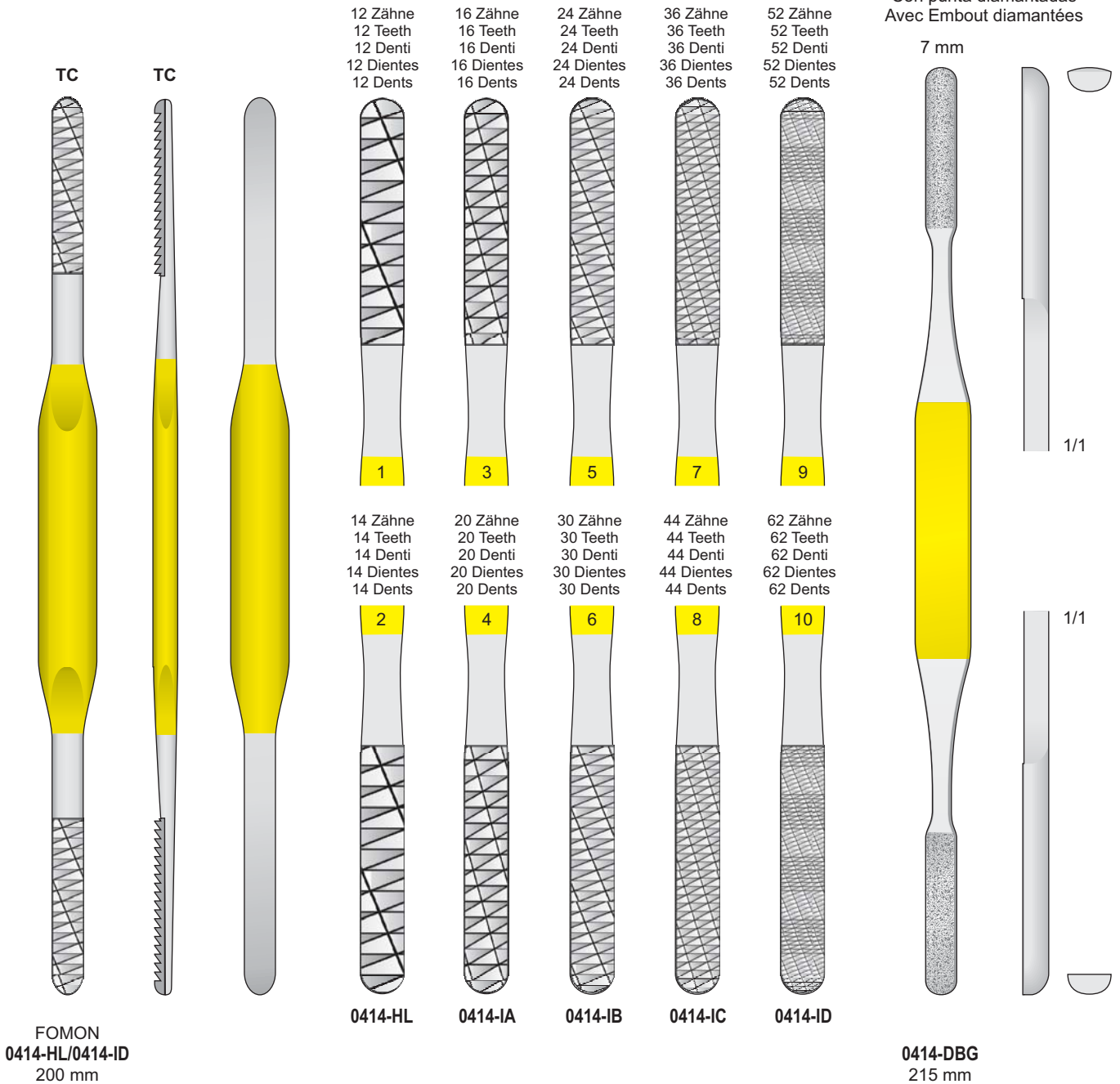

Rhinologie

Rhinology

Rinologia

Rinologia

Rhinologie

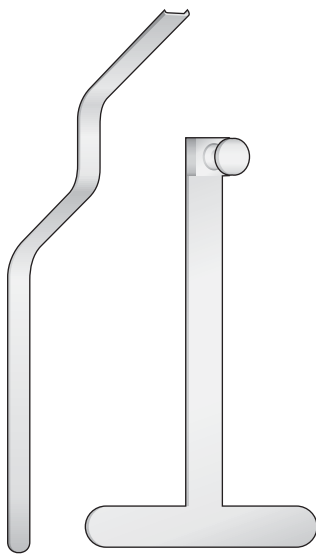

COTTLE
0414-CGD



Knochen-Knorpelquetsche
Bone crusher
Strumento per rotture e asportazione
frammenti ossei e cartilagine
Instrumento para magullar cartilagos
Instrument à écraser le cartilage

COTTLE
0414-CGE



0402-GA Ø 2,5 mm
0402-GB Ø 3,0 mm
0402-GC Ø 4,0 mm
0402-GD Ø 5,0 mm

RITTER
0402-GA/0402-GD
160 mm



Meißel zur endonasalen
Kieferhöhlenöffnung
Antrum Trocar chisel
Sgorbia per l'apertura endonasale
della cavità mascellare
Cinzel para la apertura
endonasal del seno maxilar
Gouge pour l'ouverture de la cavité
endonasale pour sinus maxillaire

FAULKNER
0414-BHD
170 mm

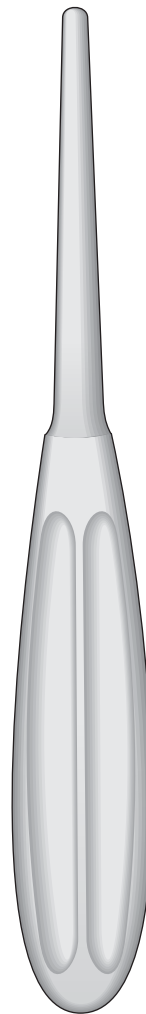

GOLDMANN
0414-CII
200 mm

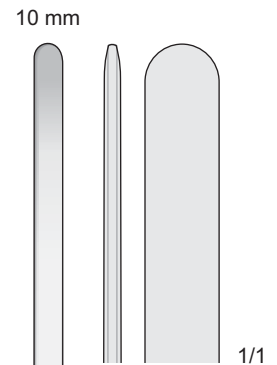

BOIES
0414-CIL
200 mm

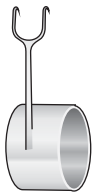

COTTLE
0414-CFL

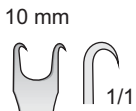

KILLNER
0219-CHD
80 mm



COTTLE
0219-BLG
160 mm



COTTLE
0219-BLH/0219-BLL
150 mm



Fig. 1
0219-BLH

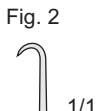

Fig. 2
0219-BLI

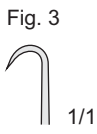

Fig. 3
0219-BLL



FRAZIER
0219-DGC 130 mm
0219-DGD 180 mm



1/1
Scharf
Sharp
Acuto
Agudo
Pointus



FRAZIER
0219-DGE 130 mm
0219-DGF 180 mm



1/1
Stumpf
Blunt
Smusso
Romo
Mousses

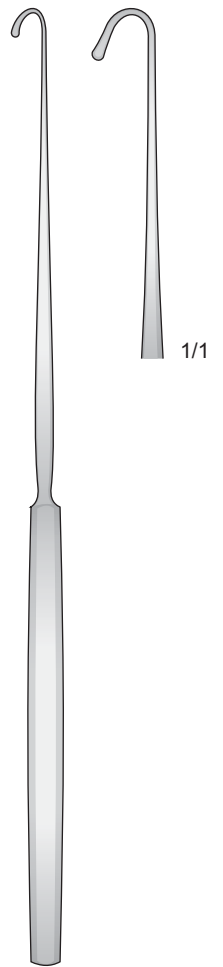

LANGE
1014-GA
220 mm

Wundhaken

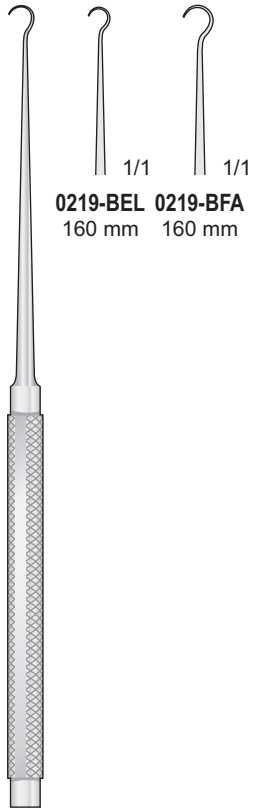

KLEINERT-KUTZ
0219-BEL/0219-BFA
160 mm

Retractors

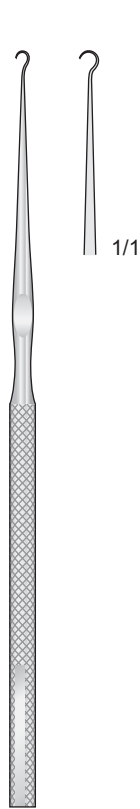

KILNER
0219-FD
150 mm

Divaricatori

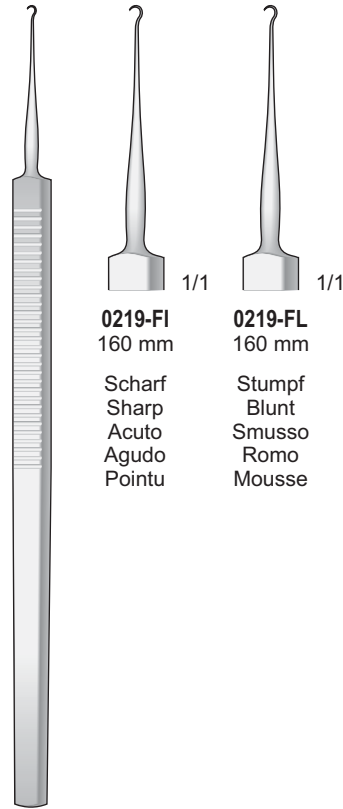

GRAEFE
0219-FI/0219-FL
160 mm

Separadores

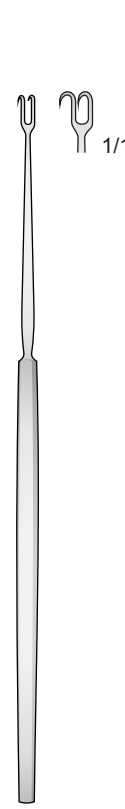

FREER
0219-CAA
150 mm

Ecarteurs

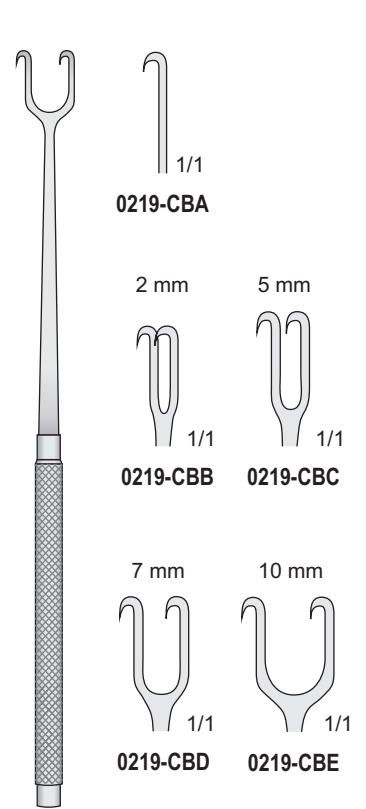

JOSEPH
0219-CBA/0219-CBE
160 mm

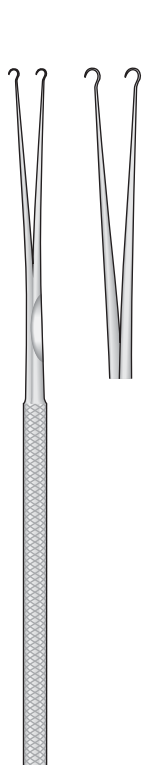

BARSKY
0219-DHA
150 mm



FOMON
0219-CBL
160 mm

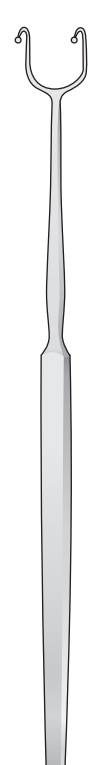

FOMON
0219-CBI
160 mm

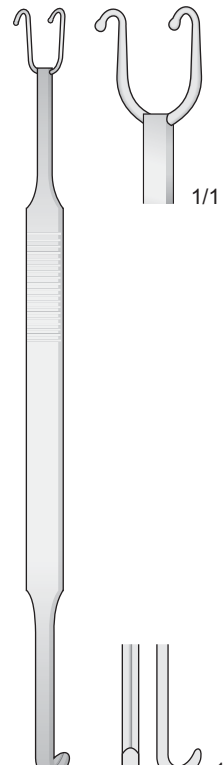

COTTLE-NEIVERT
0219-FH
200 mm

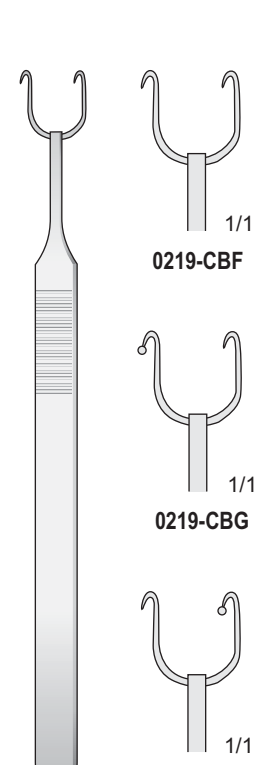

COTTLE
0219-CBF/0219-CBH
150 mm

Nasenplastik

Rhinoplastic

Rinoplastica

Rhinoplasty

Rinoplastic

Instrumente zur Nasenplastik
Instrument for Rhinoplastic

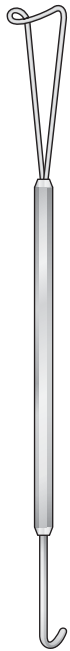

NEIVERT
0219-DID
160 mm



1/1



40 x 7 mm

Stumpf
Blunt
Smussa
Romas
Mousse



11 mm

1/1

AUFRICHT
0219-DIB
135 mm

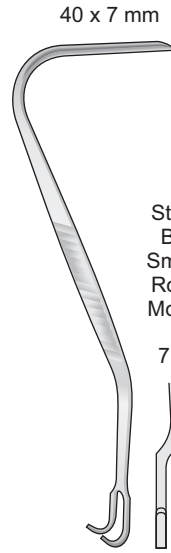

40 x 7 mm

Stumpf
Blunt
Smussa
Romas
Mousse

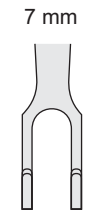

7 mm

1/1

AUFRICHT-WALTER
0219-DIH
135 mm

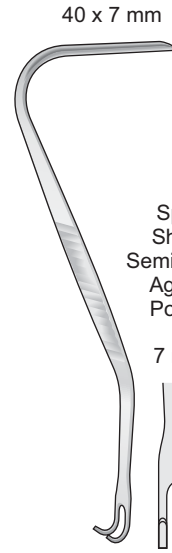

40 x 7 mm

Spitz
Sharp
Semi Acuta
Aguda
Pointu



7 mm

1/1

AUFRICHT-WALTER
0219-DII
135 mm

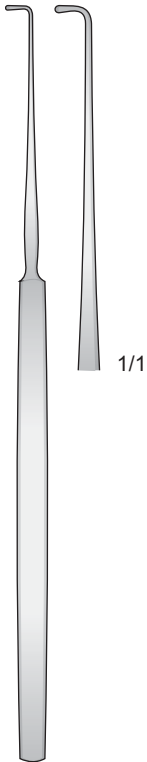

CUSHING
0219-CLG
190 mm

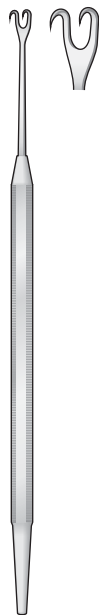

COTTLE
0219-DIC
150 mm



YANKAUER
0212-BFB/0212-BFL
170 mm



0212-BFB



0212-BFC

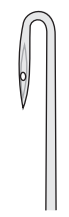

0212-BFD

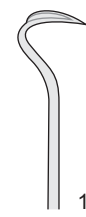

0212-BFE

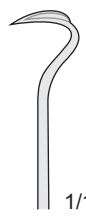

0212-BFF

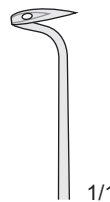

0212-BFG

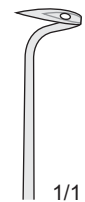

0212-BFH

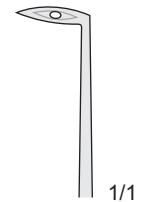

0212-BFI

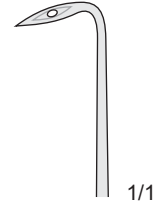

0212-BFL

Scharfe Küretten
 Sharp Curettes
 Curette taglienti
 Cucharillas cortante
 Curettes Tranchantes

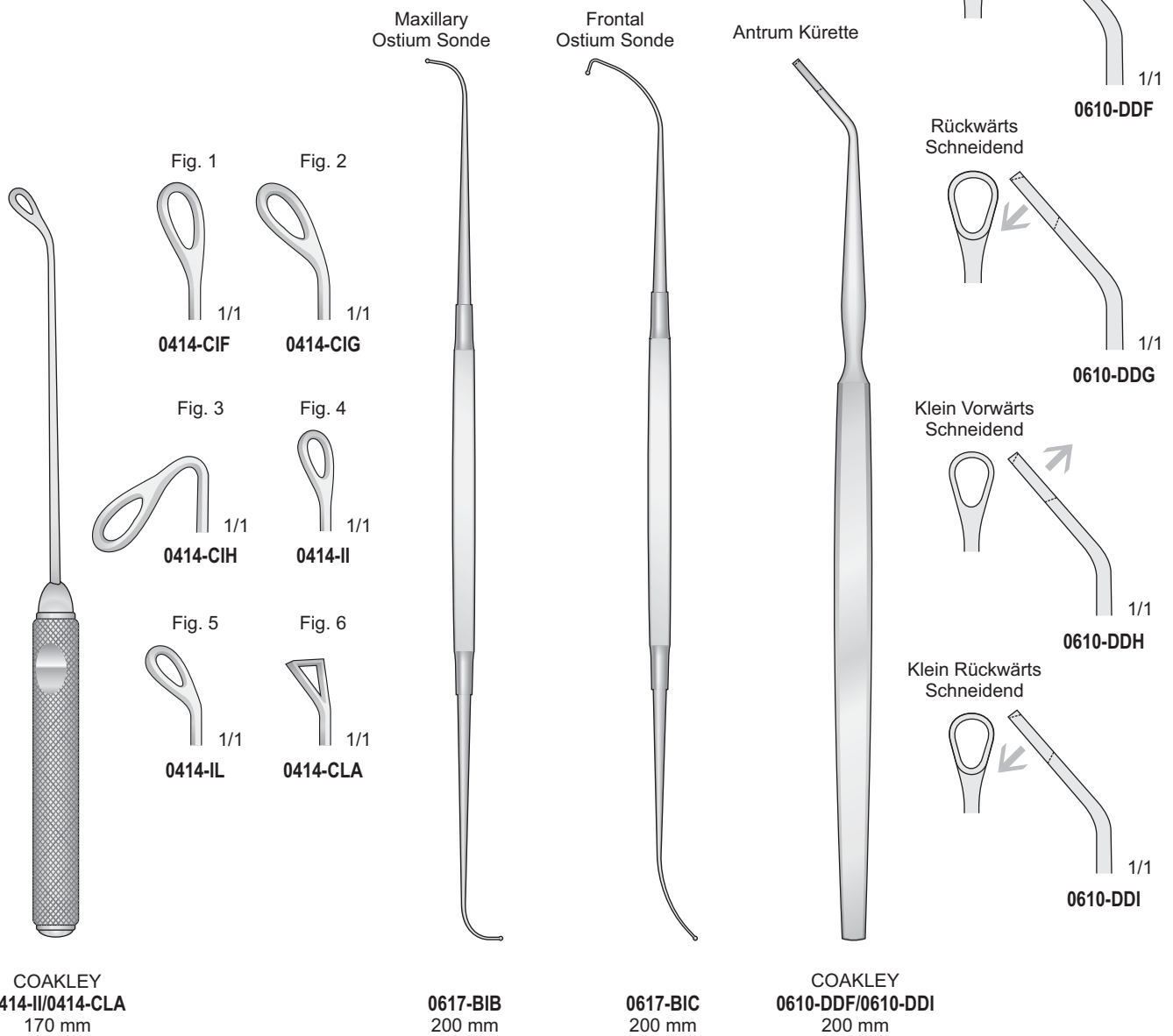

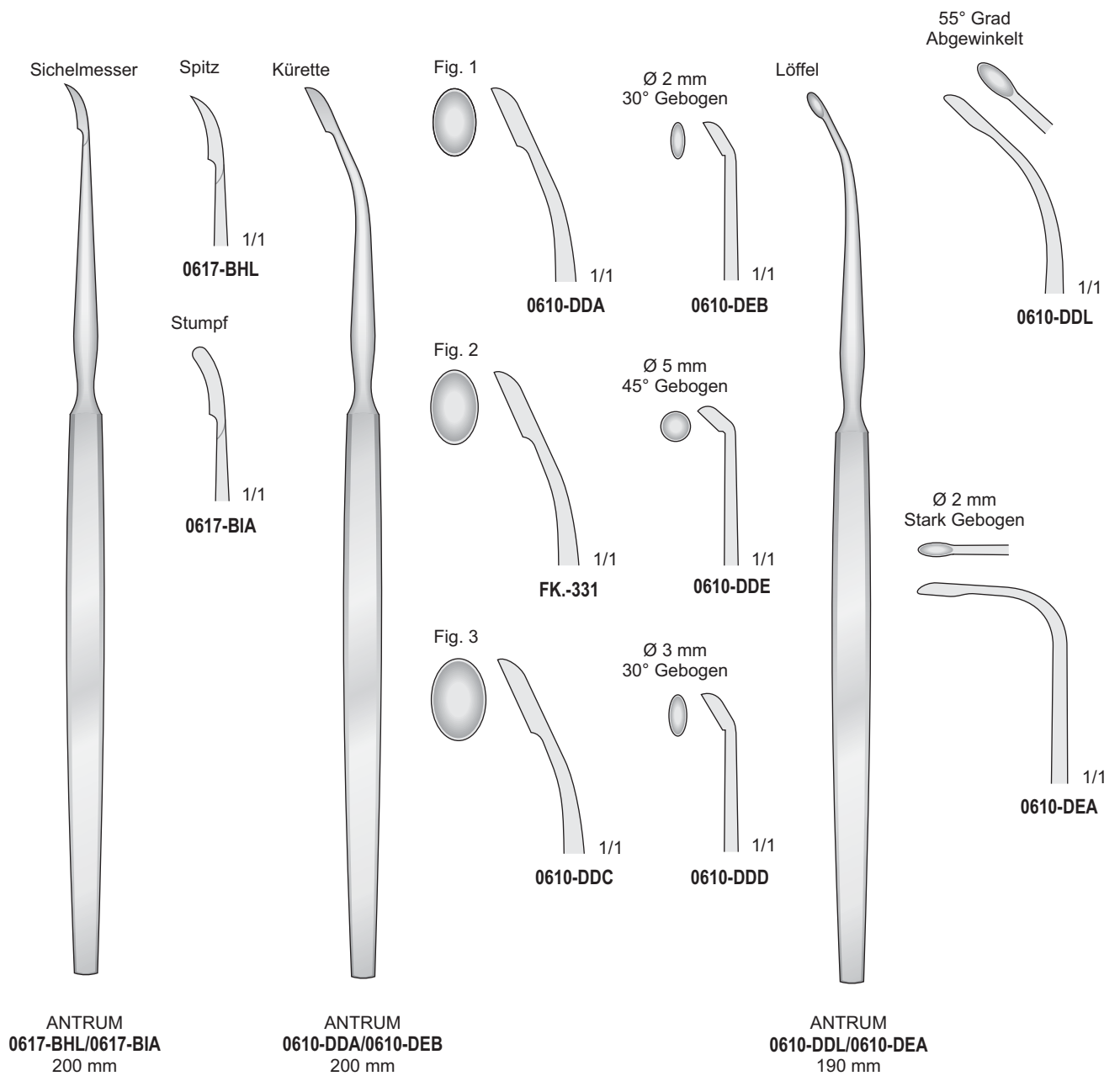

Rhinologie

Rhinology

Rinologia

Rinologia

Rhinologie

Nasenzange, aufeinanderschneidend
Nasal forceps, spoon-shaped, biting

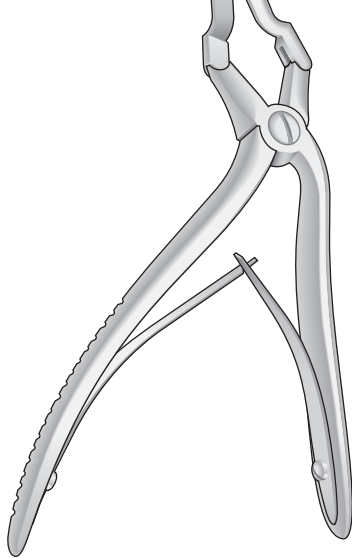
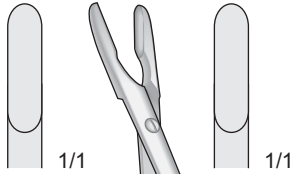

JANSEN-MIDDLETON
0614-BFA
200 mm

Nasenzange, durchschneidend
Nasal forceps, trough cutting

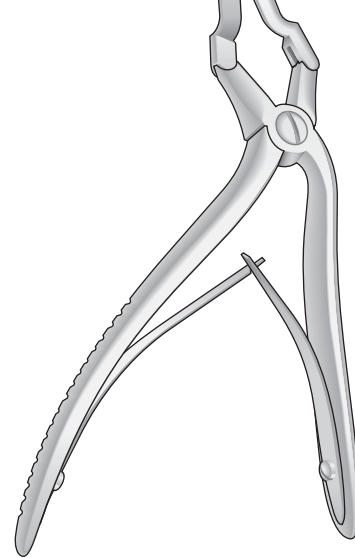
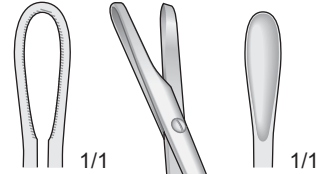

JANSEN-MIDDLETON
0614-BFB
200 mm

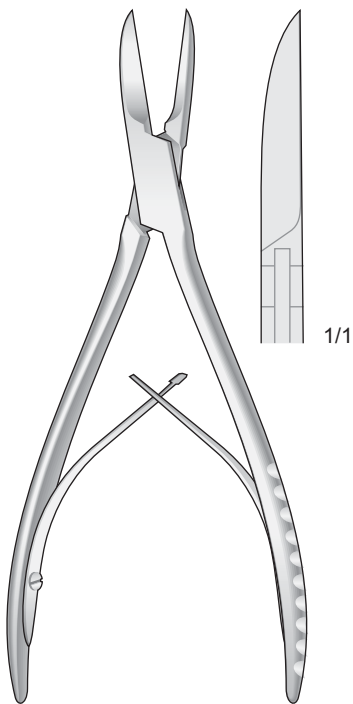

COTTLE-KAZANJIAN
0614-LF
190 mm

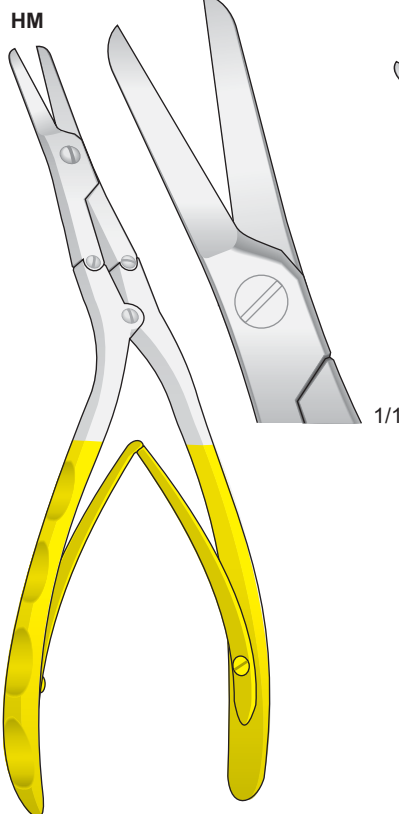

CAPLAN
0614-BEE
200 mm

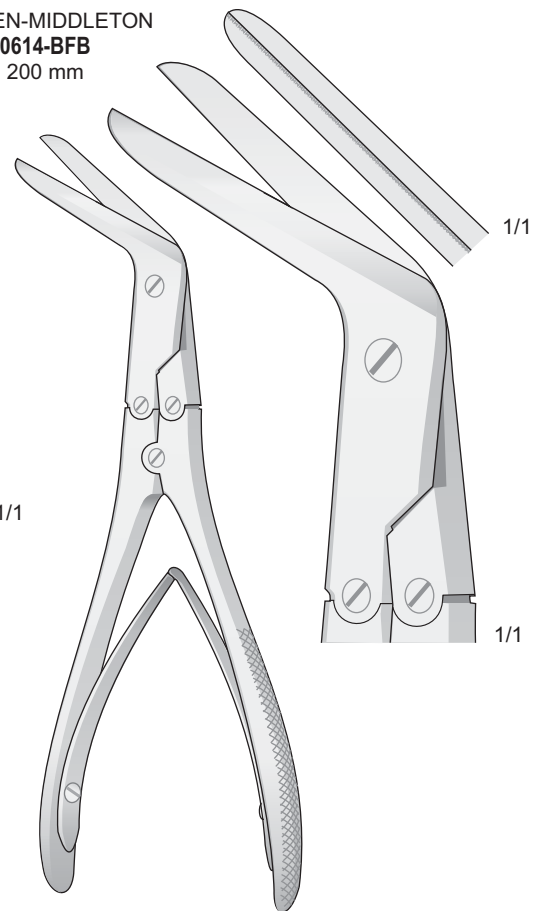

KILLIAN
0614-BED
210 mm

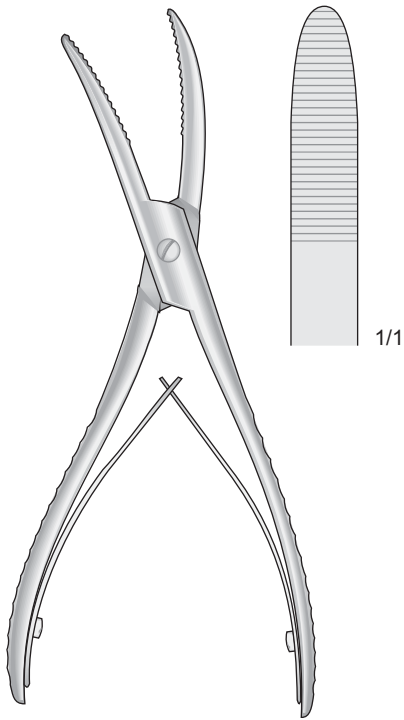

WOLFF
1123-BBD
180 mm

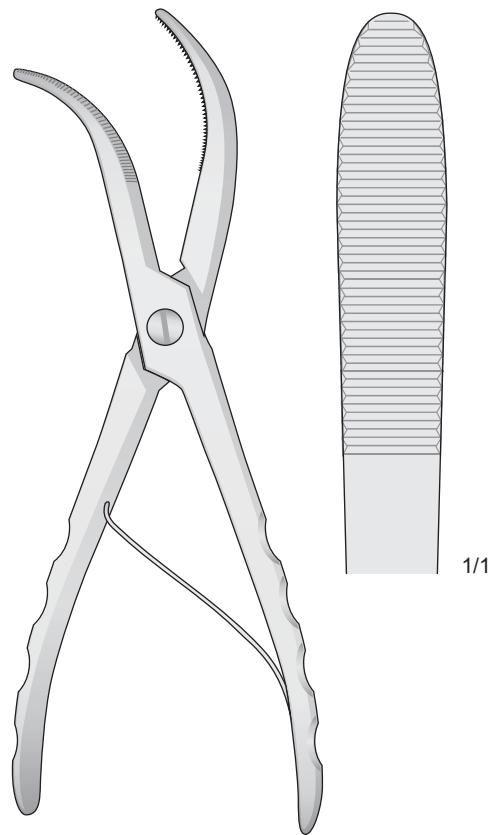

WOLFF
1123-BBE
250 mm

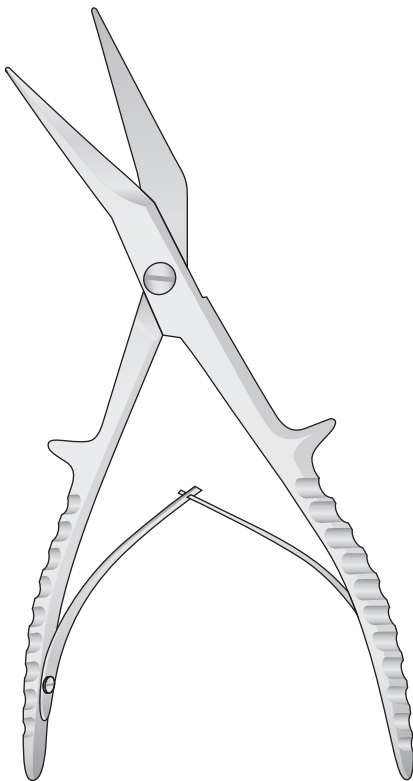

0607-BBA
195 mm

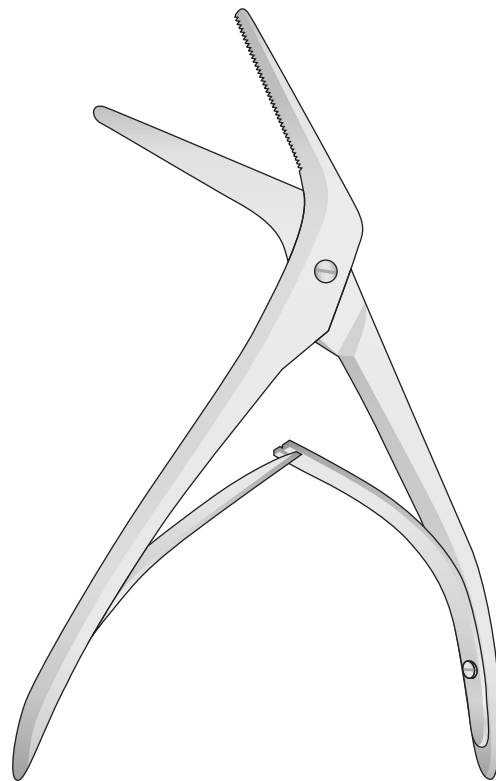

JACKSON-TESSIER
0607-BBB
190 mm

Rhinologie

Rhinology

Rinologia

Rinologia

Rhinologie

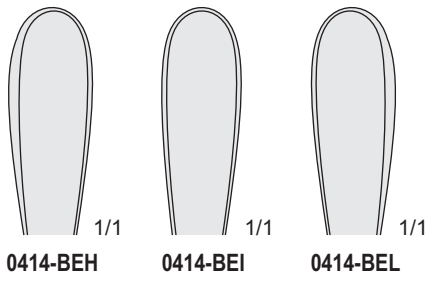
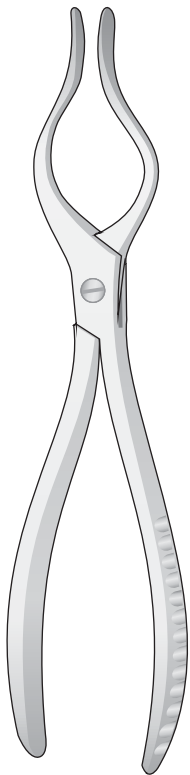

COTTLE-WALSHAM
0414-BEH/0414-BEL
230 mm

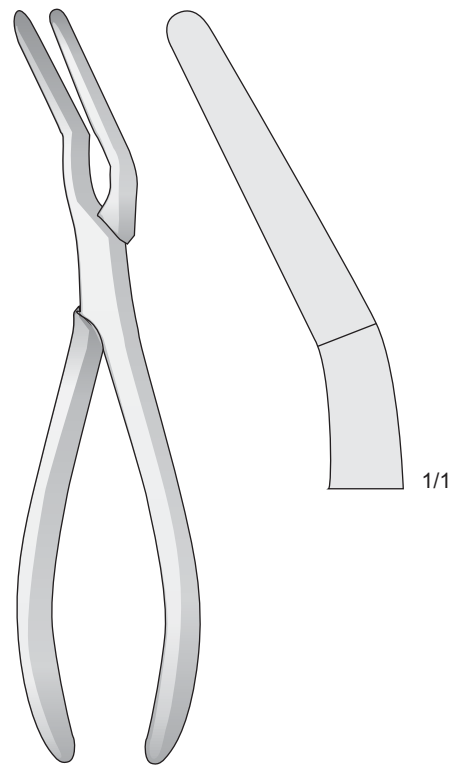

ASCH
0414-BFH
230 mm

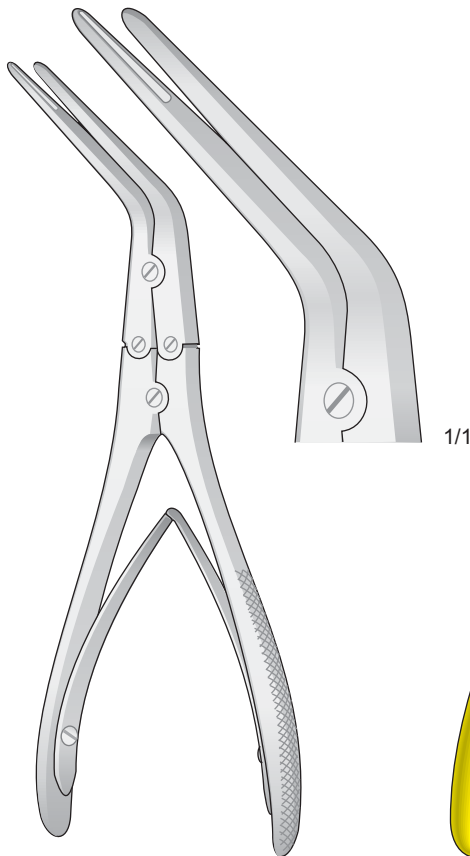

KRESSNER
0614-BEB
200 mm

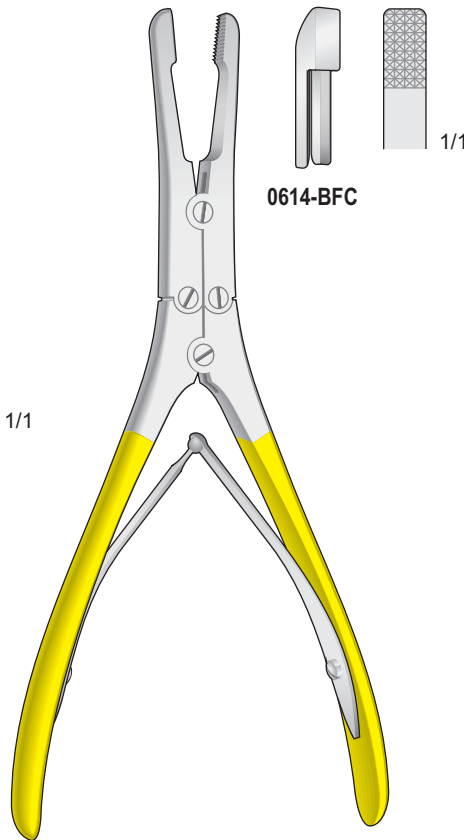

GORNEY
0614-BDC
205 mm

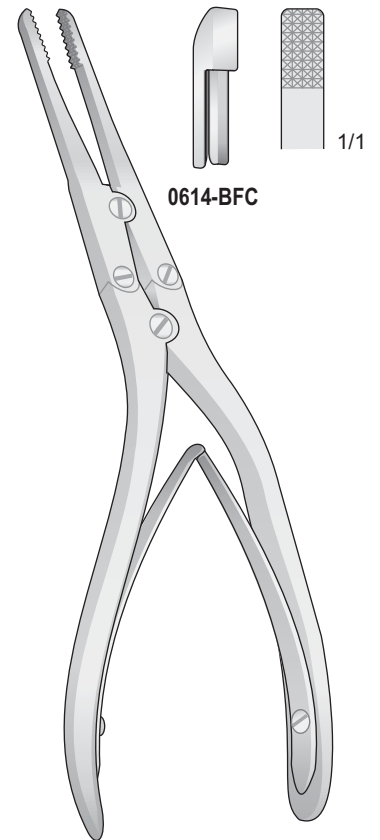

RUBIN
0614-BEC
210 mm

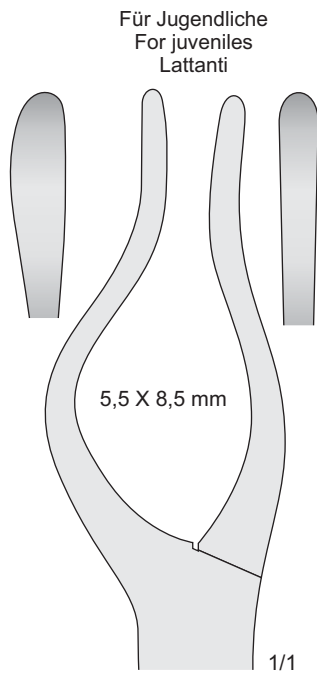

0414-BA
0414-BB
225 mm

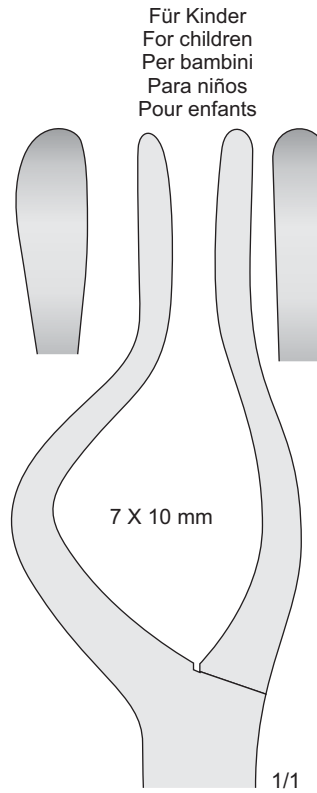

0414-BC
0414-BD
235 mm

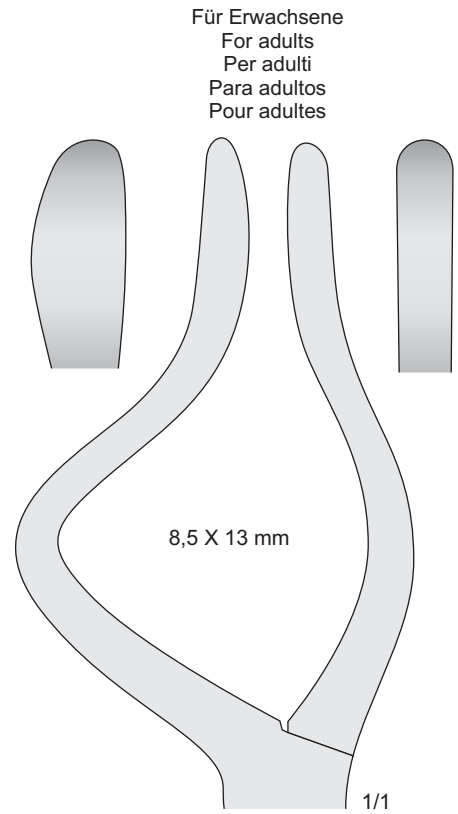

0414-BE
0414-BF
240 mm

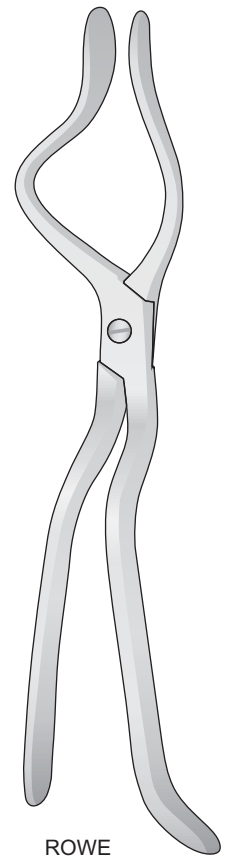
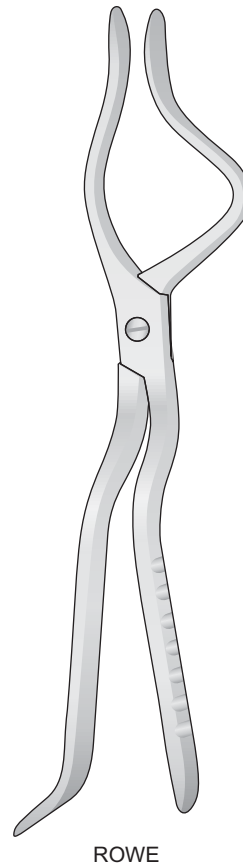
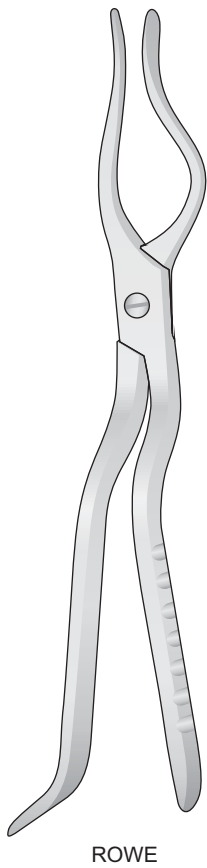

**Knochenchirurgie
Wundhaken**

**Bone holding forceps
Retractors**

**Chirurgia ossea
Divaricatori**

**Pinzas para huesos
Separadores**

**Chirurgie osseuse
Ecarteurs**

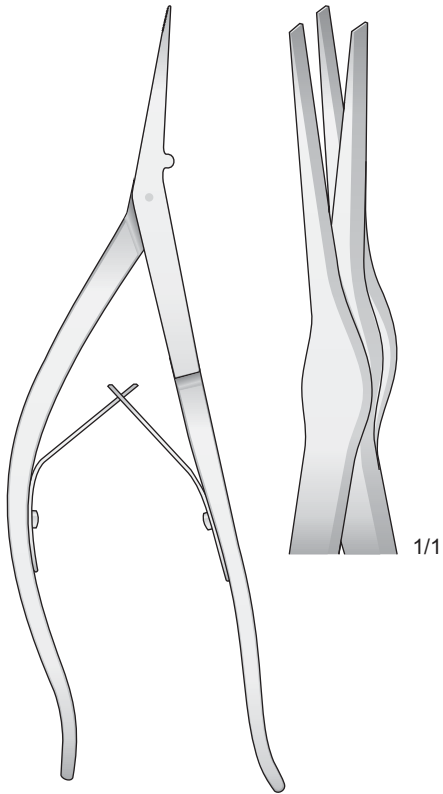

**RAMUS
0414-CEH
230 mm**

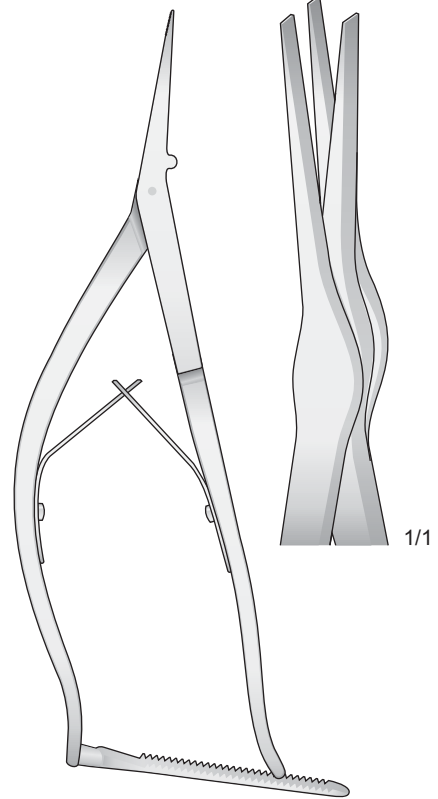

**RAMUS
0414-CEI
230 mm**

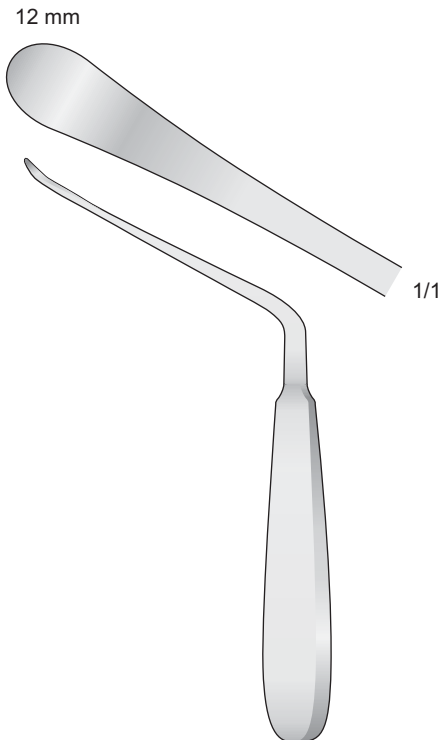

**0414-BCF
210 mm**

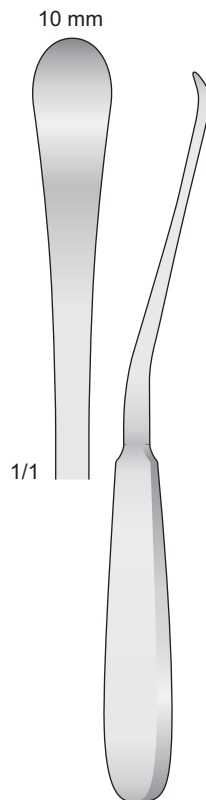

**0414-BCG
235 mm**

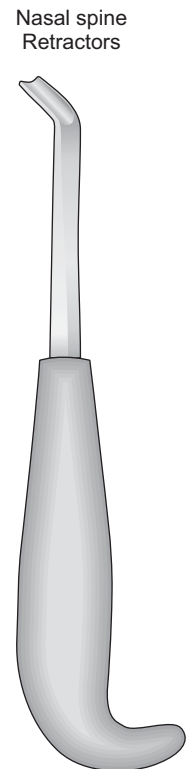

**0414-BAI
190 mm**

3.1



Mund, Hals, Throat
Mouth, Throat, Larinx
Bocca, Gola, Laringe
Boca, Garganta, Laringe
Bouche, Gorge, Larinx

Adenotomie
Adenotomy
Adenotomia
Adenotomía
Adénotomie

Adenoidectomy - Adenotomie - Adenotomi
Adenoides - Adénoïdes

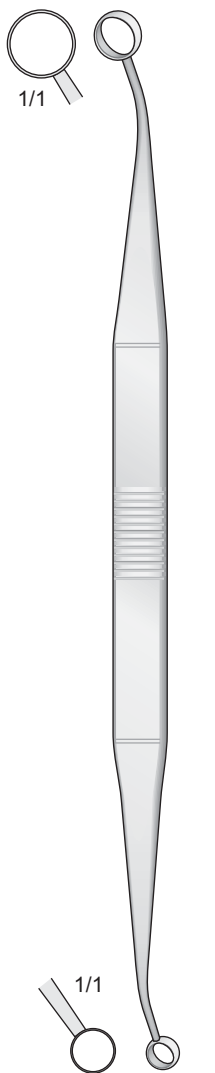

FAULKNER
0610-DEC
210 mm

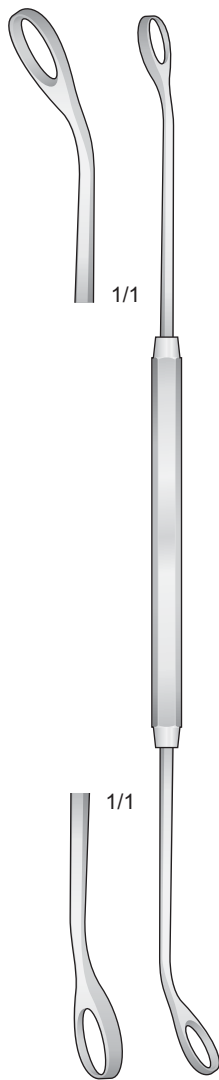

COAKLEY
0610-DED
200 mm

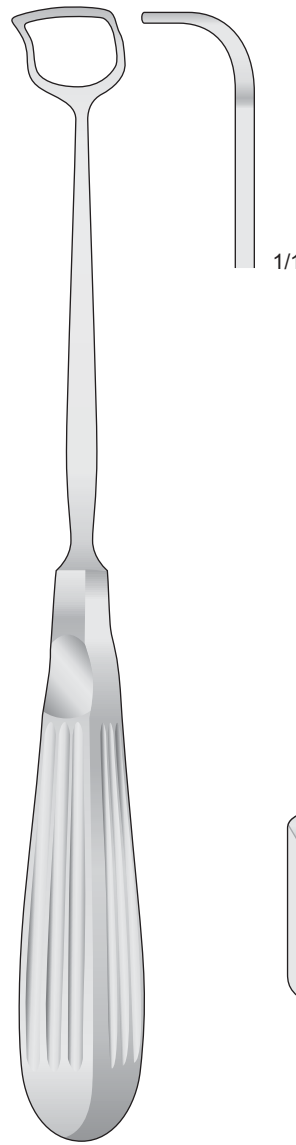

BECKMANN
0219-IE/0219-IL
220 mm

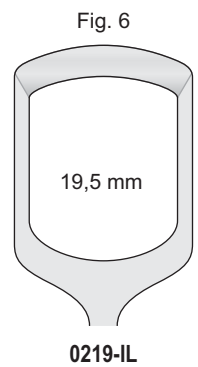
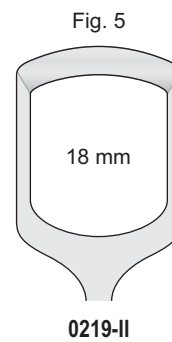
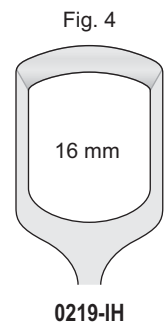
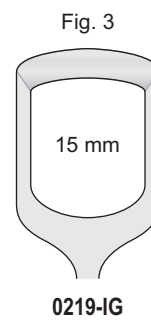
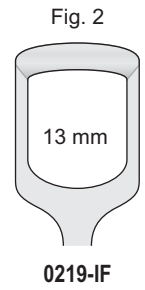
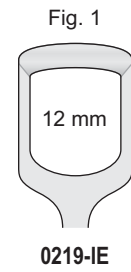

Adenotomie

Adenoidectomy

Adenotomi

Adenoides

Adénoïdes



BARNHILL
0219-DLG/0219-DLL
200 mm

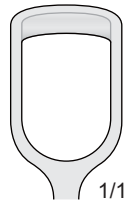

0219-DLG

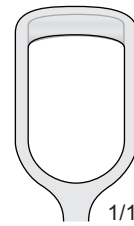

0219-DLH

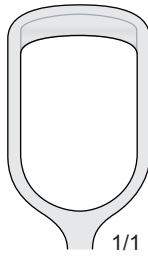

0219-DLI

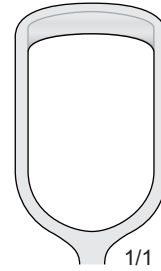

0219-DLL



BECKMANN
0219-DLA/0219-DLF
220 mm

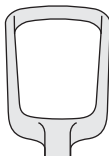

0219-DLA

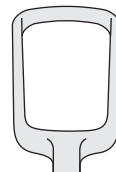

0219-DLB

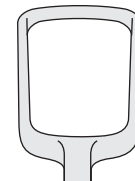

0219-DLC

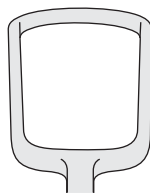

0219-DLD

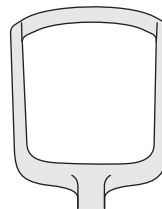

0219-DLE

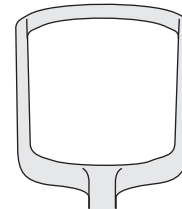

0219-DLF

Punches - Stanzen

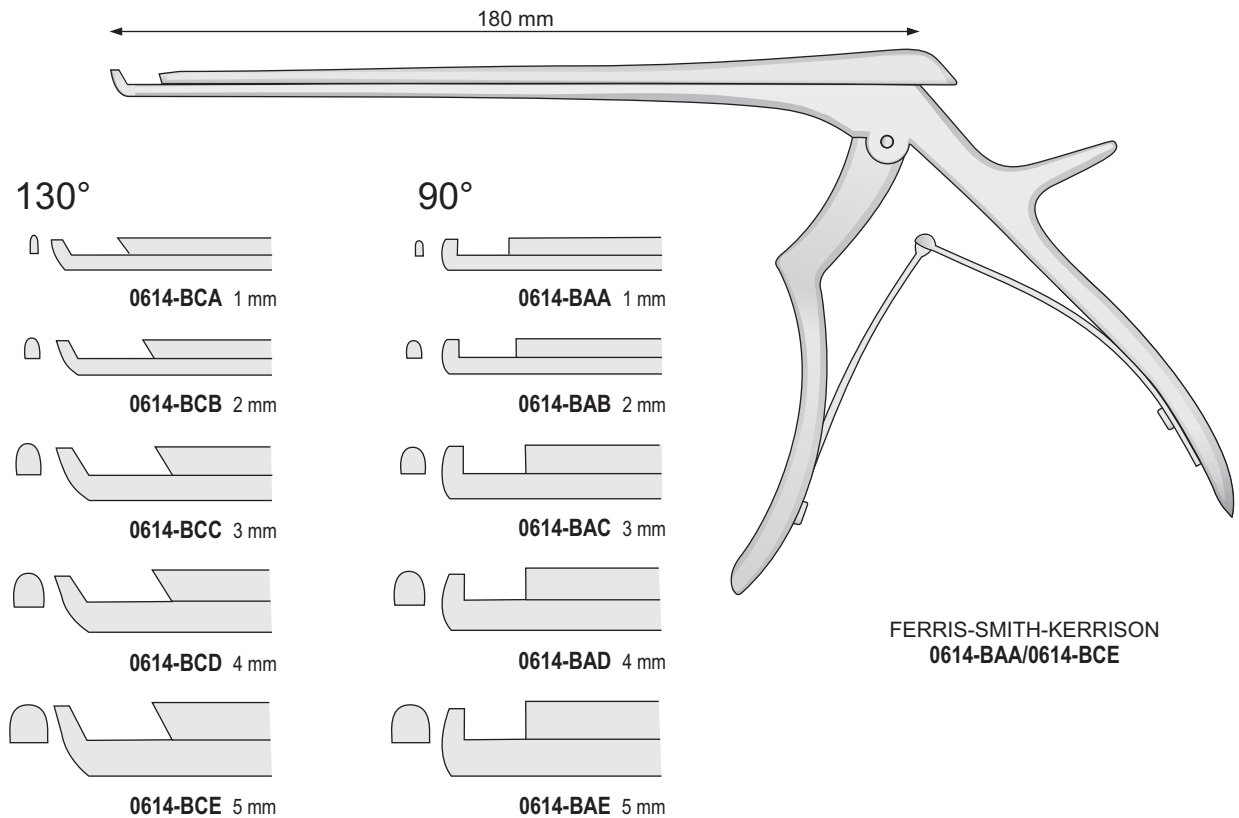
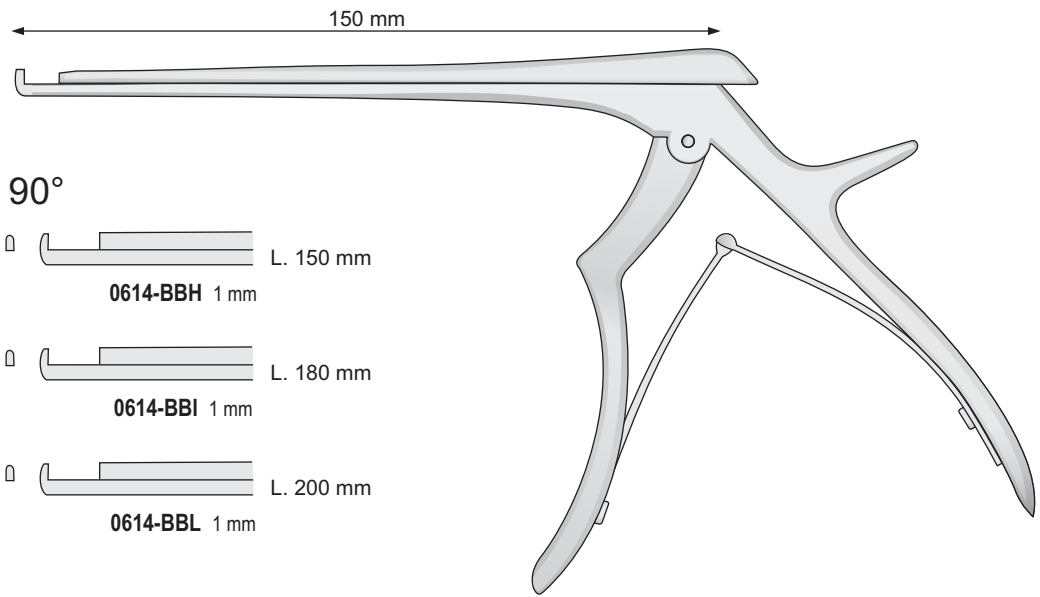

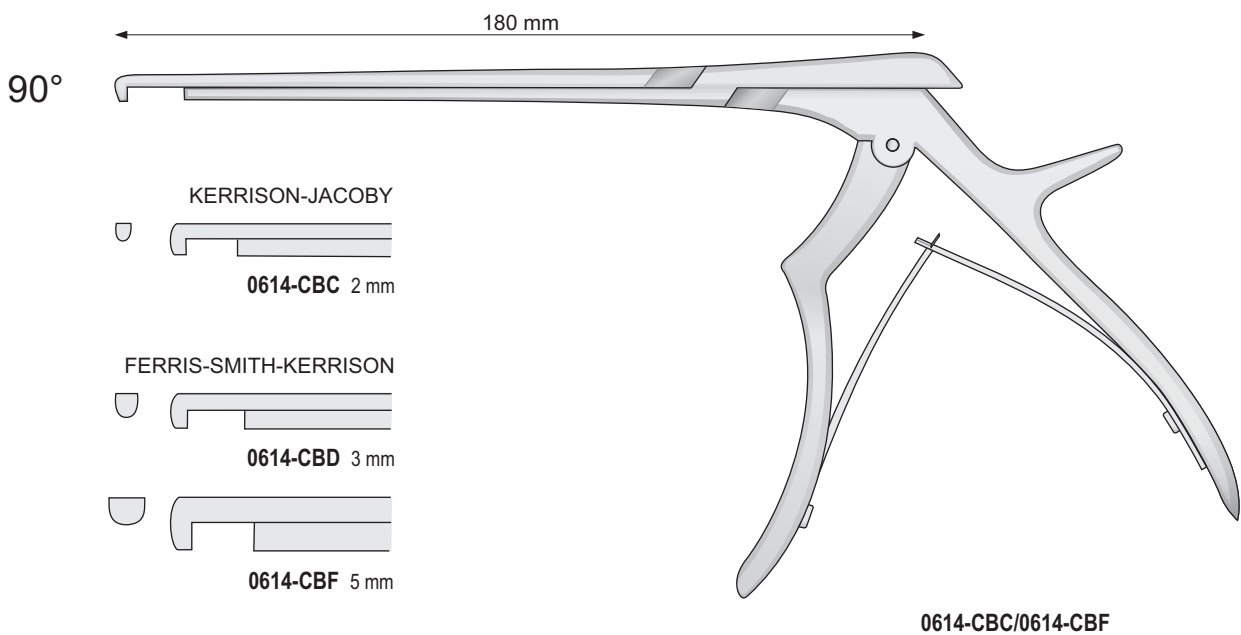
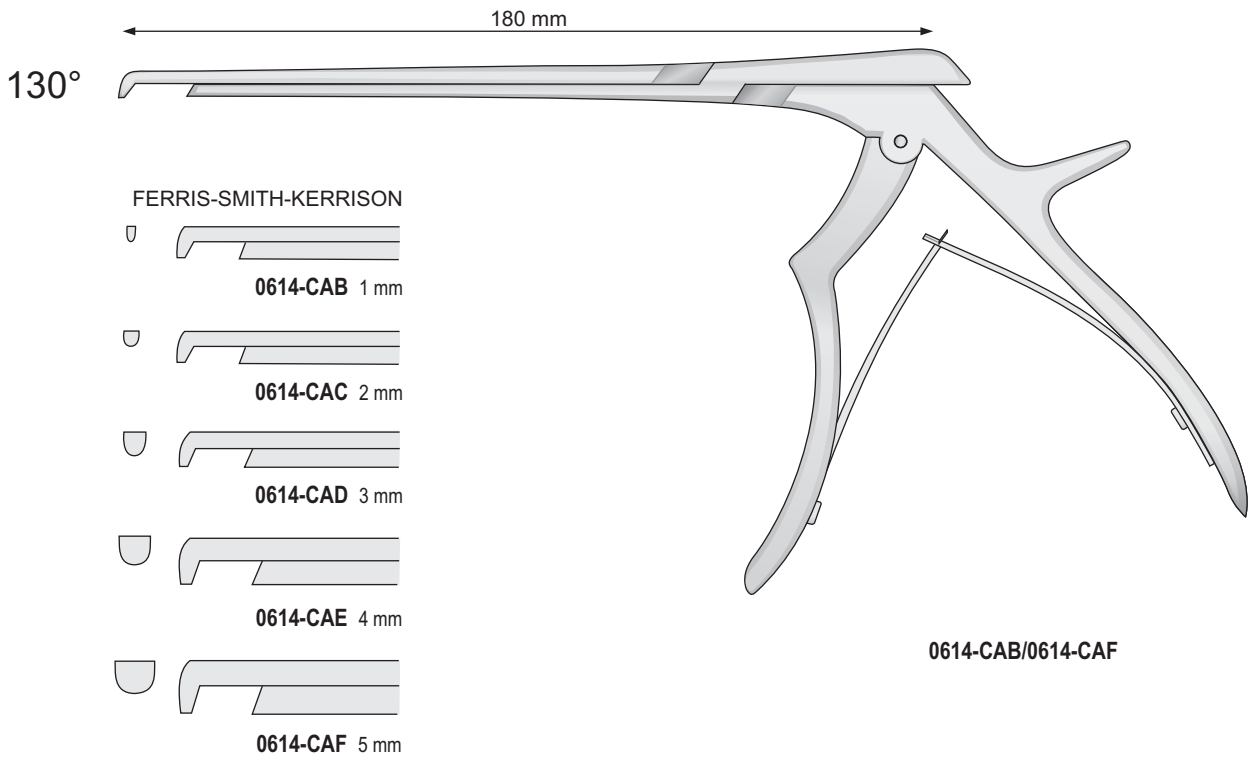

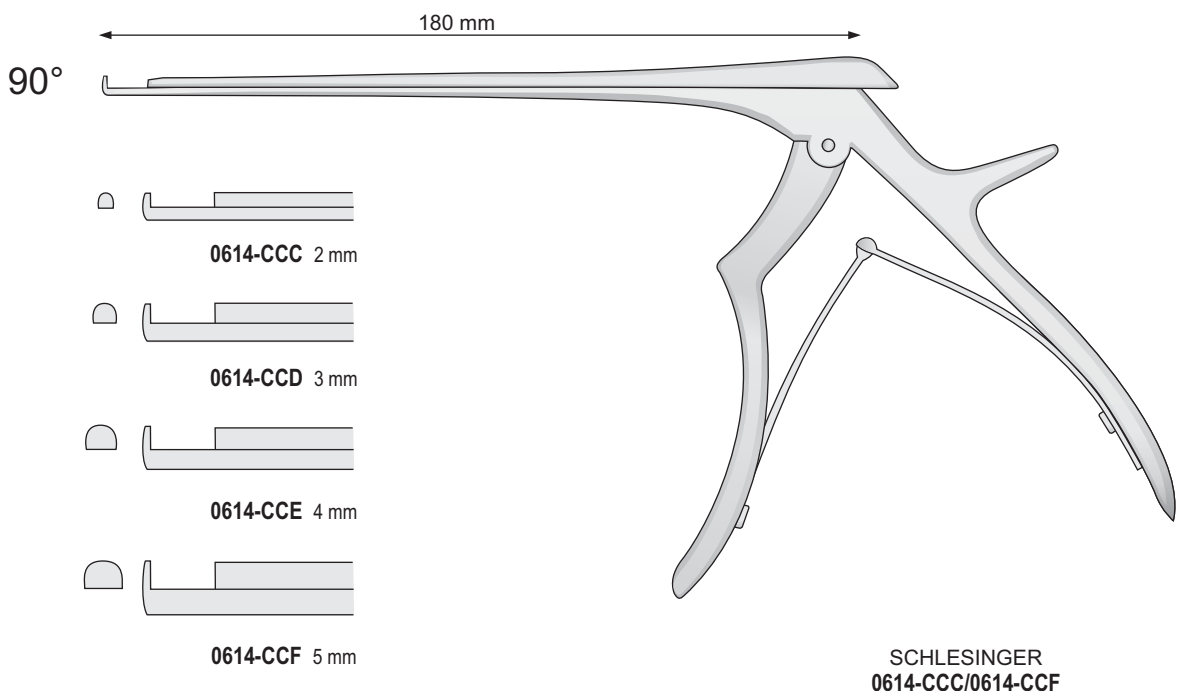
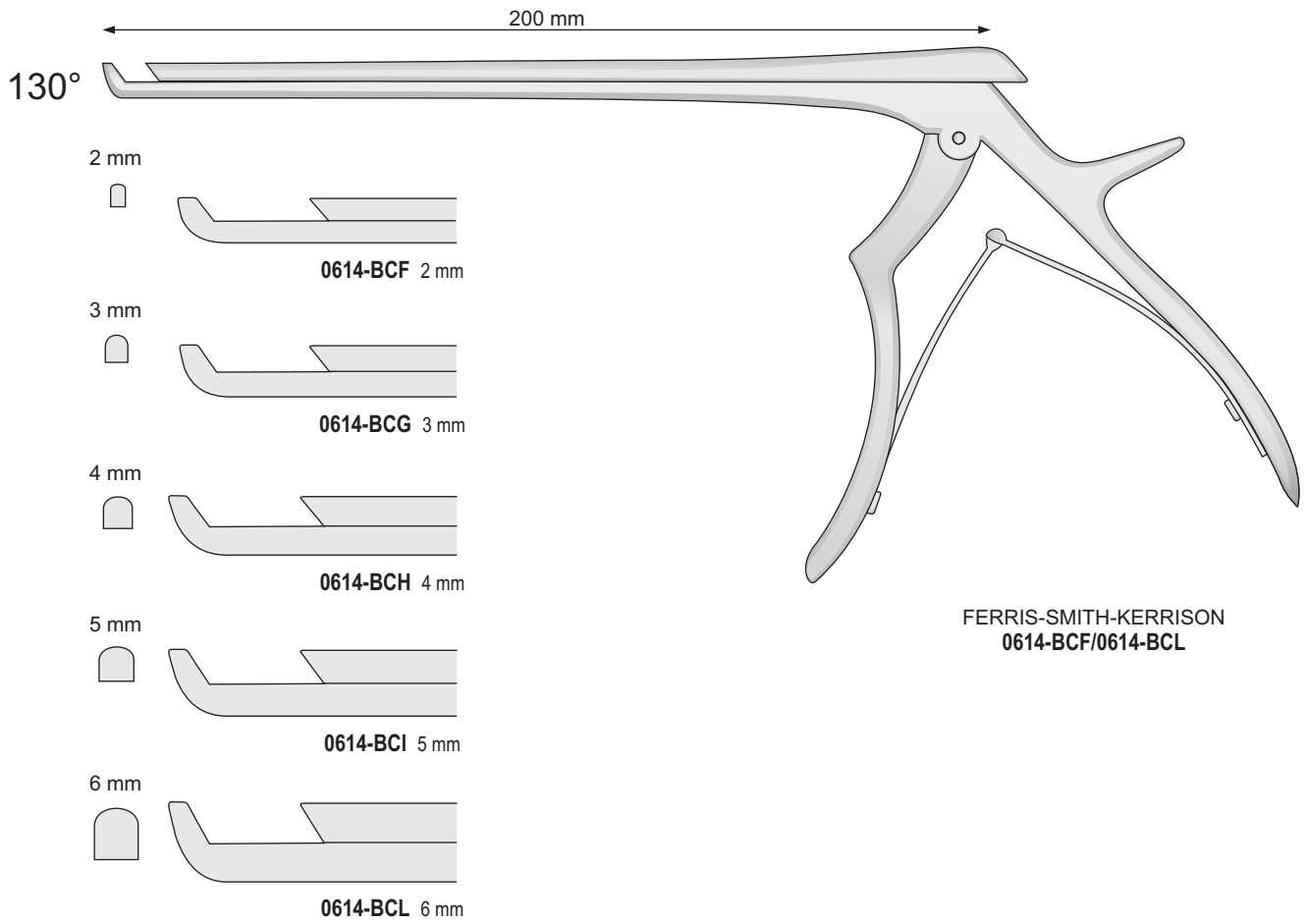

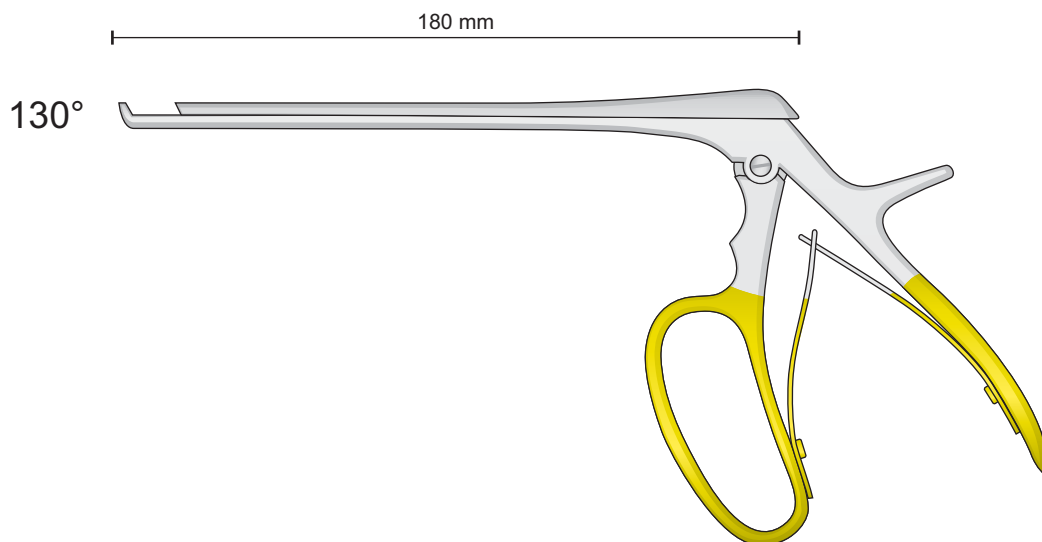
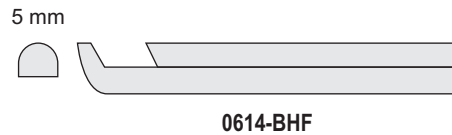
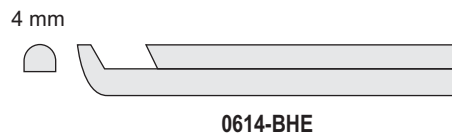
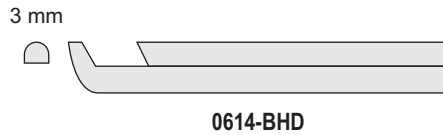
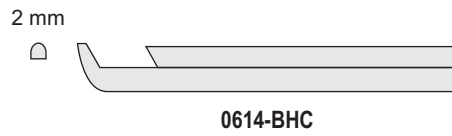
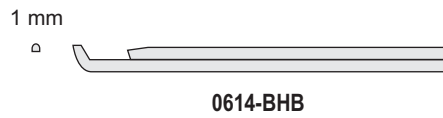

FERRIS - SMITH - KERRISON
0614-BHB/0614-BHF

Laminectomy
Rongeur

Laminectomy
rongeurs

Pinze
per biopsia

Pinzas cortantes
para laminectomia

Pincas a
laminectomia

Gerade
Stright
Diritta
Rectas
Droites

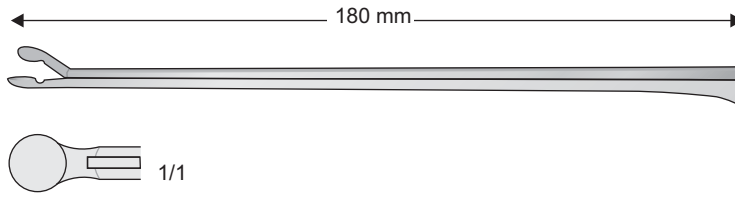

0606-CA
Ø 6 mm

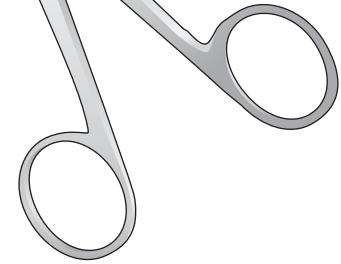

OLDBERG
0606-CA

Gerade
Stright
Diritta
Rectas
Droites

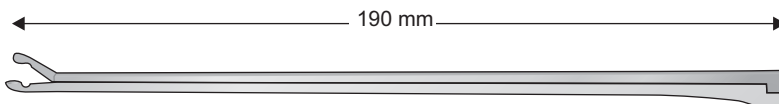

1/1
0606-CB
Ø 2,2 mm

1/1
0606-CC
Ø 3,5 mm

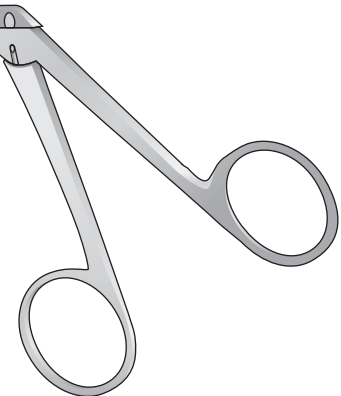

YASARGIL
0606-CB/0606-CC

Gerade
Stright
Diritta
Rectas
Droites

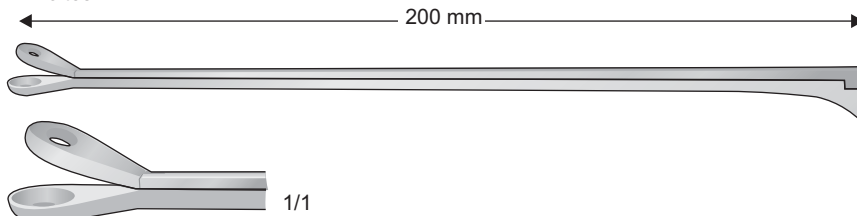

0606-CD
Ø 9 mm

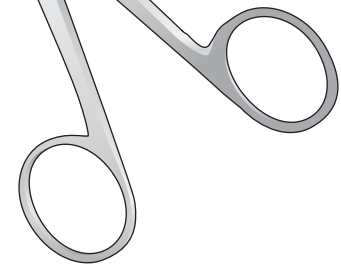

LANDOLT
0606-CD

Laminectomy
Rongeur

Laminectomy
rongeurs

Pinze
per biopsia

Pinzas cortantes
para laminectomia

Pinces a
laminectomia

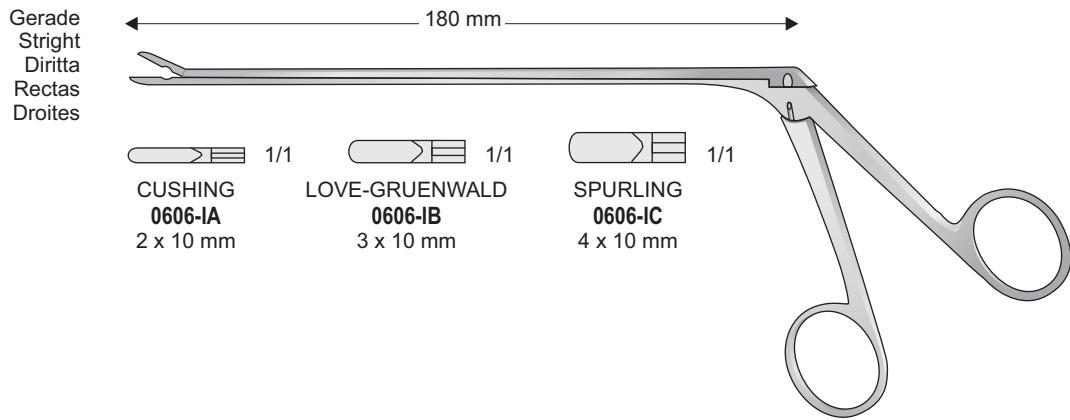

0606-IA/0606-IC

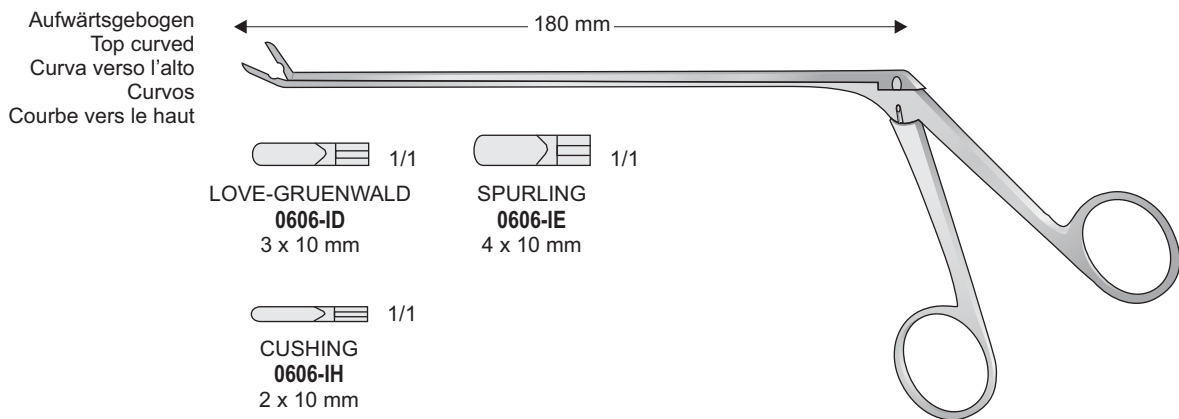

0606-ID/0606-IH

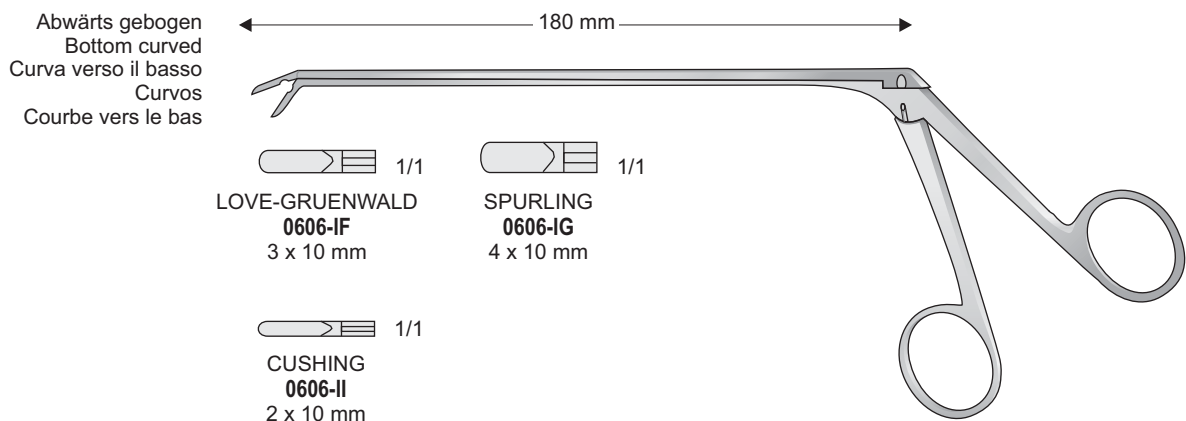

0606-IF/0606-II

Mikro-Schere

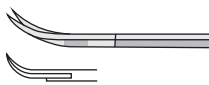

FAHLBUSCH
0606-EAB
165 mm

FAHLBUSCH
0606-EBB
230 mm

Scharfe Zange

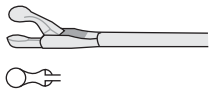

NICOLA
0606-EAC
165 mm

NICOLA
0606-EBC
230 mm

Mikro-Schere

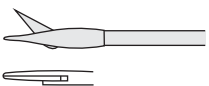

NICOLA
0606-EAD
165 mm

NICOLA
0606-EBD
230 mm

Faßzange

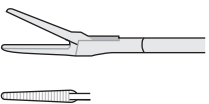

YASARGIL-NICOLA
0606-EAE
165 mm

YASARGIL-NICOLA
0606-EBE
230 mm

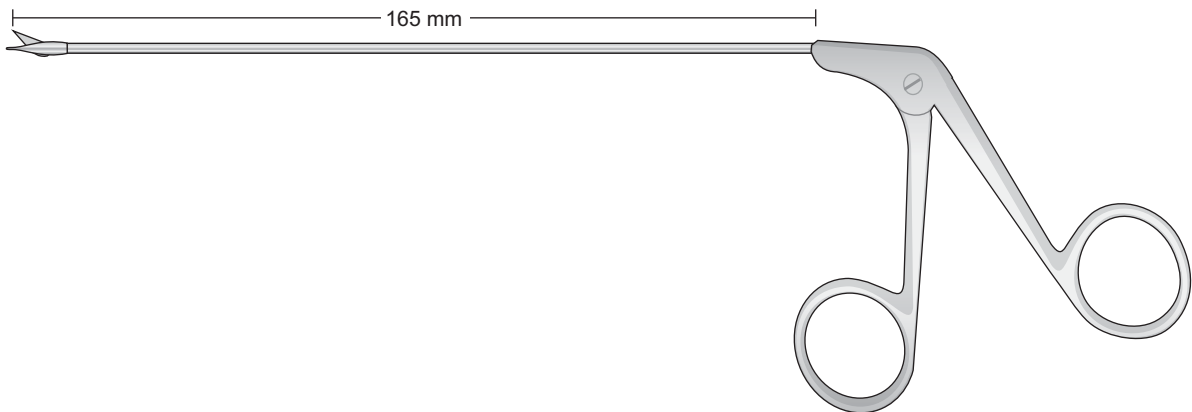

NICOLA
0606-EAD
165 mm

Hypophysektomie
-Instrumente

Pituitary
Instruments

Strumenti per
ipofisi cerebrale

Instrumentos
para hipófisis

Instruments pour la
chirurgie pituitaire

Kürette
Horizontal 45°
Curette
Horizontal 45°

Ø 4.0 mm

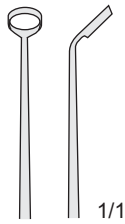

RAY
0606-DCB
180 mm

Kürette
Vertikal 45°
Curette
Vertical 45°

Ø 4.0 mm



RAY
0606-DCC
180 mm

Spekula für transssphenoidale Hypophysektomie
Specula for transssphenoidale hypophysectomy



CUSHING-LANDOLT

0606-CBA 70 x 15 mm

0606-CBB 90 x 15 mm

0606-CBC 100 x 15 mm



RAY
0606-DCB/0606-DCC
180 mm

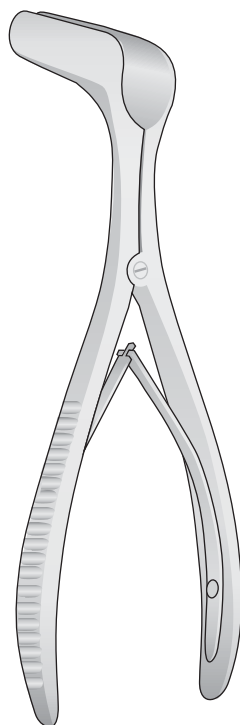

PAPAVERO-HARTMANN
1412-DL
140 mm

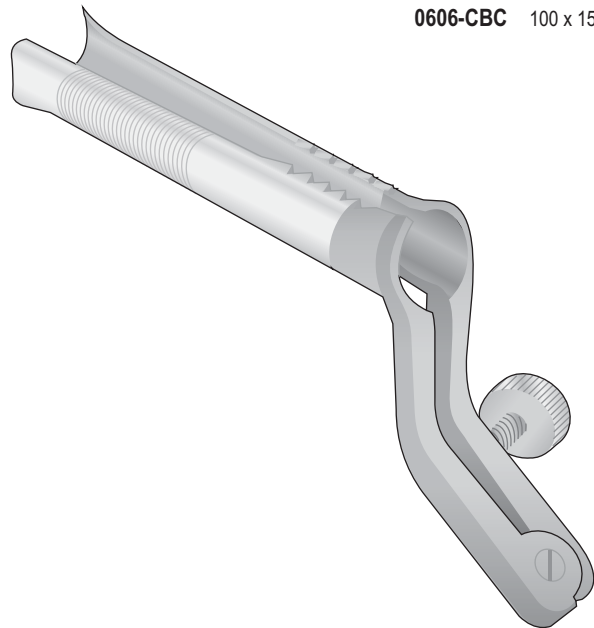

PAPAVERO-CASPAR
0606-CBE 80 x 11 mm
0606-CBF 90 x 13 mm
0606-CBG 100 x 15 mm

Rhinologie

Rhinology

Rinologia

Rinologia

Rhinologie

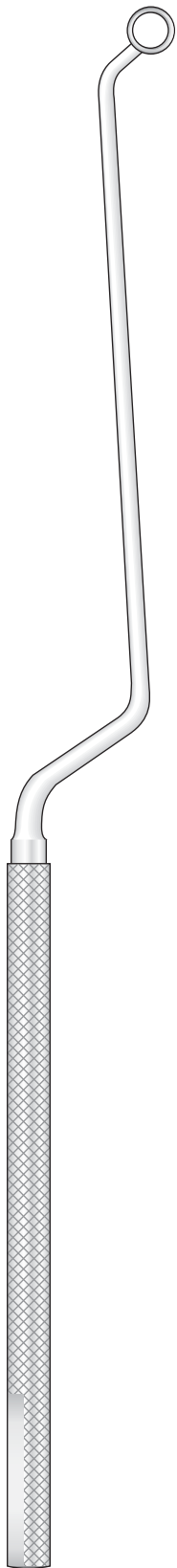

NICOLA
0606-DCD/0606-DCG
215 mm

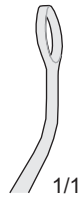

1/1
NICOLA
0606-DCD
215 mm

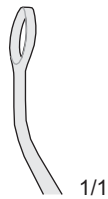

1/1
NICOLA
0606-DCE
215 mm



6,5 mm
1/1
NICOLA
0606-DCF
215 mm

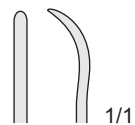

1/1
NICOLA
0606-DCG
215 mm

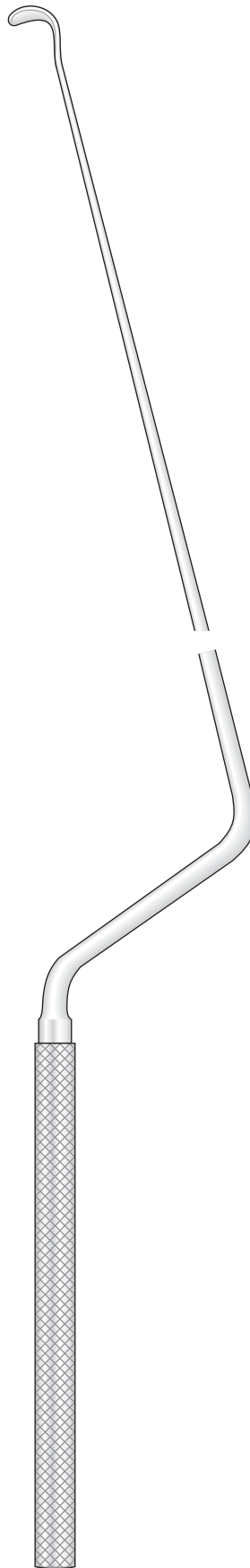

LANDOLT
0606-DEF/0606-DFC
260 mm

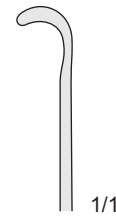

1/1
LANDOLT
0606-DEF Right/Rechts
0606-DFB Left/Links
260 mm

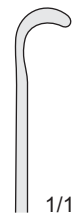

1/1
LANDOLT
0606-DEG Right/Rechts
0606-DFC Left/Links
260 mm

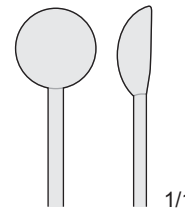

1/1
LANDOLT
0606-DEI
260 mm

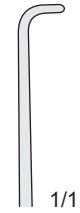

1/1
LANDOLT
0606-DEL
260 mm

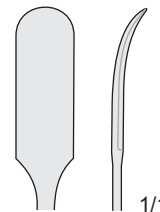

1/1
LANDOLT
0606-DEH
260 mm

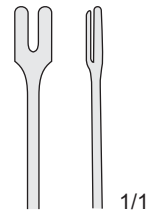

1/1
HOSOBUCHI
0606-DFA
260 mm

Rhinologie

Rhinology

Rinologia

Rinologia

Rhinologie



HARDY
0606-DDA Right/Rechts
0606-DEA Left/Links
245 mm



HARDY
0606-DEB Left/Links
245 mm



HARDY
0606-DDC Right/Rechts
0606-DEC Left/Links
245 mm



HARDY
0606-DED Left/Links
245 mm

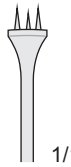

HARDY
0606-DDE
245 mm



HARDY-FAHLBUSCH
0606-DDF
245 mm



HARDY-FAHLBUSCH
0606-DDG
245 mm



LANDOLT
0606-DDA/0606-DED
245 mm

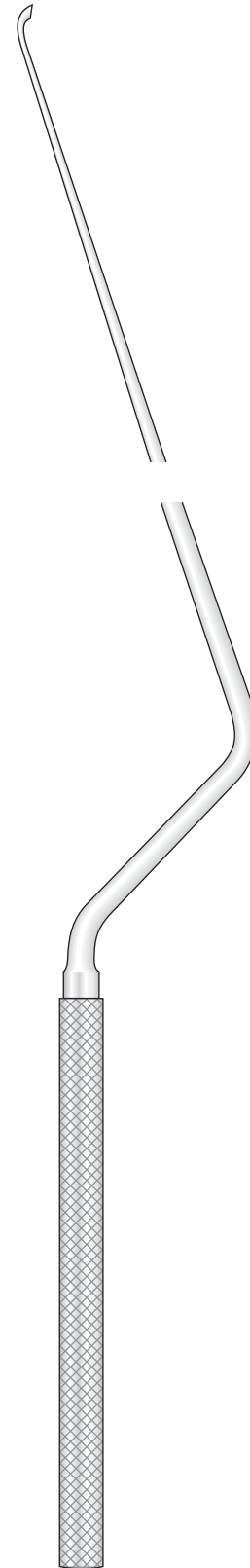
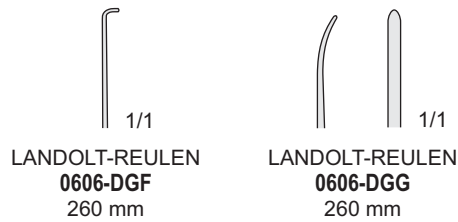
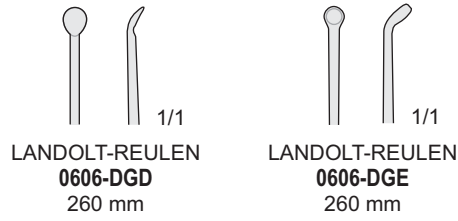
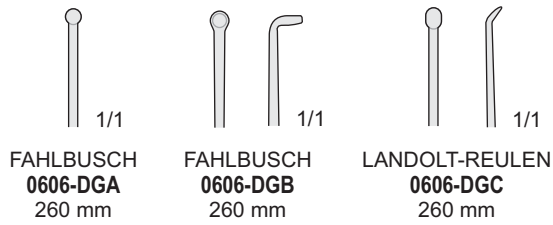

FAHLBUSCH
0606-DGA/0606-DGG
260 mm

Mikro-Raspatorien

Micro Raspatories

Micro Periostotomi

Micro Legras

Micro Rugines

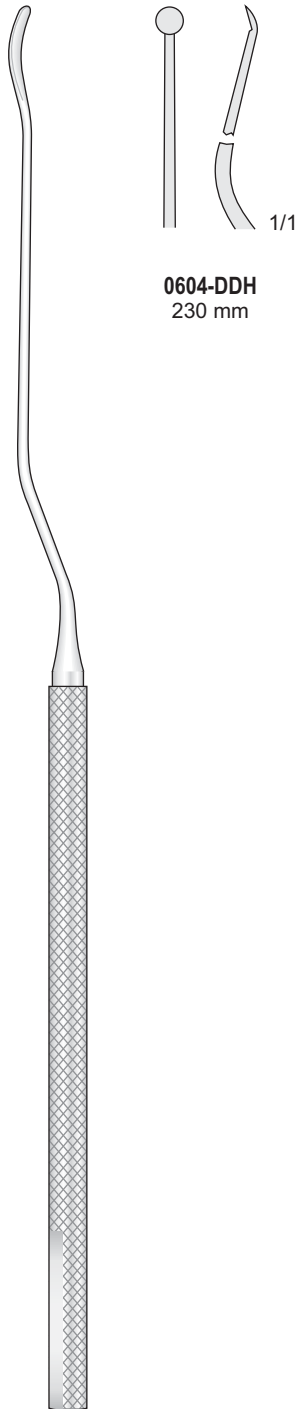

0604-DDH
230 mm

YASARGIL
0604-DDH
230 mm

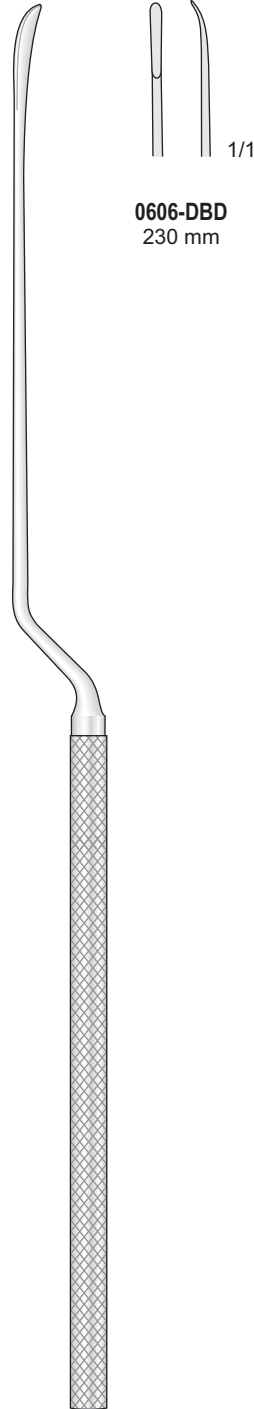

0606-DBD
230 mm

0606-DBD/0606-DBE
230 mm

Aufgebogen
Curved up
Curva in alto
Curvas hacia arriba
Courbes vers le haut

Abgebogen
Curved down
Curva in basso
Curvas hacia abajo
Courbes vers le bas

3.2



Mund, Hals, Throat
Mouth, Throat, Larinx
Bocca, Gola, Laringe
Boca, Garganta, Laringe
Bouche, Gorge, Larinx

Tonsillectomie
Tonsillectomy
Tonsillectomia

Kieferhöhlentrokare
 Antrum puncture trocars
 Trequarti per seno mascellare
 Trócares para punción del seno maxilar
 Trocarts pour sinus maxillaire

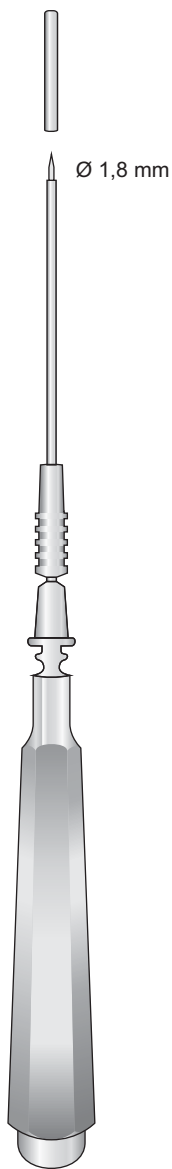

LICHTWITZ
 1917-DA
 190 mm

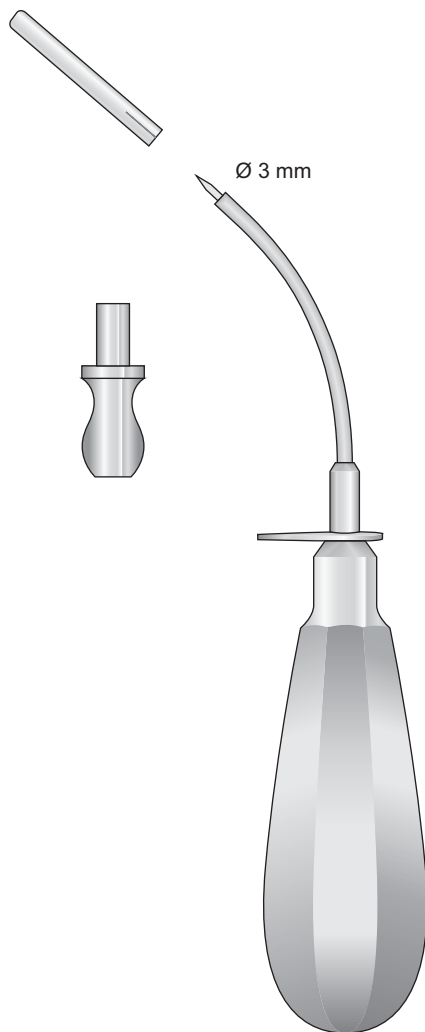

PIERCE
 1917-DC
 160 mm

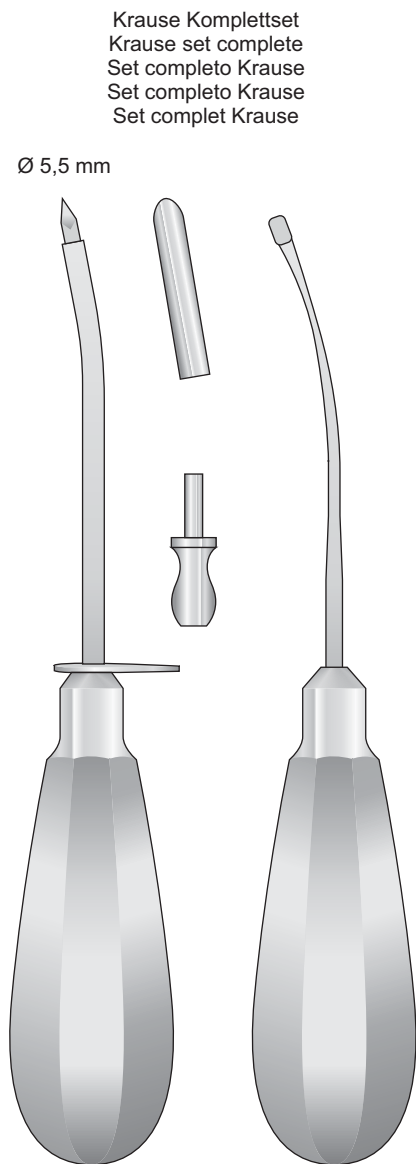

KRAUSE
 1917-DF
 160 mm

Krause Komplettsset
 Krause set complete
 Set completo Krause
 Set completo Krause
 Set complet Krause

Zungenspatel

Tongue depressor

Abbassalingua

Bejalenguas

Abaisse-langues

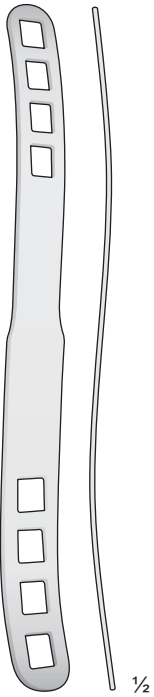

BRUENINGS
1412-AE
190 mm

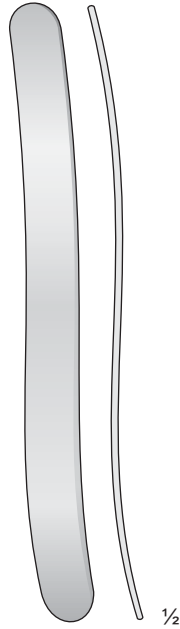

1412-AF
145 mm

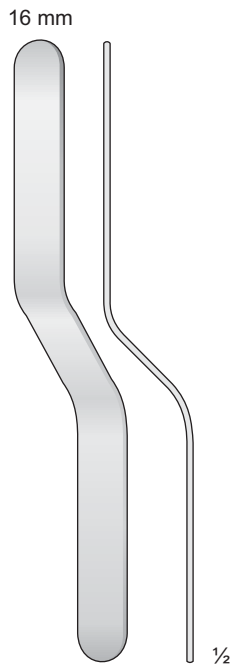

1412-AH
145 mm



1412-LI
195 mm

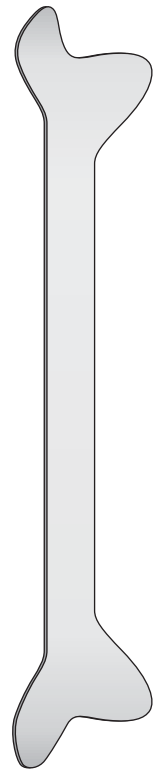

1412-BAA
180 mm

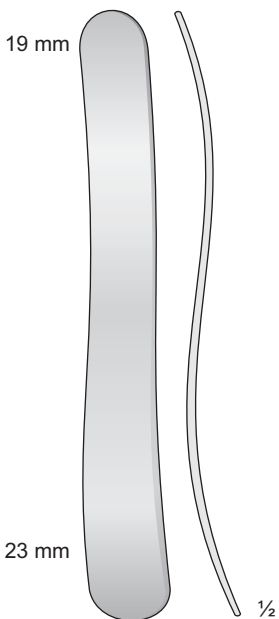

KROENIG
1412-BG
150 mm

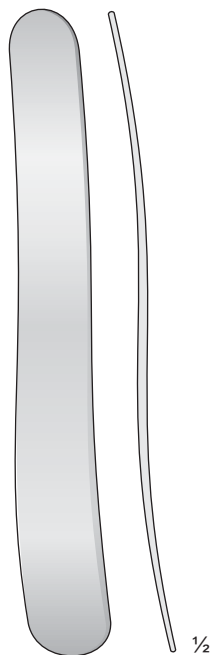

MAYO
1412-BH
170 mm

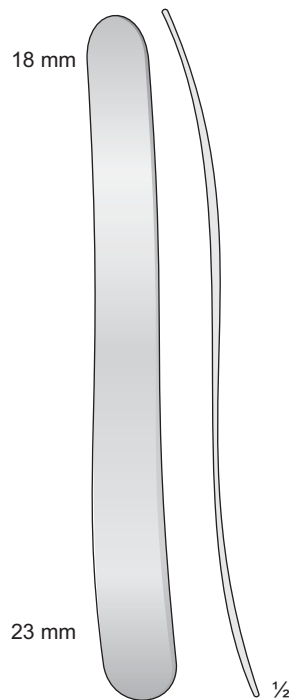

BUCHWALD
1412-BI
180 mm

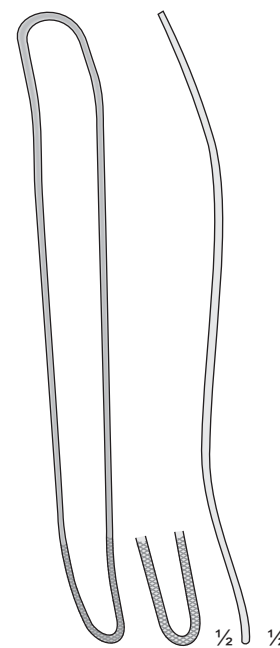

FRENZEL
1412-BL
165 mm

Spatola S Form
10 mm

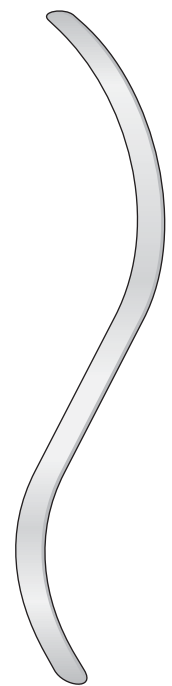

0414-BCL
180 mm

Spatel

Spatulas

Spatole

Espatulas

Spatules

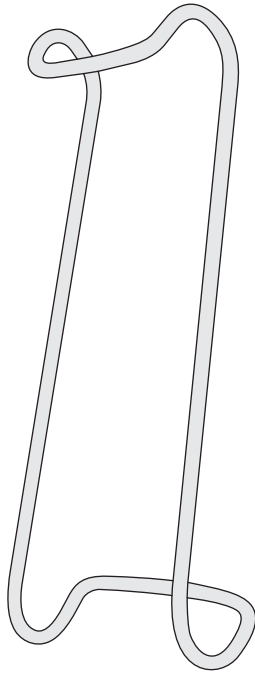

COLUMBIA
1412-GH
140 mm

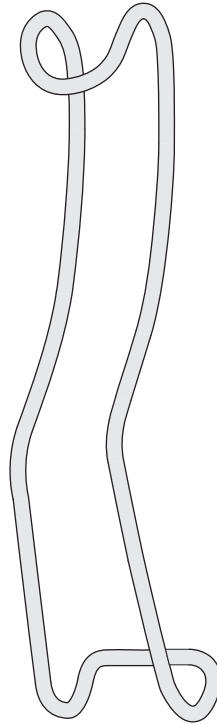

STERNBERG
1412-FA
160 mm

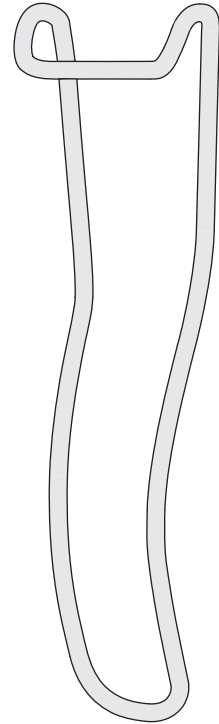

STERNBERG
1412-FC
160 mm

Biegsame - Malleable - Malleabili - Flexible - Flexible
5 mm



22 mm
1412-IA
200 mm



16 mm
1412-IB
200 mm



8 mm
1412-IC
240 mm



22 mm
1412-IH
200 mm

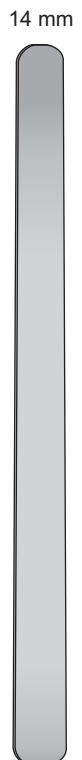

16 mm
1412-II
200 mm

Spatulas
black anodized
Spatole
antiriflesso nere

Wundhaken

Retractors

Divaricatori

Separadores

Ecarteurs

8 mm

10 mm

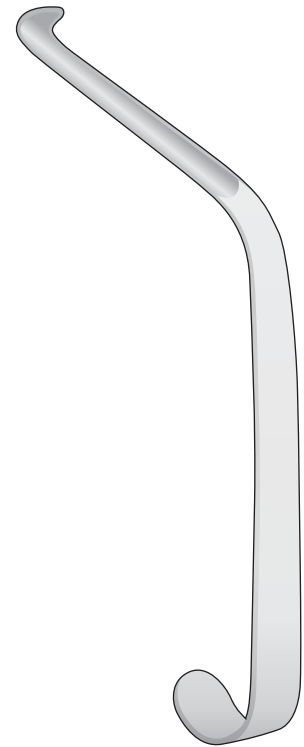
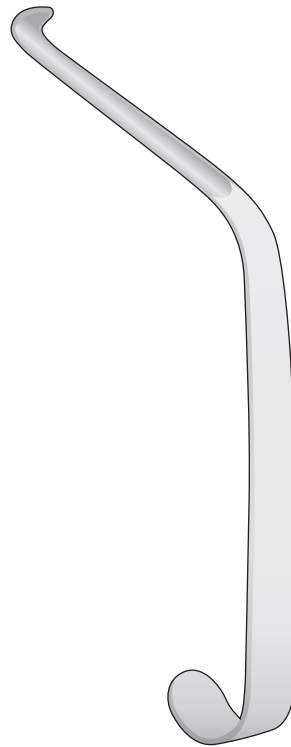

OBWEGESER
0414-EB
165 mm

OBWEGESER
0414-BEC
165 mm

Posterior
Posteriore

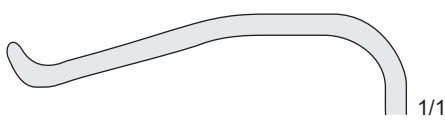

1/1

Anterior
Anteriore

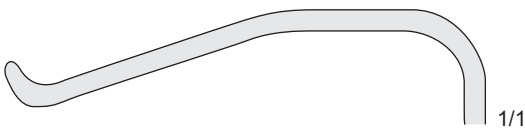

1/1

Superior
Superiore

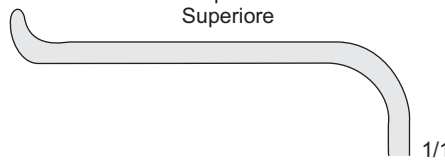

1/1

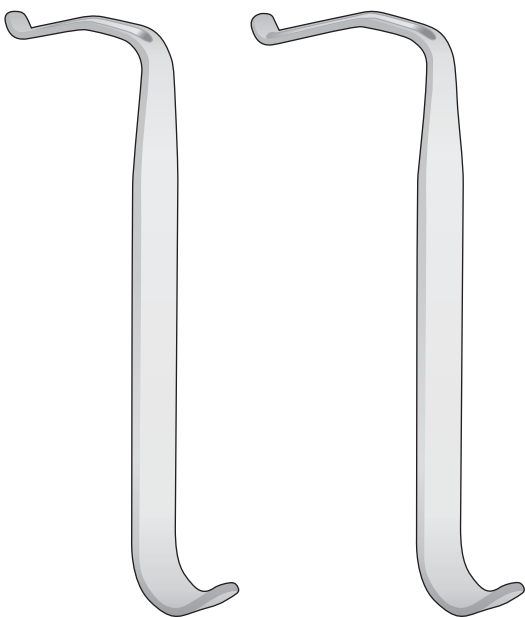

DUNN-DAUTREY
0414-LE 6,5 x 50 mm
140 mm

DUNN-DAUTREY
0414-LF 6,5 x 60 mm
140 mm

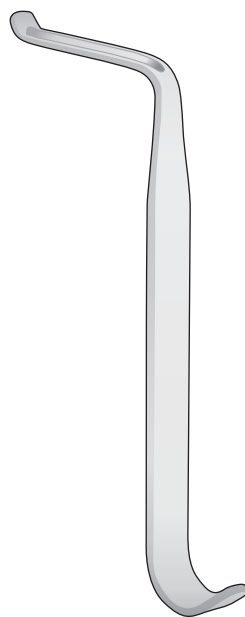

DUNN-DAUTREY
0414-LG 8 x 50 mm
140 mm

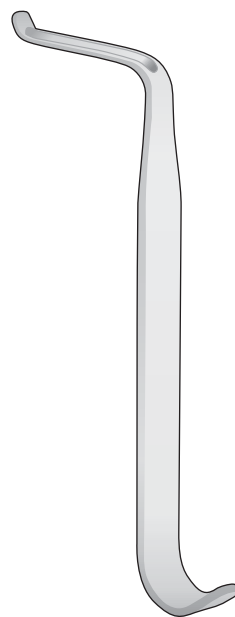

DUNN-DAUTREY
0414-LH 6,5 x 50 mm
140 mm

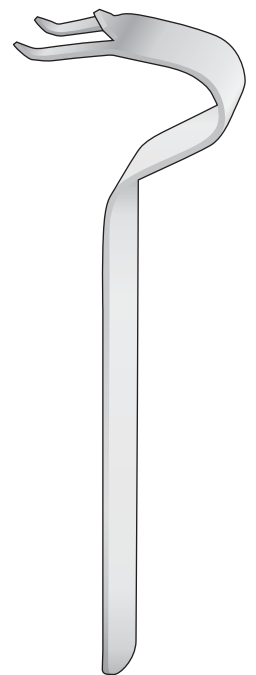

OBWEGESER
0414-EA
155 mm

Zungenspatel

Tongue depressor

Abbassalingua

Bejalenguas

Abaisse-langues

Adenotomie - Tonsillektomie

10 x 13 mm



LACK
1412-LD

13 x 19 mm



LACK
1412-LE

15 x 22 mm

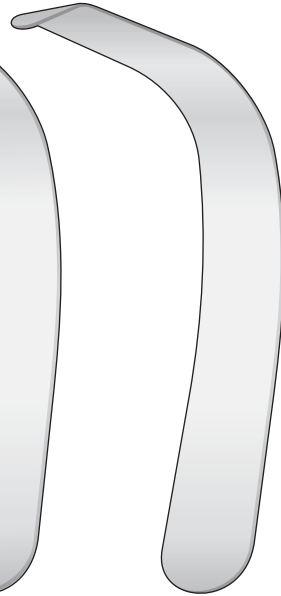

LACK
1412-LF

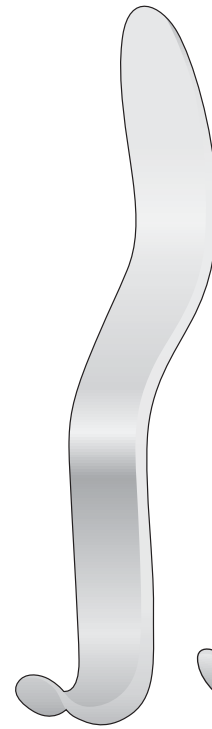

CAWOOD-MINNESOTA
1412-GG
160 mm

22 mm

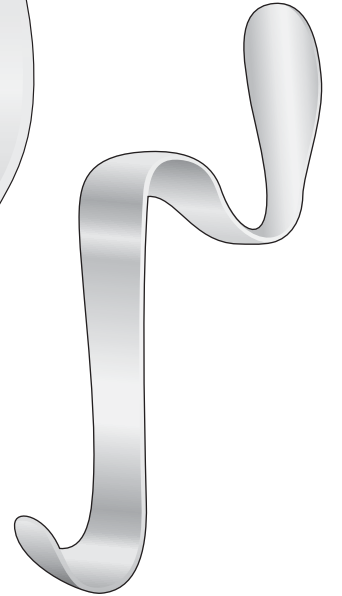

BISHOP
1412-GB
130 mm



MINNESOTA
1412-FF
140 mm

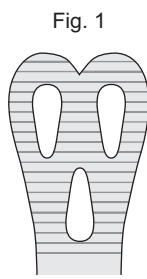

0414-AI
140 mm

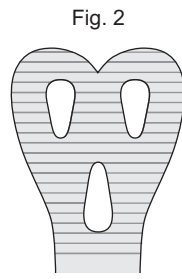

0414-AL
150 mm

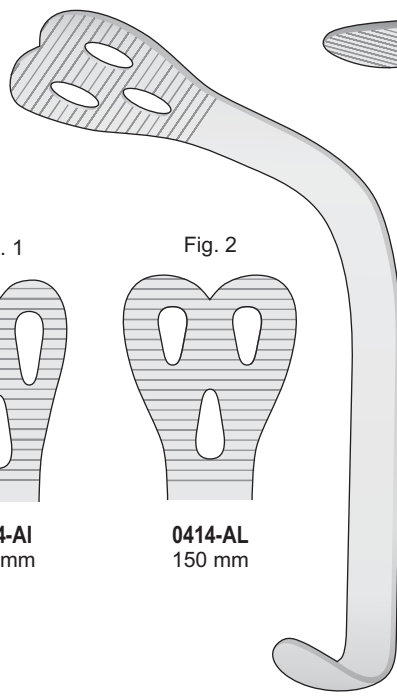

WIEDER
0414-AI/0414-AL

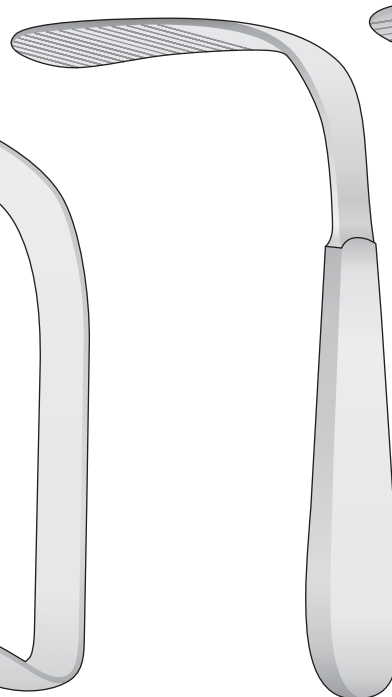

TOBOLD
1412-AI
145 mm

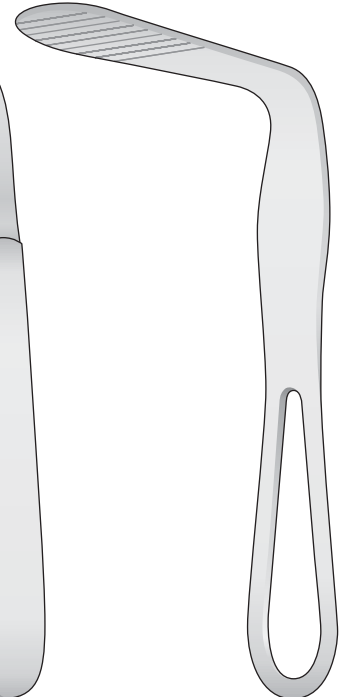

HARTMANN
1412-AG
150 mm

Mundsperrer

Mouth gags

Apribocca

Abrebocas

Ecarteur buccal

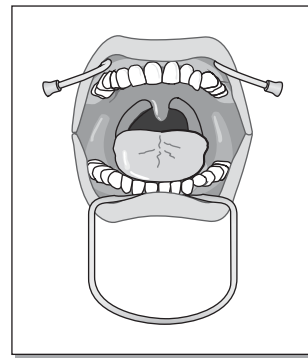

Mundsperrer ohne Absauger
Mouth gag without suction
Apribocca senza aspirazione

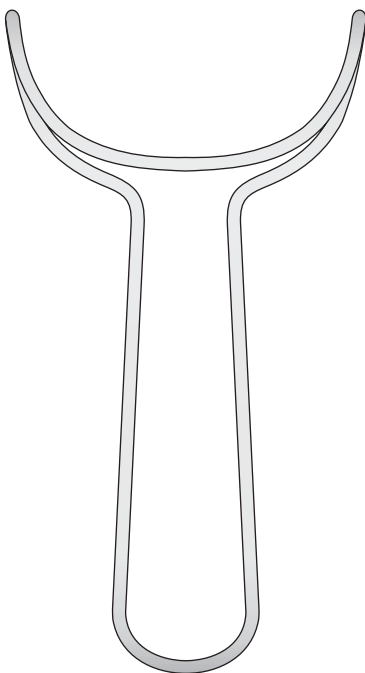

1412-LA
150 mm

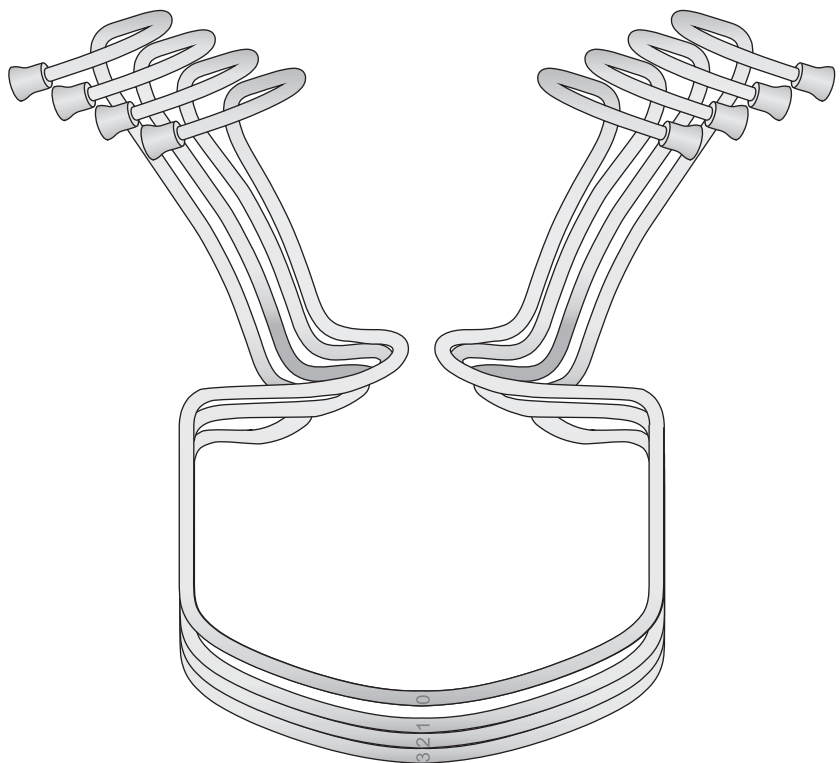

ORINGER

- 1412-HE** Fig. 0 100 x 95 mm Per bambini
- 1412-HF** Fig. 1 115 x 105 mm Per adulti
- 1412-HG** Fig. 2 115 x 110 mm Per adulti
- 1412-HH** Fig. 3 125 x 115 mm Per adulti

Mundsperrerr

Mouth gags

Apribocca

Abrebocas

Ecarteur buccal

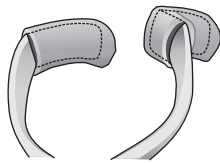

Paar Einsätzen aus Silikon für:
 Pair of silicone inserts for:
 Coppia di inserti in silicone per:
 Pareja de inserto de silicone para:
 Paire de inserts en silicon pour:

1412-EA - 1412-EB

Ø 8 mm

Ø 11 mm



1412-EA17
30 mm

1412-EB17
30 mm

Für Erwachsene - For adults
 Per adulti - Para adultos
 Pour adultes

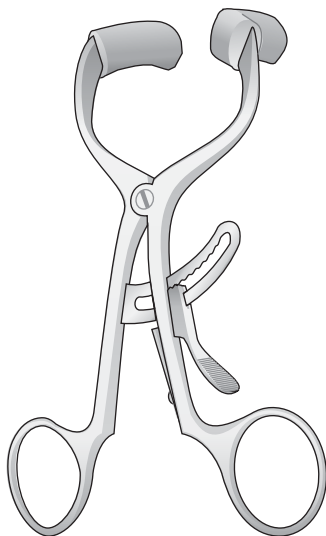

MOLT
DOYEN-JANSEN
1412-EB
140 mm

Für Erwachsene - For adults
 Per adulti - Para adultos
 Pour adultes

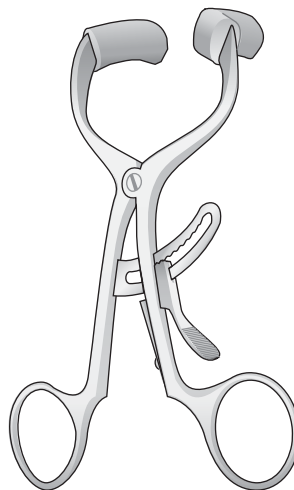

MOLT
DOYEN-COLLIN
1412-EA
120 mm

Für kinder
 For children
 Per bambini
 Para niños
 Pour enfants

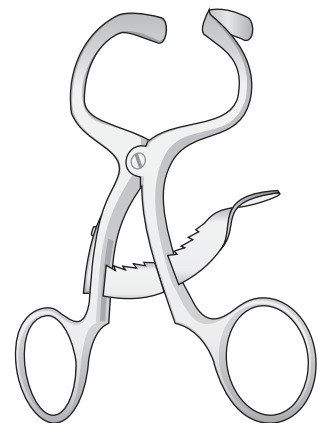

MOLT
1412-EC
100 mm

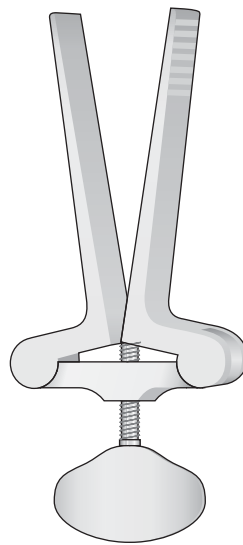

HEISTER
1412-GC
135 mm

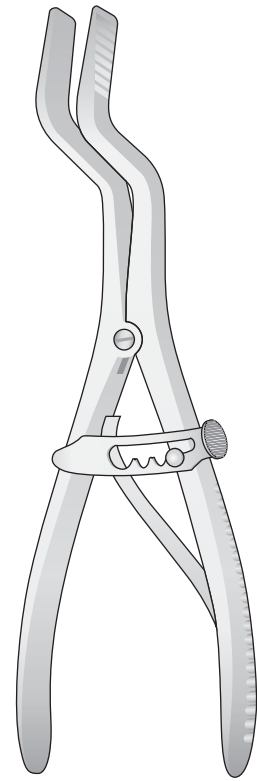

ROSER KÖNIG
1412-GA
185 mm

Mundsperrer

Mouth gags

Apribocca

Abrebocas

Ecarteur buccal

Mundsperrer
Mouth Gags
Divaricatore per bocca



WHITEHEAD
1412-BDA 90 mm
1412-BDB 110 mm
1412-BDC 130 mm
1412-BDD 150 mm

Mundsperrer mit Zungendrucker
Mouth Gags with tongue depressor
Divaricatore per bocca con abbassalingua



WHITEHEAD
1412-BDE 110 mm
1412-BDF 130 mm

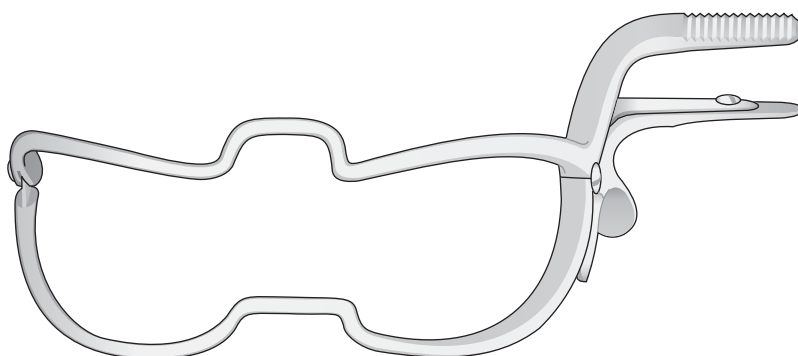

WHITEHEAD-JENNINGS
1412-BDG 90 mm
1412-BDH 110 mm
1412-BDI 130 mm
1412-BDL 150 mm

Zungendrucker

Tongue depressors

Abbassa lingua

Bejalenguas

Abaisse langues

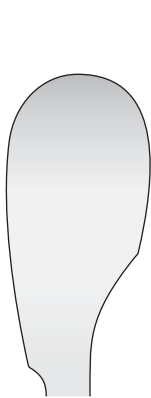

1412-BCH
28x63 mm

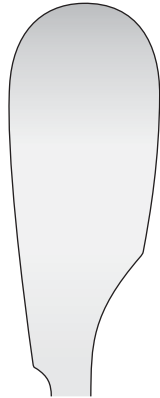

1412-BCI
33x73 mm

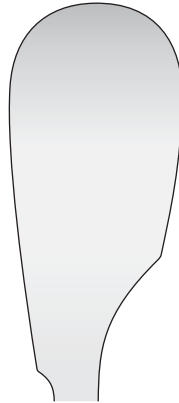

1412-BCL
37x82 mm

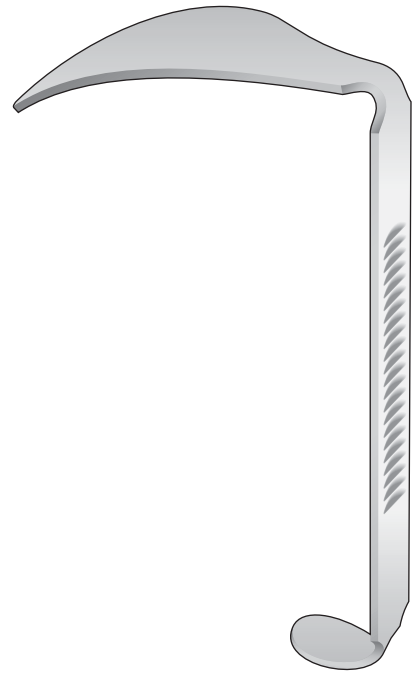

HERBERHOLD
1412-BCH/1412-BCL

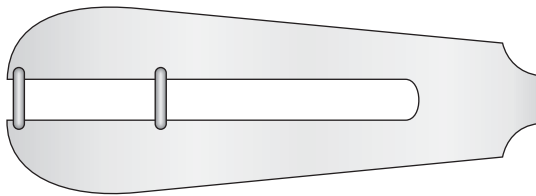

1412-BBL
38x100 mm

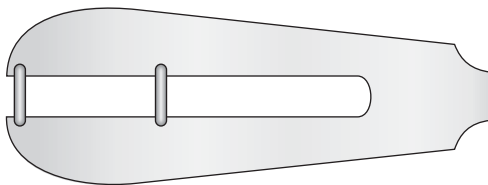

1412-BBI
37x93 mm

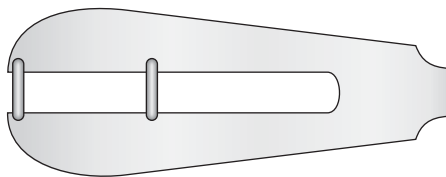

1412-BBH
34x83 mm

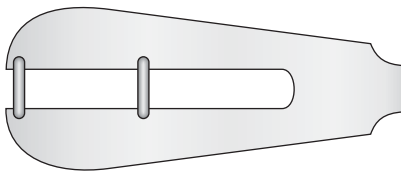

1412-BBG
32x75 mm

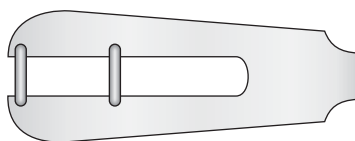

1412-BBF
28x66 mm



WÜRZBURG
1412-BBF/1412-BBL

Zungendrucker

Tongue depressors

Abbassa lingua

Bejalenguas

Abaisse langues

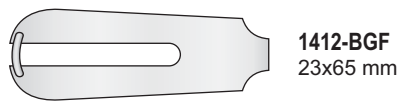
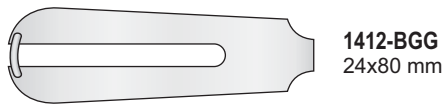
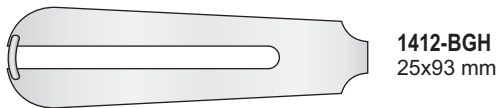
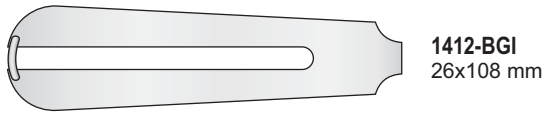

1412-BGF/1412-BGI

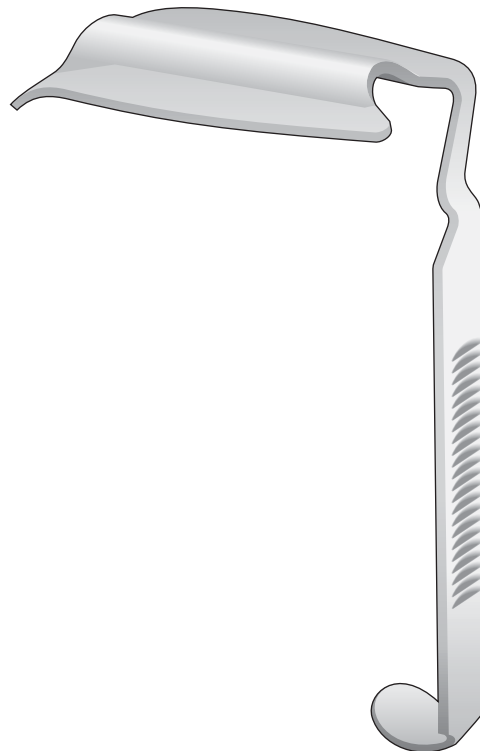
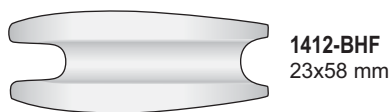
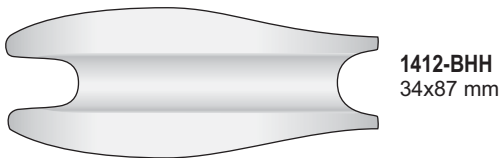
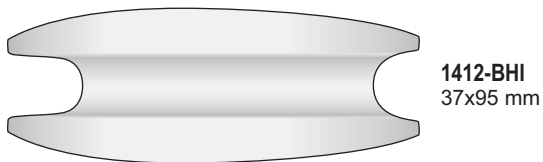

RING
1412-BHF/1412-BHI

Mundsperrer

Mouth gags

Apribocca

Abrebocas

Ecarteur buccal

Sperrer allein
Gag only
Apribocca solo
Apre-boca suelto
Manche et cadreseuls

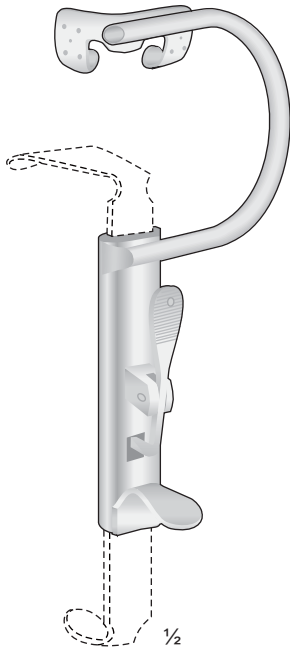

DAVIS-BOYLE
OM-141

DAVIS-BOYLE
1412-BEA
Komplet mit 5 Zungenspatel
Complete with 5 tongue depressors
Completo con 5 abbassalingua
Completo con 5 abaja lengua
Complet avec 5 abaisse-langues

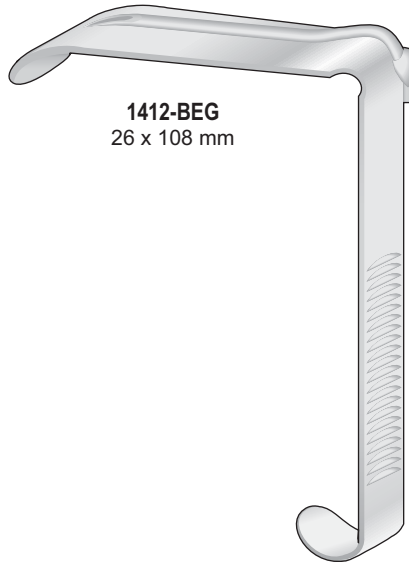

1412-BEG
26 x 108 mm

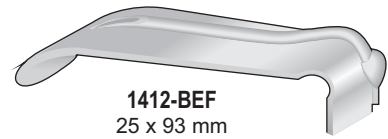

1412-BEF
25 x 93 mm

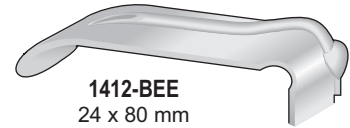

1412-BEE
24 x 80 mm

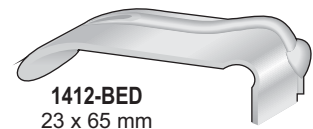

1412-BED
23 x 65 mm



1412-BEC
21 x 30 mm

Mc-IVOR
1412-BHA
Komplet mit 3 Zungenspatel
Complete with 3 tongue depressors
Completo di 3 abbassalingua
Completo con 3 abaja lengua
Complet avec 3 abaisse-langues

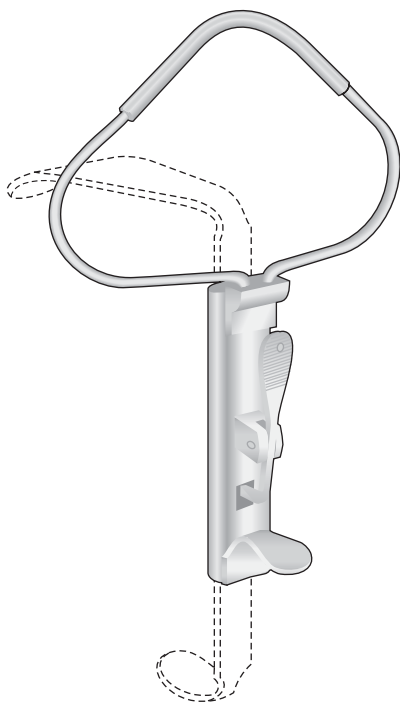

Mc-IVOR
1412-BHB



1412-BHE
26 x 100 mm

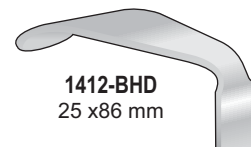

1412-BHD
25 x 86 mm

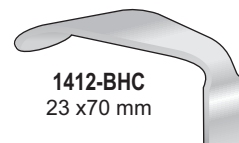

1412-BHC
23 x 70 mm

Mundsperrer Allein
Mouth Gag only
Telaio Dingmann con
due apriguancia

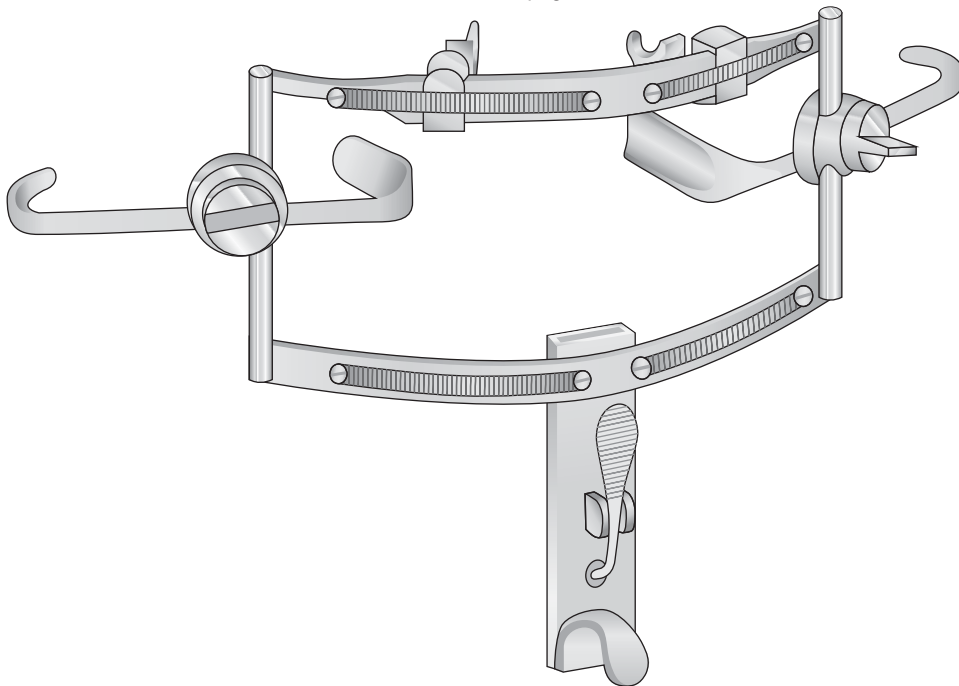

1412-BBB

Zungenspatel
Tongue depressor
Abbassalingua
Bejalenguas
Abaisse langues

Fig. 1

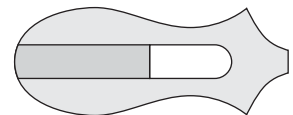

1412-BBC
24 x 62 mm

Fig. 2

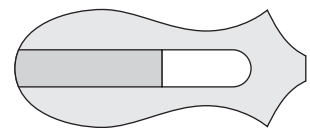

1412-BBD
28 x 65 mm

Fig. 3

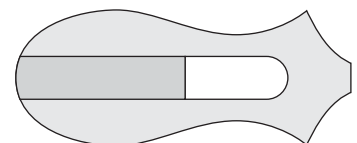

1412-BBE
31 x 75 mm

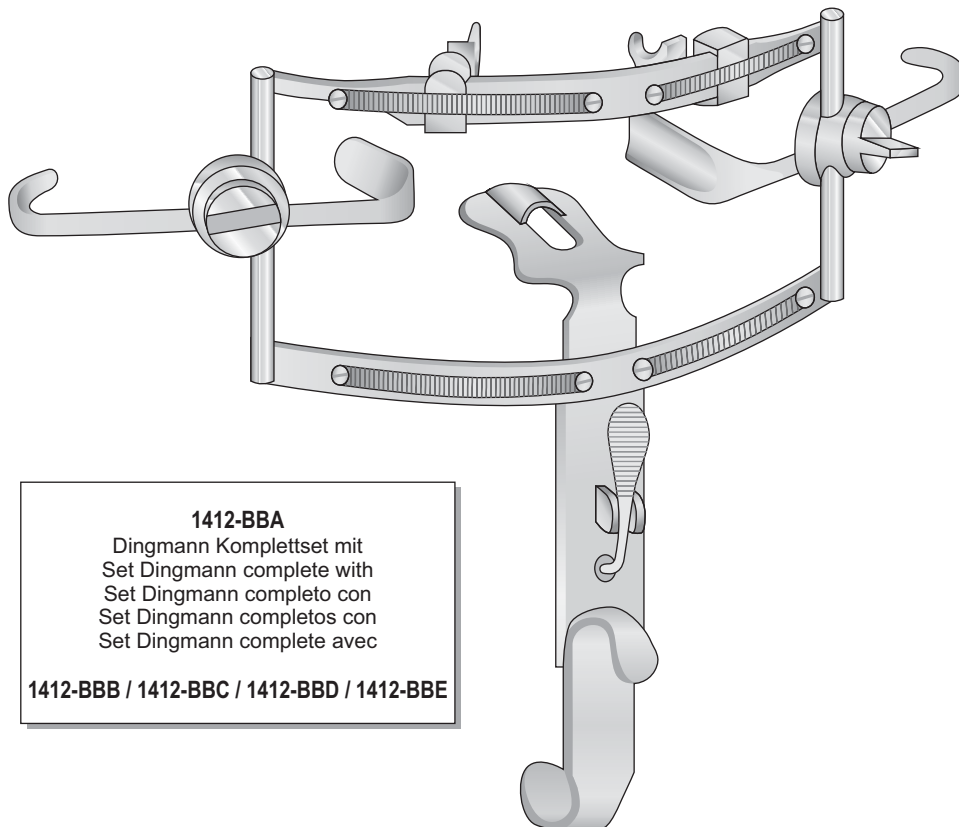

1412-BBA

Dingmann Kompletset mit
Set Dingmann complete with
Set Dingmann completo con
Set Dingmann completos con
Set Dingmann complete avec

1412-BBB / 1412-BBC / 1412-BBD / 1412-BBE

DINGMANN
1412-BBA
Set completo

Mundsperrerr

Mouth gags

Apribocca

Abrebocas

Ecarteur buccal

DAVIS-BOYLE
1412-BFA
 Komplet mit 5 Spateln
 Complete with 5 tongue blades

Für Kinder
 For children

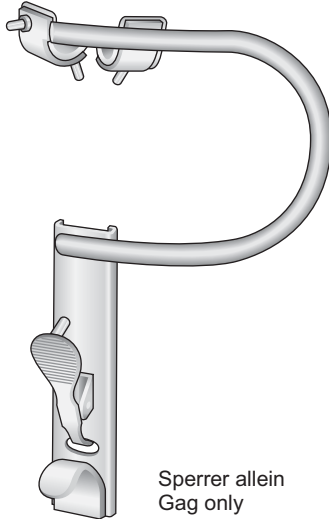

Sperrerr allein
 Gag only

DAVIS-BOYLE
1412-BFB

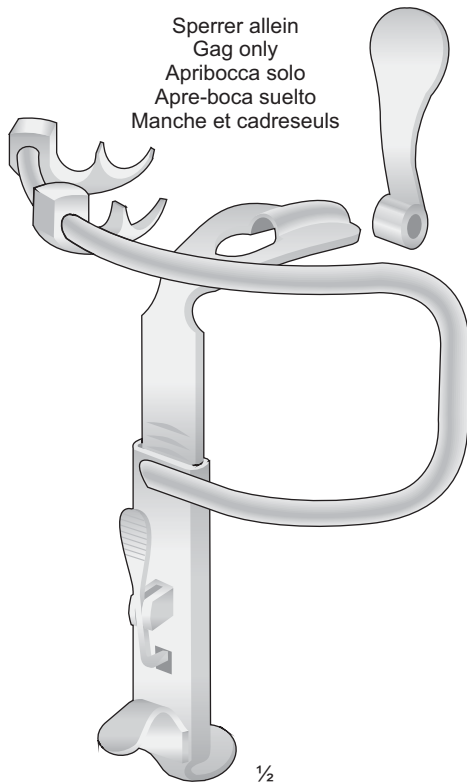

Sperrerr allein
 Gag only
 Apribocca solo
 Apre-bocca suelto
 Manche et cadreseuls

KILNER-DOUGHTY
1412-BGB

Zungenspatel
 Tongue blades

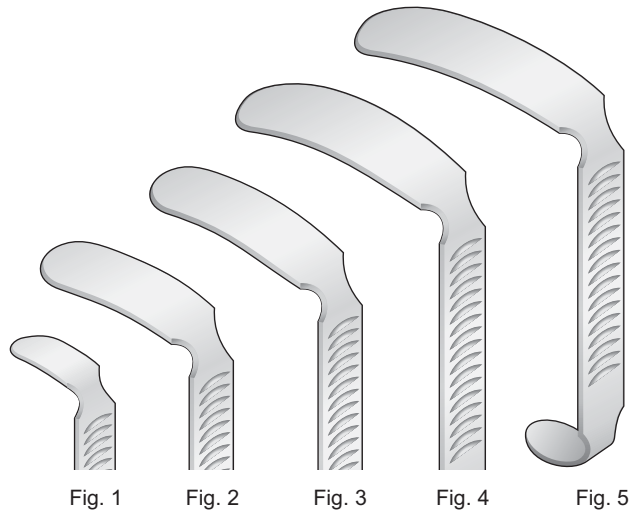

- 1412-BFC** Fig. 1 17x26 mm
- 1412-BFD** Fig. 2 19x46 mm
- 1412-BFE** Fig. 3 20x58 mm
- 1412-BFF** Fig. 4 22x71 mm
- 1412-BFG** Fig. 5 22x80 mm

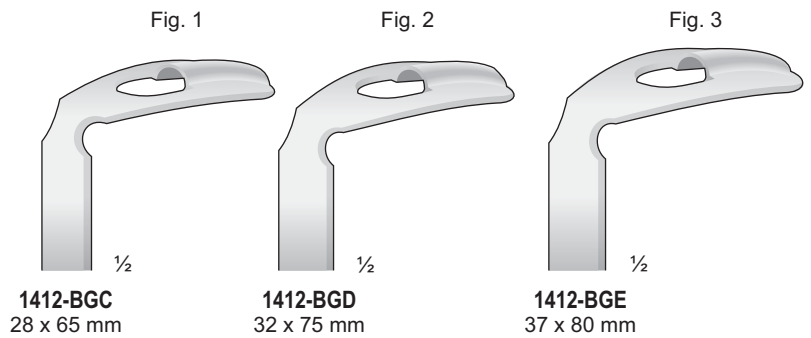

1412-BGC
 28 x 65 mm

1412-BGD
 32 x 75 mm

1412-BGE
 37 x 80 mm

KILNER-DOUGHTY
1412-BGA
 Komplet mit 3 Zungenspatel
 Complete with 3 tongue depressors
 Completo con 3 abbassalingua
 Completo con 3 abaja lengua
 Complet avec 3 abaisse-langues

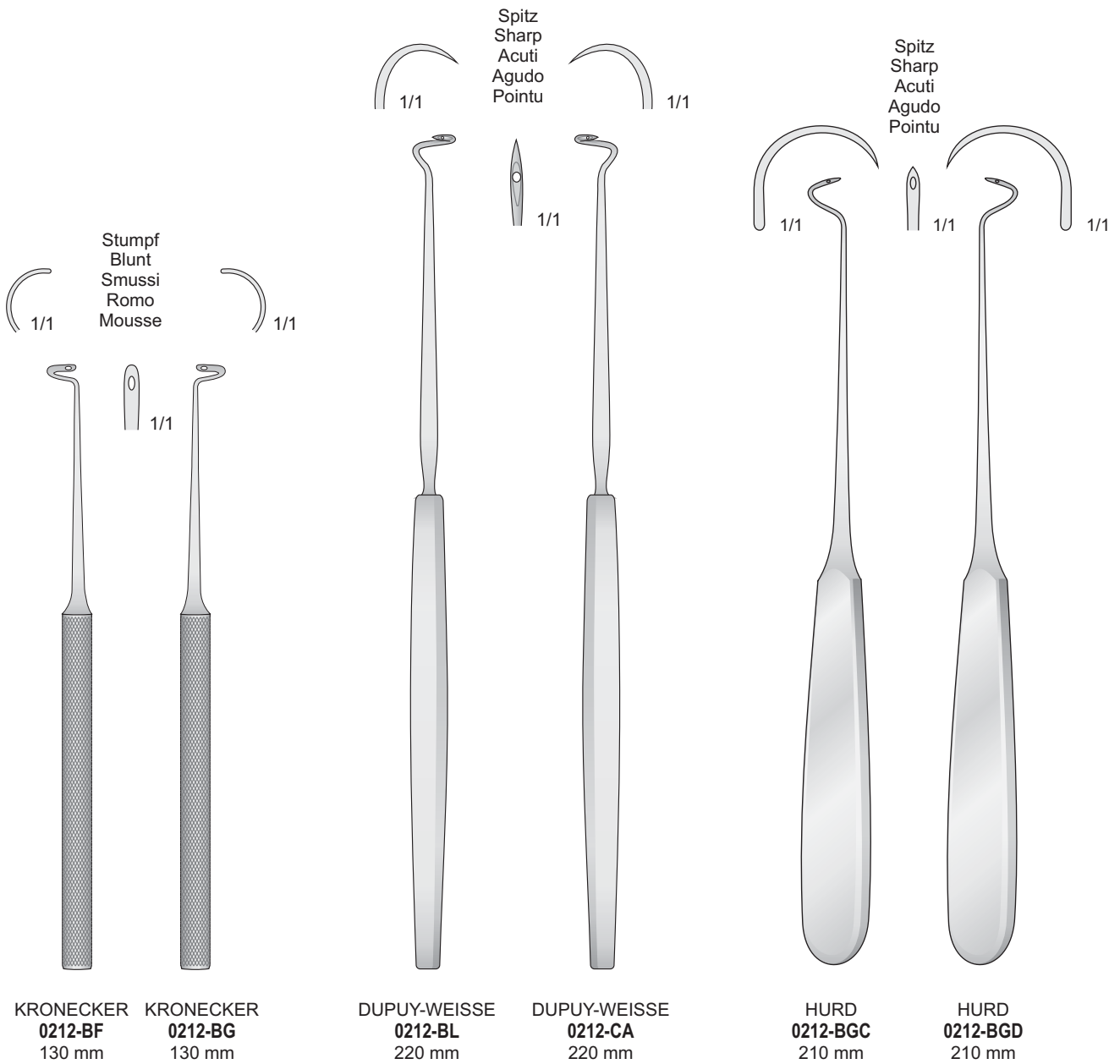

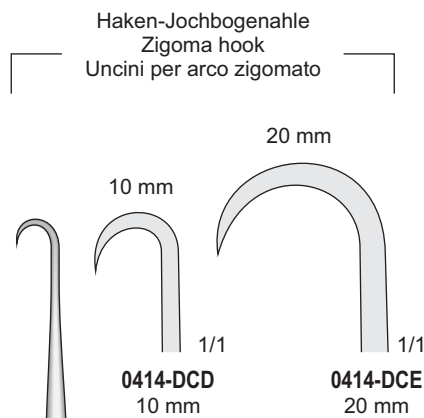

0414-DCD 10 mm
0414-DCE 20 mm
190 mm

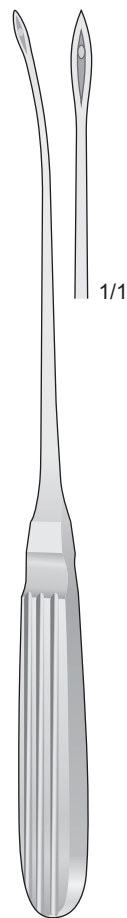

OBWEGESER
0414-DB
230 mm

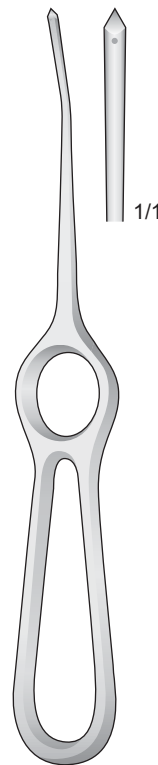

0414-DC
180 mm

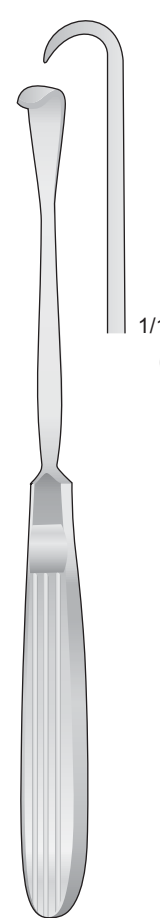

OBWEGESER
0414-BAB/0414-BAD
200 mm

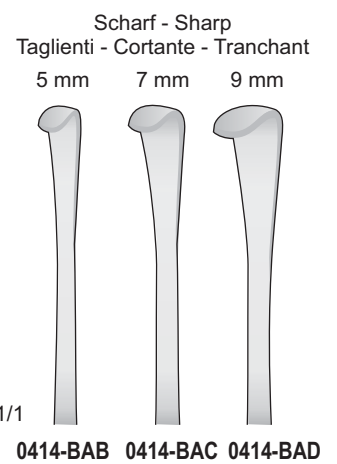

Raspatorien

Raspatories

Periostotomi

Legras

Rugines

Tonsillenhaken, Schrauben und Kehlkopfdeckelhalter
Tonsil Hooks, Screws, Epiglottis Retractors

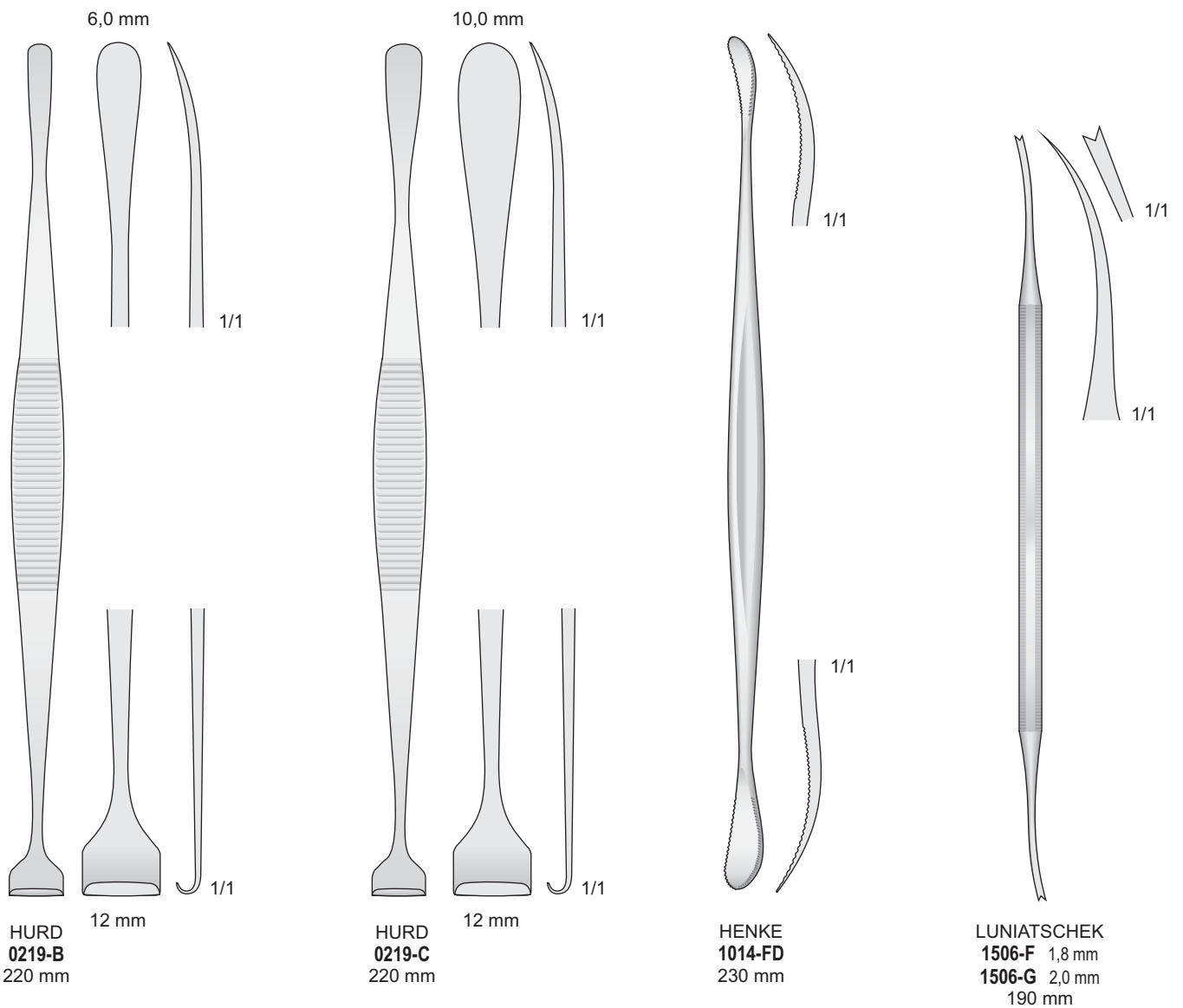

Tonsillenelevatorien und Haken
Tonsil Elevators and Hooks

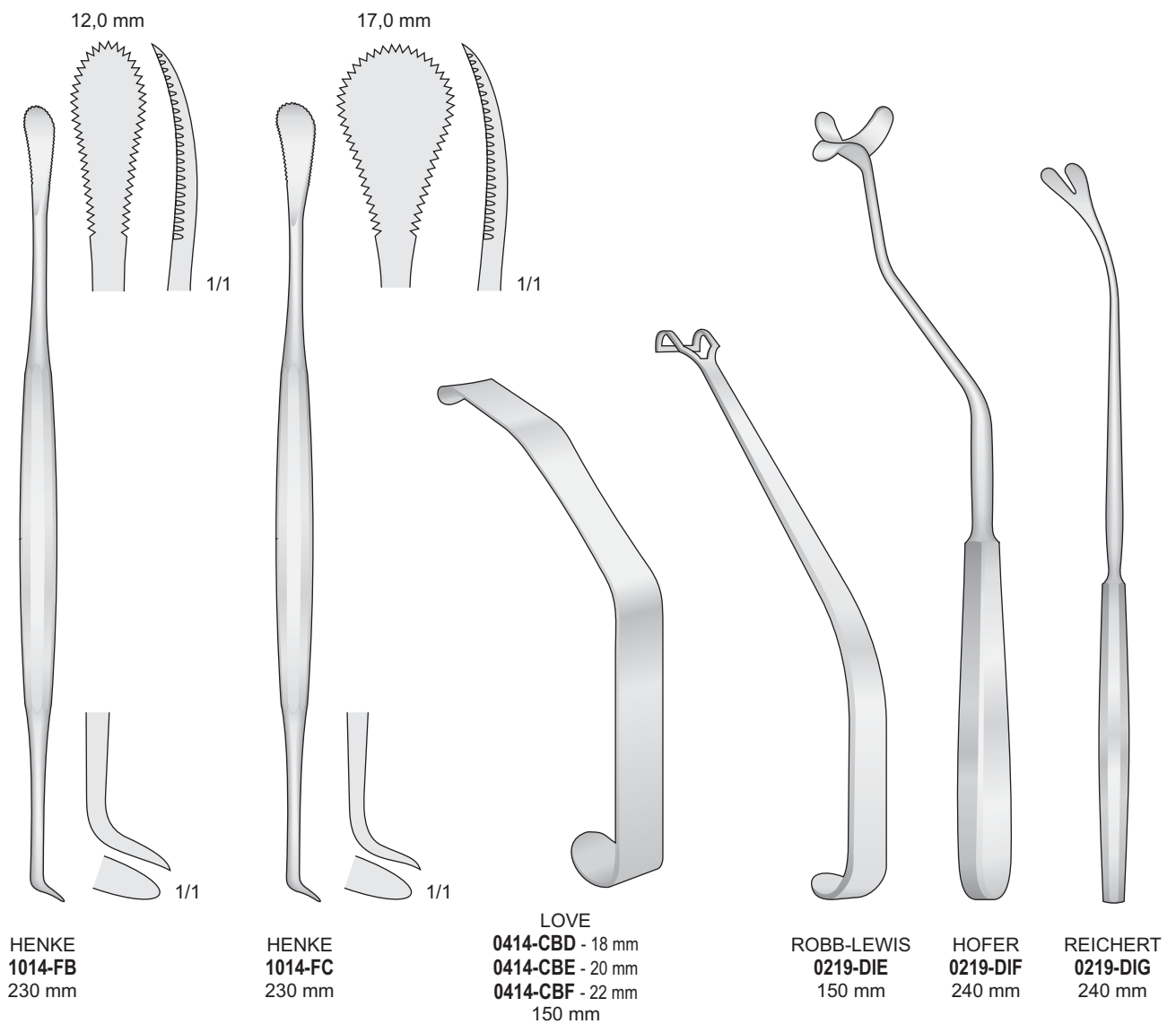

Tonsillenhaken

Tonsil Hooks

Retrattori per tonsille

Separador para amígdalas

Rétracteurs pour amygdales

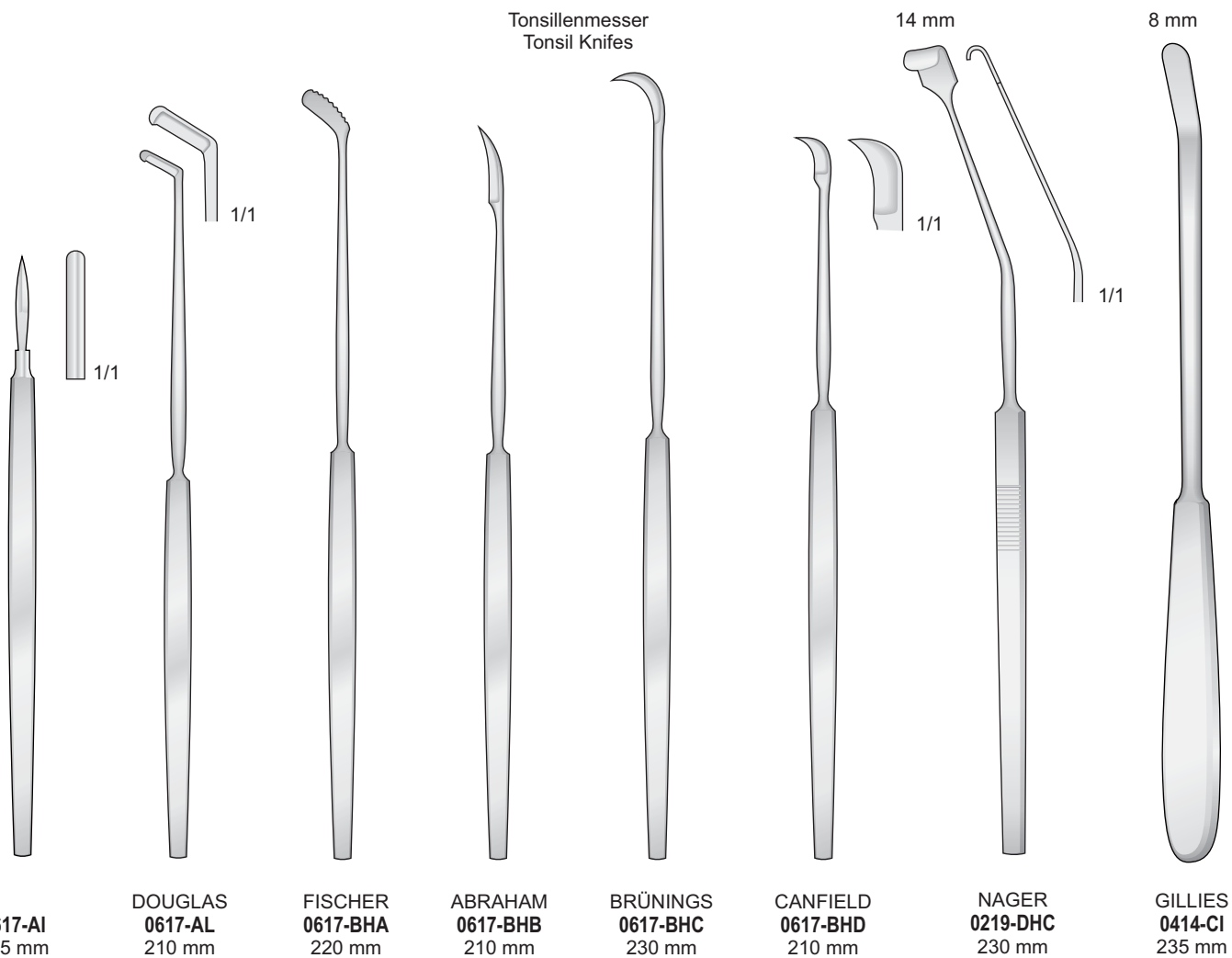

Polypenschnürer

Ear polypus snares

Pinze serranodi

Polipotomos

Serre noeuds

Ersatzklingen
Replacements blades
Lame di ricambio
Hojas de reserva
Lames de rechange

Schnürerdraht, Rolle 10 Meter
Snare wire, coil 10 meters
Filo d'acciaio per serranodi, matassina mt.10
Alambre de acero para polipotomo, rollo 10 metros
Fil d'acier pour serre-noeud, rouleau de 10 mt.

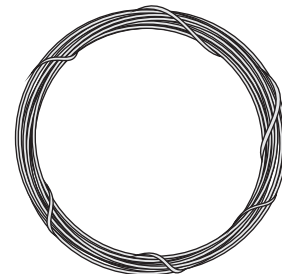
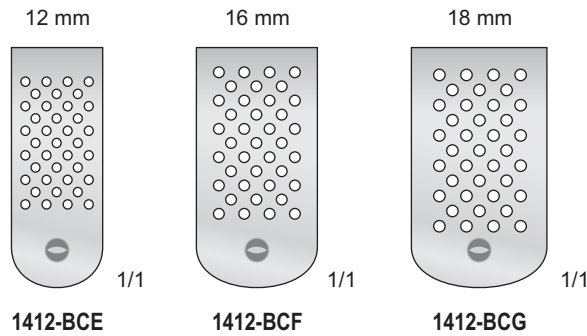

1009-CAE
0,4 mm

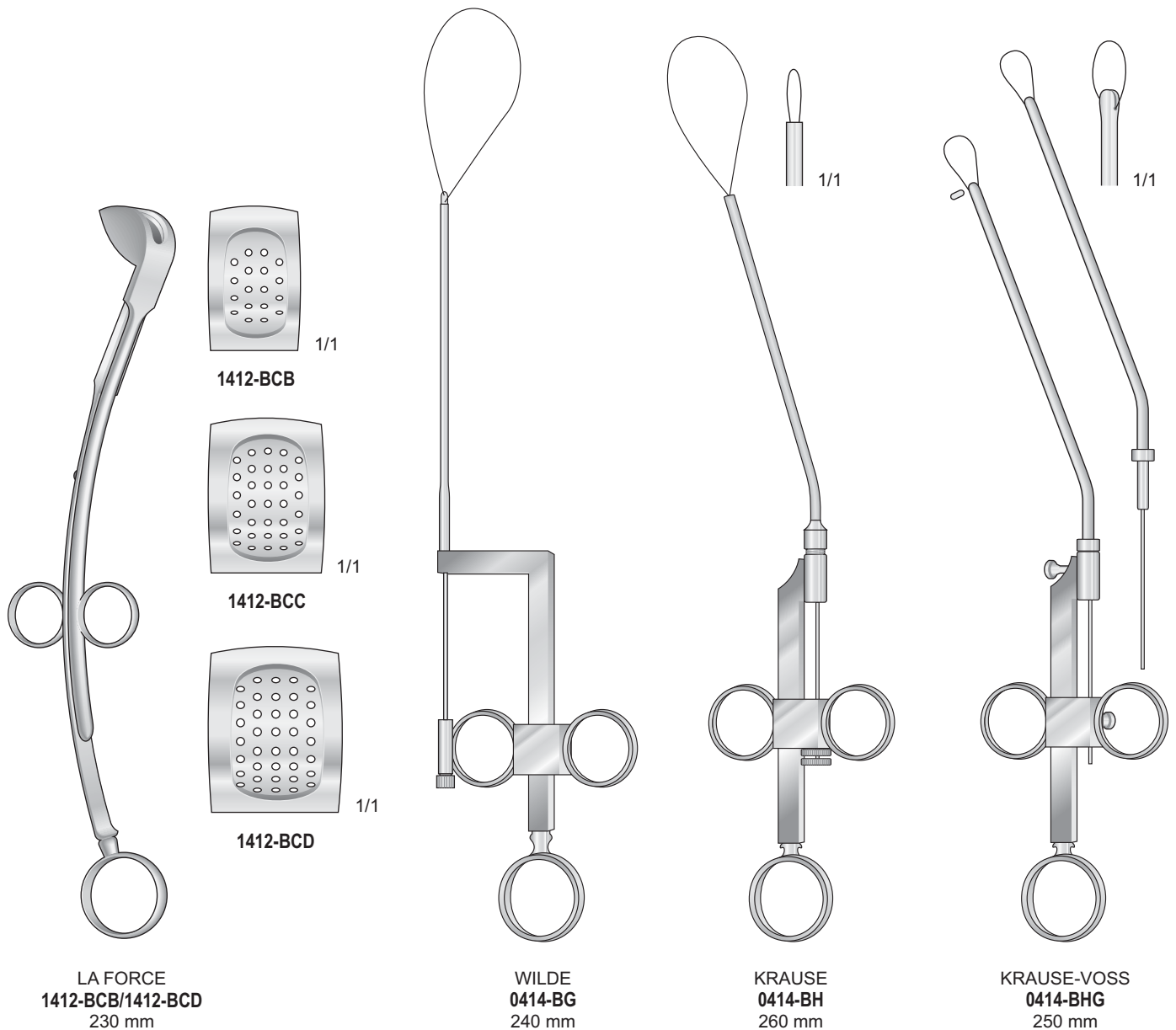

Polypenschnürer

Ear polypus snares

Pinze serranodi

Polipótomos

Serre noeuds

Schlingen, ungelötet, in Bündeln zu 100 Stück
 Snare loops unsoldered, in bundles of 100 pieces
 Anse per serranodi, in fasce da 100 pezzi
 Anses pour serre-noeud, en fasceaux de 100 pièces



0414-DDA

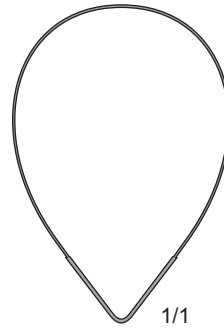

0414-DOB

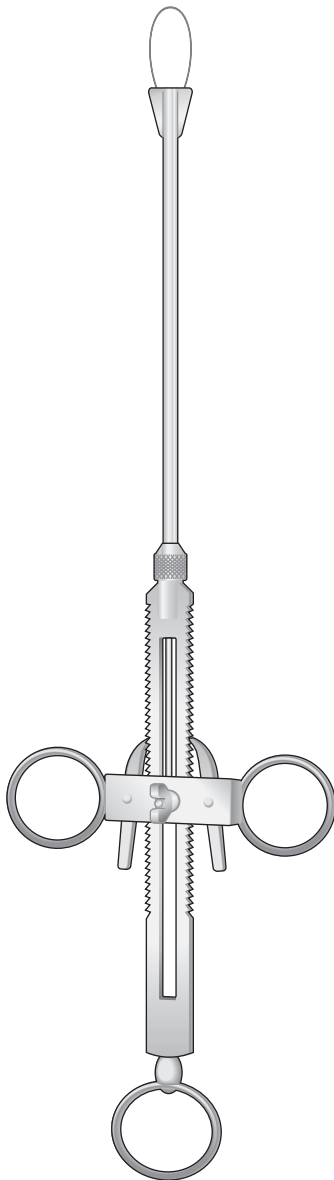

BRÜNINGS
 0414-DCG
 290 mm

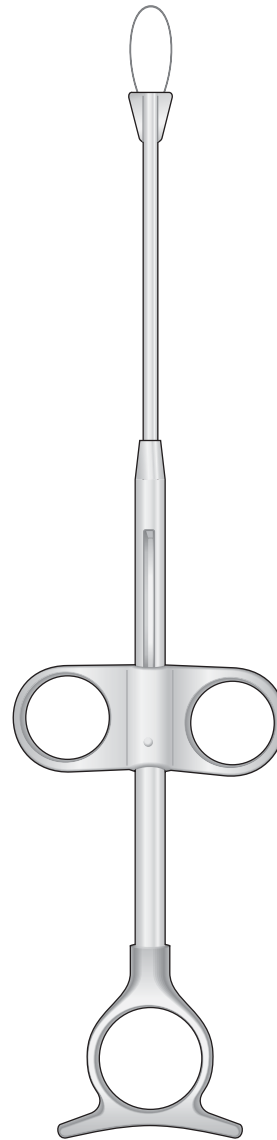

EVES
 0414-DCH
 270 mm

3.3



Mund, Hals, Throat
Mouth, Throat, Larinx
Bocca, Gola, Laringe
Boca, Garganta, Laringe
Bouche, Gorge, Larinx

Laryngo-, Broncho-, Oesophagoskopie
Laryngology, Bronchoscopy, Esophagoscopy
Laringoscopia, Broncoscopia, Esofagoscopia
Laringo-, Bronco-, Esofagoscopía
Laryngo-, Broncho-, Oesophagoscopie

Mundspiegel und griffe

Mirrors

Manici e specchietti

Espejos

Miroirs

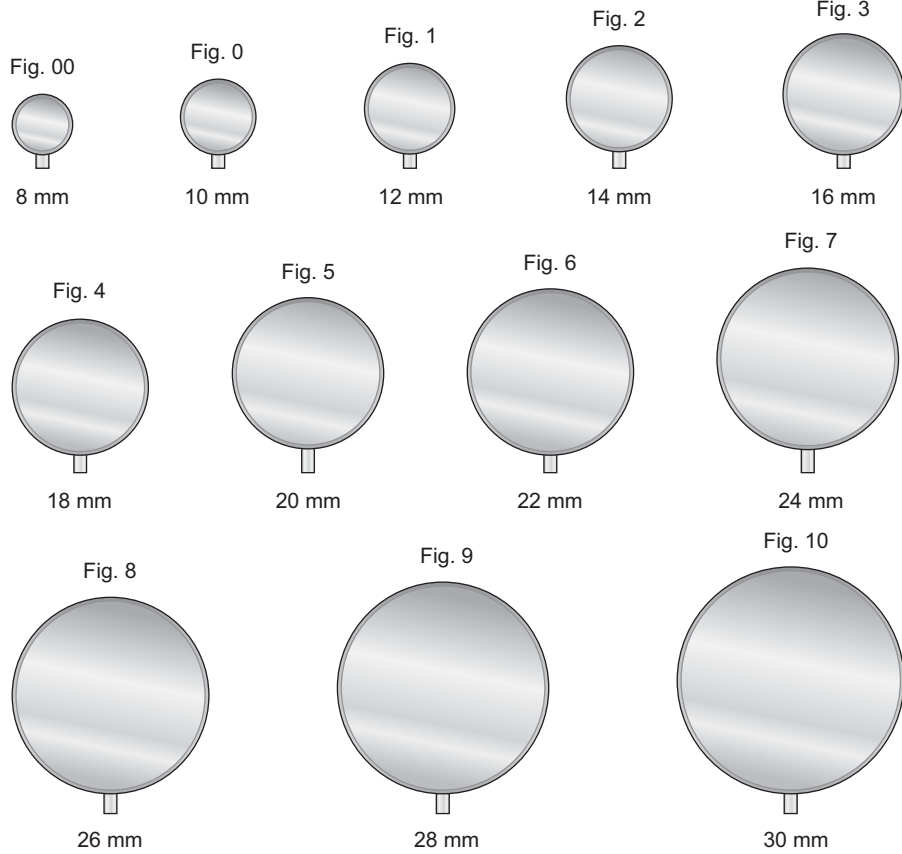

Kehlkopfspiegel mit Sechskantgriff
Laryngeal mirrors with hexagonal handle
Specchietto laringeo con manico esagonale
Espejos laringeos con mango exagonal
Miroirs laryngiens avec manche hexagonal

Inox

Spiegeldurchmesser - Diameter of mirrors - Diametro dello specchio
Diámetro de los espejos - Diamètre des miroirs

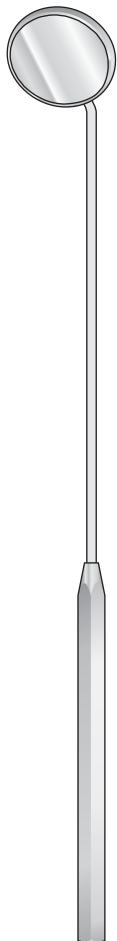

07-I/07-DA
180 mm

Spiegelgriff
Mirrors handle
Manico per specchietti
Mango para espejos
Manche à miroir

Nikel-Chrom

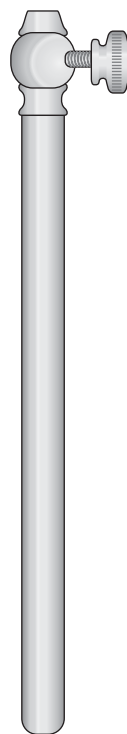

1201-G
120 mm

Kehlkopfspiegel
Laryngeal mirrors
Specchietto laringeo
Espejos laringeos
Miroirs laryngiens

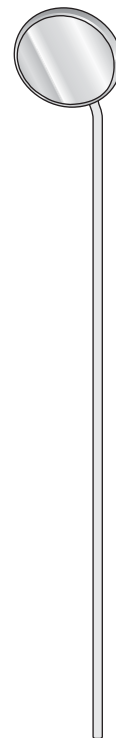

15-AA/15-AG
120 mm

	Fig.
07-I	00
07-BA	0
07-BC	1
07-BE	2
07-BG	3
07-BI	4
07-CA	5
07-CC	6
07-CE	7
07-CG	8
07-CI	9
07-DA	10

	Fig.
15-AA	00
15-A	0
15-AB	1
15-AC	2
15-AD	3
15-AE	4
15-AF	5
15-AG	6
15-AG01	7
15-AG02	8
15-AG03	9
15-AG04	10

Trachealdilatatoren Tracheal Dilators Dilatatori per tracheotomia Dilatadores traqueales Dilatateurs pour trachéotomie

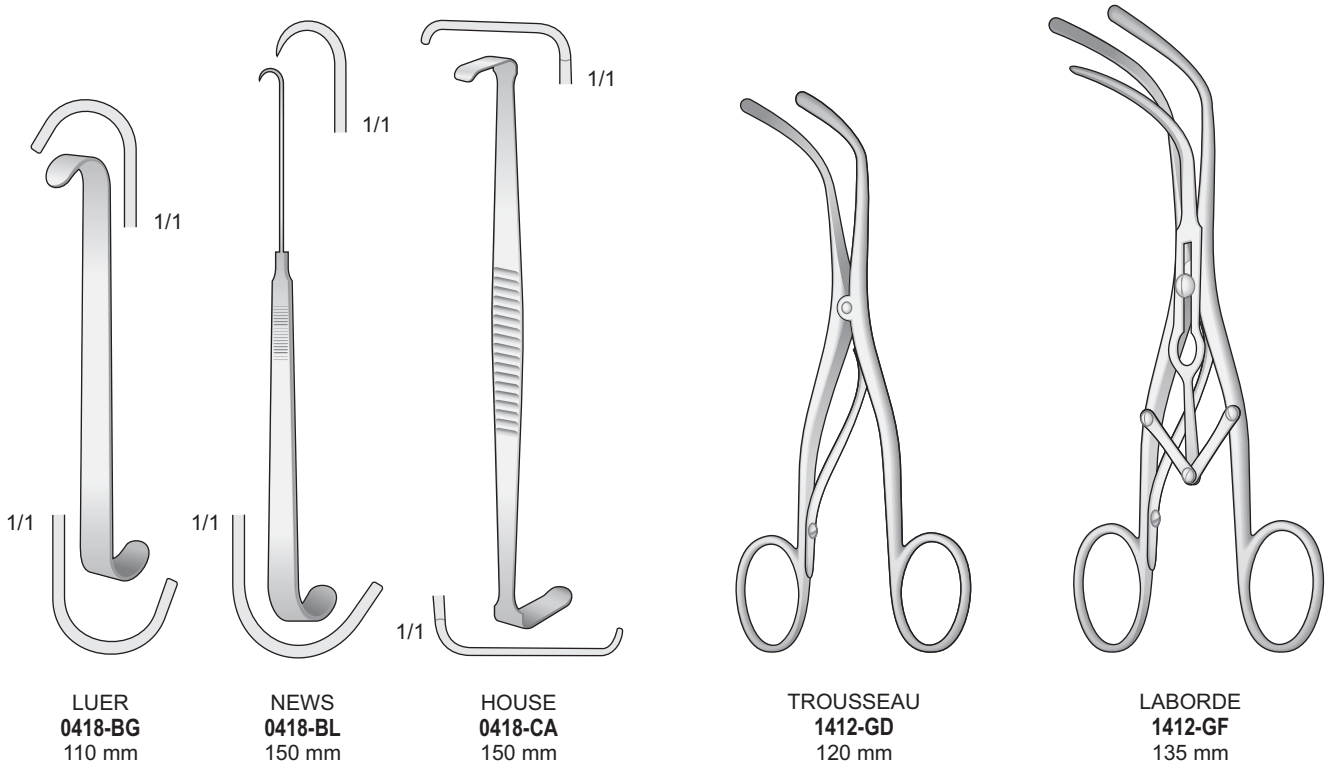
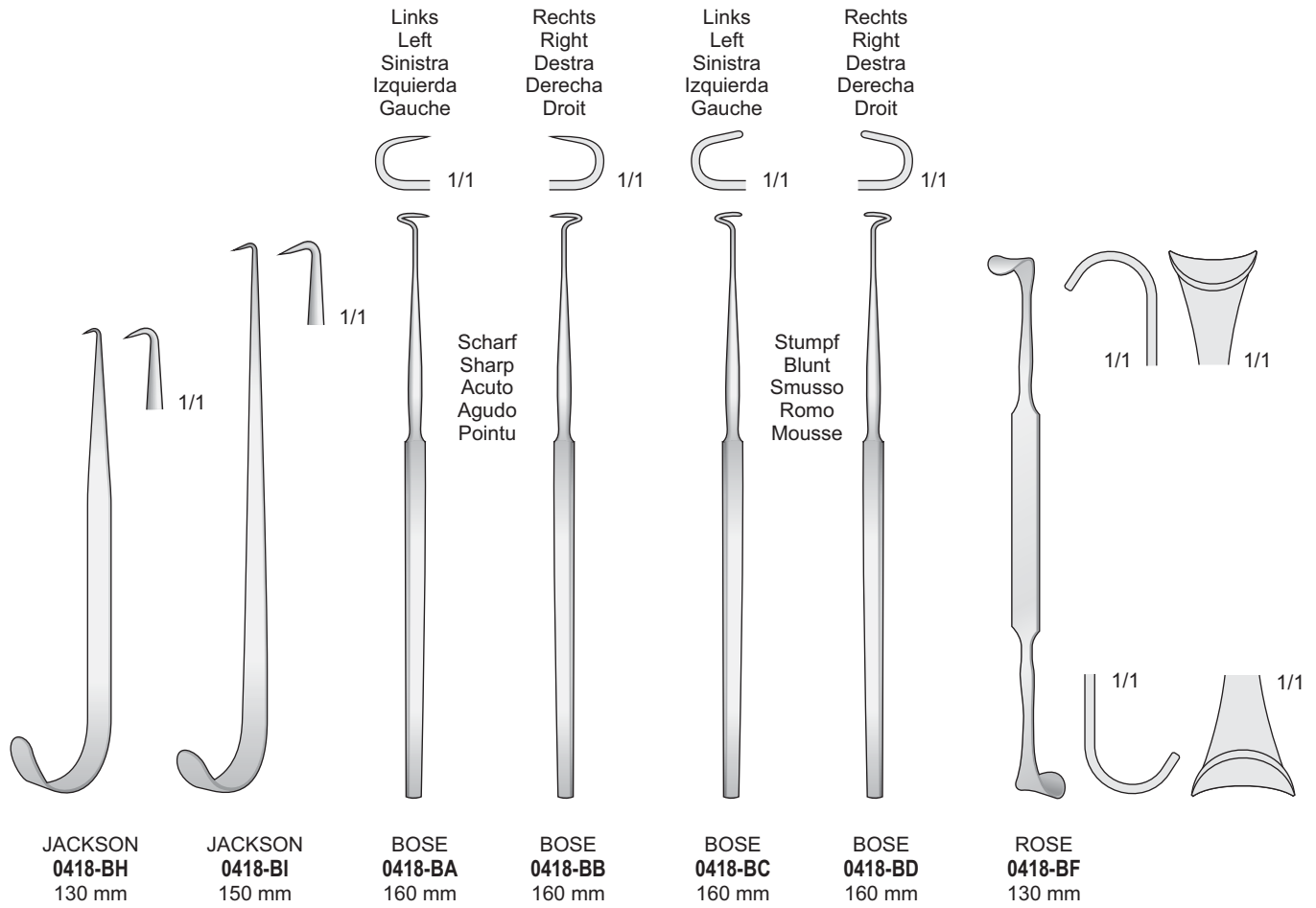

Kehlkopzangen - Laryngeal Forceps
 Pinze per laringe - Pinzas para Laringologia
 Pince au larynx

Rorhschaft	Ø 3,0 mm - 2,0 mm
Tube Shaft	Ø 3,0 mm - 2,0 mm
Misure Cannule	Ø 3,0 mm - 2,0 mm
Tige de tube	Ø 3,0 mm - 2,0 mm

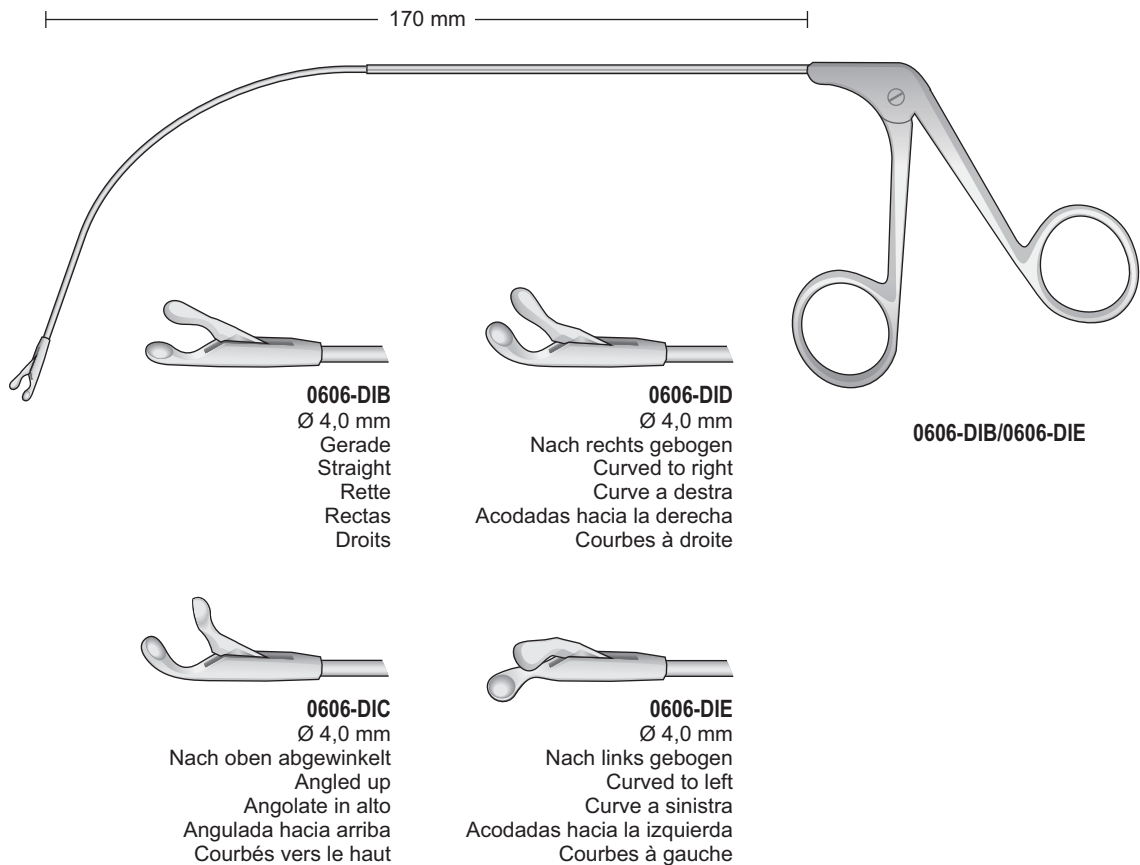
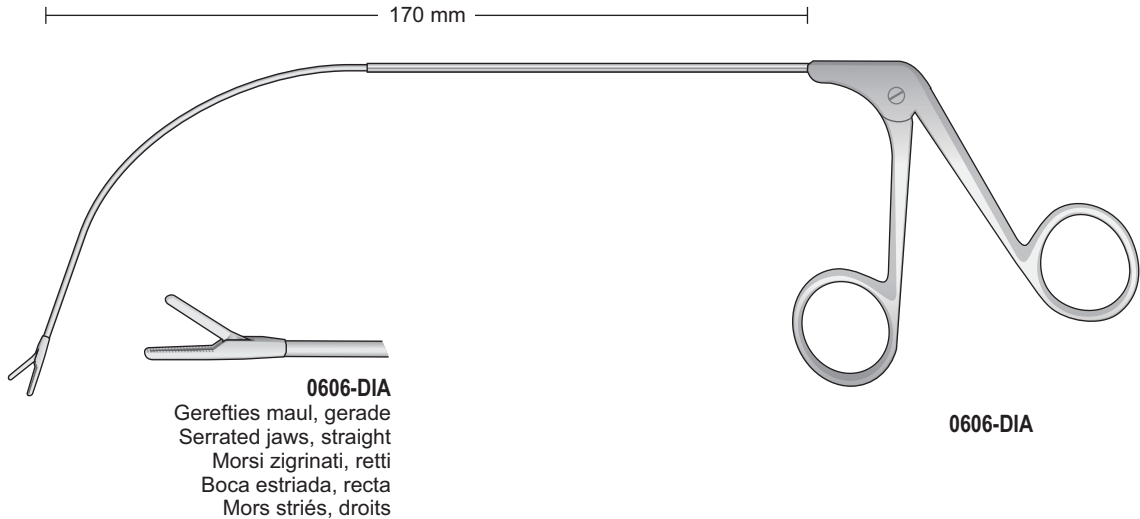



0606-EFA
Gerade
Straight
Rette
Rectas
Droits



0606-EFB
Gerade, horizontal schneidend
Straight, horizontally cutting
Rette, taglio orizzontale
Rectas, de corte horizontal
Droits, à coupe horizontale



0606-EFC
Nach links gebogen
Curved to left
Curve a sinistra
Acodadas hacia la izquierda
Courbes à gauche



0606-EFD
Nach rechts gebogen
Curved to right
Curve a destra
Acodadas hacia la derecha
Courbes à droite



0606-EFE
Nach oben abgewinkelt
Angled up
Angolate in alto
Angulada hacia arriba
Coudés vers le haut



0606-EFF
Nach unten abgewinkelt
Angled down
Angolate in basso
Angulada hacia abajo
Coudés vers le bas



0606-EFG
Gerefties mau, gerade
Serrated jaws, straight
Morsi zigrinati, retti
Boca estriada, recta
Mors striés, droits



0606-EFH
Gerefties mau, rechts gebogen
Serrated jaws, right
Morsi zigrinati, curvi a destra
Boca estriada, curva a la derecha
Mors striés, courbes à droite



0606-EFI
Gerefties mau, links gebogen
Serrated jaws, left
Morsi zigrinati, curvi a sinistra
Boca estriada, curva a la izquierda
Mors striés, courbes à gauche

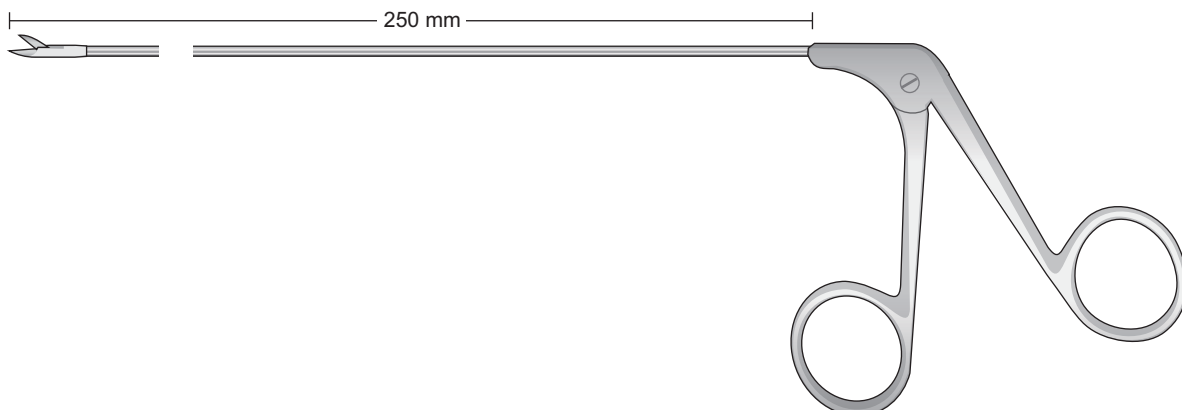

0606-EFA/0606-EFI
250 mm

Laryngologie

Laryngology

Laringologia

Laringologia

Laryngologie



0606-EFL

Rundes Löffelmaul, gerade
Round cup jaws, straight
Morso a forma di cucchiaio rotondo, retto
Boca redonda en forma de cucharilla, recta
Mors ronds en cuiller, droits



0606-EGA

Morso a forma di cucchiaio rotondo, in alto
Round cup jaws, up
Rundes Löffelmaul, nach oben
Mors ronds en cuiller, courbes en haut
Boca redonda en forma de cucharilla, arriba



0606-EGB

Rundes Löffelmaul, rechts
Round cup jaws, right
Morso a forma di cucchiaio rotondo, destra
Boca redonda en forma de cucharilla, a la derecha
Mors ronds en cuiller, courbes à droite



0606-EGC

Rundes Löffelmaul, links
Round cup jaws, left
Morso a forma di cucchiaio rotondo, sinistra
Boca redonda en forma de cucharilla, a la izquierda
Mors ronds en cuiller, courbes à gauche



0606-EGD

Ovales Löffelmaul, gerade
Oval cup jaws, straight
Morso a forma di cucchiaio ovale, retto
Boca ovalada en forma de cucharilla, recta
Mors ovales en cuiller, droits



0606-EGE

Ovales Löffelmaul, nach oben
Oval cup jaws, up
Morso a forma di cucchiaio ovale, in alto
Boca ovalada en forma de cucharilla, arriba
Mors ovales en cuiller, courbes en haut



0606-EGF

Ovales Löffelmaul, rechts
Oval cup jaws, right
Morso a forma di cucchiaio ovale, destra
Boca ovalada en forma de cucharilla, a la derecha
Mors ovales en cuiller, courbes à droite



0606-EGG

Ovales Löffelmaul, links
Oval cup jaws, left
Morso a forma di cucchiaio ovale, sinistra
Boca ovalada en forma de cucharilla, a la izquierda
Mors ovales en cuiller, courbes à gauche

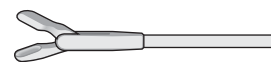

0606-EGH

Ovales Löffelmaul, gerade
Oval cup jaws, straight
Morso a forma di cucchiaio ovale, retto
Boca ovalada en forma de cucharilla, recta
Mors ovales en cuiller, droits



0606-EGI

Maulteile gefenstert
Jaw fenestrated
Morso fenestrato
Boca fenestrada
Mors ajourés

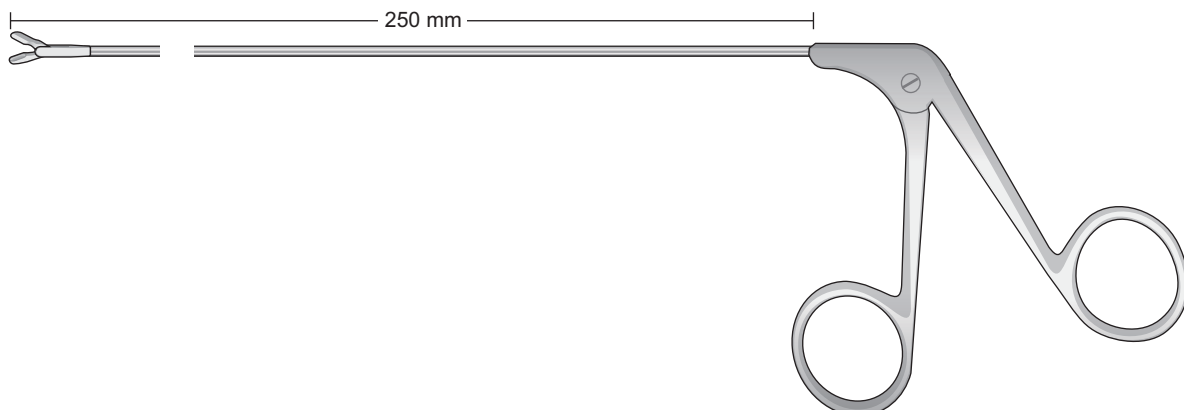

0606-EFL/0606-EGI
250 mm

Watteträger

Cotton applicators

Porta cotone

Portaalgodòn

Porte cotons

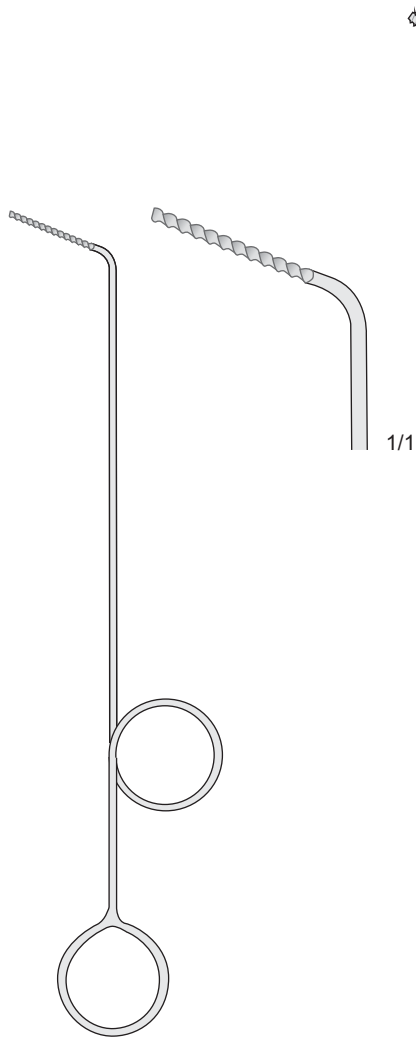
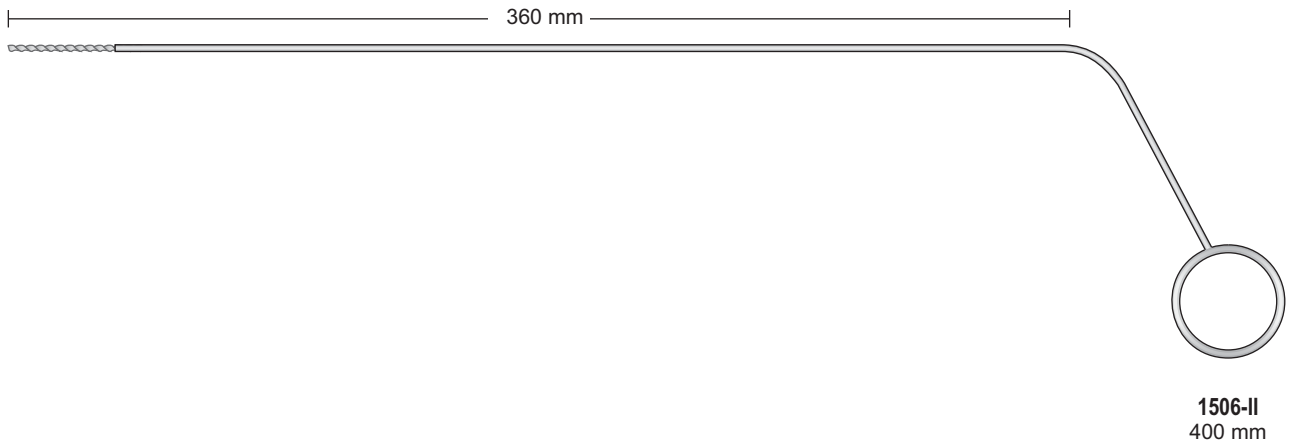

HARTMANN
1506-HD - Ø 2,3 mm
220 mm

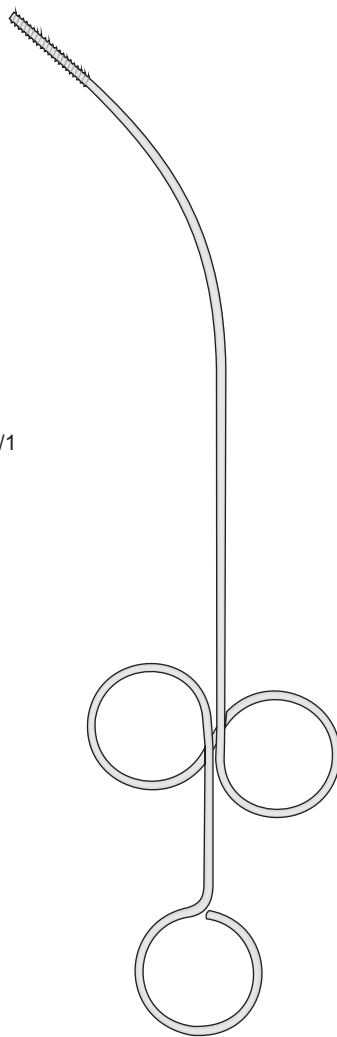

FEIN
1506-GF
250 mm



HEILDELBERG
1506-GA
180 mm

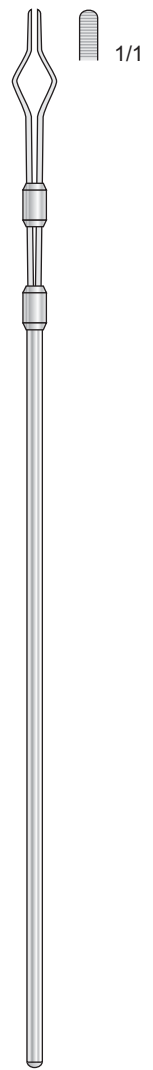

HEILDELBERG
1506-GB
170 mm

MC INTOSH



0101-02BAA
 2,5 Volt
 300 mA
 Für Spatel **0101-BAA**
 For blades **0101-BAA**
 Per lama **0101-BAA**
 Para hojas **0101-BAA**
 Pour spatules **0101-BAA**



0101-02BAB
 2,5 Volt
 300 mA
 Für Spatel **0101-BAB ÷ 0101-BAE**
 For blades **0101-BAB ÷ 0101-BAE**
 Per lame **0101-BAB ÷ 0101-BAE**
 Para hojas **0101-BAB ÷ 0101-BAE**
 Pour spatules **0101-BAB ÷ 0101-BAE**

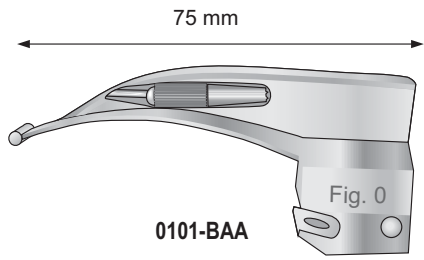

0101-BAA

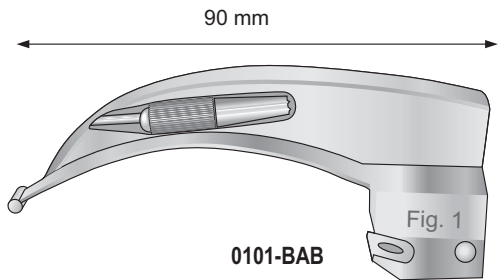

0101-BAB

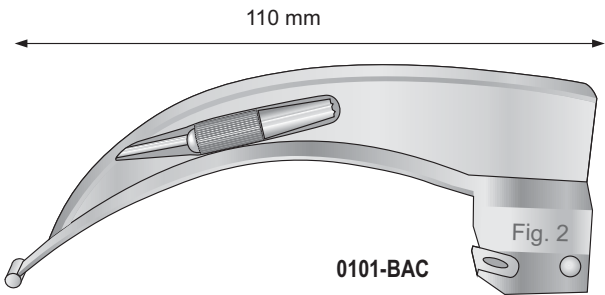

0101-BAC

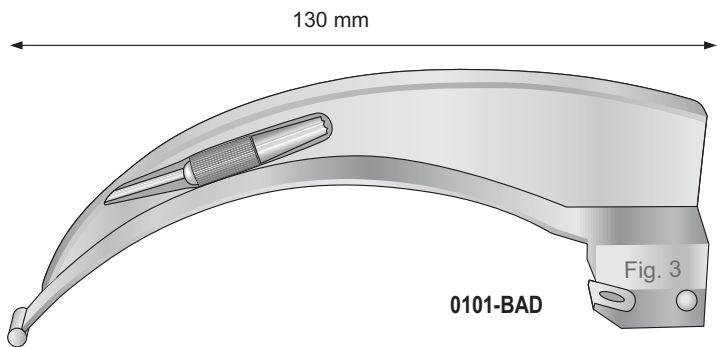

0101-BAD

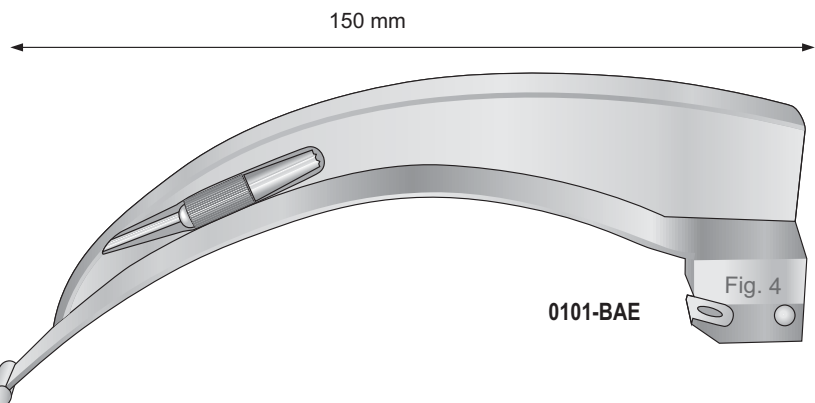

0101-BAE

MC INTOSH

Fiberoptik
Fiber Optic
Fibre ottiche
Fibra Óptica
Fibre Optic

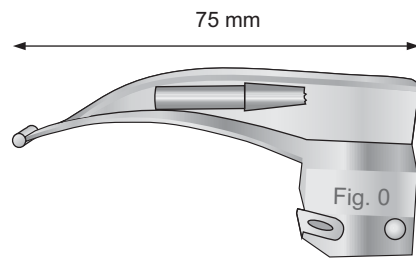
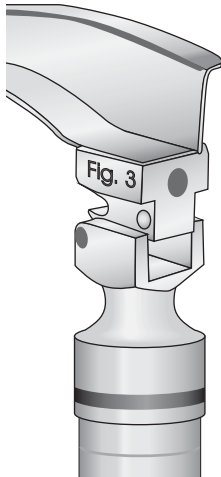

0101-FAA

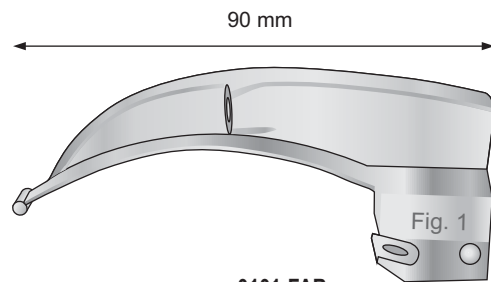

0101-FAB

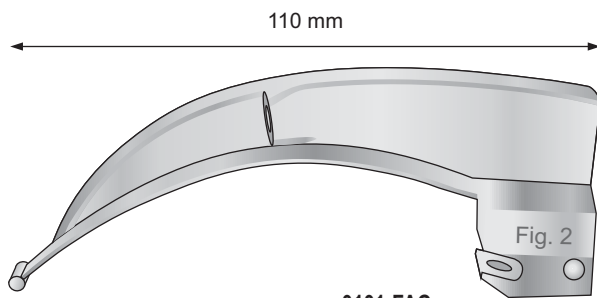

0101-FAC

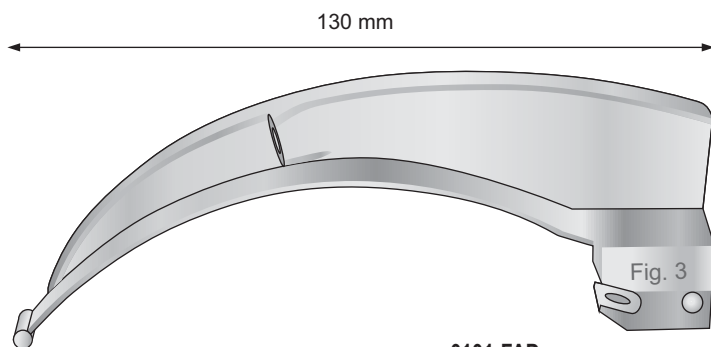

0101-FAD

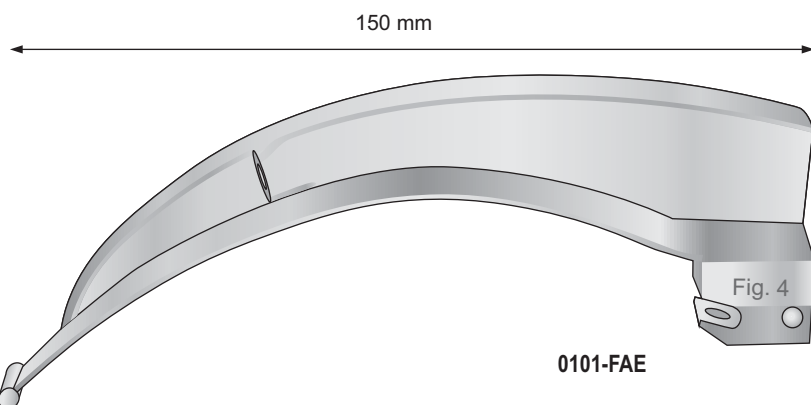

0101-FAE



MILLER



0101-02BAA
2,5 Volt
300 mA

Fiberoptik
Fiber Optic
Fibre ottiche
Fibra Óptica
Fibre Optic

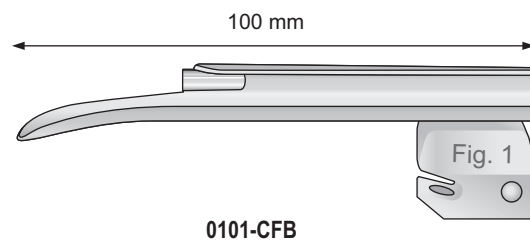
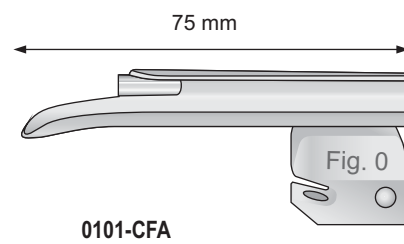
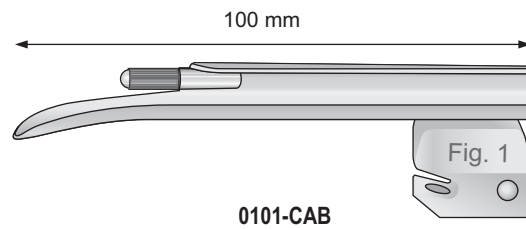
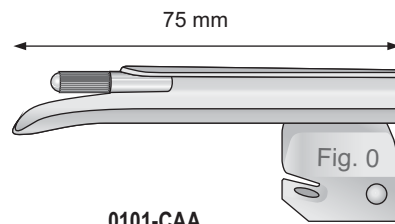

NEGUS - GUEDEL



0101-02BAA
 2,5 Volt
 300 mA
 Für Spatel **0101-EAB**
 For blades **0101-EAB**
 Per lama **0101-EAB**
 Para hojas **0101-EAB**
 Pour spatules **0101-EAB**

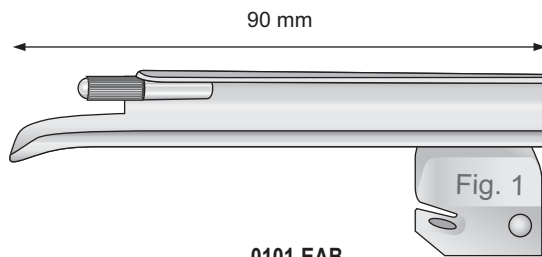

0101-EAB



0101-02BAB
 2,5 Volt
 300 mA
 Für Spatel **0101-EAC ÷ 0101-EAE**
 For blades **0101-EAC ÷ 0101-EAE**
 Per lame **0101-EAC ÷ 0101-EAE**
 Para hojas **0101-EAC ÷ 0101-EAE**
 Pour spatules **0101-EAC ÷ 0101-EAE**

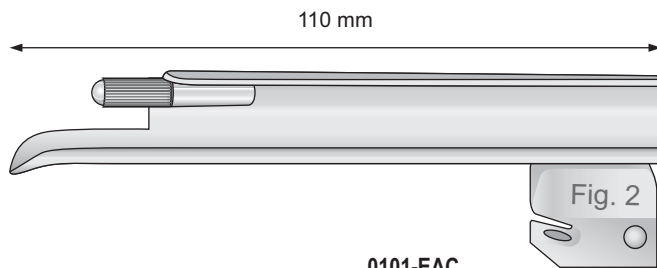

0101-EAC

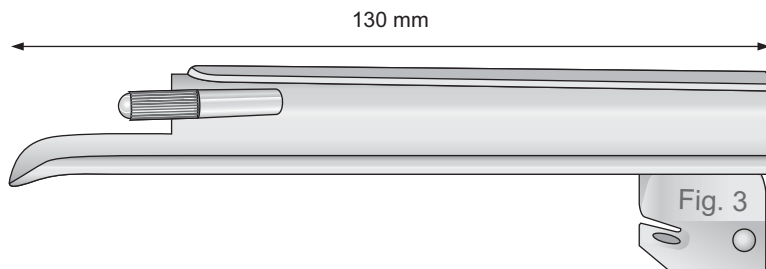

0101-EAD

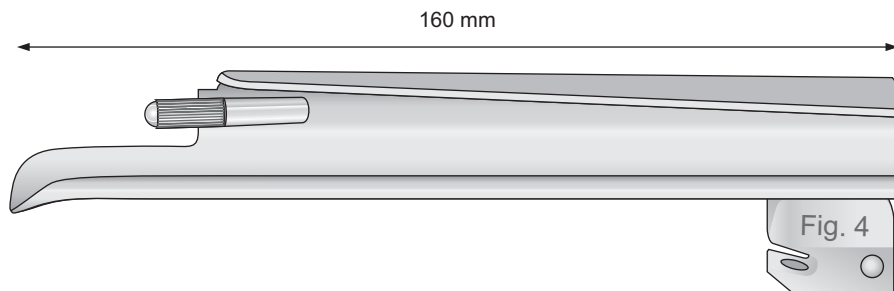

0101-EAE

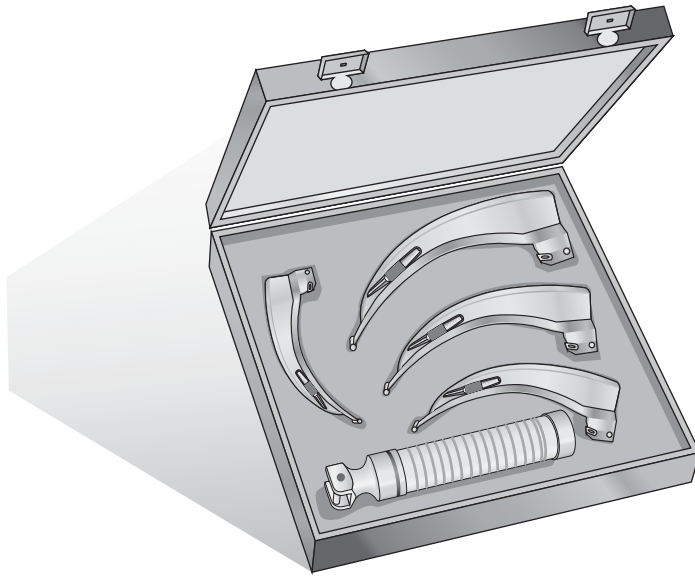

Mc INTOSH
0101-18BAD - Set 3 Blatte/Blade/Lame
0101-18BAE - Set 4 Blatte/Blade/Lame
0101-18BAF - Set 5 Blatte/Blade/Lame

MILLER
0101-18CAD - Set 3 Blatte/Blade/Lame
0101-18CAE - Set 4 Blatte/Blade/Lame
0101-18CAF - Set 5 Blatte/Blade/Lame

NEGUS-GUEDEL
0101-18EAD - Set 3 Blatte/Blade/Lame
0101-18EAE - Set 4 Blatte/Blade/Lame

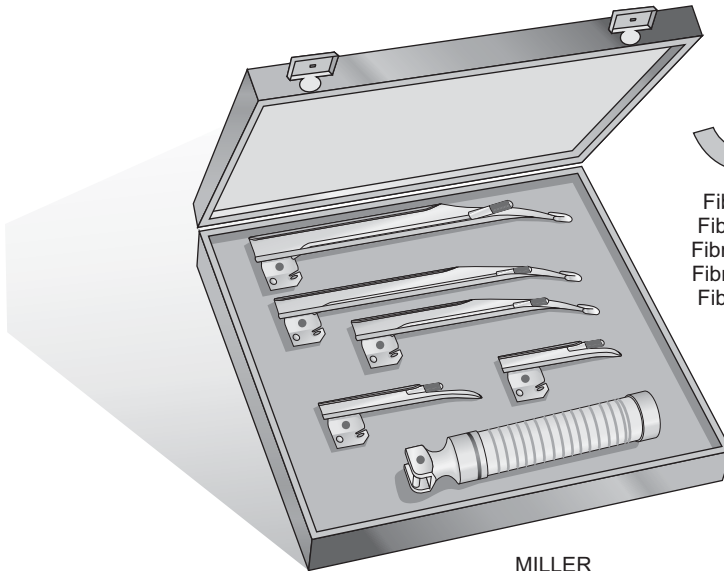

Fiberoptik
Fiber Optic
Fibre ottiche
Fibra Óptica
Fibre Optic

MILLER
0101-18CFF

MILLER
0101-18CFD - Set 3 Blatte/Blade/Lame
0101-18CFE - Set 4 Blatte/Blade/Lame
0101-18CFF - Set 5 Blatte/Blade/Lame

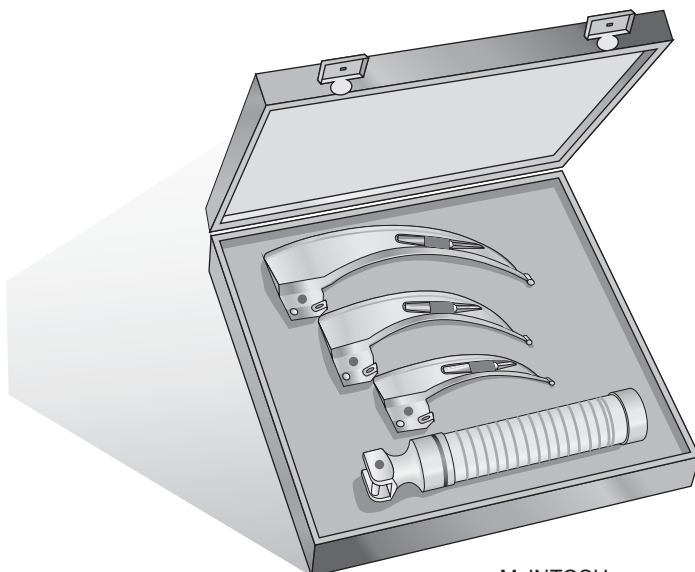

Fiberoptik
Fiber Optic
Fibre ottiche
Fibra Óptica
Fibre Optic

McINTOSH
0101-18FAD

Mc INTOSH
0101-18FAD - Set 3 Blatte/Blade/Lame
0101-18FAE - Set 4 Blatte/Blade/Lame
0101-18FAF - Set 5 Blatte/Blade/Lame

Halogenlampe - Halogen lamp
Lampada alogene - Lámpara Houlógeno
Lampe halogène



0101-BDA
640 mA



0101-02BAA
2,5 Volt
300 mA



0101-02BAB
2,5 Volt
300 mA

Griffe aus Rostfreiem Edelstahl - Handles of stainless steel - Manico in Acciaio Inossidabile

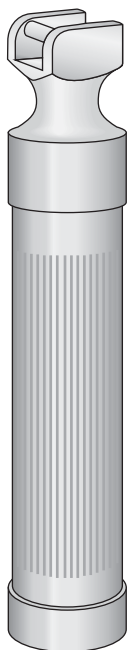

0101-HA
Ø 30 mm

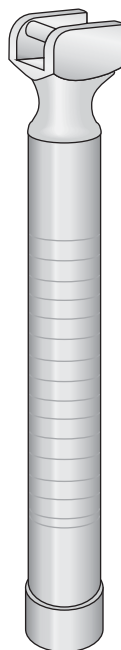

0101-IA
Ø 18 mm



Kaltlichtgriff
Fiberoptic Handle
Manico Fibre ottiche

0101-LA08
Ø 30 mm

4.1



Allgemeine HNO-Instrumentarium
General ENT Instruments
Strumentario generale per ORL
Instrumental general para ORL
Instruments généraux pour ORL

Skalpellgriffe, Skalpel, MeBinstrumente
Scalpel handles, Knives, Measuring Instrument
Manici per bisturi, Bisturi, Strumenti per misura
Mangos de bisturios, Bisturios, Instrumentos para medir
Manches de bistouris, Bistouris, Instruments à mesurer

Skalpelligriffe

Scalpel handles

Manici per bisturi

Mangos de bisturios

Manches de bistouris

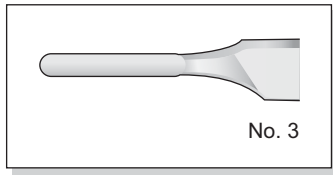

1201-02D
120 mm



1201-02D12
120 mm



1201-02H
160 mm



1201-02H10
120 mm



1201-02B
145 mm



1201-02C
145 mm

1,5 mm

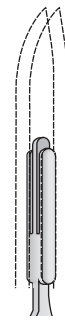

1201-02I

2,5 mm



1201-02L



1201-02I/1201-02L
155 mm

Skalpelli

Scalpel handles

Manici per bisturi

Mangos de bisturias

Manches de bistouris

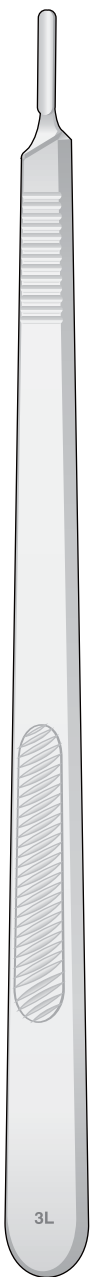
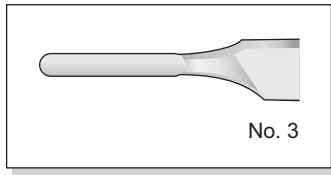

1201-02D11
200 mm

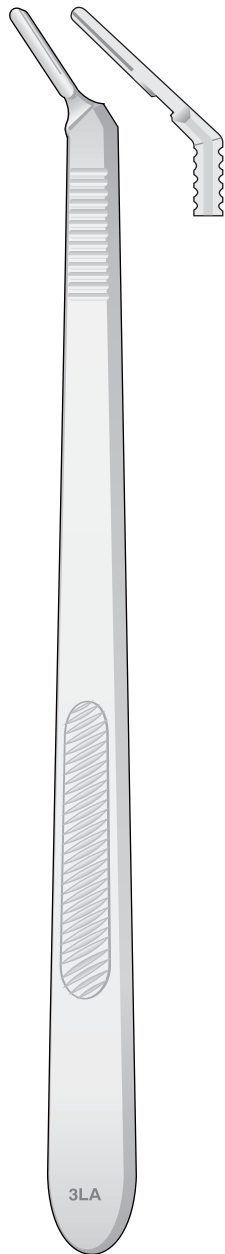

1201-02F
200 mm



1201-02BB
210 mm

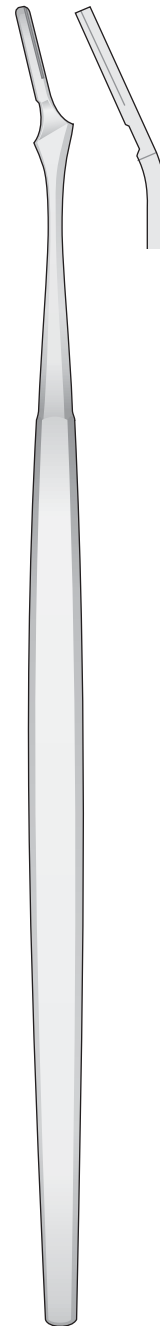

1201-02BC
210 mm

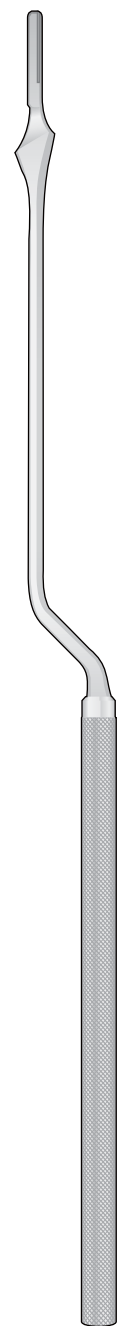

1201-02BF
210 mm

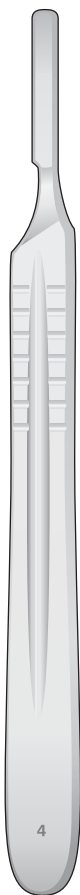
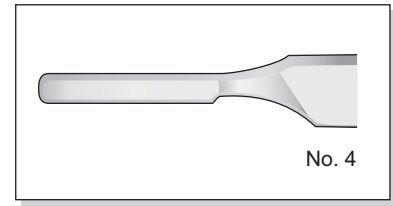

1201-02E
130 mm

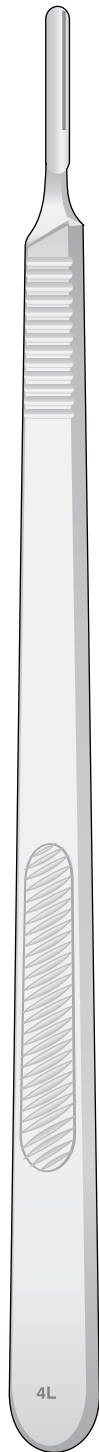

1201-02E11
210 mm



1201-02G
210 mm

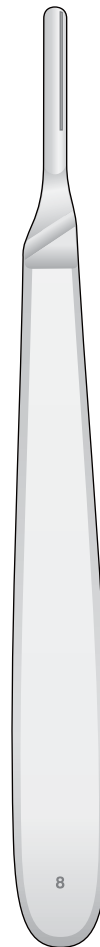

1201-02BA
140 mm

Packungen à 100
 Packages of 100 ea
 Scatole da 100 pezzi
 Cajas de 100 c/u
 Boîtes de 100 pièces

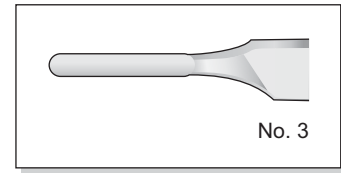

1102-BA



1102-BB

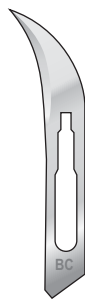

1102-BC

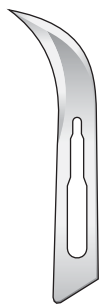

1102-BC04



1102-BD



1102-BF



1102-BF01



1102-BF03

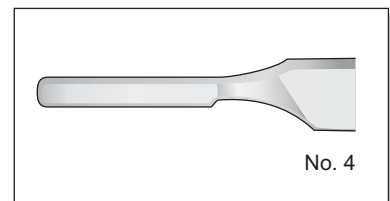

1102-BI

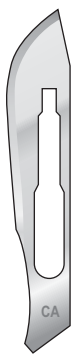

1102-CA



1102-CB



1102-CC



1102-CD



1102-CE



1102-CF



1102-DG

Mikro-Skalpellklingen,
Skalpellgriffe

Micro Scalpel Blades,
Scalpel handles

Micro lame per bisturi,
Manici per bisturi

Micro hojas de bisturi,
Mangos de bisturí

Micro lame de bistouris,
Manches pour bistouris



1102-DGB
Pack. 10 pcs



1102-DGC
Pack. 10 pcs



1102-DGD
Pack. 1 pc



1102-DGE
Pack. 10 pcs



1102-DGF
Pack. 10 pcs

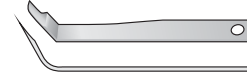

1102-DGG
Pack. 1 pc



1102-DGH
Pack. 10 pcs

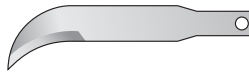

1102-DGI
Pack. 10 pcs



1102-DGL
Pack. 1 pc

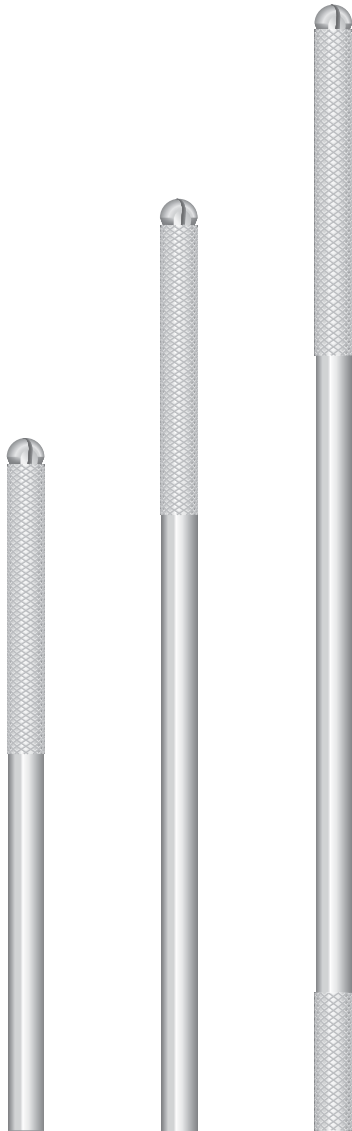

1310-B
100 mm

1310-D
130 mm

1310-C
150 mm

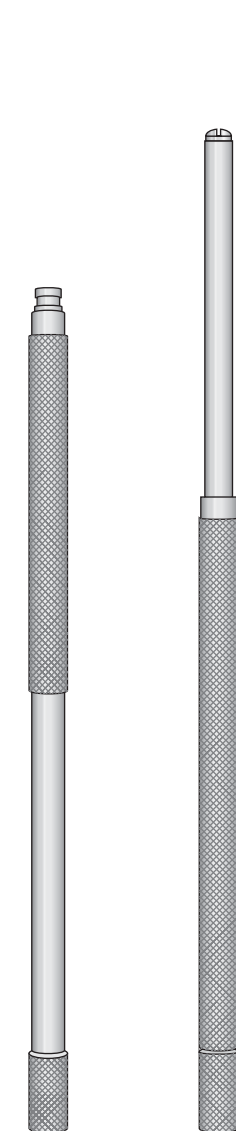

0202-EG
135 mm

0202-EI - 155 mm
0202-FA - 180 mm
0202-FC - 200 mm

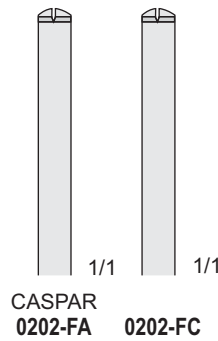

CASPAR
0202-FA **0202-FC**

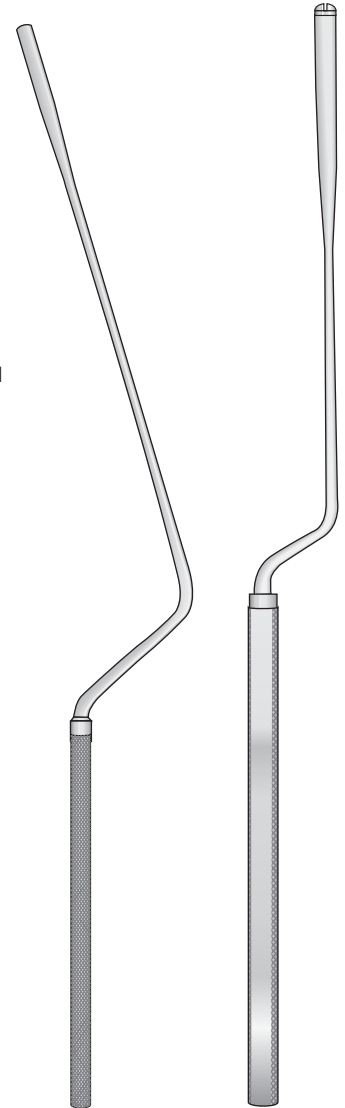

LANDOLT
0202-DI
250 mm

LANDOLT
0202-EA
210 mm

Klingenbrecher
Rasierklingen

Scalpel blade
removing forceps

Pinze togli lame
per bisturi

Pinza para quitar
hojas de bisturias

Pinces pour enlever
les lames de bistouris

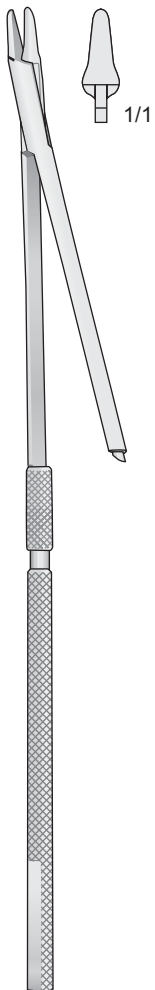

1310-IF
180 mm

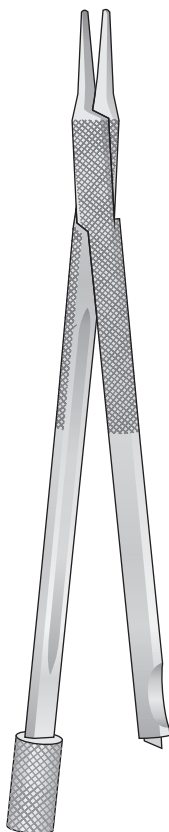

1310-BC
120 mm

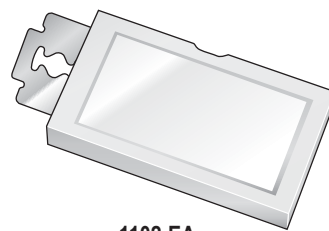
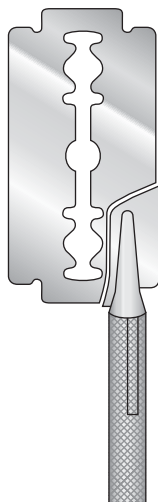

1102-EA
Packung 10 Klingen
Package 10 blades
Scatola da 10 lame
Cajita de 10 hojas
Boite de 10 lames

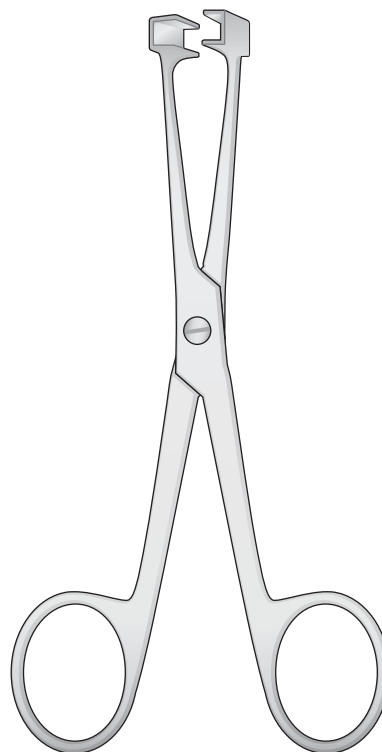

0718-BI
135 mm

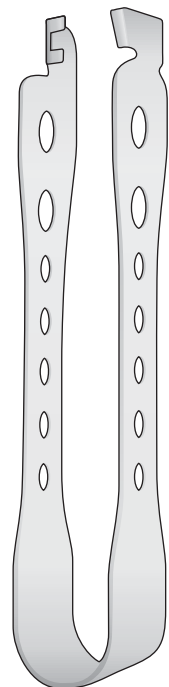

0718-BG
115 mm

Meßbereich: 0 - 80 mm
 Measuring range: 0 - 80 mm
 Campo di misura: 0 - 80 mm
 Alcance de medición: 0 - 80 mm
 Etendue de mesure: 0 - 80 mm



1417-EA
125 mm

Meßbereich: 0 - 80 mm
 Measuring range: 0 - 80 mm
 Campo di misura: 0 - 80 mm
 Alcance de medición: 0 - 80 mm
 Etendue de mesure: 0 - 80 mm

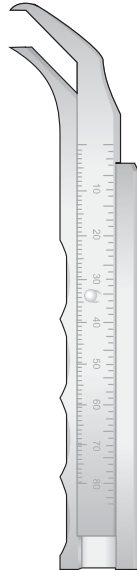

1417-EC
120 mm

Meßbereich: 0 - 80 mm
 Measuring range: 0 - 80 mm
 Campo di misura: 0 - 80 mm
 Alcance de medición: 0 - 80 mm
 Etendue de mesure: 0 - 80 mm

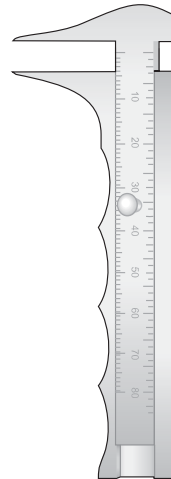

1417-EF
95 mm

Inches - mm



1118-AG
300 mm

Inches - mm



1118-AL
150 mm

Inches - mm



1118-AI
100 mm

Inches - mm



1118-AI
120 mm

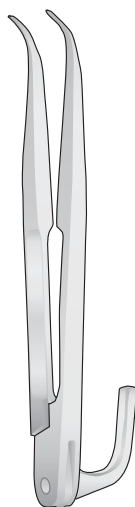

ZIELINSKY
0415-HCF
110 mm

Meßbereich: 0 - 15 mm
 Measuring range: 0 - 15 mm
 Campo di misura: 0 - 15 mm
 Alcance de medición: 0 - 15 mm
 Etendue de mesure: 0 - 15 mm

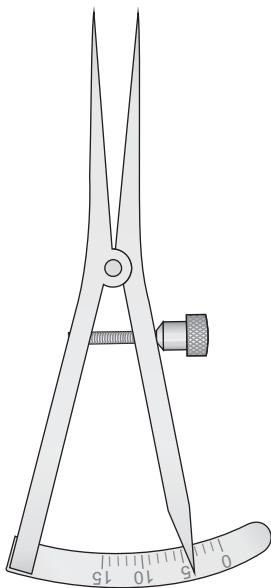

CASTROVIEJO
 1417-BF
 90 mm

Meßbereich: 0 - 20 mm
 Measuring range: 0 - 20 mm
 Campo di misura: 0 - 20 mm
 Alcance de medición: 0 - 20 mm
 Etendue de mesure: 0 - 20 mm

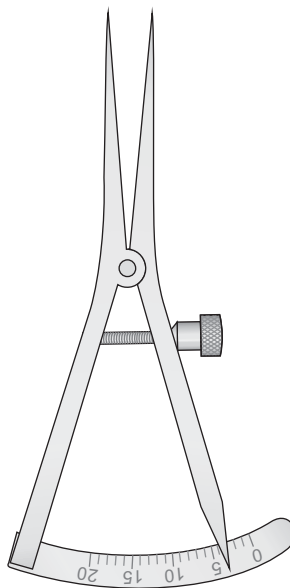

CASTROVIEJO
 1417-BH
 90 mm

Meßbereich: 0 - 20 mm
 Measuring range: 0 - 20 mm
 Campo di misura: 0 - 20 mm
 Alcance de medición: 0 - 20 mm
 Etendue de mesure: 0 - 20 mm

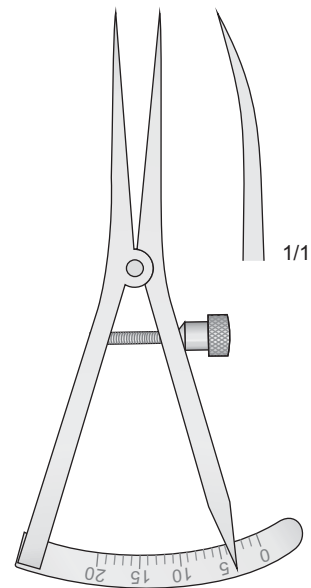

CASTROVIEJO
 1417-BL
 90 mm

4.2



Allgemeine HNO-Instrumentarium
General ENT Instruments
Strumentario generale per ORL
Instrumental general para ORL
Instruments généraux pour ORL

Scheren
Scissors
Forbici
Tijeras
Ciseaux

Mikro Scheren

Micro scissors

Micro forbici

Micro tijeras

Micro ciseaux

Spitz - Sharp - Acuta
Agudas - Pointu

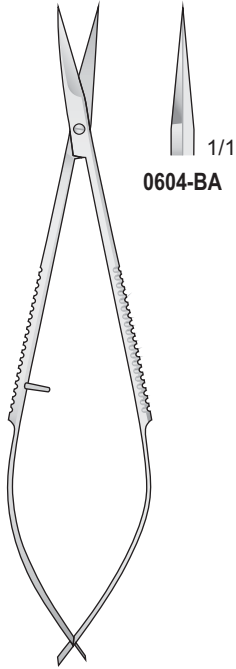

0604-BA

NOYES
0604-BA
120 mm

Spitz - Sharp - Acuta
Agudas - Pointu

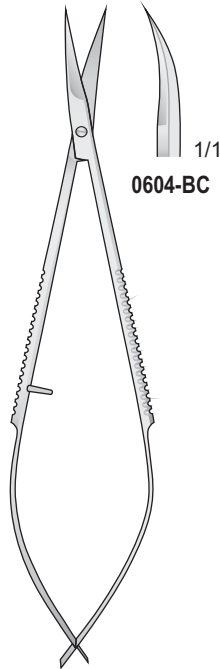

0604-BC

NOYES
0604-BC
120 mm

Spitz - Sharp - Acuta
Agudas - Pointu

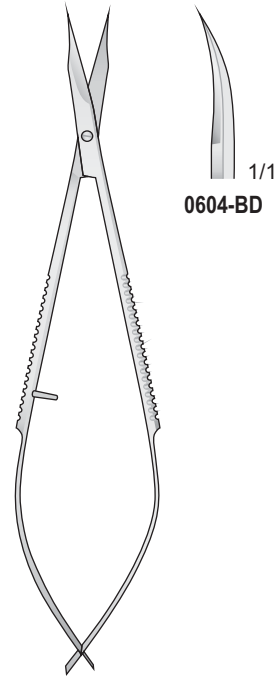

0604-BD

WESTCOTT
0604-BD
120 mm

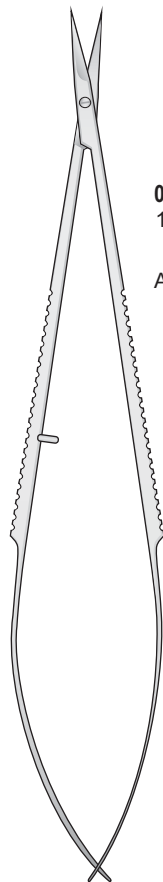

0604-AG
160 mm



0604-AI
160 mm

Spitz - Sharp
Acuta - Agudas - Pointu

0604-AG/0604-AI
160 mm

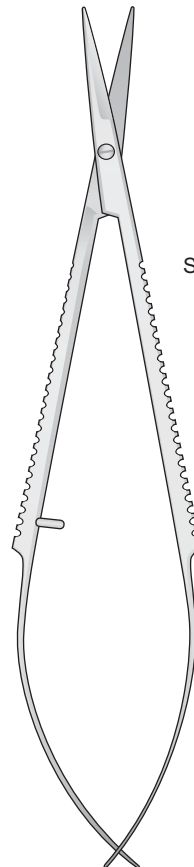

0604-EF
160 mm



0604-EG
160 mm

Stumpf - Blunt
Smussa - Romas - Mousse

0604-EF/0604-EG
160 mm

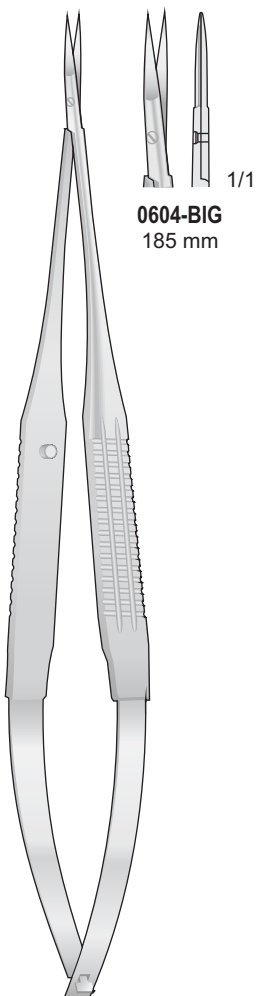

0604-BIG
185 mm

YASARGIL
0604-BIG
185 mm

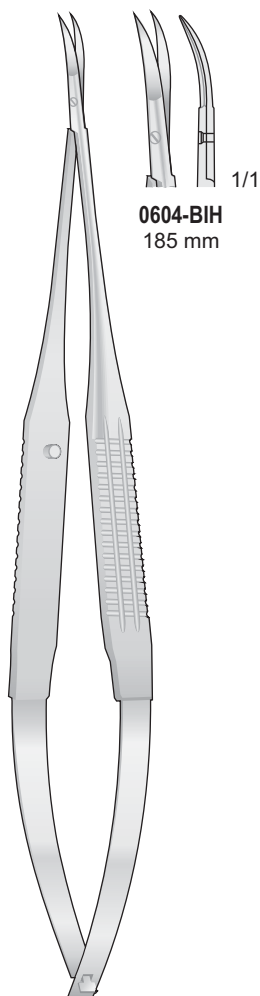

0604-BIH
185 mm

JACOBSON
0604-BIH
185 mm

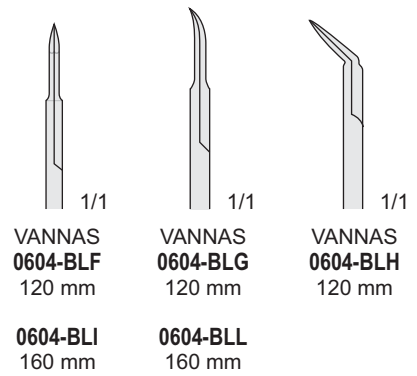
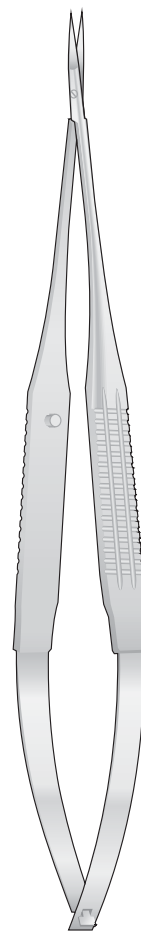

VANNAS
0604-BLF
120 mm

VANNAS
0604-BLG
120 mm

VANNAS
0604-BLH
120 mm

0604-BLI
160 mm

0604-BLL
160 mm

0604-BLF/0604-BLL

Mit Grossen Ringen
With large Rings
Forbici ad anelli grandi
Con anillos grandes
Avec anneaux larges

Iris scissors

Blepharoplasty
Blefaroplastica

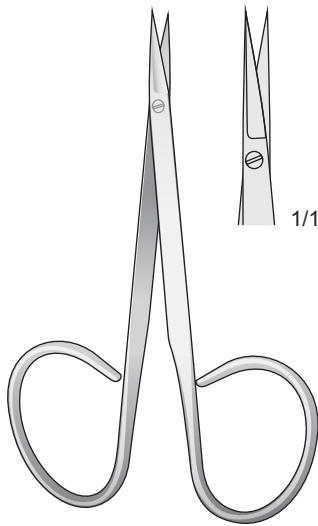

0607-CAA
95 mm

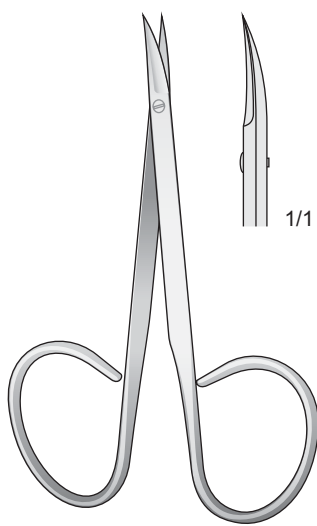

0607-CAB
95 mm

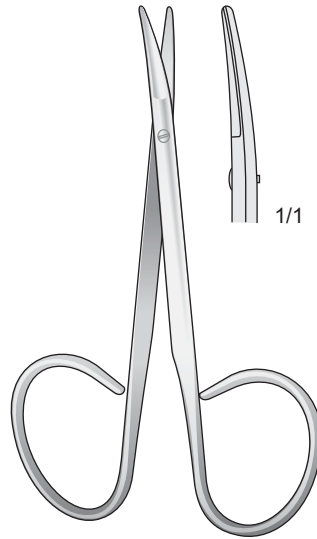

0607-CAC
95 mm

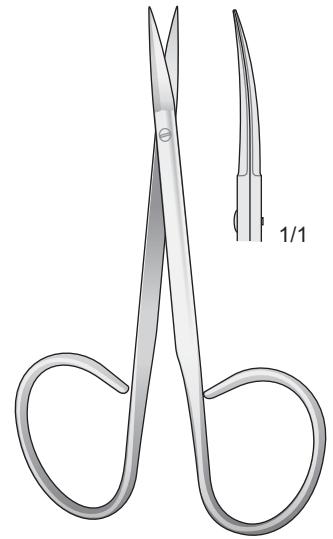

0607-CAD
105 mm

Iris scissors

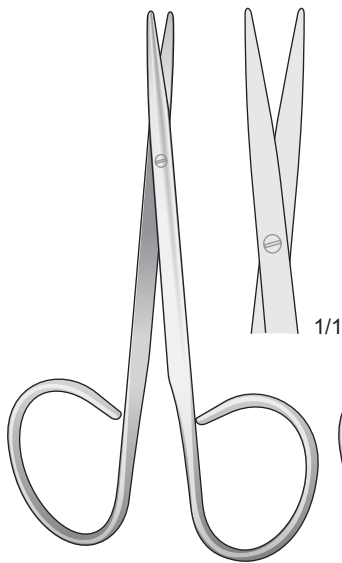

0607-CAE
100 mm

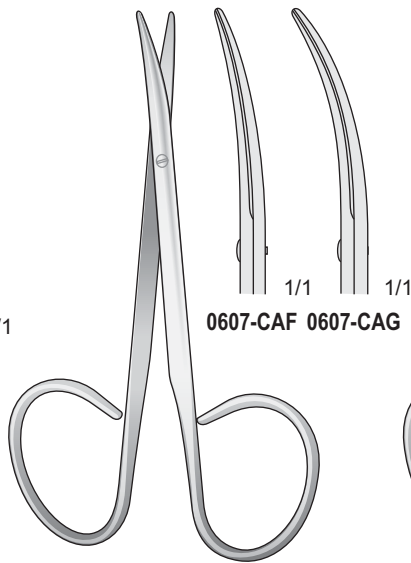

0607-CAF/0607-CAG
100 mm

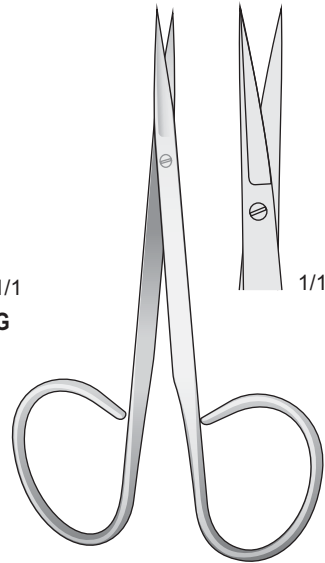

0607-CAH
105 mm

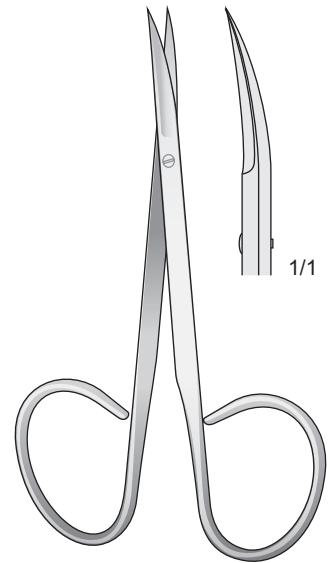

0607-CAI
105 mm

Feine Scheren

Delicate scissors

Forbici delicate

Tijeras finas

Ciseaux délicats

Mit Grossen Ringen
With large Rings
Forbici ad anelli grandi
Con anillos grandes
Avec anneaux larges

Spitz
Sharp
Acuta
Aguda
Pointu

Gezahnt
Serrated
Dentellata
Dentadas
Dentelés

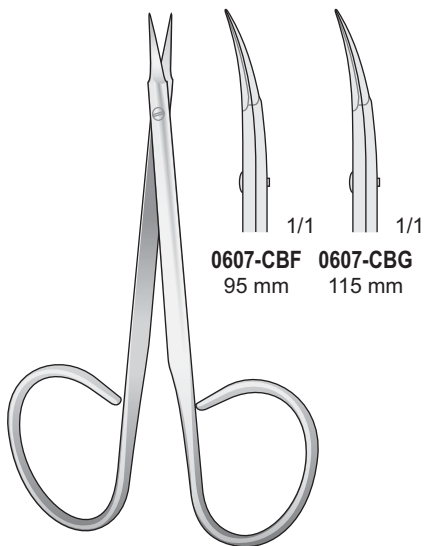

STITCH
0607-CBF/0607-CBG

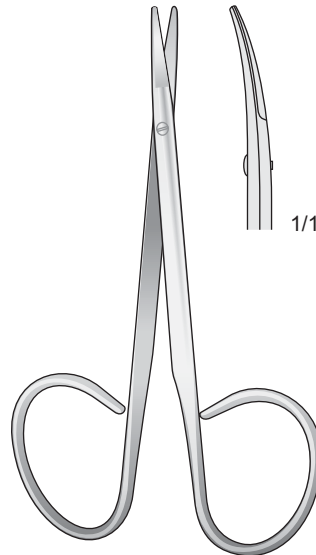

0607-CBH
100 mm

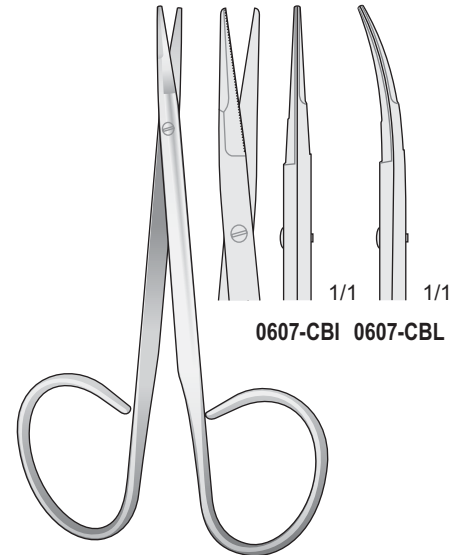

KAYE
0607-CBI/0607-CBL
105 mm

Stumpf - Blunt
Smussa - Romas
Mousse

Stumpf - Blunt
Smussa - Romas
Mousse

Spitz - Sharp
Acuta - Aguda
Pointu

Spitz - Sharp
Acuta - Aguda
Pointu

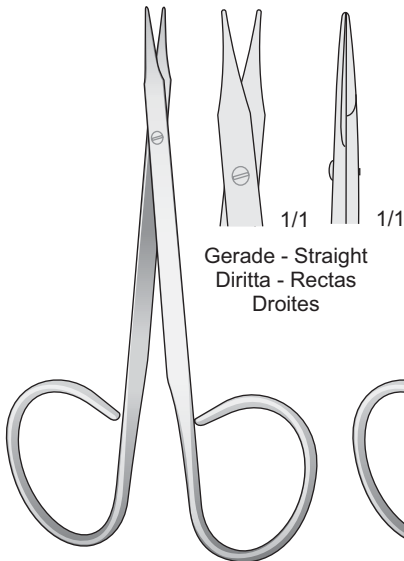

STEVENS
0607-CAL
100 mm

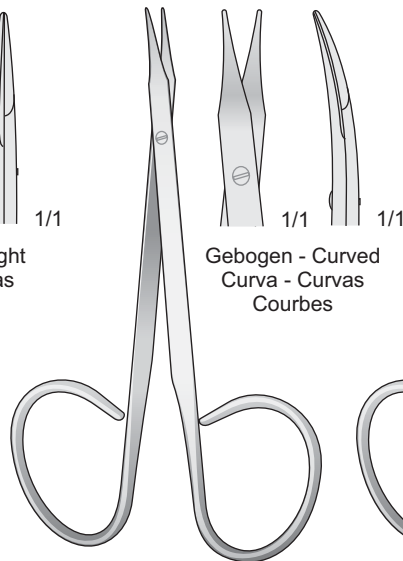

STEVENS
0607-CBA
100 mm

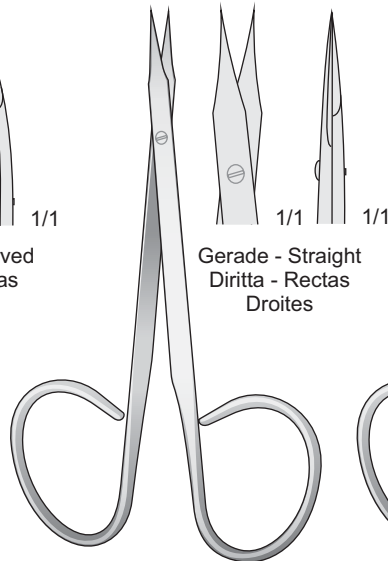

WALTON
0607-CBB
100 mm

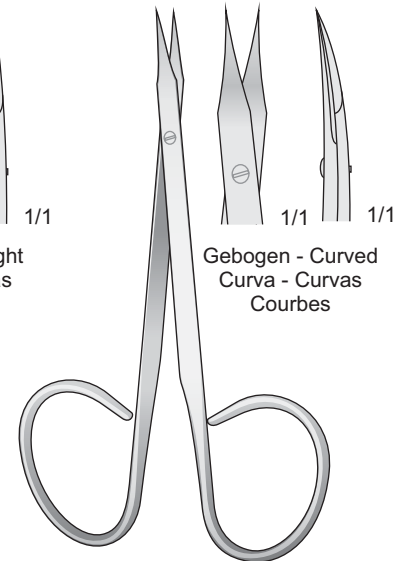

WALTON
0607-CBC
100 mm

Feine Scheren

Delicate scissors

Forbici delicate

Tijeras finas

Ciseaux délicate

Stumpf
Blunt
Smussa
Romas
Mousse

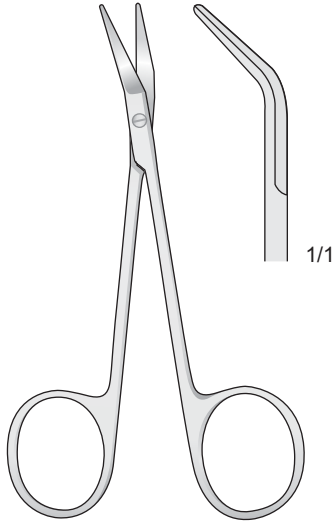

GRAEFE
0607-DA
100 mm

Spitz
Sharp
Acuta
Aguda
Pointu

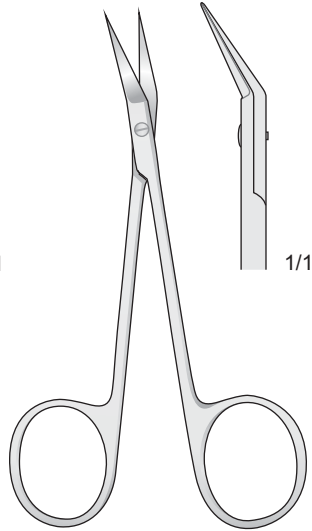

WILMER
0607-BCC
105 mm

Spitz
Sharp
Acuta
Aguda
Pointu

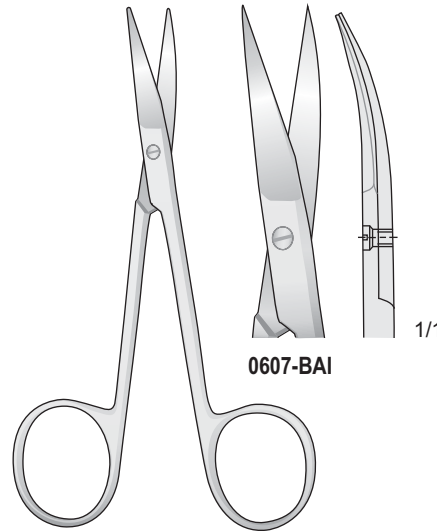

COTTLE-MASING
0607-BAI/0607-BAL
105 mm

Stumpf
Blunt
Smussa
Romas
Mousse

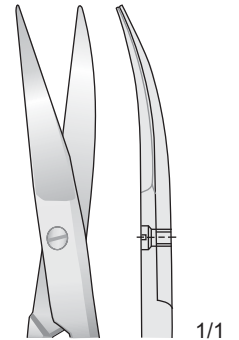

0607-BAL

Plastikscheren
Plastic Scissors
Forbici per Plastica

Spitz
Sharp
Acuta
Aguda
Pointu

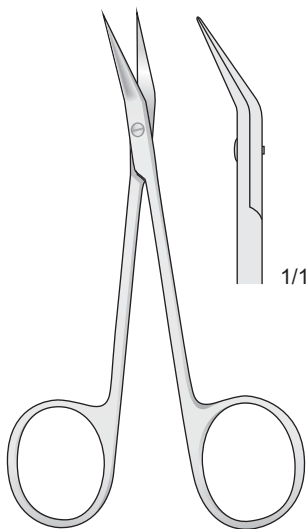

BIRO
0607-LE
100 mm

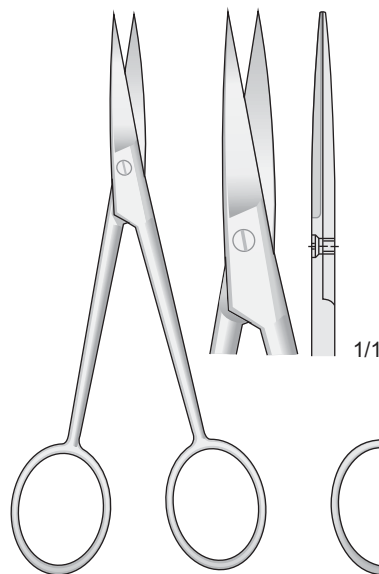

0607-BBL
110 mm

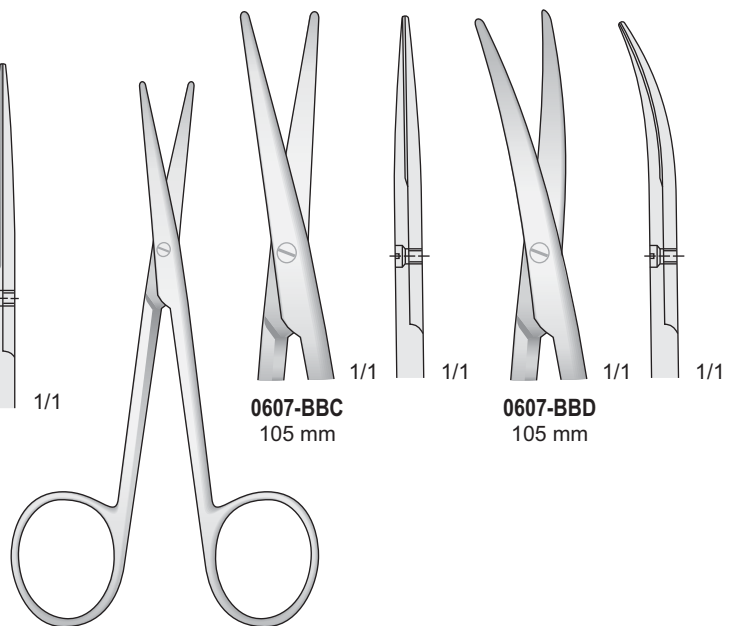

COTTLE-KNAPP
0607-BBC/0607-BBD
105 mm
(LEXER-BABY)

Feine Scheren

Delicate scissors

Forbici delicate

Tijeras finas

Ciseaux délicate

Spitz - Sharp - Acute - Agudas - Pointus

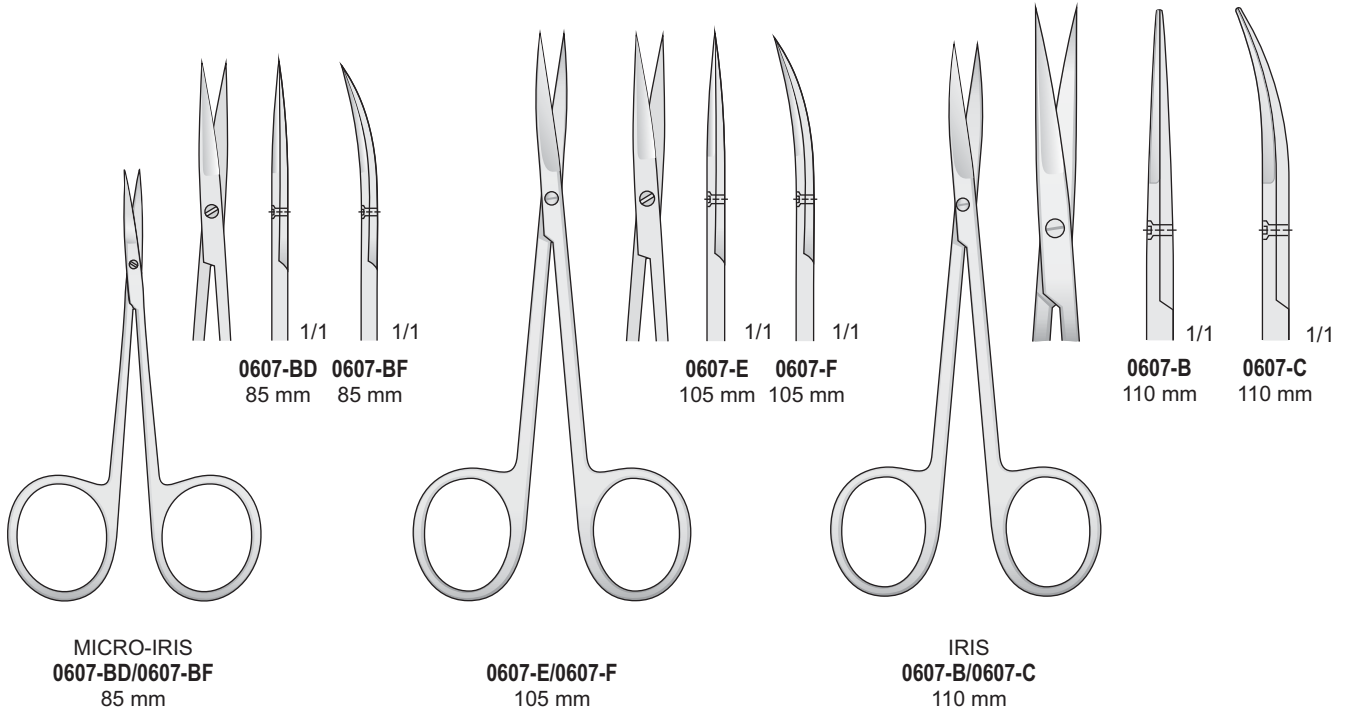

Links - Left
Per mancini - Izquierda
Gauche

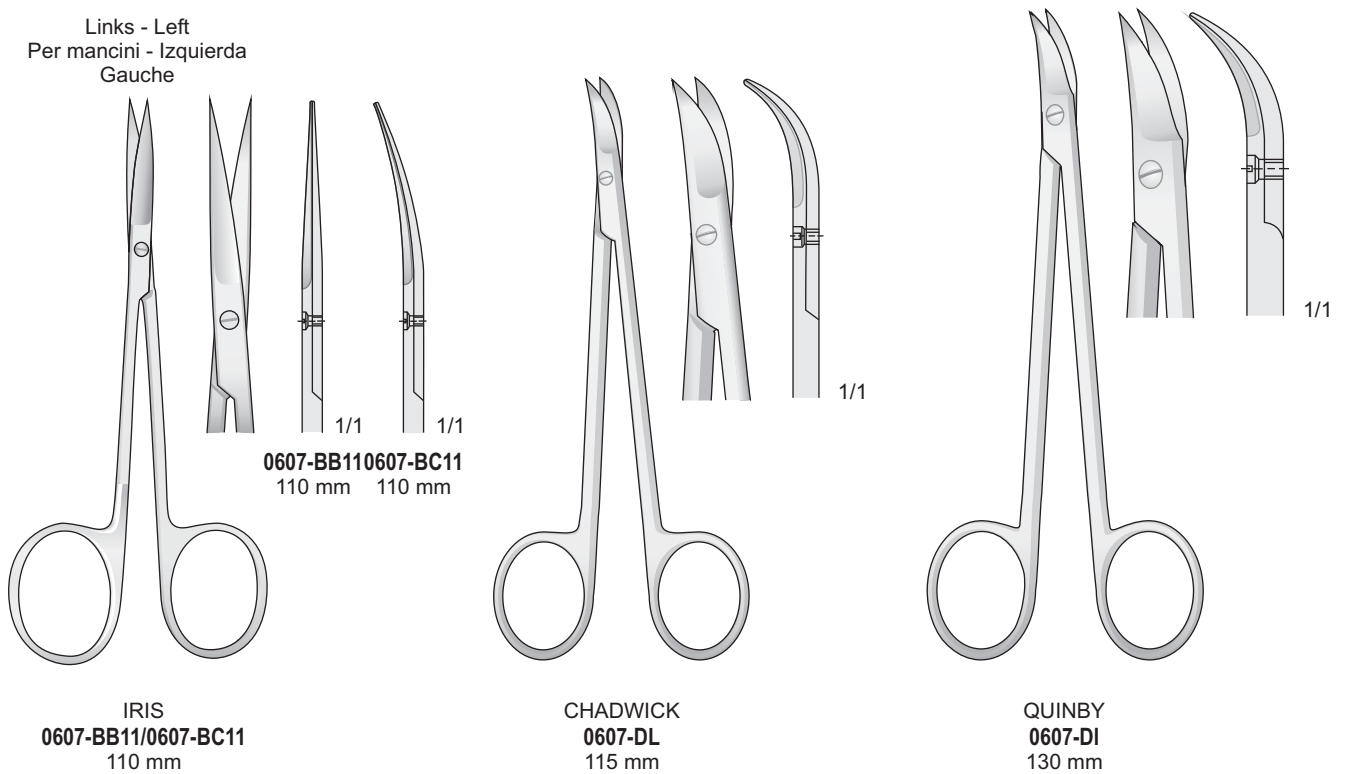

Feine Scheren

Delicate scissors

Forbici delicate

Tijeras finas

Ciseaux délicate

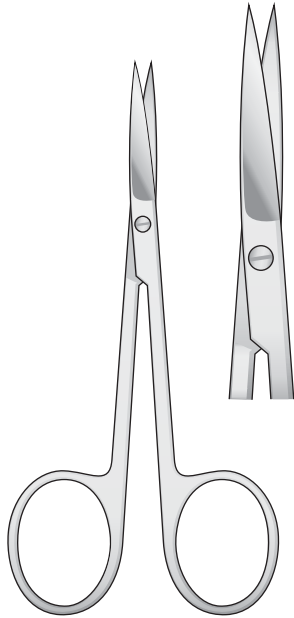

0607-CD/0607-CE
110 mm

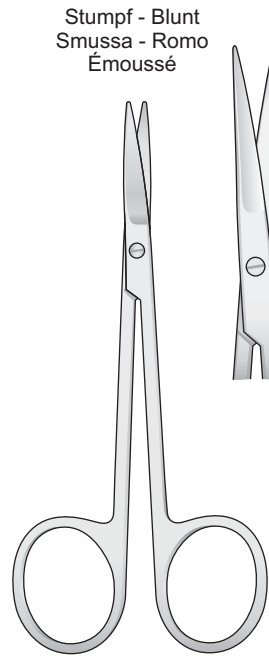
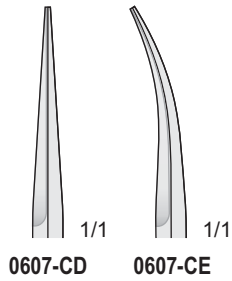

0607-BAB/0607-BAC
110 mm

Stumpf - Blunt
Smussa - Romo
Émoussé

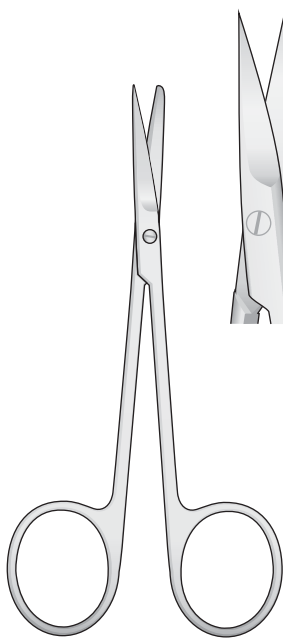
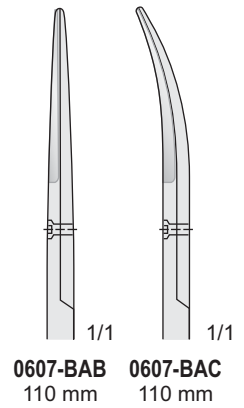

0607-BAD/0607-BAF
110 mm

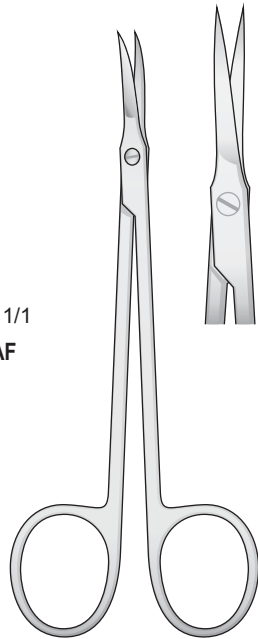
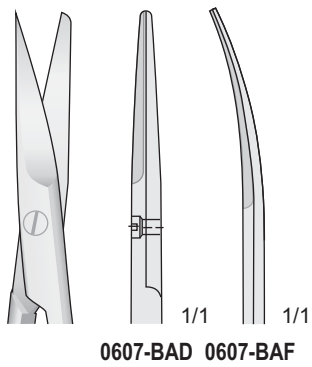

070617-18/070603-18
120 mm

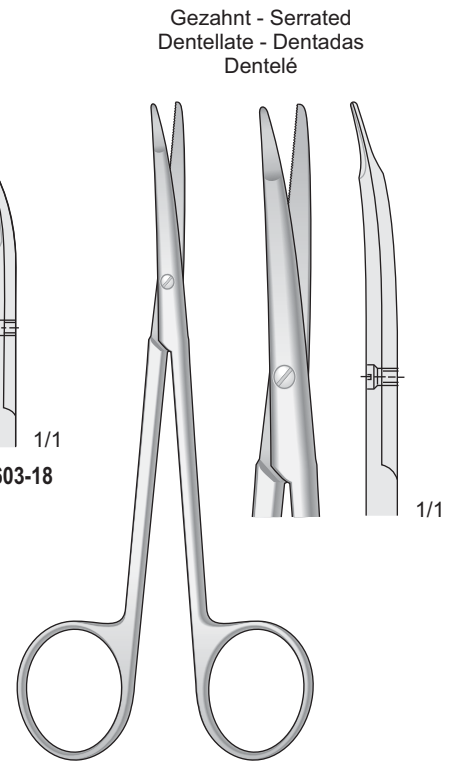
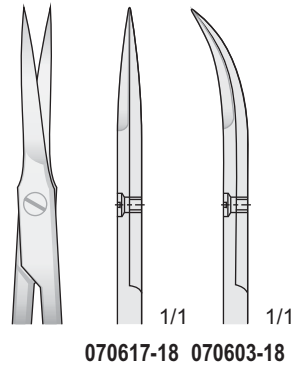

KILNER
0607-BCB
130 mm

Gezahnt - Serrated
Dentellate - Dentadas
Dentelé

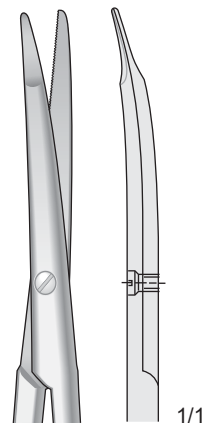

Chirurgische Scheren

Operating scissors

Forbici chirurgiche

Tijeras para cirugía general

Ciseaux chirurgicaux

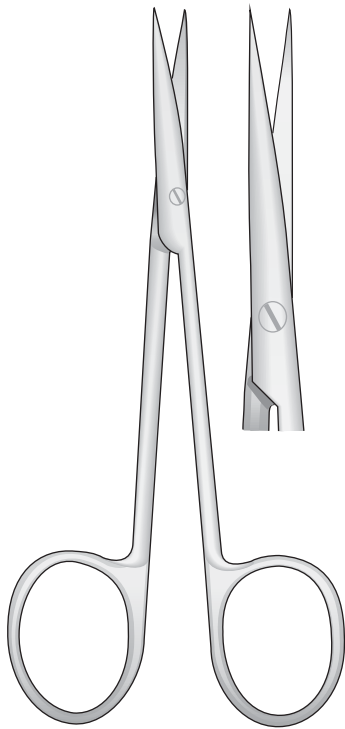

KILNER
0607-FI
115 mm

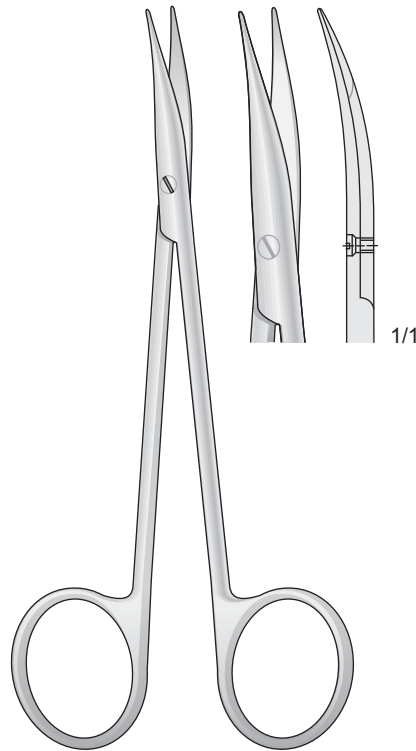

JAMESON-WERBER
0607-BCD
130 mm

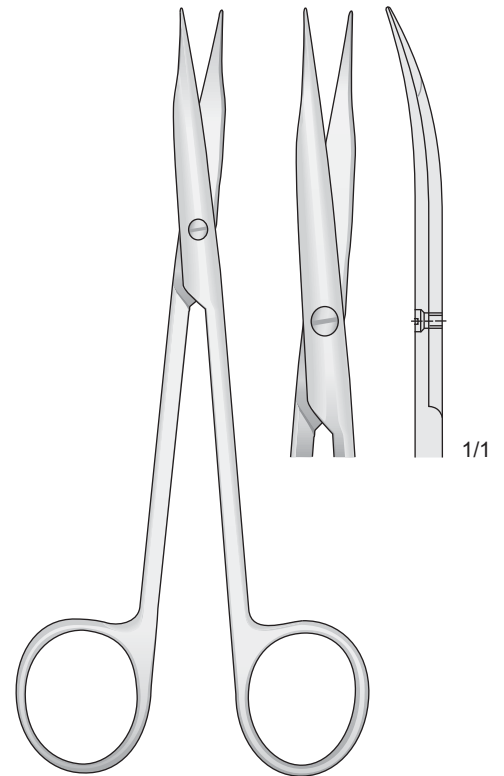

JAMESON
0607-BCE
145 mm

Mit faden bohrung - With eye for suture
Con occhiello per sutura - Tijeras para ligaduras
Avec oeil pour les sutures

Stumpf - Blunt
Smussa - Romo - Émoussé

Spitz - Sharp
Acuta - Agudo - Pointu

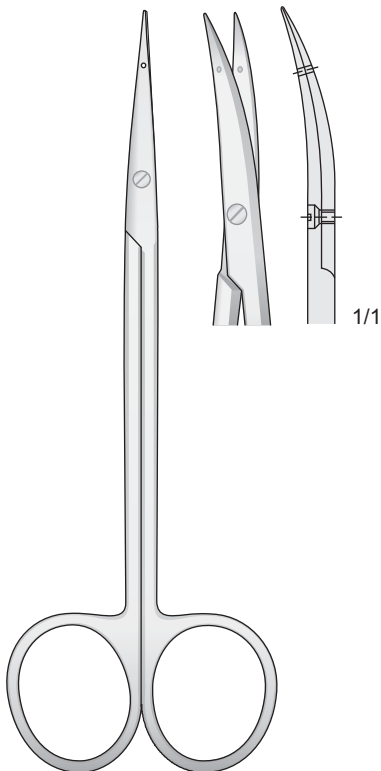

LITTLER
0607-BAA
120 mm

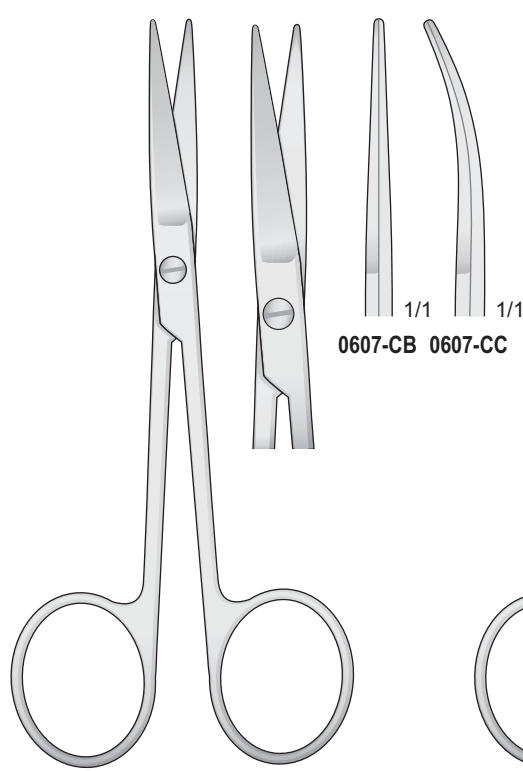

0607-CB/0607-CC
115 mm

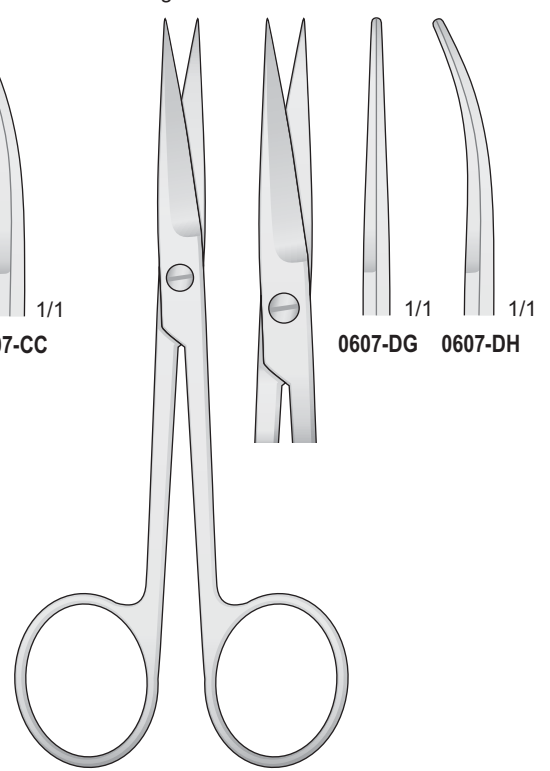

0607-DG/0607-DH
115 mm

Gezahnt - Serrated - Dentellata - Dentadas - Dentelé

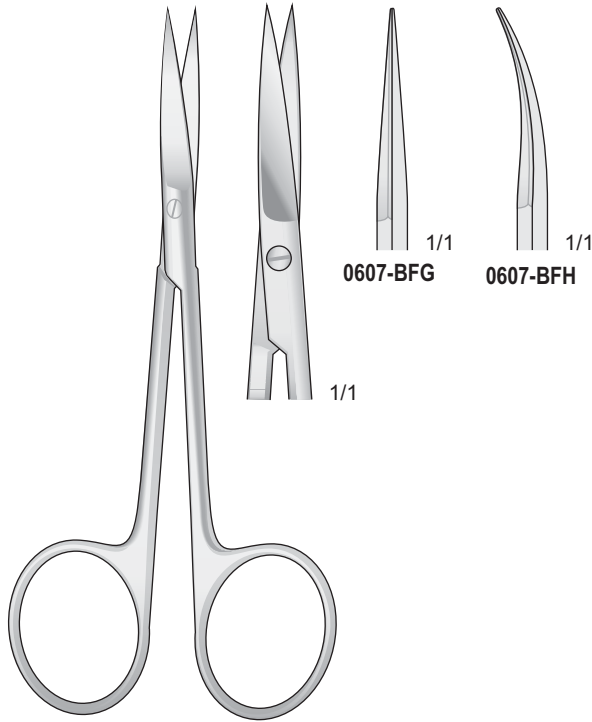

0607-BFG/0607-BFH
110 mm

Gezahnt - Serrated - Dentellata - Dentadas - Dentelé

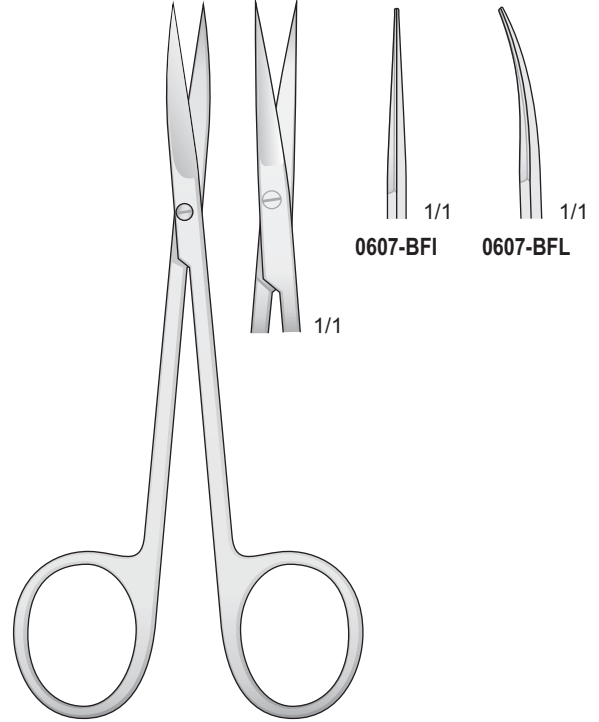

0607-BFI/0607-BFL
110 mm

Gezahnt - Serrated
Dentellata - Dentadas
Dentelé

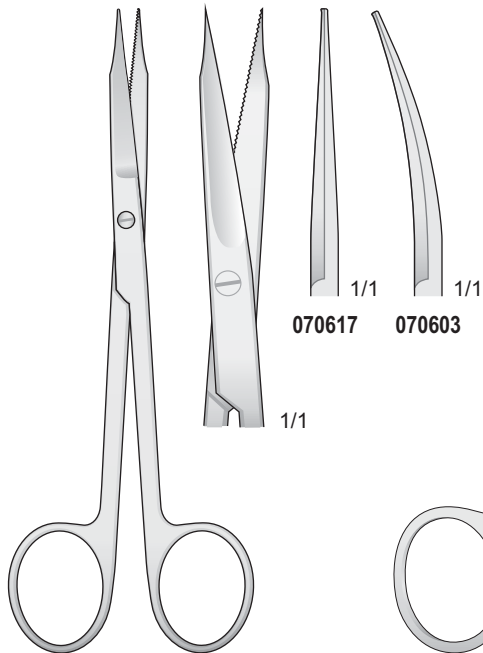

GOLDMAN-FOX
070617/070603
120 mm

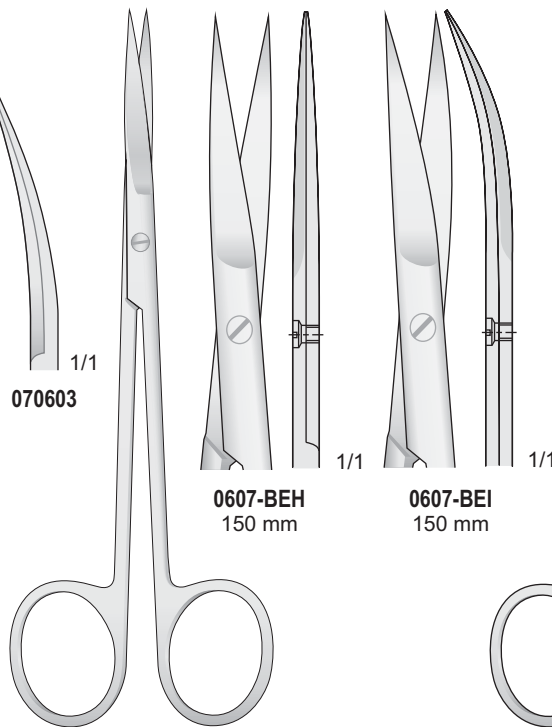

JOSEPH
0607-BEH/0607-BEI
150 mm

Spitz - Sharp
Acuta - Agudo
Pointus

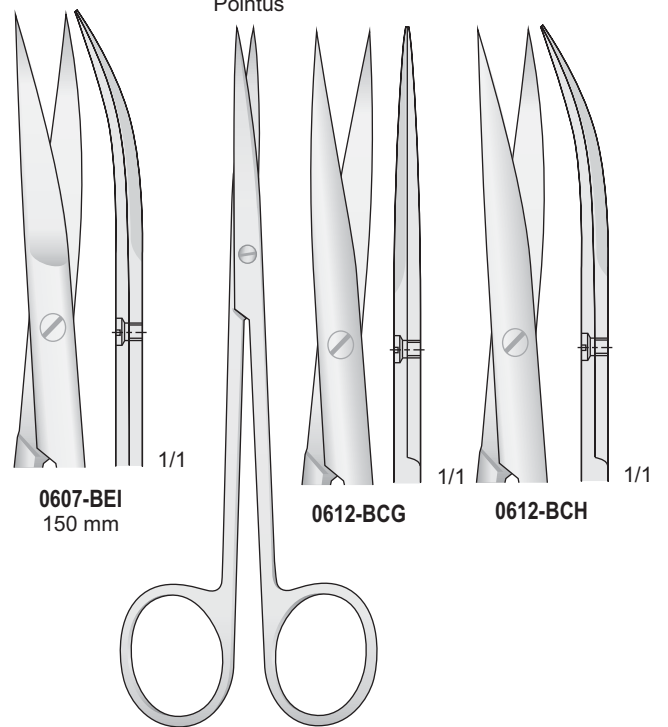

METZENBAUM
0612-BCG/0612-BCH
145 mm

Feine Scheren

Delicate scissors

Forbici delicate

Tijeras finas

Ciseaux délicate

Stumpf - Blunt - Smusse
Romas - Mousses

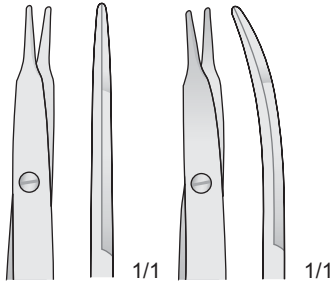

0607-FA

0607-FB

Spitz - Pointed - Acute
Agudas - Pointus

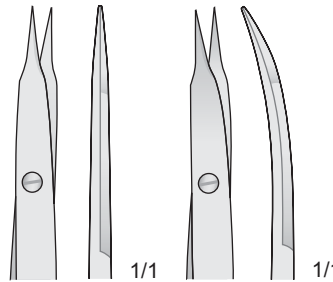

0607-FC

0607-FD

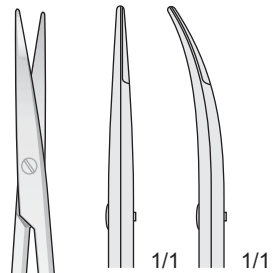

0607-LA 0607-LB

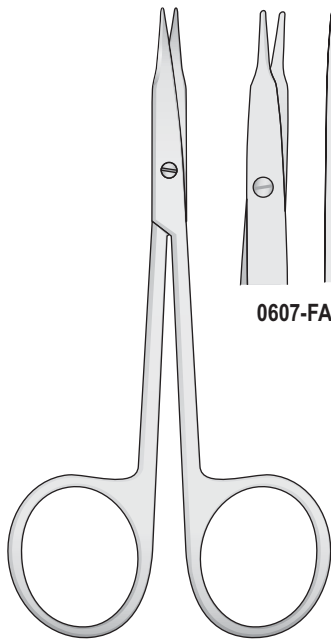

STEVENS
0607-FA/0607-FD
110 mm

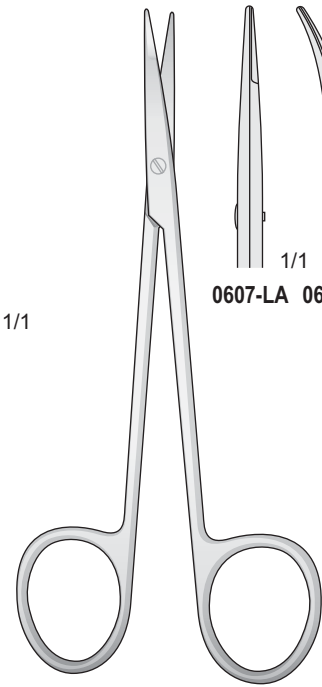

SHEA
0607-LA/0607-LB
120 mm

Stumpf - Blunt - Smussa
Romas - Mousses

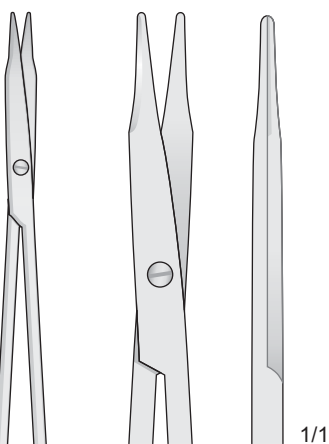

0607-FE
150 mm

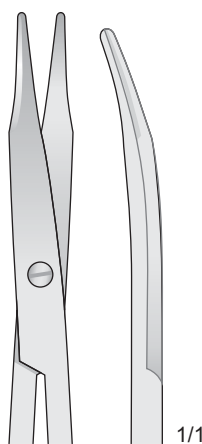

0607-FF
150 mm

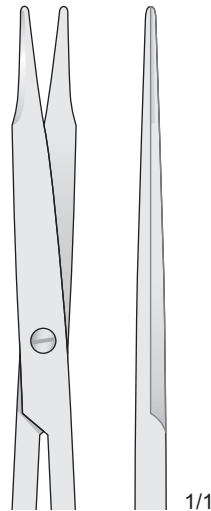

0607-FG
180 mm

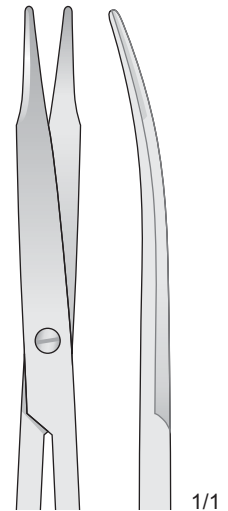

0607-FH
180 mm

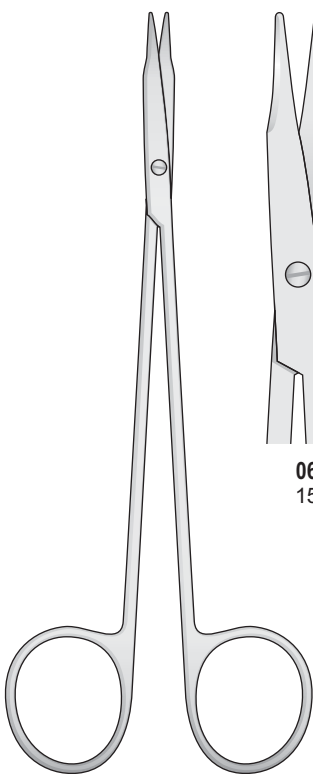

REYNOLDS
0607-FE/0607-FH

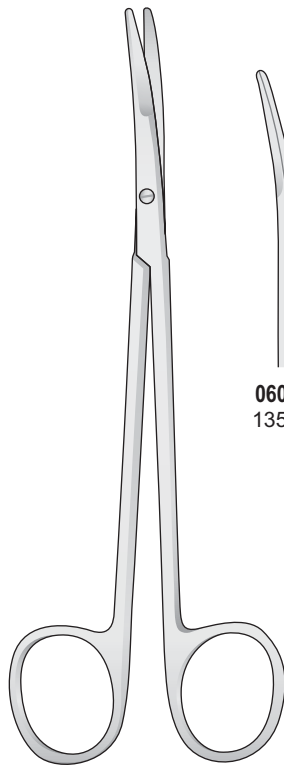

GLASSMAN
0607-GI/0607-GL

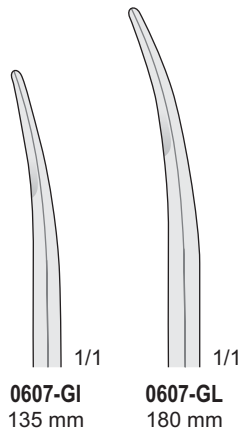

0607-GI
135 mm

0607-GL
180 mm

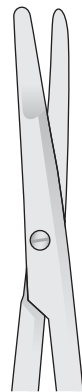

0607-GG
120 mm

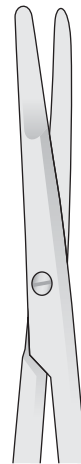

0607-BL17
135 mm

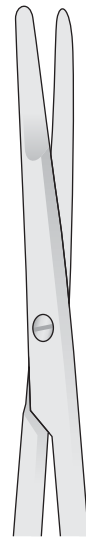

0607-G17
150 mm

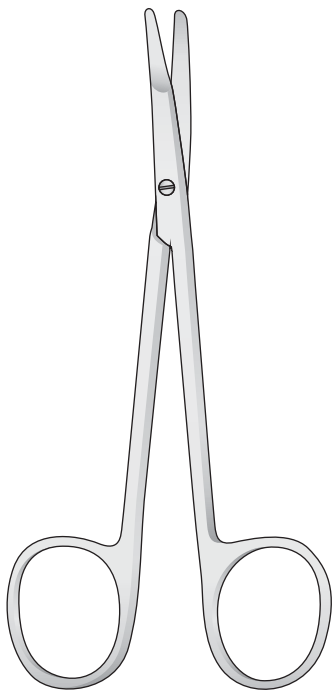

KILNER
0607-G03/0607-GG

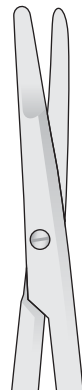

0607-GH
120 mm

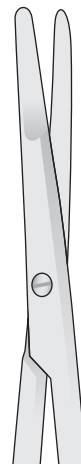

0607-BL03
135 mm

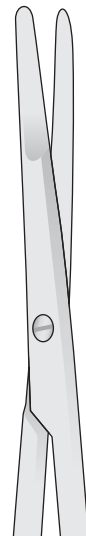

0607-G03
150 mm

Standard

Stumpf
Blunt
Smusse
Romas
Mousses

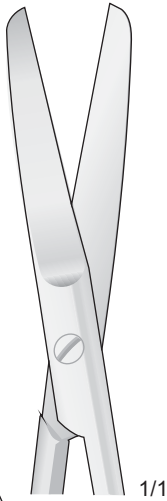
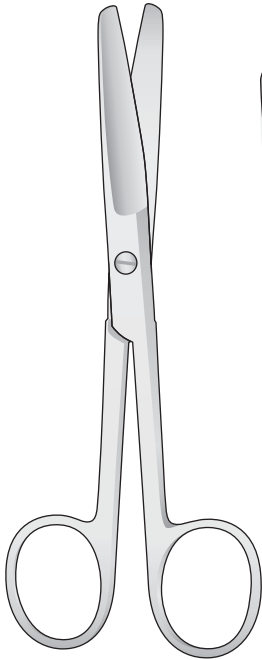

1/1

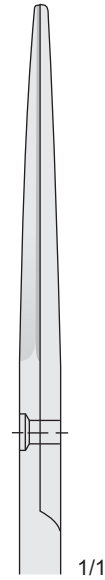

1/1

0612-DF
130 mm

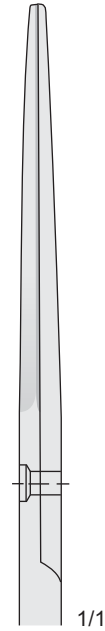

1/1

0612-L
145 mm

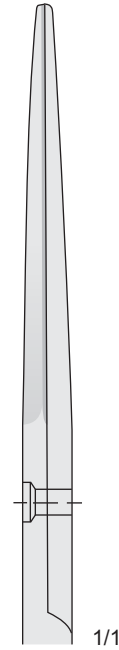

1/1

0612-DH
165 mm

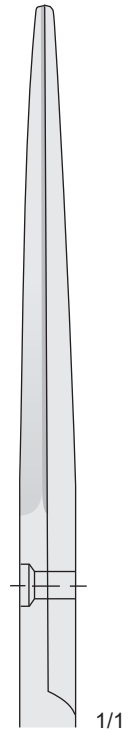

1/1

0612-DL
185 mm

0612-L/0612-DL

Stumpf - Blunt
Smusse - Romas
Mousses

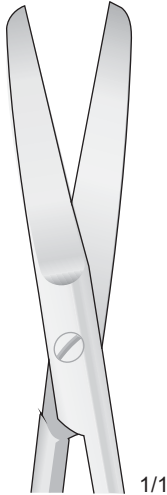
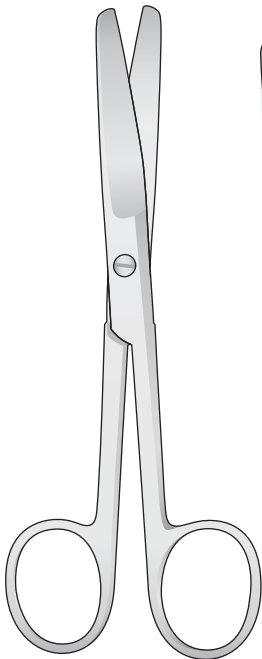

1/1

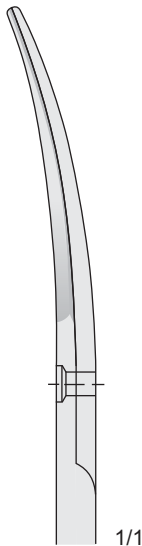

1/1

0612-DG
130 mm

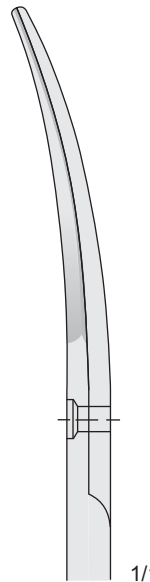

1/1

0612-BA
145 mm

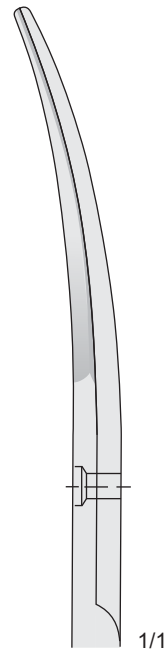

1/1

0612-DI
165 mm

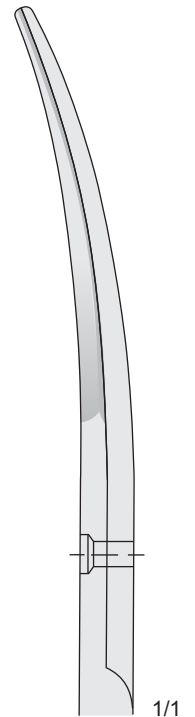

1/1

0612-EA
185 mm

0612-BA/0612-EA

Standard

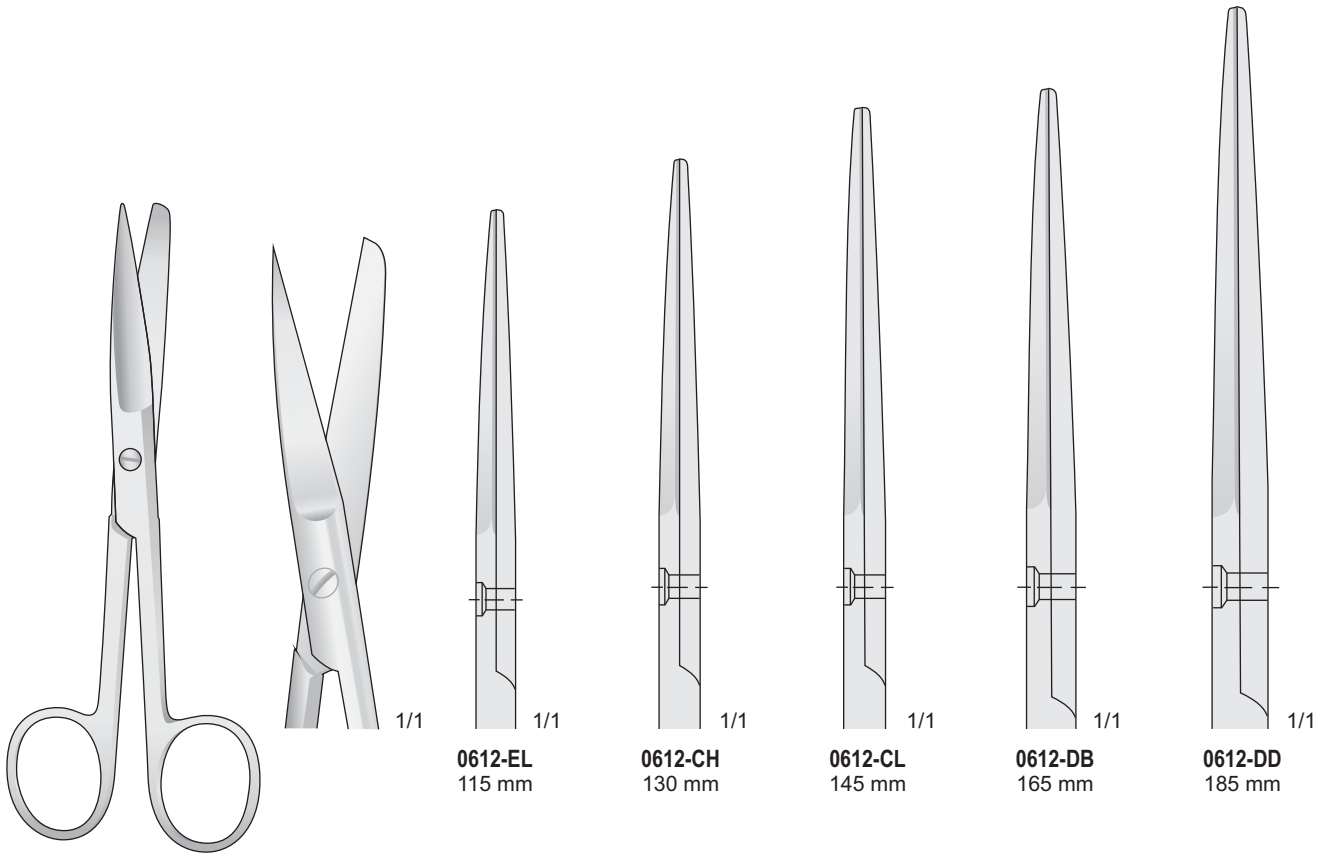

0612-CH/0612-EL

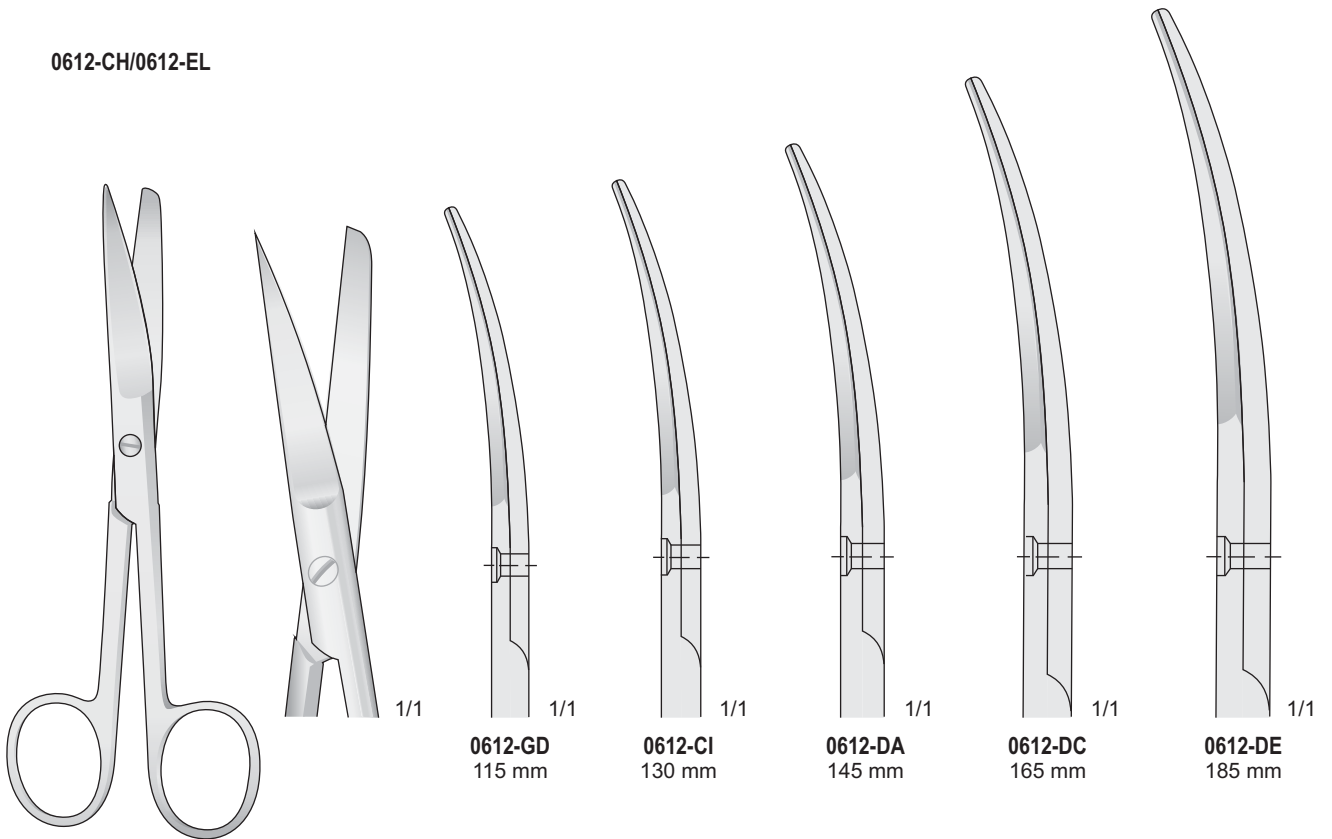

0612-CI/0612-GD

Standard

Spitz - Sharp
Acuta - Agudo - Aigu

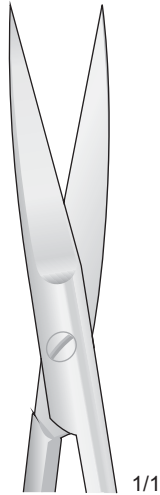
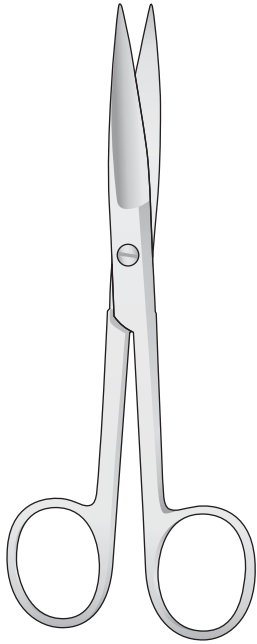

1/1

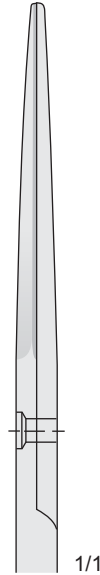

1/1

0612-EB
130 mm

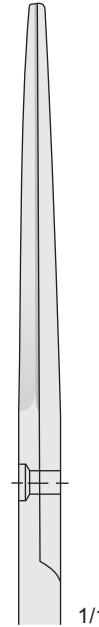

1/1

0612-H
145 mm

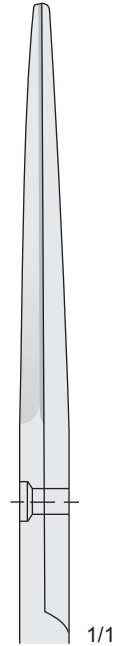

1/1

0612-ED
165 mm

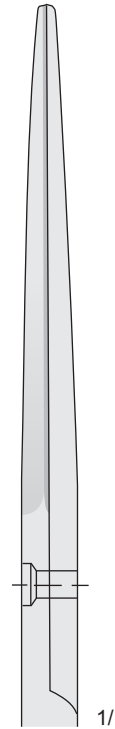

1/1

0612-EF
185 mm

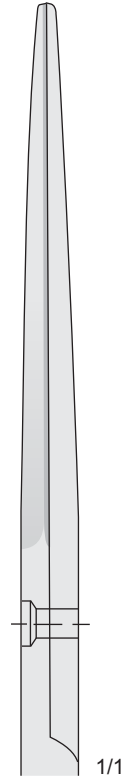

1/1

0612-HC
200 mm

0612-EB/0612-HC

Spitz - Sharp
Acuta - Agudo - Aigu

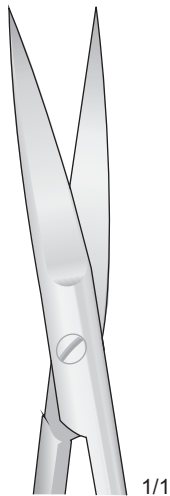
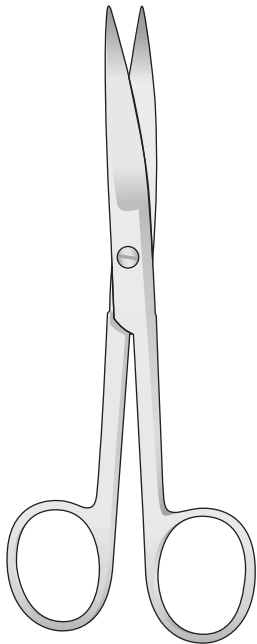

1/1

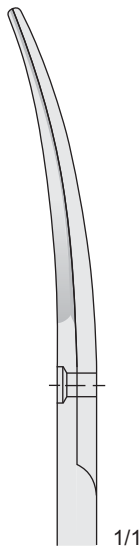

1/1

0612-EC
130 mm

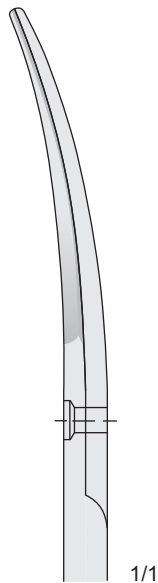

1/1

0612-I
145 mm

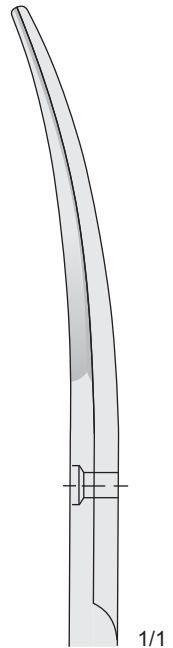

1/1

0612-EE
165 mm

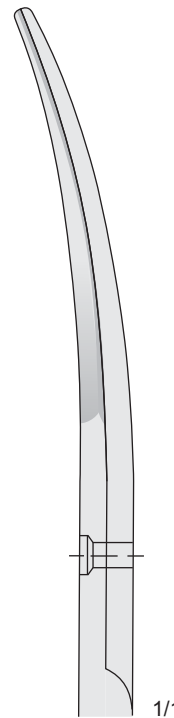

1/1

0612-EG
185 mm

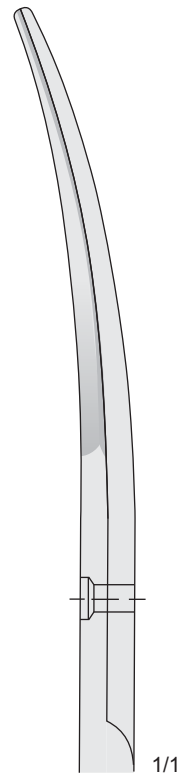

1/1

0612-HD
200 mm

0612-I/0612-HD

Feine Scheren

Delicate scissors

Forbici delicate

Tijeras finas

Ciseaux délicats

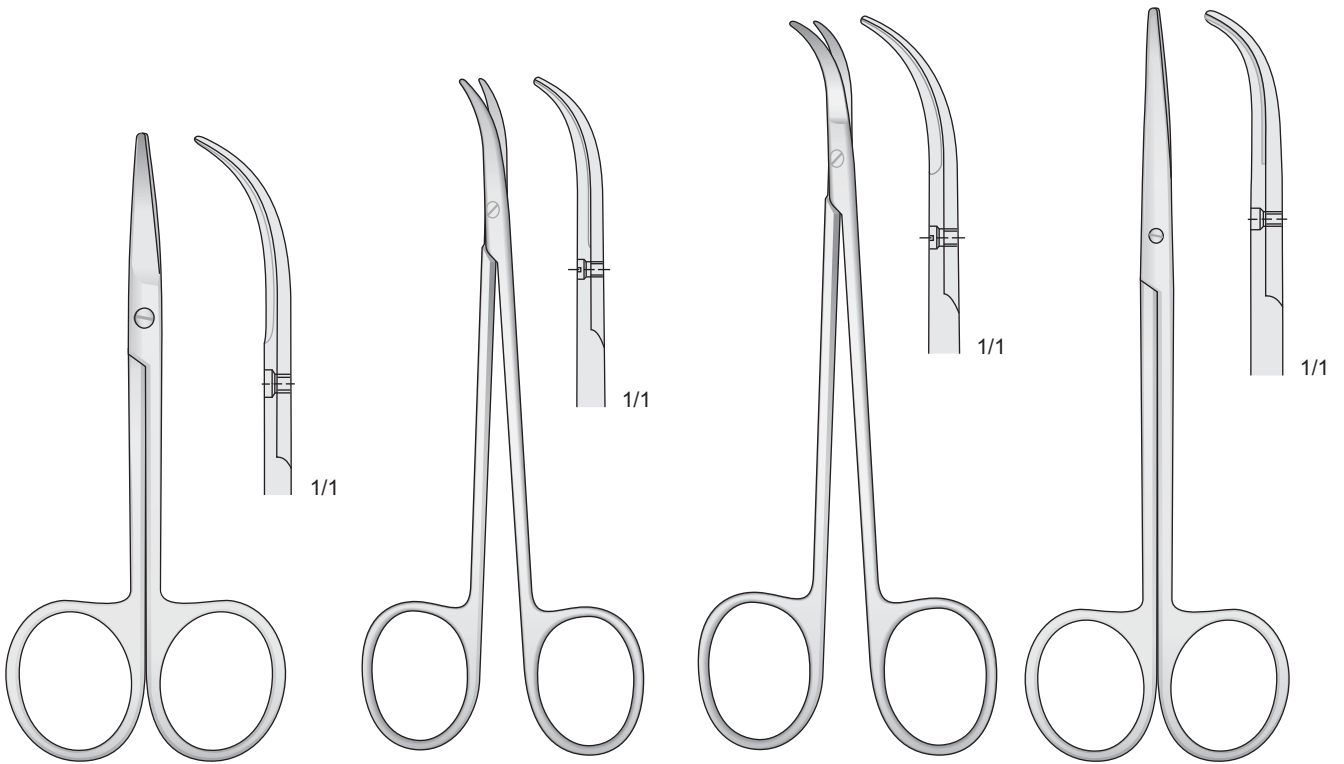

FOMON
0607-ED
110 mm

CINELLI
0607-LF
115 mm

FOMON
0607-LD
135 mm

FOMON
0607-EE
140 mm

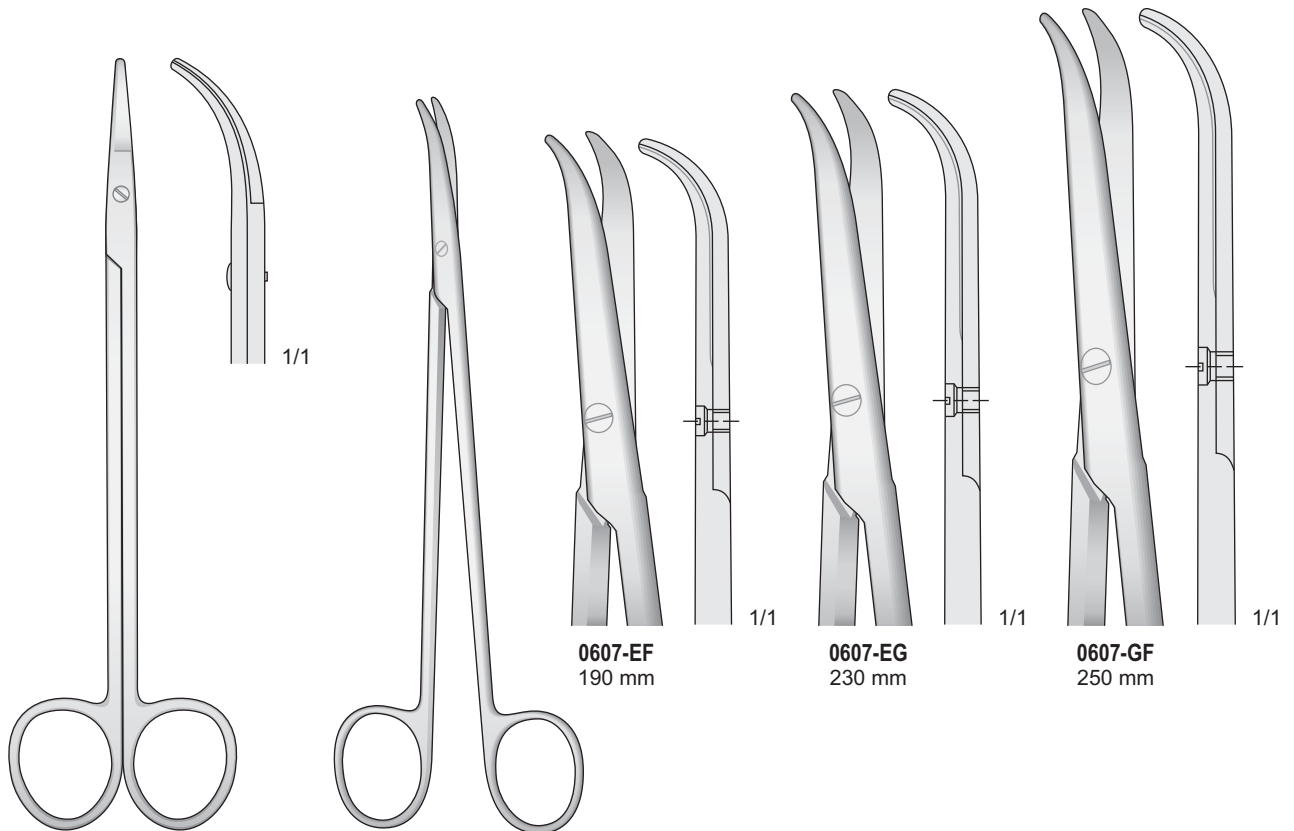

WALTON
0607-BEG
165 mm

THOREK
0607-EF/0607-GF

0607-EF
190 mm

0607-EG
230 mm

0607-GF
250 mm

Präparierscheren - Dissecting Scissors
 Forbici per dissezione - Tijeras para preparaciones - Ciseaux à dissection

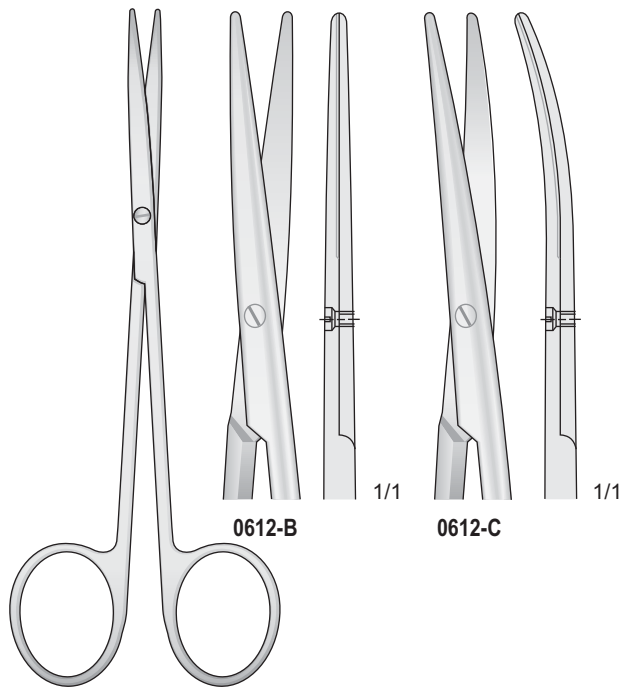

METZENBAUM
0612-B/0612-C
 145 mm

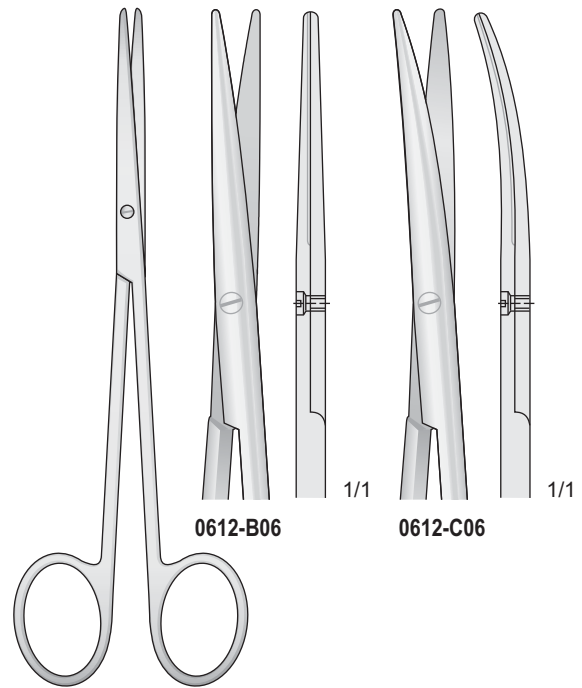

METZENBAUM-FINE
0612-B06/0612-C06
 145 mm

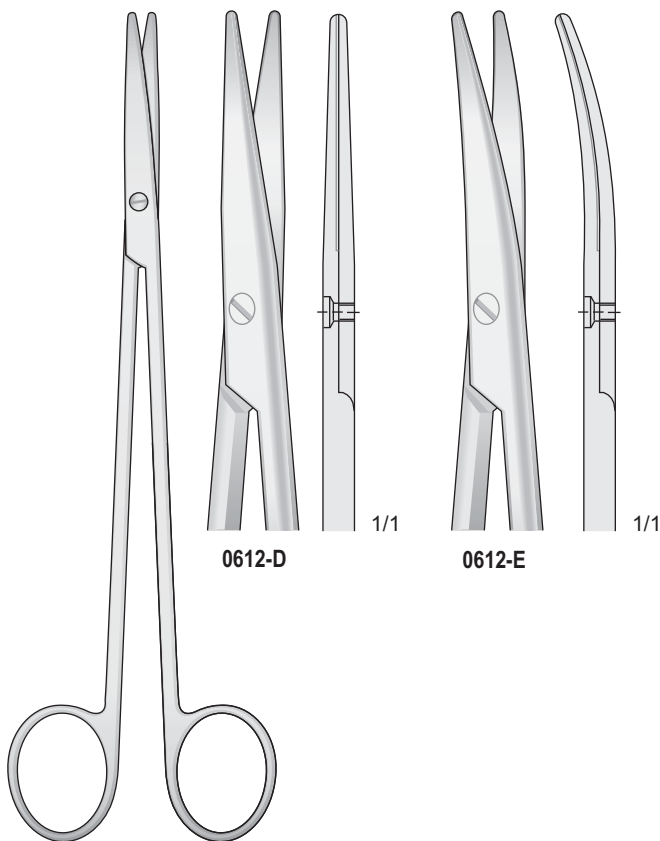

METZENBAUM
0612-D/0612-E
 185 mm

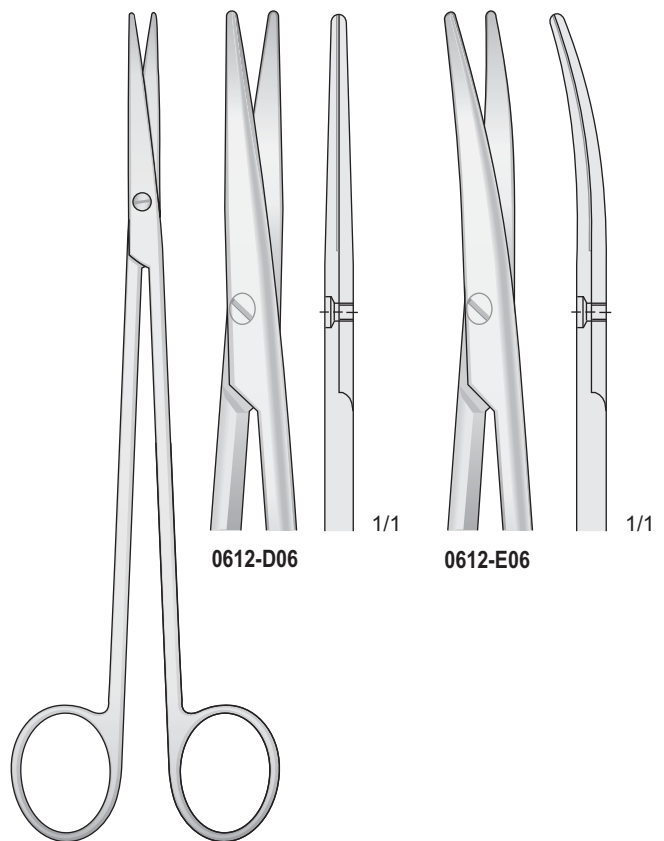

METZENBAUM-FINE
0612-D06/0612-E06
 185 mm

Präparierscheren - Dissecting Scissors
 Forbici per dissezione - Tijeras para preparaciones - Ciseaux à dissection

Spitz - Sharp
 Acuta - Agudo - Aigu

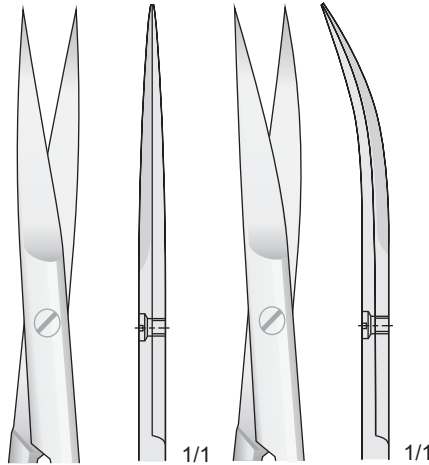
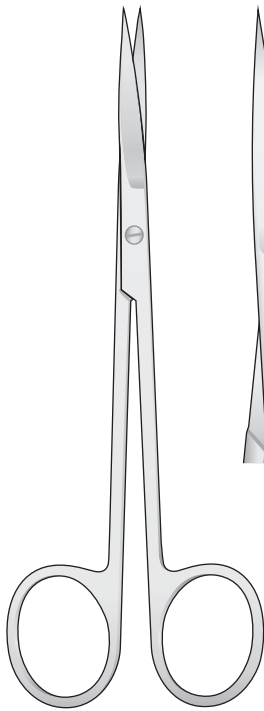

0607-CI

0607-BE

METZENBAUM
 0607-CI/0607-BE
 145 mm

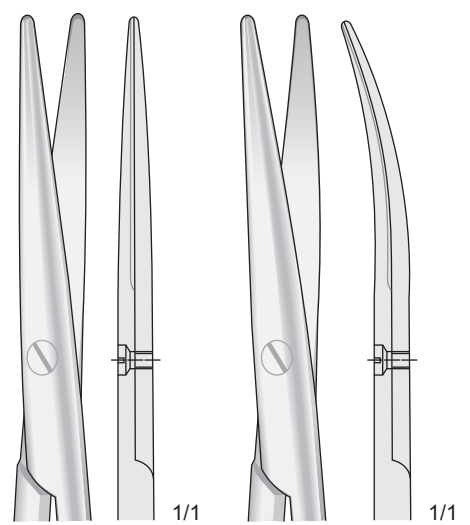
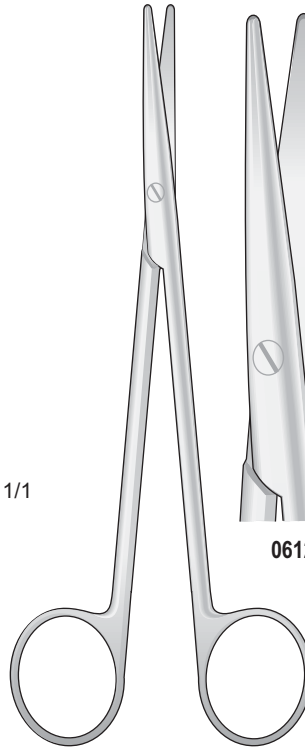

0612-HE

0612-HF

METZENBAUM
 0612-HE/0612-HF
 160 mm

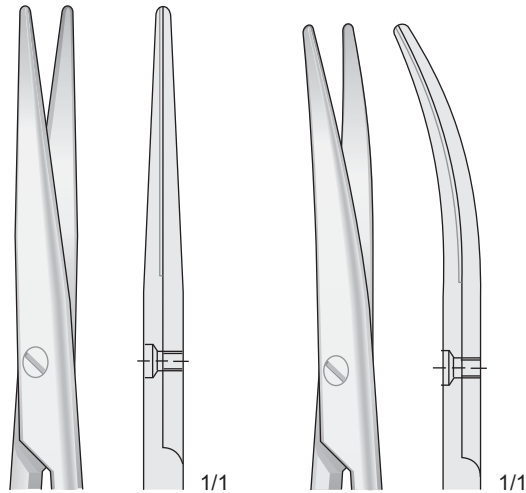
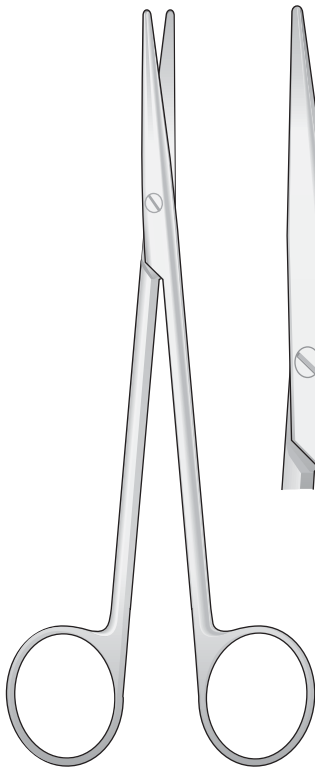

0612-HA

0612-HB

METZENBAUM
 0612-HA/0612-HB
 200 mm

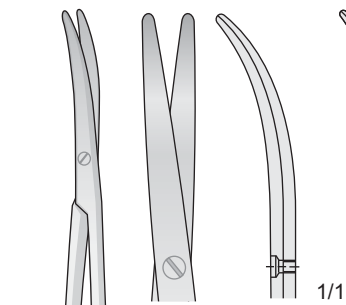
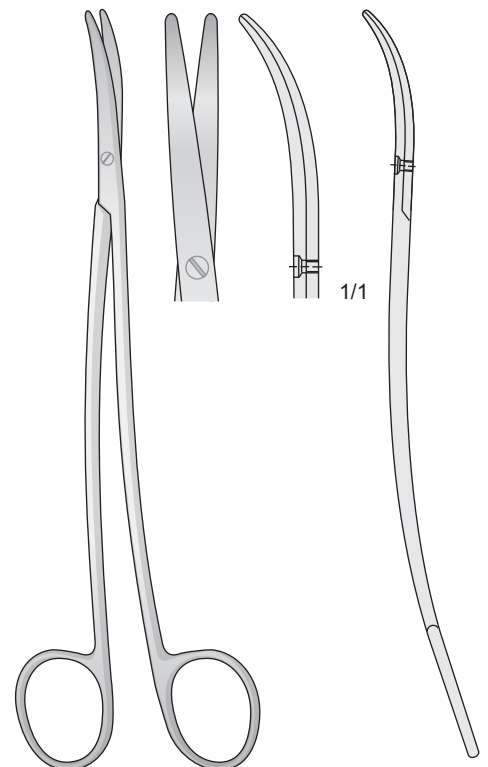

METZENBAUM-FINO
 0612-BCA - 180 mm
 0612-BCB - 200 mm
 0612-BCC - 230 mm

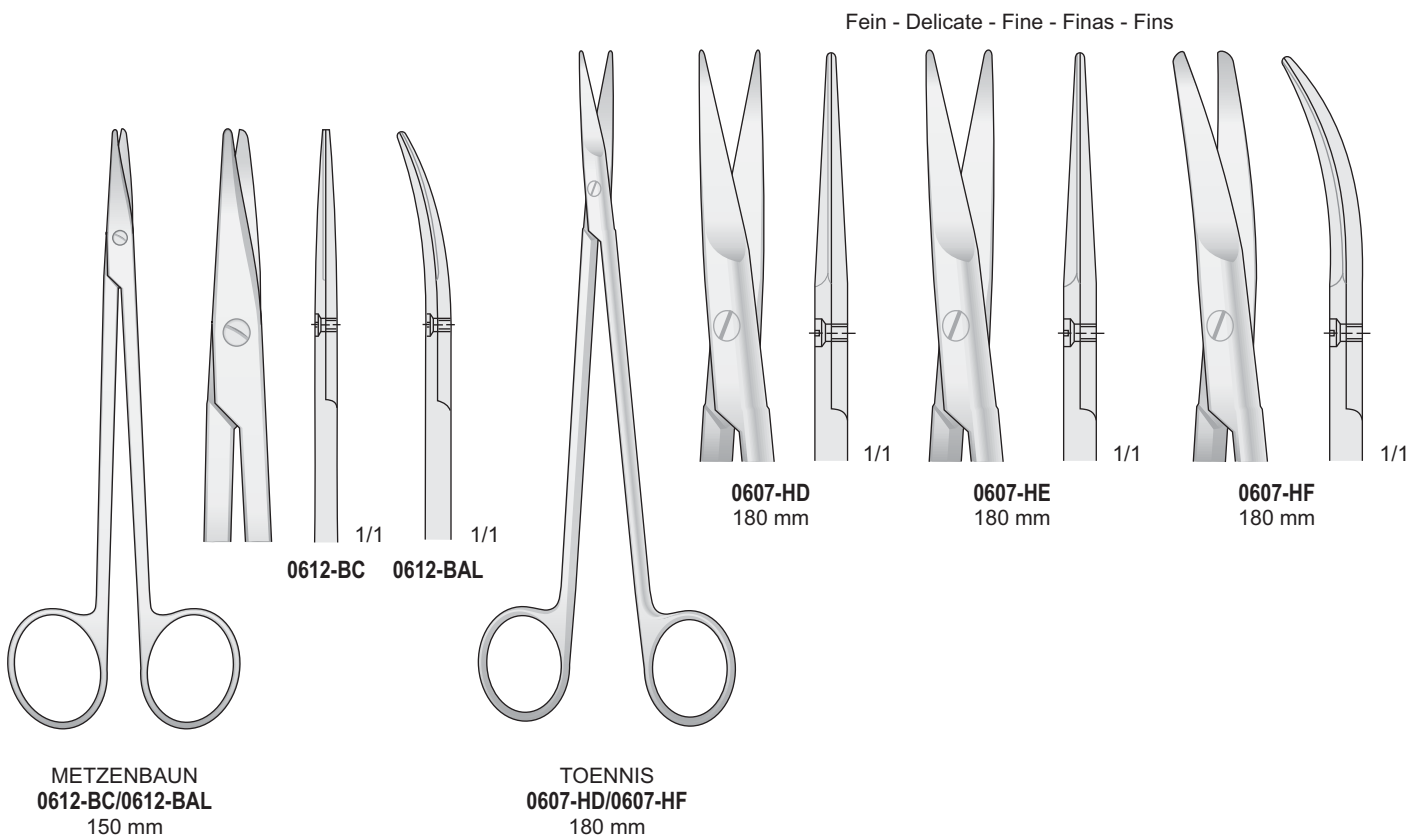
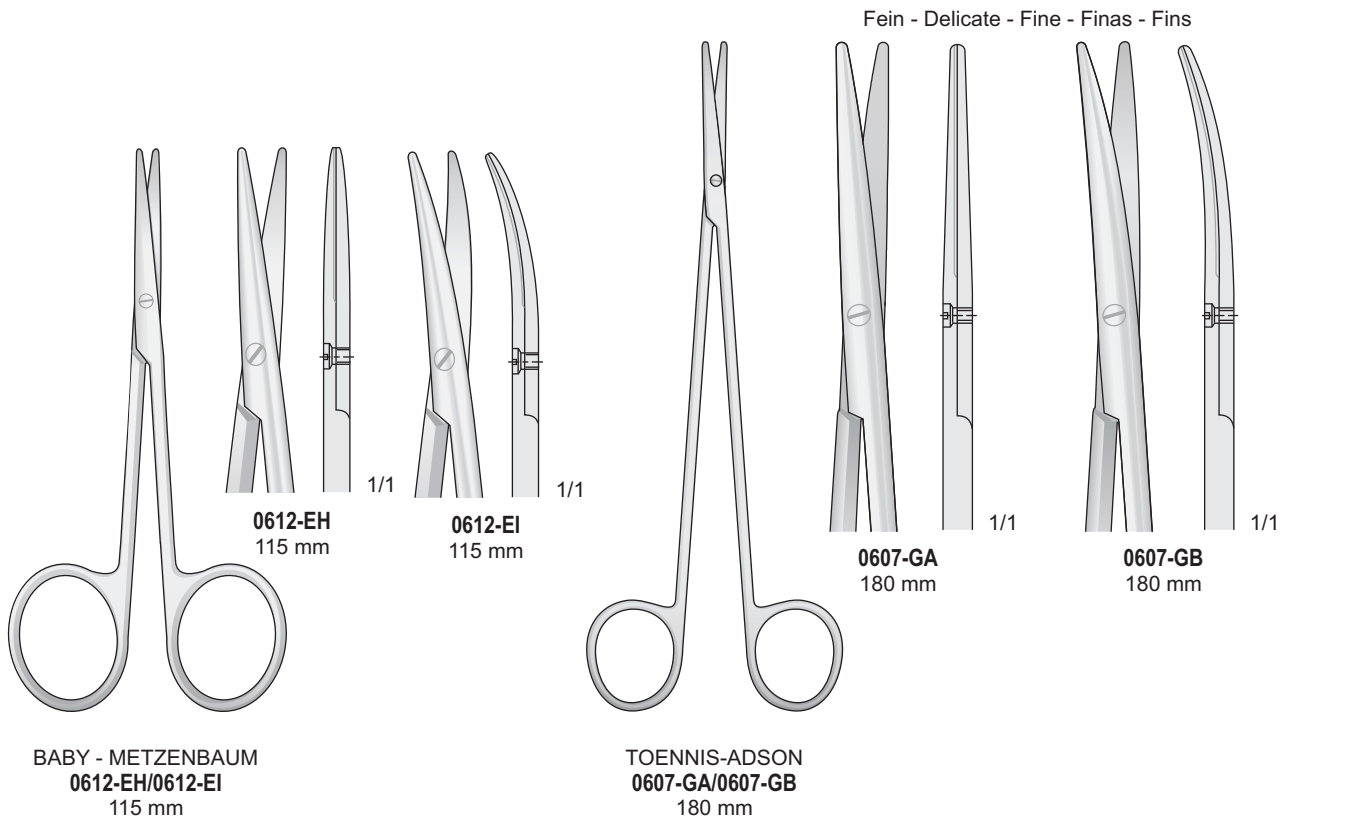

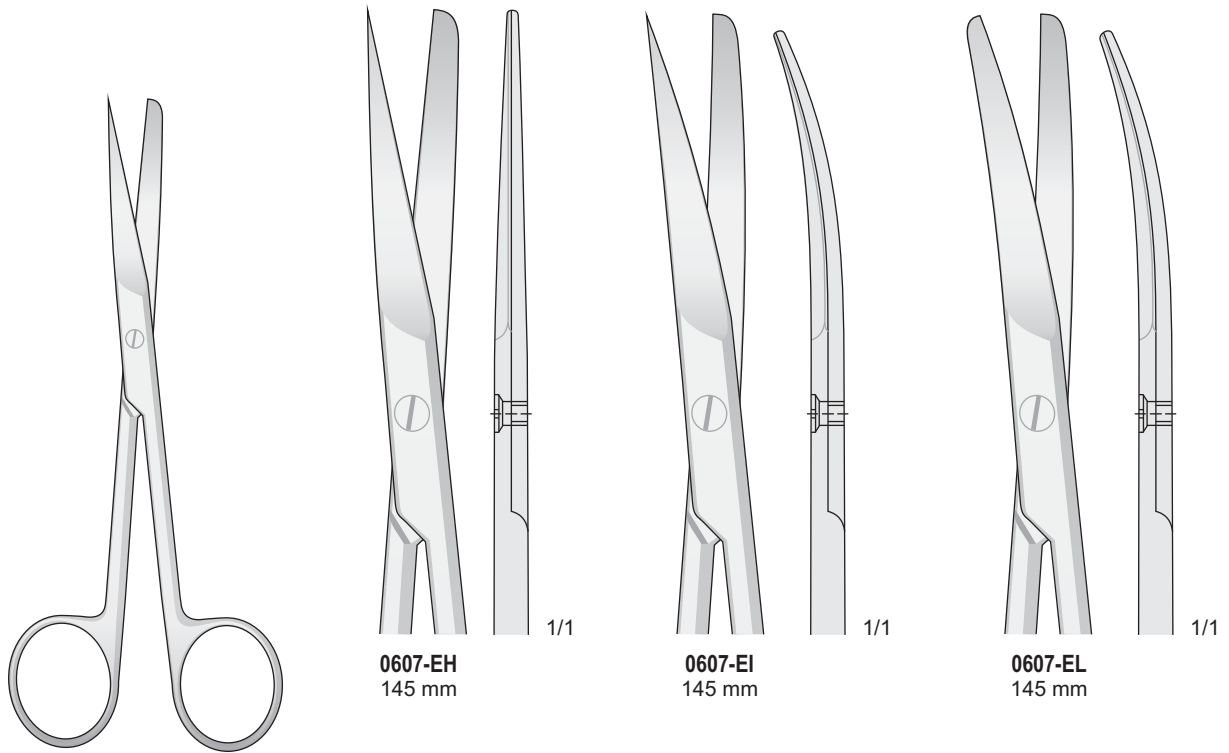

DEAVER
0607-EH/0607-EL
145 mm

Präparierscheren - Dissecting scissors - Forbici per dissezione - Tijeras para preparaciones - Ciseaux à dissection

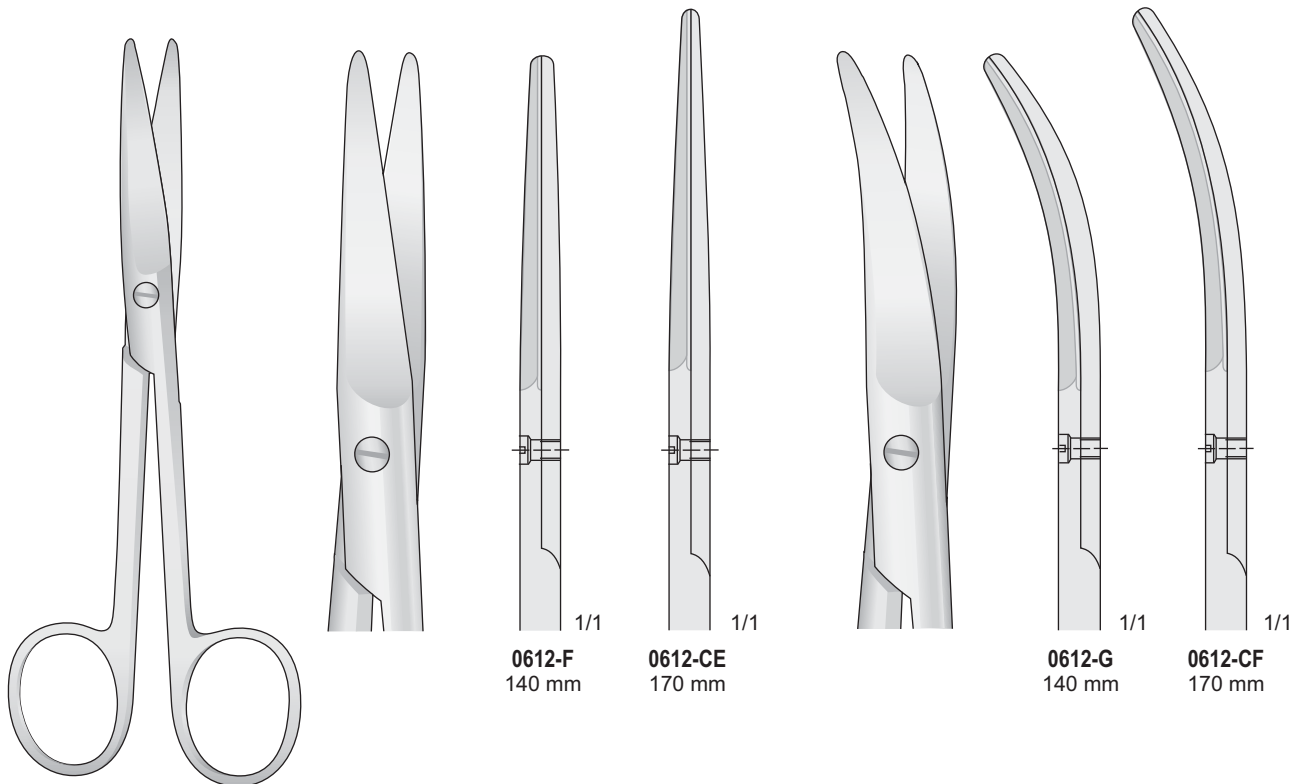

MAYO
0612-F/0612-CF

Fein - Delicate - Fine - Finas - Fins

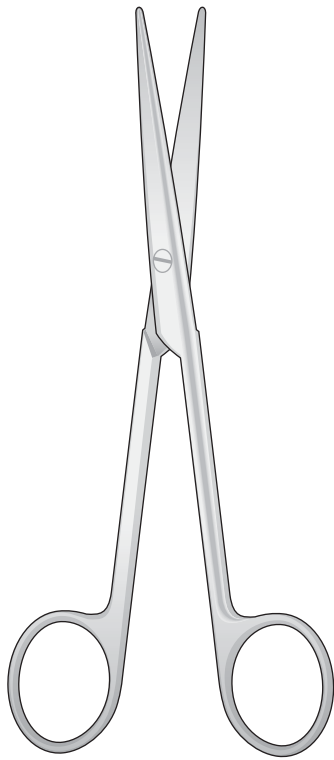

LEXER
0612-BIA/0612-BIB
165 mm

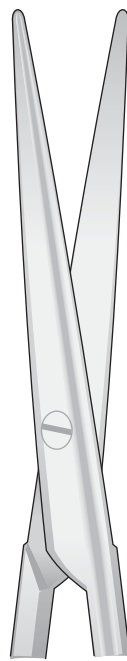

0612-BIA

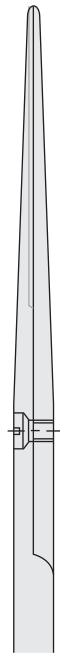

1/1

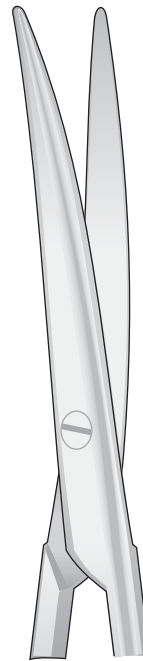

0612-BIB

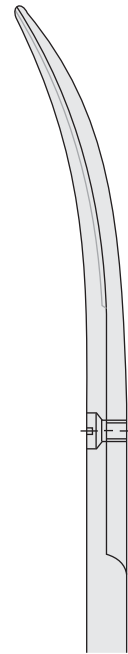

1/1

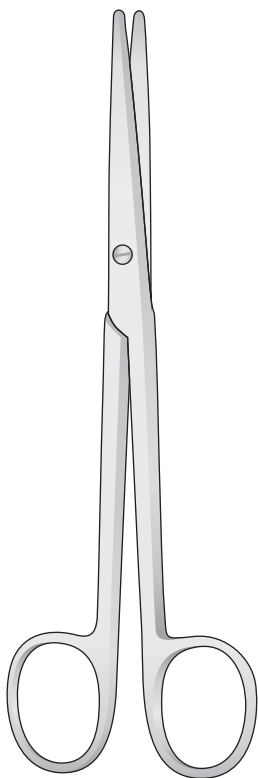

LEXER
0612-IG/0612-IL



0612-IG
160 mm

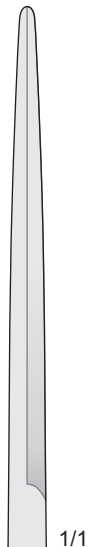

1/1



0612-IH
210 mm

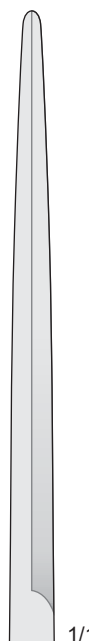

1/1

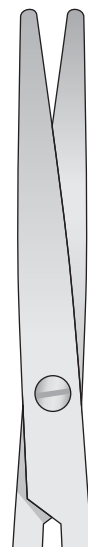

0612-II
160 mm



1/1



0612-IL
210 mm

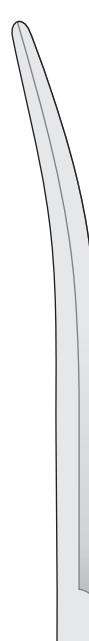

1/1

Präparierscheren - Bilateral Dissecting Scissors
 Forbici per dissezione a taglio bilaterale - Tijeras para preparaciones
 Ciseaux à dissection

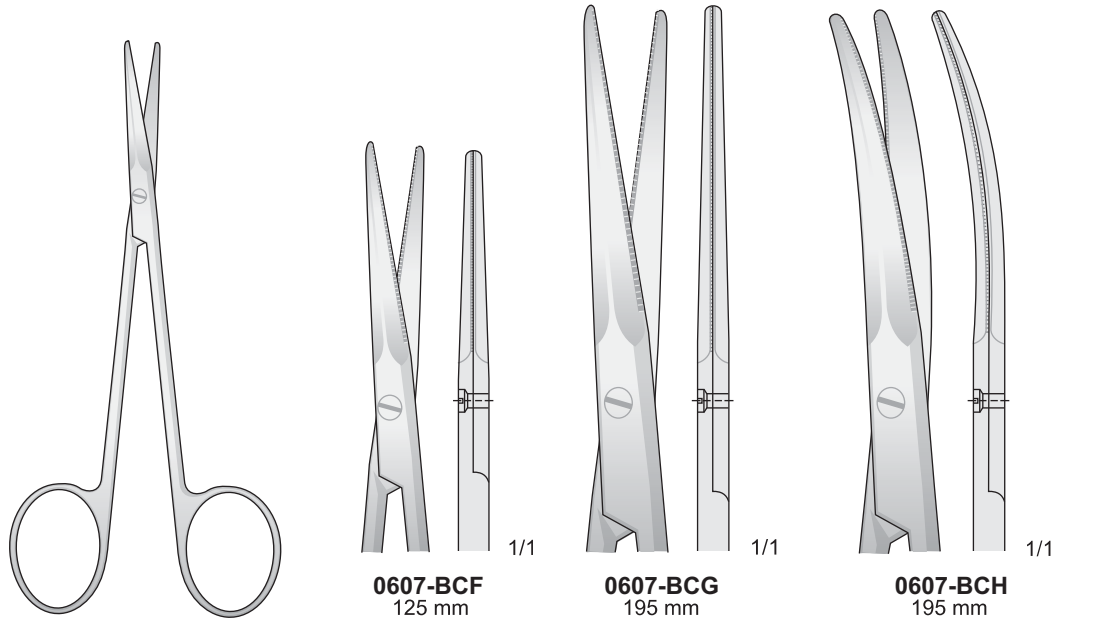

GORNEY
 0607-BCF/0607-BCH

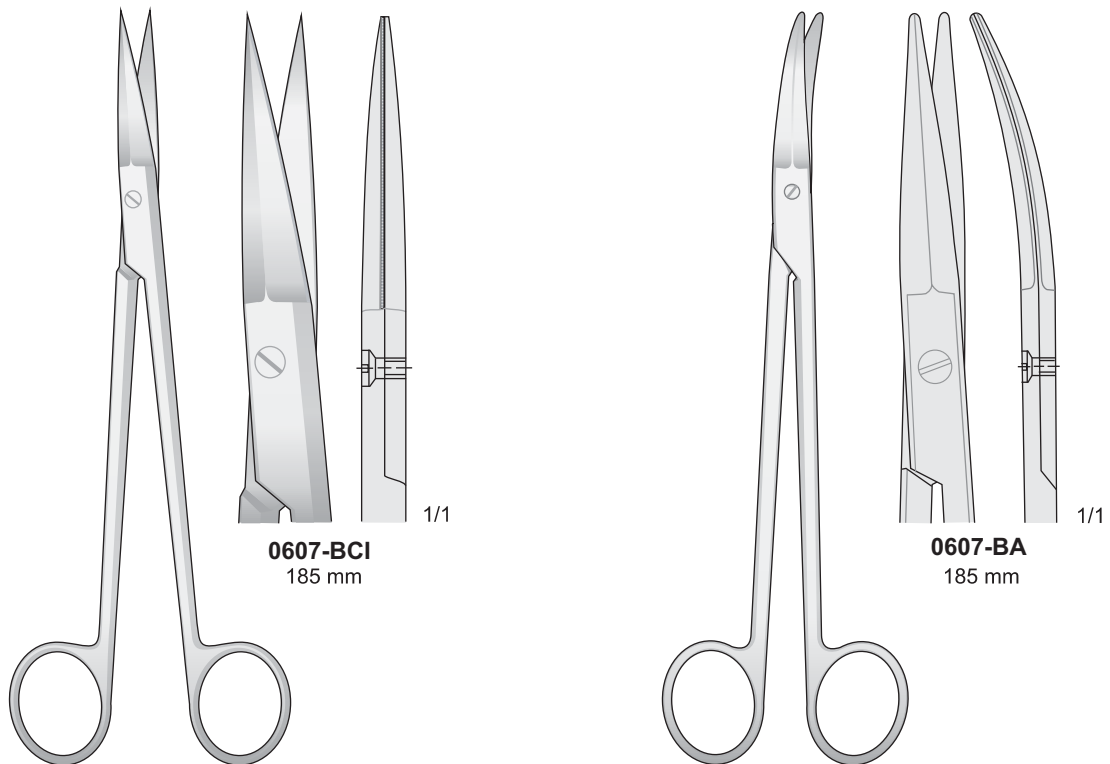

0607-BCI
185 mm

0607-BA
185 mm

Tonsillenscheren
Tonsil Scissors
Forbici per tonsille
Tijeras para amígdalas
Ciseaux pour les amygdales

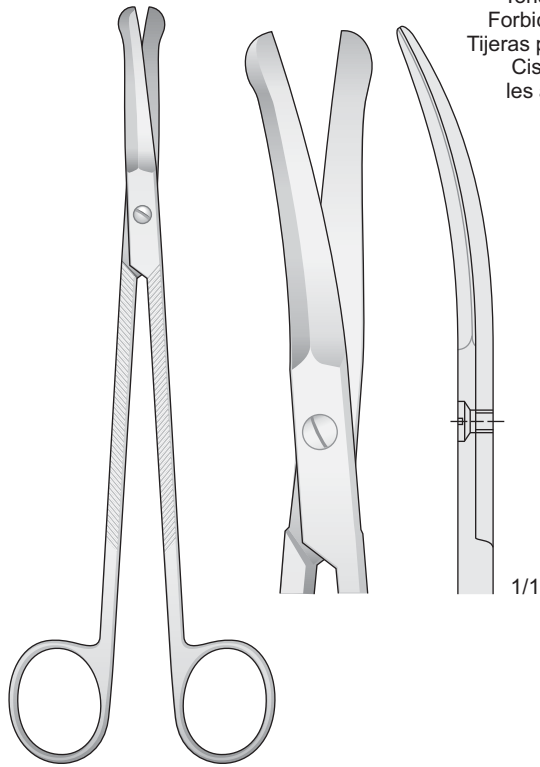

GOOD
0607-BDF
195 mm

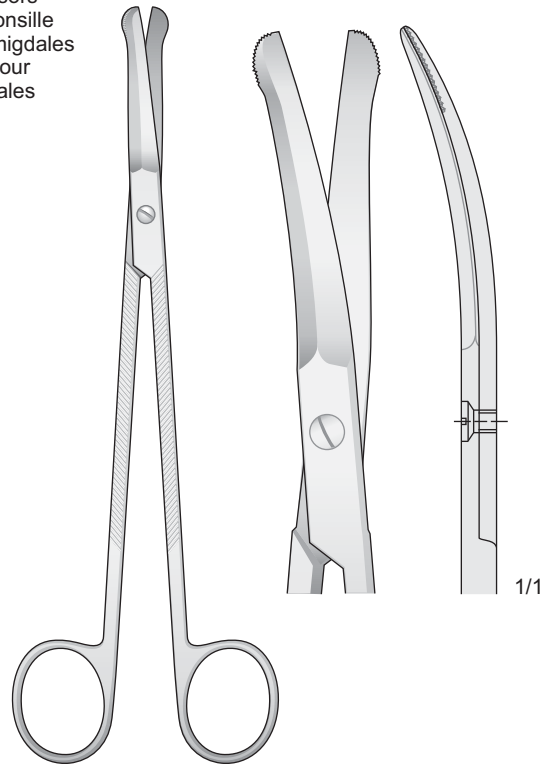

SCHWECKENDIEK
0607-BDG
195 mm

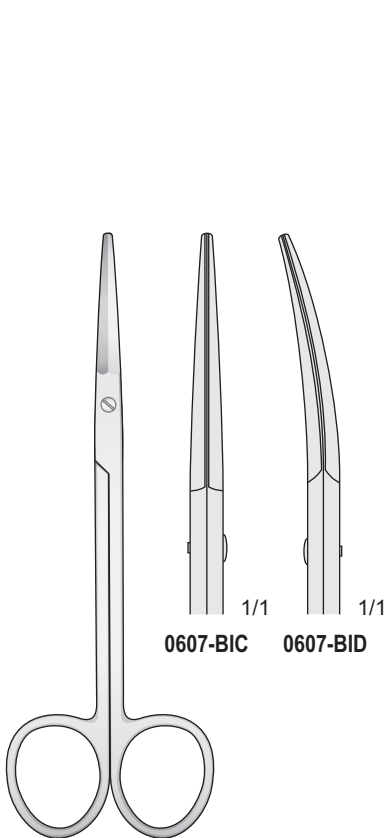

KAHN
0607-BIC/0607-BID
145 mm

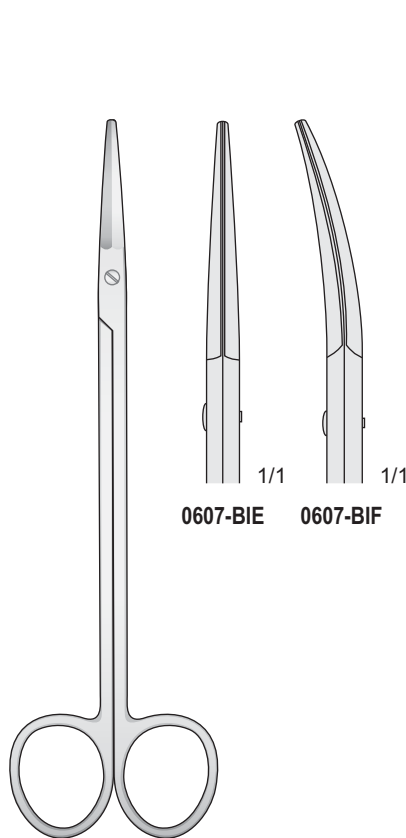

KAHN
0607-BIE/0607-BIF
180 mm

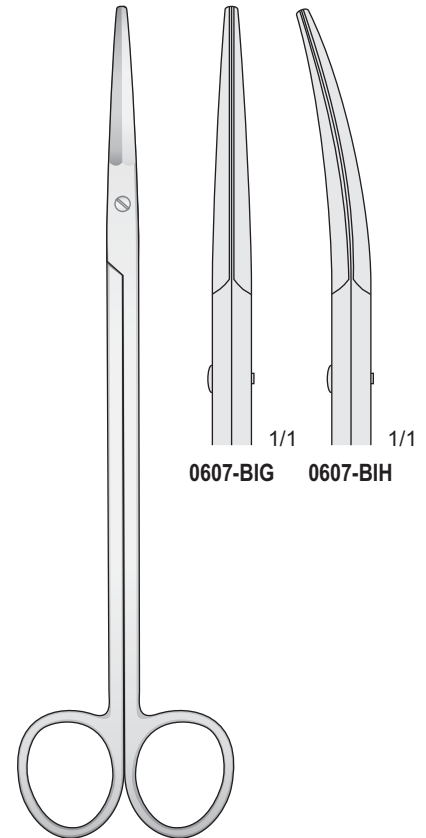

KAHN
0607-BIG/0607-BIH
205 mm

Eine Schneide gezahnt S-förmig gebogen
 One toothed cutting edge S-shaped
 Una lama dentata curva a forma S
 Una hoja dentada forma S
 Une lame dentelée courbés en S

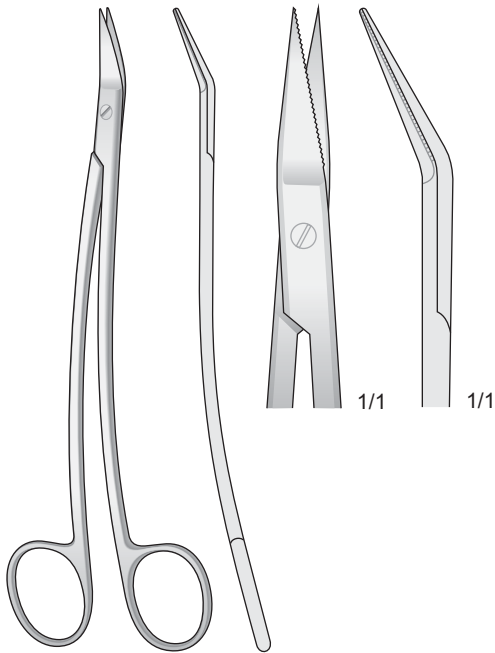

DEAN
 04050113
 175 mm

Eine Schneide gezahnt S-förmig gebogen
 One toothed cutting edge S-shaped
 Una lama dentata curva a forma S
 Una hoja dentada forma S
 Une lame dentelée courbés en S

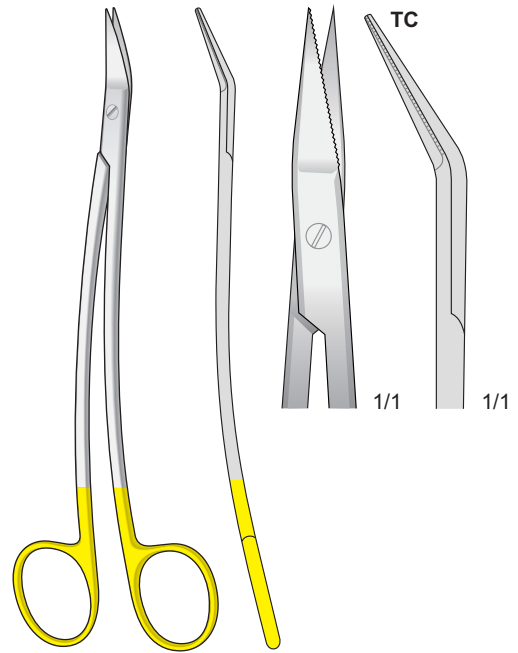

04050113-1903
 175 mm

Gezahnt - Serrated - Dentellata - Dentadas - Dentelé



DANDY
 0607-EC
 175 mm

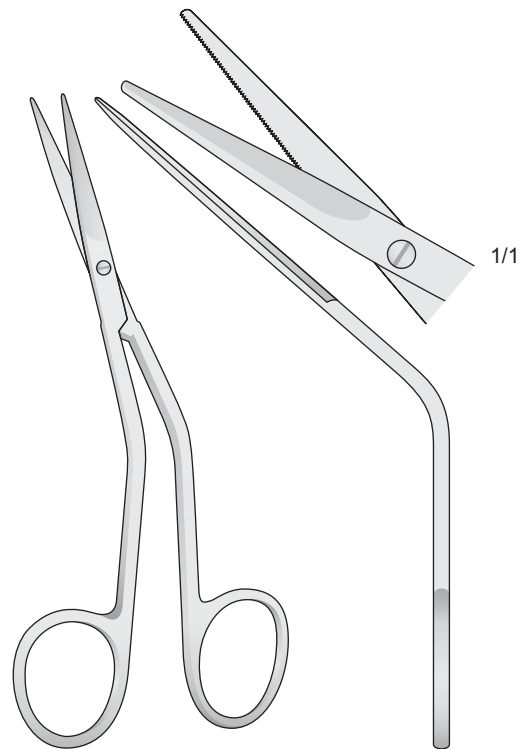

FOMON
 0607-EB
 135 mm

Nasenscheren - Nasal Scissors - Forbici nasali - Tijeras nasales - Ciseaux nasaux

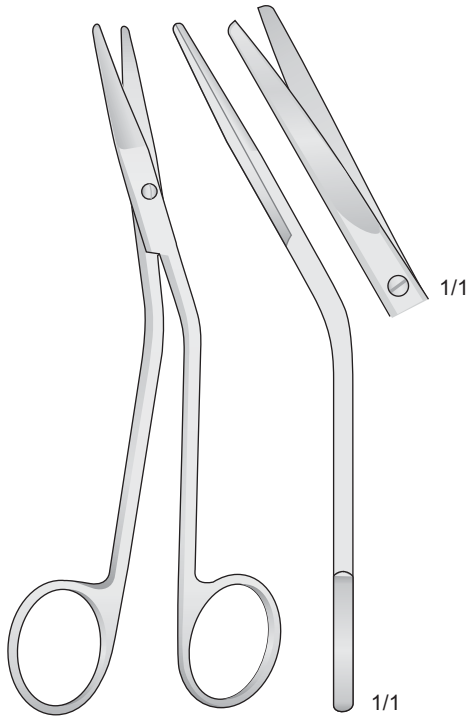

FOMON
0607-H
150 mm



HEYMANN
0607-I
180 mm

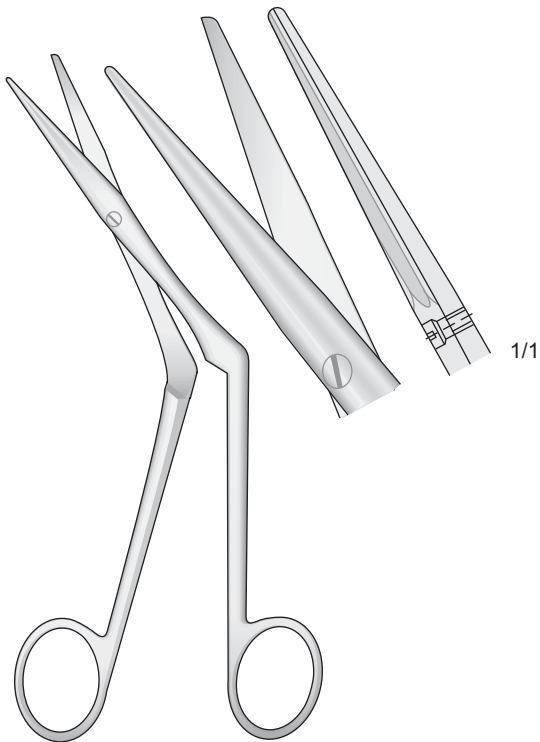

HEYMANN-KNIGHT
0607-LL
175 mm

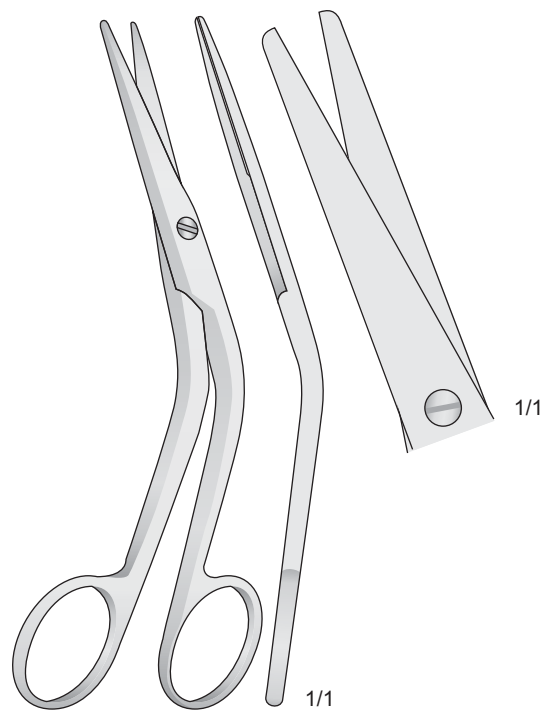

COTTLE
0607-L
160 mm

"Super-cut" scheren mikro-schliff für tissue atrauma - "Super-cut" scissors for gripping tissue and cutting interproximally
 Forbici "super-cut" estremamente taglienti per tessuti con riduzione del trauma - Tijeras "super cortes" para cortar tissue-atrauma
 Ciseaux "super cut" coupe les tissus en reduisant les risques de traumatisme

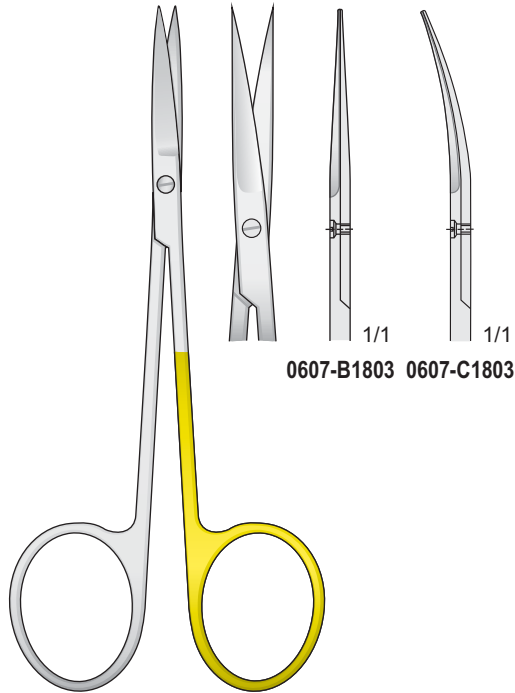

IRIS
 0607-B1803/0607-C1803
 110 mm

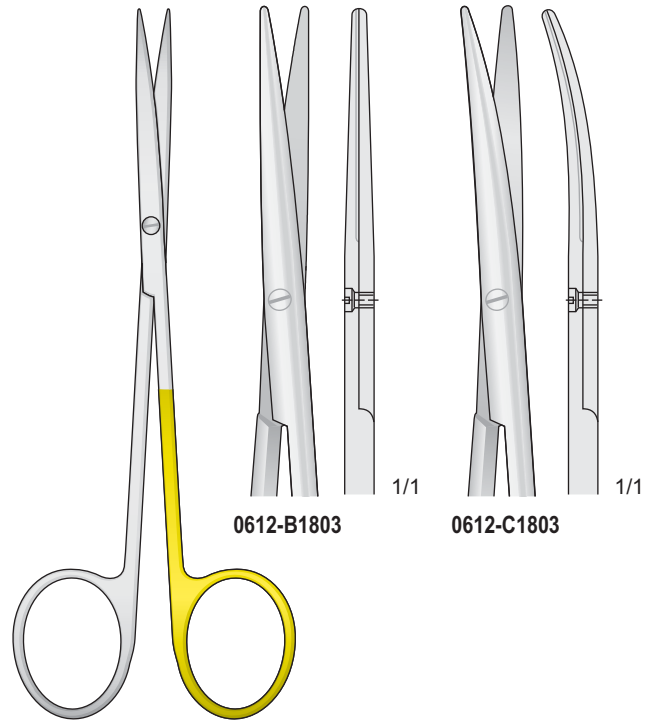

METZENBAUM
 0612-B1803/0612-C1803
 145 mm

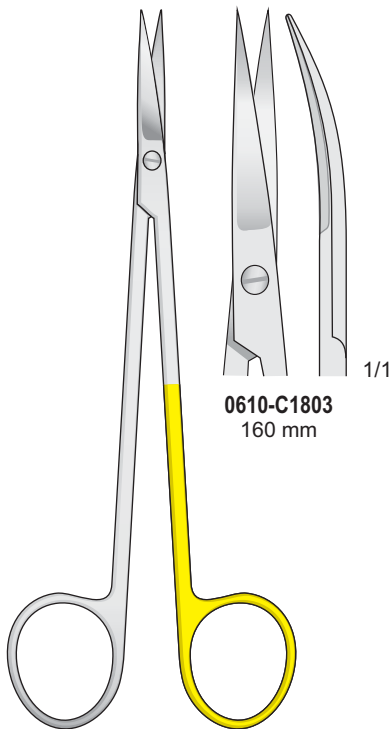

KELLY
 0610-C1803
 160 mm

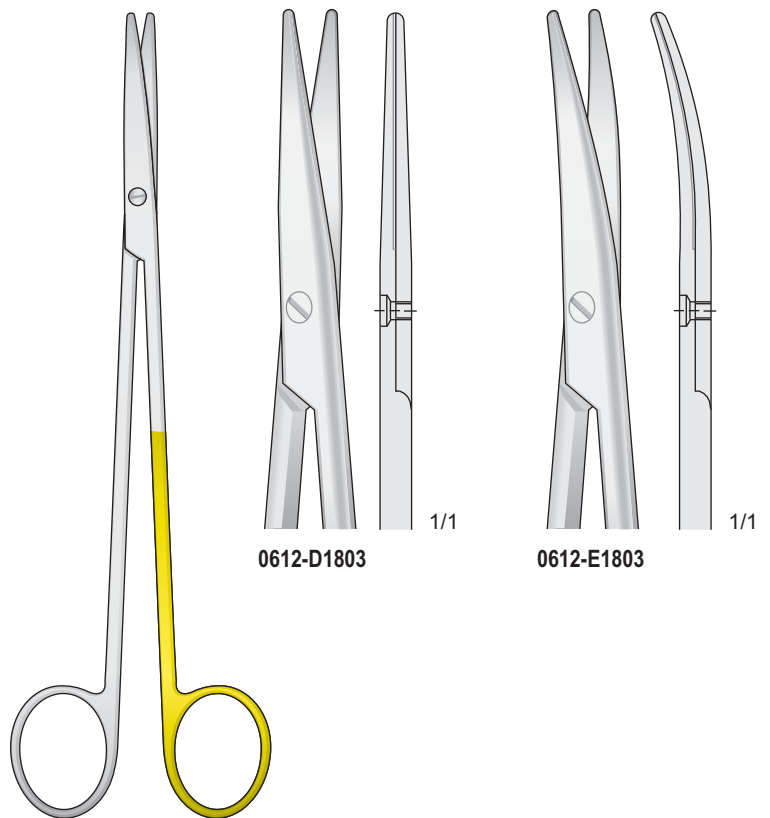

METZENBAUM
 0612-D1803/0612-E1803
 185 mm

"Super-cut" scheren mikro-schliff für tissue atrauma - "Super-cut" scissors for gripping tissue and cutting interproximally
 Forbici "super-cut" estremamente taglienti per tessuti con riduzione del trauma - Tijeras "super cortes" para cortar tissue-atrauma
 Ciseaux "super cut" coupe les tissus en réduisant les risques de traumatisme

Mit einer Schneide gezahnt - With one blade serrated
 Con una lama zigrinata - Con una hoja dentada
 Avec lame dentèle

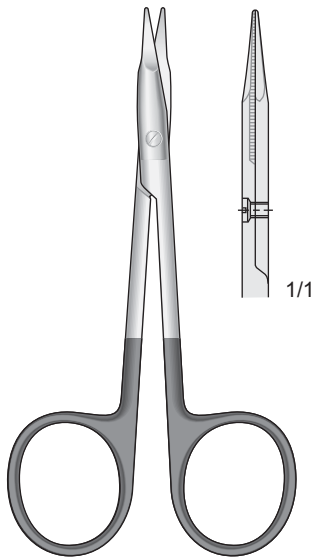

STEVENS
0612-DAC
 105 mm

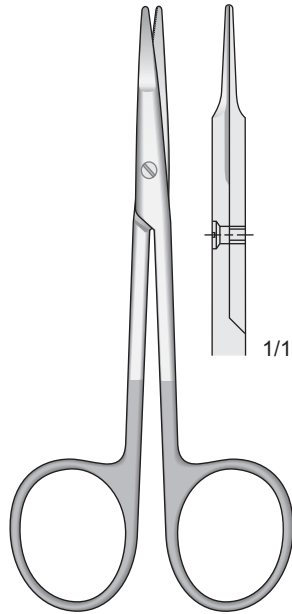

GREENBERG-PAR
0612-CLE
 115 mm

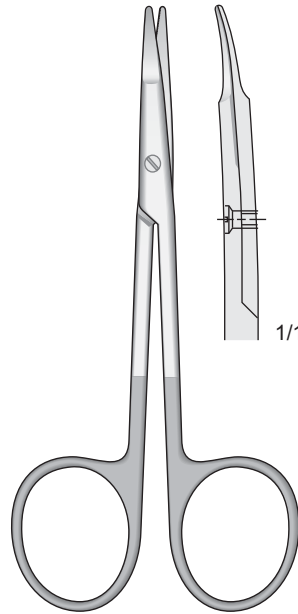

GREENBERG-PAR
0612-CLF
 115 mm

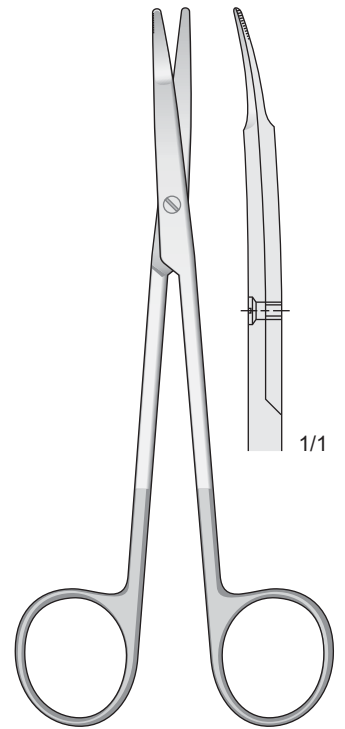

KILNER
0612-DAF
 150 mm

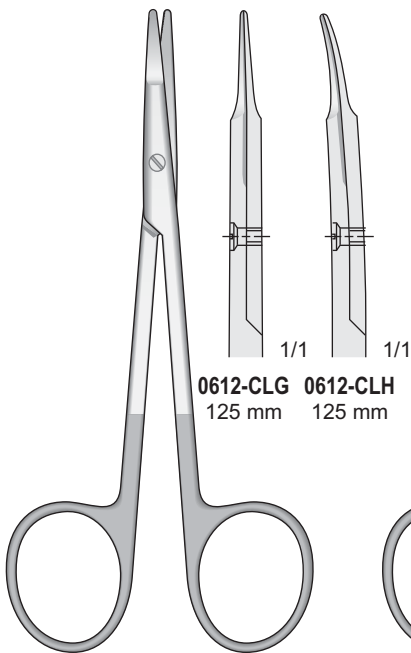

0612-CLG **0612-CLH**
 125 mm 125 mm

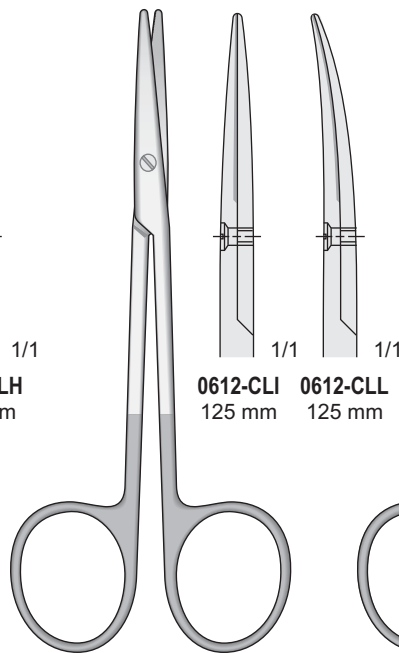

0612-CLI **0612-CLL**
 125 mm 125 mm

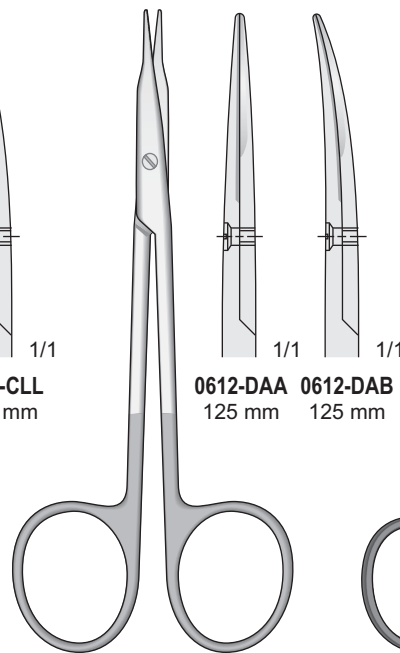

0612-DAA **0612-DAB**
 125 mm 125 mm

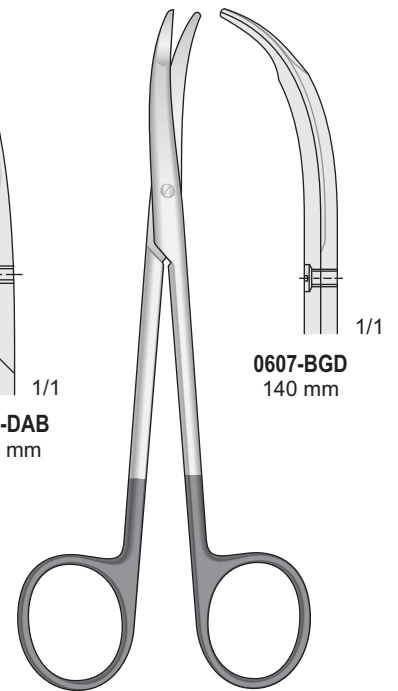

0607-BGD
 140 mm

KILNER
0612-CLG/0612-CLH
 125 mm

METZENBAUM
0612-CLI/0612-CLL
 125 mm

STEVENS
0612-DAA/0612-DAB
 125 mm

FOMON
0607-BGD
 140 mm

Knochenchirurgie
Nasenseptumschere

Bone holding forceps
Septum Scissors

Chirurgia ossea
Forbici per setto nasale

Pinzas para huesos
Tijeras para el tabique nasal

Chirurgie Osseuse
Chirurgie Osseuse

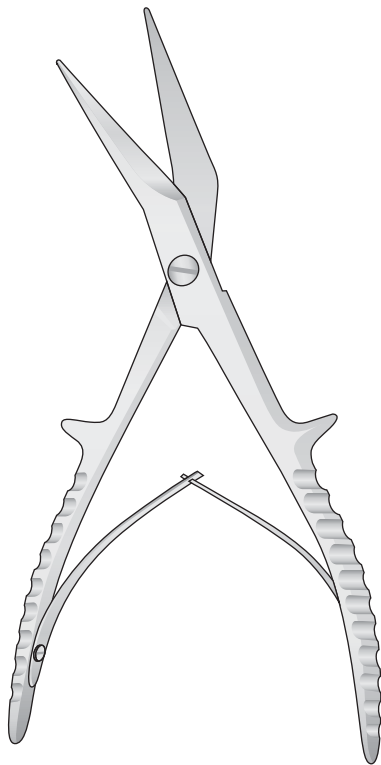

0607-BBA
195 mm

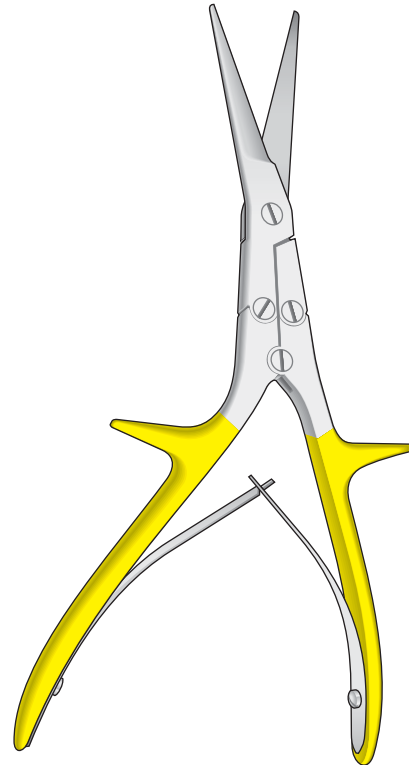

GORNEY
0614-BLA
205 mm

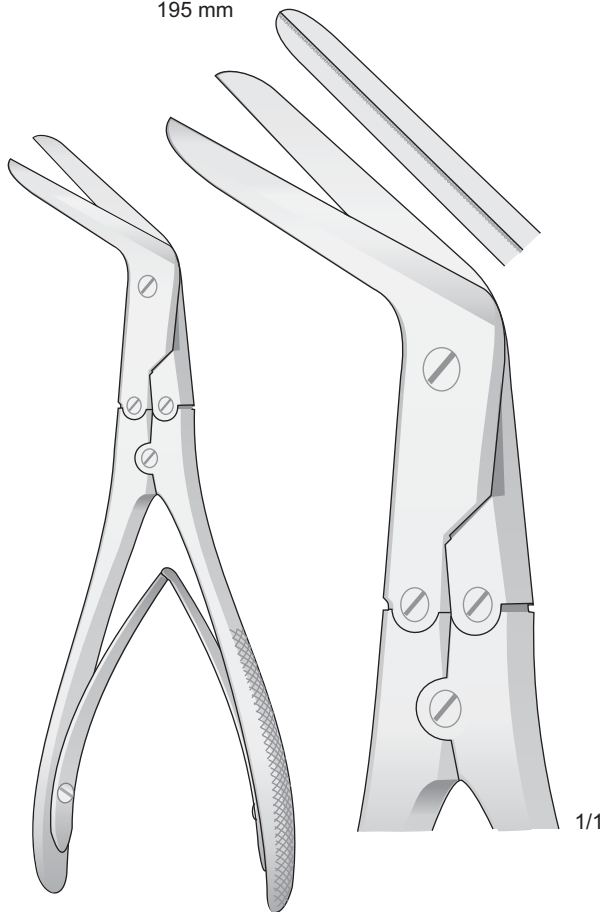

KILLIAN
0614-BED
210 mm

Gezahnt
Serrated
Dentellata
Dentadas
Dentelé

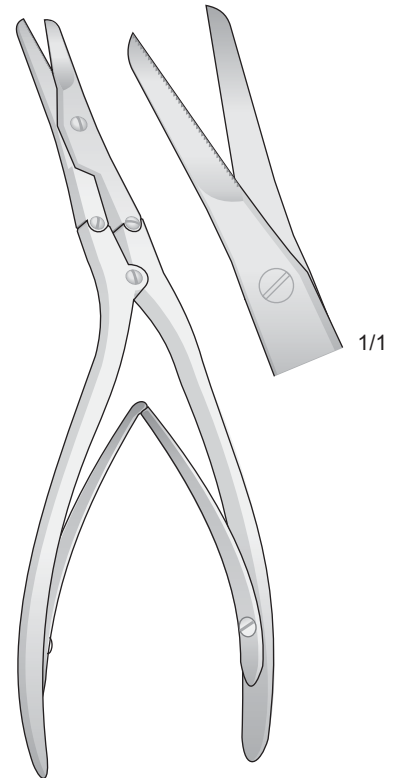

CAPLAN
0614-BEE
200 mm

Mit Hartmetalleinsätzen - Tungsten-carbide scissors
 Con punta al carburo di tungsteno - Tijeras de tungsteno - Avec plaquettes en carbure de tungstène

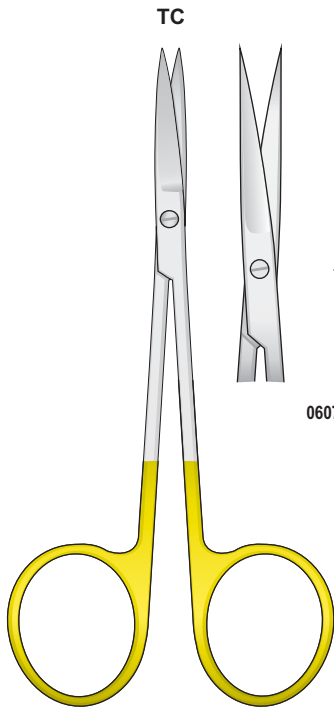

IRIS
 0607-B1903/0607-C1903
 115 mm

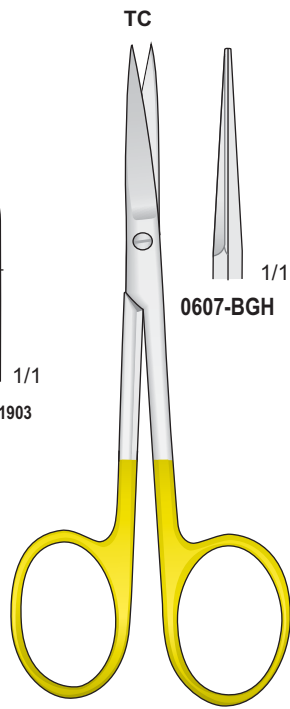
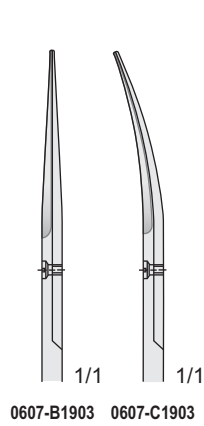

0607-BGH/0607-BGI
 110 mm

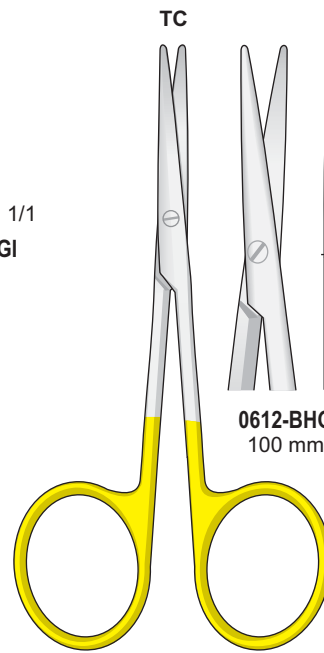
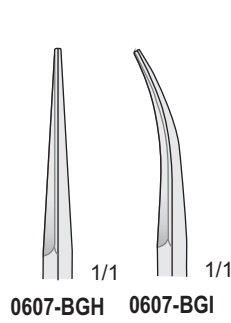

LEXER-BABY
 0612-BHG/0612-BHH
 100 mm

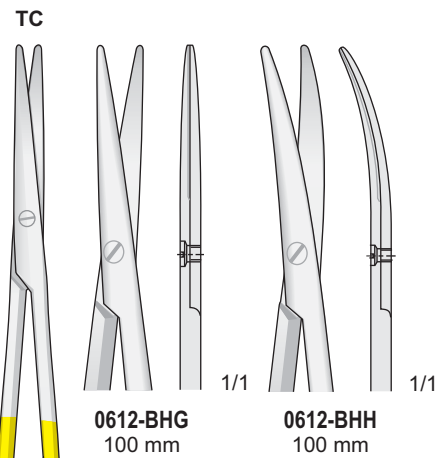

Gezahnt - Serrated - Dentellate - Dentadas - Dentée

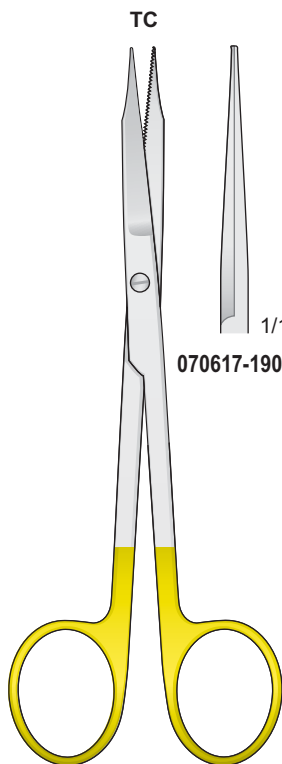

GOLDMAN-FOX
 070617-1903/070603-1903
 135 mm

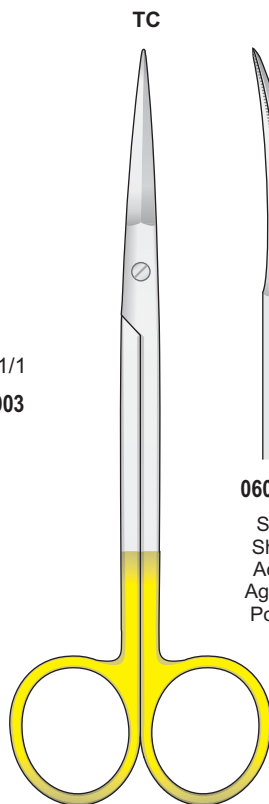
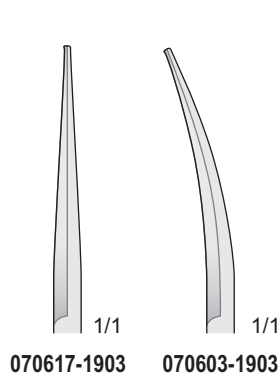

PECK-JOSEPH
 0607-LC/0607-LI
 140 mm

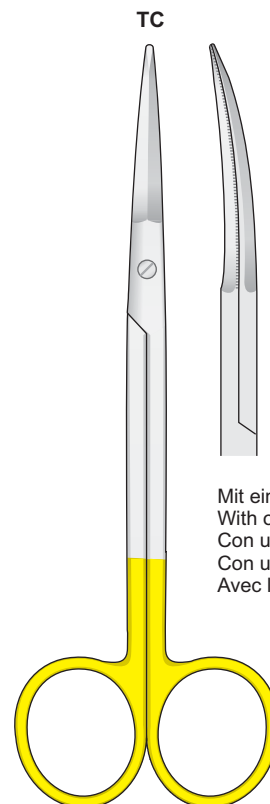
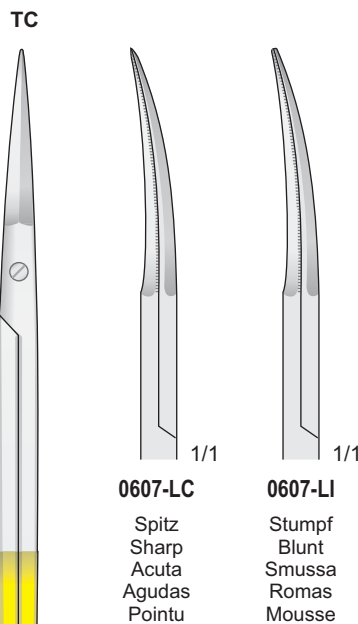

GREGORY
 0612-DDL
 140 mm

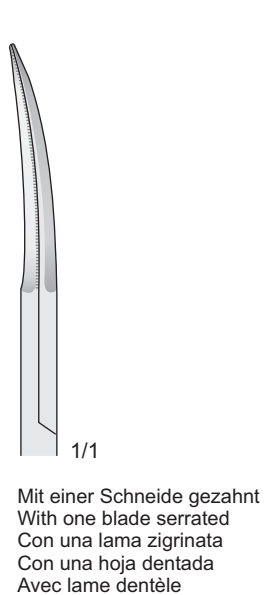

Mit einer Schneide gezahnt
 With one blade serrated
 Con una lama zigrinata
 Con una hoja dentada
 Avec lame dentée

Mit Hartmetalleinsätzen - Tungsten-carbide scissors
 Con punta al carburo di tungsteno - Tijeras de tungsteno - Avec plaquettes en carbure de tungstène

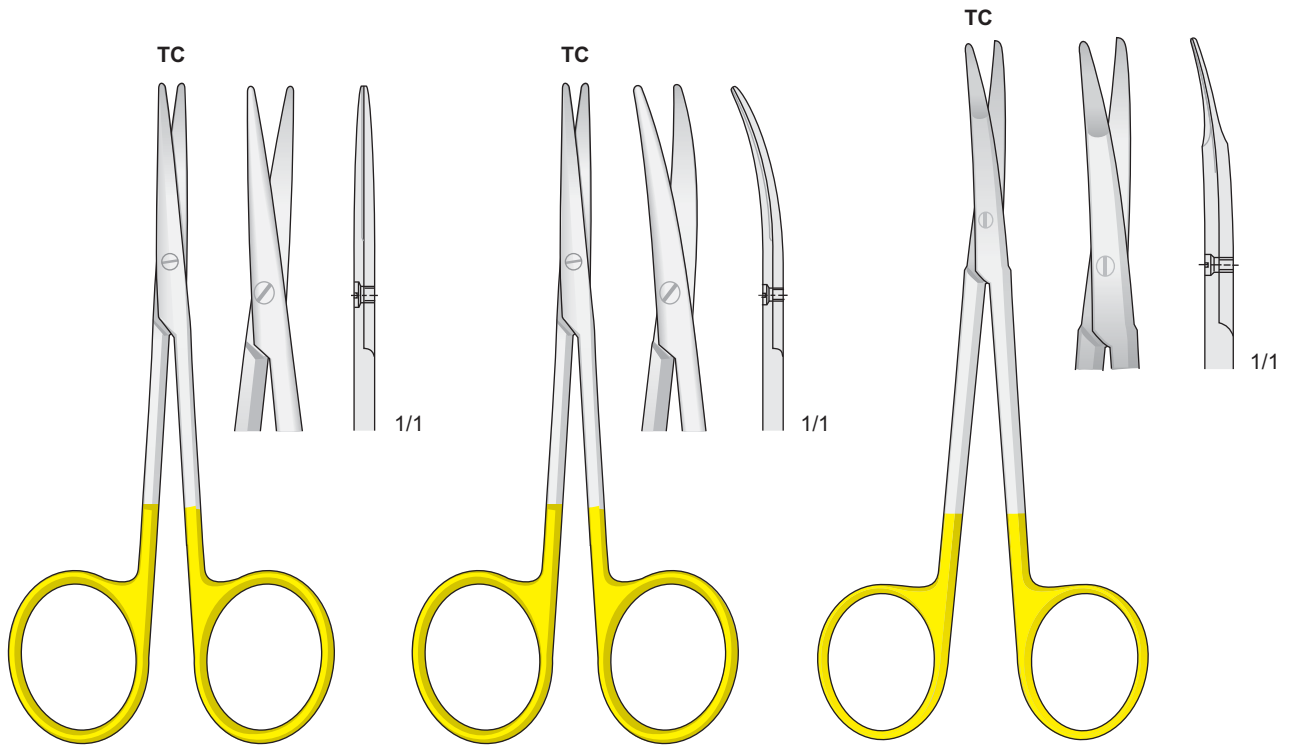

0612-BBI
115 mm

0612-BBL
115 mm

KILNER (RAGNELL)
0612-DFA
125 mm

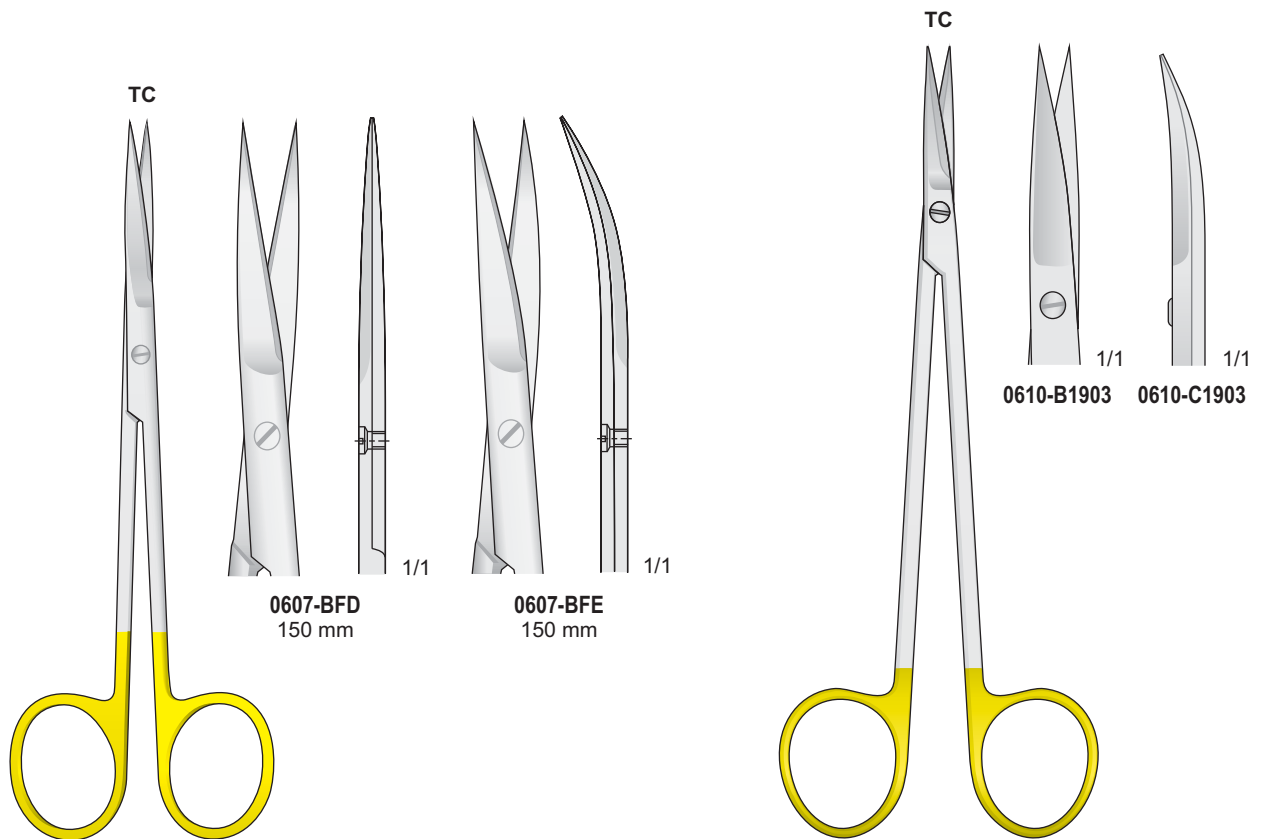

JOSEPH
0607-BFD/0607-BFE
150 mm

KELLY
0610-B1903/0610-C1903
160 mm

Mit Hartmetalleinsätzen - Tungsten-carbide scissors
 Con punta al carburo di tungsteno - Tijeras de tungsteno - Avec plaquettes en carbure de tungstène

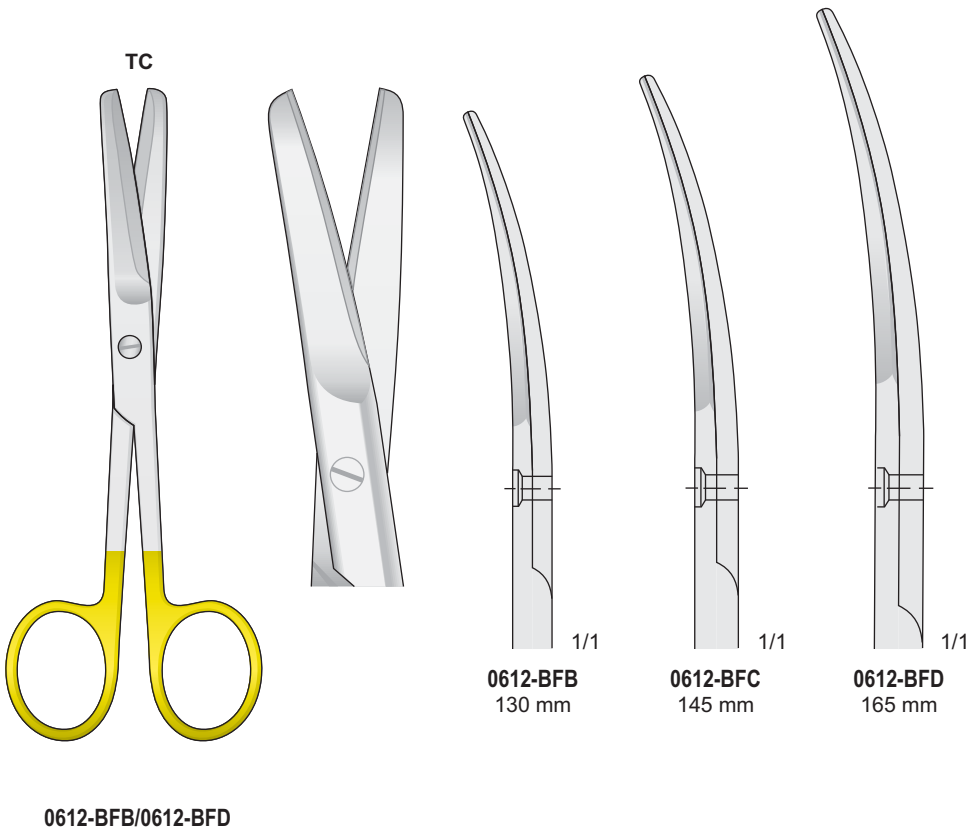
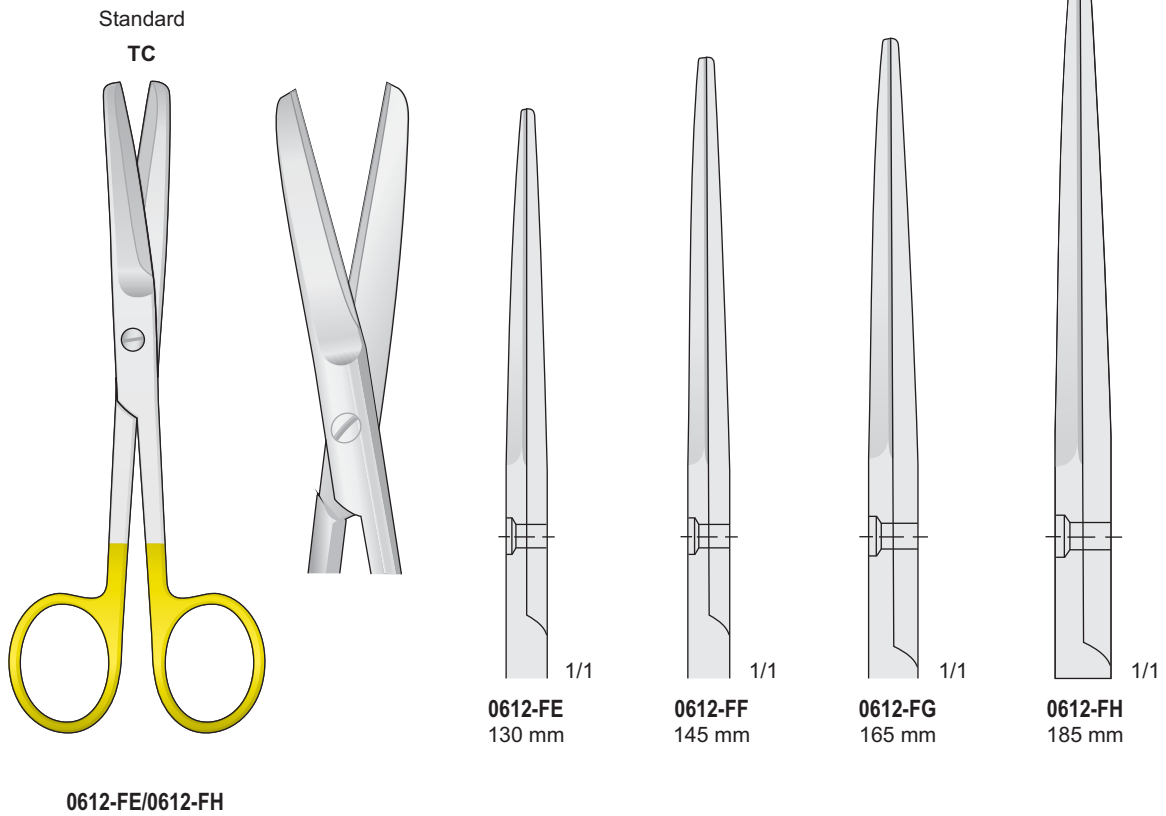

Mit Hartmetalleinsätzen - Tungsten-carbide scissors
 Con punta al carburo di tungsteno - Tijeras de tungsteno - Avec plaquettes en carbure de tungstène

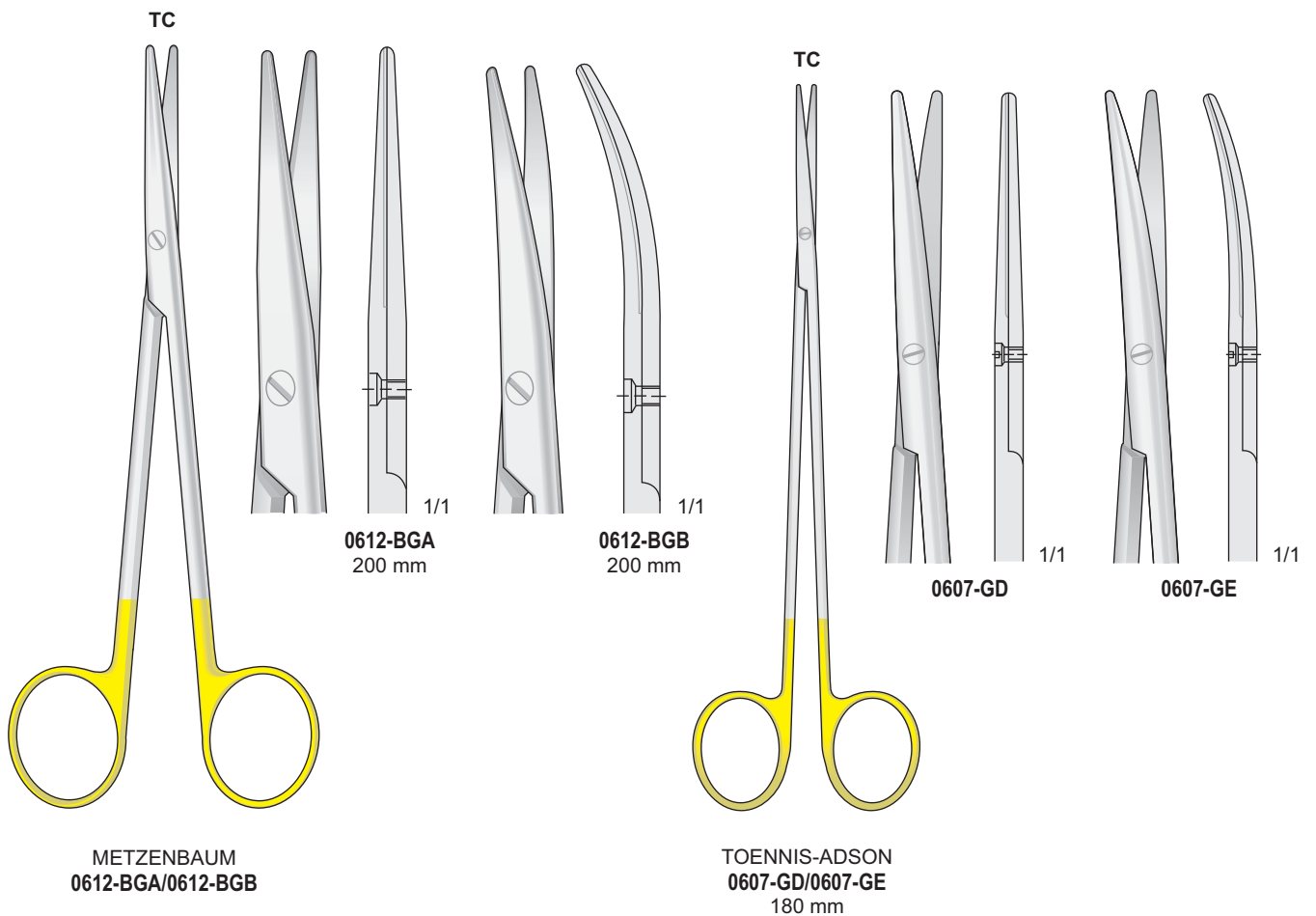
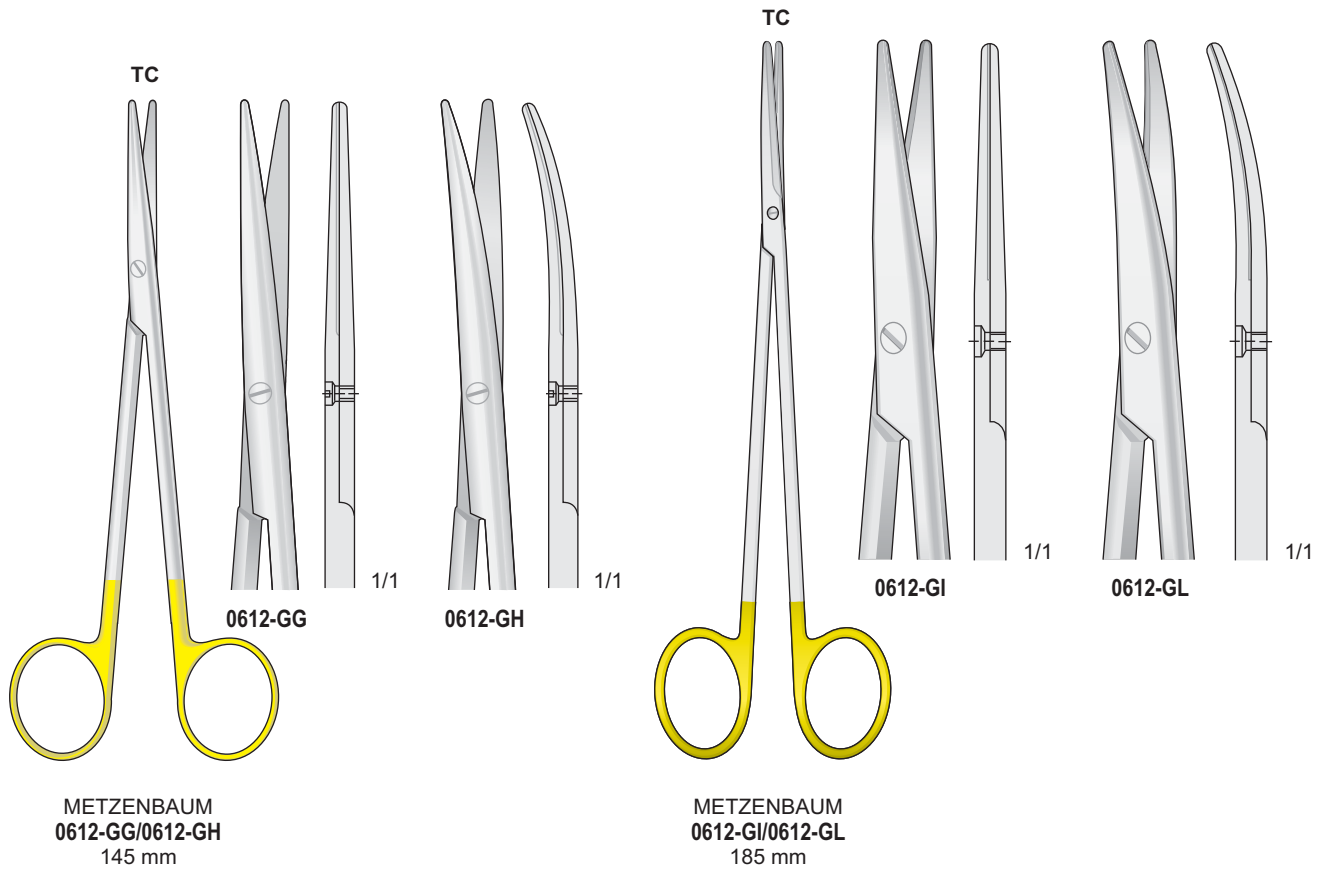

Mit Hartmetalleinsätzen - Tungsten-carbide scissors
 Con punta al carburo di tungsteno - Tijeras de tungsteno - Avec plaquettes en carbure de tungstène

TC

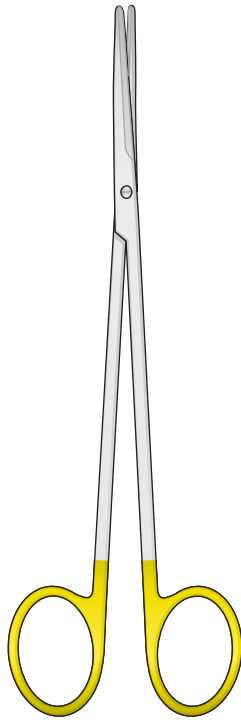

METZENBAUM-FINO
 0612-CAB/0612-CAF

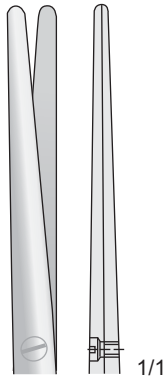

0612-CAB
 140 mm

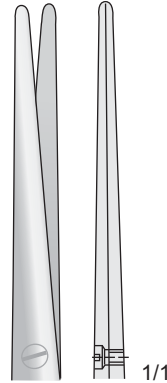

0612-CAD
 180 mm

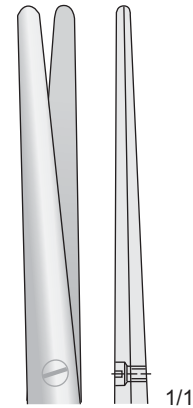

0612-CAF
 200 mm

TC

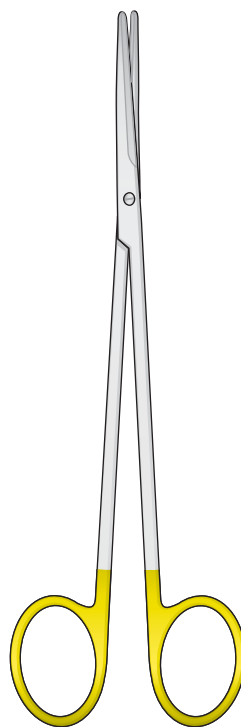

METZENBAUM-FINO
 0612-CAH/0612-CBB

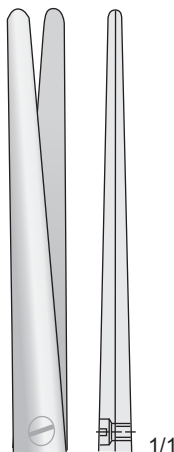

0612-CAH
 230 mm

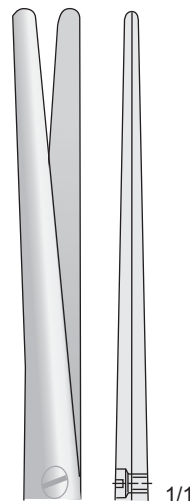

0612-CAL
 250 mm

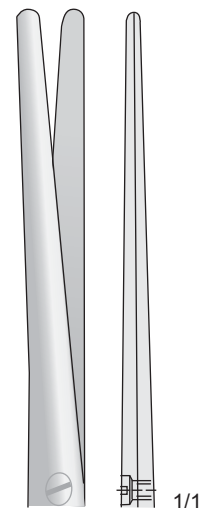

0612-CBB
 280 mm

Mit Hartmetalleinsätzen - Tungsten-carbide scissors
 Con punta al carburo di tungsteno - Tijeras de tungsteno - Avec plaquettes en carbure de tungstène

TC

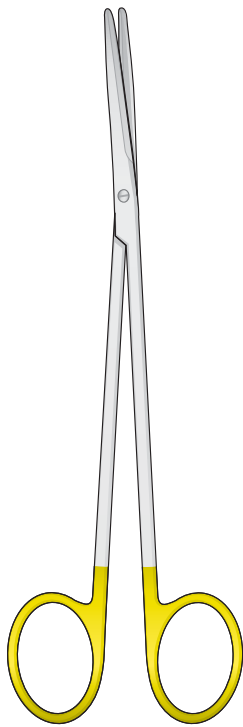

METZENBAUM-FINO
 0612-CAC/0612-CAG

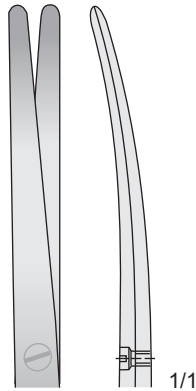

0612-CAC
 140 mm

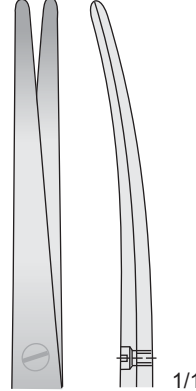

0612-CAE
 180 mm

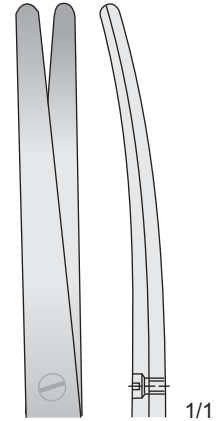

0612-CAG
 200 mm

TC

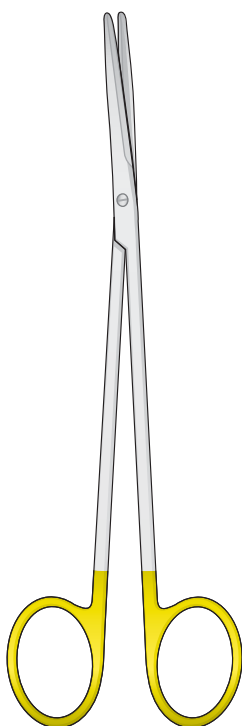

METZENBAUM-FINO
 0612-CAI/0612-CBC

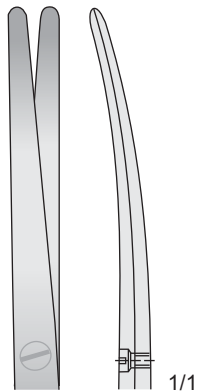

0612-CAI
 230 mm

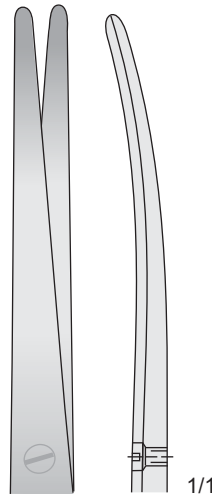

0612-CBA
 250 mm

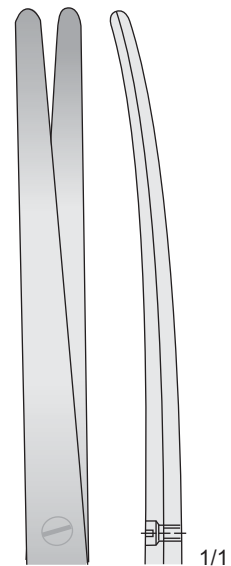

0612-CBC
 280 mm

Mit Hartmetalleinsätzen - Tungsten-carbide scissors
 Con punta al carburo di tungsteno - Tijeras de tungsteno - Avec plaquettes en carbure de tungstène

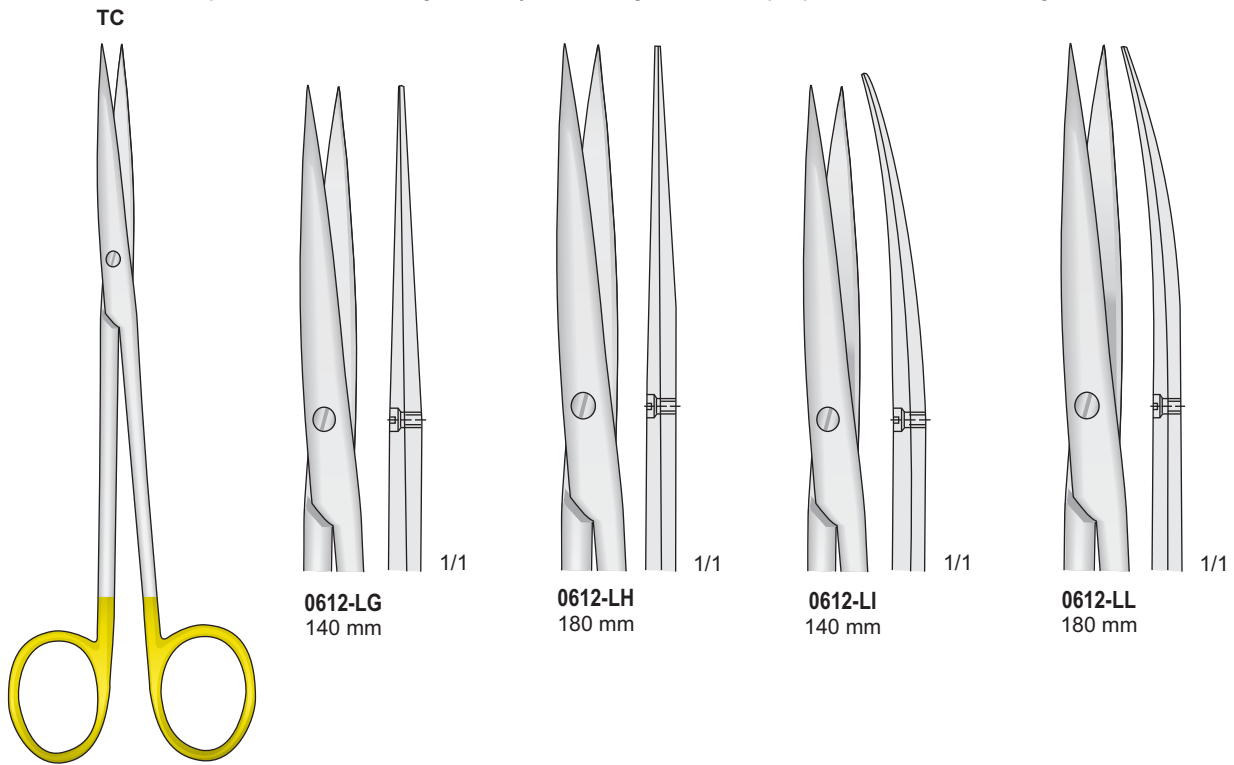

METZENBAUM-FINO
 0612-LG/0612-LL

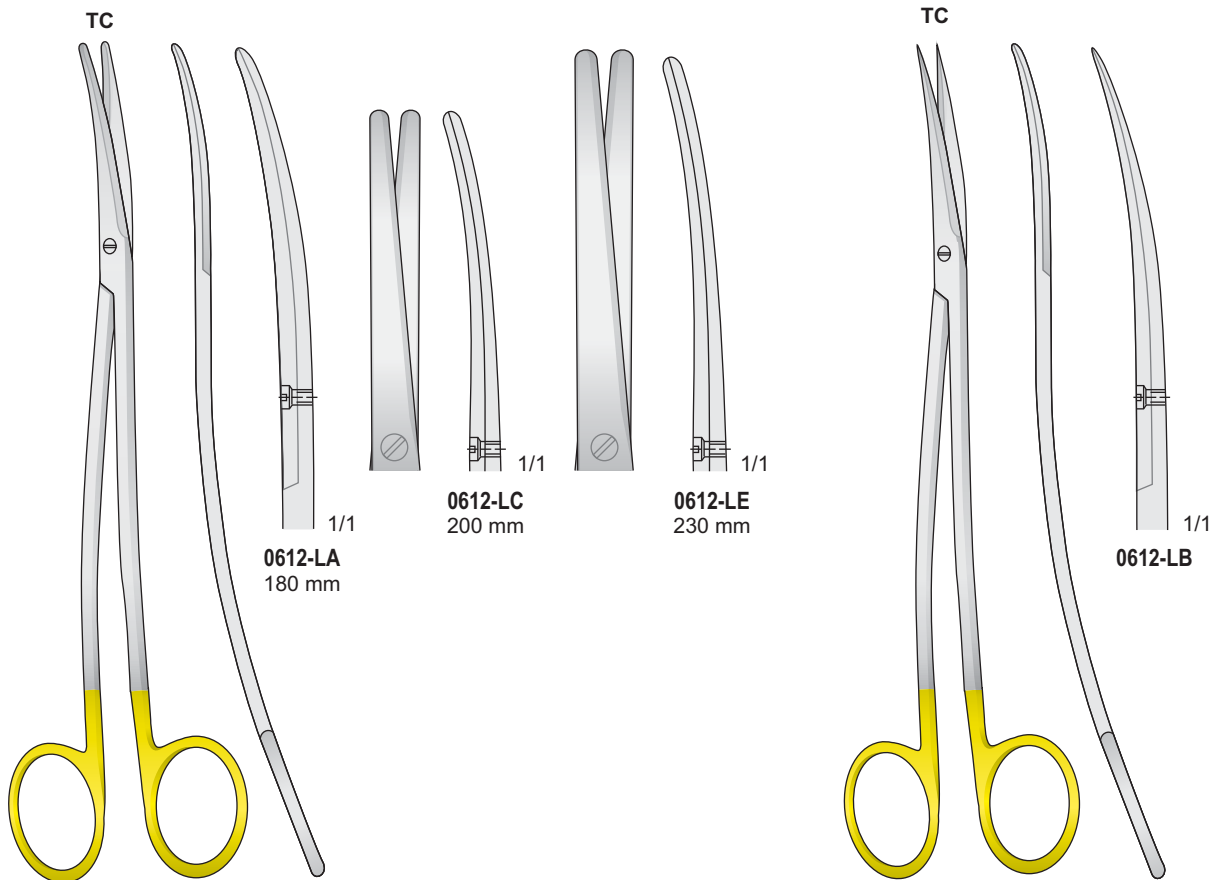

METZENBAUM-FINO
 0612-LA/0612-LE

METZENBAUM-FINO
 0612-LB
 180 mm

Mit Hartmetalleinsätzen - Tungsten-carbide scissors
 Con punta al carburo di tungsteno - Tijeras de tungsteno - Avec plaquettes en carbure de tungstène



0612-BEA
140 mm

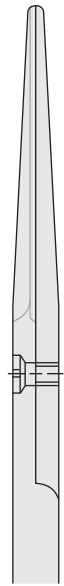

1/1

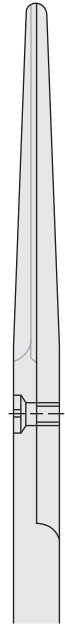

0612-BEC
170 mm

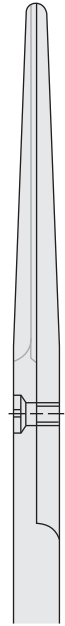

1/1



0612-BEB
140 mm

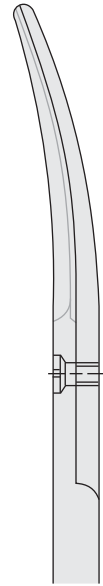

1/1



0612-BED
170 mm



1/1

MAYO
0612-BEA/0612-BED

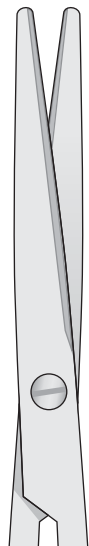
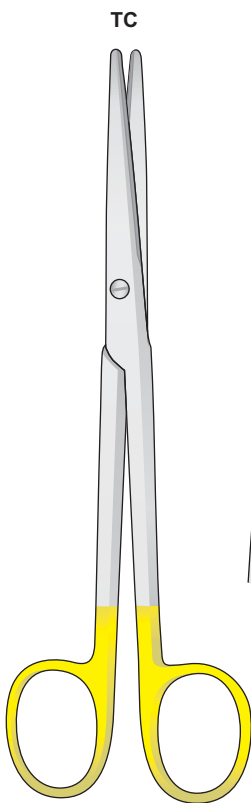

0612-BDE
160 mm

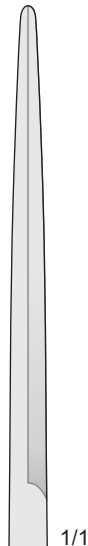

1/1

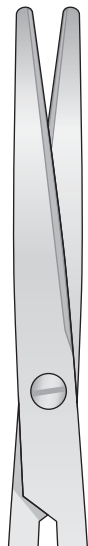

0612-BDG
160 mm



1/1

LEXER
0612-BDE/0612-BDG

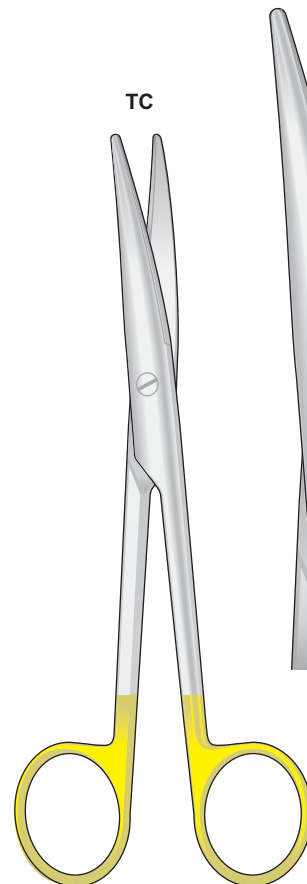

0612-BDL
165 mm

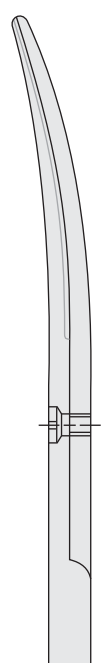

1/1

MAYO-LEXER
0612-BDL
165 mm

Mit Hartmetalleinsätzen - Tungsten-carbide scissors
 Con punta al carburo di tungsteno - Tijeras de tungsteno - Avec plaquettes en carbure de tungstène

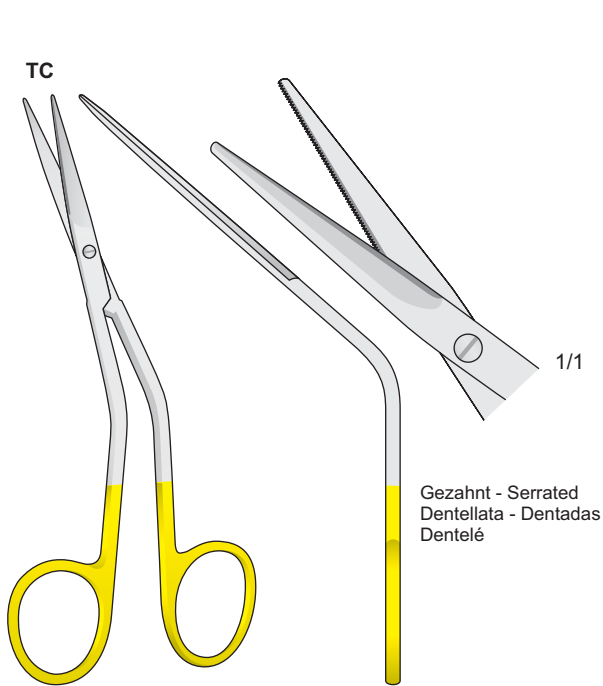

FOMON
0607-BGF
 135 mm

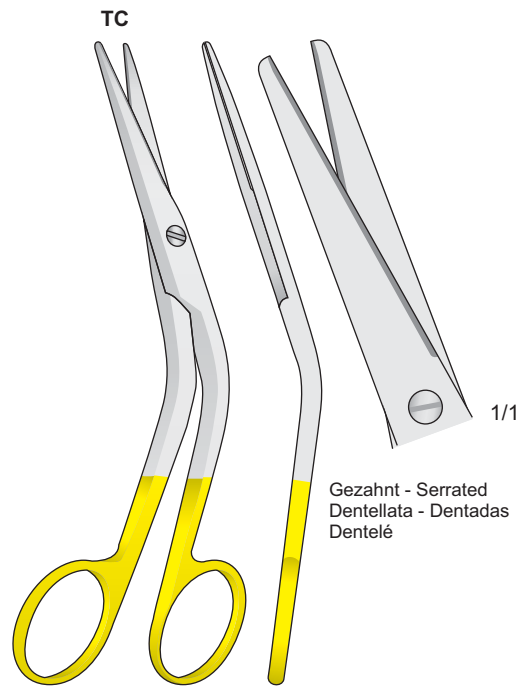

COTTLE
0607-BGG
 160 mm

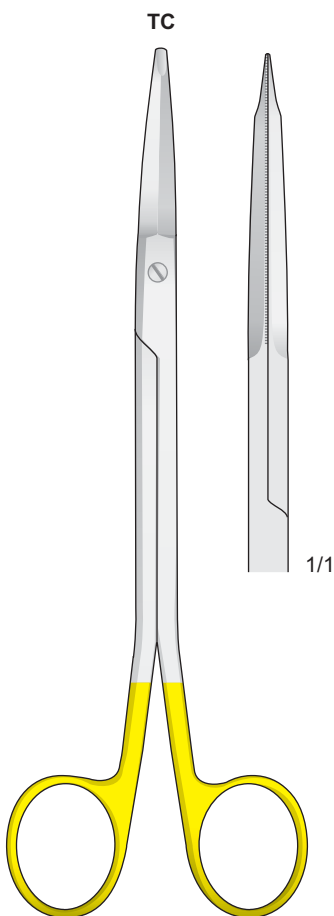

FREEMAN-GORNEY
0612-DBB
 180 mm

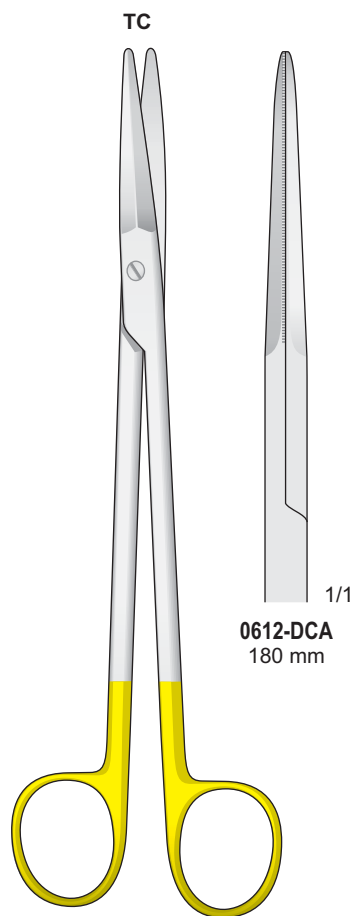

GORNEY
0612-DCA/0612-DCB
 180 mm

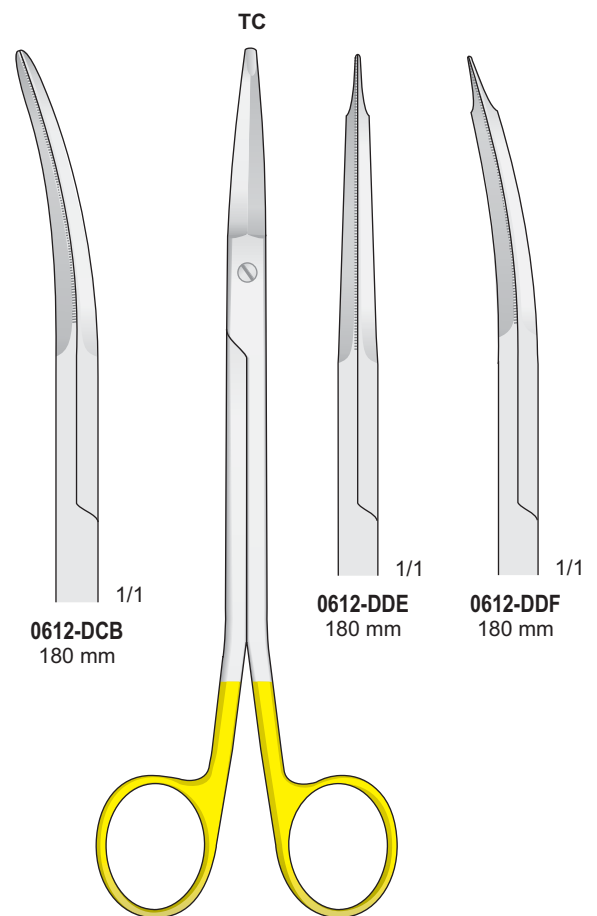

FREEMAN-KAYE
0612-DDE
 180 mm

Scheren Gezahnt

Serrated scissors

Forbici dentellate

Tijeras dentadas

Ciseaux dentelé

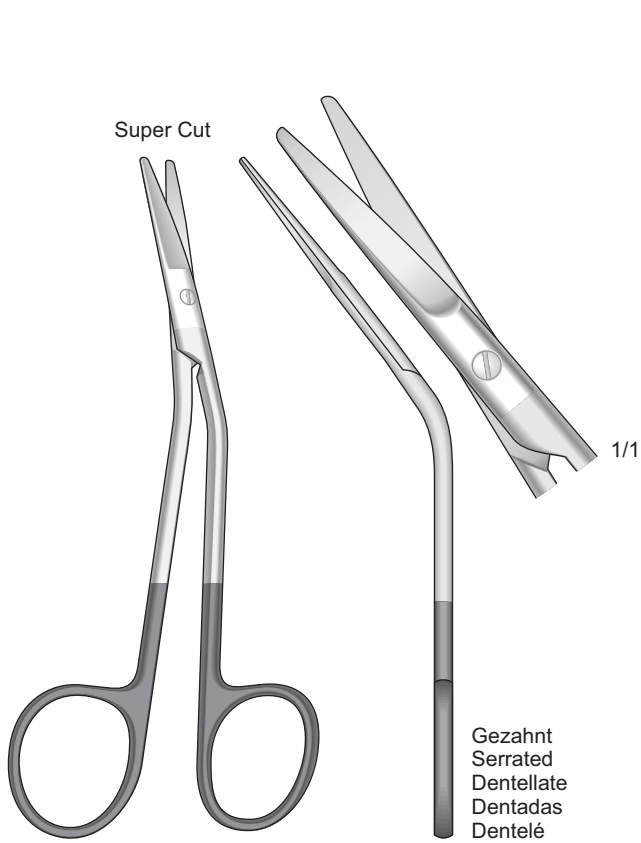

FOMON
0607-BLC
130 mm



COTTLE
0607-BLD
160 mm

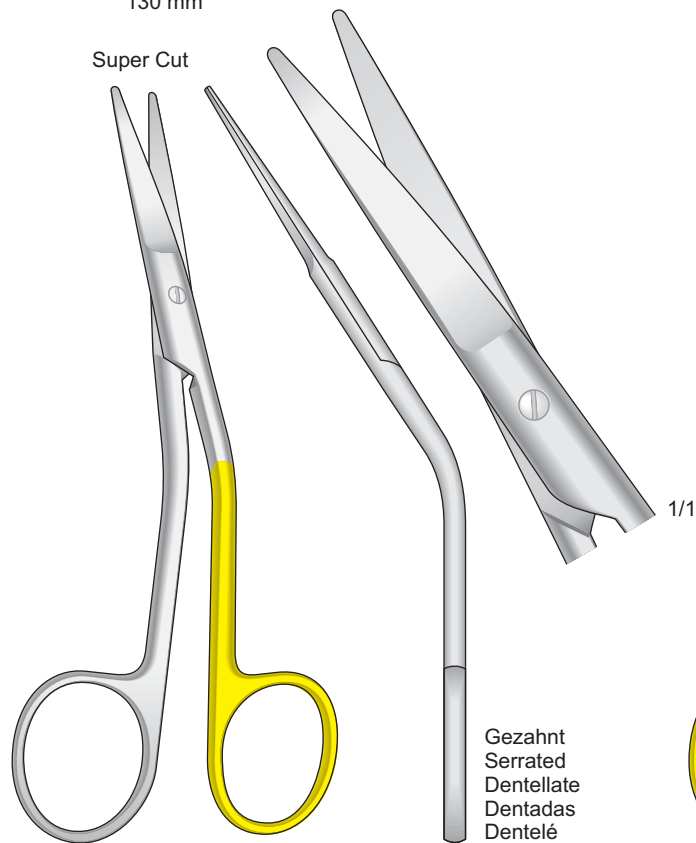

COTTLE
0607-BLE
160 mm

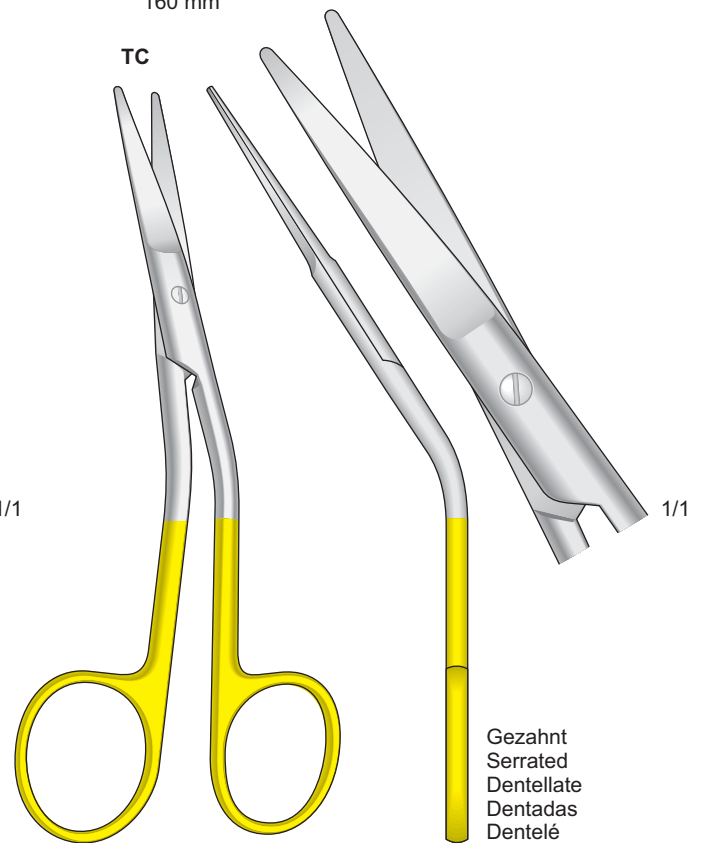

COTTLE
0607-BLF
160 mm

Scheren mit wellenschliff auf einer Schnittfläche
 Scissors cut one serrated cutting edge
 Forbici con taglio ondulato su una lama
 Ciseaux avec affutage spécial ont une lame dentée

Wellenschliff
 TC

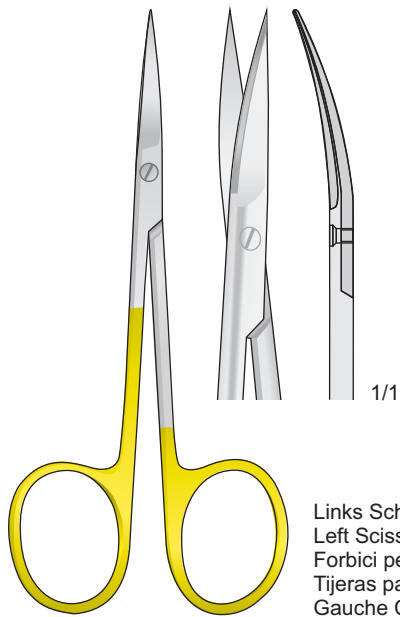

Links Scheren
 Left Scissors
 Forbici per mancini
 Tijeras para zurdos
 Gauche Ciseaux

IRIS
 0612-BAA11
 110 mm

Wellenschliff
 TC

Wellenschliff
 TC

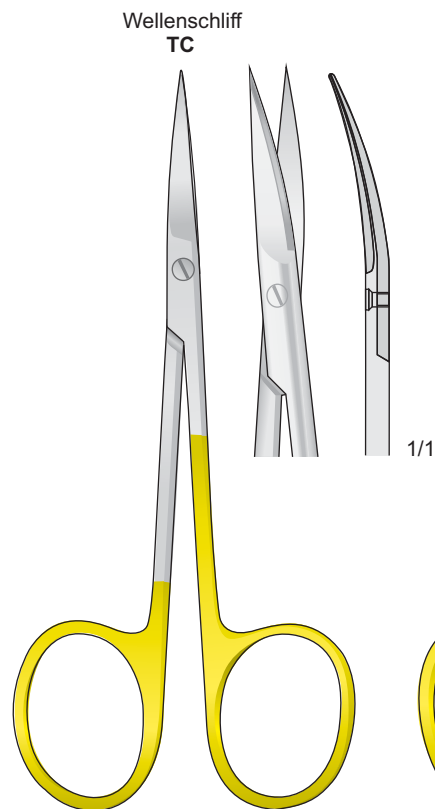

IRIS
 0612-BAA
 110 mm

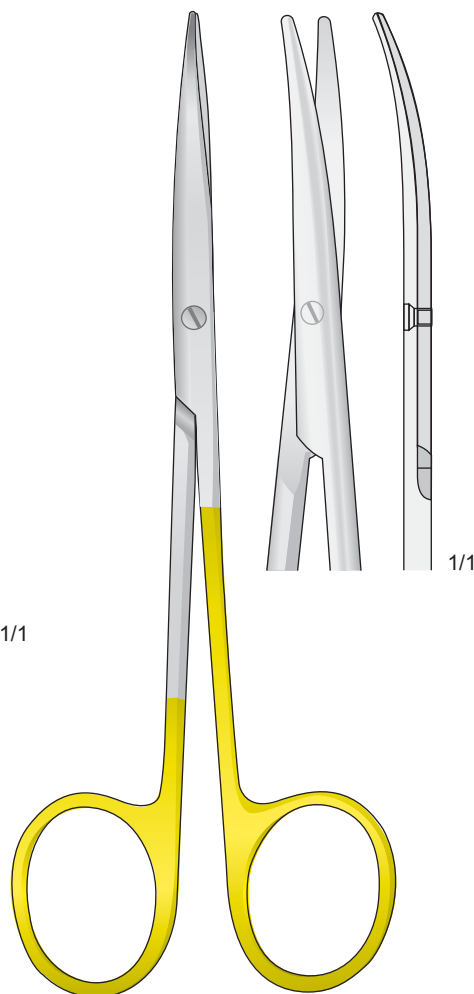

METZENBAUM
 0612-BAC
 145 mm

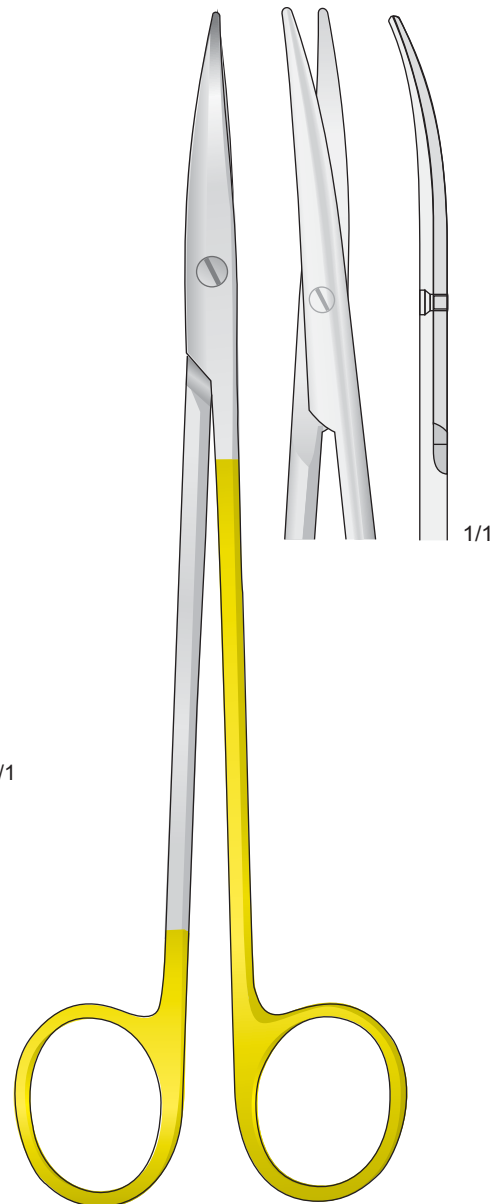

METZENBAUM
 0612-BAE
 185 mm

Ligaturscheren

Ligature scissors

Forbici per suture

Tijeras para ligaduras

Ciseaux à ligatures

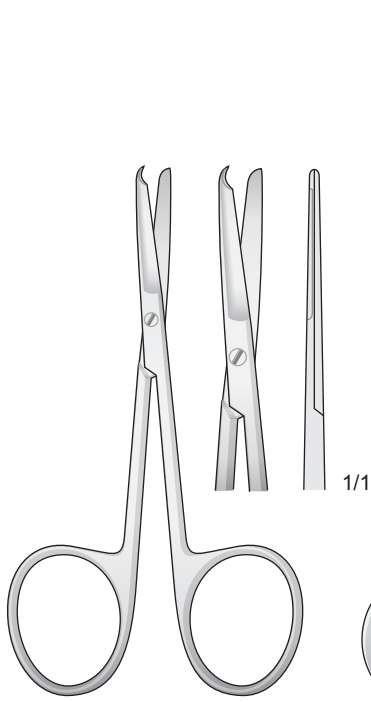

SPENCER
1803-L
90 mm

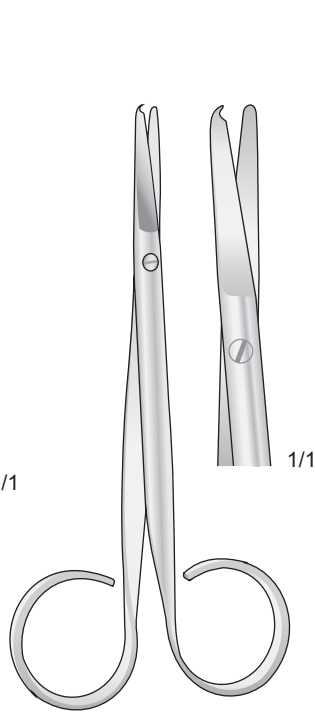

SPENCER
1803-B
110 mm

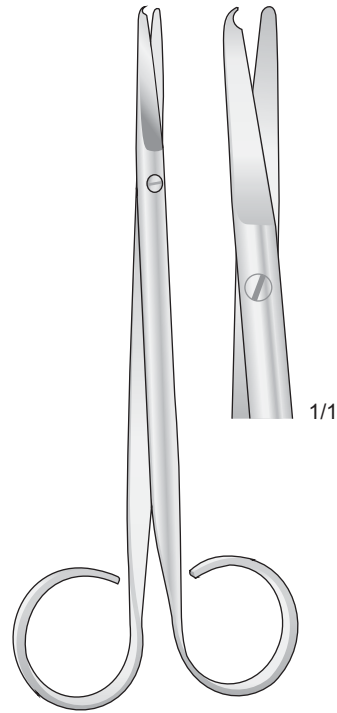

SPENCER
1803-C
145 mm

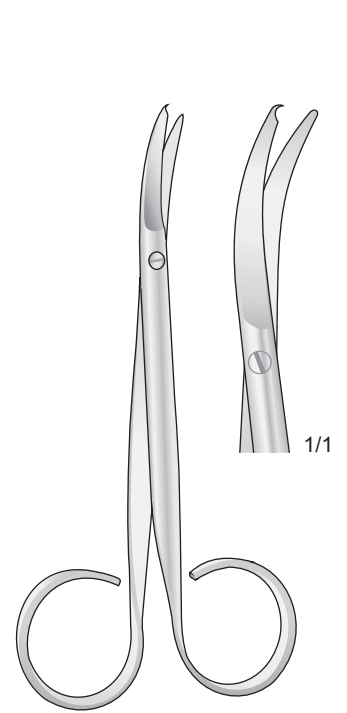

SPENCER
1803-F
110 mm

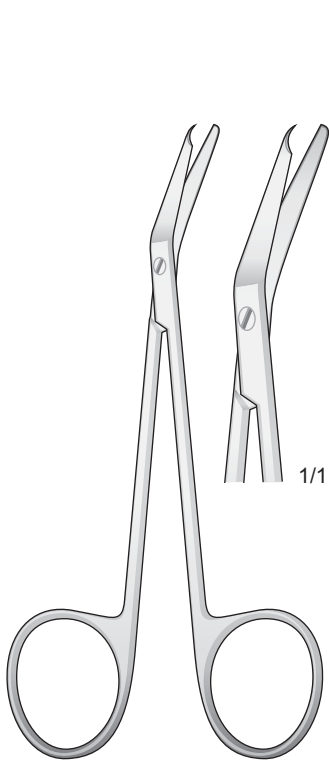

SPENCER
1803-BD
130 mm

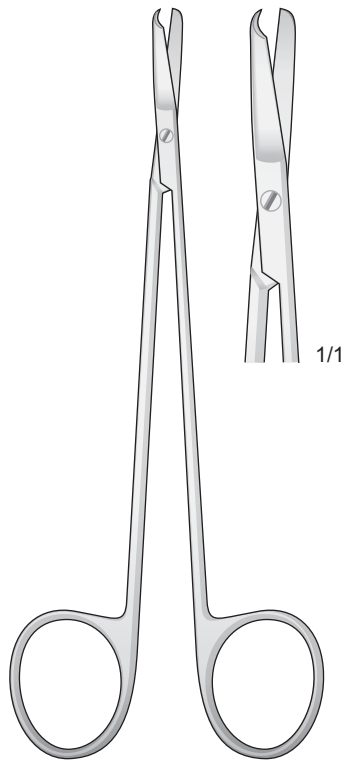

KELLY
1803-BG
150 mm



SPENCER
1803-BE
120 mm

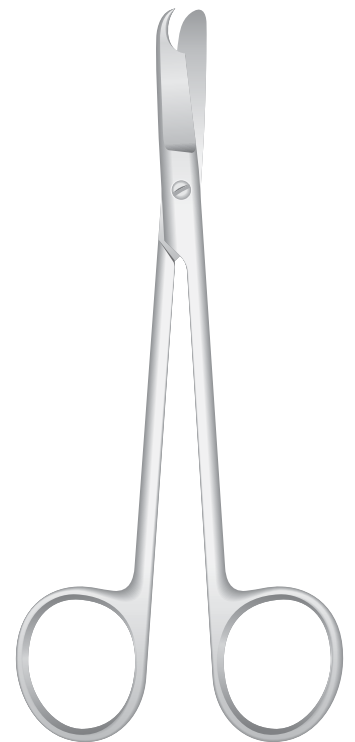

LITTAUER
1803-BF
140 mm

**Draht und
Blechscheren**

**Wire and plate
cutting scissors**

**Forbici per
fili metallici**

**Tijeras para
cortar alambre**

**Ciseaux coupe-fils
métalliques**

Draht-und Blechscherer gezahnt - Wire cutting scissor serrated
Forbice universale dentellata - Tijeras para cortar hilo de acero dentadas
Ciseaux à couper les fils métalliques

Spitz - Sharp
Acute - Agudas
Pointus

Gezahnt - Serrated
Dentellata - Dentadas
Dentelés

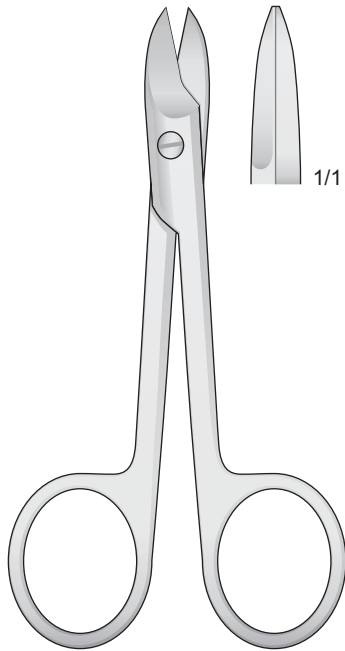

**BEEBE
0415-LB
110 mm**

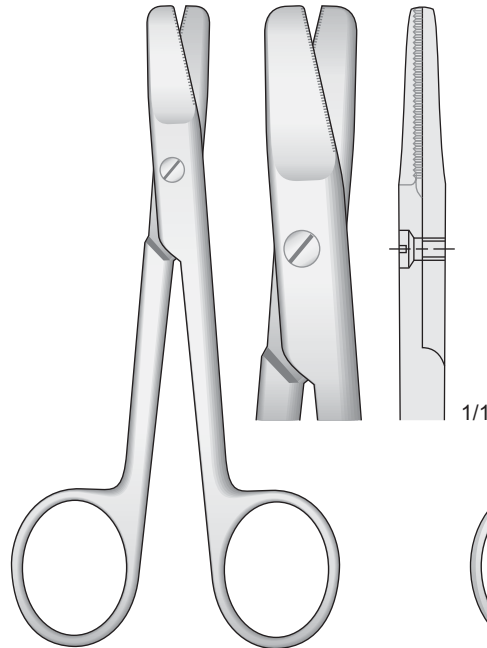

**HARVEY
0607-BGC
125 mm**

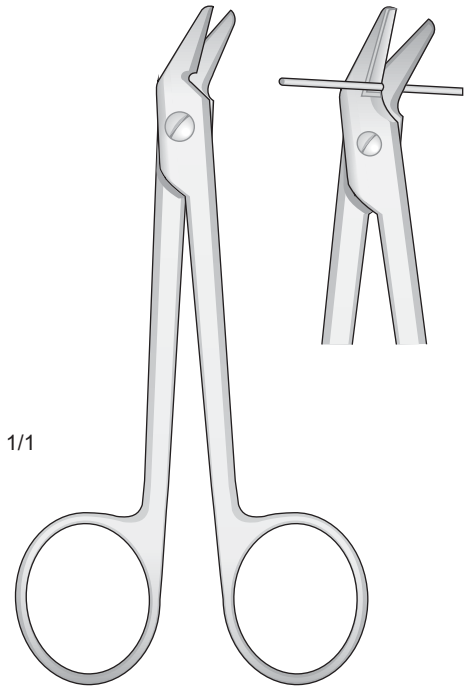

**0415-LA
120 mm**

Für harten Draht \varnothing 1 mm - For hard wire \varnothing 1 mm
Per filo duro \varnothing 1 mm - Para alambres duro \varnothing 1 mm
Pour fil dur \varnothing 1 mm

Ligaturscheren - Ligature scissors
Forbici per sutura - Tijeras para ligaduras
Ciseaux à ligatures

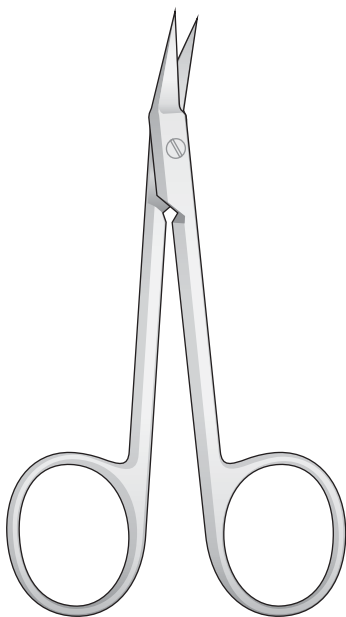

**O'BRIEN
0607-BFB
95 mm**

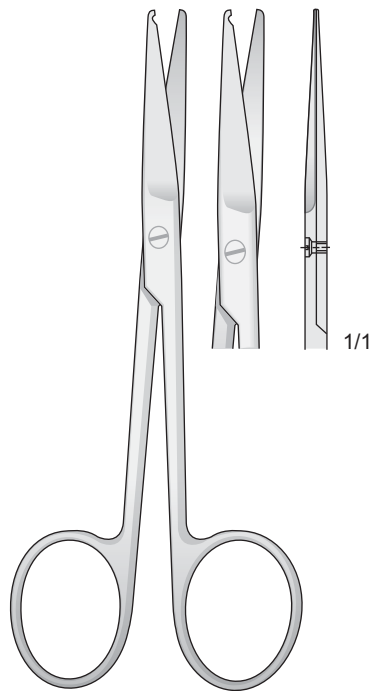

**1803-BC
115 mm**

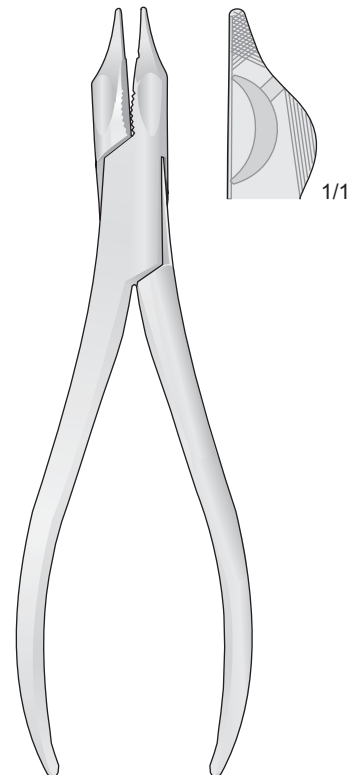

**0415-HB
150 mm**

4.3



Allgemeine HNO-Instrumentarium
General ENT Instruments
Strumentario generale per ORL
Instrumental general para ORL
Instruments généraux pour ORL

Arterienklemmen
Hemostatic Forceps
Pinze emostatiche
Pinzas hemostáticas
Pincas hémostatiques

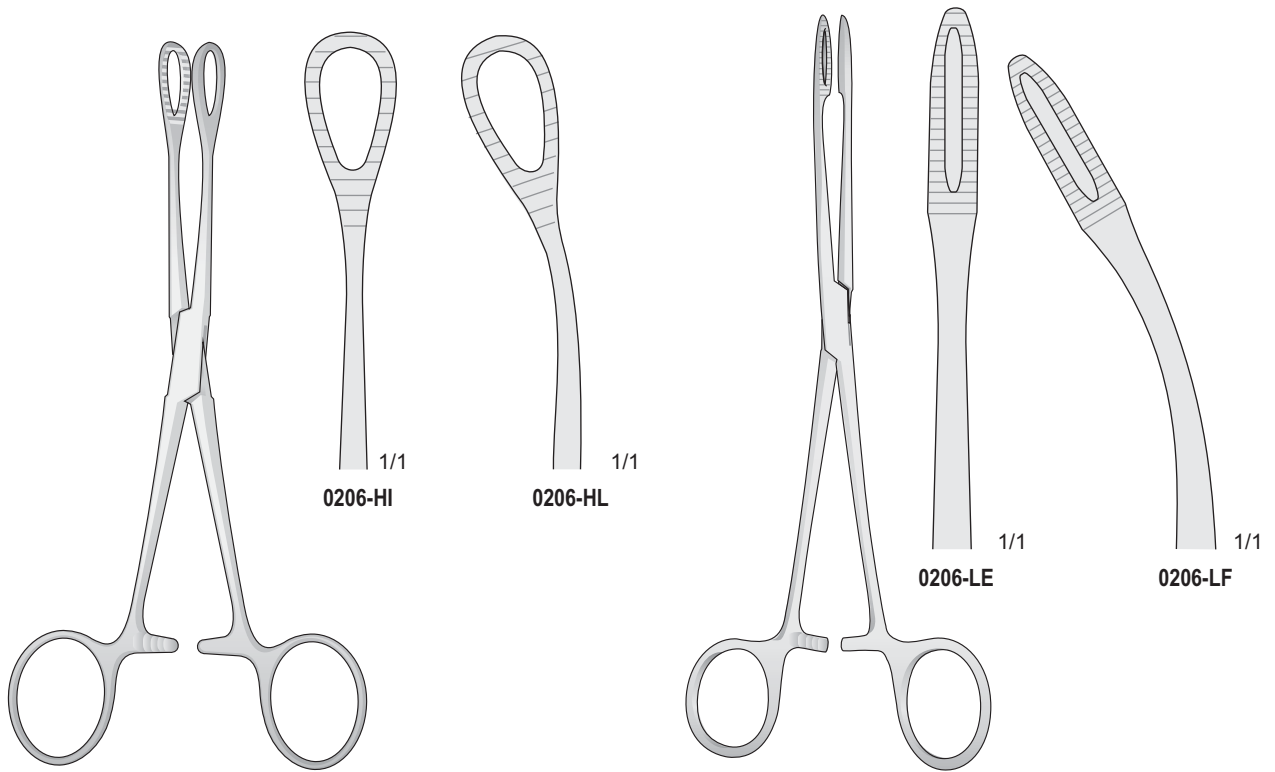

FOERSTER-BALLENGER
0206-HI/0206-HL
180 mm

GROSS
0206-LE/0206-LF
200 mm

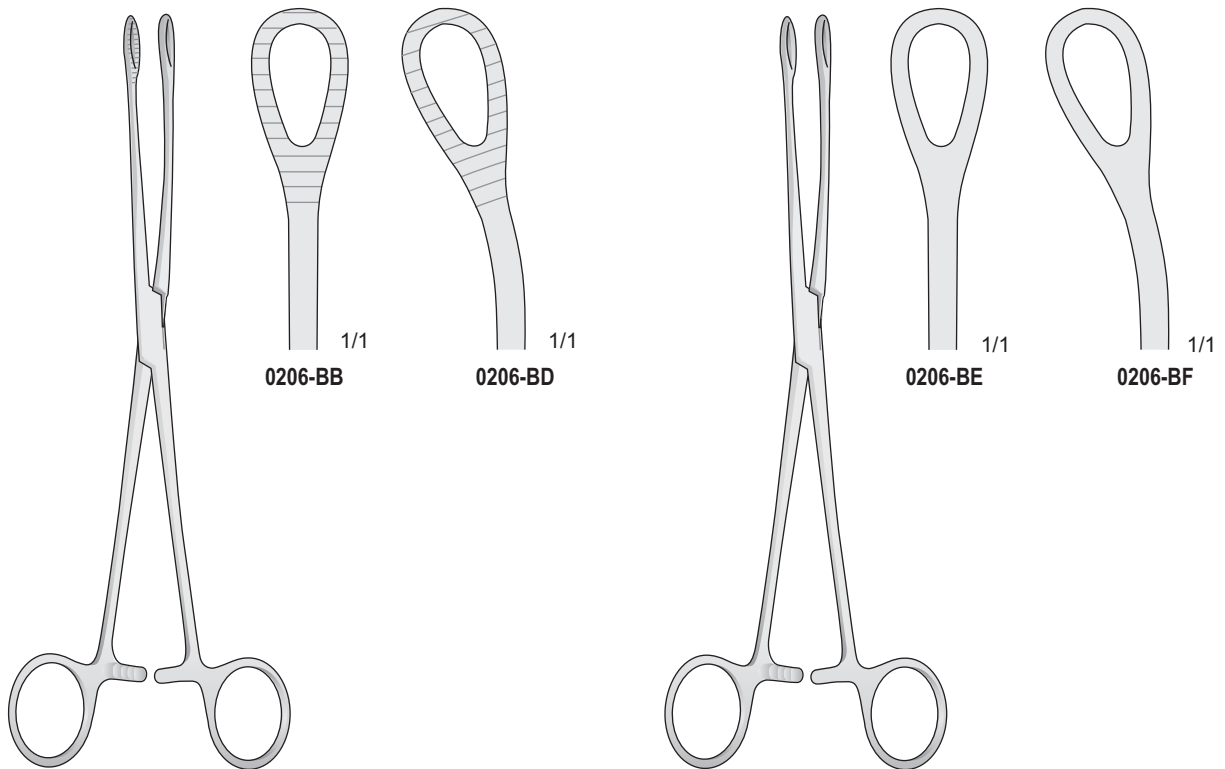

FOERSTER-BALLENGER
0206-BB/0206-BD
240 mm

FOERSTER-BALLENGER
0206-BE/0206-BF
240 mm

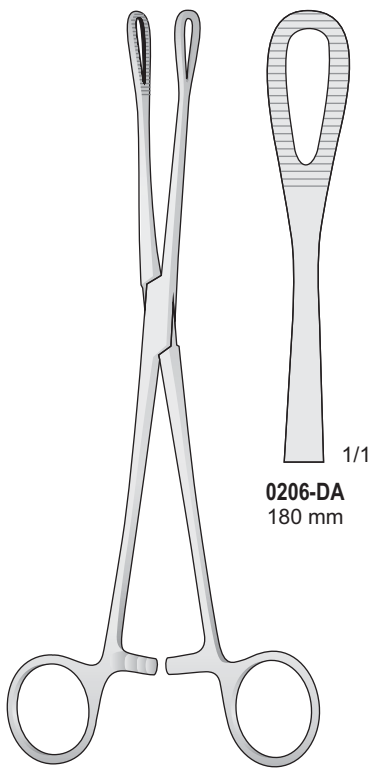

RAMPLEY
0206-DA/0206-DB

0206-DA
180 mm

0206-DB
245 mm

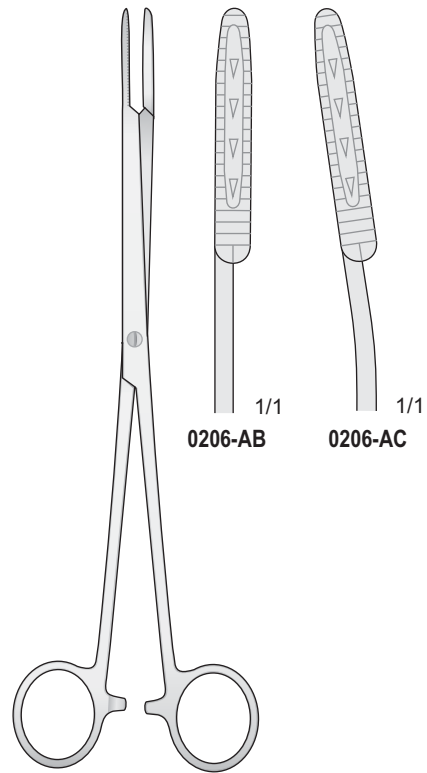

MAIER
0206-AB/0206-AC
245 mm

0206-AB

0206-AC

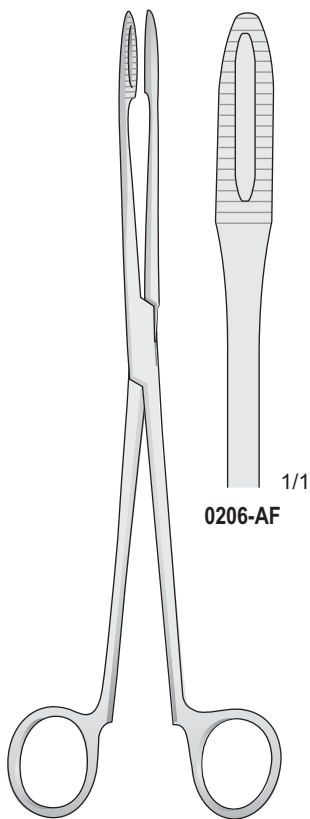

MAIER
0206-AF/0206-AG
265 mm

0206-AF

0206-AG

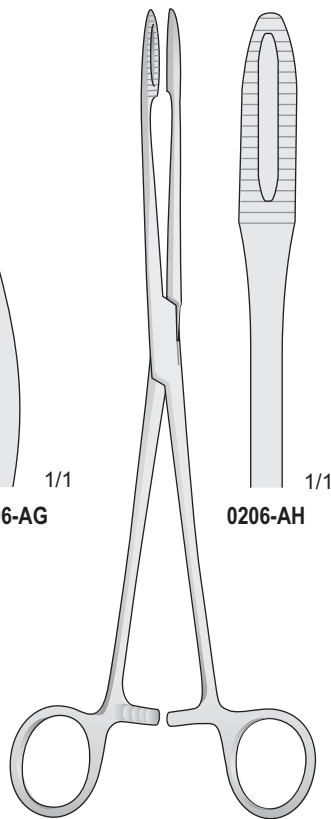

MAIER
0206-AH/0206-AI
265 mm

0206-AH

0206-AI

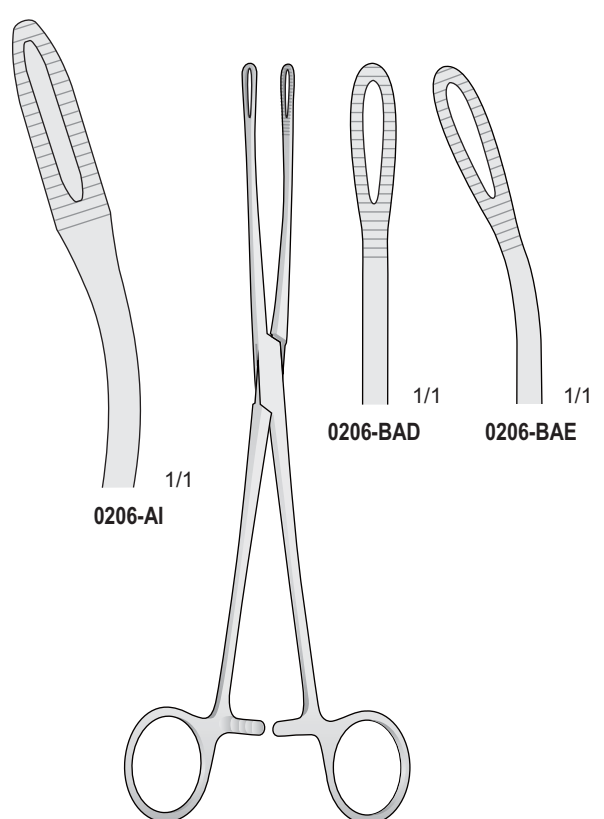

FOERSTER
0206-BAD/0206-BAE
250 mm

0206-BAD

0206-BAE

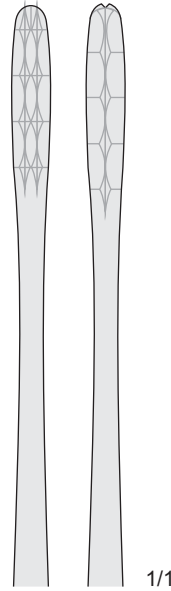
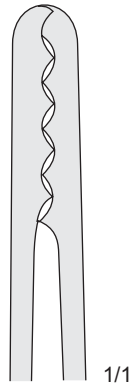

0502-CHA
220 mm

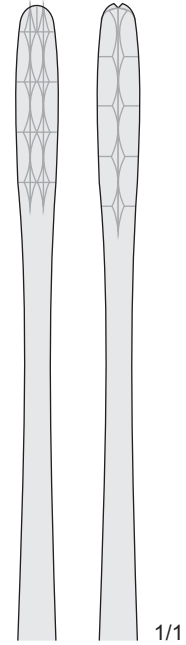

0502-CHB
250 mm

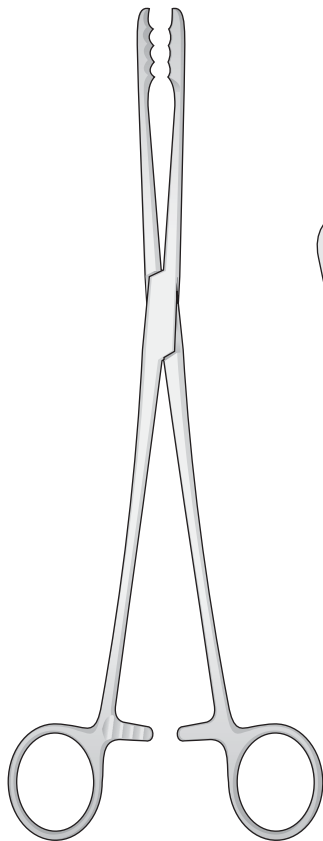

ULRICH
0502-CHA/0502-CHE

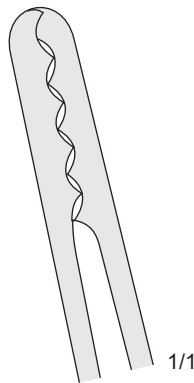

0502-CHD
220 mm

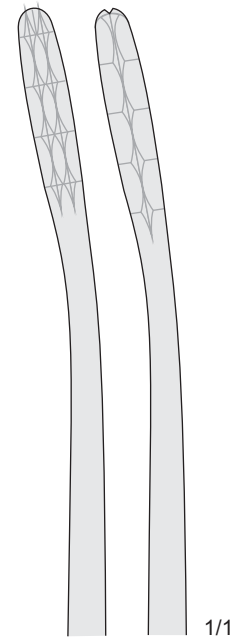

0502-CHE
250 mm

**Arterienklemmen
Tonsillen-Klemmzangen**

**Hemostatic Forceps
Tonsil Forceps**

**Pinze emostatiche
Pinze per tonsille**

**Pinzas hemostáticas
Pinzas para amígdalas**

**Pinces hémostatiques
Pincés pour amygdales**

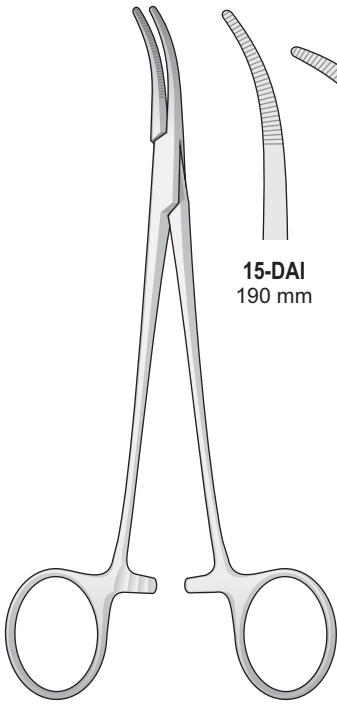

15-DAI
190 mm

15-DAL
190 mm

SCHNIDT
15-DAI/15-DAL
190 mm

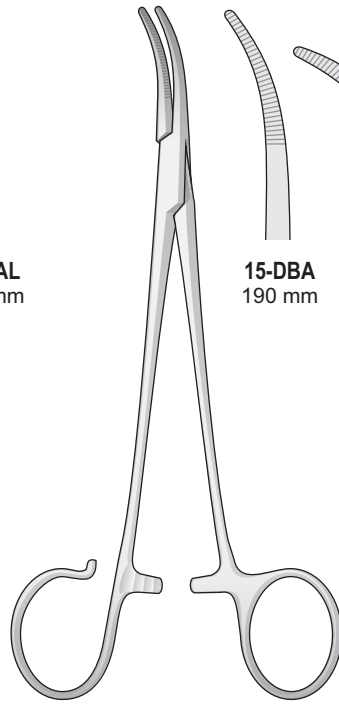

15-DBA
190 mm

15-DBB
190 mm

SCHNIDT
15-DBA/15-DBB
190 mm

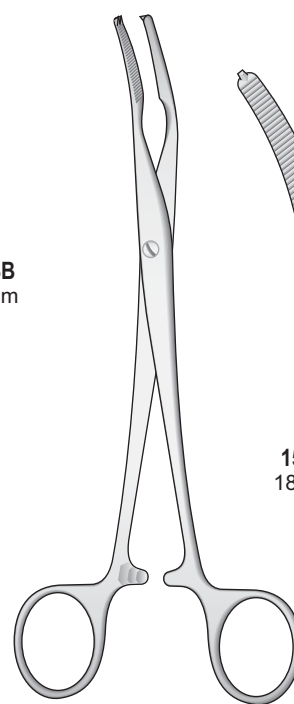

15-DBI
180 mm

15-DBL
200 mm

MIKULICZ
15-DBI/15-DBL

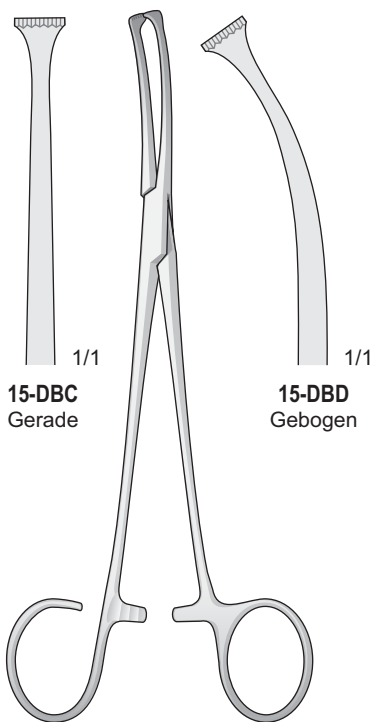

15-DBC
Gerade

15-DBD
Gebogen

COLVER
15-DBC/15-DBD
190 mm

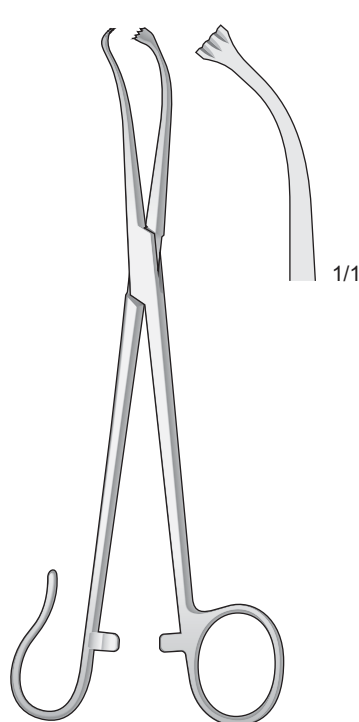

WHITE
15-DBB
180 mm

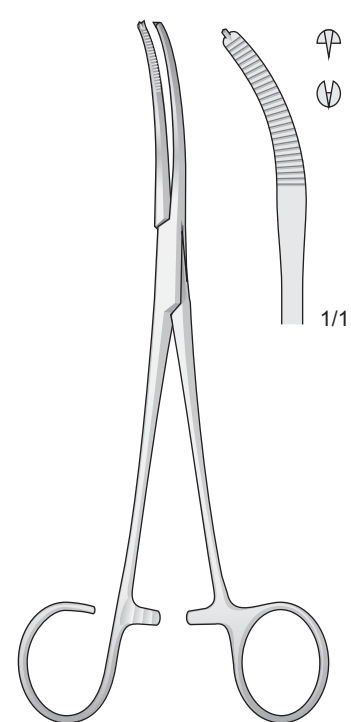

MIKULICZ
15-DCC
185 mm

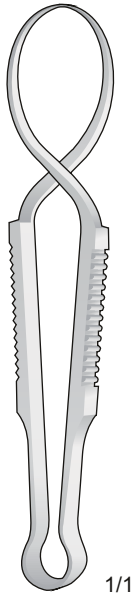

SCHAEDEL
0206-DI
85 mm

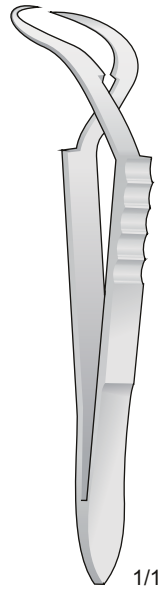

JONES
0206-EI
90 mm

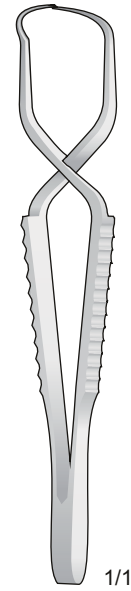

FAURE
0206-EA
85 mm

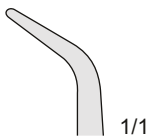

1/1

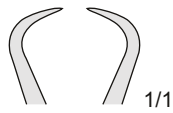

1/1

0206-EC
90 mm

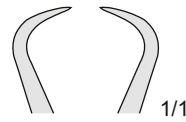

1/1

0206-EB
100 mm

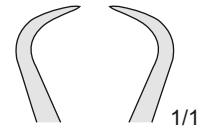

1/1

0206-EE
110 mm

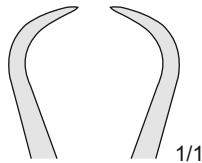

1/1

0206-EG
130 mm

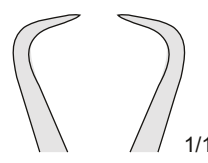

1/1

0206-ED
135 mm

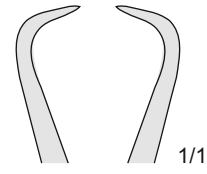

1/1

0206-EF
140 mm

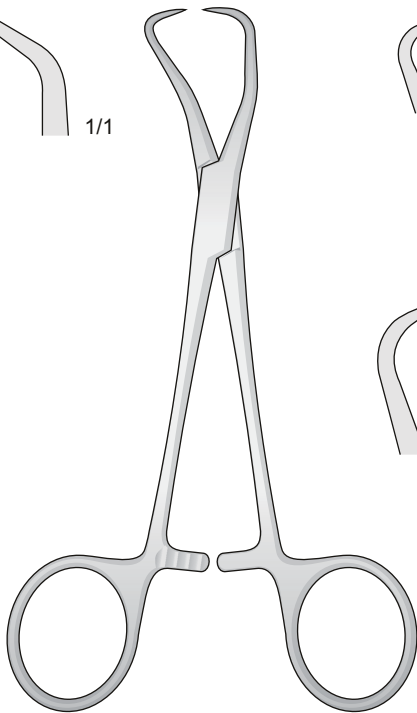

BACKHAUS
0206-EB/0206-EG

Tuchklemmen

Towel clamps

Fissateli

Pinzas de campo

Pinces pour fixer les compresses

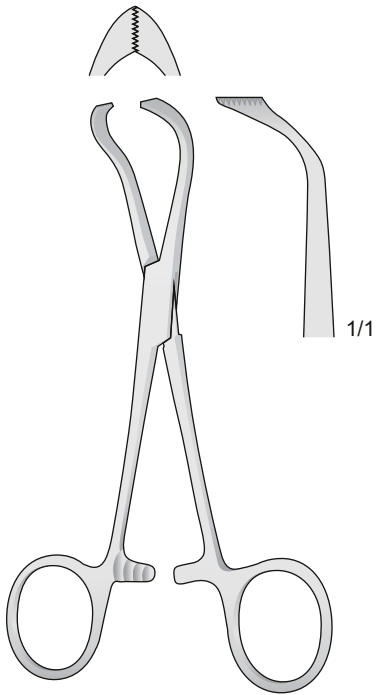

LORNA
0206-FA
100 mm

Für Papiertücher
For paper cloths
Per teli di carta
Pour Champs en papier

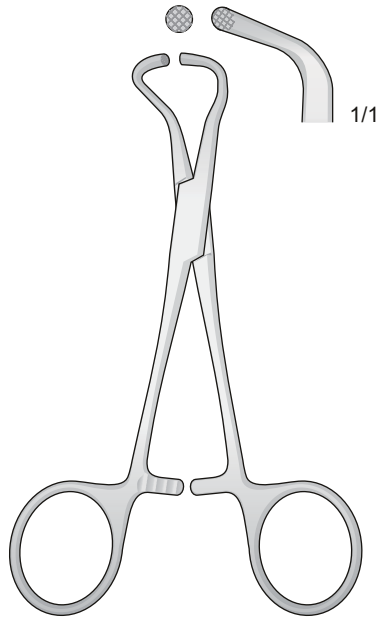

0206-HG
100 mm

Für Papiertücher
For paper cloths
Per teli di carta
Pour Champs en papier

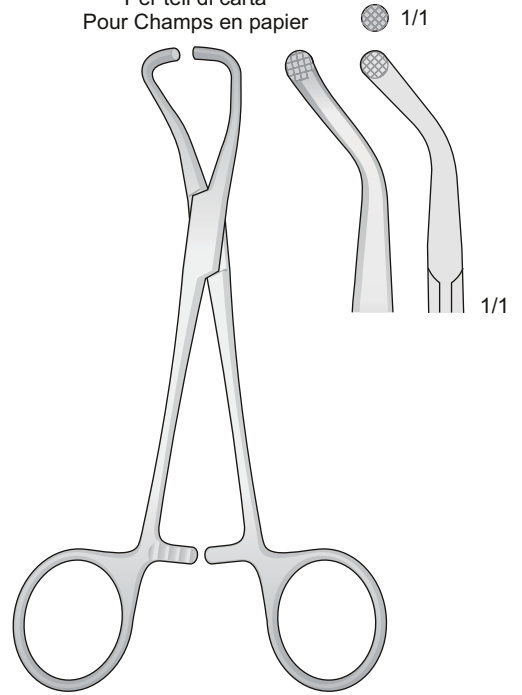

0206-FC
130 mm

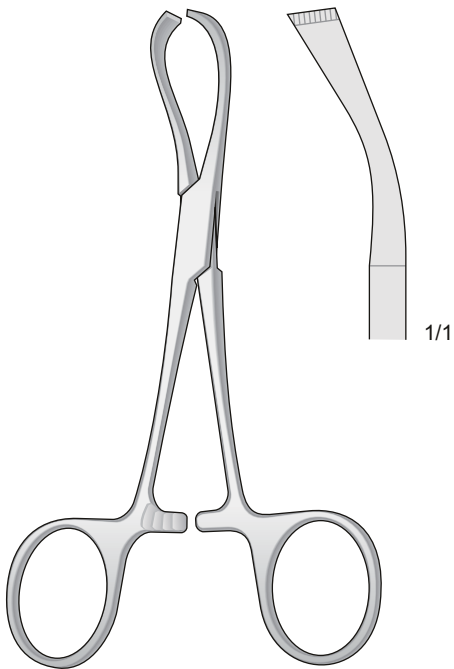

LORNA
0206-HB
130 mm

Für Papiertücher
For paper cloths
Per teli di carta
Pour Champs en papier

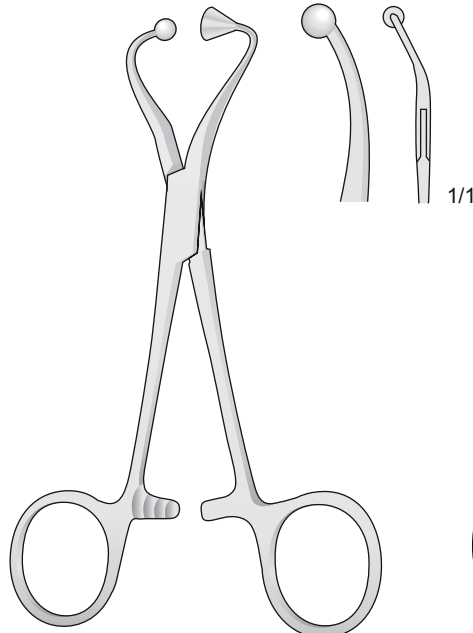

0206-HE
115 mm

Für Papiertücher
For paper cloths
Per teli di carta
Pour Champs en papier

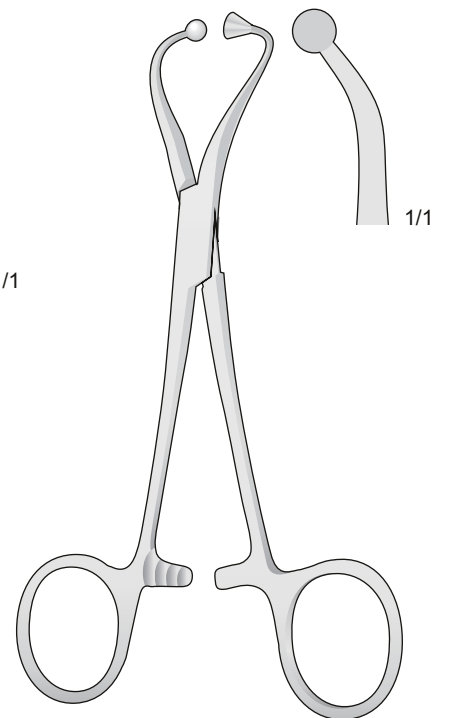

0206-HF
140 mm

Fine-Arterienklemmen

Fine
Artery forceps

Pinze emostatiche
delicate

Pinzas hemostáticas
fino

Delicate
Pincas hémostáticas

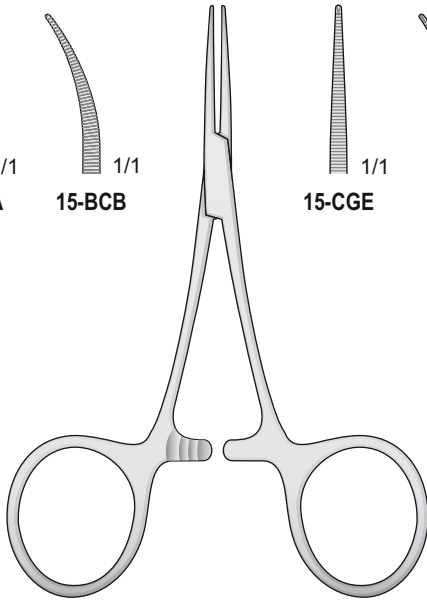
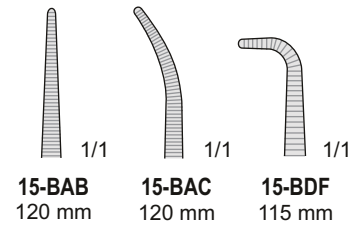
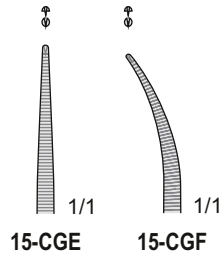
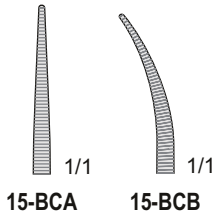

HARTMANN-BABY-MOSQUITO
15-BCA/15-CGF
95 mm

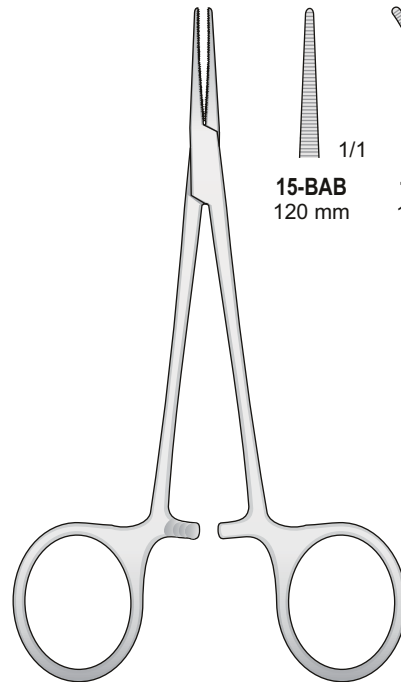

MICRO-HALSTED
15-BAB/15-BDF

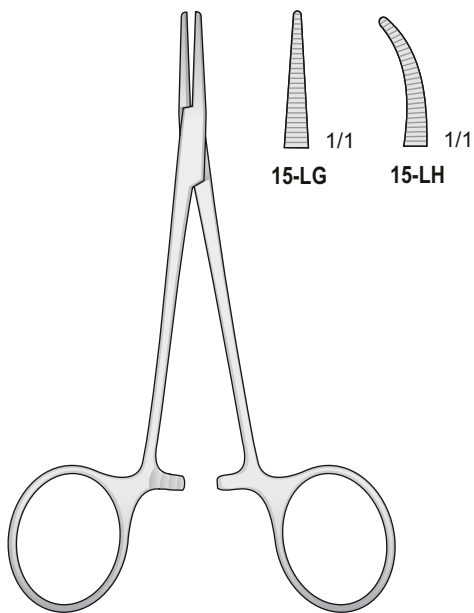

HALSTED-MOSQUITO
15-LG/15-LH
120 mm

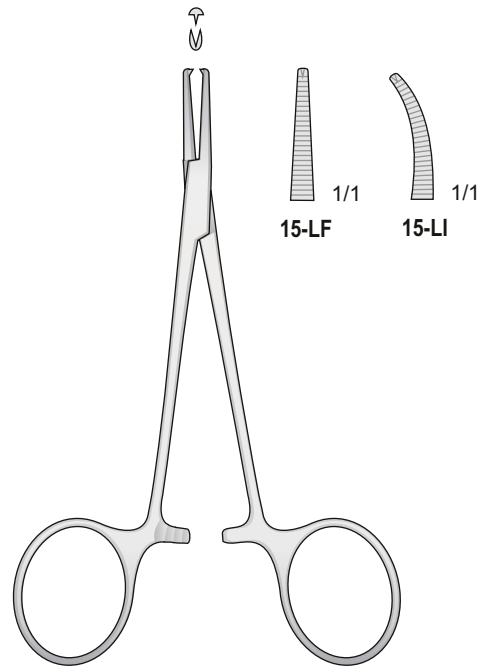

HALSTED-MOSQUITO
15-LF/15-LI
120 mm

Fine-Arterienklemmen

Fine
Artery forceps

Pinze emostatiche
delicate

Pinzas hemostáticas
fino

Delicate
Pincas hémostáticas

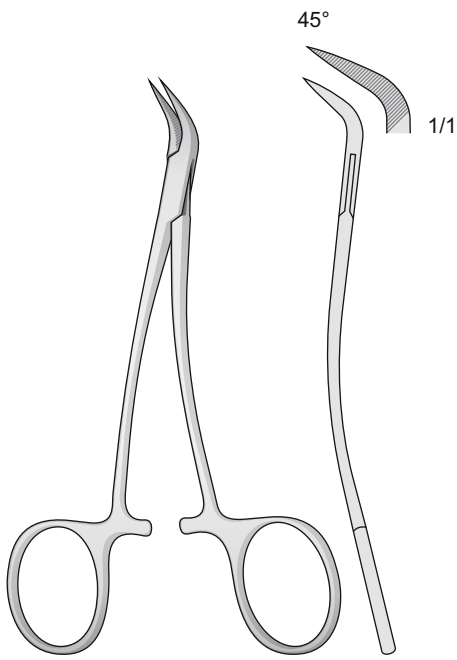

PEET
0417-EA
120 mm

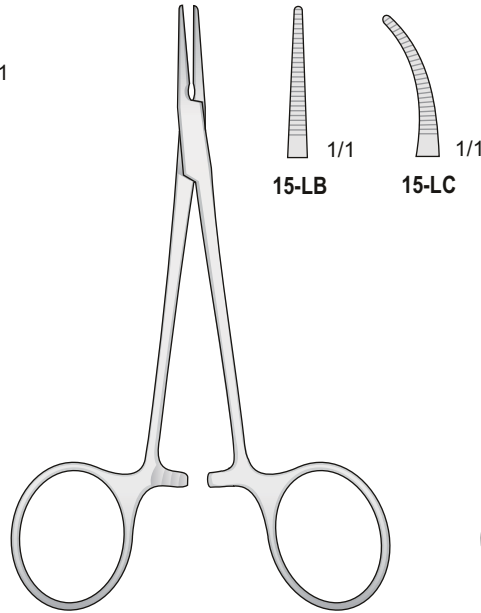

HALSTED
15-LB/15-LC
125 mm

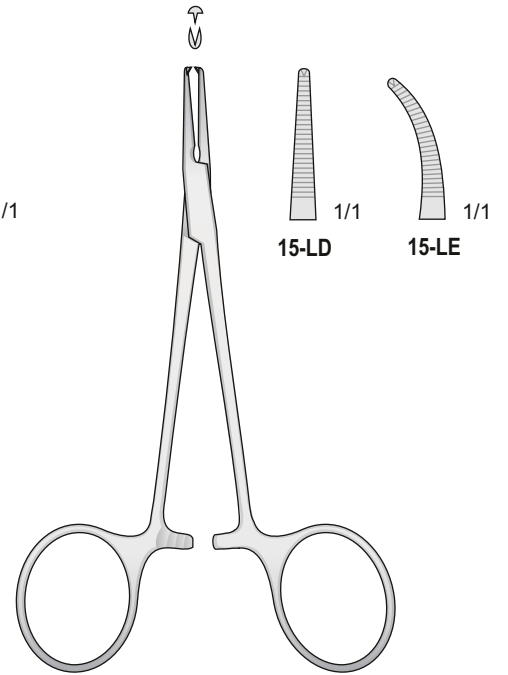

HALSTED
15-LD/15-LE
125 mm

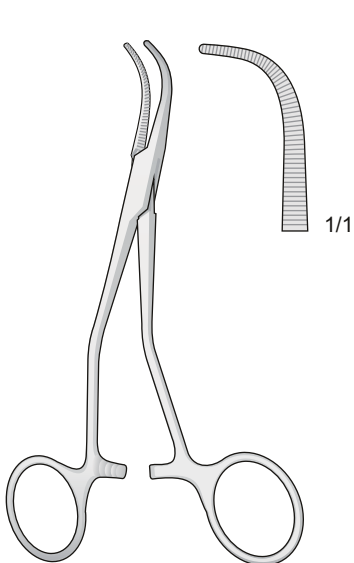

15-BF
130 mm

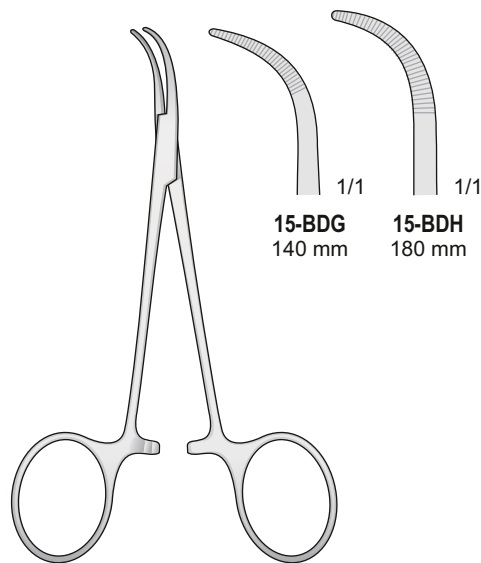

BABY-MIXTER
15-BDG/15-BDH

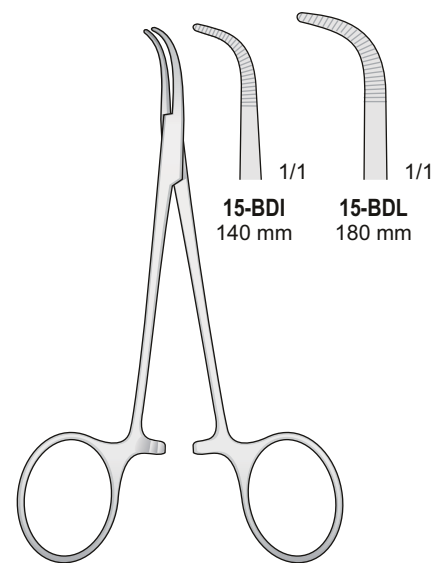

BABY-ADSON
15-BDI/15-BDL

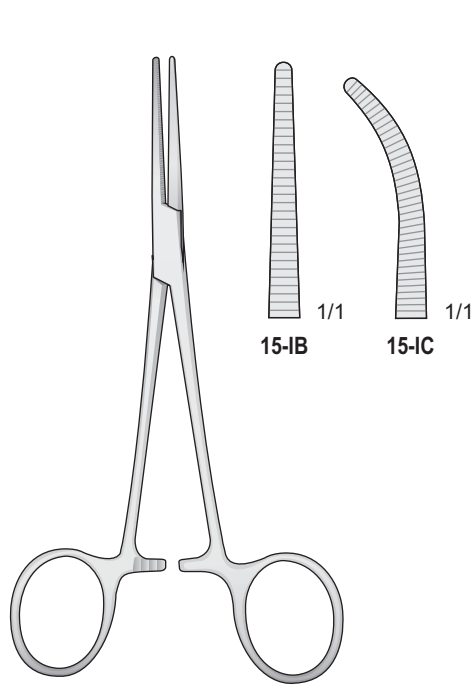

CRILE
15-IB/15-IC
140 mm

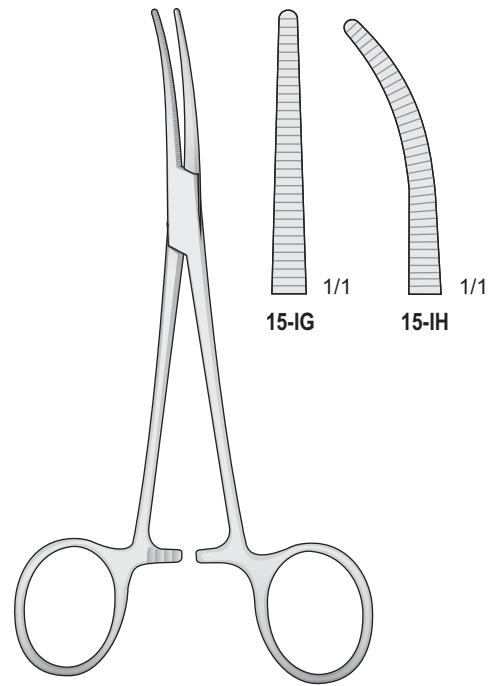

CRILE
15-IG/15-IH
160 mm

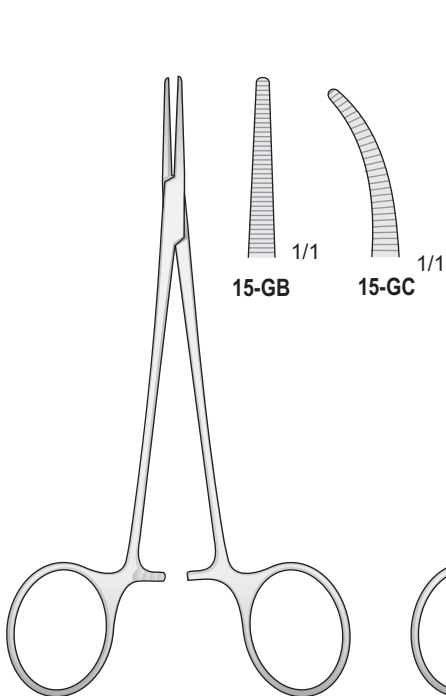

LERICHE
15-GB/15-GC
150 mm

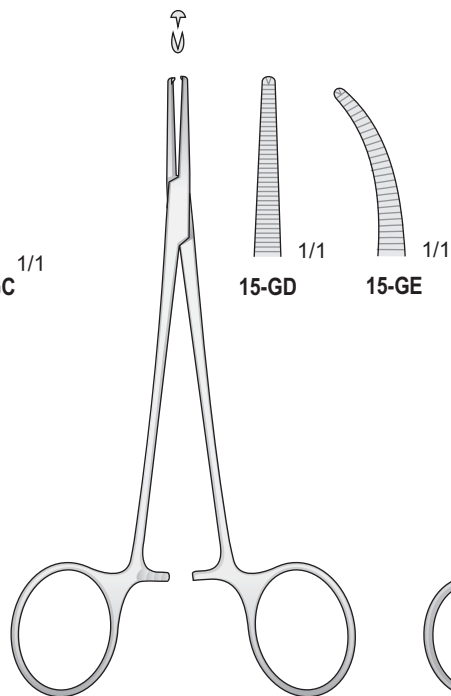

LERICHE
15-GD/15-GE
150 mm

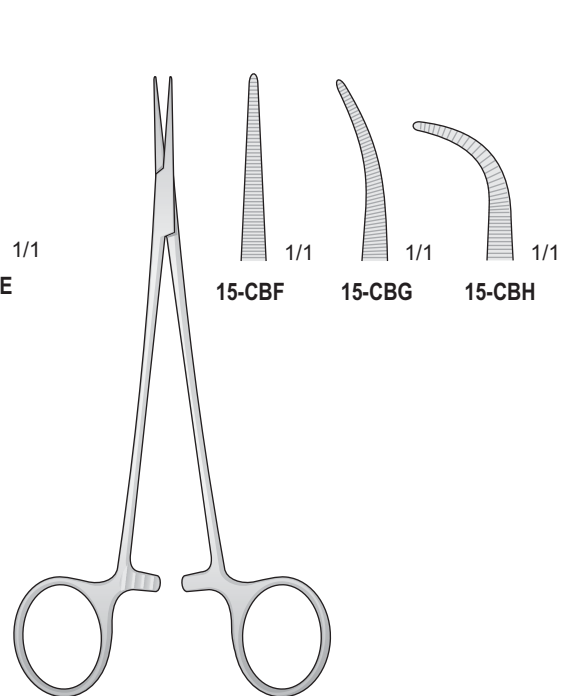

15-CBF/15-CBH
160 mm

Arterienklemmen

Hemostatic forceps

Pinze emostatiche

Pinzas hemostáticas

Pinces hémostatiques

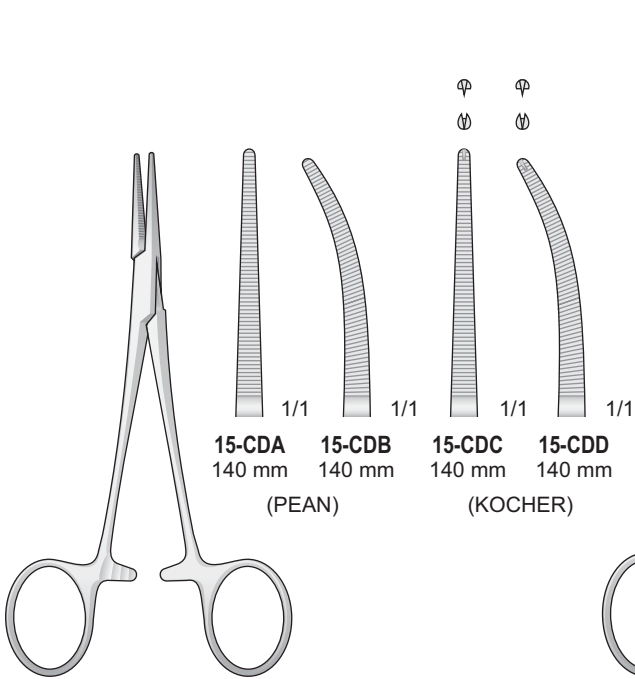

BABY-CRILE
15-CDA/15-CDD
140 mm

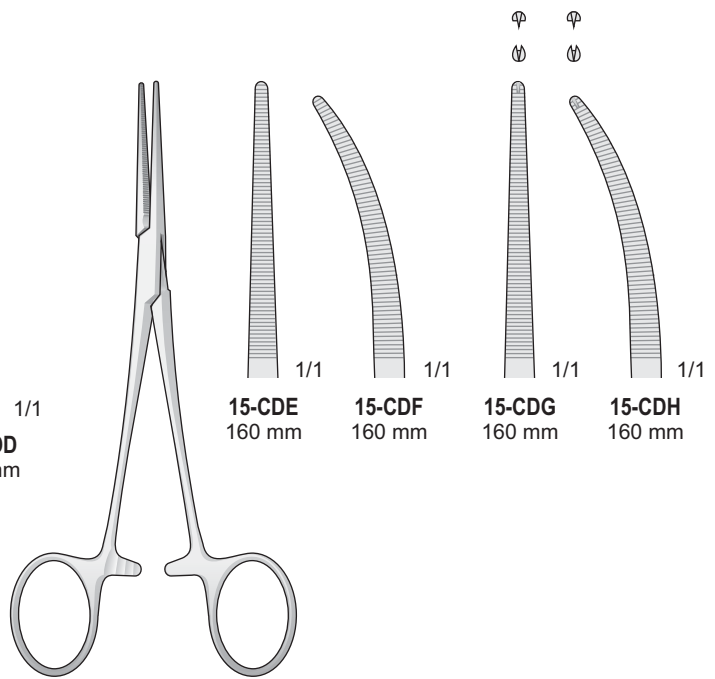

CRILE
15-CDE/15-CDH
160 mm

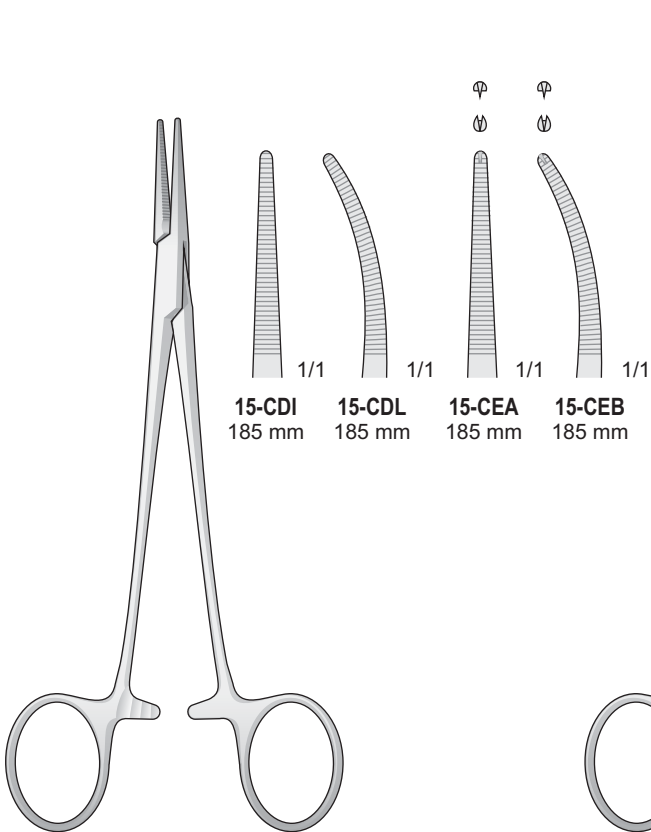

HALSTED
15-CDI/15-CEB
185 mm

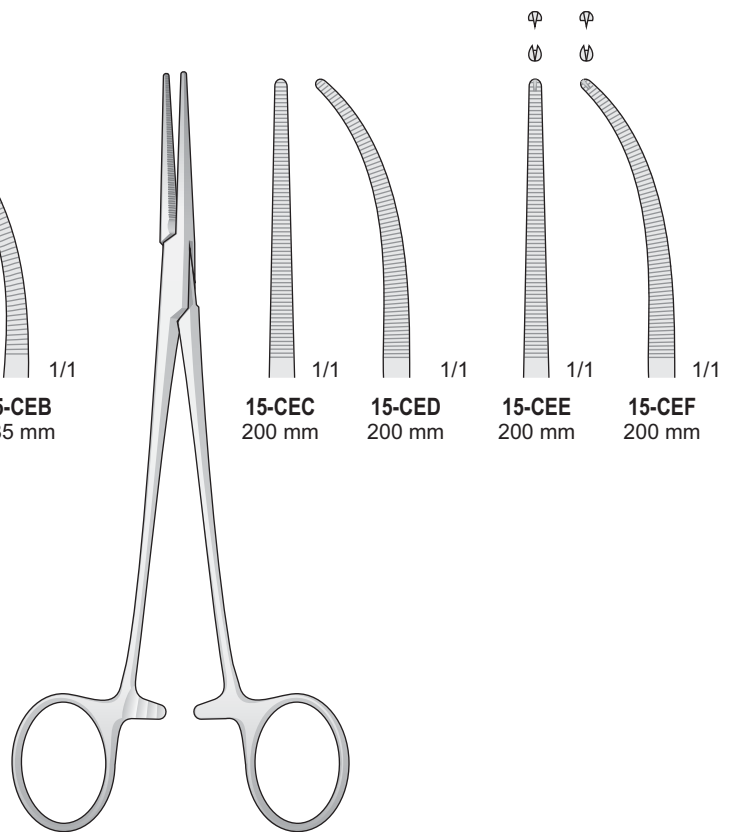

HALSTED-MOSQUITO
15-CEC/15-CEF
200 mm

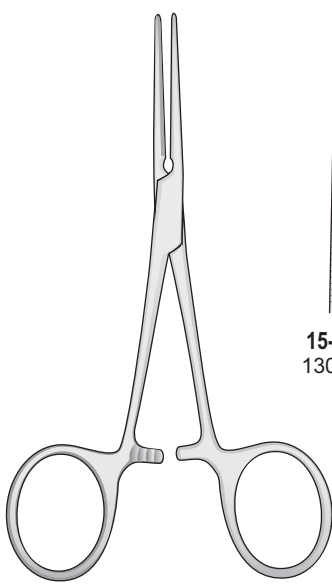

PEAN
15-CFA/15-CFF

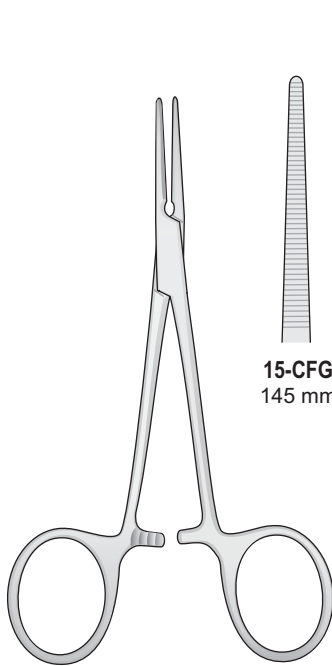
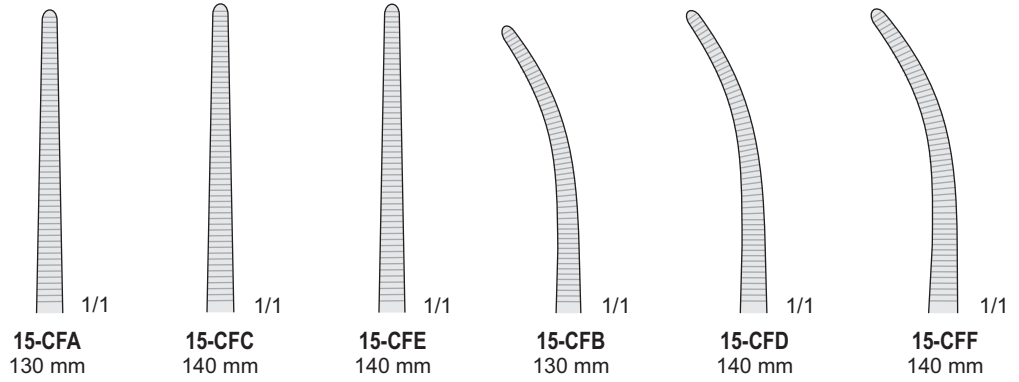

PEAN
15-CFG/15-CFL

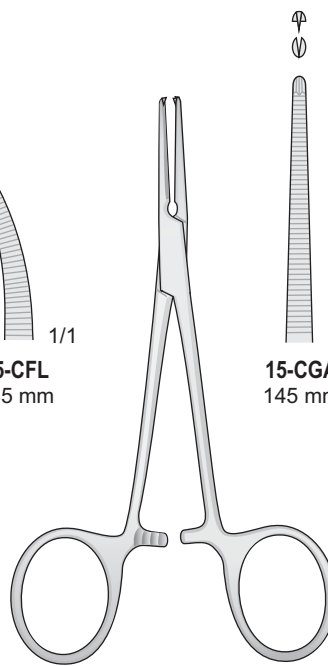
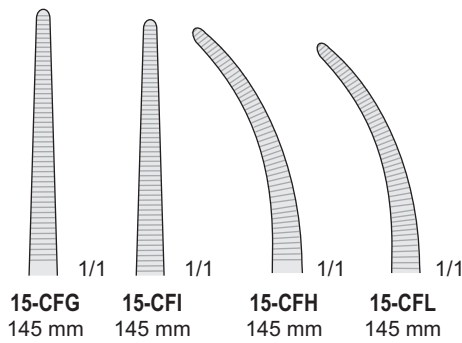

KOCHER
15-CGA/15-CGD

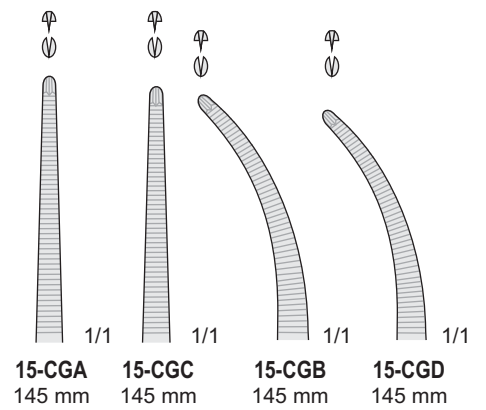

Arterienklemmen

Hemostatic forceps

Pinze emostatiche

Pinzas hemostáticas

Pinces hémostatiques

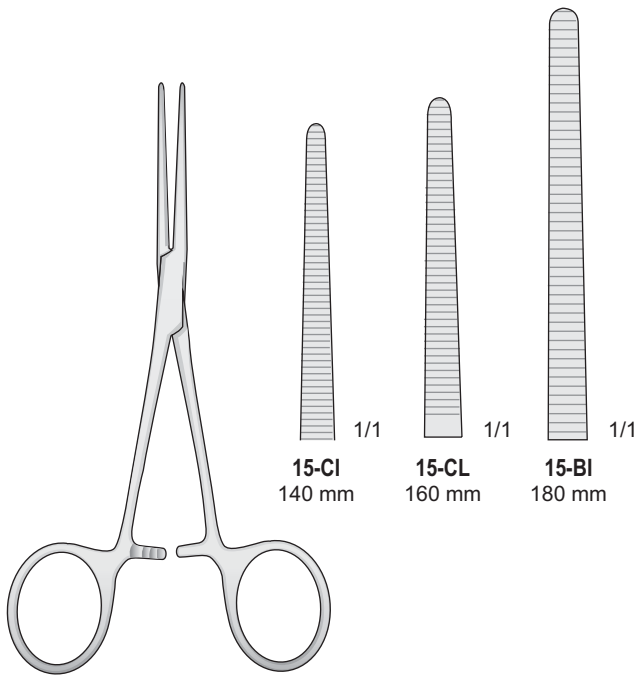

ROCHESTER-PEAN
15-BI/15-CL

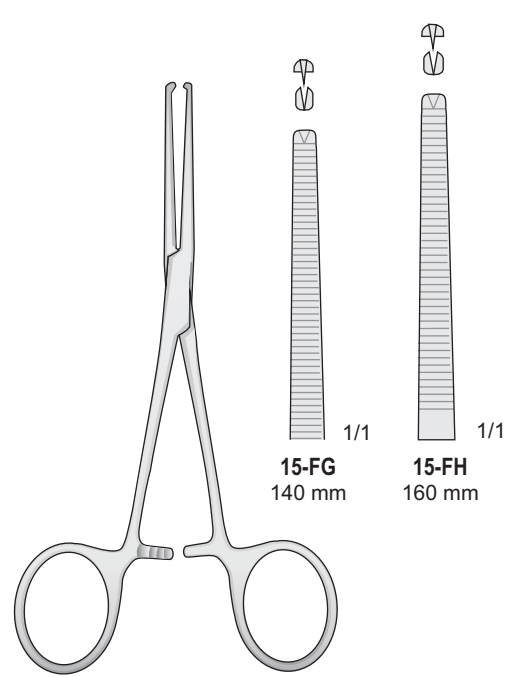

KOCHER-OCHSNER
15-FG/15-FH

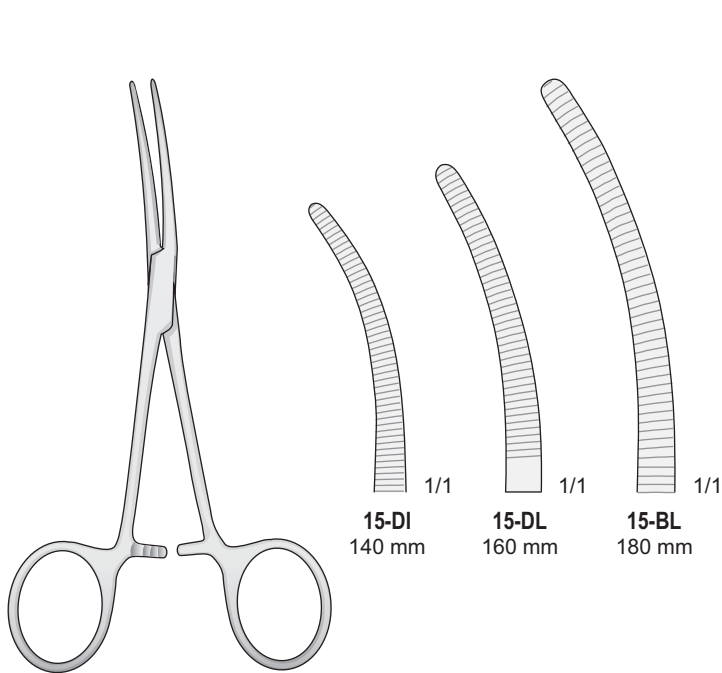

ROCHESTER-PEAN
15-BL/15-DL

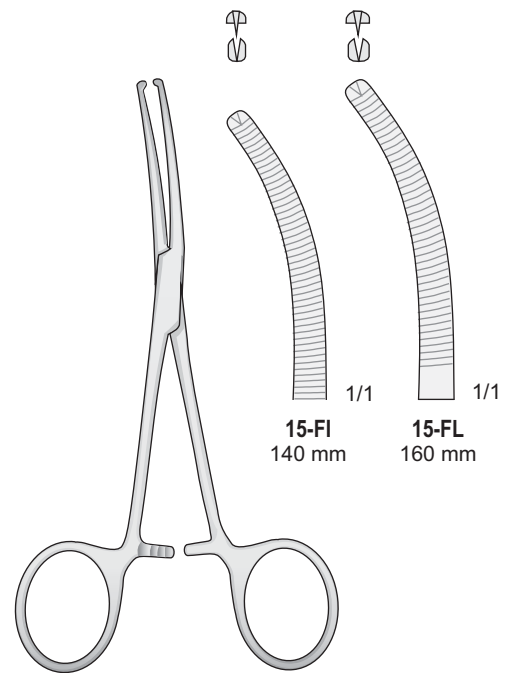

KOCHER-OCHSNER
15-FI/15-FL

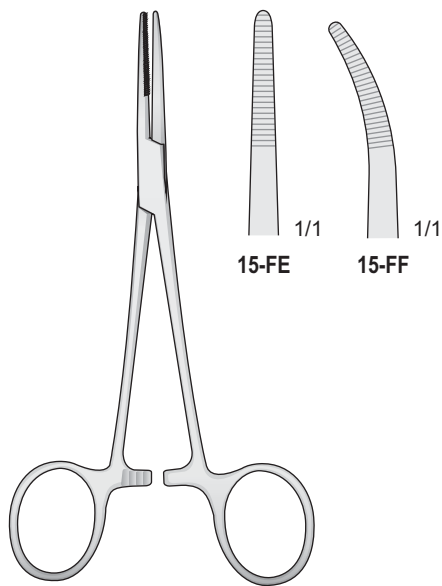

KELLY
15-FE/15-FF
140 mm

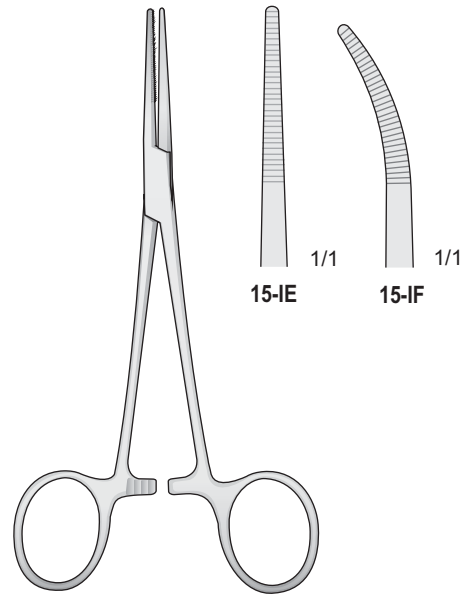

KELLY
15-IE/15-IF
140 mm

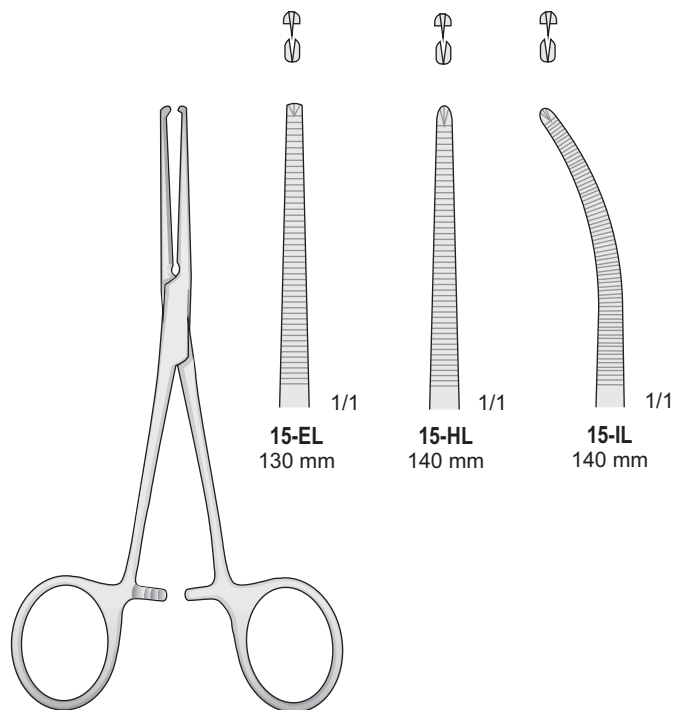

KOCHER
15-EL/15-IL

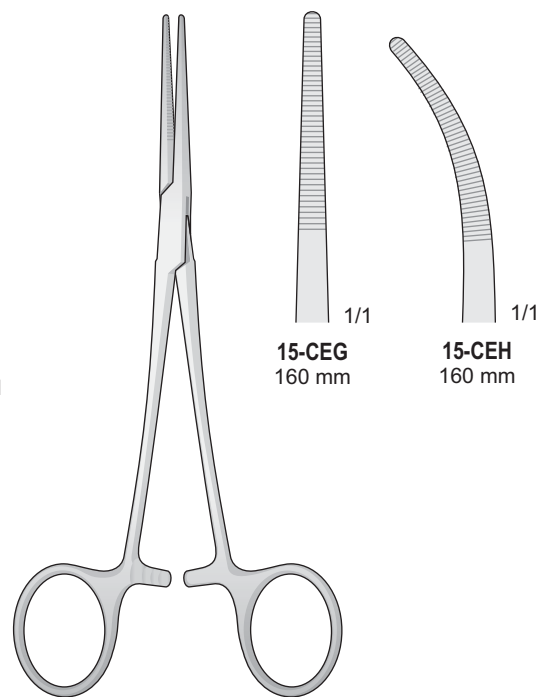

RANKIN
15-CEG/15-CEH

Arterienklemmen
Präparier und
Ligaturklemmen

Artery forceps
for preparation
and ligature

Pinze emostatiche
per preparazioni
e legature

Pinzas hemostáticas
Preparacion
y para ligaduras

Pinces hemostáticas
à disséquer
et à ligatures

Atraumatische - Atraumatic
Atraumatiche - Atraumáticas
Atraumatique

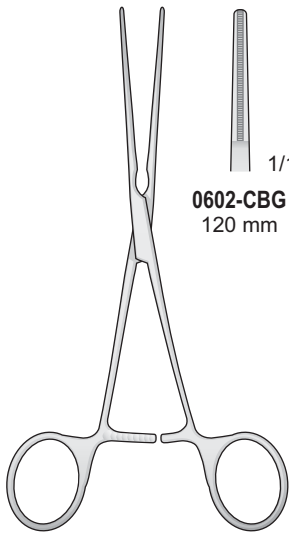

0602-CBG
120 mm

De BAKEY - MOSQUITO
0602-CBG
120 mm

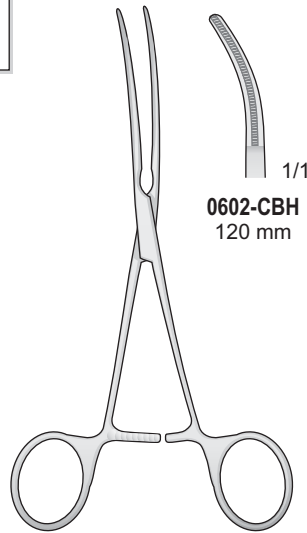

0602-CBH
120 mm

De BAKEY - MOSQUITO
0602-CBH
120 mm

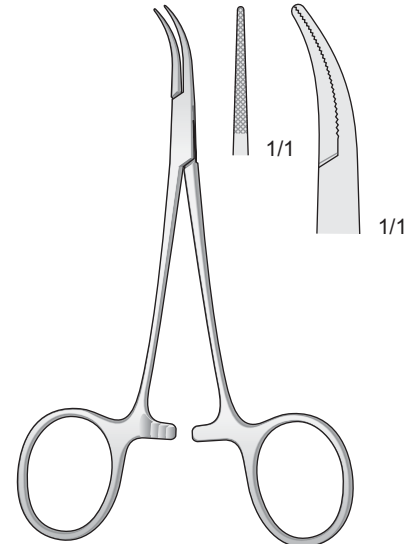

DANDY-MOSQUITO
15-DDC
120 mm

Sehr Fein
Very Fine
Molto fine

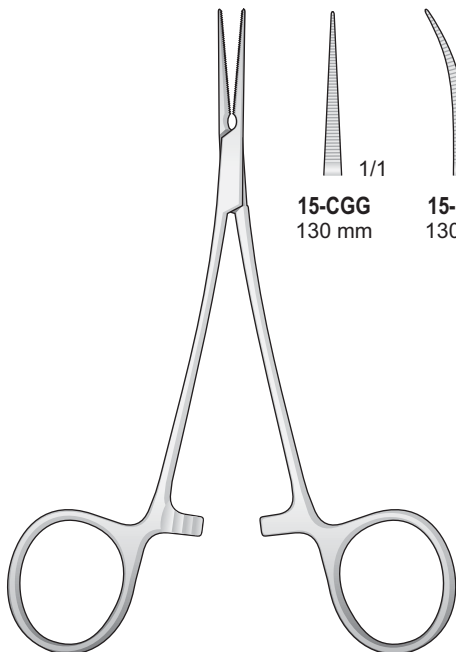

15-CGG
130 mm

15-CGH
130 mm

JACOBSON-HALSTED
15-CGG/15-CGH
130 mm

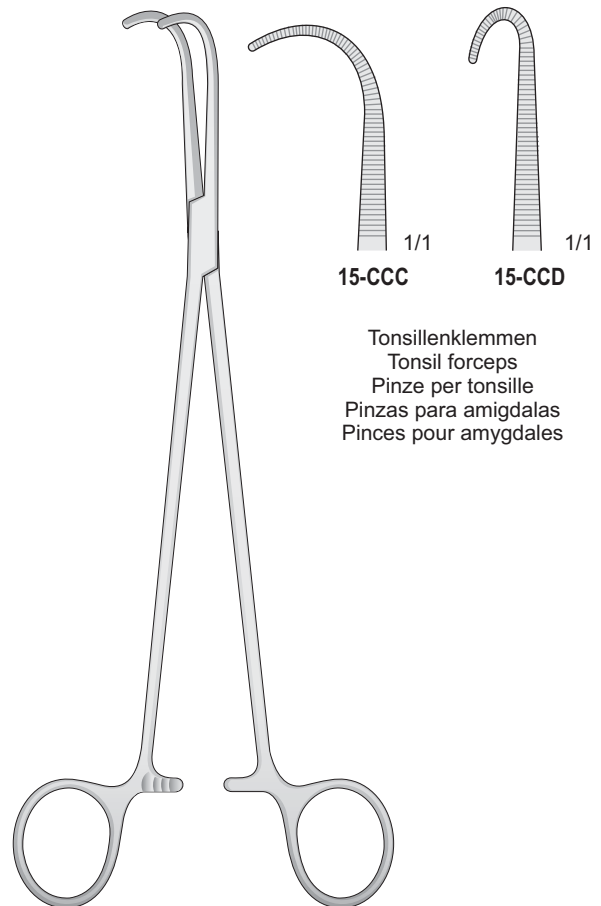

15-CCC

15-CCD

Tonsillenklemmen
Tonsil forceps
Pinze per tonsille
Pinzas para amígdalas
Pinces pour amygdales

NEGUS
15-CCC/15-CCD
190 mm

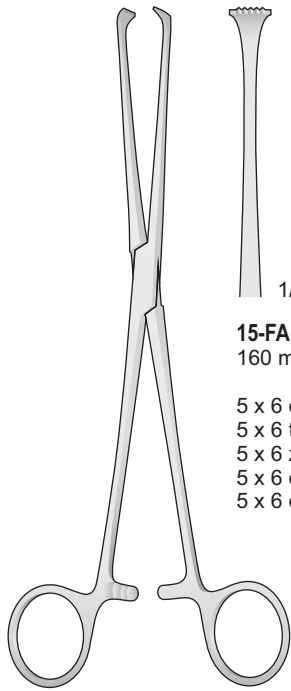

1/1

15-FA
160 mm

5 x 6 denti
5 x 6 teeth
5 x 6 zähne
5 x 6 dents
5 x 6 dientes

ALLIS
15-FA
160 mm

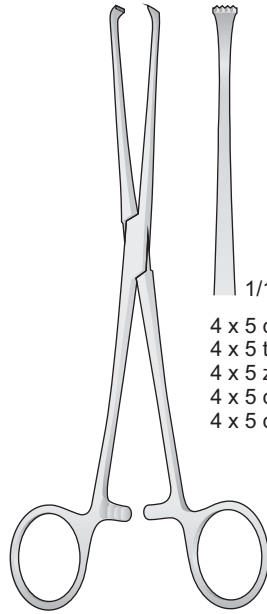

1/1

BABY-ALLIS
15-BAA
130 mm

4 x 5 denti
4 x 5 teeth
4 x 5 zähne
4 x 5 dents
4 x 5 dientes

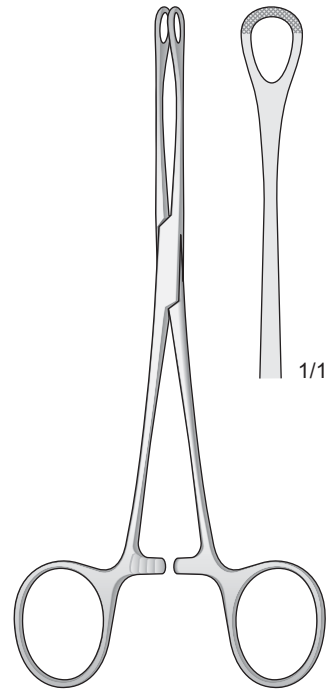

1/1

WILLIAMS
15-DCF
165 mm

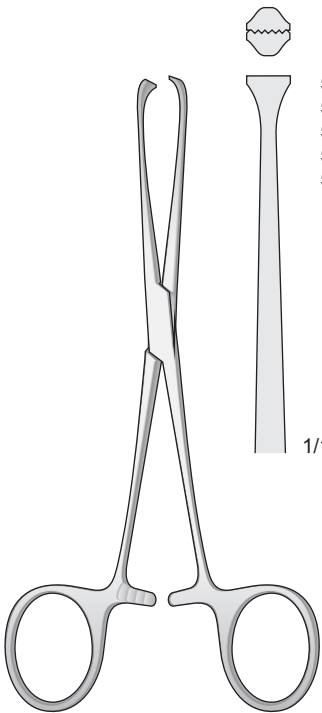

1/1

BOYS-ALLIS
15-BCL
150 mm

5x6 Zähne
5x6 Teeths
5x6 Denti
5x6 Dientes
5x6 Dents

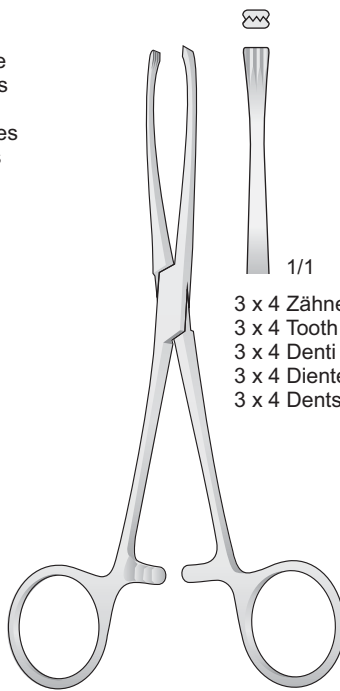

1/1

JUDD-ALLIS
15-DCE
155 mm

3 x 4 Zähne
3 x 4 Tooth
3 x 4 Denti
3 x 4 Dientes
3 x 4 Dents

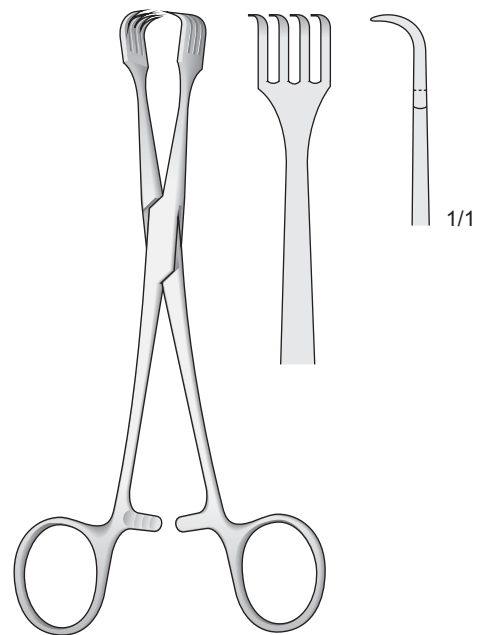

1/1

BRAUN
0206-FI
155 mm

Arterienklemmen

Hemostatic forceps

Pinze emostatiche

Pinzas hemostáticas

Pinces hémostatiques

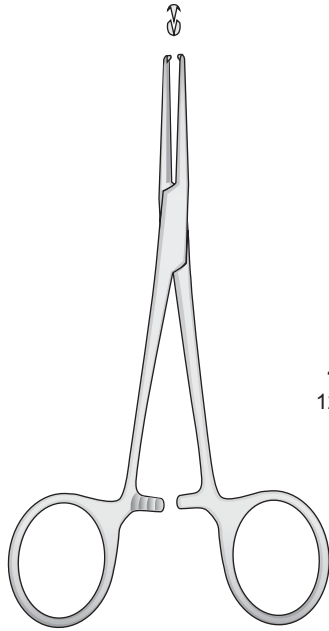

KOCHER
15-EA/15-EE

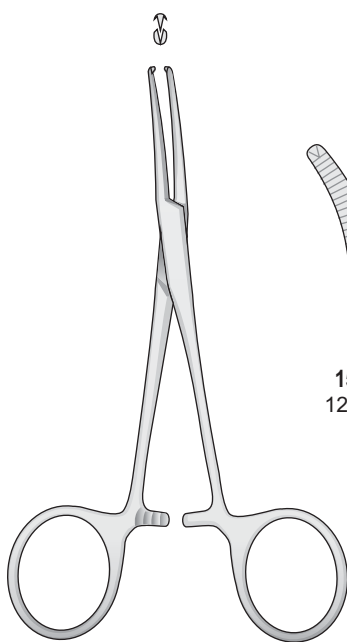
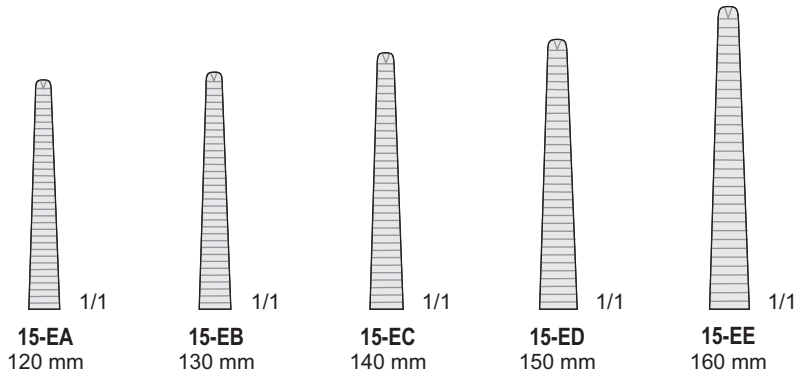

KOCHER
15-HA/15-HE

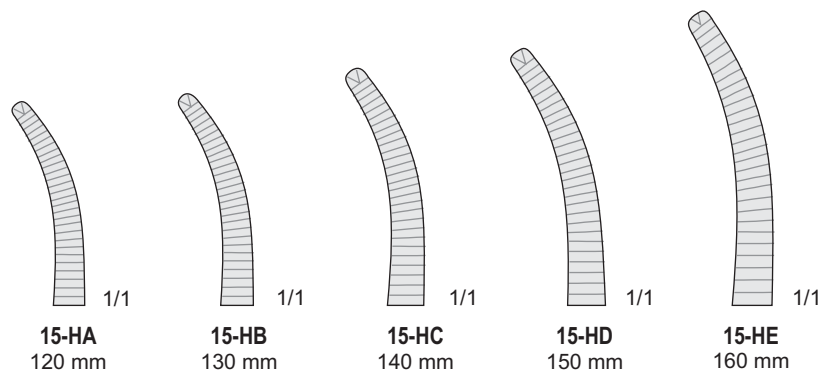

Bulldogklemmen

Bulldog clamps

Pinze Bulldog

Pinzas Bulldog

Pinces Bulldog

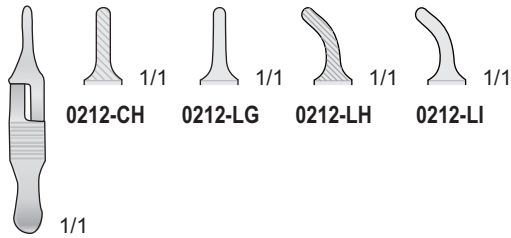

DIEFFENBACH
0212-CH/0212-LI
30 mm

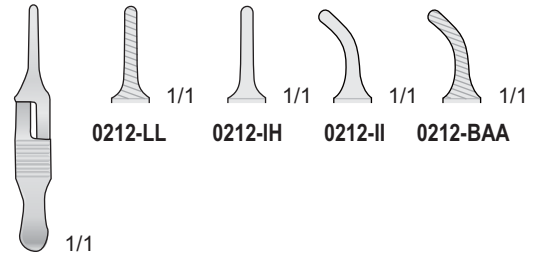

DIEFFENBACH
0212-IH/0212-BAA
30 mm

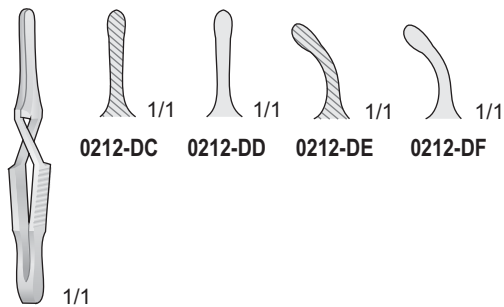

DIFFENBACH
0212-DC/0212-DF
40 mm

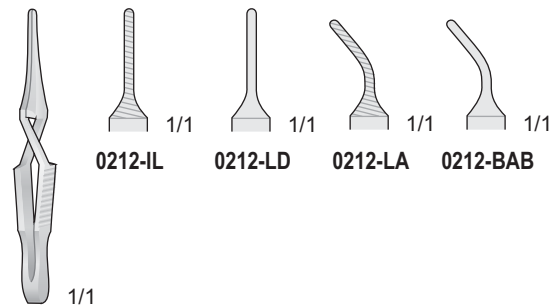

0212-IL/0212-BAB
40 mm

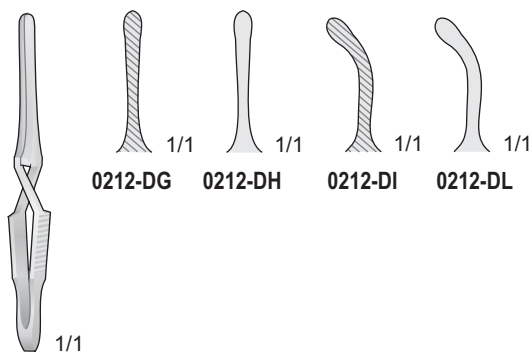

DIFFENBACH
0212-DG/0212-DL
45 mm

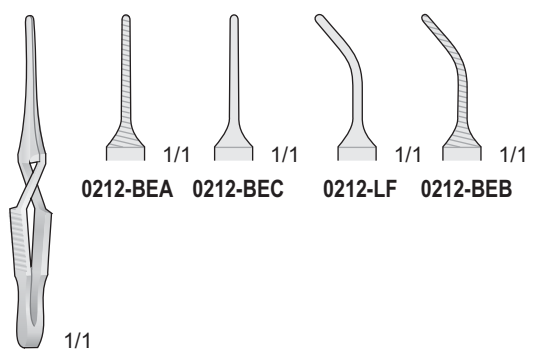

0212-LF/0212-BEC
45 mm

**Atrauma
Bulldogklemmen**

**Atrauma
Bulldog clamps**

**Pinze
Atrauma Bulldog**

**Pinzas
Atrauma Bulldog**

**Clamps
Bulldog Atrauma**

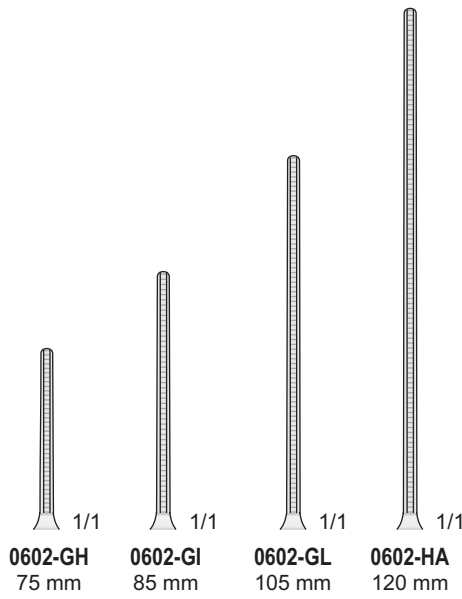

Pinza per applicare e rimuovere Bulldog clamps
Zange zum Anziehen der Bulldogklemmen
Forceps for applying and removing Bulldog clamps
Pinces pour applicateur clamps Bulldog
Pinzas de aplicación para pinzas Bulldog

0602-GH/0602-HA

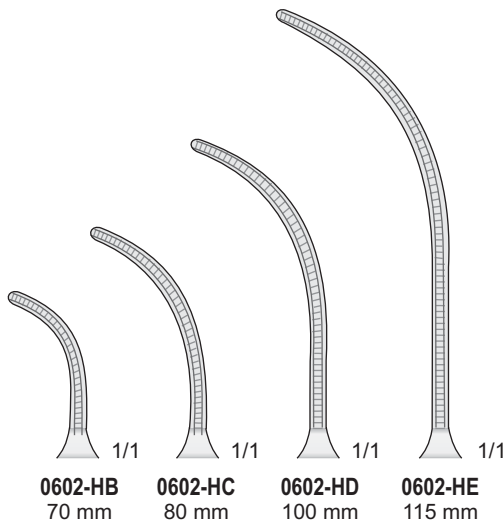

0602-HB/0602-HE

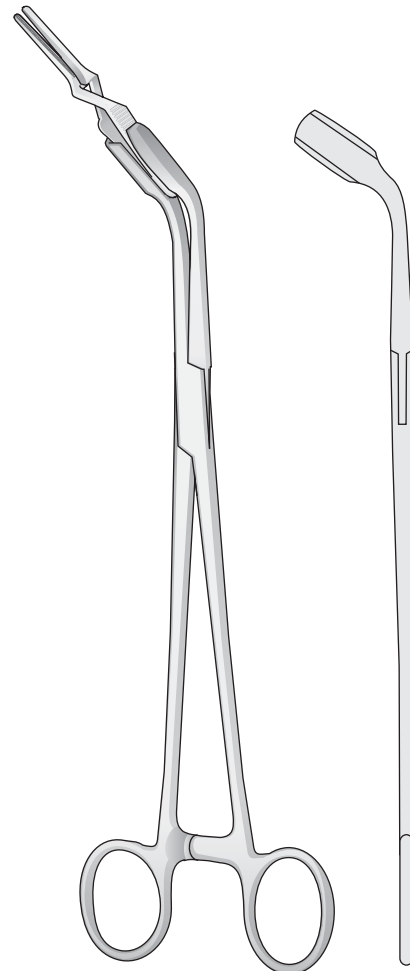

0602-HF
230 mm

4.4



Allgemeine HNO-Instrumentarium
General ENT Instruments
Strumentario generale per ORL
Instrumental general para ORL
Instruments généraux pour ORL

Pinzetten
Tissue Forceps
Pinzette
Pinzas
Pincas

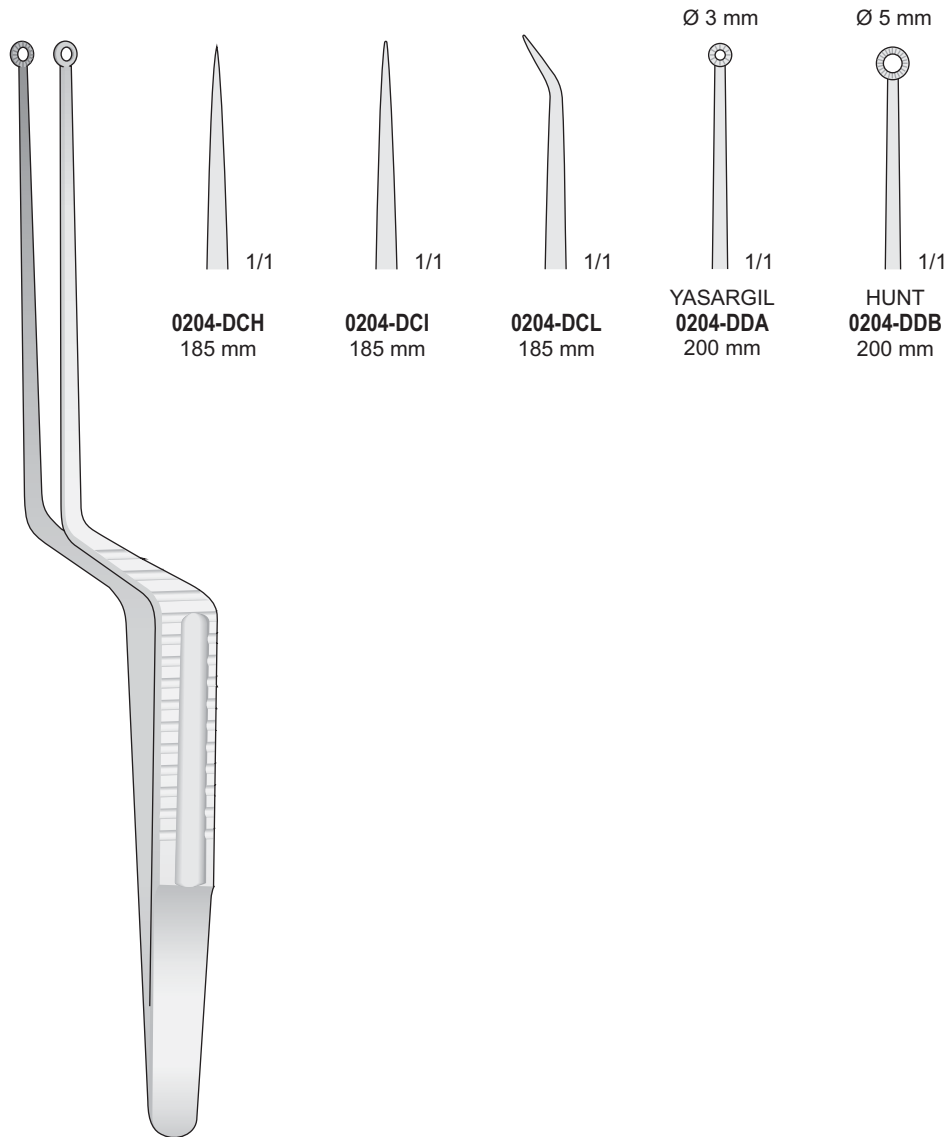

0204-DCH/0204-DDB

Tumorfasspinzetten
Tumor Grasping Forceps
Pinzette per tessuto tumorale

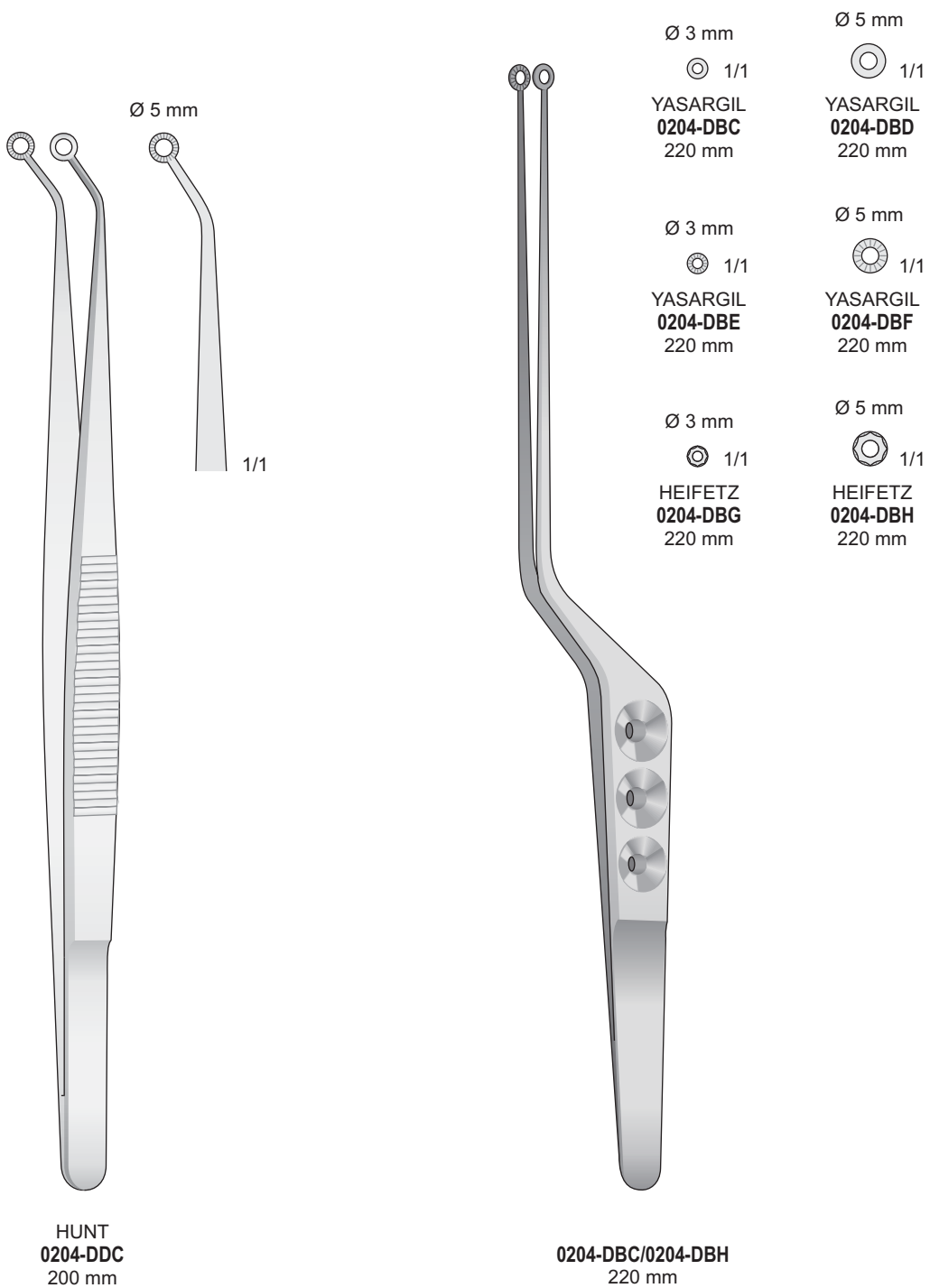

Mikro Pinzetten

Micro forceps

Micro pinzette

Pinzas finos

Micro pinces

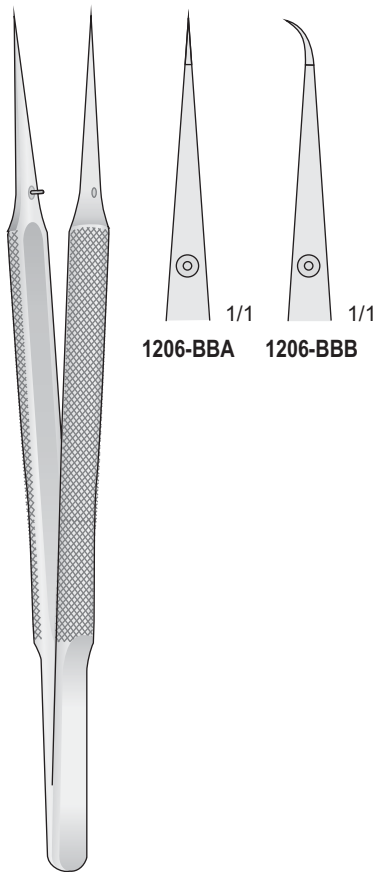

1206-BBA/1206-BBB
120 mm

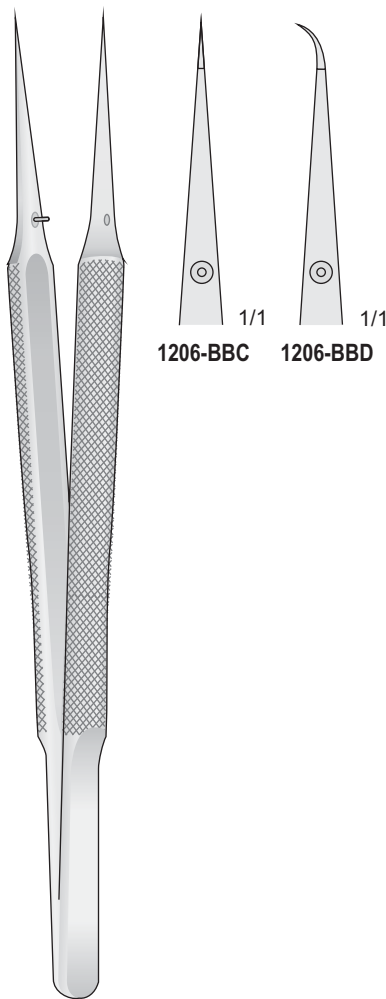

1206-BBC/1206-BBD
150 mm

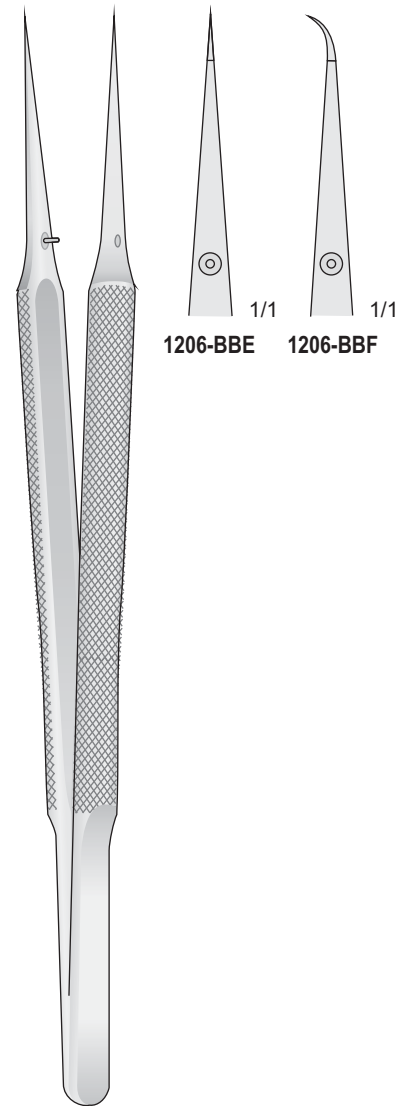

1206-BBE/1206-BBF
180 mm

Mikro Pinzetten

Micro forceps

Micro pinzette

Pinzas finos

Micro pinces

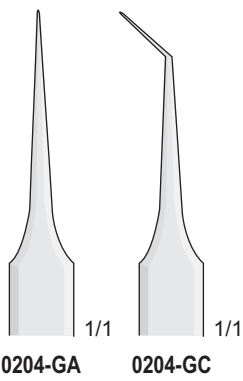
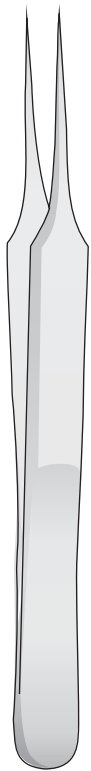

0204-GA

0204-GC

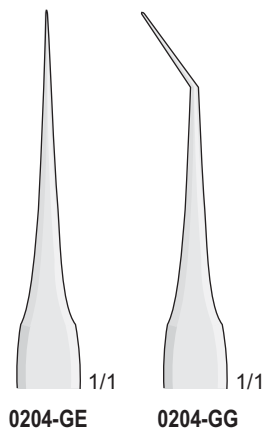
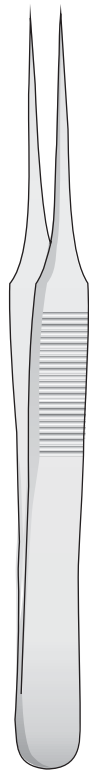

0204-GE

0204-GG

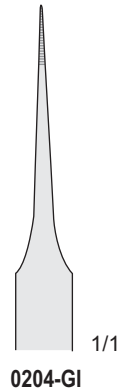

0204-GI

0204-GA/0204-GC
110 mm

0204-GE/0204-GG
110 mm

0204-GI
90 mm

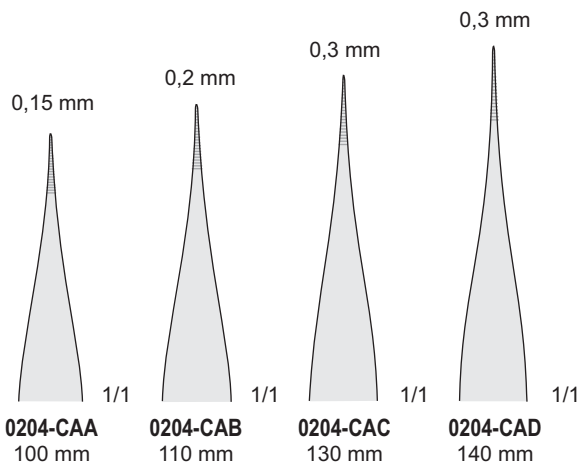
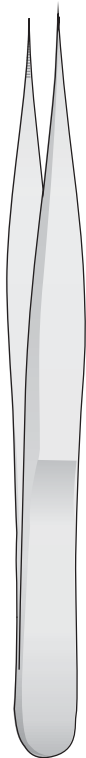

0204-CAA
100 mm

0204-CAB
110 mm

0204-CAC
130 mm

0204-CAD
140 mm



0204-CAA/0204-CAD

0204-CAF
115 mm

0204-CAG
115 mm

Pinzetten

Thumb and tissue forceps

Pinze per dissezione

Pinzas de disección

Pinces à dissection

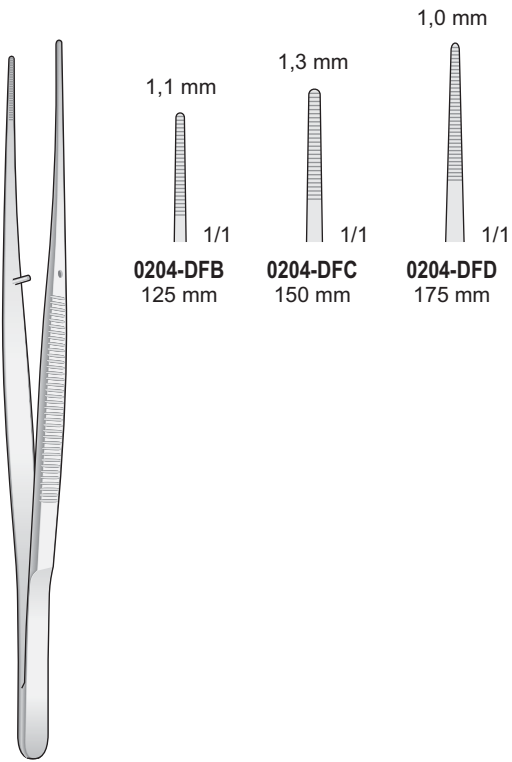

0204-DFB
125 mm

0204-DFC
150 mm

0204-DFD
175 mm

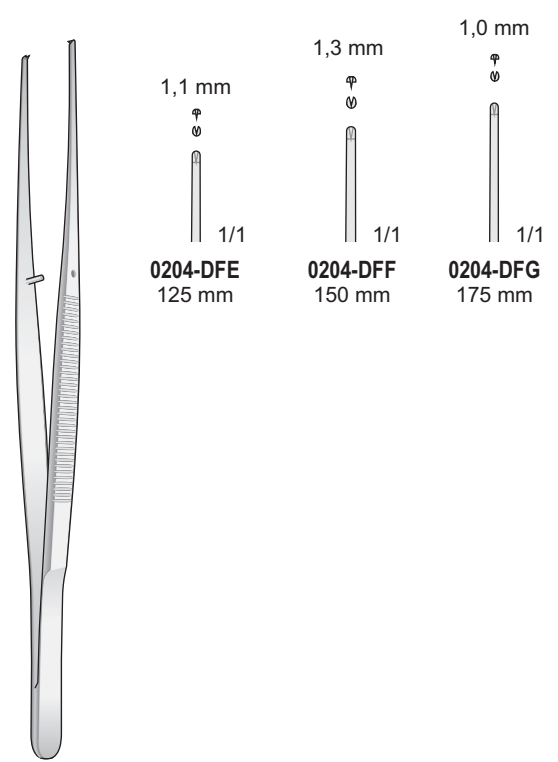

0204-DFE
125 mm

0204-DFF
150 mm

0204-DFG
175 mm

0204-DFB/0204-DFD

0204-DFE/0204-DFG

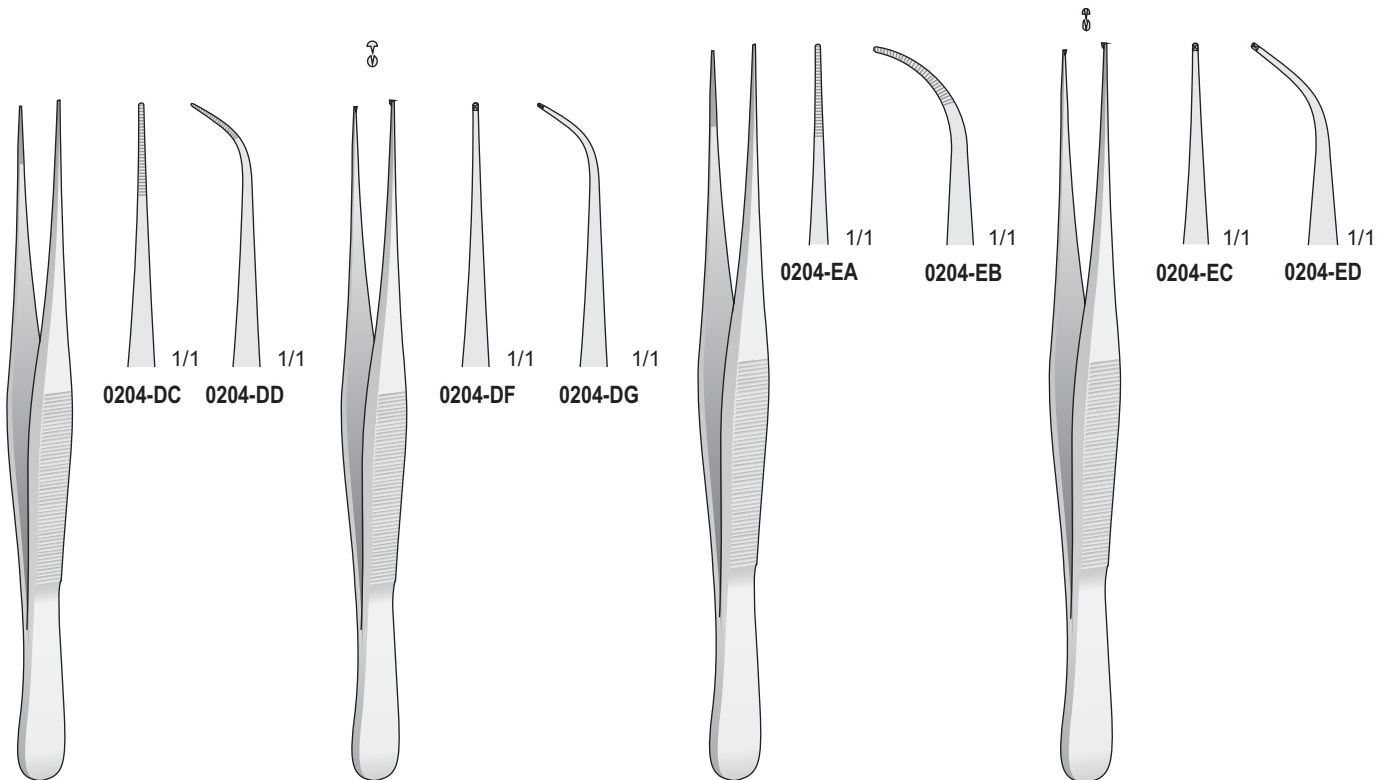

0204-DC 1/1 0204-DD 1/1

0204-DF 1/1 0204-DG 1/1

0204-EA 1/1

0204-EB 1/1

0204-EC 1/1

0204-ED 1/1

0204-DC/0204-DD
100 mm

0204-DF/0204-DG
100 mm

0204-EA/0204-EB
110 mm

0204-EC/0204-ED
110 mm

Chirurgische pinzetten

Tissue forceps

Pinzette chirurgiche

Pinzas quirúrgicas

Pinces chirurgicales



GRAEFE
0204-AE/0204-AH
100 mm

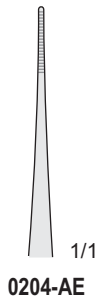

0204-AE

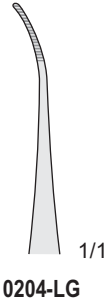

0204-LG

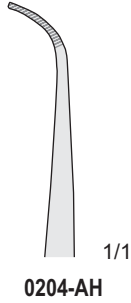

0204-AH



GRAEFE
0204-BLE/0204-BLG
100 mm

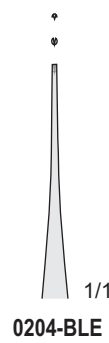

0204-BLE

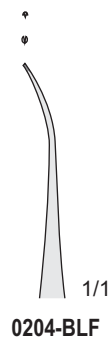

0204-BLF

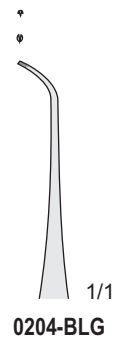

0204-BLG

Fixier und fasspinzetten
Fixation and Grasping forceps
Pinze da Fissazione-oftalmica
Pinzas de fijación y de aprehensión



GRAEFE
0204-BDF
110 mm



1/1



GRAEFE
0204-BDG
110 mm



1/1

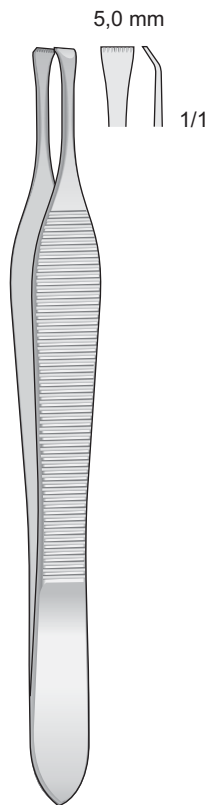

BEASLEY-BABCOCK
0204-FB
120 mm

5,0 mm

1/1

Columella-Klemmen
Columella Forceps
Pinzetta-Columella con stop
Pinzas para Columella
Pinces pour Columelle



COTTLE
0204-BEA
100 mm

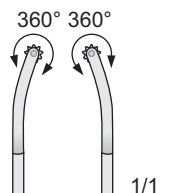

360° 360°

1/1

Chirurgische Pinzetten
Anatomische Pinzetten

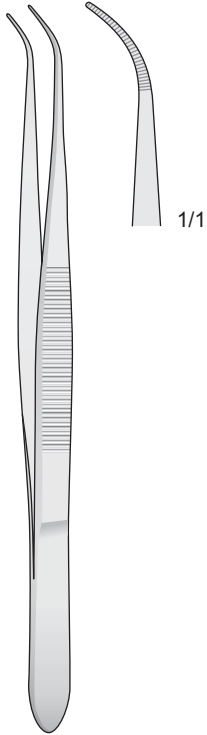

PERRY
0204-AF
125 mm

Tissue forceps
Dressing forceps

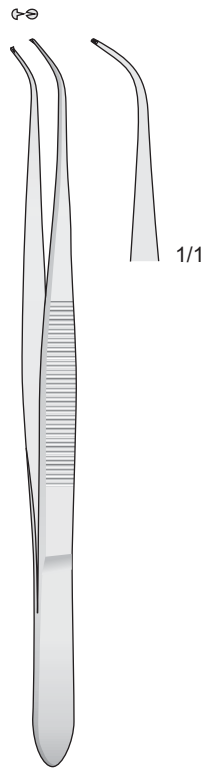

0204-AG
125 mm

Pinzette chirurgiche
Pinzette anatomiche



0204-CDI/0204-CDL

Pinzas quirúrgicas
Pinzas de disección

0,2 mm
1/1
0204-CDI
95 mm
1x2 Zähne
1x2 Teeth
1x2 Denti
1x2 Dientes
1x2 Dents

Pinces chirurgicales
Pincas anatomiques

0,8 mm
1/1
AUSTIN
0204-CDL
140 mm

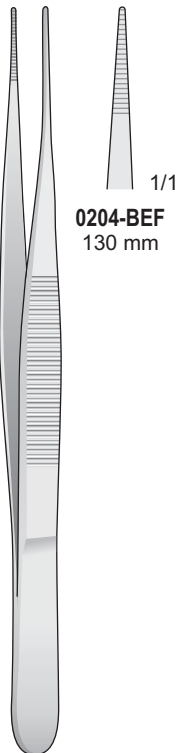

0204-BEF
130 mm

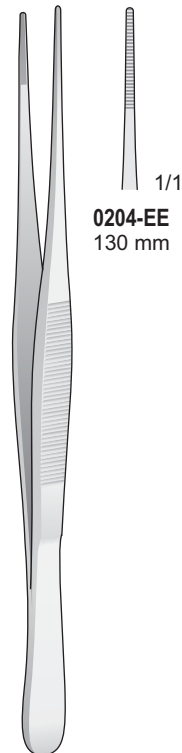

SEMKEN
0204-EE
130 mm

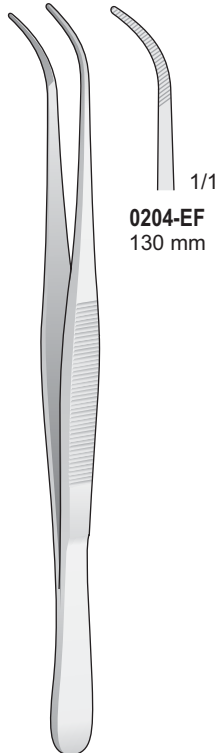

SEMKEN
0204-EF
130 mm

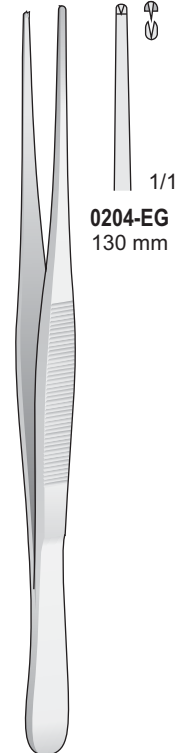

SEMKEN
0204-EG
130 mm

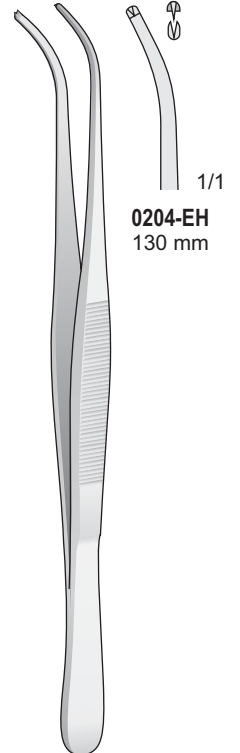

SEMKEN
0204-EH
130 mm

Chirurgische pinzetten

Tissue forceps

Pinzette chirurgiche

Pinzas quirúrgicas

Pinces chirurgicales

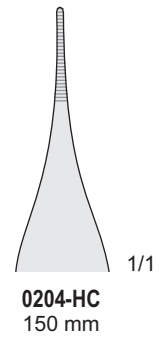
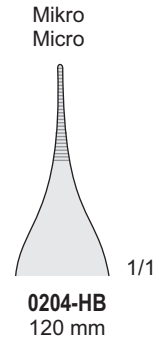
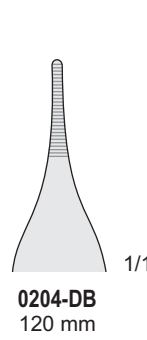
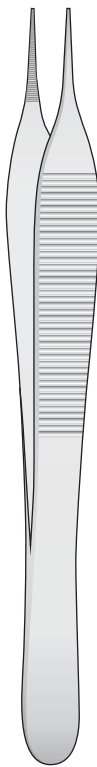
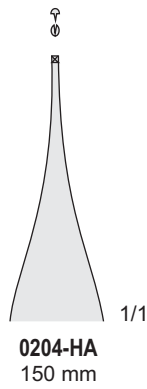
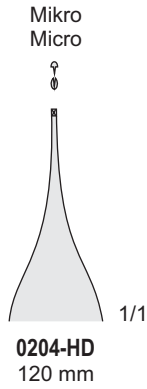
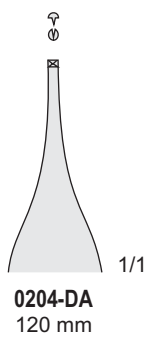
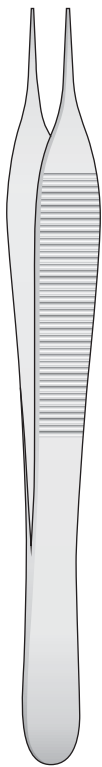

ADSON
0204-DA/0204-HD

ADSON
0204-DB/0204-HC

6x6 Zähne
6x6 Teeth
6x6 Denti
6x6 Dientes
6x6 Dents

9x9 Zähne
9x9 Teeth
9x9 Denti
9x9 Dientes
9x9 Dents

6x6 Zähne
6x6 Teeth
6x6 Denti
6x6 Dientes
6x6 Dents

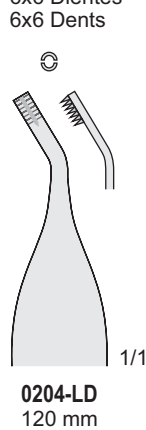
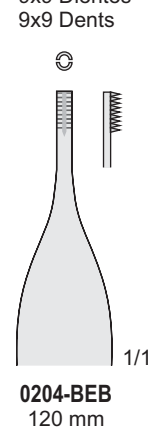
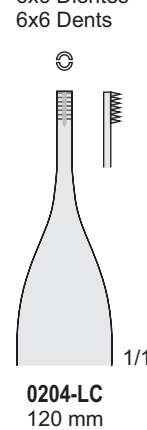
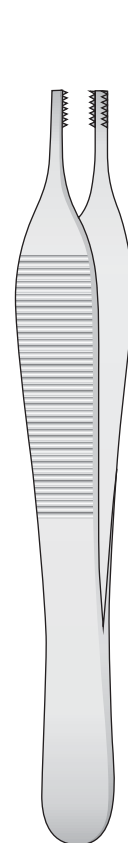
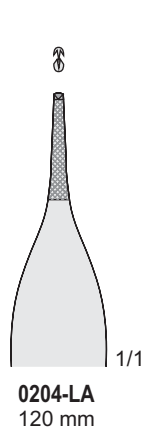
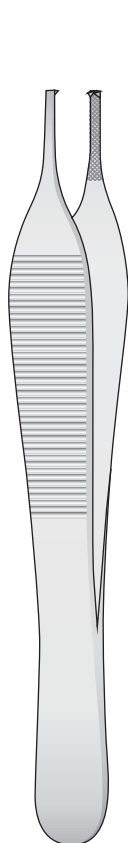
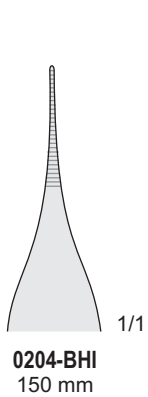
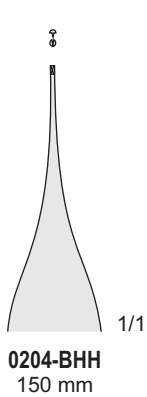
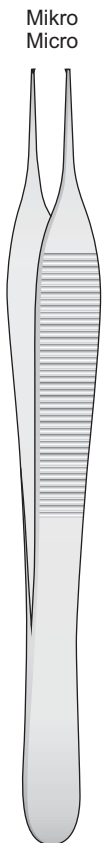

ADSON
0204-BHH/0204-BHI
150 mm

ADSON
0204-LA
120 mm

ADSON-BROWN
0204-LC/0204-BEB
120 mm

Anatomische Pinzetten

Dressing forceps

Pinzette anatomiche

Pinzas de diseccion

Pinces anatomiques

1,2 mm

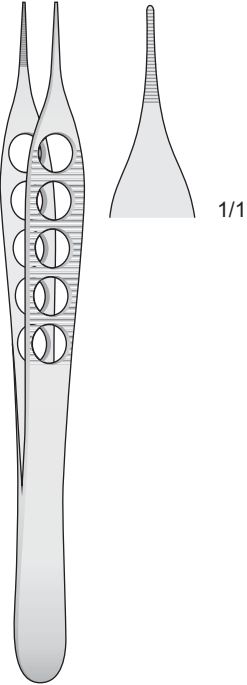

ADSON
0204-CAH
120 mm

1,2 mm

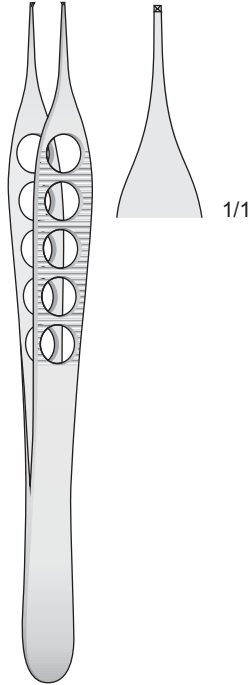

ADSON
0204-CAI
120 mm

7x7 Zähne
7x7 Teeth
7x7 Denti
7x7 Dientes
7x7 Dents

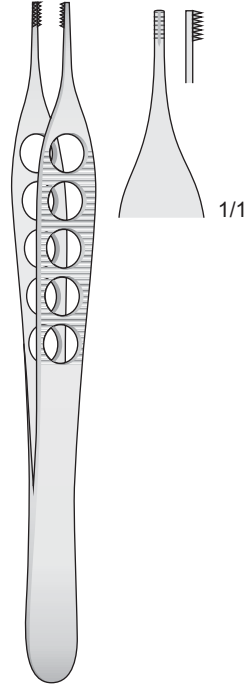

ADSON-BROWN
0204-CAL
120 mm



0204-BG/0204-BEI
160 mm

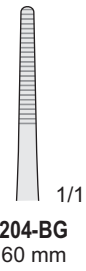

0204-BG
160 mm

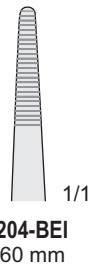

0204-BEI
160 mm

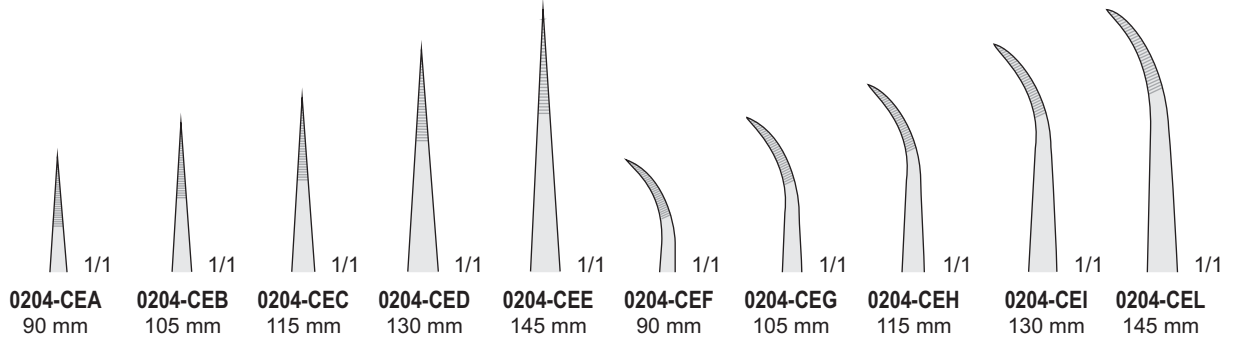

0204-CEA
90 mm

0204-CEB
105 mm

0204-CEC
115 mm

0204-CED
130 mm

0204-CEE
145 mm

0204-CEF
90 mm

0204-CEG
105 mm

0204-CEH
115 mm

0204-CEI
130 mm

0204-CEL
145 mm

0204-CEA/0204-CEL

Anatomische Pinzetten

Dressing forceps

Pinzette anatomiche

Pinzas de diseccion

Pinces anatomiques

Standard

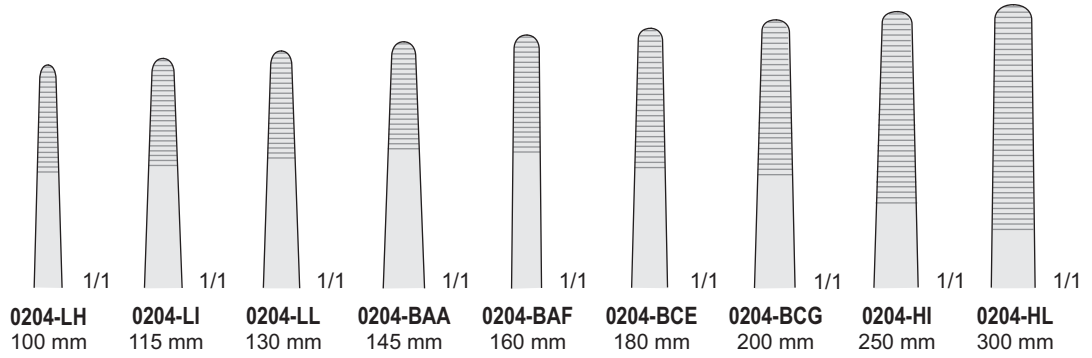

0204-HI/0204-BCG

Mod. Fine

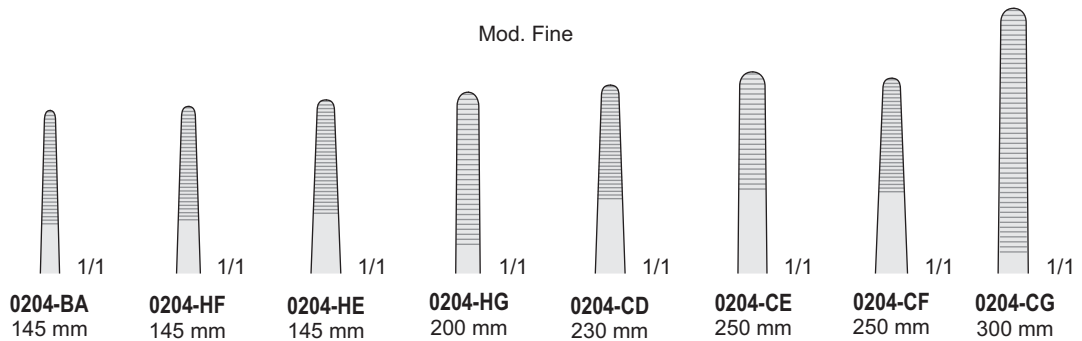

0204-BA/0204-HG

Chirurgische pinzetten

Tissue forceps

Pinzette chirurgiche

Pinzas quirúrgicas

Pinces quirúrgicas



1x2 Zähne
1x2 Teeths
1x2 Denti
1x2 Dientes
1x2 Dents

Standard

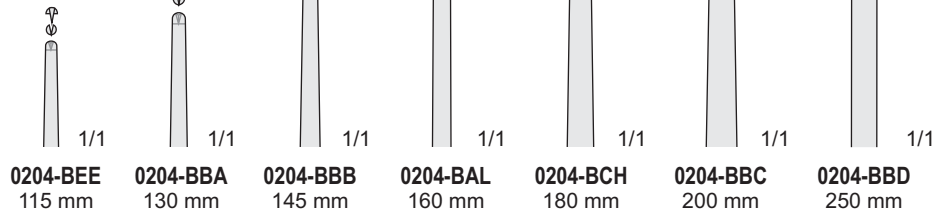

0204-BAL/0204-BEE



1x2 Zähne
1x2 Teeths
1x2 Denti
1x2 Dientes
1x2 Dents

Schmal - Narrow - Strette - Estrechadas - Étroites

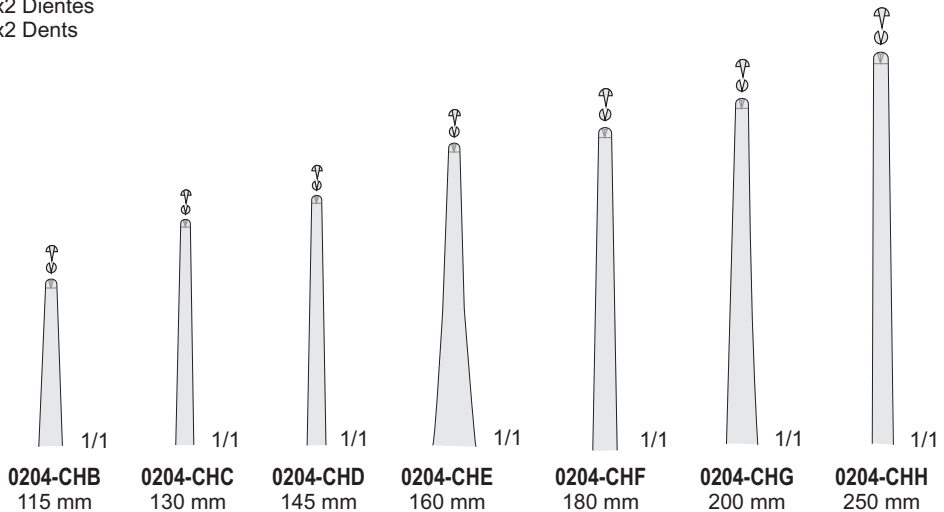

0204-CHB/0204-CHH

Chirurgische pinzetten

Tissue forceps

Pinzette chirurgiche

Pinzas quirúrgicas

Pinces chirurgicales

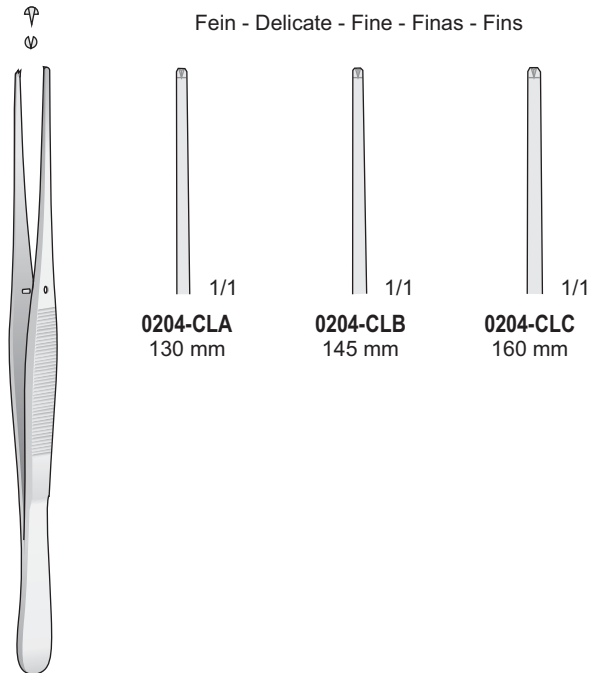
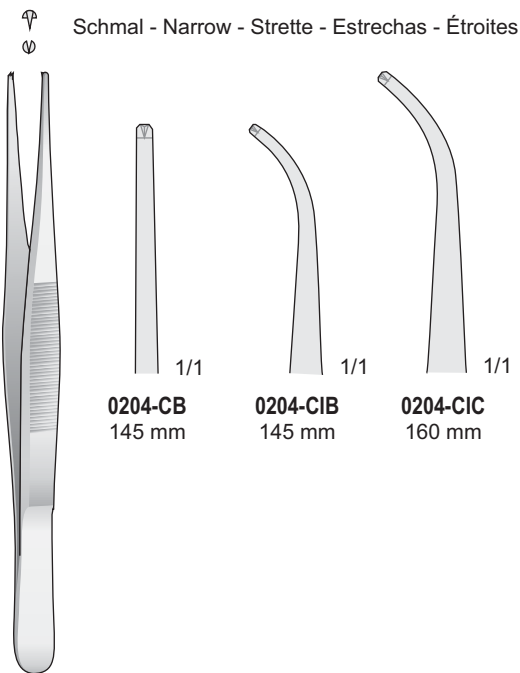

0204-CB/0204-CIC

1x2 Zähne
1x2 Teeths
1x2 Denti
1x2 Dientes
1x2 Dents

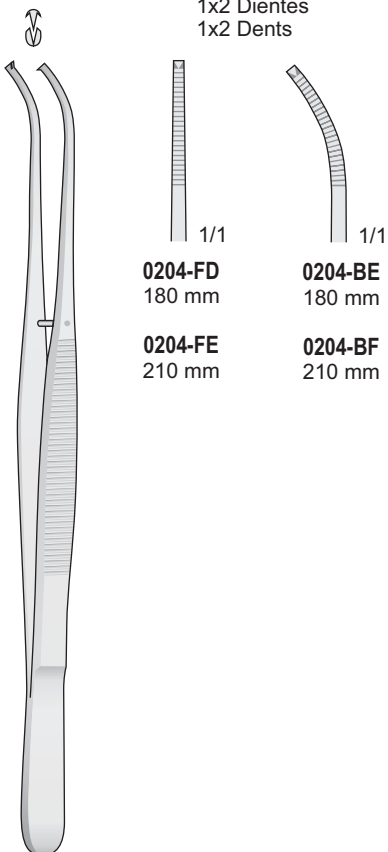

POTTS-SMITH
0204-BE/0204-FE

0204-CLA/0204-CLC

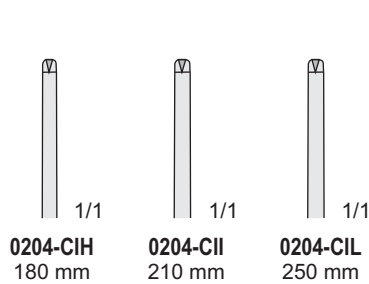

POTTS-SMITH
0204-CIH/0204-CIL

1x2 Zähne
1x2 Teeths
1x2 Denti
1x2 Dientes
1x2 Dents

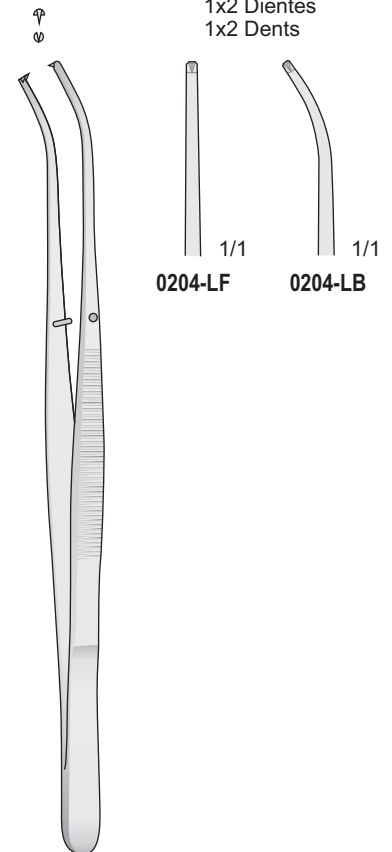

SEMKEN
0204-LB/0204-LF
150 mm

Chirurgische pinzetten

Tissue forceps

Pinzette chirurgiche

Pinzas quirúrgicas

Pinces quirúrgicas

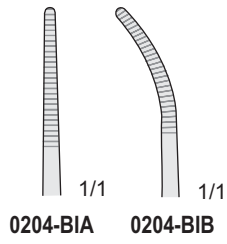

CUSHING
0204-BIA/0204-BIB
175 mm

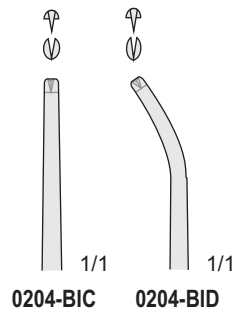

CUSHING
0204-BIC/0204-BID
175 mm

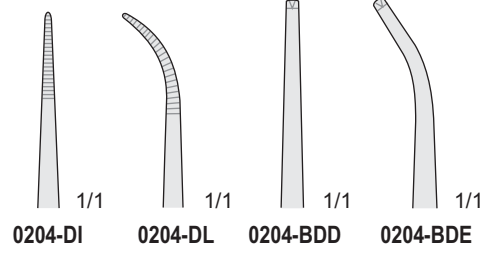

0204-DI/0204-BDE
200 mm

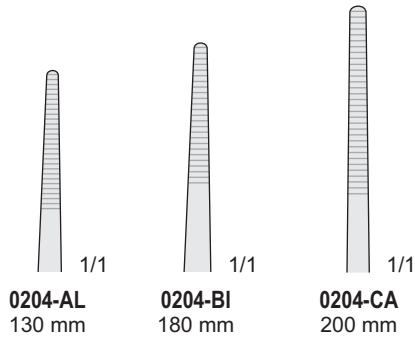

0204-AL/0204-CA

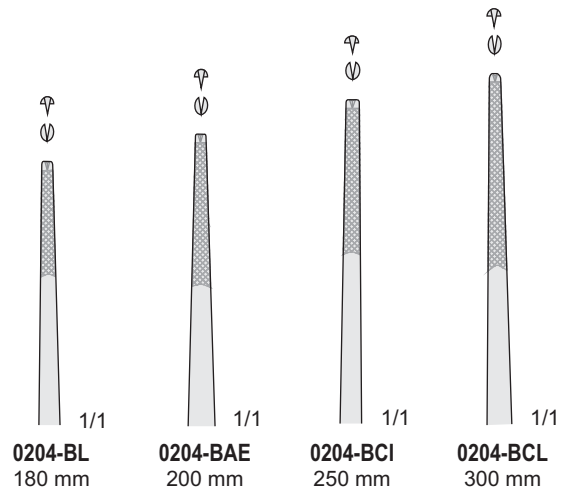

0204-BL/0204-BCL

Chirurgische pinzetten

Tissue forceps

Pinzette chirurgiche

Pinzas quirúrgicas

Pinces chirurgicales



2x3 Zähne - 2x3 Teeths
2x3 Denti - 2x3 Dientes
2x3 Dents

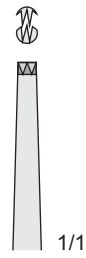

0204-BAG
115 mm

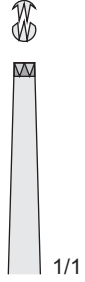

0204-BDI
145 mm

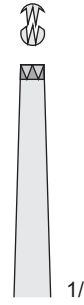

0204-BAH
160 mm

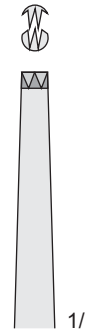

0204-BDL
180 mm

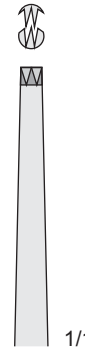

0204-BAI
200 mm

0204-BAG/0204-BDL



3x4 Zähne - 3x4 Teeths
3x4 Denti - 3x4 Dientes
3x4 Dents

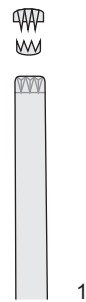

0204-BBF
145 mm

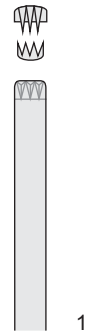

0204-BBL
160 mm

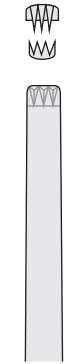

0204-BBG
200 mm

0204-BBF/0204-BBL

Tonsillenpinzette
Tonsil Forceps
Pinzette per tonsille

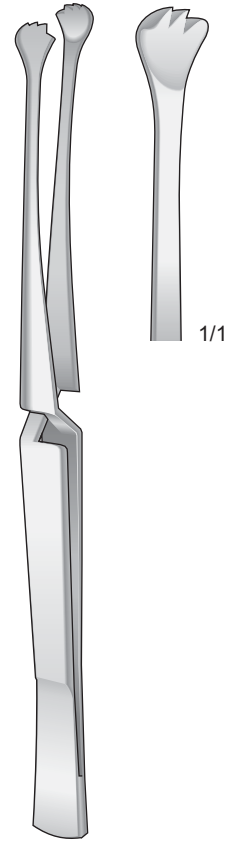

MARSCHIK
0204-BIH
220 mm

Chirurgische pinzetten

Tissue forceps

Pinzette chirurgiche

Pinzas quirúrgicas

Pinces quirúrgicas

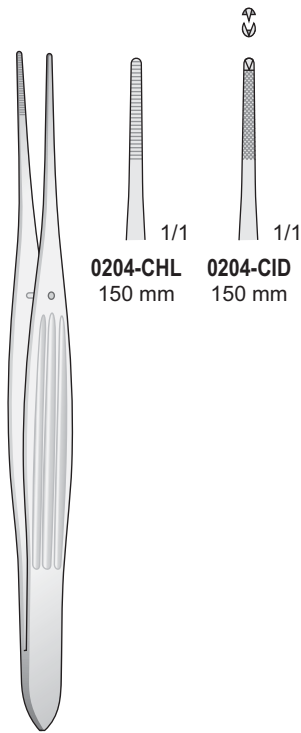

0204-CHL
150 mm

0204-CID
150 mm

McINDOE
0204-CHL/0204-CID
150 mm

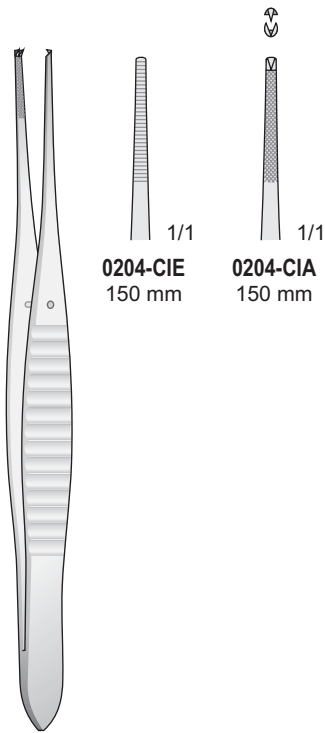

0204-CIE
150 mm

0204-CIA
150 mm

GILLIES
0204-CIA/0204-CIE
150 mm

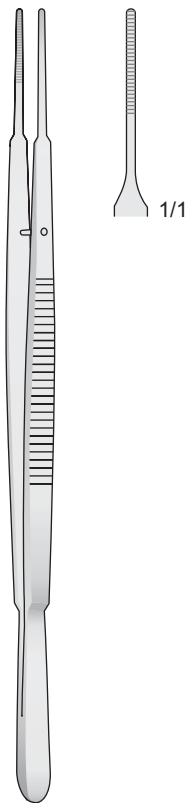

GERALD
1206-BAB
180 mm

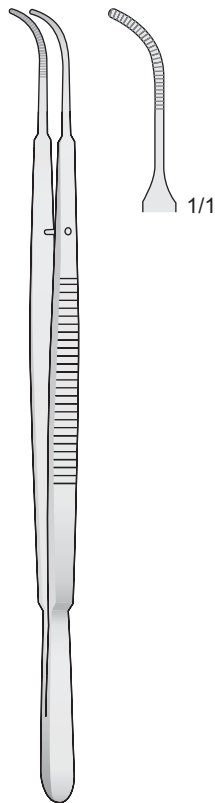

GERALD
1206-BAC
180 mm

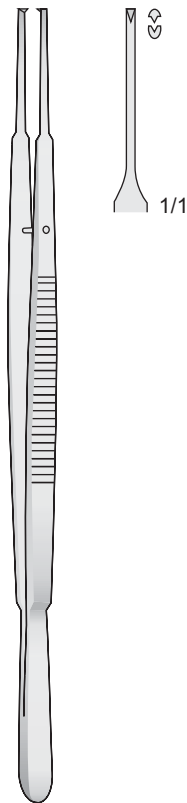

GERALD
1206-BAD
180 mm

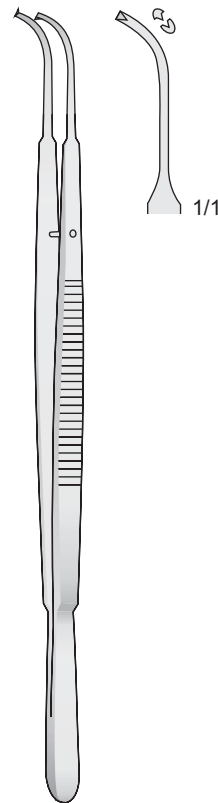

GERALD
1206-BAE
180 mm

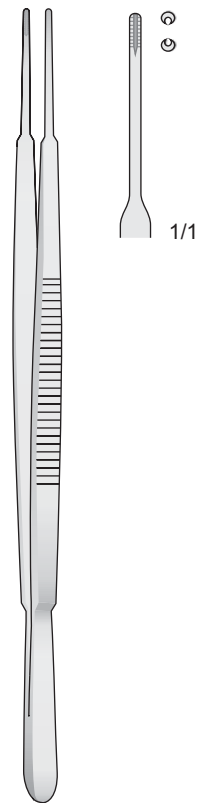

GERALD-BROWN
1206-BAF
180 mm

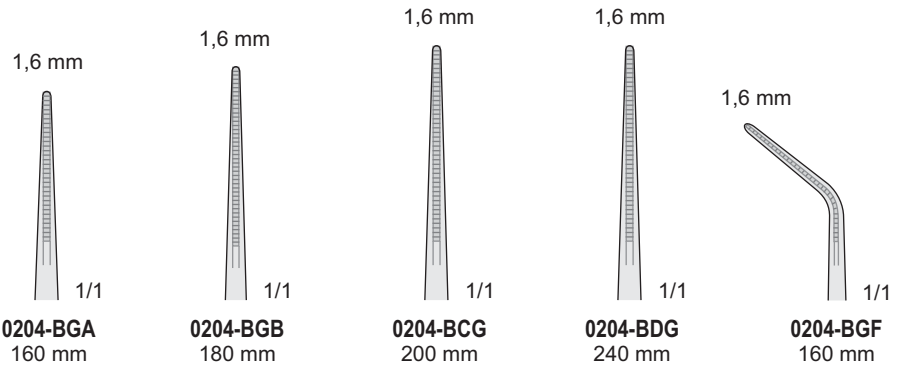

Atraumatische pinzetten
Non-traumatic vascular tissue forceps
Pinzette atraumatiche
Pinzas atraumaticas
Pincas atraumatiques

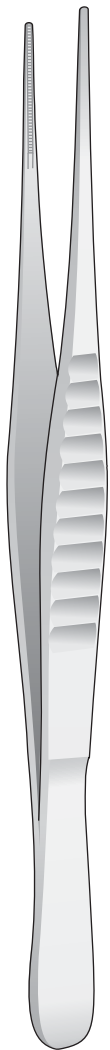

DE BAKEY
0204-IA/0204-BGI

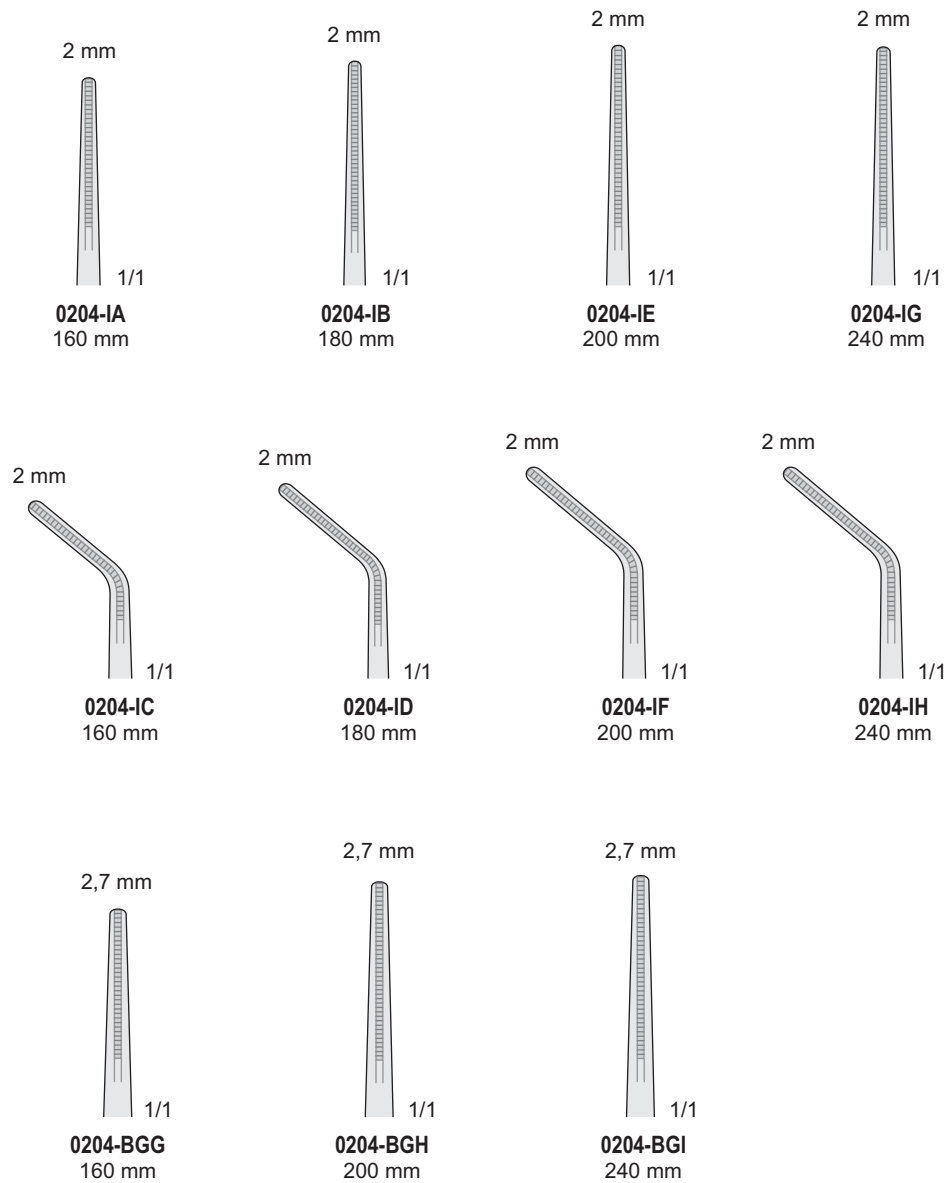

Pinzetten

Tissue forceps

Pinzette

Pinzas

Pinces

**Isoliert - Insulated - Isolate - Aislante - Isolant
Monopolar - Monopolari**

mit sterilisierfähiger Kunststoff-Isolierbeschichtung - with autoclavable plastic coated insulated handles
con rivestimento isolante in plastica sterilizzabile - con recubrimiento aislante de materia plástica esterilizable
à enduit plastique isolant, stérilisable

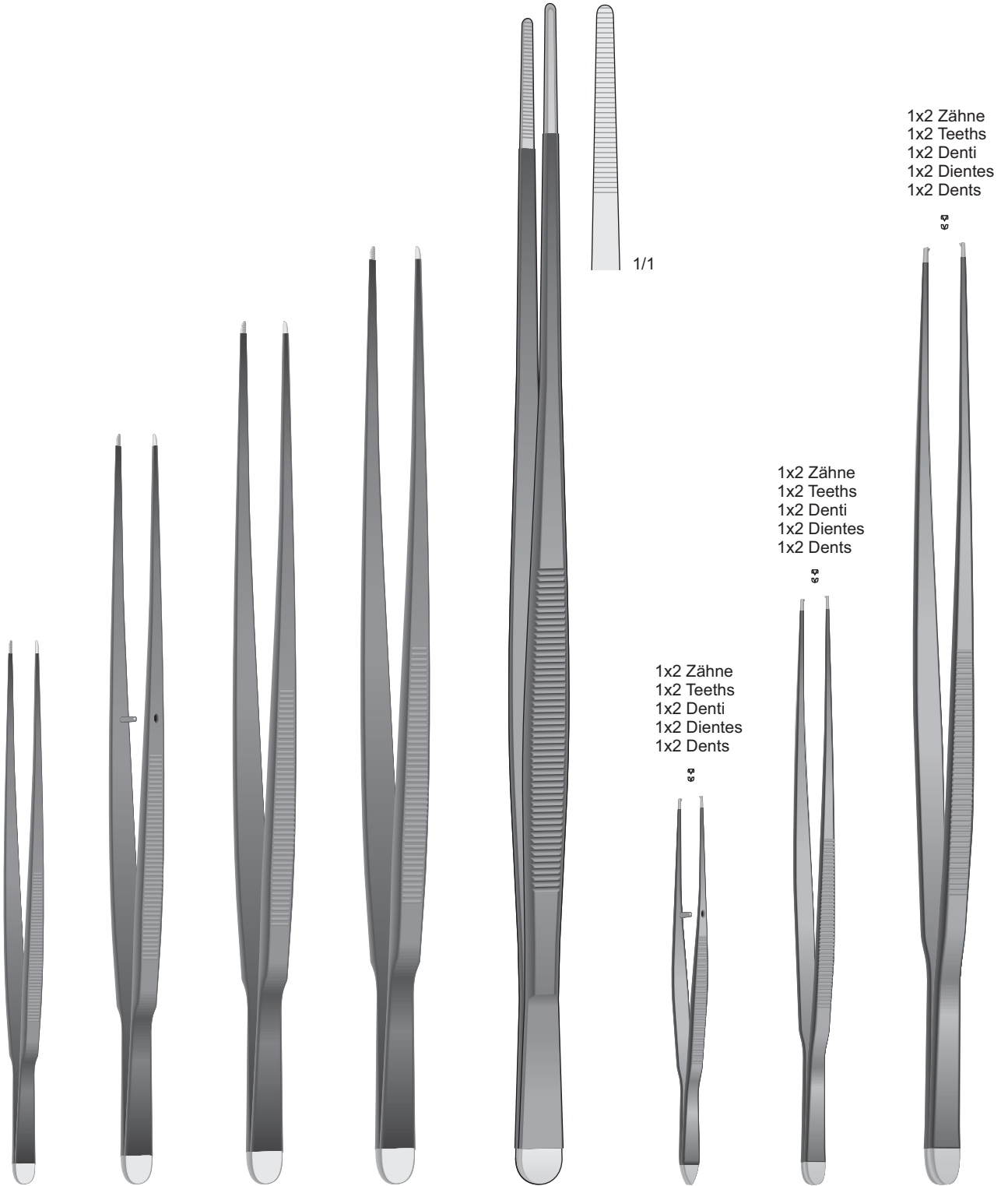

0204-BA0918
145 mm

0204-CA0918
200 mm

0204-CD0918
230 mm

0204-CE0918
250 mm

0204-CG0918
300 mm

0204-BLE0918
100 mm

0204-CHD0918
155 mm

0204-CHH9018
250 mm

Chirurgische pinzetten

Tissue forceps

Pinzette chirurgiche

Pinzas quirúrgicas

Pinces chirurgicales

Mit hartmetalleinsätzen - Tungsten-carbide forceps
 Con punta al carburo di tungsteno - Pinzas con tungsteno - Avec plaquettes en carbure de tungstène

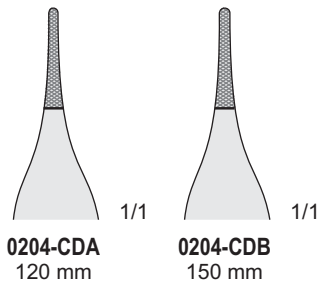
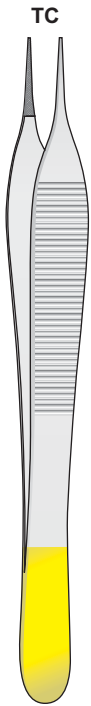

ADSON
0204-CDA/0204-CDB

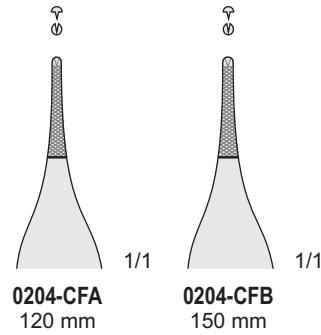
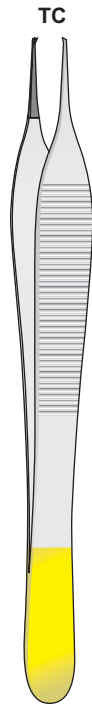

ADSON
0204-CFA/0204-CFB

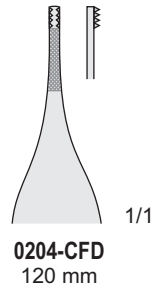

ADSON-BROWN
0204-CFD
120 mm

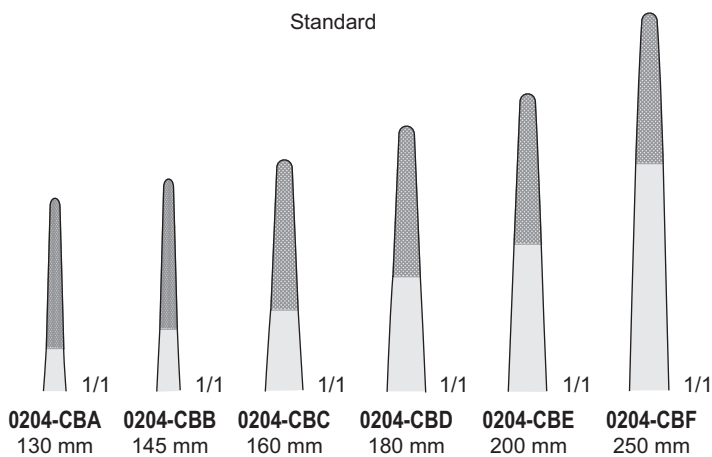

0204-CBA/0204-CBF

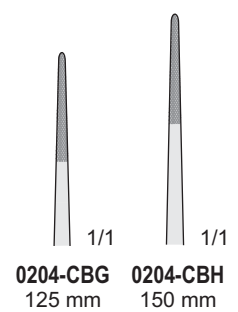

SEMKEN
0204-CBG/0204-CBH

Chirurgische pinzetten

Tissue forceps

Pinzette chirurgiche

Pinzas quirúrgicas

Pinces chirurgicales



0204-CDC
150 mm

1/1



0204-CDD
200 mm

1/1

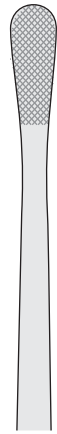

0204-CDE
250 mm

1/1



0204-CFC
180 mm

1/1

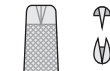

WANGENSTEEN
0204-CDC/0204-CDE

BONNEY
0204-CFC
180 mm



0204-CCG
175 mm

1/1

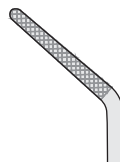

0204-CCH
175 mm

1/1



0204-CBI
180 mm

1/1

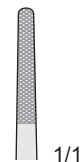

0204-CBL
200 mm

1/1

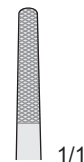

0204-CCA
250 mm

1/1



TAYLOR
0204-CCI
185 mm

1/1

Mit Dissektor-Ende
With Dissector End
Con dissettore
Con cabo disecador
Avec bout disecteur

Mit Dissektor-Ende
With Dissector End
Con dissettore
Con cabo disecador
Avec bout disecteur

Mit Dissektor-Ende
With Dissector End
Con dissettore
Con cabo disecador
Avec bout disecteur

CUSHING
0204-CCG/0204-CCH
175 mm

POTTS-SMITH
0204-CBI/0204-CCA

Mit hartmetalleinsätzen
Tungsten-carbide forceps
Con punta al carburo di tungsteno
Pinzas con tungsteno
Avec plaquettes en carbure de tungstène

TC



DE BAKEY
1206-DCA
180 mm

TC



0204-CCB/0204-CCL

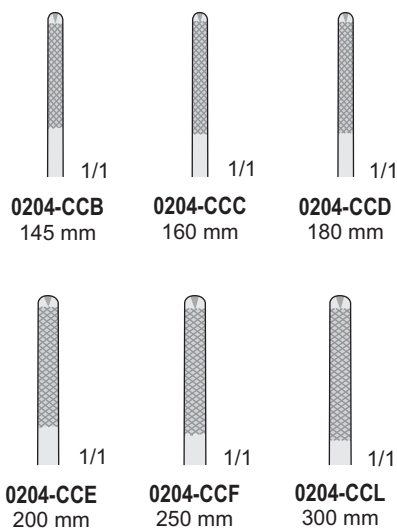

Mikro Diamantiert - Micro Diamond Jaw
Micro Punta al diamante - Micro Diamantada
Micro Diamantées



CASTROVIEJO
0204-DEH 0.5 mm
0204-DEI 0.9 mm
120 mm



BROWN
0204-DEL
120 mm



Pinzetten

Tissue forceps

Pinzette

Pinzas

Pinces

Titan - Titanium - Titanio - Titane

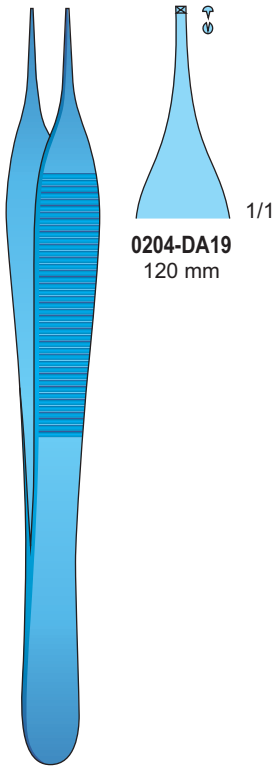

0204-DA19
120 mm

ADSON
0204-DA19
120 mm

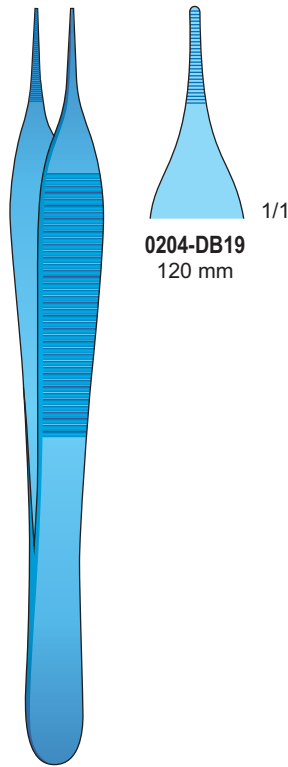

0204-DB19
120 mm

ADSON
0204-DB19
120 mm

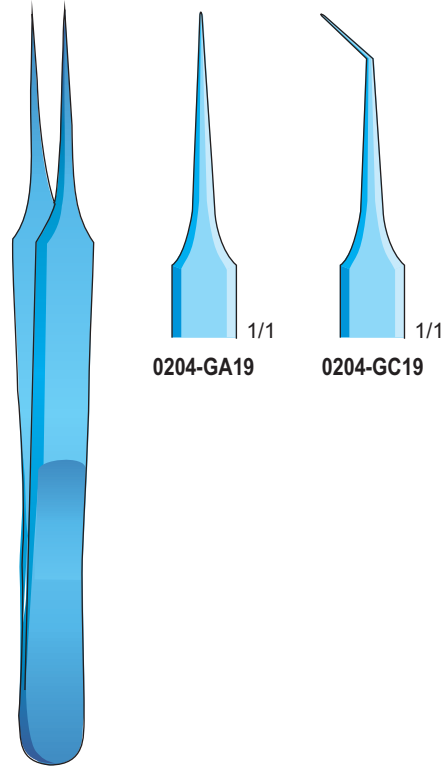

0204-GA19

0204-GC19

0204-GA19/0204-GC19
110 mm

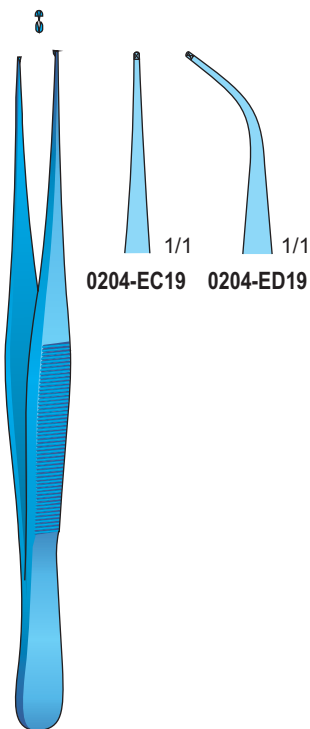

0204-EC19 0204-ED19

0204-EC19/0204-ED19
110 mm

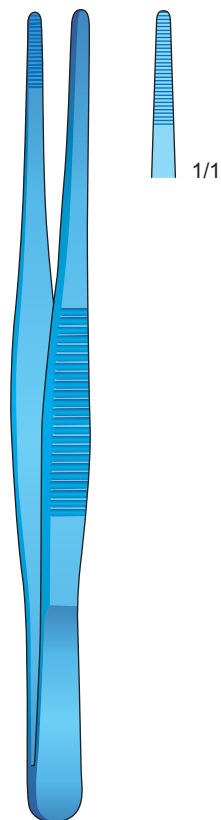

1/1

0204-HF19
145 mm

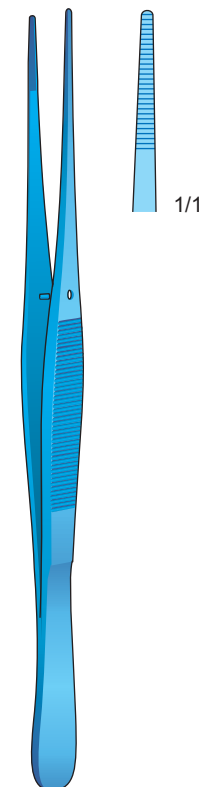

1/1

0204-AL19
130 mm

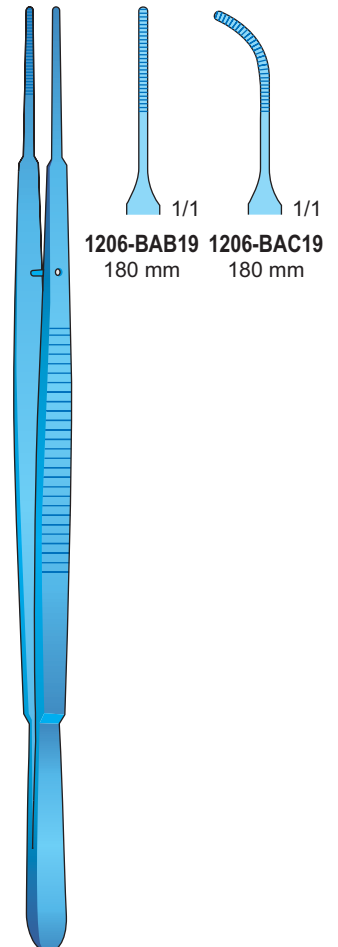

1206-BAB19 1206-BAC19
180 mm 180 mm

GERALD
1206-BAB19/1206-BAC19
180 mm

Titan - Titanium - Titanio - Titane



DE BAKEY
0204-IA19/0204-BGD19

<p>1,6 mm</p> <p>1/1</p> <p>0204-BGA19 160 mm</p>	<p>1,6 mm</p> <p>1/1</p> <p>0204-BGB19 180 mm</p>	<p>1,6 mm</p> <p>1/1</p> <p>0204-BGC19 200 mm</p>	<p>1,6 mm</p> <p>1/1</p> <p>0204-BGD19 240 mm</p>
<p>2 mm</p> <p>1/1</p> <p>0204-IA19 160 mm</p>	<p>2 mm</p> <p>1/1</p> <p>0204-IB19 180 mm</p>	<p>2 mm</p> <p>1/1</p> <p>0204-IE19 200 mm</p>	<p>2 mm</p> <p>1/1</p> <p>0204-IG19 240 mm</p>

Ohr Pinzetten

Ear forceps

Pinzette auricolari

Pinzas auriculares

Pinces auriculaires

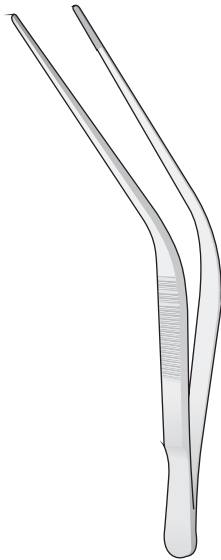

TROELTSCH
0204-CC
110 mm

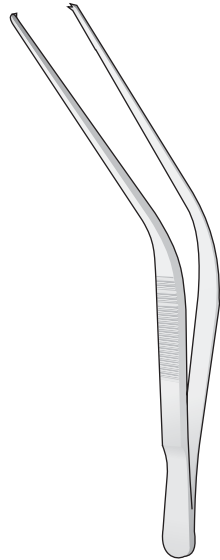

TROELTSCH
0204-BEG
110 mm

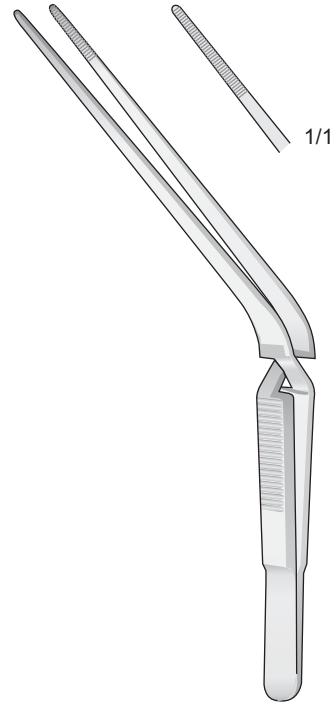

TROELTSCH
0204-BHL
130 mm

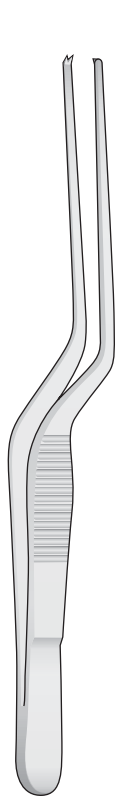

LUCAE
0204-BEH
140 mm

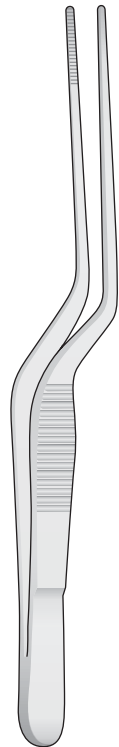

LUCAE
0204-BAB
140 mm



JANSEN
0204-BAC
160 mm



GRÜNWALD
0204-BLD
200 mm

Cilienpinzetten

Cilia forceps

Pinzette Depilatorie

Pinzas depilatorie

Pinces à épiler les cils

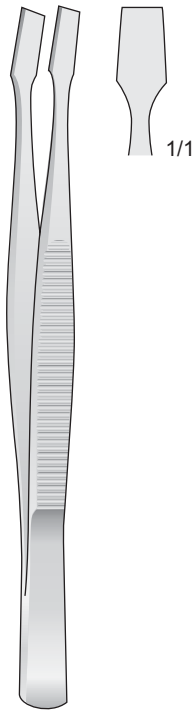

**KÜHNE
0518-EE**
105 mm

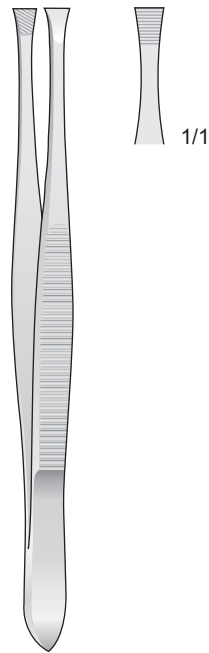

**LITTAUER
0518-GE**
85 mm

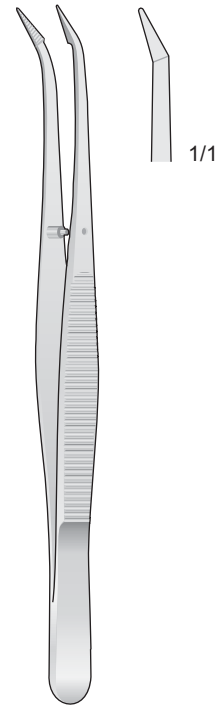

**BARRAQUER
0518-GF**
105 mm

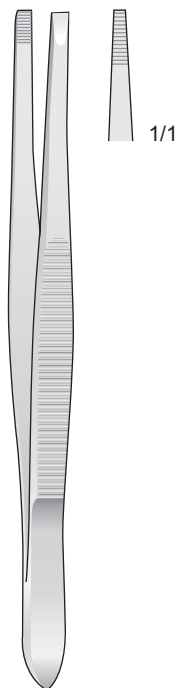

0518-EF
90 mm

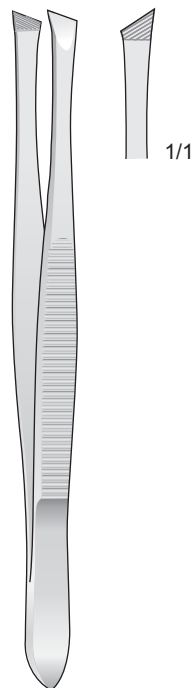

0518-EG
90 mm

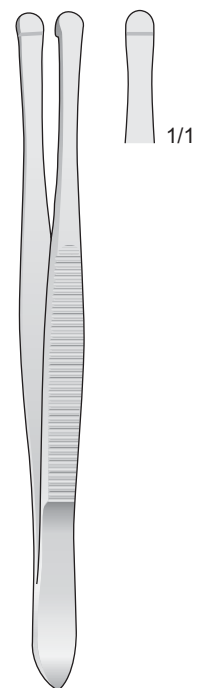

**BEER
0518-EI**
90 mm

4.5



Allgemeine HNO-Instrumentarium
General ENT Instruments
Strumentario generale per ORL
Instrumental general para ORL
Instruments généraux pour ORL

Wundhaken
Retractors
Divaricatori
Separador
Ecarteur

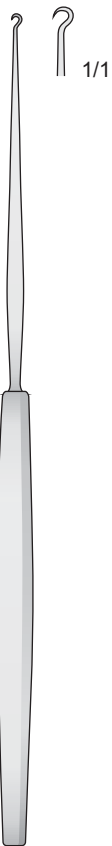

GILLIES
0219-BF
180 mm

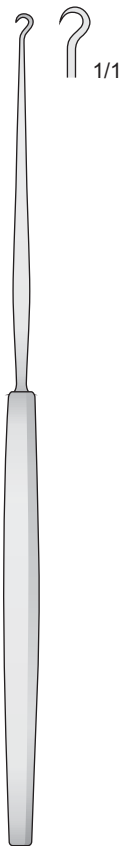

GILLIES
0219-BG
180 mm

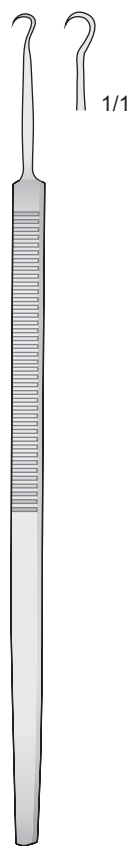

0219-CAH
160 mm

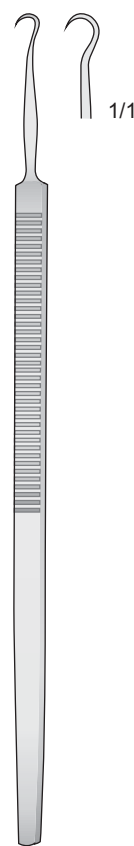

0219-CAI
160 mm

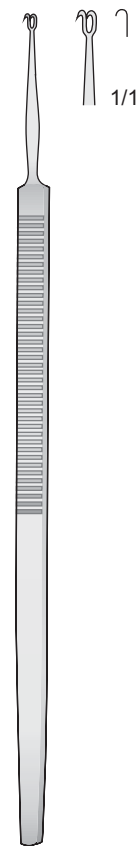

GUTHRIE
0219-CAD
160 mm

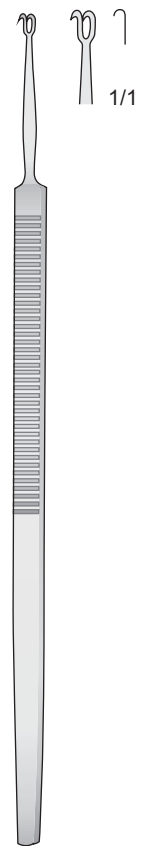

GUTHRIE
0219-CAE
160 mm

Wundhaken

Retractors

Divaricatori

Separadores

Ecarteurs

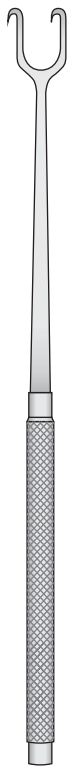

JOSEPH
0219-CBA/0219-CBE
160 mm

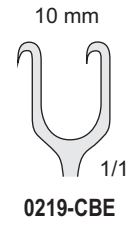
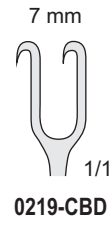
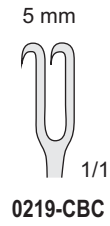
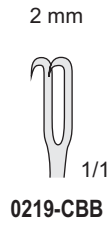

COTTLE
0219-CBF/0219-CBH
150 mm

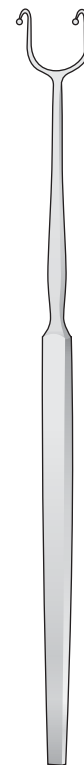
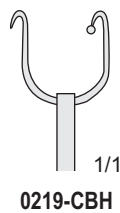
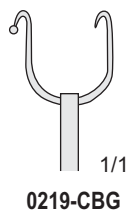
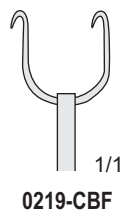

FOMON
0219-CBI
160 mm

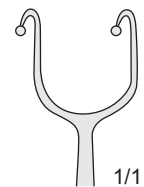

Wundhaken

Retractors

Divaricatori

Separadores

Ecarteurs

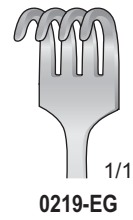
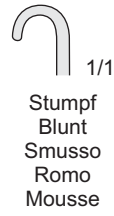
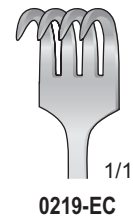
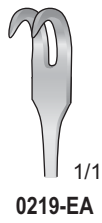
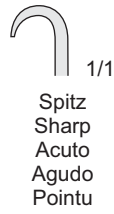

0219-EA/0219-EG
160 mm

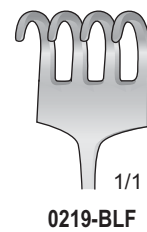
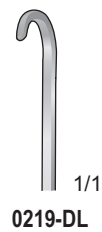
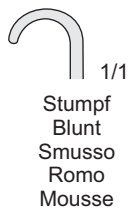
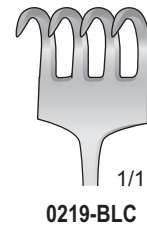
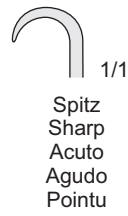

0219-DI/0219-BLF
160 mm

Wundhaken

Retractors

Divaricatori

Separadores

Ecarteurs

Nasenflügelhaken
Alar Retractor
Divaricatore per alette nasali
Separador para las alas nasales
Ecarteur pour les ailes du nez

22 x 13 mm

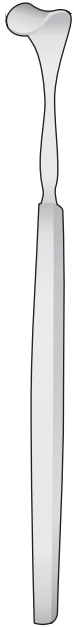

COTTLE
0219-CEF
150 mm

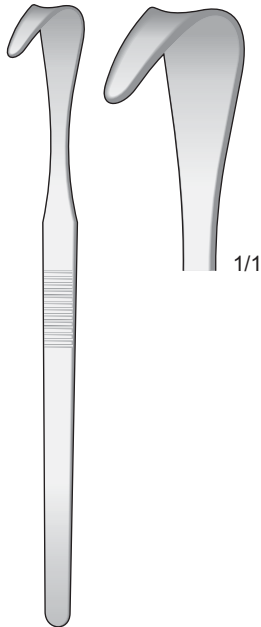

COTTLE
0219-BDI
150 mm

Feine wundhaken flexibel-spitz - Delicate retractors flexible-sharp
Divaricatori delicati flessibili-acuti - Separadores finos flexibles-agudas

Feine wundhaken flexibel-stumpf - Delicate retractors flexible-blunt
Divaricatori delicati flessibili-smussi - Separadores finos flexibles-romas

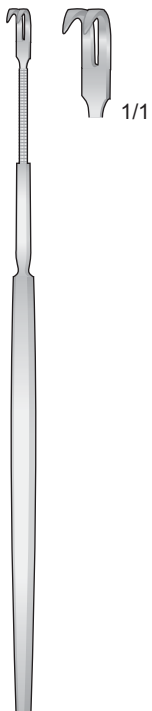

0219-FA
150 mm

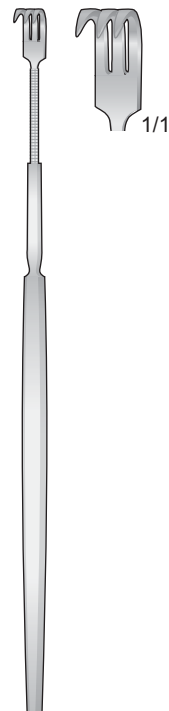

0219-FB
150 mm

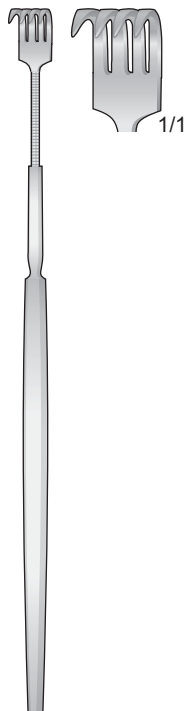

0219-FC
150 mm

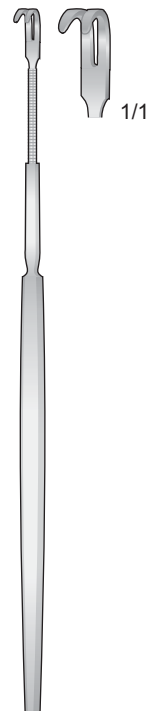

0219-FE
150 mm

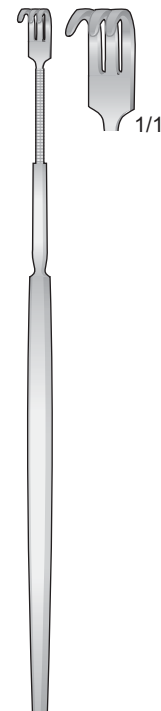

0219-FF
150 mm

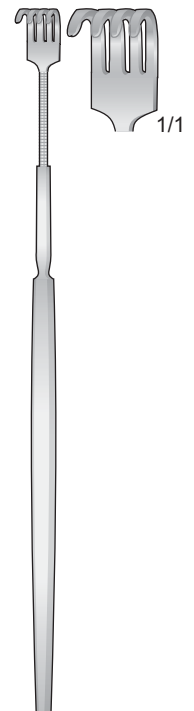

0219-FG
150 mm

Wundhaken

Retractors

Divaricatori

Separadores

Ecarteurs

Isoliert - Insulated - Isolate - Aislante - Isolant

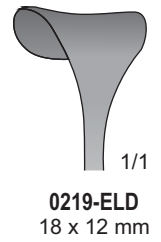
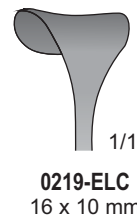
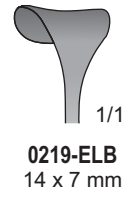
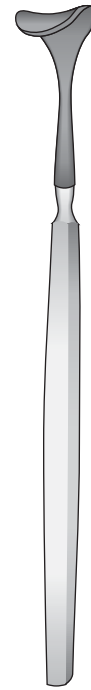
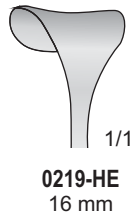
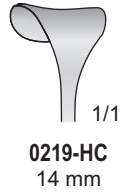
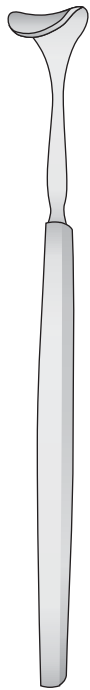

DESMARRES
0219-HA/0219-HL
140 mm

DESMARRES
0219-ELA/0219-ELD
140 mm

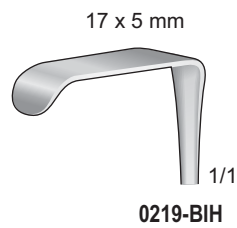
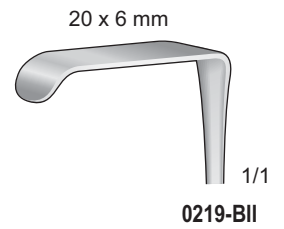
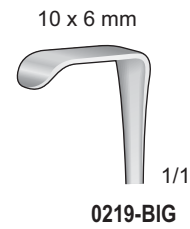

SENN GREEN
0219-EI/0219-EL
160 mm

MINI-LANGENBECK
0219-BIG/0219-BIL
160 mm

Wundhaken

Retractors

Divaricatori

Separadores

Ecarteurs



LAHEY
0219-BAL
195 mm

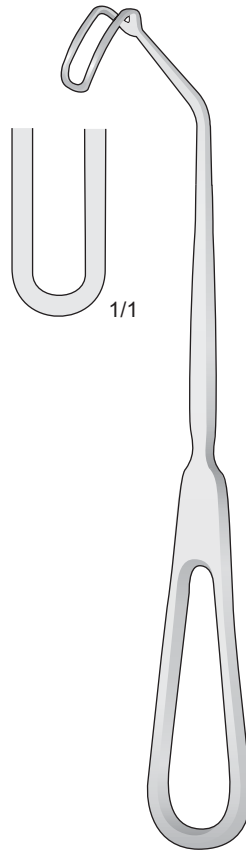

CUSHING
0219-CL
200 mm

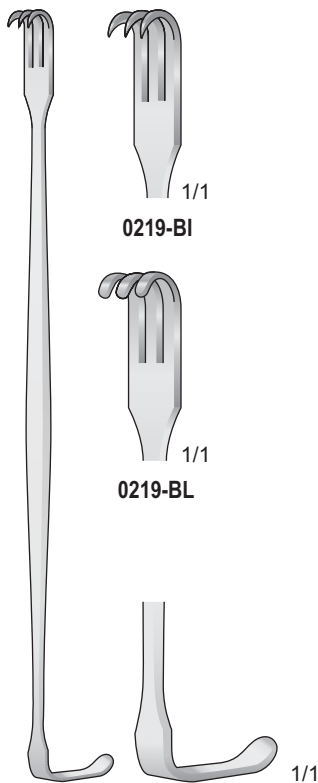

SENN-MILLER
0219-BI/0219-BL
160 mm

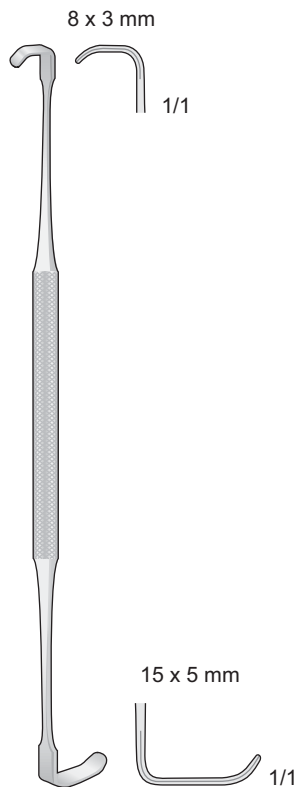

RAGNELL
0219-CH
140 mm

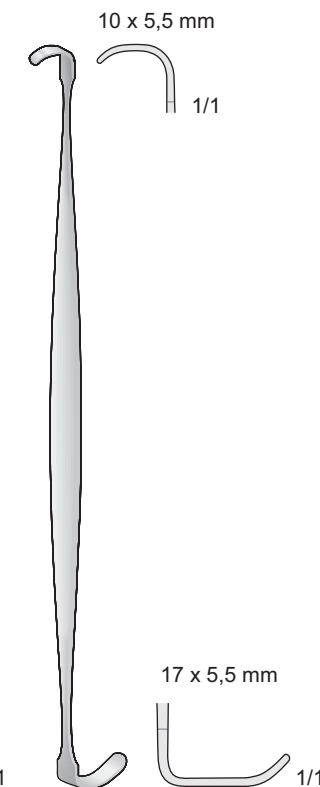

RAGNELL-DAVIS
0219-CG
140 mm

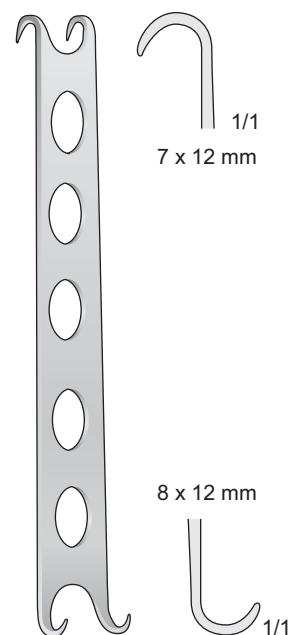

CONVERSE
0219-CC
120 mm

Wundhaken

Retractors

Divaricatori

Separadores

Ecarteurs

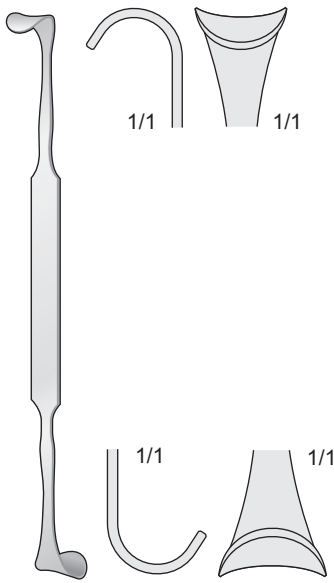

ROSE
0418-BF
130 mm

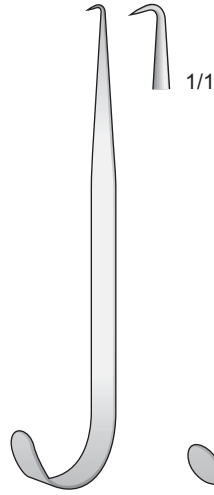

JACKSON
0418-BH
130 mm

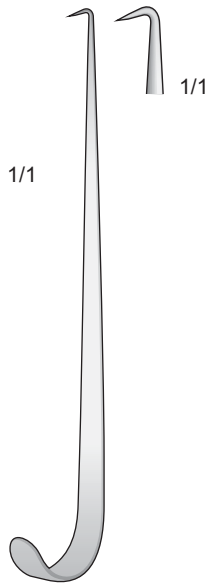

JACKSON
0418-BI
150 mm

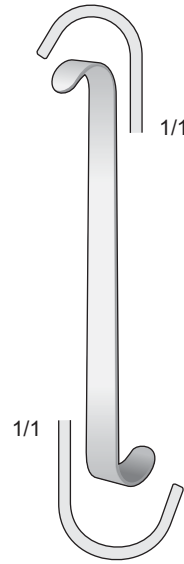

LUER
0418-BG
110 mm

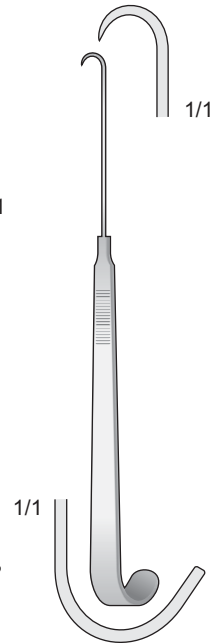

NEWS
0418-BL
150 mm

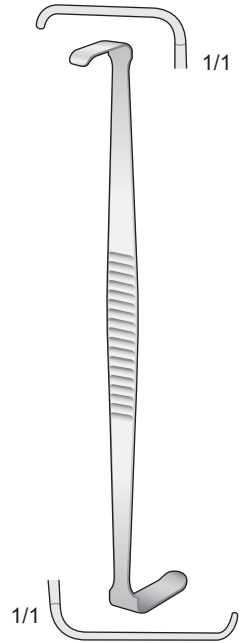

HOUSE
0418-CA
150 mm

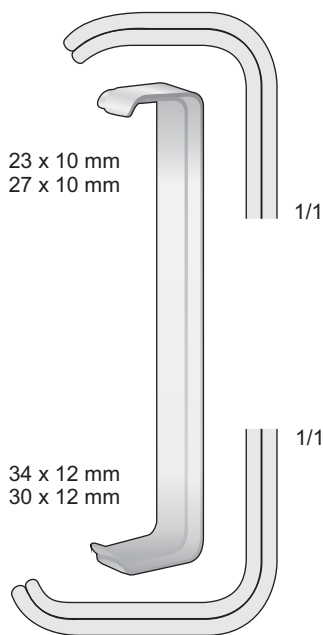

FARABEUF
0219-CA
120 mm

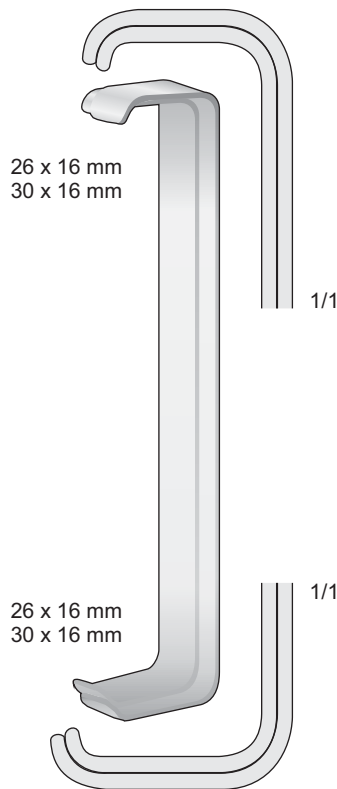

FARABEUF
0219-CF
150 mm

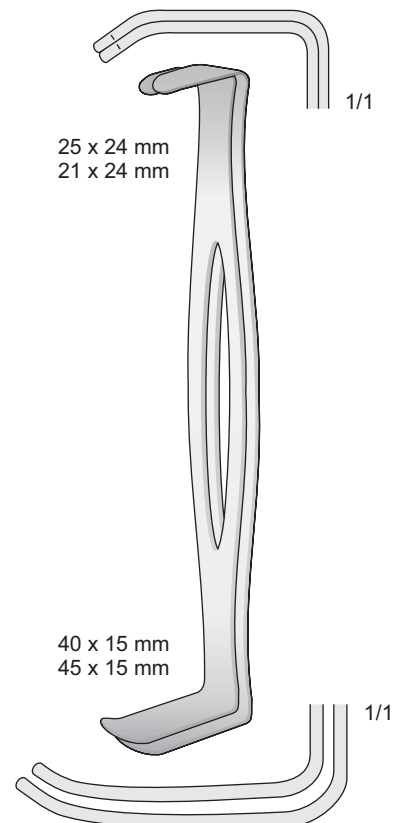

PARKER-LANGENBECK
0219-CLB
210 mm

Wundhaken

Retractors

Divaricatori

Separadores

Ecarteurs

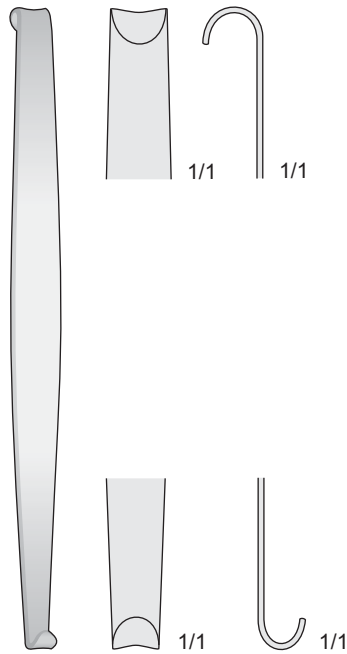

MINI-ROUX
0219-CIC
150 mm

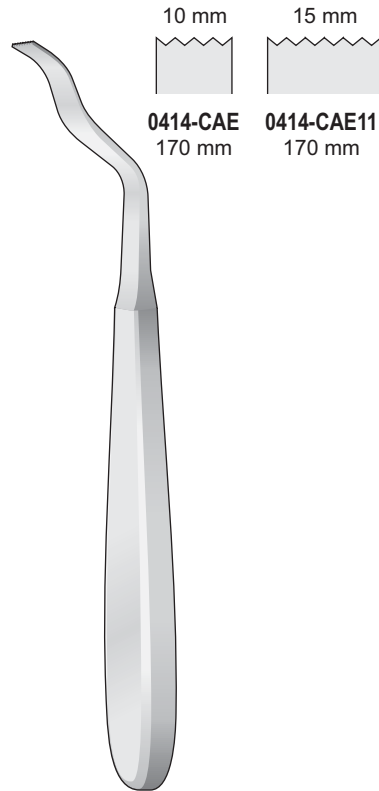

0414-CAE/0414-CAEL
170 mm

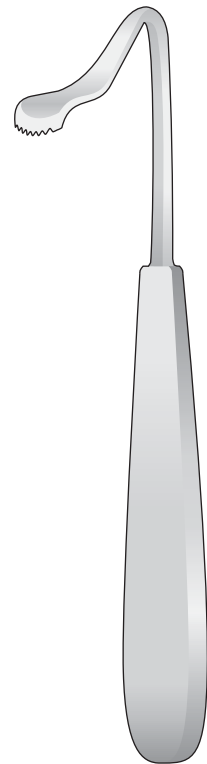

BOWLED-HENRY
0414-BHF
170 mm

0219-CID
Komplettsset
Set complete
Set completo
Set completo
Set complet

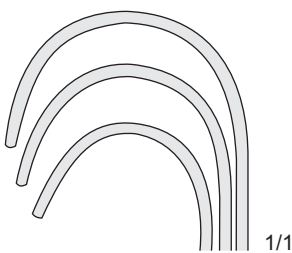

- 0219-CIE - 20x22 mm
25x28 mm
- 0219-CIF - 23x26 mm
29x38 mm
- 0219-CIG - 29x29 mm
34x44 mm

28 mm
38 mm
44 mm

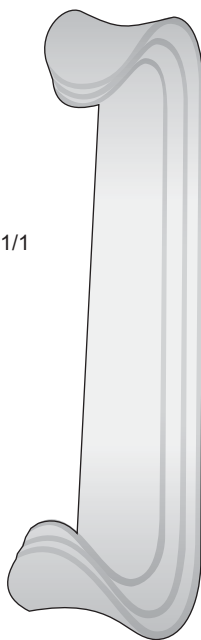

ROUX
0219-CIE/0219-CIG
165 mm

29 mm
26 mm
22 mm

20x22 mm

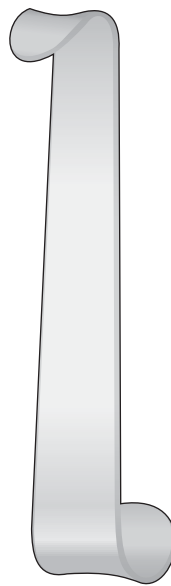

25x28 mm
ROUX-MAGNUS
0219-CIH
150 mm

23x26 mm

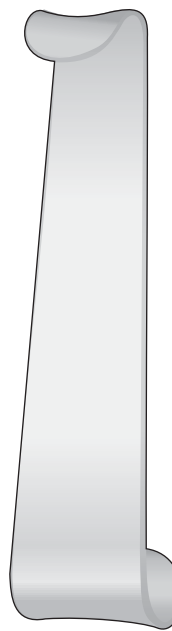

29x38 mm
ROUX-MAGNUS
0219-CII
160 mm

29x29 mm

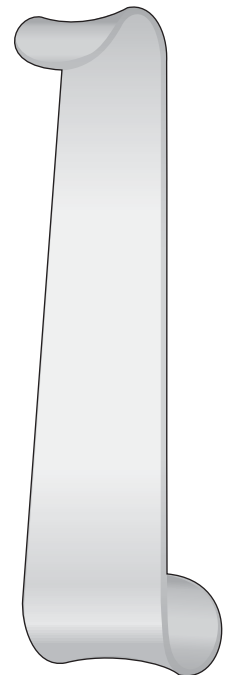

34x44 mm
ROUX-MAGNUS
0219-CIL
170 mm

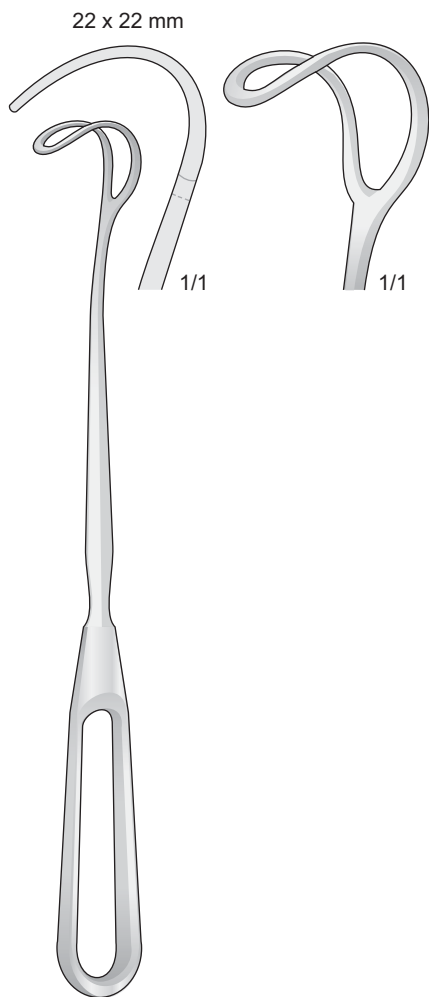

GREENE
0219-BDB
225 mm

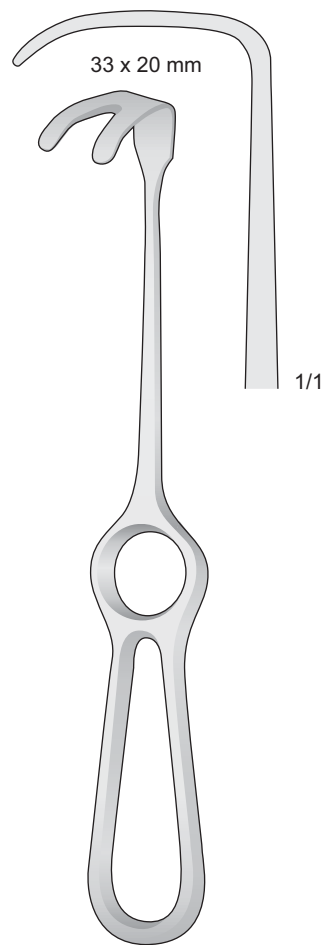

WASSMUND
0219-GL
220 mm

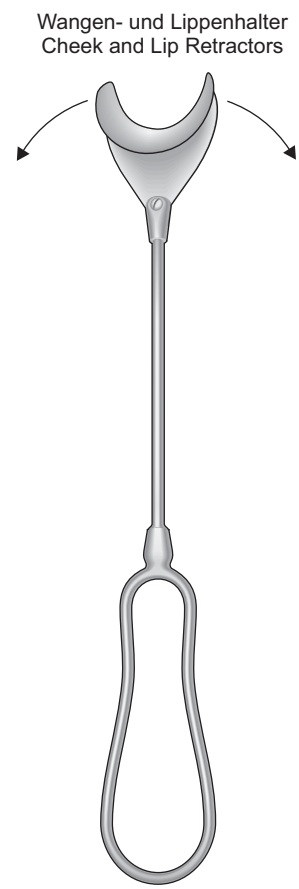

0219-BDC
200 mm

Wundhaken

Retractors

Divaricatori

Separadores

Ecarteurs

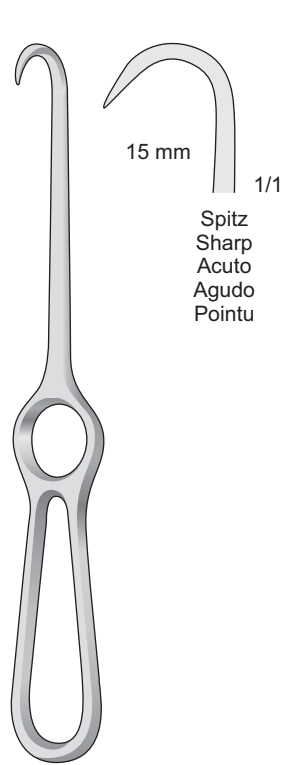

KOCHER
0219-BDL
205 mm

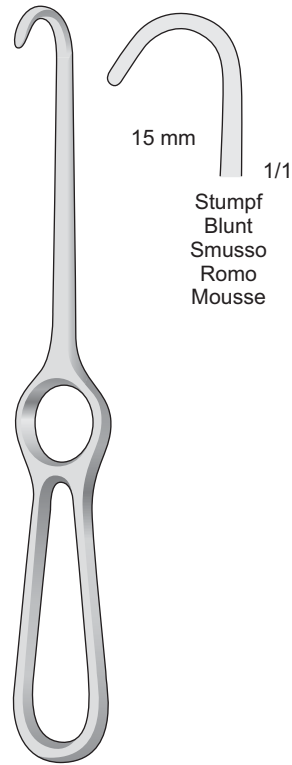

KOCHER
0219-BEA
220 mm

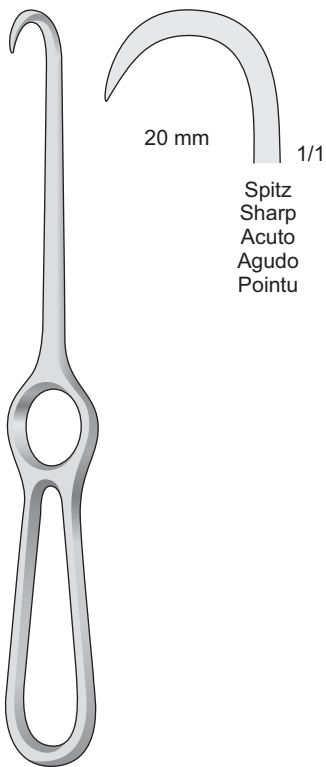

VOLKMANN
0219-BCG
220 mm

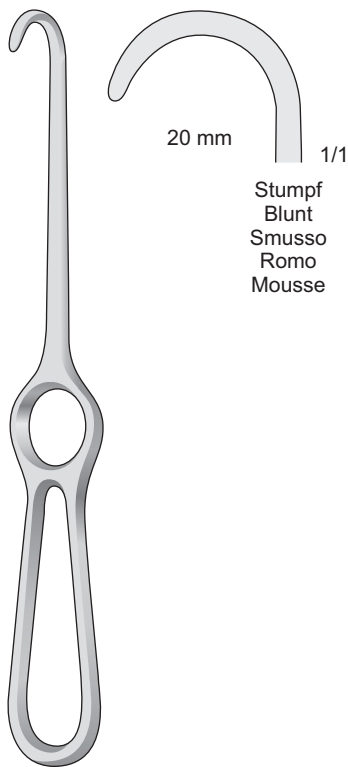

VOLKMANN
0219-BCH
220 mm

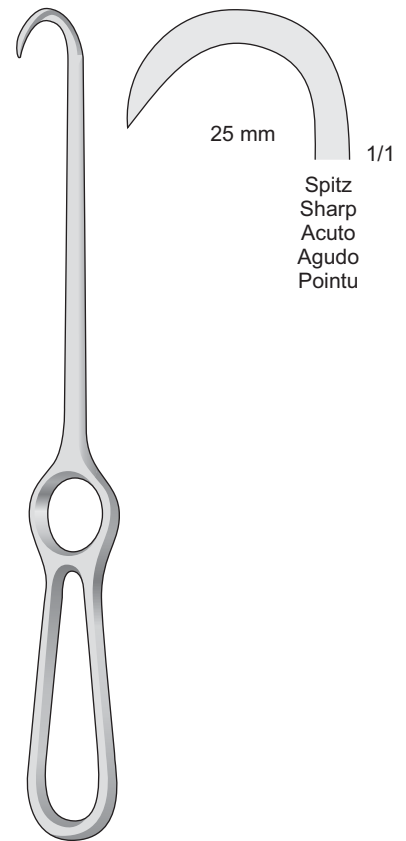

0219-BCI
245 mm

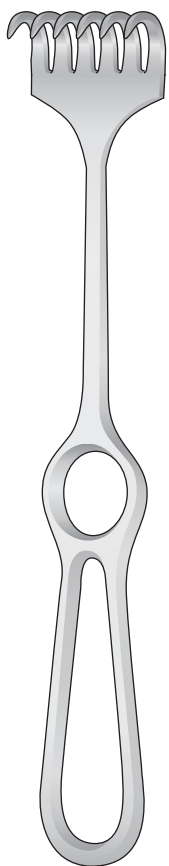

VOLKMANN
0219-BAB/0219-BAI
220 mm

Spitz
Sharp
Acuto
Agudo
Pointu

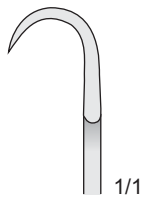

0219-BAB
9 x 8 mm



0219-BAD
9 x 13 mm



0219-BAF
9 x 19 mm

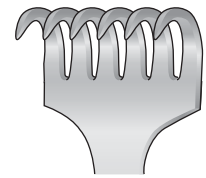

0219-BAH
9 x 29 mm

Stumpf
Blunt
Smusso
Romo
Mousse

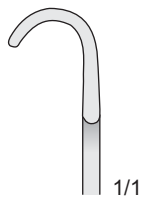

0219-BAC
9 x 8 mm



0219-BAE
9 x 13 mm



0219-BAG
9 x 19 mm

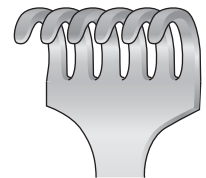

0219-BAI
9 x 29 mm

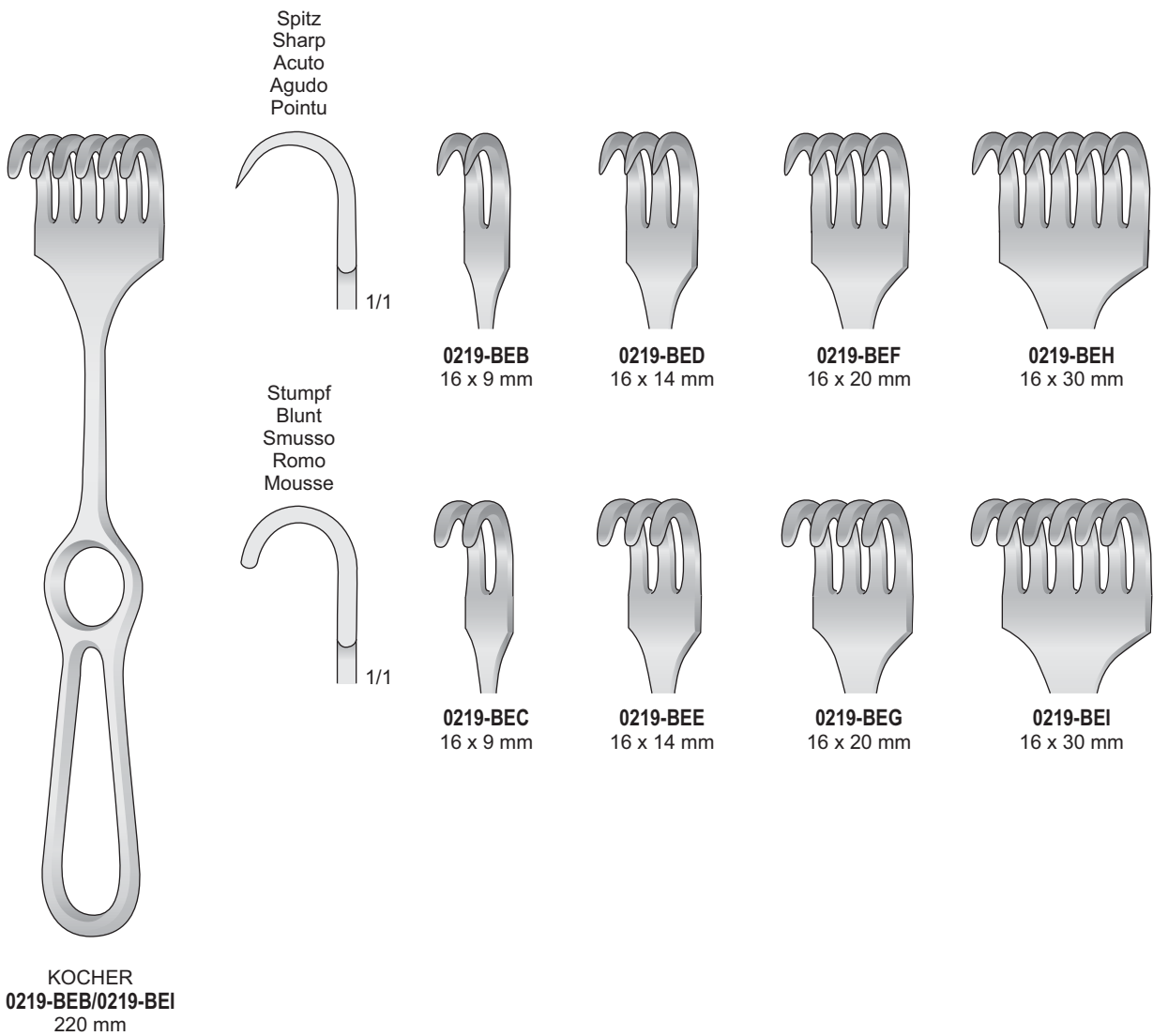

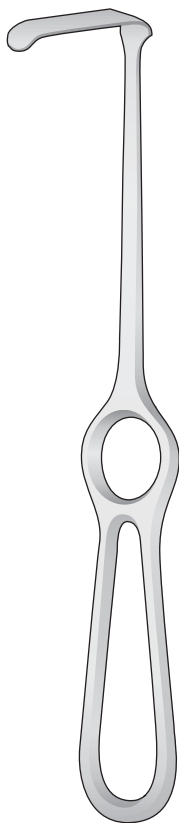

KOCHER-LANGENBECK
0219-GA/0219-CGD
215 mm

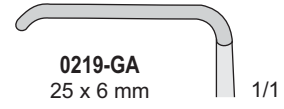

0219-GA
25 x 6 mm

1/1

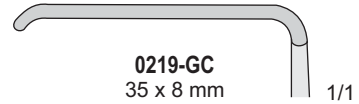

0219-GC
35 x 8 mm

1/1

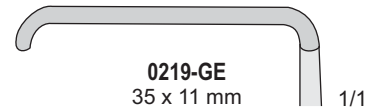

0219-GE
35 x 11 mm

1/1

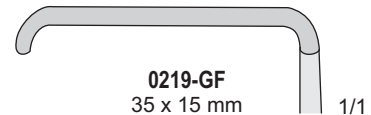

0219-GF
35 x 15 mm

1/1

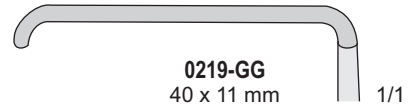

0219-GG
40 x 11 mm

1/1

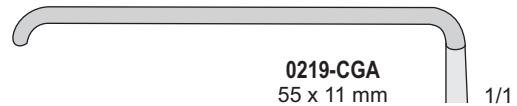

0219-CGA
55 x 11 mm

1/1



0219-CGB
70 x 14 mm

1/1

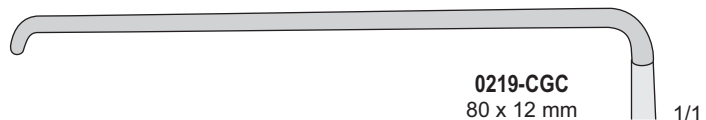

0219-CGC
80 x 12 mm

1/1



0219-CGD
80 x 16 mm

1/1

Wundhaken

Retractors

Divaricatori

Separadores

Ecarteurs



42 x 10 mm

1/1

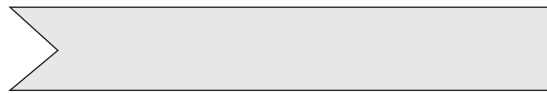

70 x 11 mm

1/1



35 x 8 mm

1/1

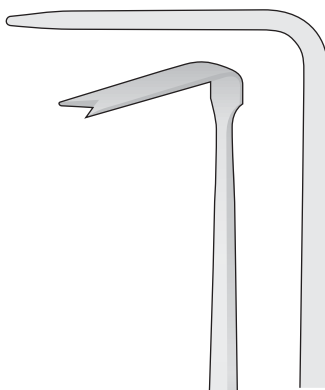

1/1

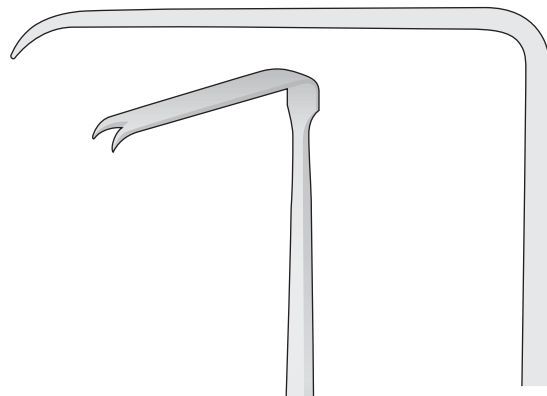

1/1

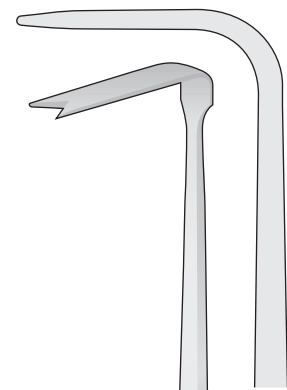

1/1

OBWEGESER
0219-GH
215 mm

0219-GI
220 mm

0219-BDA
215 mm

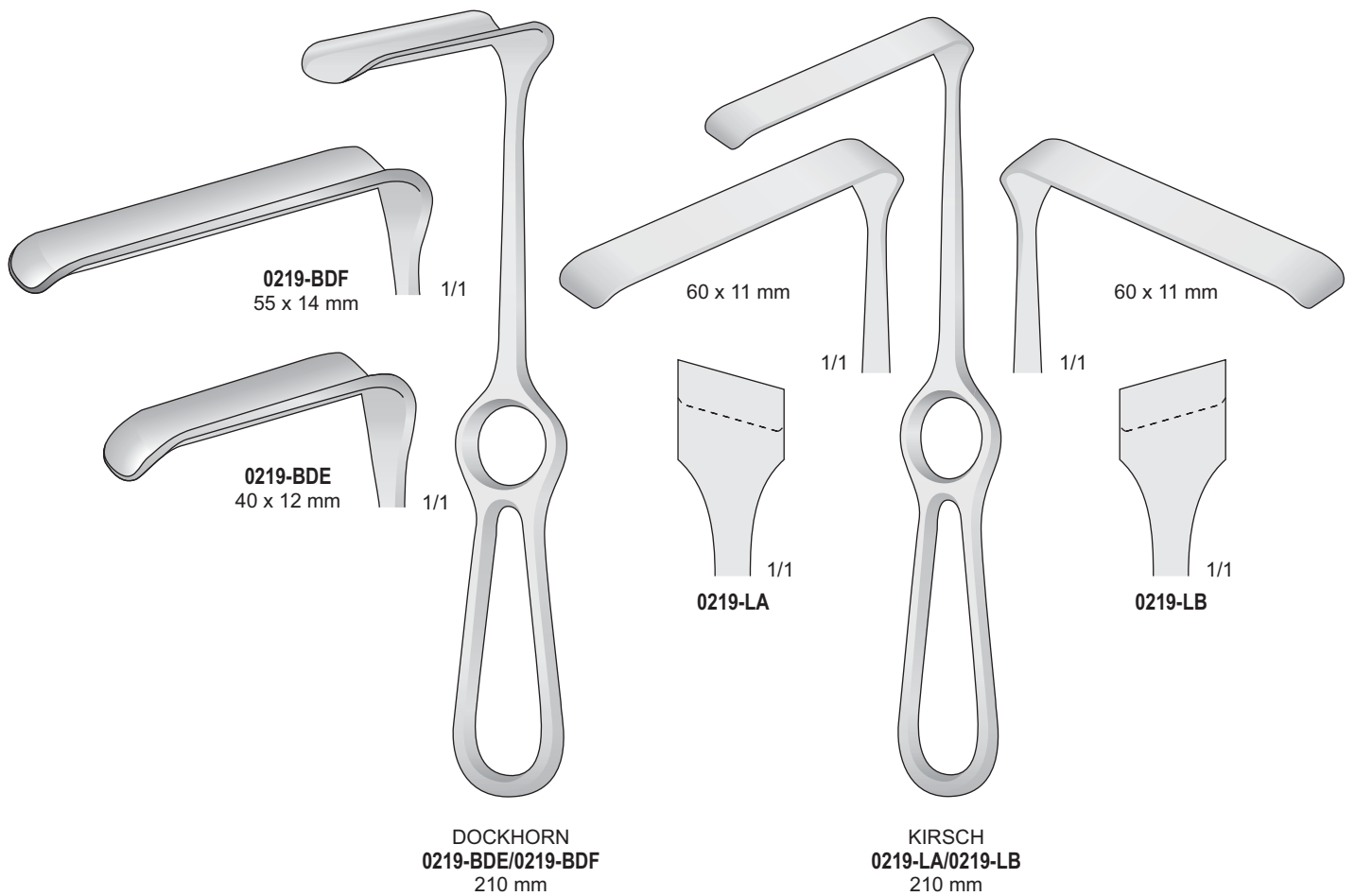

Wundhaken

Retractors

Divaricatori

Separadores

Ecarteurs

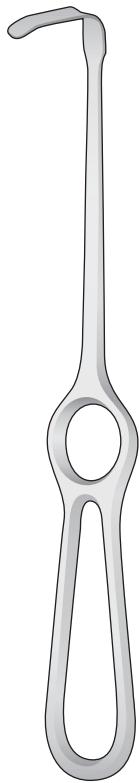

OBWEGESER
0219-BFC/0219-BFH
220 mm

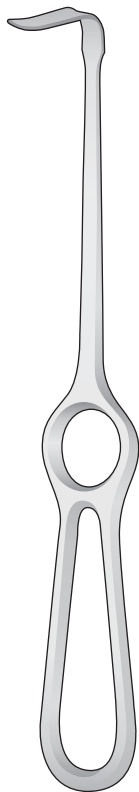

OBWEGESER
0219-LC/0219-BAA
220 mm

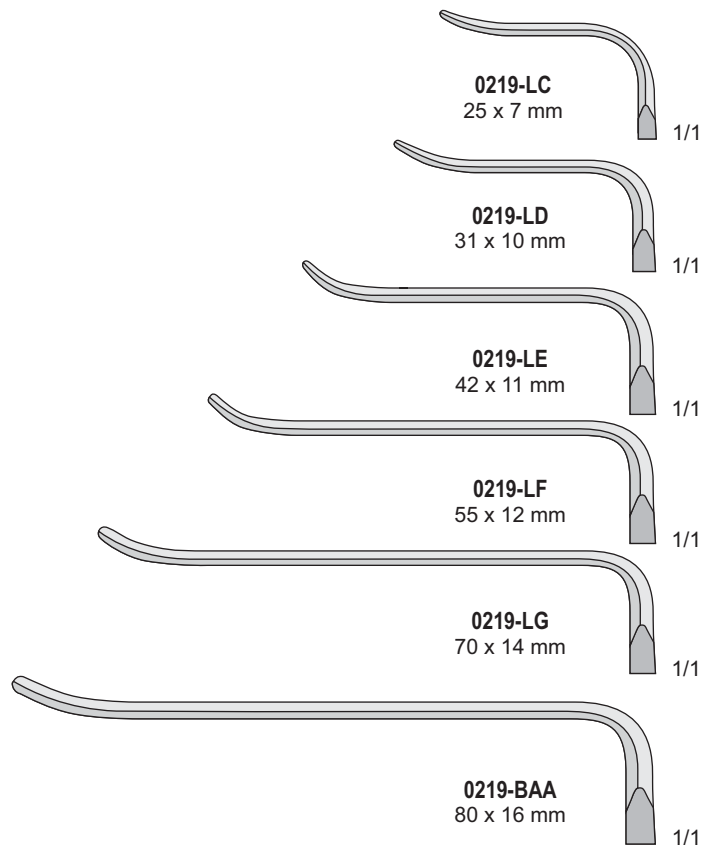
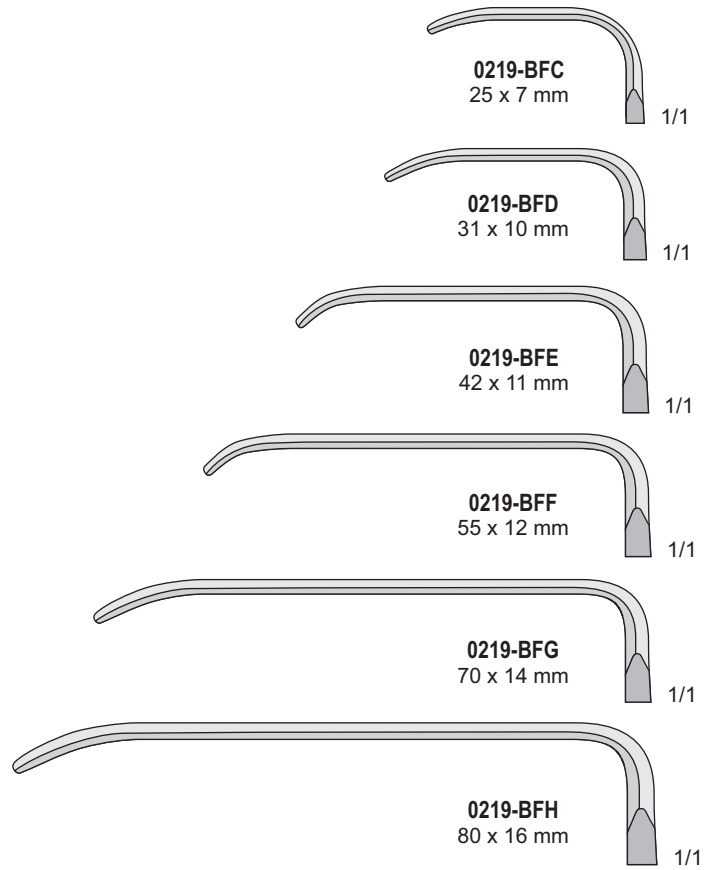

Wundhaken

Retractors

Divaricatori

Separadores

Ecarteurs

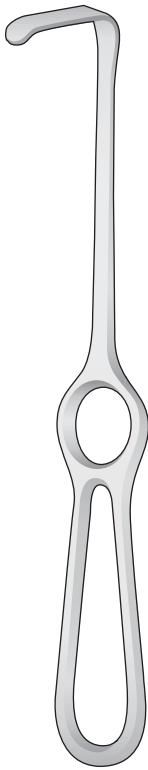

LANGENBECK
0219-DD/0219-ED
210 mm

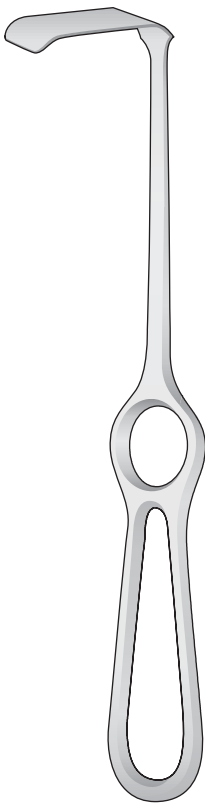

KOCHER
0219-CFA/0219-CFE
230 mm

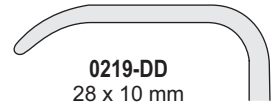

0219-DD
28 x 10 mm 1/1

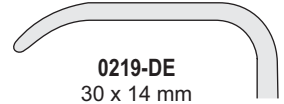

0219-DE
30 x 14 mm 1/1

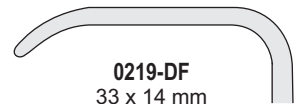

0219-DF
33 x 14 mm 1/1

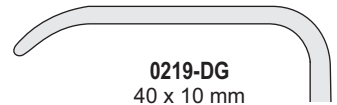

0219-DG
40 x 10 mm 1/1

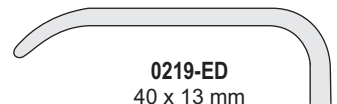

0219-ED
40 x 13 mm 1/1



0219-CFA
40 x 18 mm 1/1

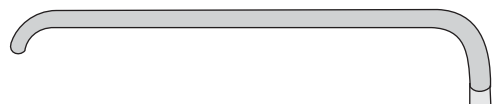

0219-CFB
60 x 20 mm 1/1

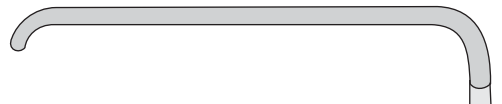

0219-CFC
60 x 25 mm 1/1



0219-CFD
75 x 30 mm 1/1

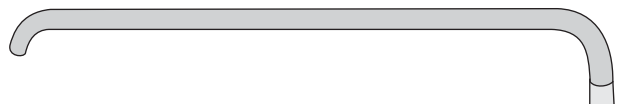

0219-CFE
75 x 40 mm 1/1

Wundhaken

Retractors

Divaricatori

Separadores

Ecarteurs

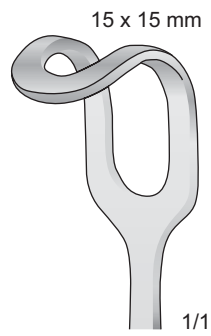

0219-IA
225 mm

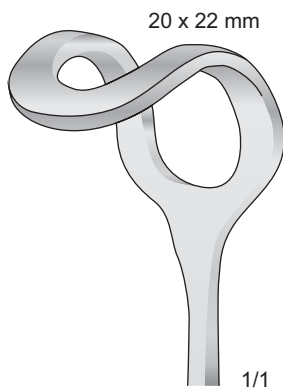

0219-IB
225 mm

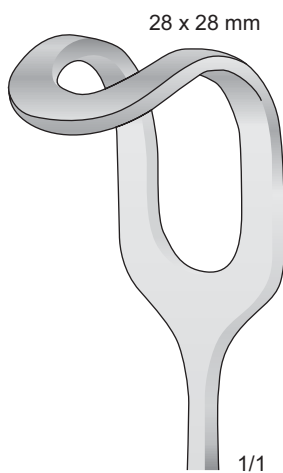

0219-IC
225 mm



KOCHER
0219-BBH/0219-BBI
205 mm

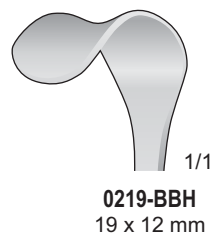

0219-BBH
19 x 12 mm

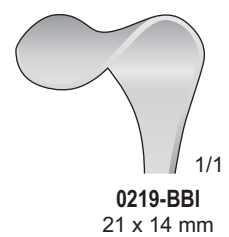

0219-BBI
21 x 14 mm

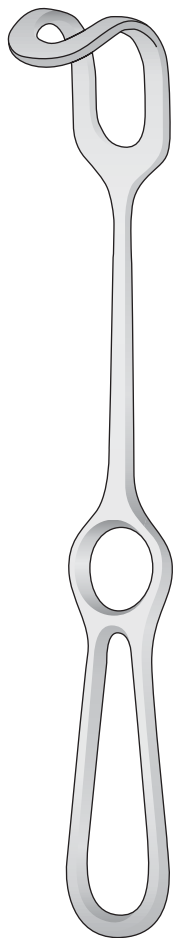

MIDDELDORPF
0219-IA/0219-IC
225 mm

Biegsame Spatel,
Niehtrostend

Malleable Spatulas,
Stainless Steel

Spatole malleabili,
acciaio inossidabile

Espátulas flexible,
Aciero inoxidable

Spatules flexible,
Acier Inoxydable

1412-IF
 Komplettsset mit 3 Spatel
 Set complete with 3 spatulas
 Set completo con 3 spatole
 Set completos con 3 espátulas
 Set complete avec 3 spatules
1412-IA + 1412-IB + 1412-IC

Schwarz Verchromt
 Black anodized
 Cromato nero
 Cromado en negro
 Chromé noir

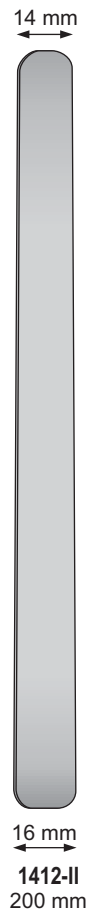
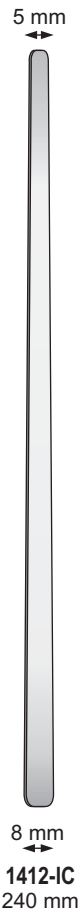
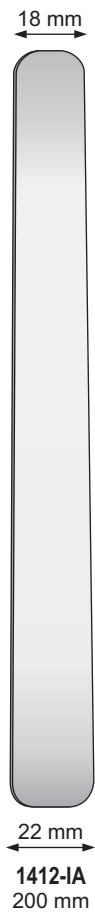

Wundspreizer

Retractors

Divaricatori

Separadores

Ecarteurs

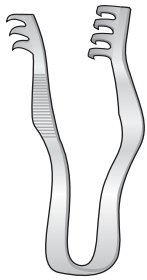

FINSEN
0221-DG/0221-DL
50 mm

Spitz 3x2 Zähne
Sharp 3x2 Teeth
Acuto 3x2 Denti
Agudas 3x2 Dientes
Pointù 3x2 Griffes

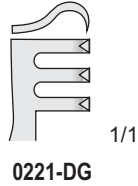

0221-DG

Stumpf 3x2 Zähne
Blunt 3x2 Teeth
Smusso 3x2 Denti
Romas 3x2 Dientes
Mousse 3x2 Griffes

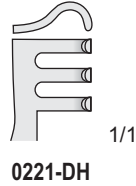

0221-DH

Spitz 3x4 Zähne
Sharp 3x4 Teeth
Acuto 3x4 Denti
Agudas 3x4 Dientes
Pointù 3x4 Griffes

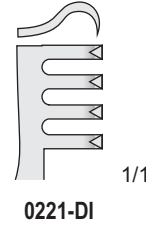

0221-DI

Stumpf 3x4 Zähne
Blunt 3x4 Teeth
Smusso 3x4 Denti
Romas 3x4 Dientes
Mousse 3x4 Griffes

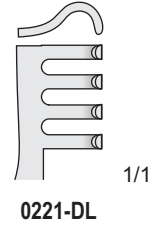

0221-DL

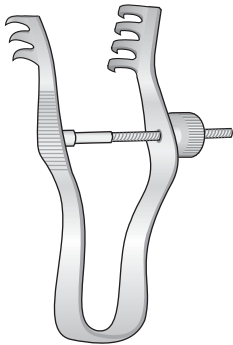

FINSEN
0221-EH/0221-EI
70 mm

Spitz
Sharp
Acuto
Agudas
Pointù

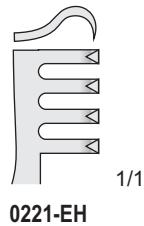

0221-EH

Stumpf
Blunt
Smusso
Romas
Mousse

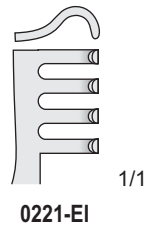

0221-EI

Spitz
Sharp
Acuto
Agudas
Pointù

Stumpf
Blunt
Smusso
Romas
Mousse

Stumpf
Blunt
Smusso
Romas
Mousse

Stumpf
Blunt
Smusso
Romas
Mousse

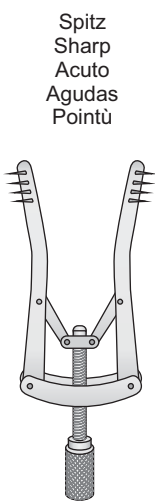

ALM
0221-BC
70 mm

Stumpf
Blunt
Smusso
Romas
Mousse

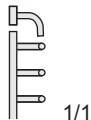

0221-EL
70 mm

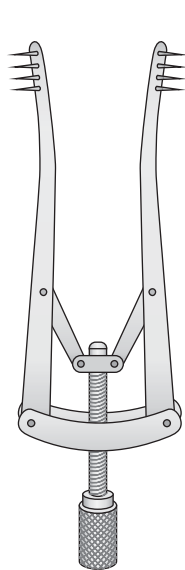

ALM
0221-BA
100 mm

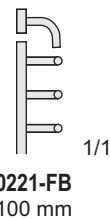

0221-FB
100 mm

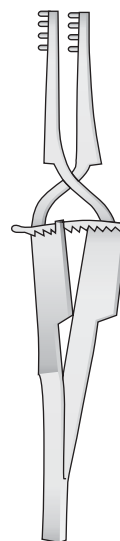

0221-AI
100 mm

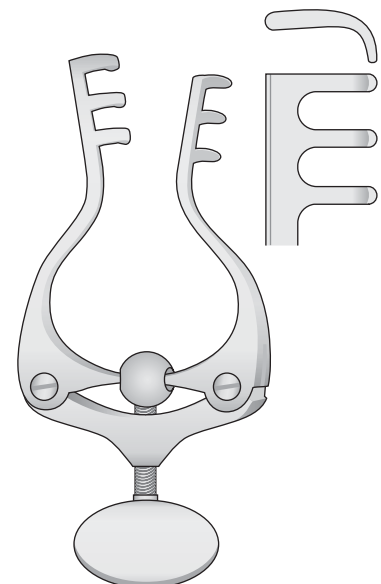

JANSEN
0221-FC
100 mm

Wundspreizer

Retractors

Divaricatori

Separadores

Ecarteurs

Spitz
Sharp
Acuto
Agudas
Pointü

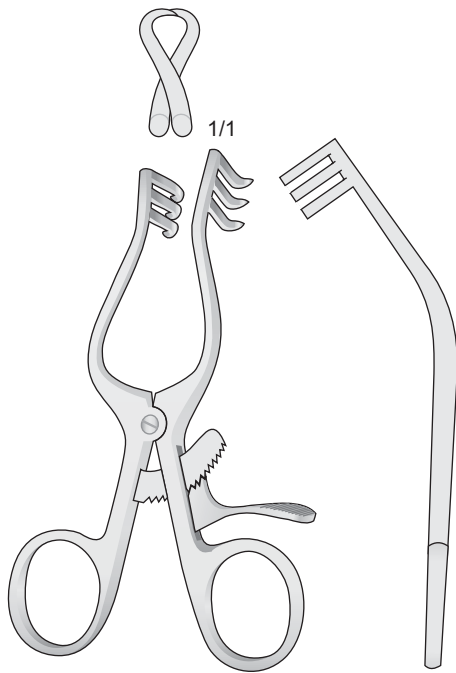

WULLSTEIN
0221-BBB
105 mm

Stumpf
Blunt
Smusso
Romas
Mousse

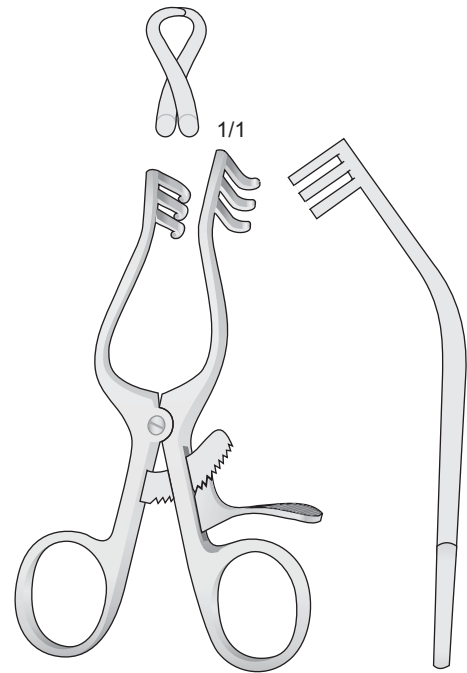

WULLSTEIN
0221-BBC
105 mm

Spitz
Sharp
Acuto
Agudas
Pointü

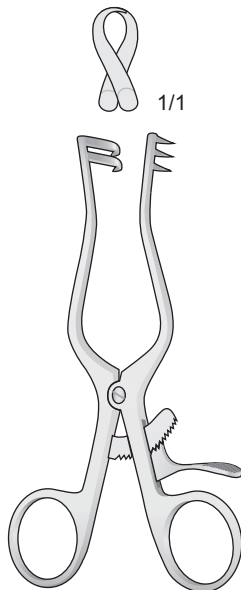

WEITLANER
0221-AH
110 mm

Stumpf
Blunt
Smusso
Romas
Mousse

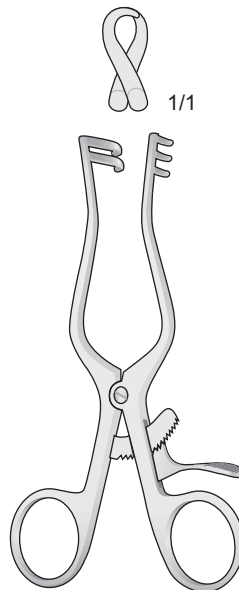

WEITLANER
0221-AL
110 mm

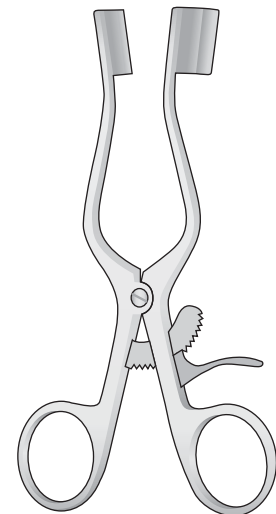
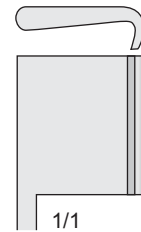

BABY-WEITLANER
0221-CG
140 mm

Wundspreizer

Retractors

Divaricatori

Separadores

Ecarteurs

Halbscharf - Semi Sharp - Semi acuto
Semi Agudas - Semi Pointu

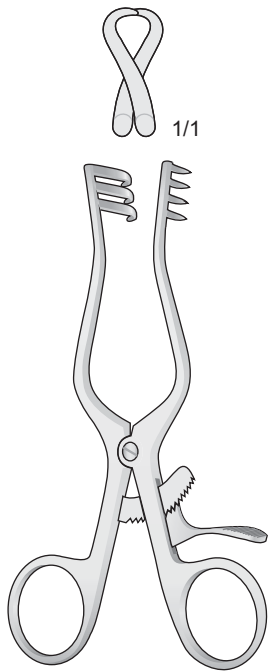

WEITLANER
0221-BI
135 mm

Spitz - Sharp - Acuto
Agudas - Pointu

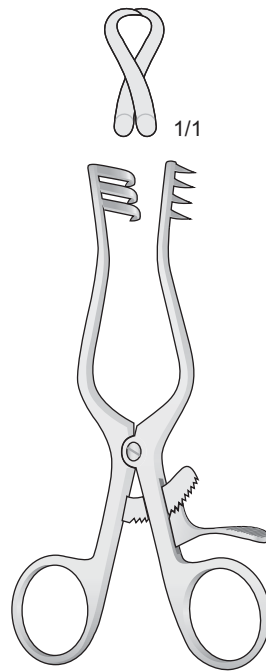

WEITLANER
0221-CA
135 mm

Stumpf - Blunt - Smusso
Romas - Mousse

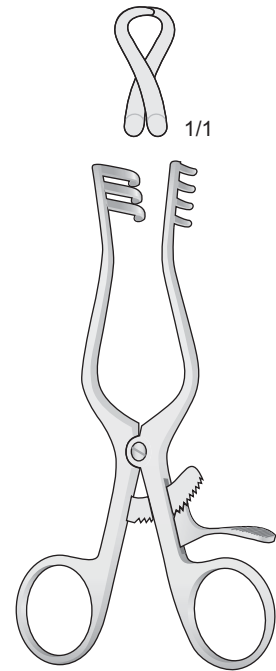

WEITLANER
0221-CC
135 mm

Halbscharf - Semi Sharp - Semi acuto
Semi Agudas - Semi Pointu

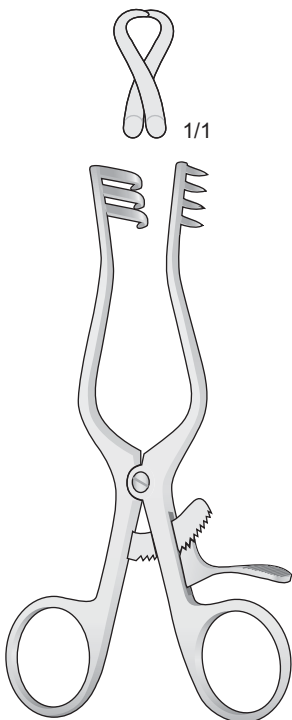

WEITLANER
0221-BL
165 mm

Spitz - Sharp - Acuto
Agudas - Pointu

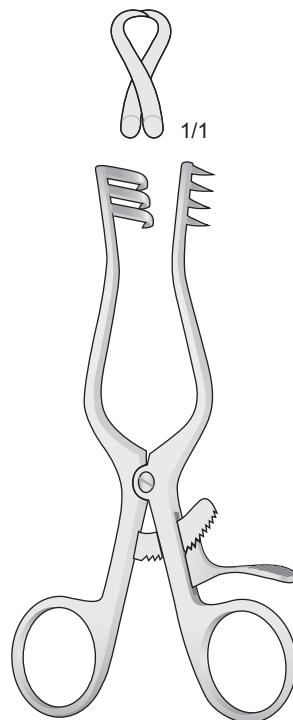

WEITLANER
0221-CB
165 mm

Stumpf - Blunt - Smusso
Romas - Mousse

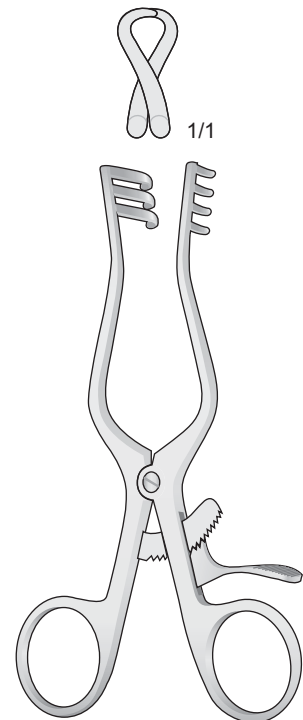

WEITLANER
0221-CD
165 mm

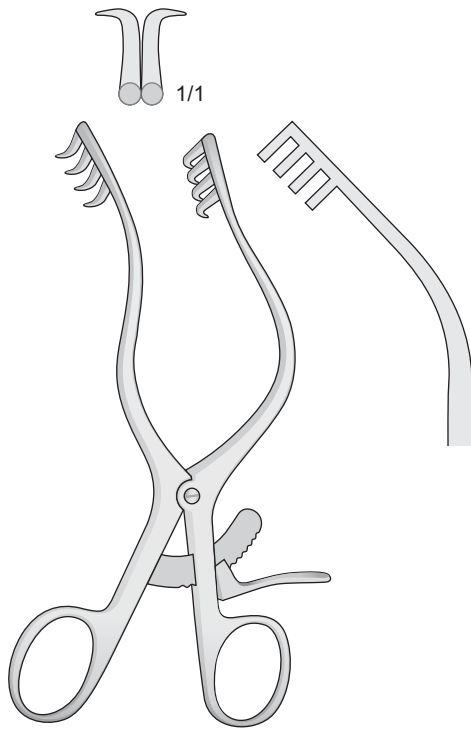

MOLLISON
0221-BBA
160 mm

Acuto - Sharp - Spitz
Pointu - Agudas

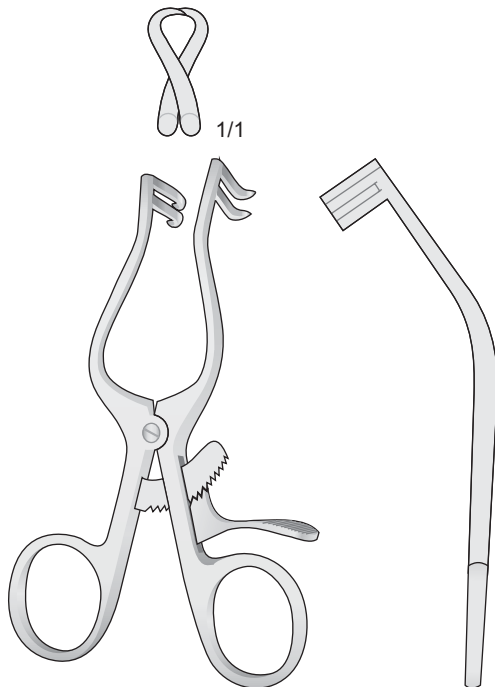

PLESTER
0221-LC
135 mm

Smusso - Blunt - Stumpf
Mousse - Romas

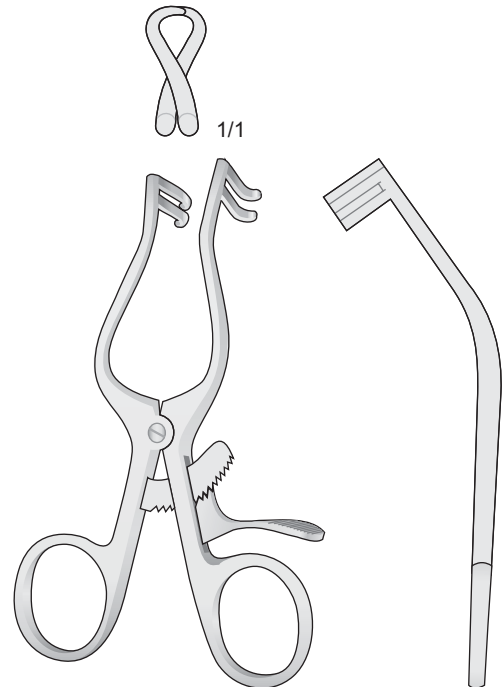

PLESTER
0221-LD
135 mm

Stumpf - Blunt - Smusso - Romas - Mousse

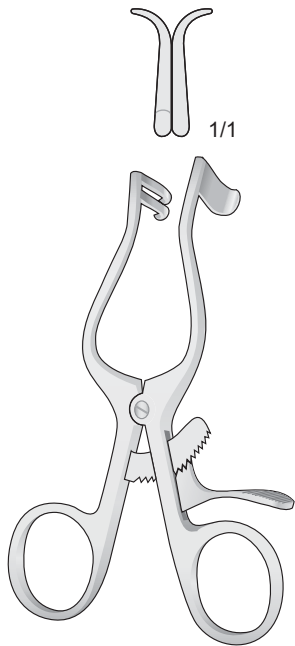

PLESTER
0221-LE
110 mm

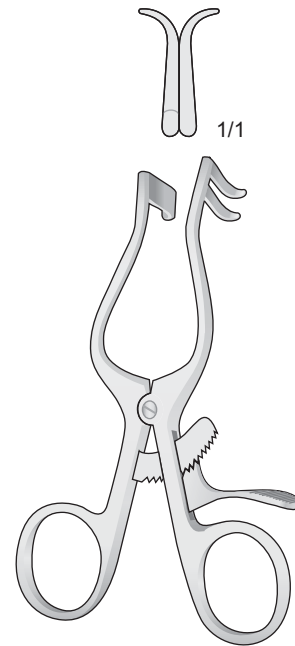

PLESTER
0221-LF
110 mm

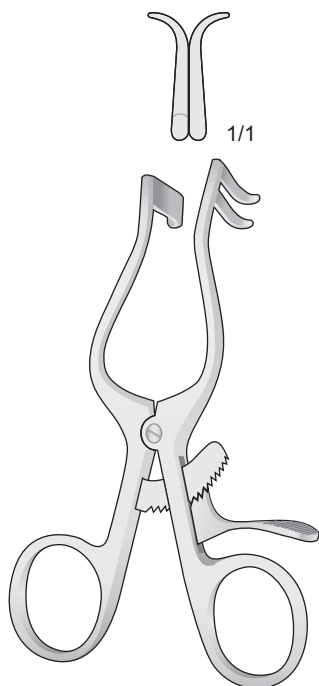

PLESTER
0221-LG
135 mm

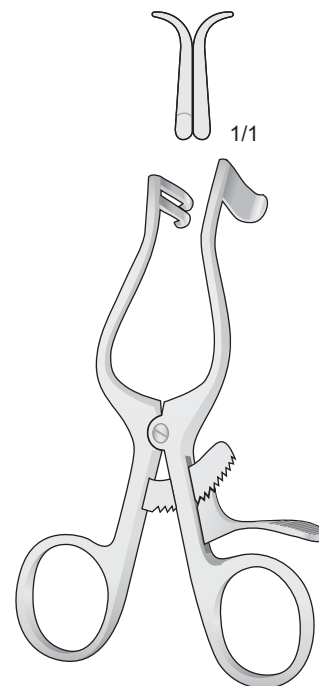

PLESTER
0221-LH
135 mm

Wundhaken

Retractors

Divaricatori

Separadores

Ecarteurs

3x4 Zähne
3x4 Teeth
3x4 Denti
3x4 Dientes
3x4 Dents

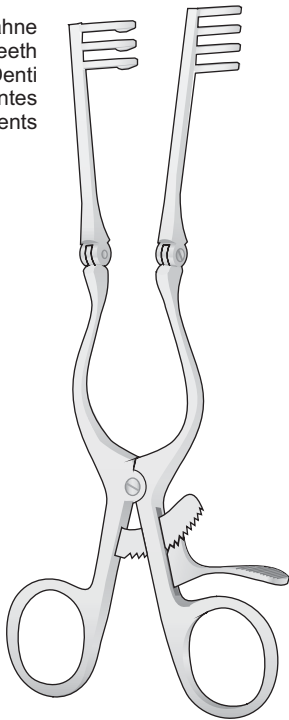

ADSON
0221-GI/0221-HA

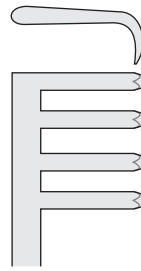

0221-GI
140 mm

Spitz
Scharp
Acuto
Agudo
Pointu

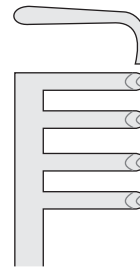

0221-HA
140 mm

Stumpf
Blunt
Smusso
Romas
Mousse

Blatte, Linkes
Blades, left
Valva, sinistro
Valvas, izquierda
Valves, gauche
13 x 20 mm

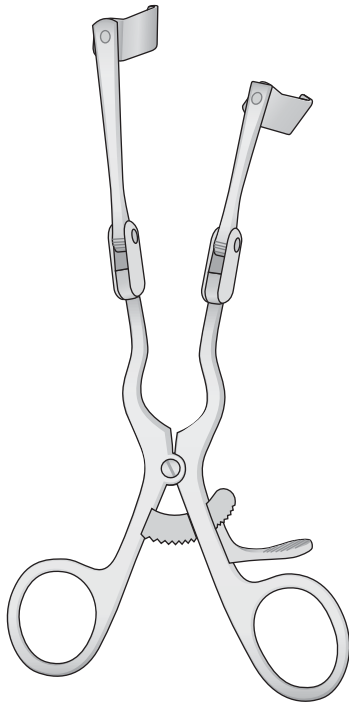

DOLWICK-REICH
0221-BAB
170 mm

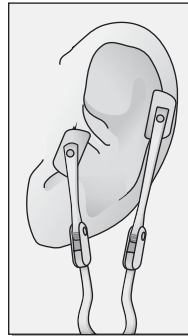

Blatte, Rechts
Blades, right
Valva, destro
Valvas, derecha
Valves, droite
13 x 20 mm

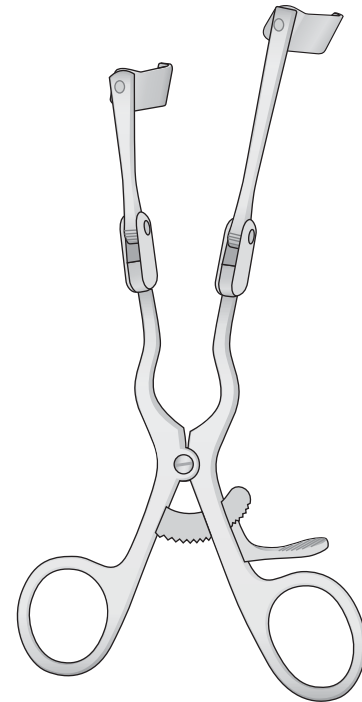

DOLWICK-REICH
0221-BAC
170 mm

4.6



Allgemeine HNO-Instrumentarium
General ENT Instruments
Strumentario generale per ORL
Instrumental general para ORL
Instruments généraux pour ORL

Nadelhalter
Needle Holders
Port'aghi
Portaagujas
Porte aiguilles

Mit Glatten maul
 With smooth jaws
 Con morso liscio
 Con mandibula lisa
 Avec mors lisses

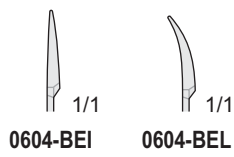
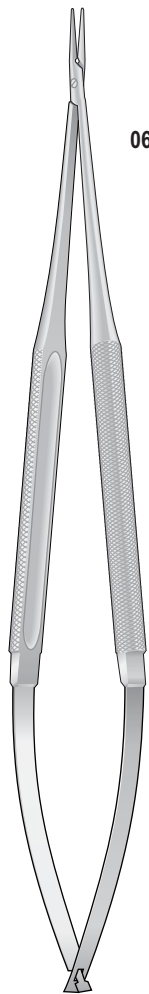

0604-BEI/0604-BEL
 185 mm

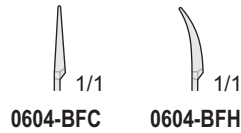
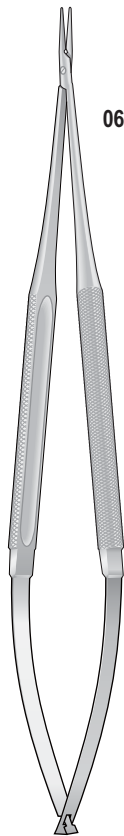

REILL
 0604-BFC/0604-BFH
 150 mm

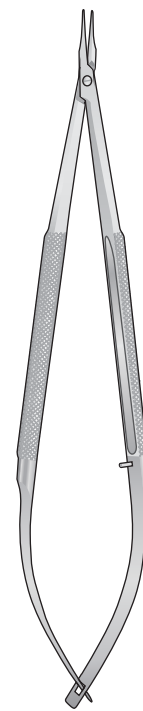

BARRAQUER
 0604-BFA/0604-BFB
 120 mm

Nadelhalter mit Hartmetalleinlagen
 Needle Holders with tungsten-carbide inserts
 Port'aghi con inserti al tungsteno
 Portaaguajas con plaquitas de carburo de tungsteno
 Porte aiguilles avec plaquettes en carbure de tungstène

Mit Glatten mau
 With smooth jaws
 Con morso liscio
 Con mandibula lisa
 Avec mors lisses

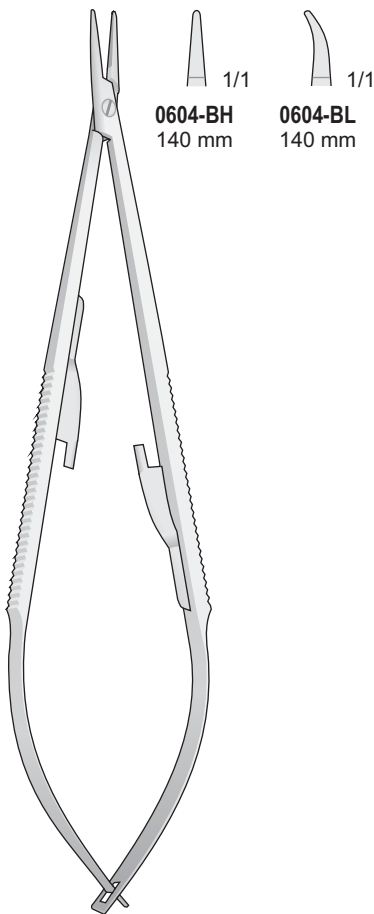

CASTROVIEJO
 0604-BH/0604-BL
 140 mm

Mit Glatten mau
 With smooth jaws
 Con morso liscio
 Con mandibula lisa
 Avec mors lisses

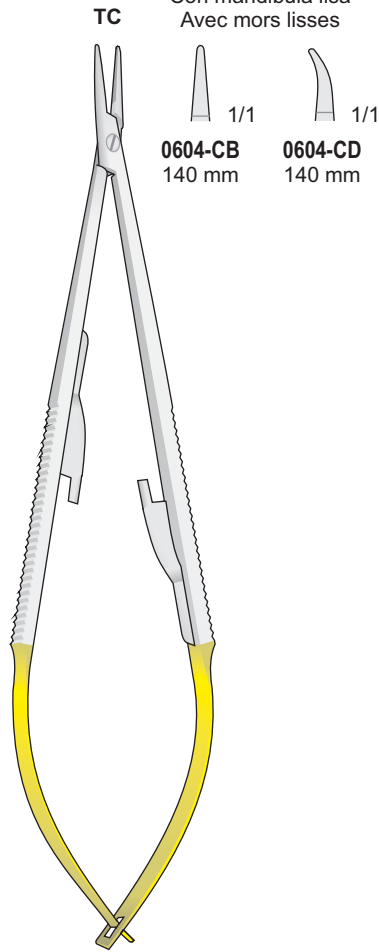

CASTROVIEJO
 0604-CB/0604-CD
 140 mm

TC

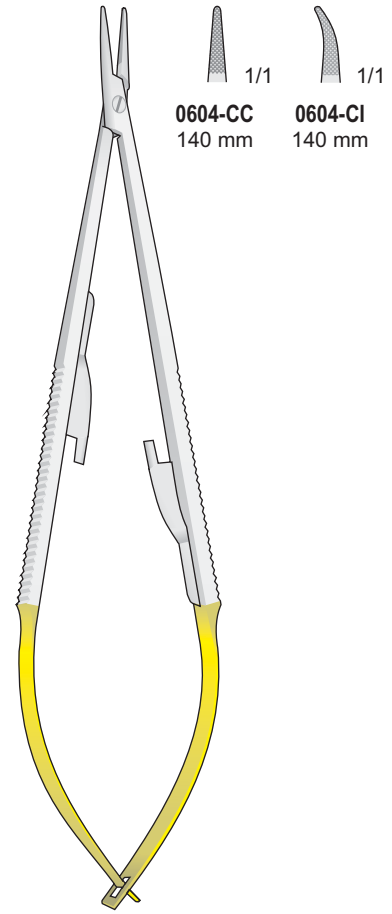

CASTROVIEJO
 0604-CC/0604-CI
 140 mm

Nadelhalter

Needle Holders

Port'aghi

Portaagujas

Porte aiguilles

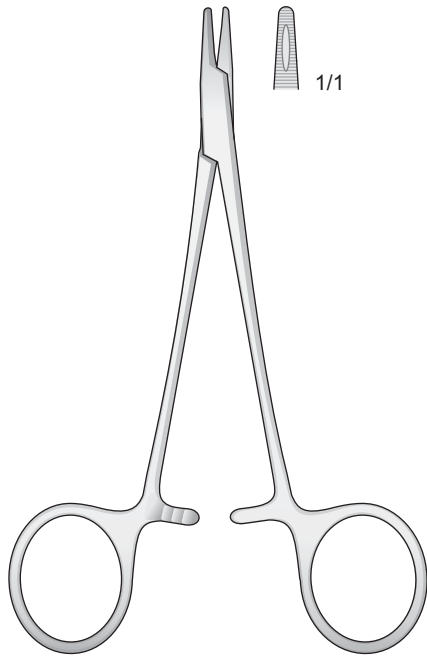

DERF
1508-DL
125 mm

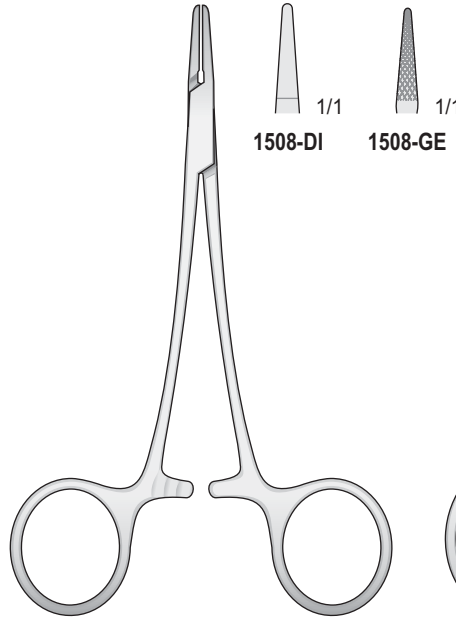

1508-DI/1508-GE
120 mm

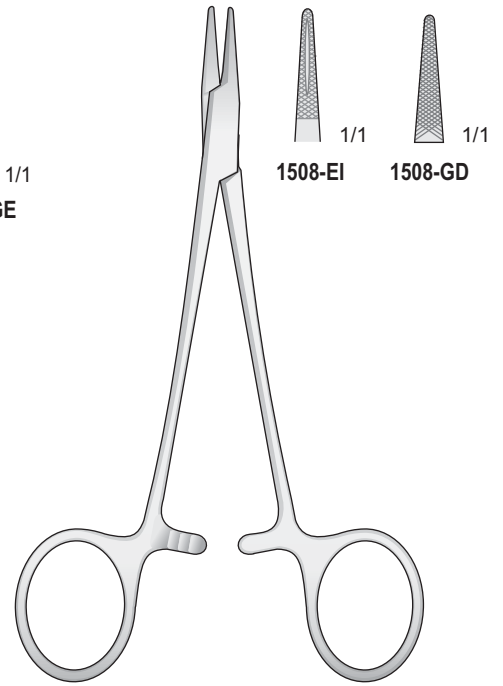

HALSEY
1508-EI/1508-GD
130 mm

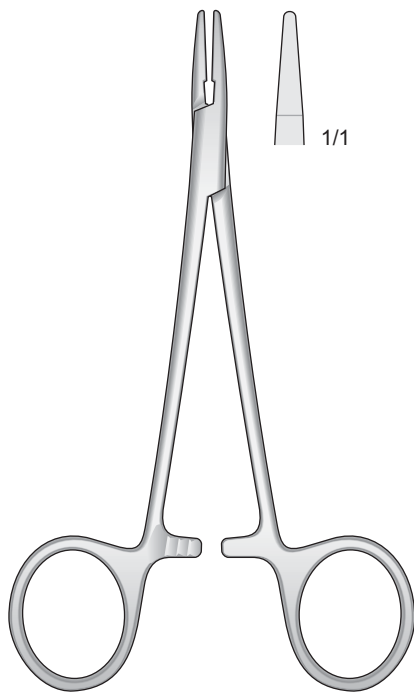

HALSEY
1508-DH
130 mm

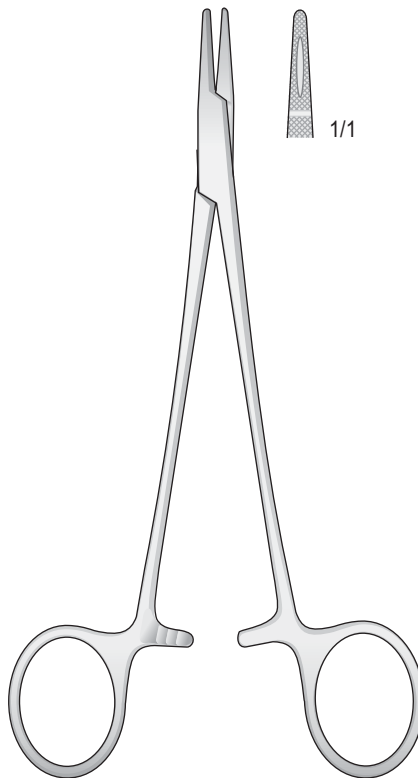

CRILE-WOOD
1508-GB
150 mm

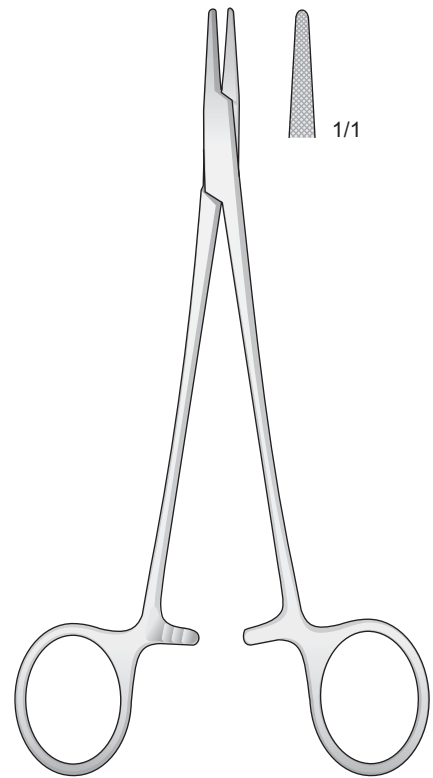

CRILE-MURRAY
1508-GC
150 mm

Nadelhalter

Needle Holders

Port'aghi

Portaagujas

Porte aiguilles

Nadelhalter mit Hartmetalleinlagen - Needle Holders with tungsten-carbide inserts
 Portaghi con inserti al tungsteno - Portaagujas con plaquitas de carburo de tungsteno
 Porte aiguilles avec plaquettes en carbure de tungstène

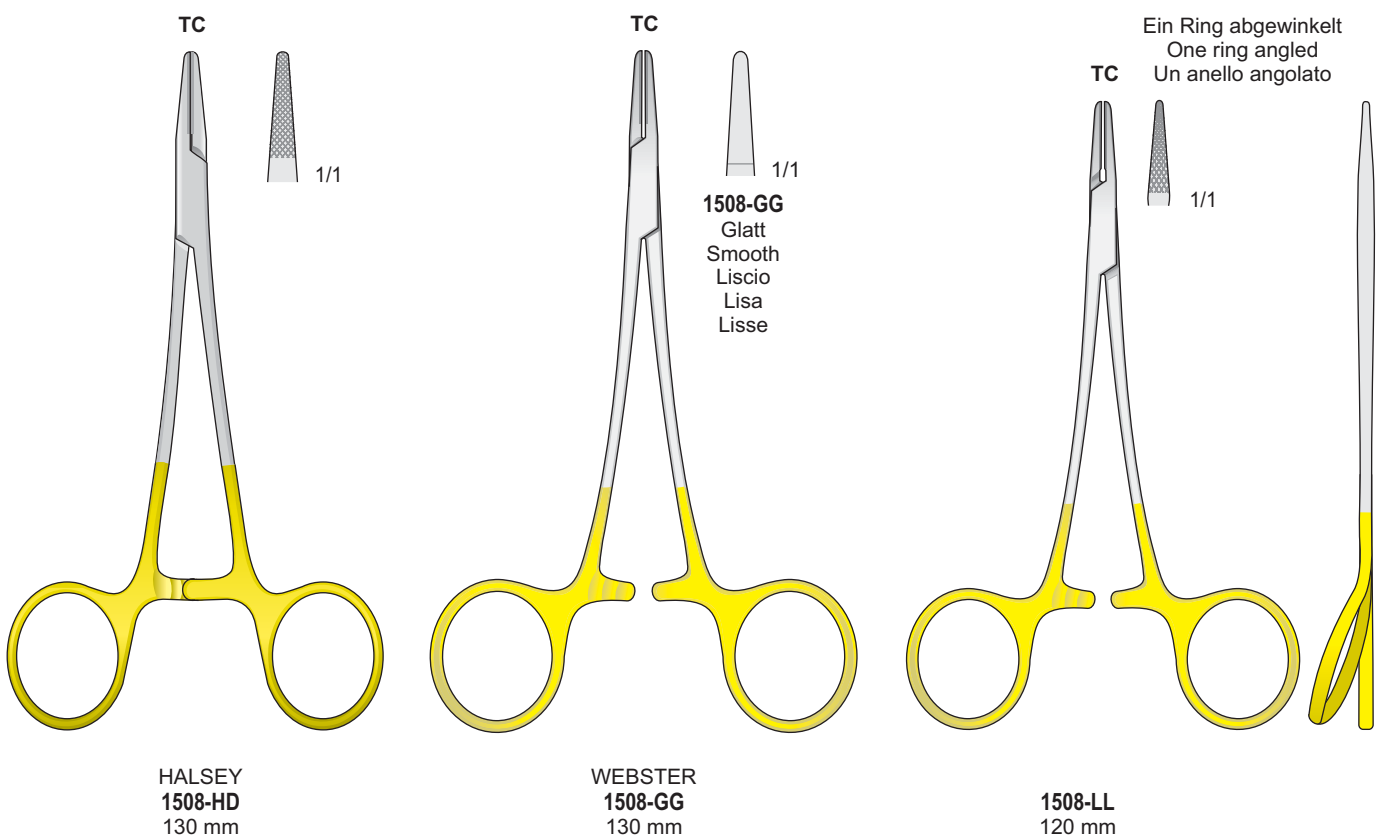
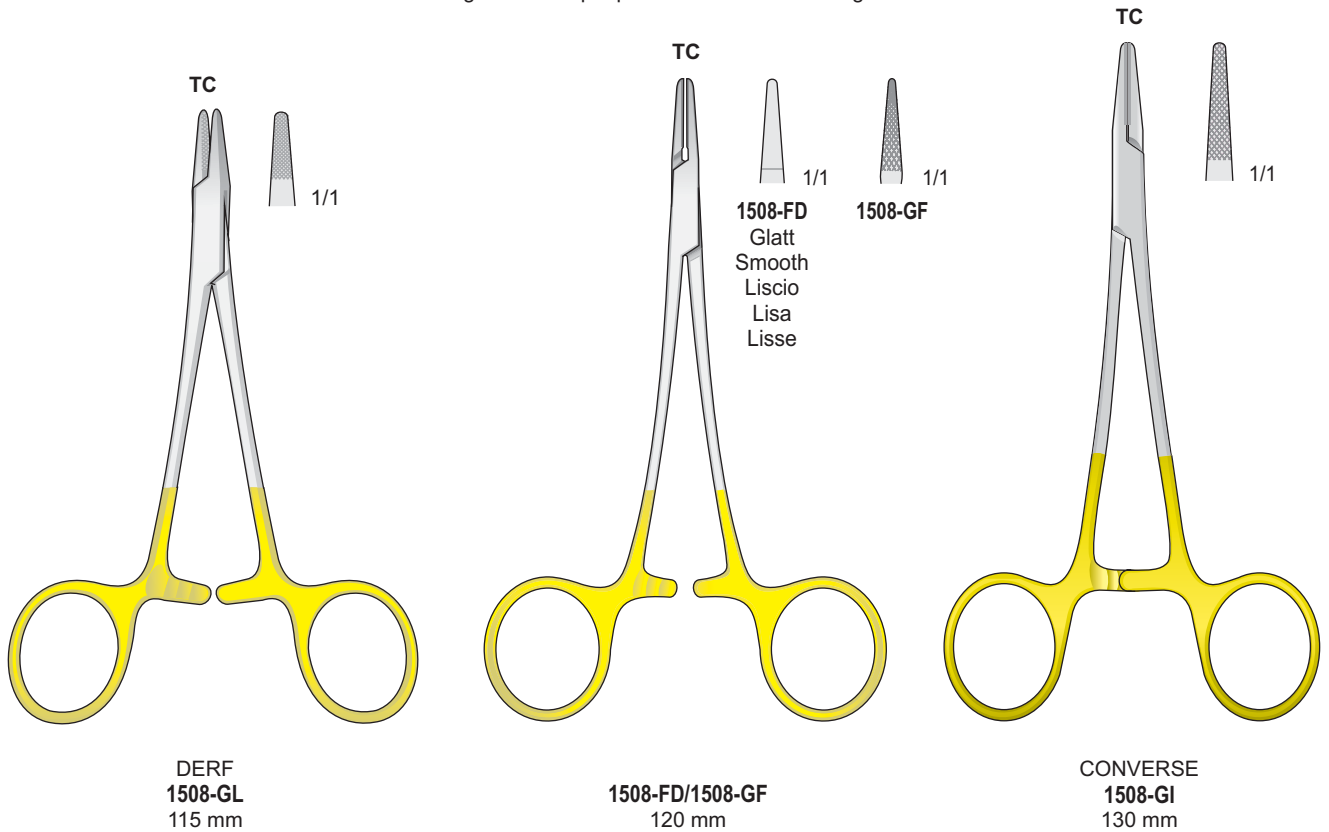

Nadelhalter mit Hartmetalleinlagen - Needle Holders with tungsten-carbide inserts
 Portaghi con inserti al tungsteno - Portaagujas con plaquitas de carburo de tungsteno
 Porte aiguilles avec plaquettes en carbure de tungstène

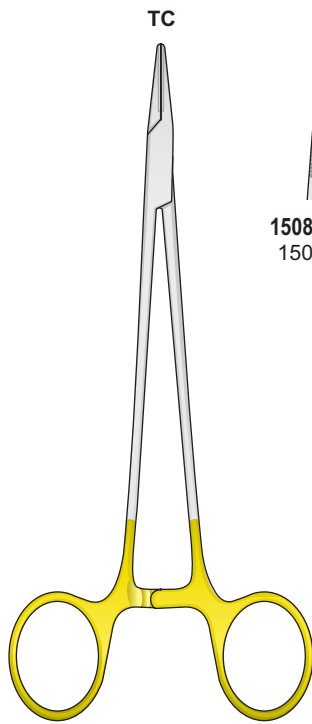

MICRO-VASCULAR
 1508-BAB/1508-BAE

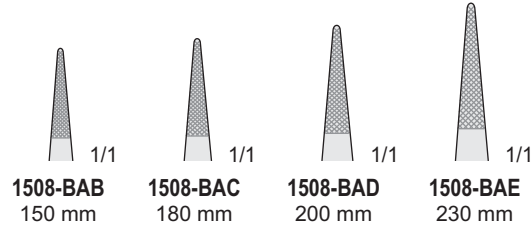

Vasculares - Vascular - Vascolari
 Vasculares - Vasculaires

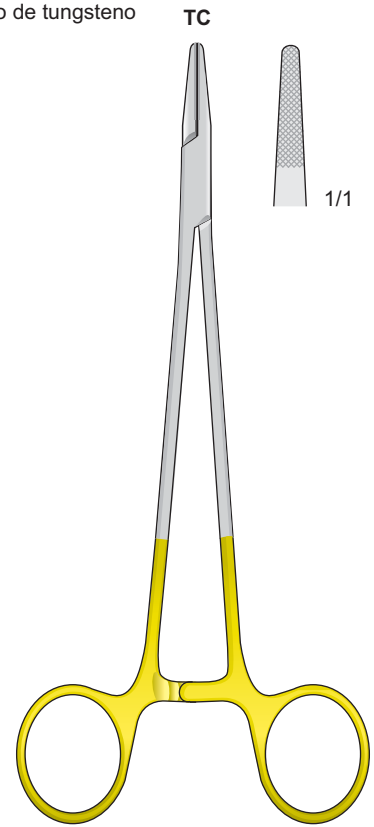

CRILE-WOOD
 1508-HH
 180 mm

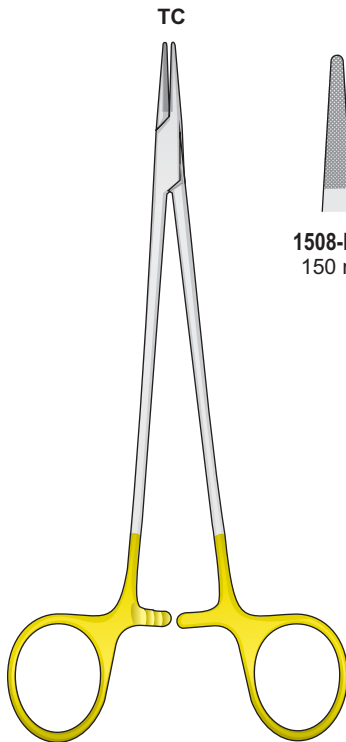

DE BAKEY
 1508-BBA/1508-BBC

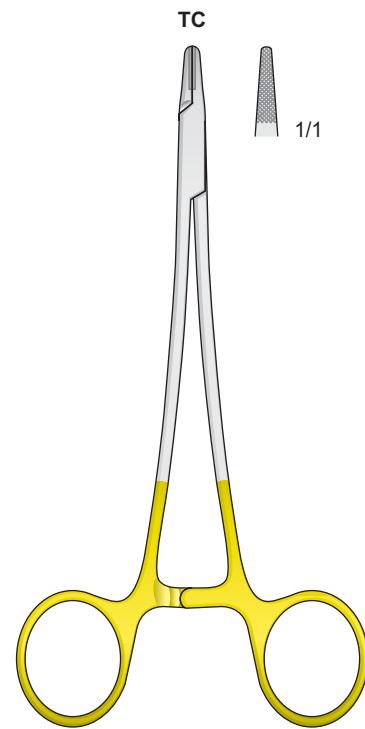
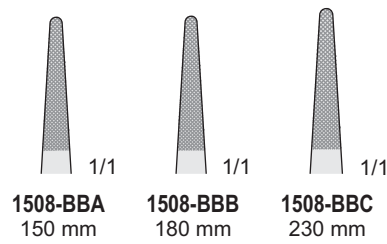

1508-HL
 145 mm

Nadelhalter

Needle Holders

Port'aghi

Portaagujas

Porte aiguilles

Nadelhalter mit Hartmetalleinlagen - Needle Holders with tungsten-carbide inserts
 Portaghi con inserti al tungsteno - Portaagujas con plaquitas de carburo de tungsteno
 Porte aiguilles avec plaquettes en carbure de tungstène

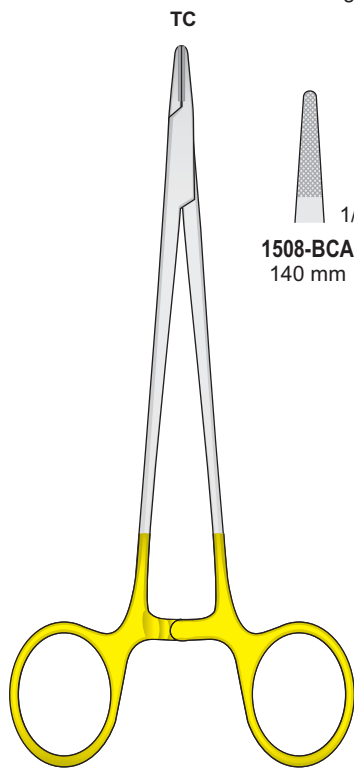

MAYO-HEGAR
 1508-BCA/1508-BCF

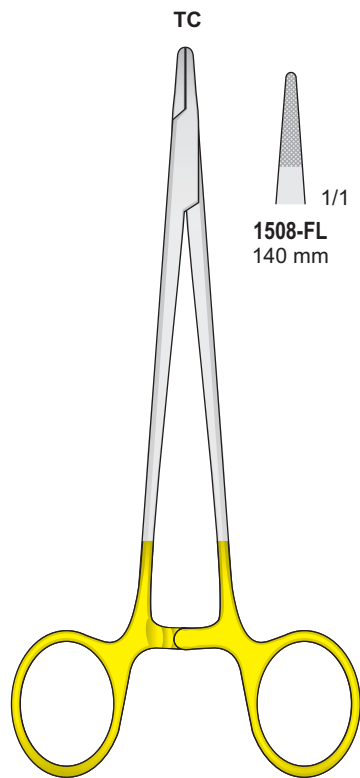
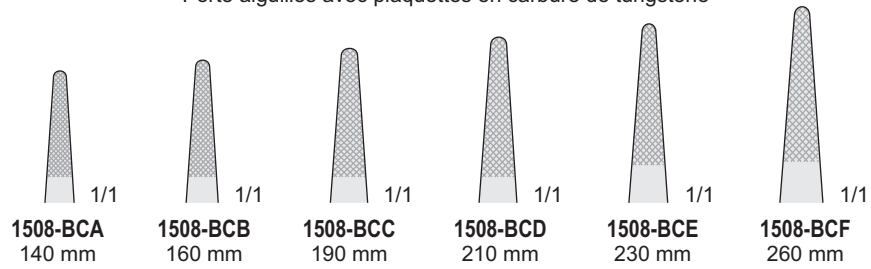

HEGAR
 1508-FL/1508-HG

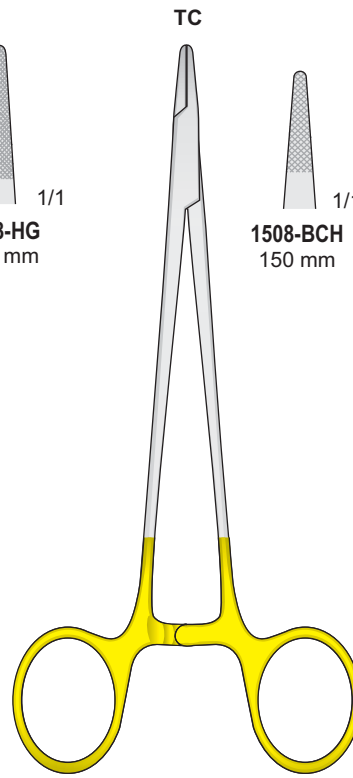
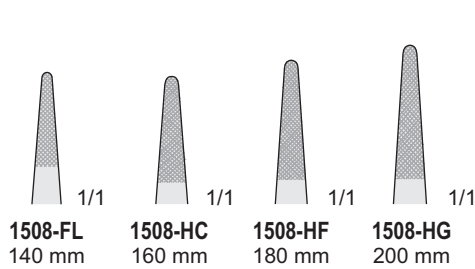

MAYO-HEGAR-FINO
 1508-BCH/1508-BCL

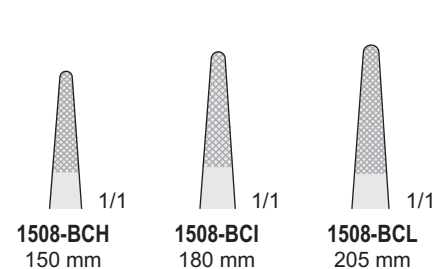

Nadelhalter mit Hartmetalleinlagen - Needle Holders with tungsten-carbide inserts
 Portaghi con inserti al tungsteno - Portaagujas con plaquitas de carburo de tungsteno
 Porte aiguilles avec plaquettes en carbure de tungstène

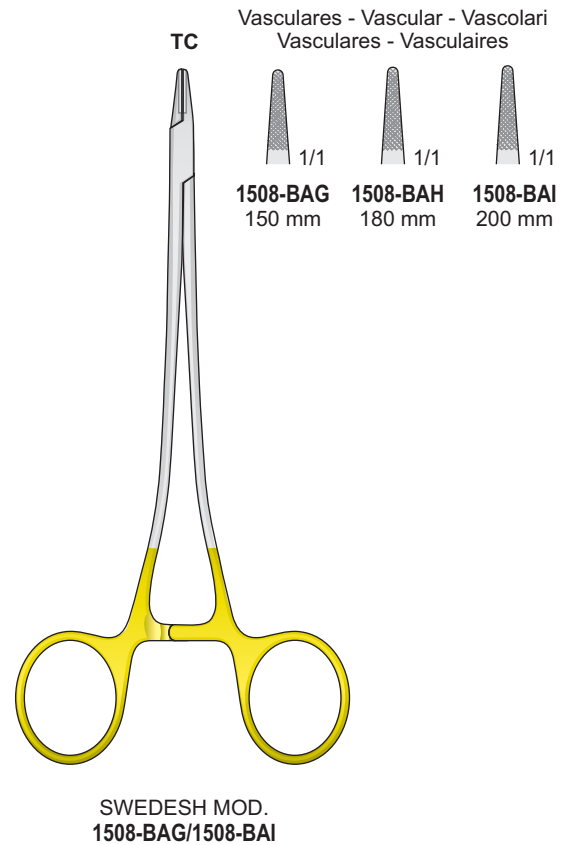
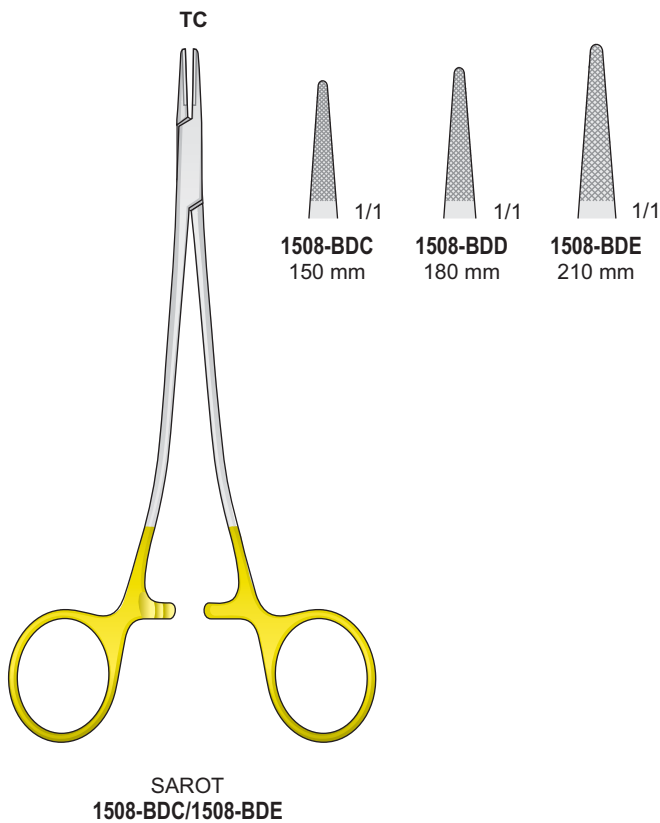
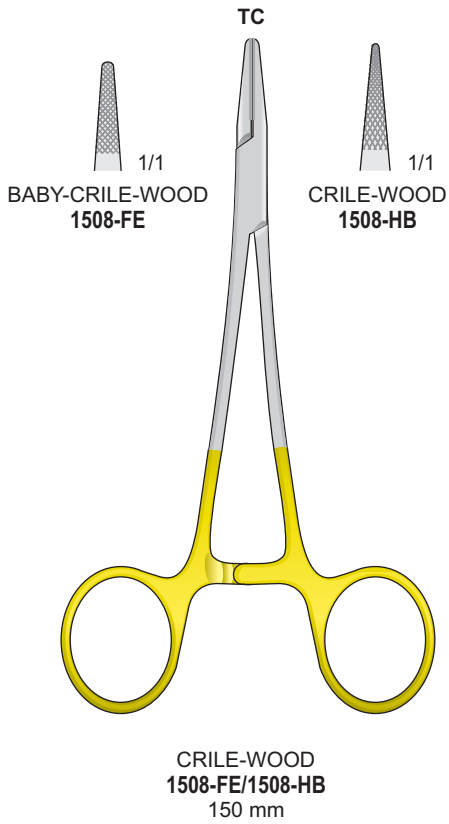

Nadelhalter

Needle Holders

Port'aghi

Portaagujas

Porte aiguilles

Nadelhalter mit Schere - Needle holders with scissors - Port'aghi con forbici - Portaagujas con tijeras - Porte aiguilles avec ciseaux

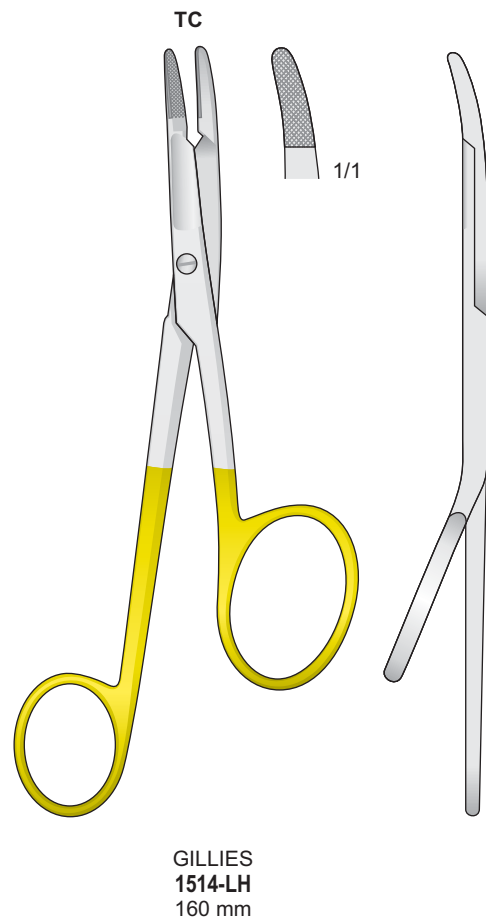
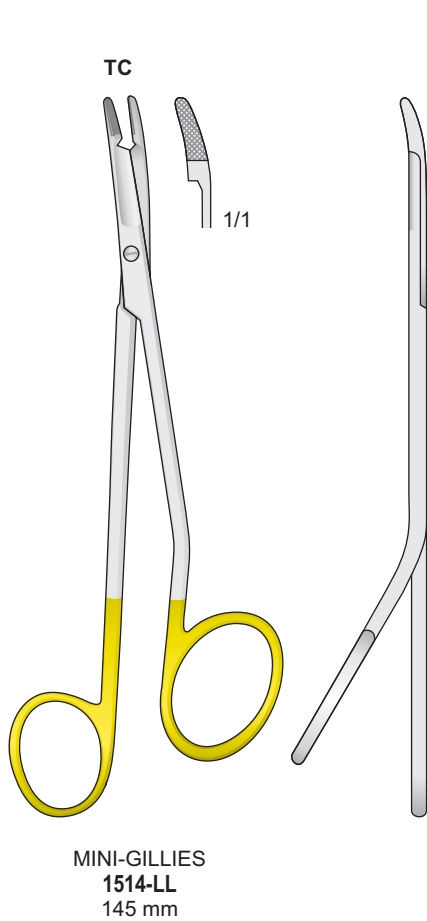
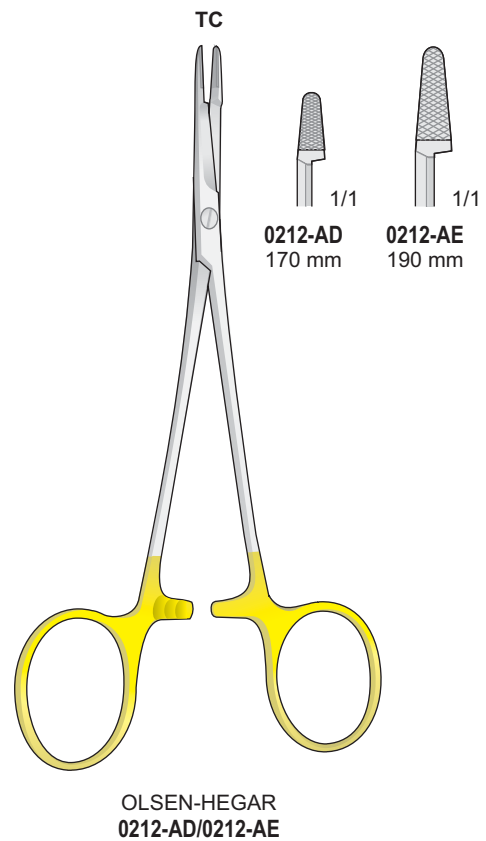
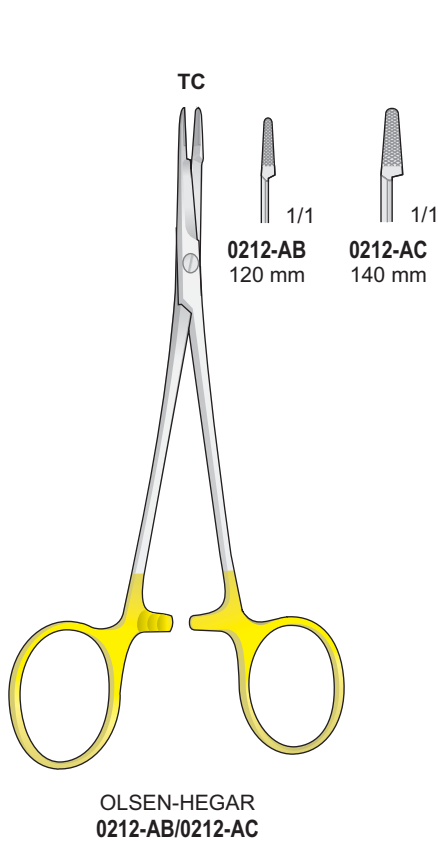

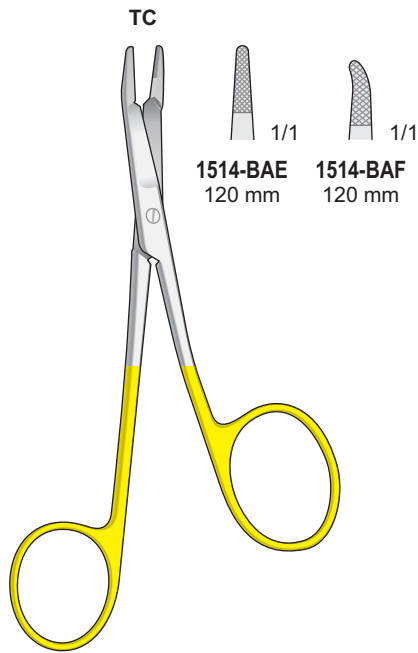

1514-BAE 120 mm 1514-BAF 120 mm

FOSTER-GILLIES
1514-BAE/1514-BAF
120 mm

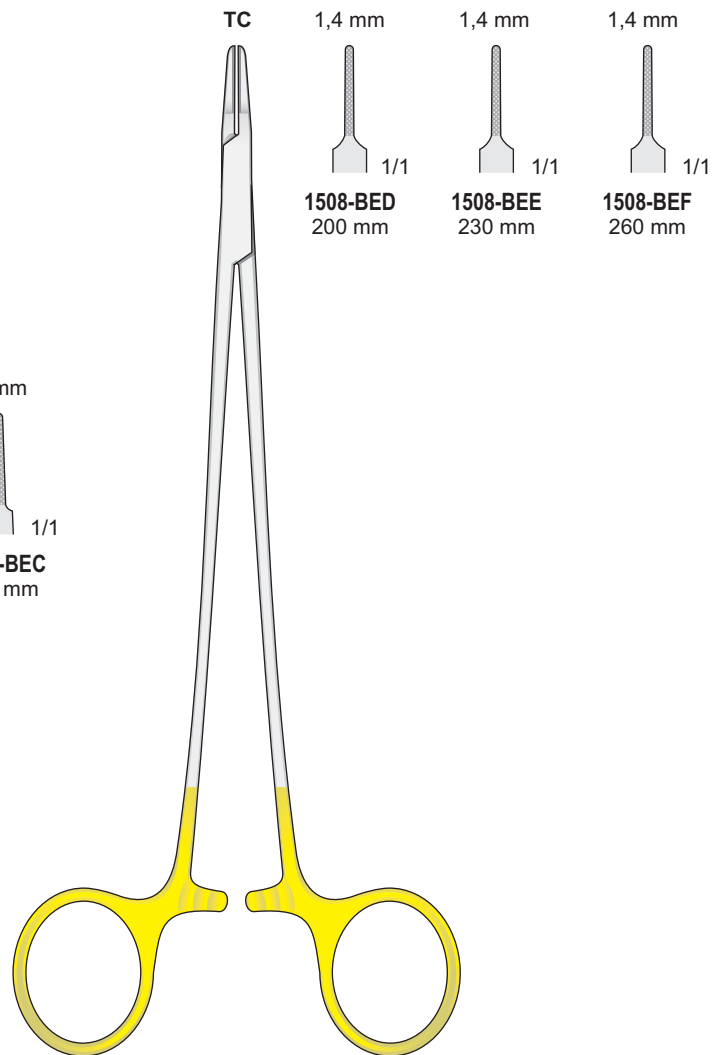

1508-BED 200 mm 1508-BEE 230 mm 1508-BEF 260 mm

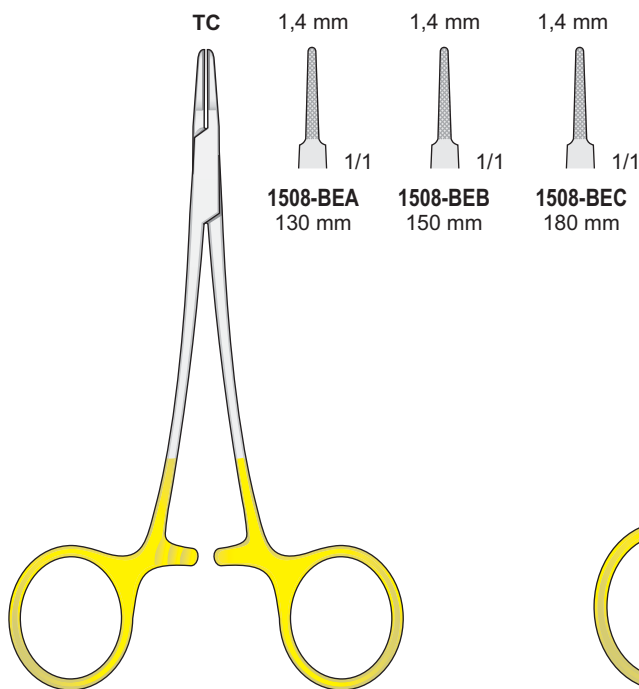

1508-BEA 130 mm 1508-BEB 150 mm 1508-BEC 180 mm

MICRO-RYDER
1508-BEA/1508-BEC

MICRO-RYDER
1508-BED/1508-BEF

Nadelhalter

Needle Holders

Port'aghi

Portaagujas

Porte aiguilles

Nadelhalter mit Hartmetalleinlagen - Needle Holders with tungsten-carbide inserts
 Port'aghi con inserti al tungsteno - Portaagujas con plaquitas de carburo de tungsteno
 Porte aiguilles avec plaquettes en carbure de tungstène

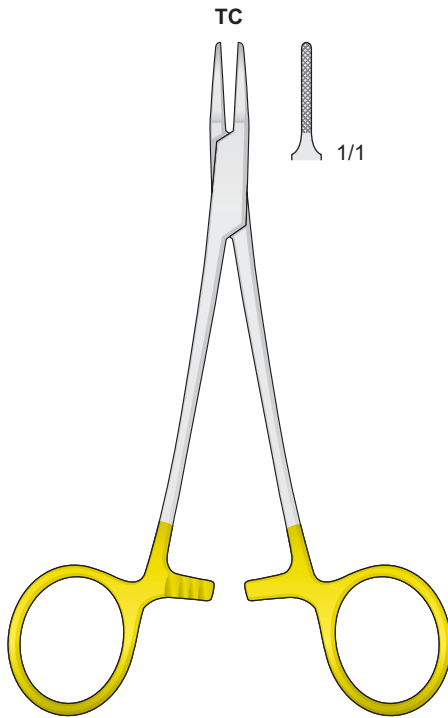

MICRO-RYDER
1508-ID
 140 mm

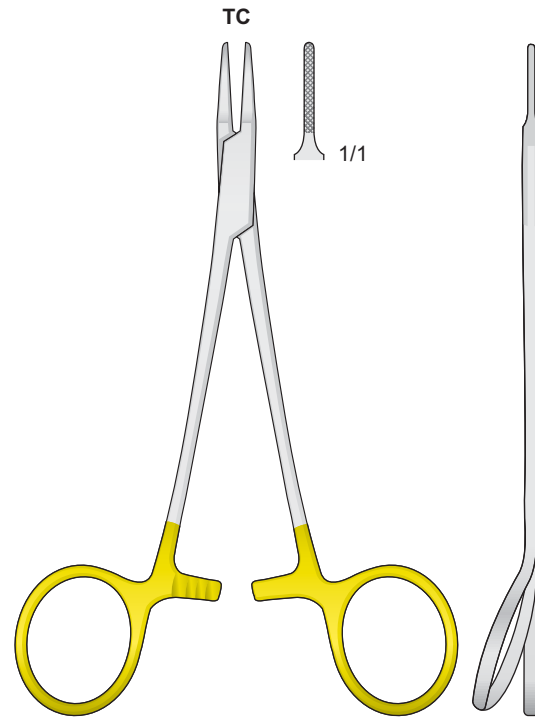

1508-IE
 140 mm

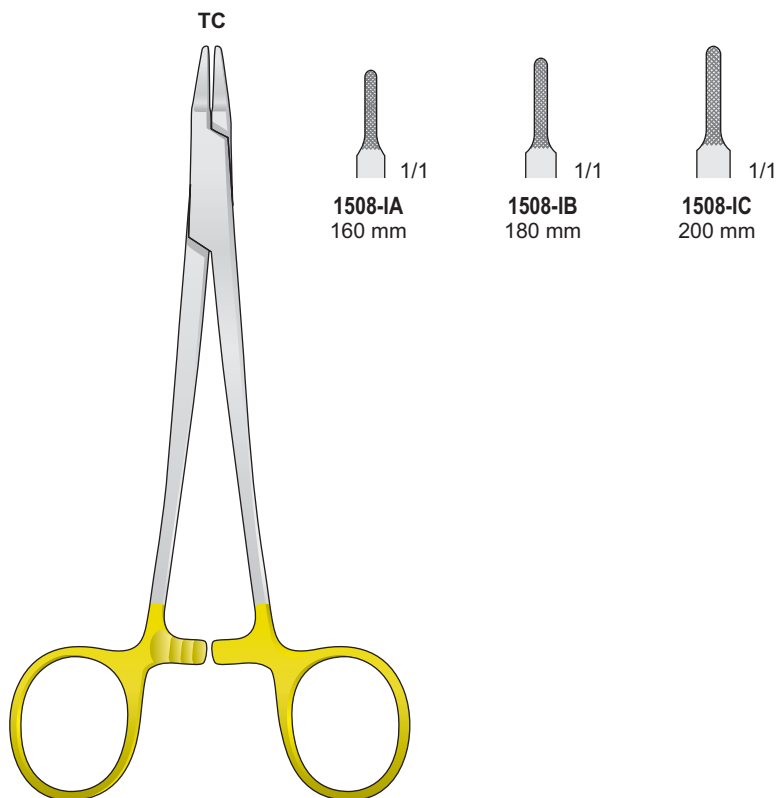

RYDER
1508-IA/1508-IC

Nadelhalter

Needle Holders

Port'aghi

Portaagujas

Porte aiguilles

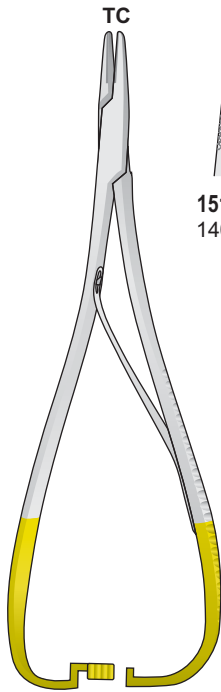

MATHIEU
1514-FA/1514-FC

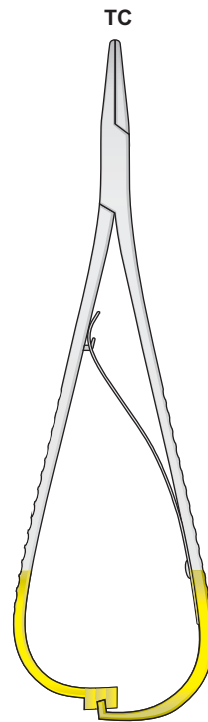
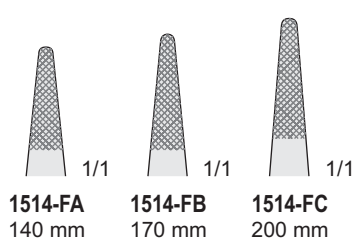

MATHIEU
1514-IC/1514-IE

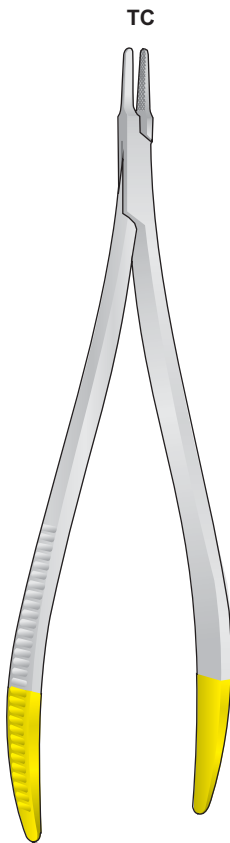
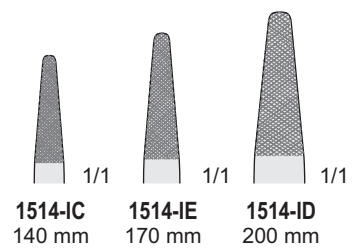

LANGENBECK-RYDER
1514-BCA
180 mm

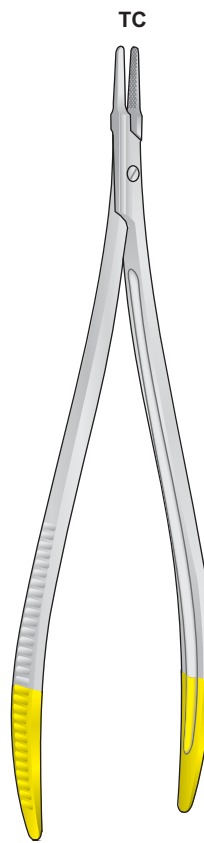
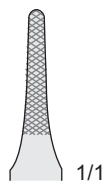

TÖNNIS-RYDER
1514-BCI/1514-BCL

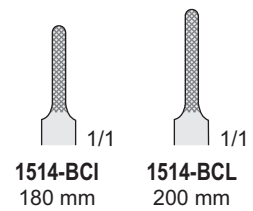

Nadelhalter mit Hartmetalleinlagen - Needle Holders with tungsten-carbide inserts
 Portaghi con inserti al tungsteno - Portaagujas con plaquitas de carburo de tungsteno
 Porte aiguilles avec plaquettes en carbure de tungstène

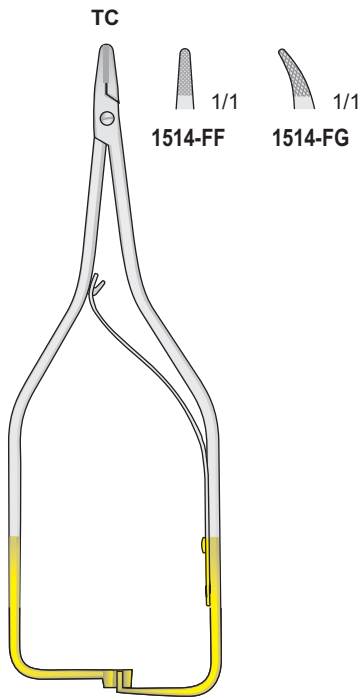

BOYNTON
1514-FF/1514-FG
120 mm

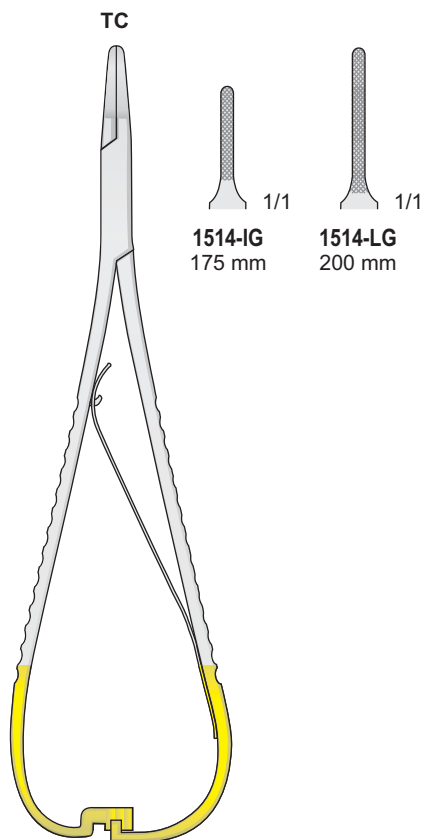

LICHTENBERG
1514-IG/1514-LG
175 mm

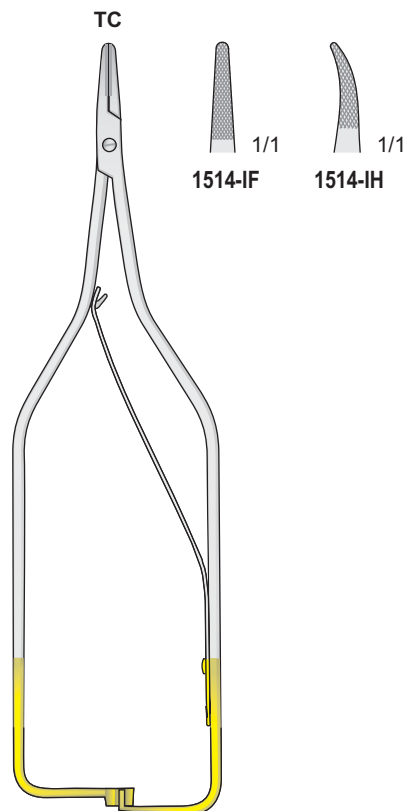

ARRUGA
1514-IF/1514-IH
160 mm

8 mm

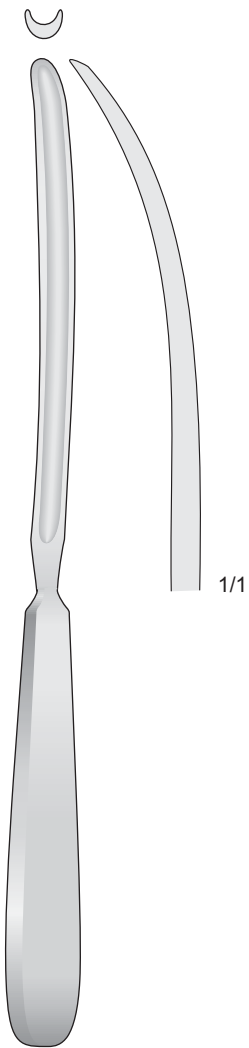

PAYR
0212-CG
215 mm

7 mm

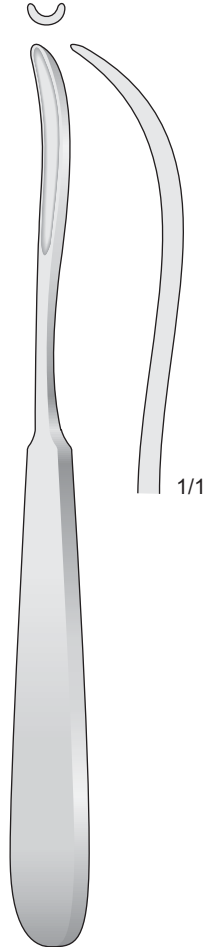

KOENIG
0212-EA
195 mm

10 mm

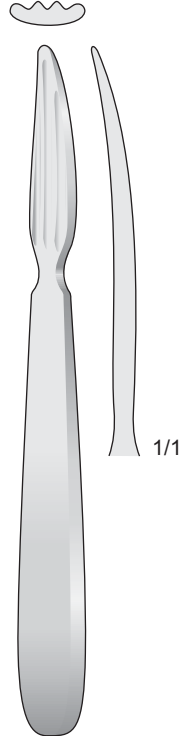

KOCHER
0212-EB
160 mm

10 mm

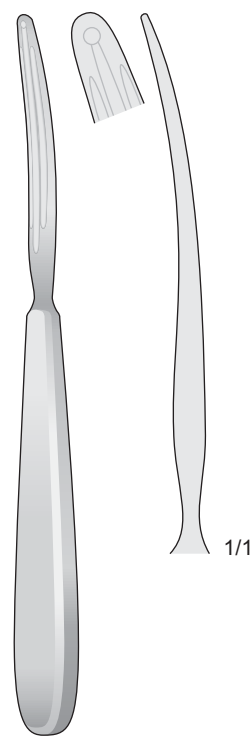

KOCHER
0212-GA
170 mm



1/1



KRONECKER
0212-BF
130 mm

Smussi
Blunt
Stumpf
Mousse
Romo



1/1

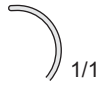

1/1



KRONECKER
0212-BG
130 mm

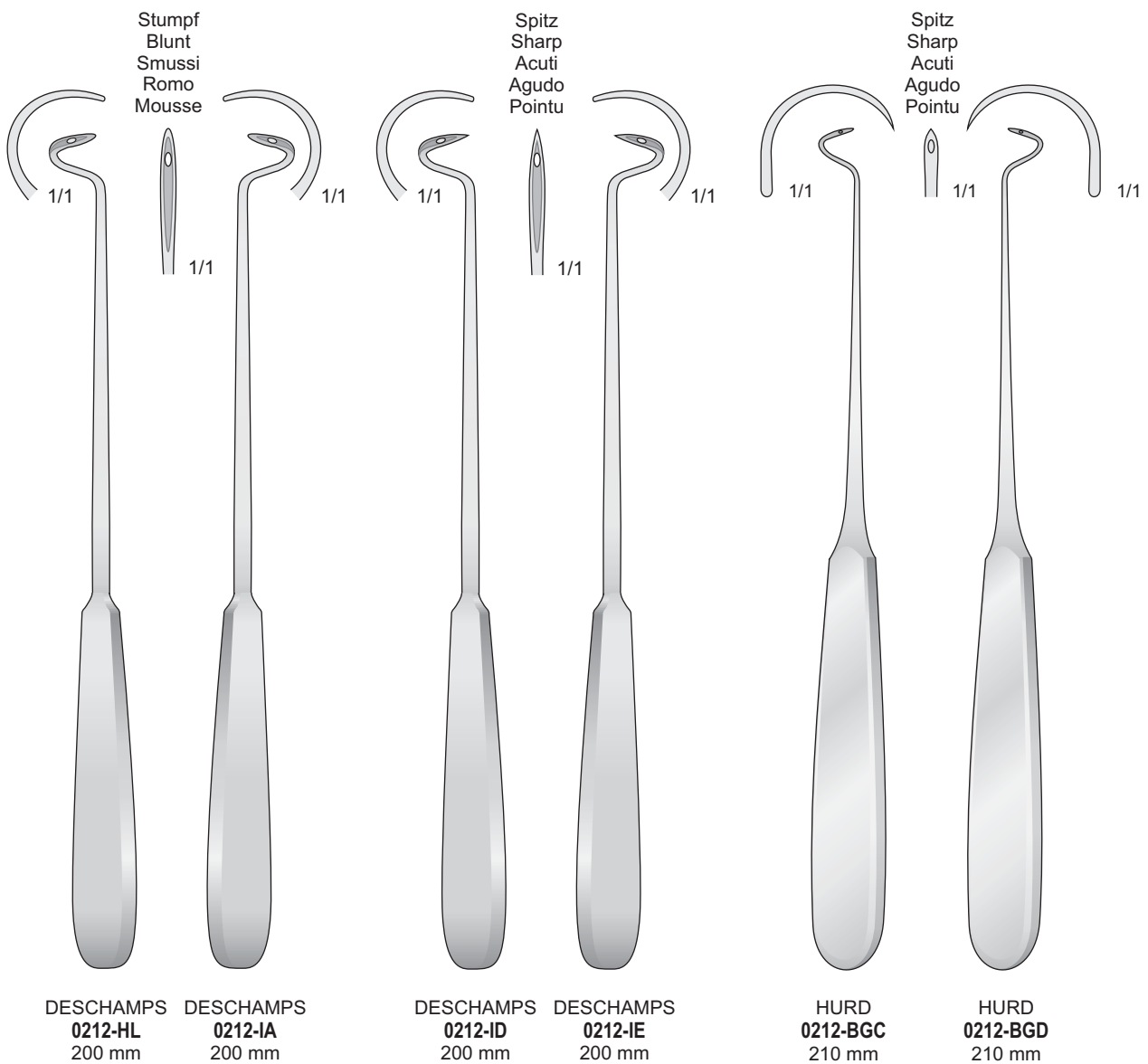

4.7



Allgemeine HNO-Instrumentarium
General ENT Instruments
Strumentario generale per ORL
Instrumental general para ORL
Instruments généraux pour ORL

Sonden und Absaugkanülen
Probes and Suction tubes
Sonde e cannule
Estiletes y Cánulas aspiradoras
Sondes et Canules aspiratrices

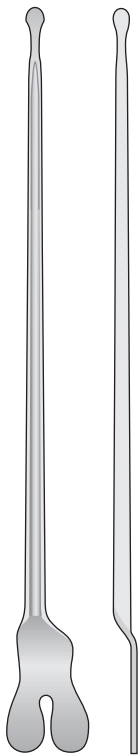

1506-FE 145 mm
1506-FF 160 mm
1506-BL 180 mm
1506-FG 200 mm

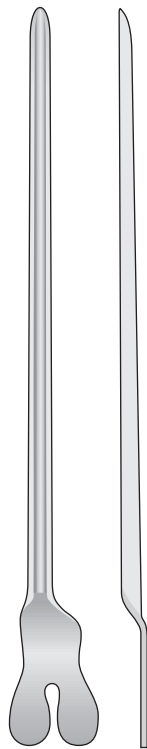

1506-FD 130 mm
1506-FH 145 mm
1506-FI 160 mm
1506-FL 180 mm
1506-BI 200 mm

Hohlsonde

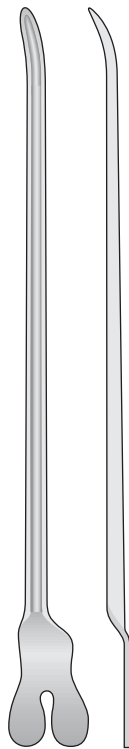

DOYEN
1506-CE
145 mm

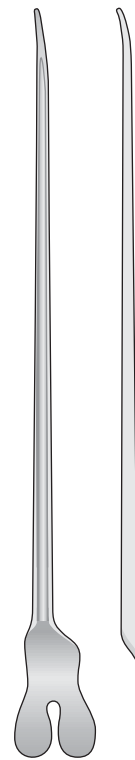

NELATON
1506-BH
160 mm



FISH
1506-LI 145 mm
1506-LL 180 mm

Sonden

Probes

Sonde bottonute

Estiletos

Sondes

Ø 1 mm



Ø 1,5 mm



Ø 2 mm



Ø 2 mm



Ø 1,5 mm



Ø 1,0 mm



1506-CA 145 mm
1506-CB 160 mm

1506-DC 130 mm
1506-CC 145 mm
1506-CF 160 mm
1506-CG 200 mm

1506-CH 145 mm
1506-CD 160 mm
1506-CI 200 mm
1506-EE 250 mm

1506-DG 130 mm
1506-BF 145 mm
1506-CL 160 mm
1506-DI 200 mm

1506-H
145 mm

STACKE
1506-BE
110 mm

BOWMAN
1506-DA 00/0 **1506-DE** 5/6
1506-DB 1/2 **1506-DF** 7/8
1506-DD 3/4 **1506-DH** 6/7

Watteträger

Cotton applicators

Porta cotone

Portaalgodòn

Porte cotons

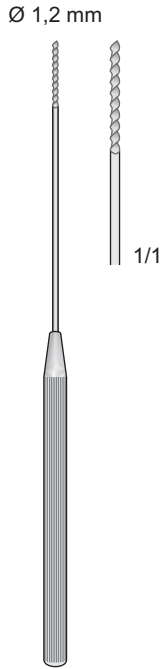

UNIVERSAL
1506-EI 120 mm
1506-EA 140 mm
1506-FA 160 mm

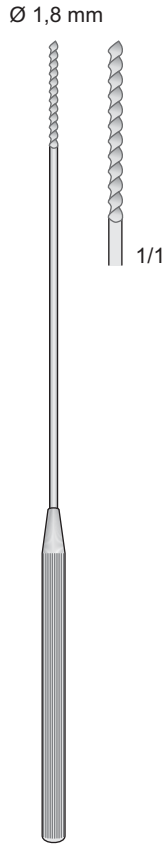

UNIVERSAL
1506-GC 120 mm
1506-GD 140 mm
1506-GE 160 mm
1506-EB 180 mm



MOD. MARTIN
1506-ED/1506-FC

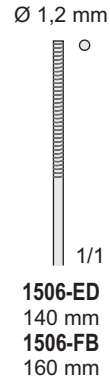

1506-ED
140 mm
1506-FB
160 mm
Rund
Round
Rotondo
Redondas
Rondes

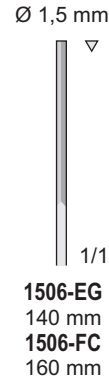

1506-EG
140 mm
1506-FC
160 mm
Dreikant
Triangular
Triangolare
Triangulares
Triangulaires

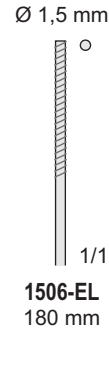

1506-EL
180 mm
Rund
Round
Rotondo
Redondas
Rondes

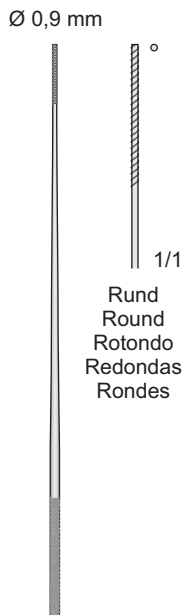

FARRELL
1506-BA 120 mm

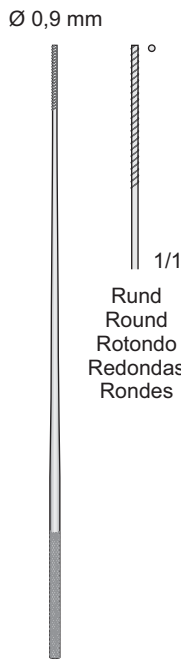

FARRELL
1506-BD 140 mm
1506-GG 160 mm
1506-GH 180 mm

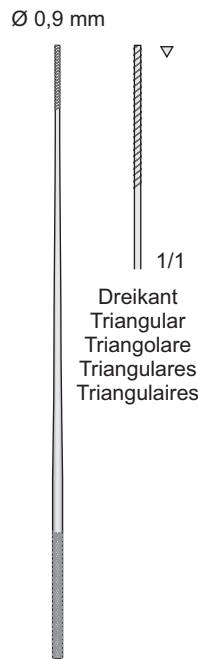

FARRELL
1506-GI 140 mm
1506-GL 160 mm

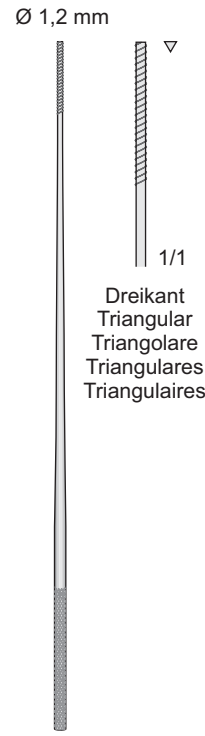

FARRELL
1506-DL 180 mm

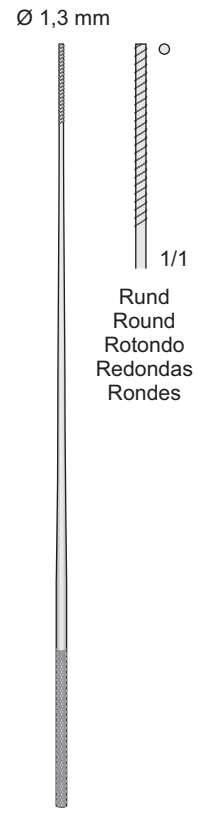

FARRELL
1506-EC 230 mm

Trokare

Trocars

Trequarti

Trócares

Trocarts

Kieferhöhlentrokare - Antrum puncture trocars - Trequarti per seno mascellare
Trócares para punción del seno maxilar - Trocarts pour sinus maxillaire

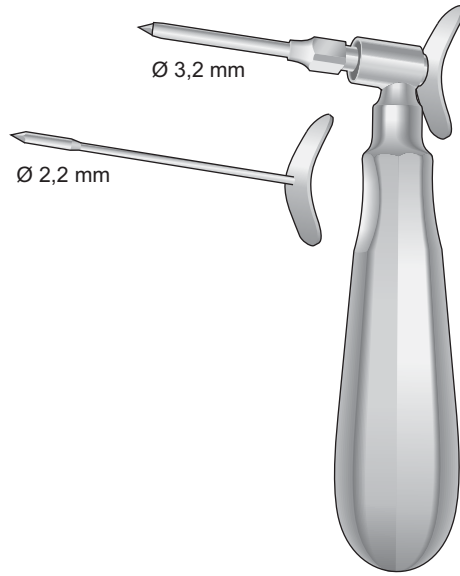

1917-HA
120 mm

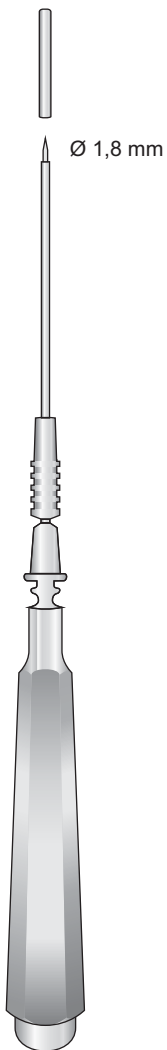

LICHTWITZ
1917-DA
190 mm

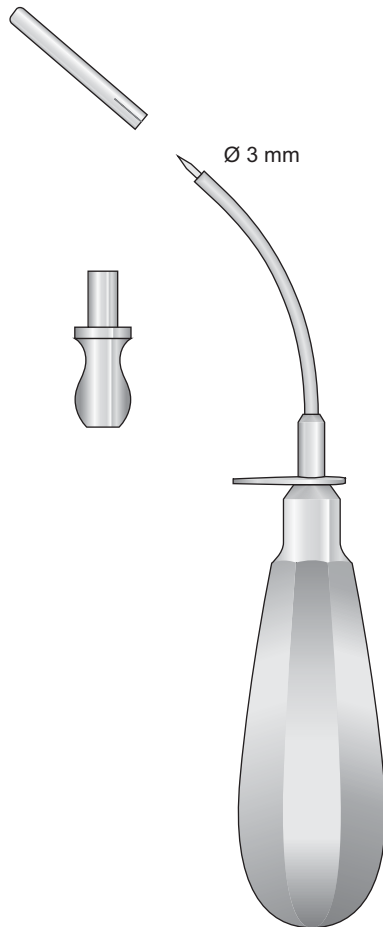

PIERCE
1917-DC
160 mm

Krause Kompletset - Krause set complete
Set completo Krause - Set completo Krause
Set complet Krause

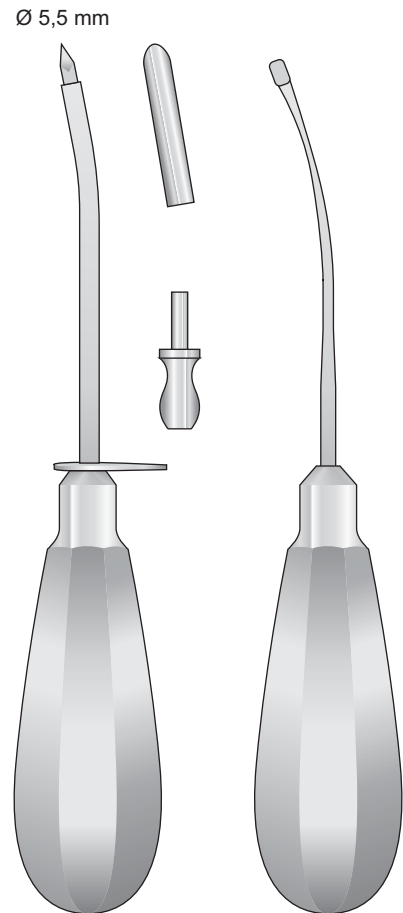

KRAUSE
1917-DF
160 mm

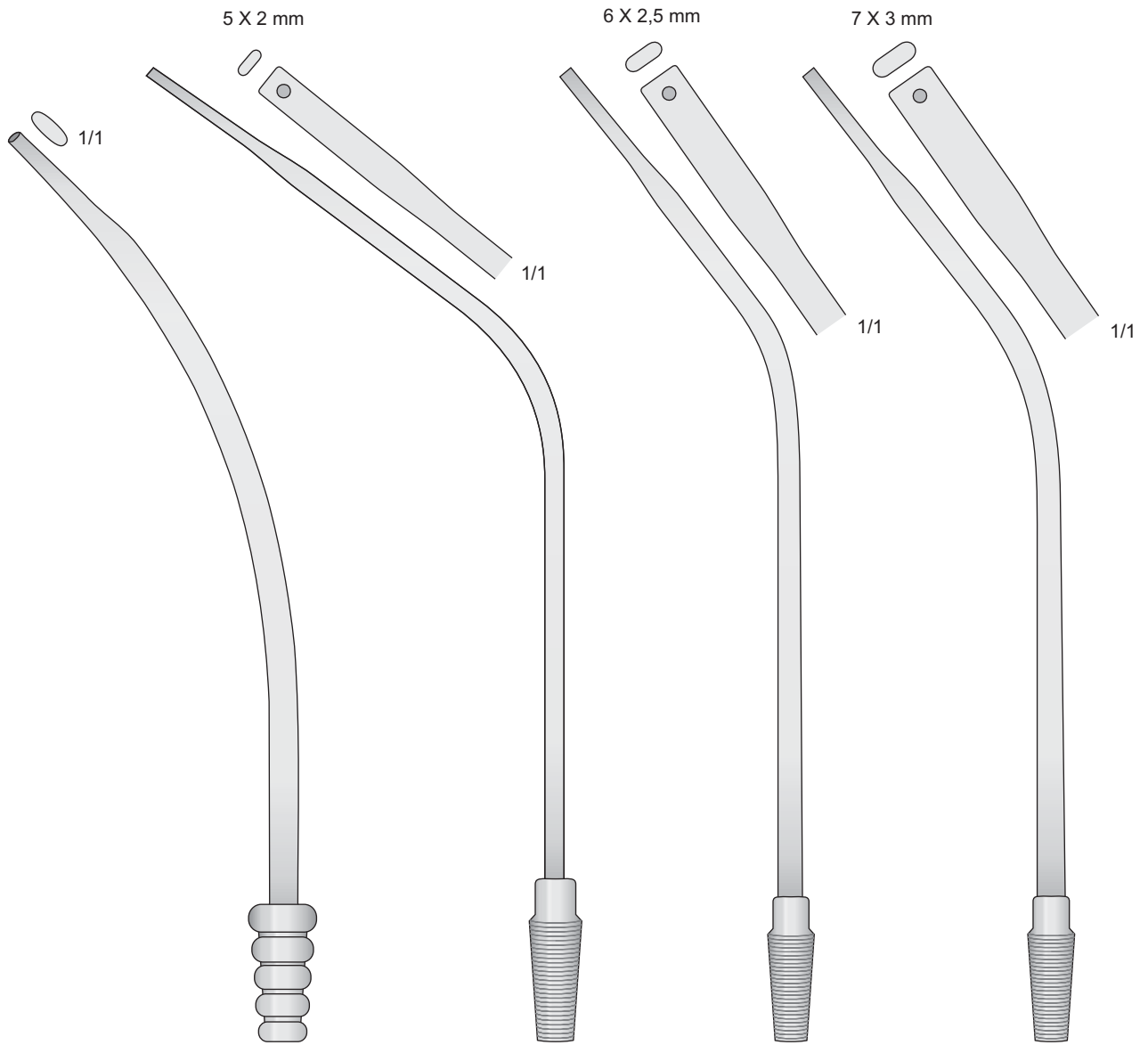

0706-CA
180 mm

0706-HF
190 mm

0706-HG
200 mm

0706-HH
200 mm

Absaugkanülen

Suctions tubes

Cannule per aspirazione

Cànulas aspiradoras

Canules aspiratrices

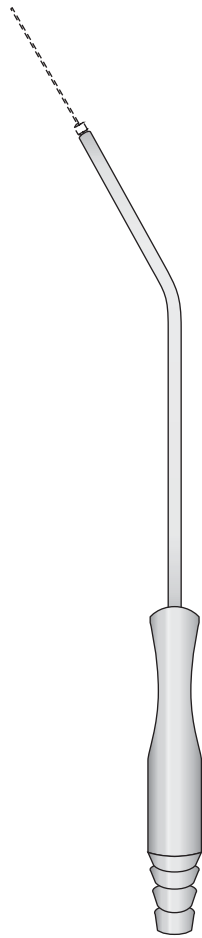

WULLSTEIN
0706-EE
140 mm

Micro Suctions tubes

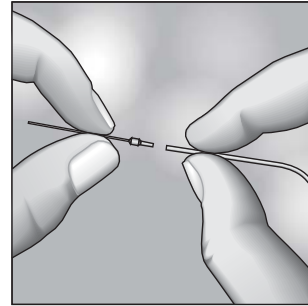
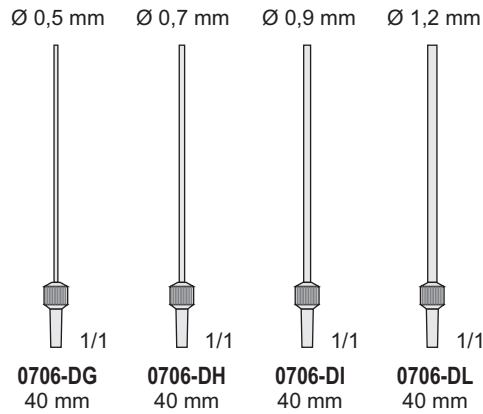

Nasensauger

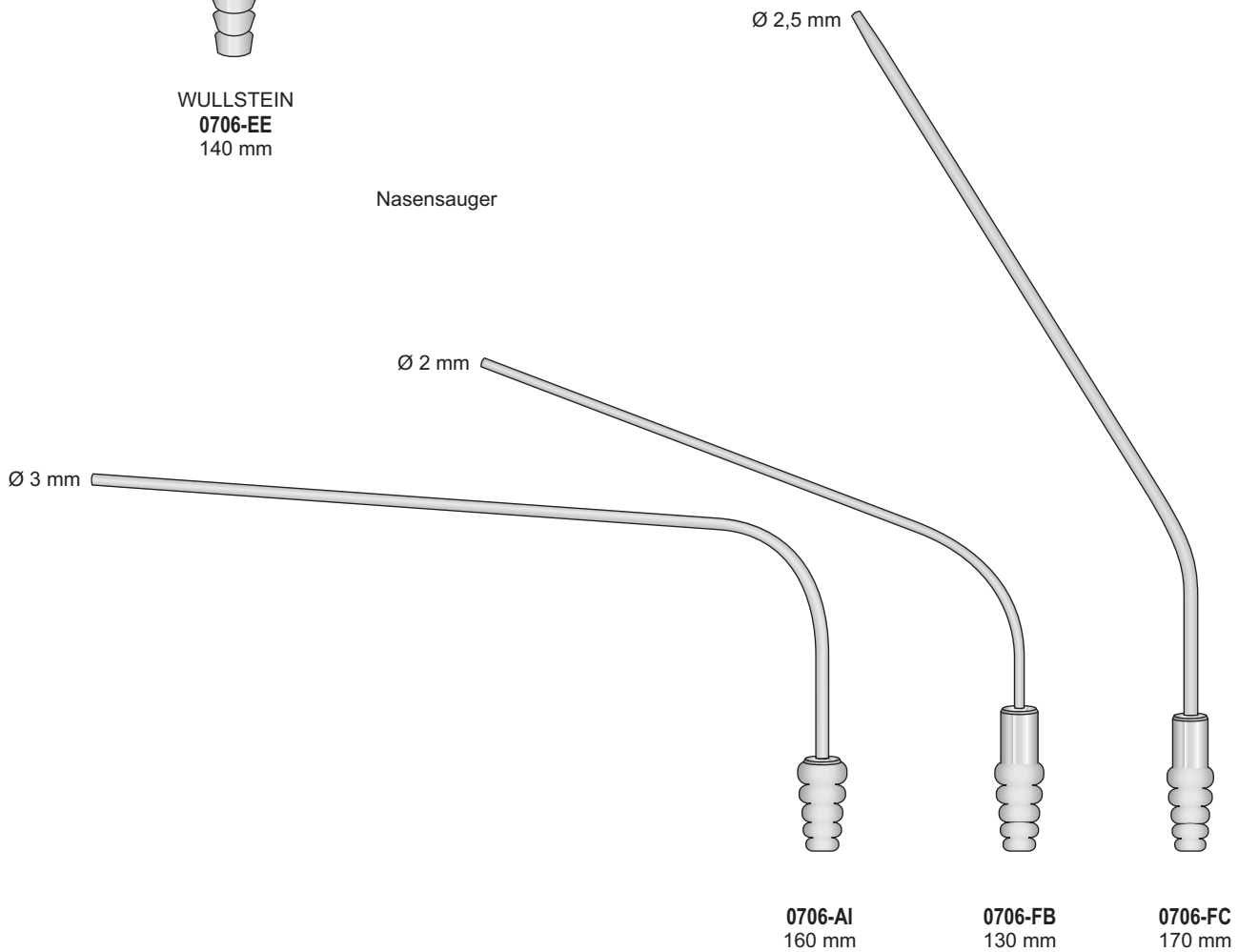

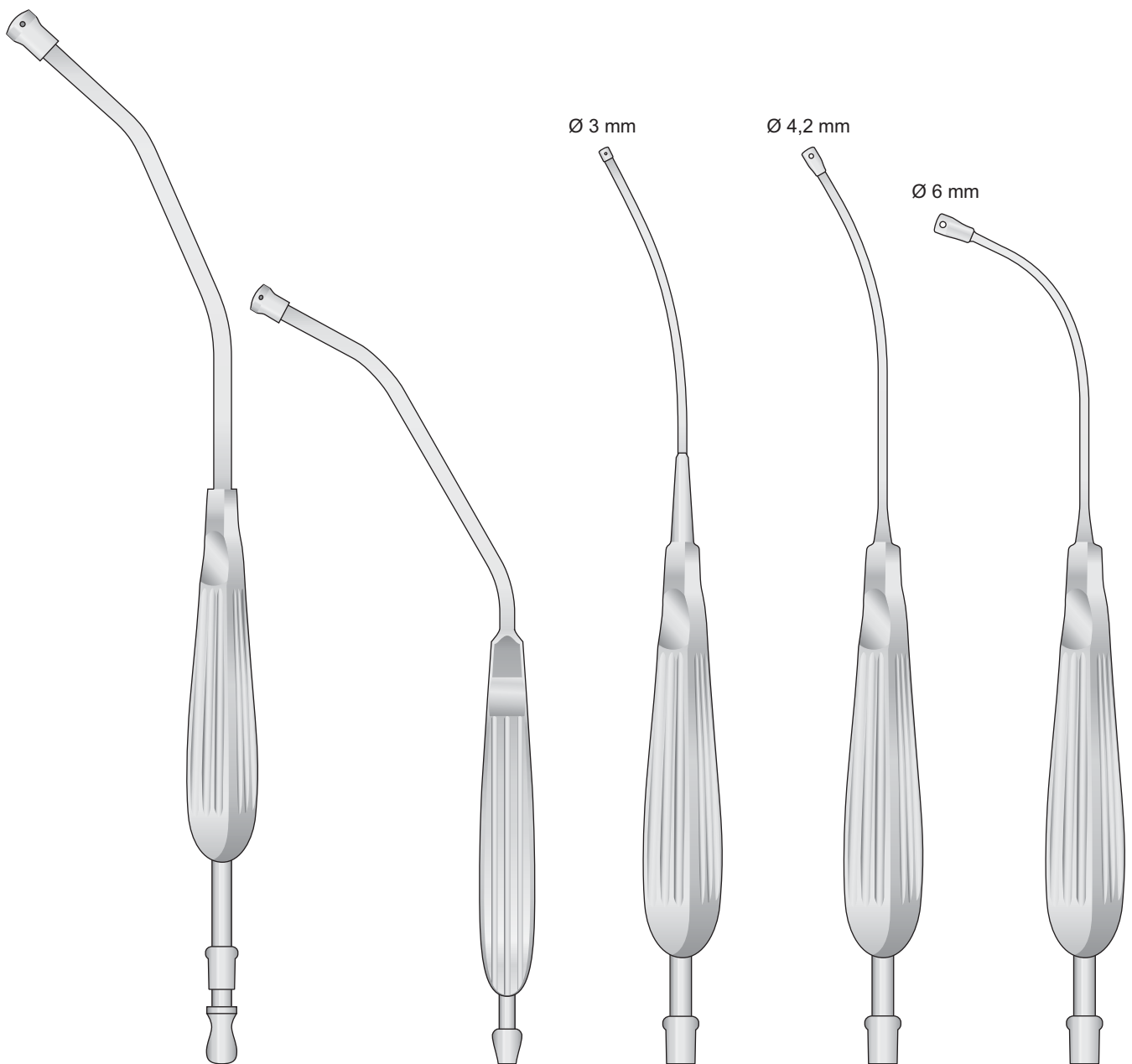

YANKAUER
0706-BC
310 mm

BABY-YANKAUER
0706-BA
200 mm

ANDREWS-PYNCHON
0706-AG
250 mm

ANDREWS-PYNCHON
0706-AH
250 mm

ANDREWS-PYNCHON
0706-FE
230 mm

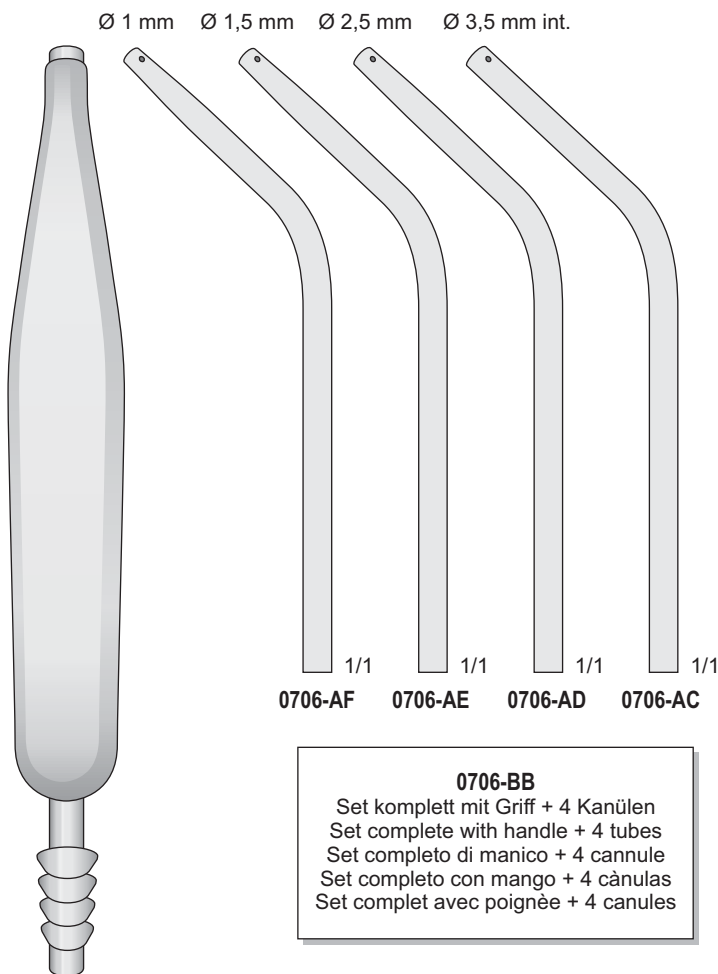

COUPLAND
0706-AB
 150 mm

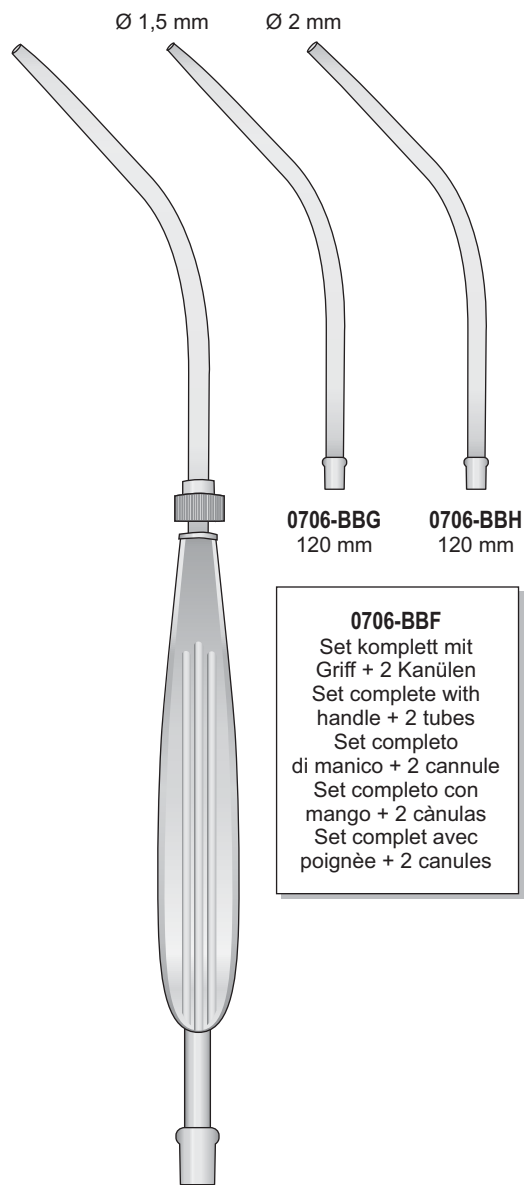

COUPLAND
0706-BBF
 270 mm

0706-BCL

Set komplett mit Griff + 4 Kanülen
 Set complete with handle + 4 tubes
 Set completo di manico + 4 cannule
 Set completo con mango + 4 càulas
 Set complet avec poignée + 4 canules

0706-BLH

Set komplett mit Griff + 4 Kanülen
 Set complete with handle + 4 tubes
 Set completo di manico + 4 cannule
 Set completo con mango + 4 càulas
 Set complet avec poignée + 4 canules

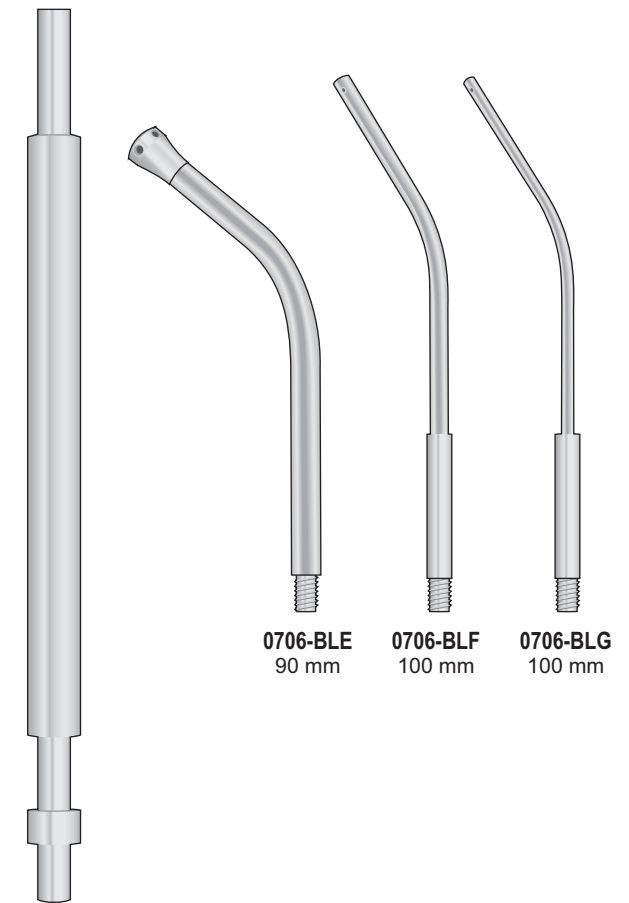
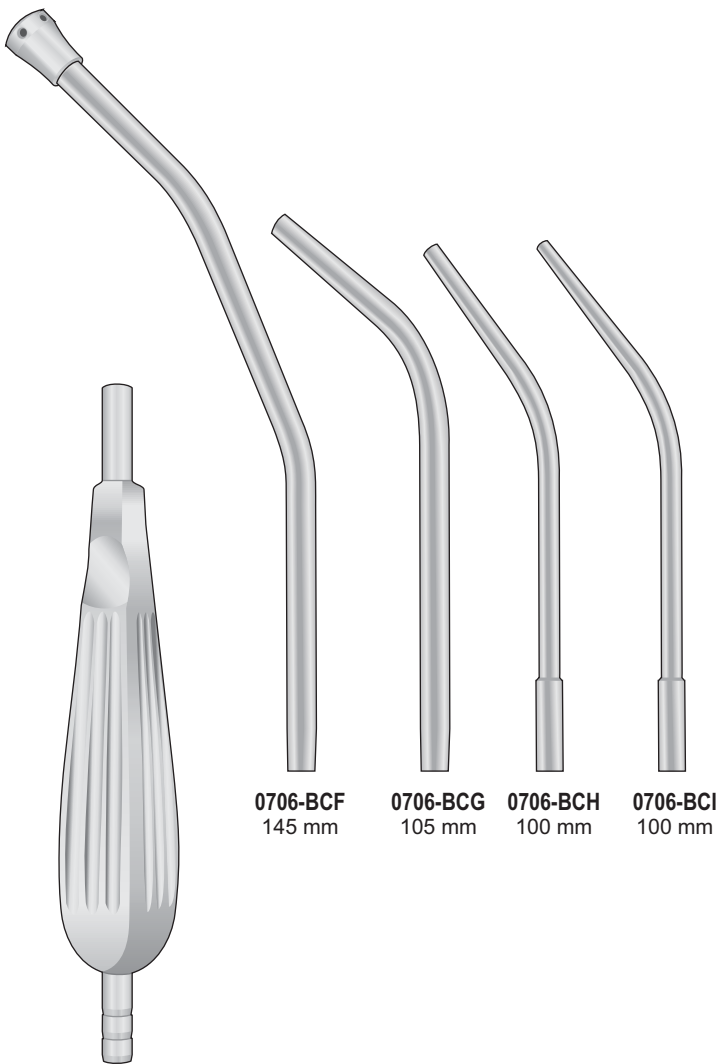

Kiefer und Stirnhöhlen-Spülkanülen
 Antrum and frontal sinus wash cannulas
 Cannule per lavaggio dei seni frontali e mascellari
 Cánulas lavadores para seno maxilar y seno frontal
 Canules pour le lavage du sinus maxillaire et frontal

Ø Innen
 Ø Inside
 Ø Interno
 Ø Interior
 Ø Intérieur

Ø Innen
 Ø Inside
 Ø Interno
 Ø Interior
 Ø Intérieur

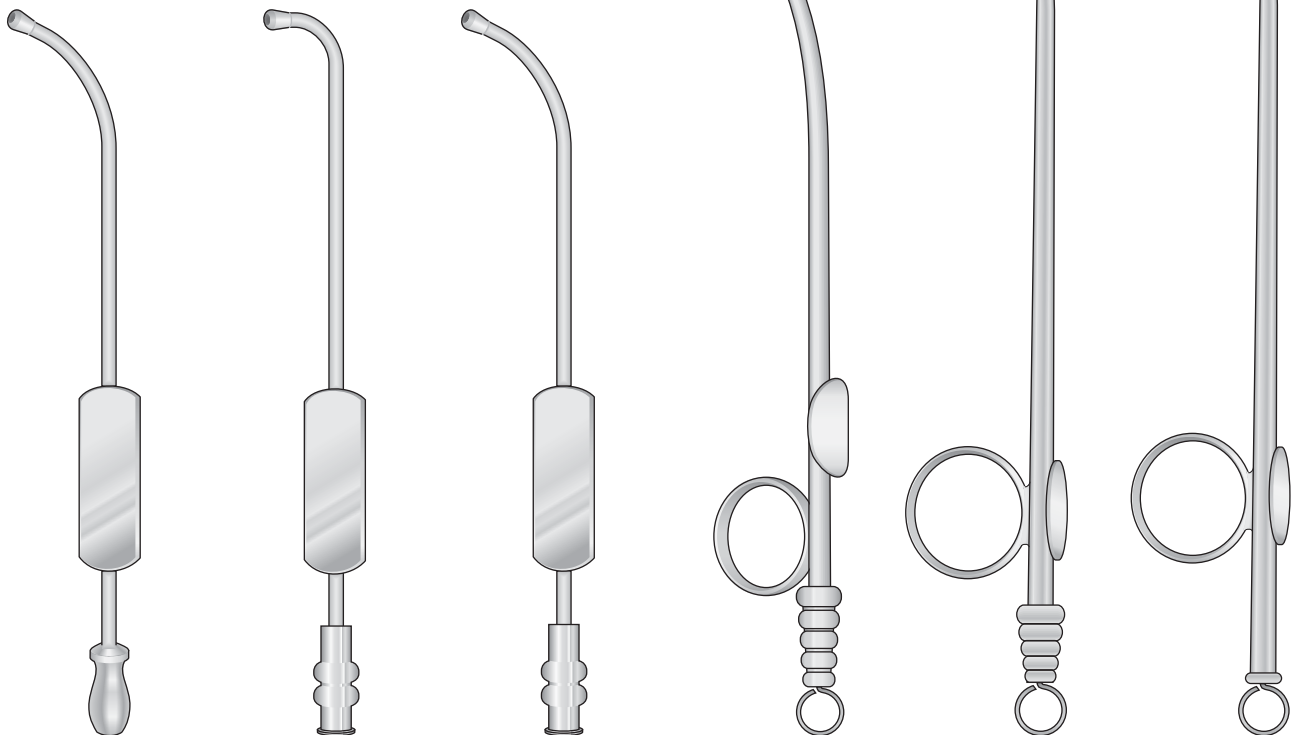

EICKEN
0706-BLI Ø 2,5 mm
0706-BLL Ø 3,0 mm
 130 mm

KILLIAN
0706-IF Ø 3 mm
0706-IH Ø 4 mm
 145 mm

KILLIAN
0706-IG Ø 3 mm
0706-II Ø 4 mm
 145 mm

0706-CFG Ø 4,5 mm
0706-CFH Ø 5,5 mm
 175 mm

MAGILL
0706-BAA Ø 1 mm
 200 mm

MAGILL
0706-BAB Ø 1 mm
0706-BAC Ø 2 mm
0706-BAD Ø 3 mm
 200 mm

Saugraspatorium Scharf - Raspatories, Scharp
 Raschietti taglienti - Raspador cortante - Rugine tranchante

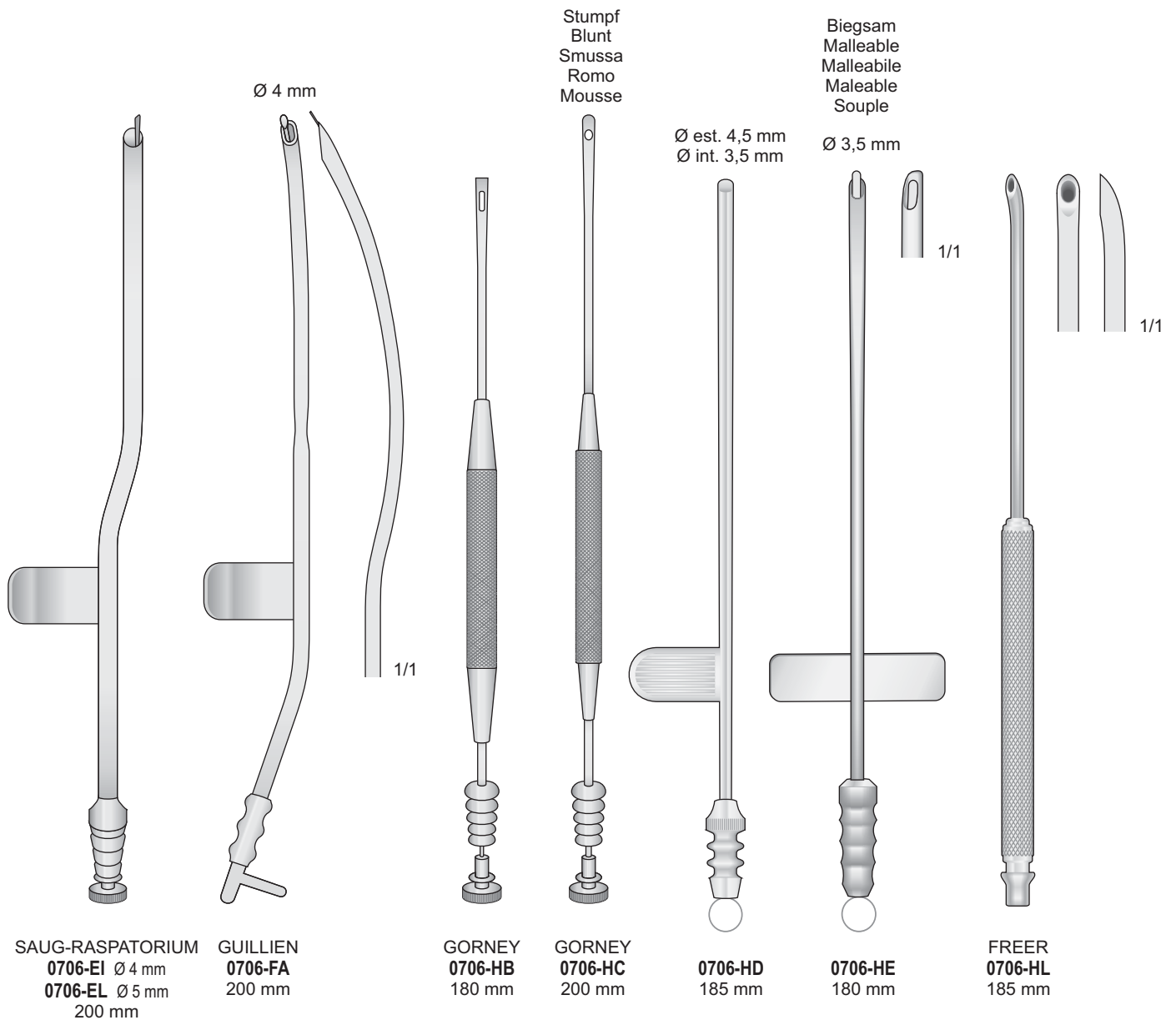

Char. 3 = 1 mm
 Char 5 = 1,7 mm
 Char 7 = 2,5 mm

Mit Unterbrecherplatte
 With finger cut-off
 Con placca d'interruzione
 Con placa desconnectadora
 Avec plaque interruptrice



BELLUCCI
0706-CDC
 Charr. 5

BARON
0706-ED
 Charr. 3

BARON
0706-EF
 Charr. 5

BARON
0706-EH
 Charr. 7

BARON
0706-GD
 Charr. 3

BARON
0706-GF
 Charr. 5

BARON
0706-GH
 Charr. 7

House Saug- und Spülrohr, Luer Konus

Saugrohr
Suction tube
Tubo per aspirazione
Tube d'aspiration

Spülrohr
Irrigation tube
Tubo per irrigazione
Tube d'irrigation

Char. 3	= 1 mm
Char 5	= 1,7 mm
Char 7	= 2,5 mm
Char 10	= 3,3 mm
Char 12	= 4 mm
Char 14	= 4,6 mm

Char. 2	= 0,6 mm
Char 4	= 1,21 mm
Char 5	= 1,7 mm
Char 7	= 2,5 mm
Char 8	= 2,7 mm
Char 12	= 4 mm

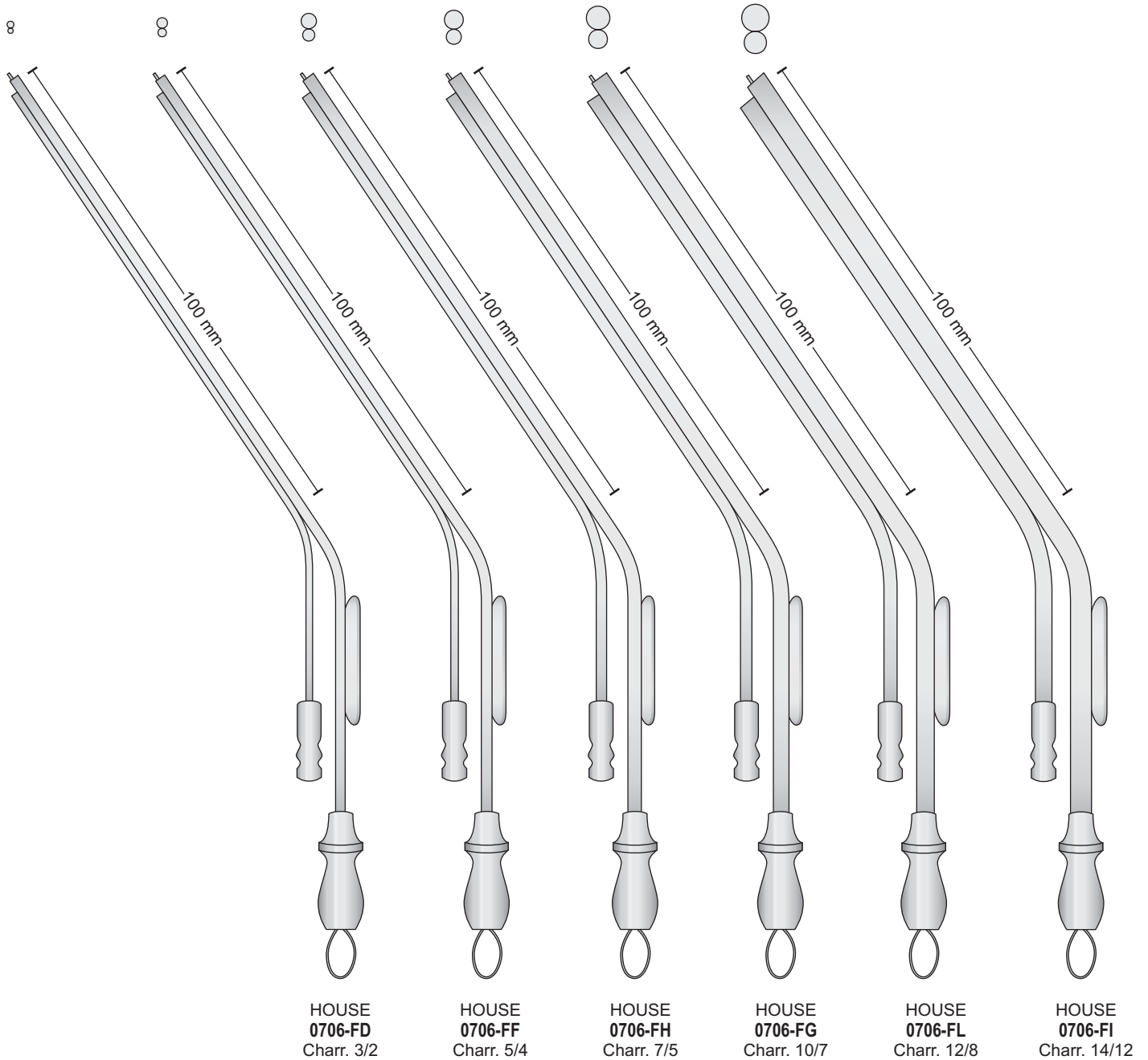

Absaugkanülen

Suctions tubes

Cannule per aspirazione

Cànulas aspiradoras

Canules aspiratrices

Oberfläche Geschwärzt
Surface Black-finish
Superficie colorata nera
Surface noircie

Oberfläche Geschwärzt
Surface Black-finish
Superficie colorata nera
Surface noircie

Biegsam
Malleable
Malleabile
Malleable
Malléables
Ø 3 mm

Biegsam
Malleable
Malleabile
Malleable
Malléables
Ø 3 mm

Biegsam
Malleable
Malleabile
Malleable
Malléables
Ø 3 mm

Biegsam
Malleable
Malleabile
Malleable
Malléables
Ø 3 mm

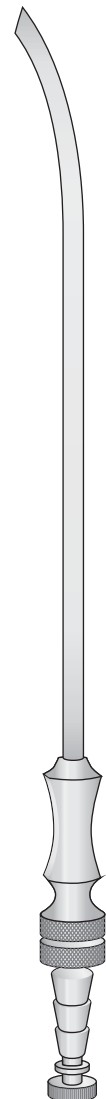
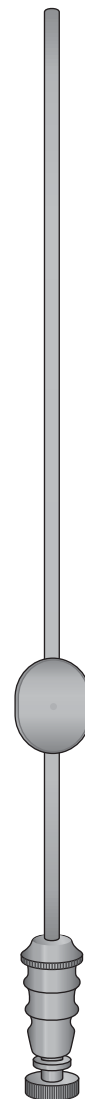
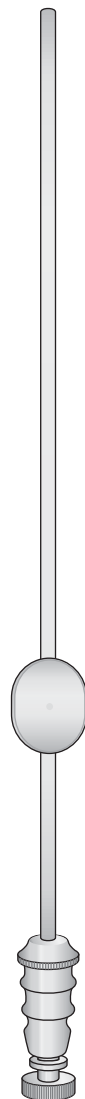
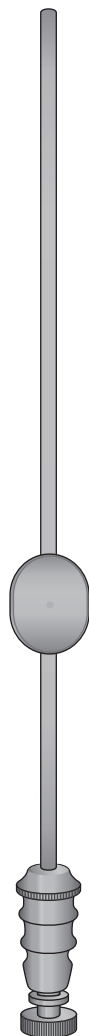
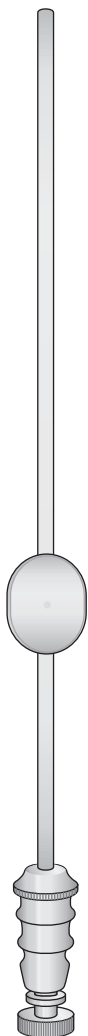

WERTHEIMER
0706-GL
160 mm

FRAZIER
0706-HA
160 mm

WERTHEIMER
0706-GA
200 mm

FRAZIER
0706-GB
200 mm

ADSON
0706-EB ch. 12 = Ø 4 mm
0706-EC ch. 15 = Ø 5 mm
210 mm

Absaugkanülen
und Spülinstrumente

Suctions tubes
and Irrigating Instruments

Cannule per aspirazione
e irrigazione

Cánulas aspiradoras
y de lavado

Canules aspiratrices
et à irrigation

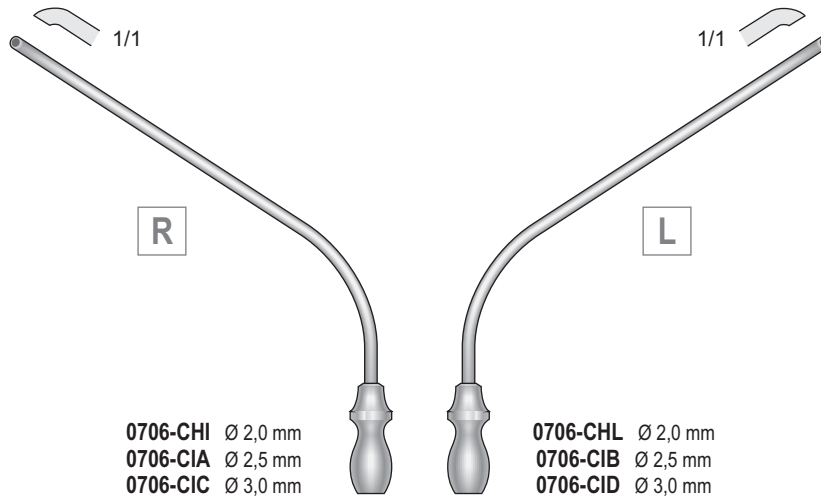

HARTMANN
0706-CHI/0706-CID
120 mm

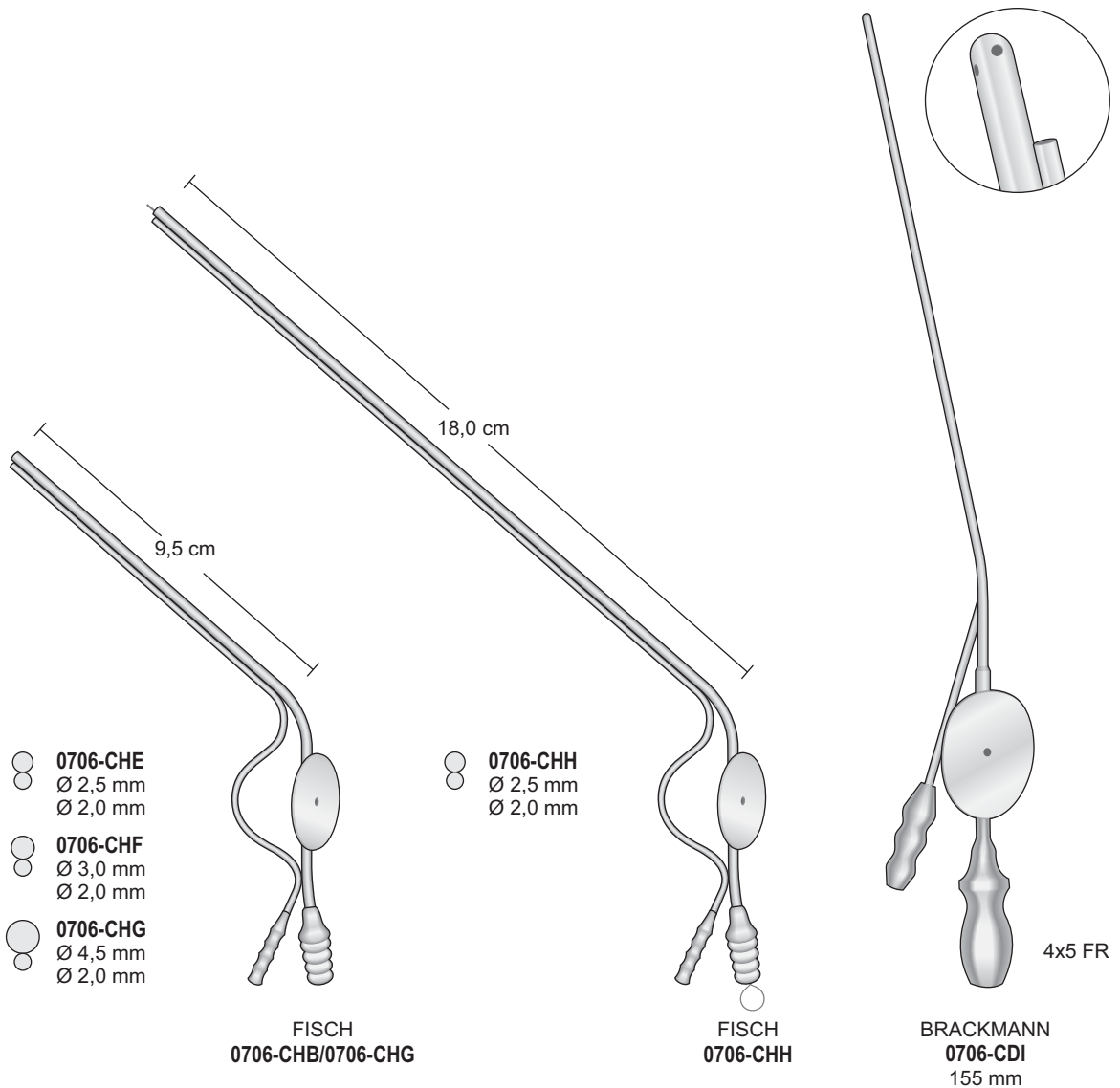

- 8 0706-CHB
Ø 1,0 mm
Ø 1,0 mm
- 8 0706-CHC
Ø 1,5 mm
Ø 1,5 mm
- 8 0706-CHD
Ø 1,9 mm
Ø 1,9 mm

- 8 0706-CHE
Ø 2,5 mm
Ø 2,0 mm
- 8 0706-CHF
Ø 3,0 mm
Ø 2,0 mm
- 8 0706-CHG
Ø 4,5 mm
Ø 2,0 mm

- 8 0706-CHH
Ø 2,5 mm
Ø 2,0 mm

Char. 6	=	2 mm
Char. 7	=	2,5 mm
Char. 8	=	2,7 mm
Char. 9	=	3 mm
Char. 10	=	3,3 mm
Char. 12	=	4 mm
Char. 15	=	5 mm

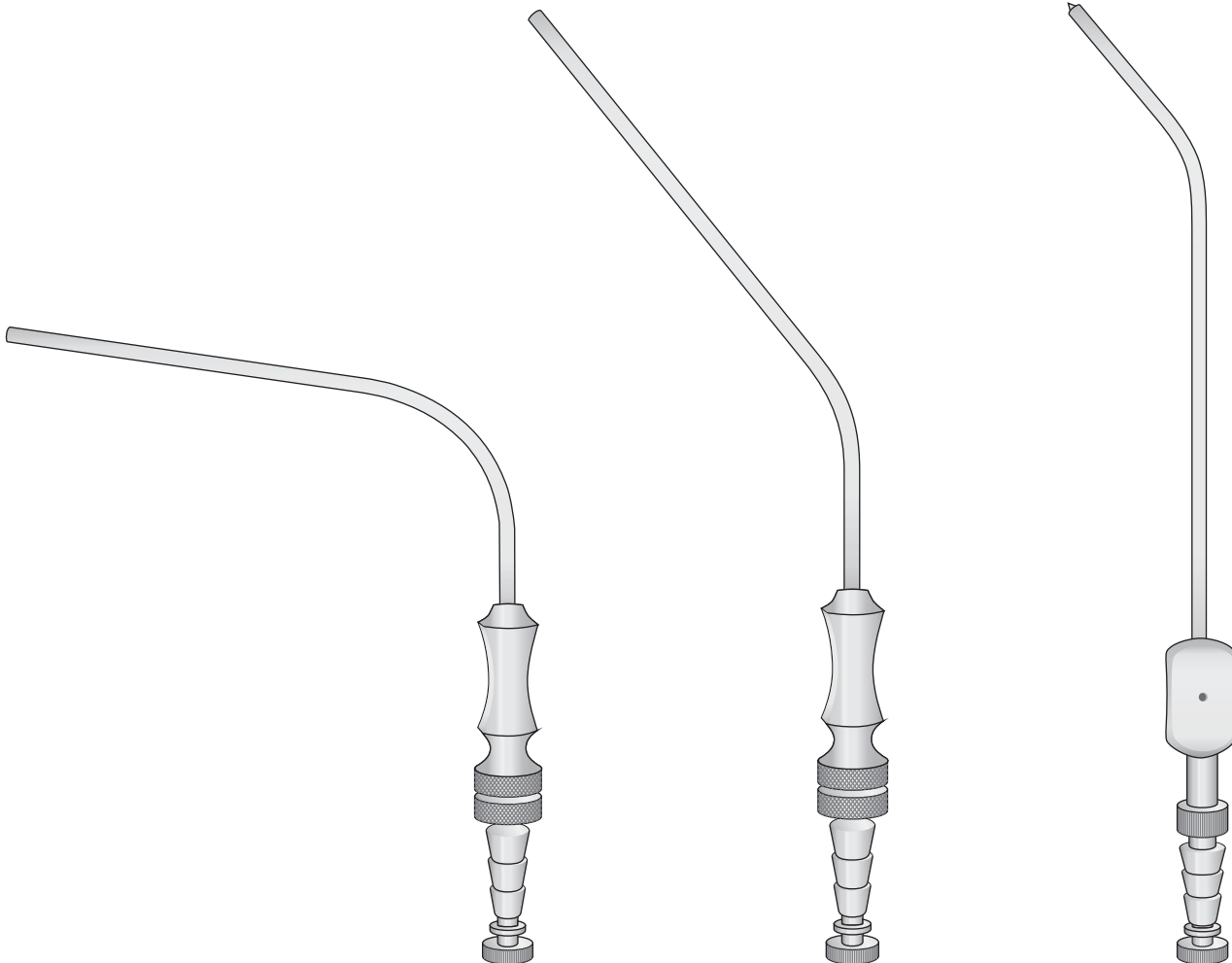

FERGUSSON

- 0706-BEA** Ch. 6 2,0 mm
- 0706-BEB** Ch. 7 2,5 mm
- 0706-BEC** Ch. 9 3,0 mm
- 0706-BEC02** Ch. 10 3,3 mm
- 0706-BED** Ch. 12 4,0 mm
- 0706-BEE** Ch. 15 5,0 mm
180 mm

FRAZIER

- 0706-CEA** Ch. 6 2,0 mm
- 0706-CEB** Ch. 7 2,5 mm
- 0706-CEB02** Ch. 8 2,7 mm
- 0706-CEC** Ch. 9 3,0 mm
- 0706-CEC02** Ch. 10 3,3 mm
- 0706-CED** Ch. 12 4,0 mm
- 0706-CEE** Ch. 15 5,0 mm
180 mm

PLESTER

- 0706-BFA** Ch. 6 2,0 mm
- 0706-BFB** Ch. 7 2,5 mm
- 0706-BFB02** Ch. 8 2,7 mm
- 0706-BFC** Ch. 9 3,0 mm
- 0706-BFC02** Ch. 10 3,3 mm
- 0706-BFD** Ch. 12 4,0 mm
- 0706-BFE** Ch. 15 5,0 mm
200 mm

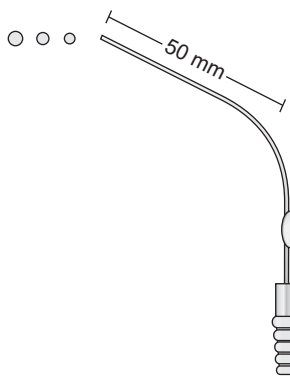

0706-CFD Ø 1,5 mm
0706-CFE Ø 1,7 mm
0706-CFF Ø 2,0 mm

BARNES
0706-CFD/0706-CFF
 100 mm

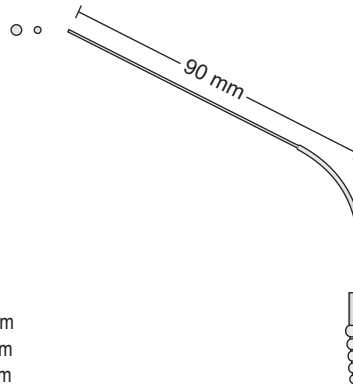

0706-CGF Ø 1,0 mm
0706-CGG Ø 1,5 mm

BARNES
0706-CGF/0706-CGG
 125 mm

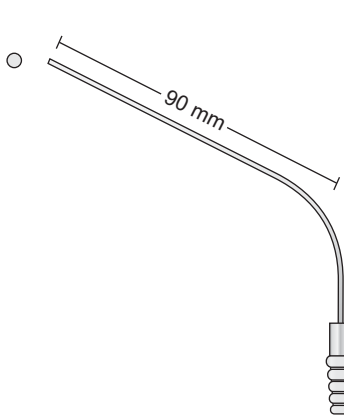

0706-CGH Ø 2,0 mm

BARNES
0706-CGH
 125 mm

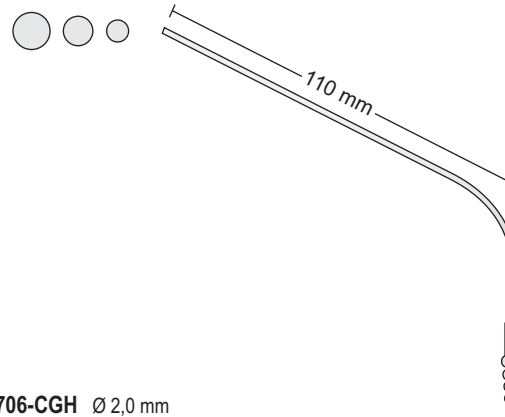

0706-CGI Ø 3,0 mm
0706-CGL Ø 4,0 mm
0706-CHA Ø 5,0 mm

BARNES
0706-CGI/0706-CHA
 150 mm

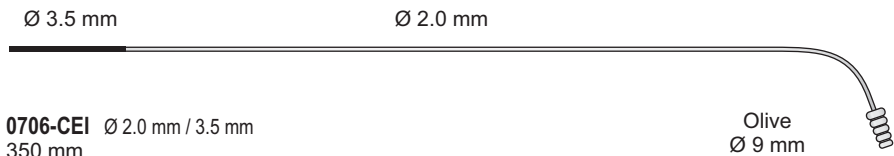

0706-CEI Ø 2,0 mm / 3,5 mm
 350 mm
0706-CEL Ø 2,0 mm / 3,5 mm
 500 mm

0706-CEI/0706-CEL

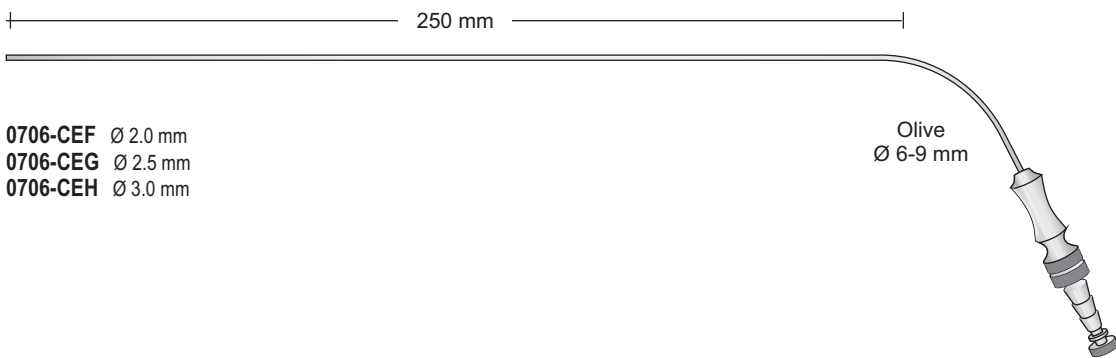

0706-CEF Ø 2,0 mm
0706-CEG Ø 2,5 mm
0706-CEH Ø 3,0 mm

0706-CEF/0706-CEH
 250 mm

Absaugkanülen

Suctions tubes

Cannule per aspirazione

Cánulas aspiradoras

Canules aspiratrices

Ohrkatheter
Ear Catheters
Sonde auricolari
Sondas auriculares
Sondes auriculaires

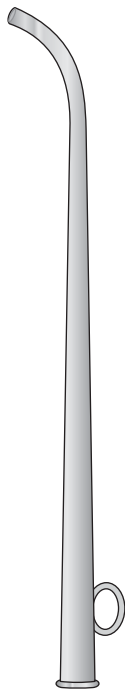

ITARD
0706-BFG/0706-BGA
145 mm

- 0706-BFG Ø 3,0 mm
- 0706-BFH Ø 3,5 mm
- 0706-BFI Ø 4,0 mm
- 0706-BFL Ø 4,5 mm
- 0706-BGA Ø 5,0 mm

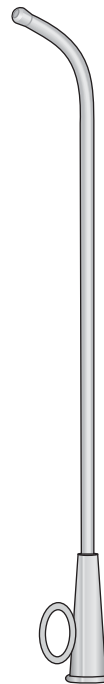

HARTMANN
0706-BGB/0706-BGH
150 mm

- 0706-BGB Ø 2,0 mm
- 0706-BGC Ø 2,5 mm
- 0706-BGD Ø 3,0 mm
- 0706-BGE Ø 3,5 mm
- 0706-BGF Ø 4,0 mm
- 0706-BGG Ø 4,5 mm
- 0706-BGH Ø 5,0 mm



0706-BGI

Kiefer und Stirnhöhlen-Spülkanülen
Antrum and frontal sinus wash cannulas
Cannule per lavaggio dei seni frontali e mascellari
Cánulas lavadores para seno maxilar y seno frontal
Canules pour le lavage du sinus maxillaire et frontal

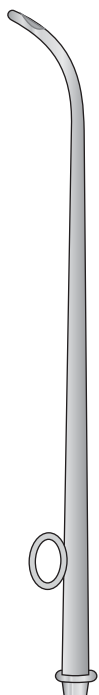

SIEBENMANN
0706-BGL/0706-BHD
150 mm

- 0706-BGL Ø 1,5 mm
- 0706-BHA Ø 1,7 mm
- 0706-BHB Ø 2,0 mm
- 0706-BHC Ø 2,5 mm
- 0706-BHD Ø 3,0 mm

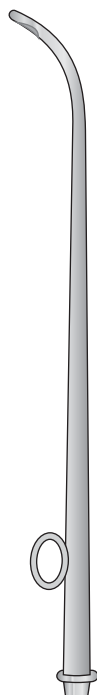

SIEBENMANN
0706-BHE/0706-BHI
150 mm

- 0706-BHE Ø 1,5 mm
- 0706-BHF Ø 1,7 mm
- 0706-BHG Ø 2,0 mm
- 0706-BHH Ø 2,5 mm
- 0706-BHI Ø 3,0 mm



0706-BHL

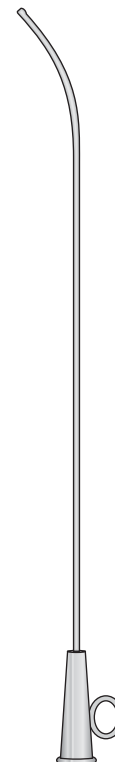

HARTMANN
0706-BBB/0706-BBD
170 mm

- 0706-BBB - Ø 1,5 mm
- 0706-BBC - Ø 2 mm
- 0706-BBD - Ø 2,5 mm

Mit LUER-LOCK-Ansatz
With LUER-LOCK attachment
Con cono LUER-LOCK
Con cono LUER-LOCK
Avec cône LUER-LOCK



ROSEN
1411-BD Ø 0,70 mm
1411-BE Ø 0,90 mm
1411-BF Ø 1,25 mm
95 mm

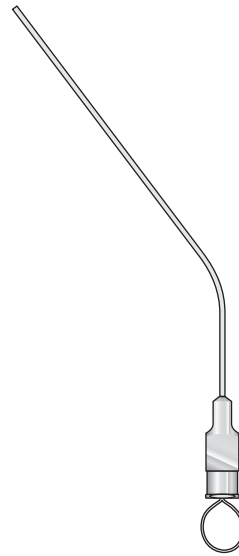

ROSEN
1411-BG Ø 0,70 mm
1411-BH Ø 0,90 mm
1411-BI Ø 1,25 mm
95 mm

WULLSTEIN Spül- und Saughandgriff mit Luer-Konus,
passend für WULLSTEIN Spül- oder Saugrohre
WULLSTEIN Irrigating suction handle, with Luer cone,
for WULLSTEIN irrigating or Suction tubes
WULLSTEIN manico per aspirazione e lavaggio, con cono Luer,
per cannule per aspirazione e lavaggio di WULLSTEIN
WULLSTEIN mango irrigador y ispirador, con con Luer, apropiado
para los tubos de lavado y de aspiración según WULLSTEIN
WULLSTEIN manche aspirateur et irrigateur, à cône Luer, s'adaptant
aux tubes aspirateurs/irrigateurs de WULLSTEIN

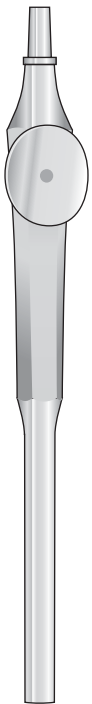

WULLSTEIN
0706-GE
120 mm

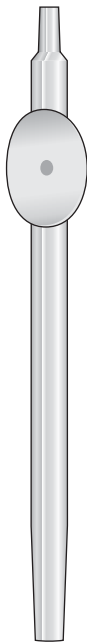

0706-GG
110 mm



0706-GC
65 mm

24 Gauge
20 Gauge

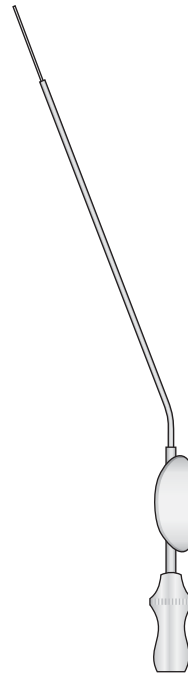

SCHUHKNECHT
0706-CFI Ø 0,9 mm
0706-CFL Ø 0,6 mm
130 mm

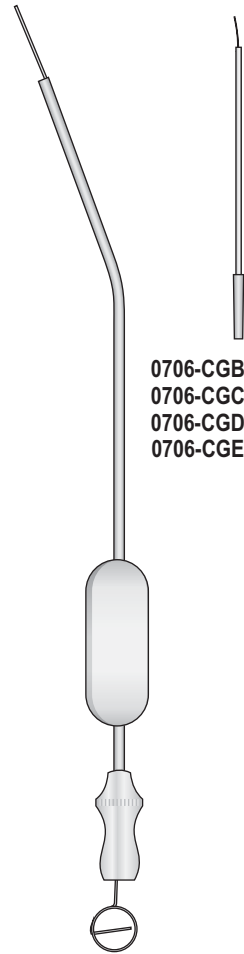

ZOELLNER
0706-CGA
180 mm

0706-CGB Ø 0,5 mm
0706-CGC Ø 0,7 mm
0706-CGD Ø 0,9 mm
0706-CGE Ø 1,2 mm

Absaugkanülen

Suctions tubes

Cannule per aspirazione

Cànullas aspiradoras

Canules aspiratrices

Mit Luer-Konus - With Luer Cone - Con cono Luer
Con cono Luer - A' cone Luer

Rostfrei - Stainless Steel
Acciaio inossidabile - Acero inoxidable
Acier Inoxydable

Saug- und Spülinstrumente
Aspirating and Irrigating instruments
Strumenti per aspirazione e lavaggio
Instrumentos de aspiración y de lavado
Instruments à aspiration et à irrigation

Ø 1 mm

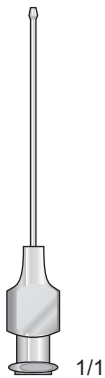

1411-CC
50 mm

Ø 2 mm

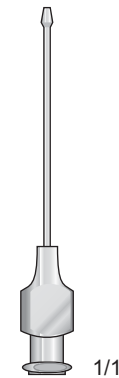

1411-CD
50 mm

Ø 3 mm

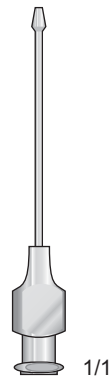

1411-CE
50 mm

Irrigating cannula
Frontal Sinus
Ø 3,5 mm



HAJEK
1411-BAA
165 mm

Ø 1,75 mm



WULLSTEIN
1411-BAB
160 mm

Ø 3,0 mm



WULLSTEIN
1411-BAC Ø 1,5 mm
1411-BAD Ø 2,0 mm
160 mm

Tonsillenkanülen
Tonsil needles
Aghi per tonsille
Agujas para amígdalas
Aiguilles pour les amygdales



1411-AB
120 mm

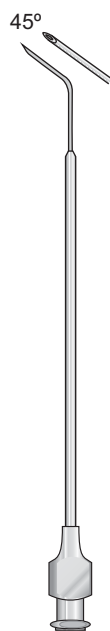

1411-AC
110 mm



1411-AD
110 mm



SEPTUN-NADEL
1411-AE
110 mm

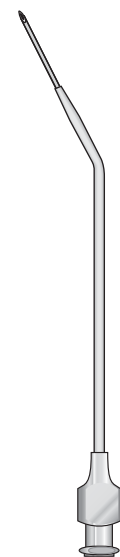

1411-AF
110 mm

Absaugkanülen

Suctions tubes

Cannule per aspirazione

Cànulas aspiradoras

Canules aspiratrices

Biegsam - Malleables
Malleabili - Maleables - Souple

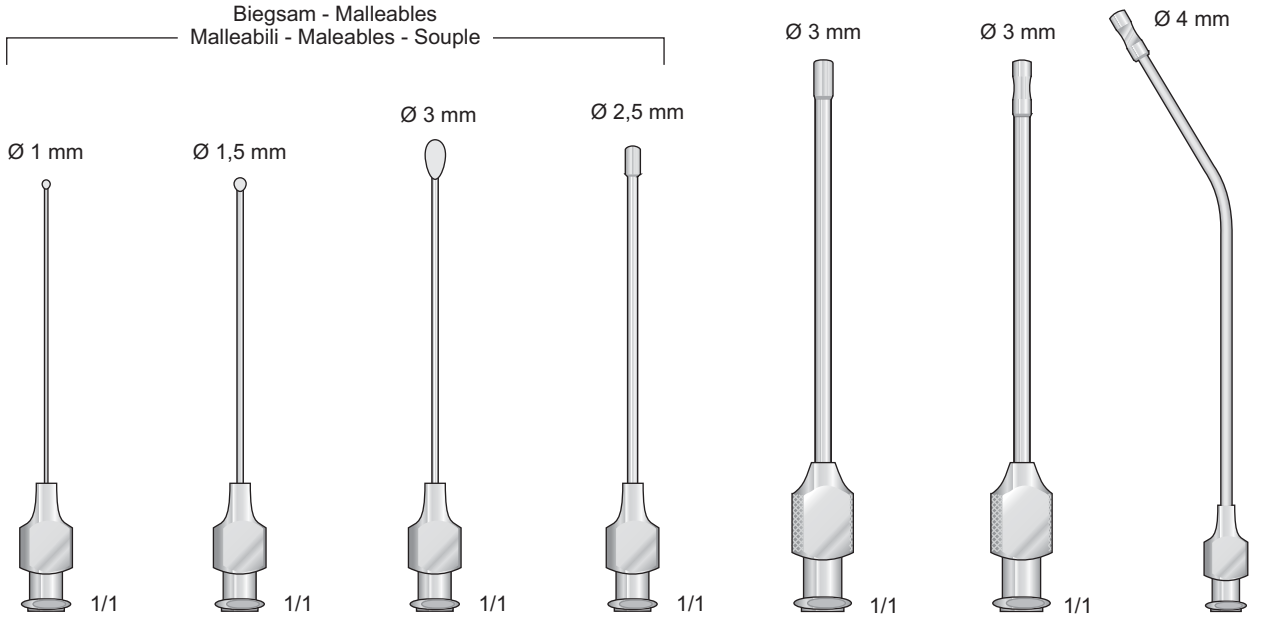

HEPARIN
1411-AH 60 mm
1411-CF 80 mm

HEPARIN
1411-AI 60 mm
1411-CG 80 mm

HEPARIN
1411-BA 65 mm

1411-AG 65 mm

1411-AL 75 mm

1411-BB 75 mm

1411-BL 95 mm

Ø 2 mm

Ø 2 mm

Ø 3 mm

Ø 2 mm

Ø 2 mm

Ø 2 mm

Ø 2 mm

Ø 2 mm

Ø 3 mm

Biegsam
Malleables
Malleabili
Maleables
Souple

1411-DE 75 mm

1411-DH 95 mm

1411-DI 95 mm

1411-DL 100 mm

1411-CI 90 mm

1411-CL 140 mm

1411-CH 150 mm

1411-GD 170 mm

1411-GE 170 mm

Absaugkanülen

Suctions tubes

Cannule per aspirazione

Cànulas aspiradoras

Canules aspiratrices

Biegsam Nadel - Malleables Needles - Aghi malleabili - Agujas maleables - Aiguilles souple

0,5 mm



1411-IG
150 mm

0,7 mm



1411-IH
150 mm

1 mm



1411-II
150 mm

1,5 mm



1411-IL
150 mm

2 mm



1411-LA
150 mm

2,5 mm



1411-LB
150 mm

3 mm



1411-LC
150 mm

Biegsam
Malleables
Malleabili
Maleables
Souple

Biegsam Nadel - Malleables Needles - Aghi malleabili - Agujas maleables - Aiguilles souple
Mit 2 Loch - With 2 Openings - Con 2 Fori - Con 2 Bucos - Avec 2 Trou

0,5 mm



1411-LD
150 mm

0,7 mm



1411-LE
150 mm

1 mm



1411-LF
150 mm

1,5 mm



1411-LG
150 mm

2 mm



1411-LH
150 mm

2,5 mm



1411-LI
150 mm

3 mm



1411-LL
150 mm

Kanülenreinigungs-
-Bürsten

Cleaning brush
for tubes

Scovolini per
pulizia cannule

Cepillo para
limpiar cánulas

Brosse de nettoyage
pour canules

Sterilisier bar
Autoclavable
Autoclavabile
Esterilizabile
Stérilisable

Handwaschbürste
Nail brushes
Spazzola per unghie
Cepillos de uñas
Brosse à ongles



0706-CAA
4 x 11 cm

Ø 2,5 mm
30 mm

Ø 5 mm
40 mm

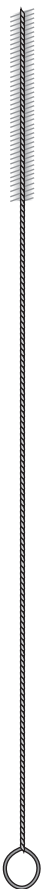

0706-EA
235 mm

Ø 2 mm
25 mm



0706-BIC
215 mm

Ø 4 mm
100 mm

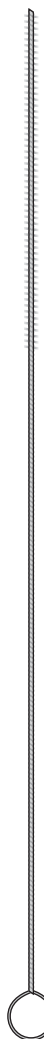

0706-BID
300 mm

Ø 6 mm
100 mm



0706-BIF
300 mm

Ø 16 mm
75 mm



0706-BII
220 mm



0706-BIG
500 mm

4.8



Allgemeine HNO-Instrumentarium
General ENT Instruments
Strumentario generale per ORL
Instrumental general para ORL
Instruments généraux pour ORL

Instrumentpflege, Gefäße
Maintenance of instruments, Receptacles
Mantenimento strumenti
Mantenimiento del Instrumental, Recipientes
Nettoyage d'Instruments, Récipientes

Sterilisierzangen zum Fassen und Halten Steriler Instrumente - Sterilizing forceps for picking up and holding of sterile instruments
 Pinze per prelevare strumenti sterilizzati - Pinzas para esterilizaci3n
 Pinces pour saisir les objets st3rilis3s

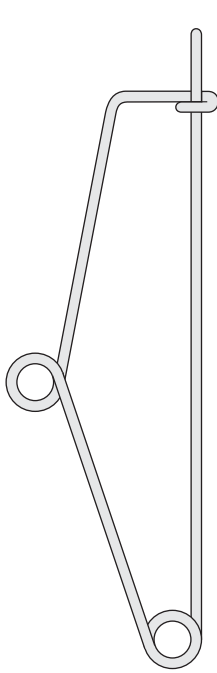

MAYO
0718-AB
140 mm

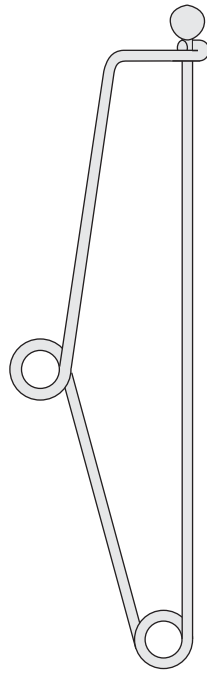

MAYO
0718-AH
140 mm

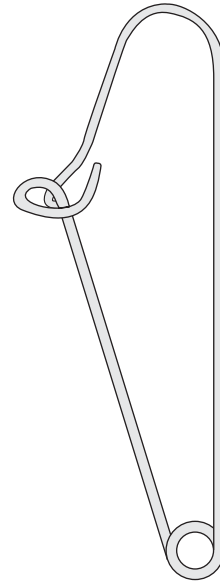

BUNT
0718-AL
110 mm



0718-AC
145 mm

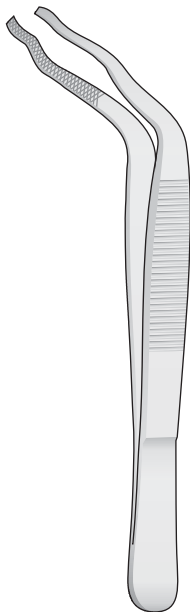

DAVIS
0718-AD
160 mm

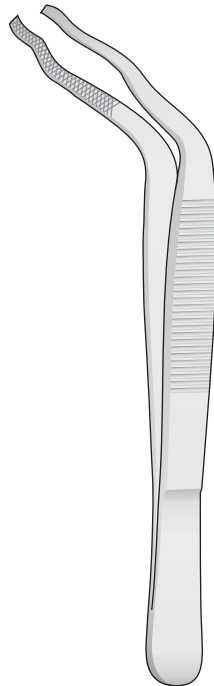

DAVIS
0718-AE
200 mm

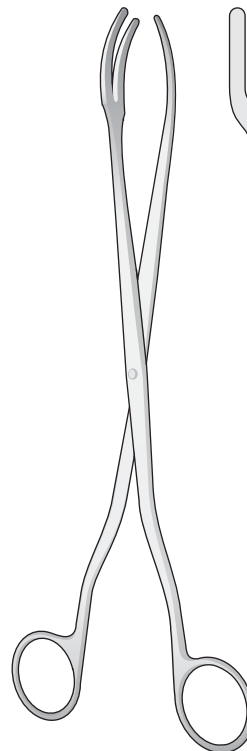

0718-BA
200 mm

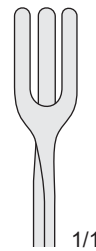

1/1

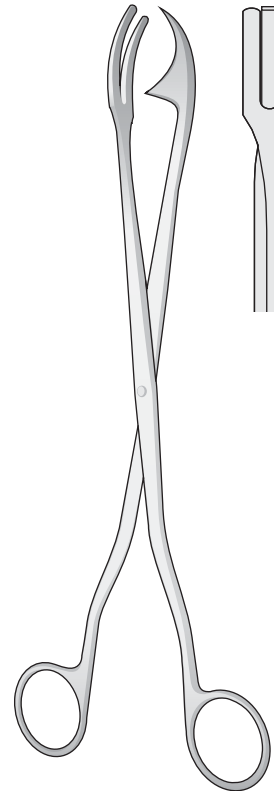

ROGGE
0718-AG
230 mm

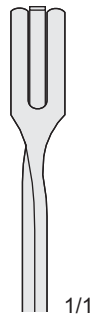

1/1

Wasserlösliche Schmiermittel von chirurgische Instrumenten
 Lubricant Oil for surgical instruments
 Olio lubrificante per strumenti chirurgici
 Lubrificante para instrumentos
 Entretien pour instruments

RODHOIL

Schmiermittel mit hoher Dichte. Es sichert den perfekten Gebrauch und die Leichtgängigkeit aller chirurgischen Instrumente. Man gibt es auf die Verbindungen und Gelenke und in alle beweglichen Teile, die Reibungen unterworfen sind.

RODHOIL

Lubricant to high density. It assures the perfect utility and fluency of all the surgical instruments. For apply in to loosens, join and in all the parts in subject movement subject to attrition.

RODHOIL

Lubrificante ad alta densità. Assicura la perfetta funzionalità e scorrevolezza di tutti gli strumenti chirurgici. Da applicare negli snodi, giunture e in tutte le parti in movimento soggette ad attrito.



0402-141117
50 cc

Das wasserlösliche Schmiermittel verlängert die Lebensdauer von chirurgische Instrumenten
 Soluble lubricant extends useful life of surgical instruments
 Lubrificante anticorrosivo e detergente per strumenti chirurgici
 Lubrificante soluble en agua, so uso prolonga la duracion de los instrumentos quirurgicos
 Lubrifiant soluble dans l'eau prolonge la vie des instruments chirurgicaux

CLEANLACT

Reinigungskonzentrat für chirurgische Instrumente. Es wirkt antibakteriell, nicht-ätzend und schmierig. Es garantiert die perfekte Erhaltung aller Instrumente aus Stahl, entfernt eventuelle Flecken, Ränder, und Bräunungen von Sterilisationen, Desinfektionen und Reinigungen mit hartem Wasser. Es sollte regelmäßig verwendet werden.

CLEANLACT

Product concentrated for surgical instruments. It explains an action anti-corrosive, antibacterium and lubricant. It guarantees the perfect maintenance of all the instruments in steel eliminating eventual stains and burnishes to sterilization, disinfection and to washings with hard waters. It used periodically.

CLEANLACT

Prodotto concentrato per strumenti chirurgici. Esplica un azione anticorrosiva batteriostatica e lubrificante. Garantisce il perfetto mantenimento di tutti gli strumenti in acciaio eliminando eventuali macchie, aloni e bruntiture dovute a sterilizzazioni, disinfezioni e a lavaggi con acque dure. Va usato periodicamente.



0402-FA12
500 cc

0402-B11
1000 cc

Gefäße
aus Edelstahl

Stainless Steel
Receptacles

Recipienti in
acciaio inossidabile

Recipientes de
acero inoxidable

Réceptacles en
acier inoxydable

Sterilbehälter für Nadeln
Box for needles
Scatola per sterilizzazione aghi da sutura
Estuche para agujas
Boite pour aiguilles de suture



0218-B
Ø 78 mm h 15 mm

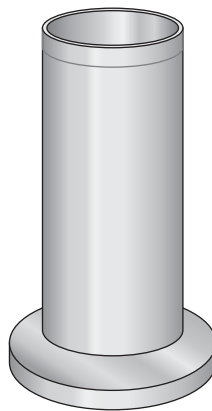

0318-FB Ø 50 mm h 100 mm
0318-FC Ø 50 mm h 150 mm
0318-FF Ø 80 mm h 180 mm

Runder Sterilbehälter mit Ausguss
Lotion bowls capsules
Capsule inox con fondo piano e becco
Capsula en acero inoxidable
Capsule en acier inoxydable

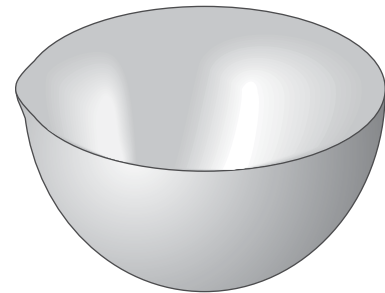

0318-AB Ø 40 mm 15 cc
0318-AC Ø 60 mm 75 cc
0318-AD Ø 80 mm 225 cc
0318-AE Ø 100 mm 325 cc
0318-AF Ø 120 mm 500 cc
0318-AG Ø 150 mm 600 cc

Nierenschalen
Kidney bowls
Bacinelle reniformi
Riñoneras
Bassins réniformes



0217-CA 200 mm
0217-CF 250 mm
0217-CI 280 mm

Schalen
Trays
Vassoi porta-strumenti
Bandejas
Bassins

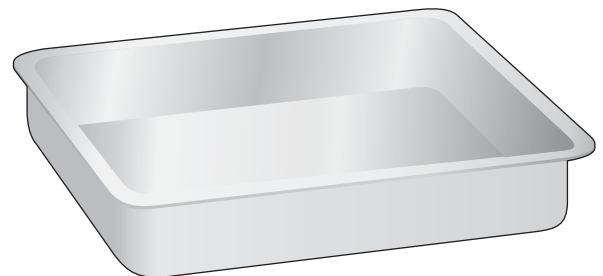

2118-CA 210 x 110 x 25 mm
2118-CG 250 x 180 x 30 mm
2118-DA 300 x 220 x 30 mm

Gefäße
aus Edelstahl

Stainless Steel
Receptacles

Recipienti in
acciaio inossidabile

Recipientes de
acero inoxidable

Réceptacles en
acier inoxydable

Rostfrei - Stainless steel - Inox
Inoxidable - Inoxydable

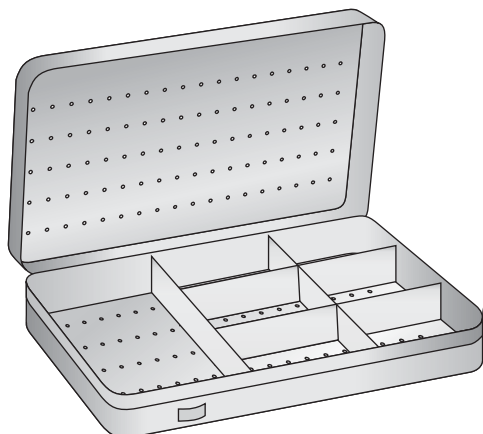

0218-CH
150 x 90 x 20 mm

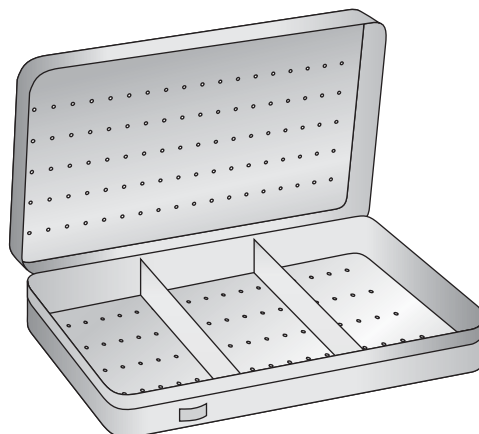

0218-CD
150 x 90 x 20 mm

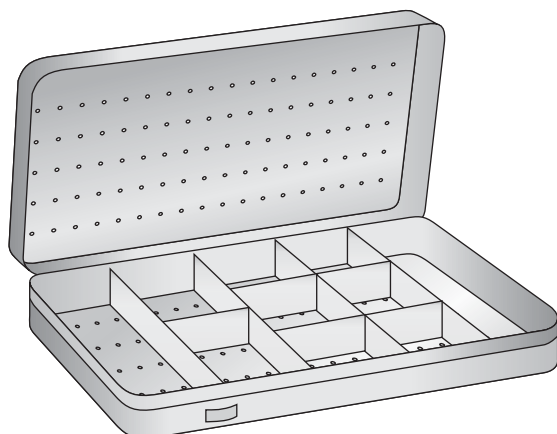

0218-CI
220 x 120 x 20 mm

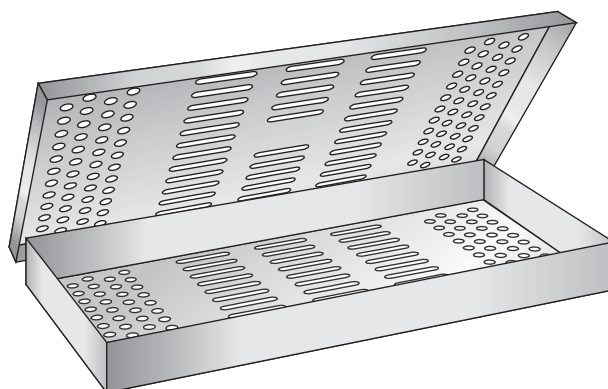

0218-EB
275 x 130 x 25 mm

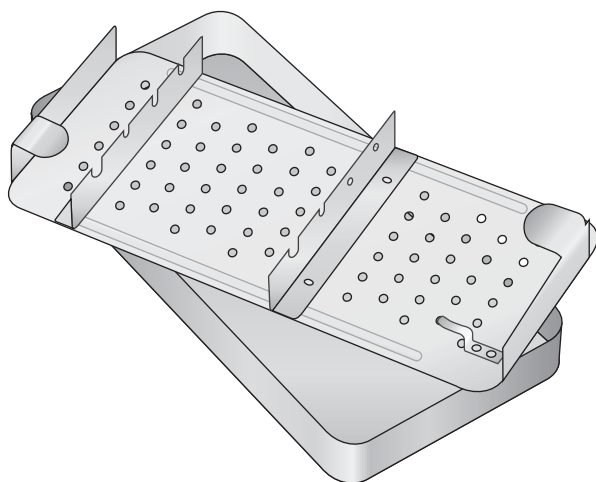

0218-DA
180 x 90 x 35 mm 2 ripiani

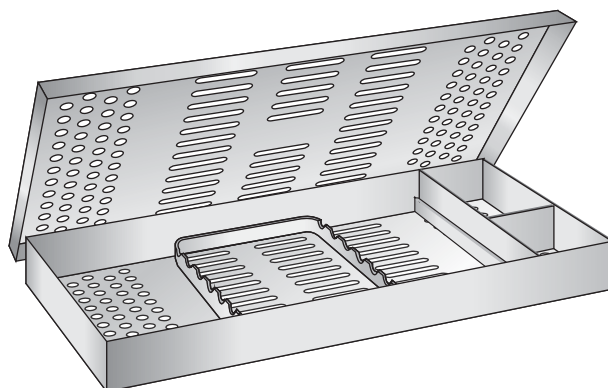

0218-EA 275 x 130 x 25 mm Con griglia e scomparti
0218-EC 285 x 190 x 25 mm Con griglia e scomparti

Steril Container



Sterilizing containers



Contenitori per sterilizzare

Contenedores para esterilización

Containers pour stériliser



Kleinsetcontainer / Mini Container

Außen / outside / esterno
exterior / extérieur
300 x 140 x 40 mm

- 0319-FFB
- 0319-FFG
- 0319-FFH
- 0319-FFI
- 0319-FFL

Innen / inside / interno
interior / intérieur
280 x 130 x 27 mm

Kleinsetcontainer / Mini Container

Außen / outside / esterno
exterior / extérieur
300 x 140 x 70 mm

- 0319-FGA
- 0319-FGB
- 0319-FGC
- 0319-FGD
- 0319-FGE

Innen / inside / interno
interior / intérieur
280 x 130 x 55 mm

Kleinsetcontainer / Mini Container

Außen / outside / esterno
exterior / extérieur
300 x 140 x 100 mm

- 0319-FGF
- 0319-FGG
- 0319-FGH
- 0319-FGI
- 0319-FGL

Innen / inside / interno
interior / intérieur
280 x 130 x 84 mm

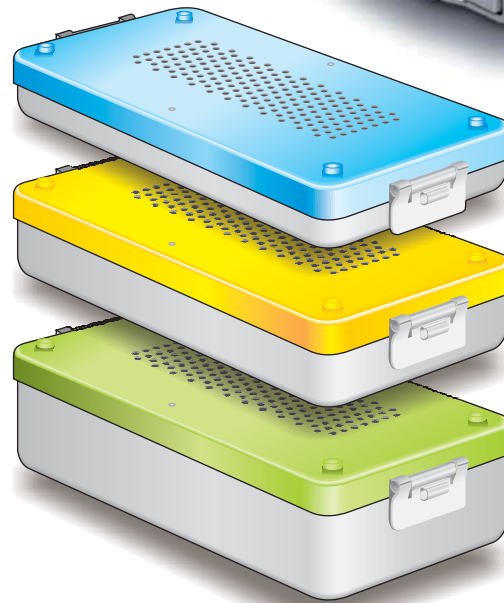

0319-GGA

94 x 215 mm - Box 1 pc.

Teflon Filter für 1200 Zyklen
Teflon Filter for 1200 cycles
Filtro in teflon per 1200 cicli
Filtro de teflón para 1200 ciclos
Filtre de téflon pour 1200 cycles



0319-GHA

Box 100 pc.

Kunststoff-Dichtungen
Plastic seals
Sigilli di plastica
Sellos de plástico
Scellés en plastique

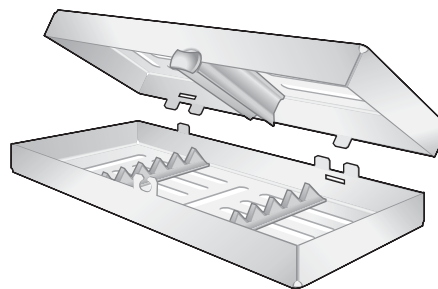

0319-GHC

Box 100 pc.

Label Einweg
Disposable-Label
Etichetta monouso
Etiqueta desechables
Étiquettes jetables

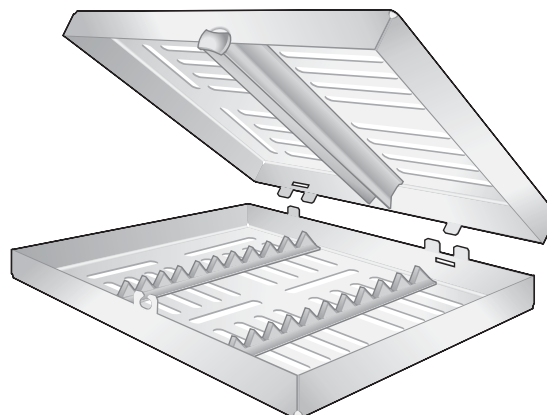

0319-HAC

65 x 65 mm

Baumwolle Handtuch Verpackung
Cotton Towel Packaging
Telo in cotone per confezionamento
Embalaje de toallas de algodón
Emballage de serviettes de coton

0218-FL

185 x 75 x 35 mm

Für 5 Instrumente
For 5 Instruments
Per 5 strumenti
Para 5 instrumentos
Pour 5 instruments

0218-GA

185 x 135 x 35 mm

Für 10 Instrumente
For 10 Instruments
Per 10 strumenti
Para 10 instrumentos
Pour 10 instruments

0218-GB

290 x 185 x 35 mm

Für 20 Instrumente
For 20 Instruments
Per 20 strumenti
Para 20 instrumentos
Pour 20 instruments

Sterilisierbar - Autoclavable
 Autoclavabili - Esterilizable
 Stérilisable

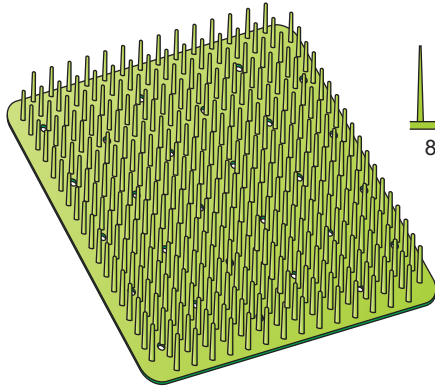

8 mm

1918-BAB
 135 x 180 mm

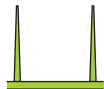
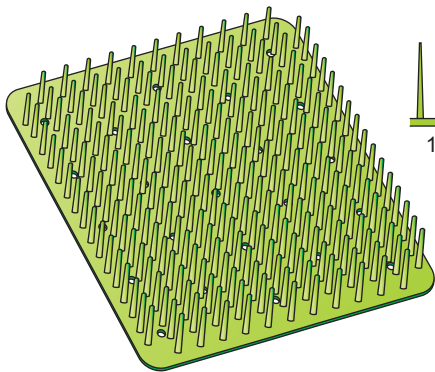

10 mm

1918-BAC
 135 x 180 mm

Silikon Matten
 Matte en silicone
 Tappeti in aghi di silicone
 Tapete en agujas de silicona
 Tapis en Silicone

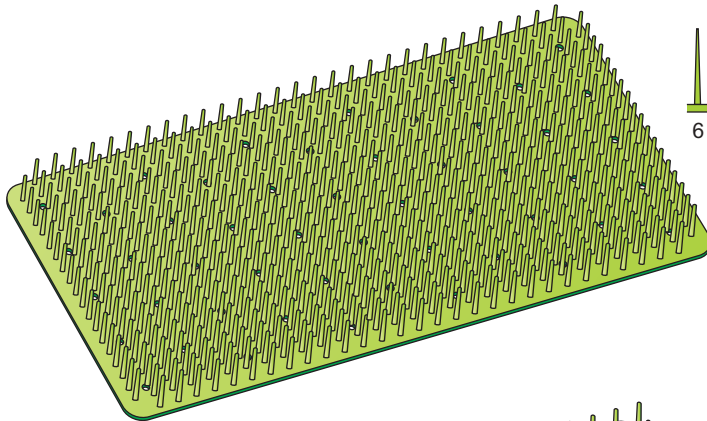

6 mm

1918-BAD
 260 x 120 mm

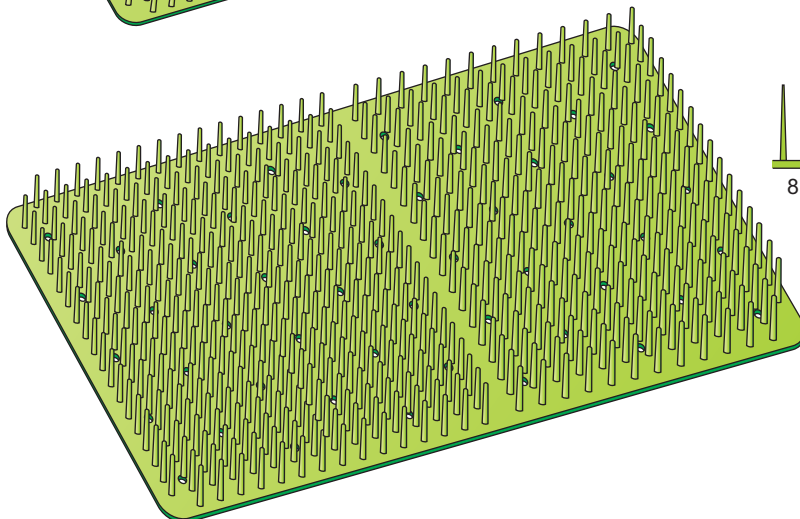

8 mm

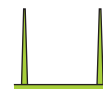

10 mm

1918-BAE
 270 x 180 mm

5.1



Inhaltverzeichnis
Index
Indice
Indice
Index

Alfabetisches Inhaltverzeichnis
Alphabetical Index
Indice alfabetico
Indice alfabetico
Index alphabetique

ABRAHAM , Retrattori per tonsille	138
ADSON , Cannule per aspirazione	312
- Divaricatori	279
- Pinzette	249
- Pinzette anatomiche	237
- Pinzette chirurgiche	236, 246
ADSON-BROWN , Pinzette anatomiche	236, 237, 246
AGNEW , Bisturi	11
ALDERDYCE , Periostotomi	20
ALEXANDER , Scalpelli	18
ALLIS , Pinze emostatiche	223
ALLPORT , Uncini	9
ALM , Divaricatori	274
ANDREWS-PYNCHON , Cannule per aspirazione	305
ANTRUM , Rinologia	97
ARRUGA , Port'aghi	294
ASCH , Rinologia	100
AUFRIEHT , Raspe nasali	88
- Rinologia	62
- Rinoplastica	95
AUFRIEHT-WALTER , Rinoplastica	95
AUSTIN , Pinzette chirurgiche	235

B

BABBUSH , Periostotomi	20
BABY-ADSON , Pinze emostatiche delicate	216
BABY-ALLIS , Pinze emostatiche	223
BABY-CRILE , Pinze emostatiche	218
BABY-CRILE-WOOD , Port'aghi	289
BABY-METZENBAUM , Forbici chirurgiche	184
BABY-MIXTER , Pinze emostatiche delicate	216
BABY-WEITLANER , Divaricatori	275
BABY-YANKAUER , Cannule per aspirazione	305
BACKHAUS , Fissateli	213
BALLENGER , Bisturi	57
- Rinologia	58, 61
BALLENGER-HAYEK , Rinologia	60
BARBARA , Micro aghi auricolari	37
BARNES , Cannule per aspirazione	315
BARNHILL , Adenotomi	106
BARON , Cannule per aspirazione	310
BARRAQUER , Micro Port'aghi	283
- Pinzette depilatorie	252
BARSKY , Divaricatori	94
BARTH , Curette	23
BEASLEY-BABCOCK , Pinzette chirurgiche	234
BECKMANN , Adenotomi	106
- Rinologia	105
- Speculum nasali	53
BEEBE , Forbici per fili metallici	206
BEER , Pinzette depilatorie	252
BELLUCCI , Cannule per aspirazione	310
- Micro Pinze auricolari	45
BEYER , Pinze ossivore	31
BILLEAU , Lacci auricolari	8
BIRO , Forbici delicate	171
BISHOP , Abbassalingua	125
BLUMENTHAL , Pinze ossivore	30
BöHLER , Pinze ossivore	32
BOIES , Rinologia	92
BONNEY , Pinzette chirurgiche	247
BOSE , Dilatatori per tracheotomia	144
BOWLED-HENRY , Divaricatori	62
BOWMAN , Sonde bottonute	300

BOYNTON , Port'aghi	294
BOYS-ALLIS , Pinze emostatiche	223
BRACKMANN , Cannule per aspirazione	313
BRAUN , Pinze emostatiche	223
BROWN , Pinzette chirurgiche	248
BRUENINGS , Abbassalingua	122
BRÜHL , Bisturi	10
BRÜNINGS , Bisturi	57
- Pinze serranodi	140
- Retrattori per tonsille	138
- Rinologia	63
BRUNS , Cucchai taglienti	26
BUCHWALD , Abbassalingua	122
BUCK , Curette auricolari	7
- Pinza per corpi estranei	13
BUCKLEY , Osteotomi	16
BUNT , Pinze per sterilizzazione	325

C

CANFIELD , Retrattori per tonsille	138
CAPLAN , Forbici chirurgiche	193
- Rinologia	98
CARTER , Rinologia	61
CASTROVIEJO , Micro Port'aghi	284
- Pinzette chirurgiche	248
- Strumenti per misura	164
CAWOOD-MINNESOTA , Abbassalingua	125
CHADWICK , Forbici delicate	172
CINELLI , Forbici delicate	181
- Osteotomi	73
- Pinze ossivore	33
COAKLEY , Rinologia	96, 105
COLUMBIA , Abbassalingua	123
COLVER , Pinze per tonsille	212
CONVERSE , Divaricatori	260
- Lime per osso	87
- Port'aghi	286
- Rinoplastica	57
COTTLE , Bisturi	57
- Divaricatori	93, 94, 256, 258
- Forbici chirurgiche	190, 202
- Forbici dentellate	203
- Martelli chirurgici	15
- Microchirurgia endolaringea	43
- Osteotomi	71, 80
- Pinzette chirurgiche	234
- Rinologia	60, 61, 62, 89, 92
- Rinoplastica	95
- Speculum nasali	53, 54, 55
COTTLE-KAZANJIAN , Rinologia	98
COTTLE-KNAPP , Forbici delicate	171
COTTLE-MASING , Forbici delicate	171
COTTLE-NEIVERT , Divaricatori	94
COTTLE-WALSHAM , Rinologia	100
COUPLAND , Cannule per aspirazione	306
COXETER , Strumenti per otologia	12
CRAIG , Rinologia	63
CRILE , Pinze emostatiche	217, 218
CRILE-MURRAY , Port'aghi	285
CRILE-WOOD , Port'aghi	285, 287, 289
CUSHING , Divaricatori	260
- Pinze per biopsia	112
- Pinzette chirurgiche	241, 247
- Rinoplastica	95

Alphabetisches Inhaltsverzeichnis	Alphabetical Index	Indice alfabetico	Indice alfabetico	Index alphabétique
CUSHING-LANDOLT , Strumenti per ipofisi cerebrale	114	FREEMAN-GORNEY , Forbici chirurgiche		202
D		FREEMAN-KAYE , Forbici chirurgiche		202
DANDY , Forbici chirurgiche	189	FREER , Bisturi		57
DANDY-MOSQUITO , Pinze emostatiche	222	- Divaricatori		94
DAVIS , Pinze per sterilizzazione	325	- Osteotomi		16
DAVIS-BOYLE , Apribocca	131, 133	- Periostotomi		20, 58, 59
DAY , Uncini	9	- Rinologia		58, 59, 61
DEAN , Forbici chirurgiche	189	FREER-YASARGIL , Rinologia		59
DEAVER , Forbici chirurgiche	185	FRENZEL , Abbassalingua		122
DeBAKEY , Pinzette	250	FRIEDMANN , Pinze ossivore		29
- Pinzette atraumatiche	244	FRIESNER , Bisturi		11
- Pinzette chirurgiche	248	G		
- Port'aghi	287	GALLAHER , Lime per osso		85
DeBAKEY-MOSQUITO , Pinze emostatiche	222	GERALD , Pinzette		249
DERF , Port'aghi	285, 286	- Pinzette chirurgiche		243
DESCHAMPS , Aghi per legature	296	GERALD-BROWN , Pinzette chirurgiche		243
DESMARRES , Divaricatori	259	GERZOG-SEXTON , Bisturi		11
DIEFFENBACH , Pinze Bulldog	225	GILLIES , Divaricatori fini		255
DIETER , Micro Pinze auricolari	44	- Pinzette chirurgiche		243
DINGMANN , Apribocca	132	- Port'aghi		290
- Raschiatore per cartilagine	12	- Retrattori per tonsille		138
DOCKHORN , Divaricatori	269	GLASSMAN , Forbici chirurgiche		177
DOLWICK-REICH , Divaricatori	279	GOLDMAN-FOX , Forbici chirurgiche		175, 194
DOUGLAS , Retrattori per tonsille	138	GOLDMANN , Rinologia		92
DOYEN , Sonde bottonute	299	GOOD , Forbici chirurgiche		188
DUNN-DAUTREY , Divaricatori	124	- Lime per osso		85
DUPUY-WEISSE , Aghi per legature	134	GORNEY , Cannule per aspirazione		309
E		- Forbici chirurgiche		187, 193, 202
EICKEN , Cannule per aspirazione	308	- Rinologia		100
EPKER , Osteotomi	76	GRAEFE , Divaricatori		94
EVES , Pinze serranodi	140	- Forbici delicate		171
F		- Pinzette chirurgiche		234
FAHLBUSCH , Rinologia	113, 117	GREENBERG-PAR , Forbici chirurgiche		192
FARABEUF , Divaricatori	261	GREENE , Divaricatori		263
- Periostotomi	21	GREGORY , Forbici chirurgiche		194
FARABEUF-COLLIN , Periostotomi	21	GREVEN , Micro Pinze auricolari		48
FARRELL , Porta cotone	301	GROSS , Cucchiaino e uncinetto		8
FAULKNER , Rinologia	92, 105	- Curette e uncinetto		8
FAURE , Fissateli	213	- Pinze per tamponi		209
FEIN , Porta cotone	148	GRÜNENWALD , Pinzette auricolari		251
FERGUSSON , Cannule per aspirazione	314	GUILLEN , Cannule per aspirazione		309
FERRIS-SMITH-KERRISON , Strumenti per ipofisi	107, 108, 109, 110	GUTHRIE , Divaricatori fini		255
FINSEN , Divaricatori	274	H		
FISCH , Cannule per aspirazione	313	HAJEK , Cannule per aspirazione		318
FISCHER , Retrattori per tonsille	138	- Martelli chirurgici		15
FISH , Sonde bottonute	299	HAJEK-GRUENWALD , Rinologia		64
FOERSTER , Pinze per tamponi	210	HALLE , Cucchiaino tagliente		24
FOERSTER-BALLENGER , Pinze per tamponi	209	- Rinologia		59
FOMON , Divaricatori	94, 256	HALSEY , Port'aghi		285, 286
- Forbici chirurgiche	189, 190, 192, 202	HALSTED , Pinze emostatiche		218
- Forbici delicate	181, 203	- Pinze emostatiche delicate		216
- Lime per osso	87	HALSTED-MOSQUITO , Pinze emostatiche		218
- Osteotomi	73	- Pinze emostatiche delicate		215
- Raspe nasali	91	HARDY , Rinologia		116
- Rinologia	59	HARDY-FAHLBUSCH , Rinologia		116
- Rinoplastica	57	HARTMANN , Abbassalingua		125
FOSTER-GILLIES , Port'aghi	291	- Cannule per aspirazione		313, 316
FRAZIER , Cannule per aspirazione	312, 314	- Diapason		5
FRAZIER , Divaricatori	93	- Pinze auricolari		14
		- Pinze auricolari per tamponamento		13
		- Porta cotone		148

Alphabetisches Inhaltsverzeichnis	Alphabetical Index	Indice alfabetico	Indice alfabetico	Index alphabétique
- Rinologia	63	- Raspe nasali		88
- Speculum nasali	51, 56	- Rinologia		59, 61, 89
- Speculum per adulti	3	- Rinoplastica		56, 57
- Speculum per bambini	3	JUDD-ALLIS , Pinze emostatiche		223
- Uncini	9	JURASZ , Rinologia		63
HARTMANN-HALLE , Speculum nasali	215	K		
HARTMANN-BABY-MOSQUITO , Pinze emostatiche delicate	52	KAHN , Forbici chirurgiche		188
HARVEY , Forbici per fili metallici	206	KAYE , Forbici delicate		170
HEERMANN , Microchirurgia endolaringea	43	KELLY , Forbici chirurgiche		191, 195
HEGAR , Port'aghi	288	- Forbici per suture		205
HEIFETZ , Micro Pinzette	230	- Pinze emostatiche		221
HEILDBERG , Porta cotone	148	KERPEL , Cucchai taglienti		25
HEISTER , Apribocca	127	KERRISON , Pinze ossivore		33
HEMINGWAY , Cucchai taglienti	25	KERRISON-JACOBY , Strumenti per ipofisi		108
HENKE , Elevatori per tonsille	137	KILIAN , Osteotomi		73
- Periostotomi	136	KILIAN-KLAUS , Osteotomi		73
- Rinologia	64	KILLIAN , Cannule per aspirazione		308
HEPARIN , Cannule per aspirazione	319	- Forbici chirurgiche		193
HERBERHOLD , Abbassa Lingua	129	- Rinologia		60, 98
HEYMANN , Forbici chirurgiche	190	- Speculum nasali		51, 52, 55
HEYMANN-KNIGHT , Forbici chirurgiche	190	KILLNER , Divaricatori		93
HOFER , Elevatori per tonsille	137	KILNER (RAGNELL) , Forbici chirurgiche		195
HOSOBUCHI , Rinologia	115	KILNER , Divaricatori		94
HOUSE , Cannule per aspirazione	311	- Forbici chirurgiche		174, 177
- Dilatatori per tracheotomia	144	- Forbici chirurgiche		192
- Divaricatori	261	- Forbici delicate		173
- Micro Cucchiai	42	KILNER-DOUGHTY , Apribocca		133
- Micro Dissettori	39	KIRSCH , Divaricatori		269
- Lime per osso	85	KLEINERT-KUTZ , Divaricatori		94
HOWARTH , Rinologia	60	- Pinze ossivore		31
HUNT , Micro Pinzette	229, 230	KOCHER , Divaricatori		264, 266, 271, 272
HURD , Aghi per legature	134, 296	- Pinze emostatiche		219, 221, 224
- Periostotomi	136	- Sonde conduttrici		295
I		KOCHER-LANGENBECK , Divaricatori		267
IRIS , Forbici chirurgiche	191, 194	KOCHER-OCHSNER , Pinze emostatiche		220
- Forbici delicate	172	KOENIG , Sonde conduttrici		295
- Forbici Wellenschliff	204	- Periostotomi		19
ITARD , Cannule per aspirazione	316	KRAUSE , Pinze serranodi		139
J		- Tre quarti		121, 302
JACKSON , Dilatatori per tracheotomia	144	KRAUSE-VOSS , Pinze serranodi		139
- Divaricatori	261	KRESSNER , Rinologia		100
JACKSON-TESSIER , Forbici ossivore	99	KROENIG , Abbassalingua		122
JACOBSON , Bisturi	10	KRONECKER , Aghi per legature		134
- Curette	23	- Sonde conduttrici		295
- Micro Forbici	168	KÜHNE , Pinzette depilatorie		252
- Uncini	9	L		
JACOBSON-HALSTED , Pinze emostatiche	222	LA FORCE , Pinze serranodi		139
JAMESON , Forbici chirurgiche	174	LABORDE , Dilatatori per tracheotomia		144
JAMESON-WERBER , Forbici chirurgiche	174	LACK , Abbassalingua		125
JANSEN , Curette	23	LAHEY , Divaricatori		260
- Divaricatori	274	LANDOLT , Manici per bisturi		161
- Periostotomi	21	- Pinze per biopsia		111
- Pinze ossivore	28	- Rinologia		115, 116
- Pinzette auricolari	251	LANDOLT-REULEN , Rinologia		117
- Pinze ossivore	30	LANGE , Divaricatori		93
JANSEN-MIDDLETON , Rinologia	98	LANGENBECK , Divaricatori		271
JANSEN-NEWHART , Lacci auricolari	8	- Elevatori		19
JONES , Fissateli	213	- Periostotomi		21
JOSEPH , Divaricatori	94, 256	- Strumenti per otologia		12
- Forbici chirurgiche	175, 195	LANGENBECK-RYDER , Port'aghi		293
- Lime per osso	85	LEMPERT , Bisturi		10

Alphabetisches Inhaltsverzeichnis	Alphabetical Index	Indice alfabetico	Indice alfabetico	Index alphabétique
- Micro Raspatori	41	MICRO-HALSTED , Pinze emostatiche delicate		215
- Pinze ossivore	30	MICRO-RYDER , Port'aghi		291, 292
- Strumenti per otologia	12	MICRO-VASCULAR , Port'aghi		287
LERICHE , Pinze emostatiche	217	MIDDELDORPF , Divaricatori		272
LEWIS , Raspe nasali	88	MIKULICZ , Pinze emostatiche		212
- Rinologia	89	MILLER , Laringoscopi		151
LEXER , Forbici chirurgiche	186, 201	- Laringoscopi e accessori		153
- Osteotomi	83	- Lime per osso		85
LEXER-BABY , Forbici chirurgiche	194	MINI-FRIEDMANN , Pinze ossivore		28
LICHTENBERG , Port'aghi	294	MINI-GILLIES , Port'aghi		290
LICHTWITZ , Tre quarti	121, 302	MINI-LAMBOTTE , Osteotomi		81
LISTON , Pinze ossivore	32	MINI-LANGENBECK , Divaricatori		259
LITTAUER , Forbici per suture	205	MINI-LEXER , Osteotomi		83
- Pinze auricolari per tamponamento	13	MINI-MALTZ , Lime per osso		85
- Pinzette depilatorie	252	MINI-ROUX , Divaricatori		262
LITTLER , Forbici chirurgiche	174	MINNESOTA , Abbassalingua		125
LÖFFEL , Rinologia	68	MODELL WIEN , Speculum nasali		53
LORNA , Fissateli	214	MOLDENHAUER , Lacci auricolari		8
LOVE , Elevatori per tonsille	137	MOLLISON , Divaricatori		277
LOVE-GRUENWALD , Pinze per biopsia	112	MOLT , Apribocca		127
LUCAE , Bisturi	11	MOLT-DOYEN-COLLIN , Apribocca		127
- Diapason	4	MOLT-DOYEN-JANSEN , Apribocca		127
- Martelli chirurgici	15	MUCK , Bisturi		10
- Pinzette auricolari	251			
- Uncini	9	N		
LUER , Dilatatori per tracheotomia	144	NAGER , Retrattori per tonsille		138
- Divaricatori	261	NEGUS , Pinze emostatiche		222
- Pinze ossivore	29	NEGUS-GUEDEL , Laringoscopi		152
LUNIATSCHEK , Periostotomi	136	- Laringoscopi e accessori		153
		NEIVERT , Rinoplastica		95
M		NEIVERT-ANDERSON , Osteotomi		74
MAGILL , Cannule per aspirazione	308	NELATON , Sonda bottonute		299
MAIER , Pinze per tamponi	210	NEWS , Dilatatori per tracheotomia		144
MALINIAC , Rinologia	62	- Divaricatori		261
MALTZ , Bisturi	57	NICOLA , Rinologia		113, 115
- Lime per osso	90	NOYES , Micro Forbici		167
- Rinologia	89			
MARSCHIK , Pinzette chirurgiche	242	O		
MARTIN , Porta cotone	301	O'BRIEN , Forbici per fili metallici		206
MARTINI , Curette	23	OBWEGESER , Aghi per legature		135
MASING , Bisturi	57	- Divaricatori		124, 268, 270
- Osteotomi	74	- Osteotomi		81, 84
- Rinologia	61	- Periostotomi		22
MATHIEU , Port'aghi	293	OLDBERG , Pinze per biopsia		111
MAYO , Abbassalingua	122	OLIVECRONA , Pinze ossivore		30
- Forbici chirurgiche	185, 201	OLSEN-HEGAR , Port'aghi		290
- Pinze per sterilizzazione	325	ORINGER , Apribocca		126
MAYO-HEGAR , Port'aghi	288			
MAYO-HEGAR-FINO , Port'aghi	288	P		
MAYO-LEXER , Forbici chirurgiche	201	PAPAVERO-CASPAR , Strumenti per ipofisi cerebrale		114
Mc DONALD , Periostotomi	20	PAPAVERO-HARTMANN , Strumenti per ipofisi cerebrale		114
McGEE , Micro Pinze auricolari	44	PARKER-LANGENBECK , Divaricatori		261
McINDOE , Osteotomi	73	PARKES , Osteotomi		72
- Pinzette chirurgiche	243	PARTSCH , Osteotomi		17
McINTOSH , Laringoscopi	149, 150	- Sgorbie		17
- Laringoscopi e accessori	153	PAYR , Sonda conduttrici		295
McIVOR , Apribocca	131	PEAN , Pinze emostatiche		219
McKENTY , Rinologia	59, 60	PECK-JOSEPH , Forbici chirurgiche		194
MEAD , Martelli chirurgici	15	PEET , Pinze emostatiche delicate		216
- Pinze ossivore	29	PENNINGTON , Rinologia		60
METZENBAUM , Forbici chirurgiche	175, 182-184, 191-192, 197	PERRY , Pinzette chirurgiche		235
- Forbici Wellenschliff	204	PIERCE , Rinologia		60
METZENBAUM-FINE , Forbici chirurgiche	182-183, 198-200			
MICRO IRIS , Forbici delicate	172			

Alphabetisches Inhaltsverzeichnis	Alphabetical Index	Indice alfabetico	Indice alfabetico	Index alphabétique
- Tre quarti	121, 302	SENN-MILLER , Divaricatori		260
PLESTER , Cannule per aspirazione	314	SEPTUN-NADEL , Cannule per aspirazione		318
- Divaricatori	277, 278	SEWALL , Rinologia		61
- Micro uncini auricolari	38	SEXTON , Bisturi		10
POLITZER , Bisturi	10, 11	SHAMBAUGH , Micro uncini auricolari		38
POTTS-SMITH , Pinzette chirurgiche	240, 247	SHAPLEIGH , Lacci auricolari		8
Q		SHEA , Forbici delicate		176
QUINBY , Forbici delicate	172	- Micro Cucchiali		42
QUIRE , Leva per corpi estranei	13	SHEEHAN , Osteotomi		77
QUISLING , Martelli chirurgici	15	SIEBENMANN , Cannule per aspirazione		316
R		SILVER , Osteotomi		74
RAGNELL , Divaricatori	260	SPENCER , Forbici per suture		205
RAGNELL-DAVIS , Divaricatori	260	SPLIT , Osteotomi		76
RAMPLEY , Pinze per tamponi	210	SPURLING , Pinze per biopsia		112
RAMUS , Divaricatori	102	STACKE , Protettore facciale		12
RANKIN , Pinze emostatiche	221	- Sonde bottonute		300
RAY , Strumenti per ipofisi cerebrale	114	STAMMBERGER , Rinologia		67
REICHERT , Elevatori per tonsille	137	STELLBRINK , Pinze ossivore		28
REILL , Micro Port'aghi	283	STERNBERG , Abbassalingua		123
REYNOLDS , Forbici delicate	176	STEVENS , Forbici chirurgiche		192
RING , Abbassa Lingua	130	- Forbici delicate		170, 176
RITTER , Rinologia	92	STITCH , Forbici delicate		170
ROBB-LEWIS , Elevatori per tonsille	137	STRUYCKEN , Rinologia		64
ROCHESTER-PEAN , Pinze emostatiche	220	SWEDESH , Port'aghi		289
ROGER , Rinologia	60	SYRINGE , siringhe auricolari		6
ROGGE , Pinze per sterilizzazione	325	T		
ROSE , Dilatatori per tracheotomia	144	TAKAHASHI , Rinologia		68
- Divaricatori	261	TAYLOR , Pinzette chirurgiche		247
ROSEN , Cannule per aspirazione	317	TESSIER , Osteotomi		72, 82
- Micro aghi auricolari	37	THOREK , Forbici delicate		181
- Micro Coltelli	40	THUDICUM , Speculum nasali		51
- Micro Raspatori	41	TIECK-HALLE , Speculum nasali		52
ROSER-KÖNIG , Apribocca	127	TILLEY , Pinze auricolari per tamponamento		13
ROUX , Divaricatori	262	TOBOLD , Abbassalingua		125
ROUX-MAGNUS , Divaricatori	62	TOENNIS , Forbici chirurgiche		184
ROWE , Pinze per riposizione	101	TOENNIS-ADSON , Forbici chirurgiche		184, 197
RUBIN , Osteotomi	75	TOENNIS-RYDER , Port'aghi		293
- Rinologia	100	TROELTSCH , Pinzette auricolari		251
RUSKIN , Pinze ossivore	31	TROUSSEAU , Dilatatori per tracheotomia		144
RUSKIN-LISTON , Pinze ossivore	32	U		
RYDEL-SEIFFERT , Diapason	4	UFFENORDE , Cucchai taglienti		25
RYDER , Port'aghi	292	ULRICH , Pinze per tamponi		211
S		UNIVERSAL , Porta cotone		301
SAROT , Port'aghi	289	V		
SAUG-RASPATORIUM , Cannule per aspirazione	309	VANNAS , Micro Forbici		168
SCHAEDEL , Fissateli	213	VOLKMANN , Cucchai taglienti		27
SCHAEDE , Cucchai taglienti	26	- Curette		24
SCHLESINGER , Strumenti per ipofisi	109	- Divaricatori		264, 265
SCHNEIDER , Periostotomi	21	W		
SCHNIDT , Pinze emostatiche	212	WAGENER , Lacci auricolari		8
SCHUHKNECHT , Cannule per aspirazione	317	- Uncini		9
- Micro Coltelli	40	WALTER , Osteotomi		78
- Micro Pinze auricolari	48	WALTON , Forbici delicate		170, 181
SCHWECKENDIEK , Forbici chirurgiche	188	- Rinologia		59
SEDILLOT , Periostotomi	21	WANGENSTEEN , Pinzette chirurgiche		247
SELDIN , Periostotomi	20	WASSMUND , Divaricatori		263
SEMKEN , Pinzette anatomiche	235	WEBSTER , Port'aghi		286
- Pinzette chirurgiche	235, 240, 246			
SENN GREEN , Divaricatori	259			

Alphabetisches Inhaltsverzeichnis	Alphabetical Index	Indice alfabetico	Indice alfabetico	Index alphabétique
WEIL-BLAKESLEY , Rinologia	65, 66			
WEITLANER , Divaricatori	275, 276			
WERTHEIMER , Cannule per aspirazione	312			
WEST , Osteotomi	80			
WESTCOTT , Micro Forbici	167			
WESTMACOTT , Pinze auricolari	14			
WHITE , Pinze per tonsille	212			
WHITEHEAD , Apribocca	128			
WHITEHEAD-JENNINGS , Apribocca	128			
WIEDER , Abbassalingua	125			
WILDE , Pinze serranodi	139			
WILLIAMS , Pinze emostatiche	223			
WILLIGER , Cucchiaino tagliente	24			
- Curette	23			
- Elevatori	19			
- Periostotomi	19			
WILMER , Forbici delicate	171			
WOLFF , Forbici ossivore	99			
WULLSTEIN , Cannule per aspirazione	304, 317, 318			
- Divaricatori	275			
- Micro Pinze auricolari	45			
- Micro Raspatori	41			
WÜRZBURG , Abbassa Lingua	129			
Y				
YANKAUER , Cannule per aspirazione	305			
- Lacci auricolari	8			
- Rinoplastica	95			
- Uncini	9			
YASARGIL , Micro Forbici	168			
- Micro Periostotomi	118			
- Micro Pinzette	229, 230			
- Pinze per biopsia	111			
YASARGIL-NICOLA , Rinologia	113			
Z				
ZAUFAL , Lacci auricolari	8			
ZAUFAL-JANSEN , Pinze ossivore	31			
ZIELINSKY , Strumenti per misura	163			
ZOELLNER , Cannule per aspirazione	317			
ZÖLLNER , Micro Coltelli	40			

5.2



Inhaltverzeichnis
Index
Indice
Indice
Index

Nummernverzeichnis
Alphanumerical Index
Indice alfanumerico
Indice alfanumerico
Index alphanumerique

Indice alfanumerico		Alfanumerical Index		Nummernverzeichnis		Index alfabétique		Indice alfanumerico	
Article	Page	Article	Page	Article	Page	Article	Page	Article	Page
HBC-BI	61	0202-EI	161	0204-IB	244	0204-IB19	250	0204-IC	244
0101-HA	154	0202-FA	161	0204-ID	244	0204-IE	244	0204-IE19	250
0101-IA	154	0202-FC	161	0204-IE	244	0204-IF	244	0204-IG	244
0101-LA08	154	0204-AE	234	0204-IG19	250	0204-IH	244	0204-LA	236
0101-BAA	149	0204-AF	235	0204-IH	244	0204-LB	240	0204-LB	240
0101-BAB	149	0204-AG	235	0204-LA	236	0204-LC	236	0204-LC	236
0101-BAC	149	0204-AH	234	0204-LB	240	0204-LD	236	0204-LD	236
0101-BAD	149	0204-AL	241	0204-LC	236	0204-LF	240	0204-LF	240
0101-BAE	149	0204-AL19	249	0204-LG	234	0204-LG	234	0204-LG	234
0101-BDA	3, 154	0204-BA	238	0204-LH	238	0204-LH	238	0204-LH	238
0101-CAA	151	0204-BA0918	245	0204-LI	238	0204-LI	238	0204-LI	238
0101-CAB	151	0204-BE	240	0204-LL	238	0204-LI	238	0204-LI	238
0101-CFA	151	0204-BF	240	0204-LM	238	0204-LM	238	0204-LM	238
0101-CFB	151	0204-BG	237	0204-LN	238	0204-LN	238	0204-LN	238
0101-EAB	152	0204-BI	241	0204-LO	238	0204-LO	238	0204-LO	238
0101-EAC	152	0204-BL	241	0204-LP	238	0204-LP	238	0204-LP	238
0101-EAD	152	0204-CA	241	0204-LQ	238	0204-LQ	238	0204-LQ	238
0101-EAE	152	0204-CA0918	245	0204-LR	238	0204-LR	238	0204-LR	238
0101-FAA	150	0204-CB	240	0204-LS	238	0204-LS	238	0204-LS	238
0101-FAB	150	0204-CC	251	0204-LT	238	0204-LT	238	0204-LT	238
0101-FAC	150	0204-CD	238	0204-LU	238	0204-LU	238	0204-LU	238
0101-FAD	150	0204-CD0918	245	0204-LV	238	0204-LV	238	0204-LV	238
0101-FAE	150	0204-CE	238	0204-LW	238	0204-LW	238	0204-LW	238
0101-02BAA	149, 151, 152, 154	0204-CE0918	245	0204-LX	238	0204-LX	238	0204-LX	238
0101-02BAB	149, 154	0204-CF	238	0204-LY	238	0204-LY	238	0204-LY	238
0101-18BAD	153	0204-CG	238	0204-LZ	238	0204-LZ	238	0204-LZ	238
0101-18BAE	153	0204-CG0918	245	0204-LA	236	0204-LA	236	0204-LA	236
0101-18BAF	153	0204-DA	236	0204-LB	240	0204-LB	240	0204-LB	240
0101-18CAD	153	0204-DA19	249	0204-LC	236	0204-LC	236	0204-LC	236
0101-18CAE	153	0204-DB	236	0204-LD	236	0204-LD	236	0204-LD	236
0101-18CAF	153	0204-DB19	249	0204-LE	236	0204-LE	236	0204-LE	236
0101-18CFD	153	0204-DC	233	0204-LF	240	0204-LF	240	0204-LF	240
0101-18CFE	153	0204-DD	233	0204-LG	234	0204-LG	234	0204-LG	234
0101-18CFF	153	0204-DF	233	0204-LH	238	0204-LH	238	0204-LH	238
0101-18EAD	153	0204-DG	233	0204-LI	238	0204-LI	238	0204-LI	238
0101-18EAE	153	0204-DI	241	0204-LJ	238	0204-LJ	238	0204-LJ	238
0101-18FAD	153	0204-DL	241	0204-LK	238	0204-LK	238	0204-LK	238
0101-18FAE	153	0204-EA	233	0204-LM	238	0204-LM	238	0204-LM	238
0101-18FAF	153	0204-EB	233	0204-LN	238	0204-LN	238	0204-LN	238
0102-AB	3	0204-EC	233	0204-LO	238	0204-LO	238	0204-LO	238
0102-AC	3	0204-EC19	249	0204-LP	238	0204-LP	238	0204-LP	238
0102-AD	3	0204-ED	233	0204-LQ	238	0204-LQ	238	0204-LQ	238
0102-AE	3	0204-ED19	249	0204-LR	238	0204-LR	238	0204-LR	238
0102-AF	3	0204-EE	235	0204-LS	238	0204-LS	238	0204-LS	238
0102-AG	3	0204-EF	235	0204-LT	238	0204-LT	238	0204-LT	238
0102-AH	3	0204-EG	235	0204-LU	238	0204-LU	238	0204-LU	238
0102-AI	3	0204-EH	235	0204-LV	238	0204-LV	238	0204-LV	238
0102-AL	3	0204-EI	235	0204-LW	238	0204-LW	238	0204-LW	238
0102-DC17	3	0204-EJ	235	0204-LX	238	0204-LX	238	0204-LX	238
0102-EB	3	0204-EK	235	0204-LY	238	0204-LY	238	0204-LY	238
0102-EB17	52	0204-EL	235	0204-LZ	238	0204-LZ	238	0204-LZ	238
0102-EL	3	0204-EM	235	0204-LA	236	0204-LA	236	0204-LA	236
0103-BB	5	0204-EN	235	0204-LB	240	0204-LB	240	0204-LB	240
0103-BC	5	0204-EO	235	0204-LC	236	0204-LC	236	0204-LC	236
0103-BD	5	0204-EP	235	0204-LD	236	0204-LD	236	0204-LD	236
0103-BE	5	0204-EQ	235	0204-LE	236	0204-LE	236	0204-LE	236
0103-BF	5	0204-ER	235	0204-LF	240	0204-LF	240	0204-LF	240
0103-BG	5	0204-ES	235	0204-LG	234	0204-LG	234	0204-LG	234
0103-BI	5	0204-ET	235	0204-LH	238	0204-LH	238	0204-LH	238
0103-BL	5	0204-EU	235	0204-LI	238	0204-LI	238	0204-LI	238
0103-CA	4	0204-EV	235	0204-LJ	238	0204-LJ	238	0204-LJ	238
0103-DA	4	0204-EW	235	0204-LK	238	0204-LK	238	0204-LK	238
0103-EA	4	0204-EX	235	0204-LM	238	0204-LM	238	0204-LM	238
0202-DI	161	0204-EY	235	0204-LN	238	0204-LN	238	0204-LN	238
0202-EA	161	0204-EZ	235	0204-LO	238	0204-LO	238	0204-LO	238
0202-EG	161	0204-IA19	250	0204-LP	238	0204-LP	238	0204-LP	238

Indice alfanumerico		Alfanumerical Index		Nummernverzeichnis		Index alphabétique		Indice alfanumerico	
Article	Page	Article	Page	Article	Page	Article	Page	Article	Page
0204-BID	241	0204-CID	243	0212-CA	134				
0204-BIH	242	0204-CIE	243	0212-CG	295				
0204-BLD	251	0204-CIH	240	0212-CH	225				
0204-BLE	234	0204-CII	240	0212-DC	225				
0204-BLE0918	245	0204-CIL	240	0212-DD	225				
0204-BLF	234	0204-CLA	240	0212-DE	225				
0204-BLG	234	0204-CLB	240	0212-DF	225				
0204-CAA	232	0204-CLC	240	0212-DG	225				
0204-CAB	232	0204-CLD	240	0212-DH	225				
0204-CAC	232	0204-DBD	230	0212-DI	225				
0204-CAD	232	0204-DBE	230	0212-DL	225				
0204-CAF	232	0204-DBF	230	0212-EA	295				
0204-CAG	232	0204-DBG	230	0212-EB	295				
0204-CAH	237	0204-DBH	230	0212-GA	295				
0204-CAI	237	0204-DCH	229	0212-HL	296				
0204-CAL	237	0204-DCI	229	0212-IA	296				
0204-CBA	246	0204-DCL	229	0212-ID	296				
0204-CBB	246	0204-DDA	229	0212-IE	296				
0204-CBC	246	0204-DOB	229	0212-IH	225				
0204-CBD	246	0204-DDC	230	0212-II	225				
0204-CBE	246	0204-DEH	248	0212-IL	225				
0204-CBF	246	0204-DEI	248	0212-LA	225				
0204-CBG	246	0204-DEL	248	0212-LD	225				
0204-CBH	246	0204-DFB	233	0212-LF	225				
0204-CBI	247	0204-DFC	233	0212-LG	225				
0204-CBL	247	0204-DFD	233	0212-LH	225				
0204-CCA	247	0204-DFE	233	0212-LI	225				
0204-CCB	248	0204-DFG	233	0212-LL	225				
0204-CCC	248			0212-BAA	225				
0204-CCD	248	0206-AB	210	0212-BAB	225				
0204-CCE	248	0206-AC	210	0212-BEA	225				
0204-CCF	248	0206-AD	210	0212-BEB	225				
0204-CCG	247	0206-AE	210	0212-BEC	225				
0204-CCH	247	0206-AG	210	0212-BFB	95				
0204-CCI	247	0206-AH	210	0212-BFC	95				
0204-CCL	248	0206-AI	210	0212-BFD	95				
0204-CDA	246	0206-AB	209	0212-BFE	95				
0204-CDB	246	0206-AC	209	0212-BFF	95				
0204-CDC	247	0206-AD	209	0212-BFG	95				
0204-CDD	247	0206-AE	209	0212-BFH	95				
0204-CDE	247	0206-AG	210	0212-BFI	95				
0204-CDI	235	0206-AH	210	0212-BFL	95				
0204-CDL	235	0206-AB	210	0212-BGC	134, 296				
0204-CEA	237	0206-AC	213	0212-BGD	134, 296				
0204-CEB	237	0206-AD	213						
0204-CEC	237	0206-AE	213	0217-CA	327				
0204-CED	237	0206-AG	213	0217-CF	327				
0204-CEE	237	0206-AH	213	0217-CI	327				
0204-CEF	237	0206-AB	213						
0204-CEG	237	0206-AC	213	0218-B	327				
0204-CEH	237	0206-AD	213	0218-CA	4				
0204-CEI	237	0206-AE	214	0218-CB	4				
0204-CEL	237	0206-AG	214	0218-CD	328				
0204-CFA	246	0206-AH	223	0218-CH	328				
0204-CFB	246	0206-AB	214	0218-CI	328				
0204-CFC	247	0206-AC	214	0218-DA	328				
0204-CFD	246	0206-AD	214	0218-EA	328				
0204-CHB	239	0206-AE	214	0218-EB	328				
0204-CHC	239	0206-AG	209	0218-EC	328				
0204-CHD	239	0206-AH	209	0218-FL	329				
0204-CHD0918	245	0206-AB	209	0218-GA	329				
0204-CHE	239	0206-AC	209	0218-GB	329				
0204-CHF	239	0206-AD	209						
0204-CHG	239	0212-AB	290	0219-B	136				
0204-CHH	239	0212-AC	290	0219-C	136				
0204-CHH9018	245	0212-AD	290	0219-BF	255				
0204-CHL	243	0212-AE	290	0219-BG	255				
0204-CIA	243	0212-BF	134, 295	0219-BI	260				
0204-CIB	240	0212-BG	134, 295	0219-BL	260				
0204-CIC	240	0212-BL	134	0219-CA	261				

Indice alfanumerico		Alfanumerical Index		Nummernverzeichnis		Index alfabétique		Indice alfanumerico	
Article	Page	Article	Page	Article	Page	Article	Page	Article	Page
0219-CC	260	0219-BAI	265	0219-CGC	267				
0219-CF	261	0219-BAL	260	0219-CGD	267				
0219-CG	260	0219-BBH	272	0219-CHD	93				
0219-CH	260	0219-BBI	272	0219-CIC	262				
0219-CL	260	0219-BCG	264	0219-CID	262				
0219-DD	271	0219-BCH	264	0219-CIE	262				
0219-DE	271	0219-BCI	264	0219-CIF	262				
0219-DF	271	0219-BDA	268	0219-CIG	262				
0219-DG	271	0219-BDB	263	0219-CIH	262				
0219-DI	257	0219-BDC	263	0219-CII	262				
0219-DL	257	0219-BDE	269	0219-CIL	262				
0219-EA	257	0219-BDF	269	0219-CLB	261				
0219-EB	257	0219-BDI	62, 258	0219-CLG	95				
0219-EC	257	0219-BDL	264	0219-DGC	93				
0219-ED	271	0219-BEA	264	0219-DGD	93				
0219-EE	257	0219-BEB	266	0219-DGE	93				
0219-EF	257	0219-BEC	266	0219-DGF	93				
0219-EG	257	0219-BED	266	0219-DHA	94				
0219-EI	259	0219-BEE	266	0219-DHC	138				
0219-EL	259	0219-BEF	266	0219-DIB	95				
0219-FA	258	0219-BEG	266	0219-DIC	95				
0219-FB	258	0219-BEH	266	0219-DID	95				
0219-FC	258	0219-BEI	266	0219-DIE	137				
0219-FD	94	0219-BEL	94	0219-DIF	137				
0219-FE	258	0219-BFA	94	0219-DIG	137				
0219-FF	258	0219-BFC	270	0219-DIH	95				
0219-FG	258	0219-BFD	270	0219-DII	95				
0219-FH	93	0219-BFE	270	0219-DLA	106				
0219-FI	94	0219-BFF	270	0219-DLB	106				
0219-FL	94	0219-BFG	270	0219-DLC	106				
0219-GA	267	0219-BFH	270	0219-DLD	106				
0219-GC	267	0219-BIG	259	0219-DLE	106				
0219-GE	267	0219-BIH	259	0219-DLF	106				
0219-GF	267	0219-BII	259	0219-DLG	106				
0219-GG	267	0219-BIL	259	0219-DLH	106				
0219-GH	268	0219-BLA	257	0219-DLI	106				
0219-GI	268	0219-BLB	257	0219-DLL	106				
0219-GL	263	0219-BLC	257	0219-ELA	259				
0219-HA	259	0219-BLD	257	0219-ELB	259				
0219-HB	259	0219-BLE	257	0219-ELC	259				
0219-HC	259	0219-BLF	257	0219-ELD	259				
0219-HD	259	0219-BLG	93						
0219-HE	259	0219-BLH	93	0221-AH	275				
0219-HF	259	0219-BLI	93	0221-AI	274				
0219-HH	259	0219-BLL	93	0221-AL	275				
0219-HL	259	0219-CAA	94	0221-BA	274				
0219-IA	272	0219-CAD	255	0221-BC	274				
0219-IB	272	0219-CAE	255	0221-BI	276				
0219-IC	272	0219-CAH	255	0221-BL	276				
0219-IE	105	0219-CAI	255	0221-CA	276				
0219-IF	105	0219-CBA	94, 256	0221-CB	276				
0219-IG	105	0219-CBB	94, 256	0221-CC	276				
0219-IH	105	0219-CBC	94, 256	0221-CD	276				
0219-II	105	0219-CBD	94, 256	0221-CG	275				
0219-IL	105	0219-CBE	94, 256	0221-DG	274				
0219-LA	269	0219-CBF	94, 256	0221-DH	274				
0219-LB	269	0219-CBG	94, 256	0221-DI	274				
0219-LC	270	0219-CBH	94, 256	0221-DL	274				
0219-LD	270	0219-CBI	94, 256	0221-EH	274				
0219-LE	270	0219-CBL	94	0221-EI	274				
0219-LF	270	0219-CCE	9	0221-EL	274				
0219-LG	270	0219-CCF	9	0221-FB	274				
0219-BAA	270	0219-CEF	62, 258	0221-FC	274				
0219-BAB	265	0219-CFA	271	0221-GI	279				
0219-BAC	265	0219-CFB	271	0221-HA	279				
0219-BAD	265	0219-CFC	271	0221-LC	277				
0219-BAE	265	0219-CFD	271	0221-LD	277				
0219-BAF	265	0219-CFE	271	0221-LE	278				
0219-BAG	265	0219-CGA	267	0221-LF	278				
0219-BAH	265	0219-CGB	267	0221-LG	278				

Indice alfanumerico		Alfanumerical Index		Nummernverzeichnis		Index alfabétique		Indice alfanumerico	
Article	Page	Article	Page	Article	Page	Article	Page	Article	Page
0221-LH	278	0402-BAB	65	0402-CBG	48				
0221-BAB	279	0402-BAB25	66	0402-CBH	48				
0221-BAC	279	0402-BAC	65	0402-CBI	48				
0221-BBA	277	0402-BAC25	66	0402-CBL	48				
0221-BBB	275	0402-BAD	65	0402-CCA	46				
0221-BBC	275	0402-BAD25	66	0402-CCB	46				
		0402-BAE	65	0402-CCC	46				
03-B	25	0402-BAE25	66	0402-CCD	46				
03-C	25	0402-BAF	65	0402-CCE	46				
03-D	25	0402-BAF25	66	0402-CCF	46				
03-E	25	0402-BAG	45	0402-CCG	46				
		0402-BAH	45	0402-141117	326				
0318-AB	327	0402-BAI	44						
0318-AC	327	0402-BAL	44	04050113	189				
0318-AD	327	0402-BBB	13	04050113-1903	189				
0318-AE	327	0402-BBD	13						
0318-AF	327	0402-BBE	13	0414-B	85				
0318-AG	327	0402-BBF	13	0414-C	85				
0318-FB	327	0402-BBG	13	0414-D	85				
0318-FC	327	0402-BBH	13	0414-AI	125				
0318-FF	327	0402-BBI	14	0414-AL	125				
		0402-BBL	14	0414-BA	101				
0402-B11	326	0402-BCA	14	0414-BB	101				
0402-BH	9	0402-BCB	14	0414-BC	101				
0402-BI	9	0402-BCC	14	0414-BD	101				
0402-BL	9	0402-BCD	14	0414-BE	101				
0402-CA	9	0402-BCE	14	0414-BF	101				
0402-CB	9	0402-BCF	14	0414-BG	139				
0402-CD	9	0402-BCL	14	0414-BH	139				
0402-CE	9	0402-BDB	63	0414-BI	81				
0402-CF	9	0402-BDC	63	0414-CA	73				
0402-CG	8	0402-BDD	63	0414-CB	73				
0402-CH	8	0402-BDE	63	0414-CC	73				
0402-CI	8	0402-BDG	63	0414-CD	73				
0402-CL	9	0402-BDH	63	0414-CE	73				
0402-DA	8	0402-BDI	63	0414-CF	73				
0402-DB	8	0402-BDL	63	0414-CG	73				
0402-DC	8	0402-BEB	65	0414-CH	73				
0402-DG	8	0402-BEB25	66	0414-CI	138				
0402-DH	8	0402-BED	65	0414-DB	135				
0402-DI	8	0402-BED25	66	0414-DC	135				
0402-DL	8	0402-BEF	65	0414-DE	74				
0402-EA	8	0402-BEF25	66	0414-DF	74				
0402-EB	8	0402-BFB	64	0414-DG	74				
0402-EC	9	0402-BFC	64	0414-DH	80				
0402-ED	9	0402-BFD	64	0414-DI	80				
0402-EE	9	0402-BFE	64	0414-DL	80				
0402-EF	9	0402-BFF	64	0414-EA	124				
0402-EG	9	0402-BHH	33	0414-EB	124				
0402-EH	8	0402-BHI	33	0414-EI	62				
0402-EI	8	0402-BHL	33	0414-FA	58				
0402-FB	12	0402-BIA	33	0414-FB	58				
0402-FC	12	0402-BIB	33	0414-FC	58				
0402-FF	8	0402-BIC	33	0414-FD	58				
0402-FG	8	0402-BID	33	0414-FE	58				
0402-GA	92	0402-BII	63	0414-FF	58				
0402-GB	92	0402-CAB	47	0414-FL	22				
0402-GC	92	0402-CAC	47	0414-GA	61				
0402-GD	92	0402-CAD	47	0414-GD	22				
0402-IG	45	0402-CAE	47	0414-GF	22				
0402-IH	45	0402-CAF	47	0414-GH	22				
0402-II	45	0402-CAG	47	0414-HA	88				
0402-IL	45	0402-CAH	47	0414-HB	88				
0402-LA	45	0402-CAI	47	0414-HC	88				
0402-LB	45	0402-CAL	47	0414-HD	89				
0402-LC	45	0402-CBA	44	0414-HE	89				
0402-LD	45	0402-CBB	44	0414-HF	89				
0402-LE	45	0402-CBD	48	0414-HG	89				
0402-LF	45	0402-CBE	48	0414-HH	88				
0402-BAA	48	0402-CBF	48	0414-HI	88				

Indice alfanumerico		Alfanumerical Index		Nummernverzeichnis		Index alfabétique		Indice alfanumerico	
Article	Page	Article	Page	Article	Page	Article	Page	Article	Page
0414-HL	91	0414-BHA	75	0414-CLE	59				
0414-IA	91	0414-BHB	75	0414-CLF	59				
0414-IB	91	0414-BHC	75	0414-CLG	59				
0414-IC	91	0414-BHD	92	0414-DAA	88				
0414-ID	91	0414-BHF	262	0414-DAB	90				
0414-IE	75	0414-BHG	139	0414-DAC	90				
0414-IF	75	0414-BHH	85	0414-DAD	90				
0414-IH	88	0414-BHI	89	0414-DAE	90				
0414-II	96	0414-BHL	89	0414-DAF	90				
0414-IL	96	0414-BIA	76	0414-DBC	90				
0414-LB	73	0414-BIB	76	0414-DBF	90				
0414-LC	73	0414-BIC	76	0414-DBG	91				
0414-LE	124	0414-BID	76	0414-DCA	72				
0414-LF	124	0414-BIE	76	0414-DCD	135				
0414-LG	124	0414-BIF	76	0414-DCE	135				
0414-LH	124	0414-BIG	76	0414-DCG	140				
0414-BAB	135	0414-BIH	76	0414-DCH	140				
0414-BAC	135	0414-BII	76	0414-DDA	140				
0414-BAD	135	0414-BIL	89	0414-DEB	140				
0414-BAI	102	0414-CAA	62	0414-EAB	62				
0414-BAL	88	0414-CAD	79	0414-EAB17	62				
0414-BBA	84	0414-CAE	262						
0414-BBB	61	0414-CAE11	262	0415-HB	206				
0414-BBC	84	0414-CAF	79	0415-LA	206				
0414-BBD	72	0414-CAI	77	0415-LB	206				
0414-BBE	72	0414-CAL	77	0415-HCF	163				
0414-BBF	72	0414-CBA	77						
0414-BBG	72	0414-CBB	61	0417-EA	216				
0414-BBI	75	0414-CBD	137						
0414-BBL	75	0414-CBE	137	0418-BA	144				
0414-BCA	84	0414-CBF	137	0418-BB	144				
0414-BCB	84	0414-CBG	73	0418-BC	144				
0414-BCC	84	0414-CBH	73	0418-BD	144				
0414-BCF	102	0414-CBI	73	0418-BF	144, 261				
0414-BCG	102	0414-CBL	71	0418-BG	144, 261				
0414-BCL	122	0414-CCF	71	0418-BH	144, 261				
0414-BDA	80	0414-CCG	71	0418-BI	144, 261				
0414-BDB	80	0414-CCH	71	0418-BL	144, 261				
0414-BDC	80	0414-CCI	71	0418-CA	144, 261				
0414-BDD	80	0414-CCL	71						
0414-BDF	72	0414-CDG	19	0502-CHA	211				
0414-BEA	80	0414-CDH	19	0502-CHB	211				
0414-BEB	80	0414-CDI	71	0502-CHD	211				
0414-BEC	124	0414-CDL	71	0502-CHE	211				
0414-BED	80	0414-CEF	12						
0414-BEE	61	0414-CEG	12	0518-EE	252				
0414-BEF	61	0414-CEH	102	0518-EF	252				
0414-BEG	61	0414-CEI	102	0518-EG	252				
0414-BEH	100	0414-CFH	79	0518-EI	252				
0414-BEI	100	0414-CFI	79	0518-GE	252				
0414-BEL	100	0414-CFL	93	0518-GF	252				
0414-BFA	71	0414-CGA	79						
0414-BFB	71	0414-CGB	79	0602-GH	226				
0414-BFC	71	0414-CGC	79	0602-GI	226				
0414-BFD	71	0414-CGD	92	0602-GL	226				
0414-BFE	71	0414-CGE	92	0602-HA	226				
0414-BFF	71	0414-CGF	12	0602-HB	226				
0414-BFG	71	0414-CGG	12	0602-HC	226				
0414-BFI	71	0414-CGH	89	0602-HD	226				
0414-BFL	74	0414-CHG	74	0602-HE	226				
0414-BGA	78	0414-CHH	74	0602-HF	226				
0414-BGB	78	0414-CHI	74	0602-CBG	222				
0414-BGC	78	0414-CIF	96	0602-CBH	222				
0414-BGD	78	0414-CIG	96						
0414-BGE	78	0414-CIH	96	0604-AG	167				
0414-BGF	78	0414-CII	92	0604-AI	167				
0414-BGG	78	0414-CIL	92	0604-BA	167				
0414-BGH	78	0414-CLA	96	0604-BC	167				
0414-BGI	87	0414-CLC	59	0604-BD	167				
0414-BGL	87	0414-CLD	59	0604-BH	284				

Indice alfanumerico		Alfanumerical Index		Nummernverzeichnis		Index alfabétique		Indice alfanumerico	
Article	Page	Article	Page	Article	Page	Article	Page	Article	Page
0604-BL	284	0606-DDD	116	0607-BB11	172				
0604-CB	284	0606-DDE	116	0607-BC11	172				
0604-CC	284	0606-DDF	116	0607-BD	172				
0604-CD	284	0606-DDG	116	0607-BE	183				
0604-CI	284	0606-DEA	116	0607-BF	172				
0604-EF	167	0606-DEB	116	0607-BL03	177				
0604-EG	167	0606-DEC	116	0607-BL17	177				
0604-BEI	283	0606-DED	116	0607-CB	174				
0604-BEL	283	0606-DEF	115	0607-CC	174				
0604-BFA	283	0606-DEG	115	0607-CD	173				
0604-BFB	283	0606-DEH	115	0607-CE	173				
0604-BFC	283	0606-DEI	115	0607-CI	183				
0604-BFH	283	0606-DEL	115	0607-DA	171				
0604-BIG	168	0606-DFA	115	0607-DG	174				
0604-BIH	168	0606-DFB	115	0607-DH	174				
0604-BLF	168	0606-DFC	115	0607-DI	172				
0604-BLG	168	0606-DGA	117	0607-DL	172				
0604-BLH	168	0606-DGB	117	0607-EB	189				
0604-BLI	168	0606-DGC	117	0607-EC	189				
0604-BLL	168	0606-DGD	117	0607-ED	181				
0604-DDH	118	0606-DGE	117	0607-EE	181				
		0606-DGF	117	0607-EF	181				
0606-BA	67	0606-DGG	117	0607-EG	181				
0606-BB	67	0606-DIA	145	0607-EH	185				
0606-BC	67	0606-DIB	145	0607-EI	185				
0606-BD	67	0606-DIC	145	0607-EL	185				
0606-BE	67	0606-DID	145	0607-FA	176				
0606-BF	67	0606-DIE	145	0607-FB	176				
0606-BG	67	0606-EAB	113	0607-FC	176				
0606-BH	64	0606-EAC	113	0607-FD	176				
0606-CA	111	0606-EAD	113	0607-FE	176				
0606-CB	111	0606-EAE	113	0607-FF	176				
0606-CC	111	0606-EBB	113	0607-FG	176				
0606-CD	111	0606-EBC	113	0607-FH	176				
0606-HA	68	0606-EBD	113	0607-FI	174				
0606-HB	68	0606-EBE	113	0607-GA	184				
0606-IA	112	0606-EFA	146	0607-GB	184				
0606-IB	112	0606-EFB	146	0607-GD	197				
0606-IC	112	0606-EFC	146	0607-GE	197				
0606-ID	112	0606-EFD	146	0607-GF	181				
0606-IE	112	0606-EFE	146	0607-GG	177				
0606-IF	112	0606-EFF	146	0607-GH	177				
0606-IG	112	0606-EFG	146	0607-GI	177				
0606-IH	112	0606-EFH	146	0607-GL	177				
0606-II	112	0606-EFI	146	0607-HD	184				
0606-BIA	68	0606-EFL	147	0607-HE	184				
0606-BIB	68	0606-EGA	147	0607-HF	184				
0606-BIC	68	0606-EGB	147	0607-LA	176				
0606-BID	68	0606-EGC	147	0607-LB	176				
0606-BIE	68	0606-EGD	147	0607-LC	194				
0606-BIF	68	0606-EGE	147	0607-LD	181				
0606-BIG	68	0606-EGF	147	0607-LE	171				
0606-BIH	68	0606-EGG	147	0607-LF	181				
0606-CBA	114	0606-EGH	147	0607-LI	194				
0606-CBB	114	0606-EGI	147	0607-LL	190				
0606-CBC	114			0607-BAA	174				
0606-CBE	114	0607-B	172	0607-BAB	173				
0606-CBF	114	0607-B1803	191	0607-BAC	173				
0606-CBG	114	0607-B1903	194	0607-BAD	173				
0606-DBD	118	0607-C	172	0607-BAF	173				
0606-DBE	118	0607-C1803	191	0607-BAI	171				
0606-DCB	114	0607-C1903	194	0607-BAL	171				
0606-DCC	114	0607-E	172	0607-BBA	99, 193				
0606-DCD	115	0607-F	172	0607-BBB	99				
0606-DCE	115	0607-G03	177	0607-BBC	171				
0606-DCF	115	0607-G17	177	0607-BBD	171				
0606-DCG	115	0607-H	190	0607-BBL	171				
0606-DDA	116	0607-I	190	0607-BCB	173				
0606-DDB	116	0607-L	190	0607-BCC	171				
0606-DDC	116	0607-BA	187	0607-BCD	174				

Indice alfanumerico		Alfanumerical Index		Nummernverzeichnis		Index alphabétique		Indice alfanumerico	
Article	Page	Article	Page	Article	Page	Article	Page	Article	Page
0607-BCE	174	0610-HG	23	0610-DEA	97				
0607-BCF	187	0610-HH	23, 37	0610-DEB	97				
0607-BCG	187	0610-HI	23, 37	0610-DEC	105				
0607-BCH	187	0610-HL	24	0610-DED	105				
0607-BCI	187	0610-IC	61						
0607-BDF	188	0610-ID	23	0611-AB	15				
0607-BDG	188	0610-IE	23	0611-AD	17				
0607-BEG	181	0610-LG	86	0611-AE	17				
0607-BEH	175	0610-LH	86	0611-AF	17				
0607-BEI	175	0610-LI	86	0611-BA12	15				
0607-BFB	206	0610-LL	86	0611-BB	15				
0607-BFD	195	0610-BBA	26	0611-BB17	15				
0607-BFE	195	0610-BBB	26	0611-BC	15				
0607-BFG	175	0610-BBC	26	0611-BC17	15				
0607-BFH	175	0610-BBD	26	0611-BD	17				
0607-BFI	175	0610-BBE	26	0611-BE	17				
0607-BFL	175	0610-BBF	26	0611-BF	17				
0607-BGC	206	0610-BBG	26	0611-BG	81				
0607-BGD	192	0610-BCA	26	0611-BH	81				
0607-BGF	202	0610-BCB	26	0611-BI	81				
0607-BGG	202	0610-BCC	26	0611-CA	16				
0607-BGH	194	0610-BCD	26	0611-CB	16				
0607-BGI	194	0610-BCE	26	0611-CC	16				
0607-BIC	188	0610-BCF	26	0611-CD	17				
0607-BID	188	0610-BCG	26	0611-CE	17				
0607-BIE	188	0610-BDA	24	0611-DA	16				
0607-BIF	188	0610-BDB	24	0611-DB	16				
0607-BIG	188	0610-BDC	24	0611-DC	81				
0607-BIH	188	0610-BDG	25	0611-DD	16				
0607-BLC	203	0610-BDH	25	0611-DF	16				
0607-BLD	203	0610-BDI	25	0611-EA	17				
0607-BLE	203	0610-BDL	25	0611-FD	81				
0607-BLF	203	0610-BHE	87	0611-FE	81				
0607-CAA	169	0610-BHF	87	0611-FI	81				
0607-CAB	169	0610-BII	25	0611-BAE	15, 43				
0607-CAC	169	0610-BIL	25	0611-BBE	17				
0607-CAD	169	0610-BLD	85	0611-BBF	17				
0607-CAE	169	0610-BLE	85	0611-BBG	17				
0607-CAF	169	0610-BLF	85	0611-BBI	17				
0607-CAG	169	0610-BLG	85	0611-BCG	17				
0607-CAH	169	0610-BLH	24	0611-BCH	17				
0607-CAI	169	0610-BLI	24	0611-BCI	15				
0607-CAL	170	0610-BLL	85	0611-BCL	15				
0607-CBA	170	0610-CDA	18	0611-BDC	17				
0607-CBB	170	0610-CDC	18	0611-BDD	80				
0607-CBC	170	0610-CDE	18	0611-BDE	80				
0607-CBF	170	0610-CEC	12	0611-BDF	17				
0607-CBG	170	0610-CEH	21	0611-BDG	17				
0607-CBH	170	0610-CEI	21	0611-BDH	15				
0607-CBI	170	0610-CEL	21	0611-BDI	17				
		0610-CFA	21	0611-BEB	79				
0610-B1903	195	0610-CFB	21	0611-BEC	79				
0610-C1803	191	0610-CFD	21	0611-BED	79				
0610-C1903	195	0610-CFE	21	0611-BEE	79				
0610-BC	19	0610-CFF	21	0611-BLA	83				
0610-GA	27	0610-CFG	21	0611-BLB	83				
0610-GB	27	0610-CFH	21	0611-BLC	83				
0610-GC	27	0610-CFI	21	0611-BLD	83				
0610-GD	27	0610-CGE	59	0611-BLE	83				
0610-GE	27	0610-CGF	59	0611-CAG	18				
0610-GF	27	0610-DDA	97	0611-CAH	18				
0610-GG	27	0610-DBB	97	0611-CAI	18				
0610-GH	27	0610-DDC	97	0611-CAL	18				
0610-GI	27	0610-DDD	97	0611-CDA	83				
0610-GL	27	0610-DDE	97	0611-CDB	83				
0610-HA	23	0610-DDF	96	0611-CDC	83				
0610-HB	23	0610-DDG	96	0611-CDD	83				
0610-HC	24	0610-DDH	96	0611-CDE	83				
0610-HD	24	0610-DDI	96	0611-CEA	83				
0610-HF	23	0610-DDL	97	0611-CEB	83				

Indice alfanumerico		Alfanumerical Index		Nummernverzeichnis		Index alfabétique		Indice alfanumerico	
Article	Page	Article	Page	Article	Page	Article	Page	Article	Page
0611-CEC	83	0612-DD	179	0612-BIA	186				
0611-CED	83	0612-DE	179	0612-BIB	186				
0611-CEE	83	0612-DF	178	0612-CAB	198				
0611-CGD	81	0612-DG	178	0612-CAC	199				
0611-CGE	81	0612-DH	178	0612-CAD	198				
0611-CGF	81	0612-DI	178	0612-CAE	199				
0611-CGG	81	0612-DL	178	0612-CAF	198				
0611-CGH	81	0612-EA	178	0612-CAG	199				
0611-CGI	81	0612-EB	180	0612-CAH	198				
0611-CGL	81	0612-EC	180	0612-CAI	199				
0611-DAH	82	0612-ED	180	0612-CAL	198				
0611-DAI	82	0612-EE	180	0612-CBA	199				
0611-DAL	82	0612-EF	180	0612-CBB	198				
0611-DBA	82	0612-EG	180	0612-CBC	199				
0611-DBB	82	0612-EH	184	0612-CLE	192				
0611-DBC	82	0612-EI	184	0612-CLF	192				
0611-DBD	82	0612-EL	179	0612-CLG	192				
0611-DBE	82	0612-FE	196	0612-CLH	192				
0611-DBF	82	0612-FF	196	0612-CLI	192				
0611-DBG	82	0612-FG	196	0612-CLL	192				
0611-DHA	43	0612-FH	196	0612-DAA	192				
0611-DHB	43	0612-GD	179	0612-DAB	192				
0611-DHC	43	0612-GG	197	0612-DAC	192				
0611-DHD	43	0612-GH	197	0612-DAF	192				
0611-DHE	43	0612-GI	197	0612-DBB	202				
0611-DHF	43	0612-GL	197	0612-DCA	202				
0611-DIA	77	0612-HA	183	0612-DCB	202				
0611-DIB	77	0612-HB	183	0612-DDE	202				
0611-DIC	77	0612-HC	180	0612-DDF	202				
0611-DID	77	0612-HD	180	0612-DDL	194				
0611-DIE	77	0612-HE	183	0612-DFA	195				
0611-DIF	77	0612-HF	183						
0611-DIG	77	0612-IG	186	0614-AI	30				
0611-DIH	77	0612-IH	186	0614-AL	30				
0611-DII	77	0612-II	186	0614-BA	30				
0611-EAE	72	0612-IL	186	0614-BF	29				
0611-EBB	72	0612-LA	200	0614-BG	29				
0611-EBC	72	0612-LB	200	0614-BH	29				
0611-EBD	72	0612-LC	200	0614-BI	29				
0611-EBE	72	0612-LE	200	0614-BL	30				
0611-EBF	72	0612-LG	200	0614-CA	31				
0611-EBG	72	0612-LH	200	0614-CB	29				
		0612-LI	200	0614-CC	28				
0612-B	182	0612-LL	200	0614-CD	28				
0612-B06	182	0612-BAA	204	0614-CE	28				
0612-B1803	191	0612-BAA11	204	0614-CF	30				
0612-C	182	0612-BAC	204	0614-DE	31				
0612-C06	182	0612-BAE	204	0614-DH	28				
0612-C1803	191	0612-BAL	184	0614-DL	28				
0612-D	182	0612-BBI	195	0614-ED	30				
0612-D06	182	0612-BBL	195	0614-EF	30				
0612-D1803	191	0612-BCA	183	0614-FI	32				
0612-E	182	0612-BCB	183	0614-FL	32				
0612-E06	182	0612-BCC	183	0614-GA	32				
0612-E1803	191	0612-BCG	175	0614-GB	32				
0612-F	185	0612-BCH	175	0614-IF	28				
0612-G	185	0612-BDE	201	0614-IH	28				
0612-H	180	0612-BDG	201	0614-II	28				
0612-I	180	0612-BDL	201	0614-IL	28				
0612-L	178	0612-BEA	201	0614-LF	98				
0612-BA	178	0612-BEB	201	0614-BAA	107				
0612-BC	184	0612-BEC	201	0614-BAB	107				
0612-CE	185	0612-BED	201	0614-BAC	107				
0612-CF	185	0612-BFB	196	0614-BAD	107				
0612-CH	179	0612-BFC	196	0614-BAE	107				
0612-CI	179	0612-BFD	196	0614-BAI	32				
0612-CL	179	0612-BGA	197	0614-BBH	107				
0612-DA	179	0612-BGB	197	0614-BBI	107				
0612-DB	179	0612-BHG	194	0614-BBL	107				
0612-DC	179	0612-BHH	194	0614-BCA	107				

Indice alfanumerico		Alfanumerical Index		Nummernverzeichnis		Index alphabétique		Indice alfanumerico	
Article	Page	Article	Page	Article	Page	Article	Page	Article	Page
0614-BCB	107	0617-DE	57	0617-BAE	37				
0614-BCC	107	0617-DF	40	0617-BAF	37				
0614-BCD	107	0617-DG	40	0617-BAG	37				
0614-BCE	107	0617-DH	40	0617-BAH	37				
0614-BCF	109	0617-DI	40	0617-BAI	37				
0614-BCG	109	0617-DL	40	0617-BAL	37				
0614-BCH	109	0617-EA	40	0617-BBA	37				
0614-BCI	109	0617-EB	40	0617-BBB	37				
0614-BCL	109	0617-EC	40	0617-BBC	37				
0614-BDC	100	0617-ED	40	0617-BBD	37				
0614-BDI	31	0617-EE	40	0617-BBE	37				
0614-BDL	31	0617-EF	40	0617-BBF	37				
0614-BEB	100	0617-EG	40	0617-BBG	37				
0614-BEC	100	0617-EH	40	0617-BBH	37				
0614-BED	98, 193	0617-EI	57	0617-BBI	37				
0614-BEE	98, 193	0617-EL	57	0617-BBL	37				
0614-BEG	32	0617-FA	10	0617-BCA	37				
0614-BFA	98	0617-FB	10	0617-BCB	37				
0614-BFB	98	0617-FC	10	0617-BCC	37				
0614-BFC	100	0617-FD	10	0617-BCD	37				
0614-BFG	31	0617-FE	11	0617-BCE	37				
0614-BFH	31	0617-FF	11	0617-BCF	38				
0614-BGC	33	0617-FG	11	0617-BCG	38				
0614-BGD	33	0617-FH	11	0617-BCH	38				
0614-BGE	33	0617-FI	11	0617-BCI	38				
0614-BGF	33	0617-FL	11	0617-BCL	38				
0614-BHB	110	0617-GA	11	0617-BDA	38				
0614-BHC	110	0617-GB	11	0617-BDB	38				
0614-BHD	110	0617-GC	11	0617-BDC	38				
0614-BHE	110	0617-GD	11	0617-BDD	38				
0614-BHF	110	0617-GE	59	0617-BDE	38				
0614-BLA	193	0617-GF	59	0617-BDF	38				
0614-CAB	108	0617-GG	61	0617-BDG	38				
0614-CAC	108	0617-GH	61	0617-BDH	38				
0614-CAD	108	0617-GI	7	0617-BDI	38				
0614-CAE	108	0617-GL	7	0617-BDL	38				
0614-CAF	108	0617-HA	7	0617-BEA	38				
0614-CBC	108	0617-HB	7	0617-BEB	39				
0614-CBD	108	0617-HC	7	0617-BEC	39				
0614-CBF	108	0617-HD	7	0617-BED	39				
0614-CCA	28	0617-HE	7	0617-BEE	39				
0614-CCC	109	0617-HF	7	0617-BEF	39				
0614-CCD	109	0617-HG	7	0617-BEG	39				
0614-CCE	109	0617-HH	7	0617-BEH	39				
0614-CCF	109	0617-HI	7	0617-BEI	39				
0614-CCL	30	0617-HL	7	0617-BEL	39				
0614-CDA	30	0617-IA	7	0617-BFA	39				
0614-ELA	63	0617-IB	7	0617-BFB	39				
		0617-IC	7	0617-BFC	39				
0617-AB	10	0617-ID	7	0617-BFD	41				
0617-AC	10	0617-IE	7	0617-BFE	41				
0617-AD	10	0617-IF	7	0617-BFF	41				
0617-AE	10	0617-IG	7	0617-BFG	41				
0617-AF	10	0617-IH	7	0617-BFH	41				
0617-AG	10	0617-II	7	0617-BFI	42				
0617-AH	10	0617-IL	7	0617-BFL	42				
0617-AI	138	0617-LA	7	0617-BGA	42				
0617-AL	138	0617-LB	7	0617-BGB	42				
0617-BB	58	0617-LC	7	0617-BGC	42				
0617-BC	57	0617-LD	7	0617-BGD	42				
0617-BD	10	0617-LE	7	0617-BGE	42				
0617-BE	10	0617-LF	7	0617-BGF	42				
0617-BF	20, 58	0617-LG	7	0617-BGG	58				
0617-BG	59	0617-LH	7	0617-BGH	58				
0617-BH	59	0617-LI	7	0617-BGI	57				
0617-BI	58	0617-LJ	7	0617-BGL	57				
0617-BL	57	0617-LK	7	0617-BHA	138				
0617-DB	40	0617-LM	7	0617-BHB	138				
0617-DC	40	0617-LN	7	0617-BHC	138				
0617-DD	40	0617-LO	7	0617-BHD	138				
		0617-LP	7						
		0617-LQ	7						
		0617-LR	7						
		0617-LS	7						
		0617-LT	7						
		0617-LU	7						
		0617-LV	7						
		0617-LW	7						
		0617-LX	7						
		0617-LY	7						
		0617-LZ	7						
		0617-MA	58						
		0617-MB	37						
		0617-MC	37						
		0617-MD	37						

Indice alfanumerico		Alfanumerical Index		Nummernverzeichnis		Index alfabétique		Indice alfanumerico	
Article	Page	Article	Page	Article	Page	Article	Page	Article	Page
0617-BHF	57	0706-HC	309	0706-BID	321				
0617-BHG	57	0706-HD	309	0706-BIF	321				
0617-BHH	57	0706-HE	309	0706-BIG	321				
0617-BHI	57	0706-HF	303	0706-BII	321				
0617-BHL	97	0706-HG	303	0706-BLD	307				
0617-BIA	97	0706-HH	303	0706-BLE	307				
0617-BIB	96	0706-HL	309	0706-BLF	307				
0617-BIC	96	0706-IF	308	0706-BLG	307				
0617050517	20, 59	0706-IG	308	0706-BLH	307				
07-I	143	0706-IH	308	0706-BLI	308				
07-BA	143	0706-II	308	0706-BLL	308				
07-BC	143	0706-LC	6	0706-CAA	321				
07-BE	143	0706-LD	6	0706-CDC	310				
07-BG	143	0706-LE	6	0706-CDI	313				
07-BI	143	0706-LG	6	0706-CEA	314				
07-CA	143	0706-LH	6	0706-CEB	314				
07-CC	143	0706-BAA	308	0706-CEB02	314				
07-CE	143	0706-BAB	308	0706-CEC	314				
07-CG	143	0706-BAC	308	0706-CEC02	314				
07-CI	143	0706-BAD	308	0706-CED	314				
07-DA	143	0706-BBB	316	0706-CEE	314				
0706-AB	306	0706-BBC	316	0706-CEF	315				
0706-AC	306	0706-BBD	316	0706-CEG	315				
0706-AD	306	0706-BBF	306	0706-CEH	315				
0706-AE	306	0706-BBG	306	0706-CEI	315				
0706-AF	306	0706-BBH	306	0706-CEL	315				
0706-AG	305	0706-BCE	307	0706-CFD	315				
0706-AH	305	0706-BCF	307	0706-CFE	315				
0706-AI	304	0706-BCG	307	0706-CFF	315				
0706-BA	305	0706-BCH	307	0706-CFG	308				
0706-BB	306	0706-BCI	307	0706-CFH	308				
0706-BC	305	0706-BCL	307	0706-CFI	317				
0706-CA	303	0706-BEA	314	0706-CFL	317				
0706-DG	304	0706-BEB	314	0706-CGA	317				
0706-DH	304	0706-BEC	314	0706-CGB	317				
0706-DI	304	0706-BEC02	314	0706-CGC	317				
0706-DL	304	0706-BED	314	0706-CGD	317				
0706-EA	321	0706-BEE	314	0706-CGE	317				
0706-EB	312	0706-BFA	314	0706-CGF	315				
0706-EC	312	0706-BFB	314	0706-CGG	315				
0706-ED	310	0706-BFB02	314	0706-CGH	315				
0706-EE	304	0706-BFC	314	0706-CGI	315				
0706-EF	310	0706-BFC02	314	0706-CGL	315				
0706-EH	310	0706-BFD	314	0706-CHA	315				
0706-EI	309	0706-BFE	314	0706-CHB	313				
0706-EL	309	0706-BFG	316	0706-CHC	313				
0706-FA	309	0706-BFH	316	0706-CHD	313				
0706-FB	304	0706-BFI	316	0706-CHE	313				
0706-FC	304	0706-BFL	316	0706-CHF	313				
0706-FD	311	0706-BGA	316	0706-CHG	313				
0706-FE	305	0706-BGB	316	0706-CHH	313				
0706-FF	311	0706-BGC	316	0706-CHI	313				
0706-FG	311	0706-BGD	316	0706-CHL	313				
0706-FH	311	0706-BGE	316	0706-CIA	313				
0706-FI	311	0706-BGF	316	0706-CIB	313				
0706-FL	311	0706-BGG	316	0706-CIC	313				
0706-GA	312	0706-BGH	316	0706-CID	313				
0706-GB	312	0706-BGI	316	070603	175				
0706-GC	317	0706-BGL	316	070603-18	173				
0706-GD	310	0706-BHA	316	070603-1903	194				
0706-GE	317	0706-BHB	316	070617	175				
0706-GF	310	0706-BHC	316	070617-18	173				
0706-GG	317	0706-BHD	316	070617-1903	194				
0706-GH	310	0706-BHE	316	0718-AB	325				
0706-GL	312	0706-BHF	316	0718-AC	325				
0706-HA	312	0706-BHG	316	0718-AD	325				
0706-HB	309	0706-BHH	316	0718-AE	325				
		0706-BHI	316						
		0706-BHL	316						
		0706-BIC	321						

Indice alfanumerico		Alfanumerical Index		Nummernverzeichnis		Index alfabétique		Indice alfanumerico	
Article	Page	Article	Page	Article	Page	Article	Page	Article	Page
0718-AG	325	1118-AI	163	1411-BE	317				
0718-AH	325	1118-AL	163	1411-BF	317				
0718-AL	325			1411-BG	317				
0718-BA	325	1123-BAL	32	1411-BH	317				
0718-BG	162	1123-BBB	32	1411-BI	317				
0718-BI	162	1123-BBD	99	1411-CC	318				
		1123-BBE	99	1411-CD	318				
1009-CAE	139			1411-CE	318				
		1201-G	143	1411-CF	319				
1014-B	19	1201-BA	43	1411-CG	319				
1014-C	19	1201-02B	157	1411-CH	319				
1014-BB	60	1201-02C	157	1411-CI	319				
1014-BC	60	1201-02D	157	1411-CL	319				
1014-BD	60	1201-02D11	158	1411-DE	319				
1014-CA	20	1201-02D12	157	1411-DH	319				
1014-CC	20	1201-02E	159	1411-DI	319				
1014-CD	20	1201-02E11	159	1411-DL	319				
1014-DA	60	1201-02F	158	1411-GD	319				
1014-DI	20	1201-02G	159	1411-GE	319				
1014-DL	20	1201-02H	157	1411-IG	320				
1014-EG	60	1201-02H10	157	1411-IH	320				
1014-FB	137	1201-02I	157	1411-II	320				
1014-FC	137	1201-02L	157	1411-IL	320				
1014-FD	136	1201-02BA	159	1411-LA	320				
1014-GA	93	1201-02BB	158	1411-LB	320				
1014-GB	60	1201-02BC	158	1411-LC	320				
1014-GC	60	1201-02BF	158	1411-LD	320				
1014-GD	60			1411-LE	320				
1014-GE	60	12050104	20	1411-LF	320				
1014-GF	60			1411-LG	320				
1014-GG	60	1206-BAB	243	1411-LH	320				
1014-GH	61	1206-BAB19	249	1411-LI	320				
1014-GI	61	1206-BAC	243	1411-LL	320				
1014-GL	61	1206-BAC19	249	1411-BAA	318				
1014-HA	59	1206-BAD	243	1411-BAB	318				
1014-HB	59	1206-BAE	243	1411-BAC	318				
1014-HC	59	1206-BAF	243	1411-BAD	318				
1014-HD	12	1206-BBA	231						
1014-HE	12	1206-BBB	231	1412-AE	122				
1014-HF	12	1206-BBC	231	1412-AF	122				
		1206-BBD	231	1412-AG	125				
1102-BA	160	1206-BBE	231	1412-AH	122				
1102-BB	160	1206-BBF	231	1412-AI	125				
1102-BC	160	1206-DCA	248	1412-BG	122				
1102-BC04	160			1412-BH	122				
1102-BD	160	1310-B	161	1412-BI	122				
1102-BF	160	1310-C	161	1412-BL	122				
1102-BF01	160	1310-D	161	1412-CA	51				
1102-BF03	160	1310-BC	162	1412-CB	51				
1102-BI	160	1310-IF	162	1412-CC	51				
1102-CA	160	1310-BAA	57	1412-CD	51				
1102-CB	160	1310-BAB	57	1412-CE	51				
1102-CC	160	1310-BAC	57	1412-CF	53				
1102-CD	160	1310-EDA	56	1412-CG	51				
1102-CE	160	1310-EDB	56	1412-CH	53				
1102-CF	160	1310-EDC	56	1412-CI	53				
1102-DG	160	1310-EDD	56	1412-CL	53				
1102-EA	162			1412-DB	51				
1102-DGB	161	1411-AB	318	1412-DC	56				
1102-DGC	161	1411-AC	318	1412-DE	56				
1102-DGD	161	1411-AD	318	1412-DG	56				
1102-DGE	161	1411-AE	318	1412-DI	56				
1102-DGF	161	1411-AF	318	1412-DL	114				
1102-DGG	161	1411-AG	319	1412-EA	127				
1102-DGH	161	1411-AH	319	1412-EA17	127				
1102-DGI	161	1411-AI	319	1412-EB	127				
1102-DGL	161	1411-AL	319	1412-EB17	127				
		1411-BA	319	1412-EC	127				
1118-AG	163	1411-BB	319	1412-EI	52				
1118-AH	163	1411-BD	317	1412-EL	52				

Indice alfanumerico		Alfanumerical Index		Nummernverzeichnis		Index alfabétique		Indice alfanumerico	
Article	Page	Article	Page	Article	Page	Article	Page	Article	Page
1412-FA	123	1412-BEG	131	15-DL	220				
1412-FB	53	1412-BFA	133	15-EA	224				
1412-FC	123	1412-BFB	133	15-EB	224				
1412-FD	53	1412-BFC	133	15-EC	224				
1412-FE	53	1412-BFD	133	15-ED	224				
1412-FF	125	1412-BFE	133	15-EE	224				
1412-FG	53	1412-BFF	133	15-EL	221				
1412-FH	53	1412-BFH	133	15-FA	223				
1412-FL	53	1412-BGA	133	15-FE	221				
1412-GA	127	1412-BGB	133	15-FF	221				
1412-GB	125	1412-BGC	133	15-FG	220				
1412-GC	127	1412-BGD	133	15-FH	220				
1412-GD	144	1412-BGE	133	15-FI	220				
1412-GF	144	1412-BGF	130	15-FL	220				
1412-GG	125	1412-BGG	130	15-GB	217				
1412-GH	123	1412-BGH	130	15-GC	217				
1412-HE	126	1412-BGI	130	15-GD	217				
1412-HF	126	1412-BHA	131	15-GE	217				
1412-HG	126	1412-BHB	131	15-HA	224				
1412-HH	126	1412-BHC	131	15-HB	224				
1412-IA	123, 273	1412-BHD	131	15-HC	224				
1412-IB	123, 273	1412-BHE	131	15-HD	224				
1412-IC	123, 273	1412-BHF	130	15-HE	224				
1412-IF	273	1412-BHG	130	15-HL	221				
1412-IH	123, 273	1412-BHH	130	15-IB	217				
1412-II	123, 273	1412-BHI	130	15-IC	217				
1412-LA	126	1412-BIB	51	15-IE	221				
1412-LD	125	1412-BIC	51	15-IF	221				
1412-LE	125	1412-BID	51	15-IG	217				
1412-LF	125	1412-BIE	51	15-IH	217				
1412-LI	122	1412-BIF	51	15-IL	221				
1412-BAA	122	1412-BIG	51	15-LB	216				
1412-BAH	52	1412-BIH	51	15-LC	216				
1412-BAI	52	1412-BLA	55	15-LD	216				
1412-BAL	52	1412-BLB	55	15-LE	216				
1412-BBA	132	1412-BLC	55	15-LF	215				
1412-BBB	132	1412-BLC11	55	15-LG	215				
1412-BBC	132	1412-BLD	55	15-LH	215				
1412-BBD	132	1412-BLE	55	15-LI	215				
1412-BBE	132	1412-BLF	55	15-BAA	223				
1412-BBF	129	1412-BLF11	55	15-BAB	215				
1412-BBG	129	1412-BLG	54	15-BAC	215				
1412-BBH	129	1412-BLH	54	15-BCA	215				
1412-BBI	129	1412-BLI	54	15-BCB	215				
1412-BBL	129			15-BCL	223				
1412-BCB	139	1417-BF	164	15-BDF	215				
1412-BCC	139	1417-BH	164	15-BDG	216				
1412-BCD	139	1417-BL	164	15-BDH	216				
1412-BCE	139	1417-EA	163	15-BDI	216				
1412-BCF	139	1417-EC	163	15-BDL	216				
1412-BCG	139	1417-EF	163	15-CBF	217				
1412-BCH	129			15-CBG	217				
1412-BCI	129	15-AA	143	15-CBH	217				
1412-BCL	129	15-A	143	15-CCC	222				
1412-BDA	128	15-AB	143	15-CCD	222				
1412-BDB	128	15-AC	143	15-CDA	218				
1412-BDC	128	15-AD	143	15-CDB	218				
1412-BDD	128	15-AE	143	15-CDC	218				
1412-BDE	128	15-AF	143	15-CDD	218				
1412-BDF	128	15-AG	143	15-CDE	218				
1412-BDG	128	15-AG01	143	15-CDF	218				
1412-BDH	128	15-AG02	143	15-CDG	218				
1412-BDI	128	15-AG03	143	15-CDH	218				
1412-BDL	128	15-AG04	143	15-CDI	218				
1412-BEA	131	15-BF	216	15-CDL	218				
1412-BEB	131	15-BI	220	15-CEA	218				
1412-BEC	131	15-BL	220	15-CEB	218				
1412-BED	131	15-CI	220	15-CEC	218				
1412-BEE	131	15-CL	220	15-CED	218				
1412-BEF	131	15-DI	220	15-CEE	218				

Indice alfanumerico		Alfanumerical Index		Nummernverzeichnis		Index alfabétique		Indice alfanumerico	
Article	Page	Article	Page	Article	Page	Article	Page	Article	Page
15-CEF	218	1506-EG	301	1508-BCE	288				
15-CEG	221	1506-EI	301	1508-BCF	288				
15-CEH	221	1506-EL	301	1508-BCH	288				
15-CFA	219	1506-FA	301	1508-BCI	288				
15-CFB	219	1506-FB	301	1508-BCL	288				
15-CFC	219	1506-FC	301	1508-BDC	289				
15-CFD	219	1506-FD	299	1508-BDD	289				
15-CFE	219	1506-FE	299	1508-BDE	289				
15-CFF	219	1506-FF	299	1508-BEA	291				
15-CFG	219	1506-FG	299	1508-BEB	291				
15-CFH	219	1506-FH	299	1508-BEC	291				
15-CFI	219	1506-FI	299	1508-BED	291				
15-CFL	219	1506-FL	299	1508-BEE	291				
15-CGA	219	1506-GA	148	1508-BEF	291				
15-CGB	219	1506-GB	148						
15-CGC	219	1506-GC	301	1514-FA	293				
15-CGD	219	1506-GD	301	1514-FB	293				
15-CGE	215	1506-GE	301	1514-FC	293				
15-CGF	215	1506-GF	148	1514-FF	294				
15-CGG	222	1506-GG	301	1514-FG	294				
15-CGH	222	1506-GH	301	1514-IC	293				
15-DAI	212	1506-GI	301	1514-ID	293				
15-DAL	212	1506-GL	301	1514-IE	293				
15-DBA	212	1506-HD	148	1514-IF	294				
15-DBB	212	1506-II	148	1514-IG	294				
15-DBC	212	1506-LI	299	1514-IH	294				
15-DBD	212	1506-LL	299	1514-LG	294				
15-DBI	212			1514-LH	290				
15-DBL	212	1508-DH	285	1514-LL	290				
15-DCC	212	1508-DI	285	1514-BAE	291				
15-DCE	223	1508-DL	285	1514-BAF	291				
15-DCF	223	1508-EI	285	1514-BCA	293				
15-DDB	212	1508-FD	286	1514-BCI	293				
15-DDC	222	1508-FE	289	1514-BCL	293				
		1508-FL	288						
1506-F	136	1508-GB	285	1705-AB	62				
1506-G	136	1508-GC	285	1705-AC	62				
1506-H	302	1508-GD	285	1705-AD	62				
1506-BA	301	1508-GE	285	1705-BA	62				
1506-BD	301	1508-GF	286						
1506-BE	300	1508-GG	286	1803-B	205				
1506-BF	300	1508-GI	286	1803-C	205				
1506-BH	299	1508-GL	286	1803-F	205				
1506-BI	299	1508-HB	289	1803-L	205				
1506-BL	299	1508-HC	288	1803-BC	206				
1506-CA	300	1508-HD	288	1803-BD	205				
1506-CB	300	1508-HF	288	1803-BE	205				
1506-CC	300	1508-HG	288	1803-BF	205				
1506-CD	300	1508-HH	287	1803-BG	205				
1506-CE	299	1508-HL	287						
1506-CF	300	1508-IA	292	1804-BF	6				
1506-CG	300	1508-IB	292						
1506-CH	300	1508-IC	292	1907-BA	16				
1506-CI	300	1508-ID	292	1907-BB	16				
1506-CL	300	1508-IE	292	1907-BC	16				
1506-DA	300	1508-LL	286	1907-CA	16				
1506-DB	300	1508-BAB	287	1907-CB	16				
1506-DC	300	1508-BAC	287	1907-CC	16				
1506-DD	300	1508-BAD	287	1907-CD	16				
1506-DE	300	1508-BAE	287	1907-EA	16				
1506-DF	300	1508-BAG	289	1907-EB	16				
1506-DG	300	1508-BAH	289						
1506-DH	300	1508-BAI	289	1917-DA	121, 302				
1506-DI	300	1508-BBA	287	1917-DC	121, 302				
1506-DL	301	1508-BBB	287	1917-DF	121, 302				
1506-EA	301	1508-BBC	287	1917-HA	302				
1506-EB	301	1508-BCA	288						
1506-EC	301	1508-BCB	288	1918-FA	6				
1506-ED	301	1508-BCC	288	1918-BAB	330				
1506-EE	300	1508-BCD	288	1918-BAC	330				

Indice alfanumerico		Alfanumerical Index		Nummernverzeichnis		Index alphabétique		Indice alfanumerico	
Article	Page	Article	Page	Article	Page	Article	Page	Article	Page
1918-BAD	330								
1918-BAE	330								
2118-CA	327								
2118-CG	327								
2118-DA	327								
22051819	20								
2207-BA	19								
2207-BC	19								
2207-BE	19								



ideal-tek
manufacturer & supplier of precision instruments 

Ideal-tek SA
via Motta 4
6828 Balerna
Switzerland

Phone: +41 91 683 32 29
Fax: +41 91 683 03 71
E-mail: info@ideal-tek.com