

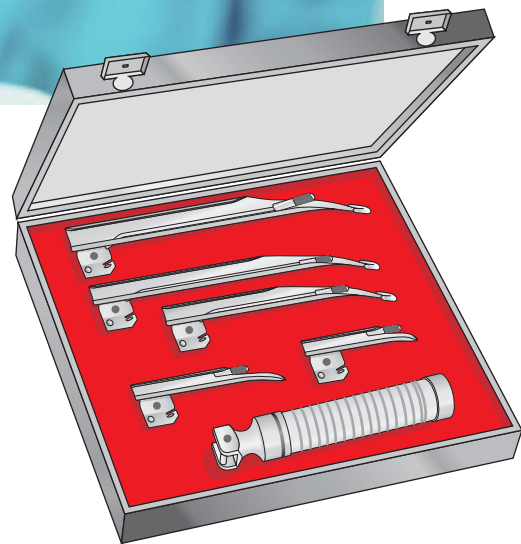

ideal-tek  
manufacturer & supplier of precision instruments 







1

Diagnostica, Anestesia  
Diagnostics, Anesthesia  
Diagnostik, Anaesthetie  
Diagnostic, Anesthésie  
Diagnòstico, Anestesia



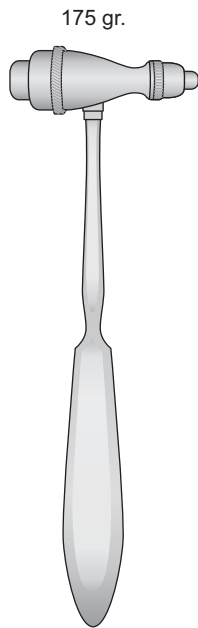

TROEMNER  
0102-BG  
140 mm

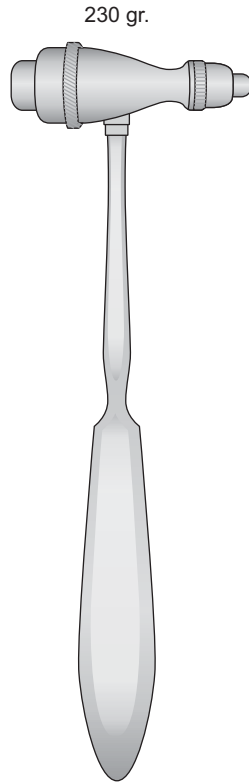

TROEMNER  
0102-BI  
240 mm

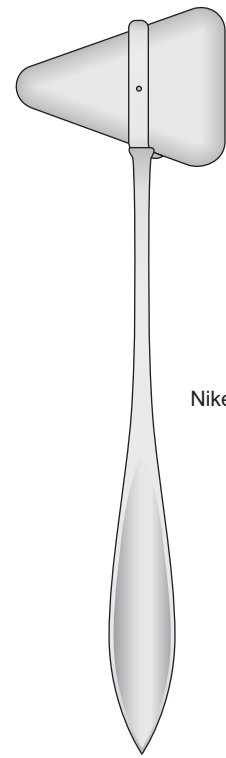

TAYLOR  
0102-BE  
200 mm

Nikel-Chrom

Con ago - With pin  
Mit Nadel - Avec aiguille  
Con aguja

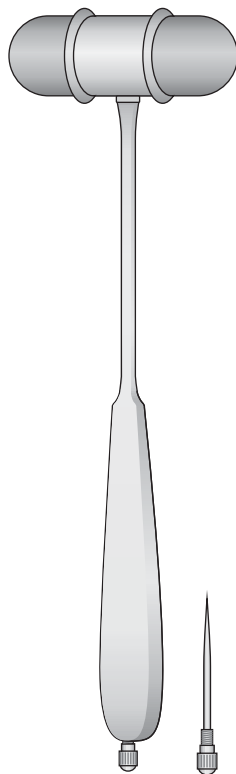

DEJERINE  
0102-BA  
200 mm

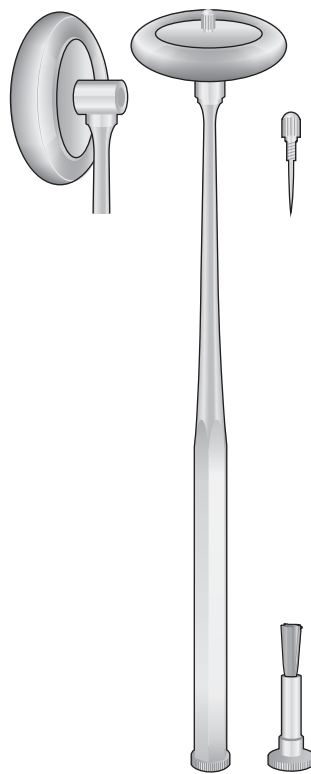

BABINSKY  
0102-BB  
255 mm

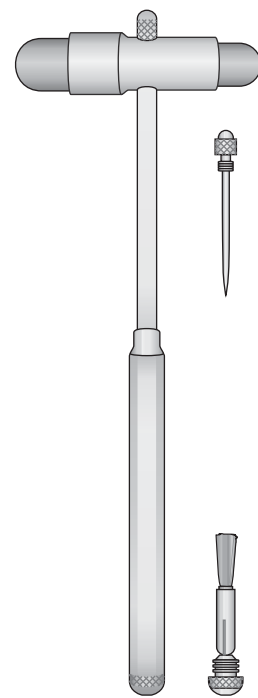

BUCK  
0102-BC  
180 mm

Abbassalingua

Tongue depressor

Zungenspatel

Abaisse-langues

Bejalenguas

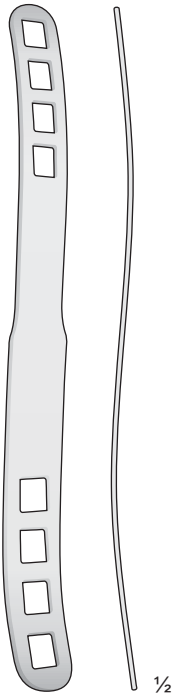

**BRUENINGS**  
**1412-AE**  
190 mm

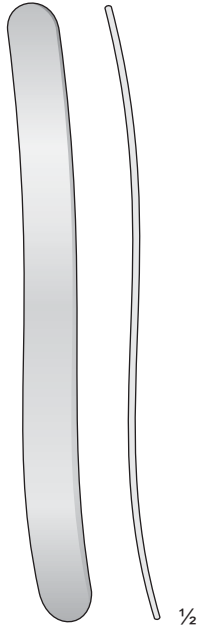

**1412-AF**  
145 mm

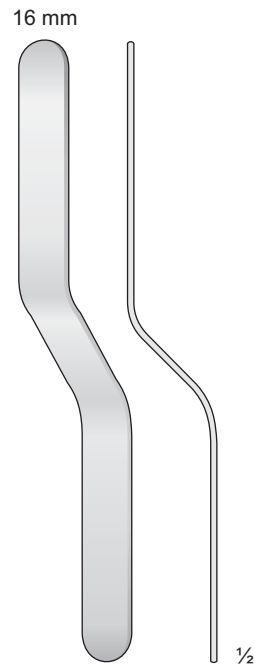

**1412-AH**  
145 mm

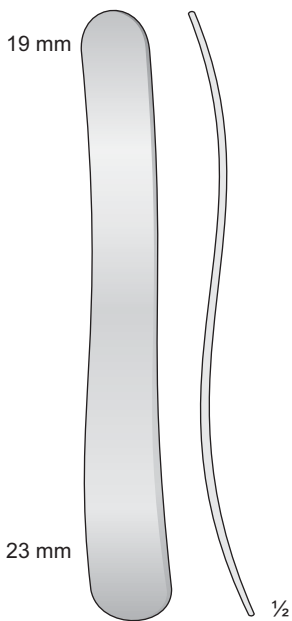

**KROENIG**  
**1412-BG**  
150 mm

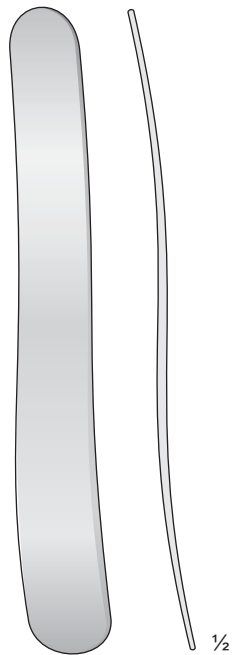

**MAYO**  
**1412-BH**  
170 mm

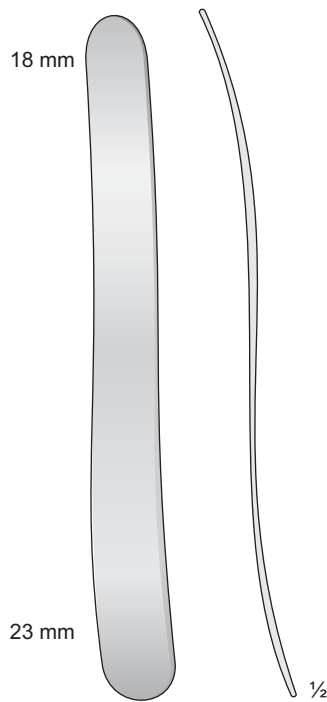

**BUCHWALD**  
**1412-BI**  
180 mm

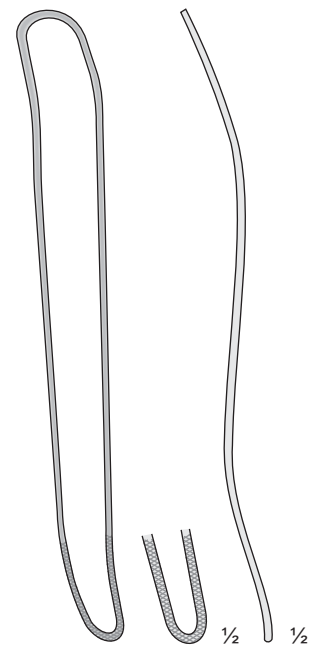

**FRENZEL**  
**1412-BL**  
165 mm

Diapason

Tuning Forks

Stimmgabeln

Diapasons

Diapasones

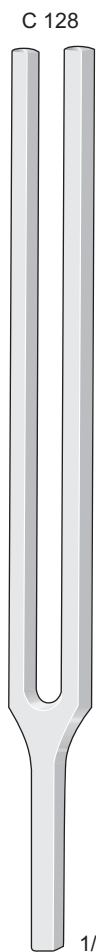

HARTMANN  
0103-BB

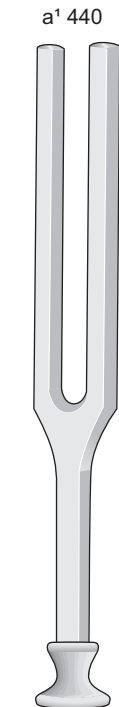

0103-CA

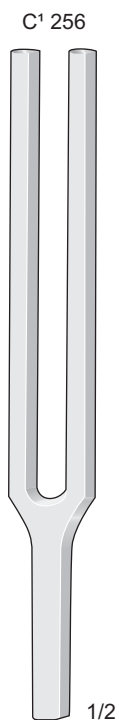

HARTMANN  
0103-BC

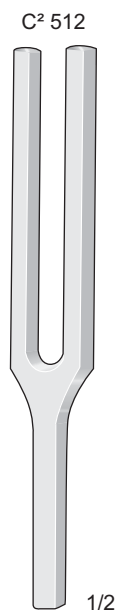

HARTMANN  
0103-BD

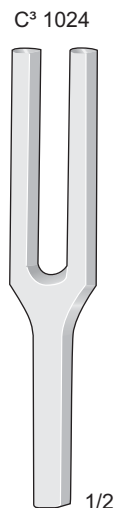

HARTMANN  
0103-BE

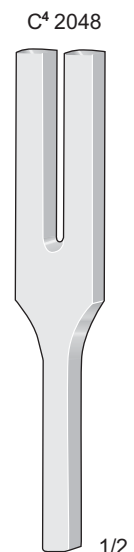

HARTMANN  
0103-BF

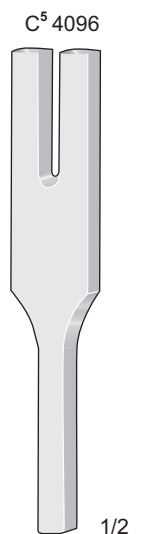

HARTMANN  
0103-BG

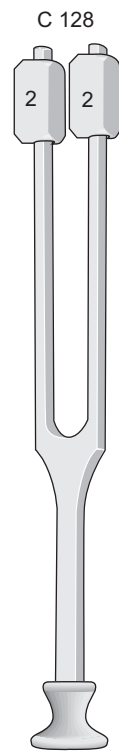

LUCAE  
0103-DA

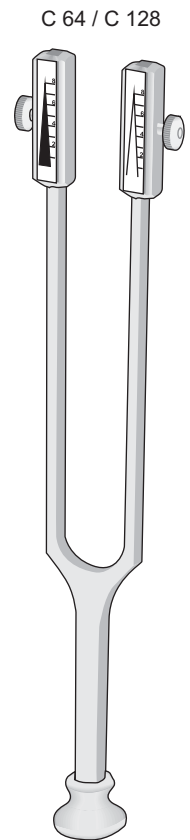
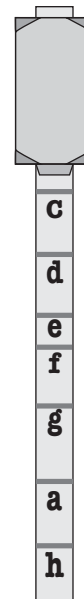

RYDEL-SEIFER  
0103-EA

C 64  
Con smorzatore - With clamps  
Mit Dämpfer - Avec curseurs  
C 128  
Senza smorzatore - Without clamps  
Ohne Dämpfer - Sans curseurs

Apribocca

Mouth gags

Mundsperrer

Ecarteur buccal

Abrebocas

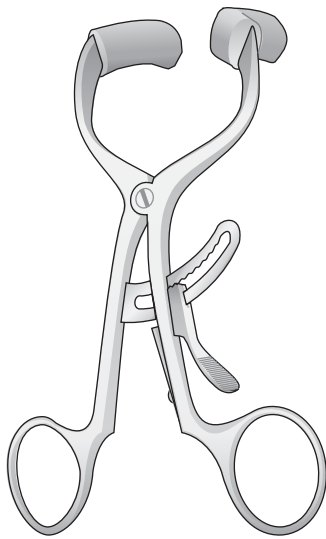

DOYEN-JANSEN  
1412-EB  
140 mm

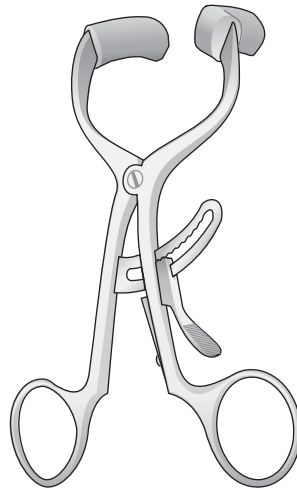

DOYEN-COLLIN  
1412-EA  
120 mm

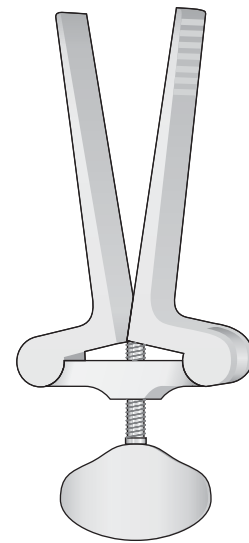

HEISTER  
1412-GC  
135 mm

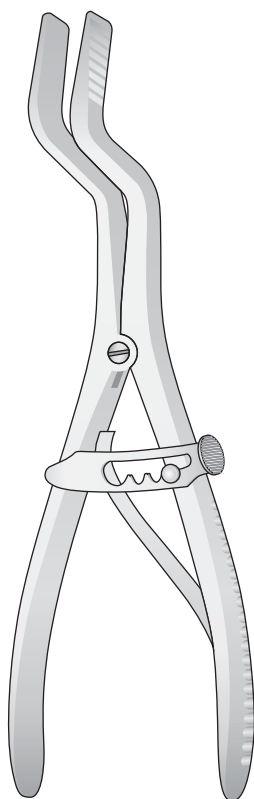

ROSER-KÖNIG  
1412-GA  
185 mm

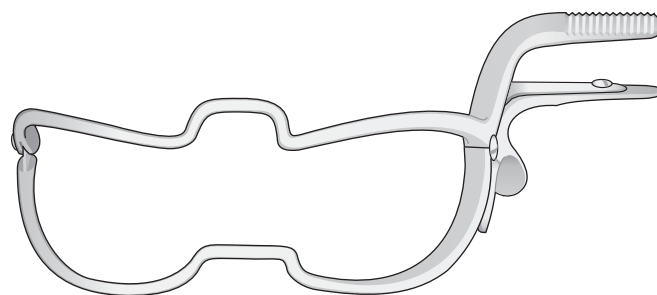

WHITEHEAD-JENNINGS  
1412-BDG 90 mm  
1412-BDH 110 mm  
1412-BDI 130 mm  
1412-BDL 150 mm



Anestesia - Anesthesia  
 Anaesthesie - Anesthésie - Anestesia



1/1

**1412-BC**  
 150 mm

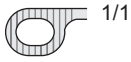

1/1

**1412-BD**  
 200 mm

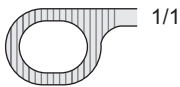

1/1

**1412-BE**  
 250 mm

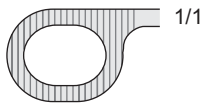

1/1

**1412-BF**  
 250 mm

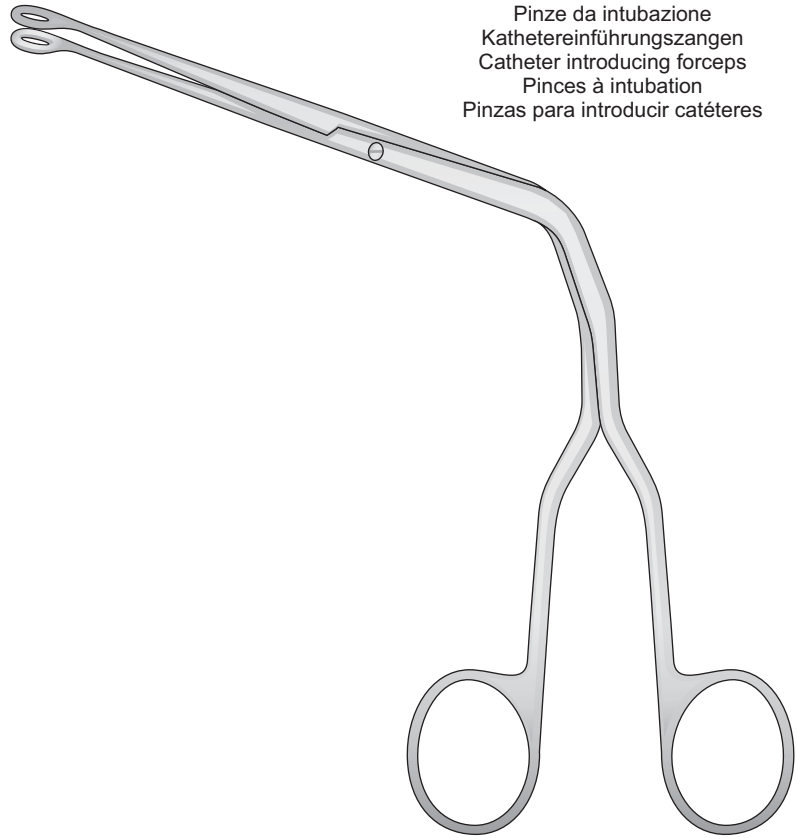

Pinze da intubazione  
 Kathetereinführungszangen  
 Catheter introducing forceps  
 Pincés à intubation  
 Pinzas para introducir catéteres

MAGILL  
**1412-BC/1412-BF**

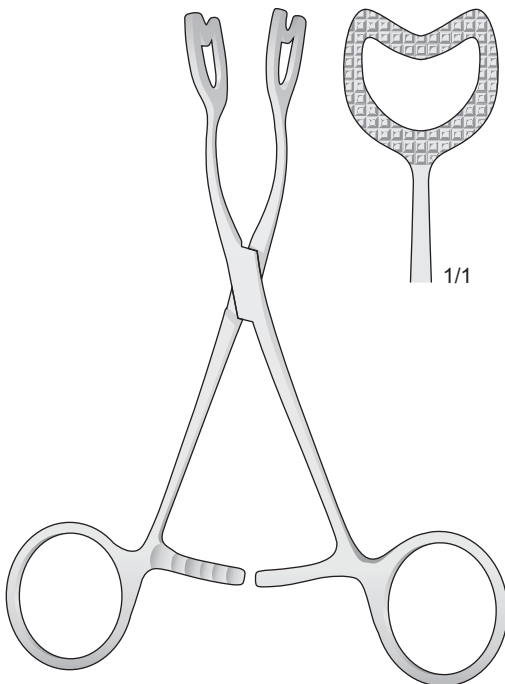

**1412-BB**  
 140 mm

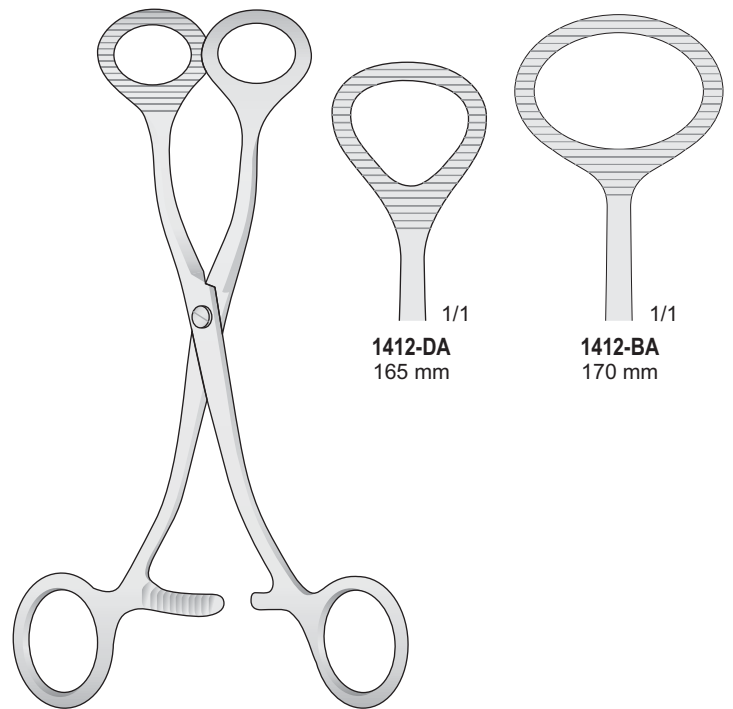

**1412-DA**  
 165 mm

**1412-BA**  
 170 mm

COLLIN  
**1412-BA/1412-DA**

Pinze tirlingua

Tongueforceps

Zungenzangen

Pinces tire-langue

Pinzas tira-lengua

Gomini di ricambio 2 pezzi  
 1 Pair of rubber pads  
 1 Paar ersatzgummi  
 1 Paire de mors caoutchouc  
 1 Paar placas de caucho

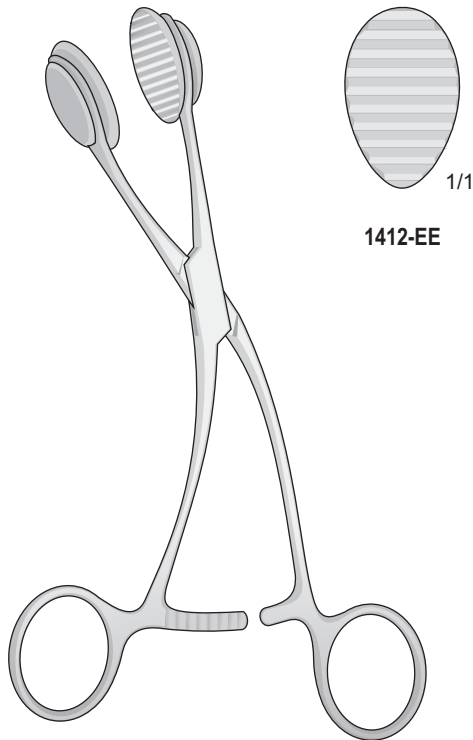

1412-EE

Pinza per batuffoli e tamponi  
 Cotton swab-Sponge holding forceps  
 Tupfer-Schwammzangen  
 Pinces à tampons et è ponges  
 Pinzas para tampones porta esponjas

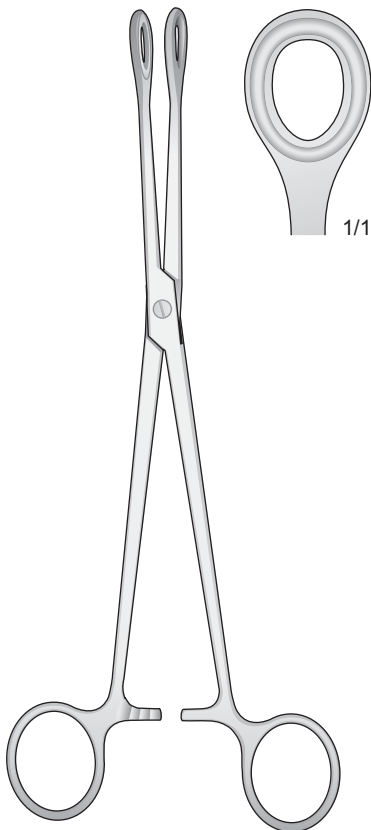

0206-BG  
 230 mm

YOUNG  
 1412-EF  
 160 mm

Gomini di ricambio 2 pezzi  
 1 Pair of rubber pads  
 1 Paar ersatzgummi  
 1 Paire de mors caoutchouc  
 1 Paar placas de caucho

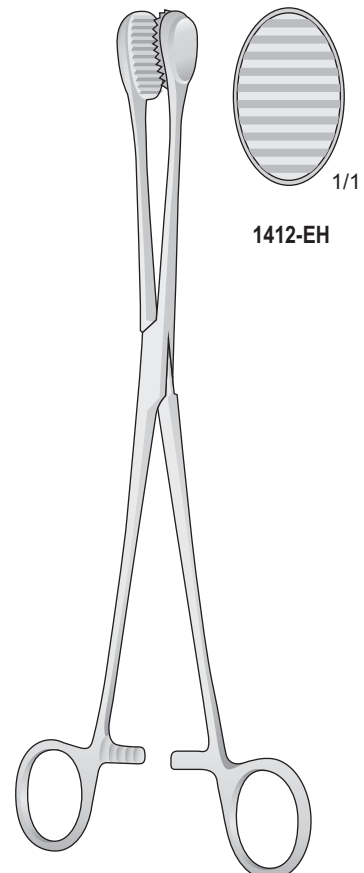

CHILD  
 1412-EG  
 240 mm

Manici e specchietti

Mirrors

Mundspiegel und griffe

Miroirs

Espejos

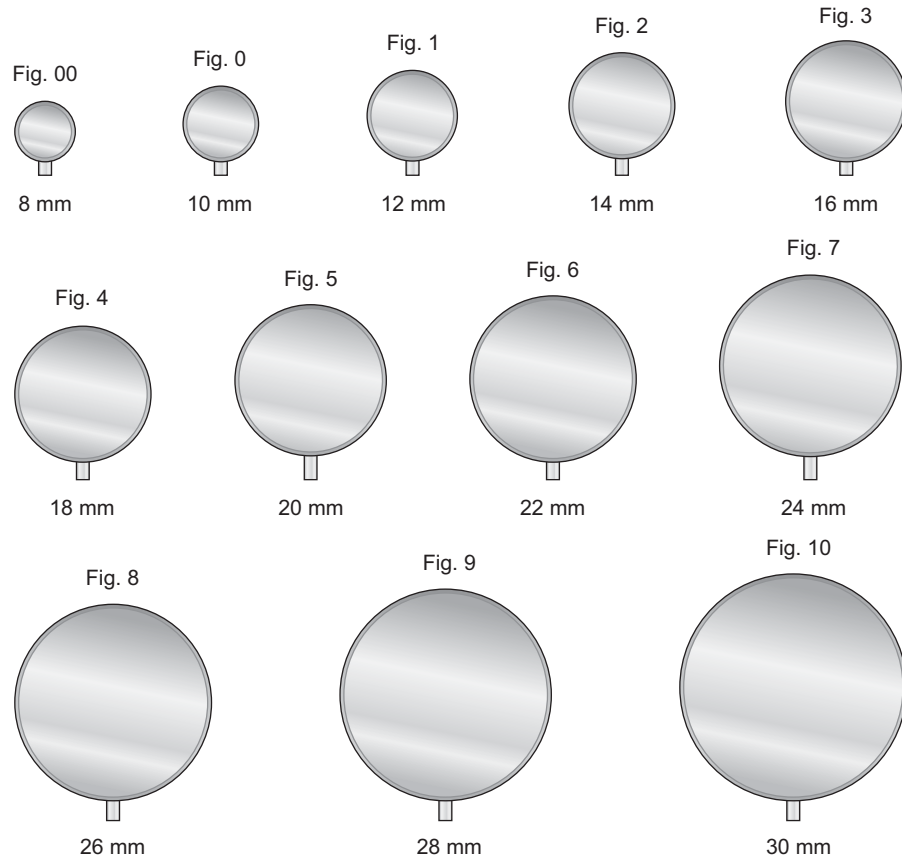

Specchietto laringeo con manico esagonale  
Kehlkopfspiegel mit Sechskantgriff  
Laryngeal mirrors with hexagonal handle  
Miroirs laryngiens avec manche hexagonal

Inox

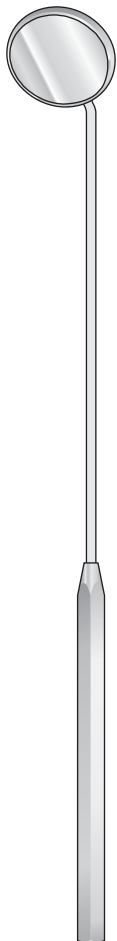

07-I/07-DA  
180 mm

Diametro dello specchio - Diameter of mirrors - Spiegeldurchmesser  
Diamètre des miroirs - Diámetro de los espejos

Manico per specchietti  
Mirrors handle  
Spiegelgriff  
Manche à miroir  
Manico para espejos

Nikel-Chrom

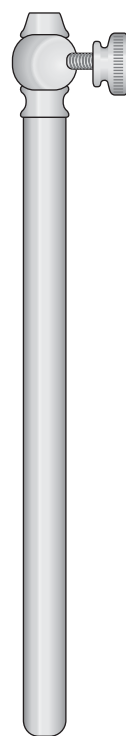

1201-G  
120 mm

Specchietto laringeo  
Laryngeal mirrors  
Kehlkopfspiegel  
Miroirs laryngiens  
Espejos laringeos

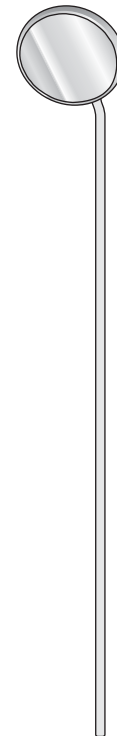

15-AA/15-AG  
120 mm

	Fig.
07-I	00
07-BA	0
07-BC	1
07-BE	2
07-BG	3
07-BI	4
07-CA	5
07-CC	6
07-CE	7
07-CG	8
07-CI	9
07-DA	10

	Fig.
15-AA	00
15-A	0
15-AB	1
15-AC	2
15-AD	3
15-AE	4
15-AF	5
15-AG	6

Duofono pediatrico  
Con 4 olive di ricambio

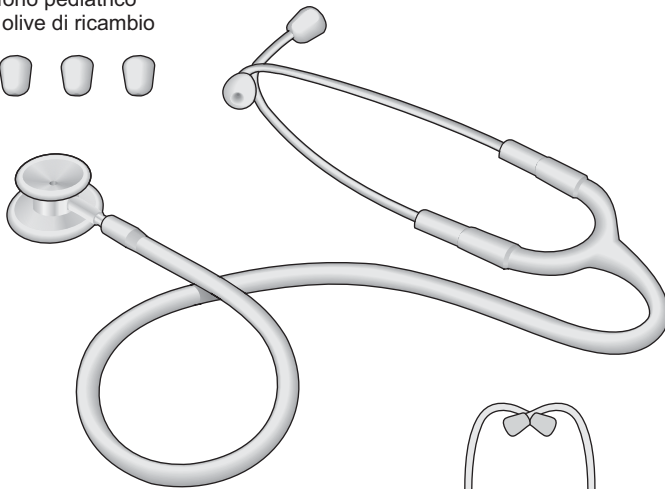

0102-FE

In legno  
Of wood  
Aus Holz  
En bois  
De madera



0102-FF  
145 mm

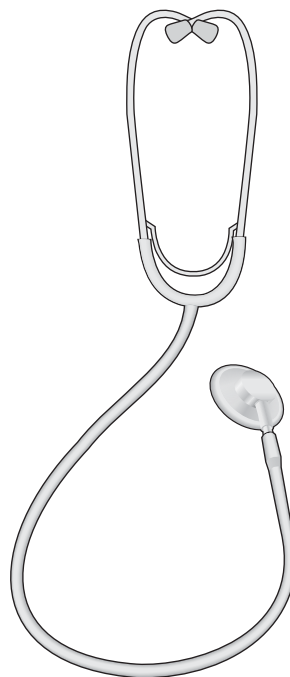

LEVIS - CLASSIC  
0102-FC

Professional  
Con 4 olive di ricambio

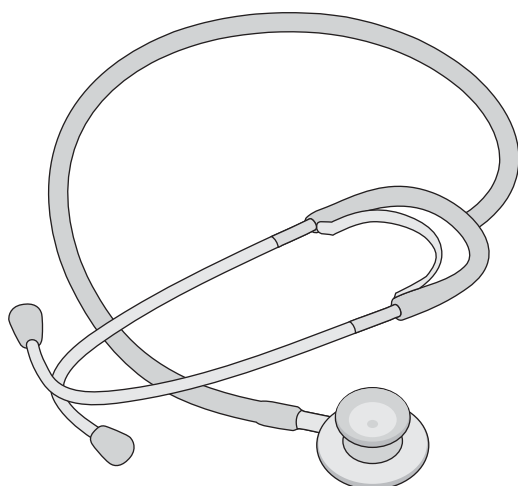

0102-FA

Fonendoscopio  
Classic

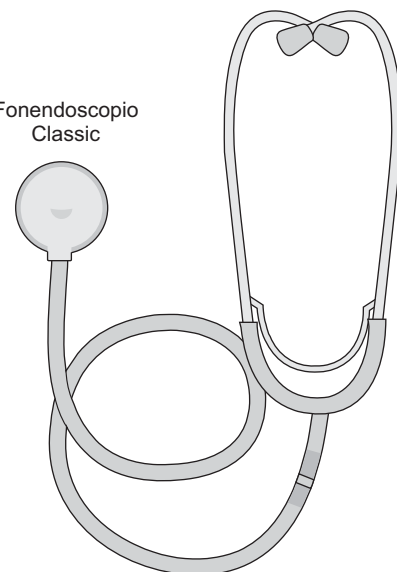

0102-FB

Laringoscopio  
MC INTOSH



**0101-02BAA**  
2,5 Volt  
300 mA

Per lama **0101-BAA**  
For blades **0101-BAA**  
Für Spatel **0101-BAA**  
Pour spatules **0101-BAA**  
Para hojas **0101-BAA**



**0101-02BAB**  
2,5 Volt  
300 mA

Per lame **0101-BAB ÷ 0101-BAE**  
For blades **0101-BAB ÷ 0101-BAE**  
Für Spatel **0101-BAB ÷ 0101-BAE**  
Pour spatules **0101-BAB ÷ 0101-BAE**  
Para hojas **0101-BAB ÷ 0101-BAE**

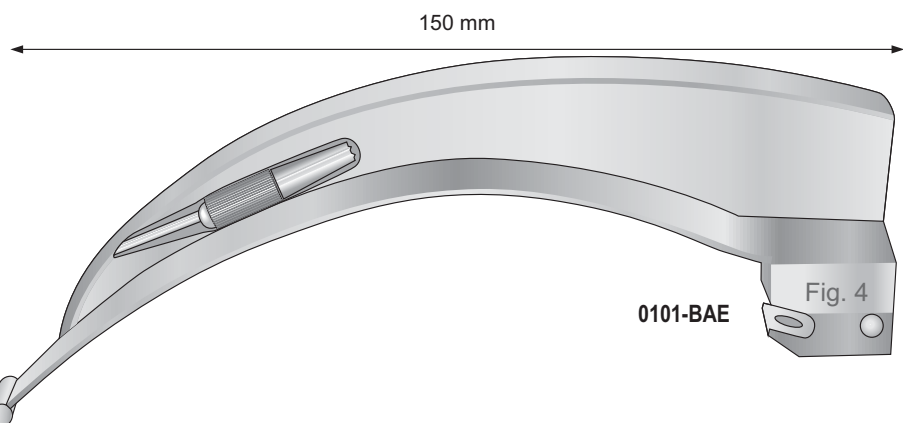
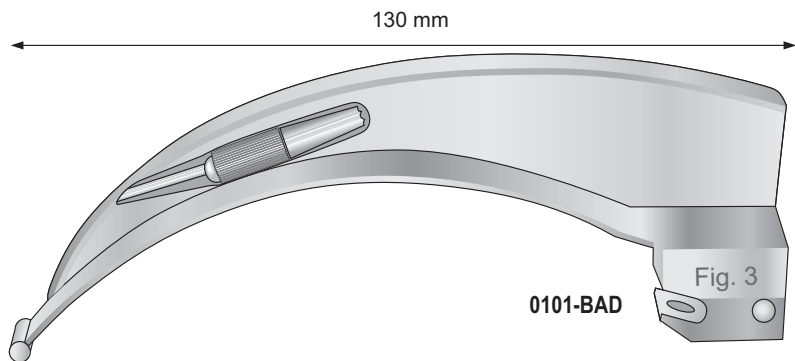
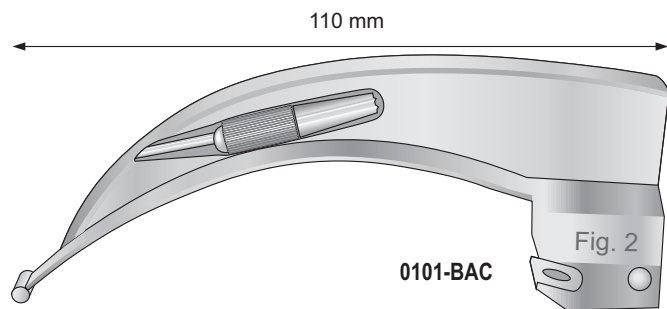
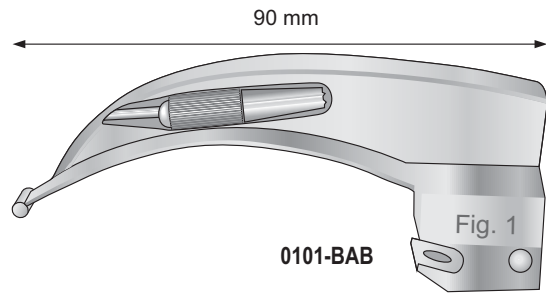
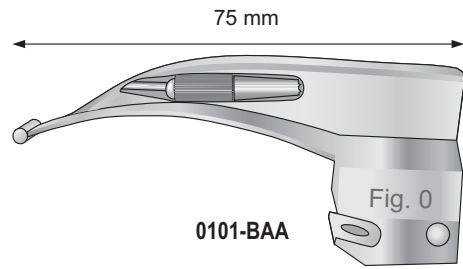

Laringoscopio  
**MILLER**

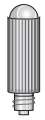

**0101-02BAA**  
2,5 Volt  
300 mA

Per lame **0101-CAA + 0101-CAD**  
For blades **0101-CAA + 0101-CAD**  
Für Spatel **0101-CAA + 0101-CAD**  
Pour spatules **0101-CAA + 0101-CAD**  
Para hojas **0101-CAA + 0101-CAD**



**0101-02BAB**  
2,5 Volt  
300 mA

Per lama **0101-CAE**  
For blades **0101-CAE**  
Für Spatel **0101-CAE**  
Pour spatules **0101-CAE**  
Para hojas **0101-CAE**

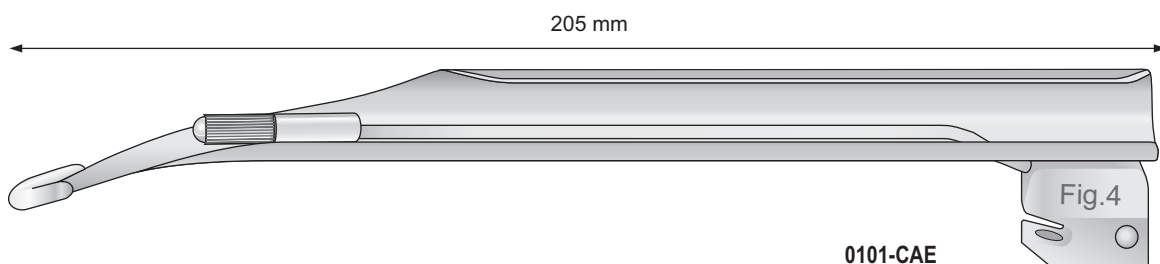
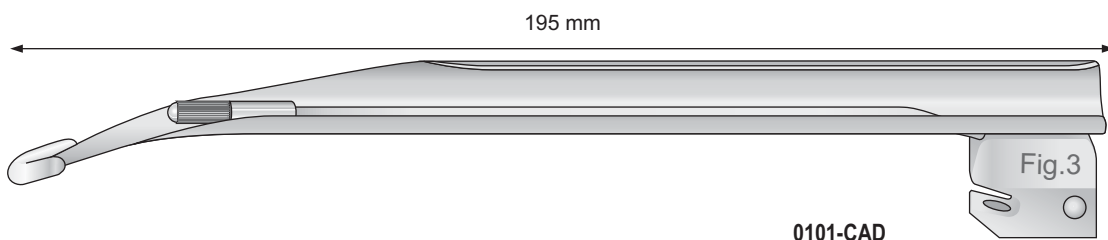
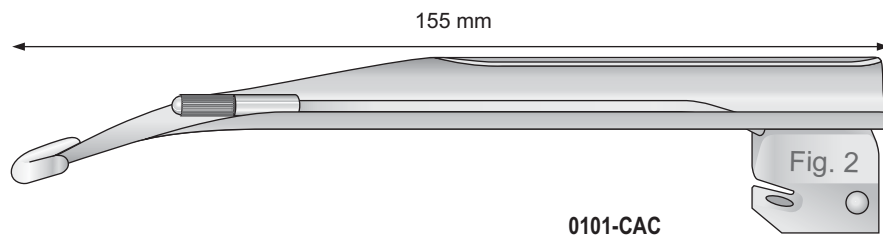
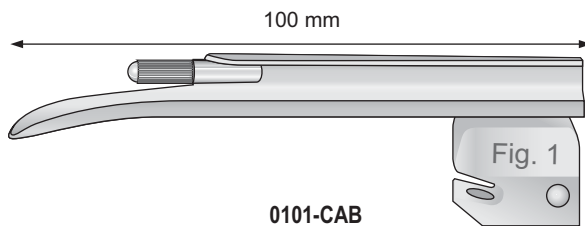
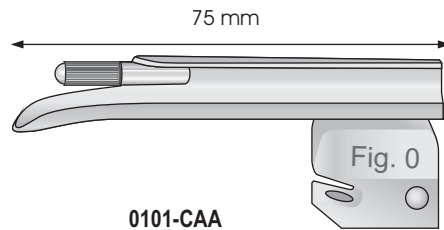

Laringoscopio  
**NEGUS - GUEDEL**



**0101-02BAA**  
2,5 Volt  
300 mA

Per lama **0101-EAB**  
For blades **0101-EAB**  
Für Spatel **0101-EAB**  
Pour spatules **0101-EAB**  
Para hojas **0101-EAB**

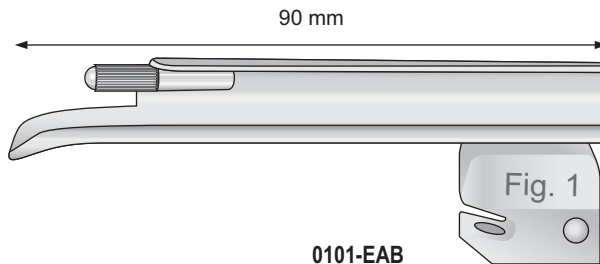

**0101-02BAB**  
2,5 Volt  
300 mA

Per lame **0101-EAC ÷ 0101-EAE**  
For blades **0101-EAC ÷ 0101-EAE**  
Für Spatel **0101-EAC ÷ 0101-EAE**  
Pour spatules **0101-EAC ÷ 0101-EAE**  
Para hojas **0101-EAC ÷ 0101-EAE**

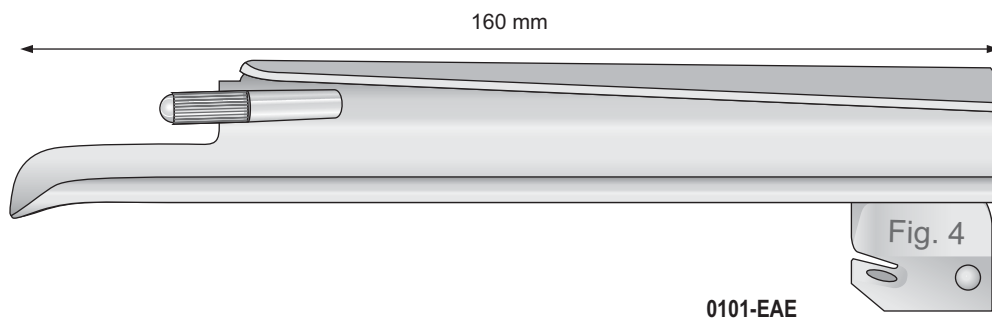
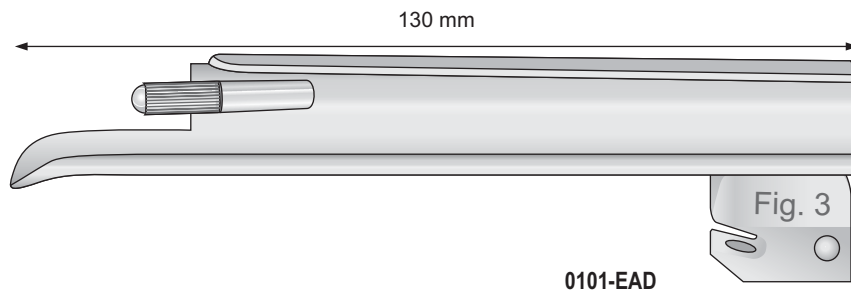
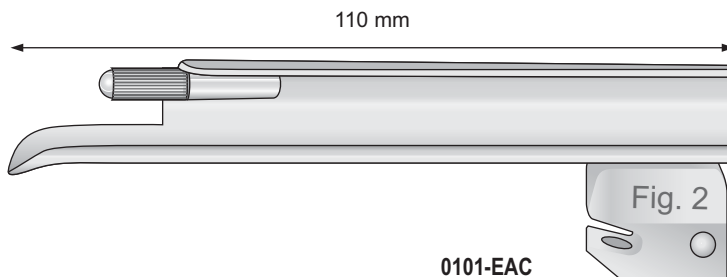

Laringoscopio  
MC INTOSH

Fibre ottiche  
Fiberoptic

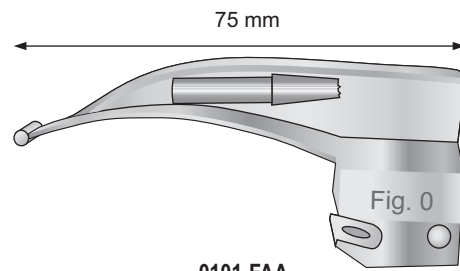
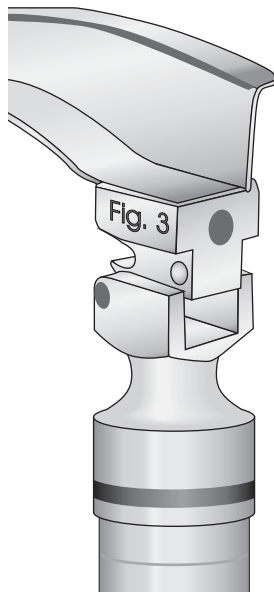

0101-FAA

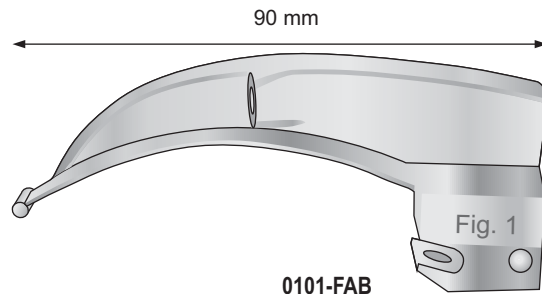

0101-FAB

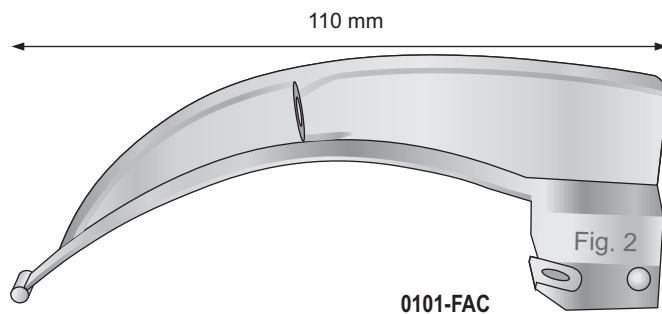

0101-FAC

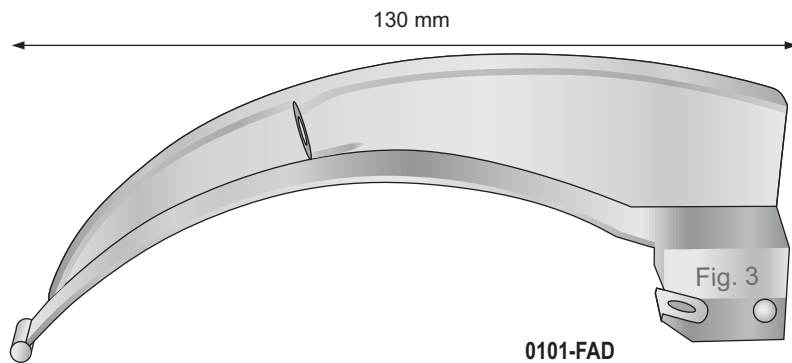

0101-FAD

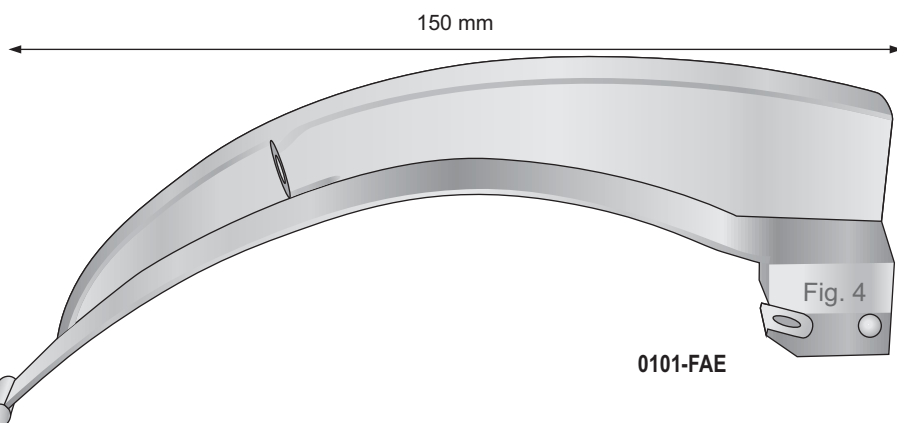

0101-FAE



Laringoscopio  
**MILLER**

Fibre ottiche  
Fiberoptic

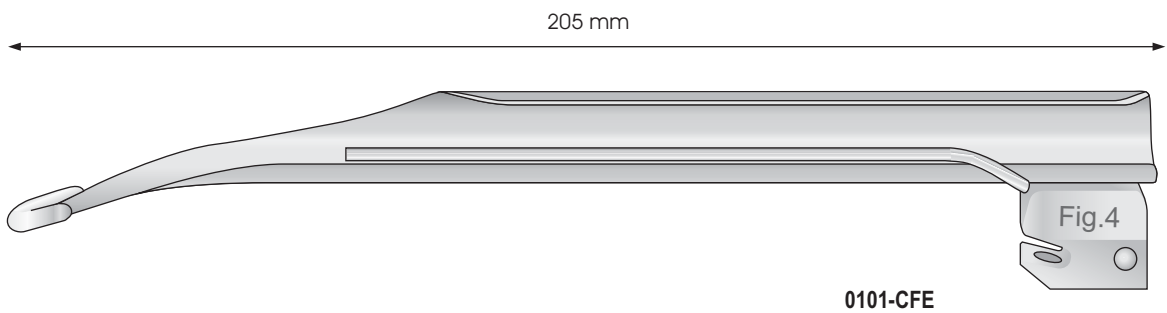
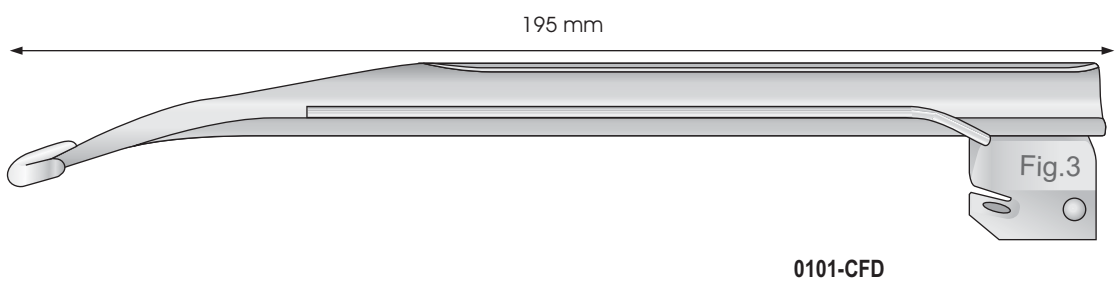
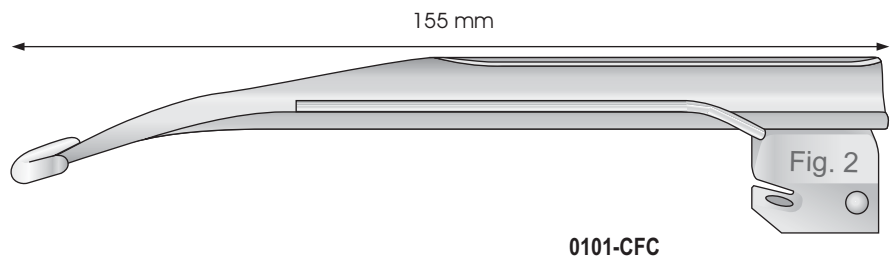
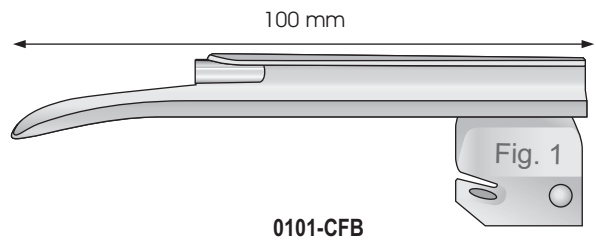
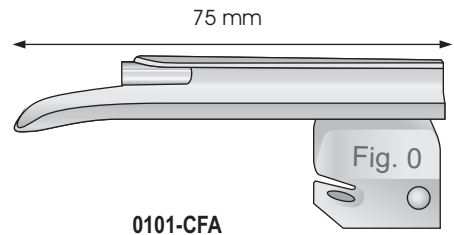

Laringoscopi e accessori

Laryngoscopes and accessories

Laryngoskope und Zubehör

Laryngoscopes et accessories

Laringoscopios y accesorios

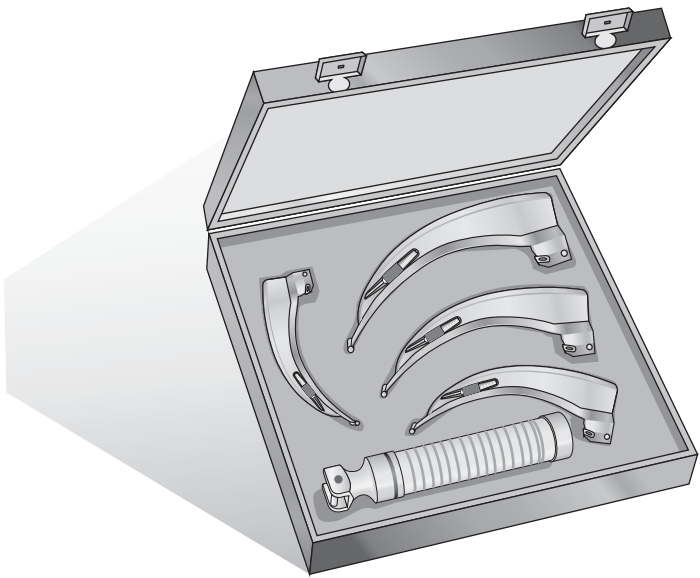

Mc INTOSH  
**0101-18BAD** - 3 blades set  
**0101-18BAE** - 4 blades set  
**0101-18BAF** - 5 blades set

MILLER  
**0101-18CAD** - 3 blades set  
**0101-18CAE** - 4 blades set  
**0101-18CAF** - 5 blades set

NEGUS-GUEDEL  
**0101-18EAD** - 3 blades set  
**0101-18EAE** - 4 blades set

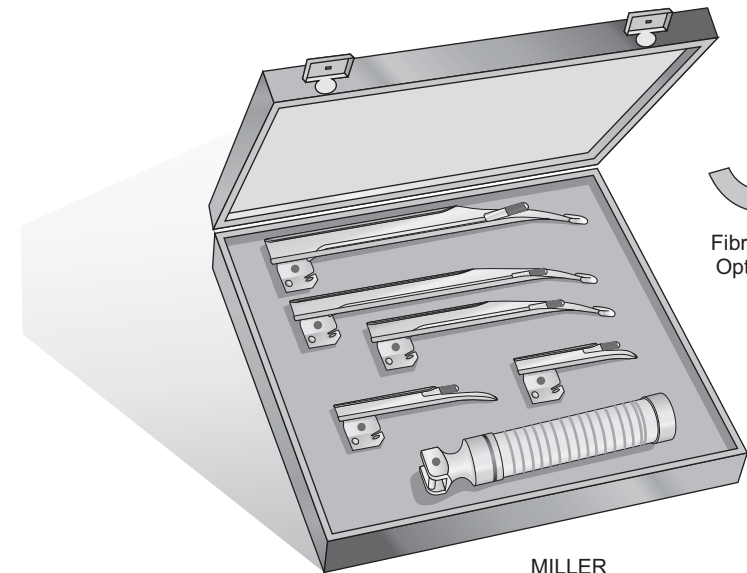

Fibre ottiche  
 Optic fibers

MILLER  
**0101-18CFF**

MILLER  
**Optic fibers**  
**0101-18CFD** - 3 blades set  
**0101-18CFE** - 4 blades set  
**0101-18CFF** - 5 blades set

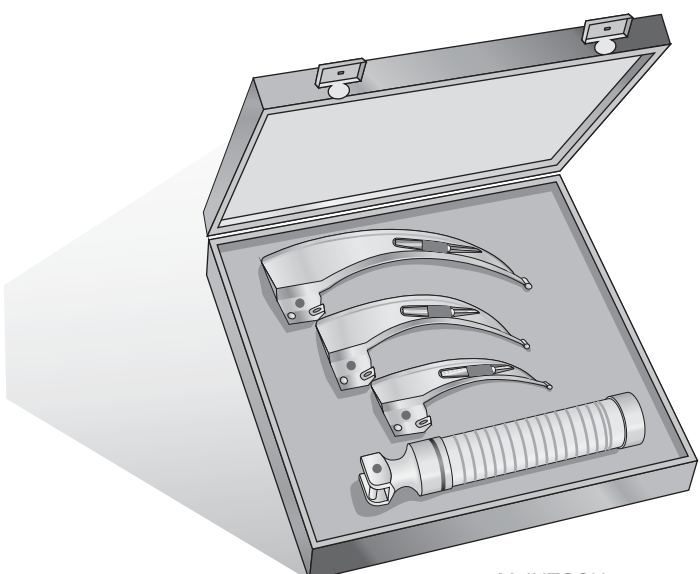

Fibre ottiche  
 Optic fibers

McINTOSH  
**0101-18FAD**

Mc INTOSH  
**Optic fibers**  
**0101-18FAD** - 3 blades set  
**0101-18FAE** - 4 blades set  
**0101-18FAF** - 5 blades set

Laringoscopi e accessori

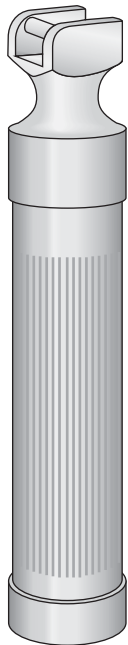

0101-19GA  
Ø 30 mm

Laryngoscopes and accessories

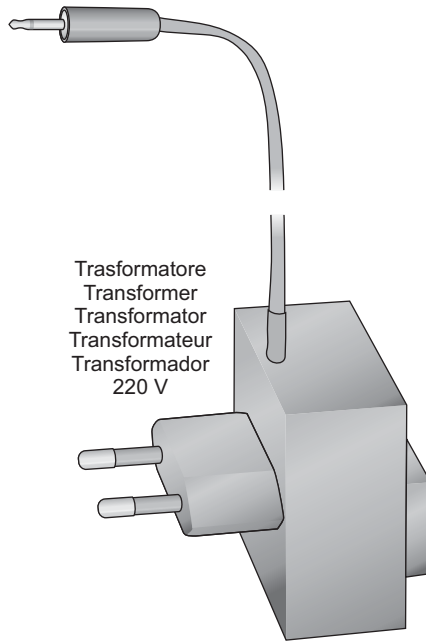

Trasformatore  
Transformer  
Transformator  
Transformateur  
Transformador  
220 V

0101-BFB

Laryngoskope und Zubehör

Laryngoscopes et accessories

Laringoscopios y accesorios

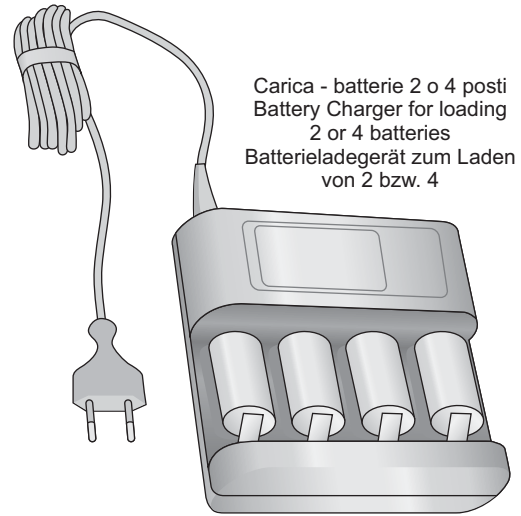

Carica - batterie 2 o 4 posti  
Battery Charger for loading  
2 or 4 batteries  
Batterieladegerät zum Laden  
von 2 bzw. 4

0101-BFD

Lampada alogene  
Halogen lamp  
Halogenlampe  
Lampe halogène  
Làmpara Houlógeno



0101-BDA  
640 mA



0101-02BAA  
2,5 Volt  
300 mA



0101-02BAB  
2,5 Volt  
300 mA

Manico in Acciaio Inossidabile - Handles of stainless steel - Griffe aus Rostfreiem Edelstahl

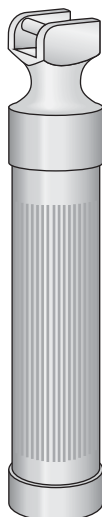

0101-HA  
Ø 30 mm

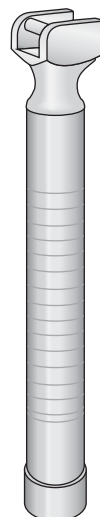

0101-IA  
Ø 18 mm

Manico Fibre ottiche  
Fiberoptic Handle  
Kaltlichtgriff



0101-LA08  
Ø 30 mm

Diagnostica - Set

Diagnostic - Sets

Diagnostik-Bestecke

Trousses à Diagnostic

Diagnóstico - Set

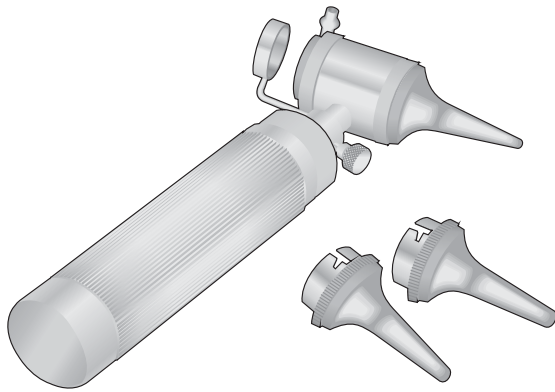

**0102-DC**

Otoscopio completo di 3 speculum e scatola  
 Otoloscope complete with 3 specula and box  
 Otoskop-Besteck komplett mit 3 Ohrtrichtern in Etui  
 Trousse à otoscopie complète avec  
 3 spéculums auriculaires en boîte

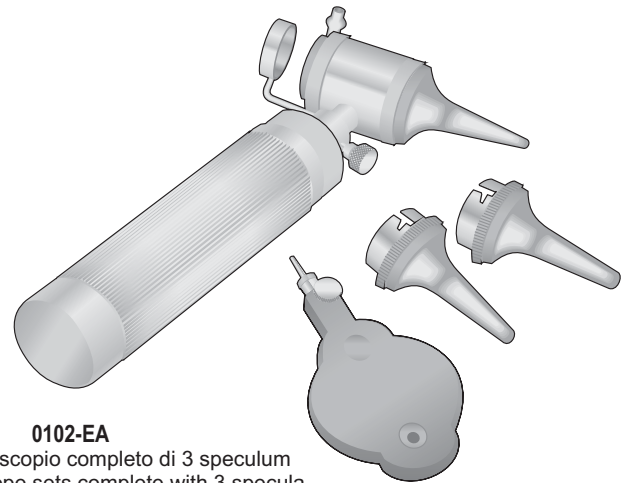

**0102-EA**

Set Oto-oftalmoscopio completo di 3 speculum  
 Oto-Ophthalmoscope sets complete with 3 specula  
 Oto-Ophthalmoskop mit 3 Ohrtrichtern  
 Trousse à oto-ophtalmoscopie avec  
 3 spéculums auriculaires

Speculum in Nylon  
 Nero - Black - Schwarz  
 Noir - Negro

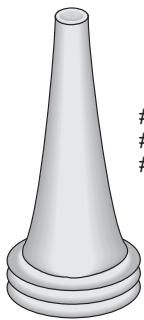

# 1 - Ø 3,0 mm  
 # 2 - Ø 4,5 mm  
 # 3 - Ø 5,5 mm

Speculum per adulti  
 Specula for adults  
 Spekulum für Erwachsene  
 Spéculum pour adultes  
 Espectula para adultos

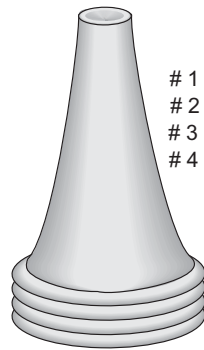

# 1 - **0102-AE** - Ø 4,5 mm  
 # 2 - **0102-AF** - Ø 5,5 mm  
 # 3 - **0102-AG** - Ø 6,5 mm  
 # 4 - **0102-AH** - Ø 7,5 mm

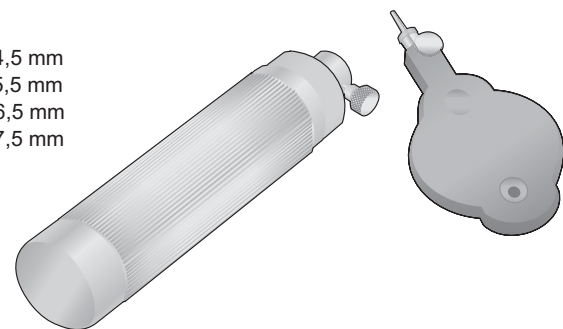

**0102-DE**

Oftalmoscopio  
 Ophthalmoscope  
 Ophthalmoskop  
 Ophtalmoscopie

**0102-DC17**

Set 3 pezzi  
 Set of 3  
 Satz zu 3  
 Jeu de 3  
 Jeu de 3  
 Fig. 1-3

**HARTMANN**

**0102-AL**

Set 4 pezzi  
 Set of 4  
 Satz zu 4  
 Jeu de 4  
 Jeu de 4  
 Fig. 1-4

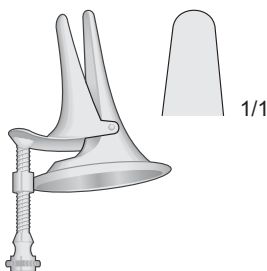

**DUPLAY**  
**0102-EB17**

Speculum nasale  
 Nasal specula  
 Nasenspekulum  
 Spéculum nasal



**0102-DI**

Lampadina per otoscopio  
 Lamp  
 Lampe  
 Lampe

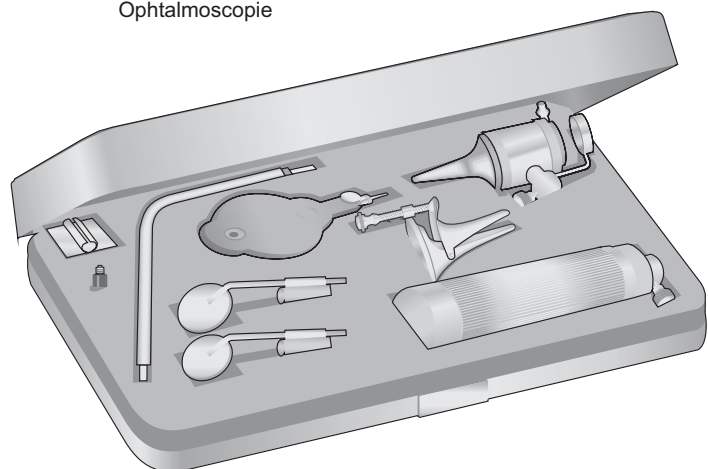

**0102-EB**

Set oto-oftalmoscopio-speculum nasale e 2 specchietti laringei  
 Oto-Ophthalmoscope-Nasal specula and 2 Laryngeal mirror  
 Oto-Ophthalmoskop-Nasenspekulum und 2 Kehlkopfspiegel  
 Trousse à Otoscopie-Ophtalmoscopie-spéculum nasal avec 2 miroirs laryngiens

Campo di misura: 0 - 15 mm  
 Measuring range: 0 - 15 mm  
 Meßbereich: 0 - 15 mm  
 Etendue de mesure: 0 - 15 mm  
 Alcance de medición: 0 - 15 mm

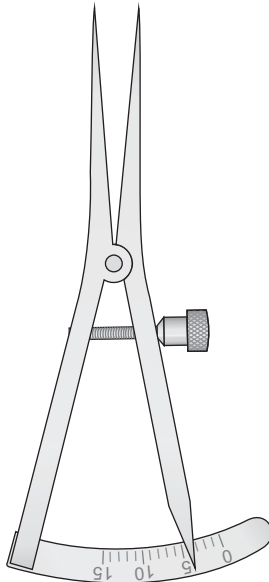

**CASTROVIEJO**  
**1417-BF**  
 90 mm

Campo di misura: 0 - 20 mm  
 Measuring range: 0 - 20 mm  
 Meßbereich: 0 - 20 mm  
 Etendue de mesure: 0 - 20 mm  
 Alcance de medición: 0 - 20 mm

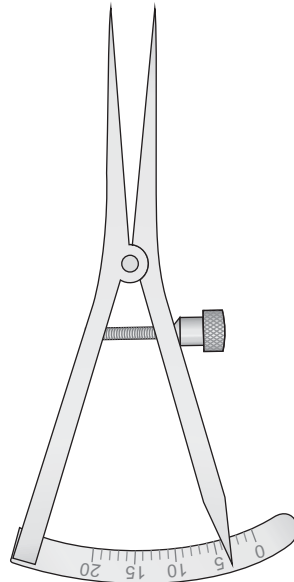

**CASTROVIEJO**  
**1417-BH**  
 90 mm

Campo di misura: 0 - 20 mm  
 Measuring range: 0 - 20 mm  
 Meßbereich: 0 - 20 mm  
 Etendue de mesure: 0 - 20 mm  
 Alcance de medición: 0 - 20 mm

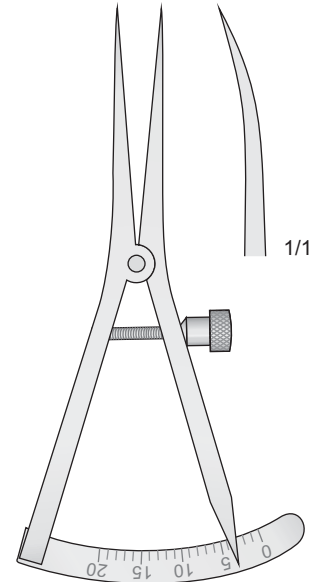

**CASTROVIEJO**  
**1417-BL**  
 90 mm

Campo di misura: 0 - 40 mm  
 Measuring range: 0 - 40 mm  
 Meßbereich: 0 - 40 mm  
 Etendue de mesure: 0 - 40 mm  
 Alcance de medición: 0 - 40 mm

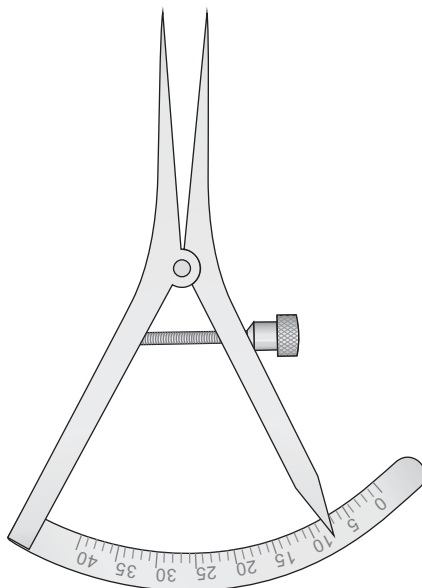

**CASTROVIEJO**  
**1417-BB**  
 90 mm

Campo di misura: 0 - 40 mm  
 Measuring range: 0 - 40 mm  
 Meßbereich: 0 - 40 mm  
 Etendue de mesure: 0 - 40 mm  
 Alcance de medición: 0 - 40 mm

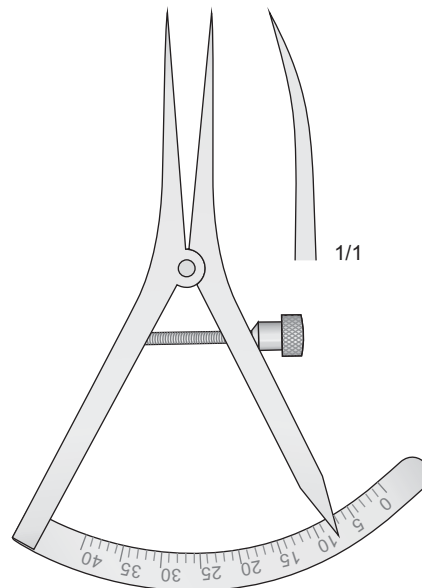

**CASTROVIEJO**  
**1417-BD**  
 90 mm

Campo di misura: 0 - 40 mm  
 Measuring range: 0 - 40 mm  
 Meßbereich: 0 - 40 mm  
 Etendue de mesure: 0 - 40 mm  
 Alcance de medición: 0 - 40 mm

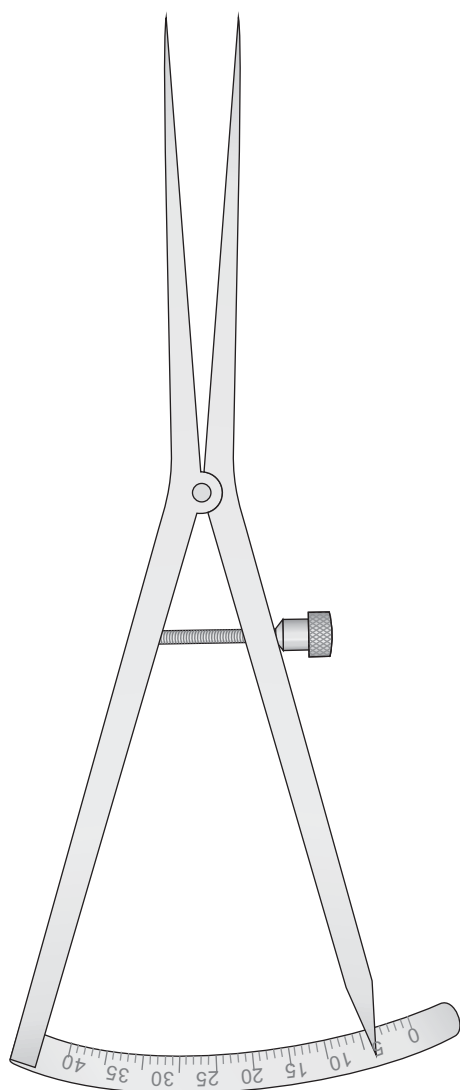

**CASTROVIEJO**  
**1417-BC**  
 170 mm

Campo di misura: 0 - 40 mm  
 Measuring range: 0 - 40 mm  
 Meßbereich: 0 - 40 mm  
 Etendue de mesure: 0 - 40 mm  
 Alcance de medición: 0 - 40 mm

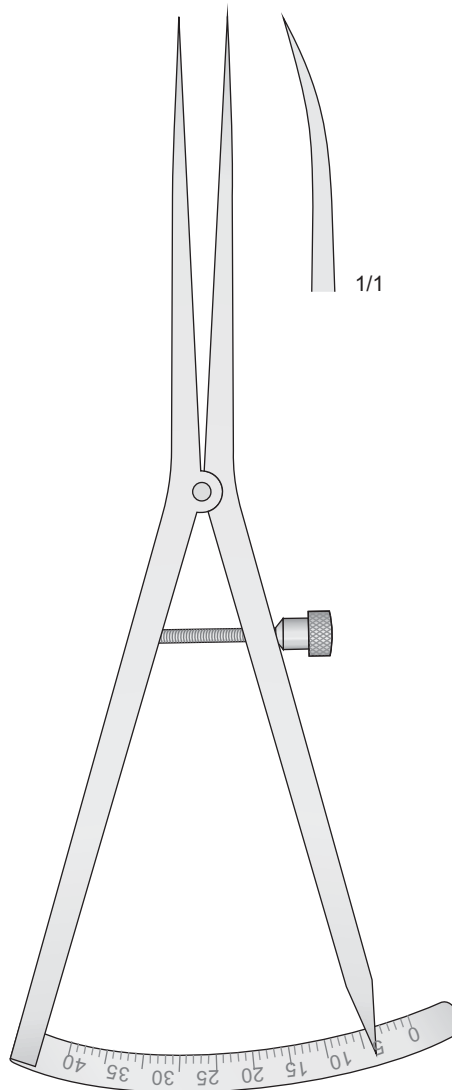

**CASTROVIEJO**  
**1417-BE**  
 170 mm

Campo di misura: 0 - 40 mm  
 Measuring range: 0 - 40 mm  
 Meßbereich: 0 - 40 mm  
 Etendue de mesure: 0 - 40 mm  
 Alcance de medición: 0 - 40 mm

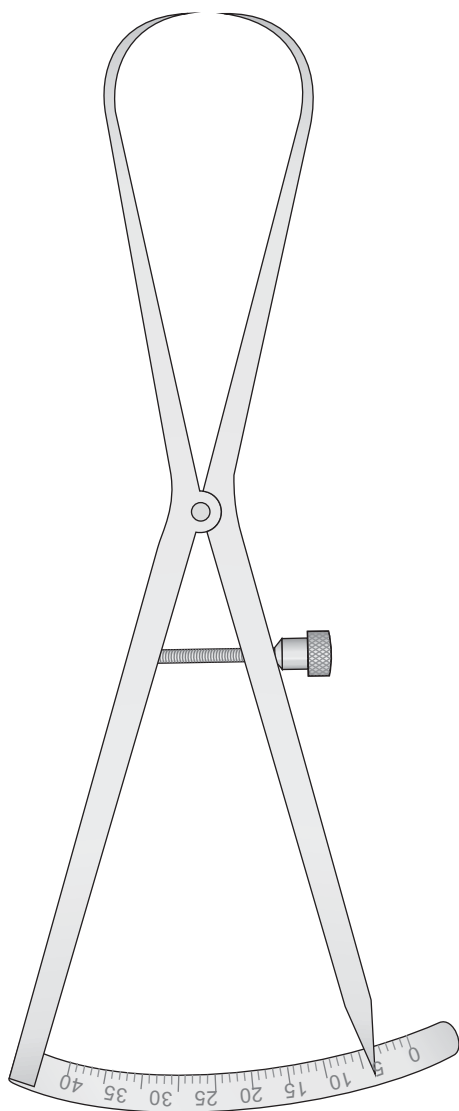

CASTROVIEJO  
**1417-BG**  
 170 mm

Campo di misura: 0 - 40 mm  
 Measuring range: 0 - 40 mm  
 Meßbereich: 0 - 40 mm  
 Etendue de mesure: 0 - 40 mm  
 Alcance de medición: 0 - 40 mm

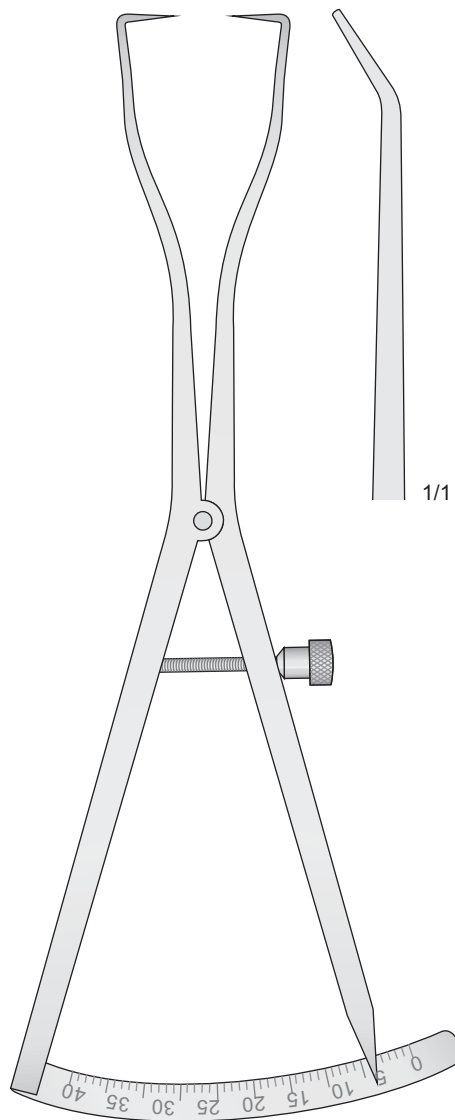

CASTROVIEJO  
**1417-BI**  
 170 mm

Strumenti per misura

Measuring instruments

Messinstrumente

Instruments à mesurer

Instrumentos para medir

Campo di misura: 0 - 80 mm  
 Measuring range: 0 - 80 mm  
 Meßbereich: 0 - 80 mm  
 Etendue de mesure: 0 - 80 mm  
 Alcance de medición: 0 - 80 mm

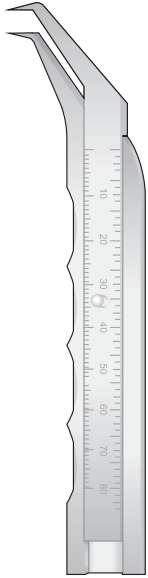

**1417-EA**  
125 mm

Campo di misura: 0 - 80 mm  
 Measuring range: 0 - 80 mm  
 Meßbereich: 0 - 80 mm  
 Etendue de mesure: 0 - 80 mm  
 Alcance de medición: 0 - 80 mm

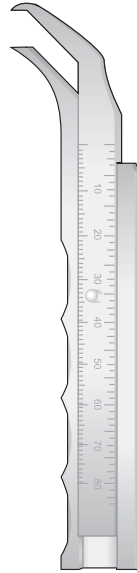

**1417-EC**  
120 mm

0,5 mm



0,5 mm



0,5 mm



0,5 mm



0,5 mm



Campo di misura: 180 mm - Measuring range: 180 mm  
 Meßbereich: 180 mm - Etendue de mesure: 180 mm - Alcance de medición: 180 mm

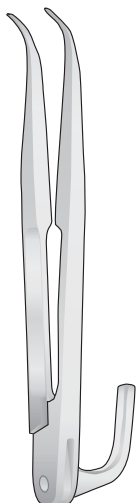

**ZIELINSKY**  
**0415-HCF**  
110 mm

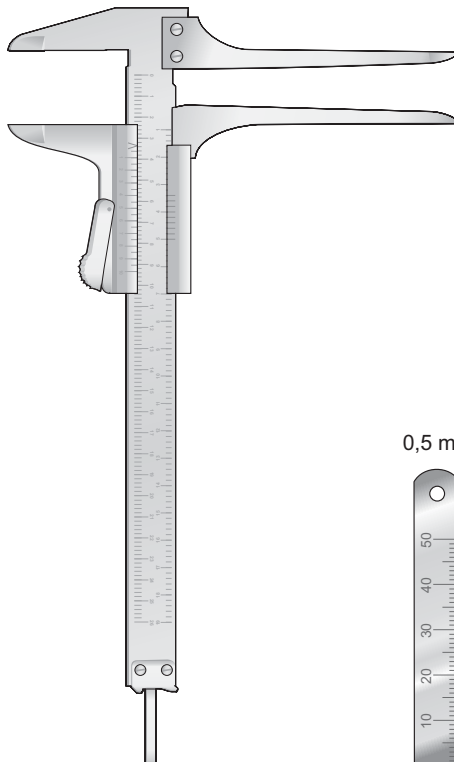

**CASPAR**  
**0507**

**1118-AH**  
50 mm

**1118-AI**  
100 mm

**1118-AL**  
150 mm

**1118-AG**  
300 mm

**1118-AF**  
500 mm



Preparazione  
Forbici per unghie

Preparation  
Nail scissors

Vorbereitung  
Nagel scheren

Préparation  
Ciseaux à ongles

Preparacion  
Tijeras para uñas

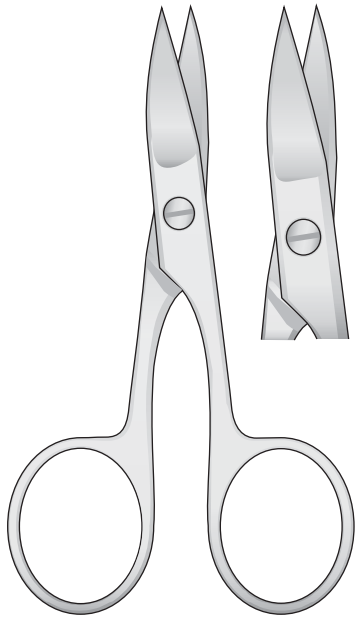

0718-CD/0718-CL

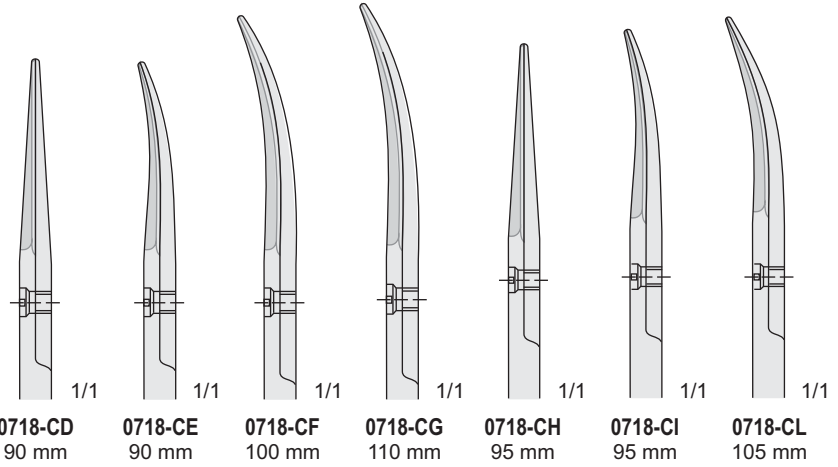

Tronchesi per unghie  
Nail cutters  
Nagelzangen  
Pince à ongles  
Pinzas para uña

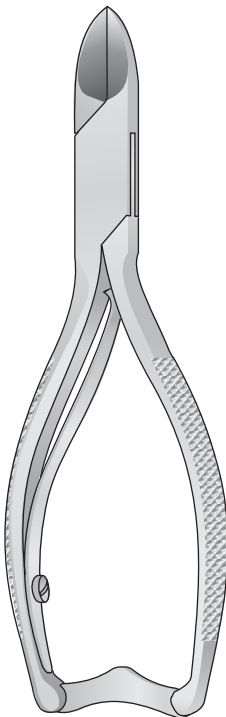

0718-CA  
135 mm

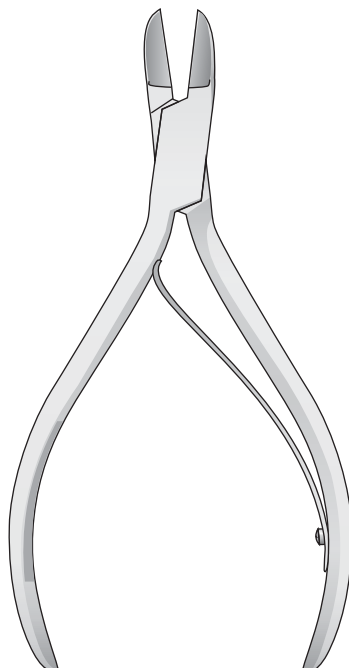

0718-CB  
120 mm

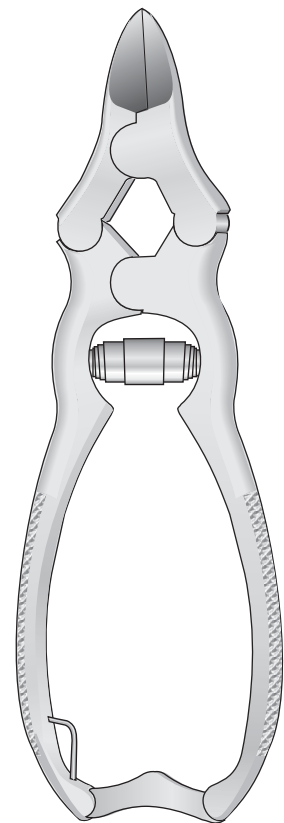

0718-CC  
155 mm

Tronchesi per unghie

Nail corner forceps

Eckenzangen

Pinces à ongles

Corta uñas

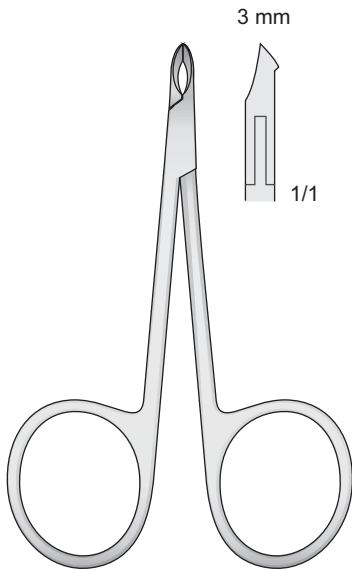

**0718-EA**  
85 mm

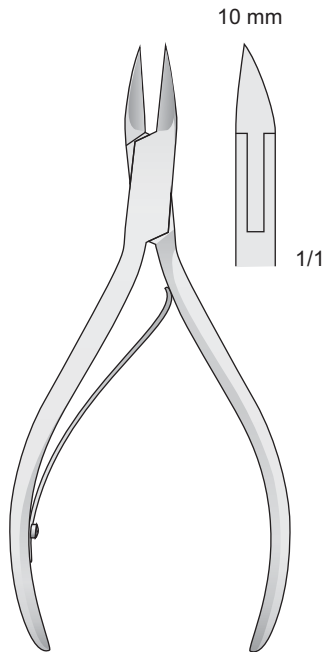

**0718-EC**  
100 mm

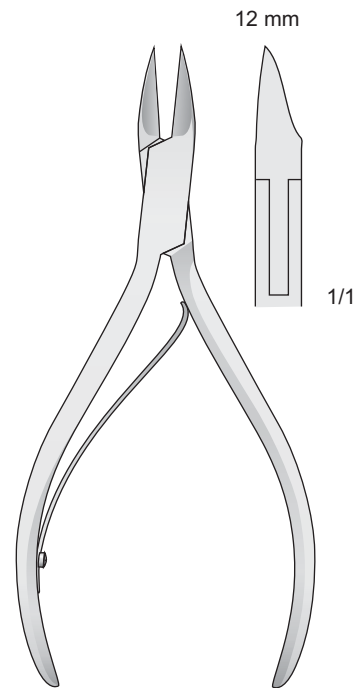

**0718-EE**  
110 mm

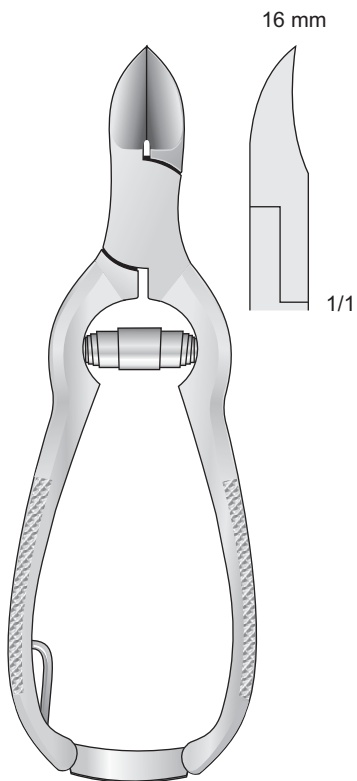

**0718-EG**  
120 mm

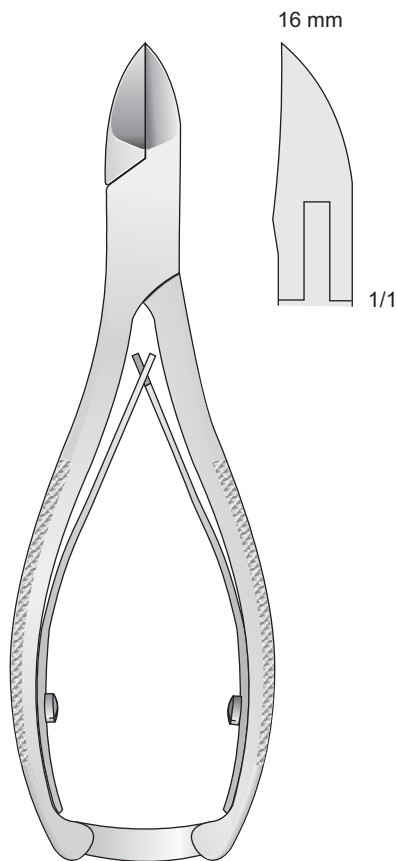

**0718-EI**  
140 mm

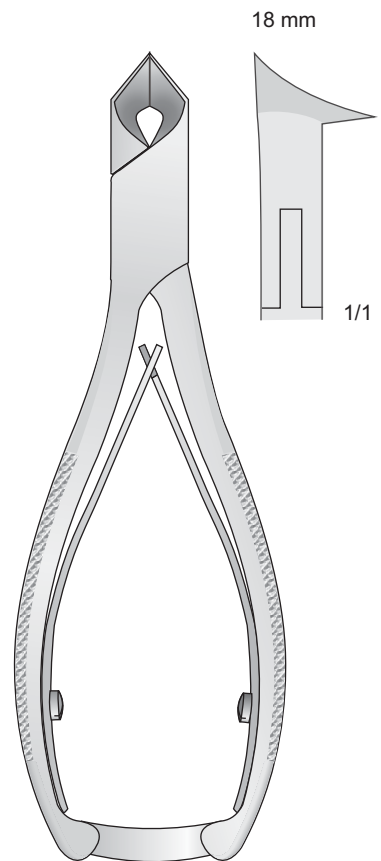

**0718-FA**  
135 mm



2

Bisturi e lame  
Knives and Scalpel blades  
Skalpellslingen  
Lames de bistouris  
Hojas de bisturías



Bisturi



GRAEFE  
1310-BI/1310-CA  
140 mm

Knives

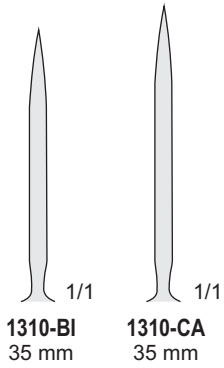

Skalpelle

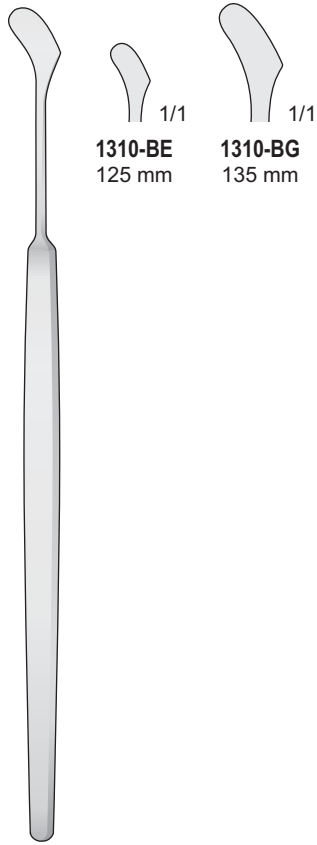

GRAEFE  
1310-BE/1310-BG

Bistouris



ZIEGLER  
1310-AG/1310-BA  
115 mm

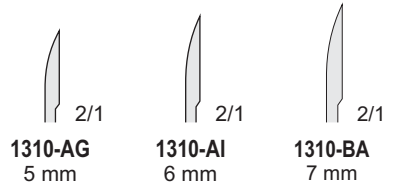

Bisturies



1310-DA/1310-EA

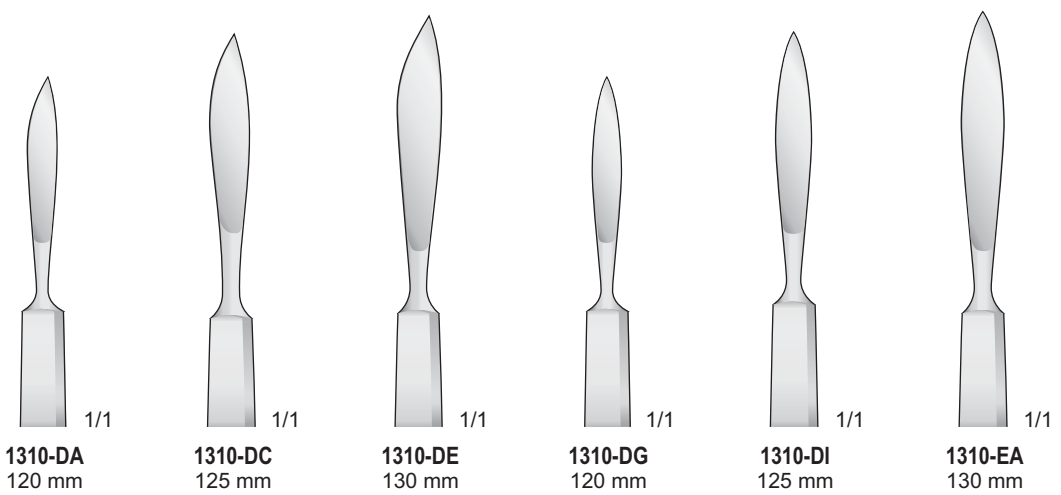

Bisturi

Knives

Skalpelle

Bistouris

Bisturies

Punche da biopsia - Dermal punches  
Haut-Trephinen - Tréphines cutanées  
Trépanos cutâneos



- 3 mm  
○  
**0611-BFA**
- 4 mm  
○  
**0611-BFB**
- 5 mm  
○  
**0611-BFC**
- 6 mm  
○  
**0611-BFD**

KEYES  
**0611-BFA/0611-BFD**  
100 mm



DESMARRES  
**1310-LF**  
135 mm



DESMARRES  
**1310-LG**  
135 mm

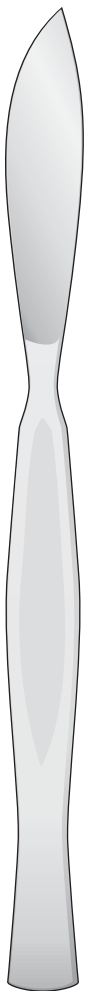

**1310-LA**  
180 mm

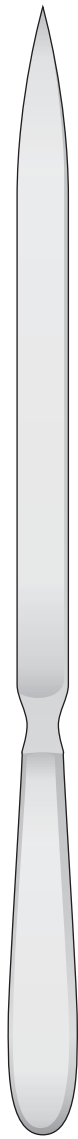

**1310-LB**  
280 mm



JOSEPH  
**1310-BAA**  
150 mm

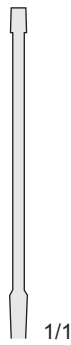

1/1



CONVERSE  
**1310-BAB**  
160 mm

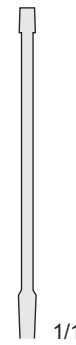

1/1



**1310-BAC**  
160 mm

Bisturi

Knives

Skalpelle

Bistouris

Bisturies



1/1

1310-DB/1310-FH



1/1

**1310-FA**  
150 mm



1/1

**1310-FB**  
155 mm



1/1

**1310-DB**  
158 mm



1/1

**1310-FC**  
160 mm



1/1

**1310-FD**  
170 mm



1/1

**1310-DF**  
175 mm



1/1

**1310-FE**  
150 mm



1/1

**1310-FF**  
155 mm



1/1

**1310-DD**  
158 mm



1/1

**1310-FG**  
160 mm



1/1

**1310-FH**  
170 mm



1/1

**1310-DH**  
175 mm

Manici per bisturi

Scalpel handles

Skalpellgriffe

Manches de bistouris

Mangos de bisturias

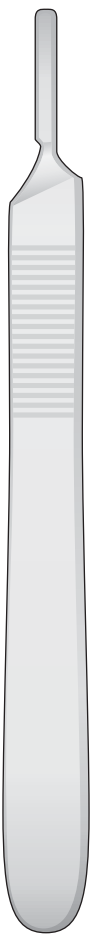
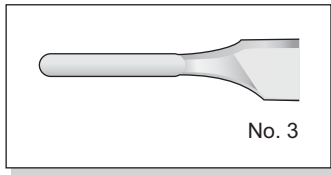

1201-02D



1201-02D12



1201-02H



1201-02H10



1201-02B



1201-02C

1,5 mm

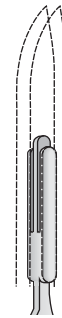

1201-02I

2,5 mm

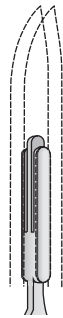

1201-02L



1201-02I/1201-02L  
155 mm



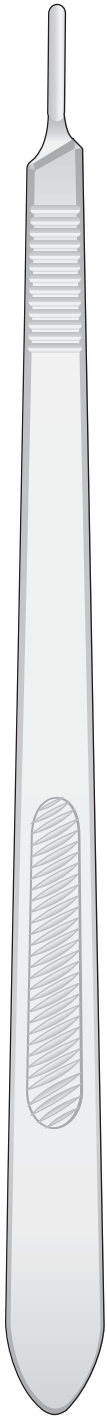
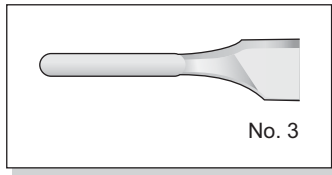

1201-02D11

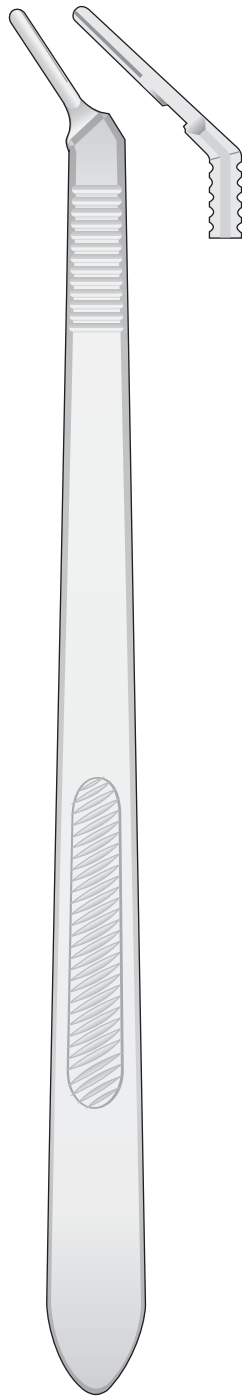

1201-02F



1201-02BB  
210 mm

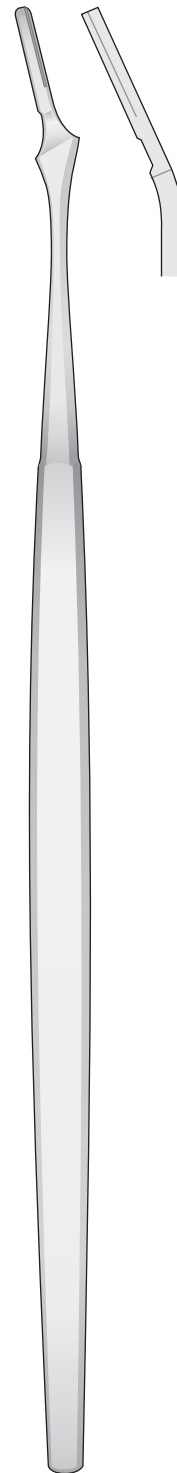

1201-02BC  
210 mm

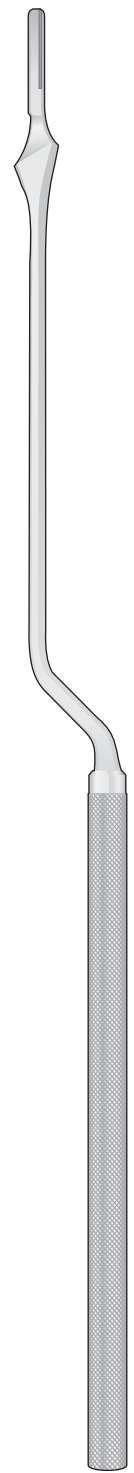

1201-02BF  
210 mm

Manici per bisturi

Scalpel handles

Skalpellegriffe

Manches de bistouris

Mangos de bisturias

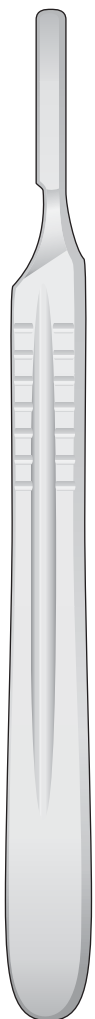
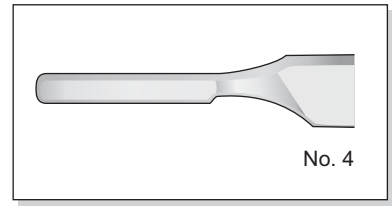

1201-02E

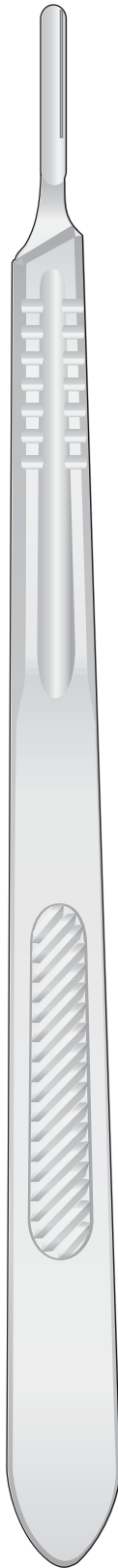

1201-02E11

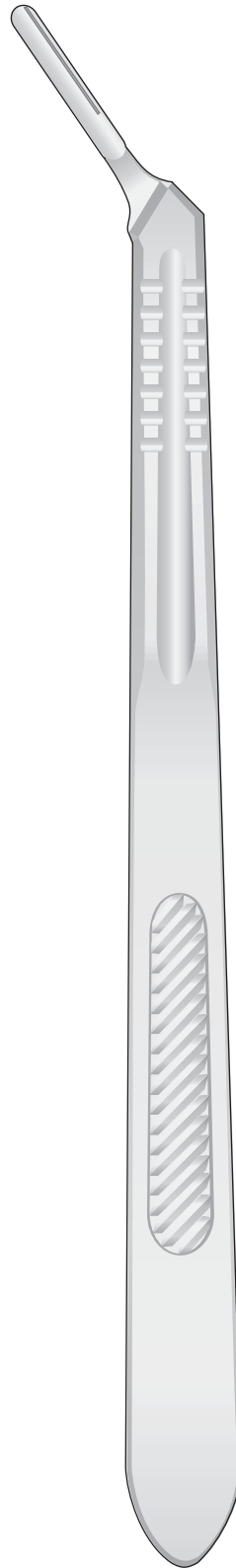

1201-02G

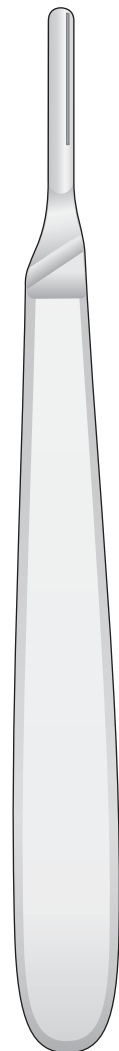

1201-02BA

Scatole da 100 pezzi  
Packungen à 100  
Packages of 100 ea  
Boîtes de 100 pièces  
Cajas de 100 c/u

Doppio taglio  
Double cutting  
Doppelschneidig  
Deux tranchants  
Doble corta

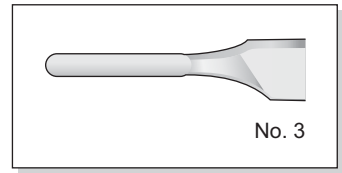

1102-BA



1102-BB

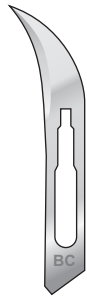

1102-BC

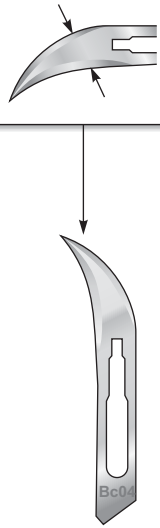

1102-BC04



1102-BD



1102-BF

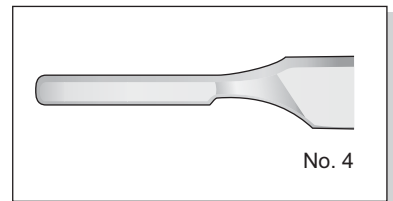

1102-BI

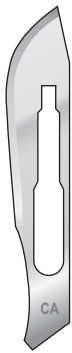

1102-CA



1102-CB



1102-CC



1102-CD



1102-CE



1102-CF



1102-DG

Manici e bisturi Scalpel handles, Knives Skalpellgriffe, Klängen Manches de bistouris, lames Mangos de bisturios, hojas



**1102-DGB**  
Pack. 10 pcs



**1102-DGC**  
Pack. 10 pcs



**1102-DGD**  
Pack. 1 pc



**1102-DGE**  
Conf. 10 pz.



**1102-DGF**  
Pack. 10 pcs



**1102-DGG**  
Pack. 1 pc



**1102-DGH**  
Pack. 10 pcs



**1102-DGI**  
Pack. 10 pcs



**1102-DGL**  
Pack. 1 pc



**1310-B**  
100 mm



**1310-C**  
150 mm



**0202-EG**  
135 mm



**0202-EI** - 155 mm  
**0202-FA** - 180 mm  
**0202-FC** - 200 mm



CASPAR  
**0202-FA**



**0202-FC**

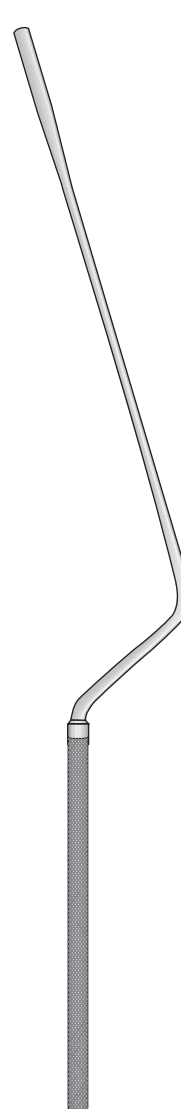

LANDOLT  
**0202-DI**  
210 mm



LANDOLT  
**0202-EA**  
250 mm

**Pinze togli lame  
per bisturi**

**Scalpel blade  
removing forceps**

**Klingenbrecher  
Rasierklingen**

**Pinces pour enlever  
les lames de bistouris**

**Pinza para quitar  
hojas de bisturíes**

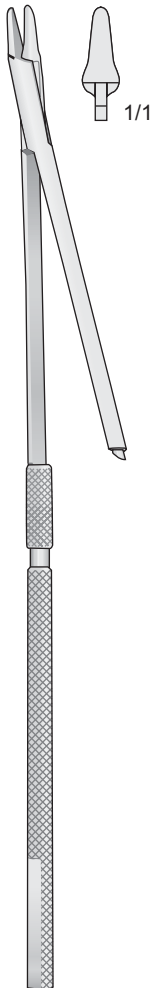

**1310-IF**  
180 mm

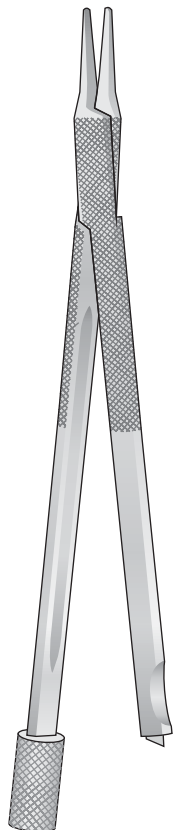

**1310-BC**  
120 mm

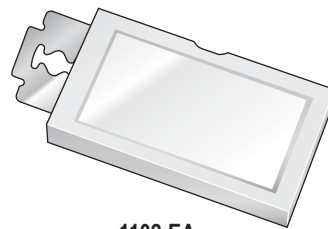
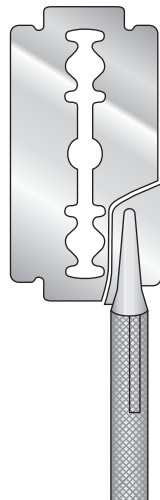

**1102-EA**  
Scatola da 10 lame  
Package 10 blades  
Packung 10 Klingen  
Boite de 10 lames  
Cajita de 10 hojas

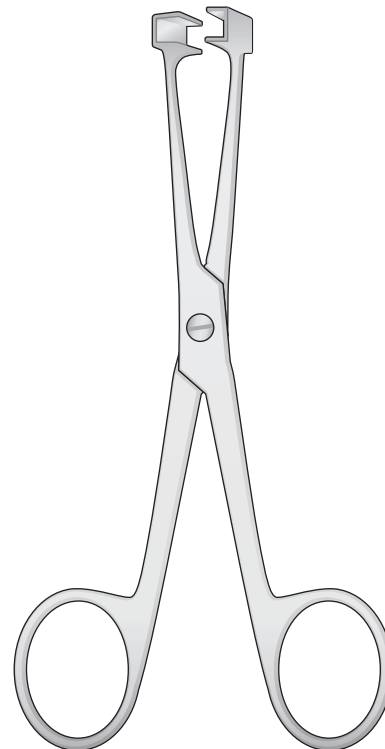

**0718-BI**  
135 mm

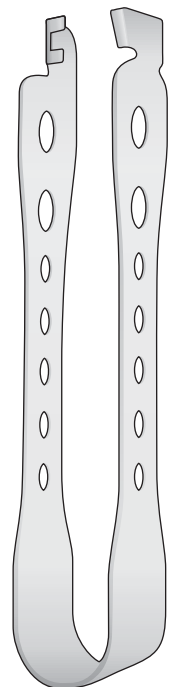

**0718-BG**  
115 mm



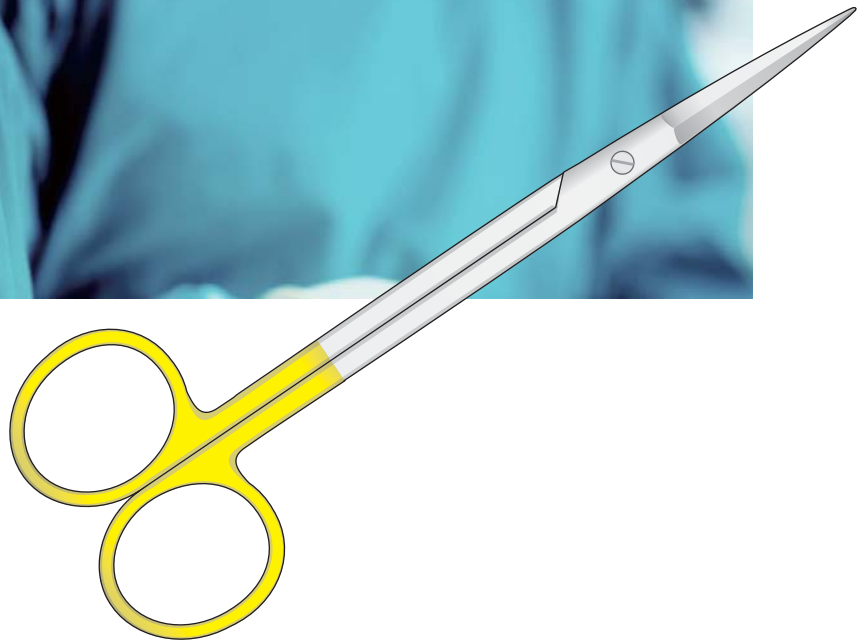

3

Forbici  
Scissors  
Scheren  
Ciseaux  
Tijeras





Micro forbici

Micro scissors

Micro Scheren

Micro ciseaux

Micro tijeras

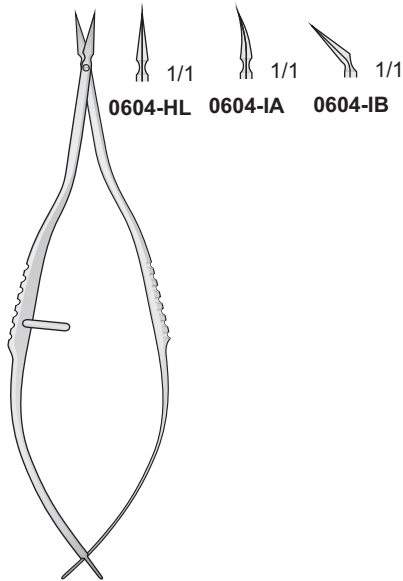

VANNAS  
0604-HL/0604-IB  
85 mm

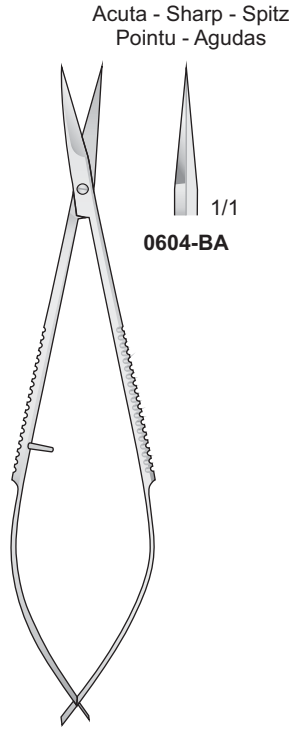

NOYES  
0604-BA  
120 mm

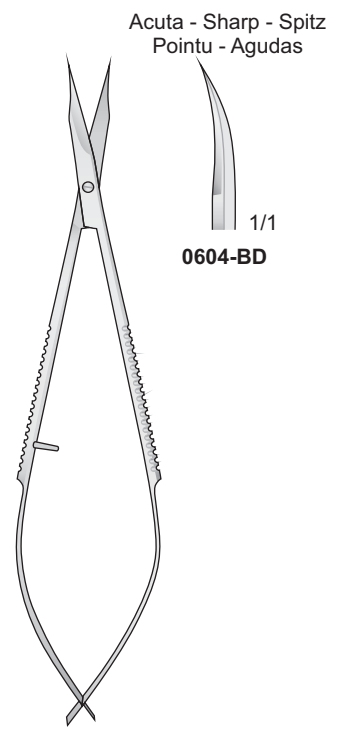

WESTCOTT  
0604-BD  
120 mm

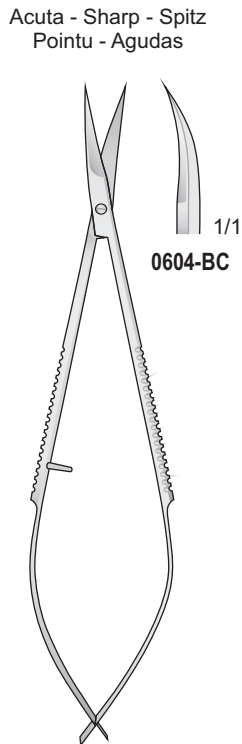

NOYES  
0604-BC  
120 mm

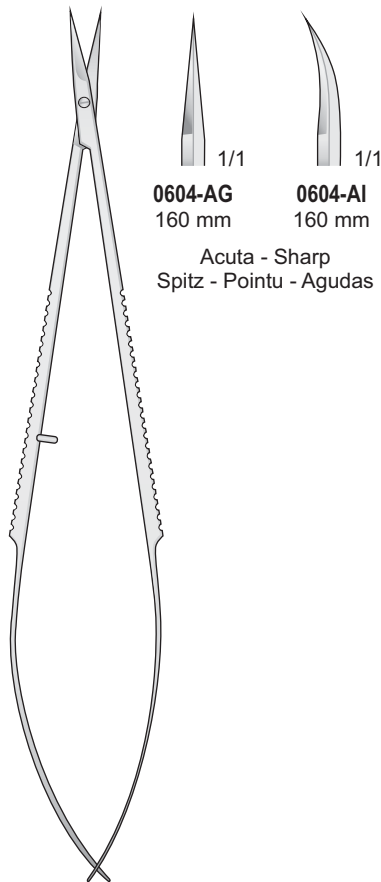

0604-AG/0604-AI  
160 mm

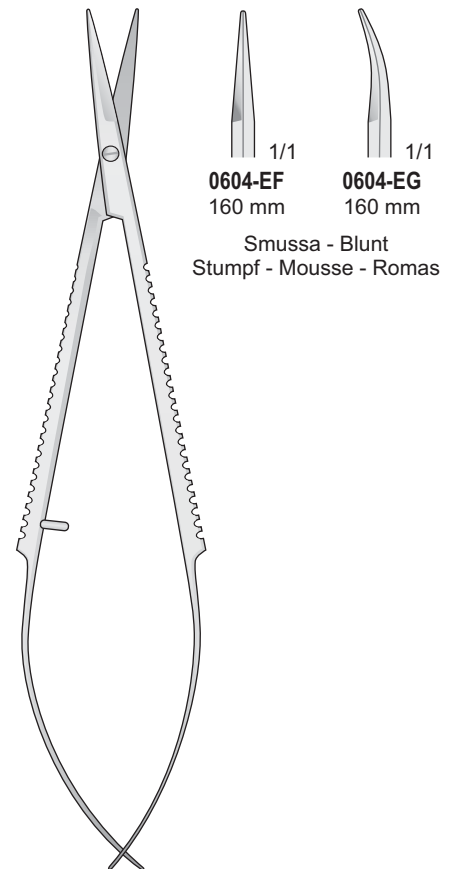

0604-EF/0604-EG  
160 mm

Micro forbici

Micro scissors

Micro Scheren

Micro ciseaux

Micro tijeras

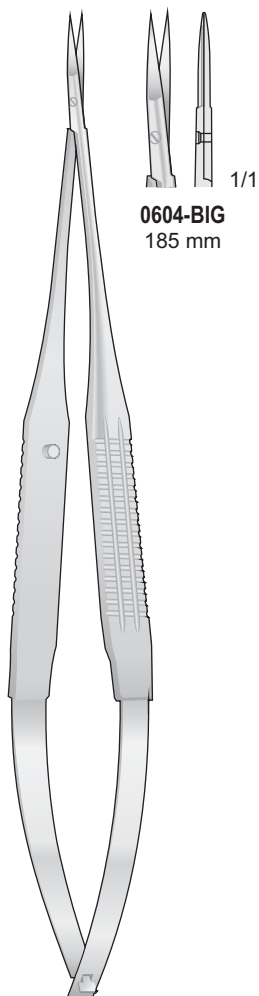

**0604-BIG**  
185 mm

YASARGIL  
**0604-BIG**  
185 mm

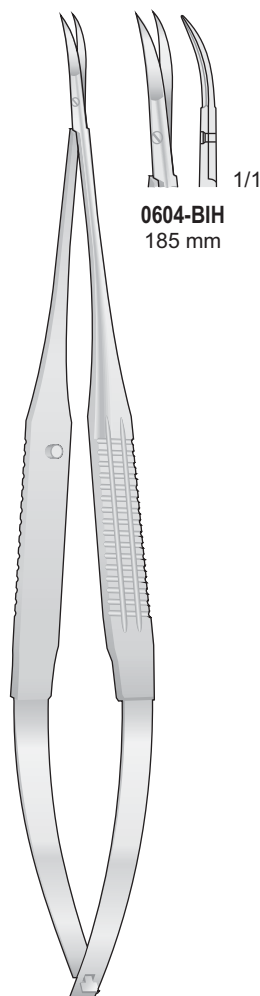

**0604-BIH**  
185 mm

JACOBSON  
**0604-BIH**  
185 mm

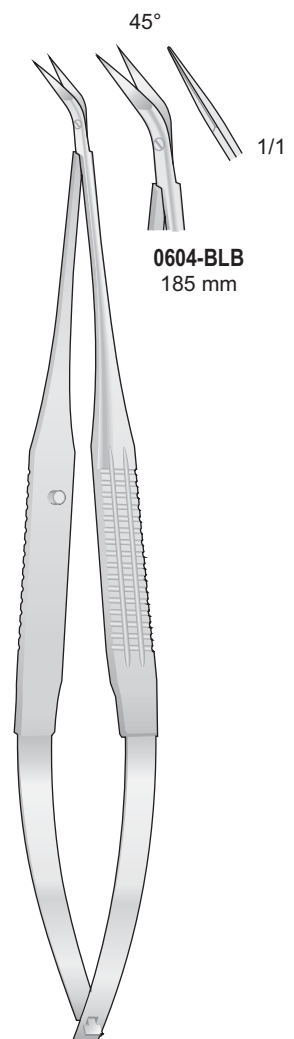

**0604-BLB**  
185 mm

POTTS-YASARGIL  
**0604-BLB**  
185 mm

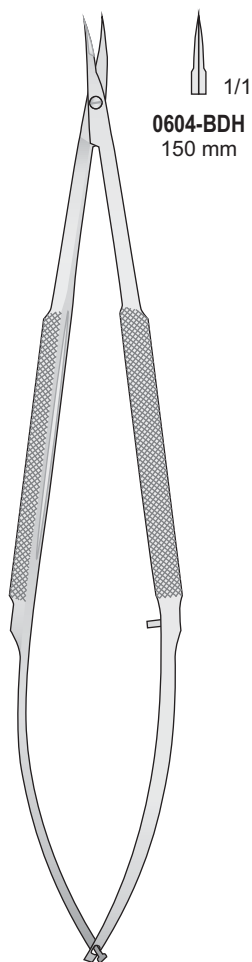

 1/1  
**0604-BDH**  
 150 mm

 1/1  
**0604-BDI**  
 150 mm

**0604-BDH/0604-BDI**  
 150 mm

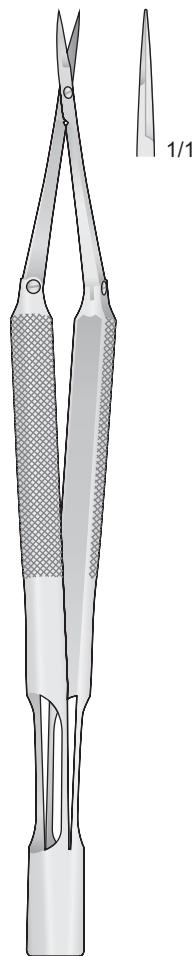

 1/1

**BROCK**  
**0604-BBA**  
 150 mm

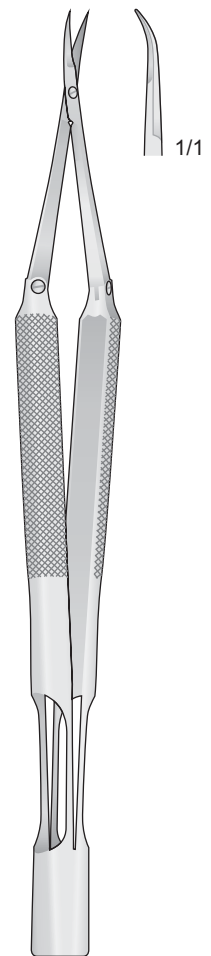

 1/1

**BROCK**  
**0604-CCD**  
 150 mm

Micro forbici  
a baionetta

Micro scissor  
bayonet-shared

Micro-Federschere  
Bayonettförmig

Micro ciseaux  
baionette

Micro tijeras  
Bajonet

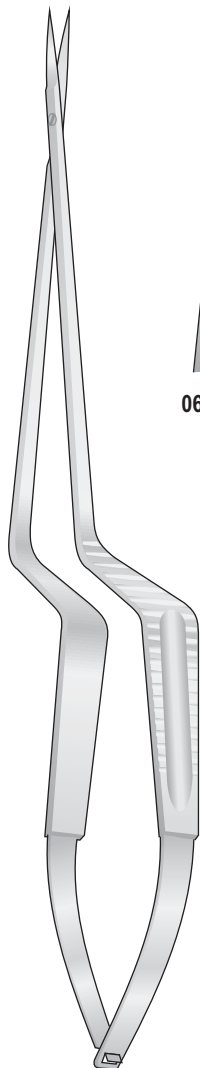

0604-DAG

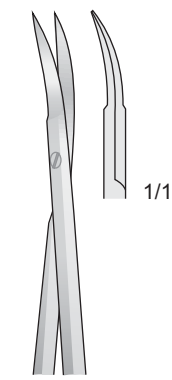

0604-DAH

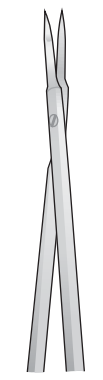

0604-DBA

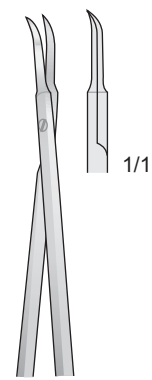

0604-DBB

0604-DAG/0604-DBB  
190 mm

Micro forbici  
a baionetta

Micro scissor  
bayonet-shared

Micro-Federschere  
Bayonettförmig

Micro ciseaux  
baionette

Micro tijeras  
Bajonet

Dentellata  
Sawedge  
Gezahnt  
Dentelés  
Dentadas

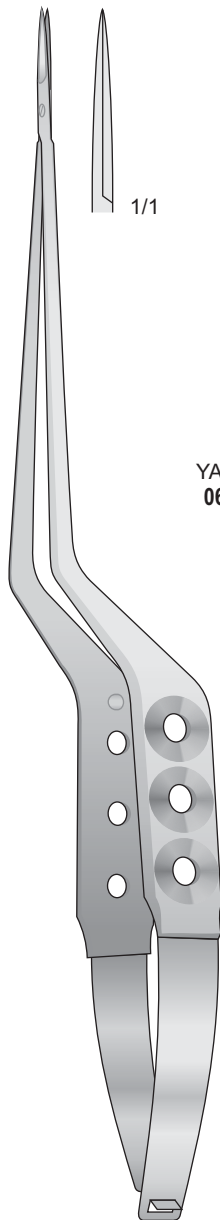

YASARGIL  
0604-EAI  
225 mm

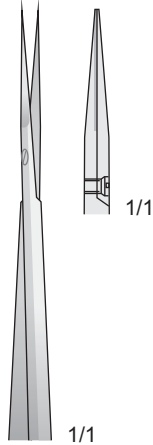

YASARGIL  
0604-EAL

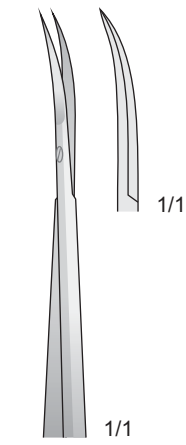

YASARGIL  
0604-EBB

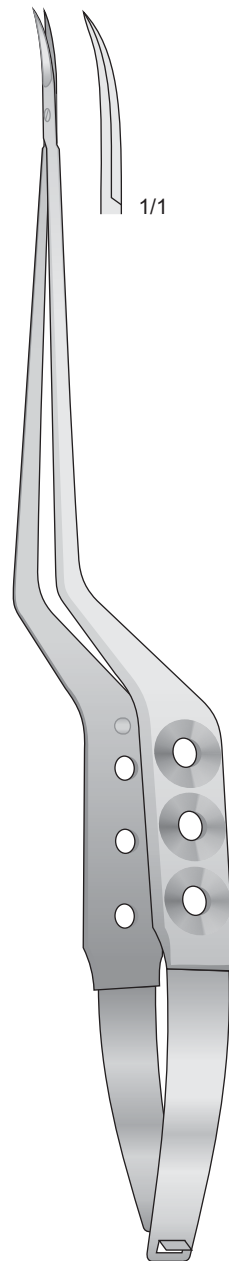

YASARGIL  
0604-EBC  
245 mm

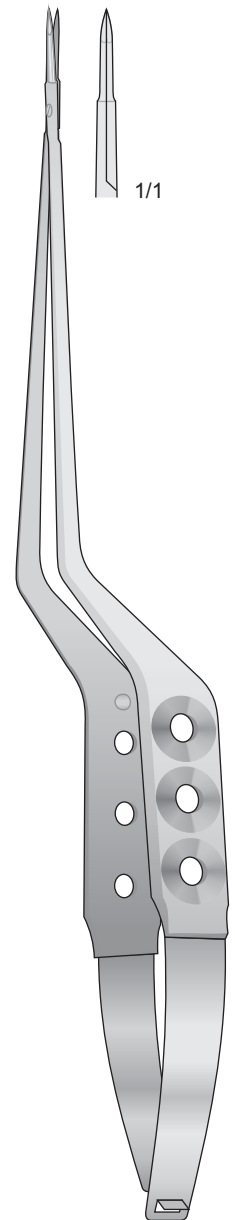

VANNAS  
0604-EBA  
225 mm

Forbici delicate

Delicate scissors

Feine Scheren

Ciseaux délicate

Tijeras finas

Acute  
Pointed  
Spitz  
Pointus  
Agudas

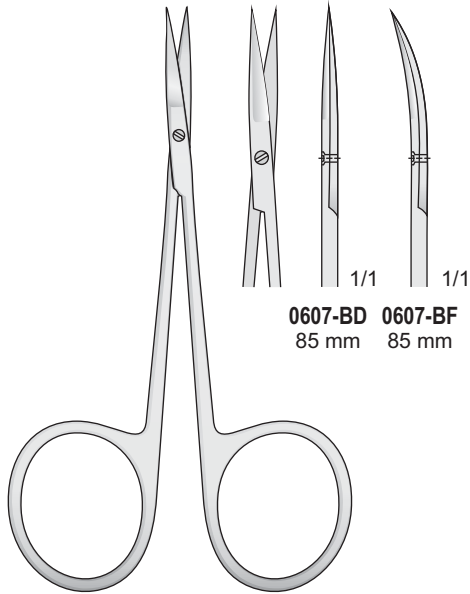

MICRO-IRIS  
0607-BD/0607-BF  
85 mm

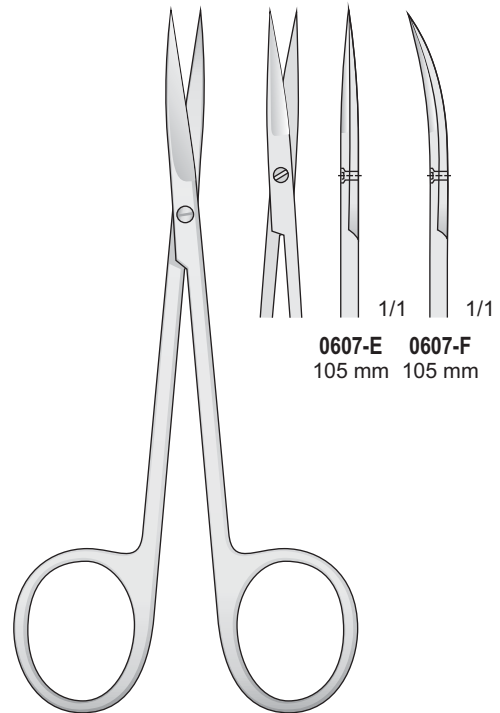

0607-E/0607-F  
105 mm

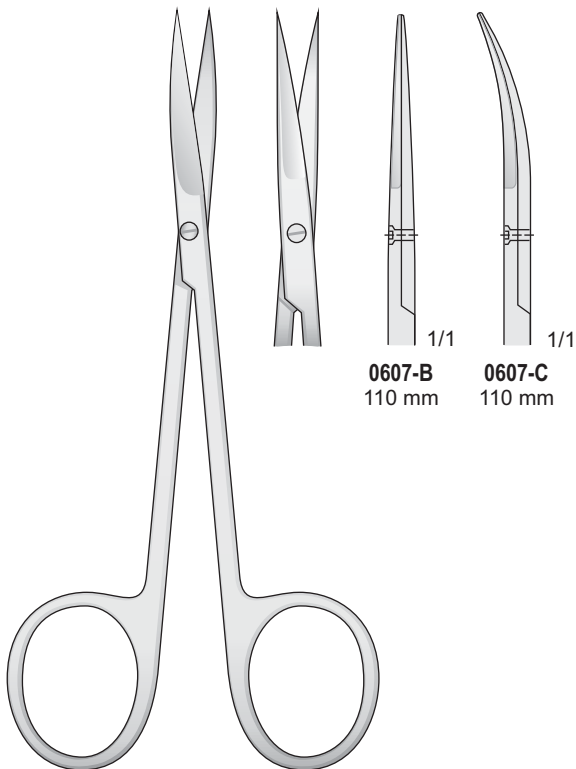

IRIS  
0607-B/0607-C  
110 mm

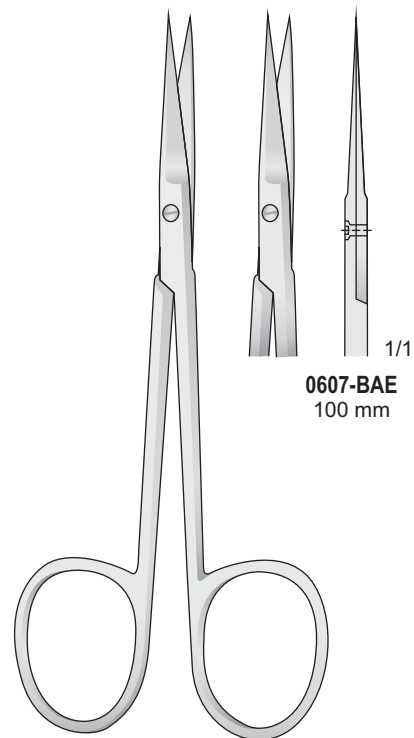

0607-BAE  
100 mm

Forbici delicate

Delicate scissors

Feine Scheren

Ciseaux délicate

Tijeras finas

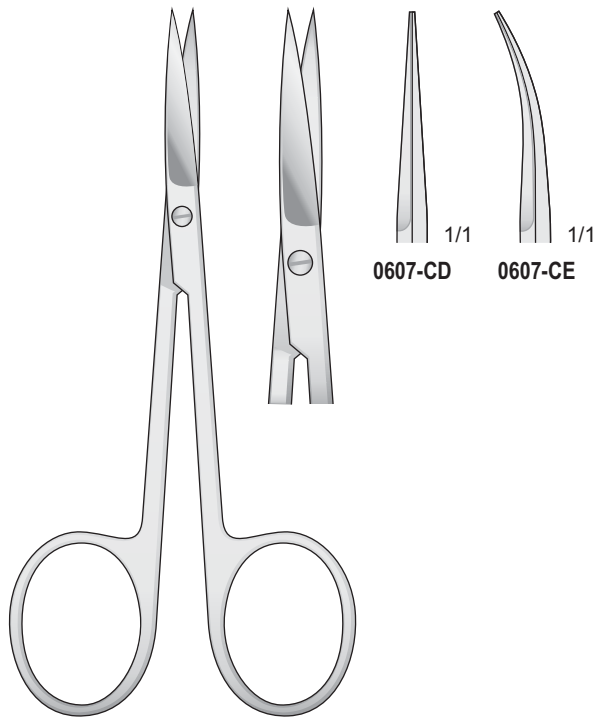

**0607-CD/0607-CE**  
110 mm

Smussa - Blunt  
Stumpf - Émoussé - Romo

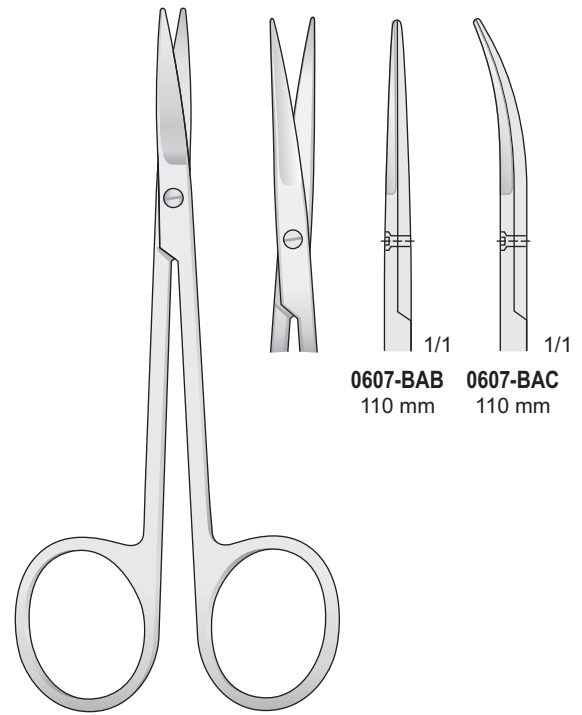

**0607-BAB/0607-BAC**  
110 mm

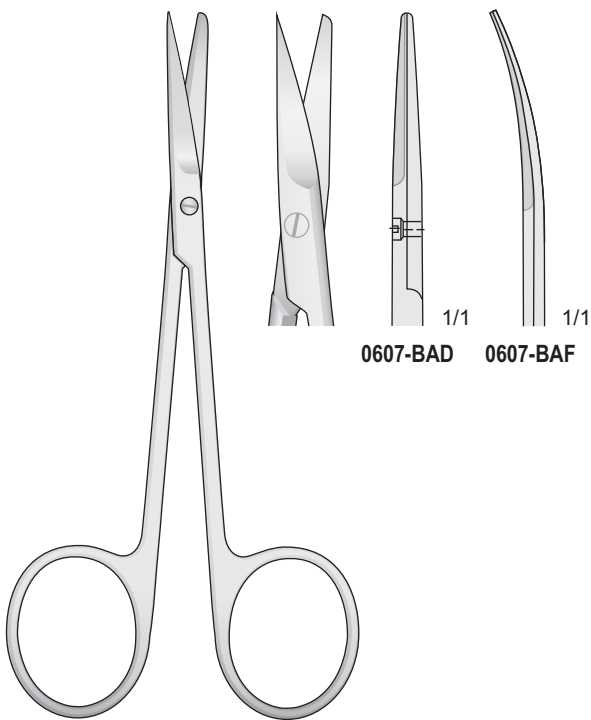

**0607-BAD/0607-BAF**  
110 mm

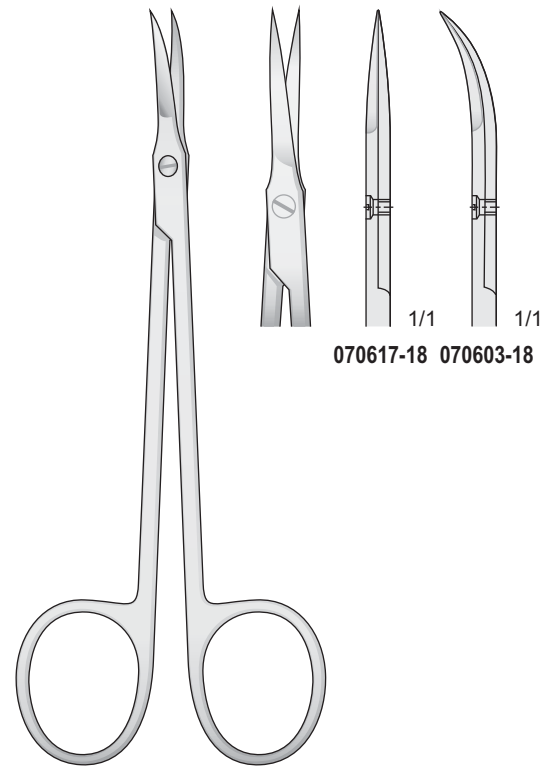

**070617-18/070603-18**  
120 mm

Forbici delicate

Delicate scissors

Feine Scheren

Ciseaux délicate

Tijeras finas

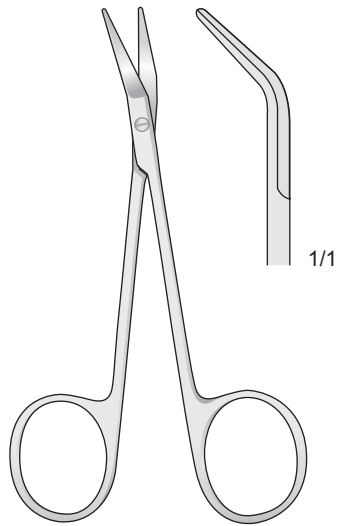

**GRAEFE**  
**0607-DA**  
100 mm

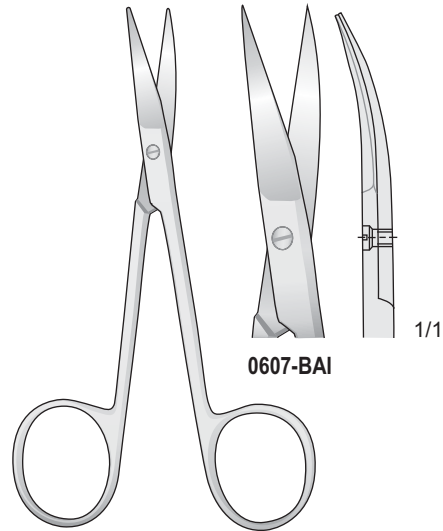

**COTTLE-MASING**  
**0607-BAI/0607-BAL**  
105 mm

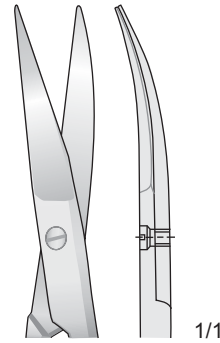

**0607-BAL**

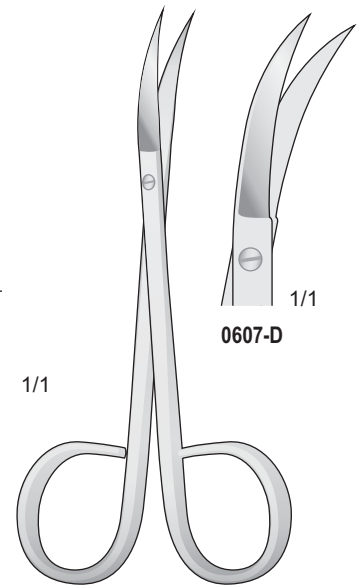

**0607-D**  
115 mm

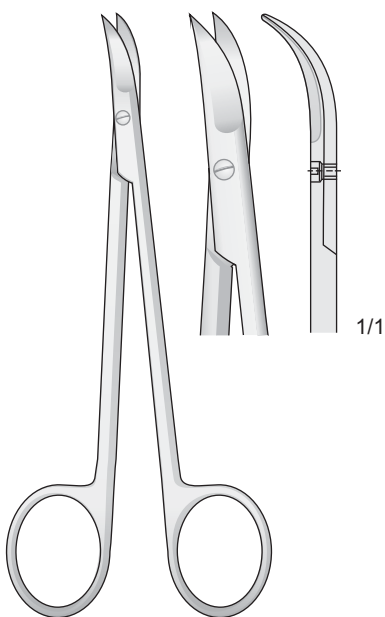

**CHADWICK**  
**0607-DL**  
115 mm

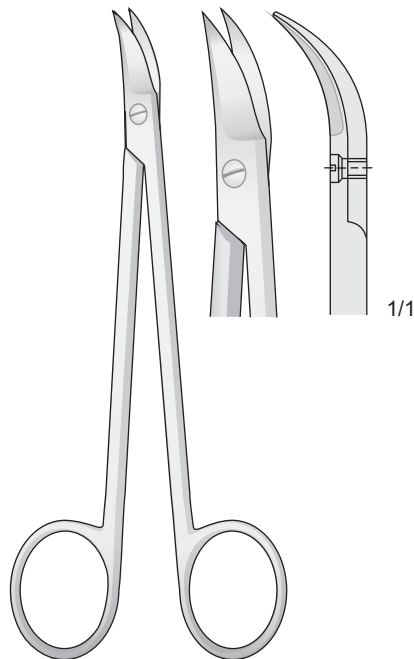

**QUINBY**  
**0607-DI**  
130 mm

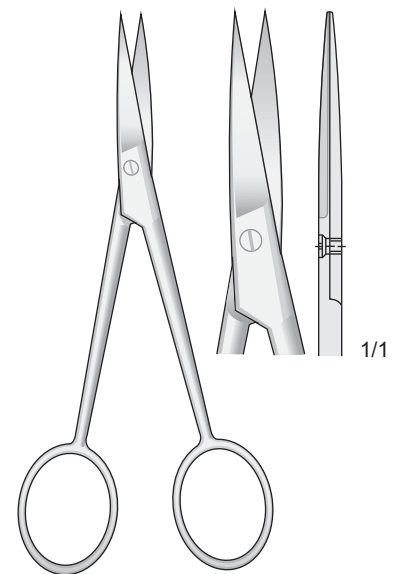

**0607-BBL**  
110 mm



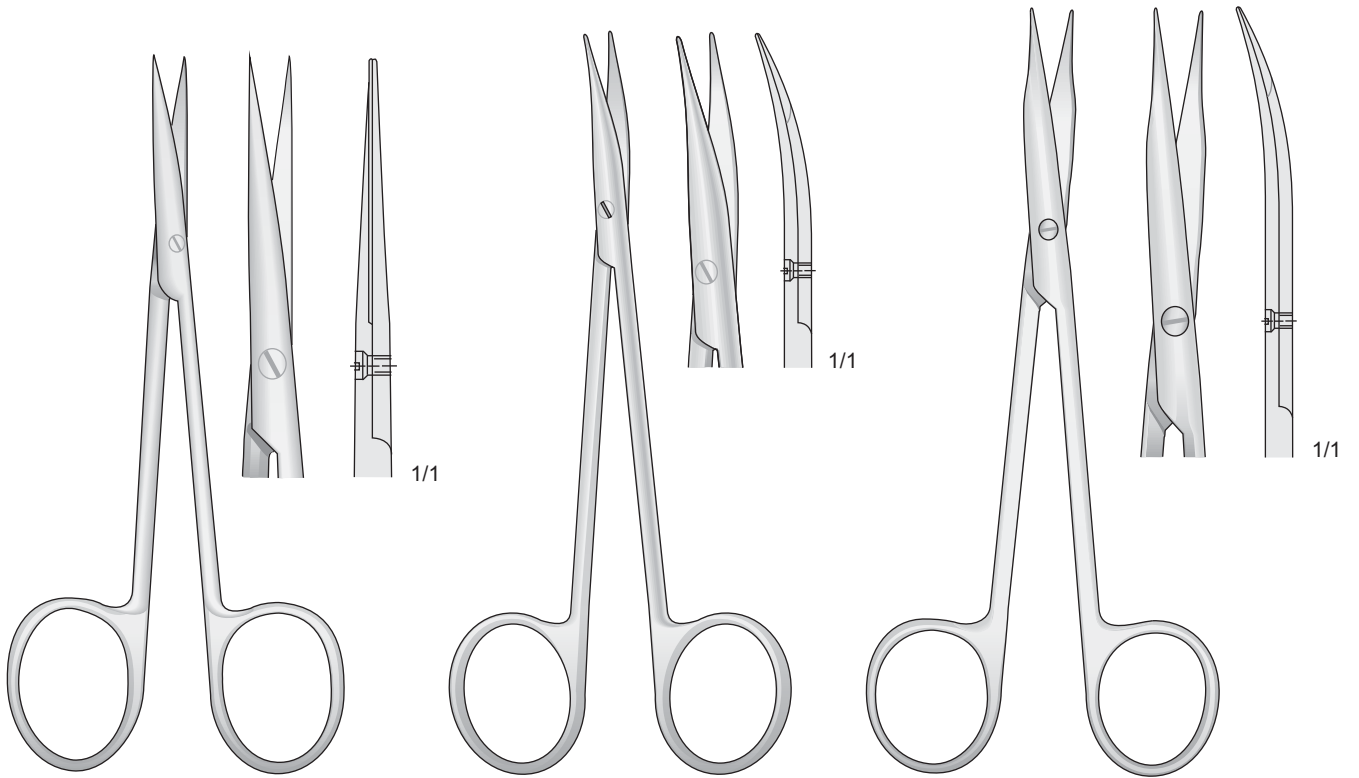

**KILNER**  
**0607-FI**  
115 mm

**JAMESON-WERBER**  
**0607-BCD**  
130 mm

**JAMESON**  
**0607-BCE**  
145 mm

Smussa - Blunt  
Stumpf - Émoussé - Romo

Acuta - Sharp  
Spitz - Aigu - Agudo

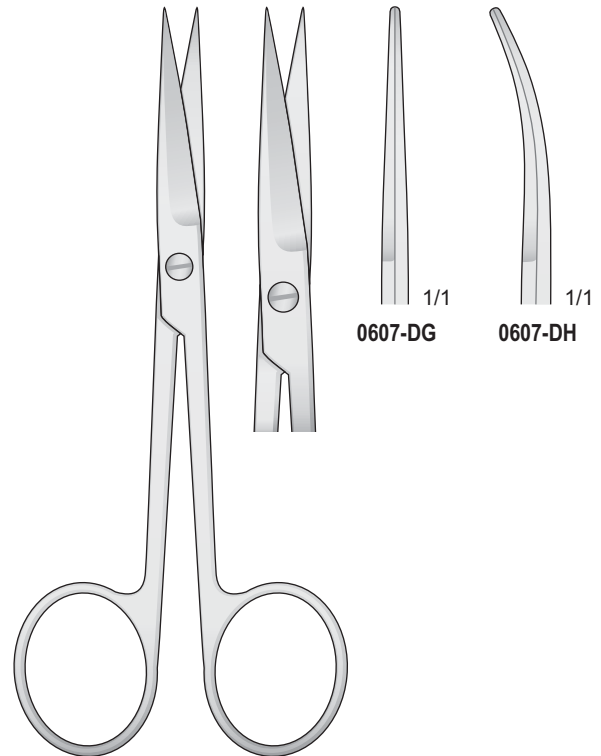
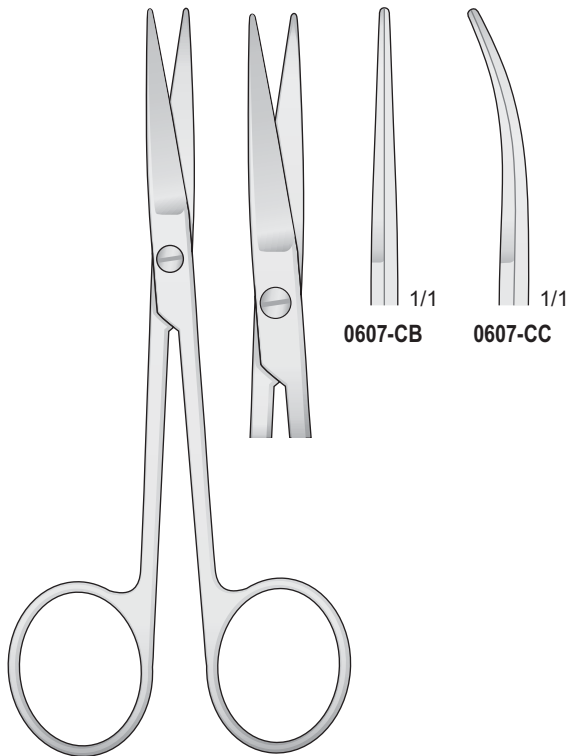

**0607-CB/0607-CC**  
115 mm

**0607-DG/0607-DH**  
115 mm

Forbici delicate

Delicate scissors

Feine Scheren

Ciseaux délicate

Tijeras finas

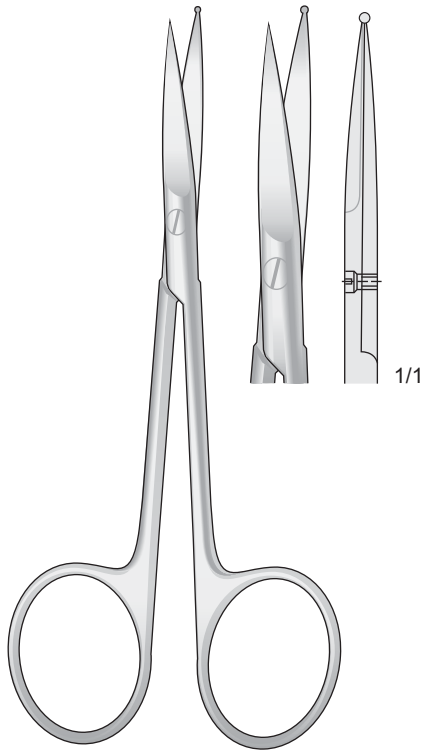

**0607-BDB**  
120 mm

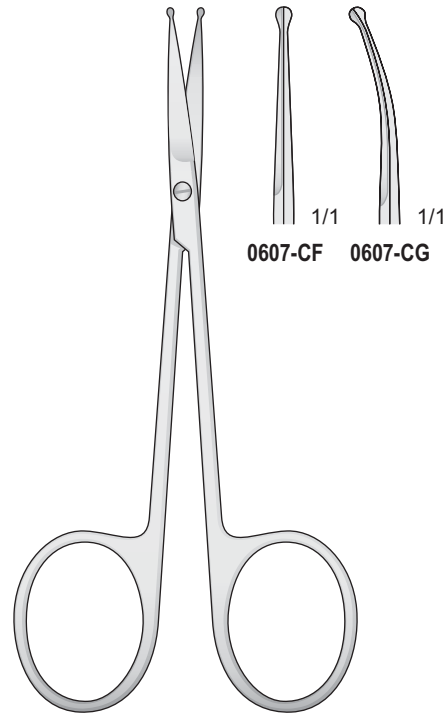

**0607-CF/0607-CG**  
110 mm

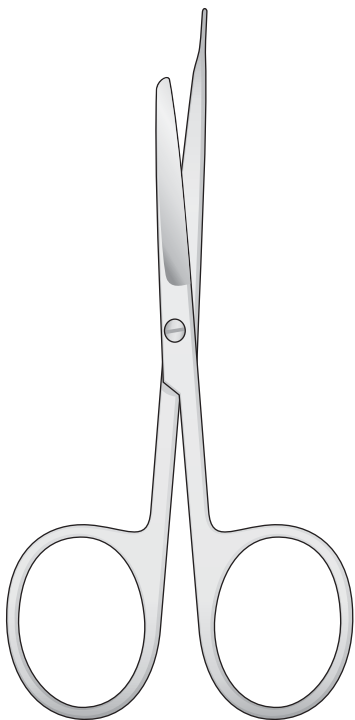

**0607-CH**  
100 mm

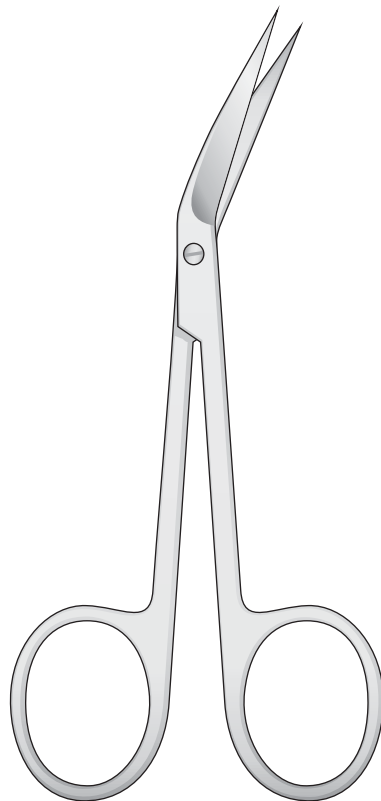

**1110-B**  
115 mm

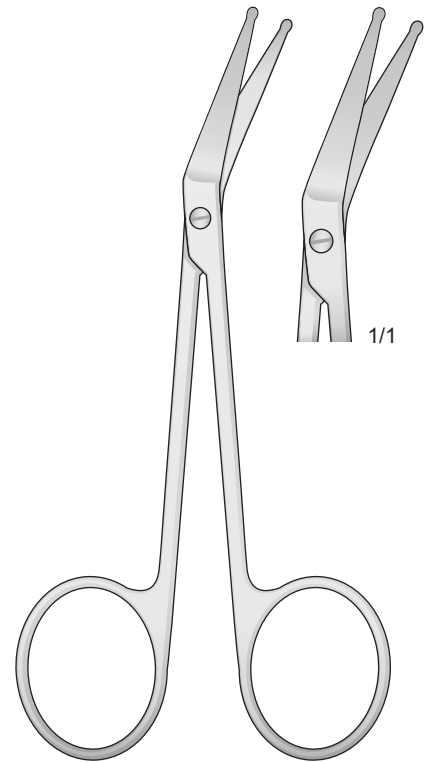

**LOCKLIN MOD.**  
**1110-D**  
110 mm

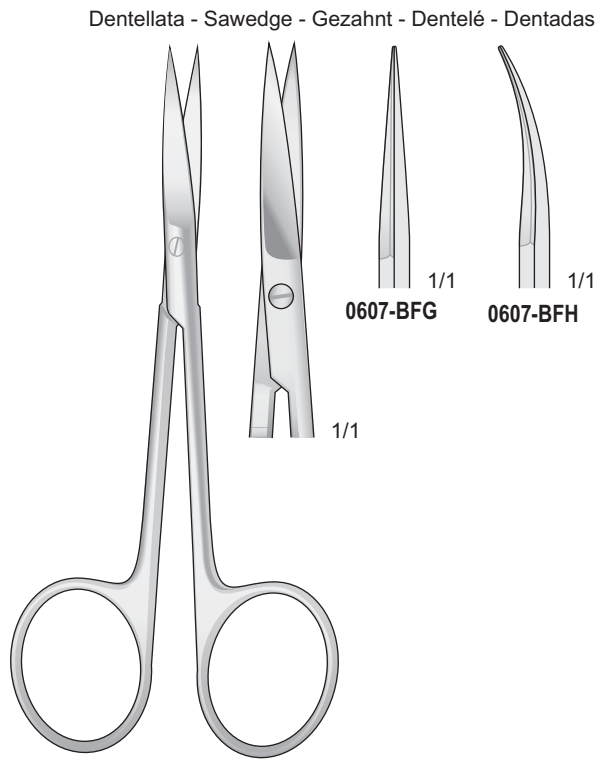

**0607-BFG/0607-BFH**  
110 mm

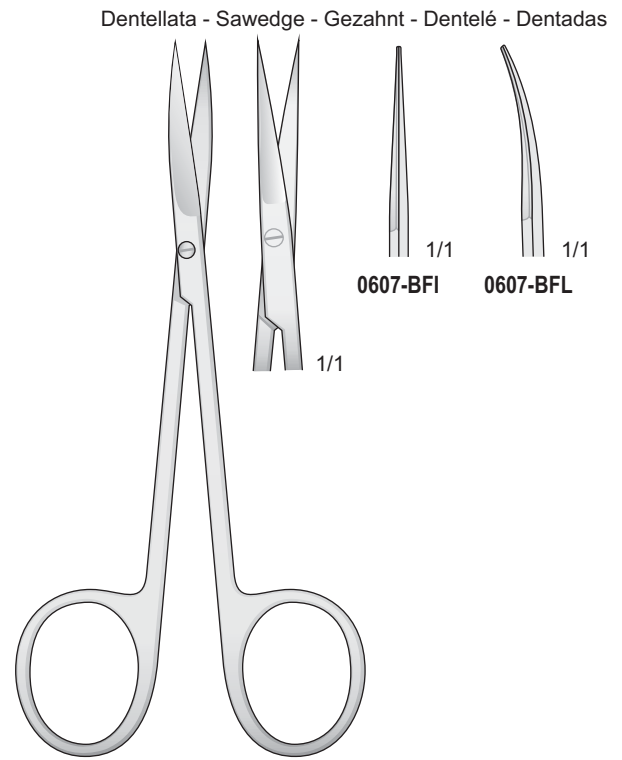

**0607-BFI/0607-BFL**  
110 mm

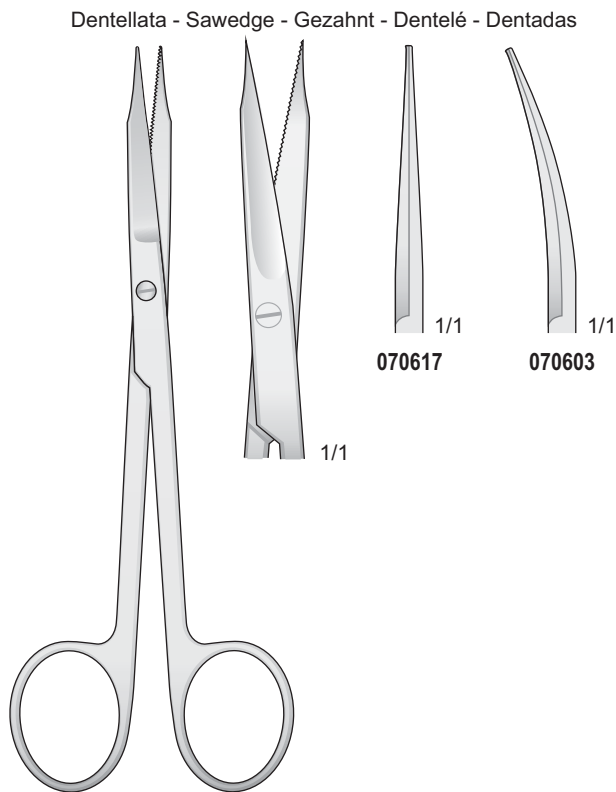

**GOLDMAN-FOX**  
**070617/070603**  
120 mm

Forbici delicate

Delicate scissors

Feine Scheren

Ciseaux délicate

Tijeras finas

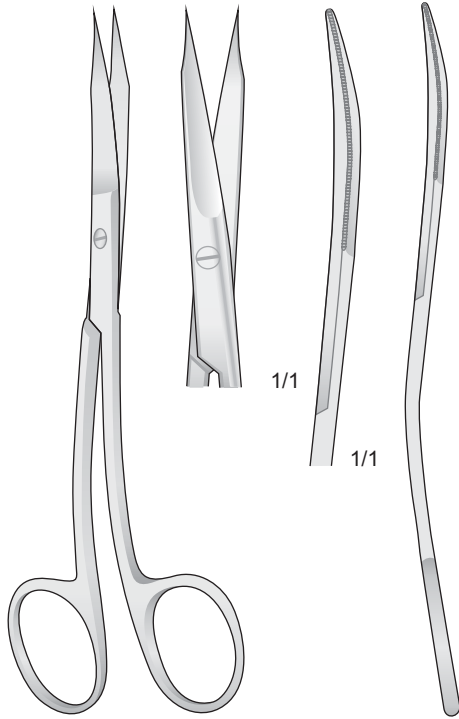

GOLDMAN-FOX S FORM  
070618  
130 mm

Dentellate  
Saw edge  
Gezahnt  
Dentelé  
Dentadas

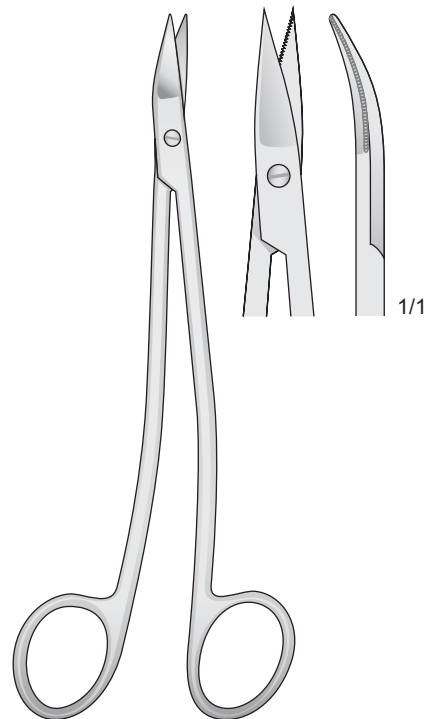

NEUMANN  
0607-CA  
130 mm

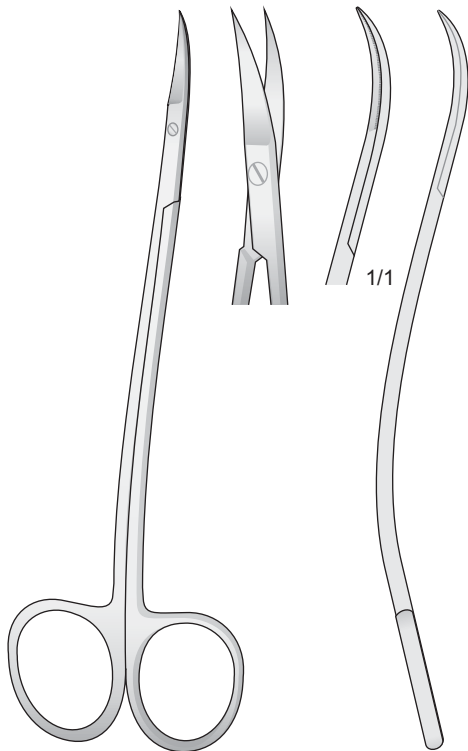

LA GRANGE  
1107-B  
115 mm

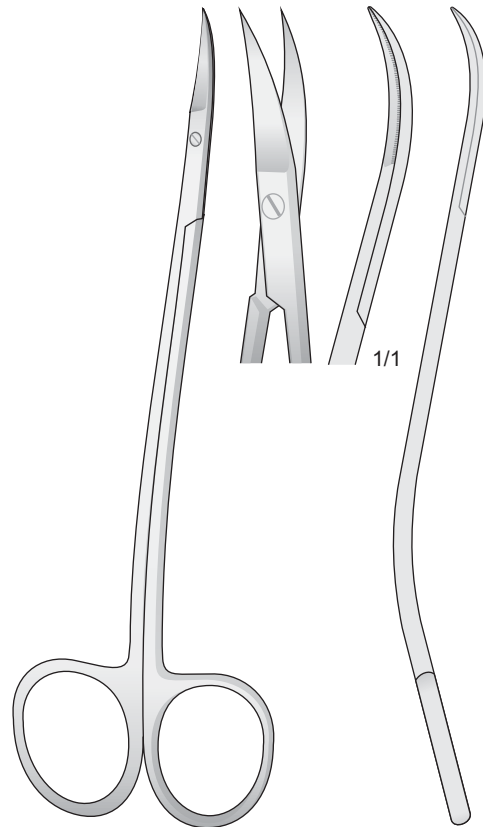

LA GRANGE  
1107-G  
155 mm

Smusse - Blunt - Stumpf - Mousses - Romas

Acute - Pointed - Spitz - Pointus - Agudas

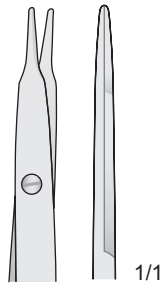
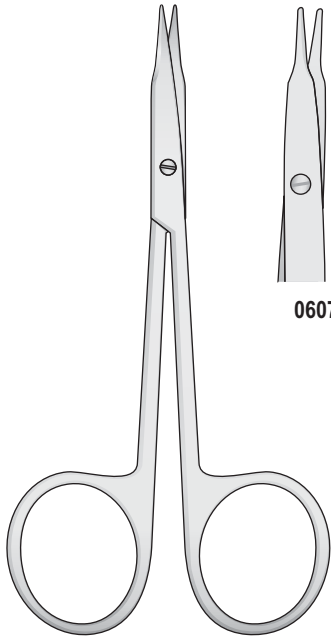

0607-FA

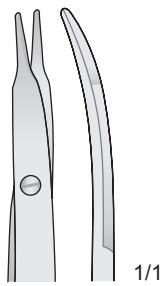

0607-FB

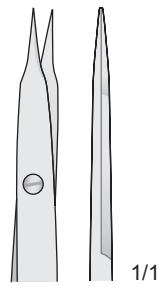

0607-FC

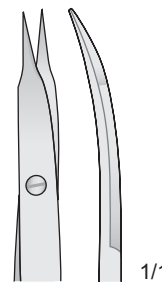

0607-FD

STEVENS  
0607-FA/0607-FD  
110 mm

Smussa - Blunt - Stumpf  
Mousse - Romas

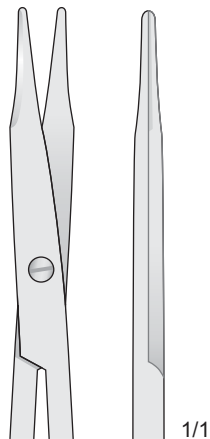
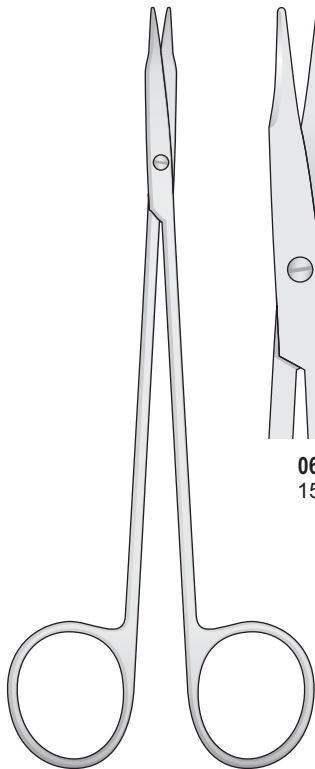

0607-FE  
150 mm

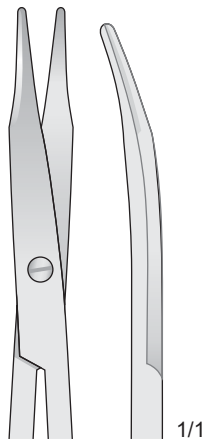

0607-FF  
150 mm

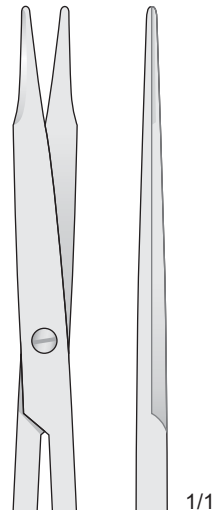

0607-FG  
180 mm

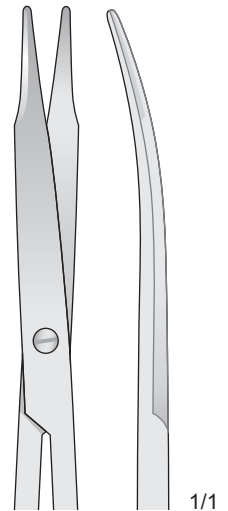

0607-FH  
180 mm

REYNOLDS  
0607-FE/0607-FH

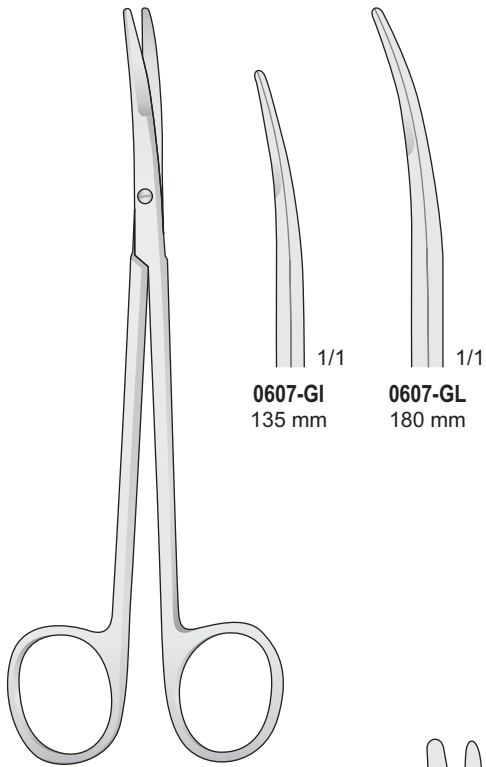

GLASSMAN  
0607-GI/0607-GL

0607-GI  
135 mm

0607-GL  
180 mm

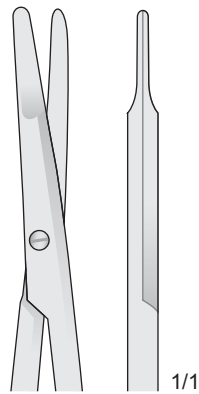

0607-GG  
120 mm

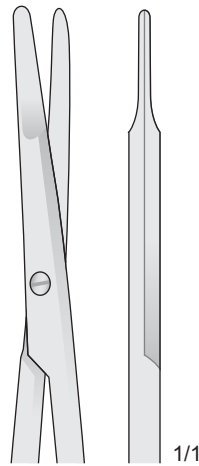

0607-BL17  
135 mm

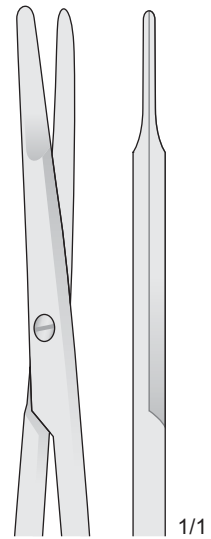

0607-G17  
150 mm

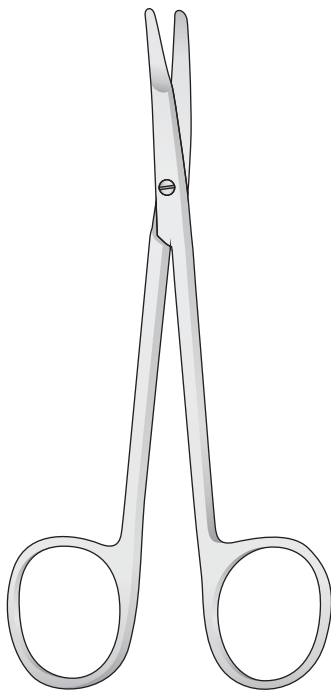

KILNER  
0607-G03/0607-GG

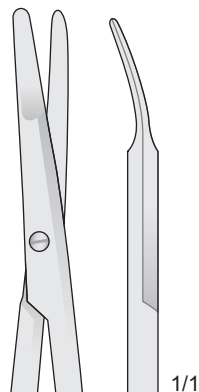

0607-GH  
120 mm

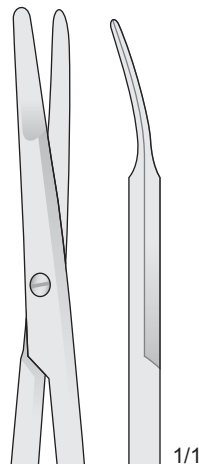

0607-BL03  
135 mm

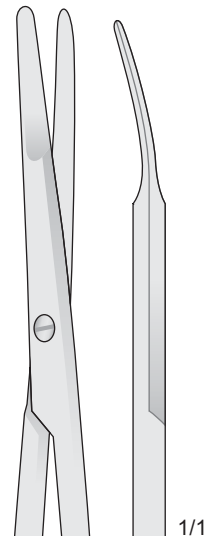

0607-G03  
150 mm

Dentellate  
Saw edge  
Gezahnt  
Dentelés  
Dentadas

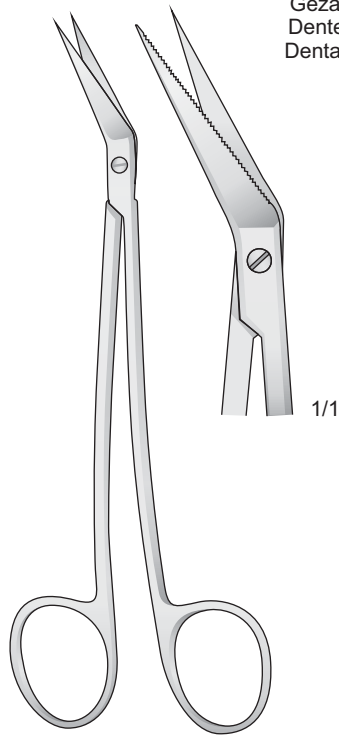

LOCKLIN  
1110-C  
160 mm

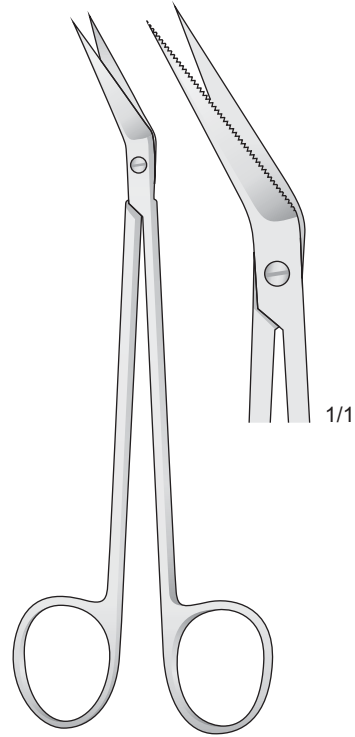

LOCKLIN  
1110-E  
160 mm

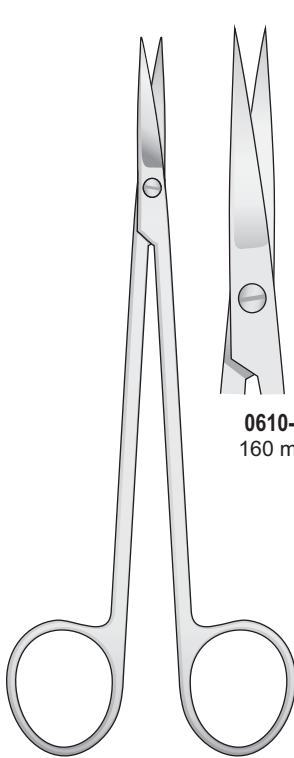

KELLY  
0610-B/0610-IH

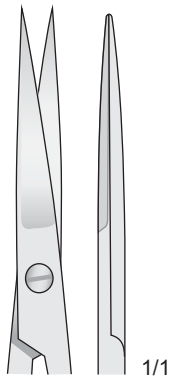

0610-B  
160 mm

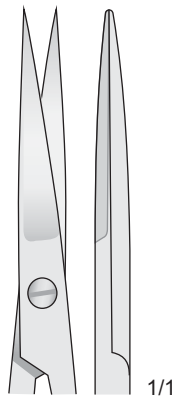

0610-IH  
180 mm

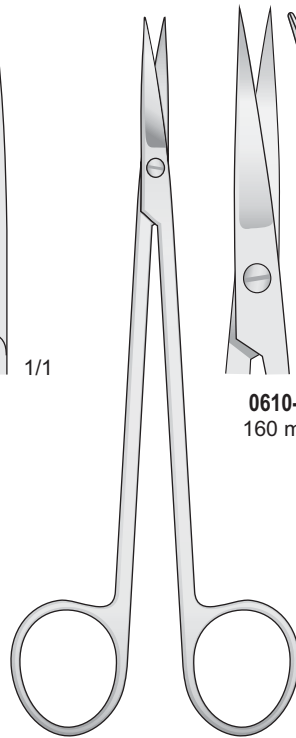

KELLY  
0610-C/0610-II

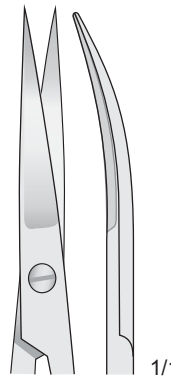

0610-C  
160 mm

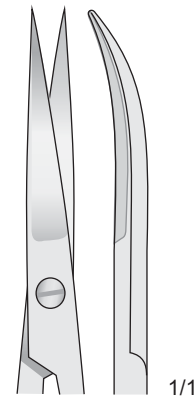

0610-II  
180 mm

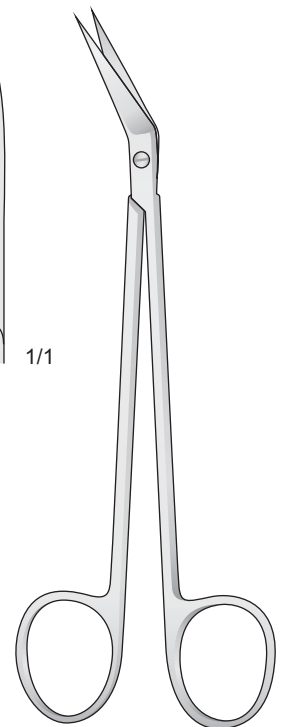

KELLY  
0610-BA  
160 mm

Standard

Smusse  
Blunt  
Stumpf  
Mousses  
Romas

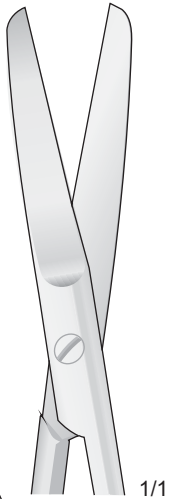
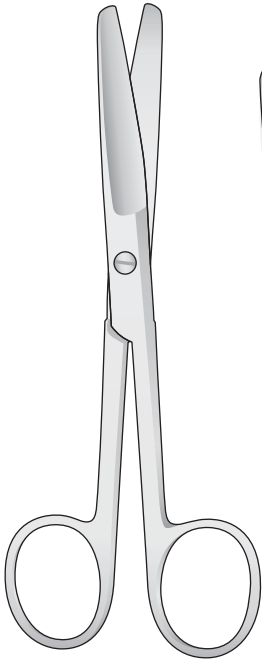

1/1

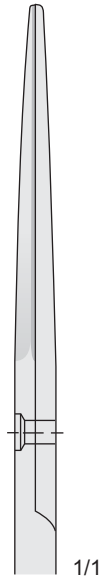

1/1

**0612-DF**  
130 mm

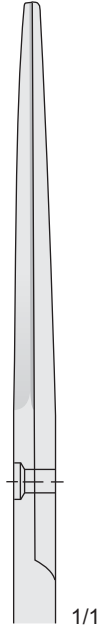

1/1

**0612-L**  
145 mm

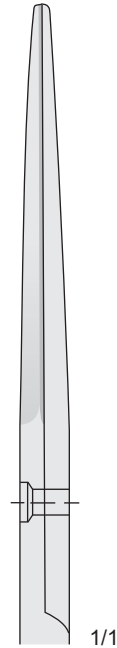

1/1

**0612-DH**  
165 mm

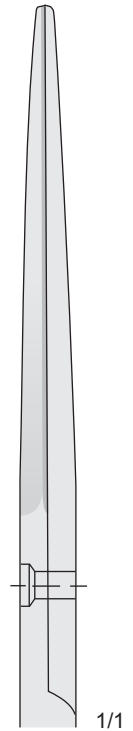

1/1

**0612-DL**  
185 mm

**0612-L/0612-DL**

Smusse - Blunt  
Stumpf - Mousses  
Romas

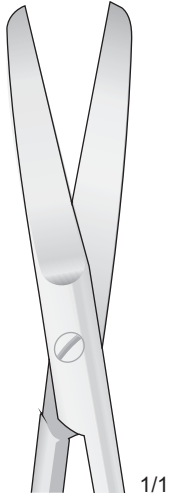
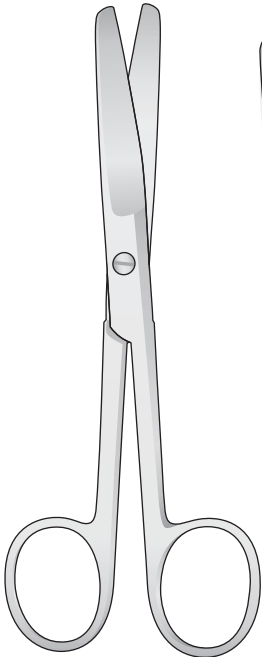

1/1

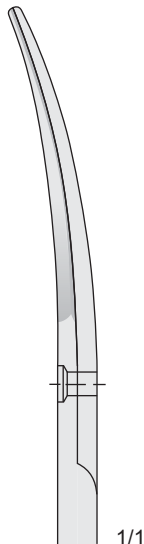

1/1

**0612-DG**  
130 mm

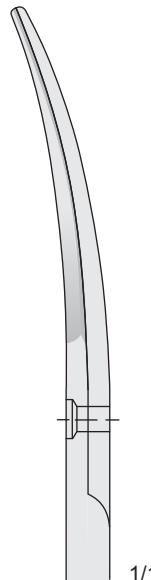

1/1

**0612-BA**  
145 mm

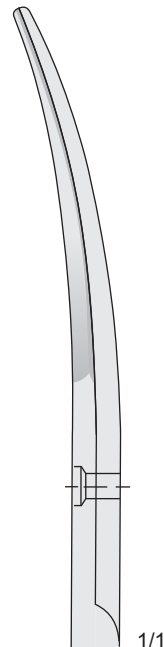

1/1

**0612-DI**  
165 mm

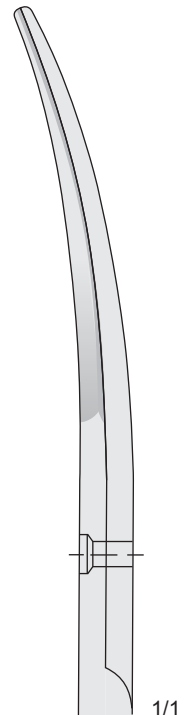

1/1

**0612-EA**  
185 mm

**0612-BA/0612-EA**



Standard

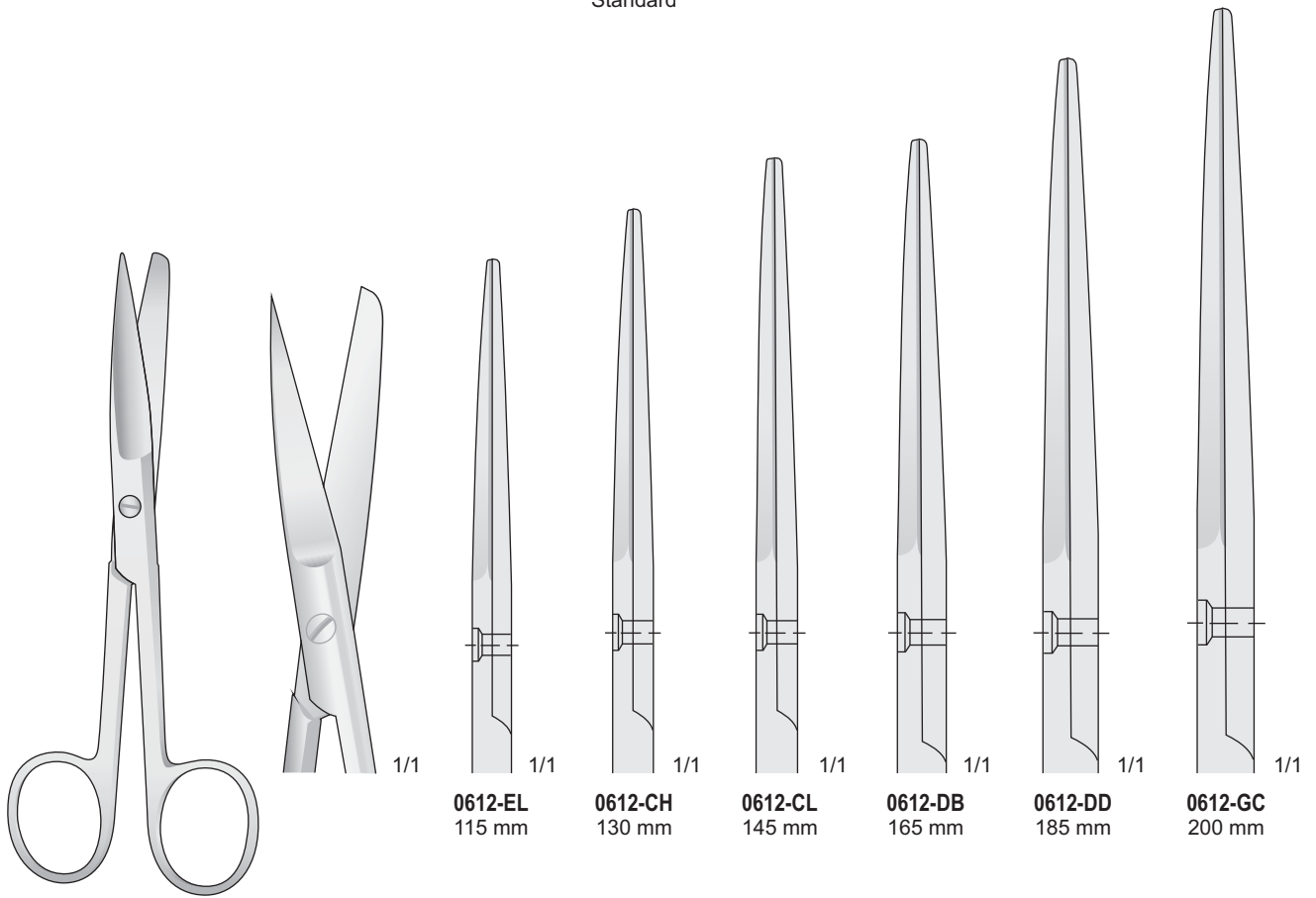

0612-CH/0612-GC

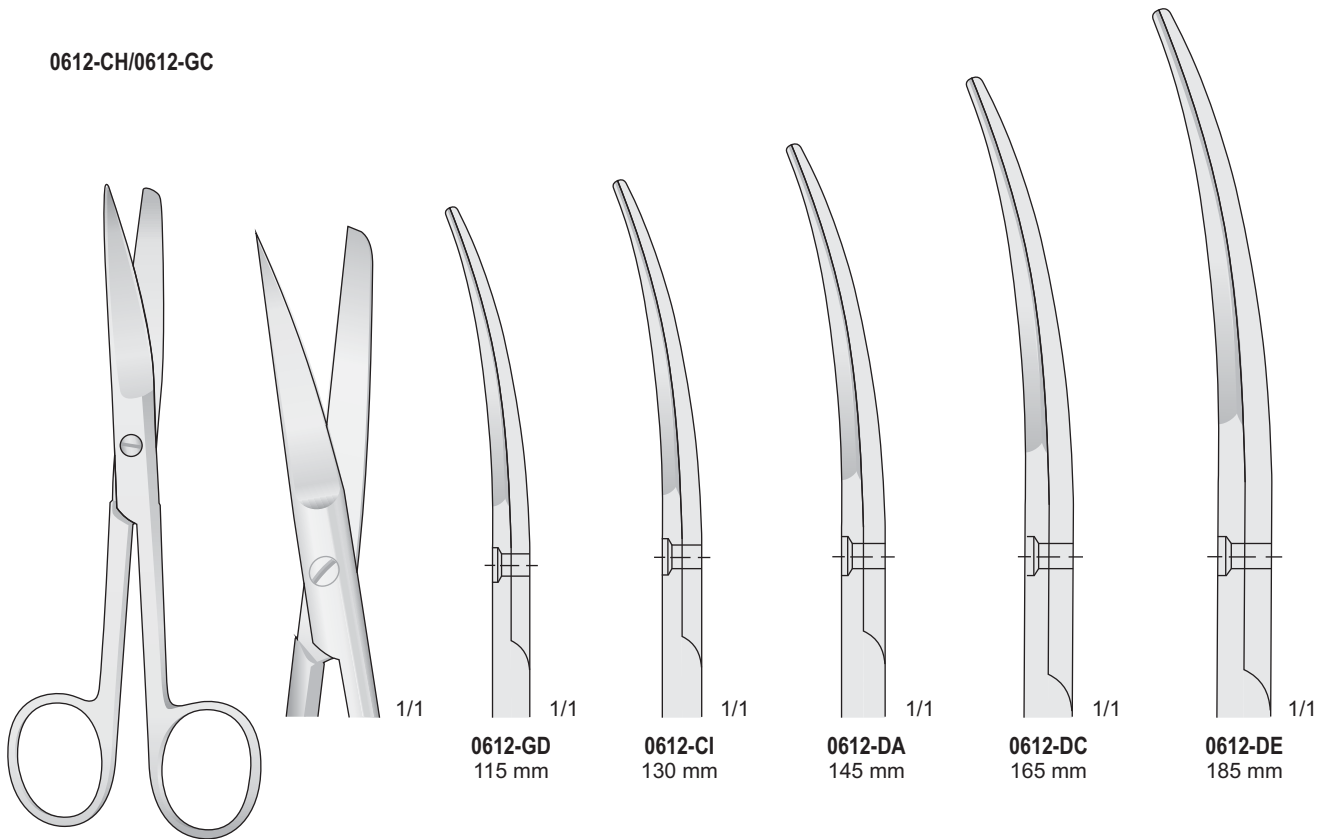

0612-CI/0612-GD

Standard

Acuta - Sharp  
Spitz - Aigu - Agudo

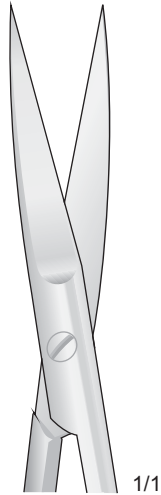
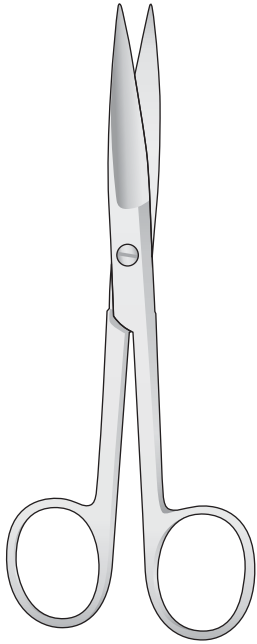

1/1

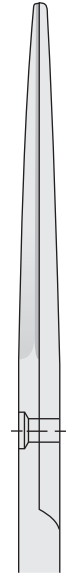

1/1

**0612-EB**  
130 mm

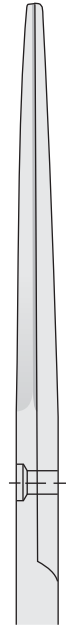

1/1

**0612-H**  
145 mm



1/1

**0612-ED**  
165 mm

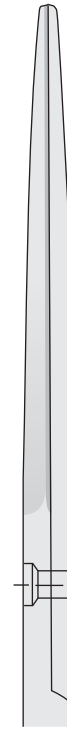

1/1

**0612-EF**  
185 mm

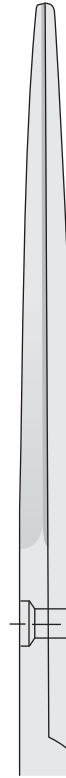

1/1

**0612-HC**  
200 mm

0612-EB/0612-HC

Acuta - Sharp  
Spitz - Aigu - Agudo

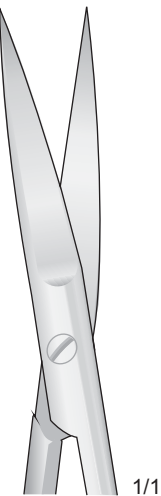
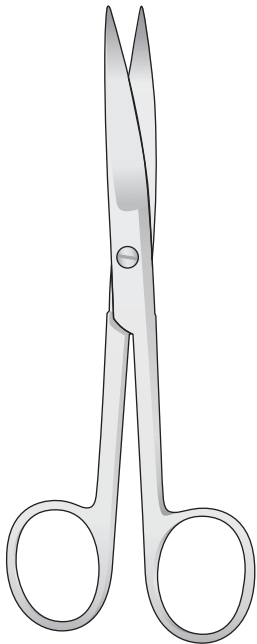

1/1

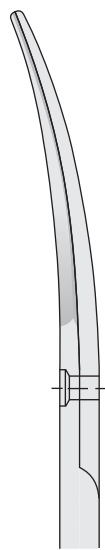

1/1

**0612-EC**  
130 mm

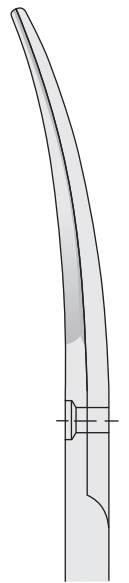

1/1

**0612-I**  
145 mm

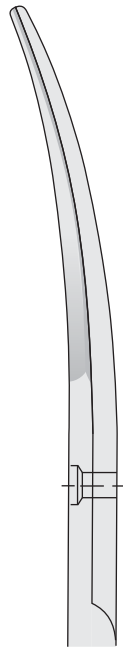

1/1

**0612-EE**  
165 mm



1/1

**0612-EG**  
185 mm



1/1

**0612-HD**  
200 mm

0612-I/0612-HD

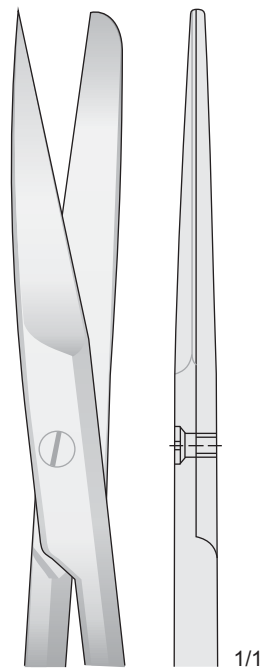
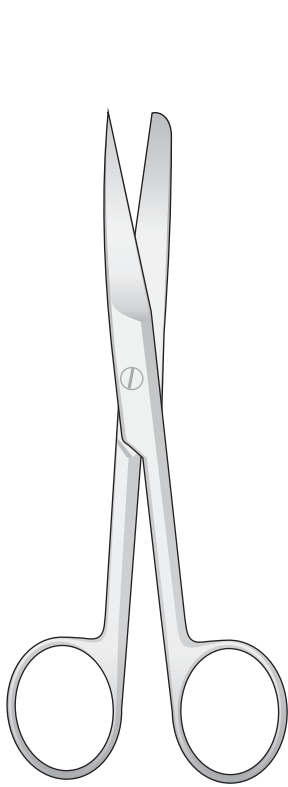

**0607-EH**  
145 mm

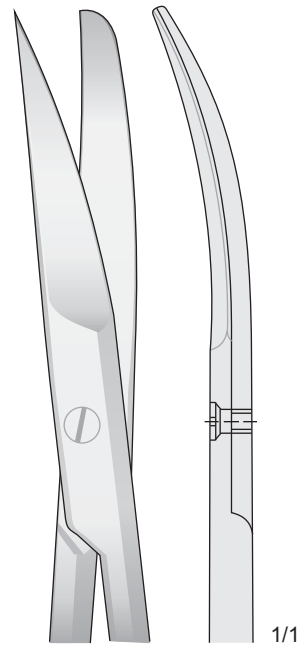

**0607-EI**  
145 mm

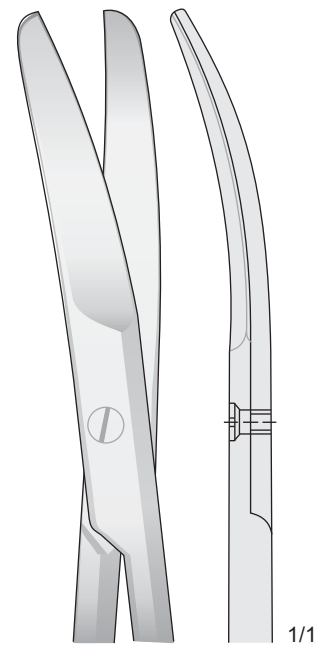

**0607-EL**  
145 mm

DEAVER  
**0607-EH/0607-EL**  
145 mm

Forbici da incisione - Incision scissors  
Inzisionscheren - Ciseaux à incision  
Tijeras para incisión

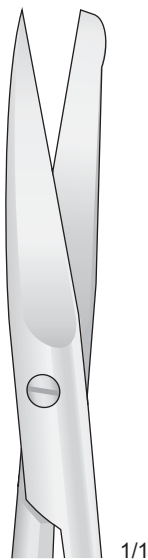
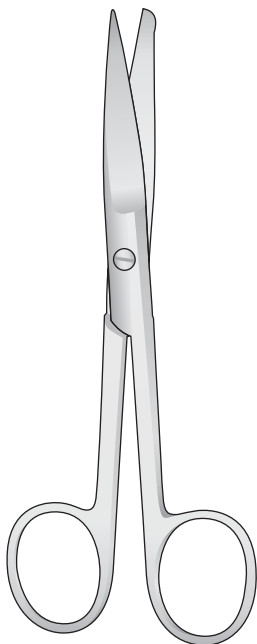

**0607-BG**  
130 mm

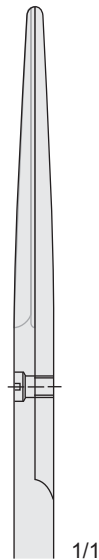

**0607-BH**  
145 mm

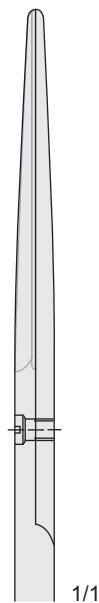

**0607-BBH**  
165 mm

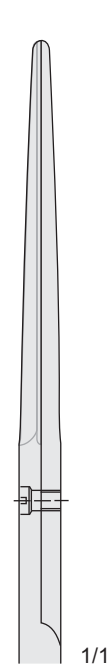

**0607-BI**  
185 mm

**0607-BG/0607-BI**



WERTHEIM  
0607-BEA/0607-BEC

Con una lama dentellata  
With one blade serrated  
Mit eine Schneide gezahnt  
Avec lame dentèle  
Con una hoja dentada

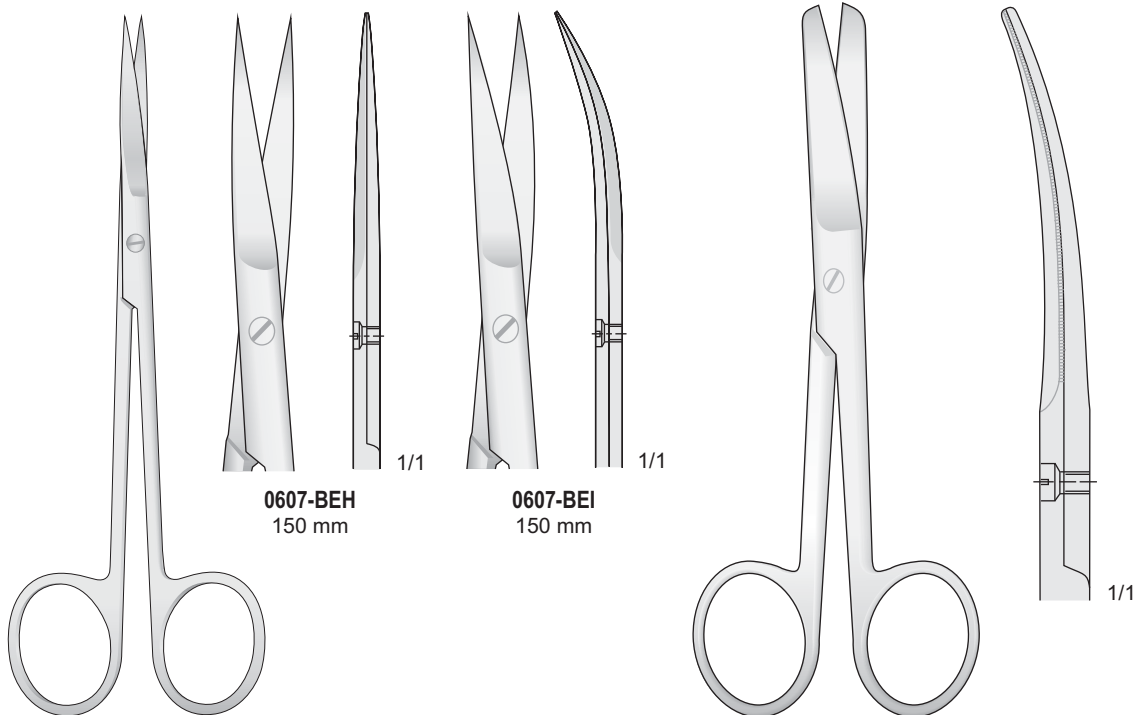

JOSEPH  
0607-BEH/0607-BEI  
150 mm

0607-BBG  
165 mm

Forbici delicate

Delicate scissors

Feine Scheren

Ciseaux délicate

Tijeras finas

Con occhiello per sutura - With eye for suture  
 Mit faden bohrung - Avec oeil pour les sutures  
 Tijeras para ligaduras

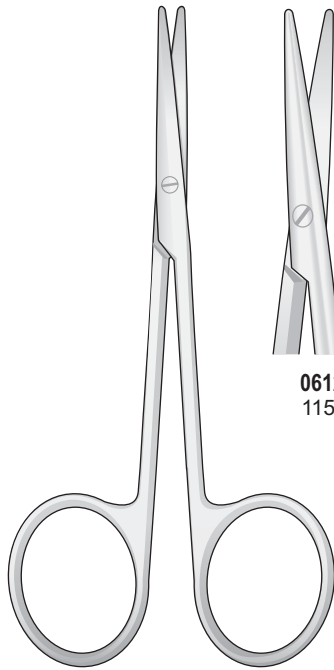

**BABY - METZENBAUM**  
**0612-EH/0612-EI**  
 115 mm

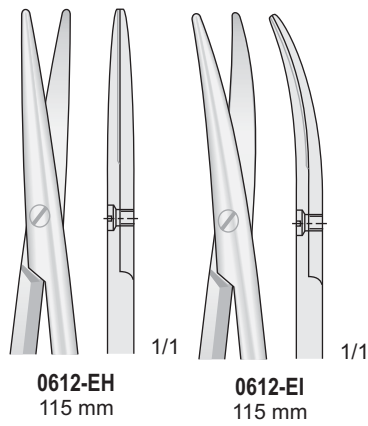

**0612-EH**  
 115 mm

**0612-EI**  
 115 mm

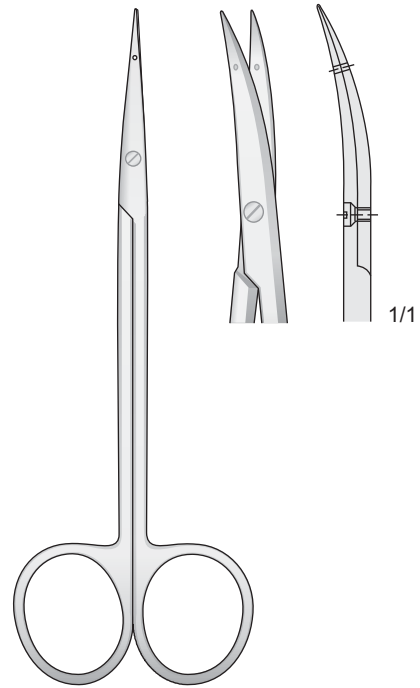

**LITTLER**  
**0607-BAA**  
 120 mm

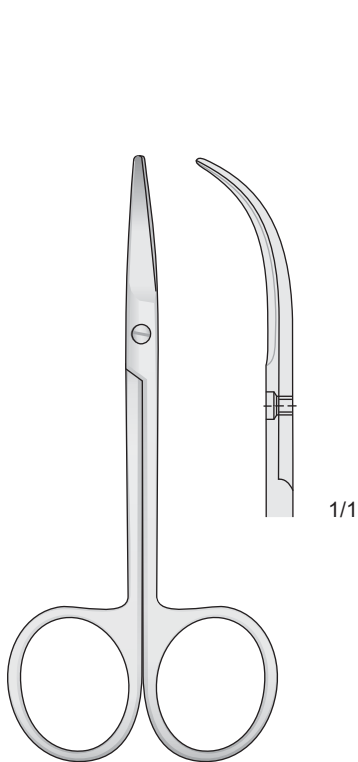
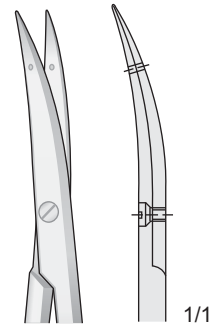

**FOMON**  
**0607-ED**  
 110 mm

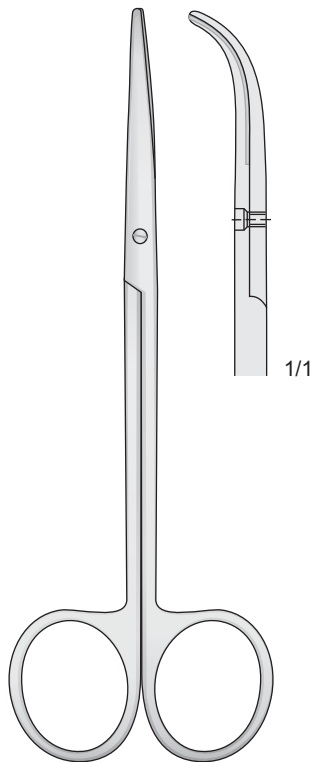

**0607-EE**  
 140 mm

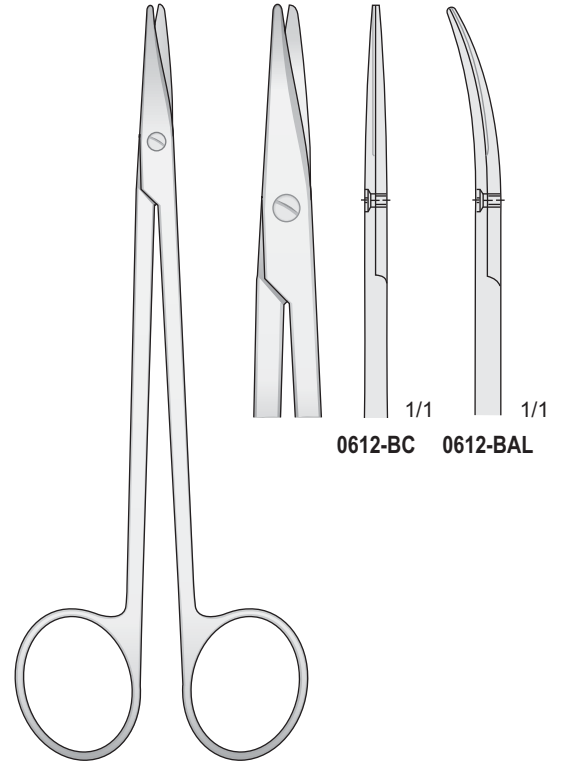

**METZENBAUN**  
**0612-BC/0612-BAL**  
 150 mm

**0612-BC** **0612-BAL**

Forbici per dissezione - Dissecting Scissors  
 Präparierscheren - Ciseaux à dissection - Tijeras para preparaciones

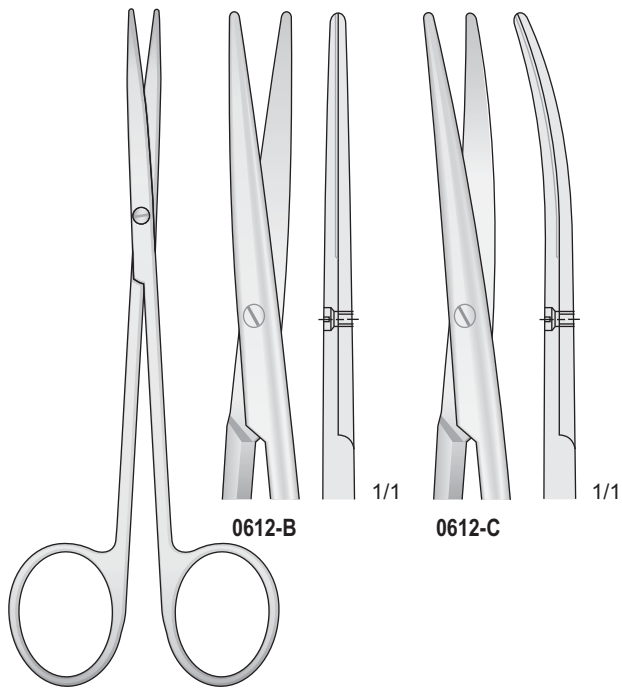

0612-B

0612-C

METZENBAUM  
 0612-B/0612-C  
 145 mm

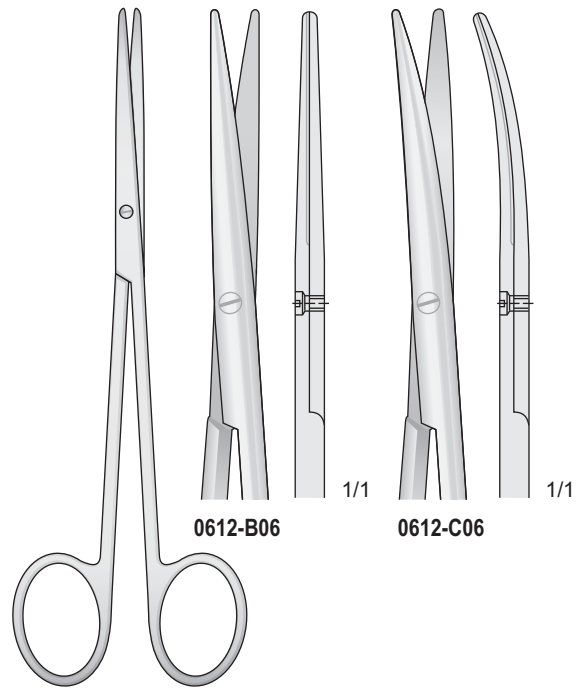

0612-B06

0612-C06

METZENBAUM-FINE  
 0612-B06/0612-C06  
 145 mm

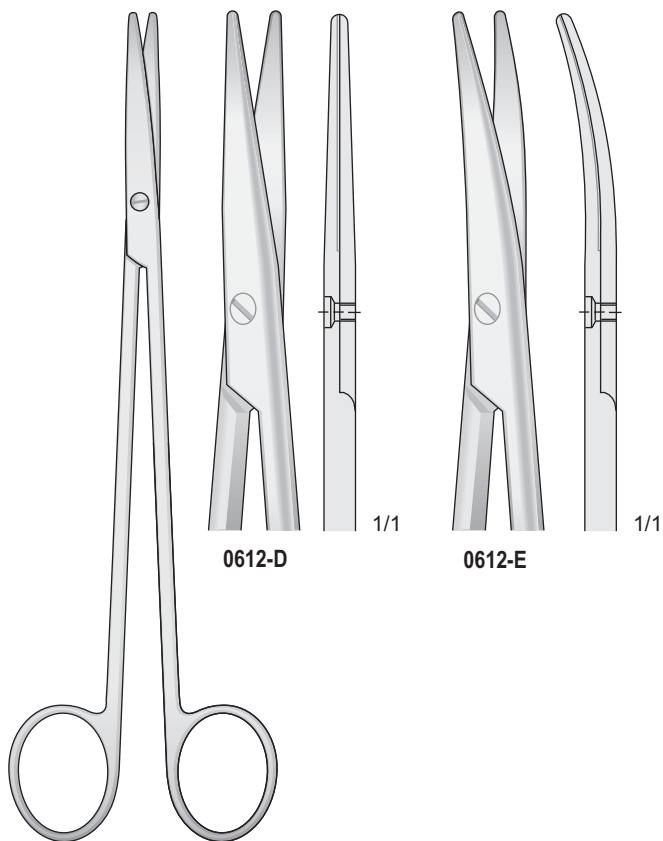

0612-D

0612-E

METZENBAUM  
 0612-D/0612-E  
 185 mm

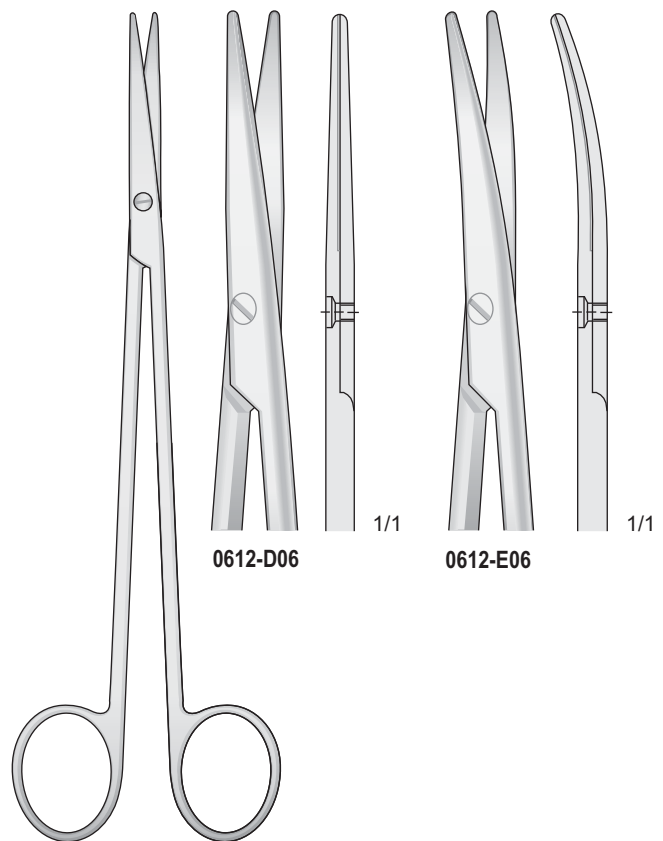

0612-D06

0612-E06

METZENBAUM-FINE  
 0612-D06/0612-E06  
 185 mm

Forbici per dissezione - Dissecting Scissors  
 Präparierscheren - Ciseaux à dissection - Tijeras para preparaciones

Acuta - Sharp  
 Spitz - Aigu - Agudo

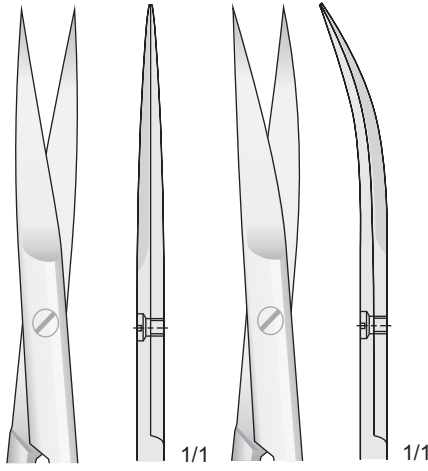
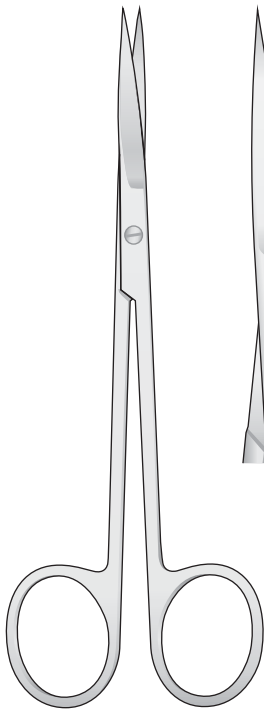

0607-CI

0607-BE

METZENBAUM  
 0607-CI/0607-BE  
 145 mm

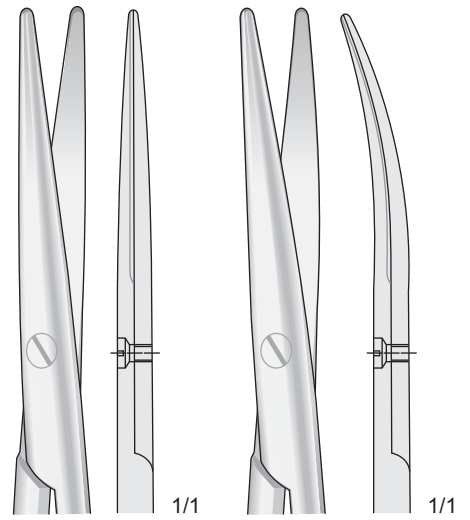
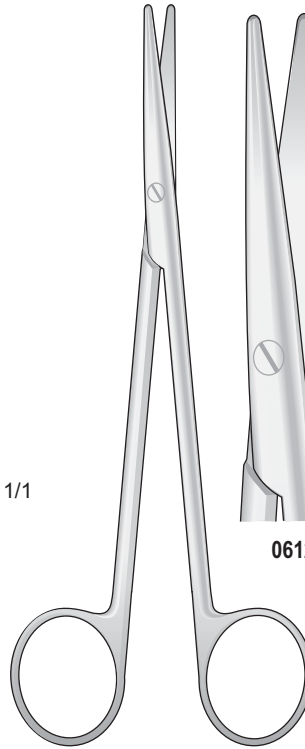

0612-HE

0612-HF

METZENBAUM  
 0612-HE/0612-HF  
 160 mm

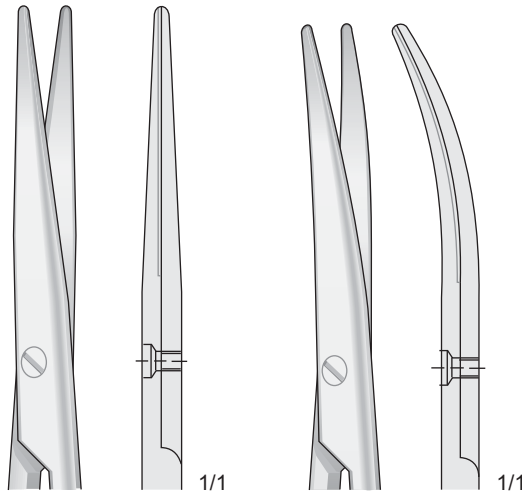
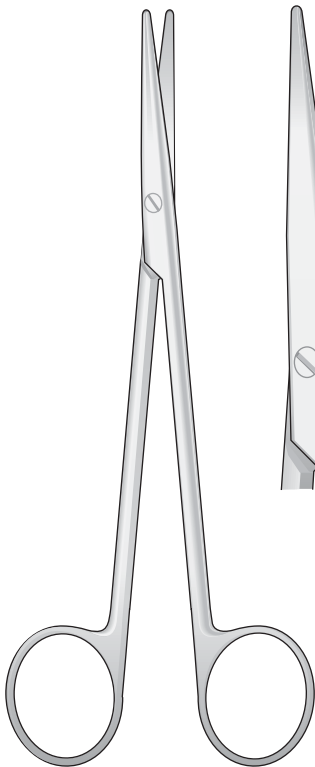

0612-HA

0612-HB

METZENBAUM  
 0612-HA/0612-HB  
 200 mm

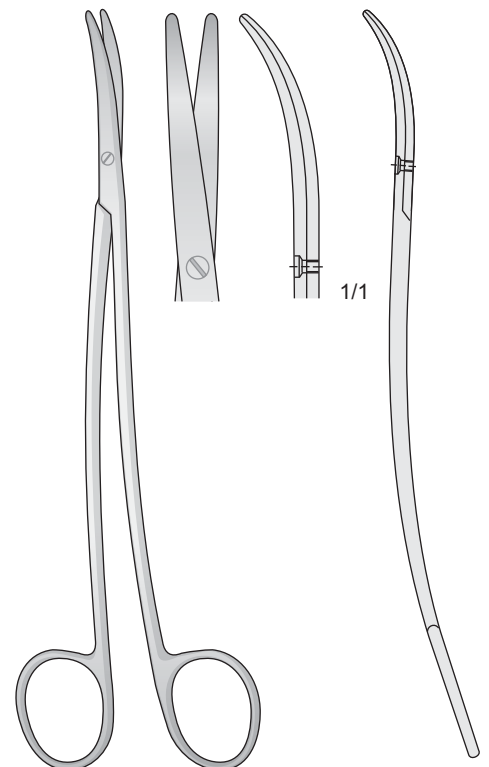

METZENBAUM-FINO  
 0612-BCA - 180 mm  
 0612-BCB - 200 mm  
 0612-BCC - 230 mm

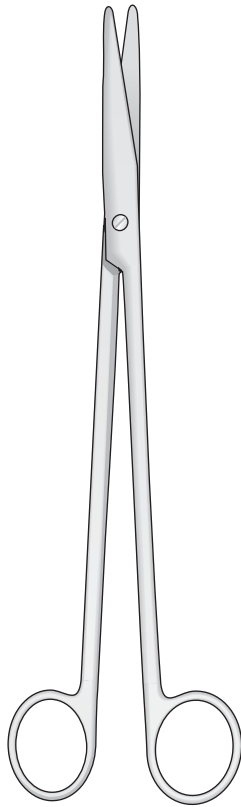

NELSON-METZENBAUM  
0612-BB/0612-BB4

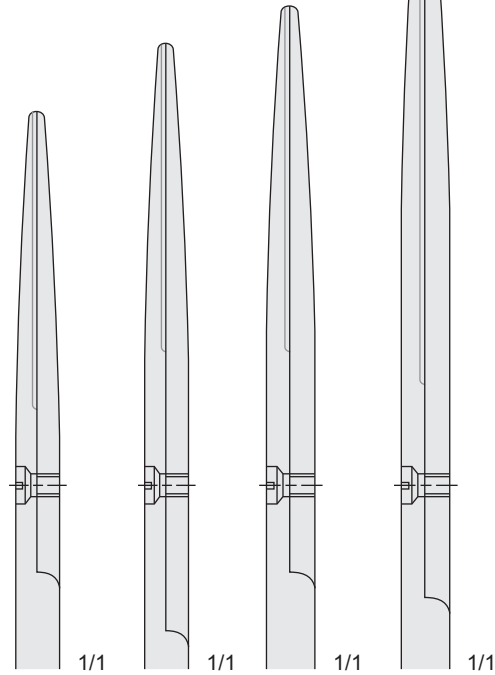
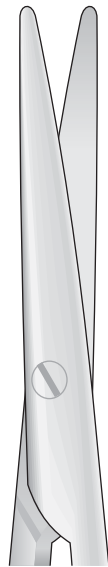

0612-BB    0612-BBC    0612-BBD    0612-BBE  
230 mm    250 mm    280 mm    305 mm

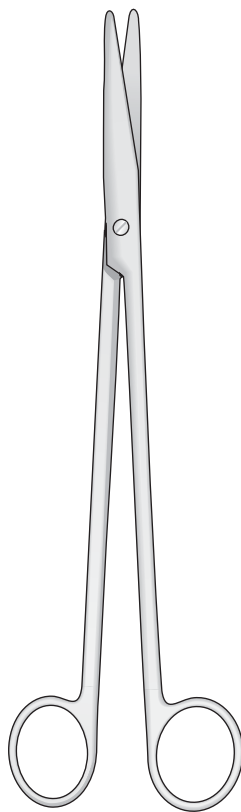

NELSON-METZENBAUM  
0612-BD/0612-BBH

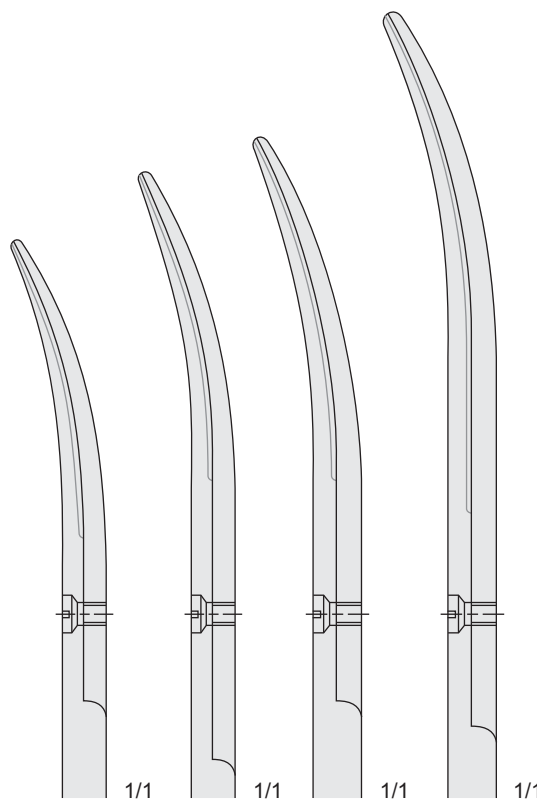
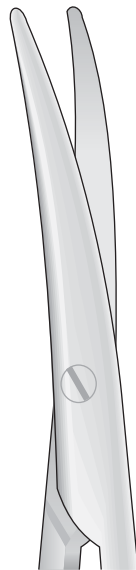

0612-BD    0612-BBF    0612-BBG    0612-BBH  
230 mm    250 mm    280 mm    305 mm



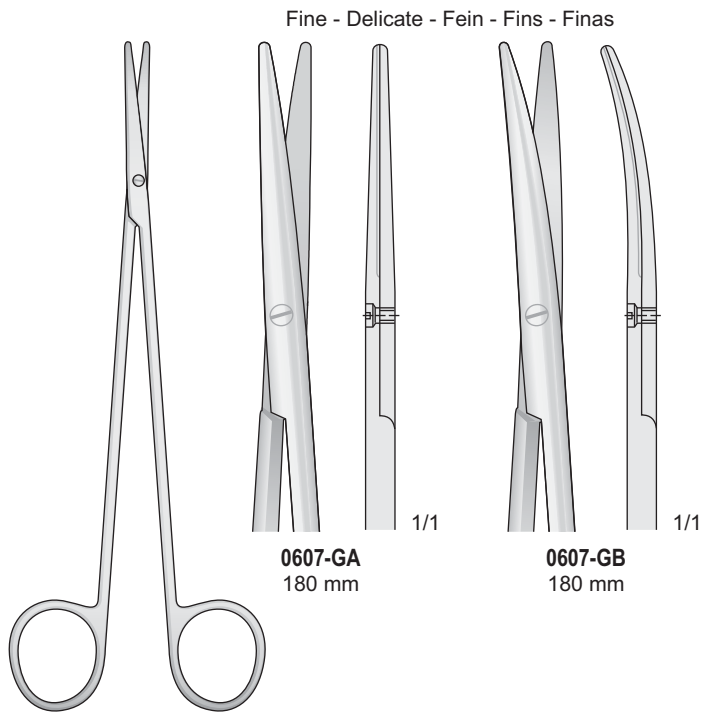

TOENNIS-ADSON  
**0607-GA/0607-GB**  
180 mm

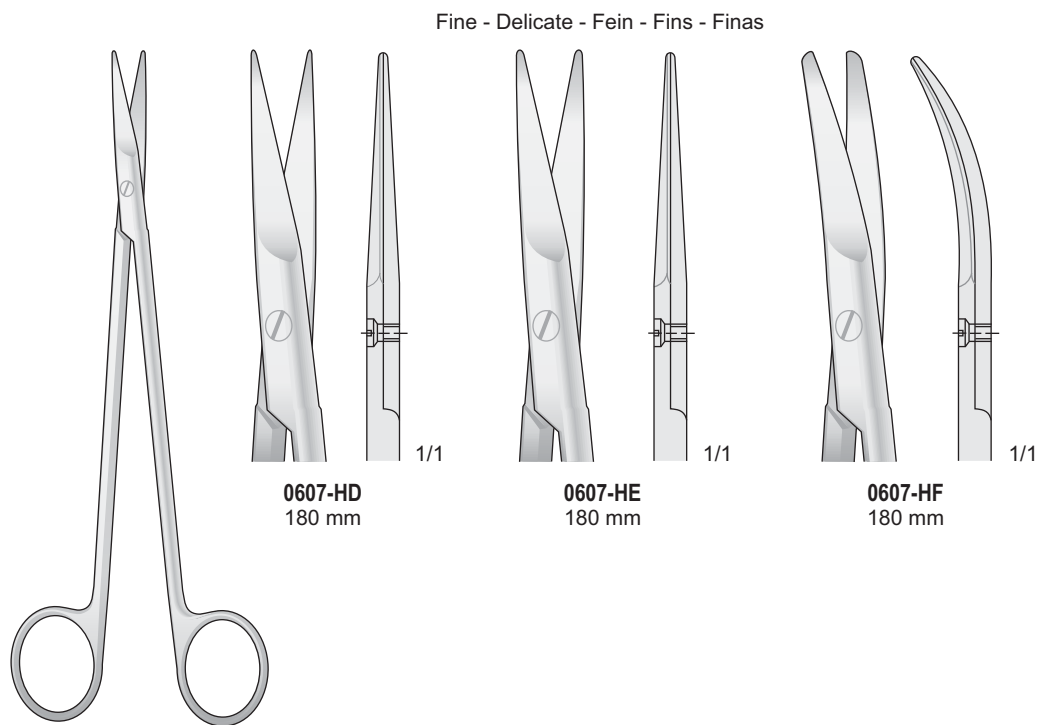

TOENNIS  
**0607-HD/0607-HF**  
180 mm

Forbici per dissezione - Dissecting scissors - Präparierscheren - Ciseaux à dissection - Tijeras para preparaciones

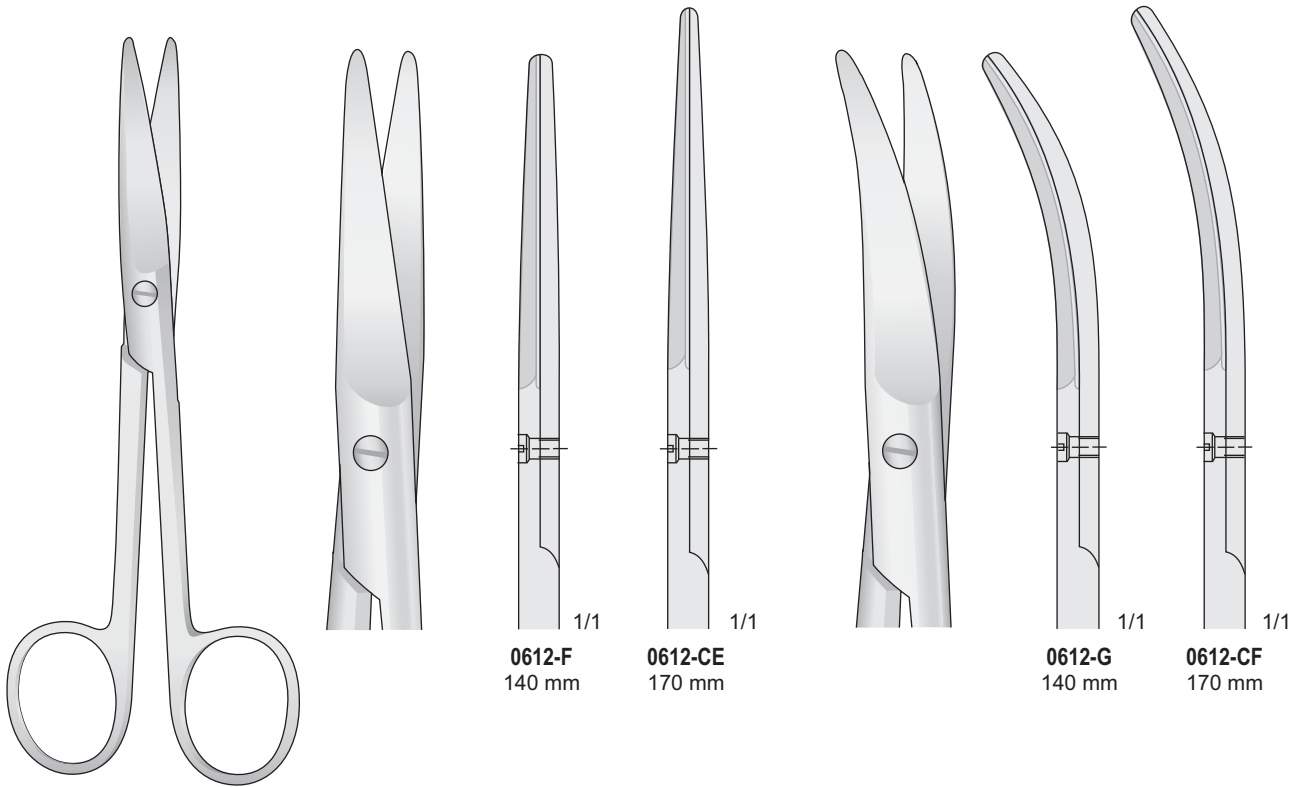

MAYO  
0612-F/0612-CF

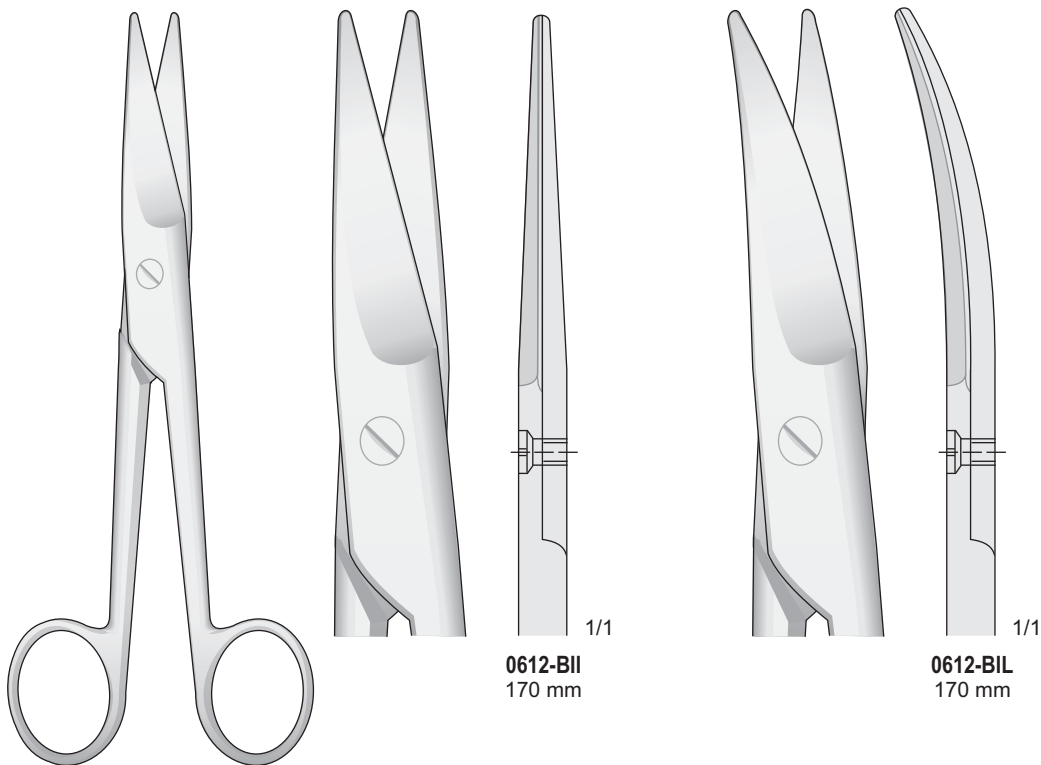

MAYO-NOBLE  
0612-BII/0612-BIL

Forbici per dissezione - Dissecting scissors - Präparierscheren - Ciseaux à dissection - Tijeras para preparaciones

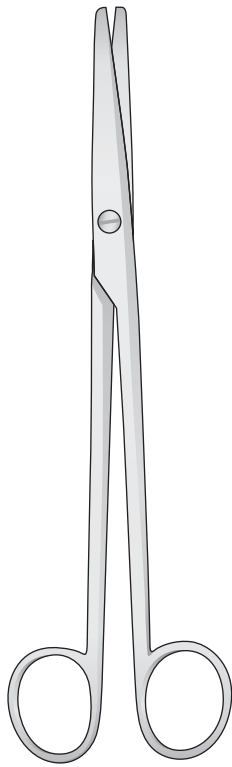

MAYO  
0612-IA/0612-IC

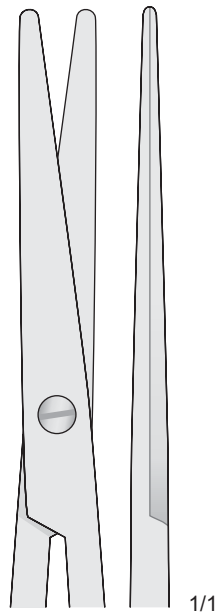

0612-IA  
160 mm

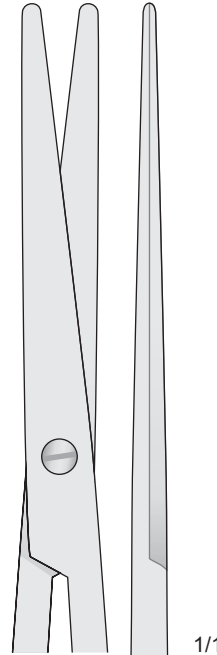

0612-IB  
190 mm

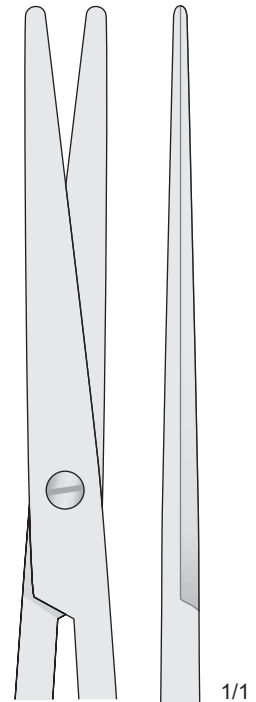

0612-IC  
210 mm

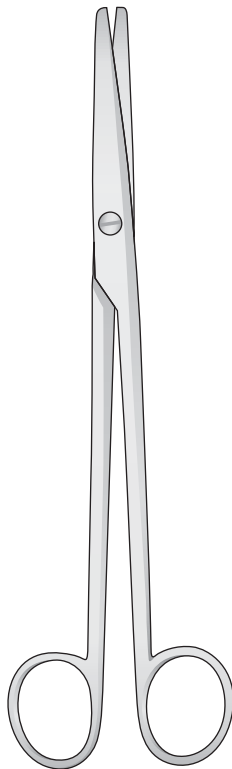

MAYO  
0612-ID/0612-IF

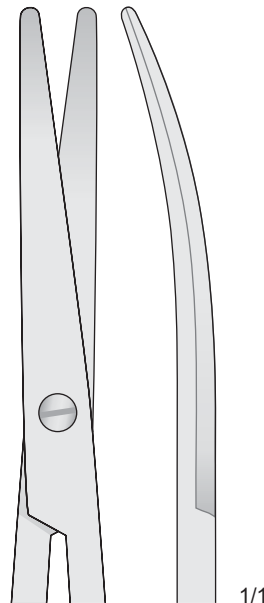

0612-ID  
160 mm

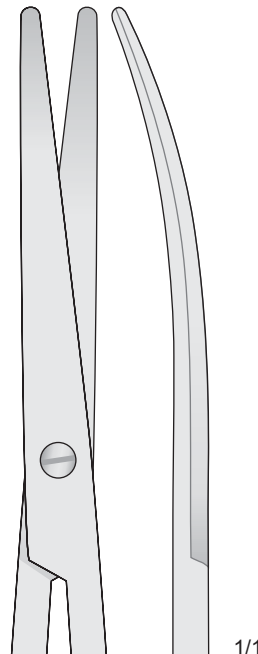

0612-IE  
190 mm

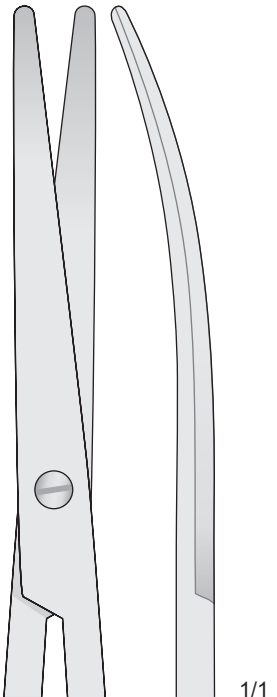

0612-IF  
210 mm

Fine - Delicate - Fein - Fins - Finas

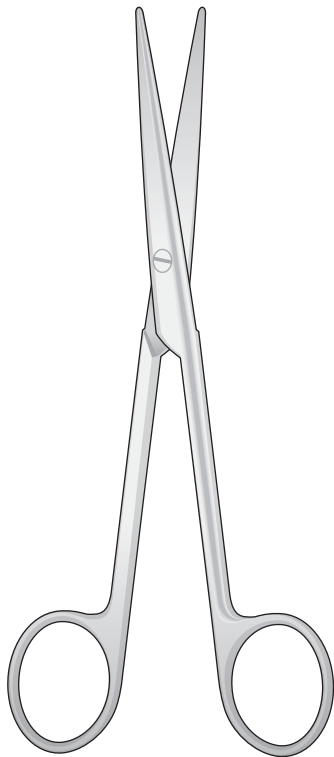

LEXER  
0612-BIA/0612-BIB  
165 mm

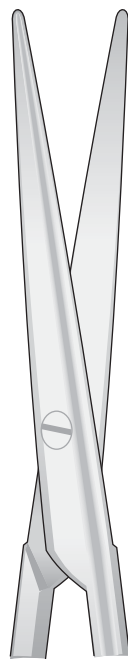

0612-BIA

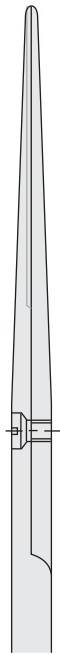

1/1

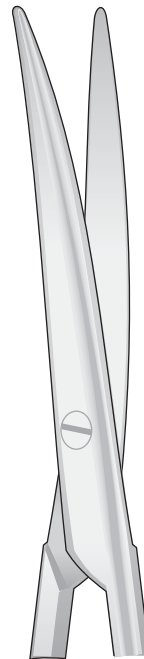

0612-BIB

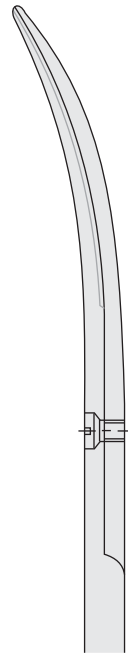

1/1

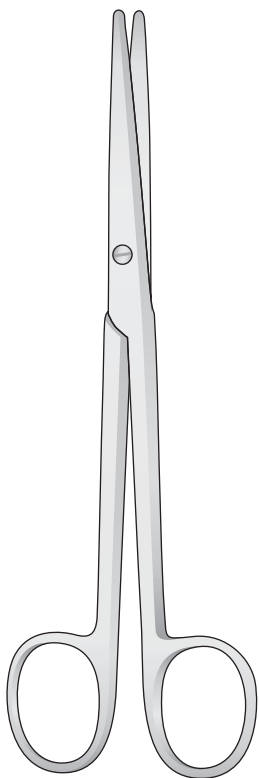

LEXER  
0612-IG/0612-IL

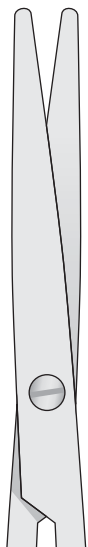

0612-IG  
160 mm



1/1



0612-IH  
210 mm



1/1

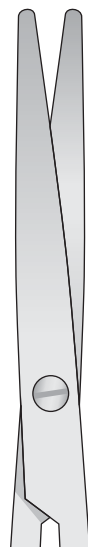

0612-II  
160 mm



1/1



0612-IL  
210 mm

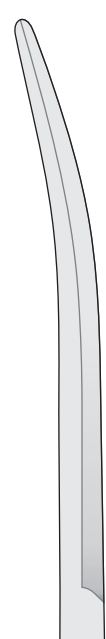

1/1

Forbici per dissezione - Dissecting Scissors - Präparierscheren - Ciseaux à dissection - Tijeras para preparaciones

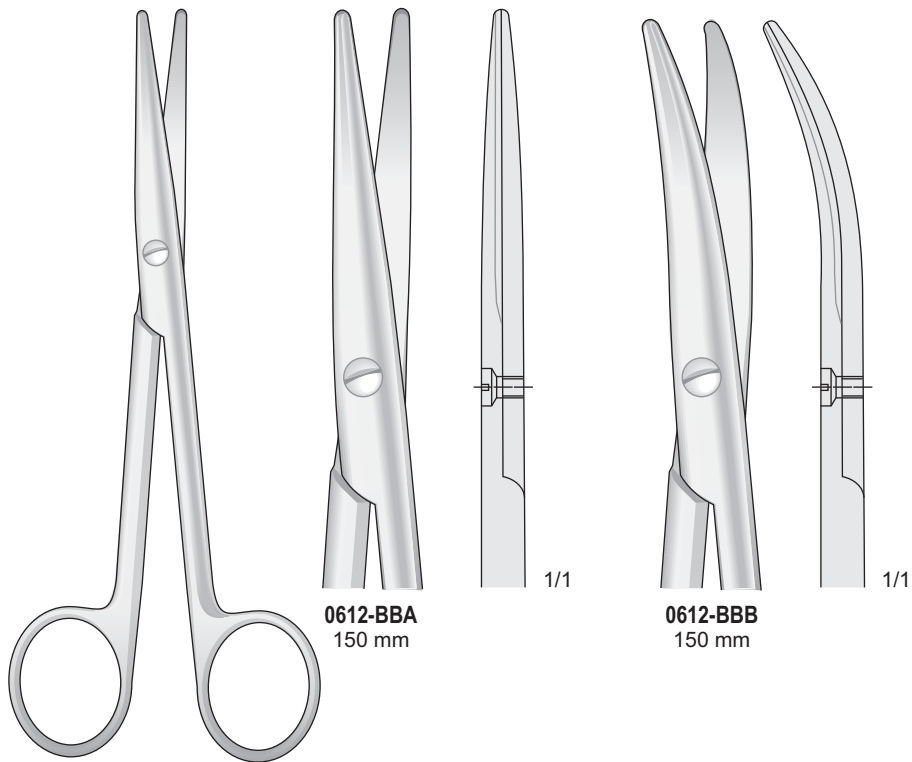

**0612-BBA**  
150 mm

**0612-BBB**  
150 mm

STILLE  
**0612-BBA/0612-BBB**  
150 mm

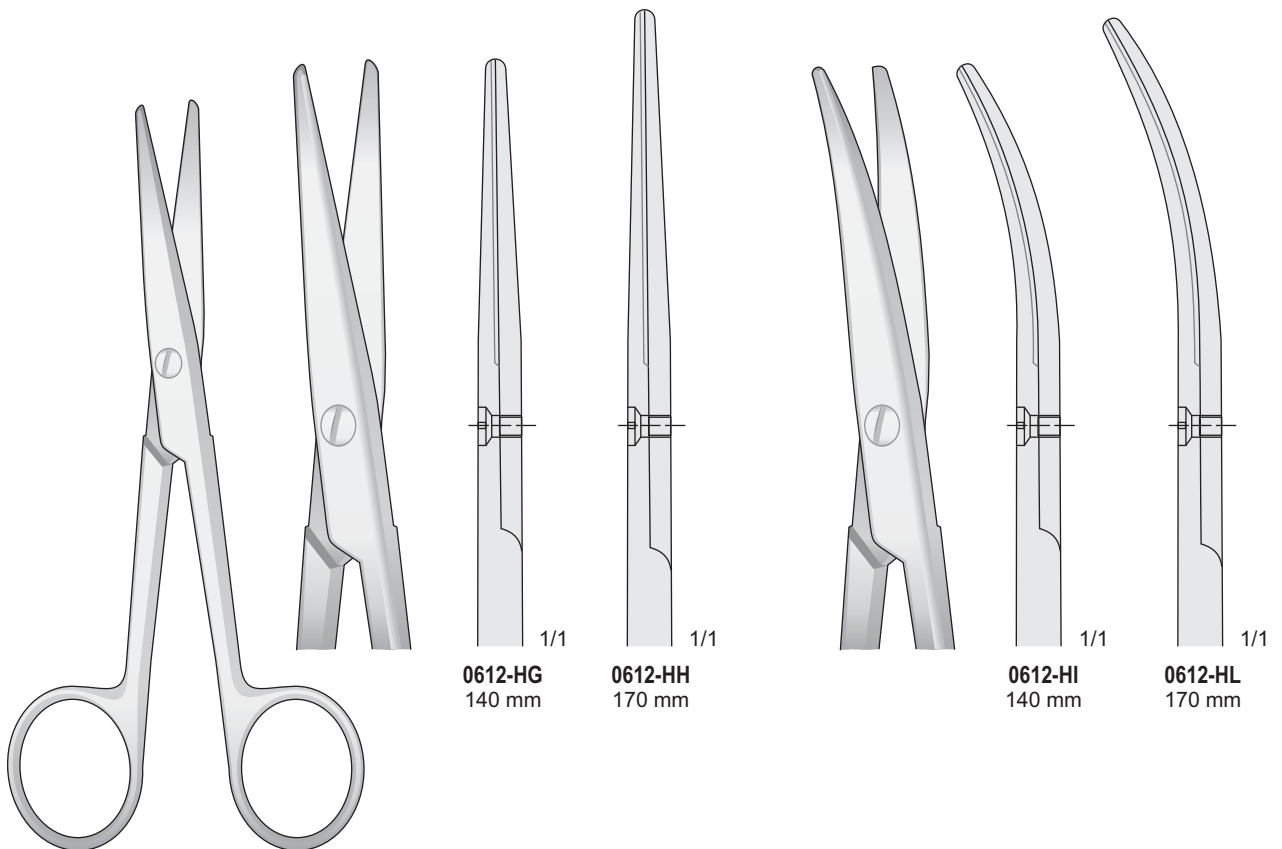

**0612-HG**  
140 mm

**0612-HH**  
170 mm

**0612-HI**  
140 mm

**0612-HL**  
170 mm

MAYO-STILLE  
**0612-HG/0612-HL**

Forbici per dissezione a taglio bilaterale - Bilateral Dissecting Scissors  
 Präparierscheren - Ciseaux à dissection - Tijeras para preparaciones

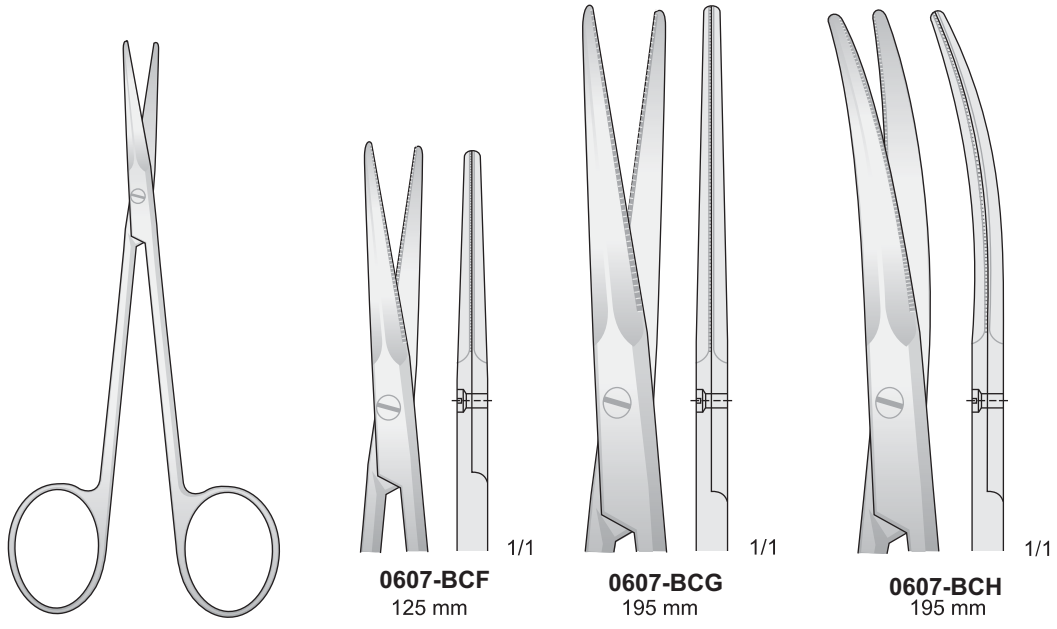

GORNEY  
**0607-BCF/0607-BCH**

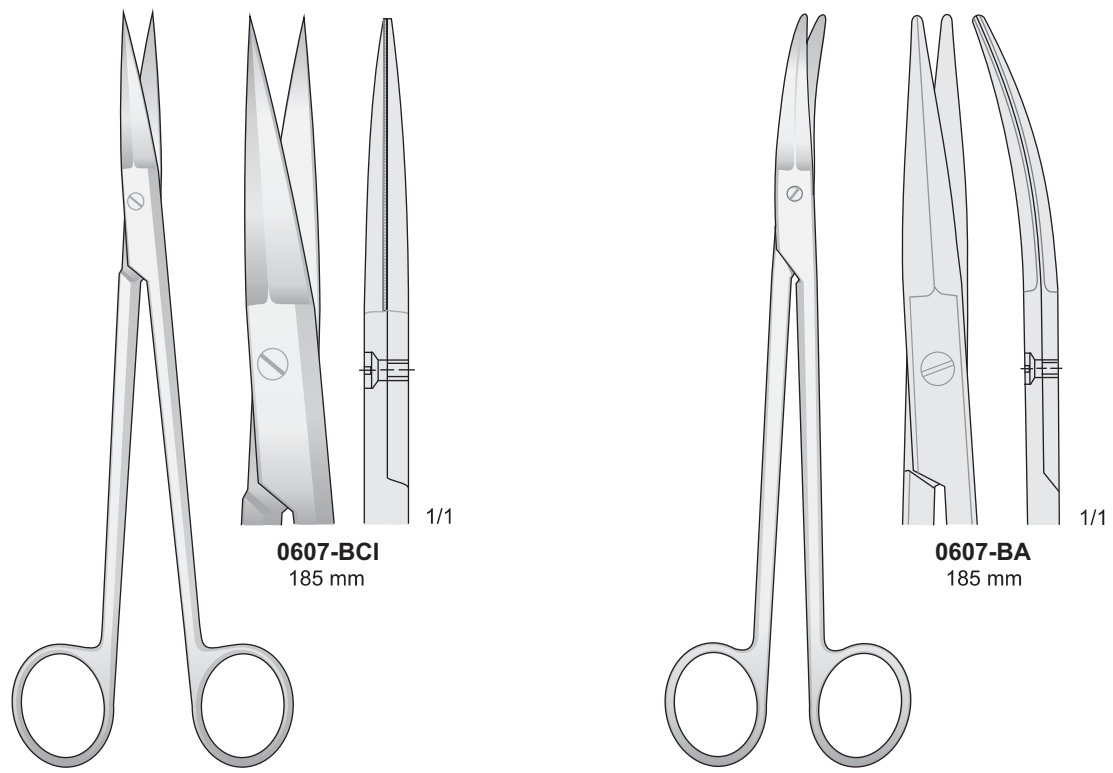

**0607-BCI**  
185 mm

**0607-BA**  
185 mm

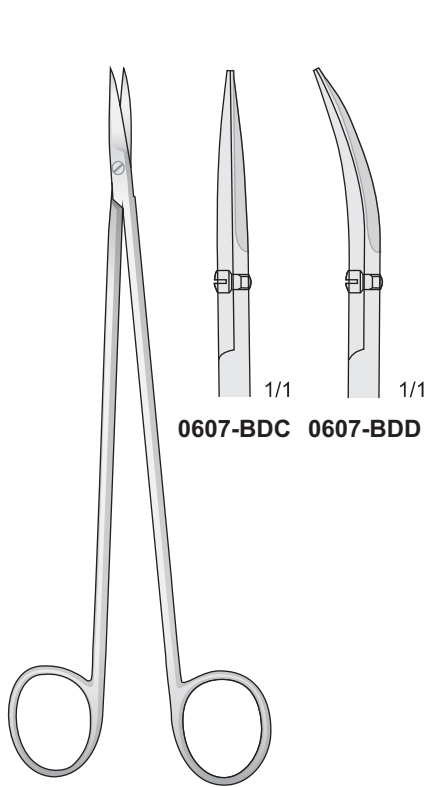

**0607-BDC 0607-BDD**

**0607-BDC/0607-BDD**

190 mm

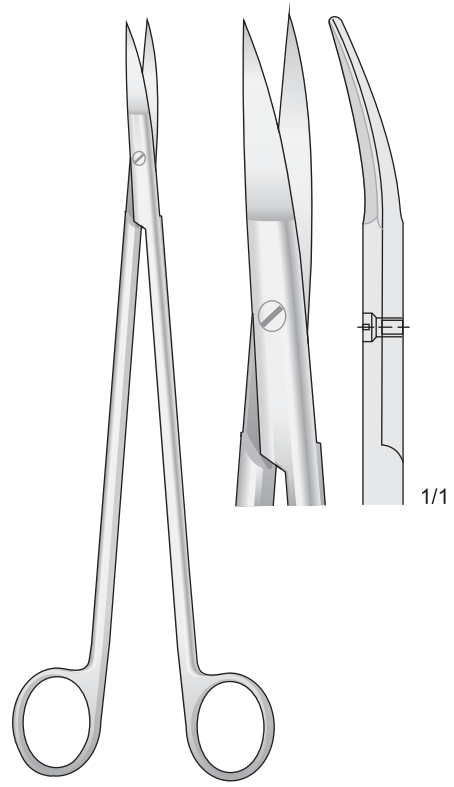

STRULLY  
**0607-BAG**

220 mm

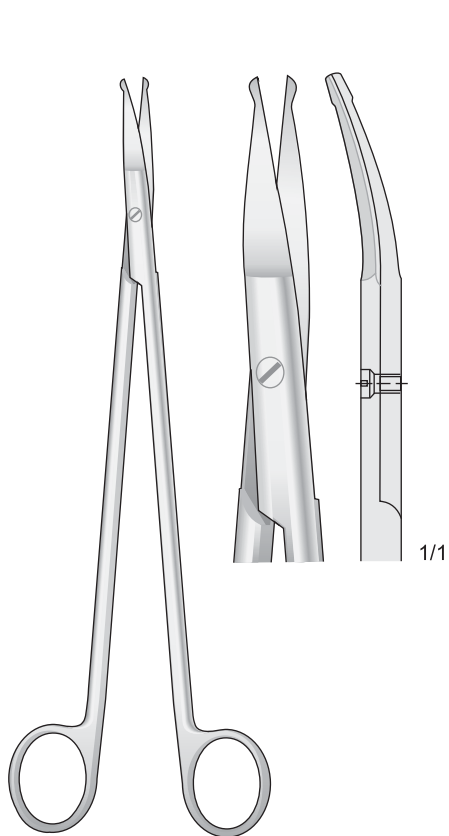

STRULLY  
**0607-BAH**

220 mm

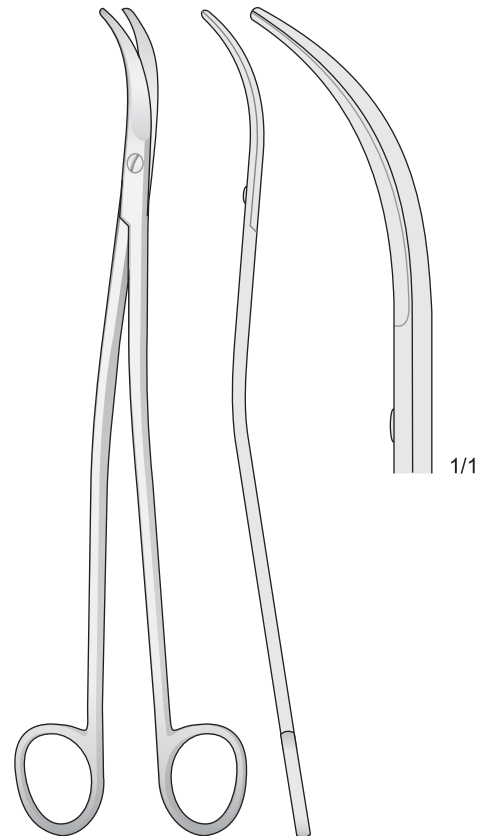

SATINSKY  
**0607-II**

245 mm

Dentellata - Serrated - Gezahnt - Dentelé - Dentadas

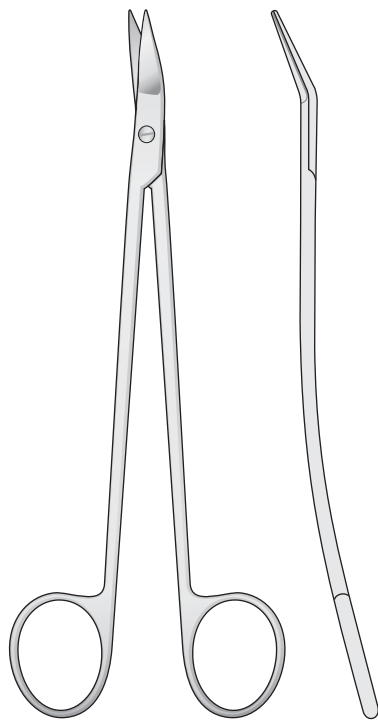

DEAN  
04050113  
180 mm

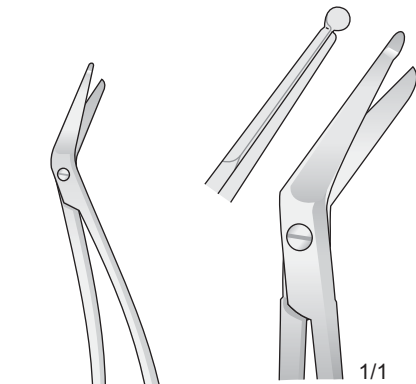
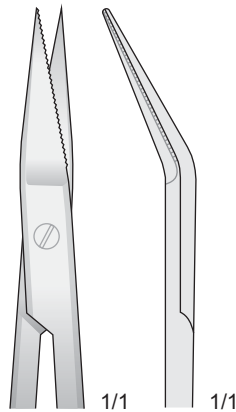

SCHMIEDEN-TAYLOR  
0607-BFC  
155 mm

Dentellata - Serrated - Gezahnt - Dentelé - Dentadas

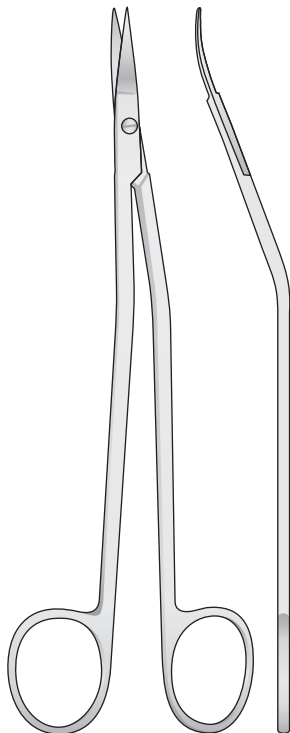

DANDY  
0607-EC  
175 mm

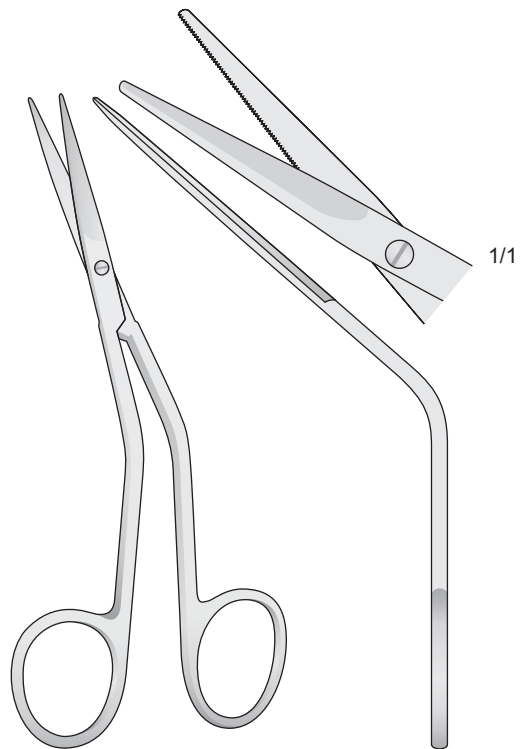

FOMON  
0607-EB  
135 mm



Forbici nasali - Nasal Scissors - Nasenscheren - Ciseaux nasaux - Tijeras nasales

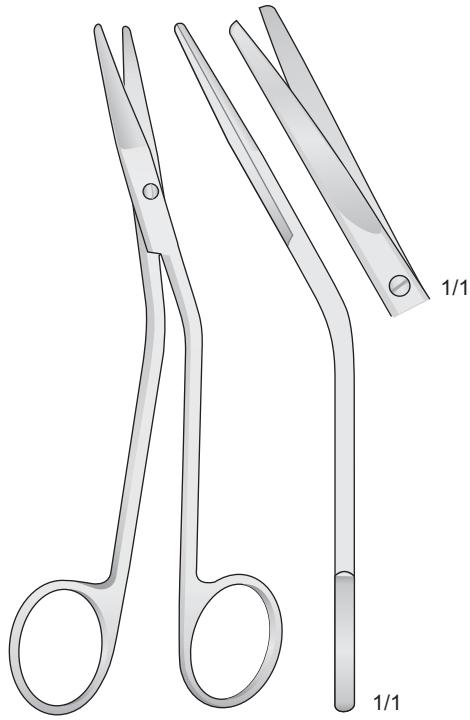

**FOMON**  
**0607-H**  
150 mm



**HEYMANN**  
**0607-I**  
180 mm

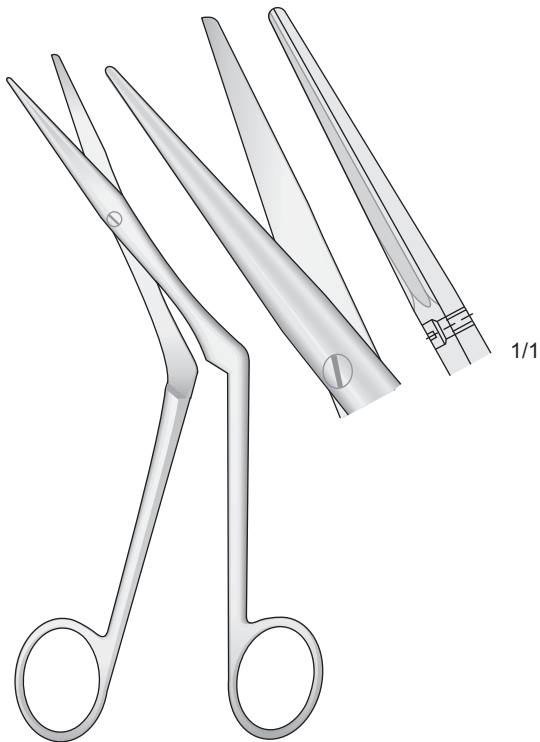

**HEYMANN-KNIGHT**  
**0607-LL**  
175 mm

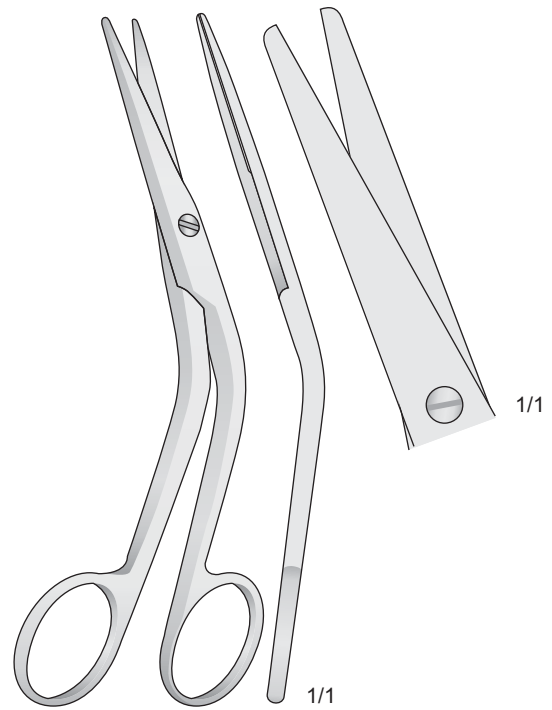

**COTTLE**  
**0607-L**  
160 mm

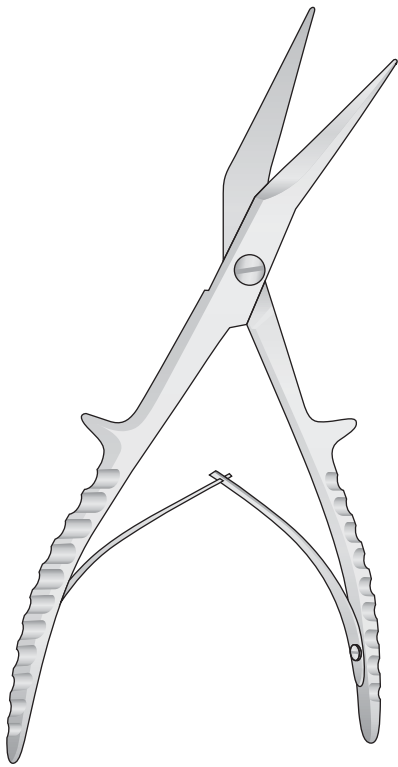

**0607-BBA**  
195 mm

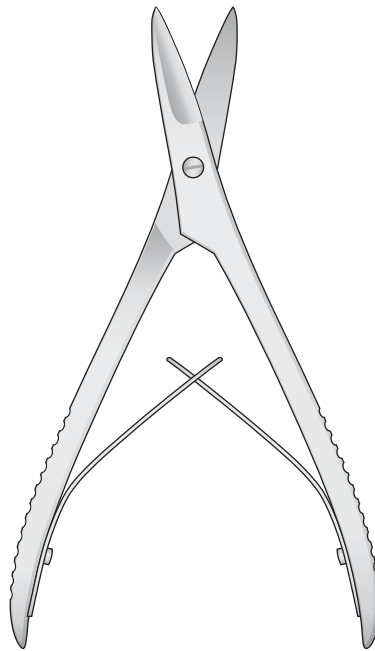

**0614-GD**  
160 mm

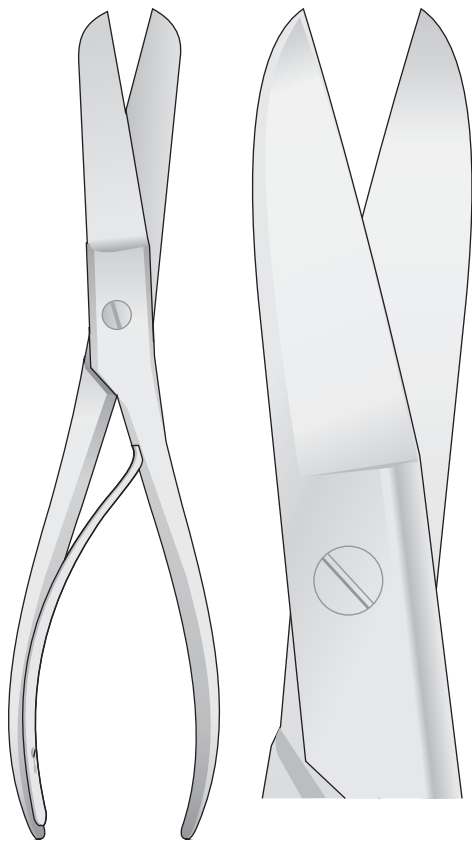
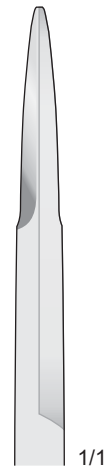

**0607-EA**  
230 mm

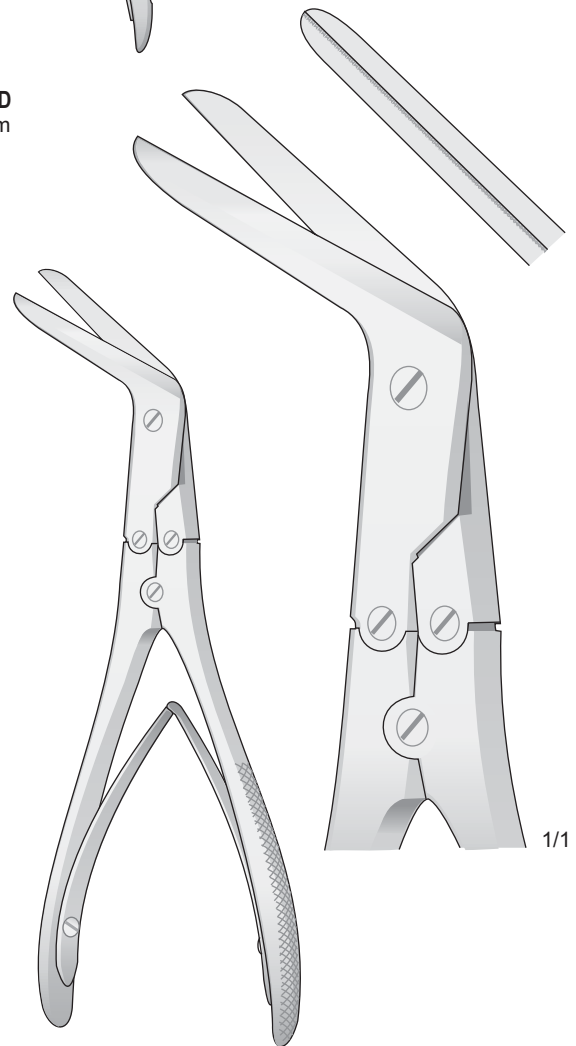
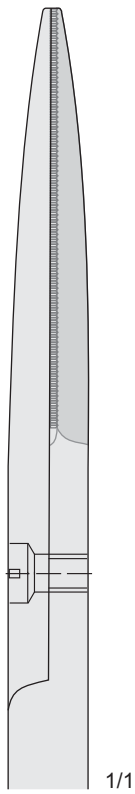

**KILLIAN**  
**0614-BED**  
210 mm

1/1

Forbici vascolari

Vascular scissors

Gefäß Scheren

Ciseaux vasculaires

Tijeras vasculares

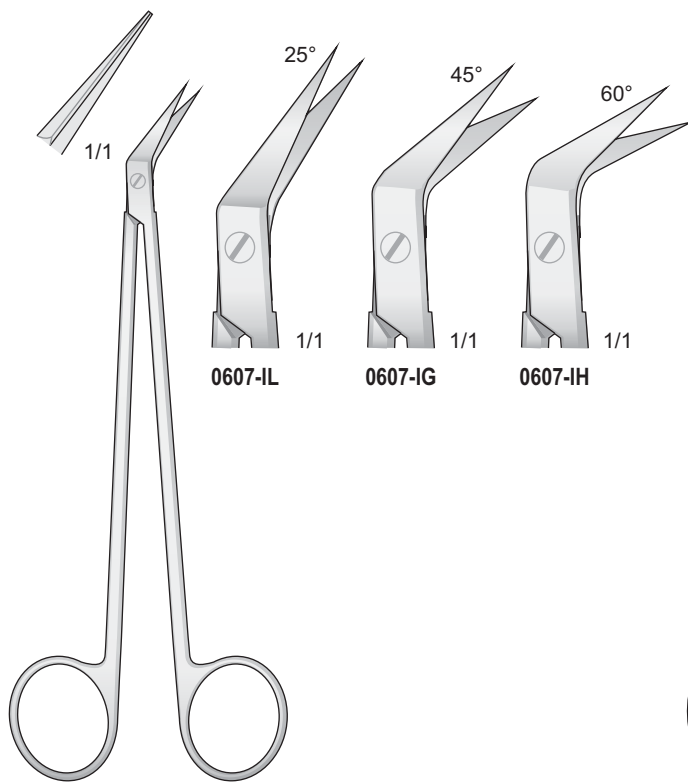

DE BAKEY (POTTS-SMITH)  
0607-IG/0607-IL  
160 mm

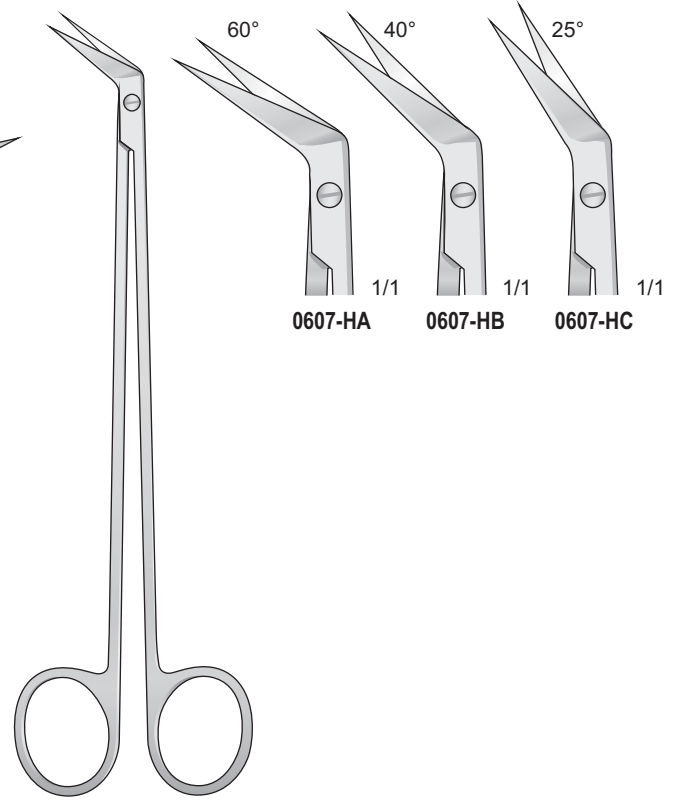

POTTS-SMITH  
0607-HA/0607-HC  
190 mm

Smussa - Blunt - Stumpf  
Mousse - Romas

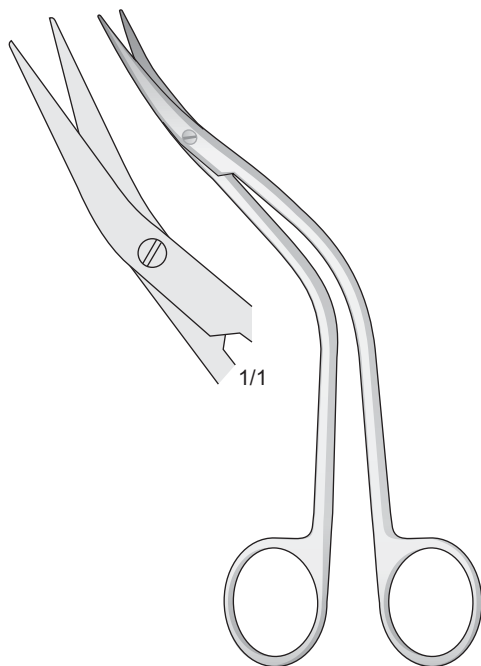

DE BAKEY  
0607-HI  
155 mm

Acuta - Sharp - Spitz  
Pointu - Agudas

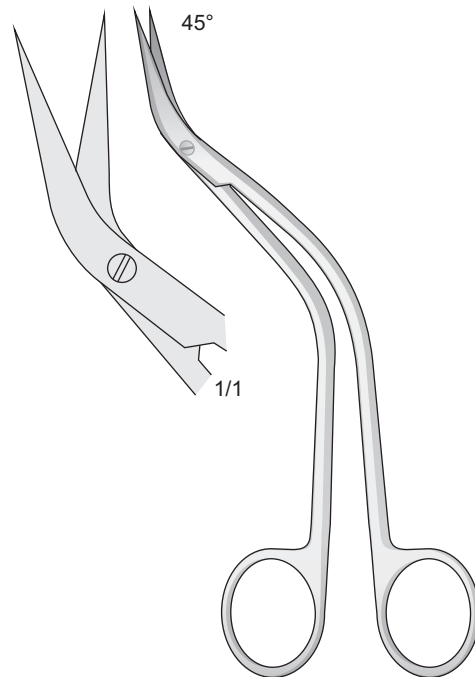

DE BAKEY  
0607-HL  
155 mm

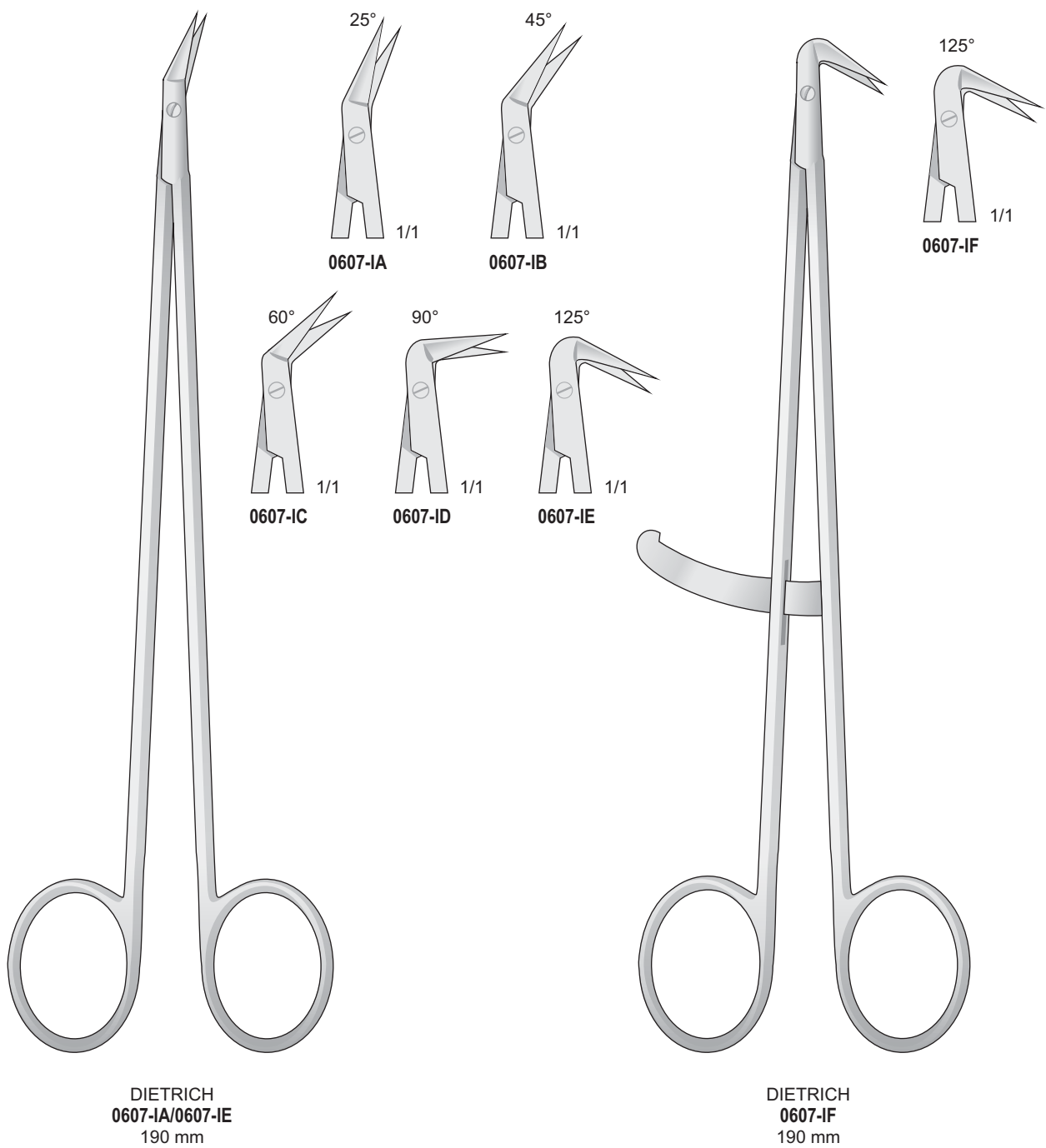

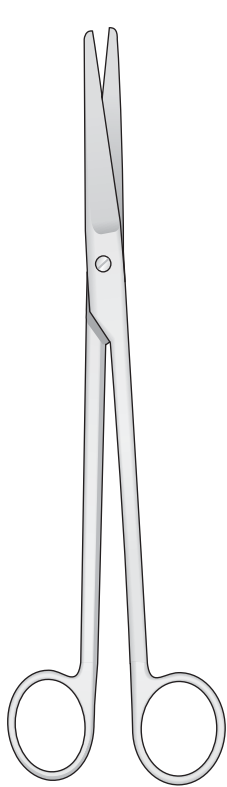

**MAYO-HARRINGTON**  
0612-BI/0612-BL  
230 mm

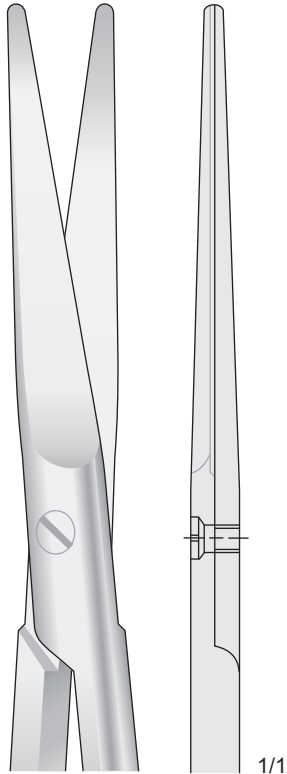

**0612-BI**  
230 mm

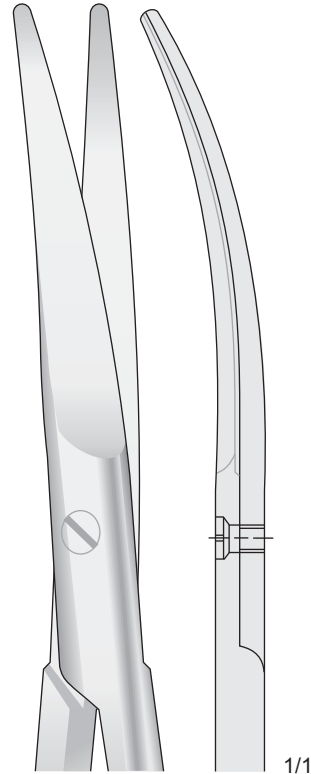

**0612-BL**  
230 mm

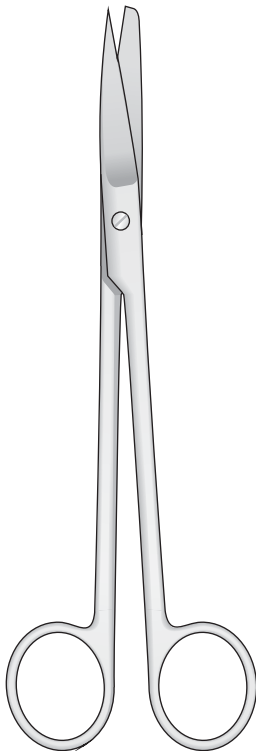

**SIMS**  
0612-BE/0612-BH

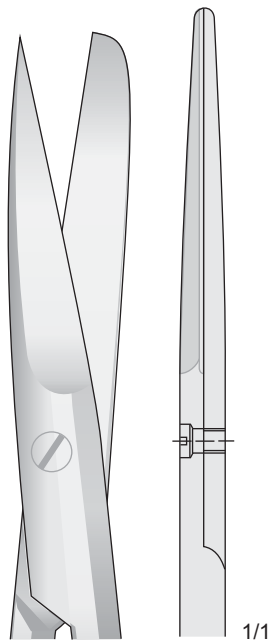

**0612-BE**  
200 mm

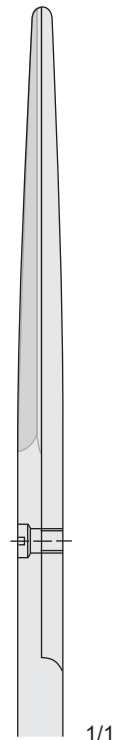

**0612-BG**  
230 mm

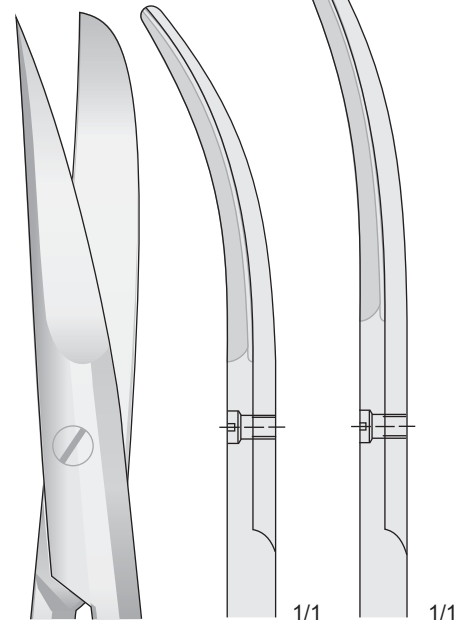

**0612-BF**  
200 mm

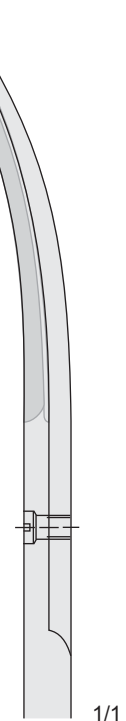

**0612-BH**  
230 mm

Forbici chirurgiche    Operating scissors    Chirurgische Scheren    Ciseaux chirurgicaux    Tijeras para cirugia general

Punte smusse

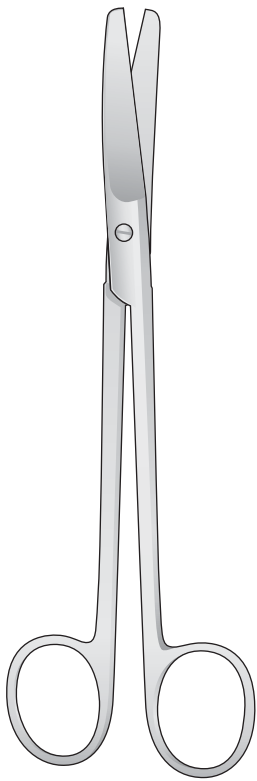

SIMS  
0612-CA/0612-CD

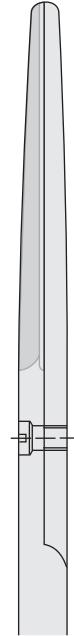
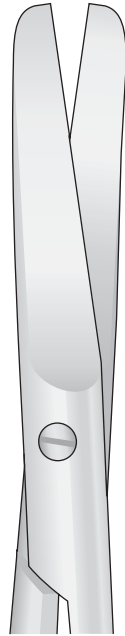

0612-CA  
200 mm

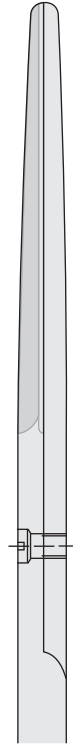

0612-CC  
230 mm



0612-CB  
200 mm

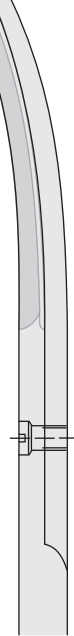

0612-CD  
230 mm

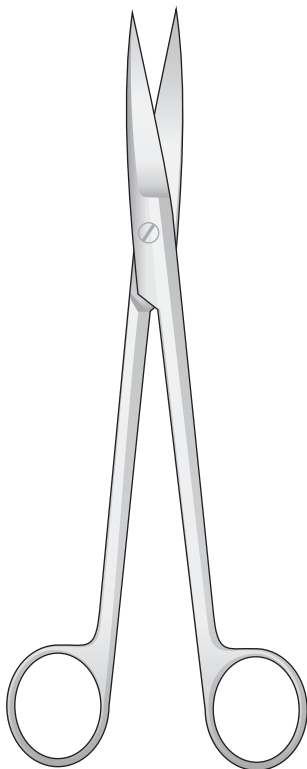

SIMS  
0607-BDI  
200 mm

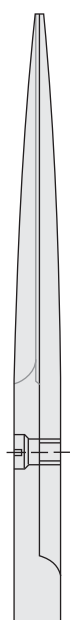

0607-BDI  
200 mm

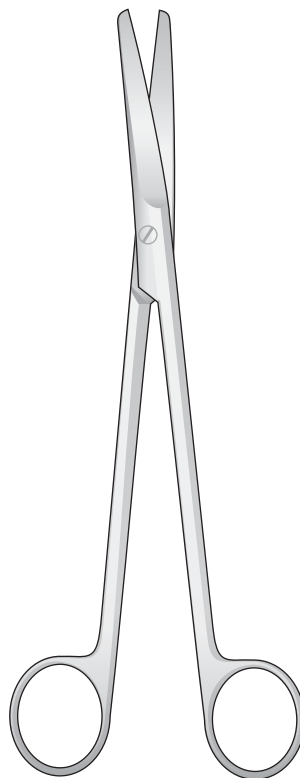

SIMS  
0607-BDL  
210 mm

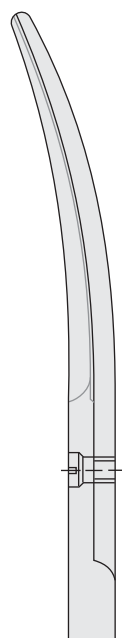

0607-BDL  
210 mm

Forbici per episiotomia - Episotomy scissors  
 Episotomie-Scheren - Ciseaux à épisotomie  
 Tijeras para episiotomia

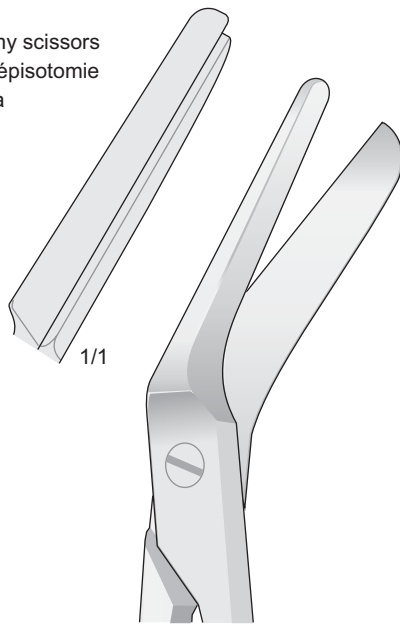
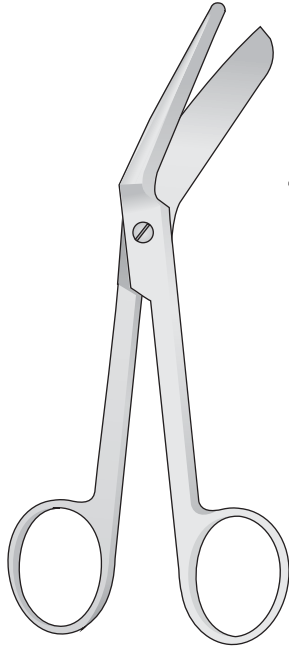

**0607-DE**  
145 mm

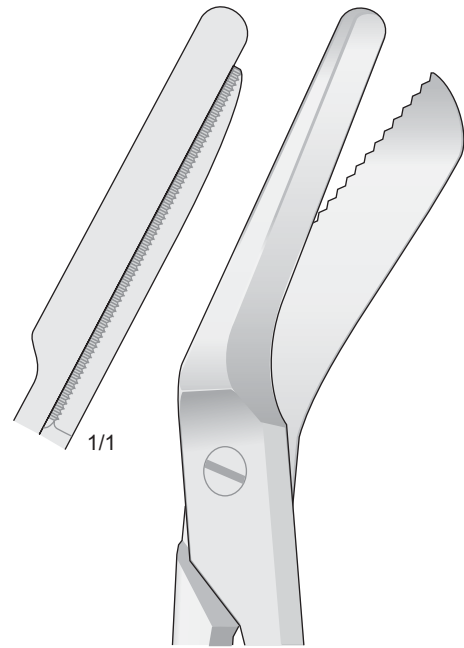

**0607-LG**  
200 mm

**BRAUN-STADLER**  
0607-DE/0607-LG

Forbici per cordone ombelicale - Umbilical cord scissors  
 Nabelschnur Scheren - Ciseaux à cordon ombilical  
 Tijeras umbilicales

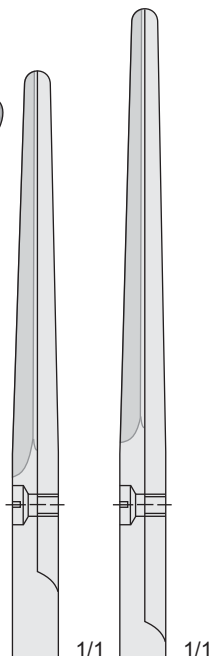
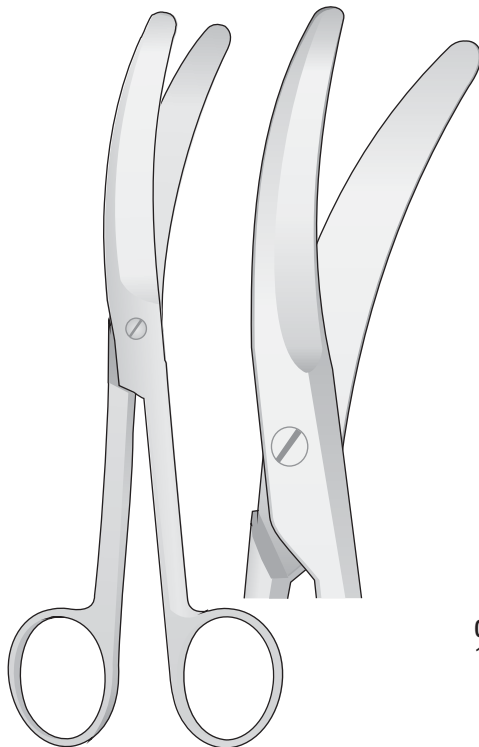

**0607-LH**  
135 mm

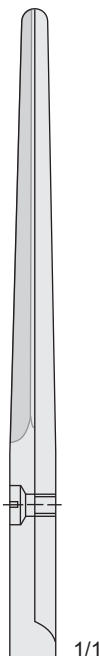

**0607-DF**  
160 mm

**0607-DF/0607-LH**

Forbici per cefalotomia - Cephalotomy scissors  
 Kephilotomie Scheren - Ciseaux à cèphalotomie  
 Tijeras para cefalotomia

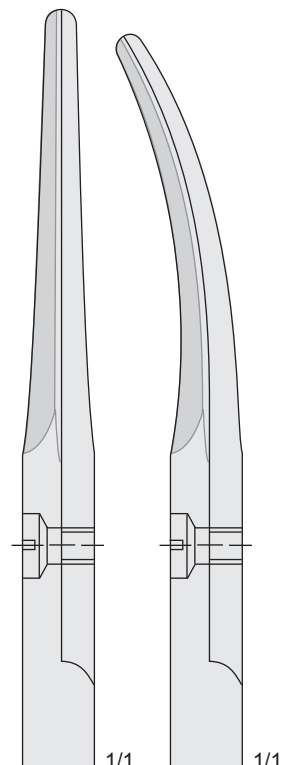

**0612-CG**  
270 mm

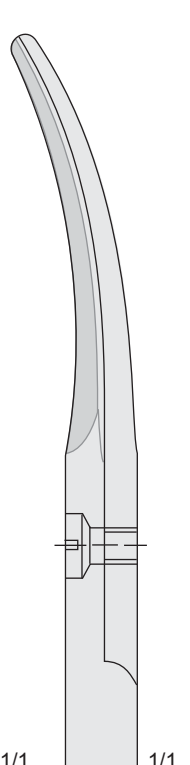

**0612-BHF**  
270 mm

**DUBOIS**  
0612-CG/0612-BHF

Forbici per utero  
 Uterine scissors  
 Uterusschere  
 Ciseaux utérins  
 Tijeras para útero

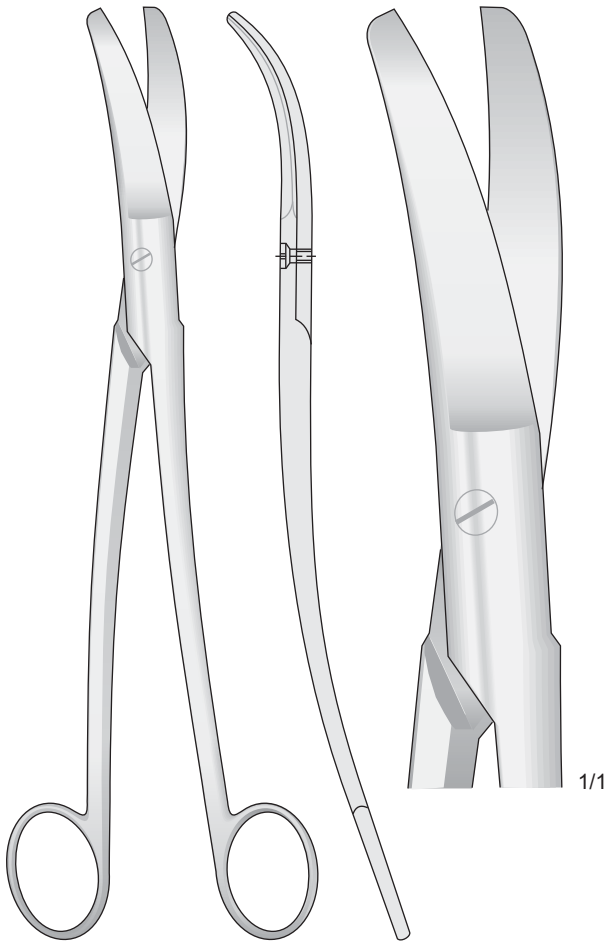

**SIEBOLD**  
**0607-BEE**  
 245 mm

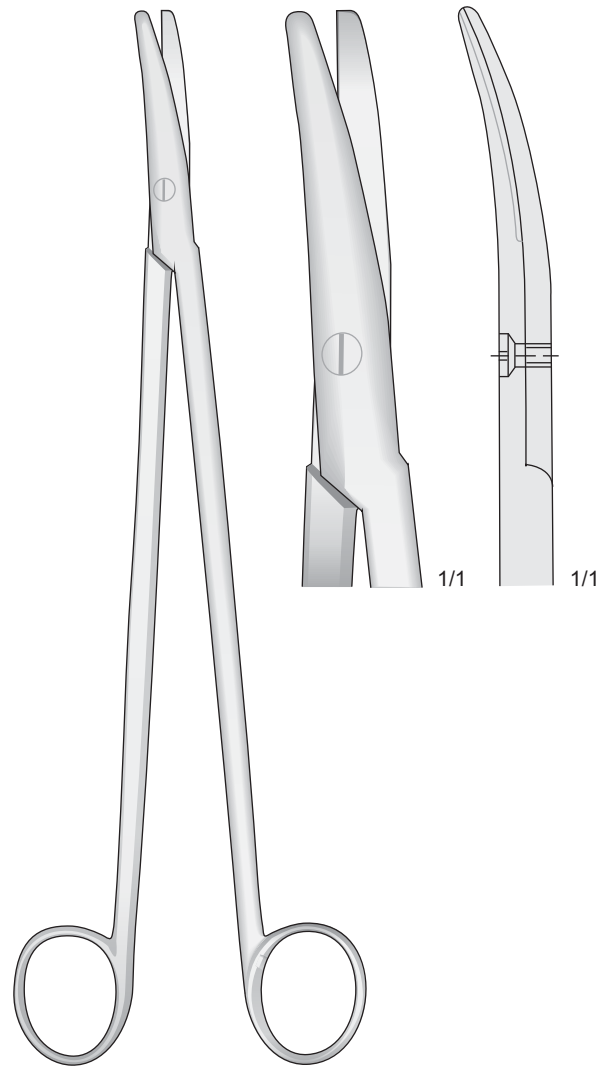

**WELLER**  
**0607-BCL**  
 280 mm



Forbici per Enterotomia  
Bowel Scissors  
Darmscheren  
Ciseaux-Entérotomes  
Enterótomos

Forbici per Episiotomia  
Episiotomy Scissors  
Episiotomie-Scheren  
Ciseaux à épisiotomie  
Tijeras para Episiotomia

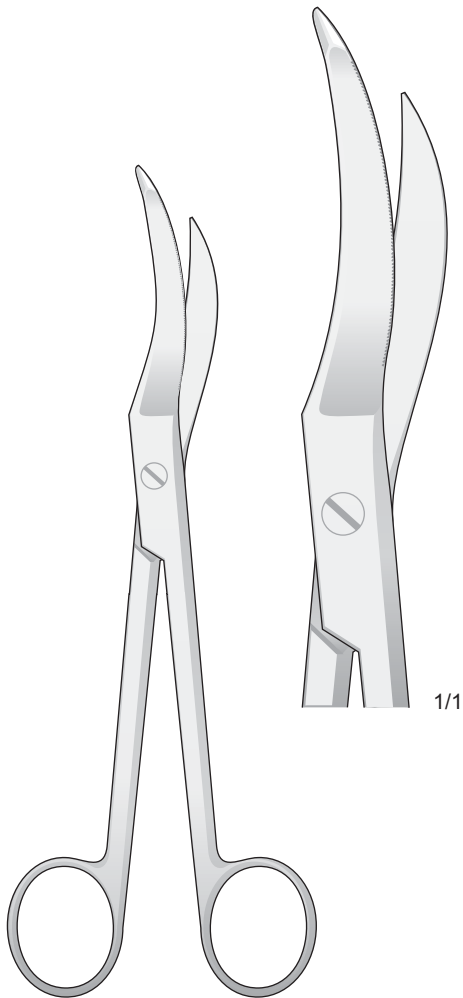

WALDMANN  
0607-BEL  
180 mm

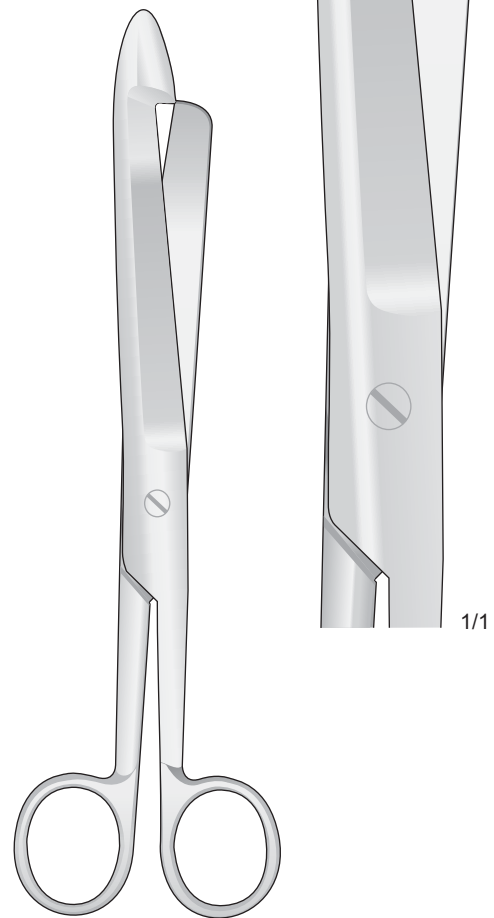

0607-BIA  
210 mm

Forbici chirurgiche    Operating scissors    Chirurgische Scheren    Ciseaux chirurgicaux    Tijeras para cirugía general

Forbici "super-cut" estremamente taglienti per tessuti con riduzione del trauma - "Super-cut" scissors for gripping tissue and cutting interproximally  
 "Super-cut" scheren micro-schliff für tissue atrauma - Ciseaux "super cut" coupe les tissus en reduisant les risques de traumatisme  
 Tijeras "super cortes" para cortar tissue-atrauma

Forbici Dentellate  
 Scissors Serrateds  
 Gezahnte Scheren  
 Ciseaux Dentelé  
 Tijeras Dentada

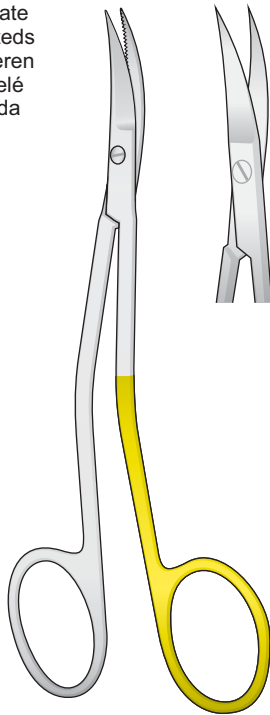

LA GRANGE  
 1107-B1803/1107-C1803  
 115 mm



1/1

Acute  
 Sharp  
 Spitz  
 Pointu  
 Agudas

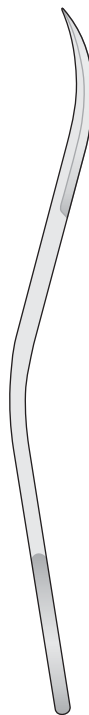

LA GRANGE  
 1107-B1803

Smusse  
 Blunt  
 Stumpf  
 Mousse  
 Romas



LA GRANGE  
 1107-C1803

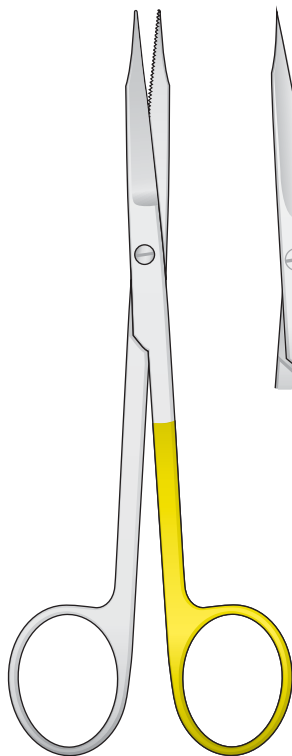

GOLDMAN-FOX  
 070617-1803/070603-1803  
 135 mm



1/1

070617-1803

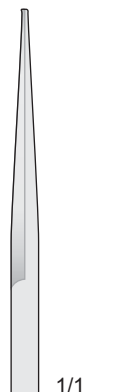

1/1

070603-1803

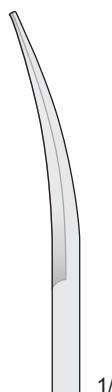

1/1

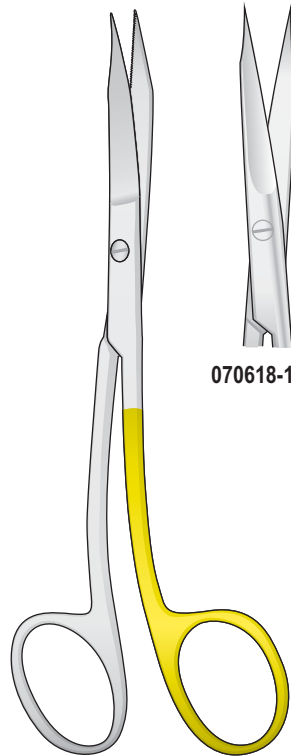

GOLDMAN-FOX S FORM  
 070618-1803  
 130 mm



1/1

070618-1803

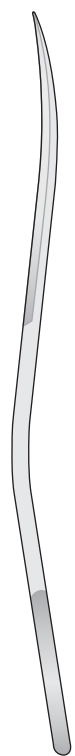

Forbici "super-cut" estremamente taglienti per tessuti con riduzione del trauma - "Super-cut" scissors for gripping tissue and cutting interproximally  
 "Super-cut" scheren micro-schliff für tissue atrauma - Ciseaux "super cut" coupe les tissus en reduisant les risques de traumatisme  
 Tijeras "super cortes" para cortar tissue-atrauma

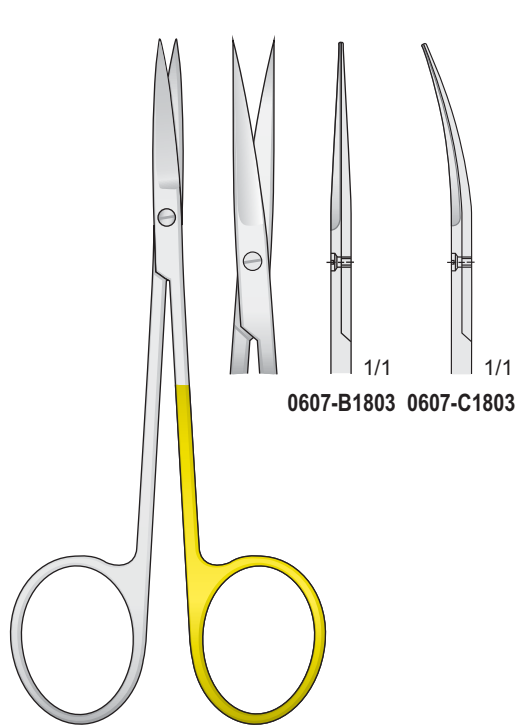

IRIS  
 0607-B1803/0607-C1803  
 110 mm

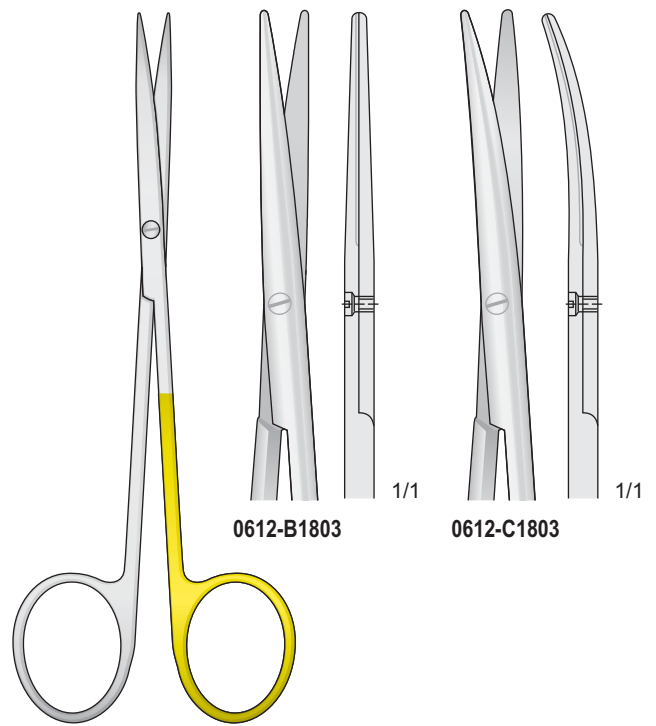

METZENBAUM  
 0612-B1803/0612-C1803  
 145 mm

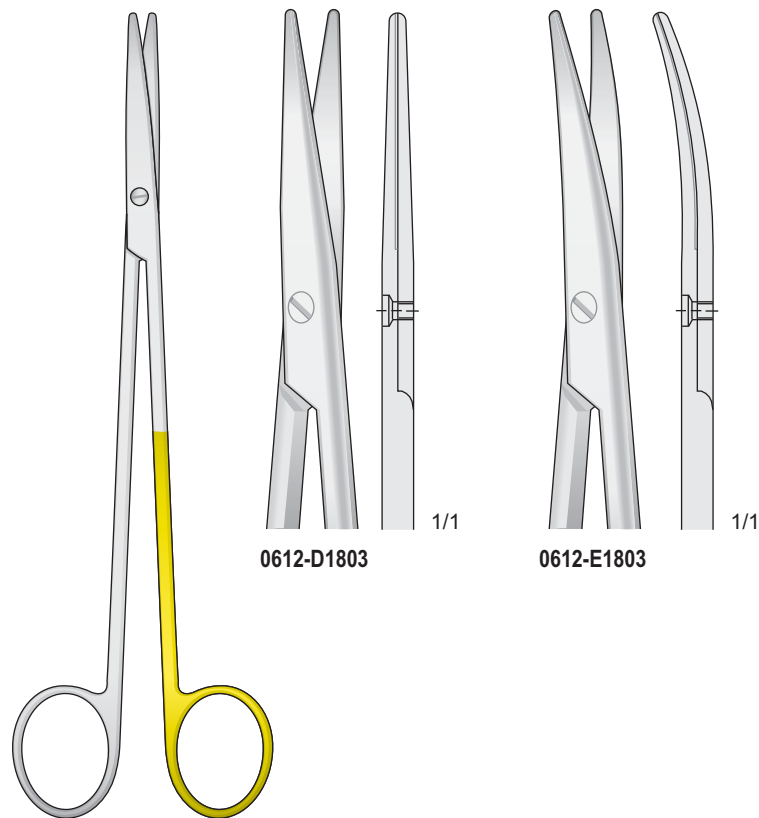

METZENBAUM  
 0612-D1803/0612-E1803  
 185 mm

Forbici chirurgiche    Operating scissors    Chirurgische Scheren    Ciseaux chirurgicaux    Tijeras para cirugia general

Forbici "super-cut" estremamente taglienti per tessuti con riduzione del trauma - "Super-cut" scissors for gripping tissue and cutting interproximally  
 "Super-cut" scheren micro-schliff für tissue atrauma - Ciseaux "super cut" coupe les tissus en reduisant les risques de traumatisme  
 Tijeras "super cortes" para cortar tissue-atrauma

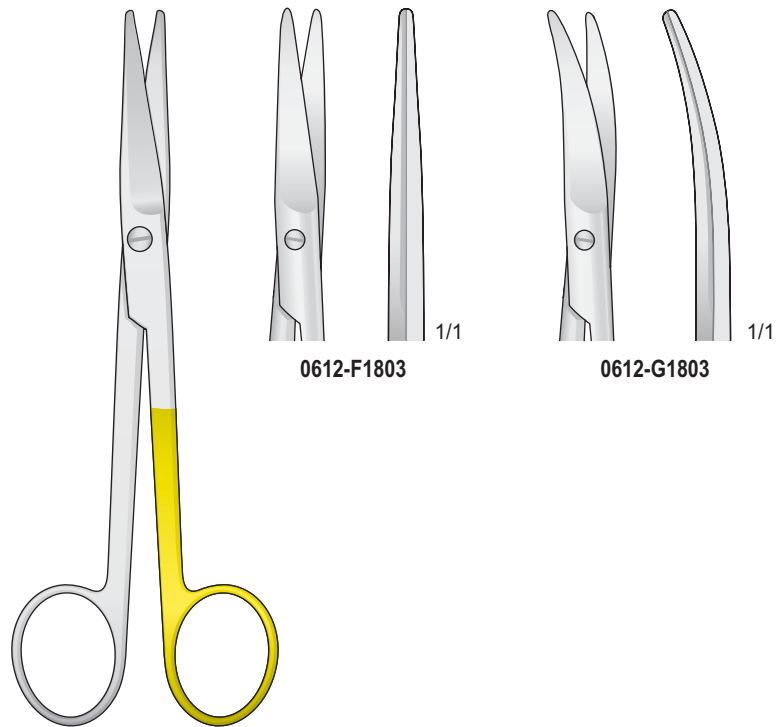

MAYO  
 0612-F1803/0612-G1803  
 140 mm

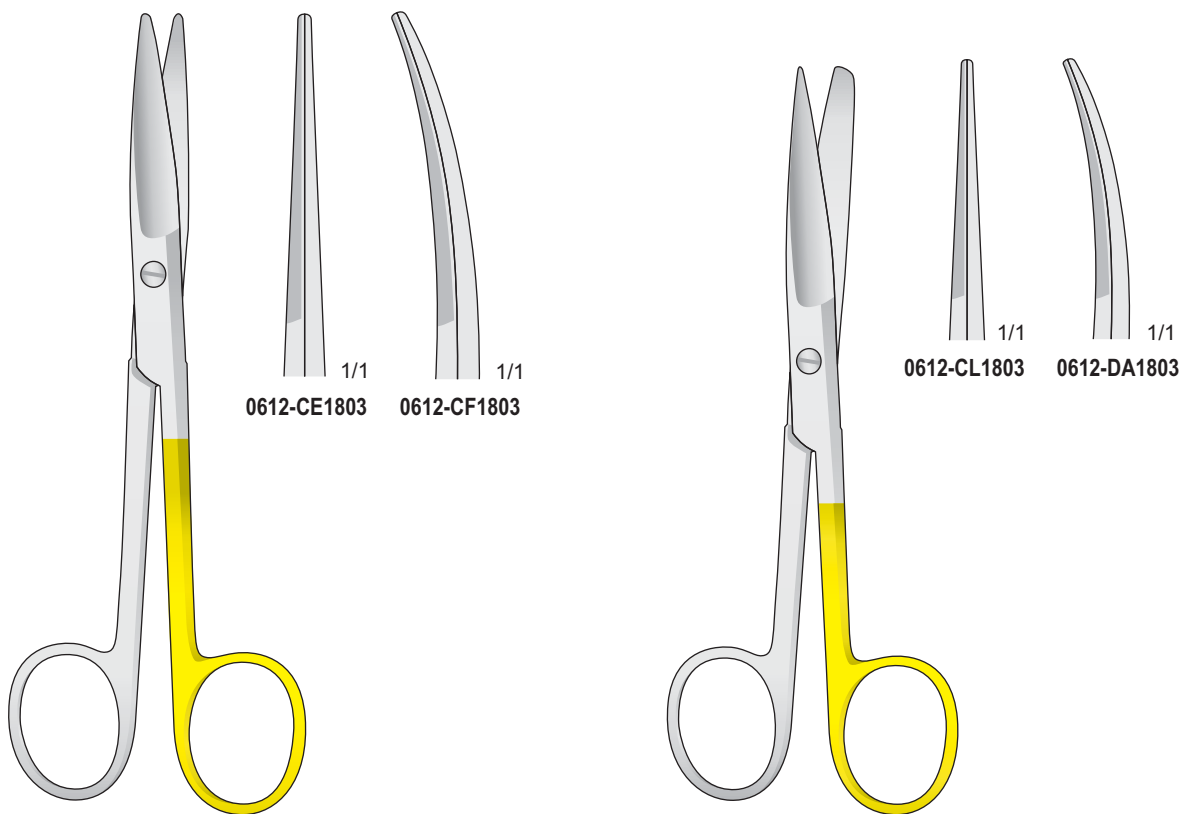

MAYO  
 0612-CE1803/0612-CF1803  
 170 mm

0612-CL1803/0612-DA1803  
 145 mm

Forbici per mancini

Left scissors

Links Scheren

Gauche Ciseaux

Tijeras para zurdos

L = mancini  
left  
links  
gauche  
izquierda

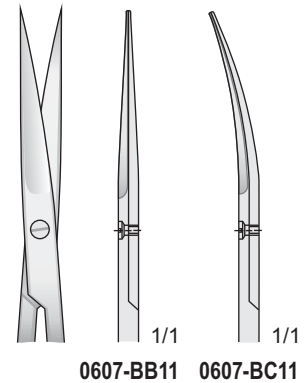
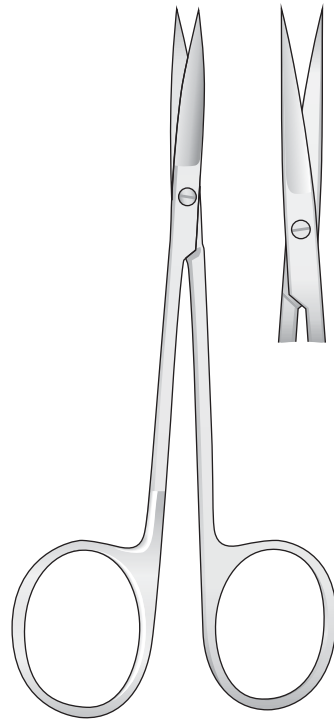

0607-BB11 0607-BC11

IRIS  
0607-BB11/0607-BC11  
110 mm

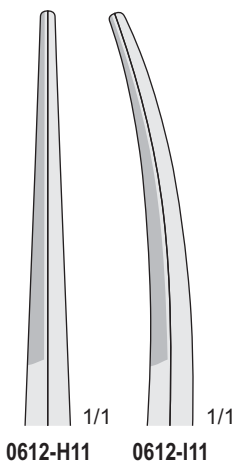
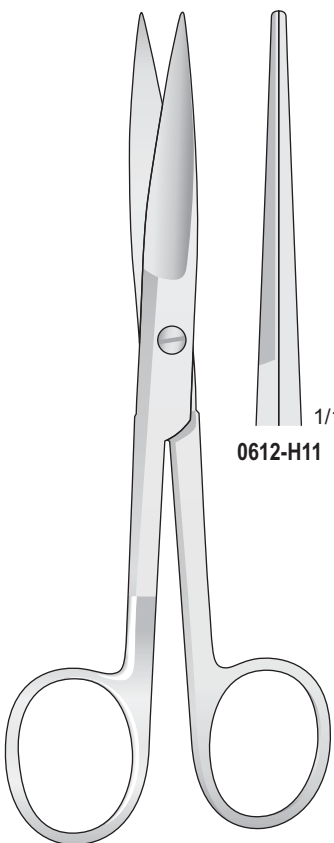

0612-H11 0612-I11

0612-H11/0612-I11  
145 mm

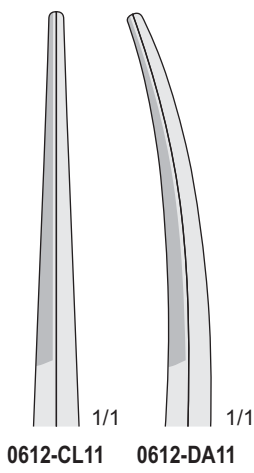
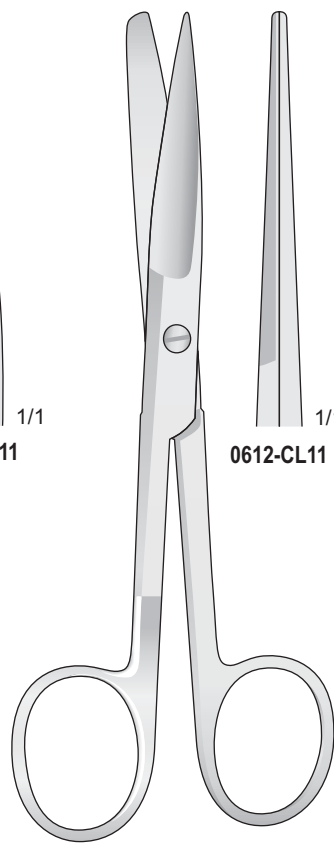

0612-CL11 0612-DA11

0612-CL11/0612-DA11  
145 mm

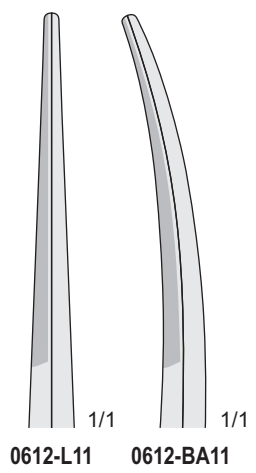
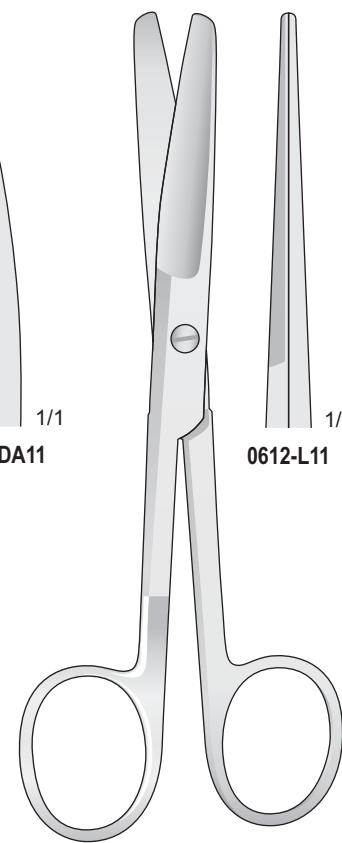

0612-L11 0612-BA11

0612-L11/0612-BA11  
145 mm

Con punta al carburo di tungsteno - Tungsten-carbide scissors  
 Mit Hartmetalleinsätzen - Avec plaquettes en carbure de tungstène - Tijeras de tungsteno

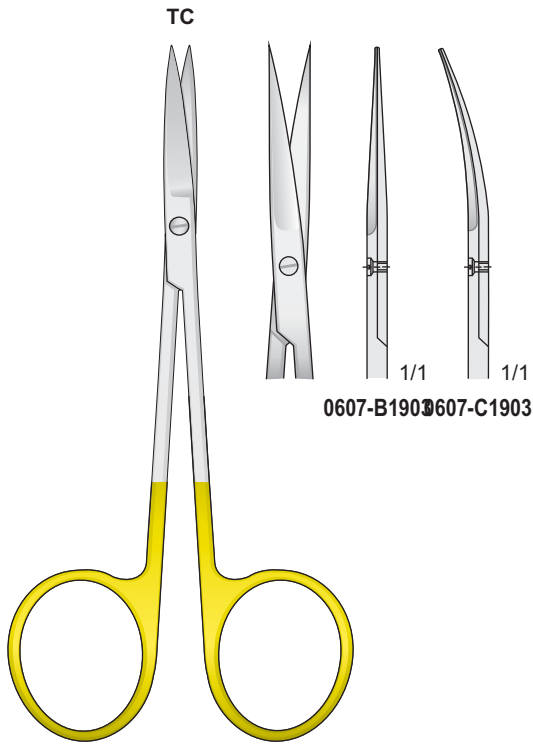

IRIS  
 0607-B1903/0607-C1903  
 115 mm

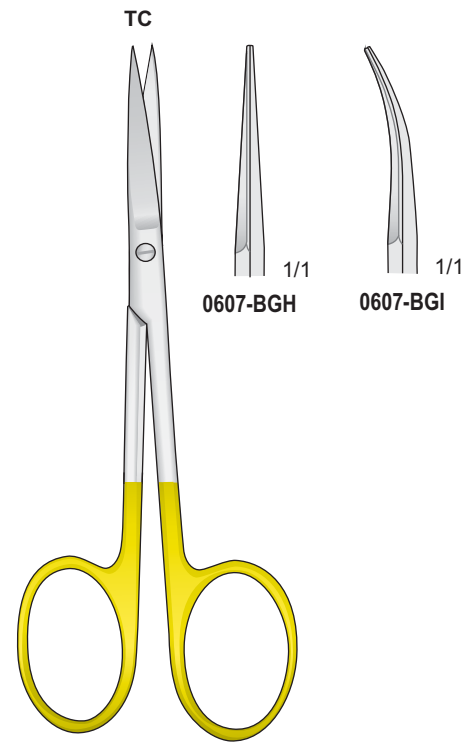

0607-BGH/0607-BGI  
 110 mm

Dentellata  
 Serrated  
 Gezahnt  
 Dentée  
 Dentadas

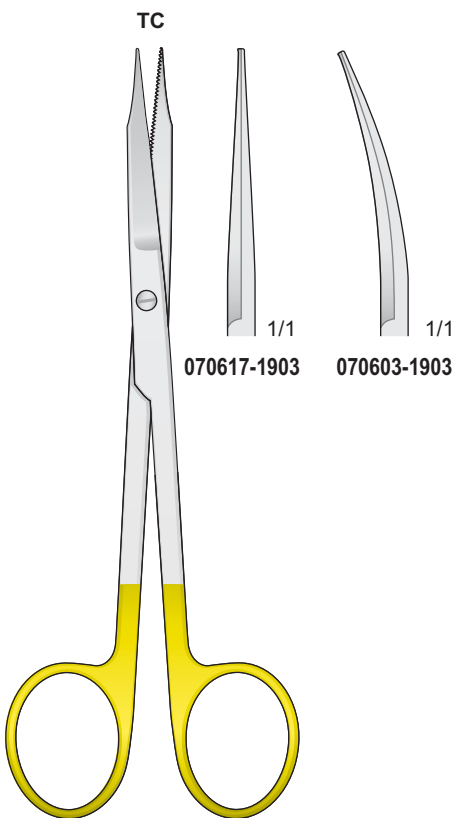

GOLDMAN-FOX  
 070617-1903/070603-1903  
 135 mm

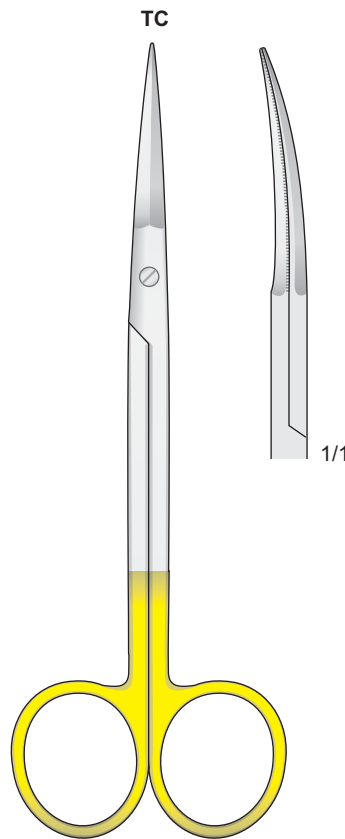

PECK-JOSEPH  
 0607-LC  
 140 mm

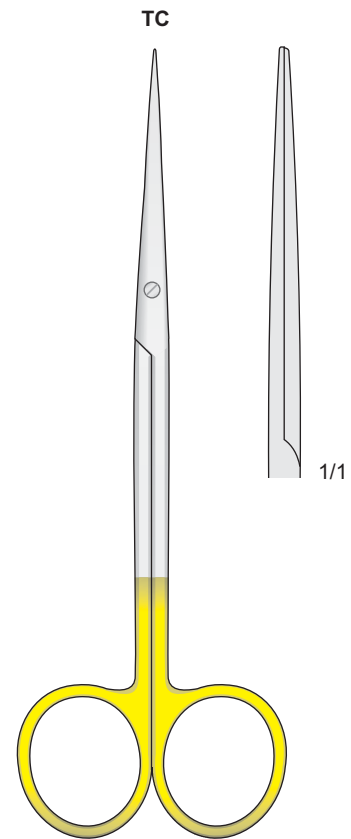

METZENBAUM-FINO  
 0612-LG  
 140 mm

Con punta al carburo di tungsteno - Tungsten-carbide scissors  
 Mit Hartmetalleinsätzen - Avec plaquettes en carbure de tungstène - Tijeras de tungsteno

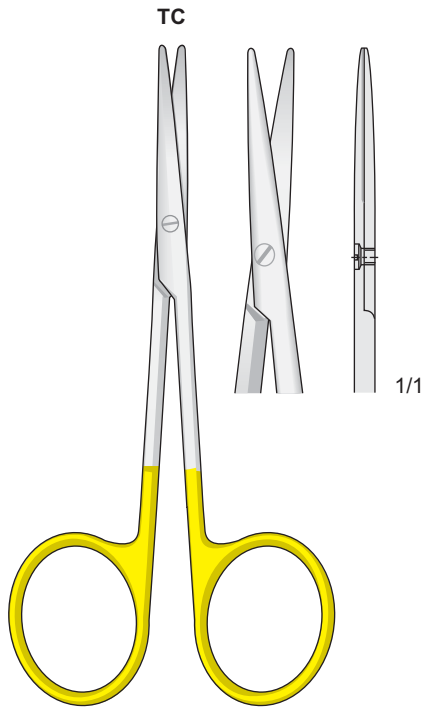

0612-BBI  
115 mm

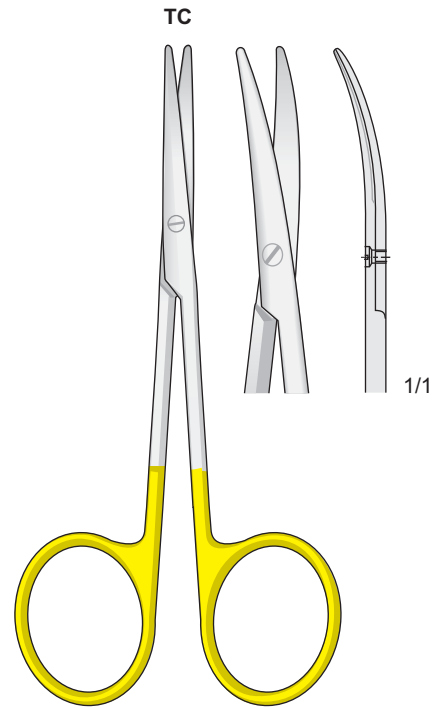

0612-BBL  
115 mm

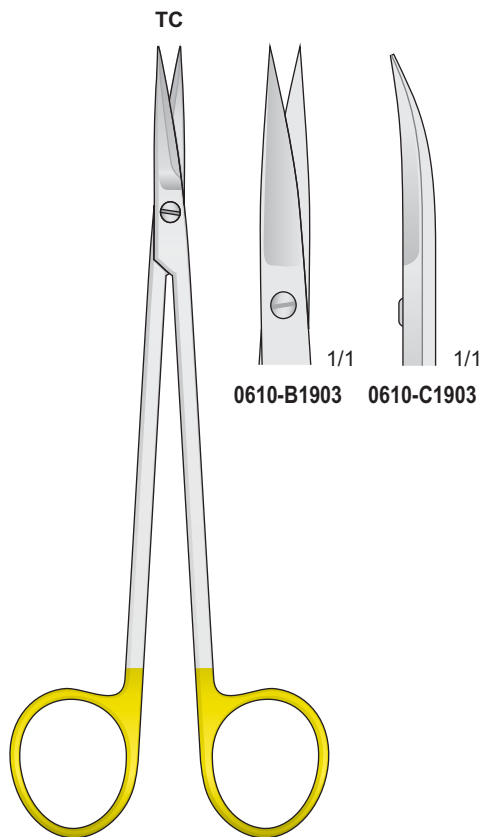

KELLY  
0610-B1903/0610-C1903  
160 mm

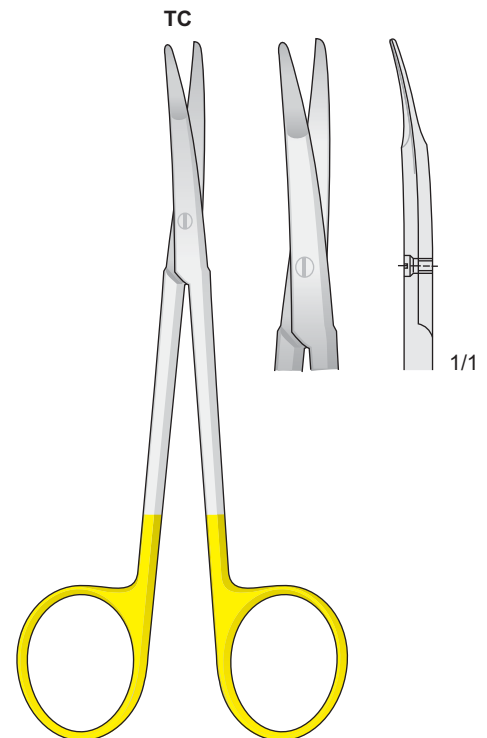

KILNER (RAGNELL)  
0612-DFA  
125 mm

Con punta al carburo di tungsteno - Tungsten-carbide scissors  
 Mit Hartmetalleinsätzen - Avec plaquettes en carbure de tungstène - Tijeras de tungsteno

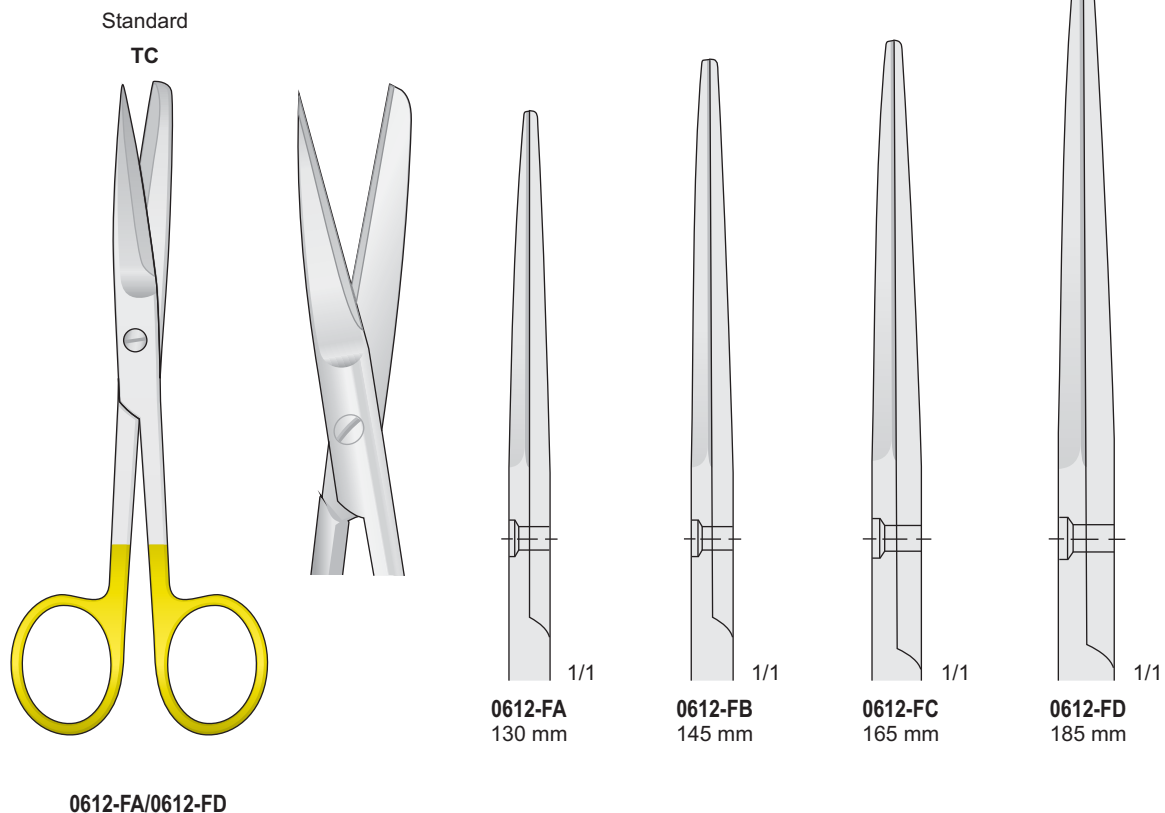



Con punta al carburo di tungsteno - Tungsten-carbide scissors  
 Mit Hartmetalleinsätzen - Avec plaquettes en carbure de tungstène - Tijeras de tungsteno

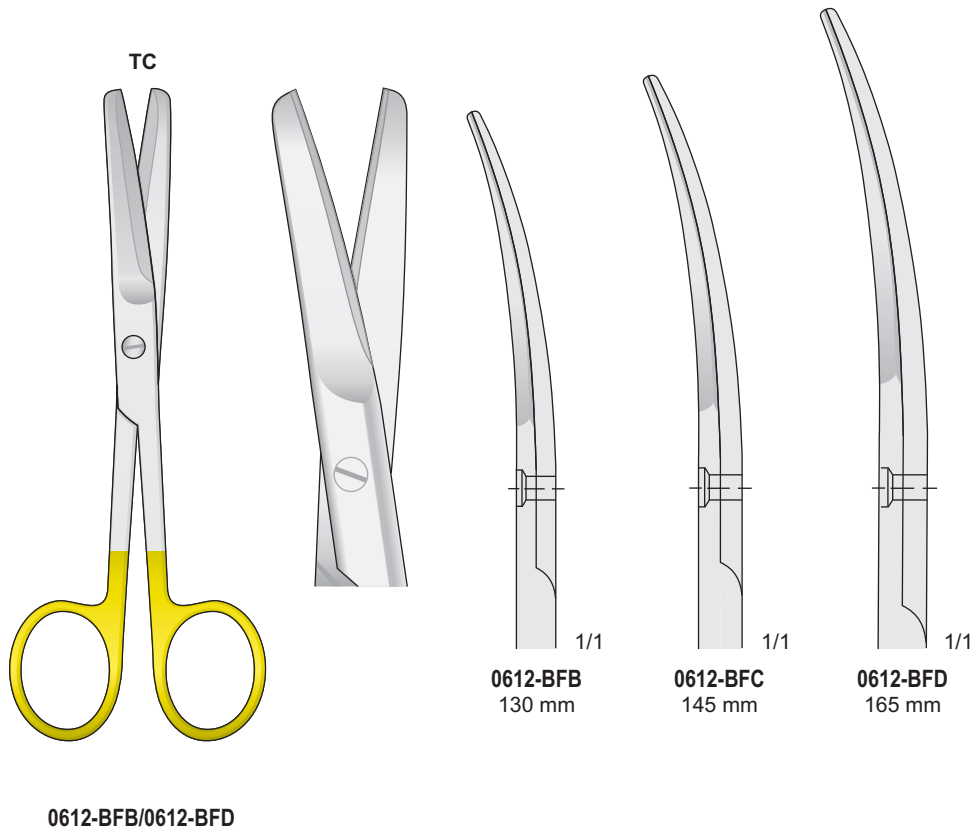
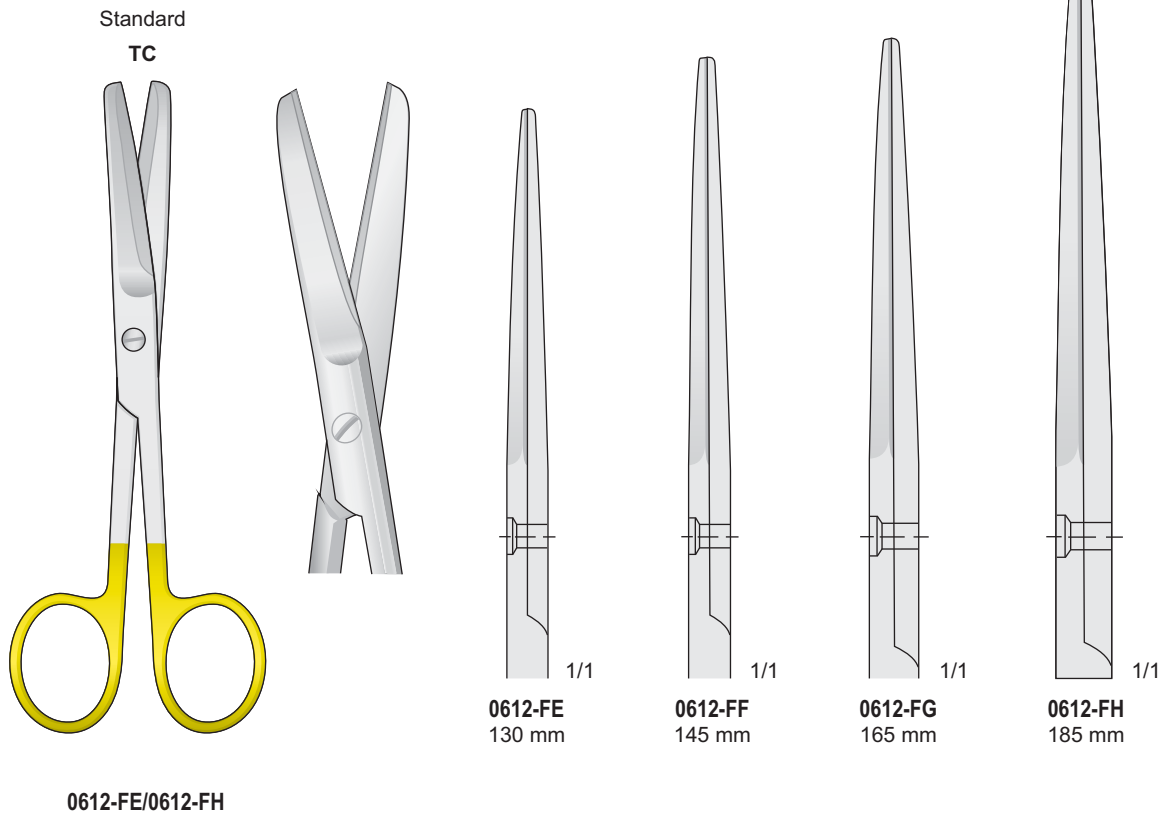

Con punta al carburo di tungsteno - Tungsten-carbide scissors  
 Mit Hartmetalleinsätzen - Avec plaquettes en carbure de tungstène - Tijeras de tungsteno

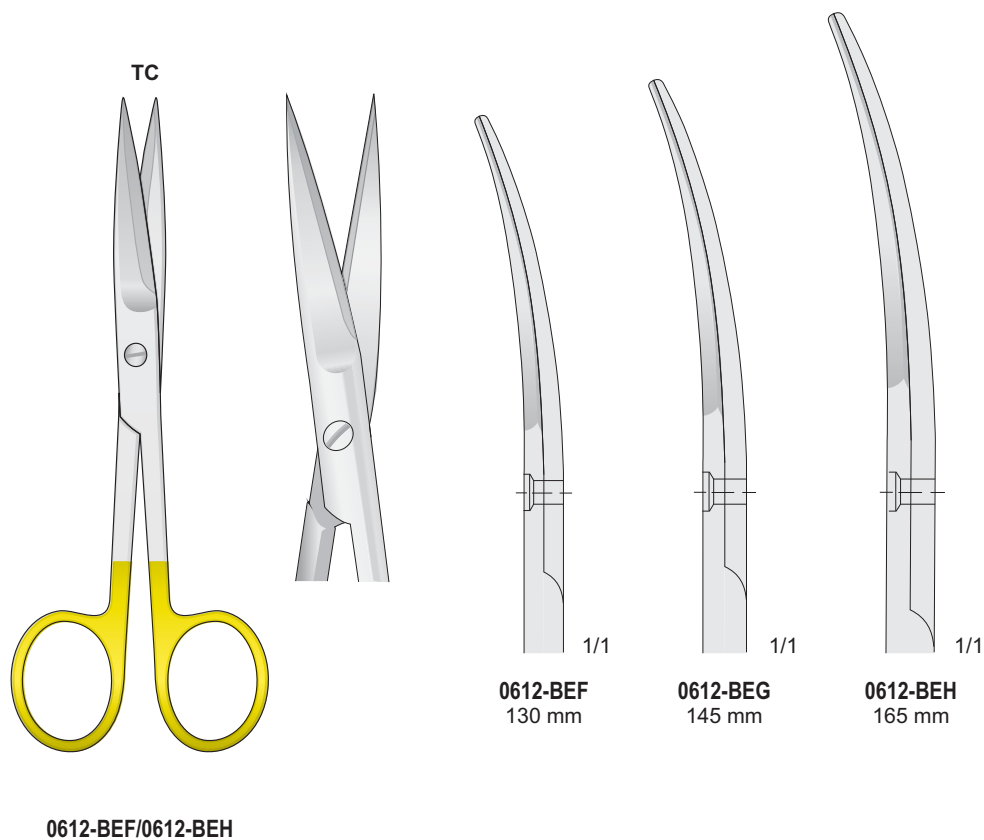
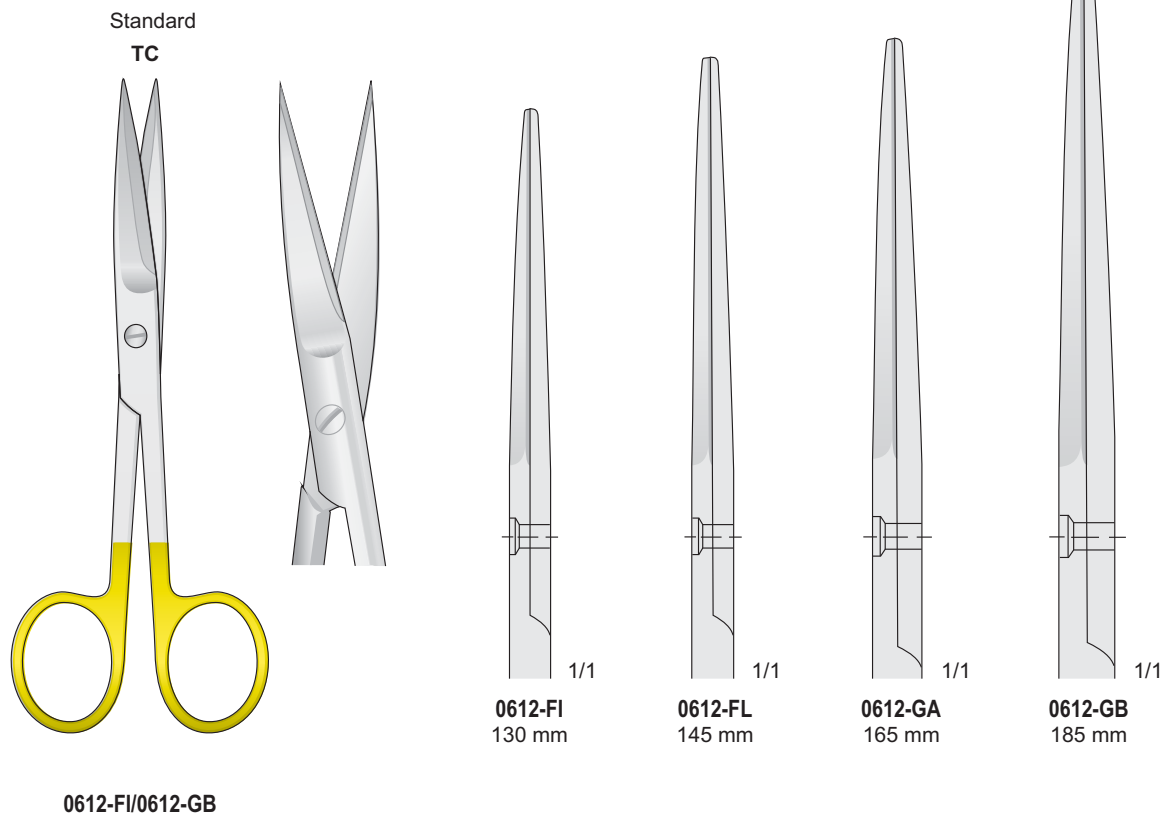

Con punta al carburo di tungsteno - Tungsten-carbide scissors  
 Mit Hartmetalleinsätzen - Avec plaquettes en carbure de tungstène - Tijeras de tungsteno

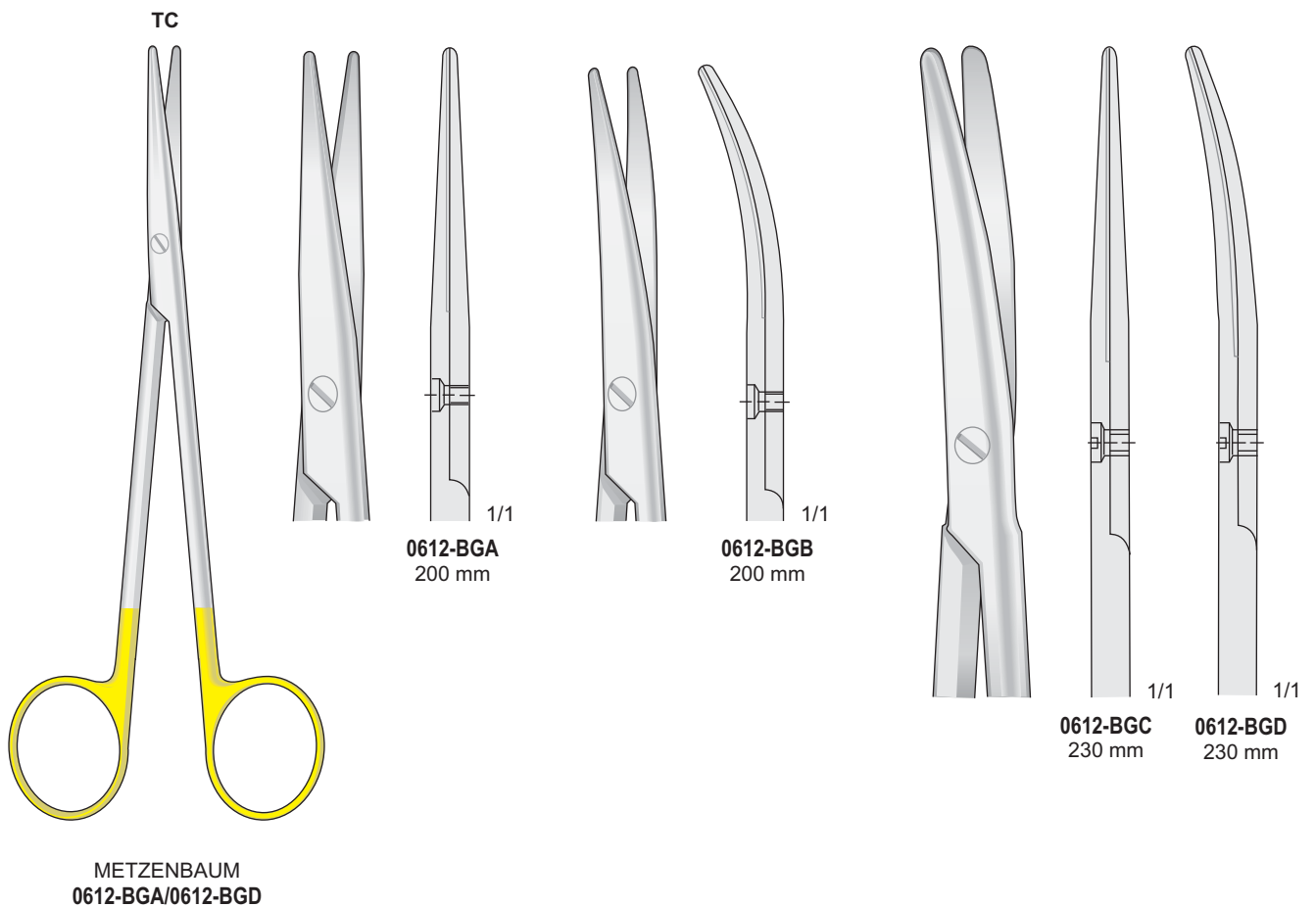
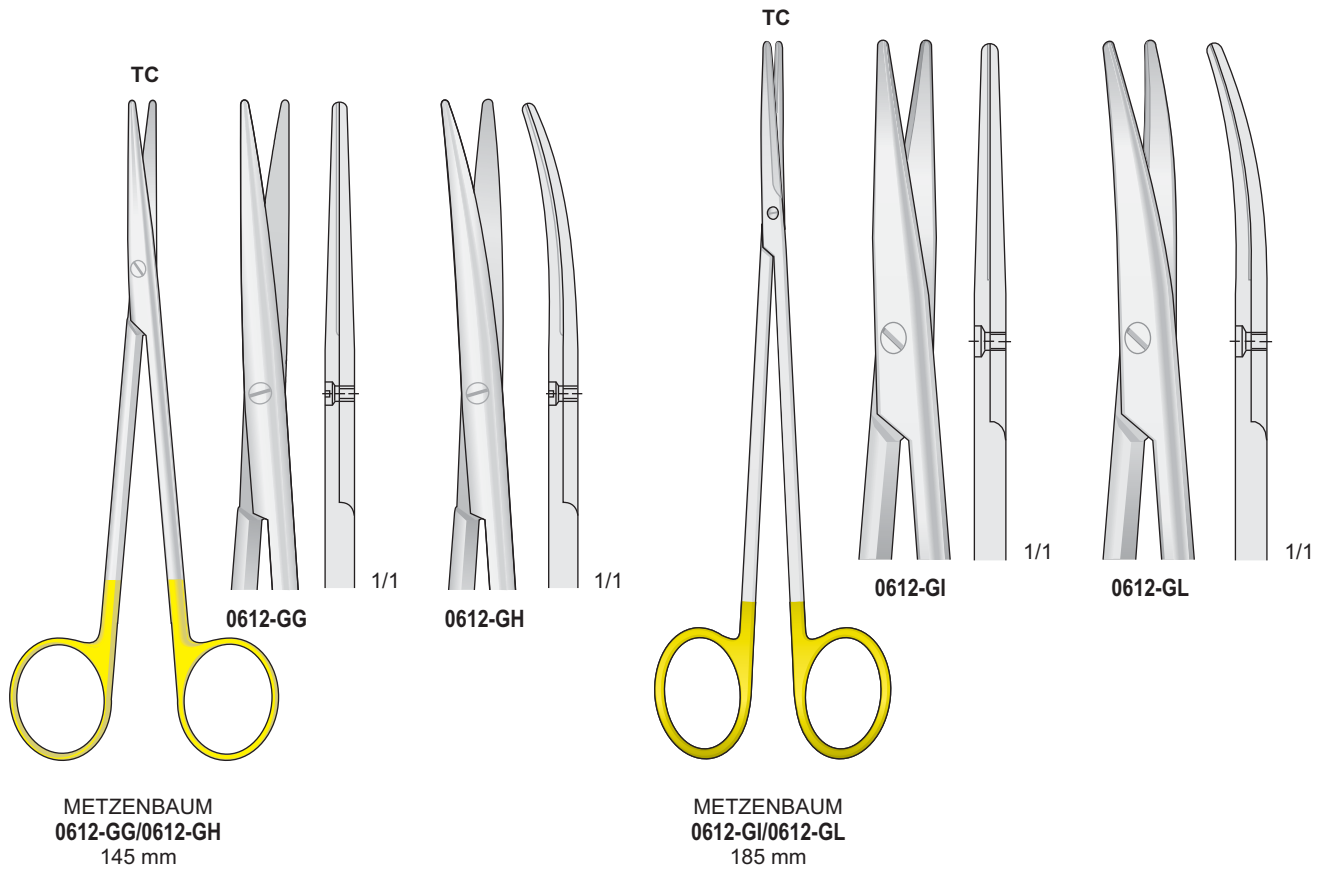

Con punta al carburo di tungsteno - Tungsten-carbide scissors  
 Mit Hartmetalleinsätzen - Avec plaquettes en carbure de tungstène - Tijeras de tungsteno

TC

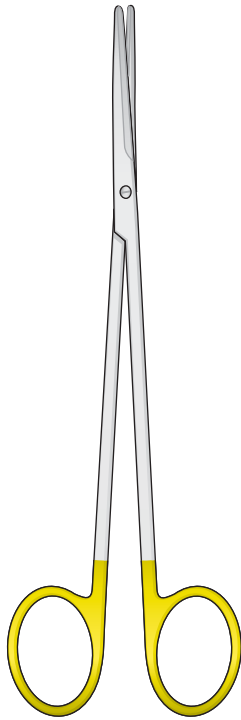

METZENBAUM-FINO  
 0612-CAB/0612-CAF

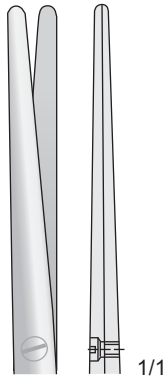

0612-CAB  
 140 mm

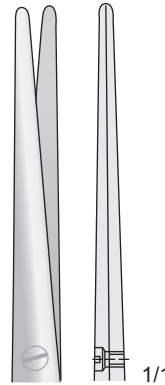

0612-CAD  
 180 mm

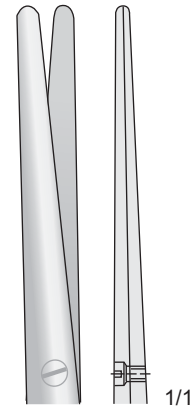

0612-CAF  
 200 mm

TC

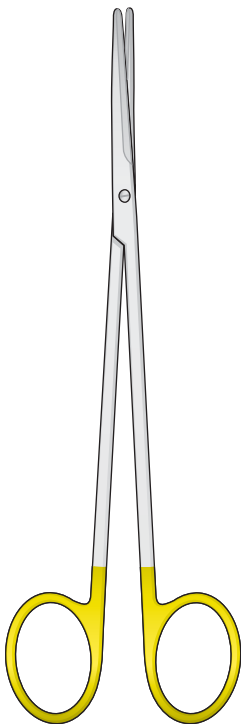

METZENBAUM-FINO  
 0612-CAH/0612-CBB

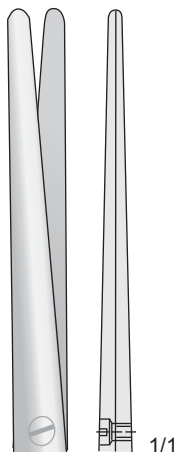

0612-CAH  
 230 mm

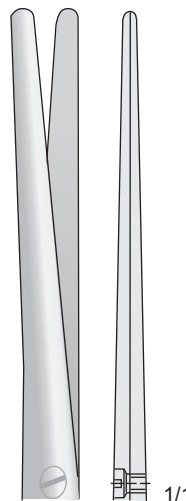

0612-CAL  
 250 mm

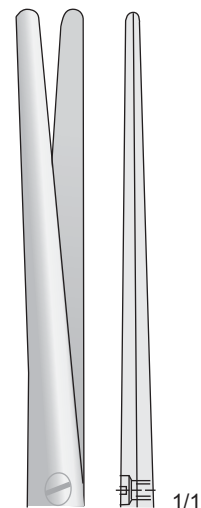

0612-CBB  
 280 mm

Con punta al carburo di tungsteno - Tungsten-carbide scissors  
 Mit Hartmetalleinsätzen - Avec plaquettes en carbure de tungstène - Tijeras de tungsteno

TC

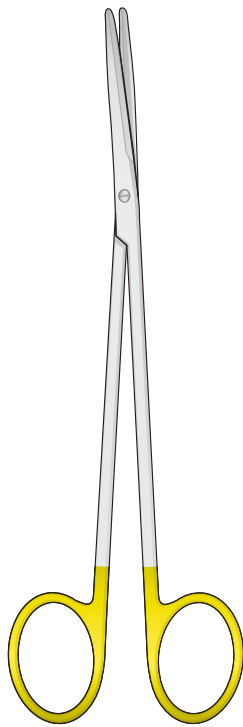

METZENBAUM-FINO  
 0612-CAC/0612-CAG

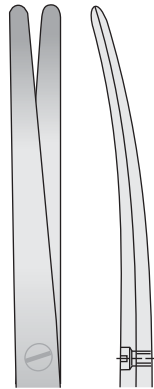

0612-CAC  
 140 mm

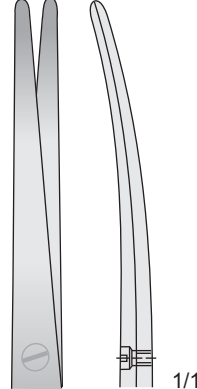

0612-CAE  
 180 mm



0612-CAG  
 200 mm

TC

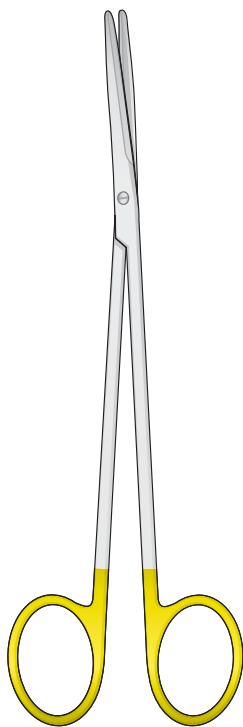

METZENBAUM-FINO  
 0612-CAI/0612-CBC

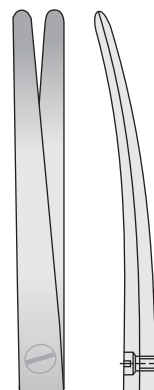

0612-CAI  
 230 mm

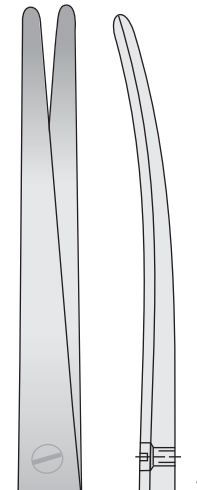

0612-CBA  
 250 mm

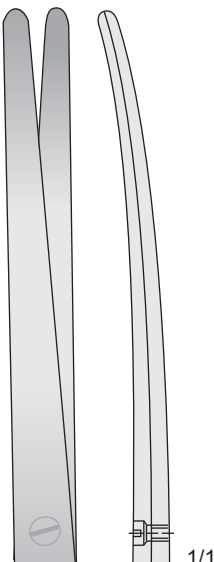

0612-CBC  
 280 mm

Con punta al carburo di tungsteno - Tungsten-carbide scissors  
 Mit Hartmetalleinsätzen - Avec plaquettes en carbure de tungstène - Tijeras de tungsteno

TC

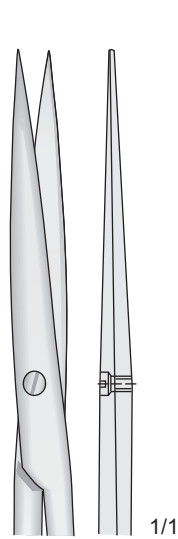
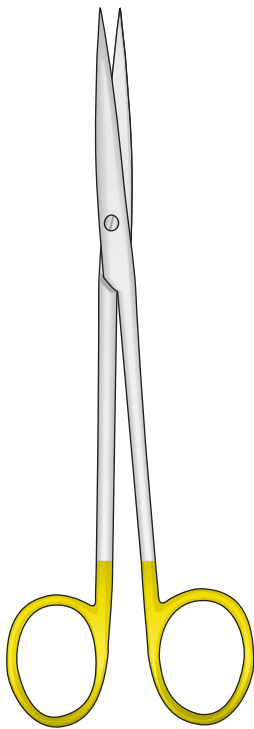

**0612-LG**  
140 mm

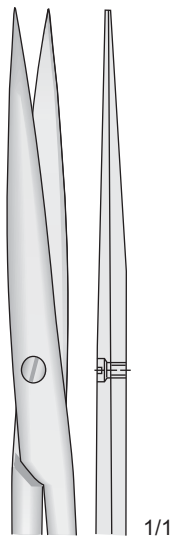

**0612-LH**  
180 mm

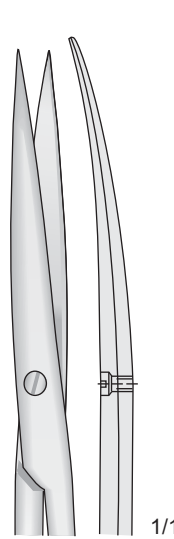

**0612-LI**  
140 mm

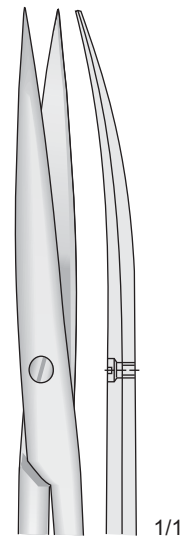

**0612-LL**  
180 mm

METZENBAUM-FINO  
0612-LG/0612-LL

TC

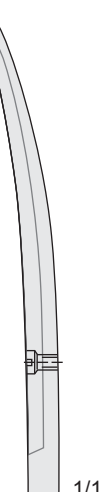
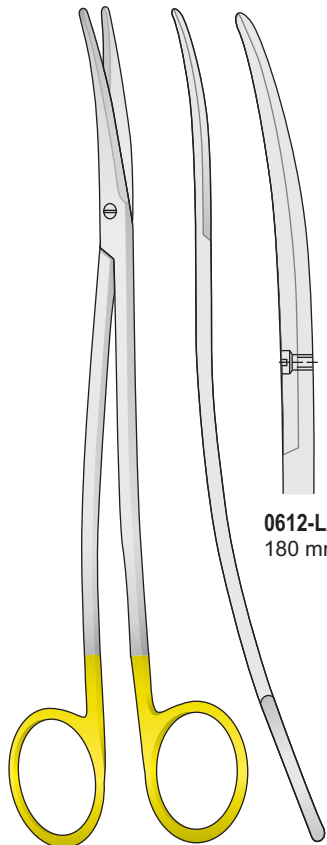

**0612-LA**  
180 mm

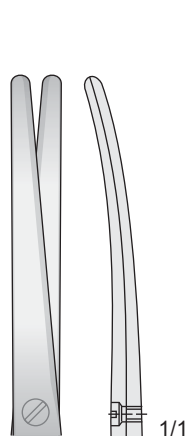

**0612-LC**  
200 mm

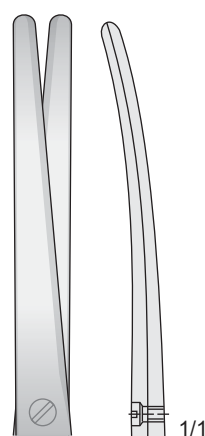

**0612-LE**  
230 mm

METZENBAUM-FINO  
0612-LA/0612-LE

TC

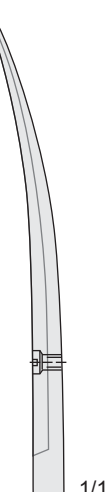
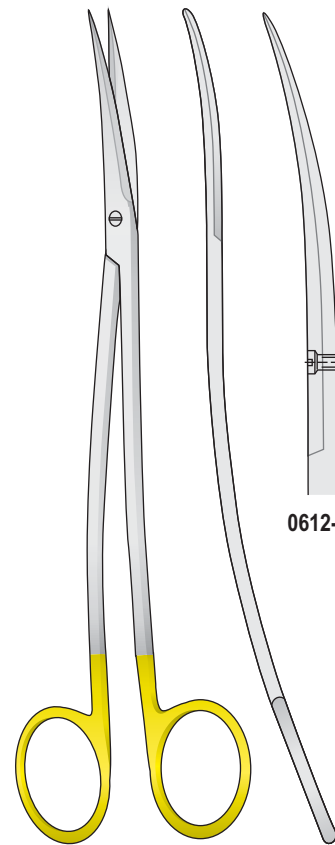

**0612-LB**

METZENBAUM-FINO  
0612-LB  
180 mm

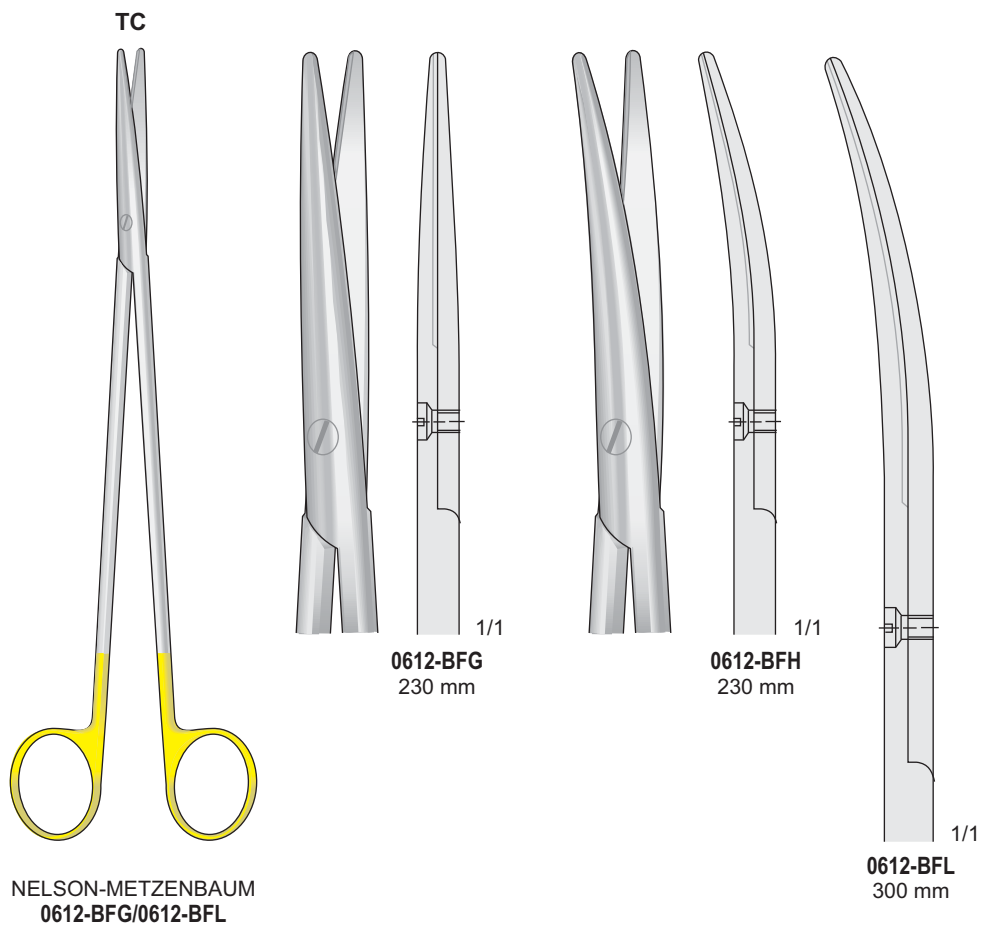
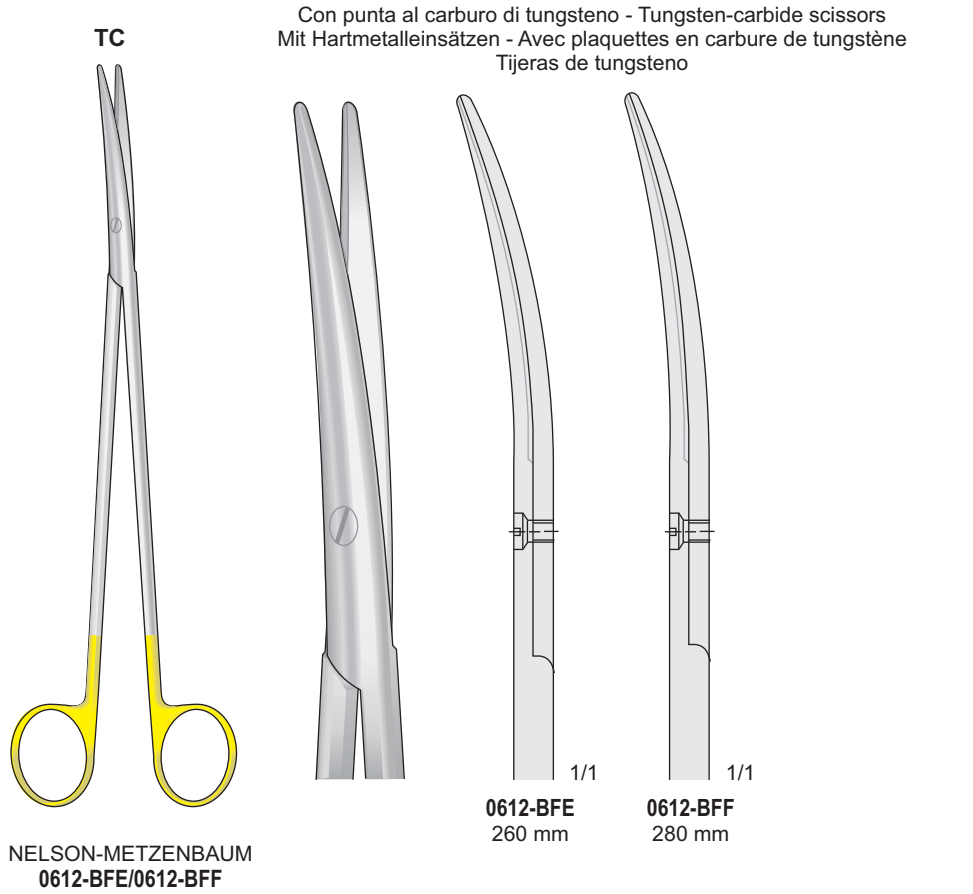

TC    Con punta al carburo di tungsteno - Tungsten-carbide scissors  
 Mit Hartmetalleinsätzen - Avec plaquettes en carbure de tungstène - Tijeras de tungsteno

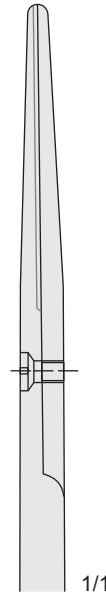
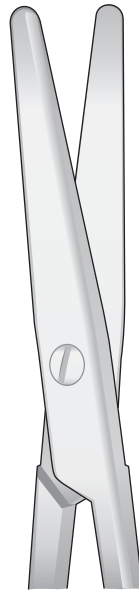
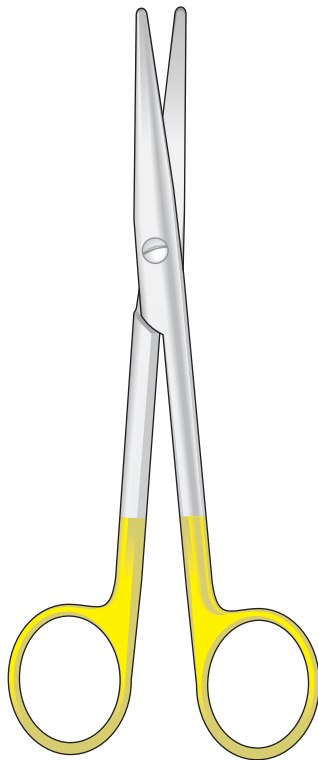

0612-BDA  
140 mm

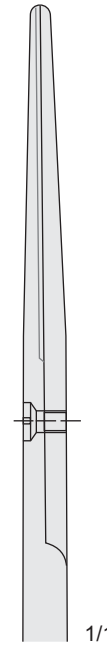

0612-BDB  
170 mm

MAYO-STILLE  
0612-BDA/0612-BDB

TC

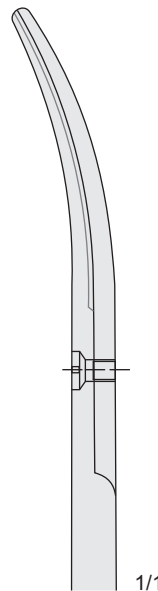
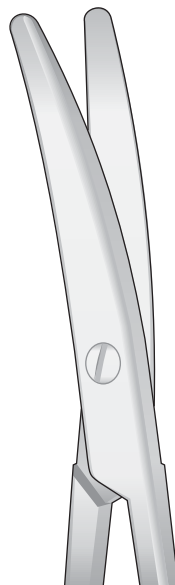
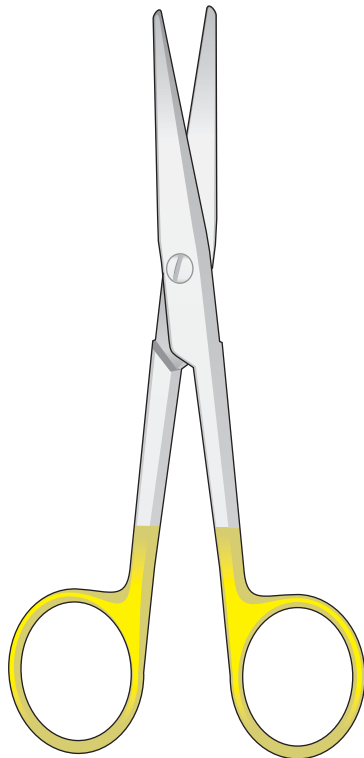

0612-BDC  
140 mm

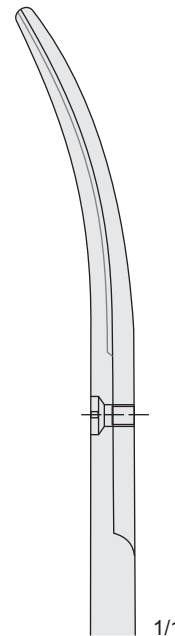

0612-BDD  
170 mm

MAYO-STILLE  
0612-BDC/0612-BDD



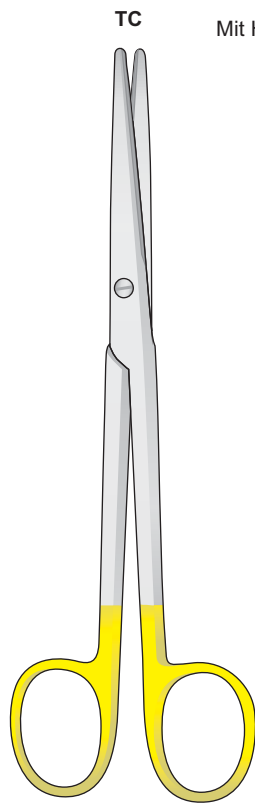

LEXER  
0612-BDE/0612-BDF

Con punta al carburo di tungsteno - Tungsten-carbide scissors  
Mit Hartmetalleinsätzen - Avec plaquettes en carbure de tungstène - Tijeras de tungsteno

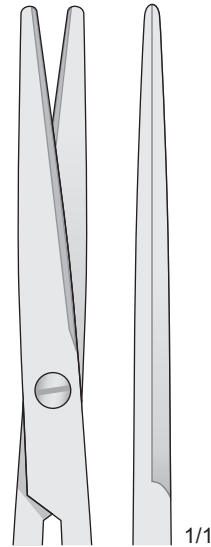

0612-BDE  
160 mm

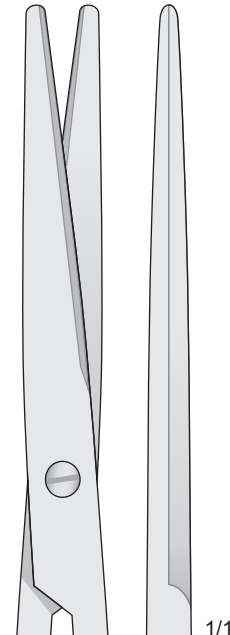

0612-BDF  
210 mm

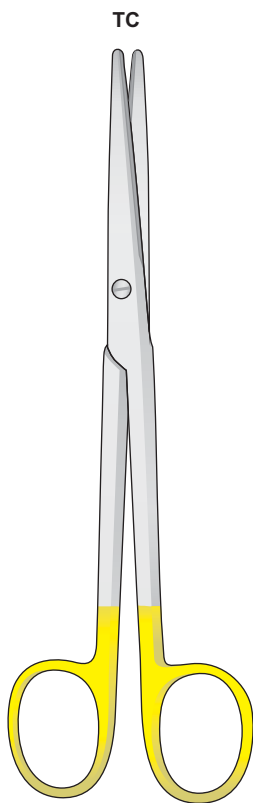

LEXER  
0612-BDG/0612-BDH

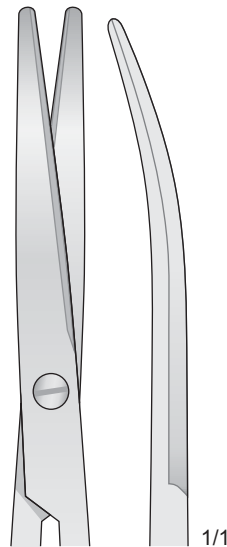

0612-BDG  
160 mm

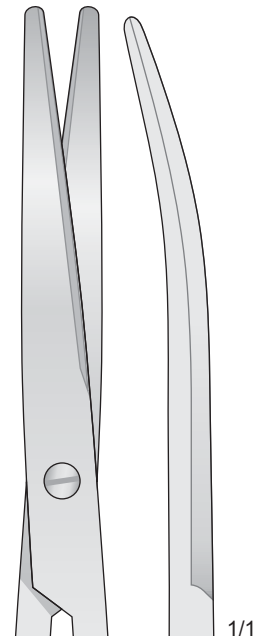

0612-BDH  
210 mm

Con punta al carburo di tungsteno - Tungsten-carbide scissors  
 Mit Hartmetalleinsätzen - Avec plaquettes en carbure de tungstène - Tijeras de tungsteno

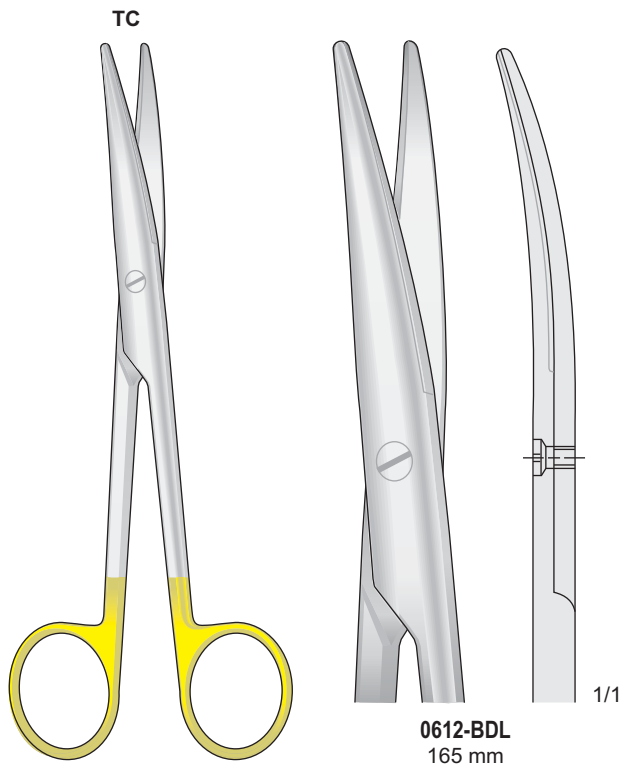

MAYO-LEXER  
0612-BDL  
165 mm

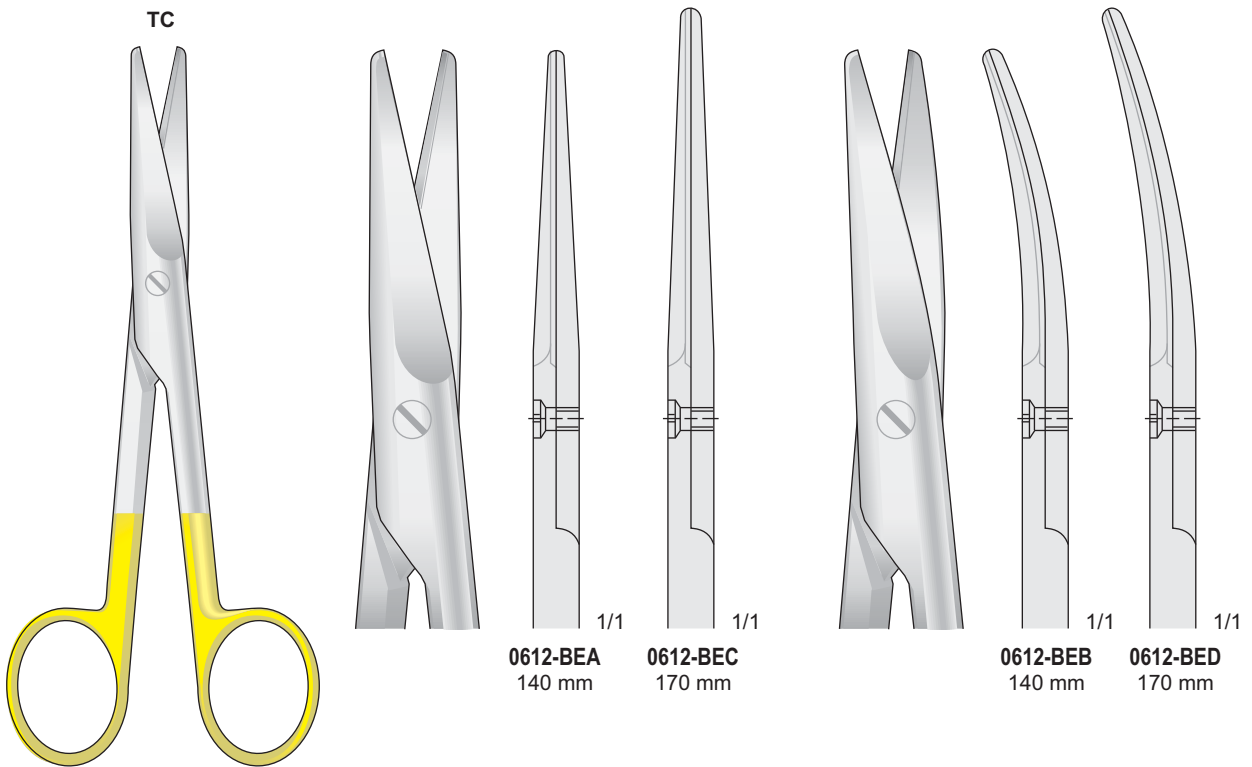

MAYO  
0612-BEA/0612-BED

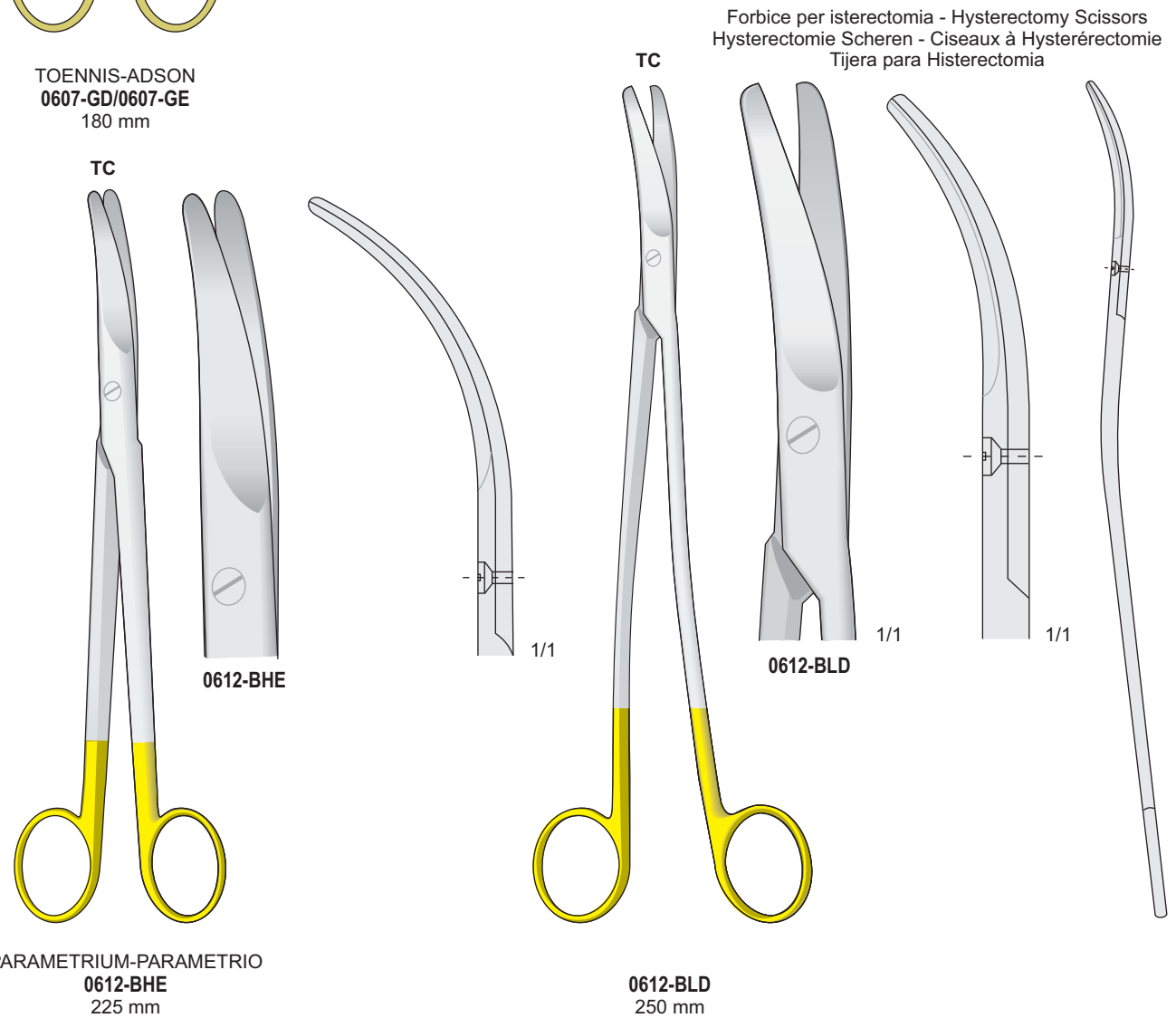
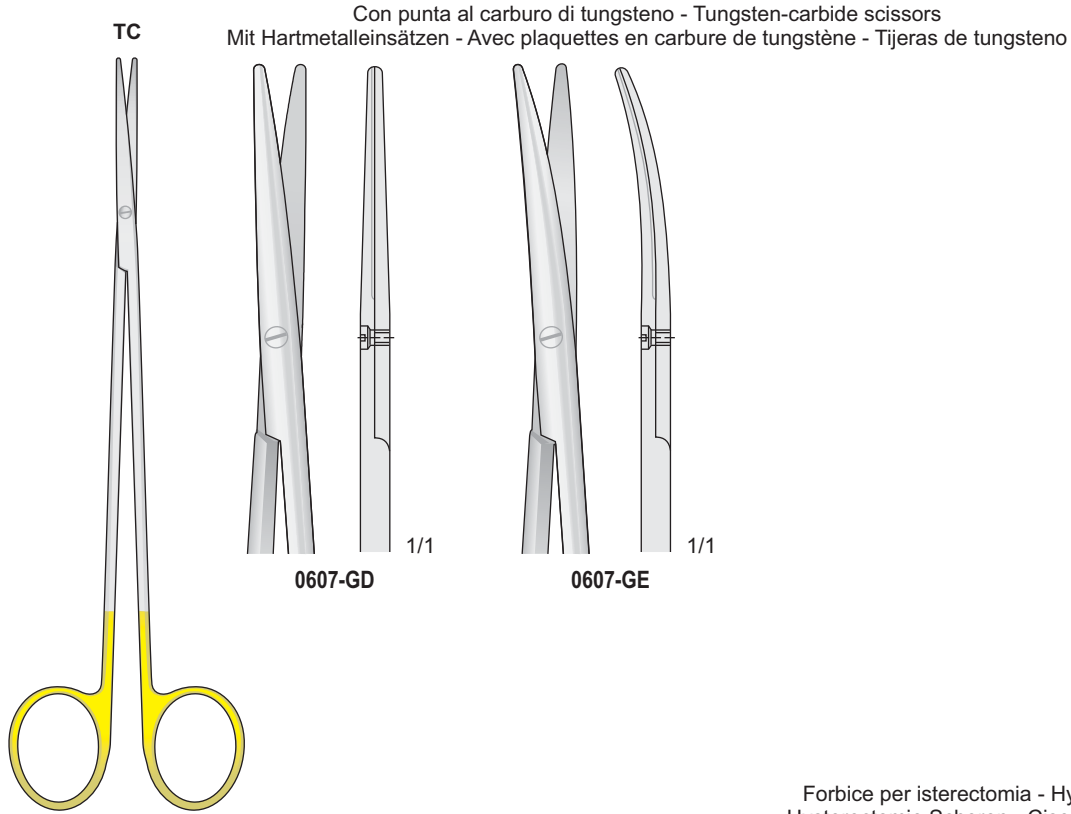

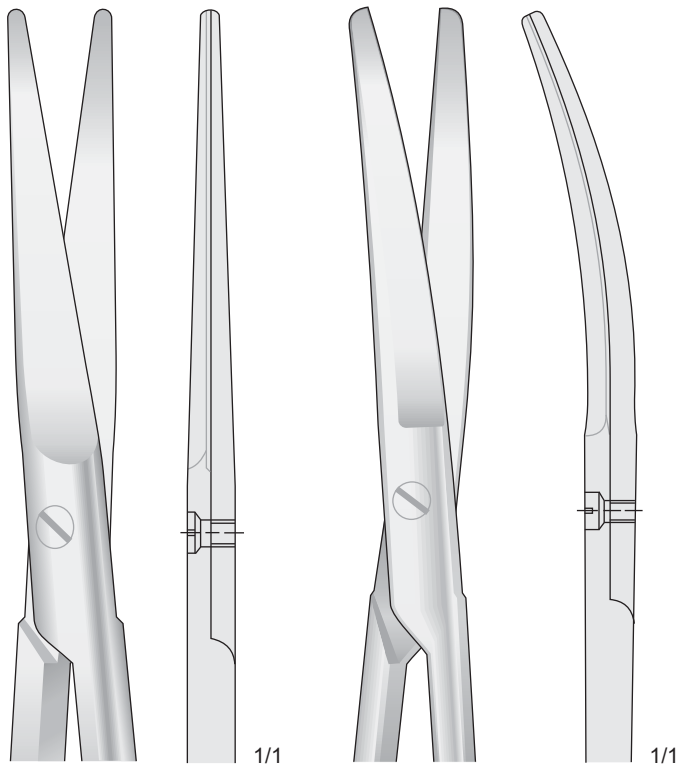

0612-BLA

0612-BLE

Con punta al carburo di tungsteno  
 Tungsten-carbide scissors  
 Mit Hartmetalleinsätzen  
 Avec plaquettes en carbure de tungstène  
 Tijeras de tungsteno

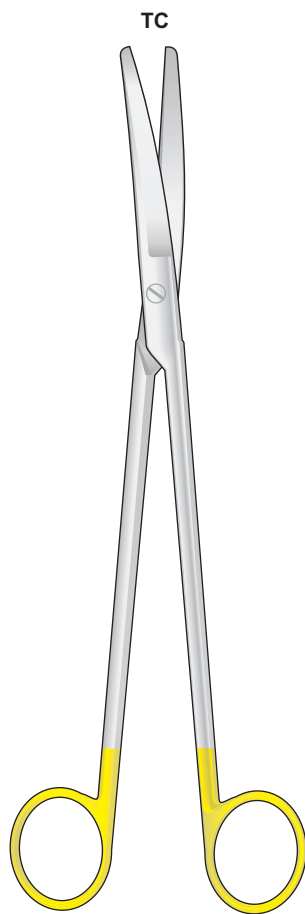

WERTHEIM  
 0612-BLA/0612-BLE  
 230 mm

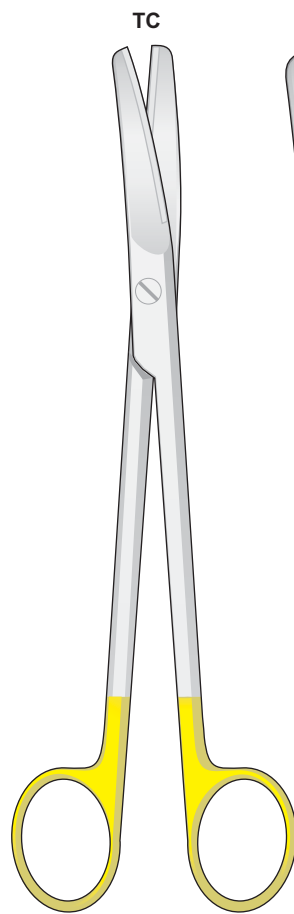

SIMS  
 0612-BLB/0612-BLC

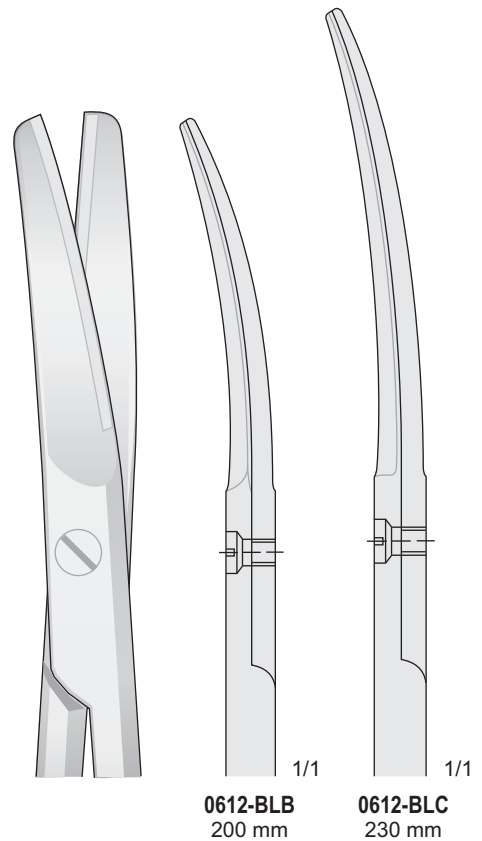

0612-BLB  
 200 mm

0612-BLC  
 230 mm

Forbici con taglio ondulato su una lama  
 Scissors cut one serrated cutting edge  
 Scheren mit wellenschliff auf einer Schnittfläche  
 Ciseaux avec affutage spécial ont une lame dentée

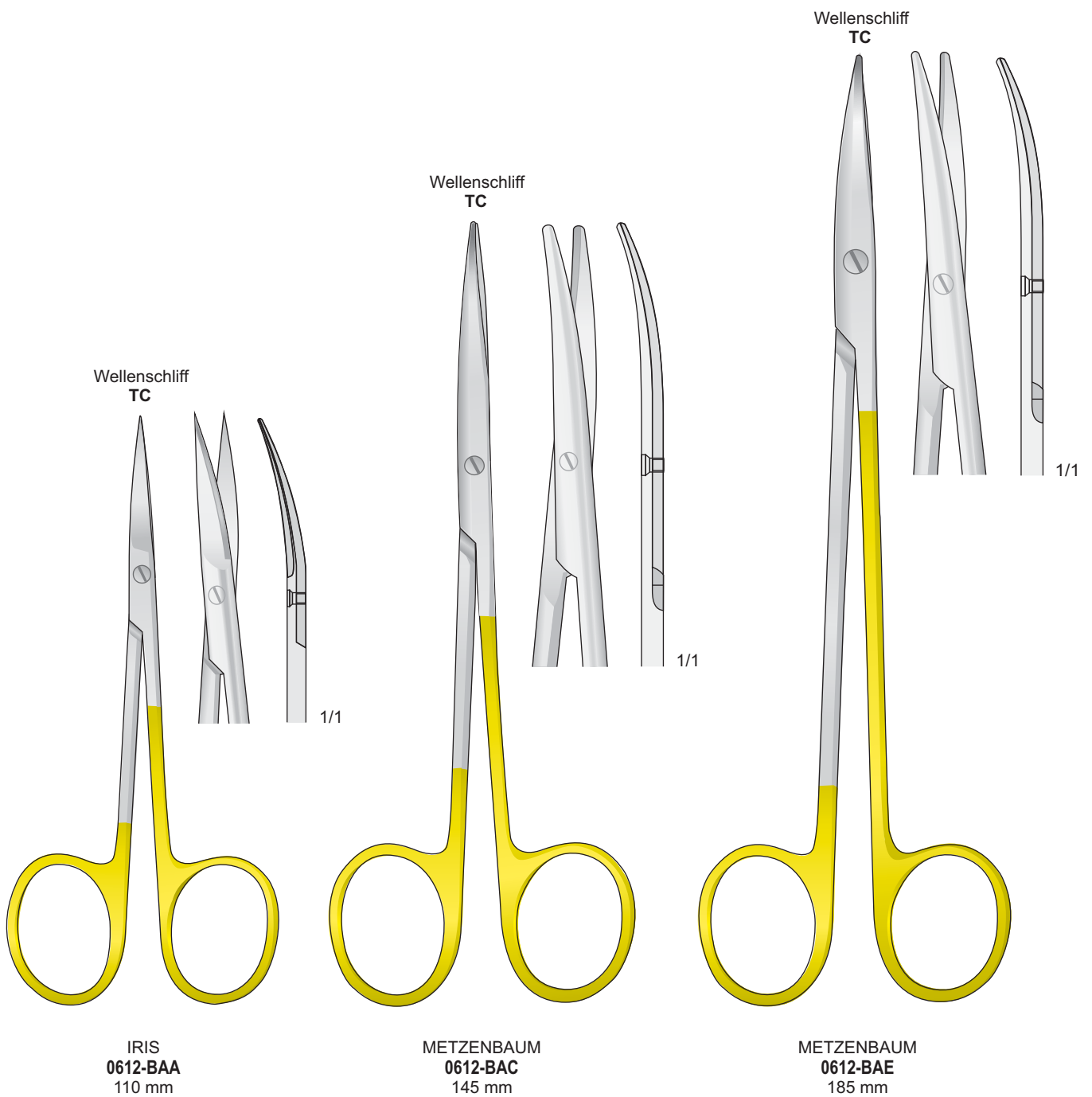

Forbici per suture

Ligature scissors

Ligatur scheren

Ciseaux à ligatures

Tijeras para ligaduras

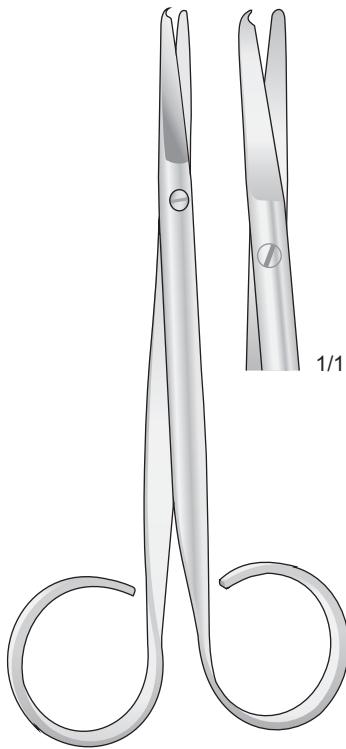

SPENCER  
1803-B  
110 mm

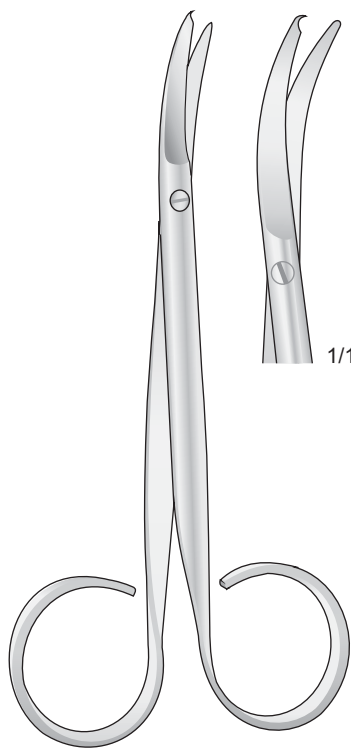

SPENCER  
1803-F  
110 mm

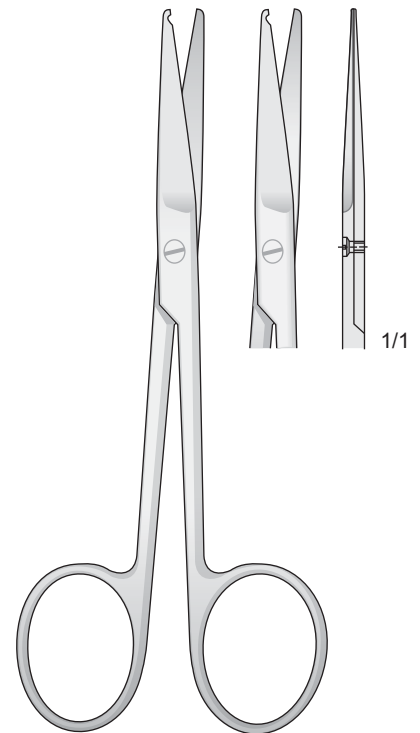

1803-BC  
115 mm

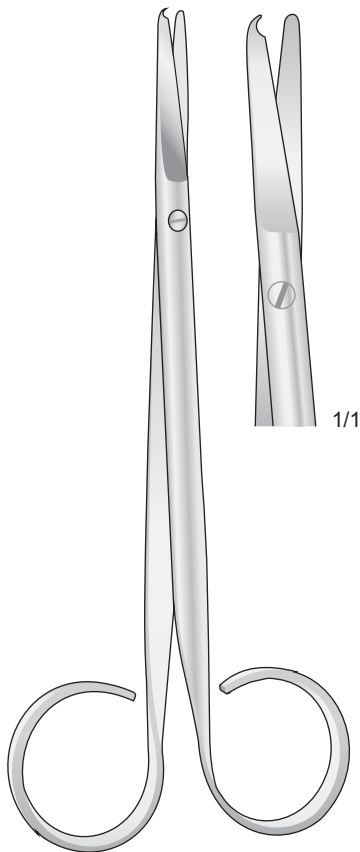

SPENCER  
1803-C  
145 mm

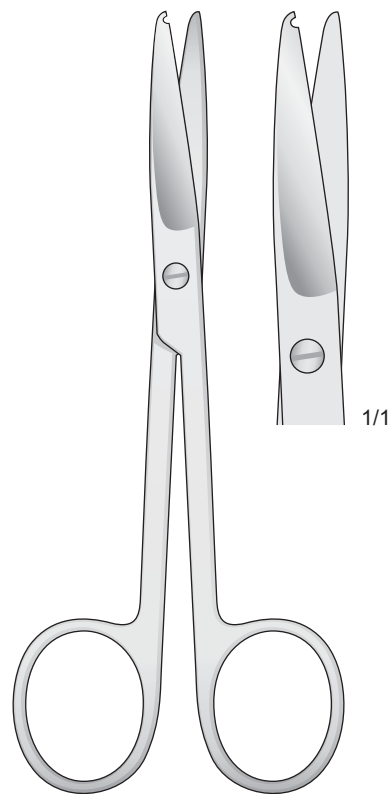

SPENCER  
1803-BA  
135 mm

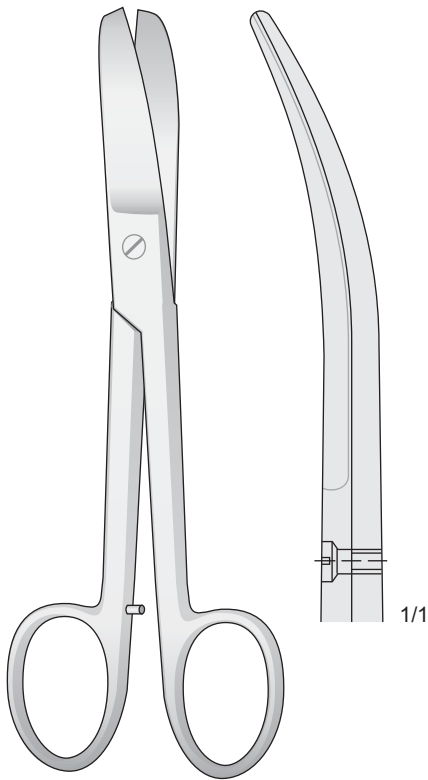

LORENZ  
0607-BFA  
230 mm



BRUNS  
0607-BIB  
240 mm

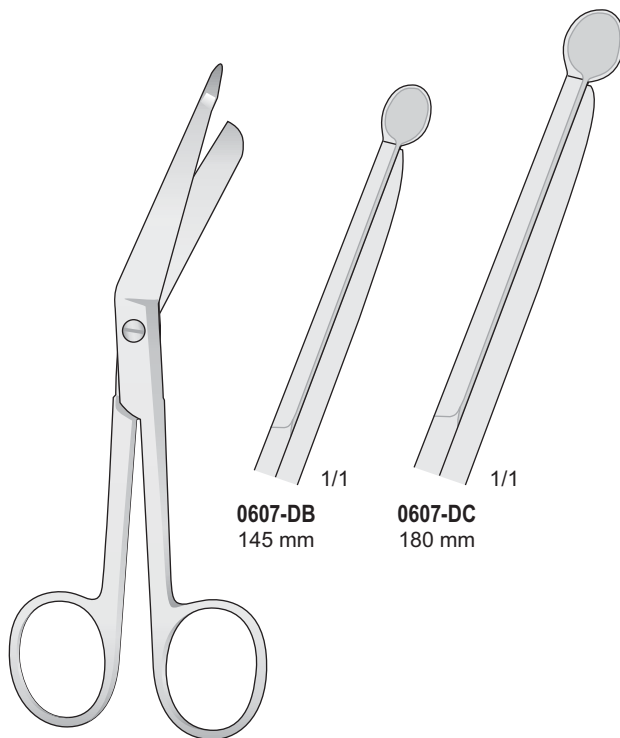

LISTER  
0607-DB/0607-DC

0607-DB  
145 mm

0607-DC  
180 mm



ESMARCH  
0607-DD

0607-DD  
200 mm

Forbici per  
fili metallici

Wire and plate  
cutting scissors

Draht und  
Blechscheren

Ciseaux coupe-fils  
métalliques

Tijeras para  
cortar alambre

Forbice universale dentellata  
Draht-und Blechscheren gezahnt  
Wire cutting scissor serrated  
Coupe-fils dentelés  
Tijeras para cortar hilo de acero dentadas

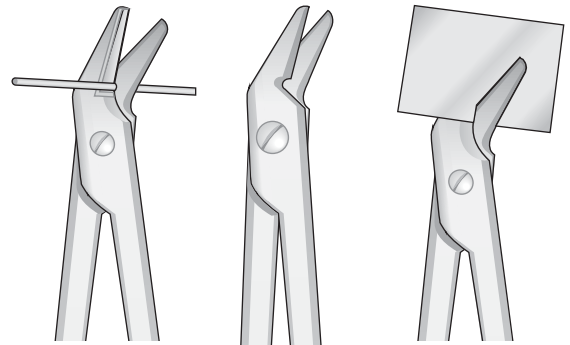

Con punta al carburo di tungsteno  
Tungsten-carbide scissors  
Mit Hartmetalleinsätzen  
Avec plaquettes en carbure de tungstène  
Tijeras de tungsteno

Wire Cutter  
TC

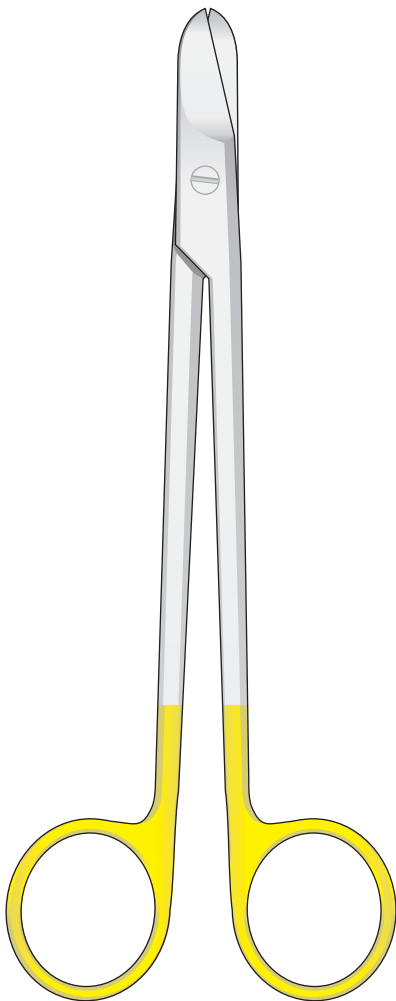

SMITH  
0607-BGA  
160 mm

Wire Cutter  
TC

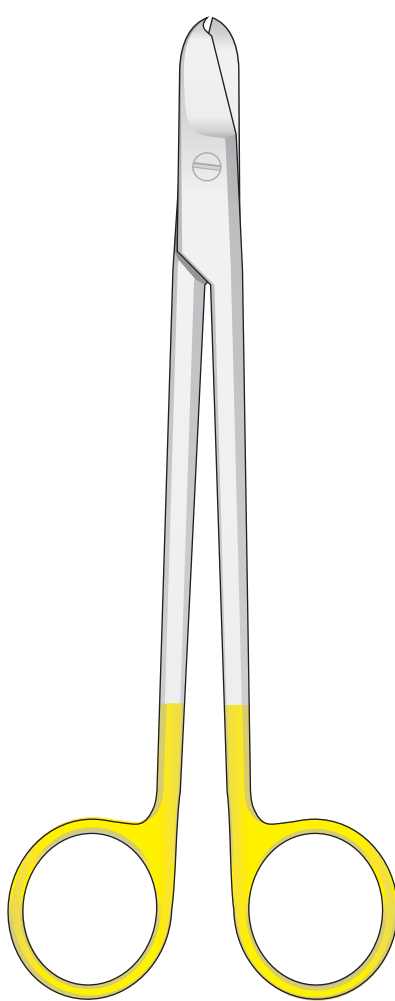

SMITH  
0607-BGB  
160 mm

0415-LA  
120 mm

TC

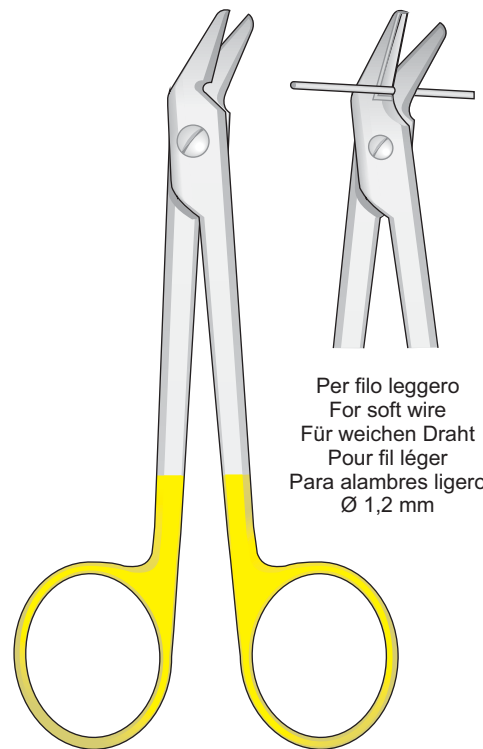

0415-BCA  
120 mm

Per filo leggero  
For soft wire  
Für weichen Draht  
Pour fil léger  
Para alambres ligero  
Ø 1,2 mm



Forbici per  
fili metallici

Wire and plate  
cutting scissors

Draht und  
Blechscheren

Ciseaux coupe-fils  
métalliques

Tijeras para  
cortar alambre

Smusse - Blunt - Stumpf - Mousses - Romas

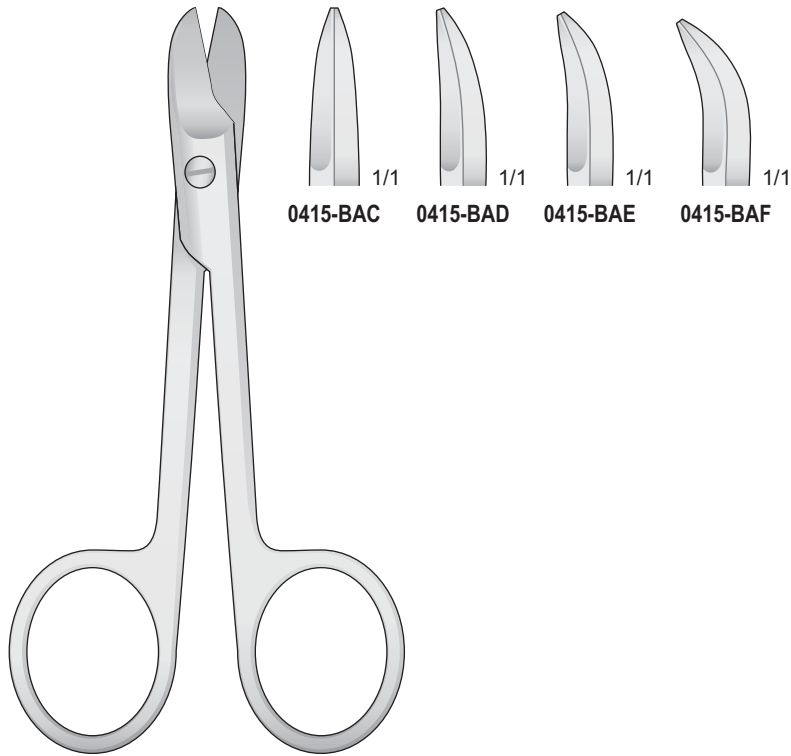

0415-BAC

0415-BAD

0415-BAE

0415-BAF

BEEBE  
0415-BAC/0415-BAF  
110 mm

Acute - Sharp - Spitz - Pointus - Agudas

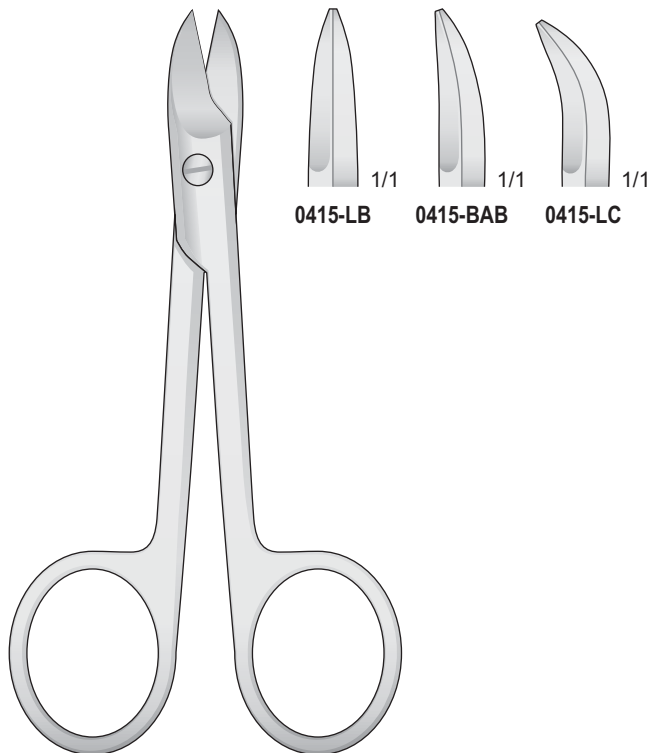

0415-LB

0415-BAB

0415-LC

BEEBE  
0415-LB/0415-BAB  
110 mm

Forbici per unghie

Nail Scissors

Nagelscheren

Ciseaux pour les ongles

Tijeras para hojas

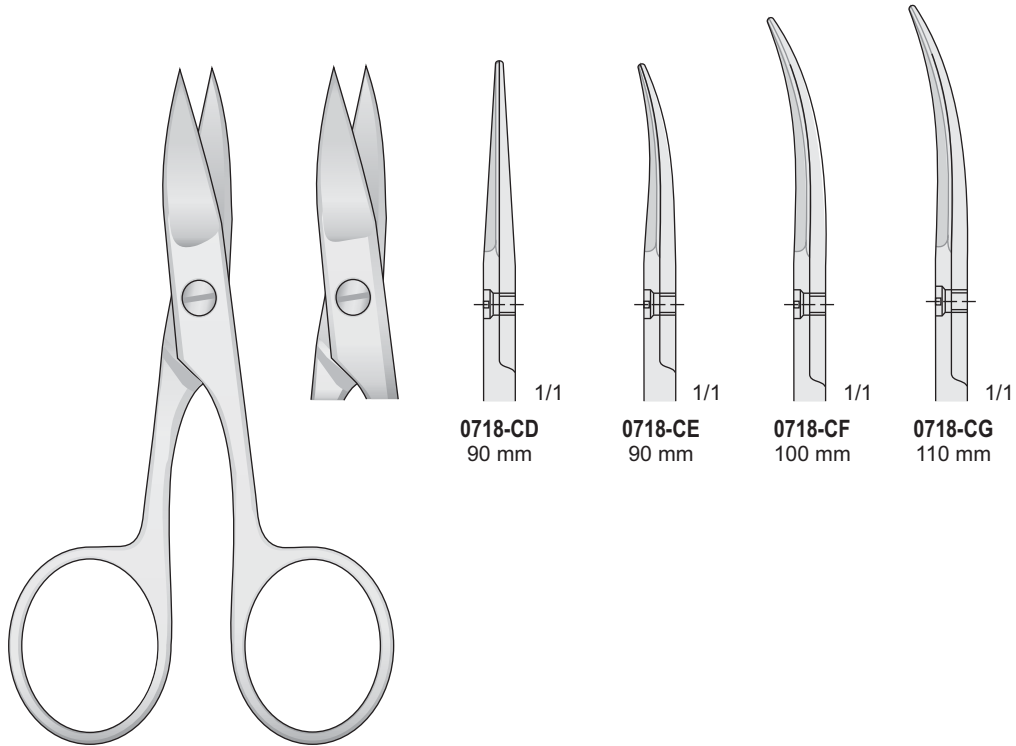

**0718-CD**  
90 mm

**0718-CE**  
90 mm

**0718-CF**  
100 mm

**0718-CG**  
110 mm

**0718-CD/0718-CG**



**0718-CH**  
95 mm

**0718-CI**  
95 mm

**0718-CL**  
105 mm

**0718-CH/0718-CL**



4

Pinzette  
Tissue forceps  
Pinzetten  
Pincés  
Pinzas



Micro pinzette

Delicate forceps

Micro Pinzetten

Micro pinces

Pinzas finos

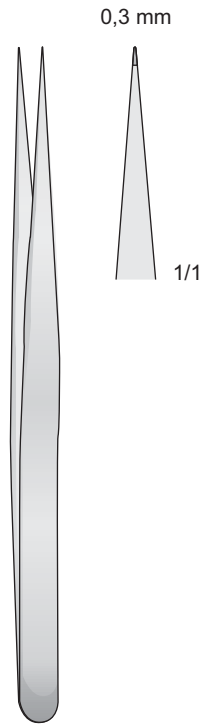

**0204-CDF**  
120 mm

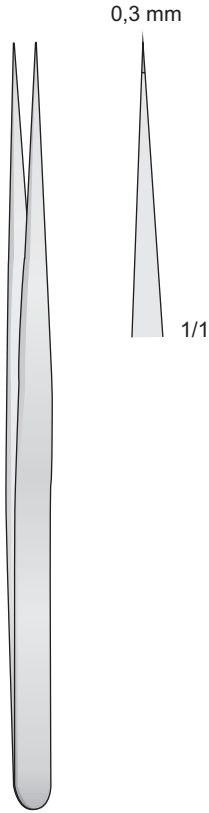

**VISE**  
**0204-CDG**  
135 mm

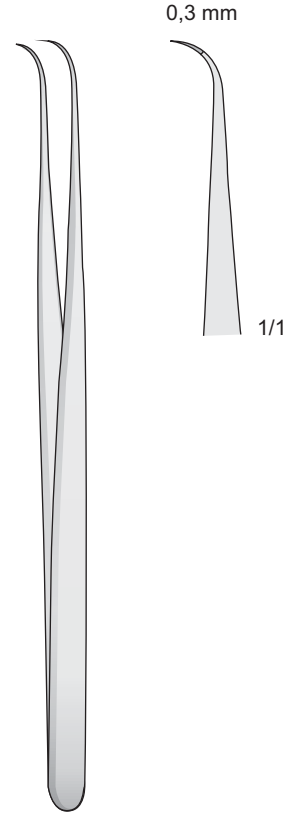

**VISE**  
**0204-CDH**  
135 mm

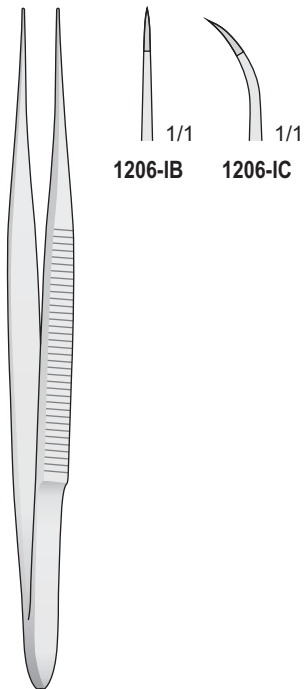

**1206-IB/1206-IC**  
125 mm

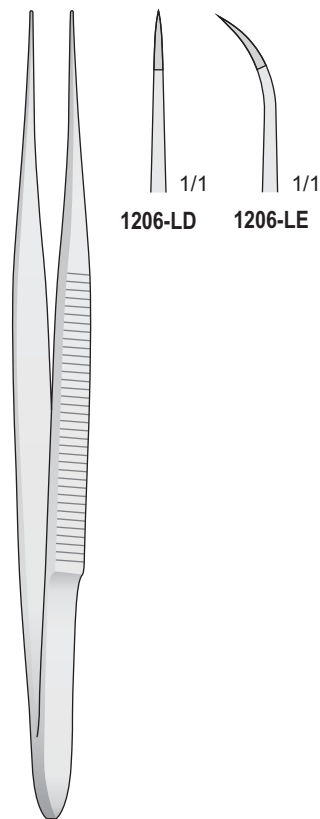

**1206-LD/1206-LE**  
150 mm

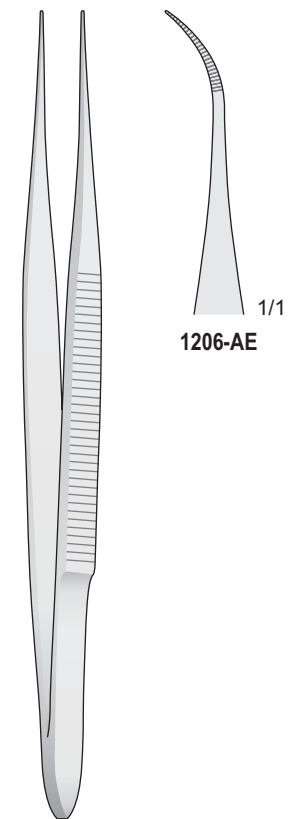

**1206-AE**  
150 mm

Micro pinzette

Delicate forceps

Micro Pinzetten

Micro pinces

Pinzas finos

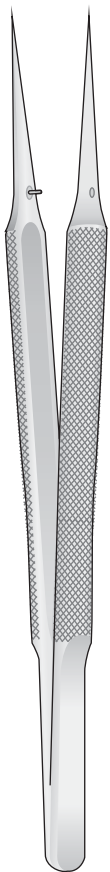

1206-BBA

1206-BBB

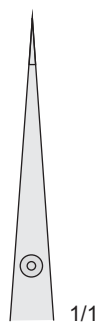

1/1

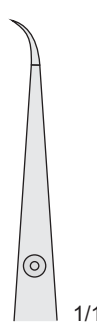

1/1

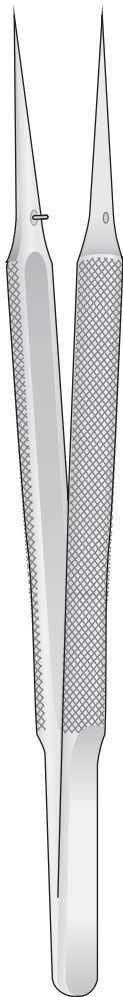

1206-BBC

1206-BBD

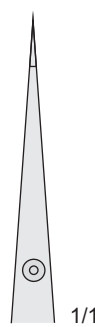

1/1

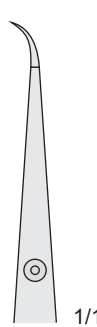

1/1

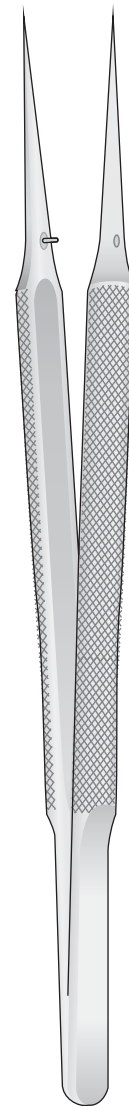

1206-BBE

1206-BBF

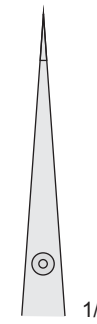

1/1

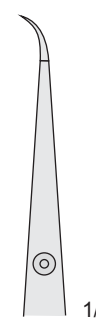

1/1

1206-BBA/1206-BBB  
120 mm

1206-BBC/1206-BBD  
150 mm

1206-BBE/1206-BBF  
180 mm

Micro pinzette

Delicate forceps

Micro Pinzetten

Micro pinces

Pinzas finos

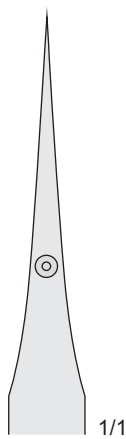
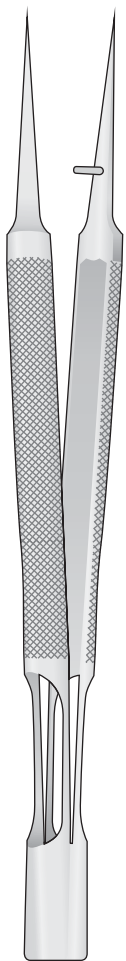
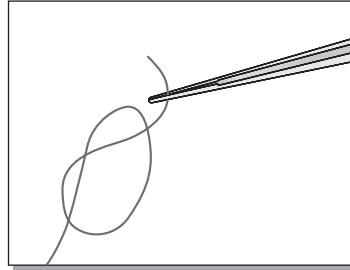

**BROCK  
0604-CAB**  
130 mm

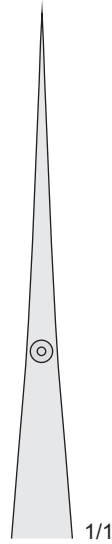
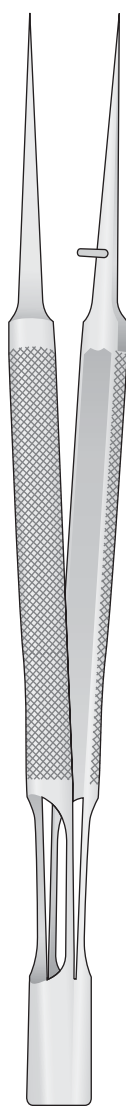

**BROCK  
0604-CAC**  
150 mm

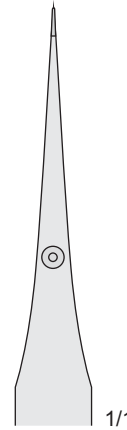
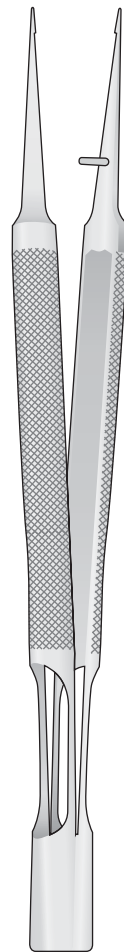

**BROCK  
0604-CAD**  
130 mm

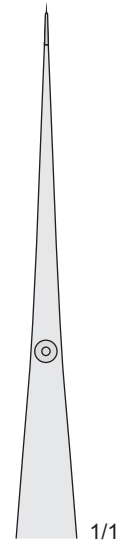
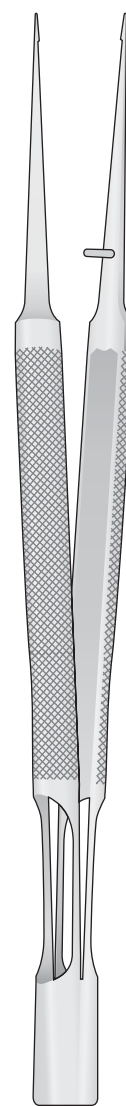

**BROCK  
0604-CAD**  
150 mm

Micro pinzette

Delicate forceps

Micro Pinzetten

Micro pinces

Pinzas finos

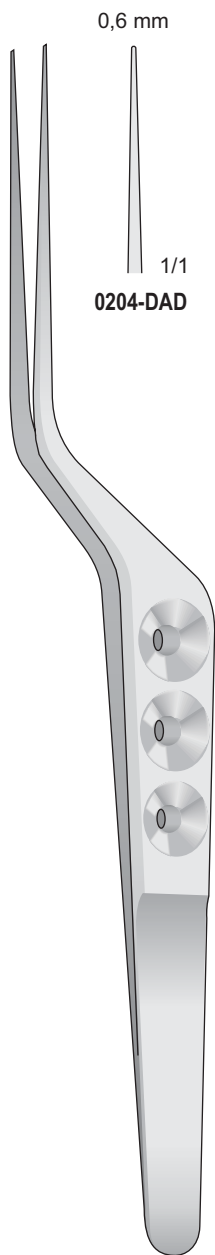

YASARGIL  
0204-DAD  
180 mm

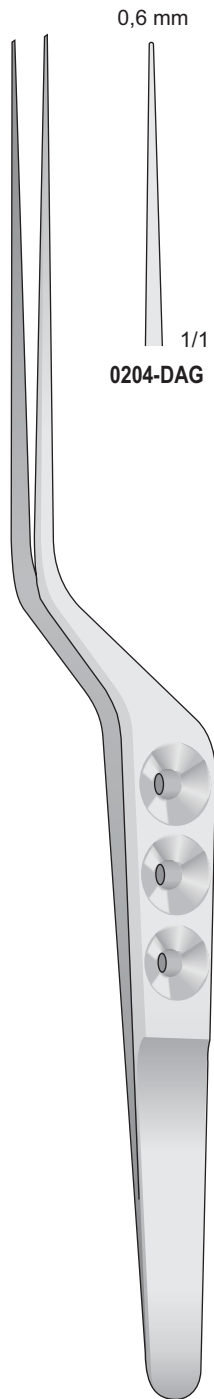

YASARGIL  
0204-DAG  
200 mm

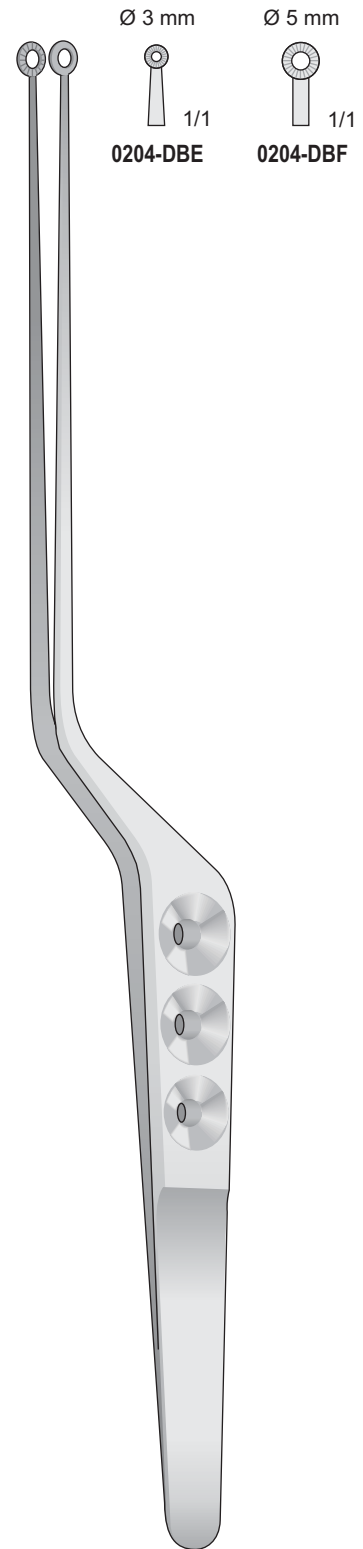

YASARGIL  
0204-DBE/0204-DBF  
220 mm





Ø 1 mm



**1206-BCE** - 150 mm  
**1206-BCF** - 180 mm  
**1206-BCG** - 210 mm  
**1206-BEI** - 230 mm

Ø 2 mm



**1206-BCH** - 150 mm  
**1206-BCI** - 180 mm  
**1206-BCL** - 210 mm  
**1206-BEL** - 230 mm

1206-BCE/1206-BEL



Titanio - Titan - Titane

Ø 1 mm



**1206-BEC19** - 150 mm  
**1206-BED19** - 180 mm  
**1206-BEE19** - 210 mm

Ø 2 mm



**1206-BEF19** - 150 mm  
**1206-BEG19** - 180 mm  
**1206-BEH19** - 210 mm

1206-BEC19/1206-BEH19

Micro pinzette

Delicate forceps

Micro Pinzetten

Micro pinces

Pinzas finos

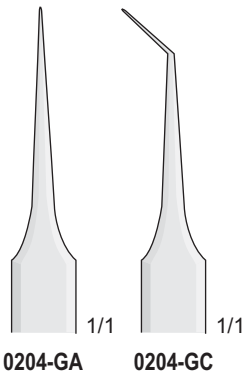
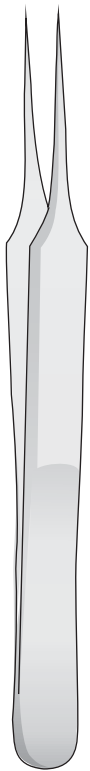

0204-GA

1/1

0204-GC

1/1

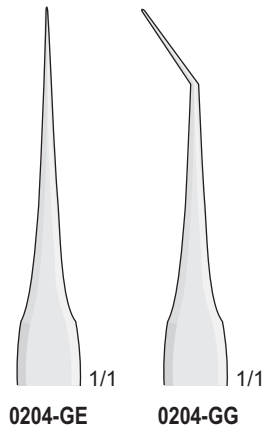
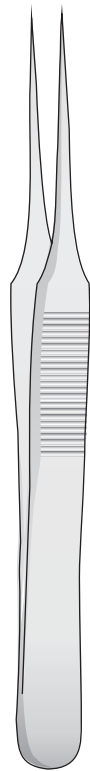

0204-GE

1/1

0204-GG

1/1

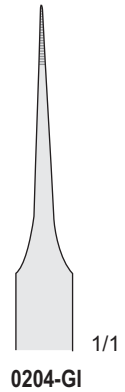

0204-GI

1/1

0204-GA/0204-GC  
110 mm

0204-GE/0204-GG  
110 mm

0204-GI  
90 mm

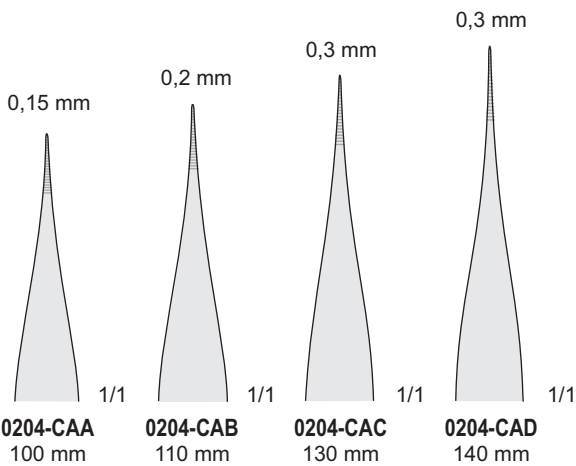
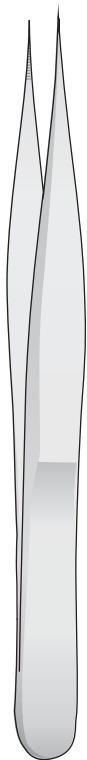

0204-CAA  
100 mm

1/1

0204-CAB  
110 mm

1/1

0204-CAC  
130 mm

1/1

0204-CAD  
140 mm

1/1



0204-CAA/0204-CAD

0204-CAF  
115 mm

0204-CAG  
115 mm

Pinze per dissezione

Thumb and tissue forceps

Pinzetten

Pinces à dissection

Pinzas de disecció

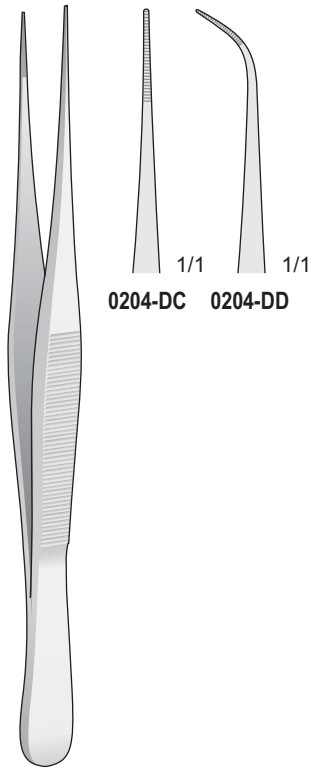

0204-DC 0204-DD

0204-DC/0204-DD  
100 mm

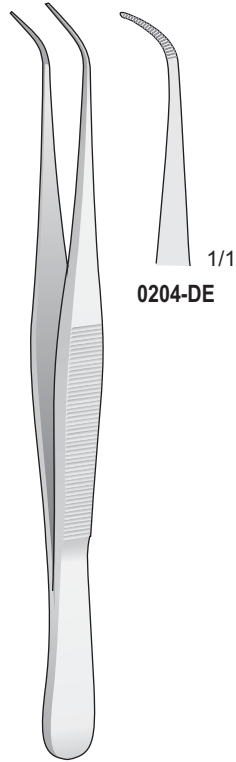

0204-DE

0204-DE  
100 mm

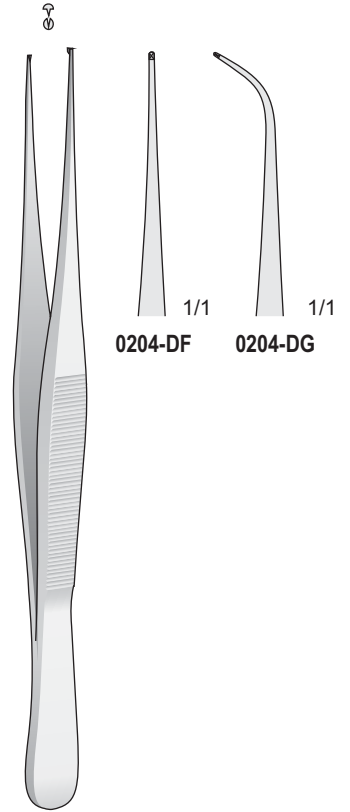

0204-DF 0204-DG

0204-DF/0204-DG  
100 mm

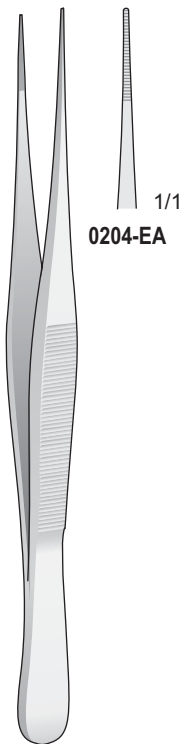

0204-EA

0204-EA  
110 mm

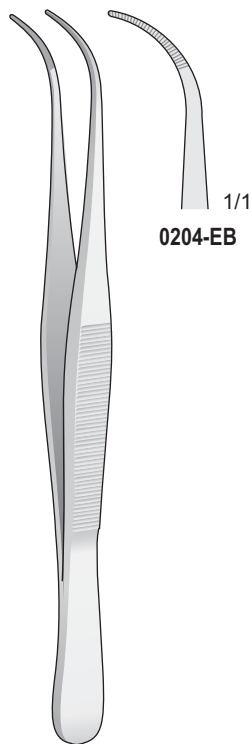

0204-EB

0204-EB  
110 mm

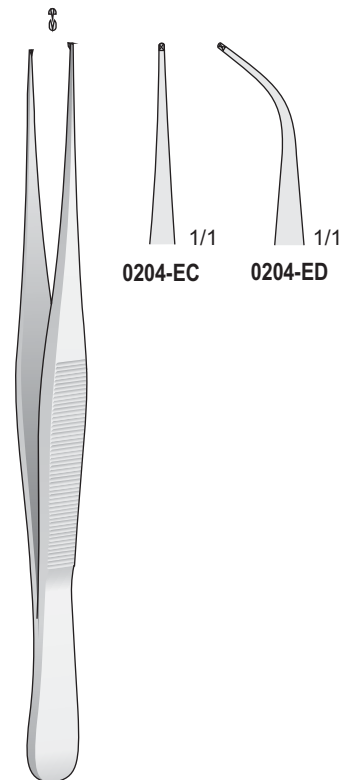

0204-EC 0204-ED

0204-EC/0204-ED  
110 mm

Pinzette chirurgiche

Tissue forceps

Chirurgische pinzetten

Pinces chirurgicales

Pinzas quirúrgicas



GRAEFE  
0204-AE/0204-AH  
100 mm

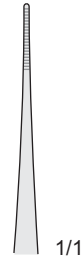

0204-AE 1/1

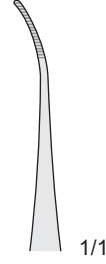

0204-LG 1/1

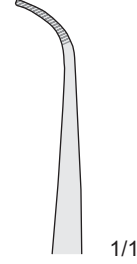

0204-AH 1/1



GRAEFE  
0204-BLE/0204-BLG  
100 mm

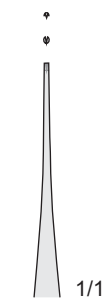

0204-BLE 1/1

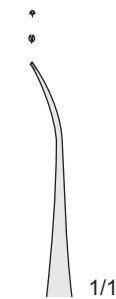

0204-BLF 1/1

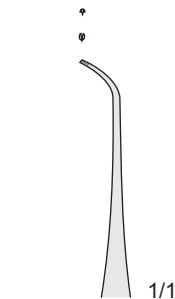

0204-BLG 1/1

Pinzette chirurgiche

Tissue forceps

Chirurgische pinzetten

Pinces chirurgicales

Pinzas quirúrgicas

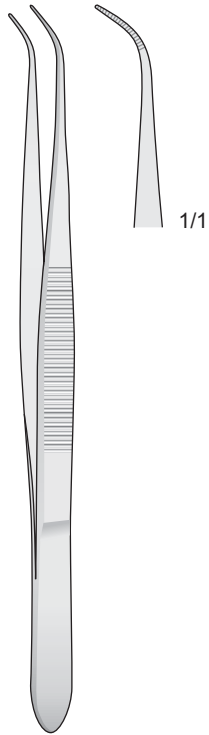

PERRY  
0204-AF  
125 mm

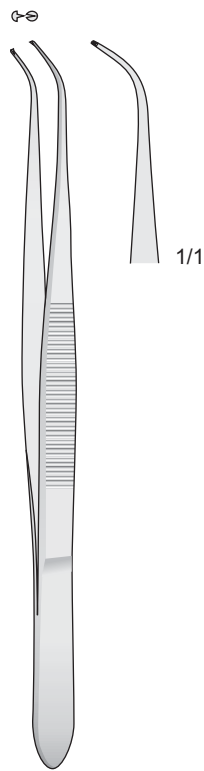

PERRY  
0204-AG  
125 mm

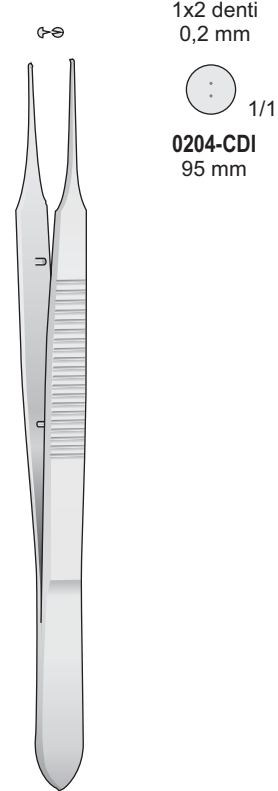

0204-CDI/0204-CDL

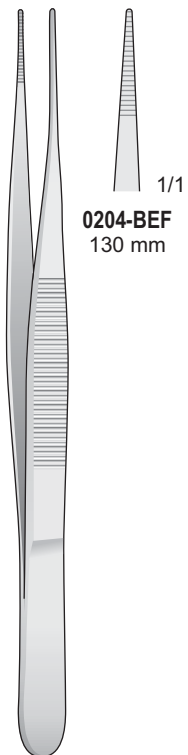
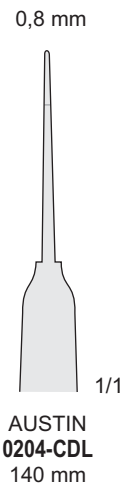

0204-BEF  
130 mm

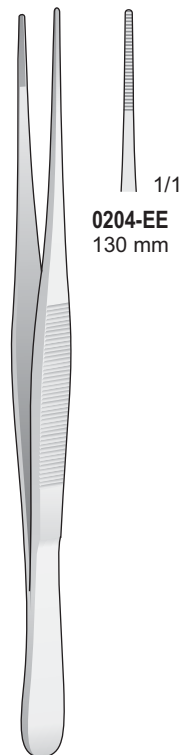

SEMKEN  
0204-EE  
130 mm

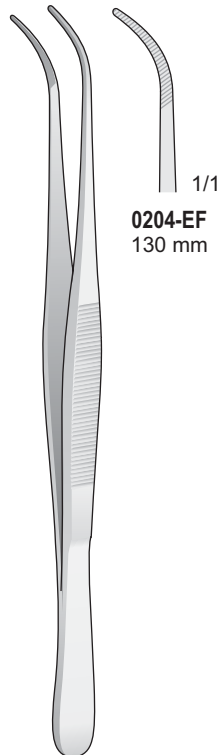

SEMKEN  
0204-EF  
130 mm

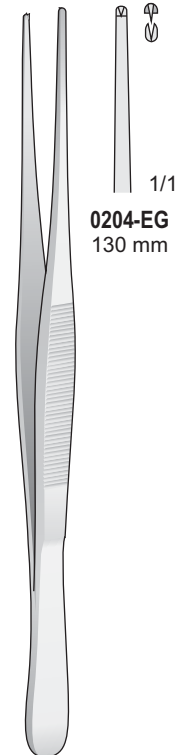

SEMKEN  
0204-EG  
130 mm

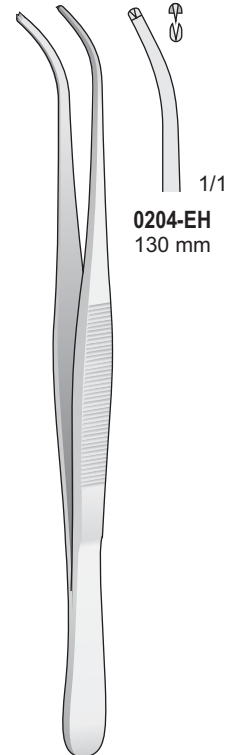

SEMKEN  
0204-EH  
130 mm

Pinzette chirurgiche

Tissue forceps

Chirurgische pinzetten

Pinces chirurgicales

Pinzas quirúrgicas

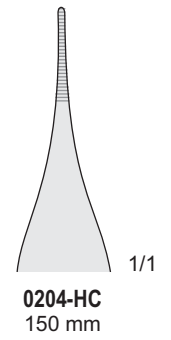
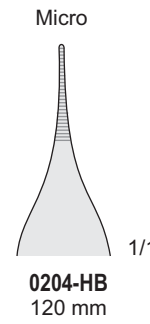
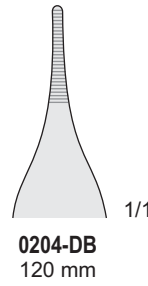
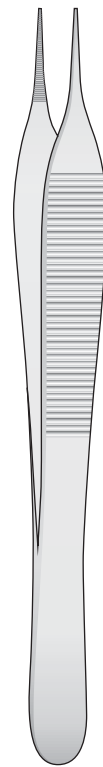
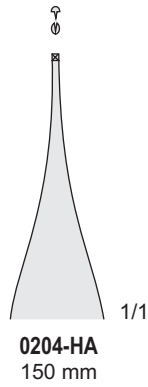
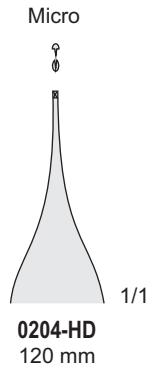
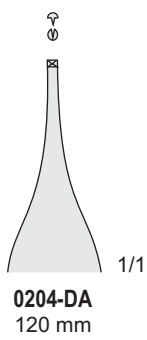
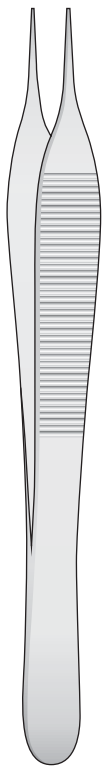

ADSON  
0204-DA/0204-HD

ADSON  
0204-DB/0204-HC

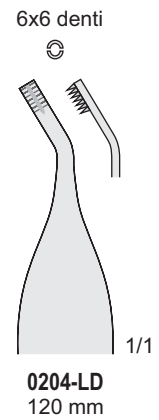
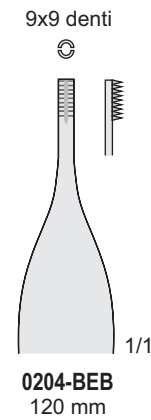
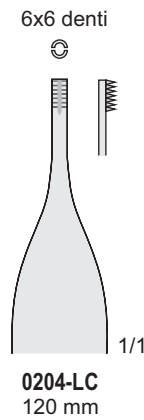
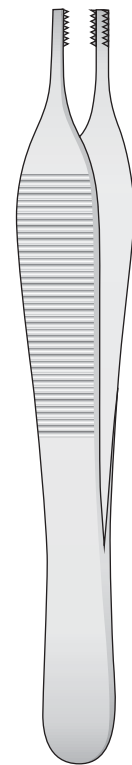
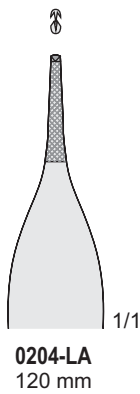
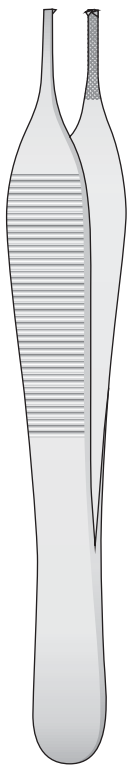









ADSON  
0204-LA  
120 mm

ADSON-BROWN  
0204-LC/0204-BEB  
120 mm

Standard











								
1/1	1/1	1/1	1/1	1/1	1/1	1/1	1/1	1/1
<b>0204-LH</b> 100 mm	<b>0204-LI</b> 115 mm	<b>0204-LL</b> 130 mm	<b>0204-BAA</b> 145 mm	<b>0204-BAF</b> 160 mm	<b>0204-BCE</b> 180 mm	<b>0204-BCG</b> 200 mm	<b>0204-HI</b> 250 mm	<b>0204-HL</b> 300 mm

0204-HI/0204-BCG

Mod. Fine



							
1/1	1/1	1/1	1/1	1/1	1/1	1/1	1/1
<b>0204-BA</b> 145 mm	<b>0204-HF</b> 145 mm	<b>0204-HE</b> 145 mm	<b>0204-HG</b> 200 mm	<b>0204-CD</b> 230 mm	<b>0204-CE</b> 250 mm	<b>0204-CF</b> 250 mm	<b>0204-CG</b> 300 mm

0204-BA/0204-HG

Pinzette anatomiche

Dressing forceps

Anatomische Pinzetten

Pinces anatomiques

Pinzas de diseccion

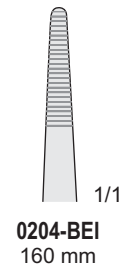
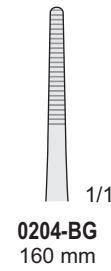
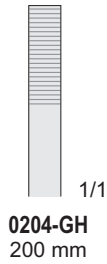
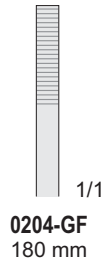
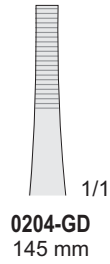
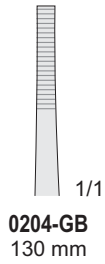

STILLE  
0204-GB/0204-GH

0204-BG/0204-BEI  
160 mm

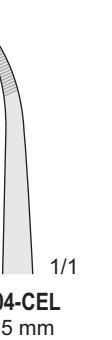
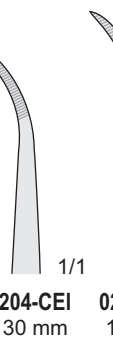
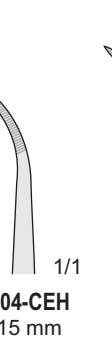
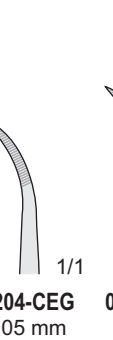
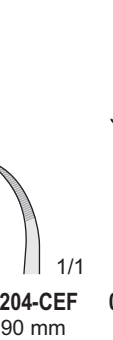
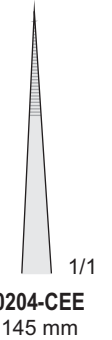
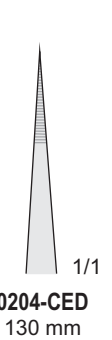
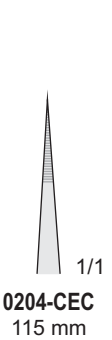

0204-CEA/0204-CEL





1 x 2 Denti - 1 x 2 Teeth - 1 x 2 Zähne - 1 x 2 Dents - 1 x 2 Dientes



Standard

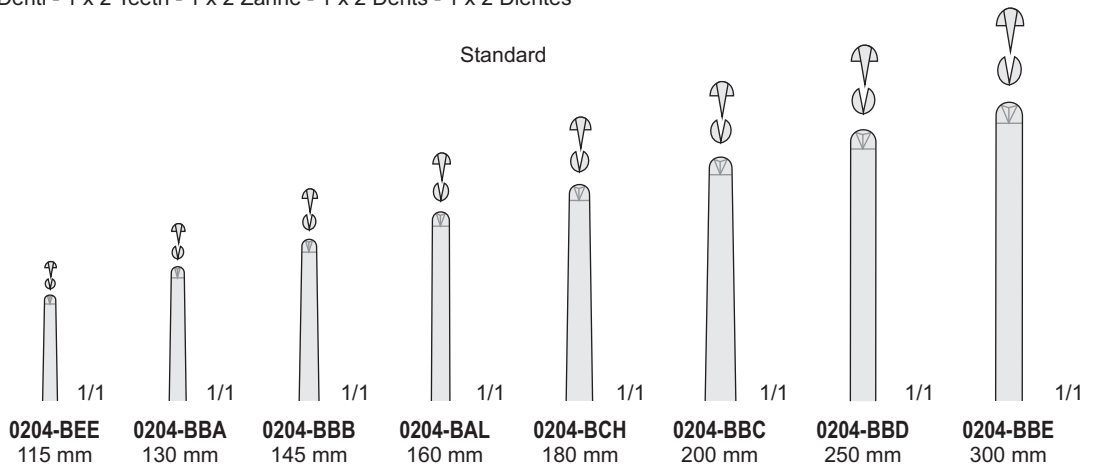

0204-BAL/0204-BEE



1 x 2 Denti - 1 x 2 Teeth - 1 x 2 Zähne - 1 x 2 Dents - 1 x 2 Dientes



Strette - Schmal - Narrow - Étroites - Estrechas

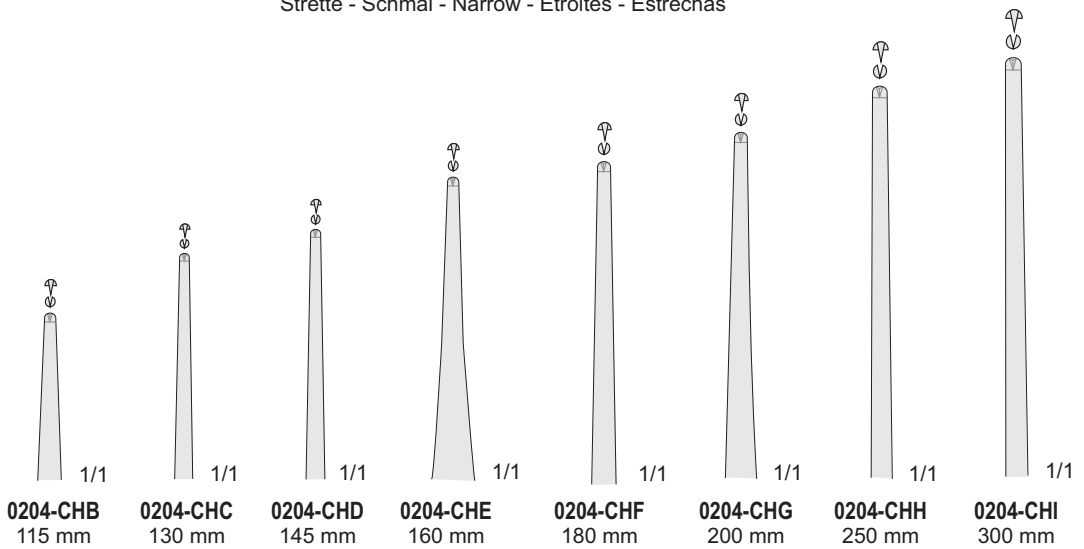

0204-CHB/0204-CHI

Pinzette chirurgiche

Tissue forceps

Chirurgische pinzetten

Pinces chirurgicales

Pinzas quirúrgicas

Strette - Schmal - Narrow - Étroites - Estrechas

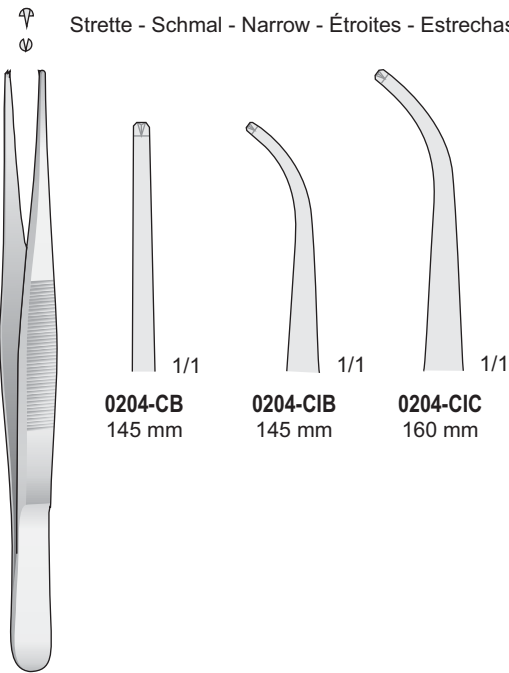

**0204-CB**  
145 mm

**0204-CIB**  
145 mm

**0204-CIC**  
160 mm

Fine - Delicate - Fein - Fines - Finas

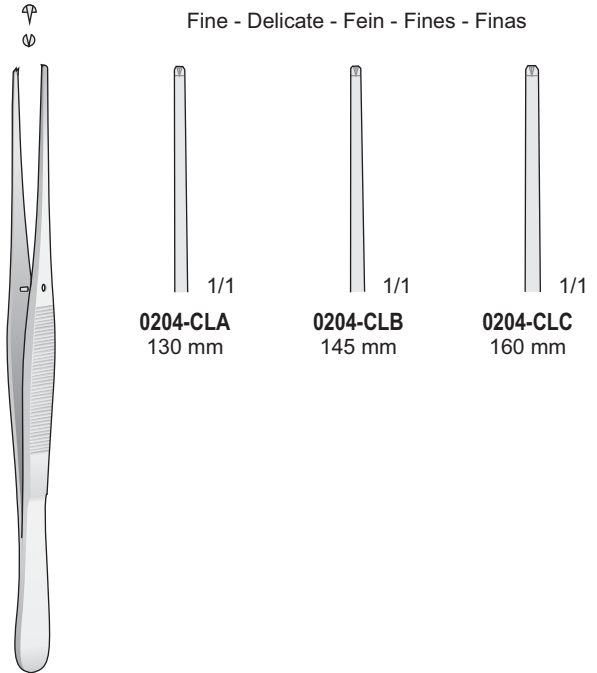

**0204-CLA**  
130 mm

**0204-CLB**  
145 mm

**0204-CLC**  
160 mm

**0204-CB/0204-CIC**

1 x 2 Denti  
1 x 2 Teeth  
1 x 2 Zähne  
1 x 2 Dents  
1 x 2 Dientes

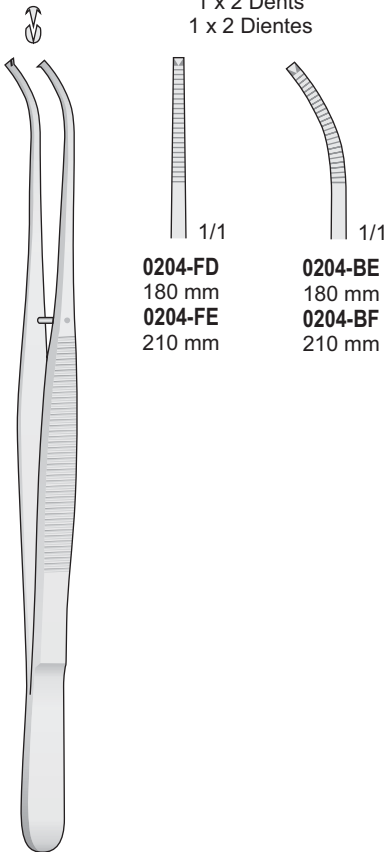

**0204-FD**  
180 mm  
**0204-FE**  
210 mm

**0204-BE**  
180 mm  
**0204-BF**  
210 mm

**0204-CLA/0204-CLC**

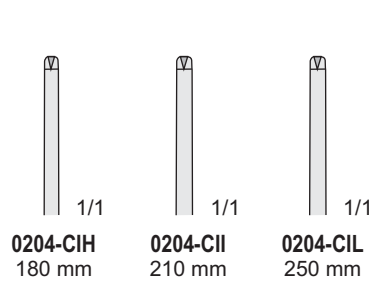

**0204-CIH**  
180 mm

**0204-CII**  
210 mm

**0204-CIL**  
250 mm

1 x 2 Denti  
1 x 2 Teeth  
1 x 2 Zähne  
1 x 2 Dents  
1 x 2 Dientes

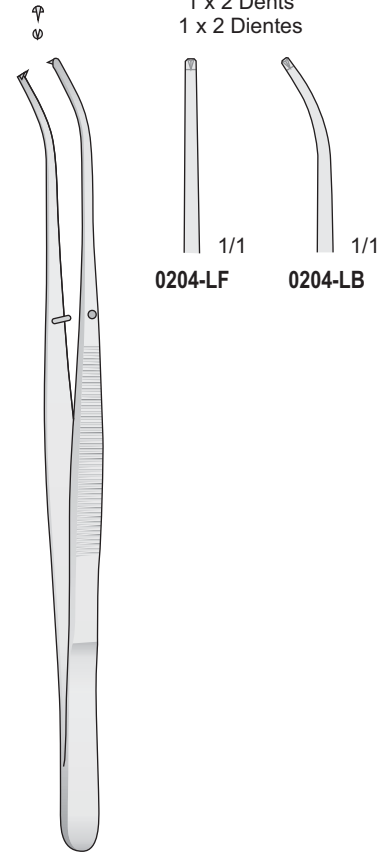

**0204-LF**  
150 mm

**0204-LB**  
150 mm

POTTS-SMITH  
**0204-BE/0204-FE**

POTTS-SMITH  
**0204-CIH/0204-CIL**

SEMKEN  
**0204-LB/0204-LF**  
150 mm

Pinzette chirurgiche

Tissue forceps

Chirurgische pinzetten

Pinces chirurgicales

Pinzas quirúrgicas

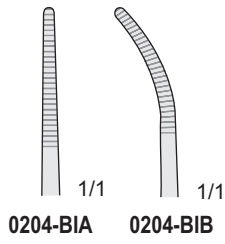

CUSHING  
0204-BIA/0204-BIB  
175 mm

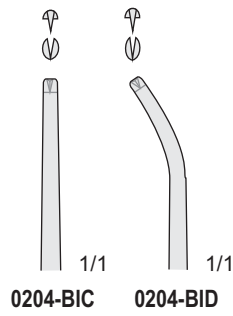

CUSHING  
0204-BIC/0204-BID  
175 mm

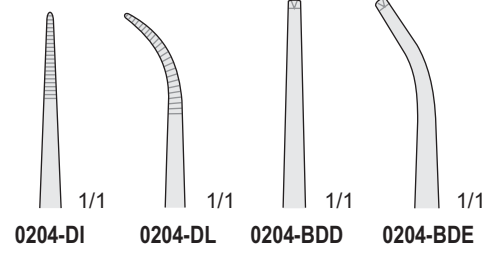

0204-DI/0204-BDE  
200 mm

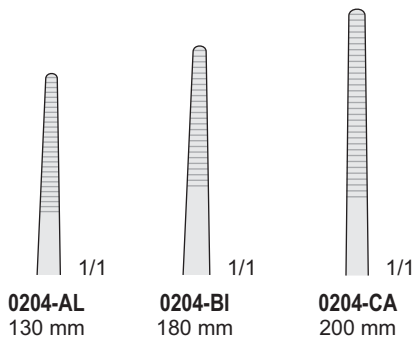

0204-AL/0204-CA

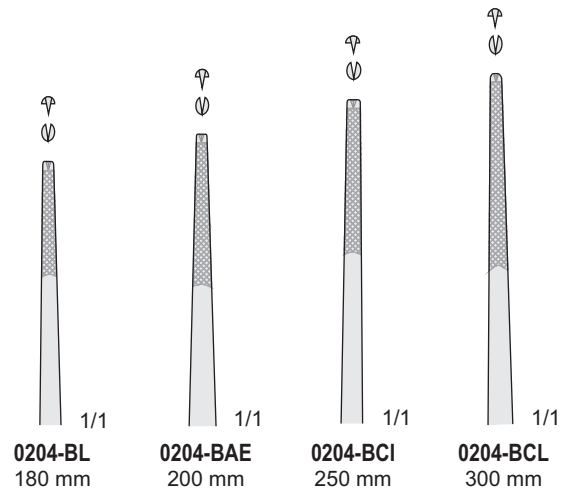

0204-BL/0204-BCL

Pinzette chirurgiche

Tissue forceps

Chirurgische pinzetten

Pinces chirurgicales

Pinzas quirúrgicas

2 x 3 Denti - 2 x 3 Teeth - 2 x 3 Zähne  
2 x 3 Dents - 2 x 3 Dientes

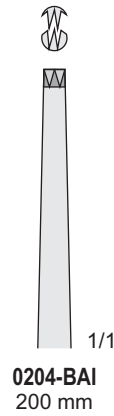
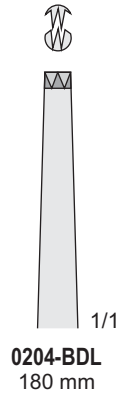
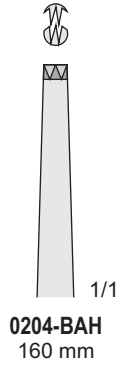
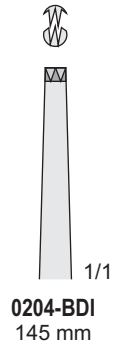
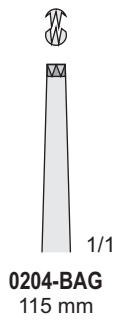

0204-BAG/0204-BDL

3 x 4 Denti - 3 x 4 Teeth - 3 x 4 Zähne  
3 x 4 Dents - 3 x 4 Dientes

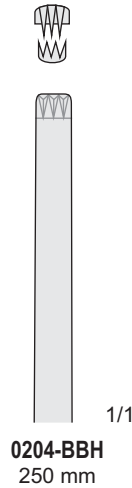
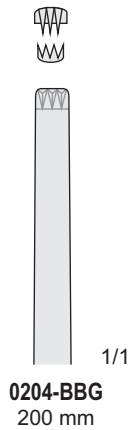
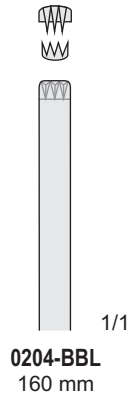
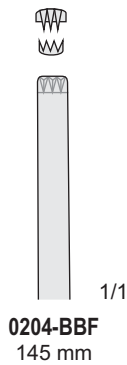

4 x 5 Denti  
4 x 5 Teeth  
4 x 5 Zähne  
4 x 5 Dents  
4 x 5 Dientes

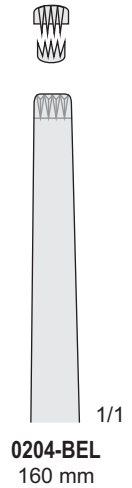
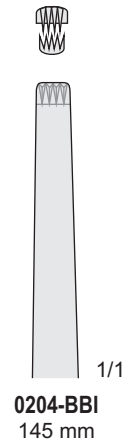

0204-BBF/0204-BBL

0204-BBI/0204-BEL

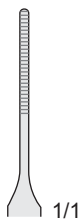

GERALD  
1206-BAB  
180 mm

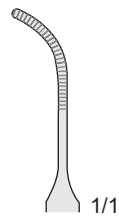
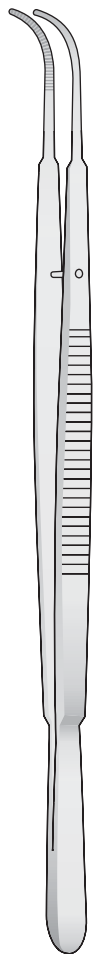

GERALD  
1206-BAC  
180 mm

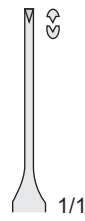

GERALD  
1206-BAD  
180 mm

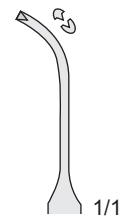

GERALD  
1206-BAE  
180 mm

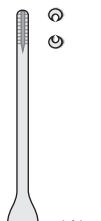

GERALD-BROWN  
1206-BAF  
180 mm

Pinzette per vasi e per tumori  
 Vascular and tumor forceps  
 Gefäß und Tumorpinzetten  
 Pinces vasculaires et pour tumeurs

3 x 4 Denti  
 3 x 4 Teeth  
 3 x 4 Zähne  
 3 x 4 Dents  
 3 x 4 Dientes

4 x 5 Denti  
 4 x 5 Teeth  
 4 x 5 Zähne  
 4 x 5 Dents  
 4 x 5 Dientes

2 x 3 Denti  
 2 x 3 Teeth  
 2 x 3 Zähne  
 2 x 3 Dents  
 2 x 3 Dientes

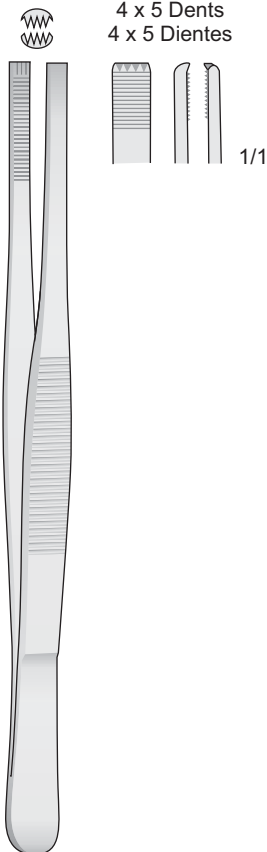

ADLERKREUTZ  
 0204-CI - 150 mm  
 0204-BFF - 200 mm  
 0204-BFG - 250 mm

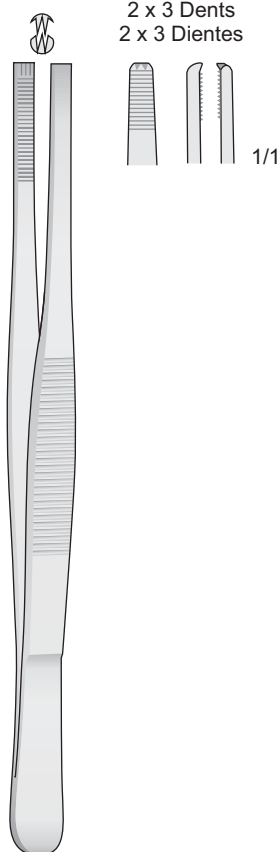

ADLERKREUTZ  
 0204-BFD - 150 mm  
 0204-BFE - 200 mm

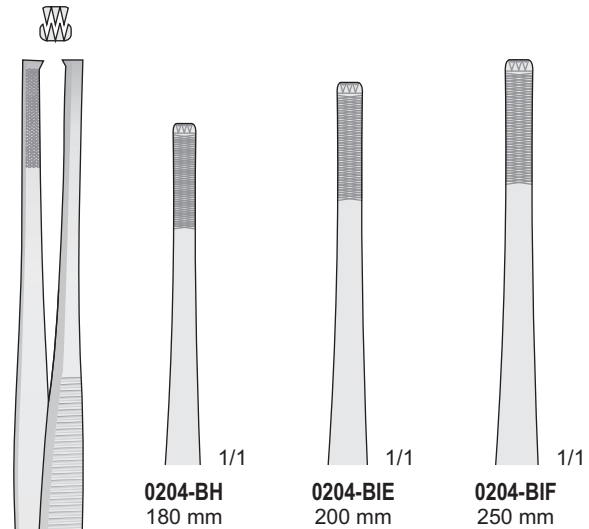

STILLE-BARRAYA  
 0204-BH/0204-BIF

Pinzette anatomiche

Dressing forceps

Anatomische Pinzetten

Pinces Anatomiques

Pinzas de diseccion



DURANTE  
0204-BFB/0204-BFC

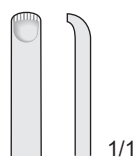

0204-BFB  
140 mm

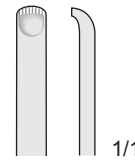

0204-BFC  
160 mm

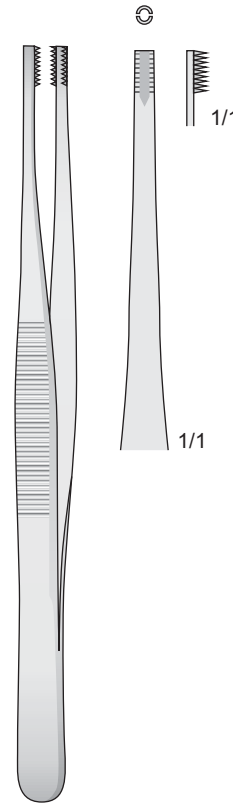

BROWN  
0204-LE  
150 mm

8 x 8 Denti  
8 x 8 Teeth  
8 x 8 Zähne  
8 x 8 Dents  
8 x 8 Dientes

1/1

1/1

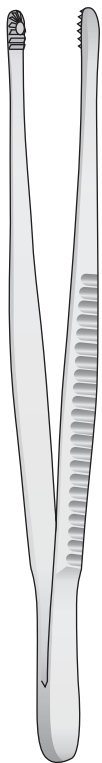

RUSSIAN  
0204-CH/0204-BHG

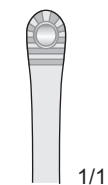

0204-CH  
150 mm

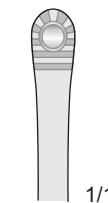

0204-BHF  
200 mm

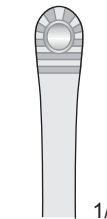

0204-BHG  
250 mm



SELMAN  
0204-BFH  
150 mm

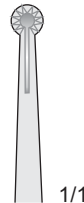

1/1



SINGLEY-TUTTLE  
0204-CL  
230 mm



1/1



MAYO-RUSSIAN  
0204-DH  
230 mm



1/1

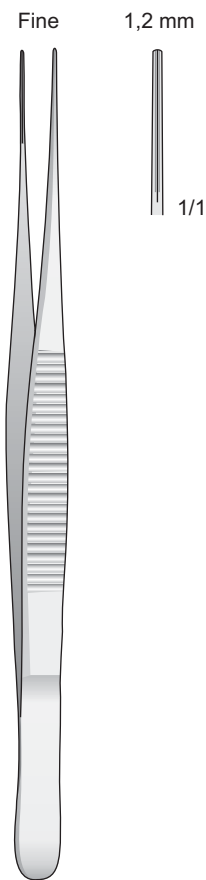

DE BAKEY  
0204-BIG  
195 mm



DE BAKEY  
0204-BLA/0204-BLC

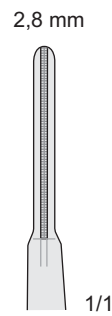

0204-BLA  
200 mm

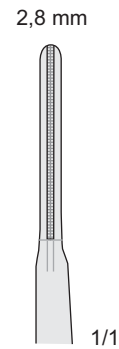

0204-BLB  
250 mm

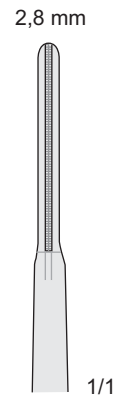

0204-BLC  
300 mm



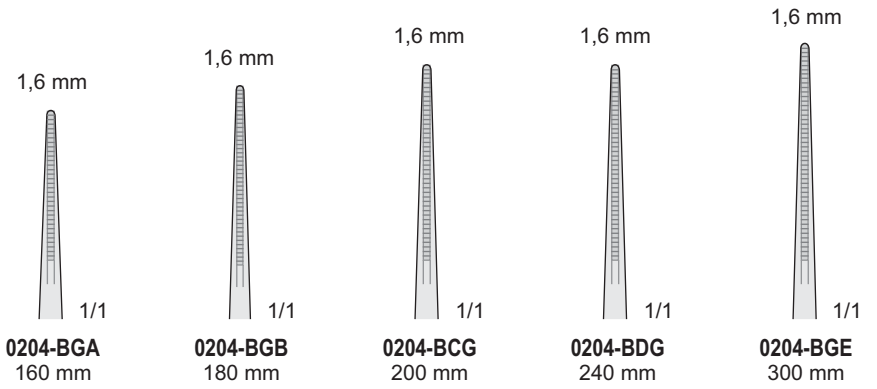

Pinzette atraumatiche  
 Non-traumatic vascular tissue forceps  
 Atraumatische pinzetten  
 Pinces atraumatiques  
 Pinzas atraumaticas



DE BAKEY  
**0204-IA/0204-BGE**

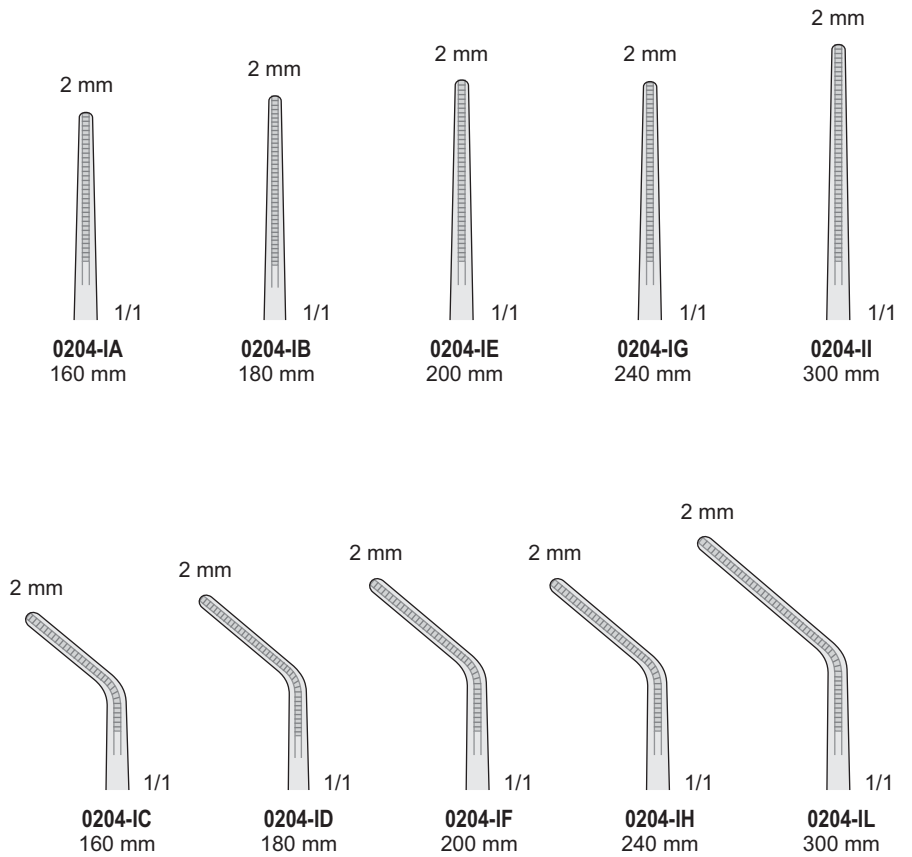

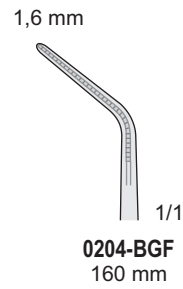

Pinzette atraumatiche  
Atraumatische pinzetten  
Atraumatic vascular tissue forceps  
Pincés atraumatiques  
Pinzas atraumaticas

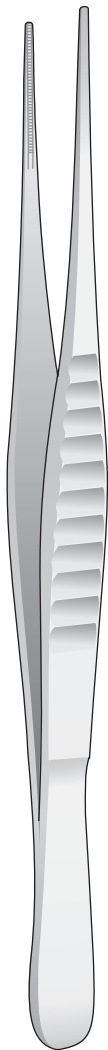

DE BAKEY  
0204-BGF/0204-BHD

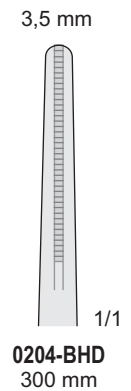
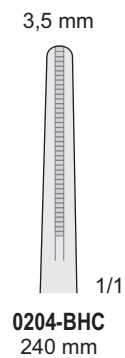
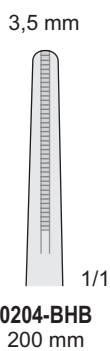
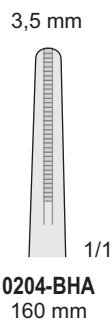
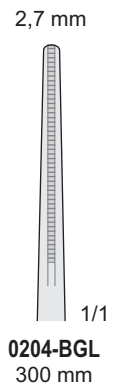
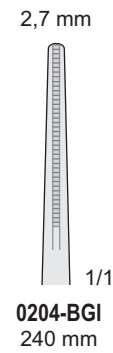
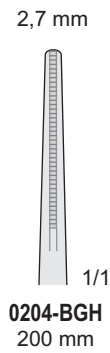
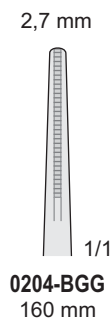

Micro pinzette

Delicate forceps

Micro Pinzetten

Micro pinces

Pinzas finos

Pinze da Fissazione-oftalmica - Fixier und fasspinzetten  
 Fixation and Grasping forceps - Pinzas de fijación y de aprehensión

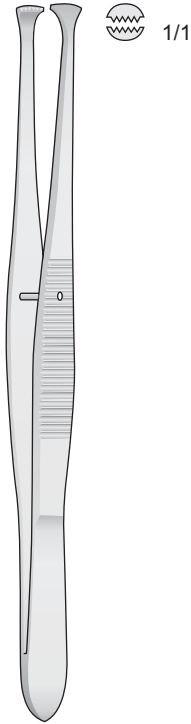

GRAEFE  
 0204-BDF  
 110 mm

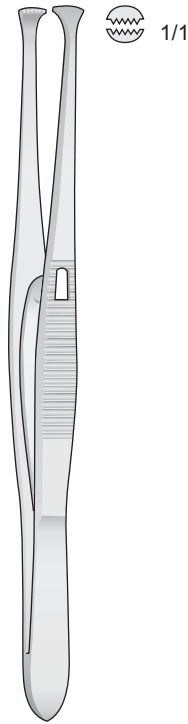

GRAEFE  
 0204-BDG  
 110 mm

Pinzetta-Columella  
 con stop

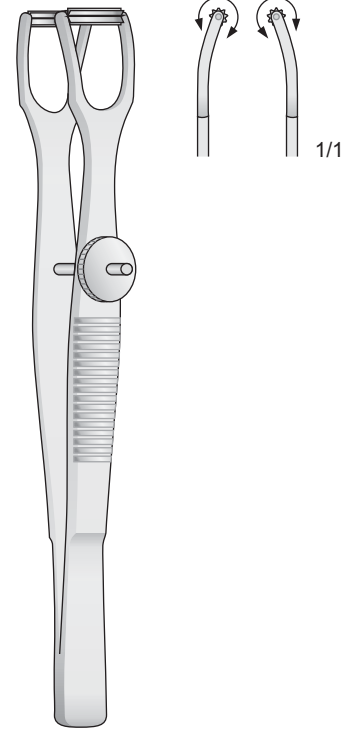

COTTLE  
 0204-BEA  
 100 mm

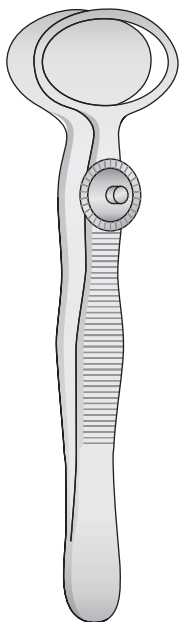

DESMARRES  
 0204-BDA/0204-BDC  
 90 mm

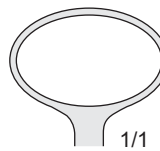

0204-BDA  
 20 mm

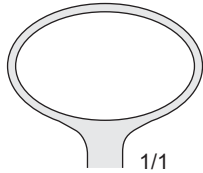

0204-BDB  
 26 mm

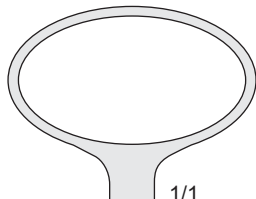

0204-BDC  
 31 mm

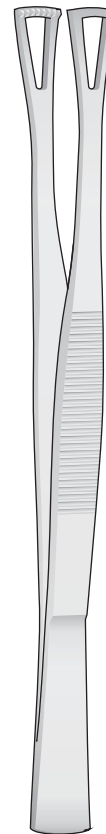

DUVAL  
 0204-BLI/0204-BLL

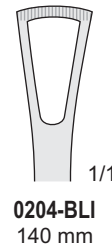

0204-BLI  
 140 mm

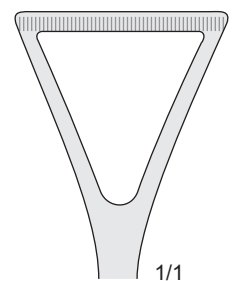

0204-BLL  
 200 mm

Pinze intestinali  
 Intestinal forceps  
 Darmpinzetten  
 Pincés pour préhension de l'intestin  
 Pinzas intestinales

Pinzette chirurgiche

Tissue forceps

Chirurgische pinzetten

Pinces chirurgicales

Pinzas quirúrgicas

Con punta al carburo di tungsteno - Tungsten-carbide forceps  
 Mit hartmetalleinsätzen - Avec plaquettes en carbure de tungstène - Pinzas con tungsteno

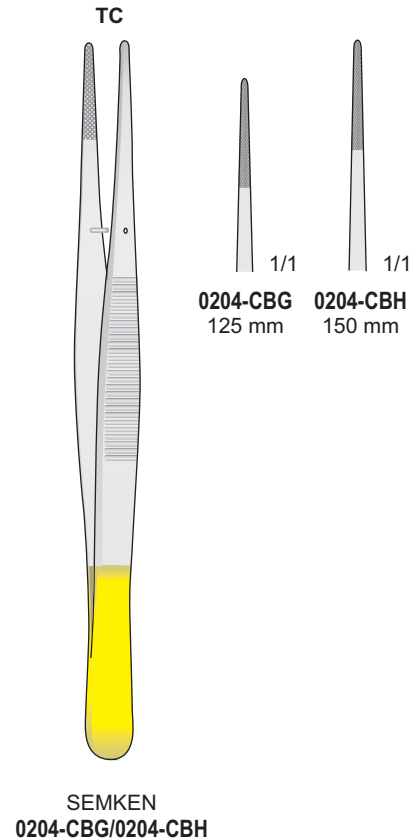
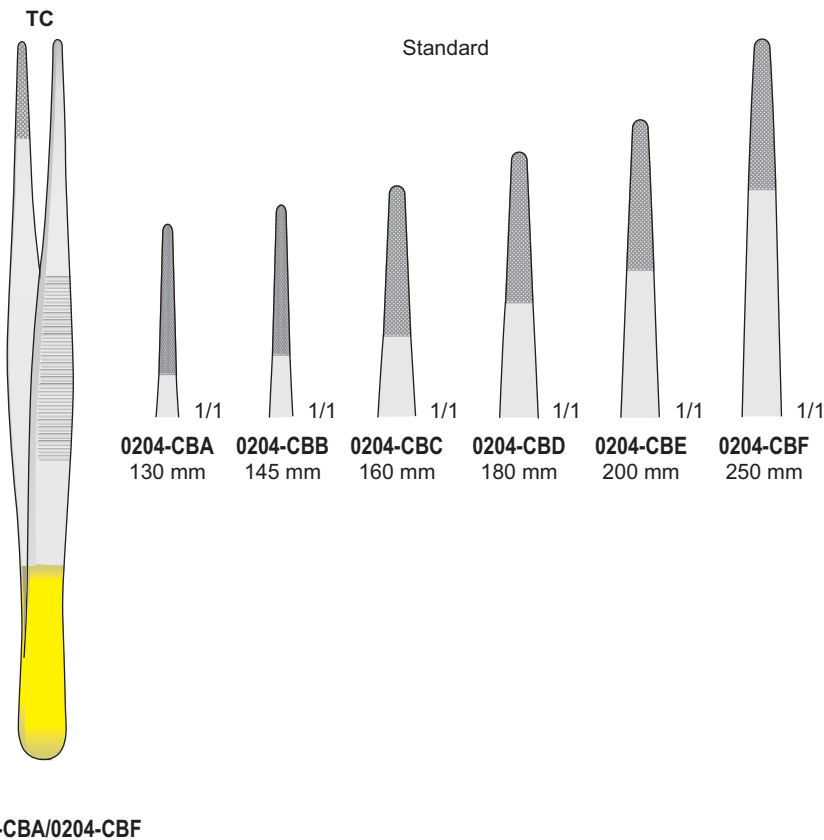
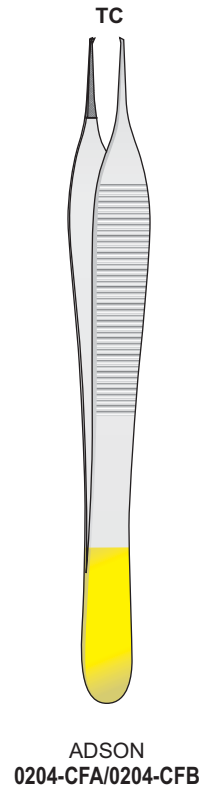
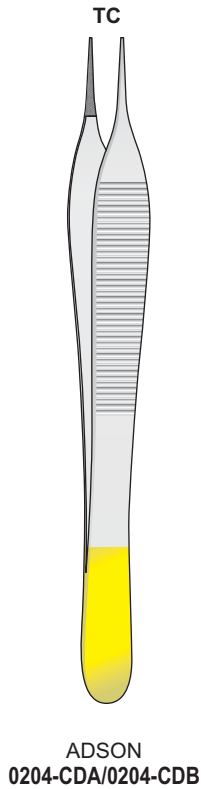

Pinzette chirurgiche

Tissue forceps

Chirurgische pinzetten

Pinces chirurgicales

Pinzas quirúrgicas

TC



WANGENSTEEN  
0204-CDC/0204-CDE

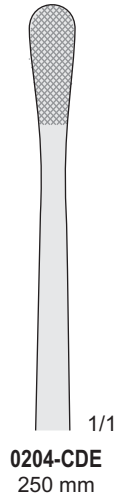
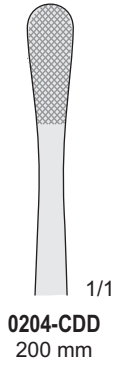
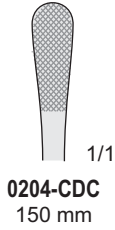

TC



BONNEY  
0204-CFC  
180 mm

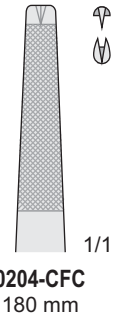

TC



CUSHING  
0204-CCG/0204-CCH  
175 mm

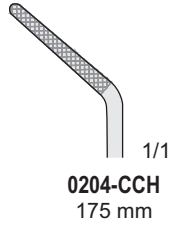
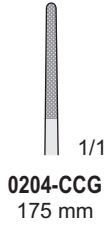

Con dissetore  
With Dissector End  
Mit Dissektor-Ende  
Avec bout disecteur  
Con cabo disecador

TC



POTTS-SMITH  
0204-CBI/0204-CCA

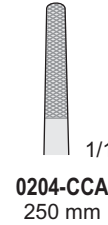
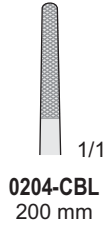
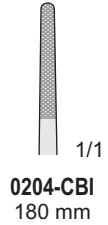

Con dissetore  
With Dissector End  
Mit Dissektor-Ende  
Avec bout disecteur  
Con cabo disecador

TC

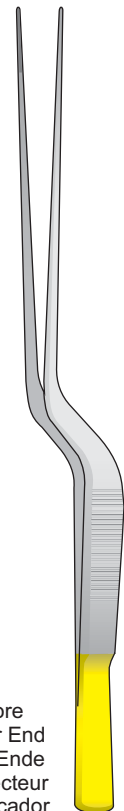

TAYLOR  
0204-CCI  
185 mm

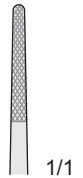

Con dissetore  
With Dissector End  
Mit Dissektor-Ende  
Avec bout disecteur  
Con cabo disecador

Con punta al carburo di tungsteno  
 Tungsten-carbide forceps  
 Mit hartmetalleinsätzen  
 Avec plaquettes en carbure de tungstène  
 Pinzas con tungsteno

TC



DE BAKEY  
 1206-DCA  
 180 mm

TC



0204-CCB/0204-CCL

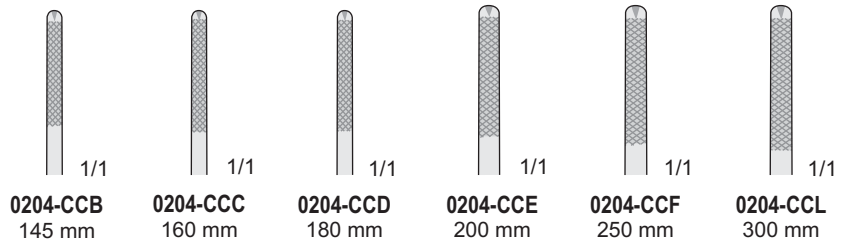

Pinzette auricolari

Ear forceps

Ohr Pinzetten

Pinces auriculaires

Pinzas auricolares

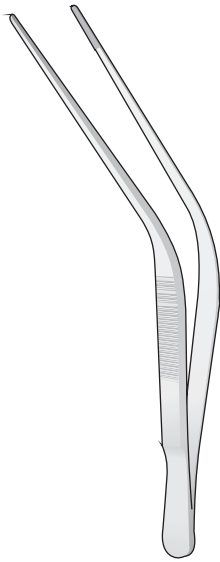

TROELTSCH  
0204-CC  
110 mm

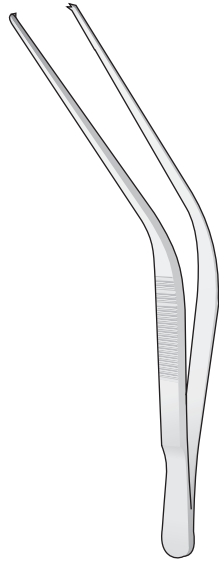

TROELTSCH  
0204-BEG  
110 mm

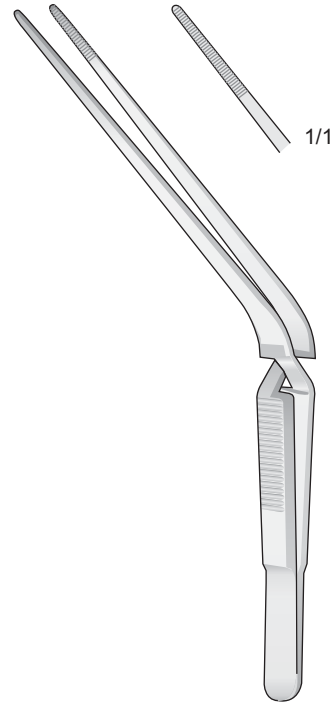

TROELTSCH  
0204-BHL  
130 mm



LUCAE  
0204-BEH  
140 mm

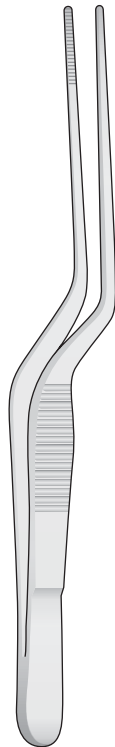

LUCAE  
0204-BAB  
140 mm



JANSEN  
0204-BAC  
160 mm



GRÜNWALD  
0204-BLD  
200 mm

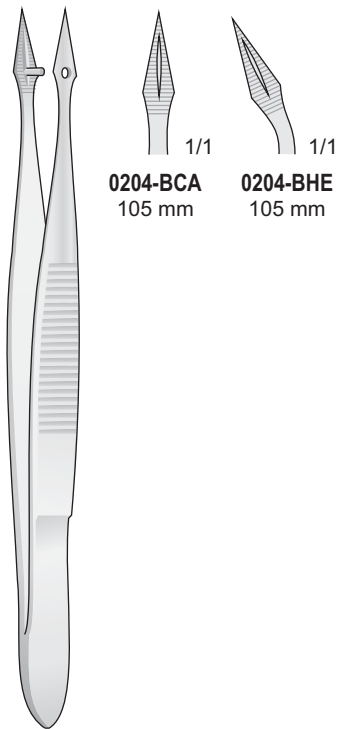

**0204-BCA**  
105 mm

**0204-BHE**  
105 mm

HUNTER  
**0204-BCA/0204-BHE**

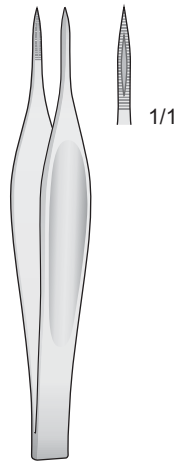

FEICHENFELD  
**0204-BCB**  
75 mm

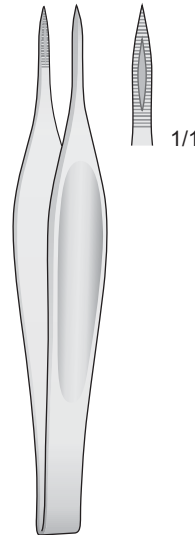

FEICHENFELD  
**0204-BCC**  
90 mm

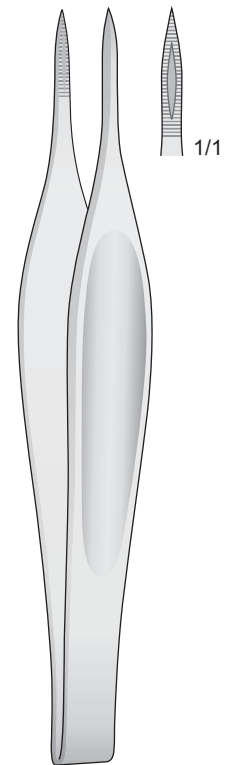

FEICHENFELD  
**0204-BCD**  
115 mm

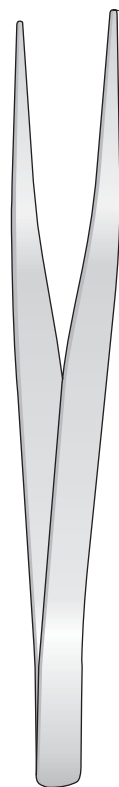

**0204-FA**  
150 mm

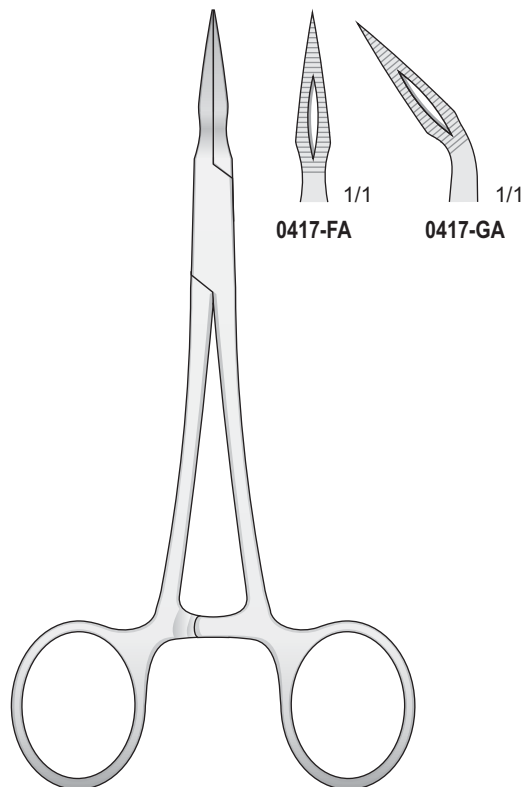

**0417-FA** **0417-GA**

STIEGLITZ  
**0417-FA/0417-GA**  
140 mm



Pinzette Depilatorie

Cilia forceps

Cilienpinzetten

Pinces à épiler les cils

Pinzas depilatorie

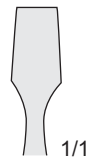

**KÜHNE**  
**0518-EE**  
105 mm

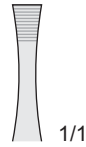

**LITTAUER**  
**0518-GE**  
85 mm

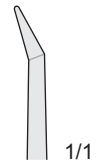

**BARRAQUER**  
**0518-GF**  
105 mm

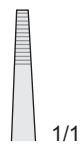

**0518-EF**  
90 mm

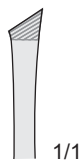

**0518-EG**  
90 mm



**BERGH**  
**0518-EH**  
105 mm

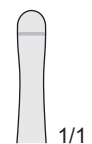

**BEER**  
**0518-EI**  
90 mm





ideal-tek

manufacturer & supplier of precision instruments 

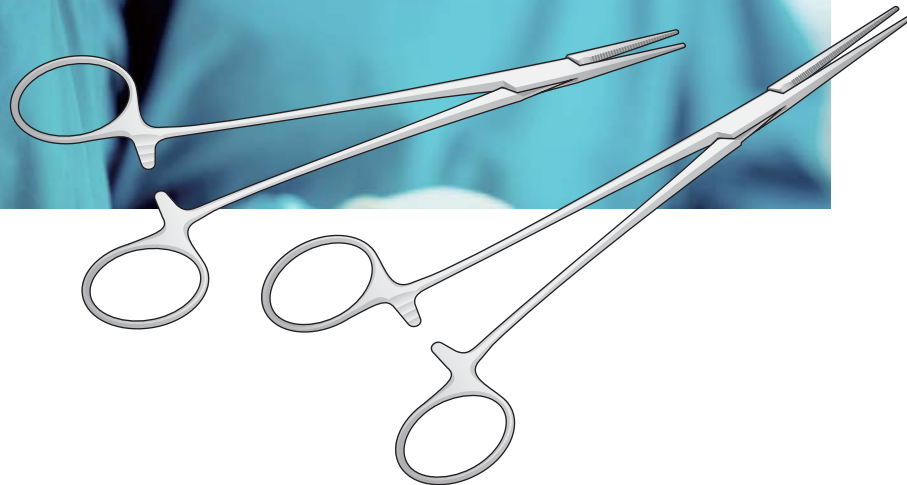

5

Fissateli, Pinze emostatiche  
Towel forceps, Hemostatics forceps  
Tuchklemmen, Arterienklemmen  
Pincas à campos, Pincas hèmostatiques  
Pinzas para campos, Pinzas hemostáticas



Pinze emostatiche

Hemostatic forceps

Arterienklemmen

Pinces hémostatiques

Pinzas hemostáticas

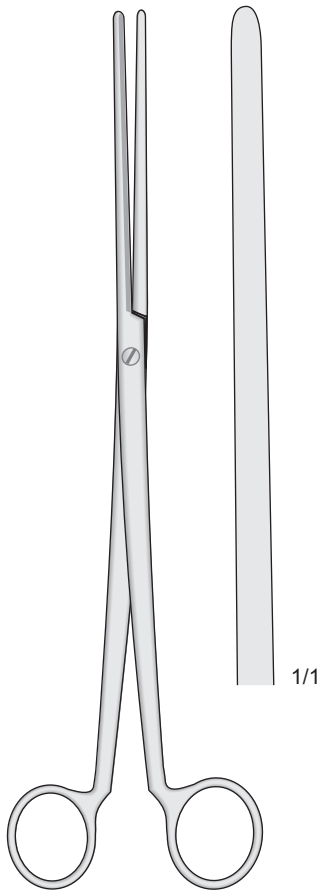

**COLLIN  
0206-AD**  
260 mm

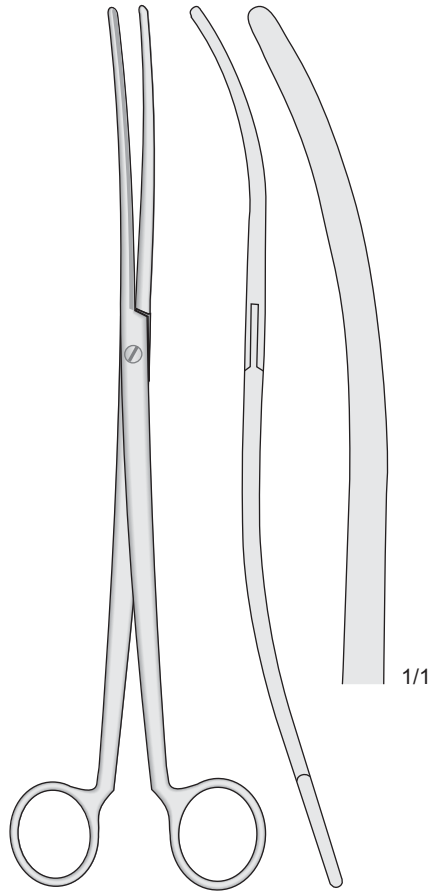

**COLLIN  
0206-AE**  
260 mm

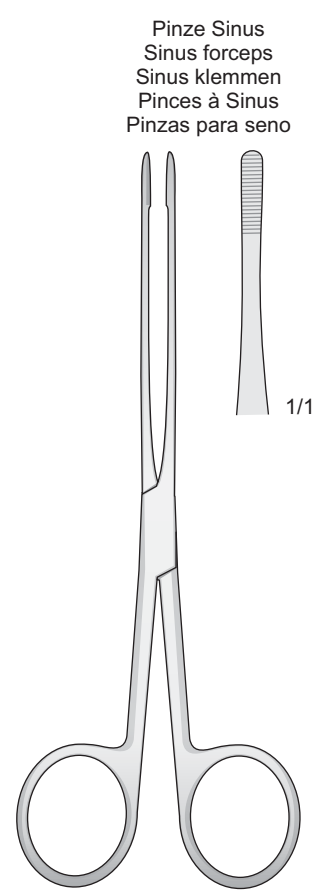

Pinze Sinus  
Sinus forceps  
Sinus klemmen  
Pinces à Sinus  
Pinzas para seno

**LISTER  
0206-CA**  
150 mm

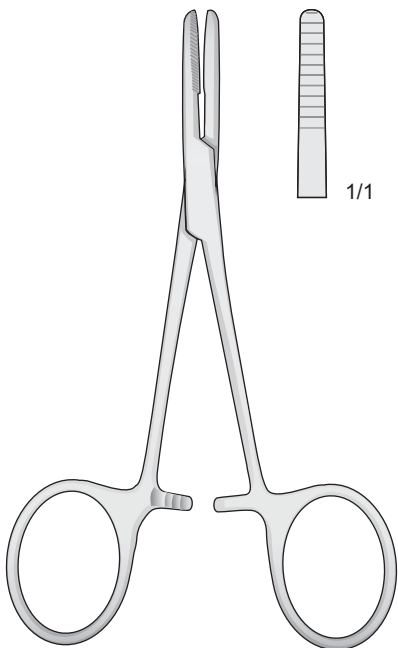

**TERRIER  
15-GA**  
130 mm

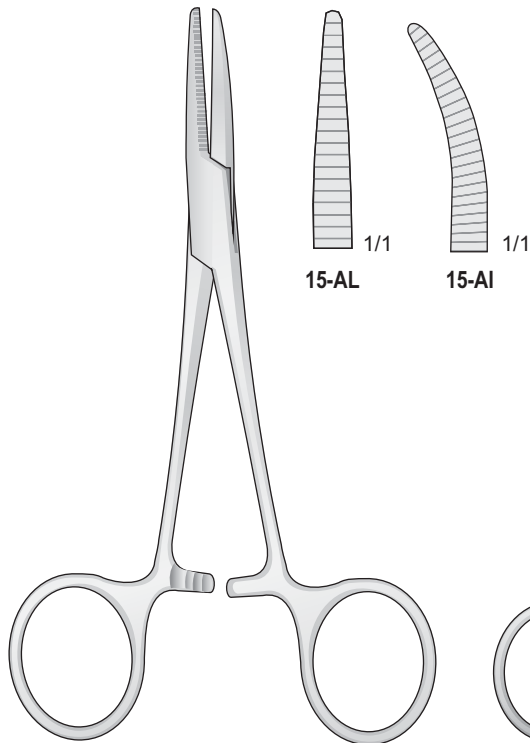

**JONES  
15-AL/15-AI**  
150 mm

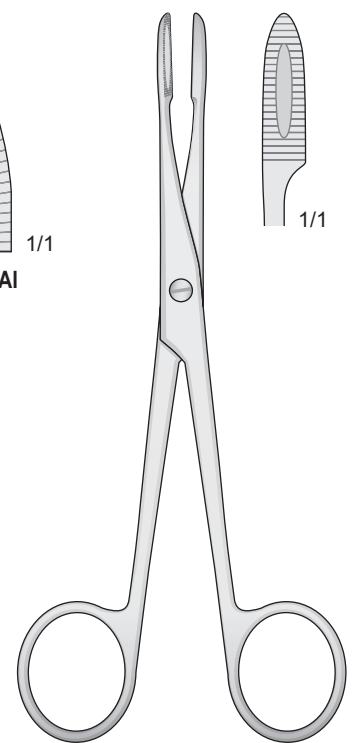

**GROSS  
0206-BA - 130 mm  
0206-BC - 160 mm**

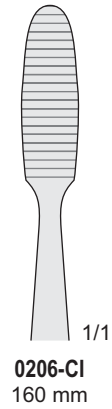
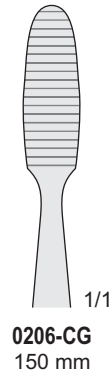
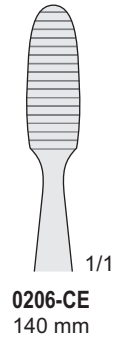
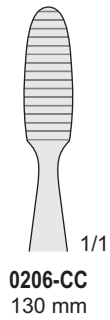
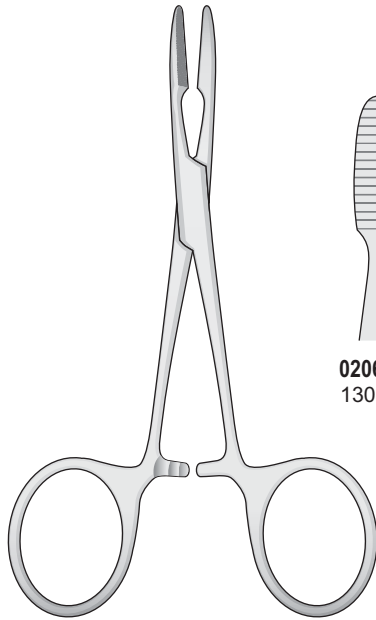

PEAN-MURPHY  
0206-CC/0206-CI

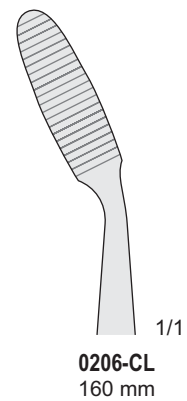
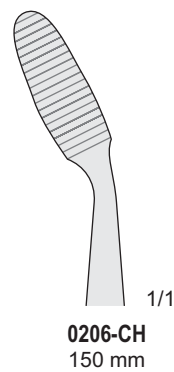
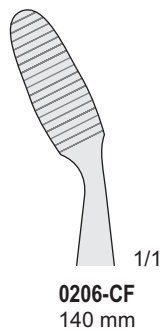
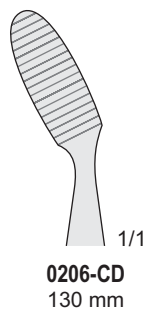
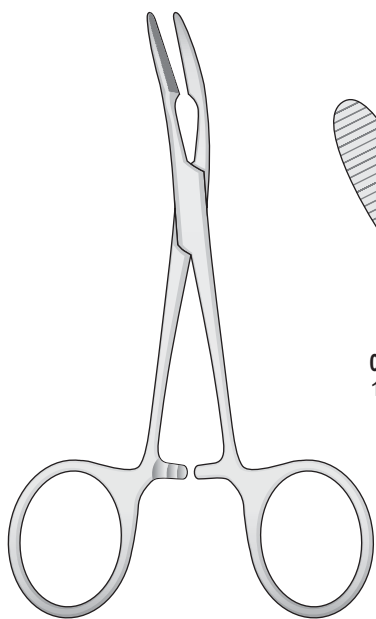

PEAN-MURPHY  
0206-CD/0206-CL

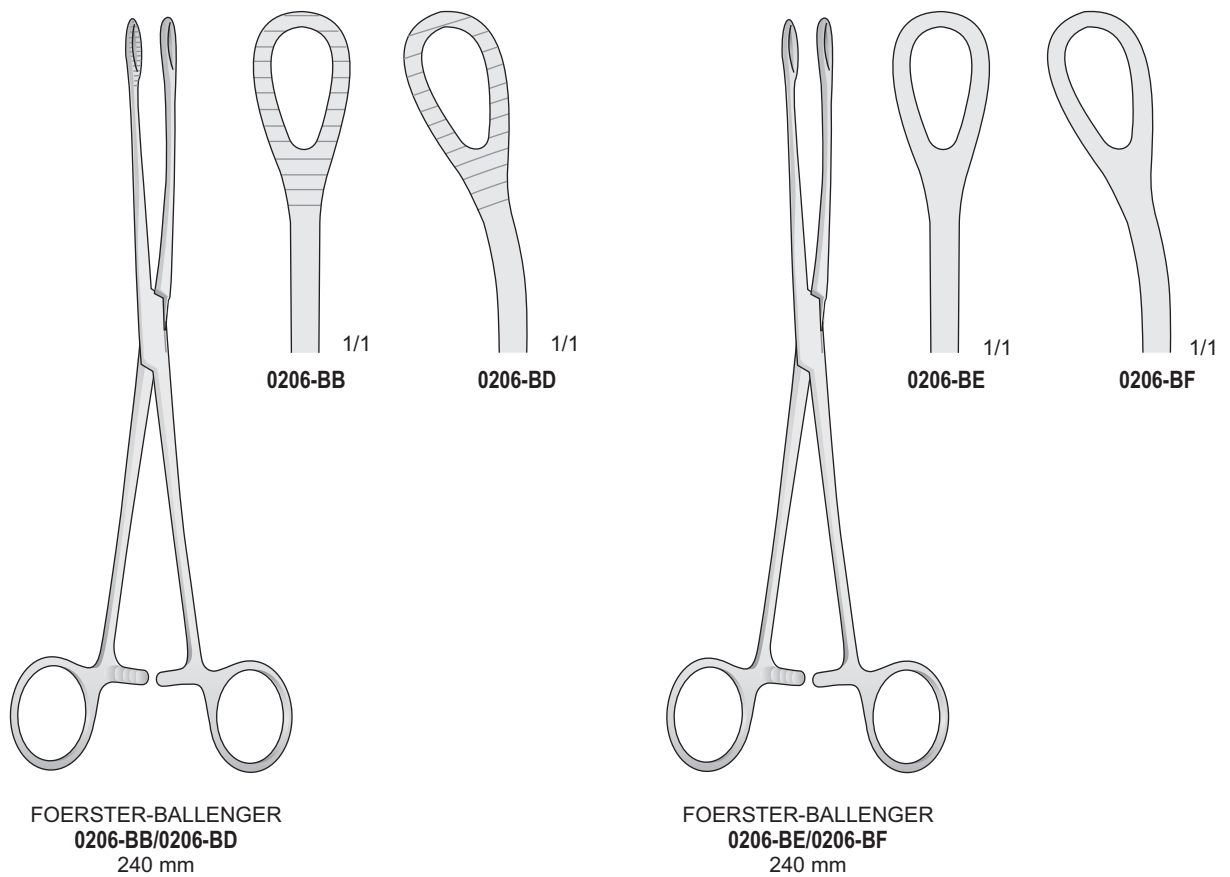
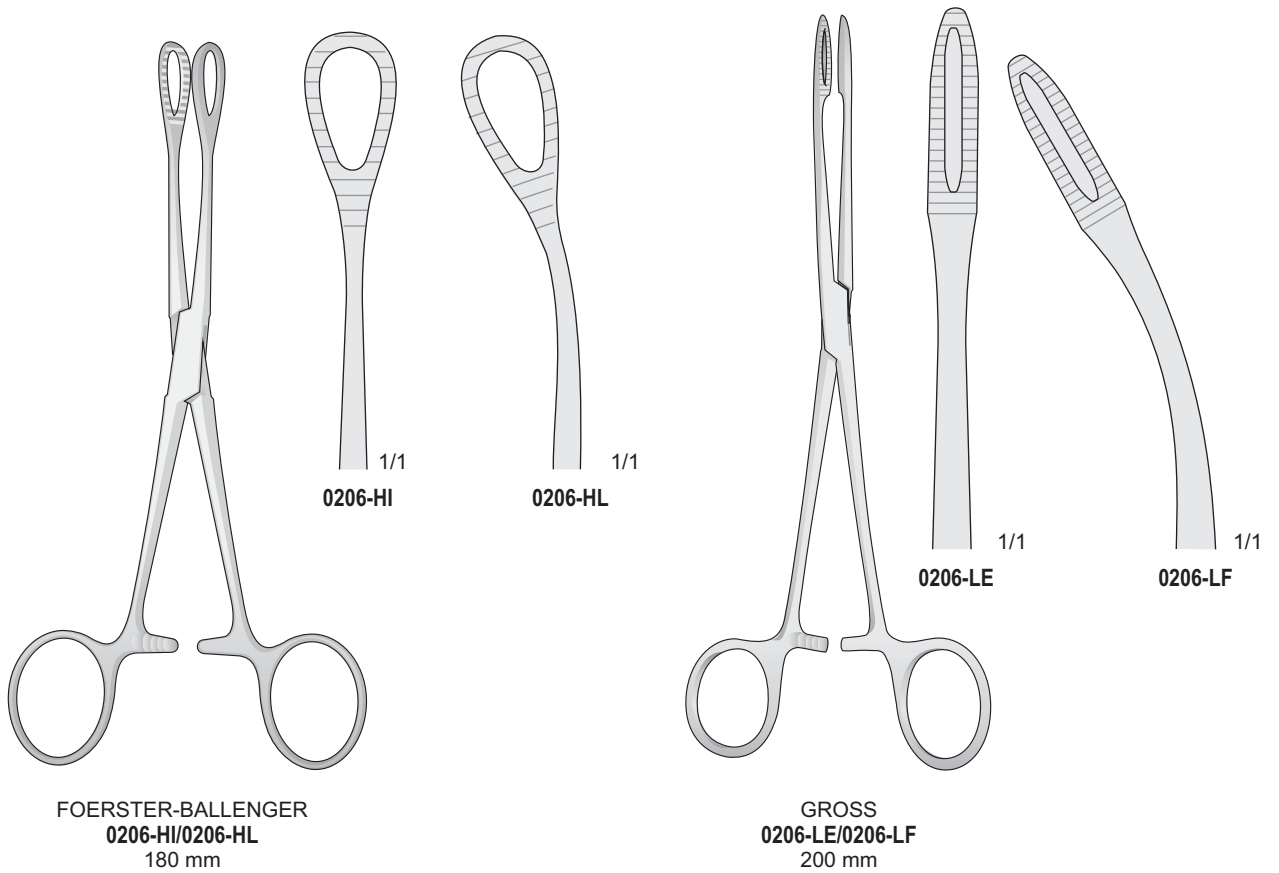

Pinze per tamponi Sponge and dressing forceps Schwamm und tamponzangen Pincés à tampons Pinzas para tampones

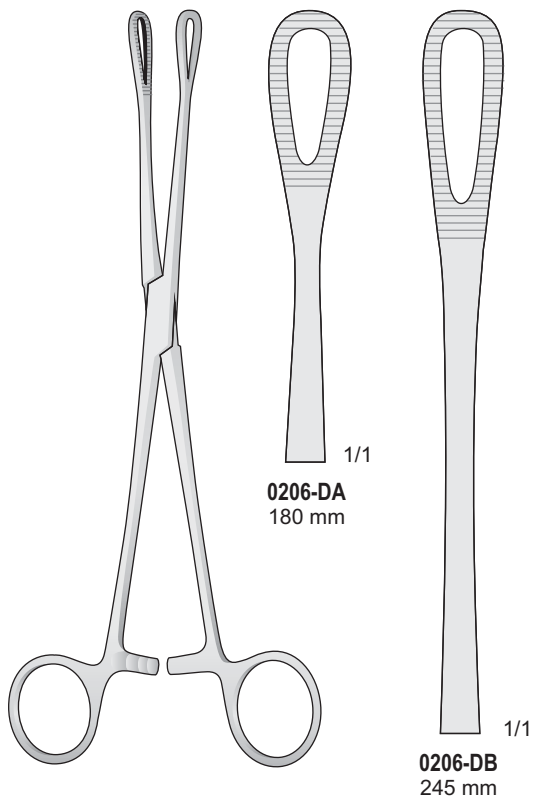

RAMPLEY  
0206-DA/0206-DB

0206-DA  
180 mm

0206-DB  
245 mm

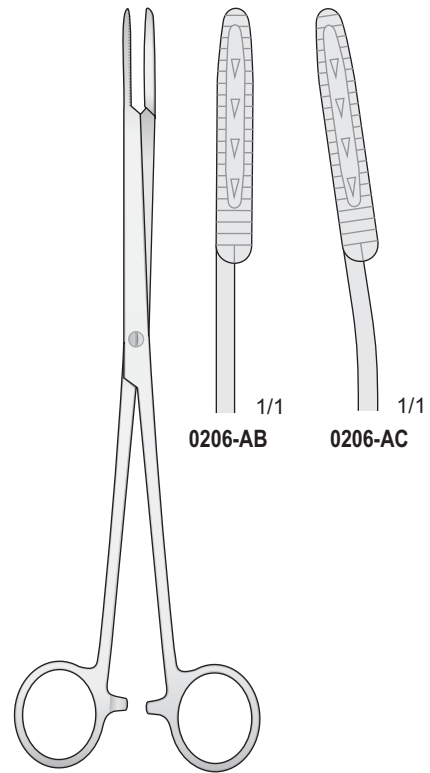

MAIER  
0206-AB/0206-AC  
245 mm

0206-AB

0206-AC

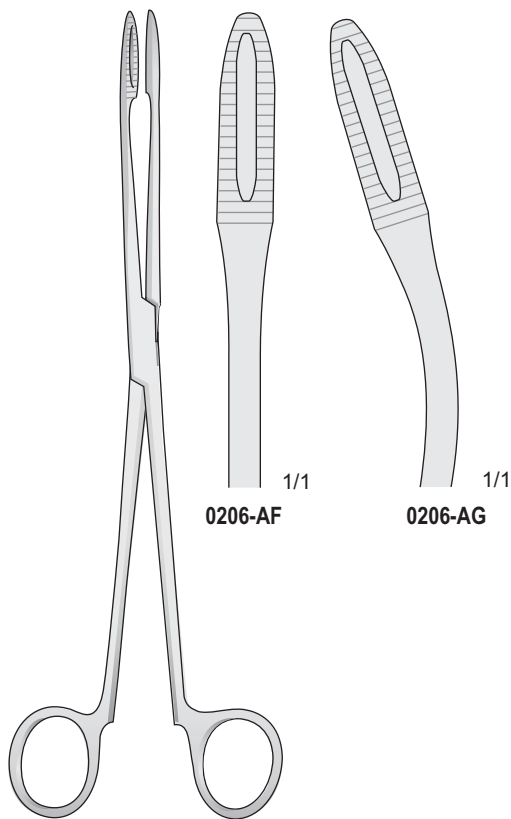

MAIER  
0206-AF/0206-AG  
265 mm

0206-AF

0206-AG

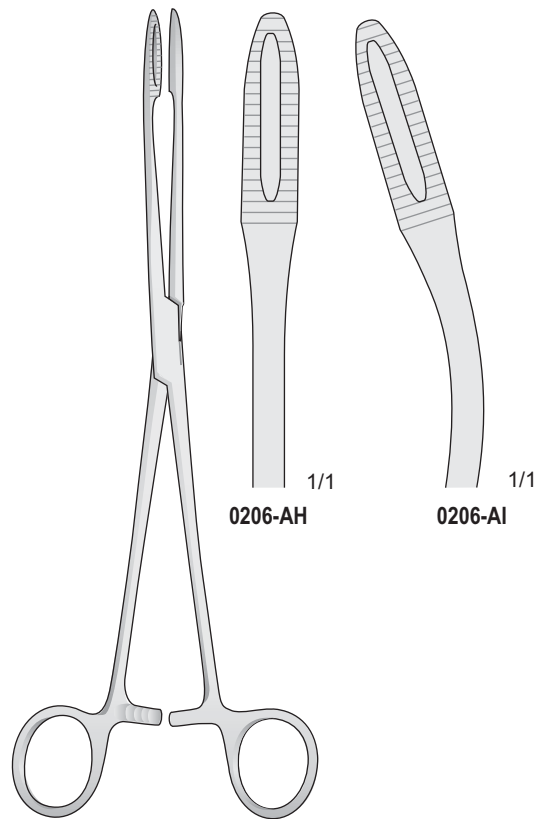

MAIER  
0206-AH/0206-AI  
265 mm

0206-AH

0206-AI



Pinze tirlingua

Tongueforceps

Zungenzangen

Pinces tire-langue

Pinzas tira-lengua

Gommini di ricambio 2 pezzi - Pair, Rubber jaws, only  
 Paar, Gummipolster, Allein - Paire, mors en caotchouc, seuls  
 Par, Bocas de goma, sueltas

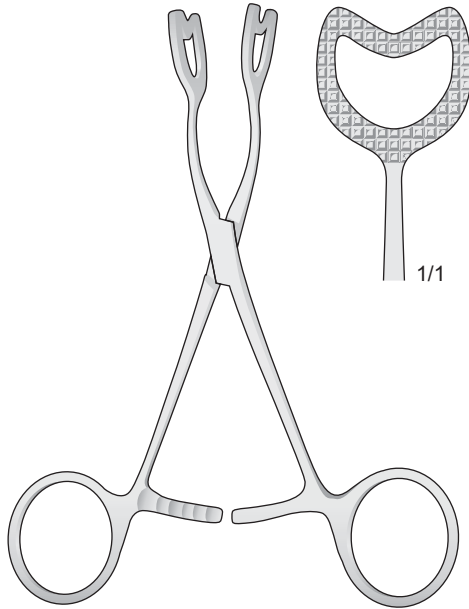

**1412-BB**  
140 mm

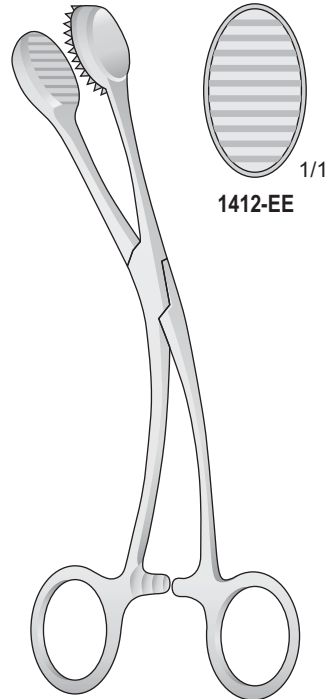

**YOUNG**  
**1412-EF**  
160 mm

Gommini di ricambio 2 pezzi - Pair, Rubber jaws, only  
 Paar, Gummipolster, Allein - Paire, mors en caotchouc, seuls  
 Par, Bocas de goma, sueltas

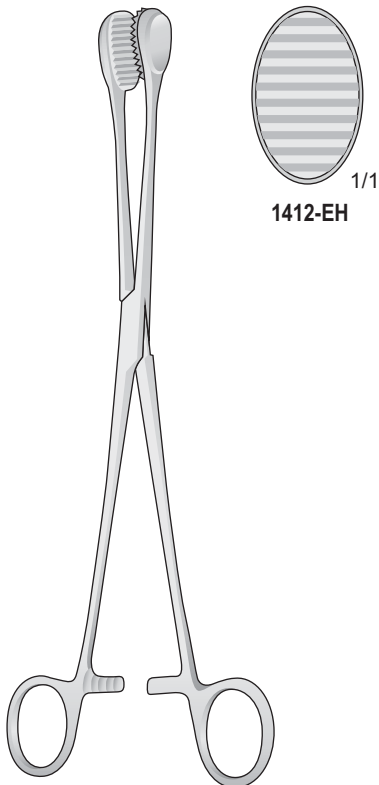

**CHILD**  
**1412-EG**  
240 mm

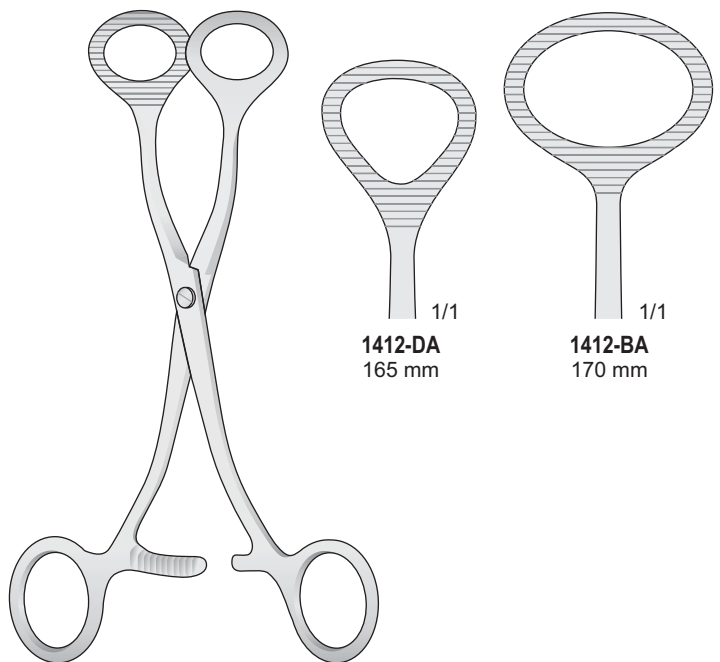

**COLLIN**  
**1412-BA/1412-DA**

Pinze emostatiche

Artery forceps

Arterienklemmen

Pinces hémostatiques

Pinzas hemostáticas

Pinza per batuffoli e tamponi  
 Cotton swab-sponge holding forceps  
 Tupfer-Schwammzangen - Pinces à tampons et éponges  
 Pinzas para tampones porta esponjas

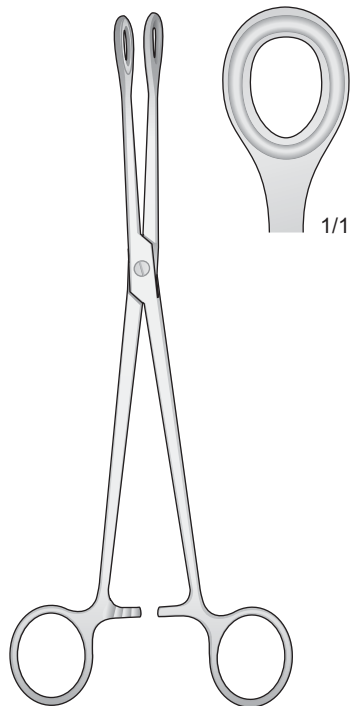

**0206-BG**  
230 mm

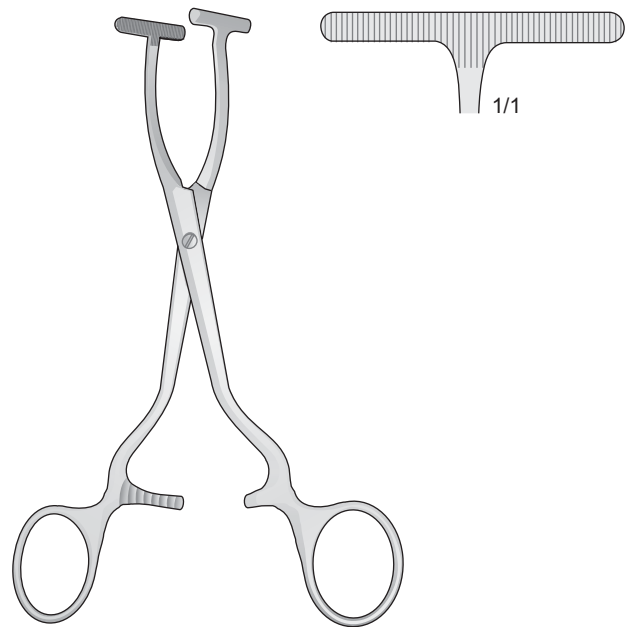

**15-CAH**  
150 mm

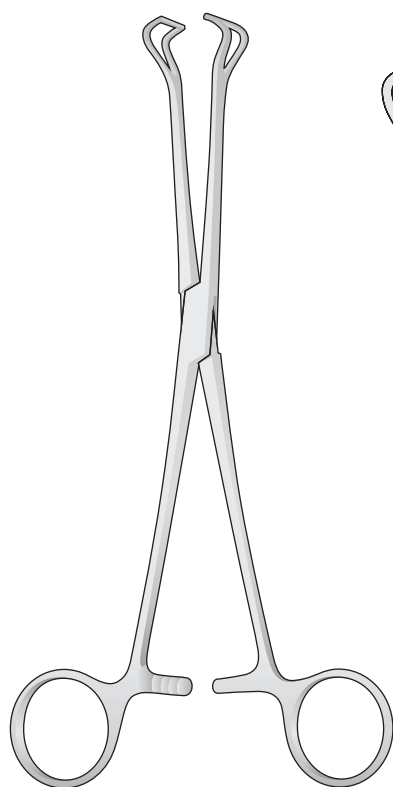

**BABCOCK**  
**15-BAD/15-BCG**

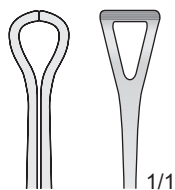

**15-BAD**  
155 mm

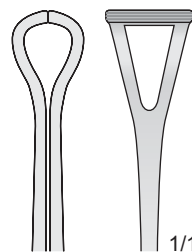

**15-BBD**  
180 mm

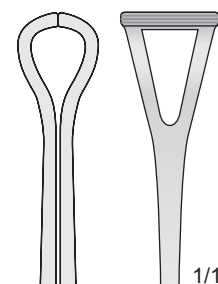

**15-BBE**  
240 mm

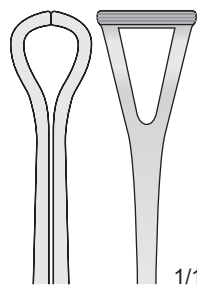

**15-BCE**  
260 mm

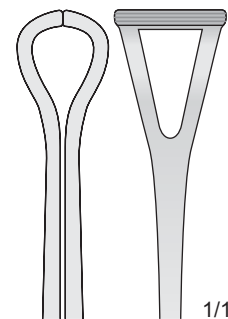

**15-BCG**  
300 mm

Pinze per afferrare i tessuti

Gum and tissue forceps

Gewebe und organ Fasszangen

Pinces pour saisir les tissue

Pinzas para coger las encias

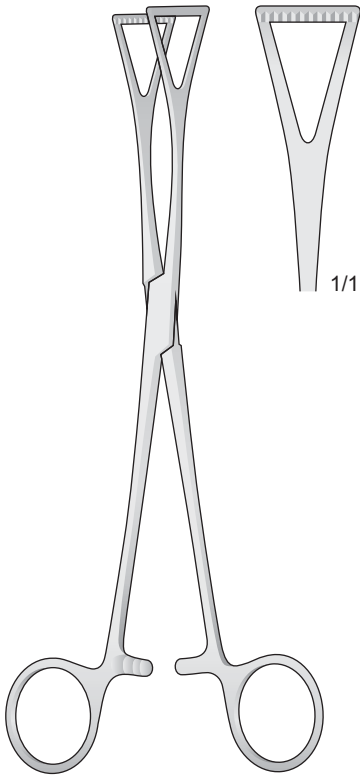

DUVAL  
15-LL  
185 mm

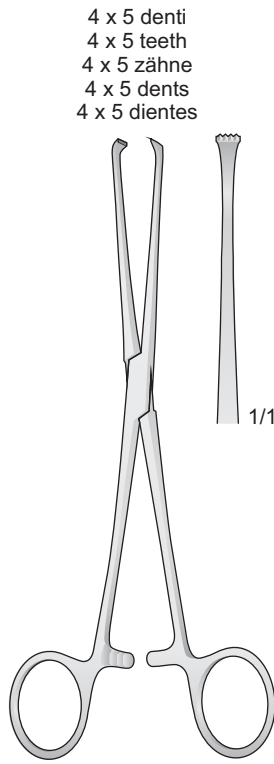

4 x 5 denti  
4 x 5 teeth  
4 x 5 zähne  
4 x 5 dents  
4 x 5 dientes

BABY-ALLIS  
15-BAA  
130 mm

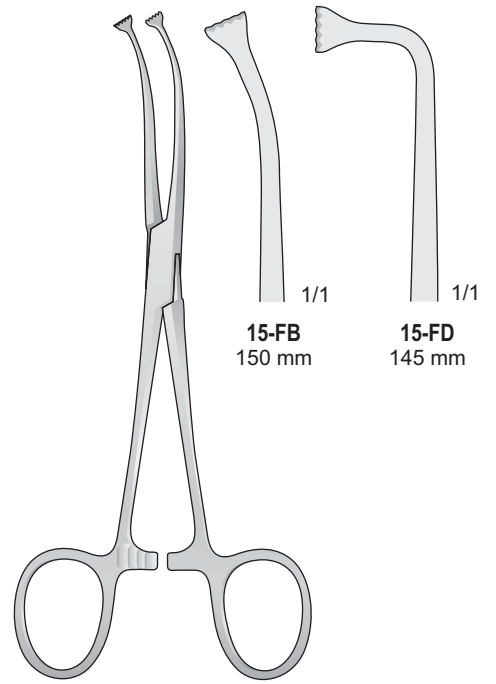

ALLIS  
15-FB/15-FD

15-FB  
150 mm

15-FD  
145 mm

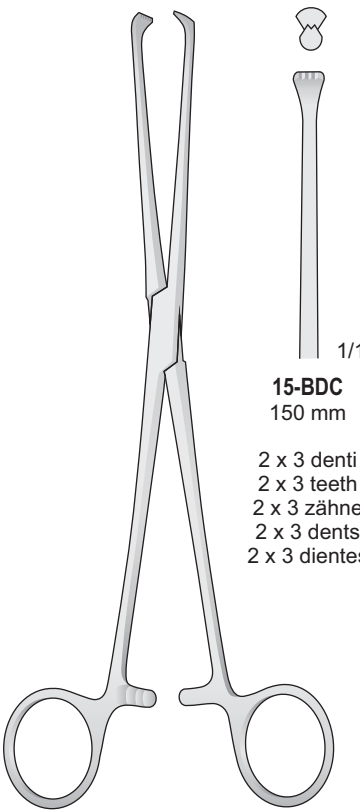

ALLIS  
15-FA/15-BBI

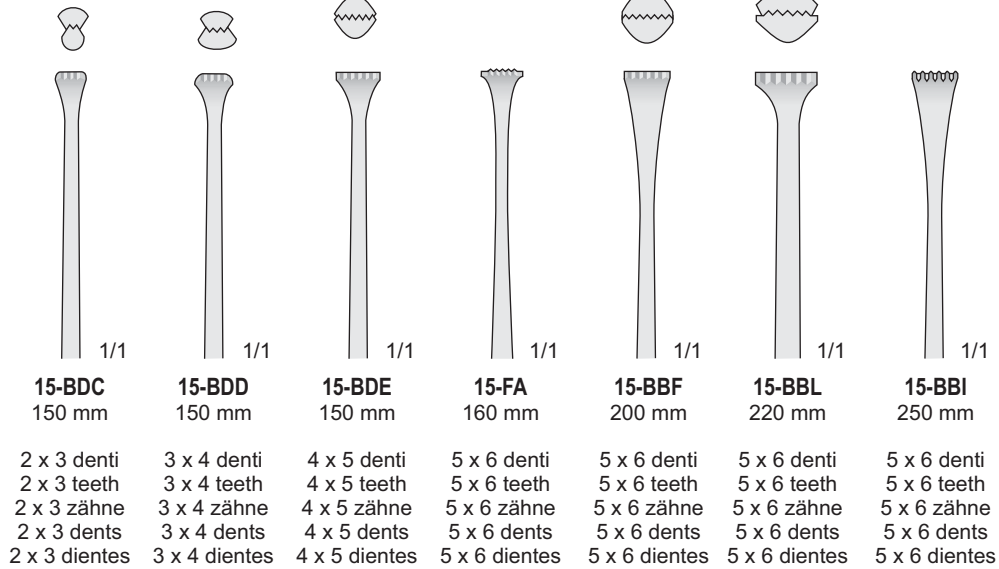

15-BDC  
150 mm

15-BDD  
150 mm

15-BDE  
150 mm

15-FA  
160 mm

15-BBF  
200 mm

15-BBL  
220 mm

15-BBI  
250 mm

2 x 3 denti  
2 x 3 teeth  
2 x 3 zähne  
2 x 3 dents  
2 x 3 dientes

3 x 4 denti  
3 x 4 teeth  
3 x 4 zähne  
3 x 4 dents  
3 x 4 dientes

4 x 5 denti  
4 x 5 teeth  
4 x 5 zähne  
4 x 5 dents  
4 x 5 dientes

5 x 6 denti  
5 x 6 teeth  
5 x 6 zähne  
5 x 6 dents  
5 x 6 dientes

5 x 6 denti  
5 x 6 teeth  
5 x 6 zähne  
5 x 6 dents  
5 x 6 dientes

5 x 6 denti  
5 x 6 teeth  
5 x 6 zähne  
5 x 6 dents  
5 x 6 dientes

5 x 6 denti  
5 x 6 teeth  
5 x 6 zähne  
5 x 6 dents  
5 x 6 dientes

Fissateli

Towel clamps

Tuchklemmen

Pinces pour fixer les compresses

Pinzas de campo

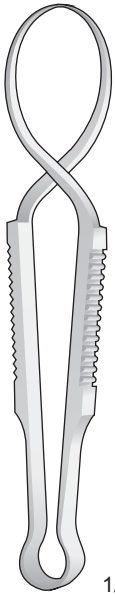

1/1

SCHAEDEL  
0206-DI  
85 mm

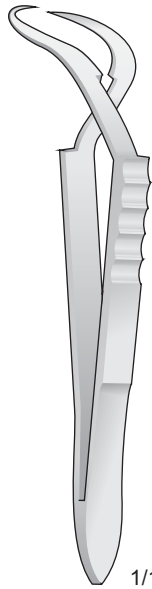

1/1

JONES  
0206-EI  
90 mm

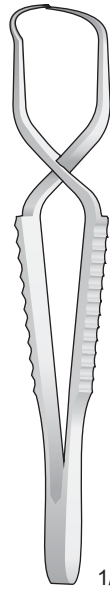

1/1

FAURE  
0206-EA  
85 mm

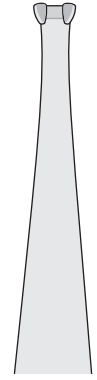
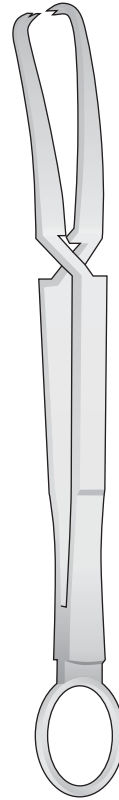

1/1

1/1

DOYEN  
0206-DG  
180 mm

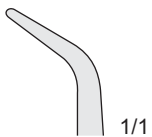

1/1

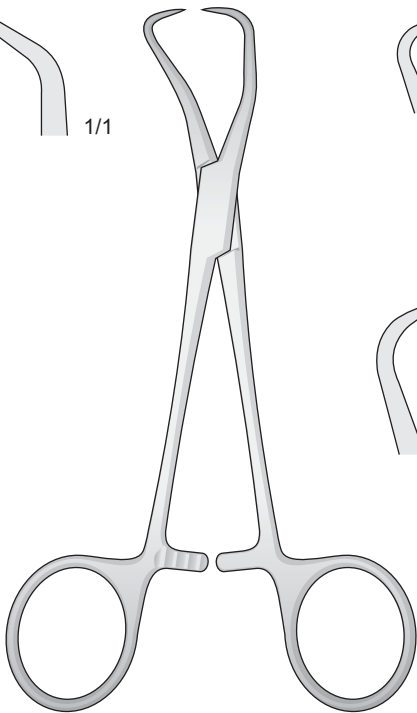

BACKHAUS  
0206-EC/0206-EG

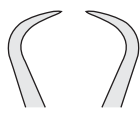

1/1

0206-EC  
90 mm

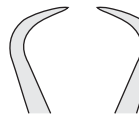

1/1

0206-EB  
100 mm

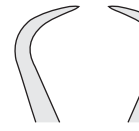

1/1

0206-EE  
110 mm

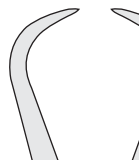

1/1

0206-EG  
130 mm

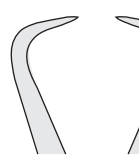

1/1

0206-ED  
135 mm

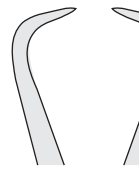

1/1

0206-EF  
140 mm

Fissateli

Towel clamps

Tuchklemmen

Pinces pour fixer les compresses

Pinzas de campo

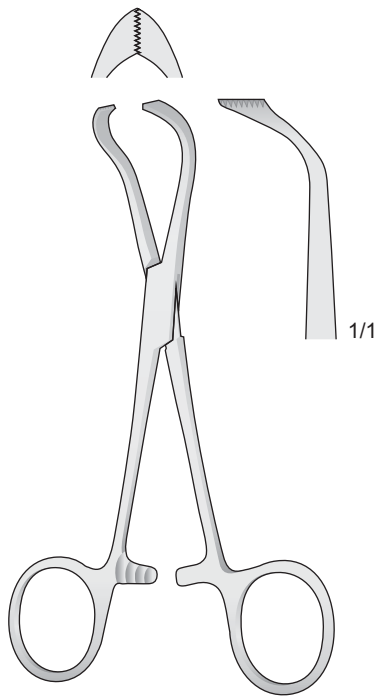

LORNA  
0206-FA  
100 mm

Per teli di carta  
For paper cloths  
Für Papiertücher  
Pour Champs en papier

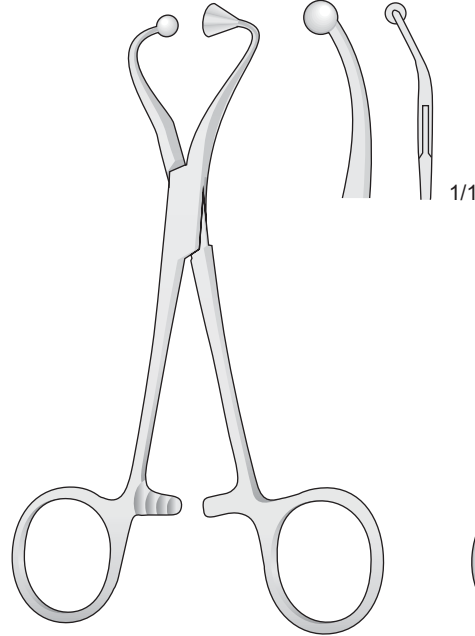

0206-HE  
115 mm

Per teli di carta  
For paper cloths  
Für Papiertücher  
Pour Champs en papier

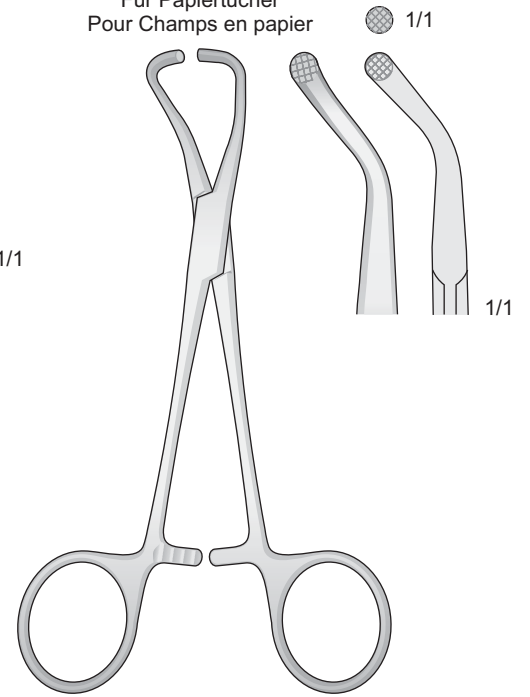

0206-FC  
130 mm

Per teli di carta  
For paper cloths  
Für Papiertücher  
Pour Champs en papier

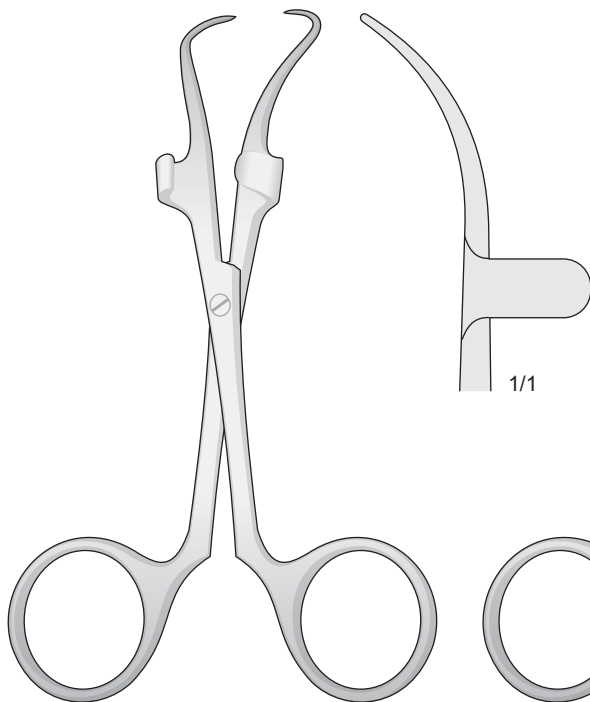

ROBIN  
0206-HC  
140 mm

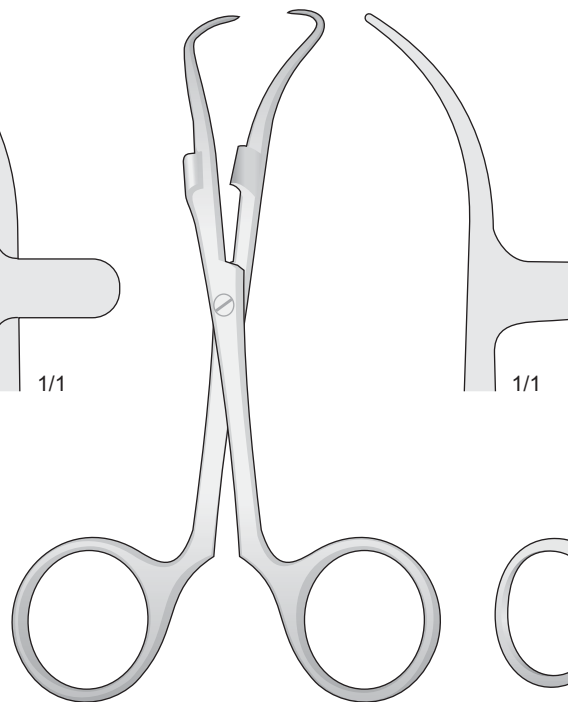

ROBIN  
0206-HD  
140 mm

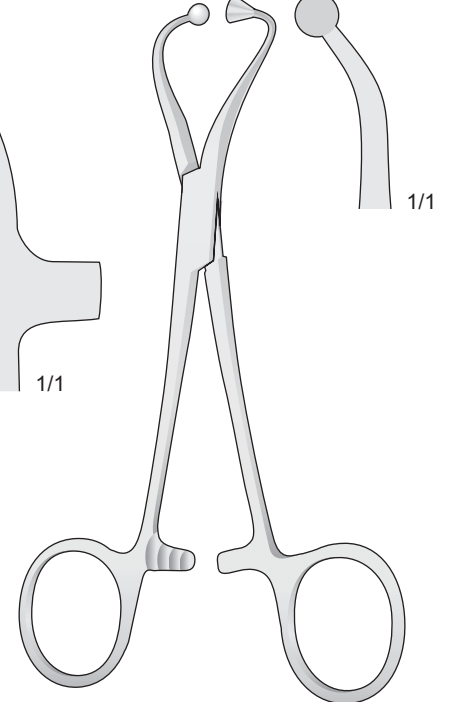

0206-HF  
140 mm

Fissateli

Towel clamps

Tuchklemmen

Pinces pour fixer les compresses

Pinzas de campo

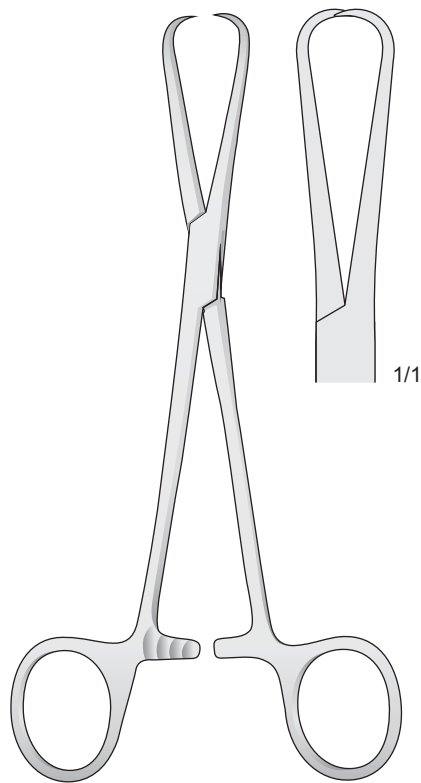

BERNHARD  
0206-IC  
165 mm

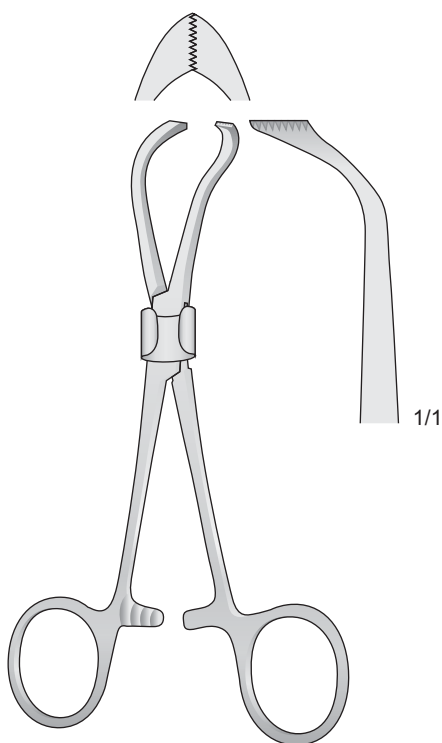

0206-IF Ø 9 mm    0206-IG Ø 12 mm  
0206-IH Ø 14 mm    0206-II Ø 17 mm  
100 mm

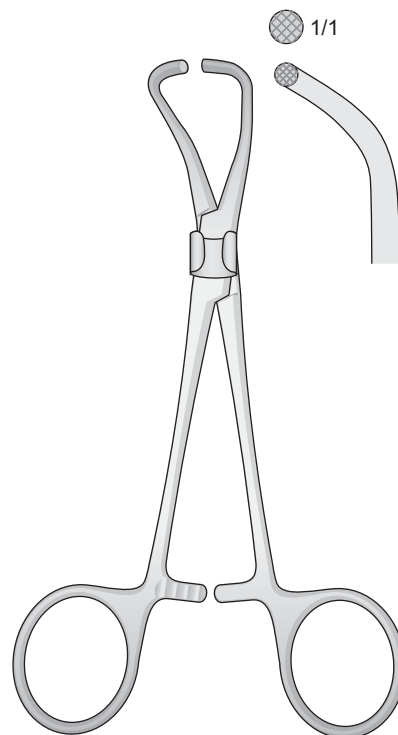

0206-LA Ø 9 mm    0206-LB Ø 12 mm  
0206-LC Ø 14 mm    0206-LD Ø 17 mm  
130 mm

Pinze emostatiche delicate

Fine Artery forceps

Fine-Arterienklemmen

Delicate Pincers hémostatiques

Pinzas hemostáticas fino

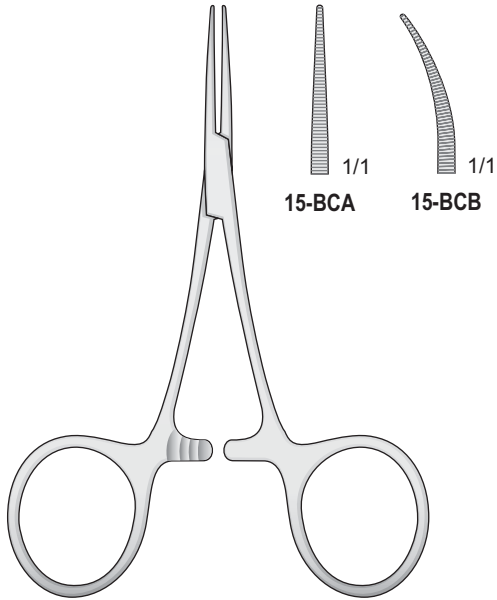

HARTMANN-BABY-MOSQUITO  
15-BCA/15-BCB  
95 mm

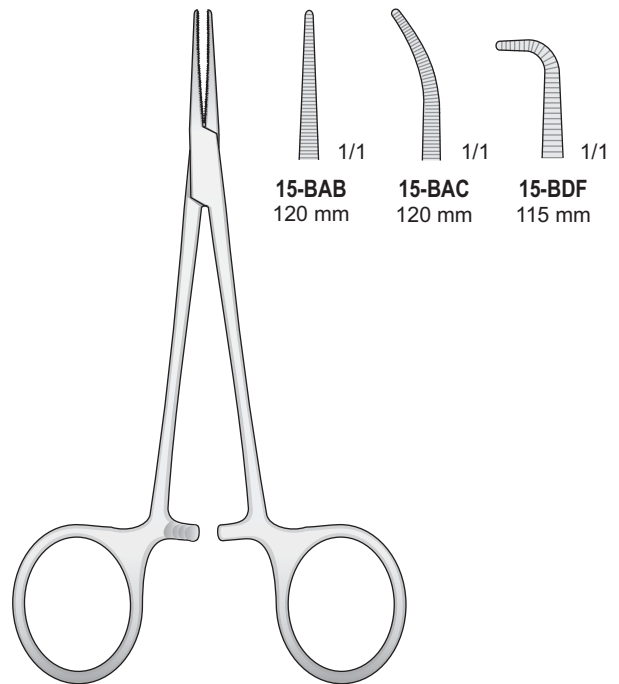

MICRO-HALSTED  
15-BAB/15-BDF

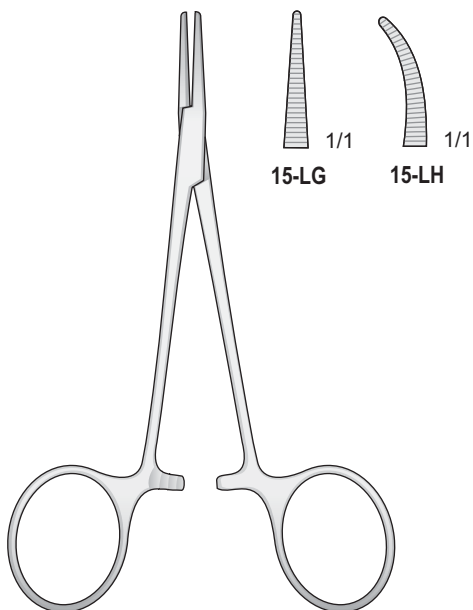

HALSTED-MOSQUITO  
15-LG/15-LH  
120 mm

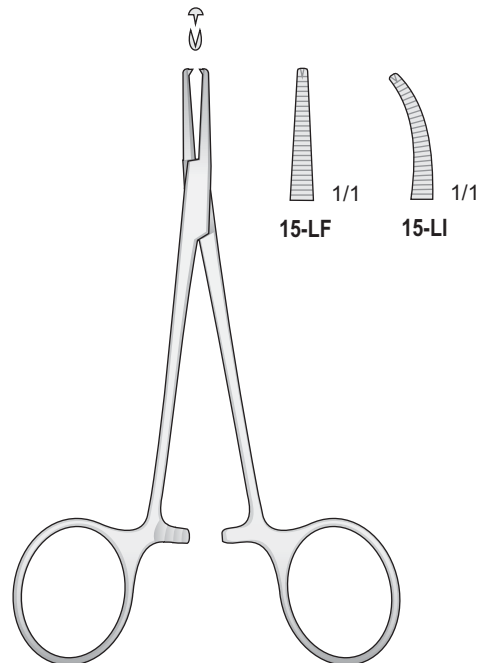

HALSTED-MOSQUITO  
15-LF/15-LI  
120 mm

Pinze emostatiche delicate

Fine Artery forceps

Fine-Arterienklemmen

Delicate Pincers hémostatiques

Pinzas hemostáticas fino

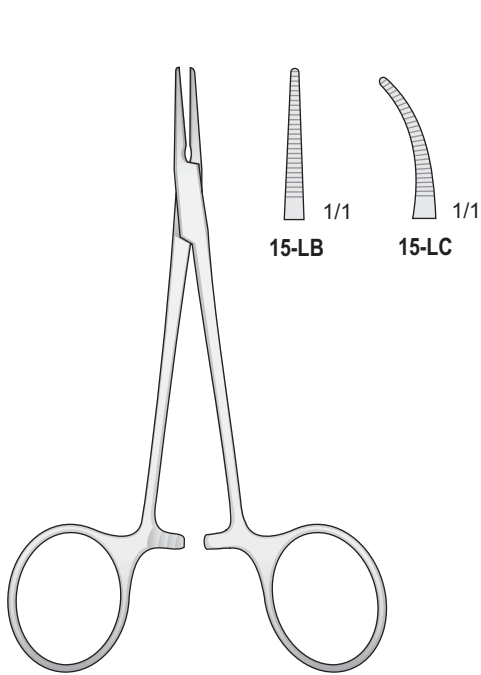

HALSTED  
15-LB/15-LC  
125 mm

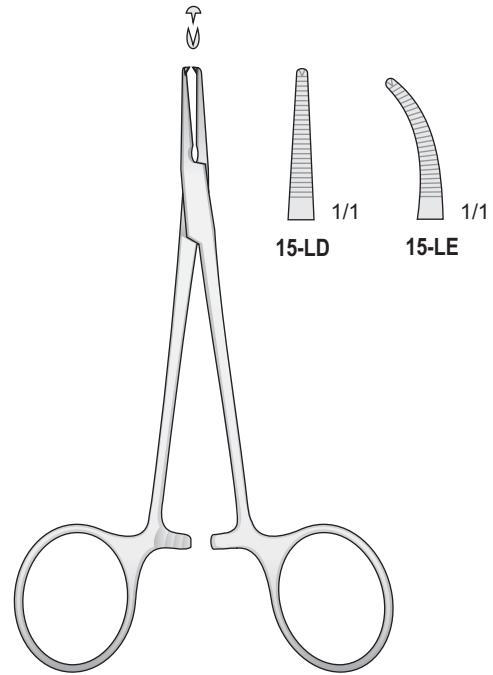

HALSTED  
15-LD/15-LE  
125 mm

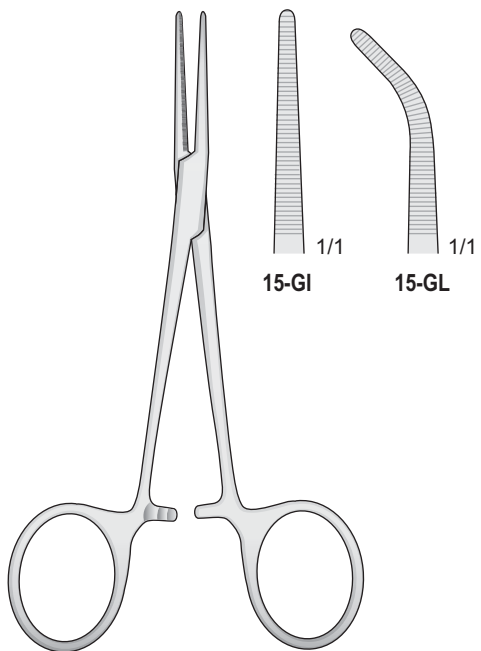

GIDEF  
15-GI/15-GL  
140 mm

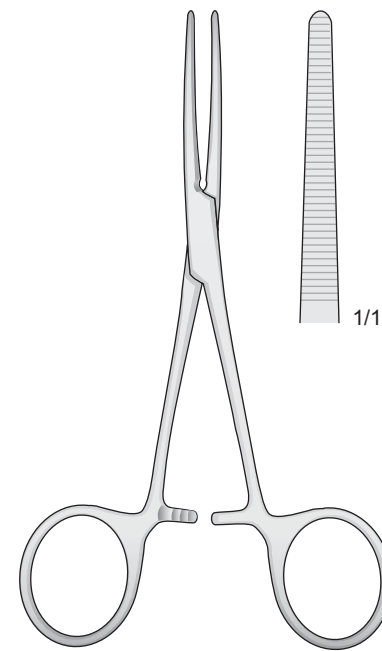

PEAN  
15-BH  
140 mm



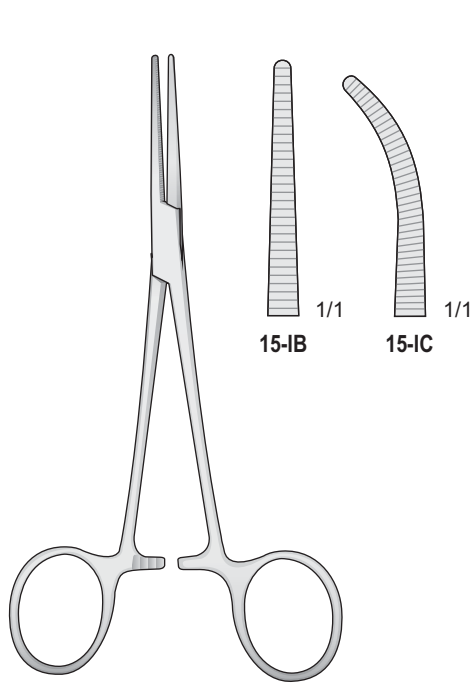

CRILE  
15-IB/15-IC  
140 mm

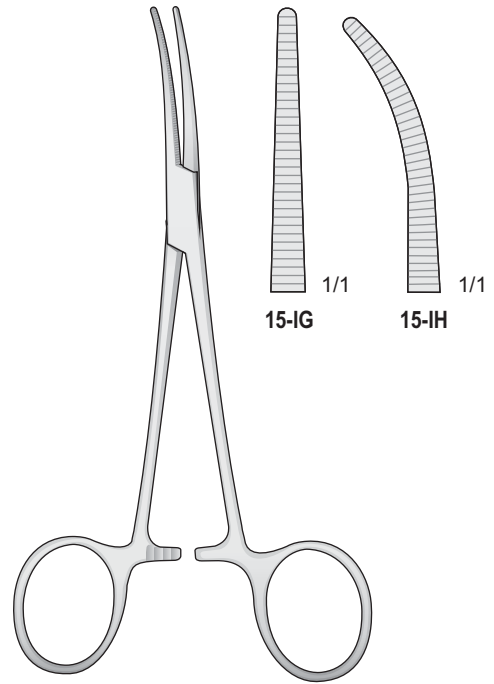

CRILE  
15-IG/15-IH  
160 mm

Curve sul lato  
Curved to side  
Seitwärts gebogen  
Courbes latérales  
Curvas laterales

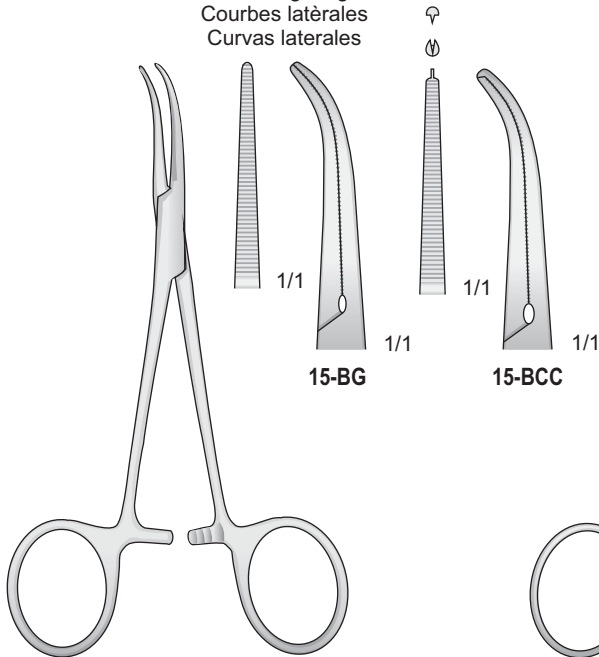

DANDY  
15-BG/15-BCC  
140 mm

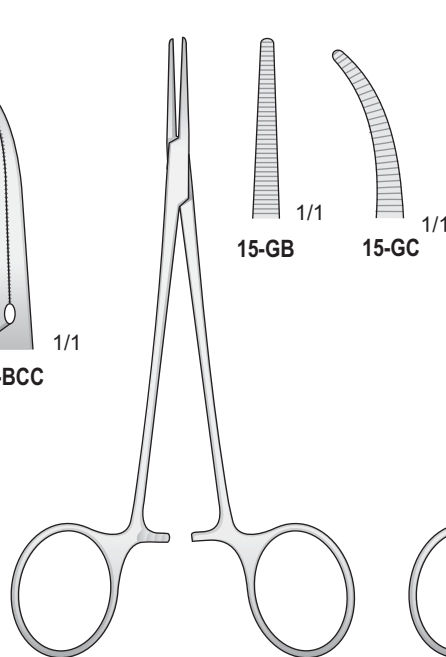

LERICHE  
15-GB/15-GC  
150 mm

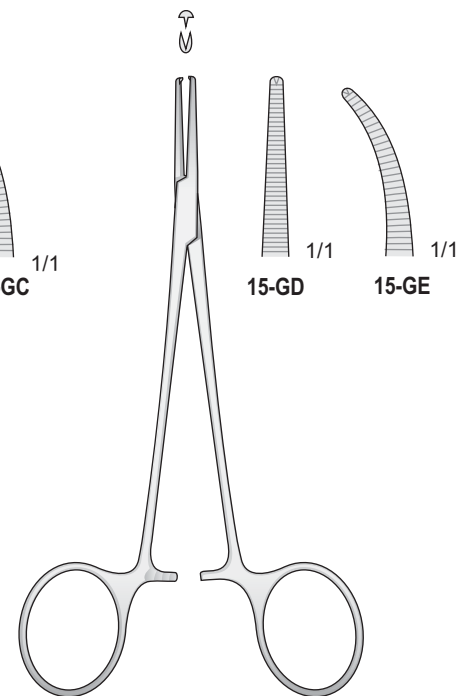

LERICHE  
15-GD/15-GE  
150 mm

Pinze emostatiche

Hemostatic forceps

Arterienklemmen

Pinces hémostatiques

Pinzas hemostáticas

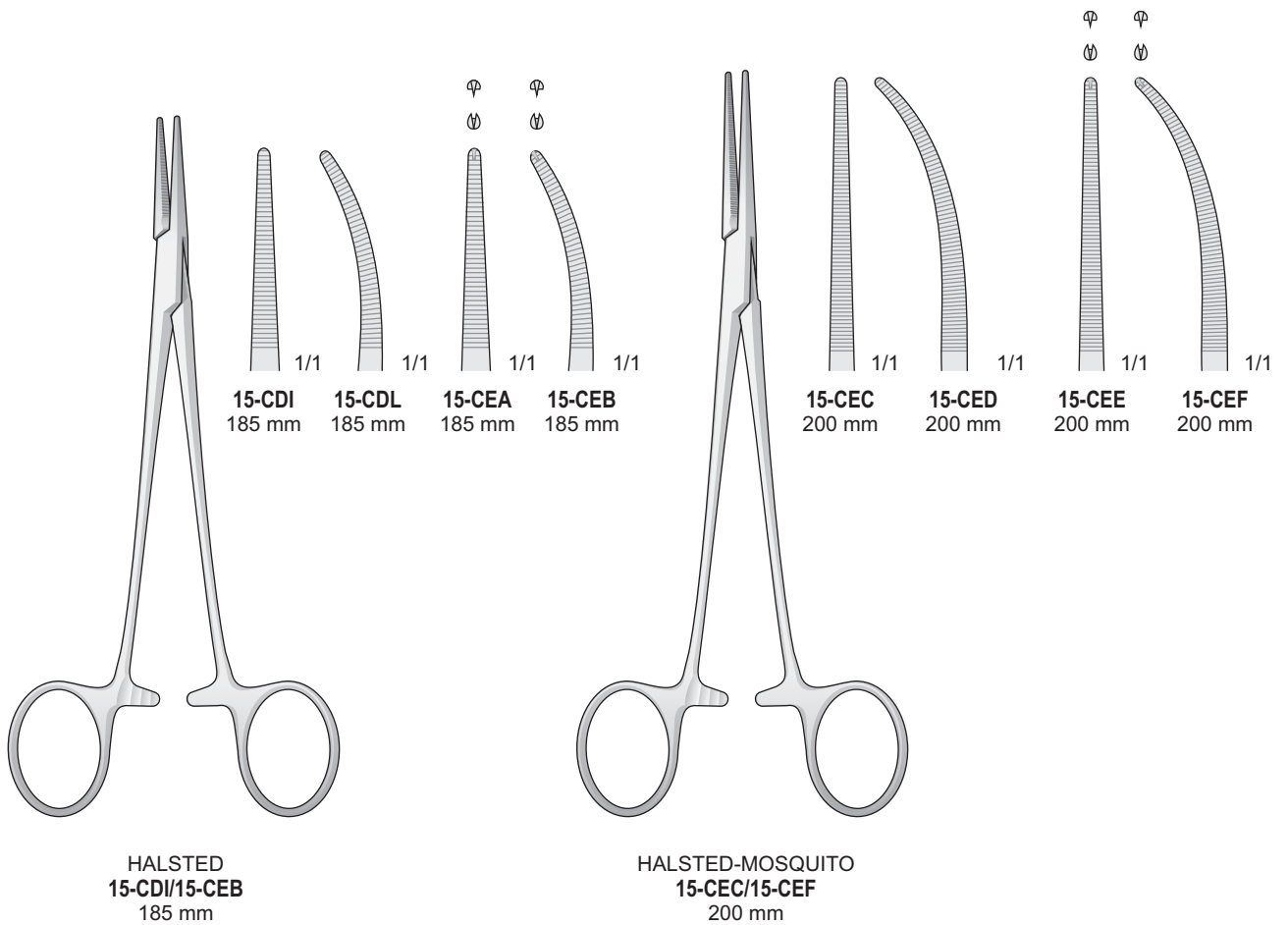
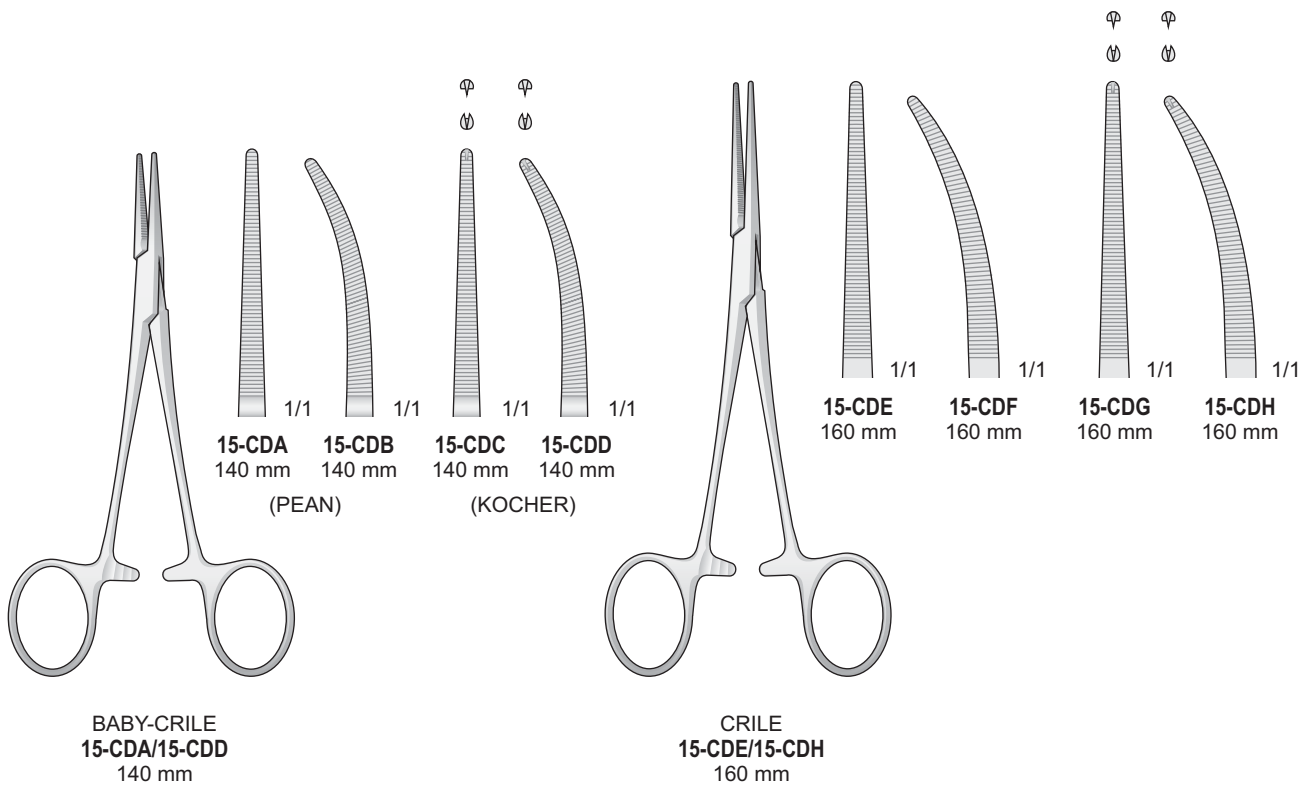

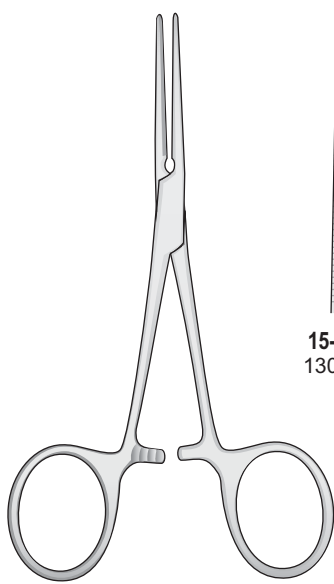

PEAN  
15-CFA/15-CFF

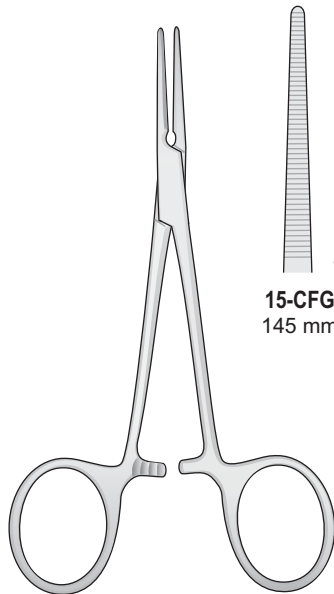
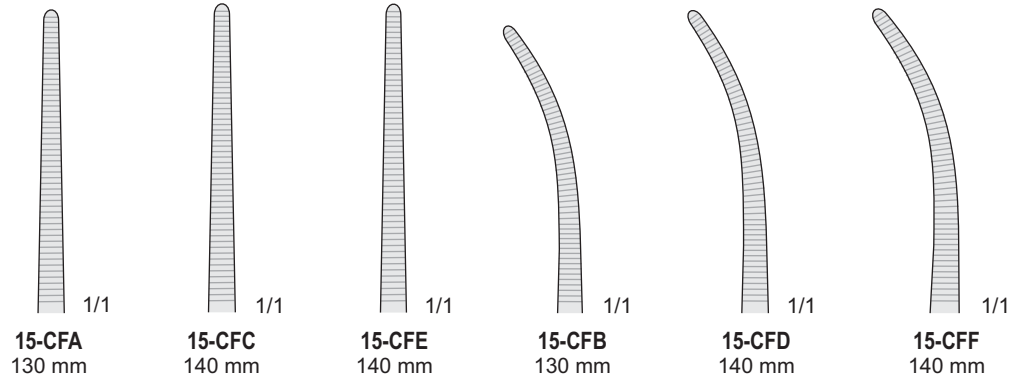

PEAN  
15-CFG/15-CFL

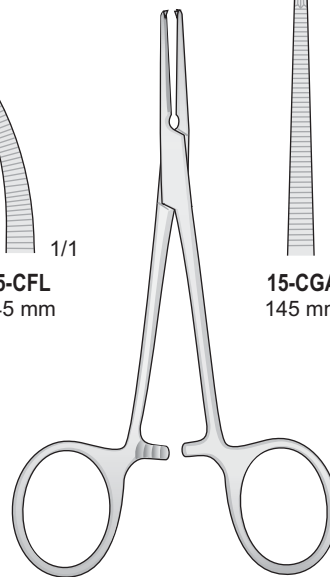
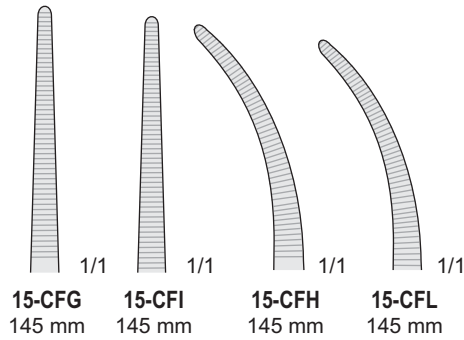

KOCHER  
15-CGA/15-CGD

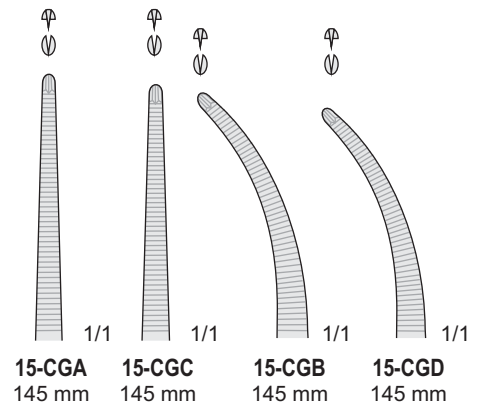

Pinze emostatiche

Hemostatic forceps

Arterienklemmen

Pinces hémostatiques

Pinzas hemostáticas

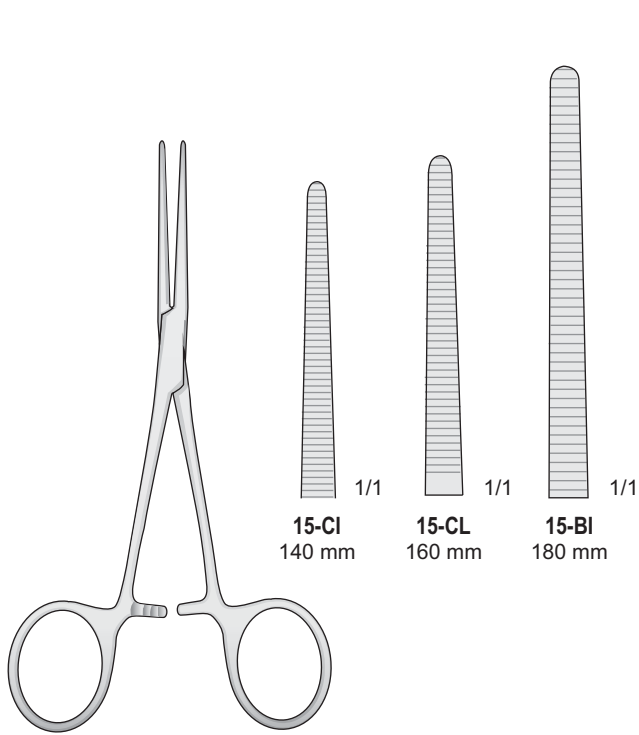

ROCHESTER-PEAN  
15-CI/15-BI

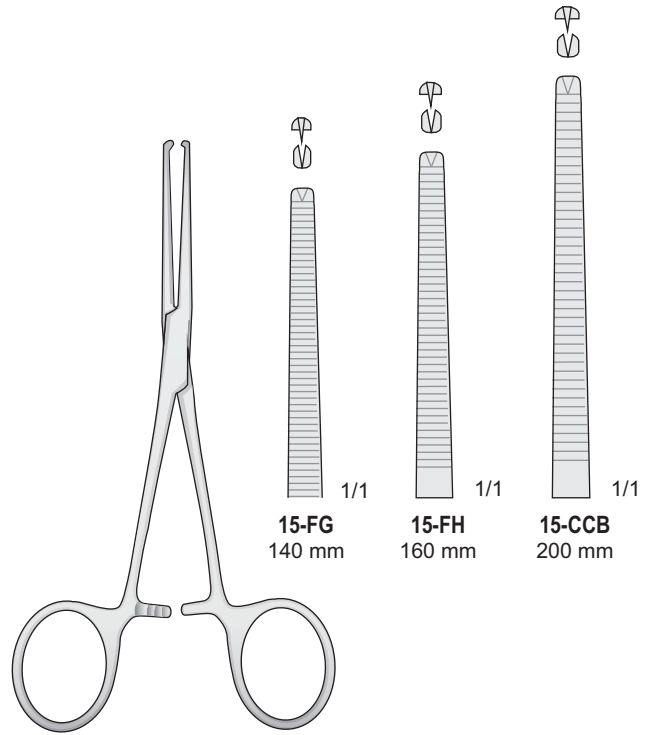

KOCHER-OCHSNER  
15-FG/15-CCB

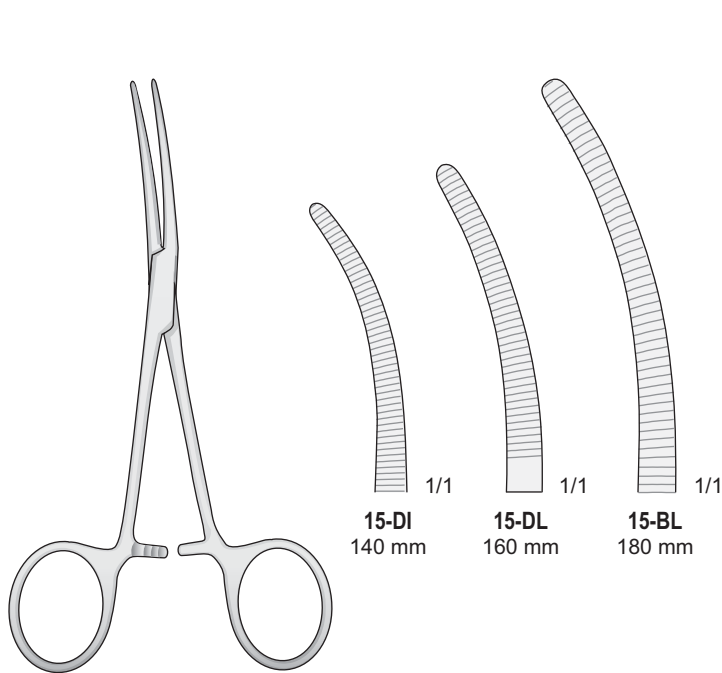

ROCHESTER-PEAN  
15-DI/15-BL

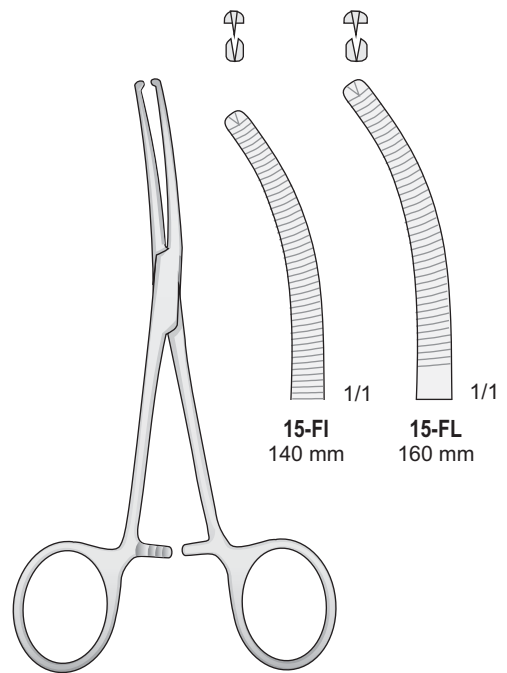

KOCHER-OCHSNER  
15-FI/15-FL

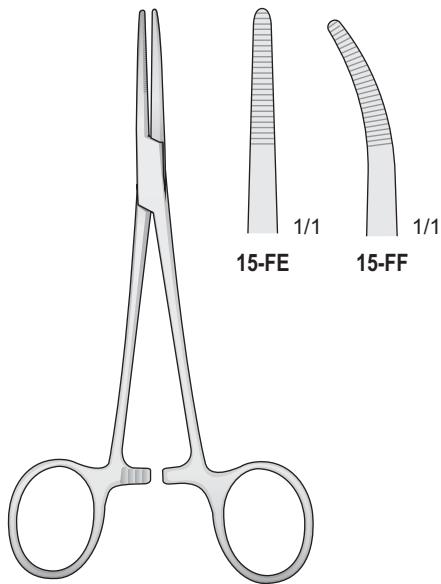

KELLY  
15-FE/15-FF  
140 mm

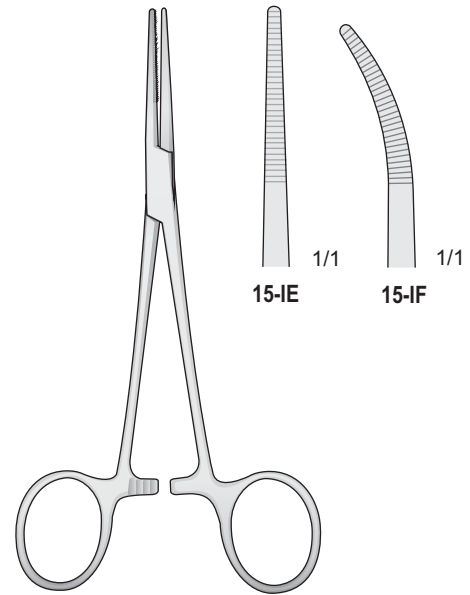

KELLY  
15-IE/15-IF  
140 mm

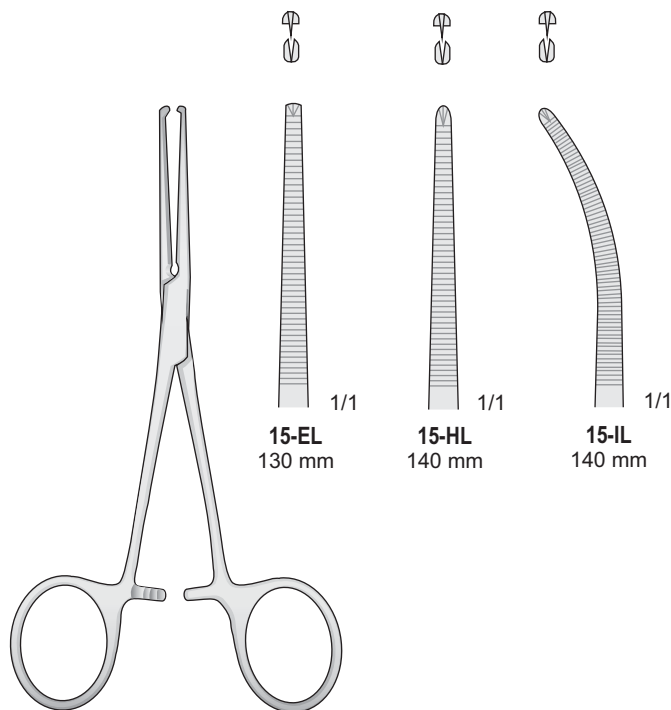

KOCHER  
15-EL/15-IL

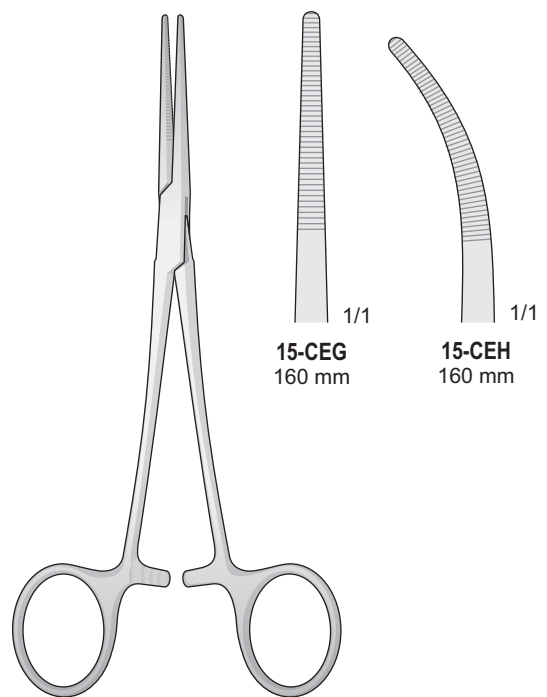

RANKIN  
15-CEG/15-CEH

Pinze emostatiche

Hemostatic forceps

Arterienklemmen

Pinces hémostatiques

Pinzas hemostáticas

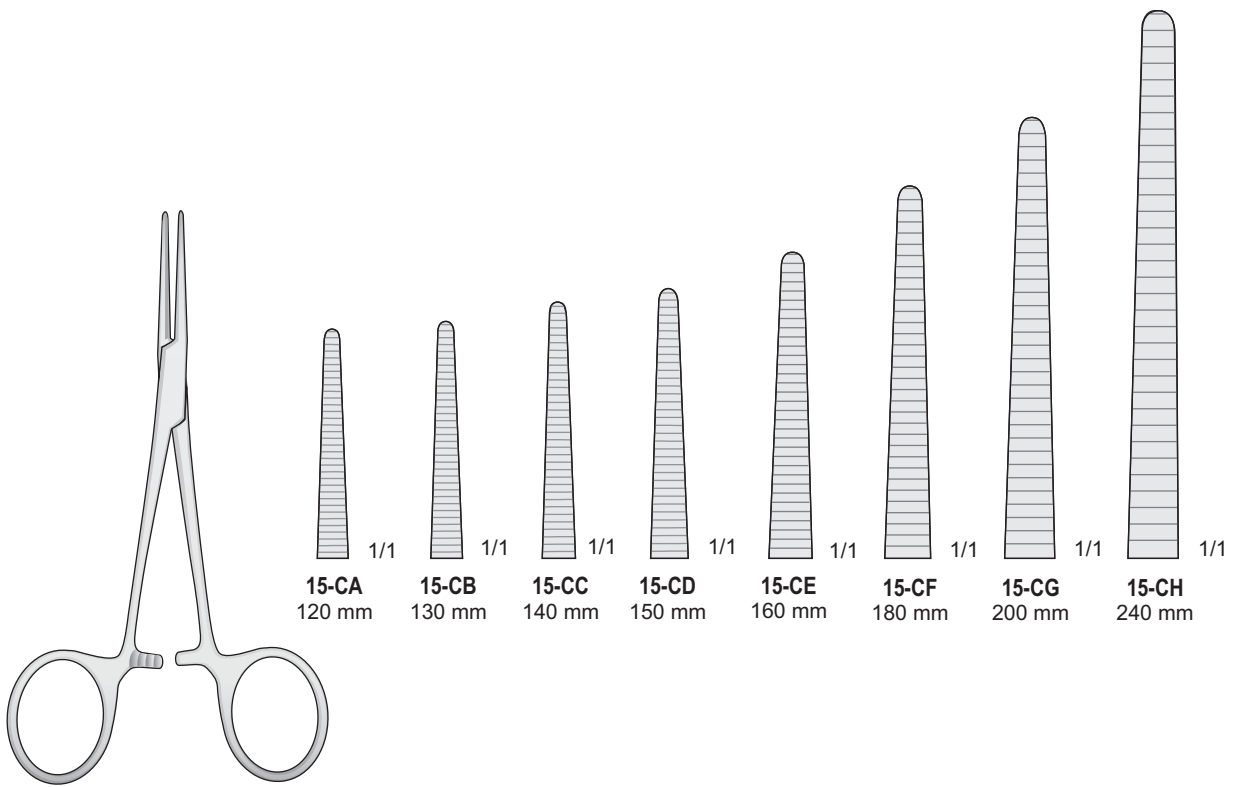

PEAN  
15-CA/15-CH

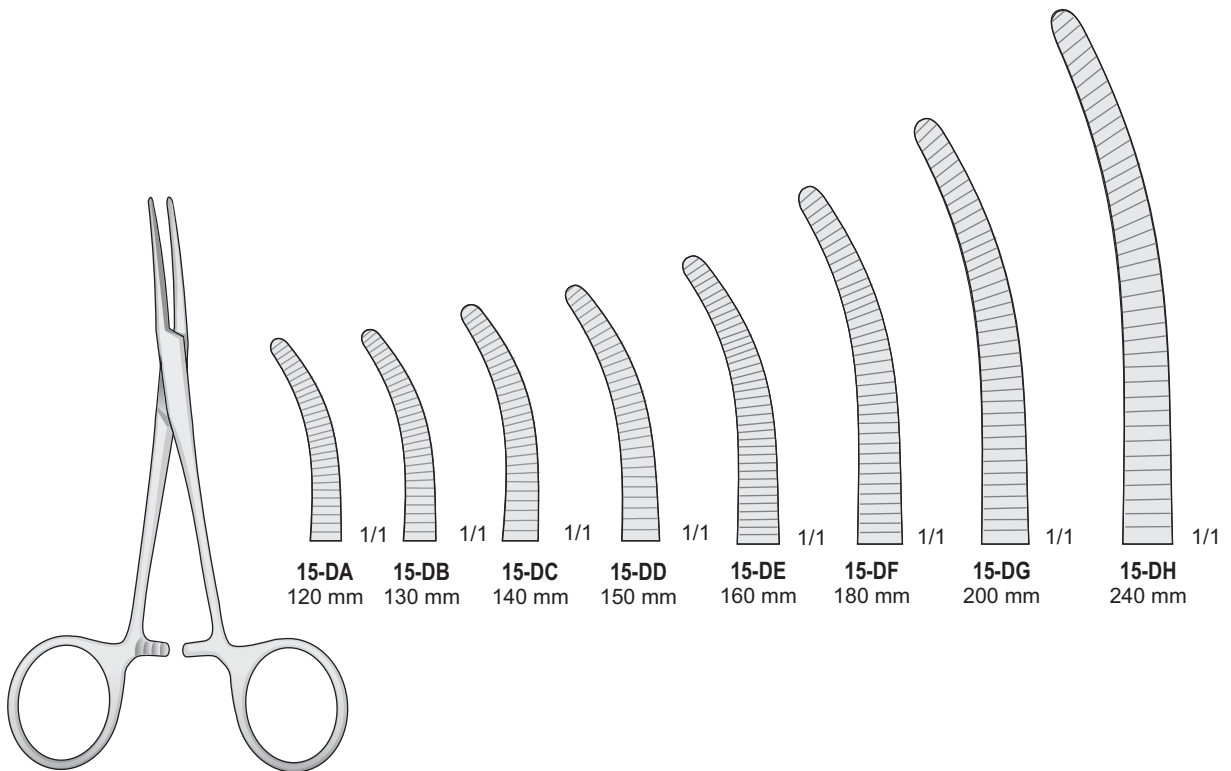

PEAN  
15-DA/15-DH

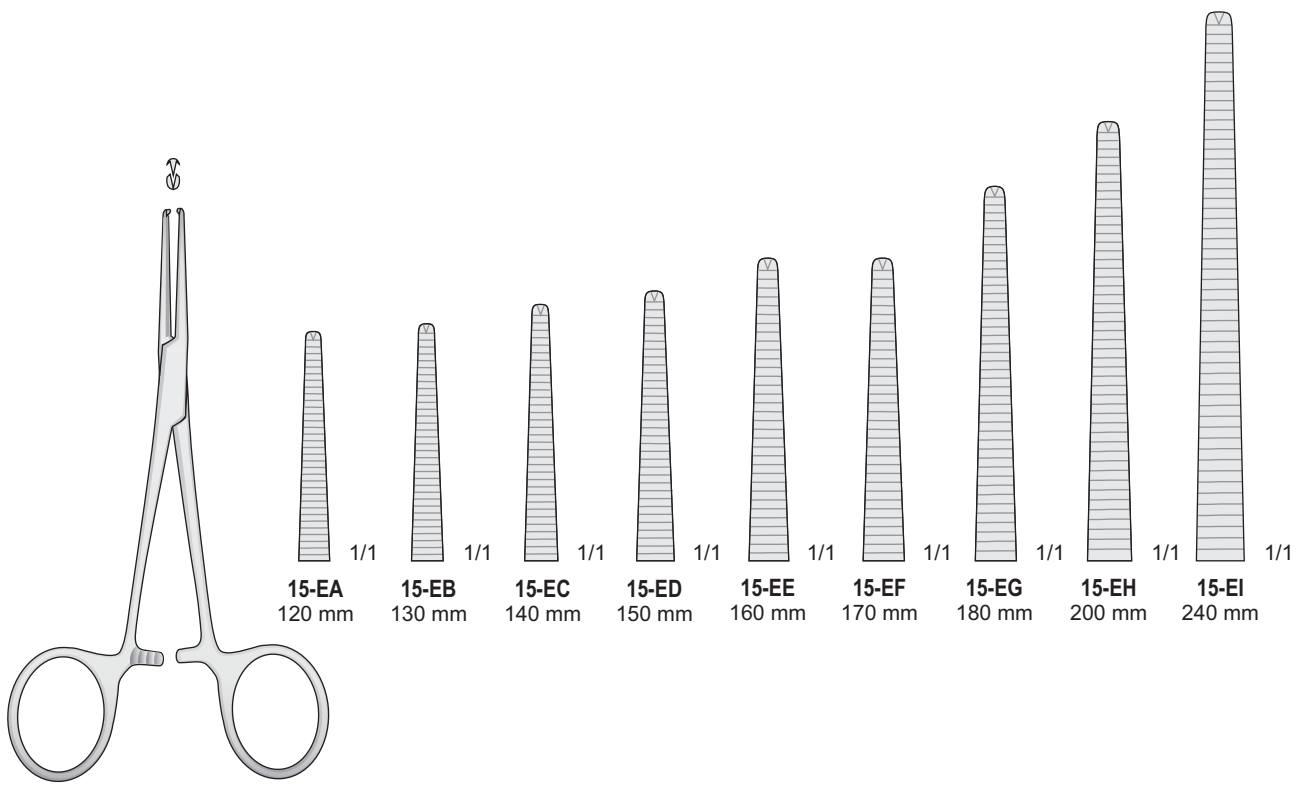

KOCHER  
15-EA/15-EH

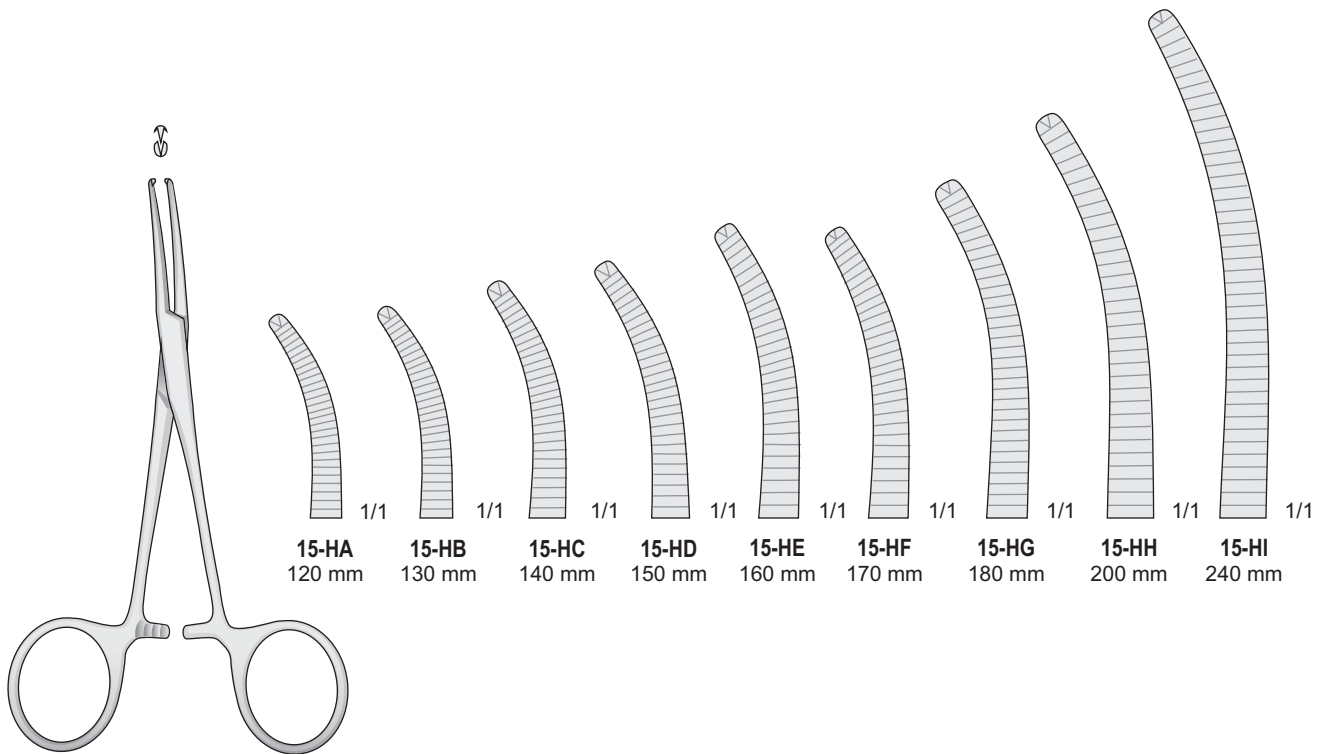

KOCHER  
15-HA/15-HH

Pinze emostatiche

Hemostatic forceps

Arterienklemmen

Pinces hémostatiques

Pinzas hemostáticas

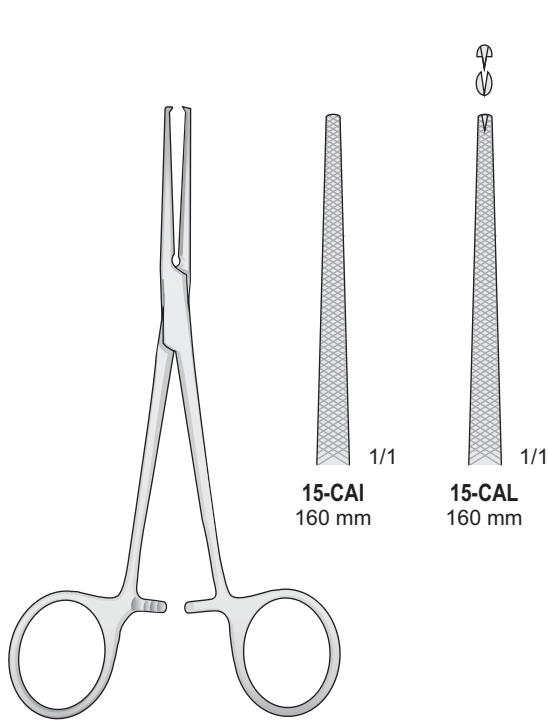

DIXON-LOVELACE  
15-CAI/15-CAL

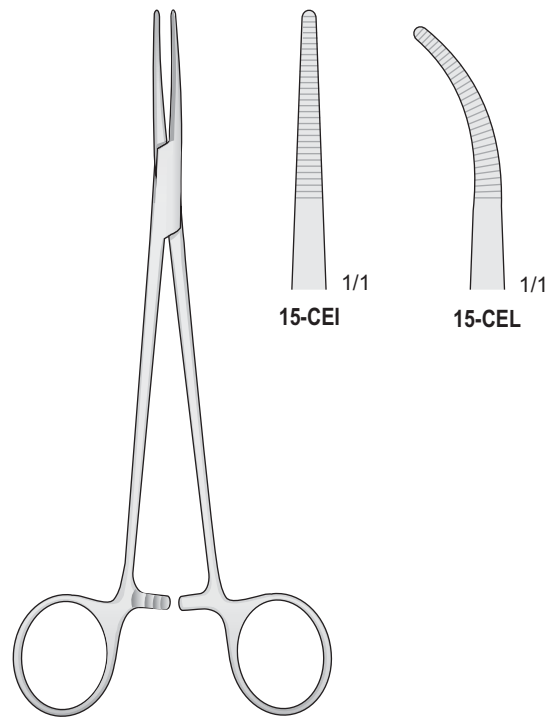

BIRKETT  
15-CEI/15-CEL  
180 mm

Pinza per peritoneo - Peritoneal clamps forceps  
Pritoneum klemmen - Pinces-camps pour les péritoine  
Pinzas-clamps para peritoneo

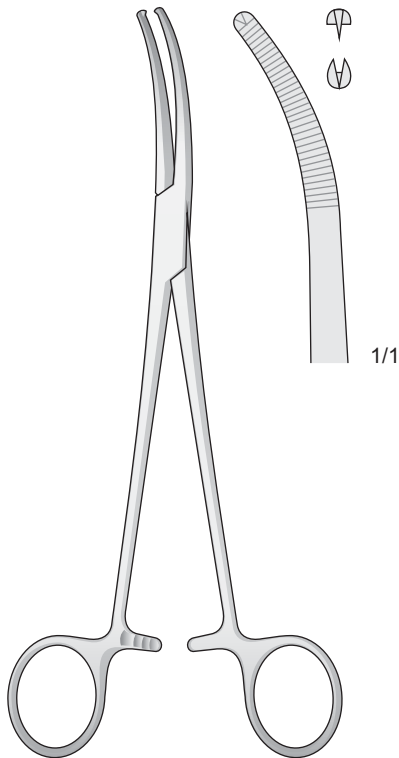

MIKULICZ  
15-BAE  
190 mm

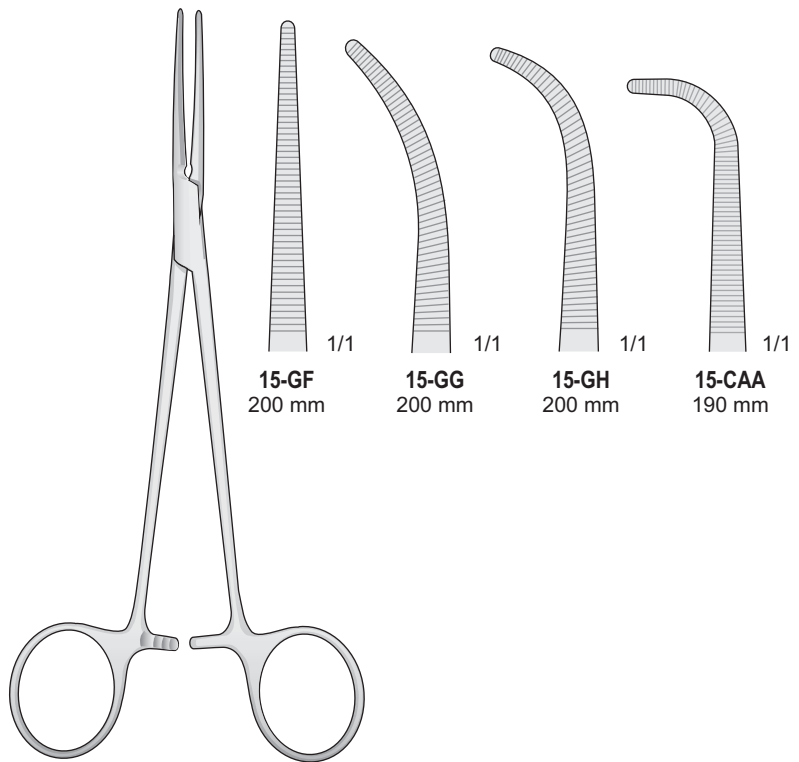

HEISS  
15-GF/15-CAA



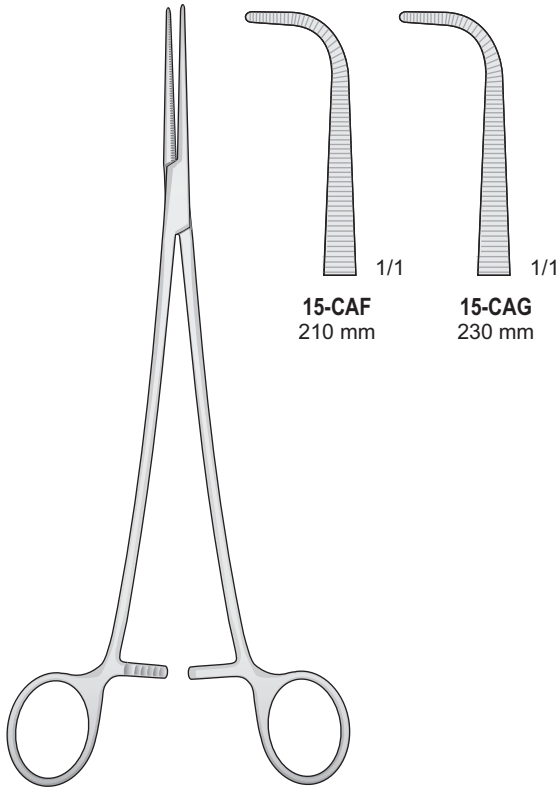

BENGOLEA  
15-CAF/15-CAG

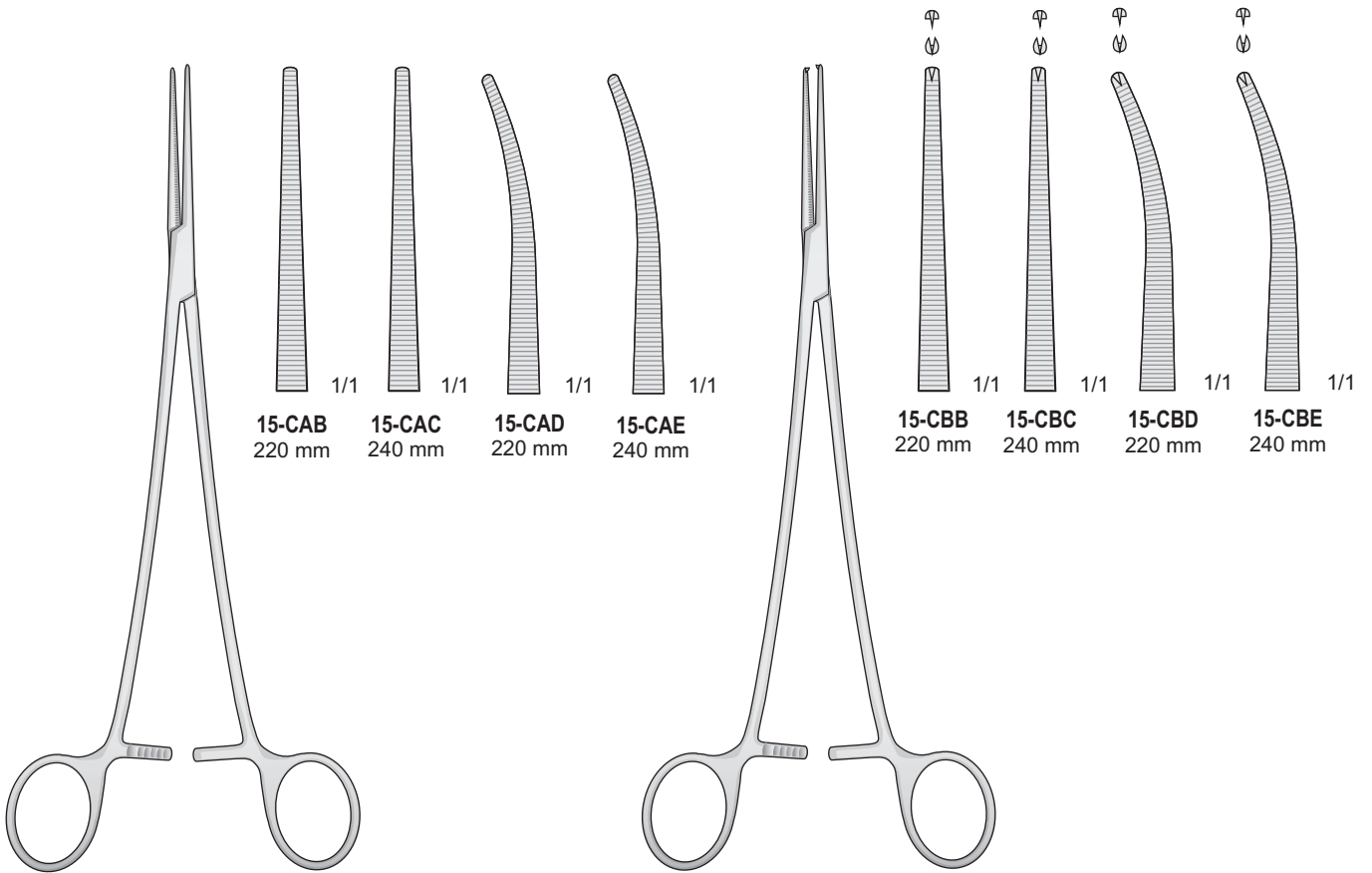

BENGOLEA  
15-CAB/15-CAE

BENGOLEA  
15-CBB/15-CBE

Pinze emostatiche  
per preparazioni  
e legature

Artery forceps  
for preparation  
and ligature

Arterienklemmen  
Präparier und  
Ligaturklemmen

Pinces hemostatiques  
à disséquer  
et à ligatures

Pinzas hemostáticas  
Preparacion  
y para ligaduras

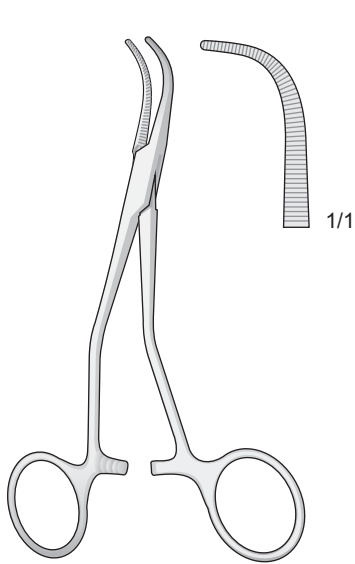

**15-BF**  
130 mm

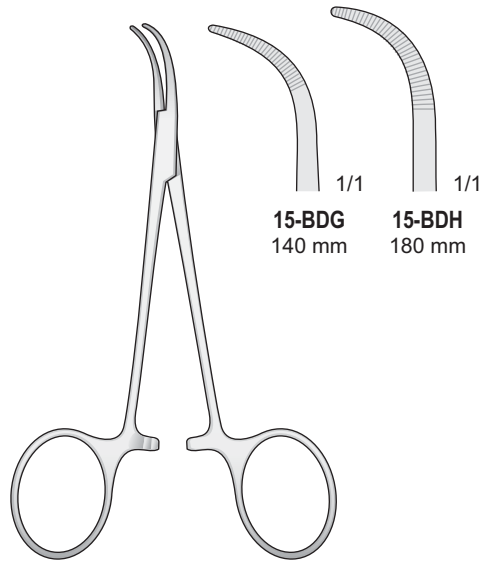

**BABY-MIXTER**  
**15-BDG/15-BDH**

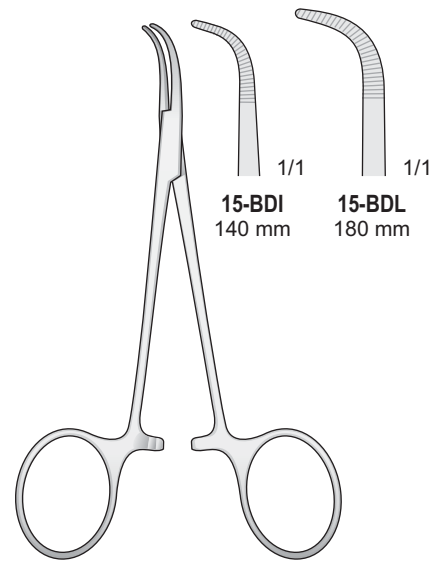

**BABY-ADSON**  
**15-BDI/15-BDL**

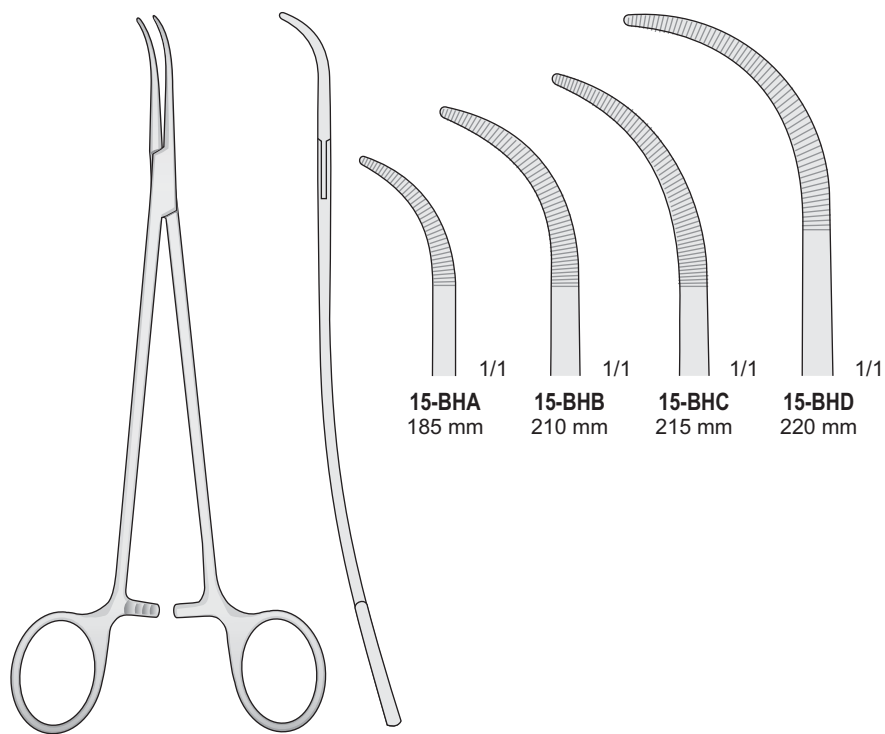

**15-BHA/15-BHC**

Pinze emostatiche  
per preparazioni  
e legature

Artery forceps  
for preparation  
and ligature

Arterienklemmen  
Präparier und  
Ligaturklemmen

Pinces hemostatiques  
à disséquer  
et à ligatures

Pinzas hemostáticas  
Preparacion  
y para ligaduras

Passafili

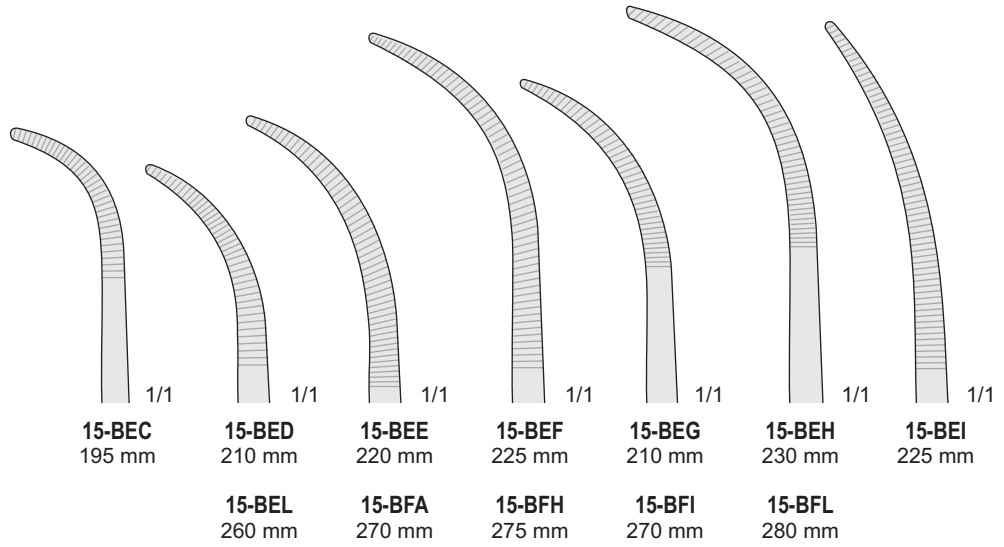
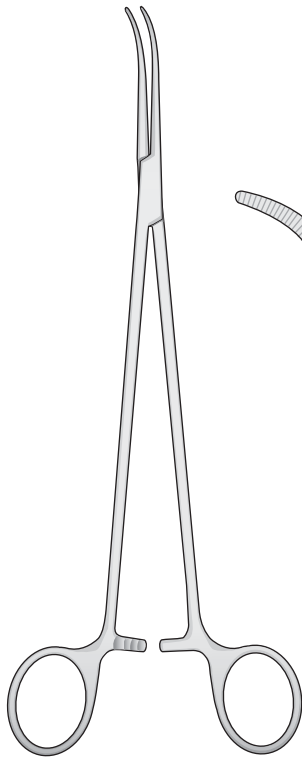

OVERHOLT-GEISSENDORFER  
15-BEC/15-BFL

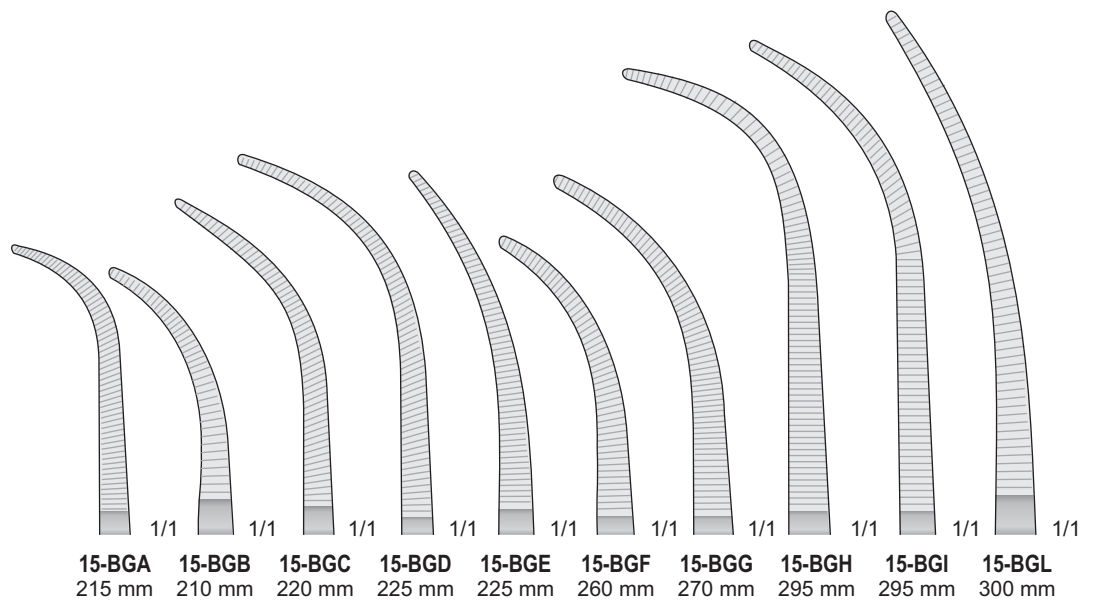
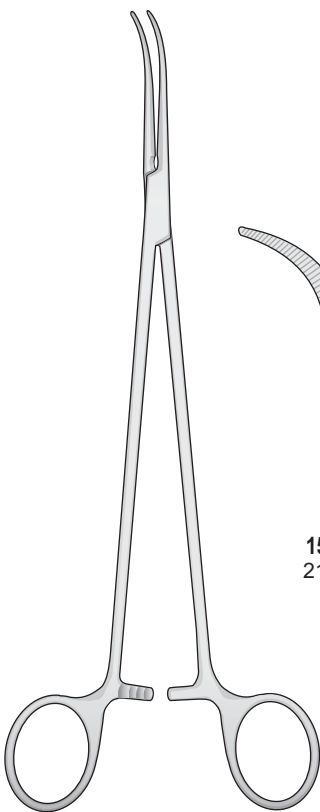

OVERHOLT  
15-BGA/15-BGL

Pinze emostatiche  
per preparazioni  
e legature

Artery forceps  
for preparation  
and ligature

Arterienklemmen  
Präparier und  
Ligaturklemmen

Pinces hemostatiques  
à disséquer  
et à ligatures

Pinzas hemostáticas  
Preparacion  
y para ligaduras

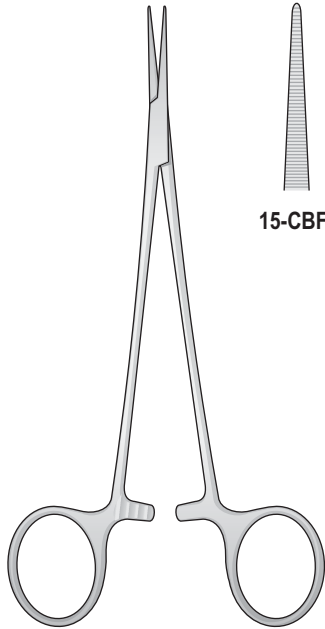

15-CBF/15-CBH  
160 mm

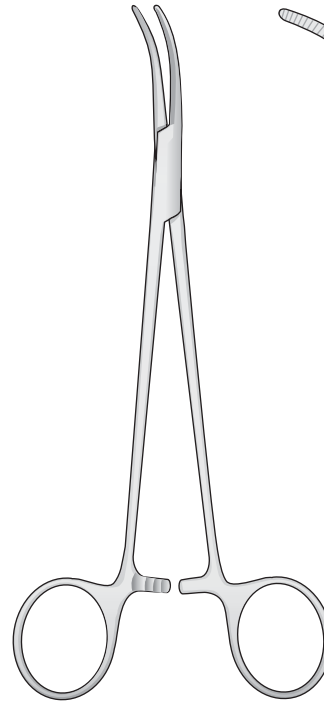
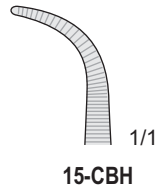
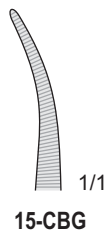
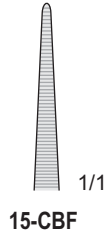

ROCHESTER-PEAN  
15-CBA  
180 mm

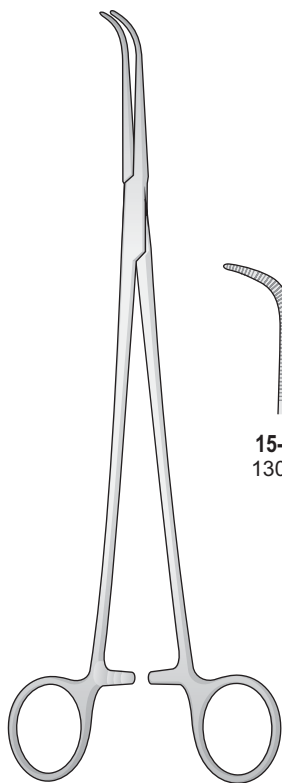
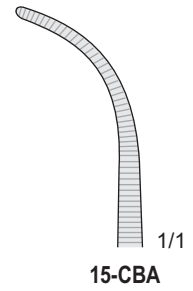

GEMINI  
15-BLB/15-BLH

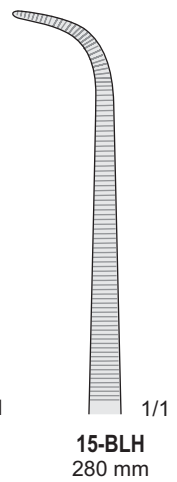
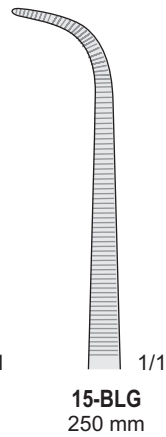
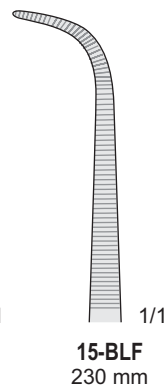
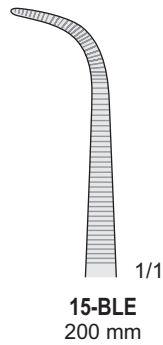
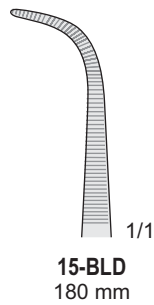
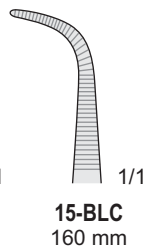
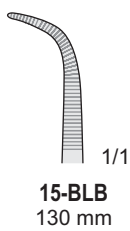

Pinze emostatiche  
per preparazioni  
e legature

Artery forceps  
for preparation  
and ligature

Arterienklemmen  
Präparier und  
Ligaturklemmen

Pinces hemostatiques  
à disséquer  
et à ligatures

Pinzas hemostáticas  
Preparacion  
y para ligaduras

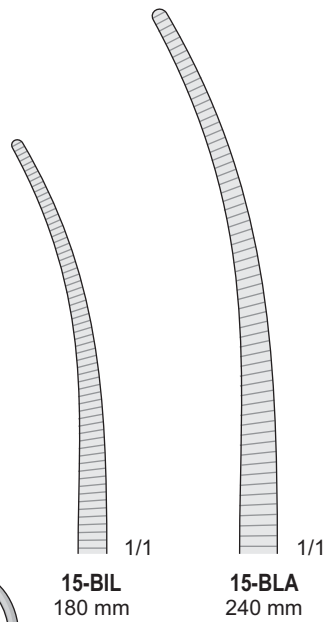
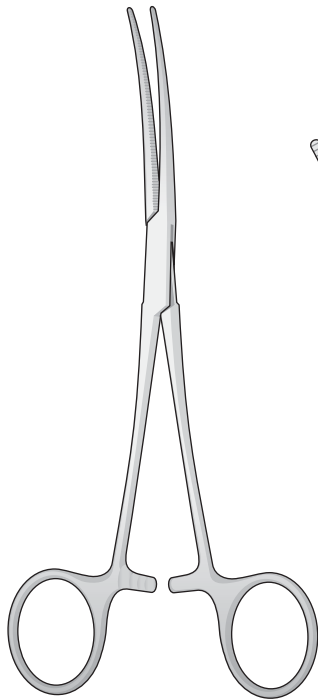

CRAFOORD  
15-BIL/15-BLA

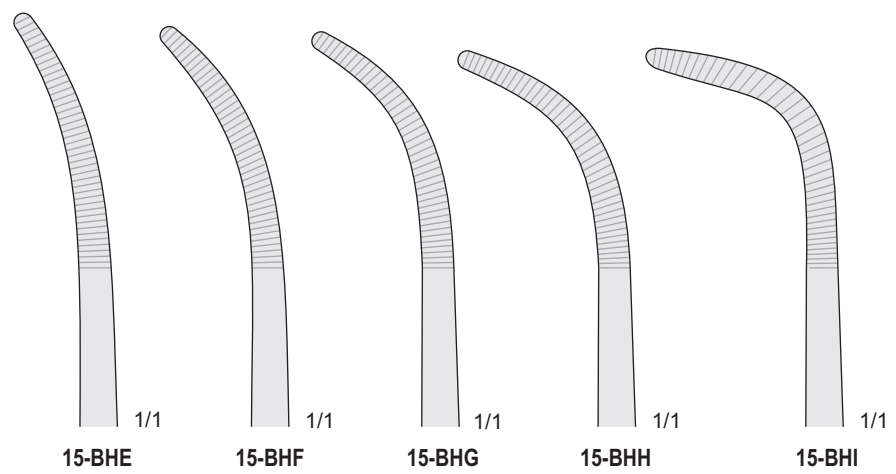
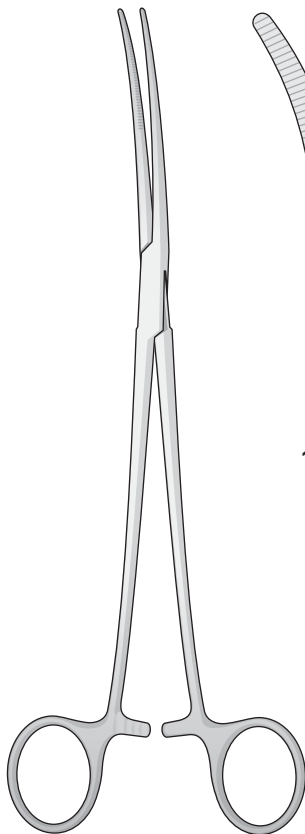

RUMEL  
15-BHE/15-BHI  
240 mm

Pinze emostatiche  
per preparazioni  
e legature

Artery forceps  
for preparation  
and ligature

Arterienklemmen  
Präparier und  
Ligaturklemmen

Pinces hemostatiques  
à disséquer  
et à ligatures

Pinzas hemostáticas  
Preparacion  
y para ligaduras

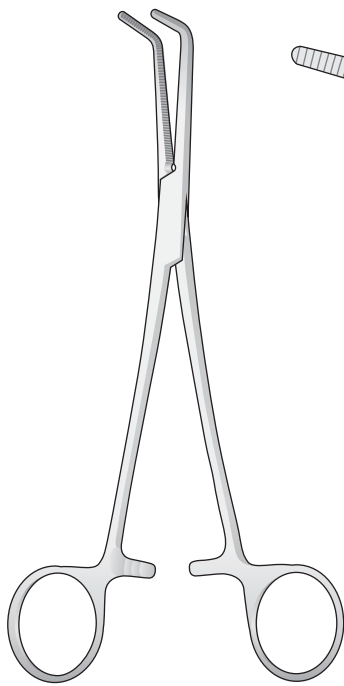

MIXTER  
15-BCD/15-BCF

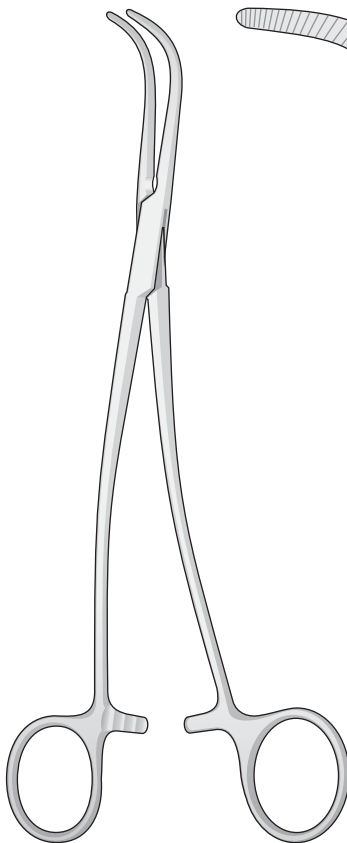
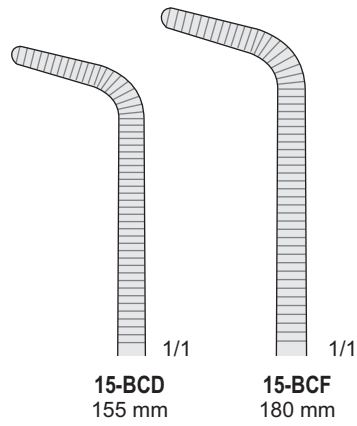

GRAY  
15-BHL/15-BIA  
220 mm

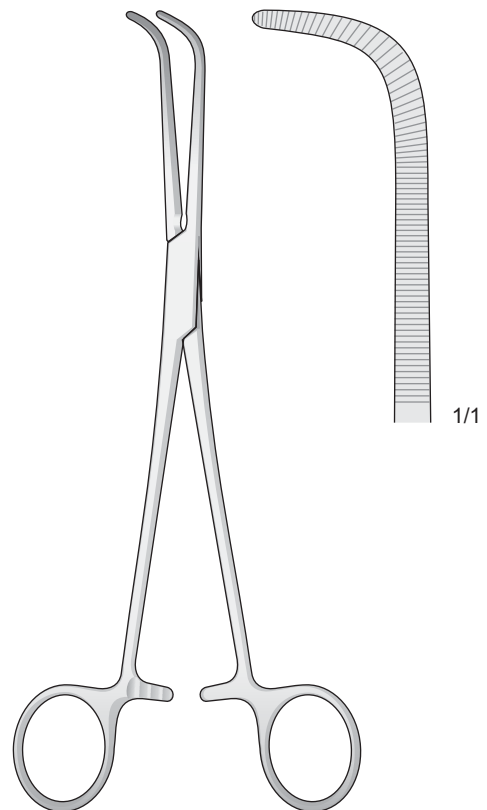
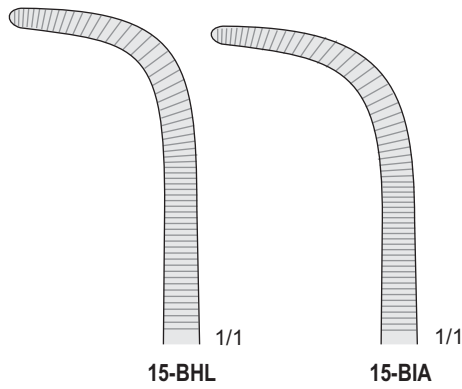

WIKSTROEM  
15-BIB  
205 mm

Pinze emostatiche  
per preparazioni  
e legature

Artery forceps  
for preparation  
and ligature

Arterienklemmen  
Präparier und  
Ligaturklemmen

Pinces hemostatiques  
à disséquer  
et à ligatures

Pinzas hemostáticas  
Preparacion  
y para ligaduras

Pinze per tonsille  
Tonsil forceps  
Tonsillenklemmen  
Pincas pour amygdales  
Pinzas para amigdalas

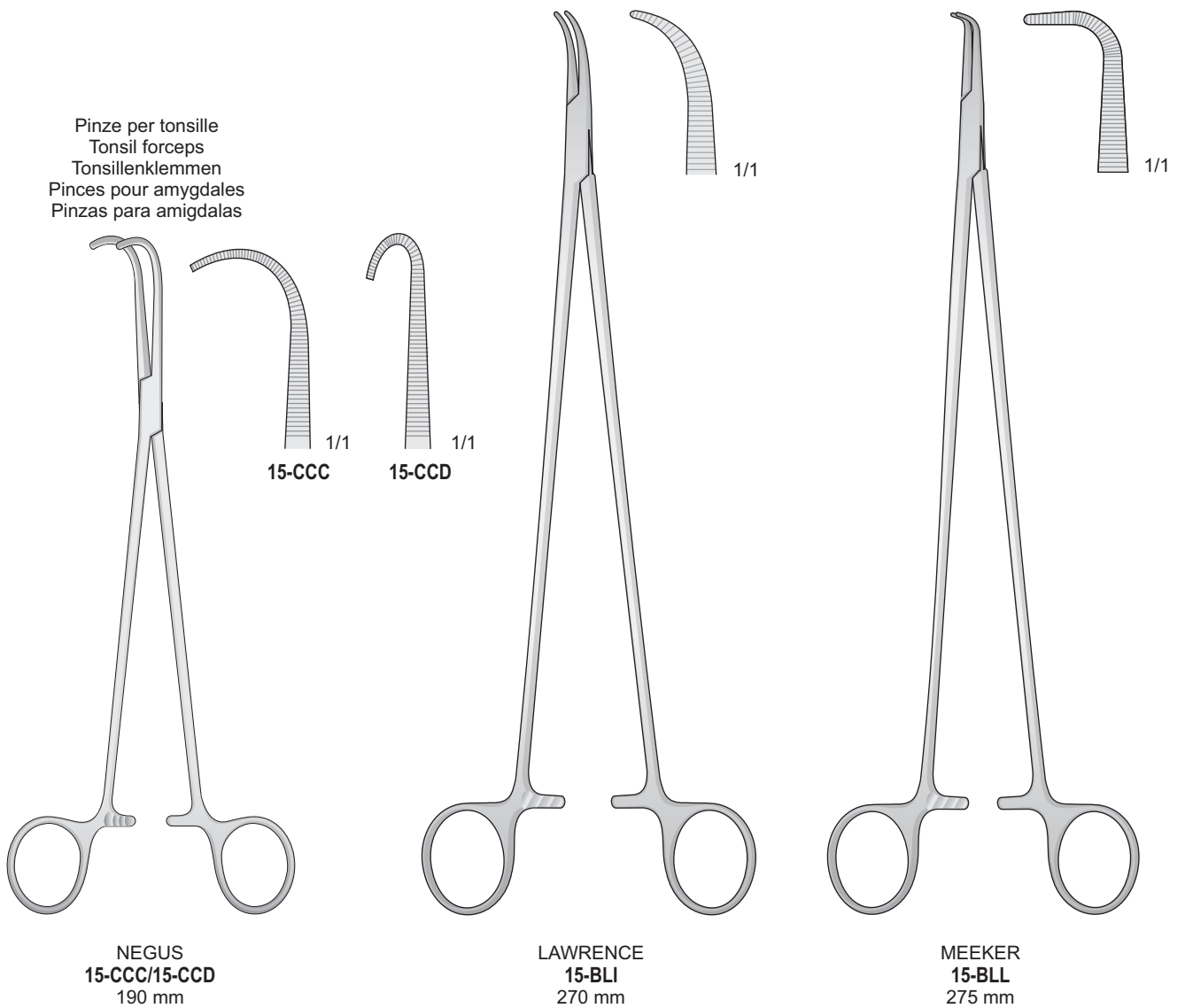

Pinze emostatiche

Hemostatic forceps

Arterienklemmen

Pinces hémostatiques

Pinzas hemostáticas

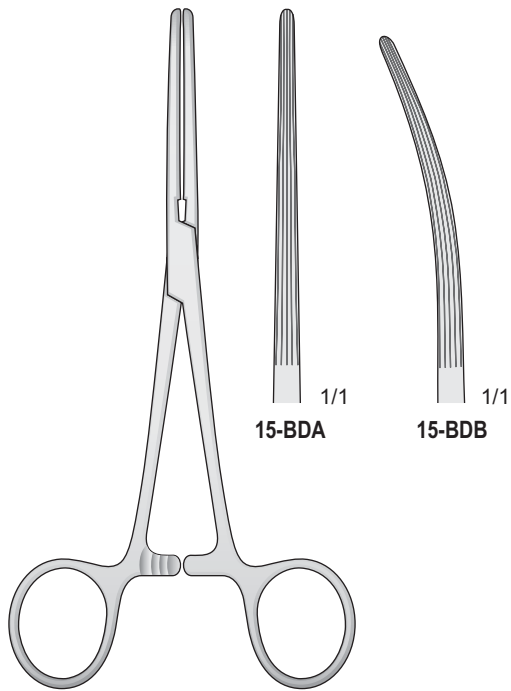

BAINBRIDGE  
15-BDA/15-BDB  
150 mm

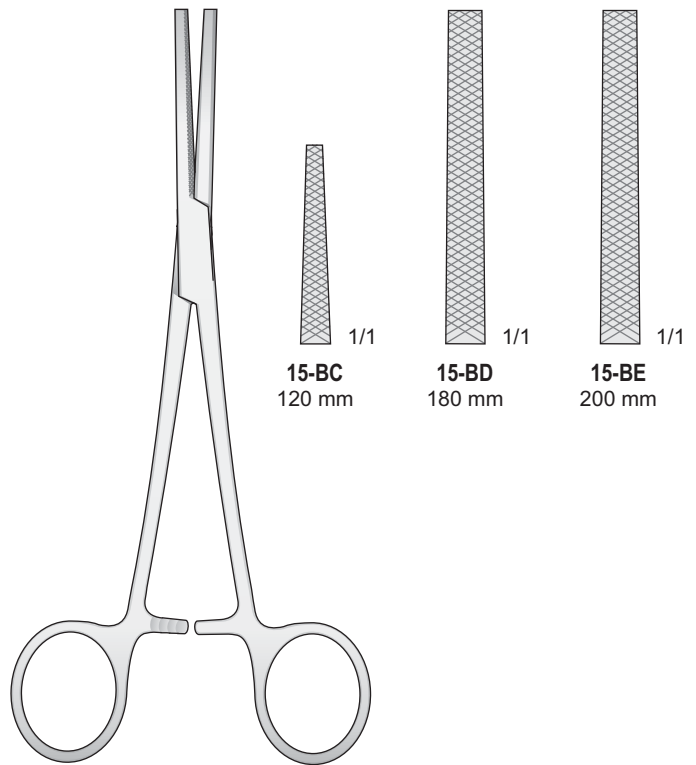

15-BC/15-BE

Angiotribe - Druckklemmen  
Angiotribes - Pinzas-clamps para presión progresiva

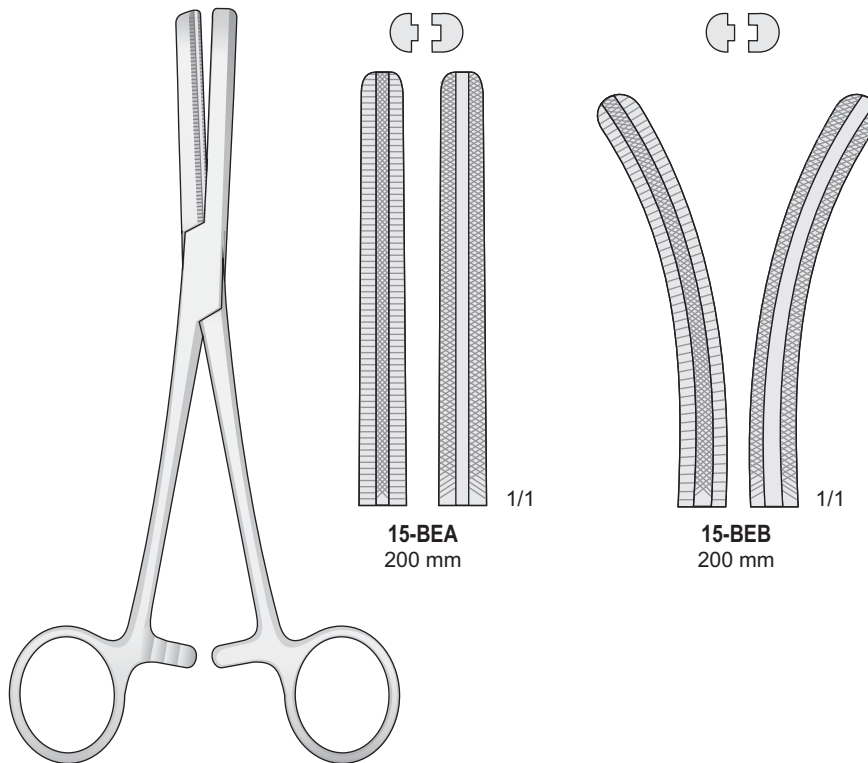

FERGUSON  
15-BEA/15-BEB



Pinze serratubi

Tubing Clamps

Schlauchklemmen

Pinces presse-tubes

Pinzas cierra-tubos

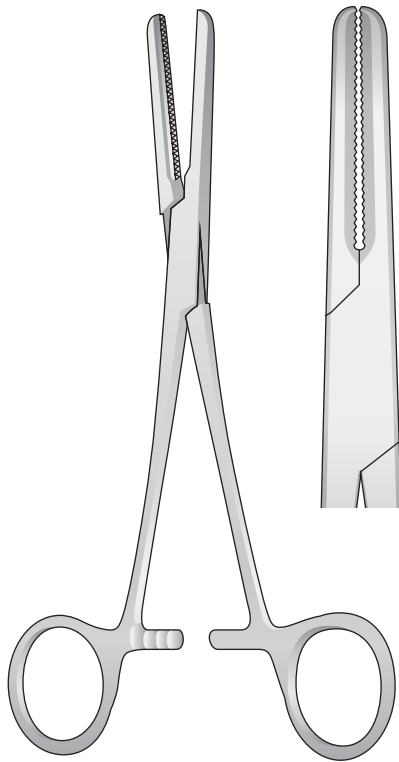

15-BFB/15-BFD

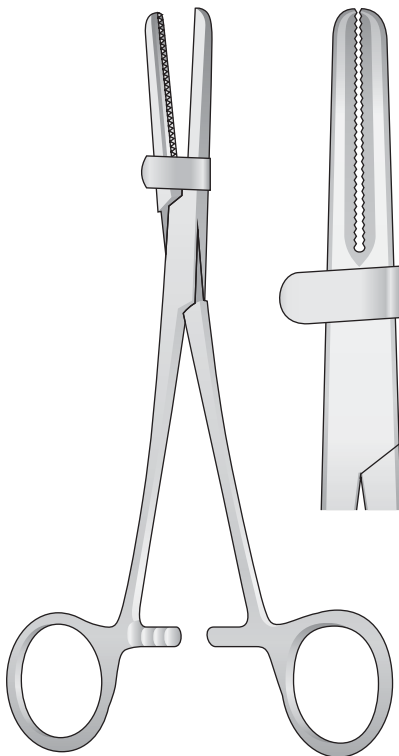
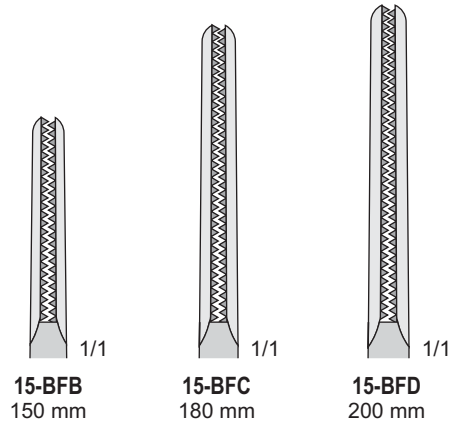

15-BFE/15-BFG

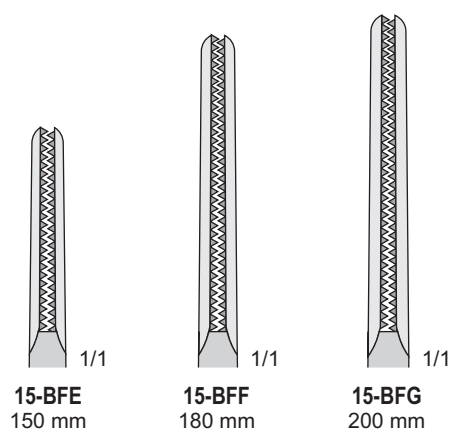

Pinze serratubi

Tubing Clamps

Schlauchklemmen

Pinces presse-tubes

Pinzas cierra-tubos

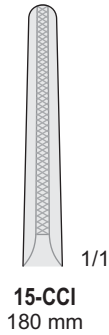
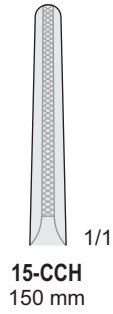
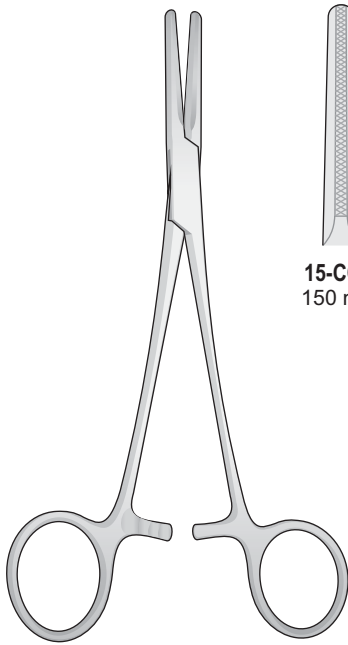

15-CCH/15-CCI

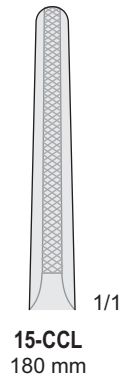
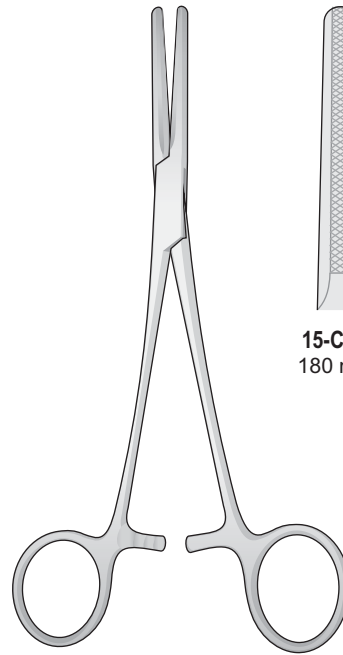

15-CCL  
180 mm

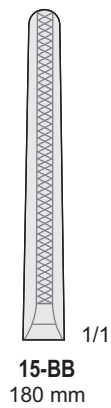
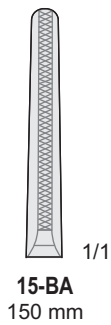
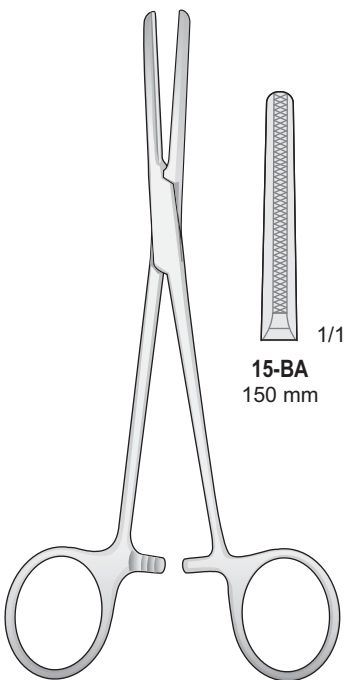

15-BA/15-BB

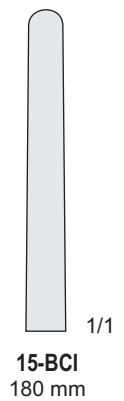
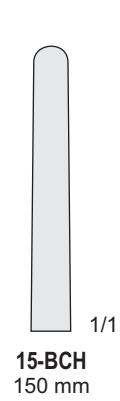
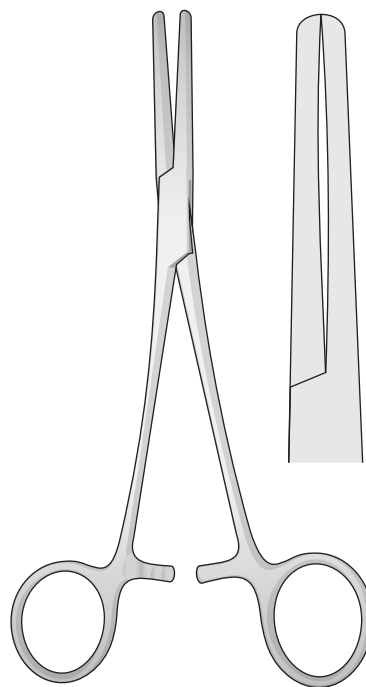

15-BCH/15-BCI



6

Enterostati, Pinze atraumatiche  
Atraumatic vessel clamps  
Atraumatische Gefäßklemmen  
Pincés atraumatiques  
Pinzas vasculares atraumáticas



Pinze intestinali  
elastiche

Intestinal clamps  
soft elastic

Darmklemmen  
Elastisch

Pinces  
intestinales

Pinzas  
intestinales

Atraumatiche - Atraumatic  
Atraumatische - Atraumatiques - Atraumáticas

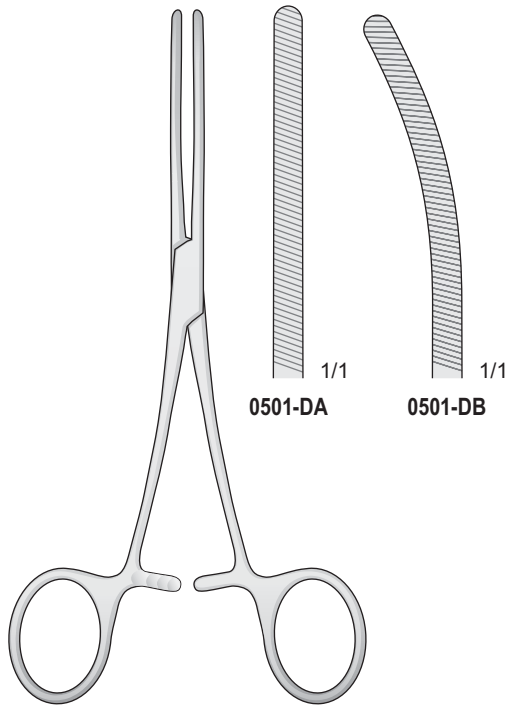

DOYEN  
0501-DA/0501-DB  
170 mm

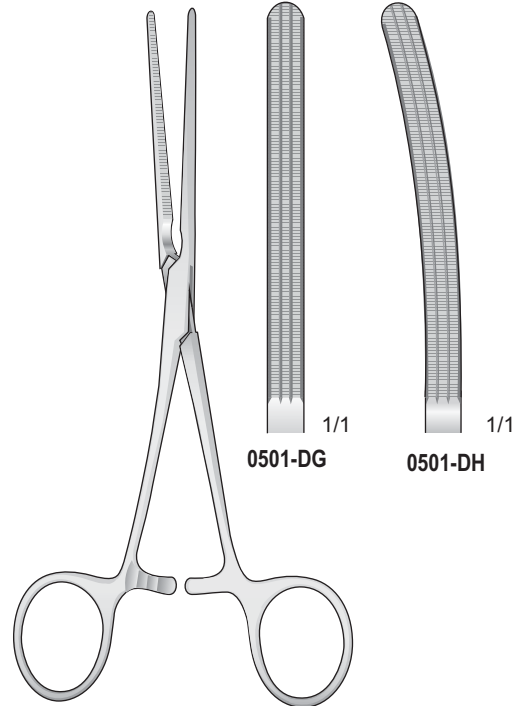

DOYEN  
0501-DG/0501-DH  
170 mm

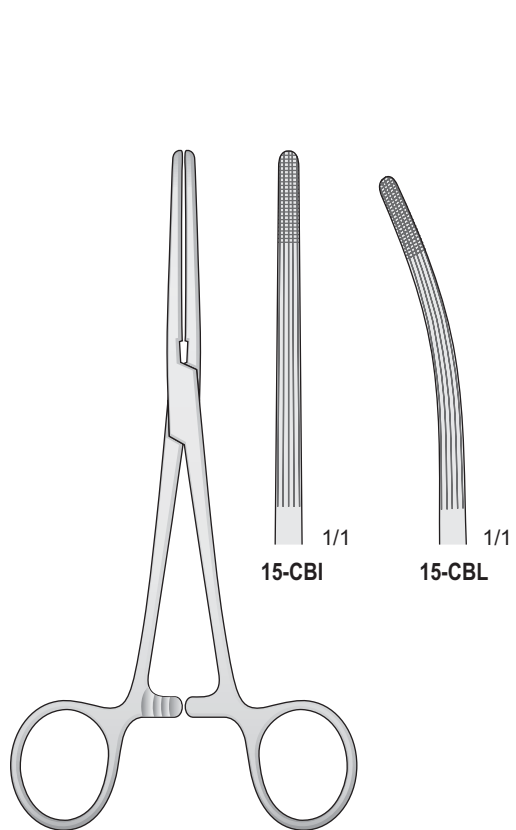

ROCHESTER-CARMALT  
15-CBI/15-CBL  
160 mm

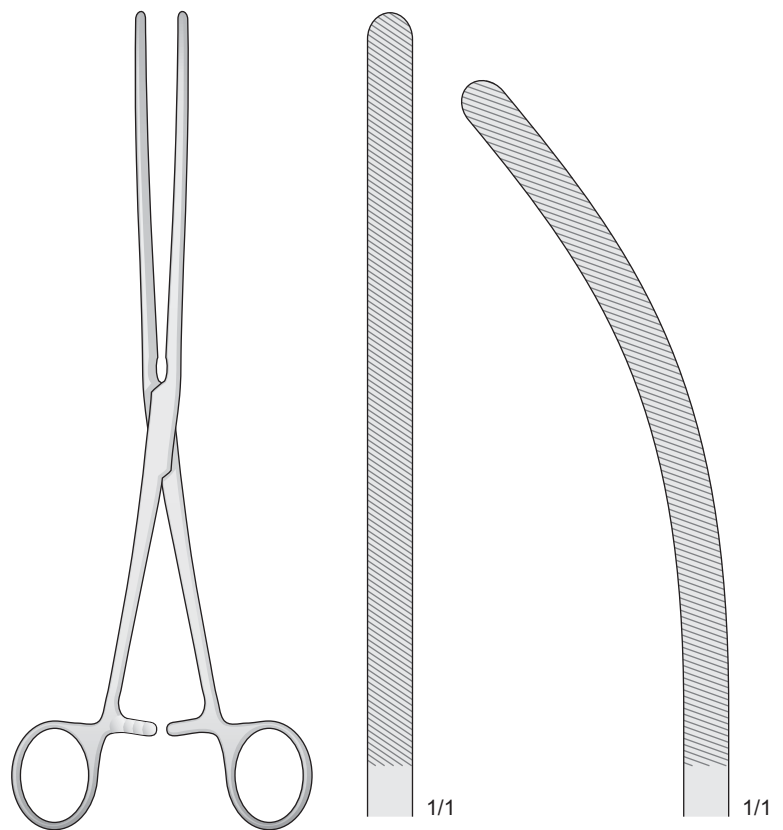

DOYEN  
0501-DC/0501-DD  
230 mm

Pinze intestinali  
elastiche

Intestinal clamps  
soft elastic

Darmklemmen  
Elastisch

Pinces  
intestinales

Pinzas  
intestinales

Elastiche - Elastisch - Elastich - Elastic - Elasticas

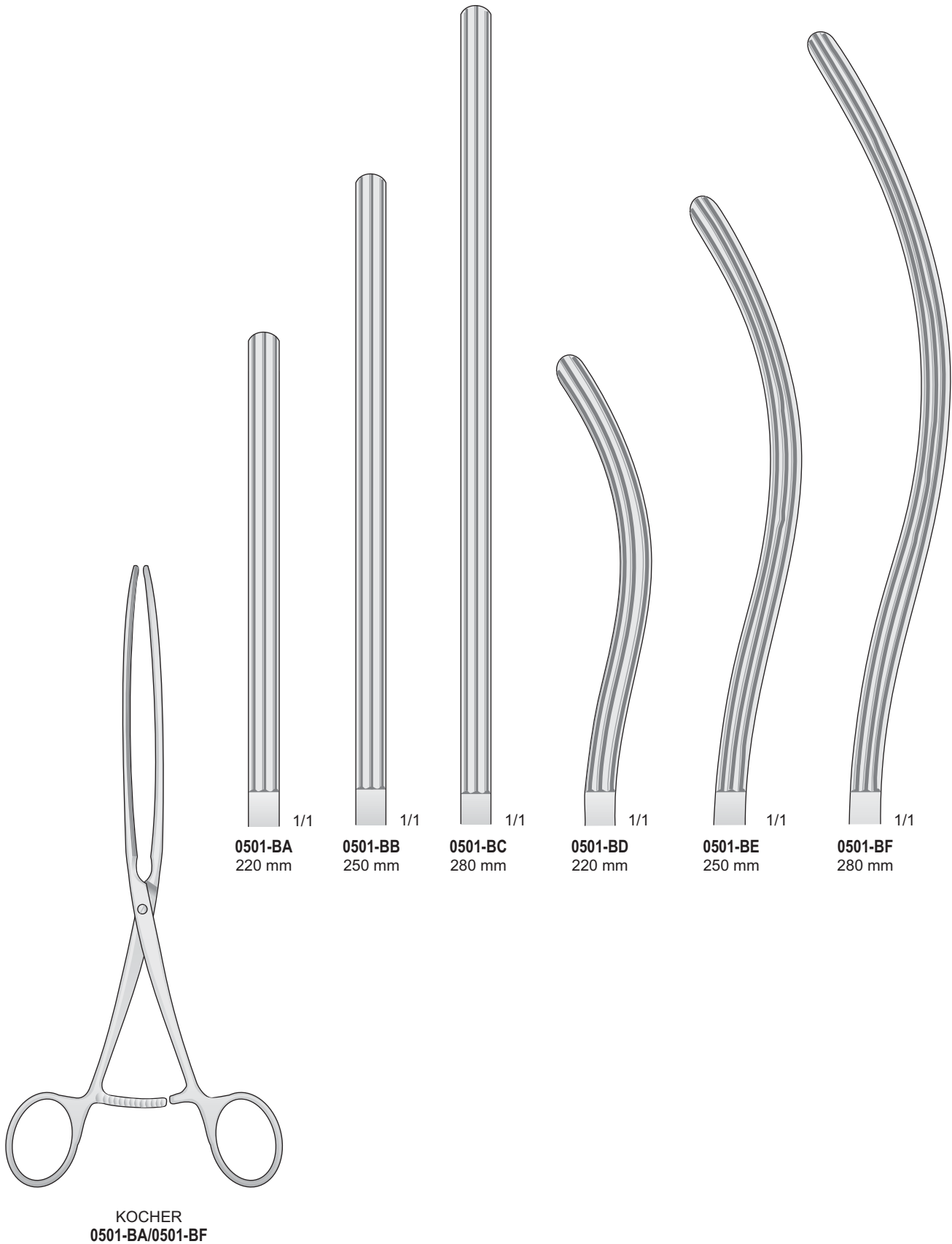

Pinze intestinali  
elastiche

Intestinal clamps  
soft elastic

Darmklemmen  
Elastisch

Pinces  
intestinales

Pinzas  
intestinales

Atraumatiche - Atraumatic  
Atraumatische - Atraumatiques - Atraumáticas

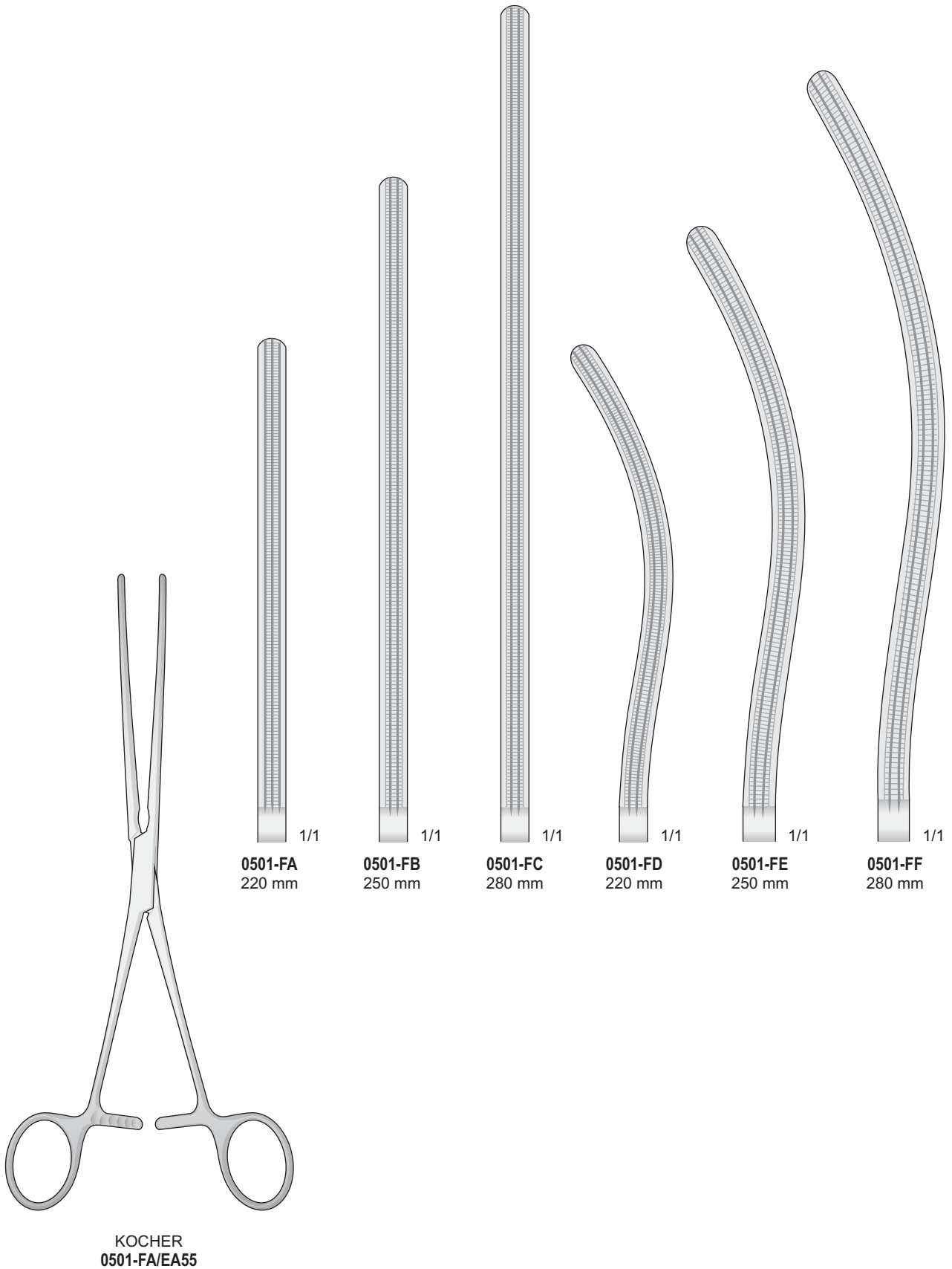

Pinze per intestino  
e stomaco

Intestinal-stomach  
clamps

Darm-magen  
Gefäßklemmen

Pinces-clamps  
pour l'intestin et l'estomac

Pinzas intestinales  
stomacales

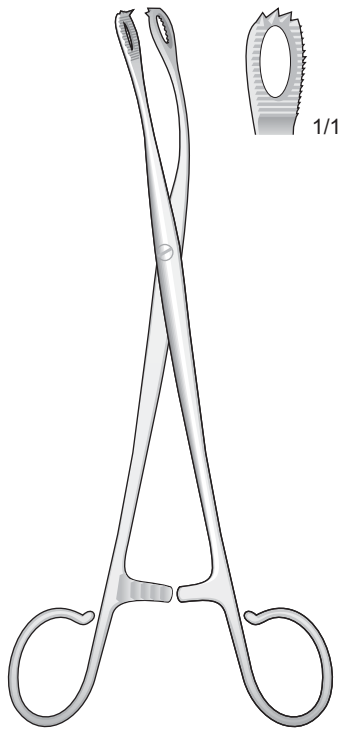

BLOHMKE  
15-CCA  
200 mm

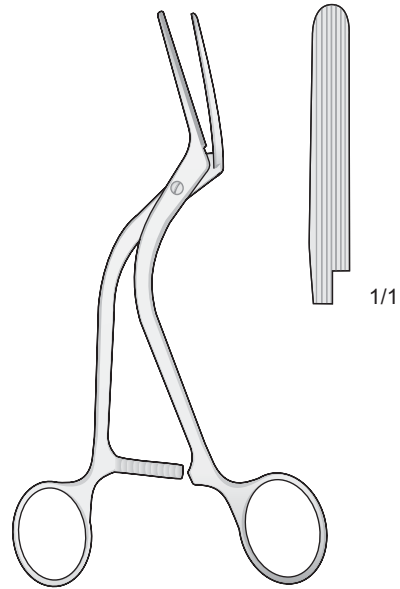

HÖPFNER  
15-AH  
165 mm

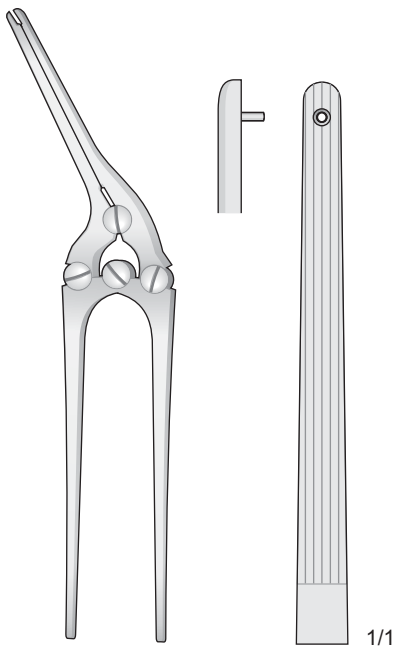

PAYR  
0501-CA  
200 mm

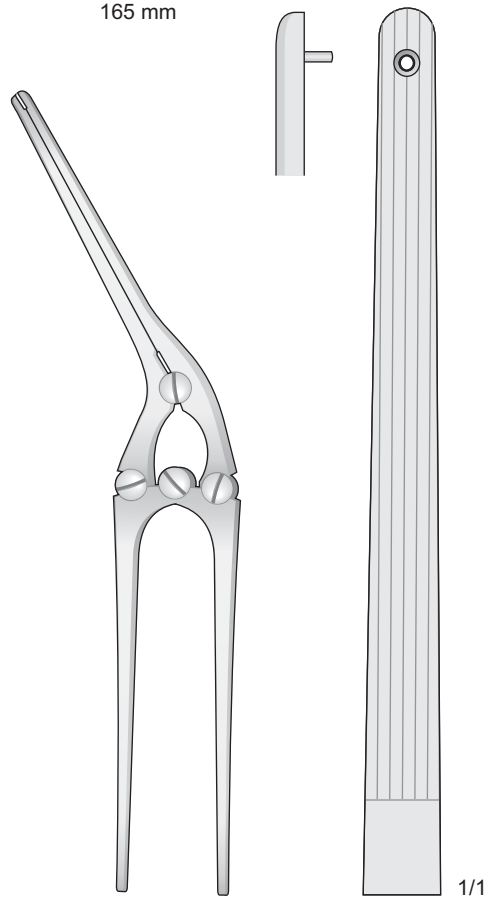

PAYR  
0501-CB  
280 mm



Pinze per  
peduncoli renali

Kidney pedicle  
clamps forceps

Nierenstielklemmen

Pinces-clamps pour  
pédicules rénaux

Pinzas clamps para  
pedúnculos renales

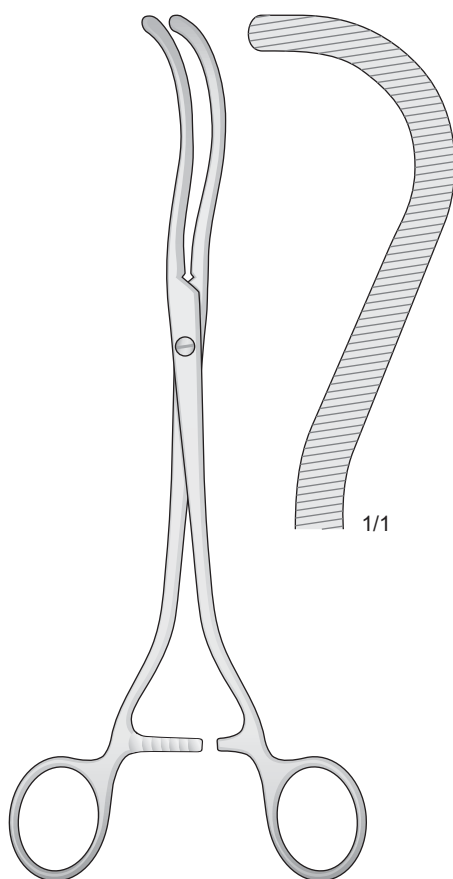

GUYON  
0502-DB  
235 mm

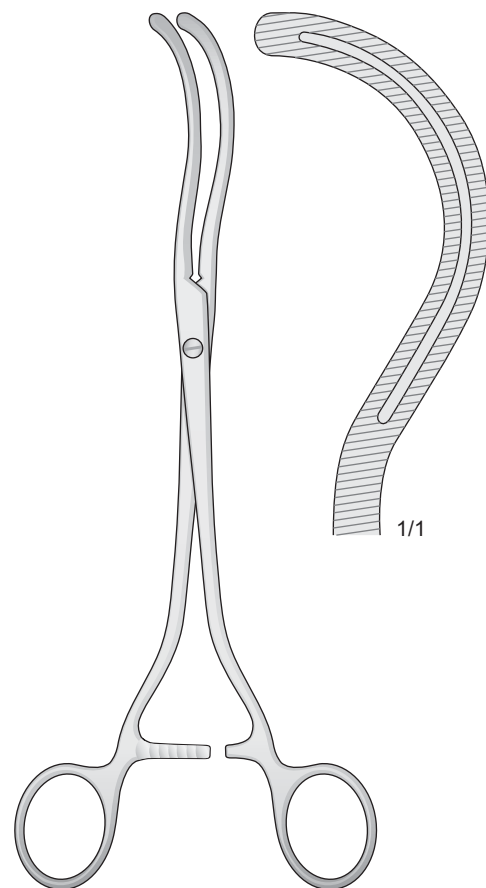

STILLE  
0502-DC  
240 mm

Pinze per  
peduncoli renali

Kidney pedicle  
clamps forceps

Nierenstielklemmen

Pinces-clamps pour  
pédicules rénaux

Pinzas clamps para  
pedúnculos renales

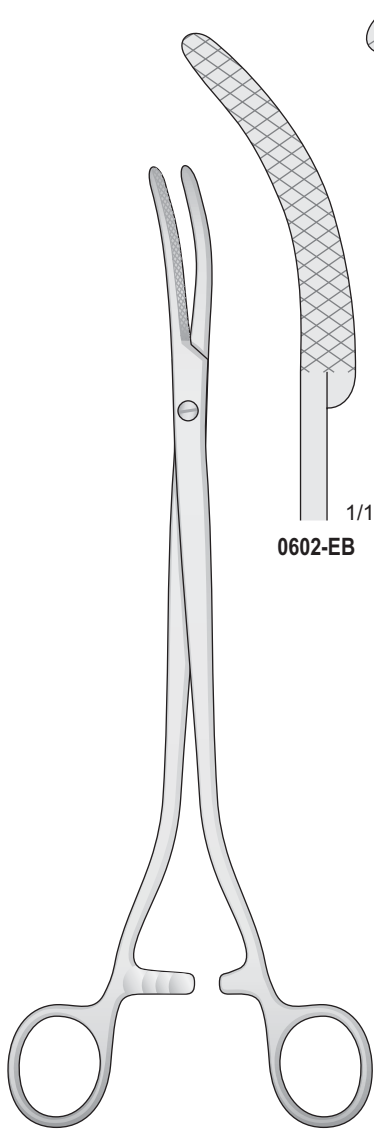

WERTHEIM  
0602-EB  
260 mm

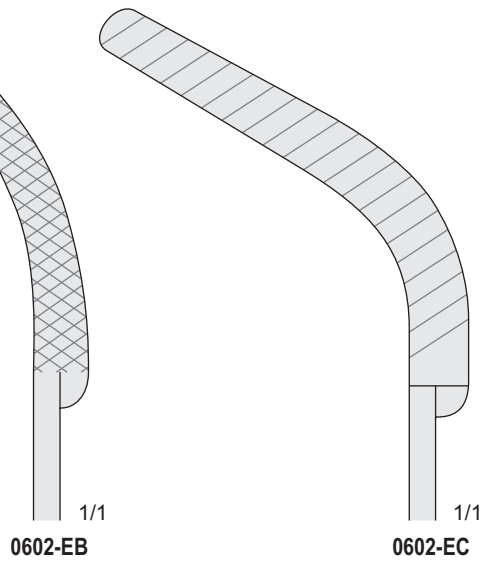

0602-EC

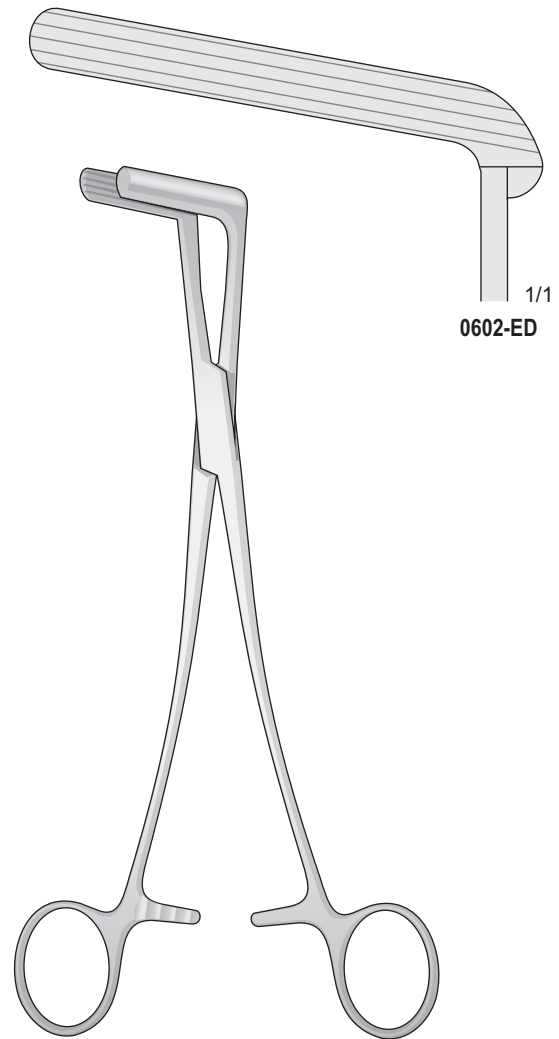

WERTHEIM  
0602-EC/0602-ED  
235 mm

Pinze Bulldog

Bulldog clamps

Bulldogklemmen

Pinces Bulldog

Pinzas Bulldog

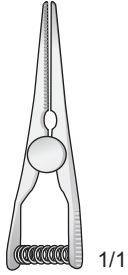

0602-IE  
35 mm

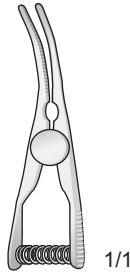

0602-IF  
35 mm

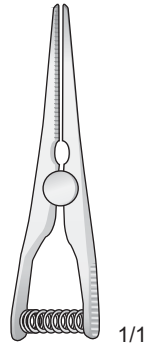

0602-IG  
45 mm

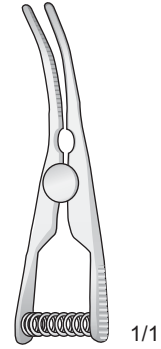

0602-IH  
45 mm

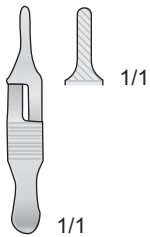

0212-CH  
30 mm

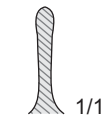

0212-DC



0212-DD



0212-DE

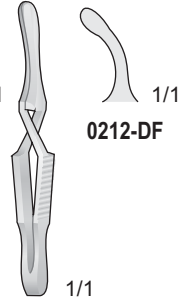

0212-DF



0212-LD  
40 mm

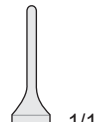

0212-LF

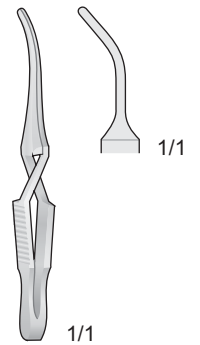

0212-LF  
45 mm

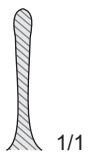

0212-DG



0212-DH

DIFFENBACH  
0212-DG/0212-DH  
45 mm

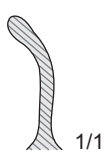

0212-DI

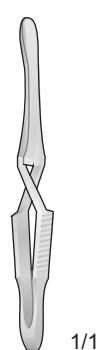

0212-DL

DIFFENBACH  
0212-DI/0212-DL  
45 mm

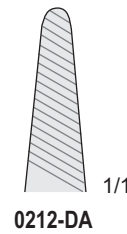

0212-DA



0212-DB

DIFFENBACH  
0212-DA/0212-DB  
60 mm

**Pinze  
Atrauma Bulldog**



**0602-GH/0602-HA**

**Atrauma  
Bulldog clamps**

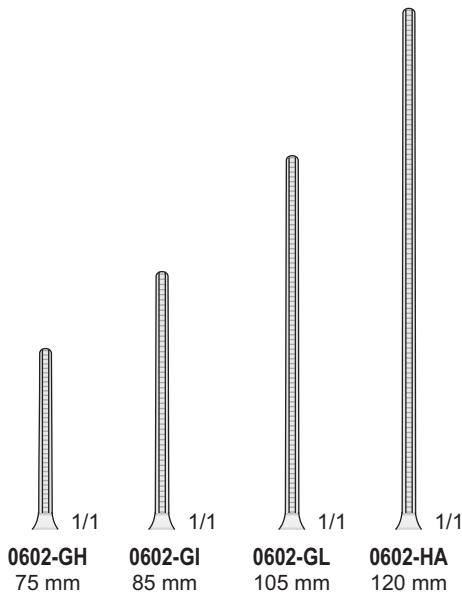

**Atrauma  
Bulldogklemmen**

**Clamps  
Bulldog Atrauma**

**Pinzas  
Atrauma Bulldog**



Pinza per applicare e rimuovere Bulldog clamps  
Zange zum Anziehen der Bulldogklemmen  
Forceps for applying and removing Bulldog clamps  
Pinces pour applicateur clamps Bulldog  
Pinzas de aplicación para pinzas Bulldog

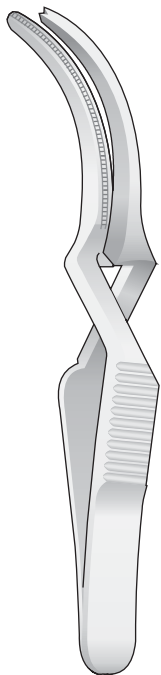

**0602-HB/0602-HE**

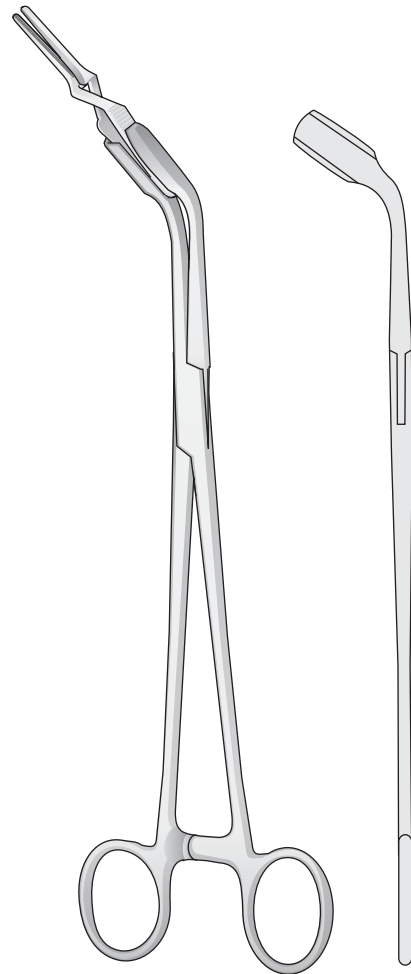
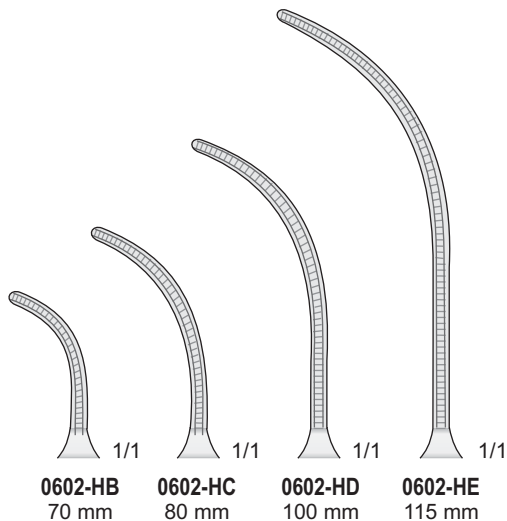

**0602-HF**  
230 mm

Pinze  
Atrauma Bulldog

Atrauma  
Bulldog clamps

Atrauma  
Bulldogklemmen

Clamps  
Bulldog Atrauma

Pinzas  
Atrauma Bulldog

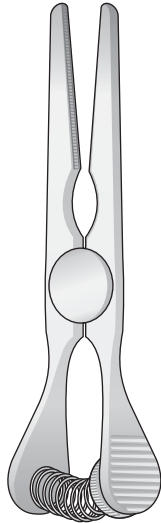

GLOVER  
0602-HG/0602-HL

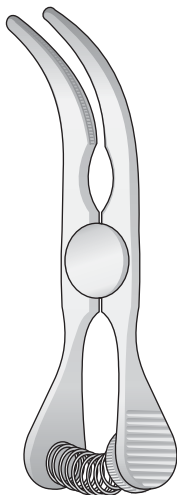
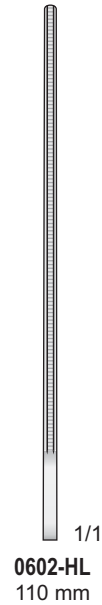
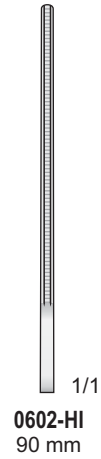
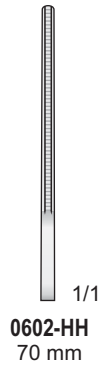
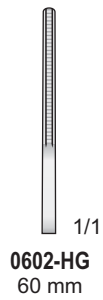

GLOVER  
0602-IA/0602-ID

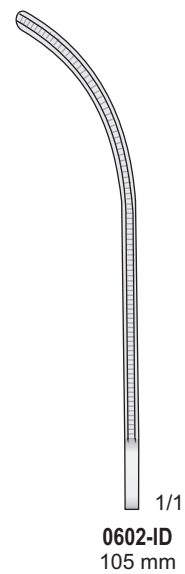
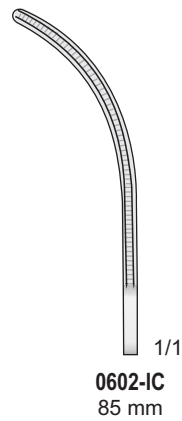
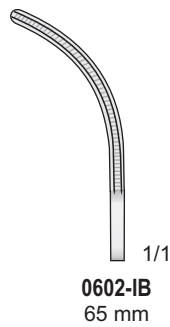
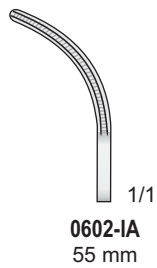

Pinze  
Atrauma Bulldog

Atrauma  
Bulldog clamps

Atrauma  
Bulldogklemmen

Clamps  
Bulldog Atrauma

Pinzas  
Atrauma Bulldog

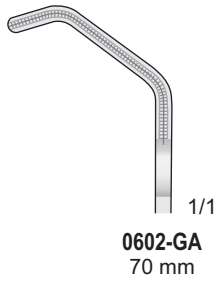
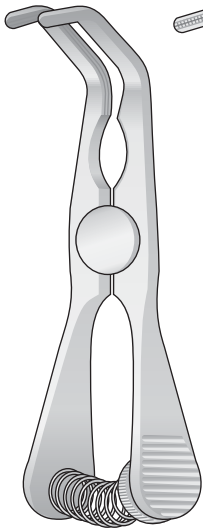

DE BAKEY-SATINSKY  
**0602-GA**  
70 mm

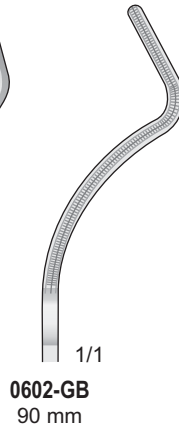
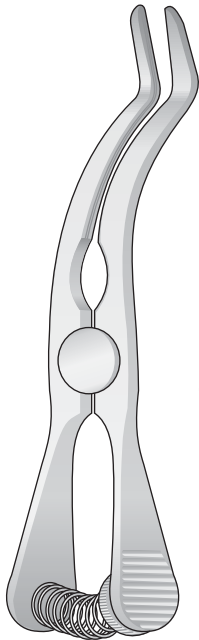

DE BAKEY-CAROTIS  
**0602-GB**  
90 mm

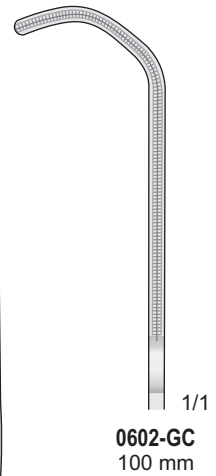
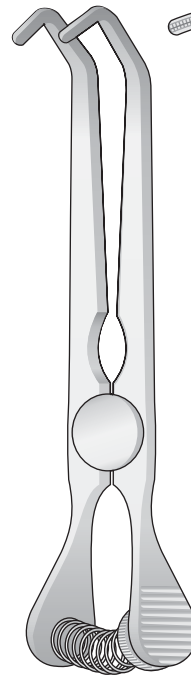

DE BAKEY-SATINSKY  
**0602-GC**  
100 mm

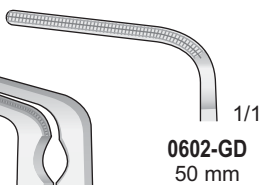
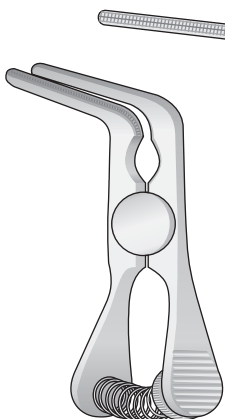

GLOVER  
**0602-GD**  
50 mm

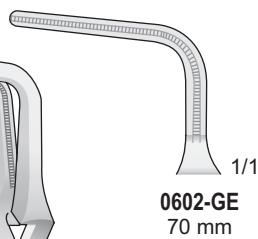
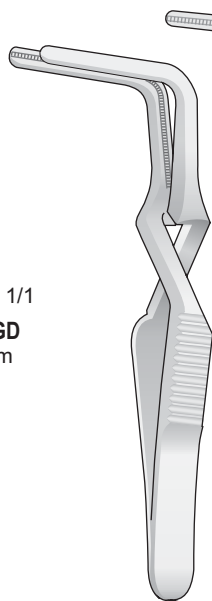

SANTULLI  
**0602-GE**  
70 mm

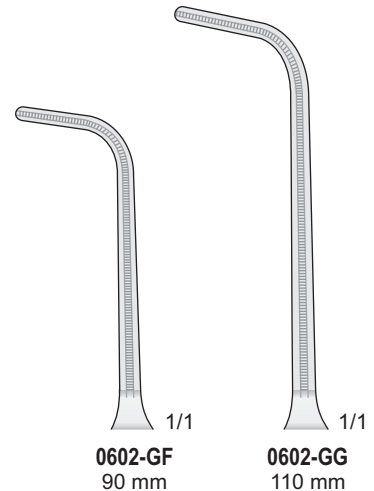
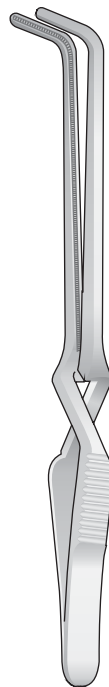

**0602-GF/0602-GG**

Pinze  
atraumatiche

Atraumatic  
vessel clamps

Atraumatische  
Gefäßklemmen

Pinces vasculaires  
atrauma

Pinzas vasculares  
atraumáticas

Pinze atraumatiche per neonati e bambini  
Atraumatic Vessel clamps for babies and children  
Atraumatische Gefäßklemmen für Säuglinge und Kinder  
Pinces vasculaires atraumatiques pour enfants  
Pinzas vasculares atraumáticas para niños

Modelli estremamente fini  
Delicate - Fein - Fins - Finas

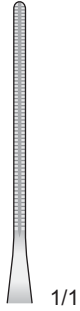

**0602-CEB**  
140 mm

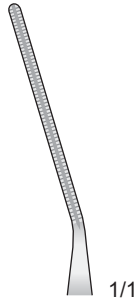

**0602-CEC**  
140 mm

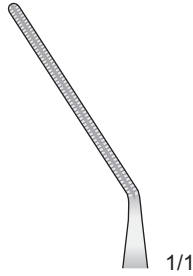

**0602-CED**  
140 mm

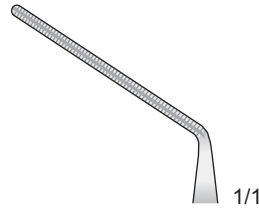

**0602-CEE**  
130 mm

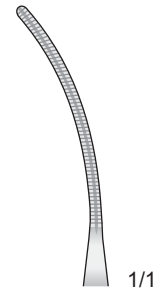

**0602-CEF**  
140 mm



**0602-CEG**  
130 mm



**0602-CEH**  
130 mm

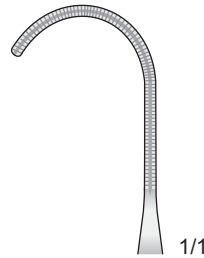

**0602-CEI**  
140 mm

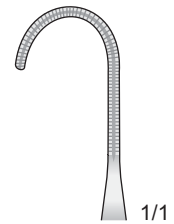

**0602-CEL**  
135 mm

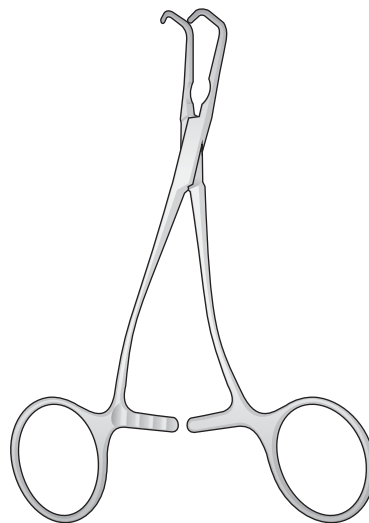

**0602-CEB/FB249**  
130 mm

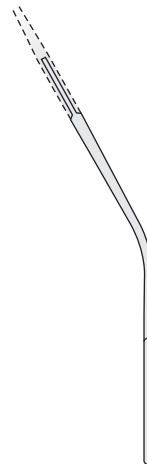

Pinze  
atraumatiche

Atraumatic  
vessel clamps

Atraumatische  
Gefäßklemmen

Pinces vasculaires  
atrauma

Pinzas vasculares  
atraumáticas



Atraumatic  
Atraumatic  
Atraumatische  
Atraumatiques  
Atraumaticas

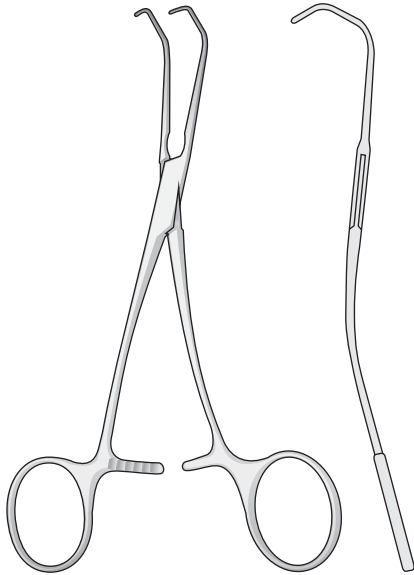

CASTANEDA  
0602-CDG/0602-CDL  
155 mm

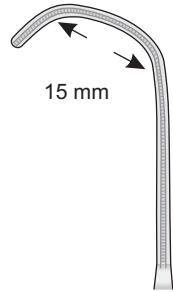

0602-CDG  
48 mm

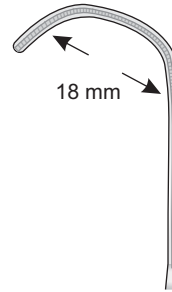

0602-CDH  
52 mm

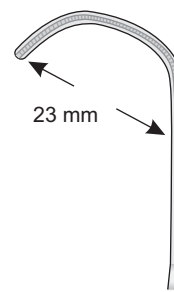

0602-CDI  
56 mm

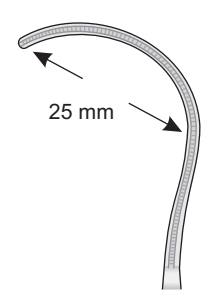

0602-CDL  
50 mm

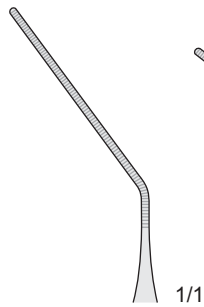

0602-CFB

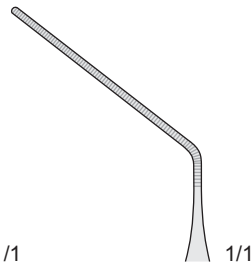

0602-CFC

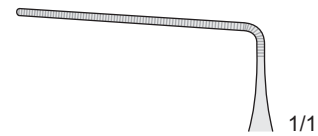

0602-CFD

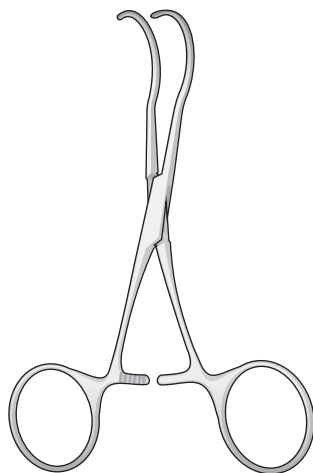

CASTANEDA  
0602-CFB/0604-CFH  
120 mm

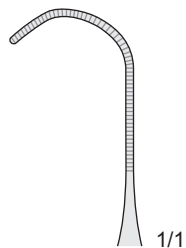

0602-CFE

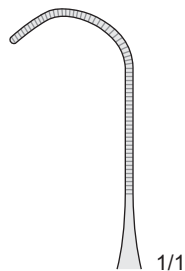

0602-CFF

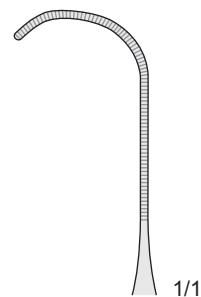

0602-CFG

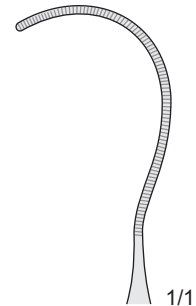

0602-CFH



Pinze vascolari  
atraumatiche

Atraumatic  
vessel clamps

Atraumatische  
Gefäßklemmen

Pinces hémostatiques  
atraumatiques

Pinzas vasculares  
atraumáticas

Pinze per neonati e bambini  
Atraumatic vessel clamps for babys and children  
Säugling - und Kinderklemmen  
Pinces-clamps pour nouveaux-nés et enfants  
Pinzas vasculares atraumáticas para niños

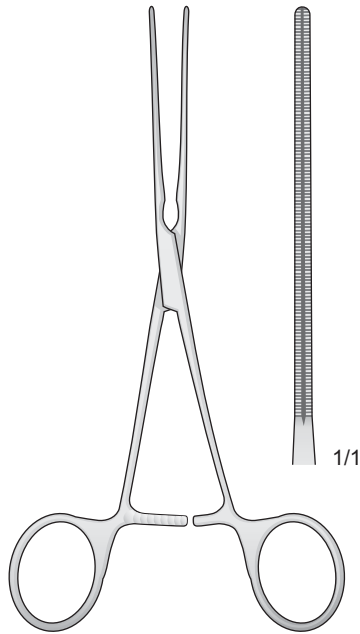

**0602-CBB**  
165 mm

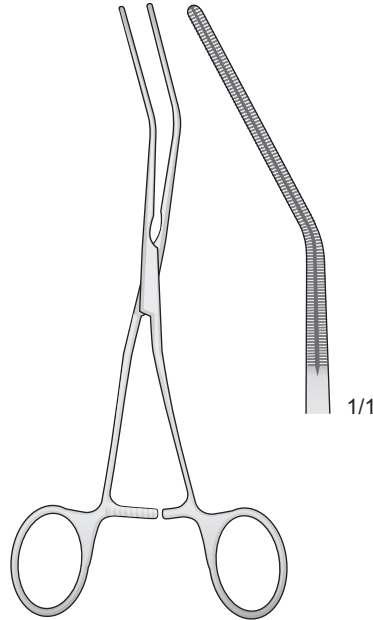

**0602-CBC**  
160 mm

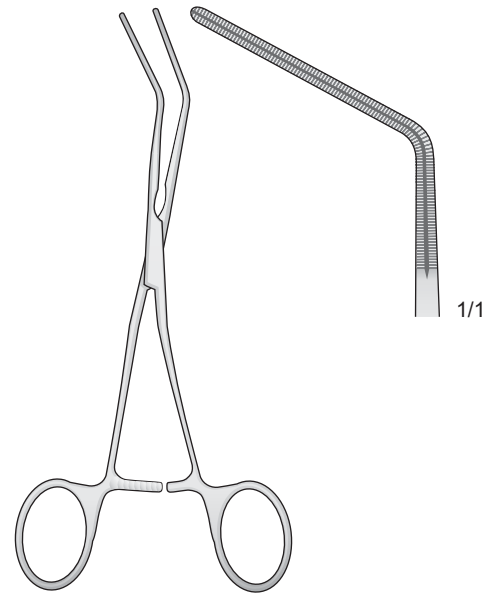

**0602-CBD**  
150 mm

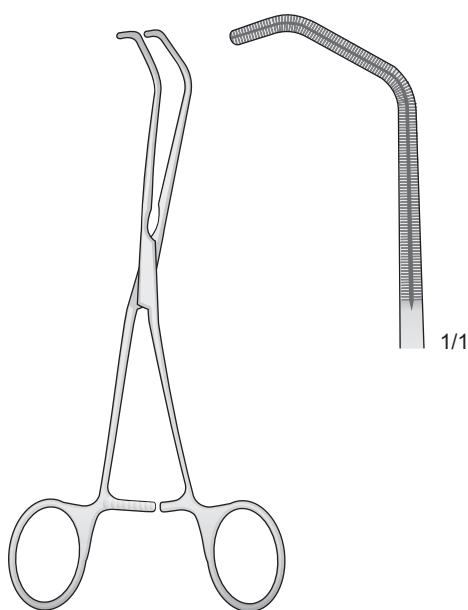

**0602-CBE**  
150 mm

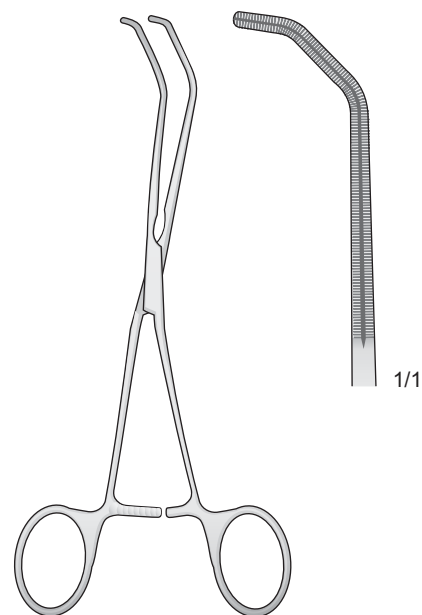

**0602-CBF**  
155 mm

Pinze vascolari  
atraumatiche

Atraumatic  
vessel clamps

Atraumatische  
Gefäßklemmen

Pinces hémostatiques  
atraumatiques

Pinzas vasculares  
atraumáticas

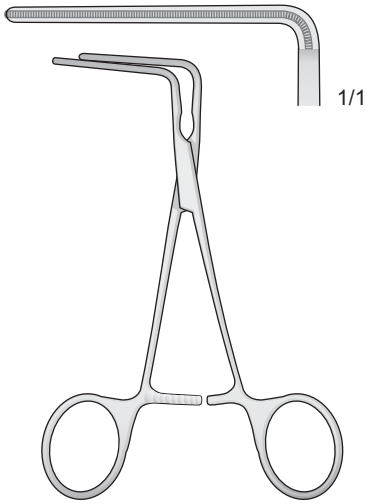

De BAKEY  
**0602-CAB**  
100 mm

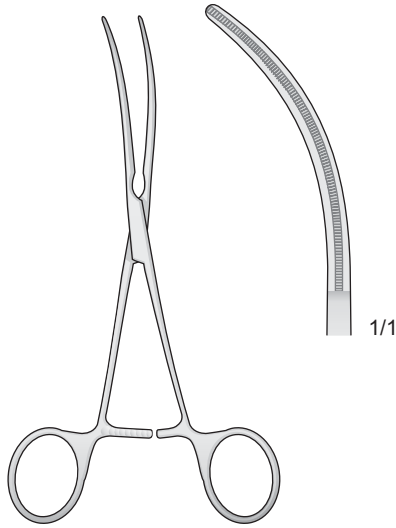

De BAKEY  
**0602-CAC**  
110 mm

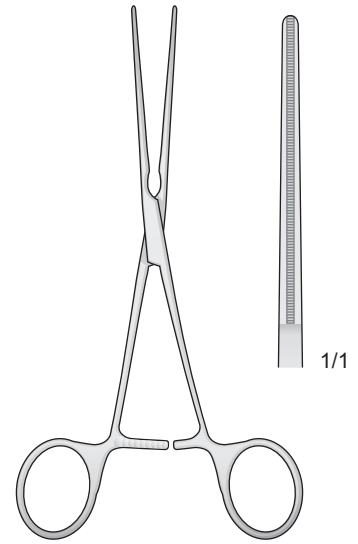

De BAKEY  
**0602-CAD**  
120 mm

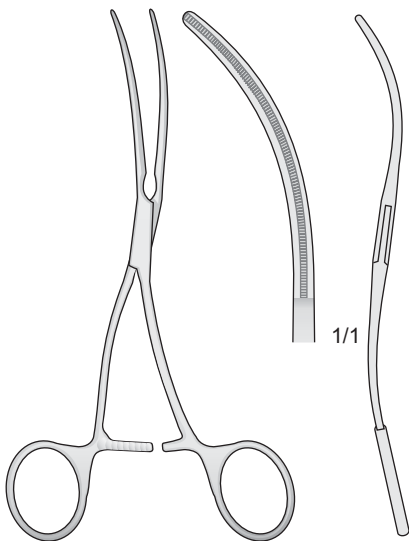

De BAKEY  
**0602-CAE**  
120 mm

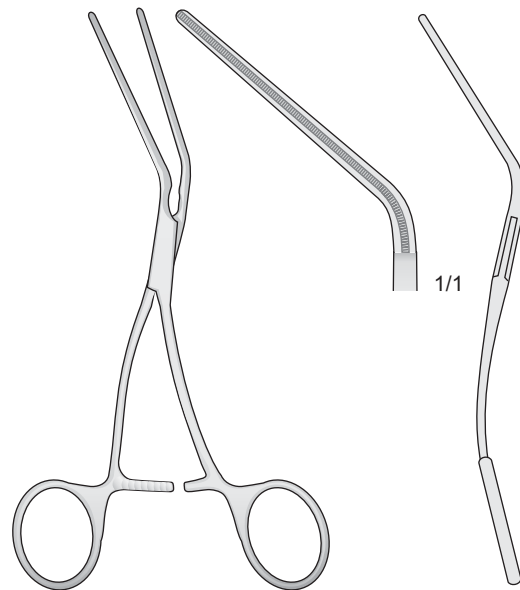

De BAKEY  
**0602-CAF**  
130 mm

Pinze  
atraumatiche

Atraumatic  
vessel clamps

Atraumatische  
Gefäßklappen

Pinces vasculaires  
atrauma

Pinzas vasculares  
atraumáticas

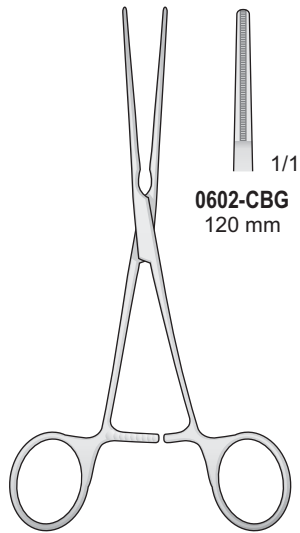

**0602-CBG**  
120 mm

De BAKEY - MOSQUITO  
**0602-CBG**  
120 mm

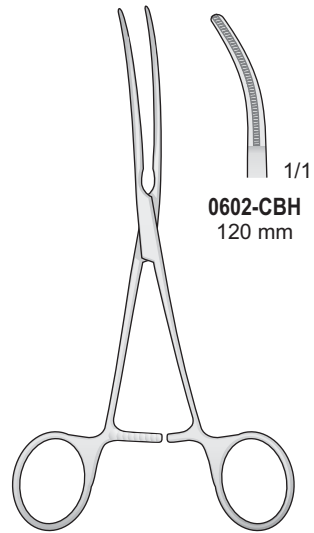

**0602-CBH**  
120 mm

De BAKEY - MOSQUITO  
**0602-CBH**  
120 mm

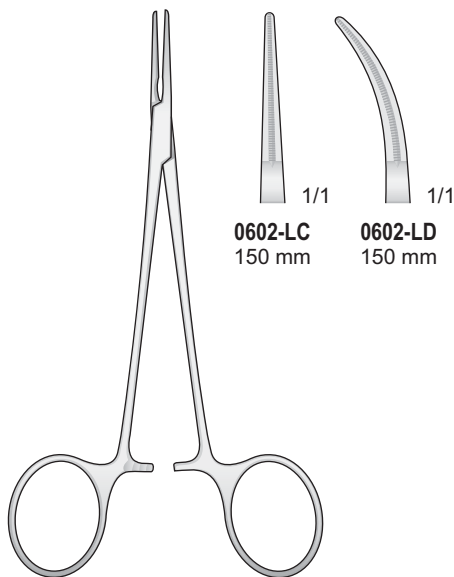

**0602-LC**  
150 mm

**0602-LD**  
150 mm

De BAKEY - MOSQUITO  
**0602-LC/0602-LD**  
150 mm

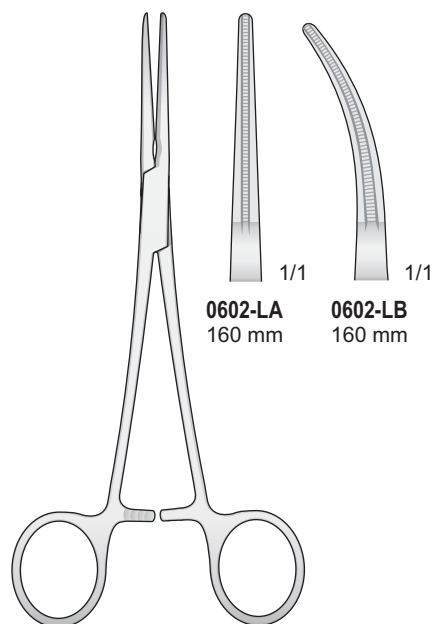

**0602-LA**  
160 mm

**0602-LB**  
160 mm

De BAKEY - RANKIN  
**0602-LA/0602-LB**  
160 mm

Pinze vascolari  
atraumatiche

Atraumatic  
vessel clamps

Atraumatische  
Gefäßklemmen

Pinces hémostatiques  
atraumatiques

Pinzas vasculares  
atraumáticas

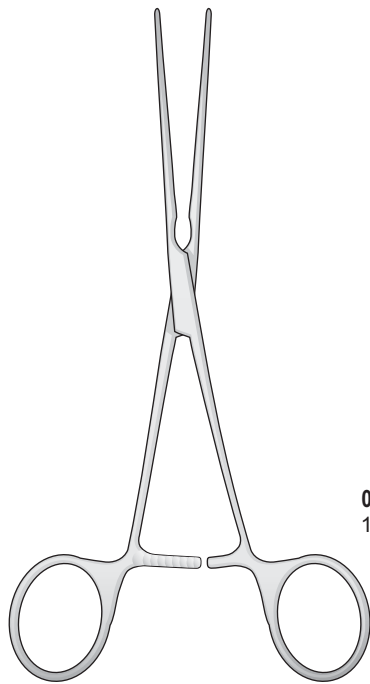

De BAKEY - PEAN  
0602-EF/0602-EL

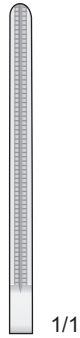

0602-EF  
140 mm

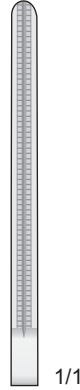

0602-EH  
160 mm

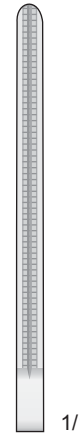

0602-EI  
180 mm

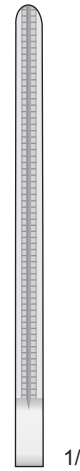

0602-EL  
200 mm

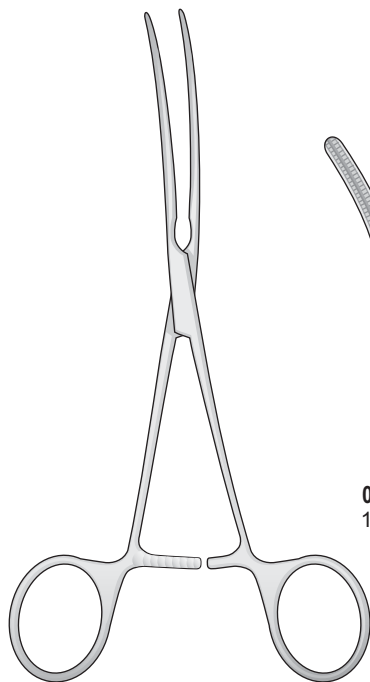

De BAKEY - PEAN  
0602-FF/0602-FL

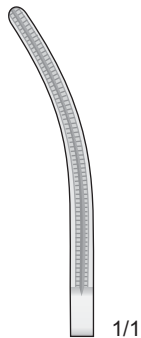

0602-FF  
140 mm

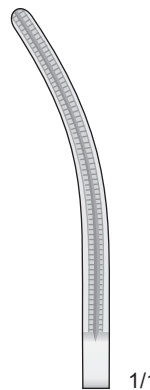

0602-FH  
160 mm

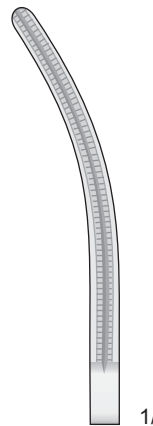

0602-FI  
180 mm

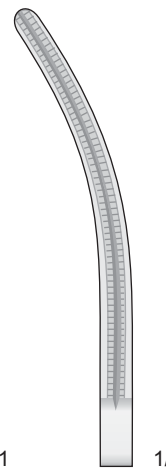

0602-FL  
200 mm

Pinze vascolari  
atraumatiche

Atraumatic  
vessel clamps

Atraumatische  
Gefäßklemmen

Pinces hémostatiques  
atraumatiques

Pinzas vasculares  
atraumáticas

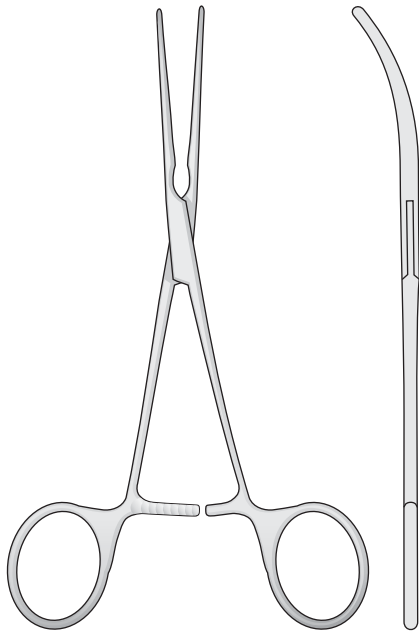

De BAKEY  
0602-CC/0602-CD  
165 mm

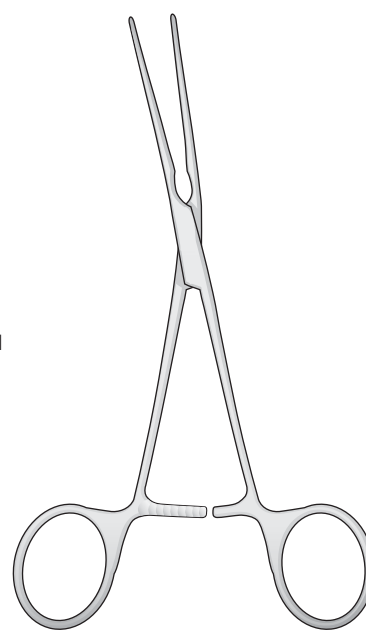
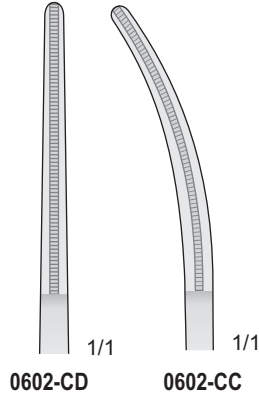

De BAKEY  
0602-CE  
165 mm

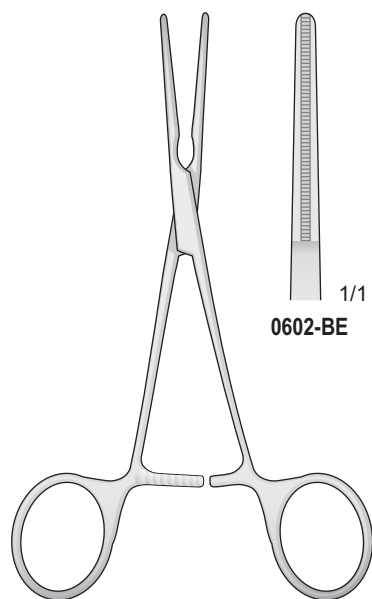
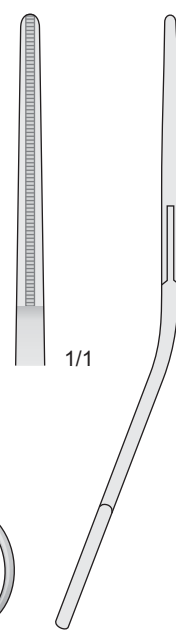

De BAKEY - BAINBRIDGE  
0602-BE/0602-BF  
155 mm

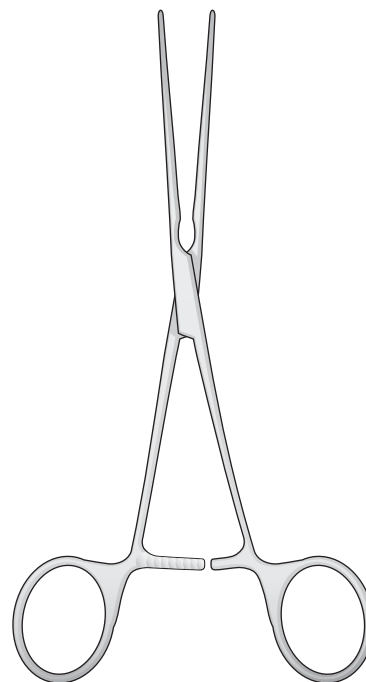
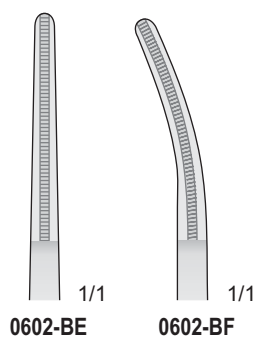

De BAKEY - BAINBRIDGE  
0602-AB/0602-AC  
180 mm

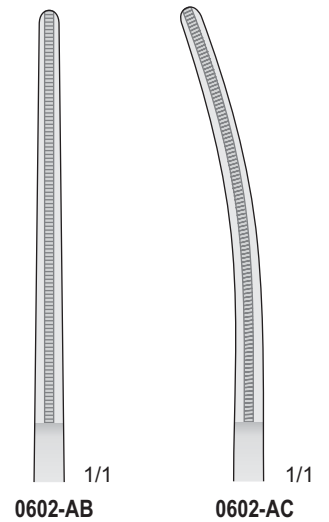

Pinze vascolari  
atraumatiche

Atraumatic  
vessel clamps

Atraumatische  
Gefäßklemmen

Pinces hémostatiques  
atraumatiques

Pinzas vasculares  
atraumáticas

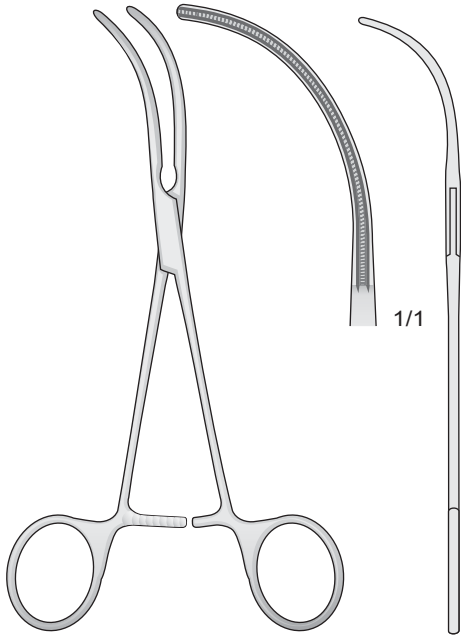

De BAKEY  
**0602-BDD**  
160 mm

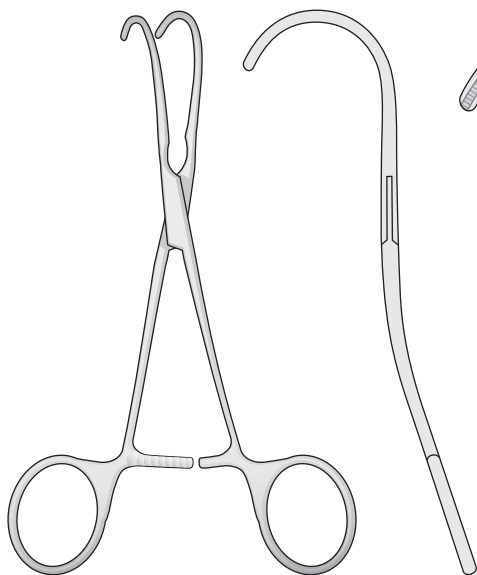

De BAKEY  
**0602-BL/0602-CA**  
150 mm

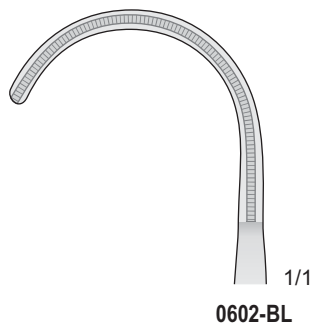

**0602-BL**

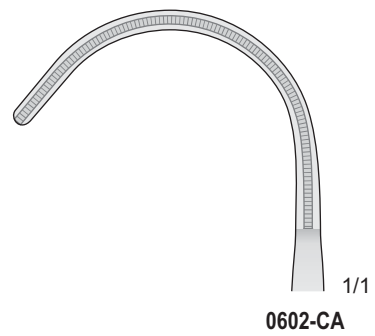

**0602-CA**

Pinze vascolari  
atraumatiche

Atraumatic  
vessel clamps

Atraumatische  
Gefäßklemmen

Pinces hémostatiques  
atraumatiques

Pinzas vasculares  
atraumáticas

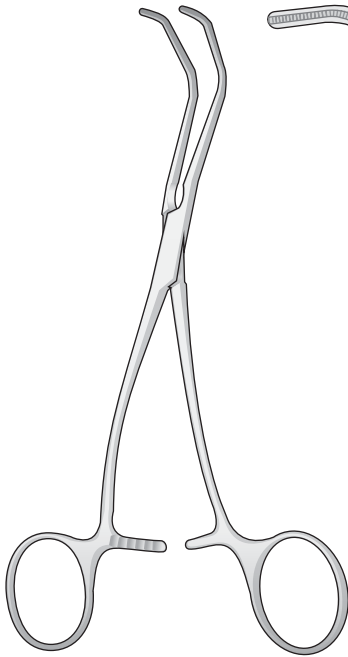

De-BAKEY  
0602-BLB  
170 mm

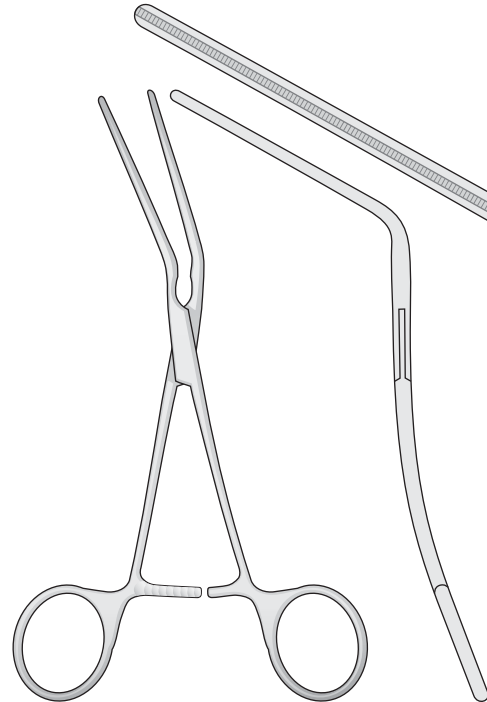
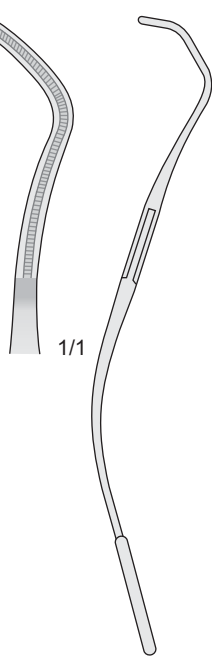

De BAKEY  
0602-CB  
165 mm

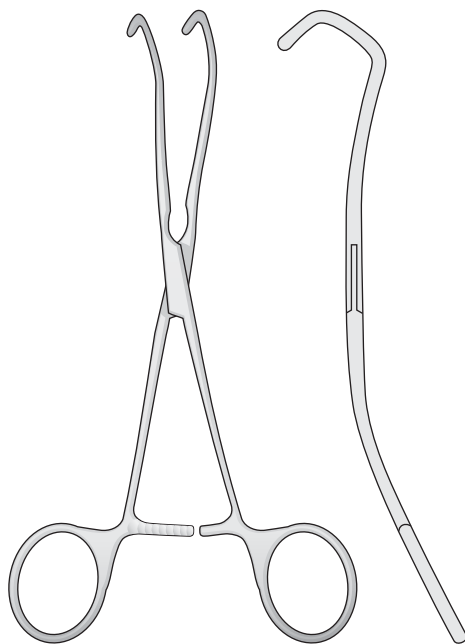

DERRA  
0602-AD/0602-AE  
170 mm

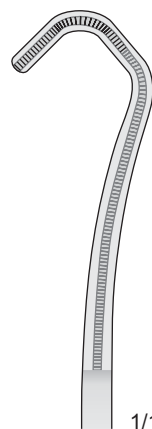

0602-AD

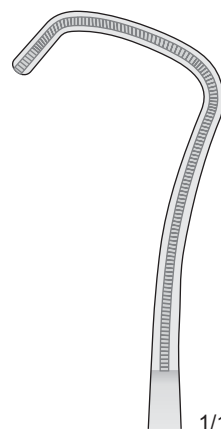

0602-AE

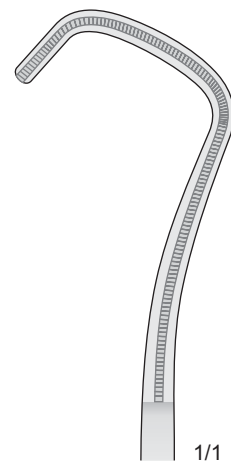

0602-AF

Pinze vascolari  
atraumatiche

Atraumatic  
vessel clamps

Atraumatische  
Gefäßklemmen

Pinces hémostatiques  
atraumatiques

Pinzas vasculares  
atraumáticas

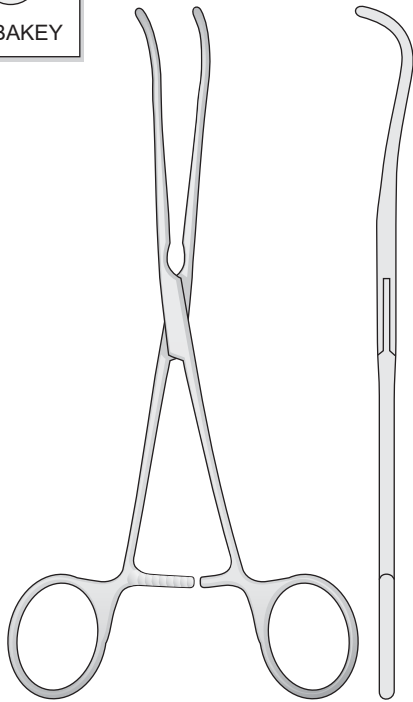

De BAKEY  
**0602-BI**  
190 mm

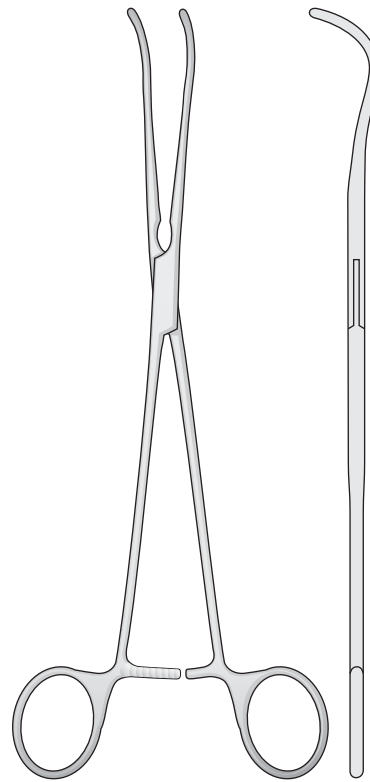
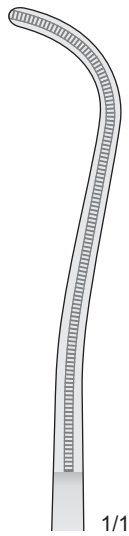

De BAKEY  
**0602-DH**  
230 mm

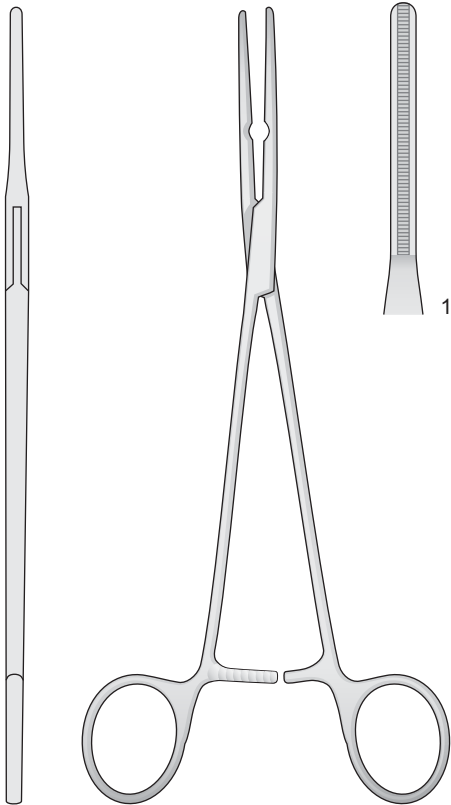
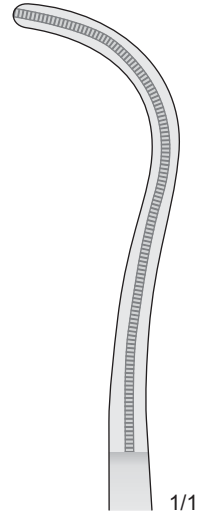

De BAKEY  
**0602-DF**  
215 mm

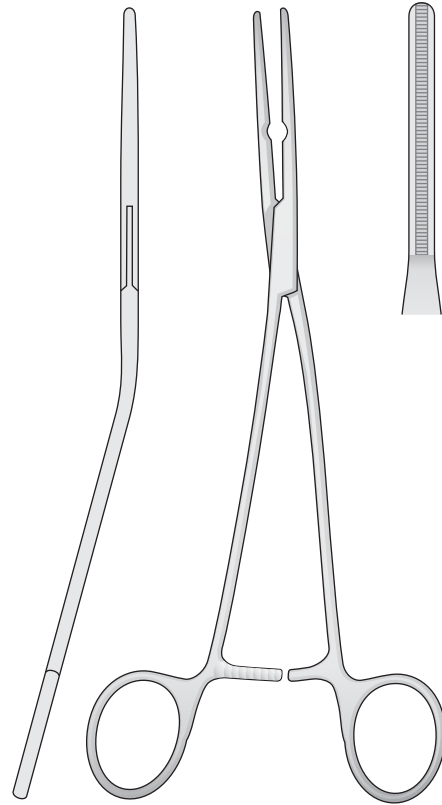
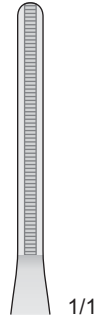

De BAKEY  
**0602-DG**  
215 mm

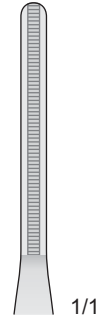



Pinze vascolari  
atraumatiche

Atraumatic  
vessel clamps

Atraumatische  
Gefäßklemmen

Pinces hémostatiques  
atraumatiques

Pinzas vasculares  
atraumáticas

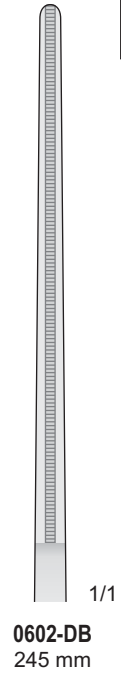
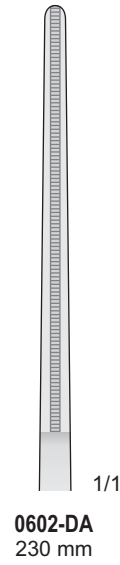
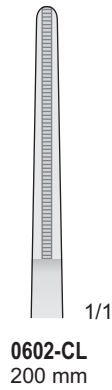
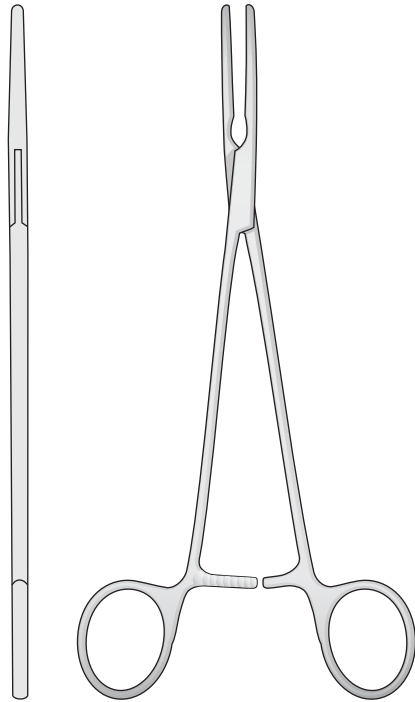

De BAKEY  
**0602-CL/0602-DB**

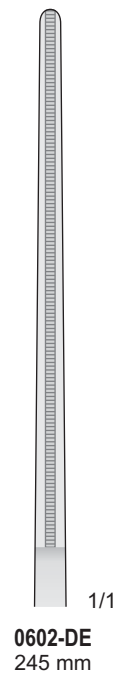
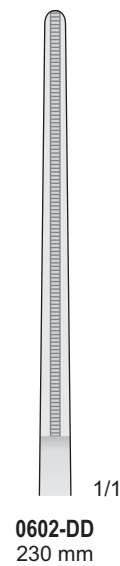
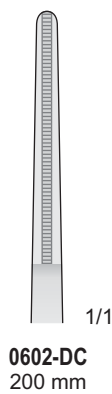
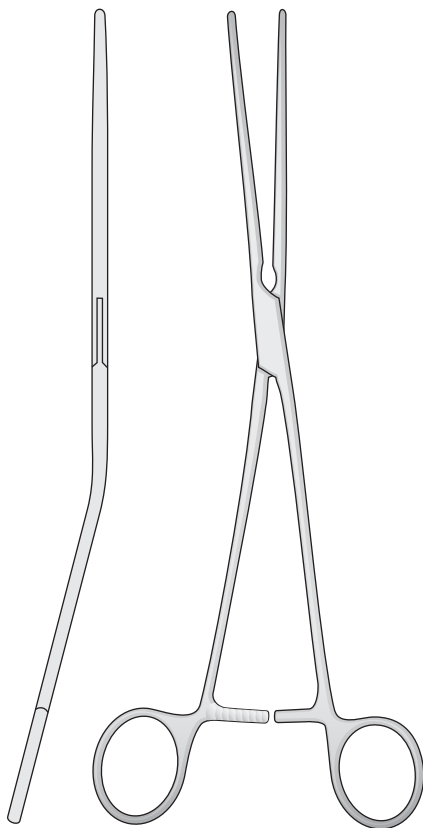

De BAKEY  
**0602-DC/0602-DE**

Pinze vascolari  
atraumatiche

Atraumatic  
vessel clamps

Atraumatische  
Gefäßklemmen

Pinces hémostatiques  
atraumatiques

Pinzas vasculares  
atraumáticas

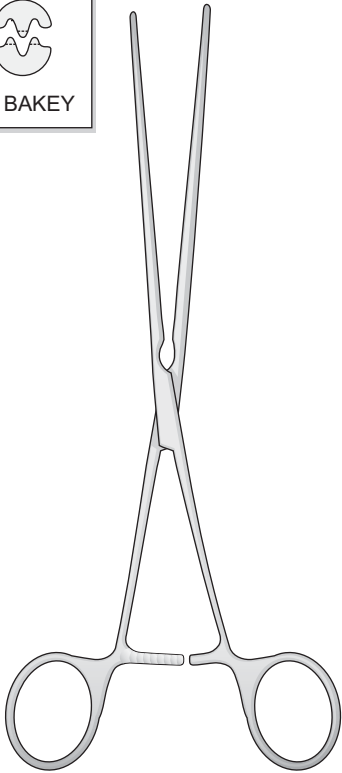

De BAKEY  
**0602-AL**  
220 mm

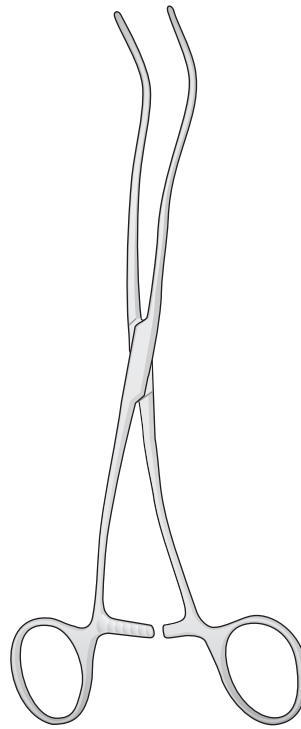
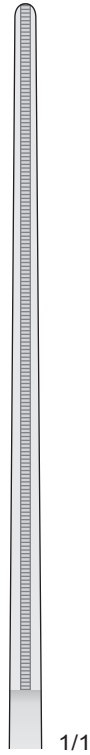

De BAKEY  
**0602-BH**  
200 mm

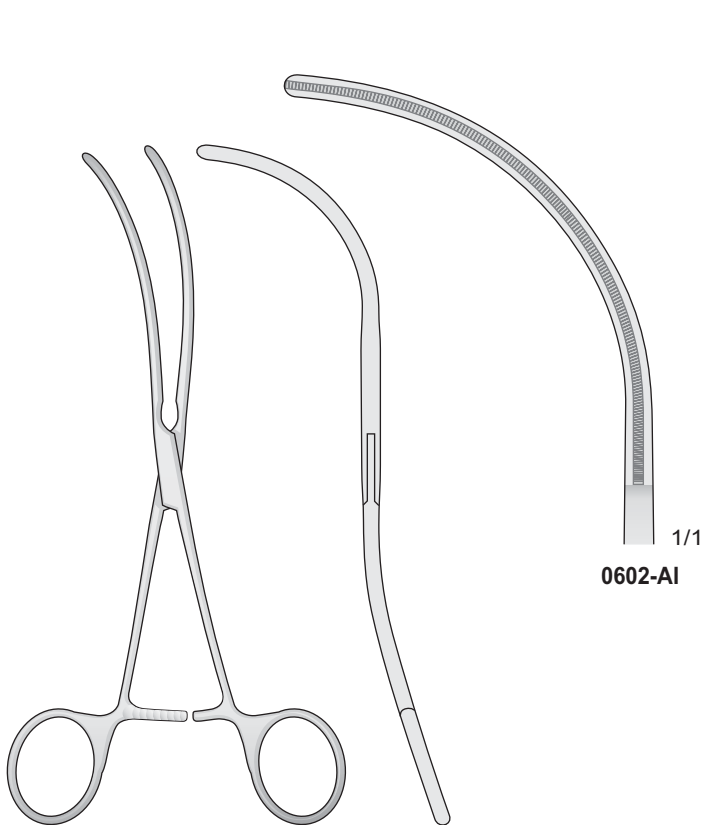
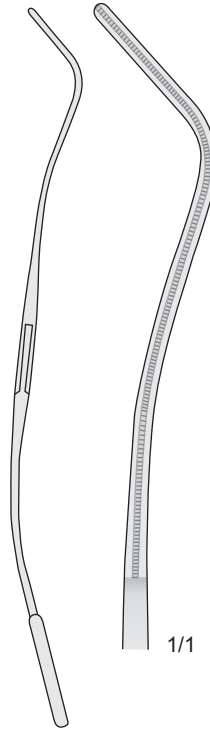

De BAKEY  
**0602-AI**  
180 mm

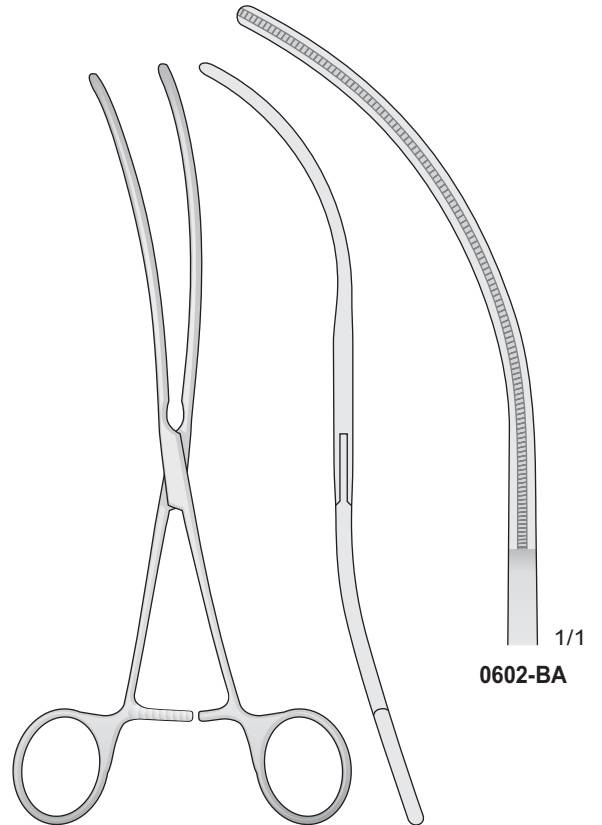

De BAKEY  
**0602-BA**  
200 mm

Pinze vascolari  
atraumatiche

Atraumatic  
vessel clamps

Atraumatische  
Gefäßklemmen

Pinces hémostatiques  
atraumatiques

Pinzas vasculares  
atraumáticas

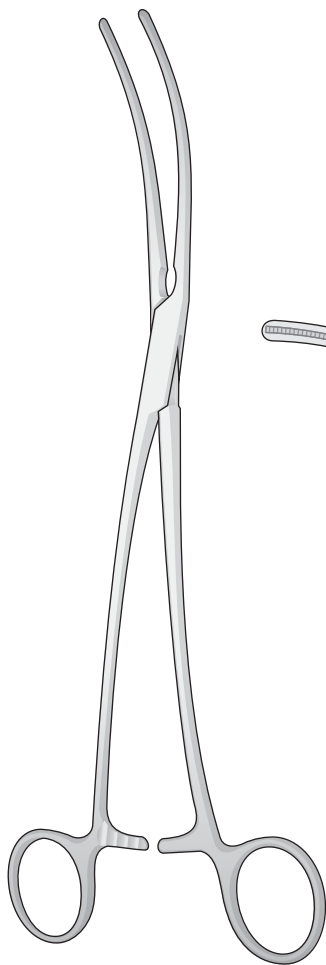

De BAKEY-BAHNSON  
0602-BGF/0602-BGH

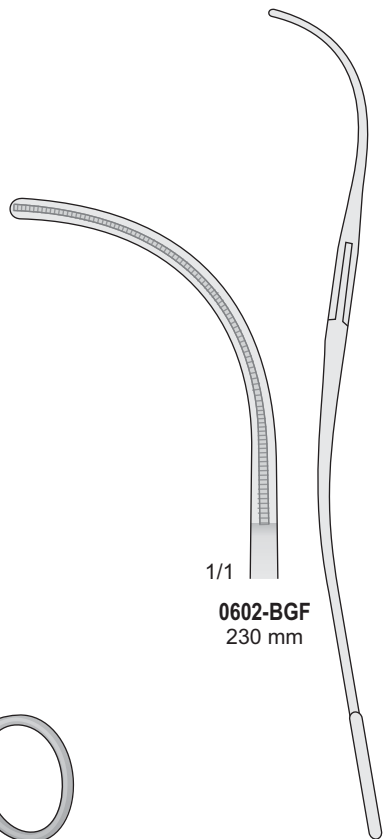

1/1  
0602-BGF  
230 mm

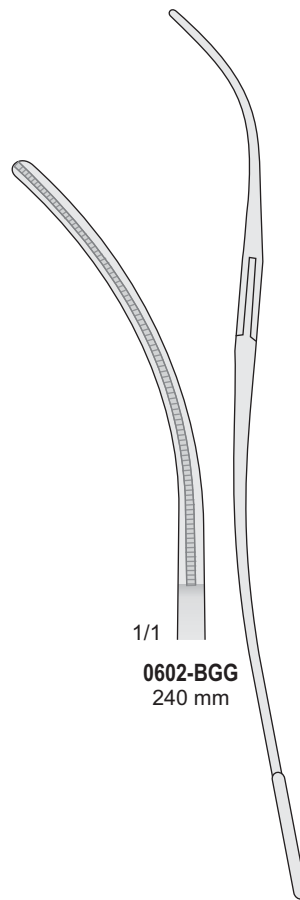

1/1  
0602-BGG  
240 mm

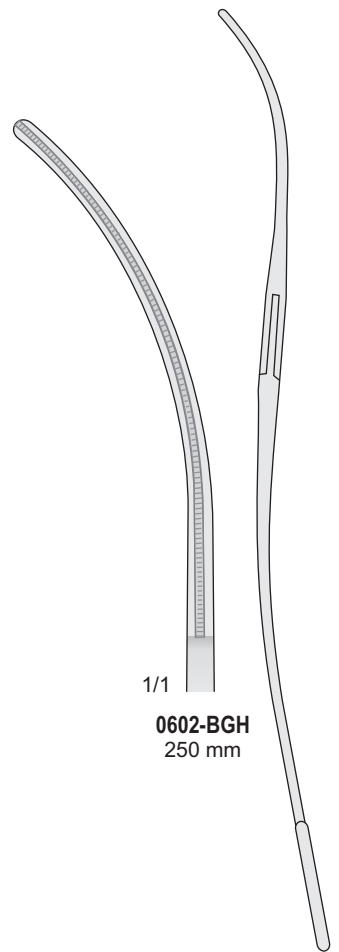

1/1  
0602-BGH  
250 mm

Pinze vascolari  
atraumatiche

Atraumatic  
vessel clamps

Atraumatische  
Gefäßklemmen

Pinces hémostatiques  
atraumatiques

Pinzas vasculares  
atraumáticas

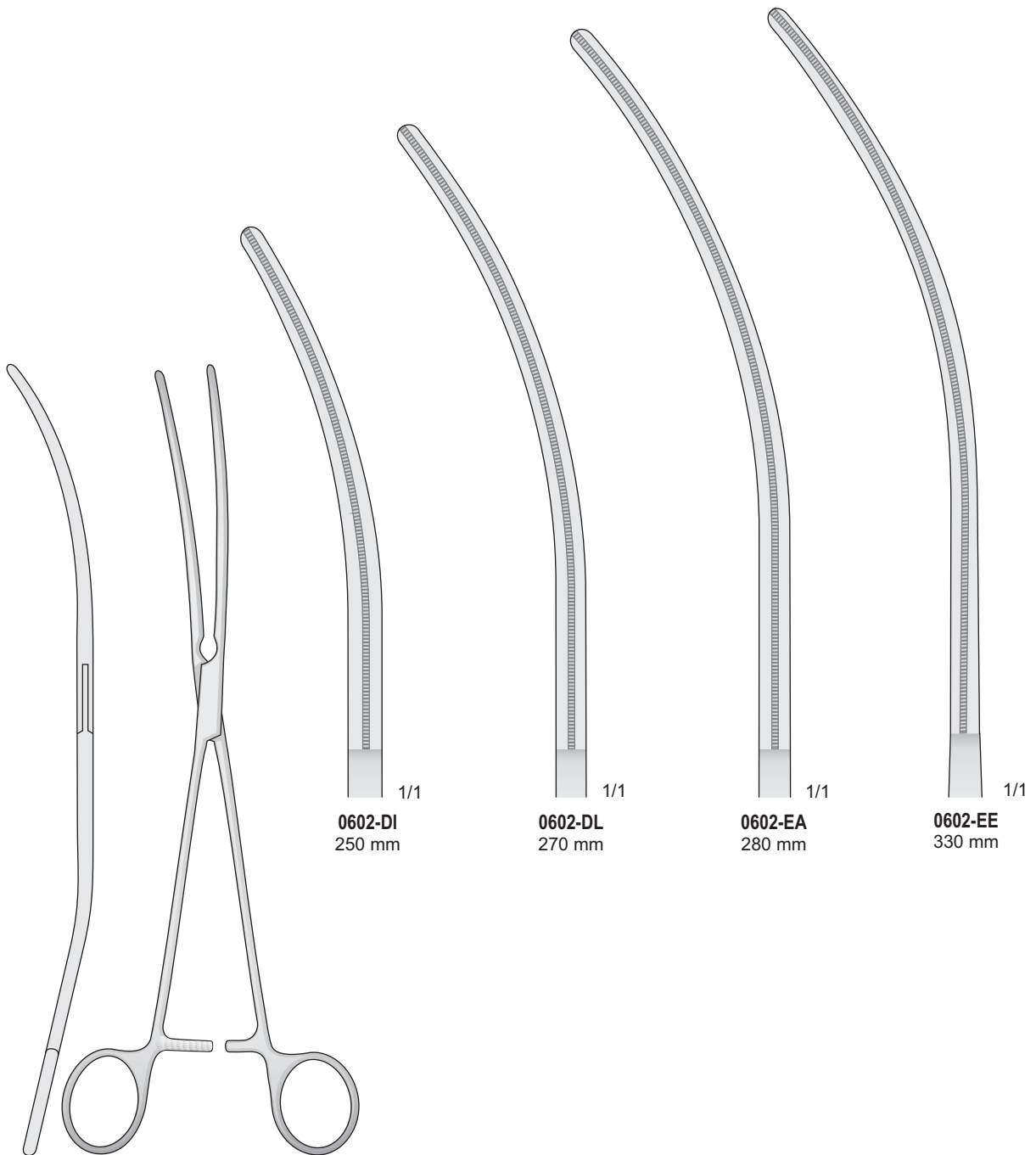

0602-DI  
250 mm

0602-DL  
270 mm

0602-EA  
280 mm

0602-EE  
330 mm

De BAKEY  
0602-DI/0602-EE

Pinze vascolari  
atraumatiche

Atraumatic  
vessel clamps

Atraumatische  
Gefäßklemmen

Pinces hémostatiques  
atraumatiques

Pinzas vasculares  
atraumáticas

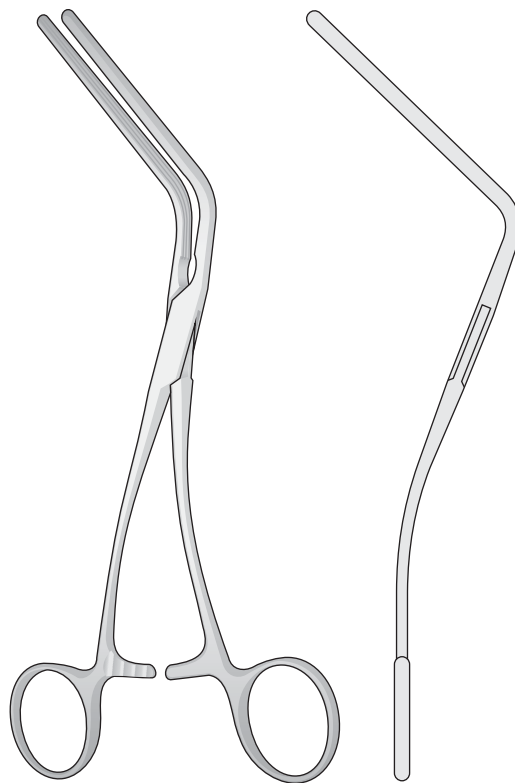
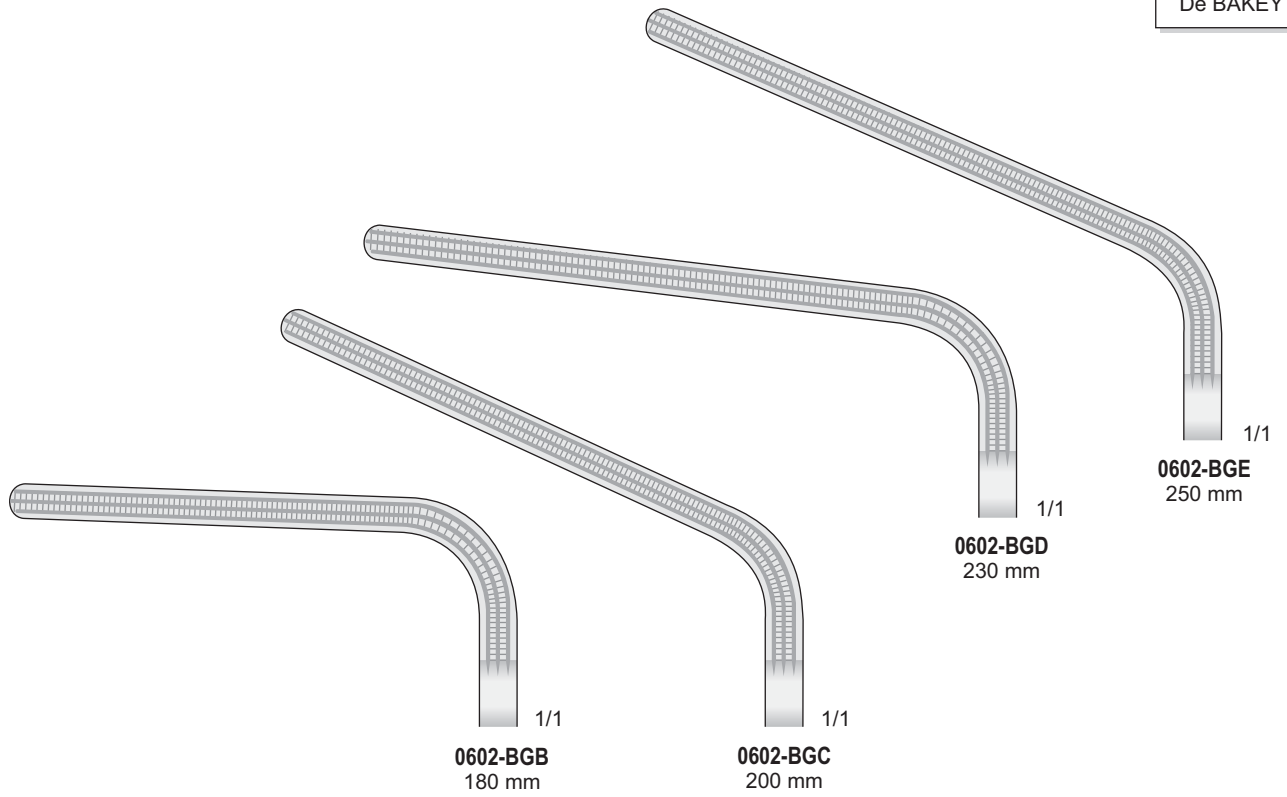

MORRIS-De BAKEY  
0602-BGB/0602-BGE

Pinze vascolari  
atraumatiche

Atraumatic  
vessel clamps

Atraumatische  
Gefäßklemmen

Pinces hémostatiques  
atraumatiques

Pinzas vasculares  
atraumáticas

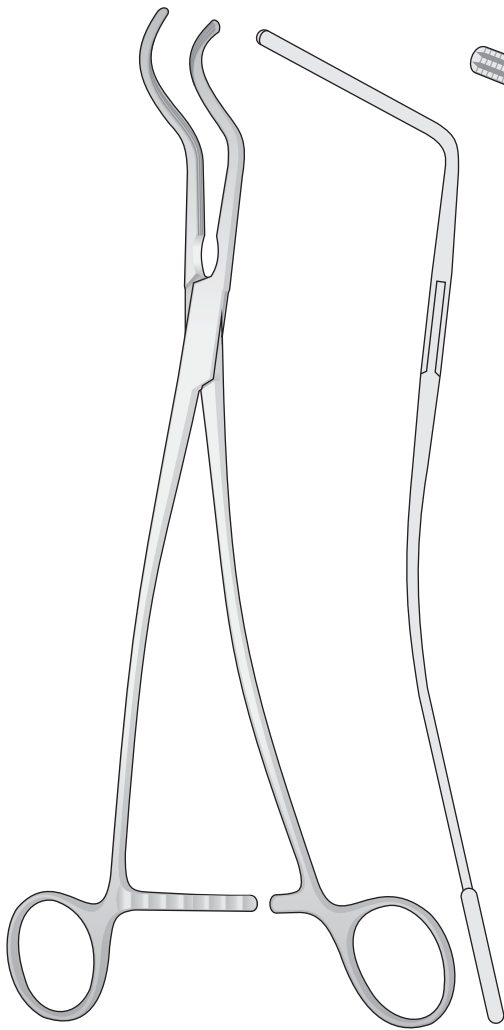

De BAKEY  
**0602-BEA**  
270 mm

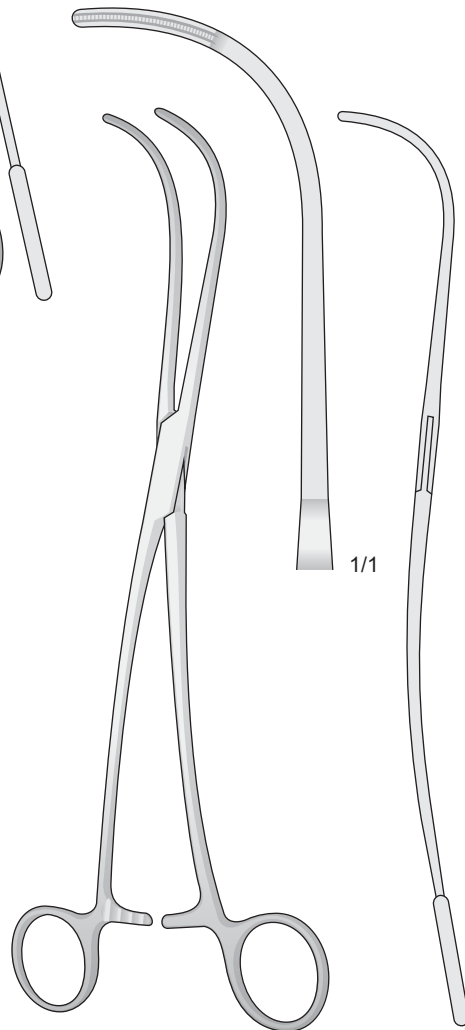
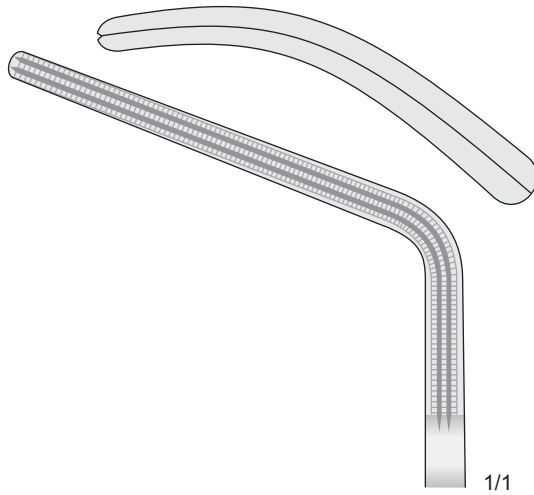

De BAKEY  
**0602-BEB**  
240 mm

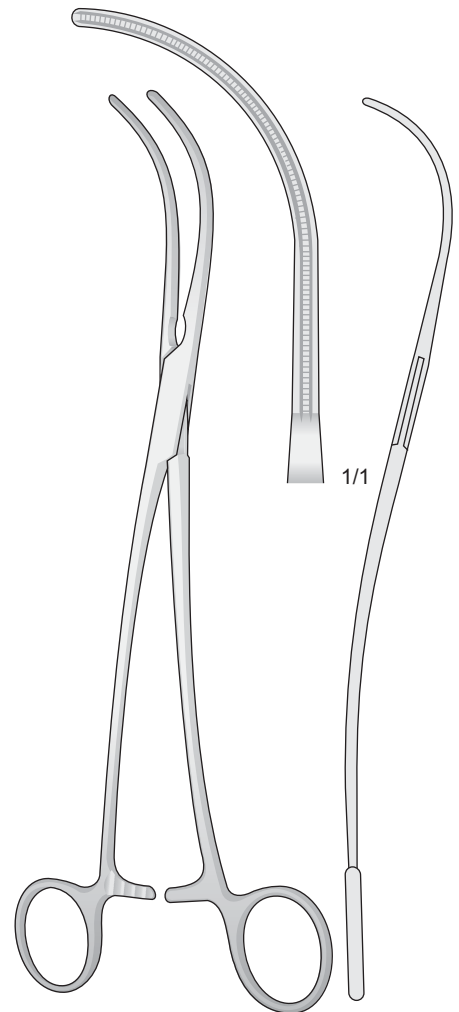

De BAKEY  
**0602-BEC**  
240 mm

Pinze vascolari  
atraumatiche

Atraumatic  
vessel clamps

Atraumatische  
Gefäßklemmen

Pinces hémostatiques  
atraumatiques

Pinzas vasculares  
atraumáticas

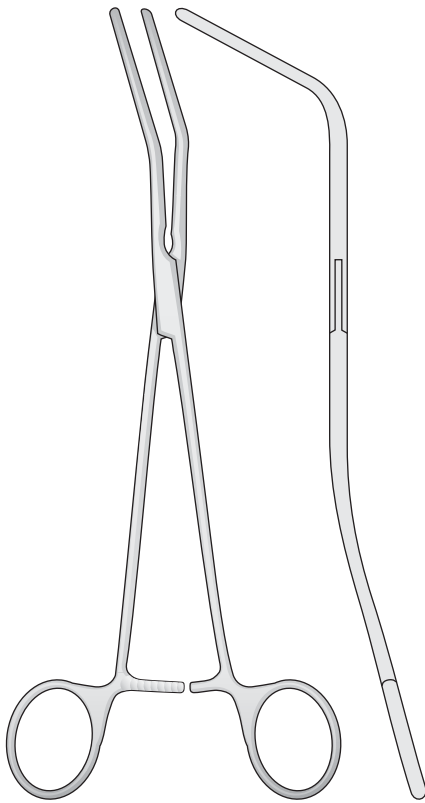

De BAKEY  
0602-CF/0602-CI

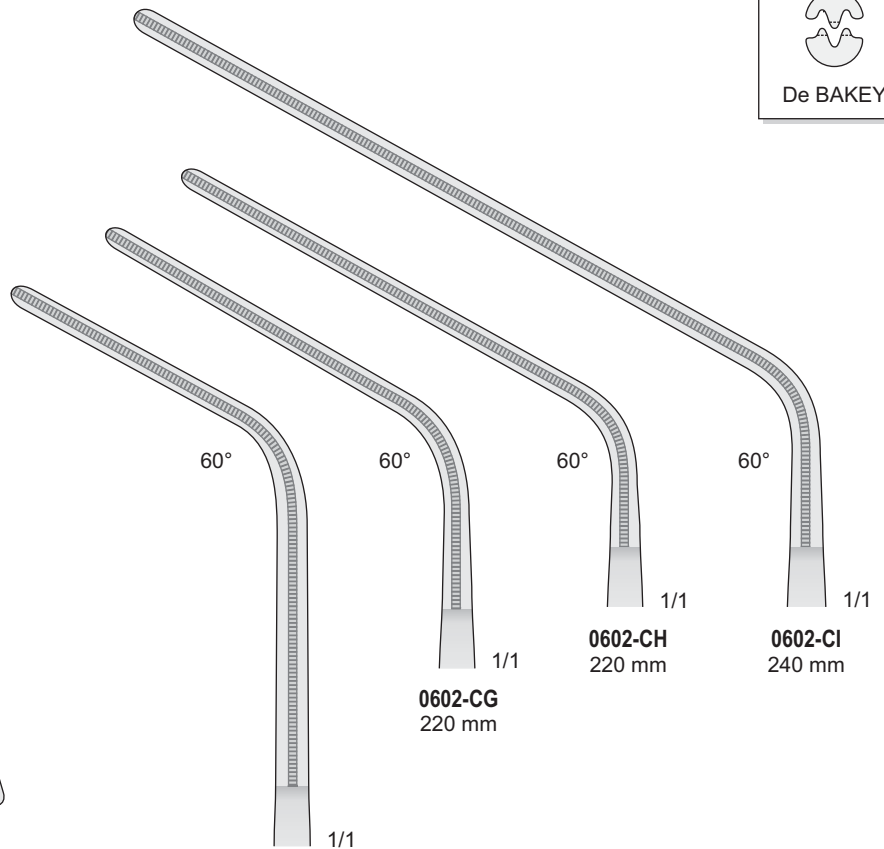

0602-CF  
230 mm

0602-CG  
220 mm

0602-CH  
220 mm

0602-CI  
240 mm

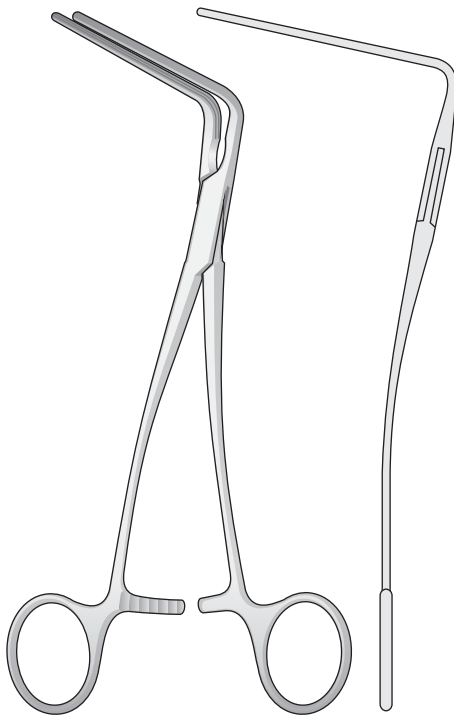

De-BAKEY  
0602-BIA/0602-BID

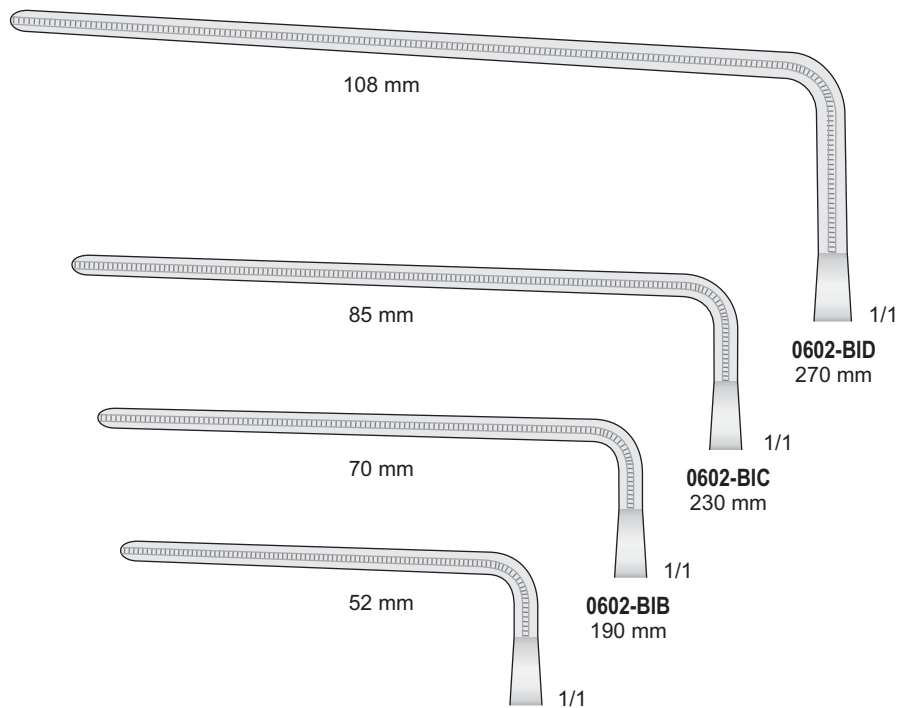

0602-BIA  
180 mm

0602-BIB  
190 mm

0602-BIC  
230 mm

0602-BID  
270 mm

Pinze vascolari  
atraumatiche

Atraumatic  
vessel clamps

Atraumatische  
Gefäßklemmen

Pinces hémostatiques  
atraumatiques

Pinzas vasculares  
atraumáticas



De BAKEY-SATINSKY  
0602-CGF/0602-CGH

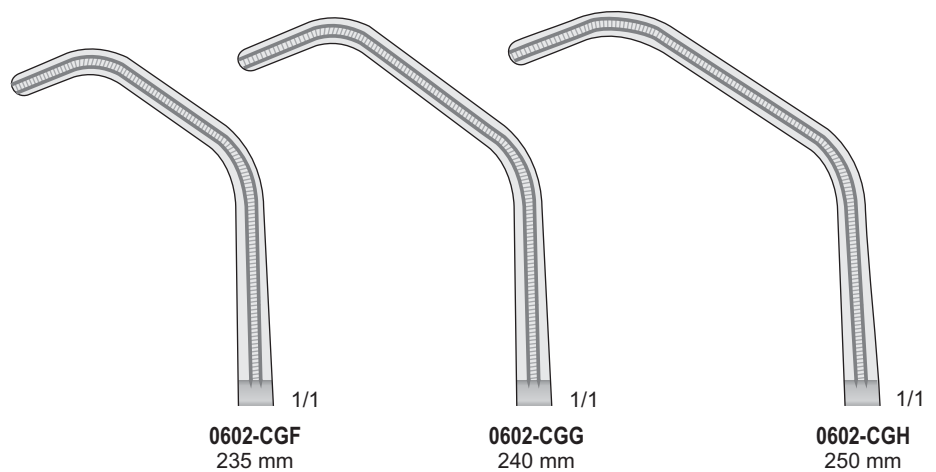

0602-CGF  
235 mm

0602-CGG  
240 mm

0602-CGH  
250 mm



Pinze vascolari  
atraumatiche

Atraumatic  
vessel clamps

Atraumatische  
Gefäßklemmen

Pinces hémostatiques  
atraumatiques

Pinzas vasculares  
atraumáticas

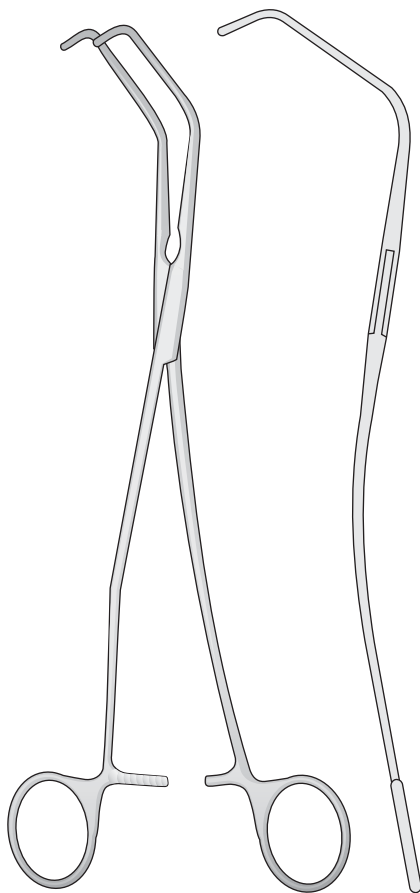
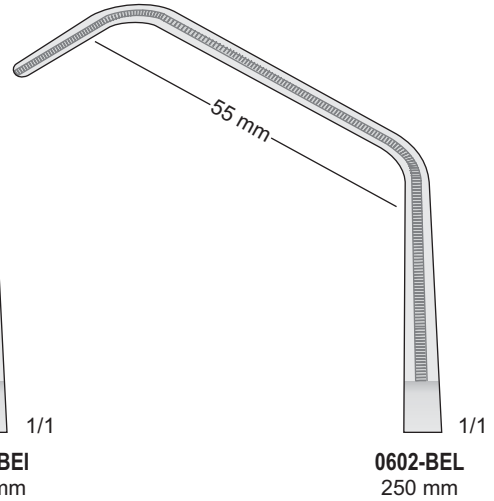
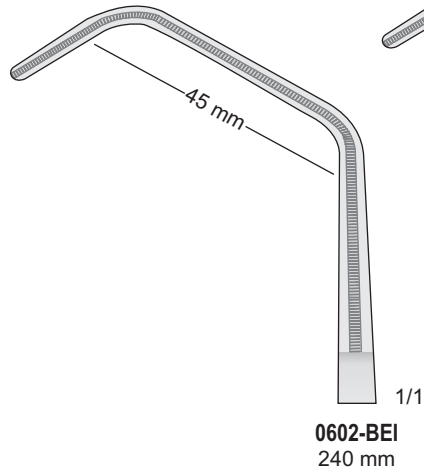
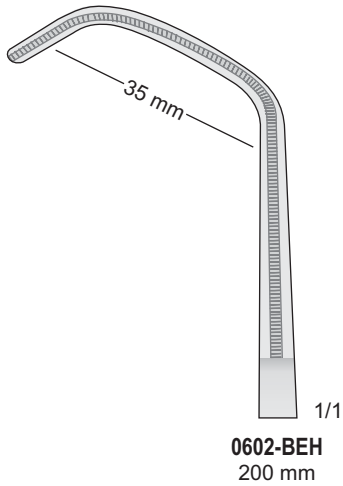

De-BAKEY  
0602-BEH/0602-BFB

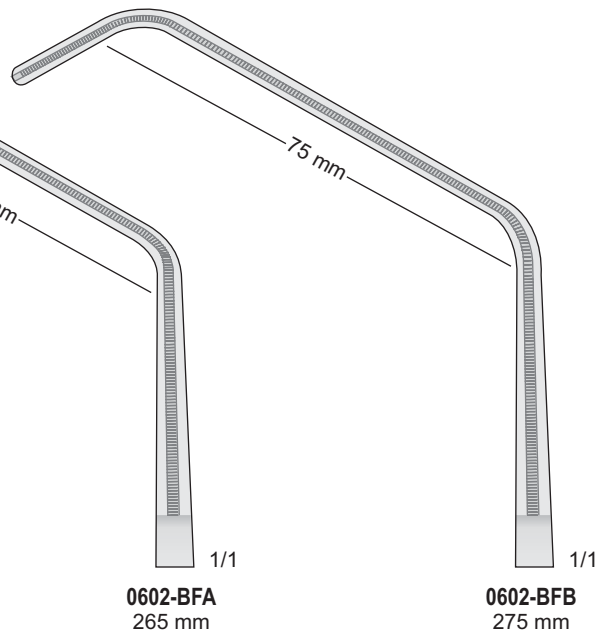
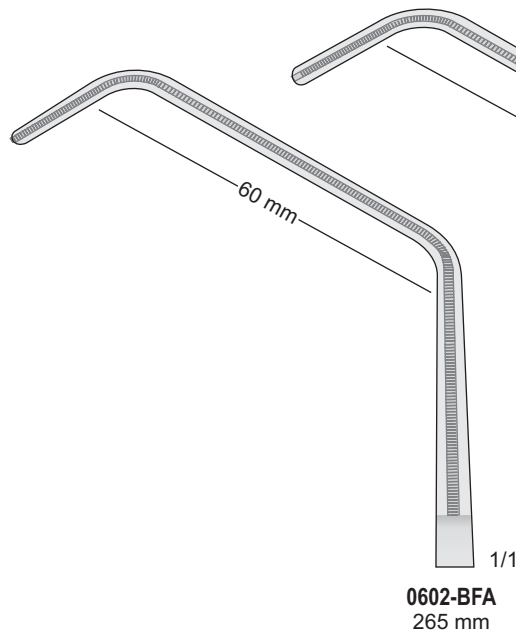

Pinze vascolari  
atraumatiche

Atraumatic  
vessel clamps

Atraumatische  
Gefäßklemmen

Pinces hémostatiques  
atraumatiques

Pinzas vasculares  
atraumáticas

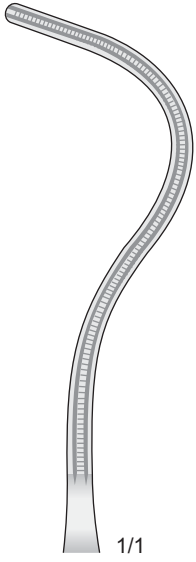

**0602-BFD**  
240 mm

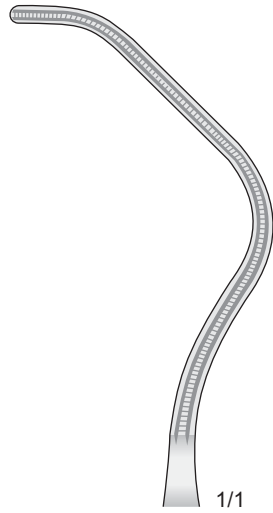

**0602-BFE**  
240 mm

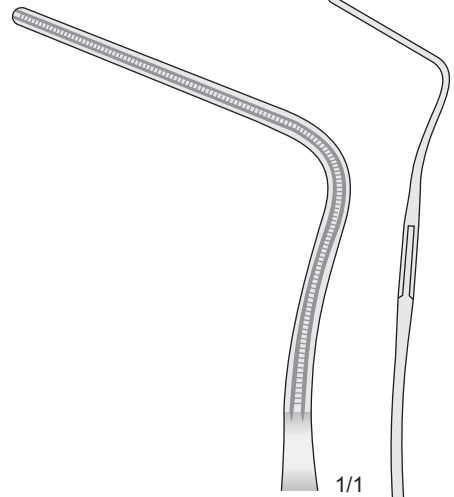
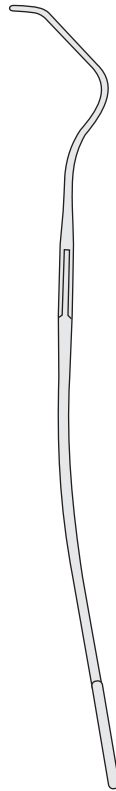

**0602-BFF**  
240 mm

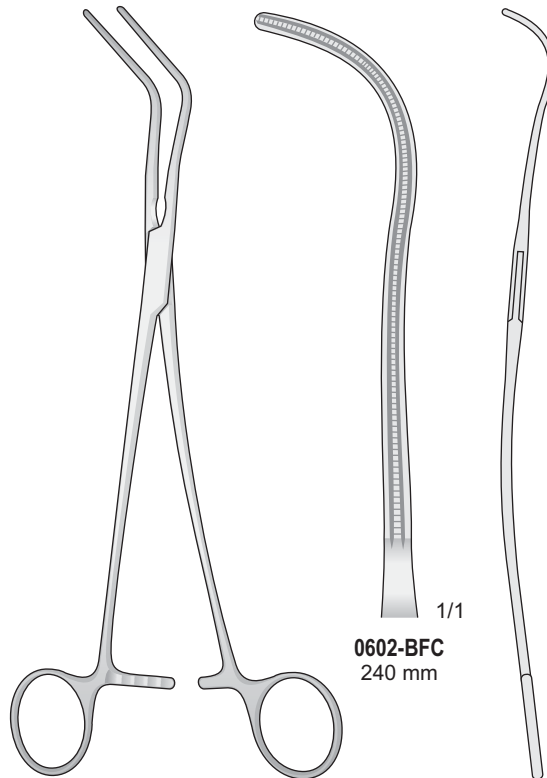

**0602-BFC**  
240 mm

De BAKEY-HARKEN  
**0602-BFC/0602-BFF**

Pinze vascolari  
atraumatiche

Atraumatic  
vessel clamps

Atraumatische  
Gefäßklemmen

Pinces hémostatiques  
atraumatiques

Pinzas vasculares  
atraumáticas

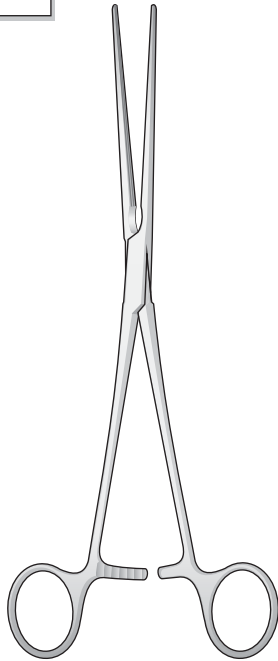

De BAKEY  
0602-BGI/0602-BHB



1/1  
0602-BGI  
215 mm



1/1  
0602-BGL  
230 mm



1/1  
0602-BHA  
270 mm



1/1  
0602-BHB  
315 mm

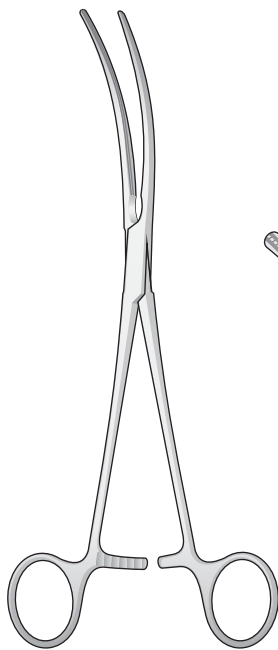

De BAKEY  
0602-BHC/0602-BHF

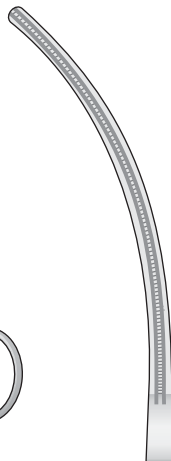

1/1  
0602-BHC  
215 mm

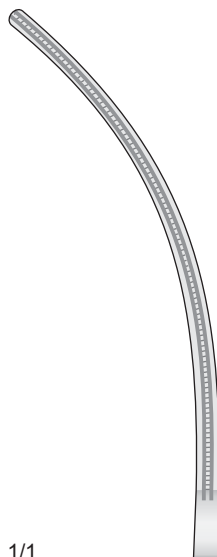

1/1  
0602-BHD  
230 mm

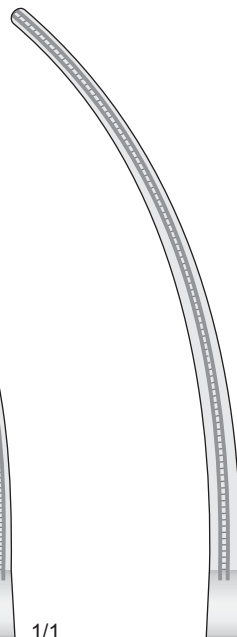

1/1  
0602-BHE  
270 mm

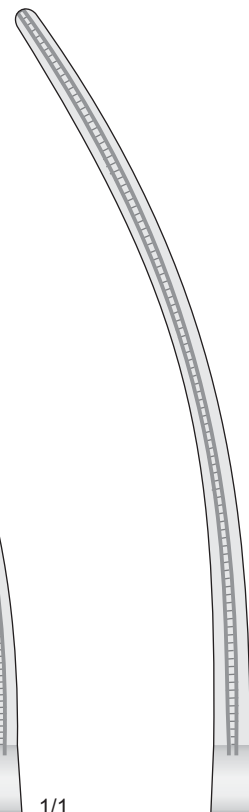

1/1  
0602-BHF  
310 mm

Pinze vascolari  
atraumatiche

Atraumatic  
vessel clamps

Atraumatische  
Gefäßklemmen

Pinces hémostatiques  
atraumatiques

Pinzas vasculares  
atraumáticas

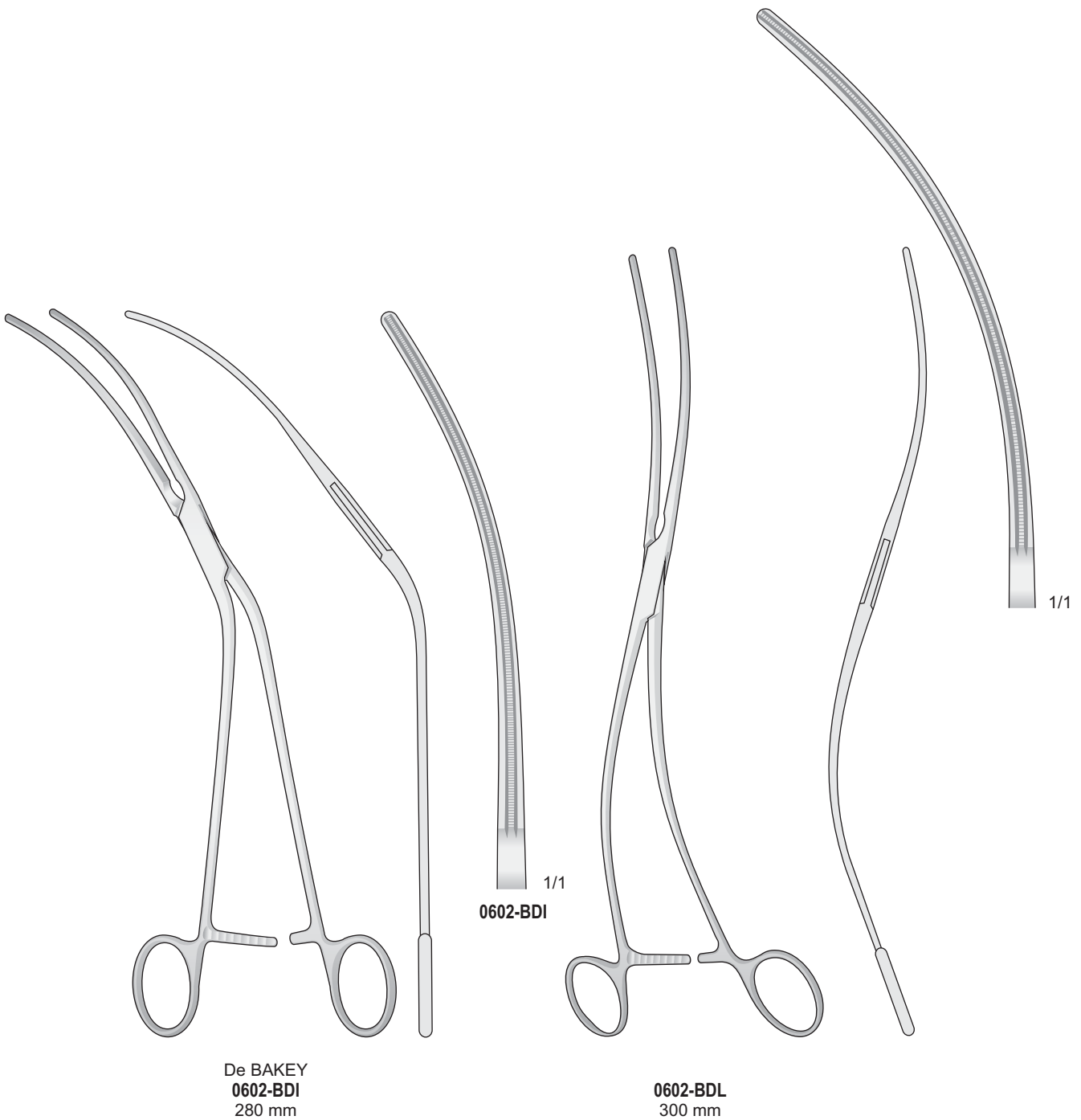

Pinze vascolari  
atraumatiche

Atraumatic  
vessel clamps

Atraumatische  
Gefäßklemmen

Pinces hémostatiques  
atraumatiques

Pinzas vasculares  
atraumáticas

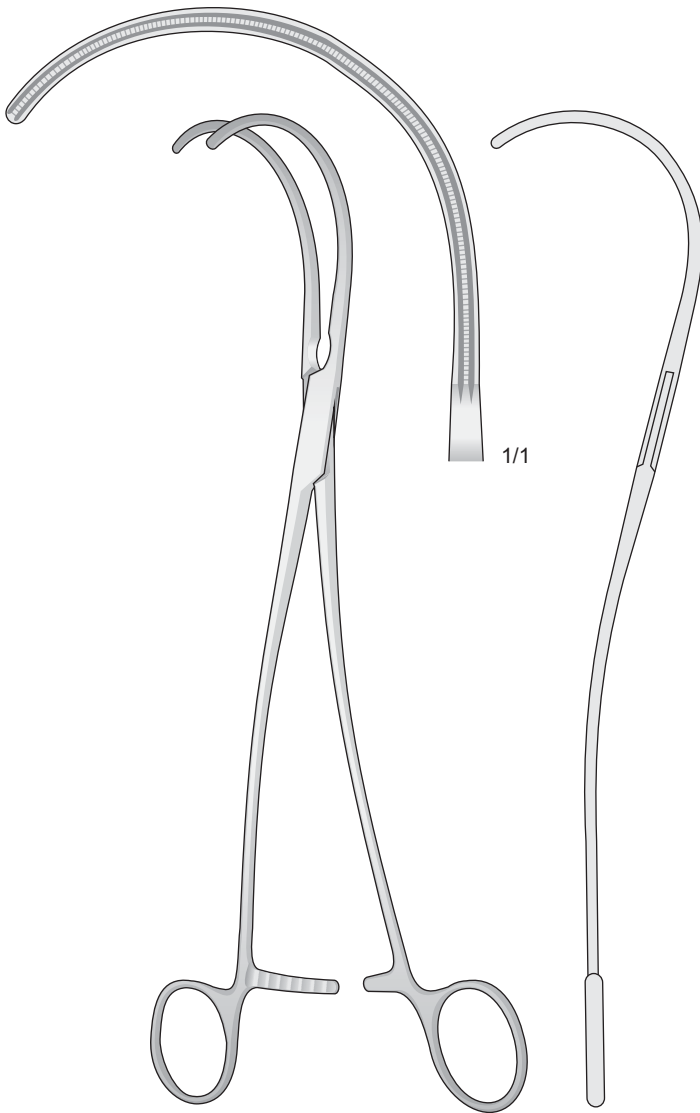

De BAKEY  
0602-BED  
260 mm

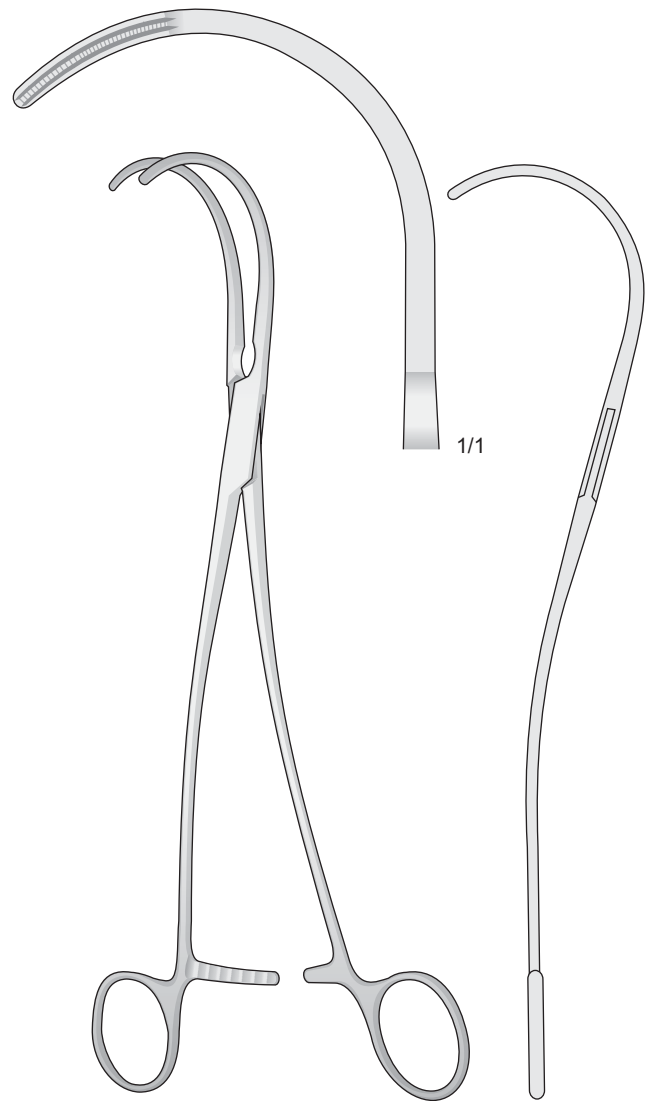

De BAKEY  
0602-BEE  
250 mm

Pinze vascolari  
atraumatiche

Atraumatic  
vessel clamps

Atraumatische  
Gefäßklemmen

Pinces hémostatiques  
atraumatiques

Pinzas vasculares  
atraumáticas

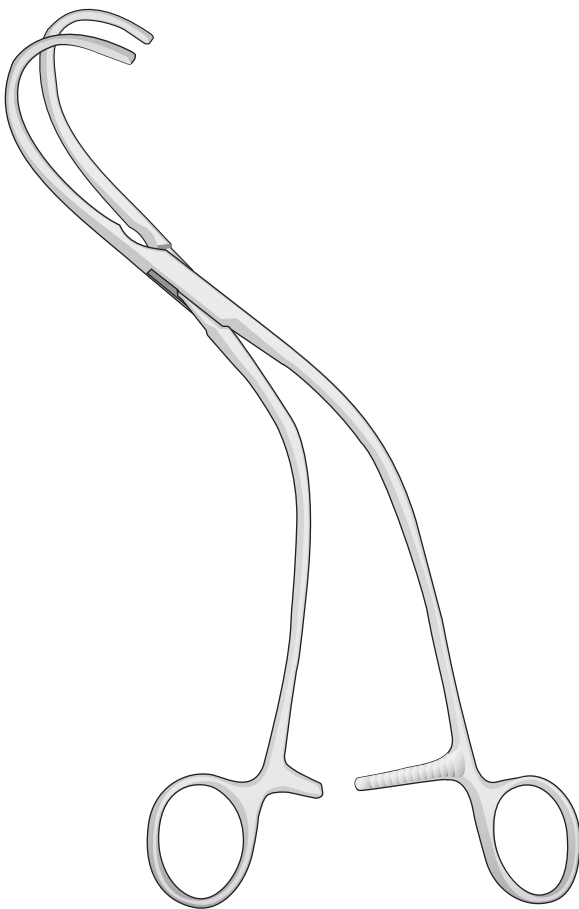
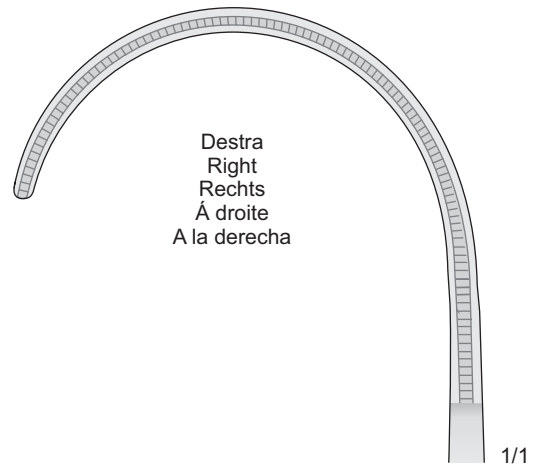
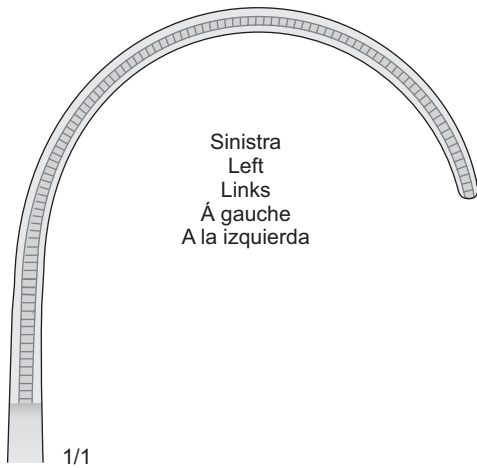

WEBER  
0602-BEF  
260 mm

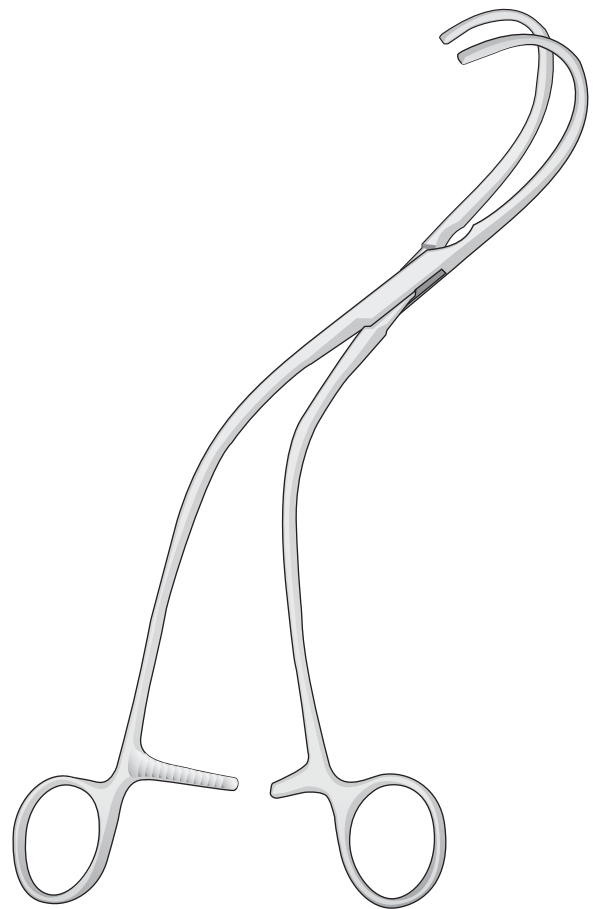

WEBER  
0602-BEG  
260 mm

Pinze vascolari  
atraumatiche

Atraumatic  
vessel clamps

Atraumatische  
Gefäßklemmen

Pinces hémostatiques  
atraumatiques

Pinzas vasculares  
atraumáticas

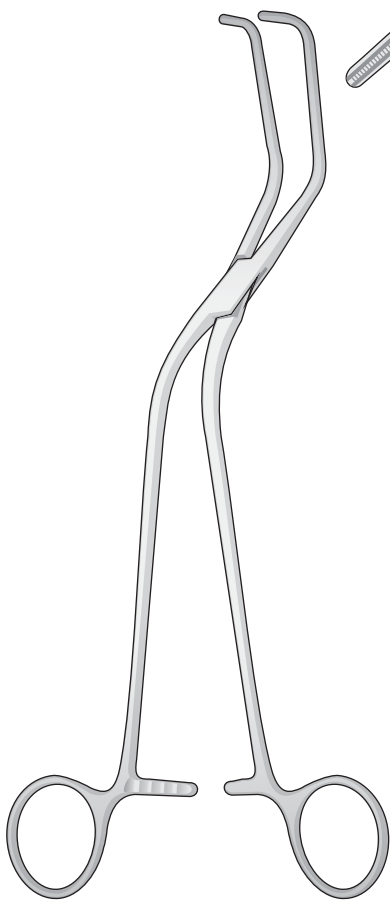

OCHSNER  
0602-LE  
235 mm

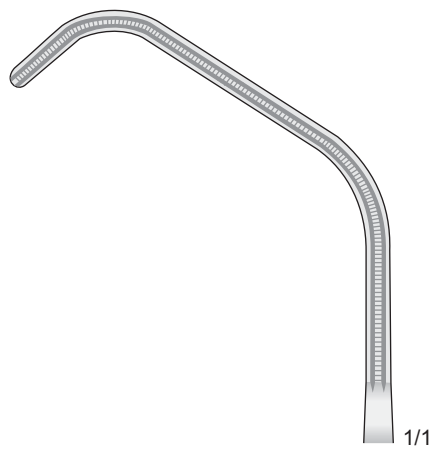

1/1

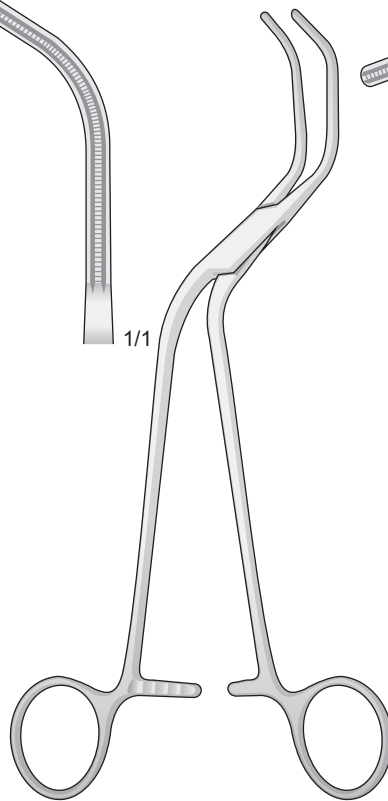

DIETRICH  
0602-LF  
210 mm

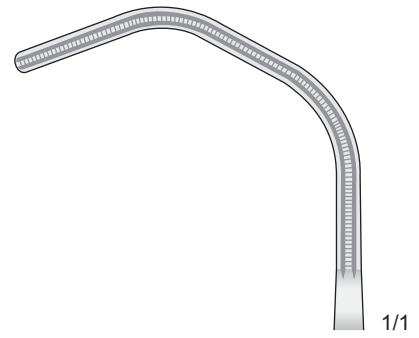

1/1

Pinze vascolari  
atraumatiche

Atraumatic  
vessel clamps

Atraumatische  
Gefäßklemmen

Pinces hémostatiques  
atraumatiques

Pinzas vasculares  
atraumáticas

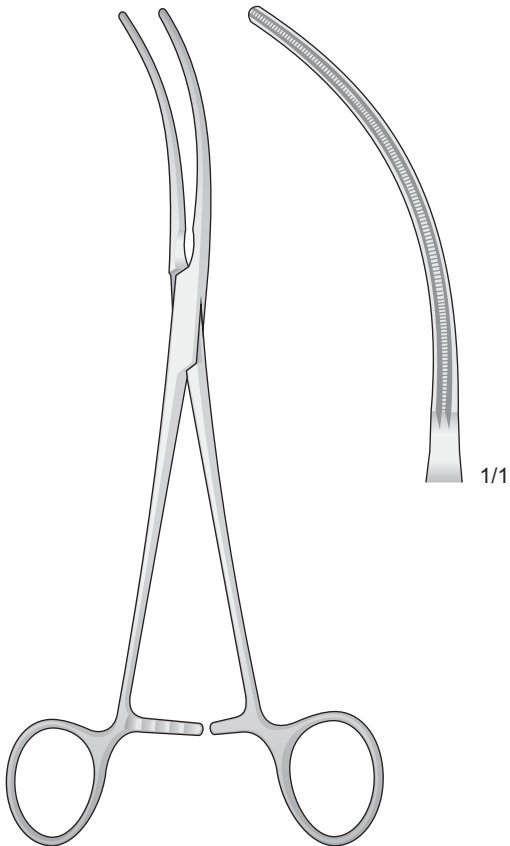

POTTS  
0602-BDB  
220 mm

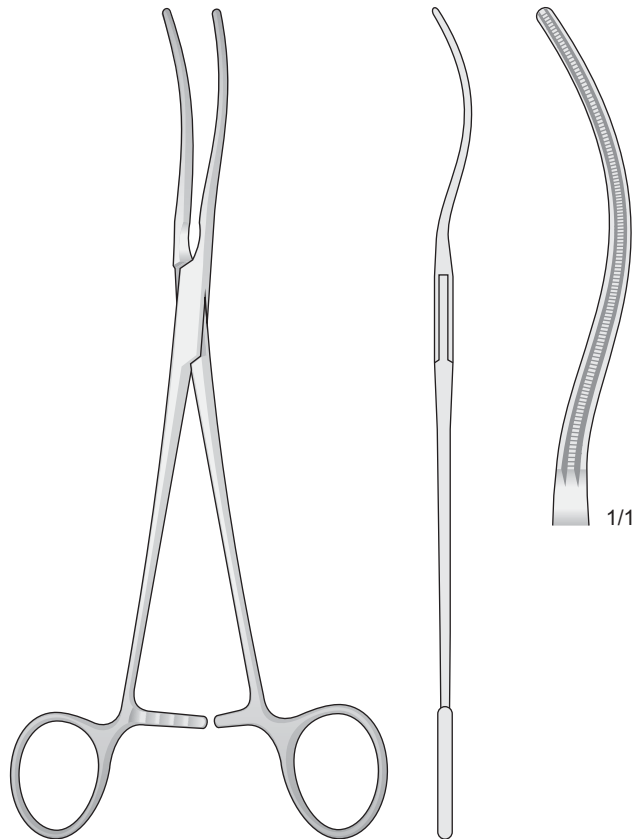

POTTS  
0602-BDC  
220 mm



Pinze vascolari  
atraumatiche

Atraumatic  
vessel clamps

Atraumatische  
Gefäßklemmen

Pinces hémostatiques  
atraumatiques

Pinzas vasculares  
atraumáticas

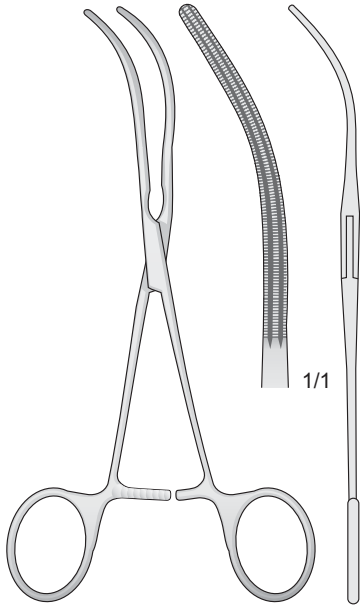

GLOVER  
0602-BIE  
170 mm

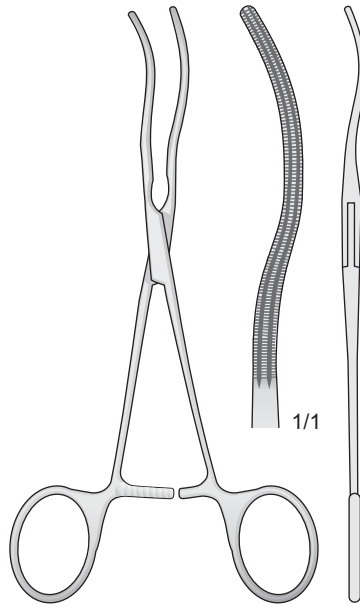

0602-BIF  
170 mm

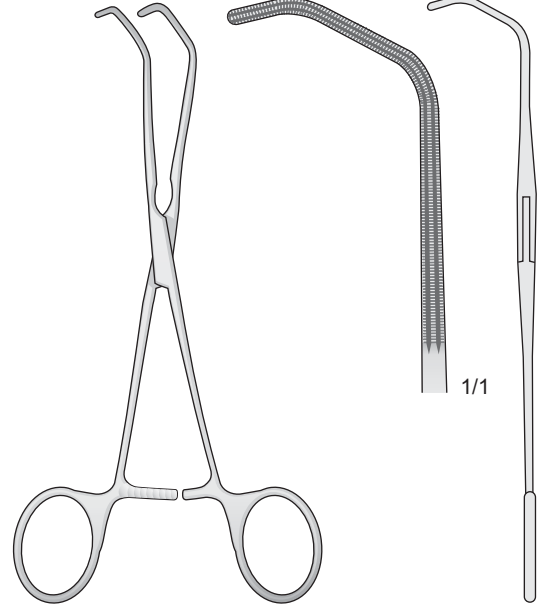

BECK  
0602-BIG  
170 mm

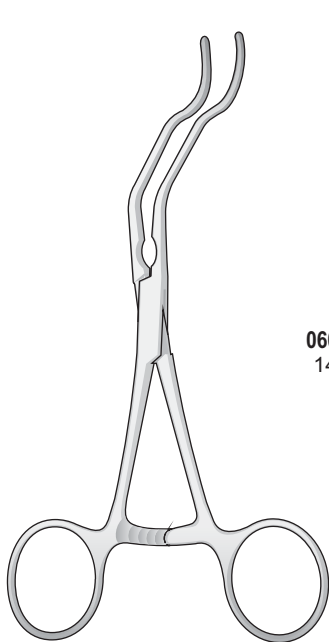

GREGORY  
0602-BBA/0602-BBC

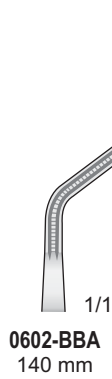

0602-BBA  
140 mm



0602-BBB  
160 mm



0602-BBC  
180 mm

Pinze vascolari  
atraumatiche

Atraumatic  
vessel clamps

Atraumatische  
Gefäßklemmen

Pinces hémostatiques  
atraumatiques

Pinzas vasculares  
atraumáticas

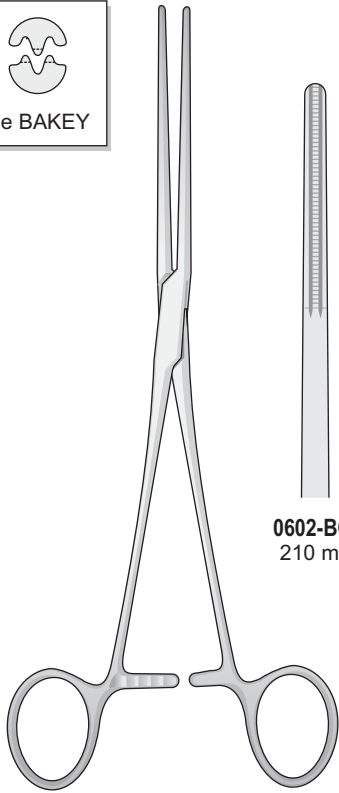

POTTS  
0602-BCF/0602-BCG

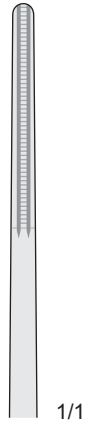

0602-BCF  
210 mm

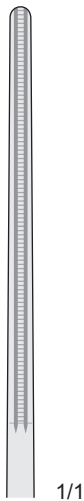

0602-BCG  
220 mm

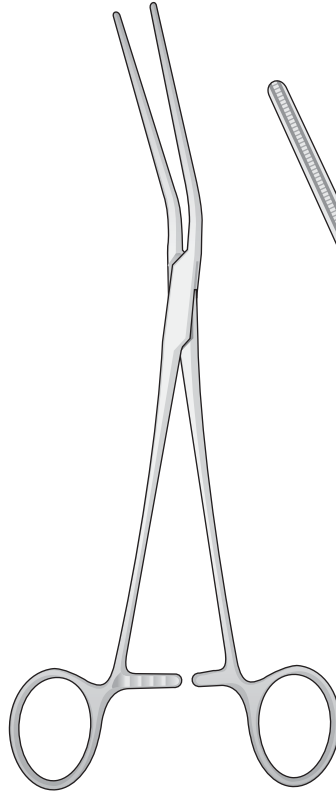

POTTS  
0602-BCH/0602-BCI

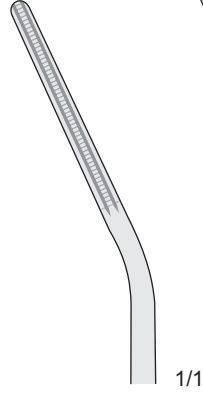

0602-BCH  
210 mm



0602-BCI  
220 mm

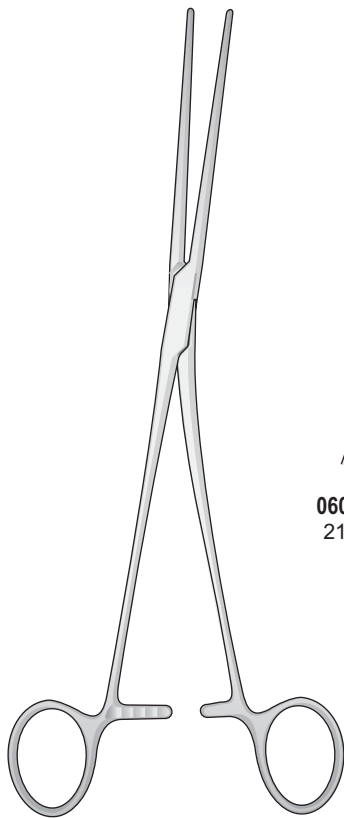
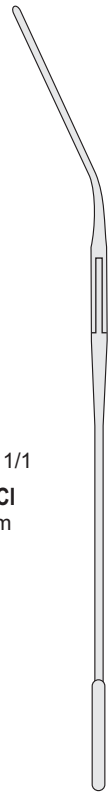

POTTS  
0602-BCL/0602-BDA



0602-BCL  
210 mm



0602-BDA  
220 mm

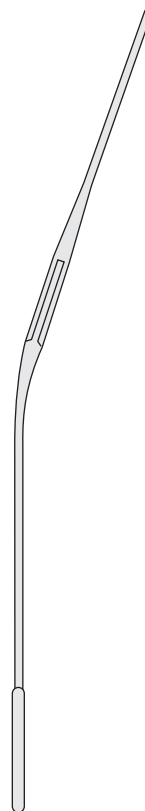

Pinze vascolari  
atraumatiche

Atraumatic  
vessel clamps

Atraumatische  
Gefäßklemmen

Pinces hémostatiques  
atraumatiques

Pinzas vasculares  
atraumáticas



LEES  
0602-BFG/0602-BFH

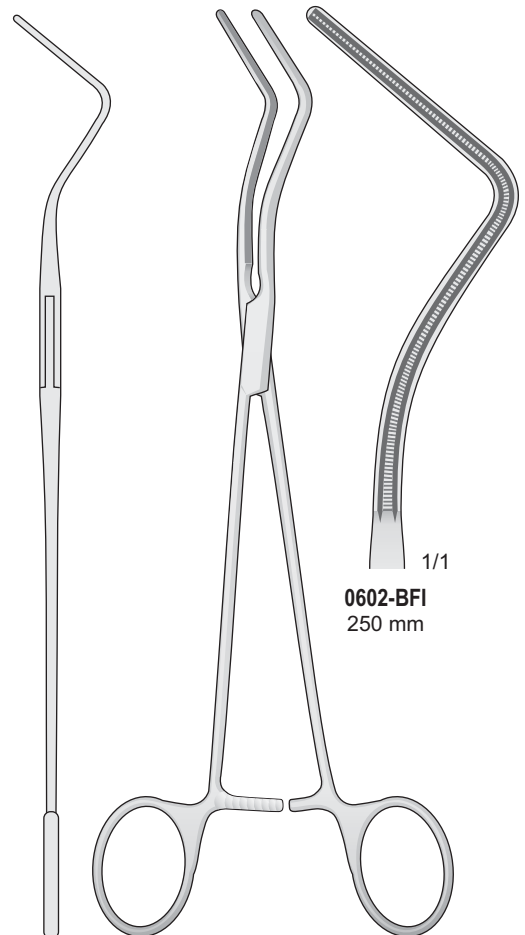

LEES  
0602-BFI  
250 mm

Pinze vascolari  
atraumatiche

Atraumatic  
vessel clamps

Atraumatische  
Gefäßklemmen

Pinces hémostatiques  
atraumatiques

Pinzas vasculares  
atraumáticas

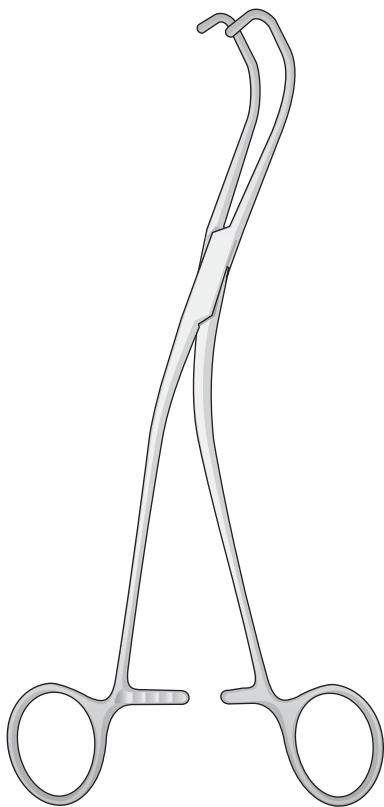

LAMBERT-KAY  
0602-BFL/0602-BGA

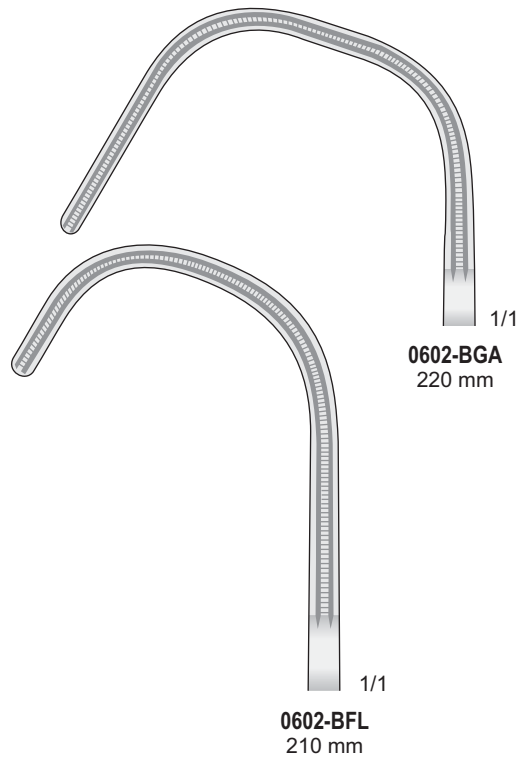
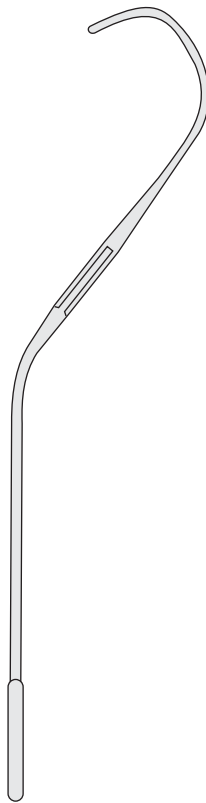

Pinze vascolari  
atraumatiche

Atraumatic  
vessel clamps

Atraumatische  
Gefäßklemmen

Pinces hémostatiques  
atraumatiques

Pinzas vasculares  
atraumáticas

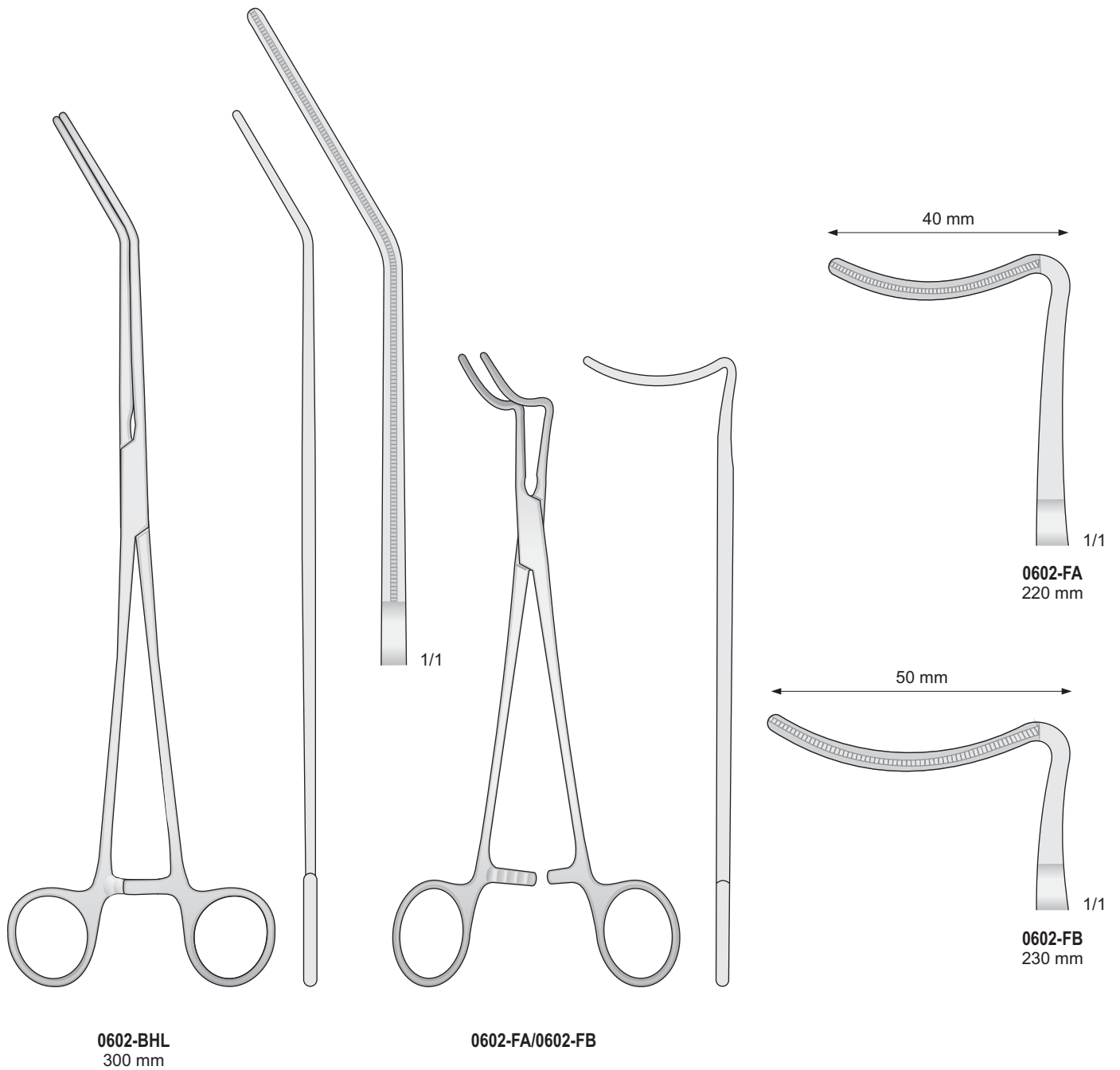

Pinze vascolari  
atraumatiche

Atraumatic  
vessel clamps

Atraumatische  
Gefäßklemmen

Pinces hémostatiques  
atraumatiques

Pinzas vasculares  
atraumáticas

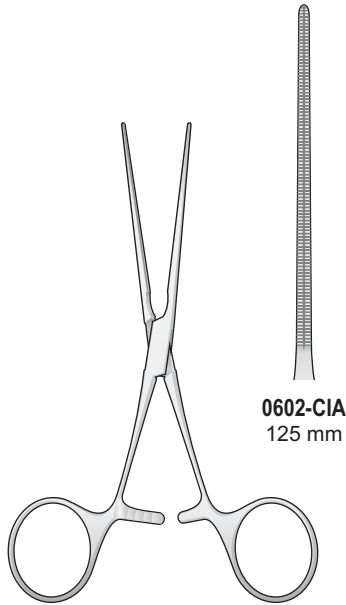
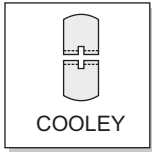

0602-CIA  
125 mm

0602-CIB  
115 mm

COOLEY  
0602-CIA/0602-CIB

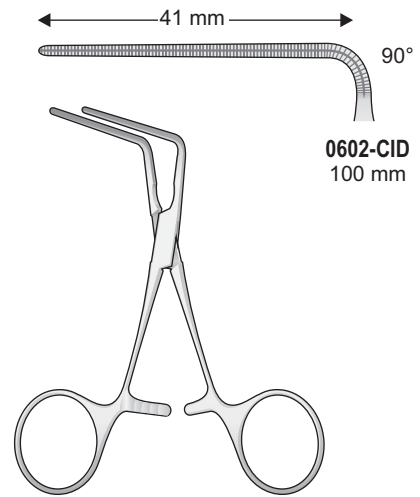

0602-CID  
100 mm

COOLEY  
0602-CID

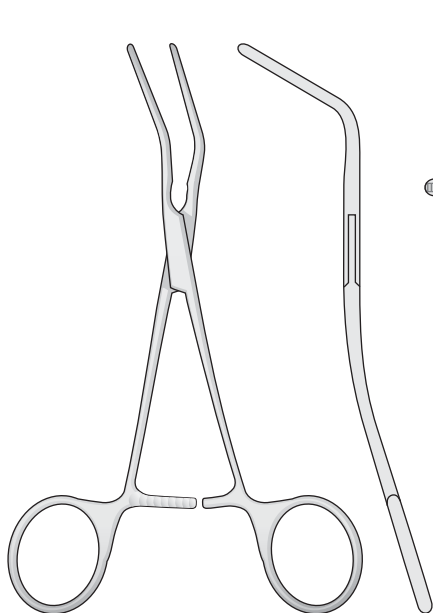

0602-BB  
140 mm

0602-BC  
150 mm

0602-BD  
160 mm

COOLEY  
0602-BB/0602-BD

Pinze vascolari  
atraumatiche

Atraumatic  
vessel clamps

Atraumatische  
Gefäßklemmen

Pinces hémostatiques  
atraumatiques

Pinzas vasculares  
atraumáticas

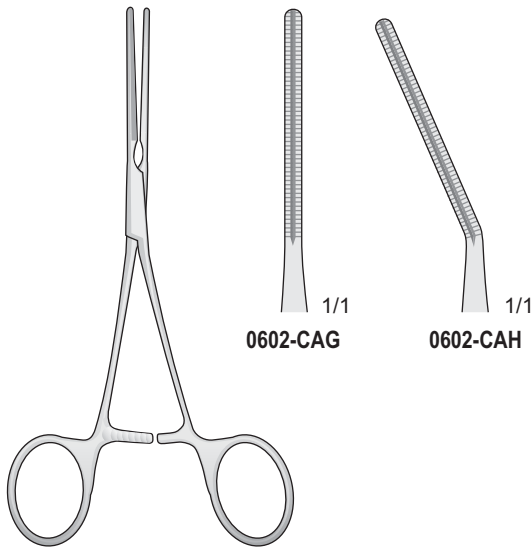
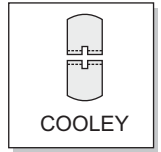

COOLEY  
0602-CAG/0602-CAH  
140 mm

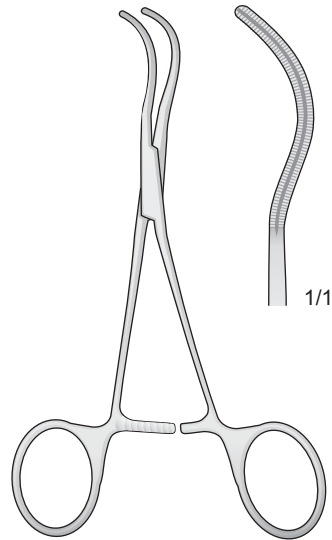

COOLEY  
0602-CBA  
140 mm

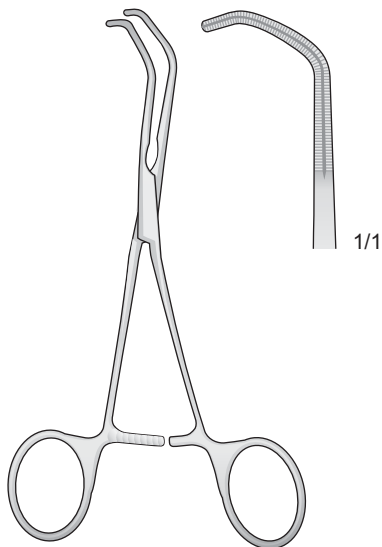

COOLEY  
0602-CAL  
140 mm

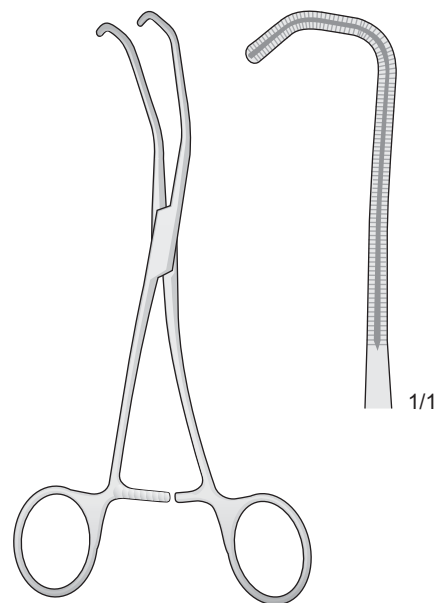

COOLEY  
0602-BLA  
160 mm

Pinze vascolari  
atraumatiche

Atraumatic  
vessel clamps

Atraumatische  
Gefäßklemmen

Pinces hémostatiques  
atraumatiques

Pinzas vasculares  
atraumáticas

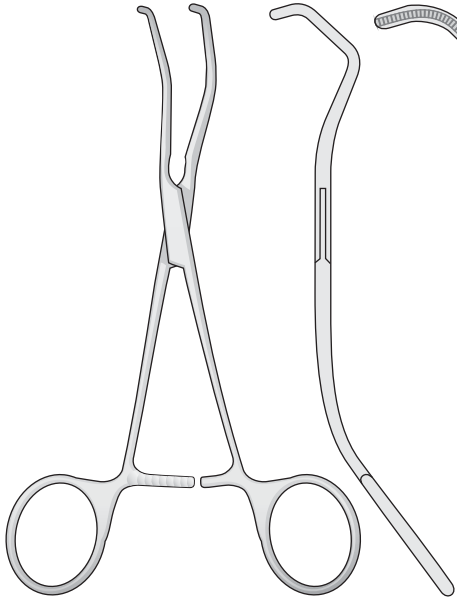
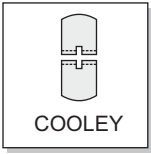

COOLEY  
**0602-BG**  
160 mm

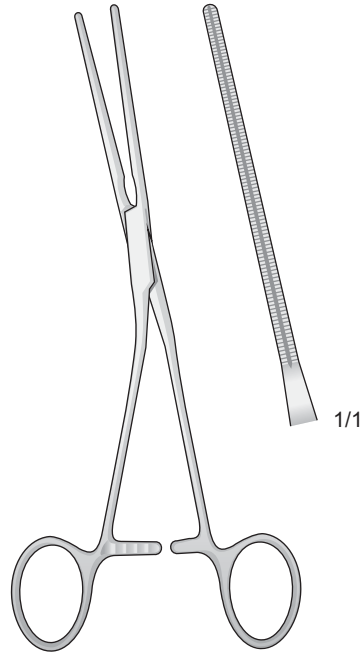
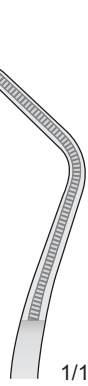

COOLEY  
**0602-BLF**  
170 mm

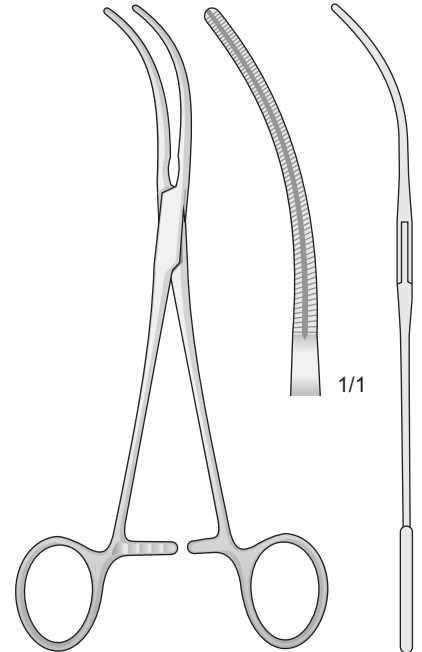
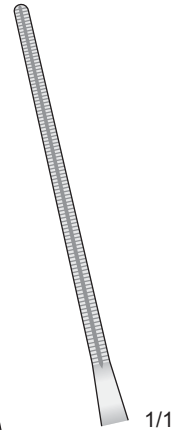

COOLEY  
**0602-BLG**  
170 mm

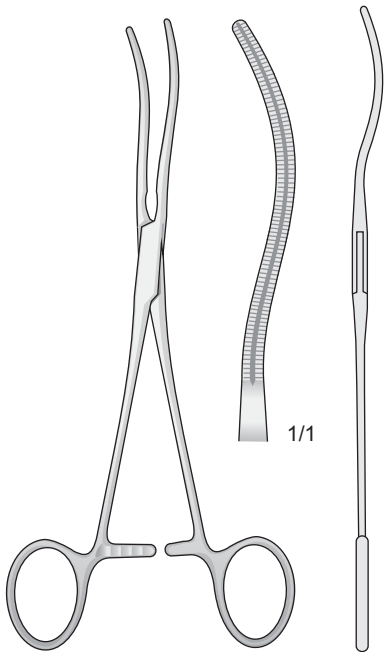
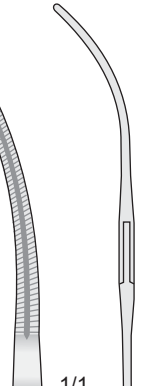

COOLEY  
**0602-BLH**  
170 mm

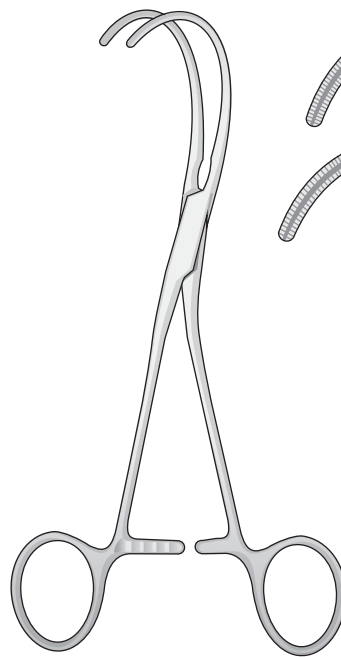
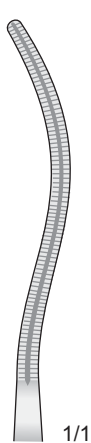

COOLEY  
**0602-BLI/0602-BLL**  
170 mm

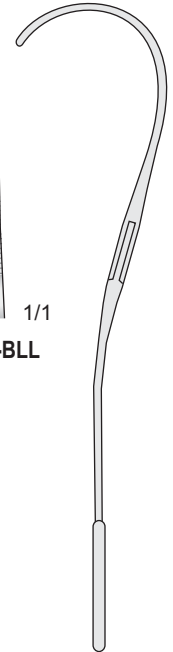
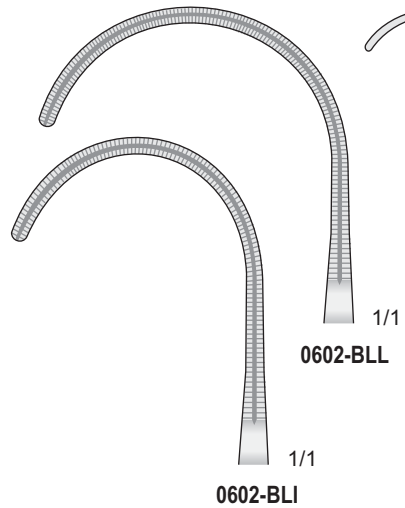



Pinze vascolari  
atraumatiche

Atraumatic  
vessel clamps

Atraumatische  
Gefäßklemmen

Pinces hémostatiques  
atraumatiques

Pinzas vasculares  
atraumáticas

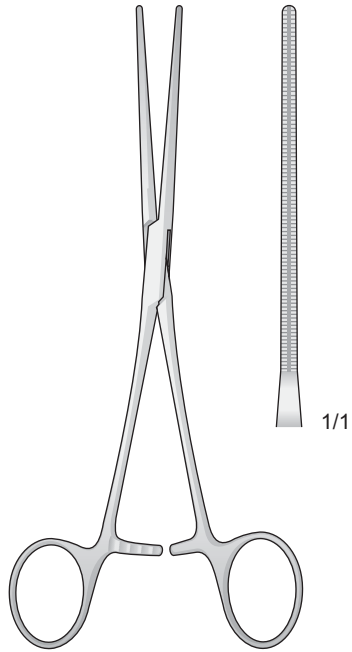

COOLEY  
0602-BII  
170 mm

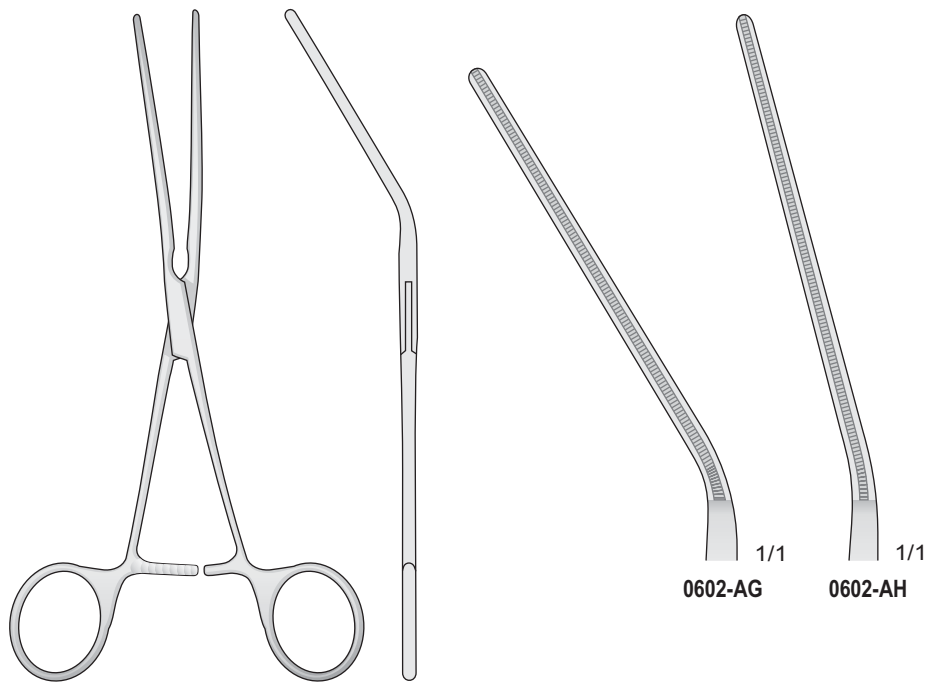

LELAND - JONES  
0602-AG/0602-AH  
190 mm

Pinze vascolari  
atraumatiche

Atraumatic  
vessel clamps

Atraumatische  
Gefäßklemmen

Pinces hémostatiques  
atraumatiques

Pinzas vasculares  
atraumáticas

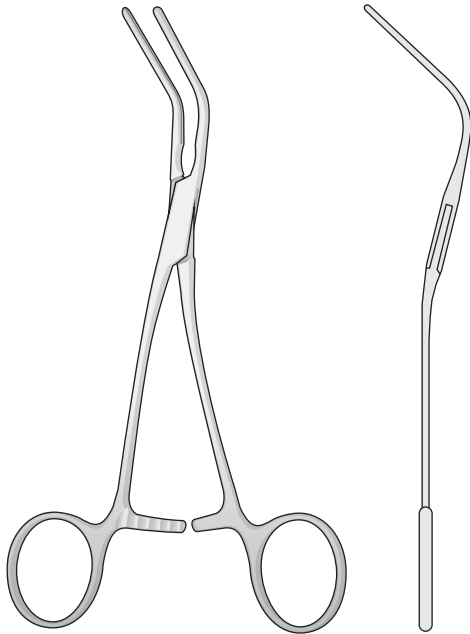
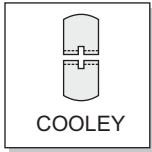

COOLEY  
0602-BLC/0602-BLE

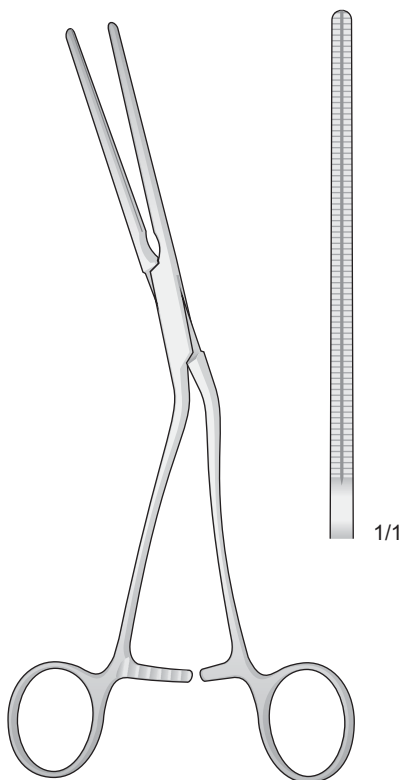
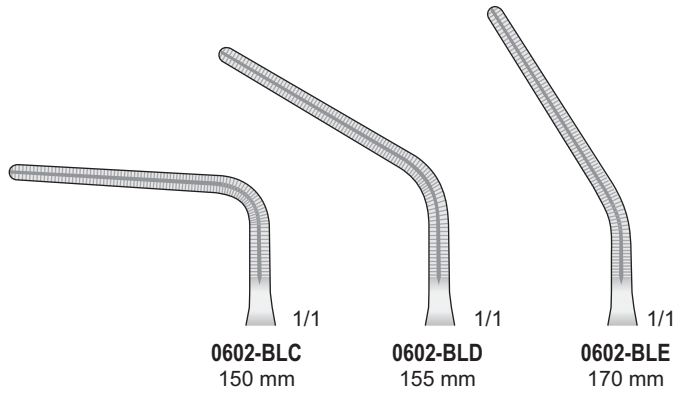

COOLEY  
0602-BIH  
210 mm

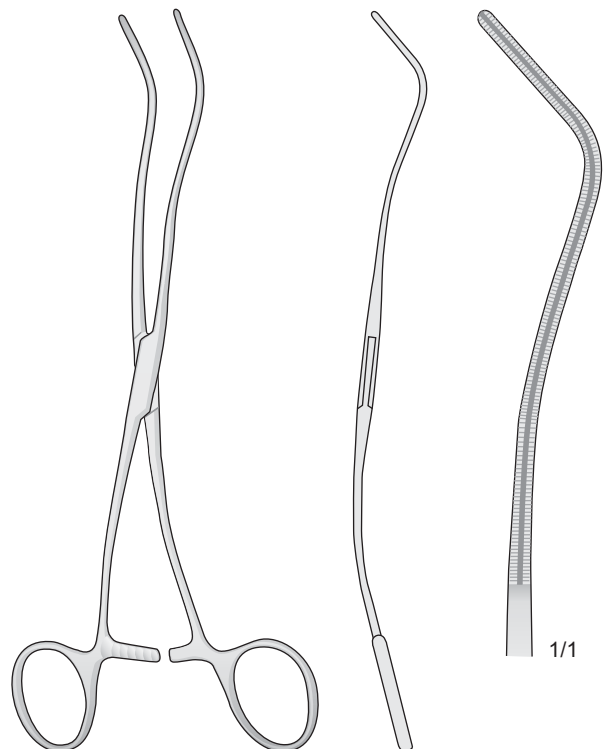

COOLEY  
0602-BIL  
200 mm

Pinze vascolari  
atraumatiche

Atraumatic  
vessel clamps

Atraumatische  
Gefäßklemmen

Pinces hémostatiques  
atraumatiques

Pinzas vasculares  
atraumáticas

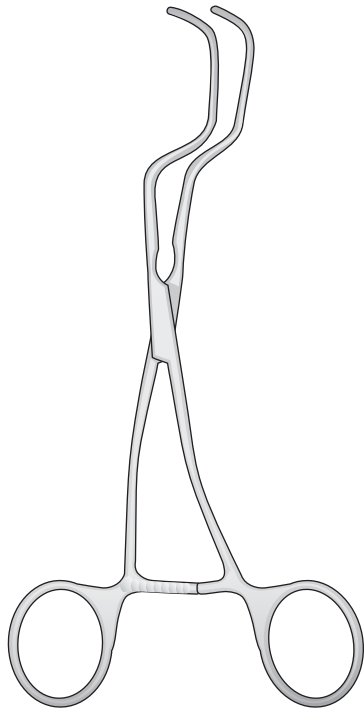

DALE  
0602-LG  
185 mm

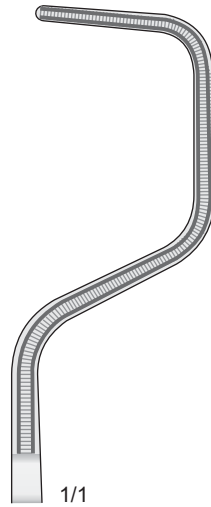

1/1  
0602-LG  
185 mm

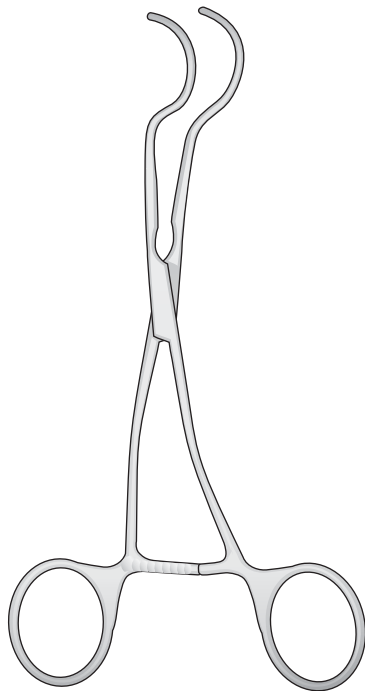

DALE  
0602-LH/0602-LL

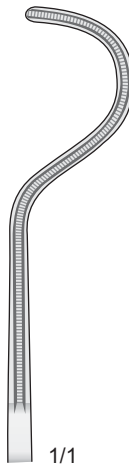

1/1  
0602-LH  
170 mm

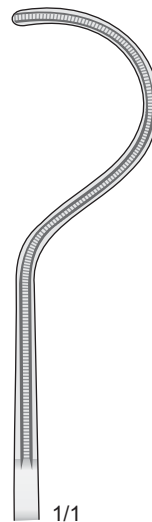

1/1  
0602-LI  
175 mm

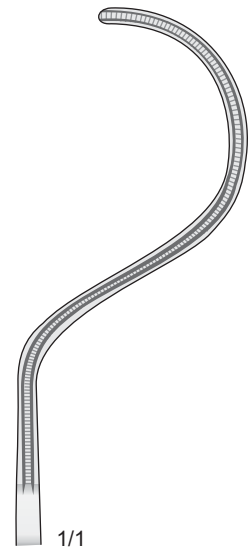

1/1  
0602-LL  
185 mm

Pinze  
atraumatiche

Atraumatic  
clamps

Atraumatische  
Klemmen

Pinces  
atraumatiques

Pinzas  
atraumáticas

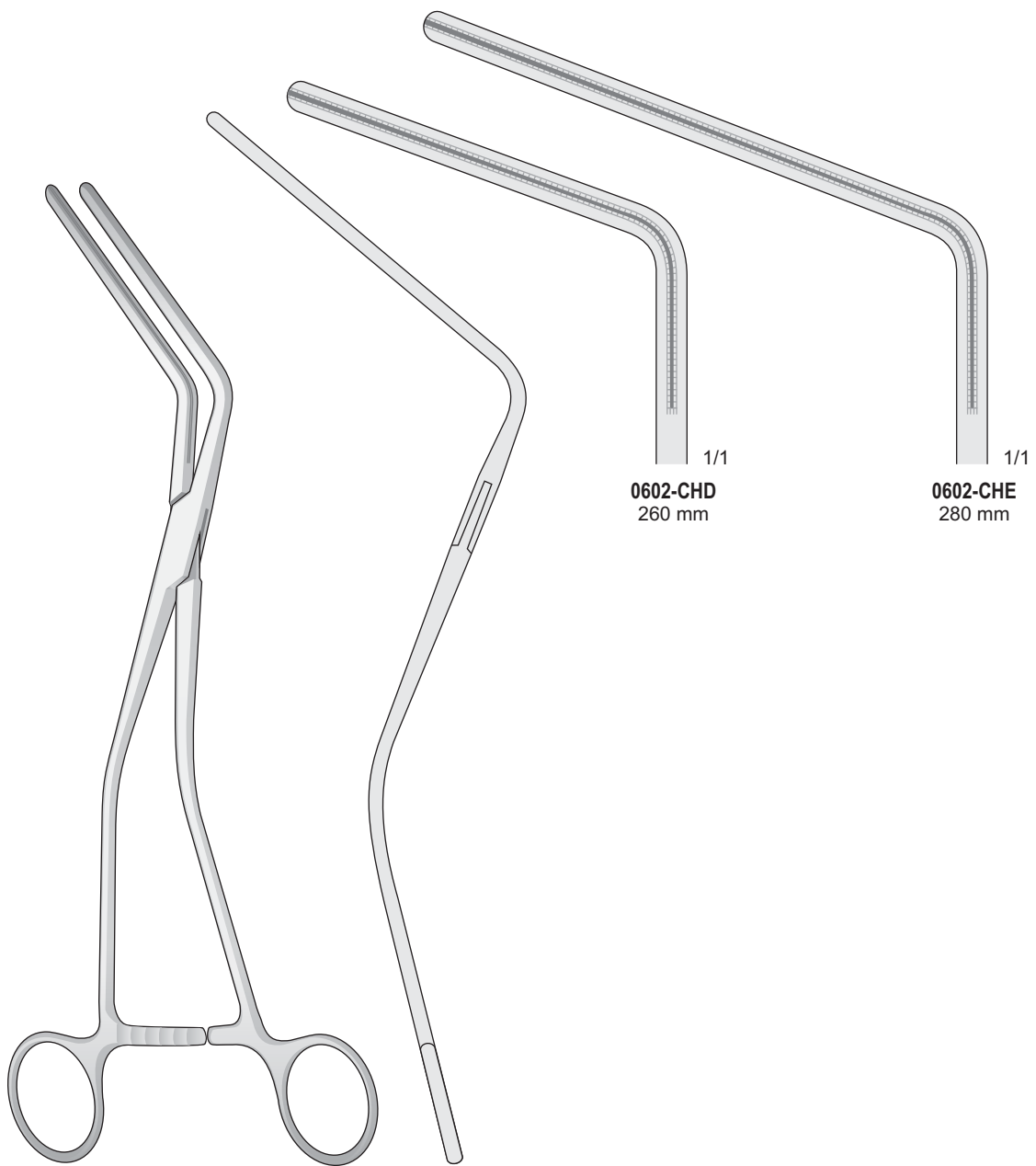

HAYES  
0602-CHD/0602-CHE

Pinze  
atraumatiche

Atraumatic  
clamps

Atraumatische  
Klemmen

Pinces  
atraumatiques

Pinzas  
atraumàticas

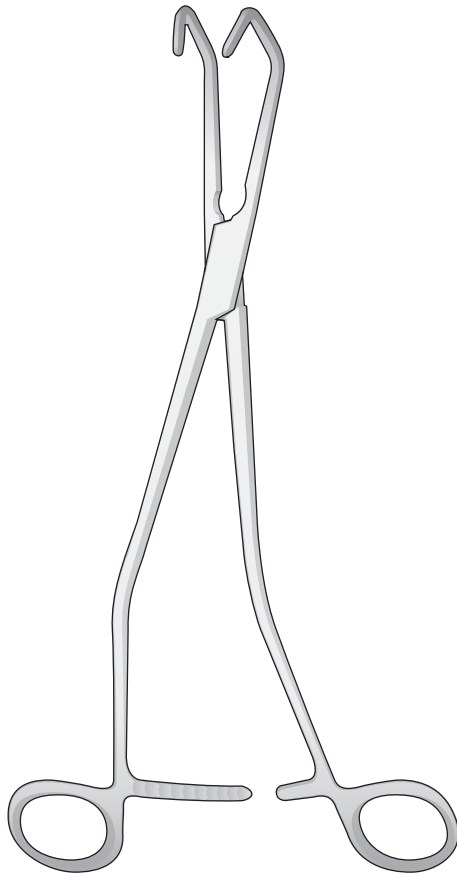

HOPT  
0602-CGI - 230 mm  
0602-CGL - 235 mm  
0602-CHA - 240 mm

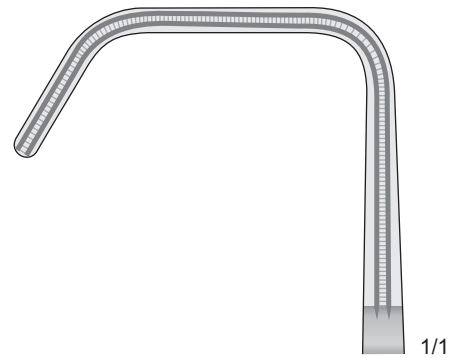

1/1  
0602-CGI  
40 mm

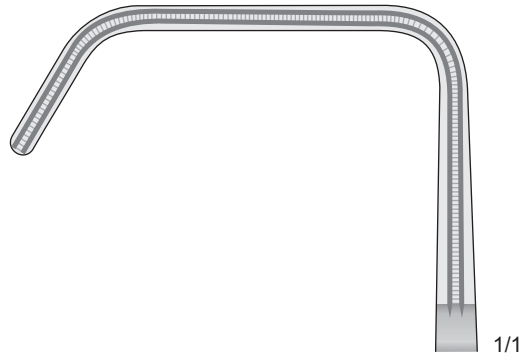

1/1  
0602-CGL  
50 mm



1/1  
0602-CHA  
60 mm

Pinze  
atraumatiche

Atraumatic  
clamps

Atraumatische  
Klemmen

Pinces  
atraumatiques

Pinzas  
atraumàticas

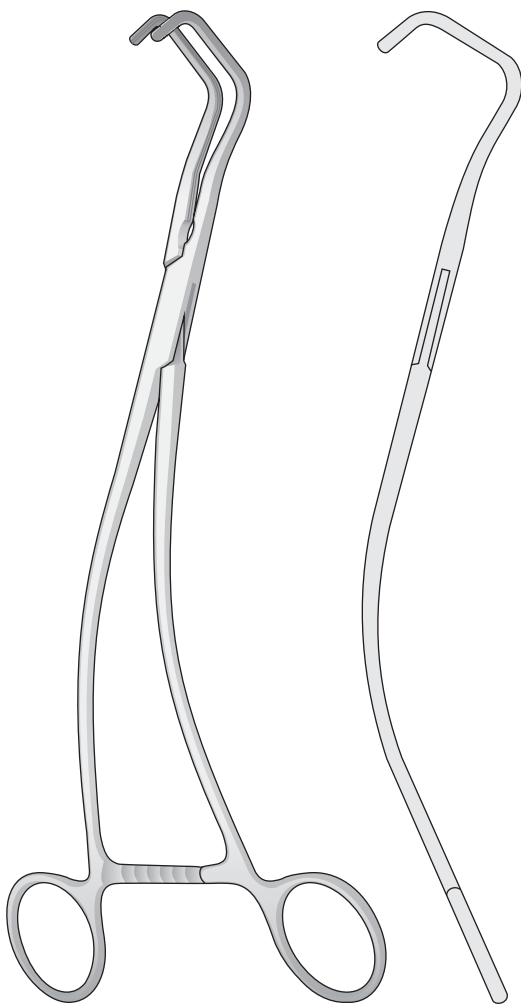

URO-TANGENTIAL  
0602-CHB/0602-CHC  
260 mm

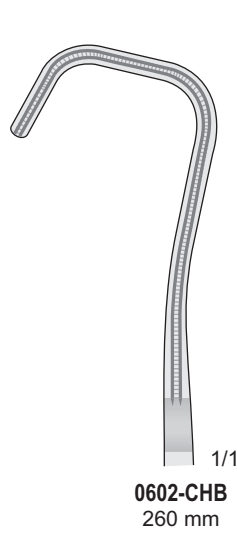

0602-CHB  
260 mm

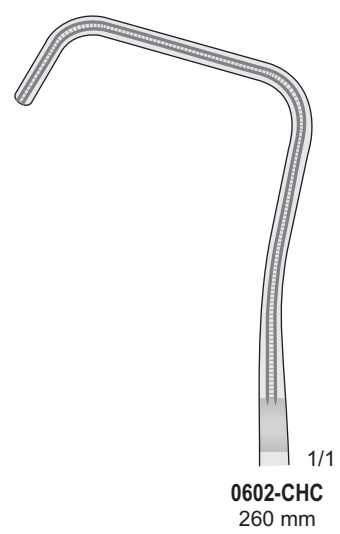

0602-CHC  
260 mm

Pinze vascolari  
atraumatiche

Atraumatic  
vessel clamps

Atraumatische  
Gefäßklemmen

Pinces hémostatiques  
atraumatiques

Pinzas vasculares  
atraumáticas

Per bambini  
For children  
Kinderklemmen  
Pour enfants  
Para niños

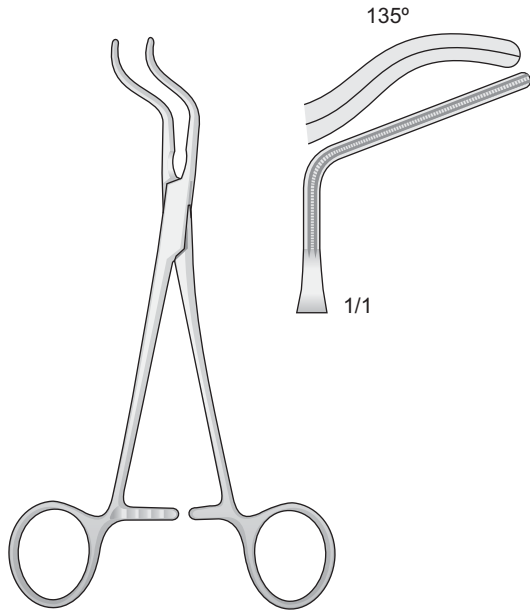

SUBRAMANIAN-MINIATURE  
**0602-BHG**  
155 mm

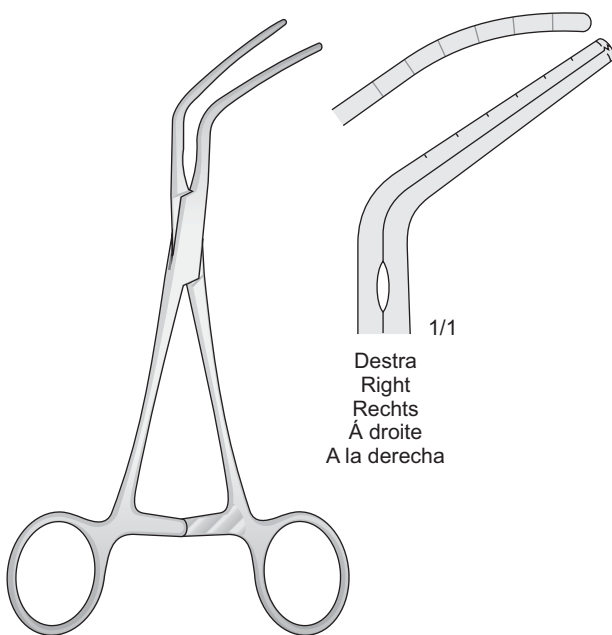

Destra  
Right  
Rechts  
À droite  
A la derecha

SUBRAMANIAN  
**0602-BHH**  
160 mm

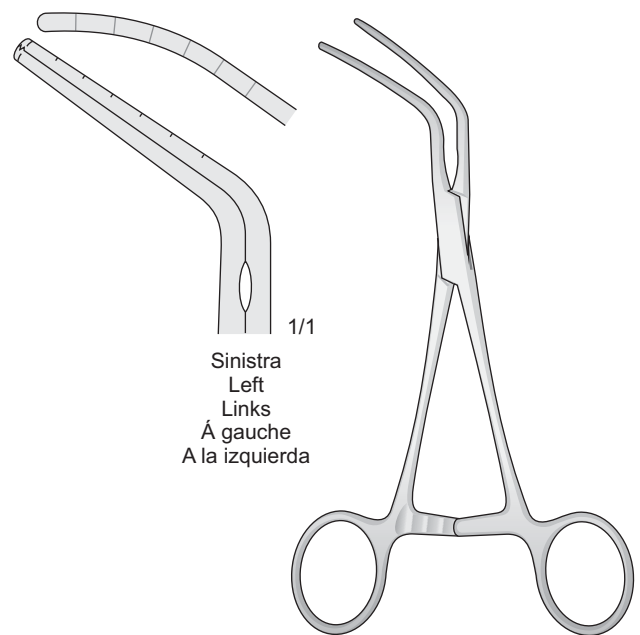

Sinistra  
Left  
Links  
À gauche  
A la izquierda

SUBRAMANIAN  
**0602-BHI**  
160 mm

Pinze vascolari  
atraumatiche

Atraumatic  
vessel clamps

Atraumatische  
Gefäßklemmen

Pinces hémostatiques  
atraumatiques

Pinzas vasculares  
atraumáticas

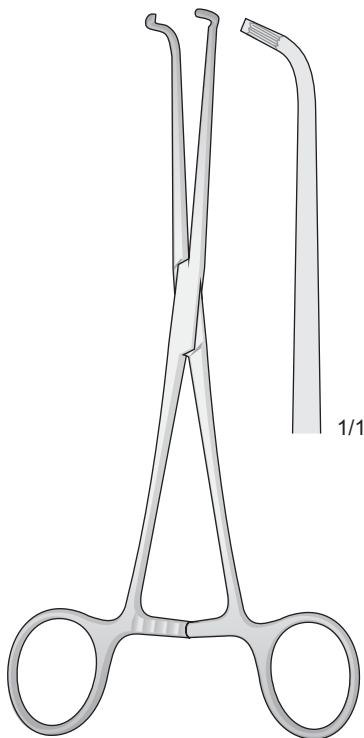

JAVID  
0602-BBD  
180 mm

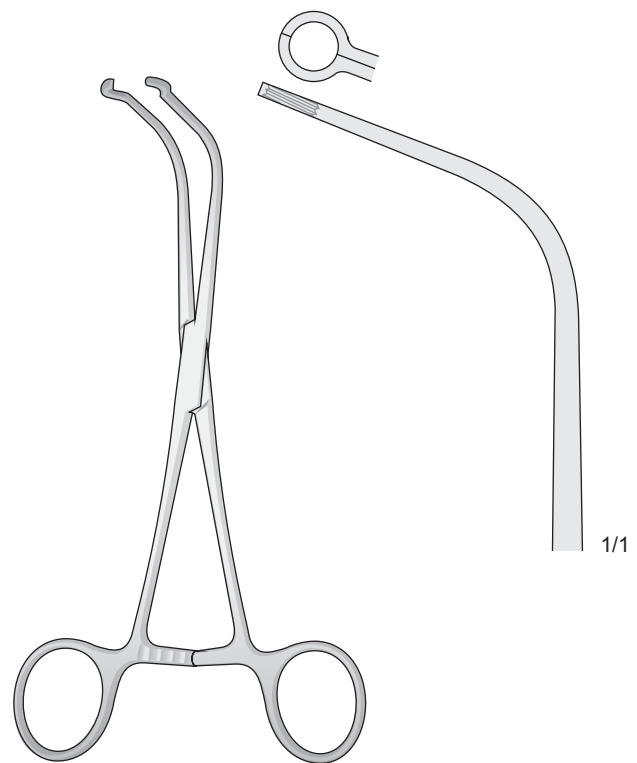

JAVID  
0602-BBE  
190 mm



Atraumatiche - Atraumatic - Atraumatiche  
Atraumatique - Atraumáticas

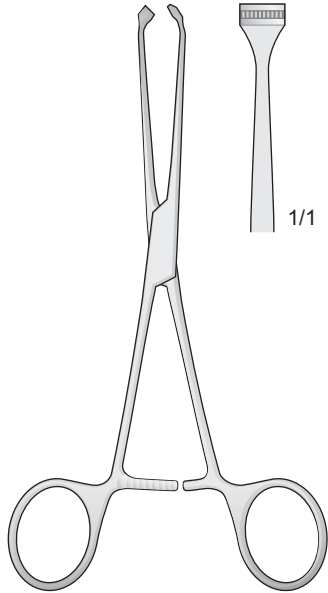

ALLIS  
15-FC  
150 mm

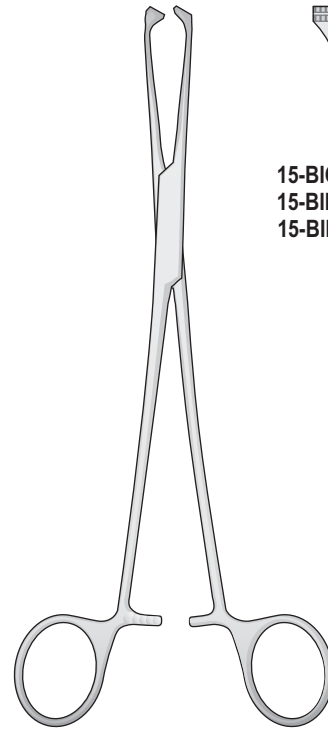

ALLIS  
15-BIC/15-BIE

1/1  
15-BIC - 190 mm  
15-BID - 250 mm  
15-BIE - 300 mm

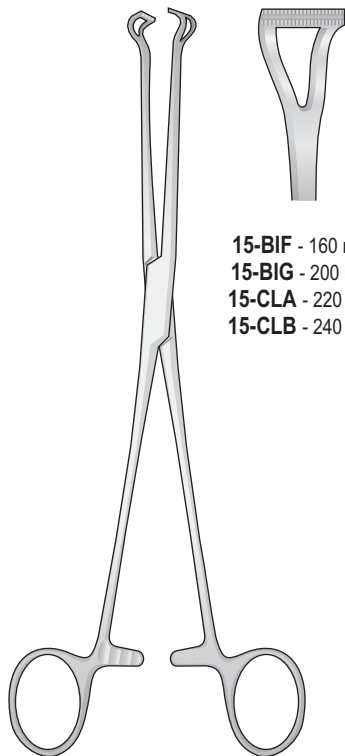

BABCOCK  
15-BIF/15-CLB

15-BIF - 160 mm  
15-BIG - 200 mm  
15-CLA - 220 mm  
15-CLB - 240 mm

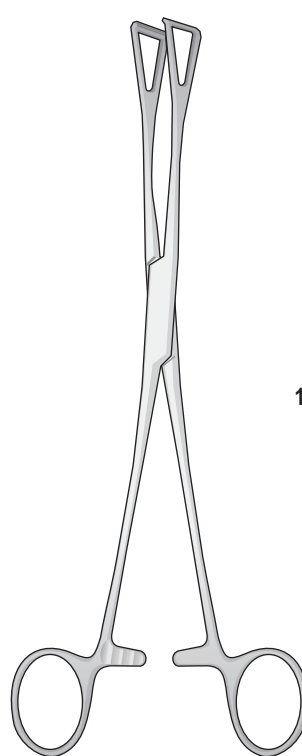

DUVAL  
15-BIH/15-BII

14 mm  
15-BIH - 200 mm

18 mm  
15-BII - 200 mm

Pinze vascolari  
atraumatiche

Atraumatic  
vessel clamps

Atraumatische  
Gefäßklemmen

Pinces hémostatiques  
atraumatiques

Pinzas vasculares  
atraumáticas

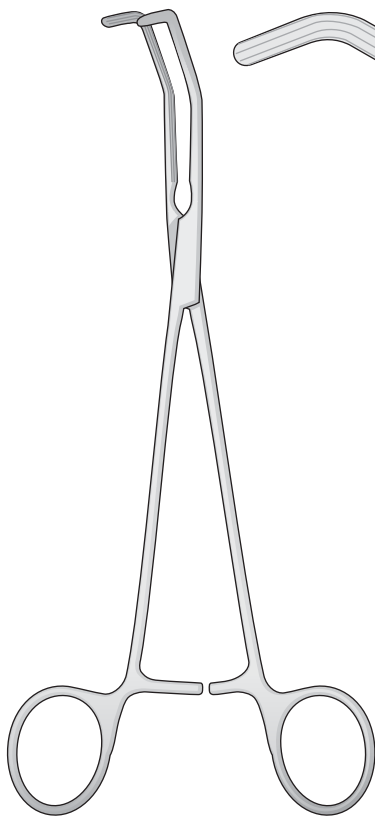

PRICE - THOMAS  
0602-FC  
220 mm

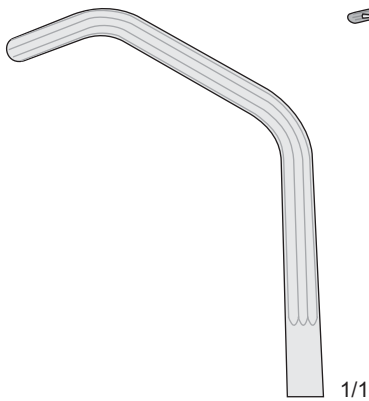

1/1  
0602-FC  
220 mm

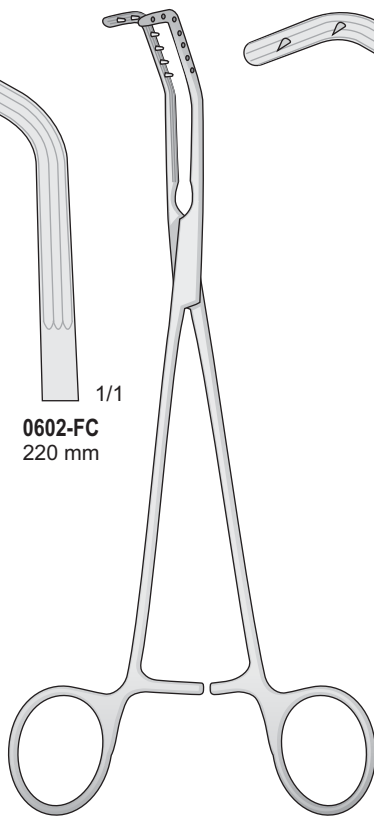

PRICE - THOMAS  
0602-FD/0602-FE

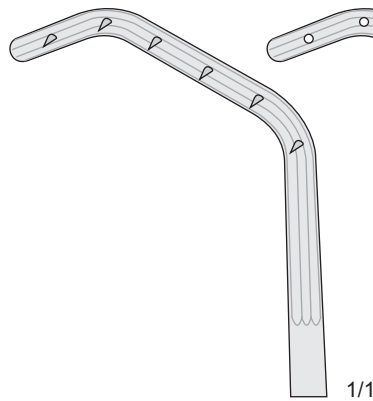

1/1  
0602-FD  
220 mm

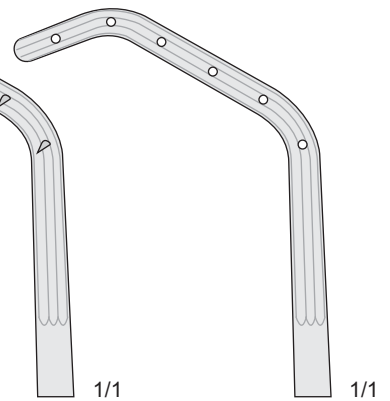

1/1  
0602-FE  
220 mm

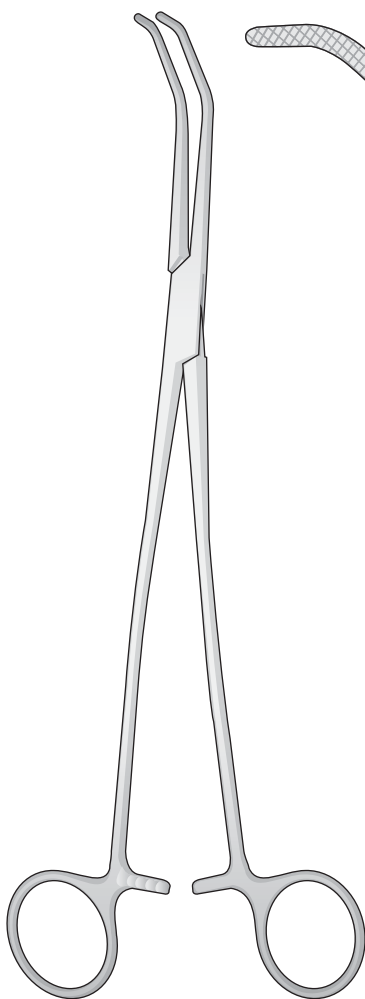

SATINSKY  
0602-II/0602-IL  
260 mm

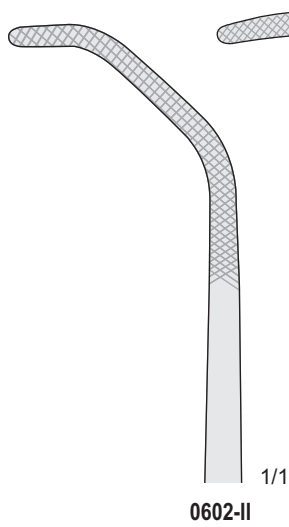

0602-II

1/1



0602-IL

1/1

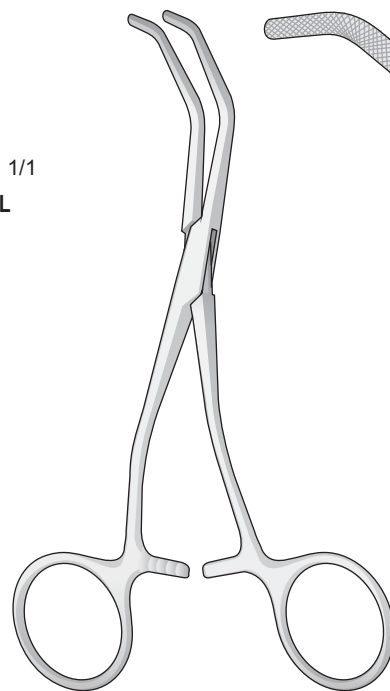

BABY-SATINSKY  
0602-EG  
150 mm

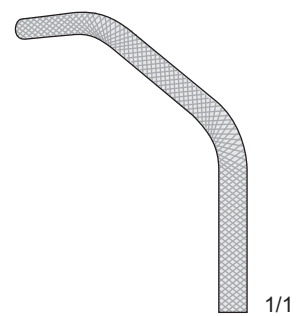

1/1

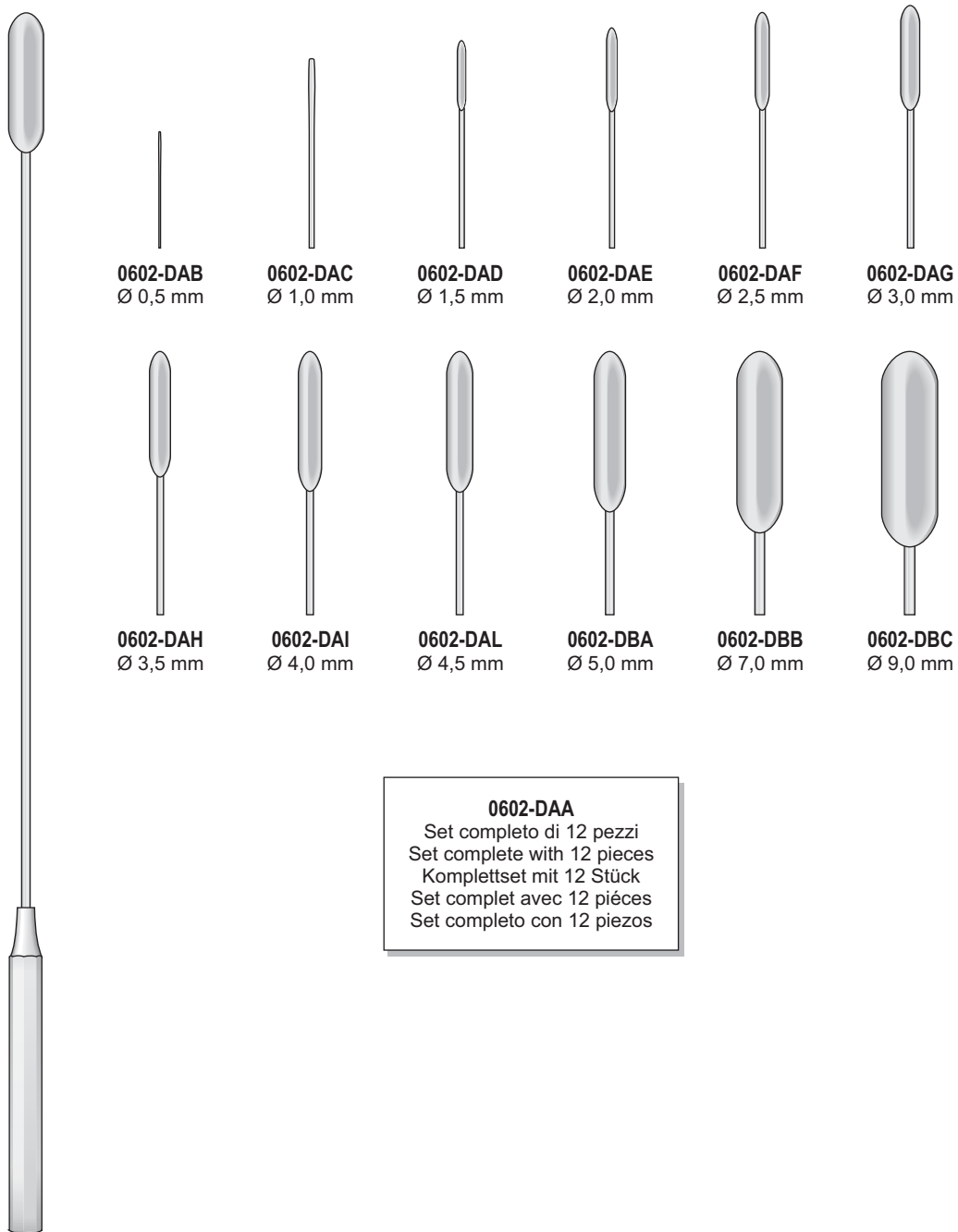

**0602-DAB**  
Ø 0,5 mm

**0602-DAC**  
Ø 1,0 mm

**0602-DAD**  
Ø 1,5 mm

**0602-DAE**  
Ø 2,0 mm

**0602-DAF**  
Ø 2,5 mm

**0602-DAG**  
Ø 3,0 mm

**0602-DAH**  
Ø 3,5 mm

**0602-DAI**  
Ø 4,0 mm

**0602-DAL**  
Ø 4,5 mm

**0602-DBA**  
Ø 5,0 mm

**0602-DBB**  
Ø 7,0 mm

**0602-DBC**  
Ø 9,0 mm

**0602-DAA**  
Set completo di 12 pezzi  
Set complete with 12 pieces  
Komplettset mit 12 Stück  
Set complet avec 12 pièces  
Set completo con 12 piezas

DE BAKEY  
**0602-DAB/0602-DBC**  
190 mm

0602-DFB - 140 mm - Ø 1,0  
 0602-DFC - 140 mm - Ø 1,5  
 0602-DFD - 140 mm - Ø 2,0  
 0602-DFE - 140 mm - Ø 2,5  
 0602-DFF - 140 mm - Ø 3,0  
 0602-DFG - 140 mm - Ø 3,5  
 0602-DFH - 140 mm - Ø 4,0  
 0602-DFI - 140 mm - Ø 4,5  
 0602-DFL - 140 mm - Ø 5,0

0602-DGB - 210 mm - Ø 1,0  
 0602-DGC - 210 mm - Ø 1,5  
 0602-DGD - 210 mm - Ø 2,0  
 0602-DGE - 210 mm - Ø 2,5  
 0602-DGF - 210 mm - Ø 3,0  
 0602-DGG - 210 mm - Ø 3,5  
 0602-DGH - 210 mm - Ø 4,0  
 0602-DGI - 210 mm - Ø 4,5  
 0602-DGL - 210 mm - Ø 5,0

**0602-DFA**

Set completo di 9 pezzi  
 Set complete with 9 pieces  
 Komplettsset mit 9 Stück  
 Saet complet avec 9 pièces  
 Set completo con 9 piezas

**0602-DGA**

Set completo di 9 pezzi  
 Set complete with 9 pieces  
 Komplettsset mit 9 Stück  
 Saet complet avec 9 pièces  
 Set completo con 9 piezas

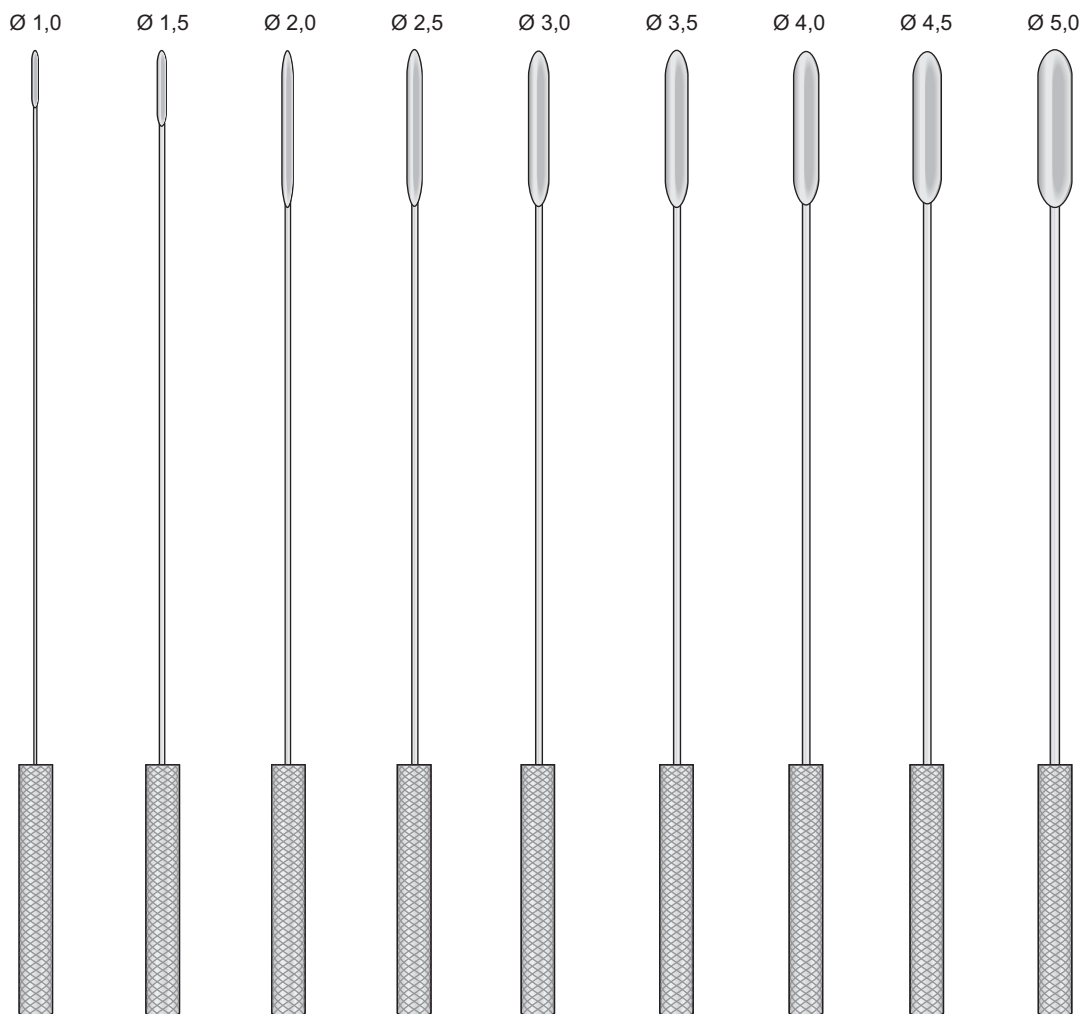

GARRETT  
 0602-DFB/0602-DGL

Stripper anello tira vene

Vein stripper

Ringstripper

Stripper à anneau

Sonda para vârices

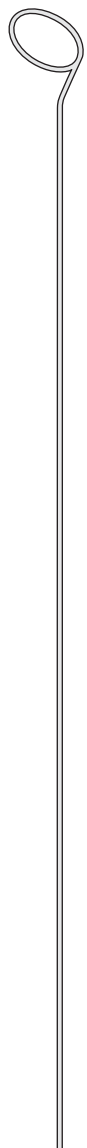

Ø 2 mm  
○ 1/1  
**0602-DIB**

Ø 4 mm  
○ 1/1  
**0602-DID**

Ø 7 mm  
○ 1/1  
**0602-DIF**

Ø 10 mm  
○ 1/1  
**0602-DIH**

Ø 14 mm  
○ 1/1  
**0602-DIL**

Ø 3 mm  
○ 1/1  
**0602-DIC**

Ø 6 mm  
○ 1/1  
**0602-DIE**

Ø 8,5 mm  
○ 1/1  
**0602-DIG**

Ø 12 mm  
○ 1/1  
**0602-DII**



**0602-DIA**  
120 mm

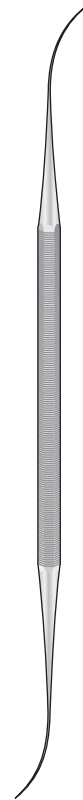

**VARADY**  
**0602-BAH**  
180 mm

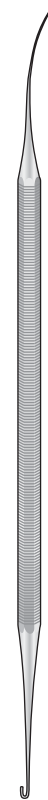

**VARADY**  
**0602-BAI**  
180 mm

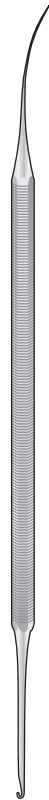

**VARADY**  
**0602-BAL**  
180 mm

Aghi vascolari malleabili - Gefäßspülkanülen  
Ø 3 mm    Ø 4 mm    Ø 5 mm    Ø 6 mm



**SCHMID**  
**1411-DA**  
150 mm



**SCHMID**  
**1411-DB**  
150 mm

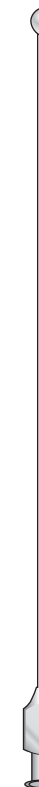

**SCHMID**  
**1411-DC**  
150 mm



**SCHMID**  
**1411-DD**  
150 mm

**VOLLMAR**  
**0602-DIB/0602-DIL**  
500 mm

Dilatatori per  
valvola mitralica

Dilator for  
mitral valve

Dilatator für  
mitralstenosen

Dilatateurs

Dilatadores para  
valvula mitral

AP. 9-45 mm

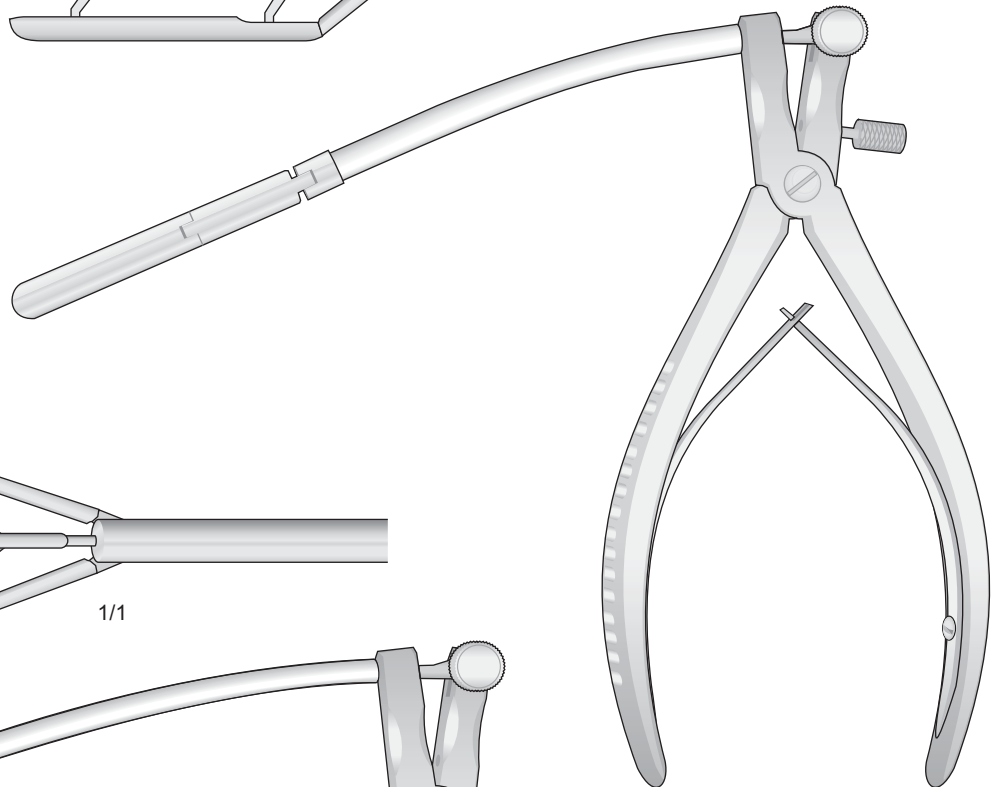
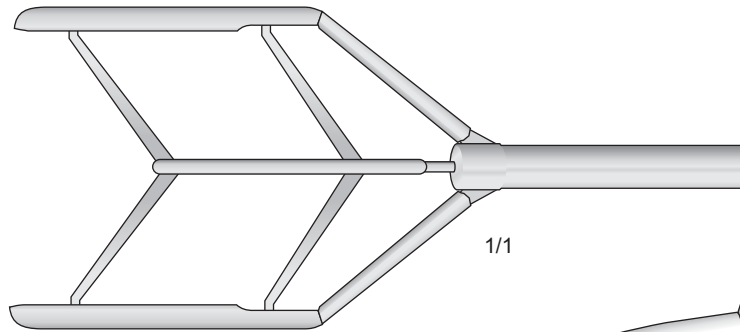

AP. 8-15 mm

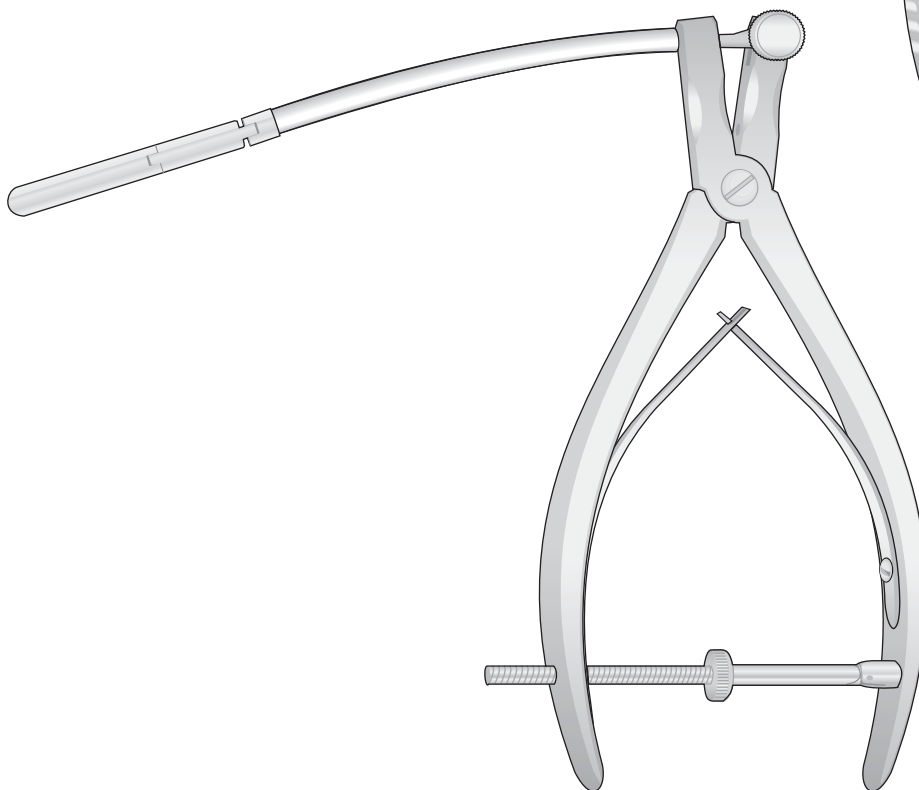
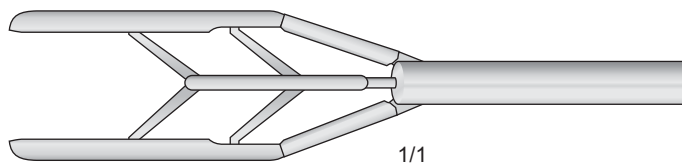





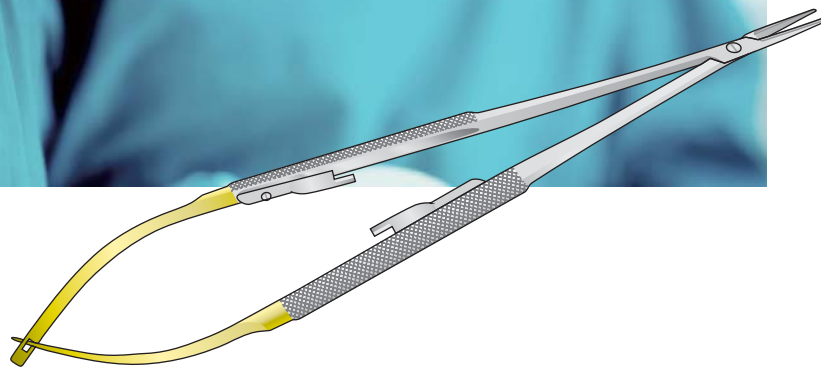

7

Port'aghi, Aghi per legature  
Needle holders, Ligature needles  
Nadelhalter, Unterbindungsnadeln  
Porte aiguilles, Aiguilles à ligatures  
Portaagujas, Agujas para ligaduras



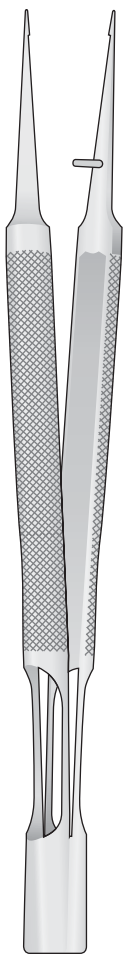
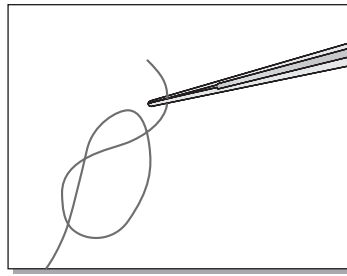

**BROCK**  
**0604-CAD**  
130 mm

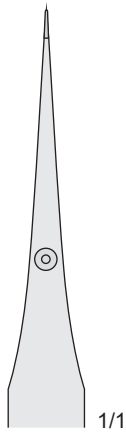

1/1

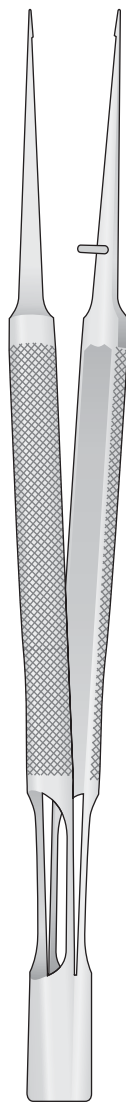

**BROCK**  
**0604-CAD**  
150 mm

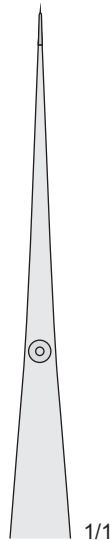

1/1

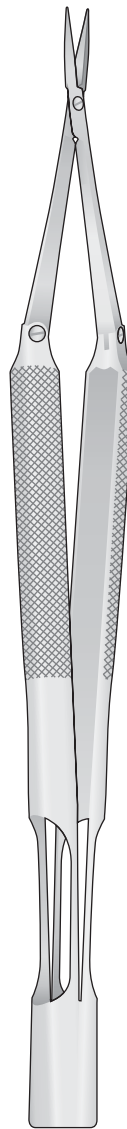

**BROCK**  
**0604-CBB**  
150 mm

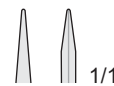

1/1

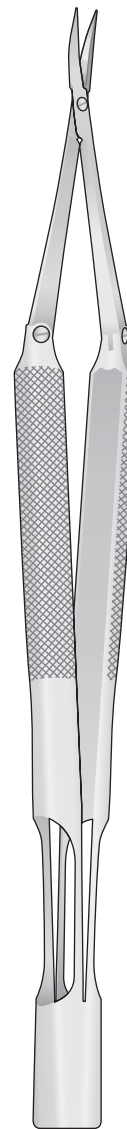

**BROCK**  
**0604-CBD**  
150 mm



1/1

Micro port'aghi

Micro Needle Holders

Micro Nadelhalter

Micro porte aiguilles

Micro portaagujas

Con morso liscio  
Smooth jaws  
Glattes Maul  
A' mors lisses  
Mandibula lisa

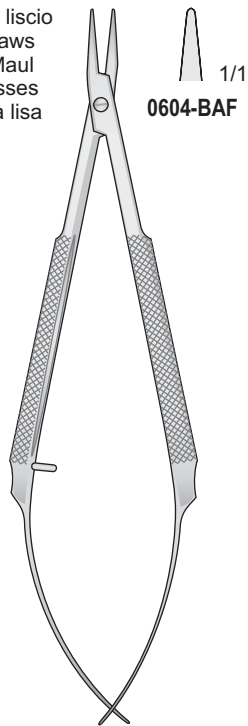

0604-BAF



0604-BAG

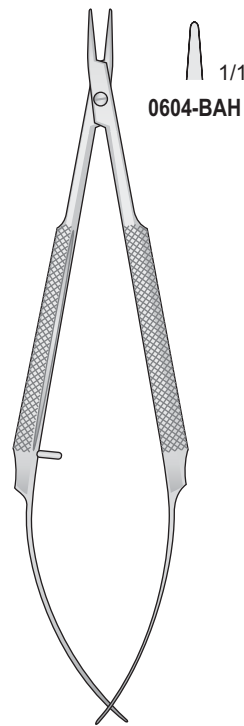

0604-BAH



0604-BAI

0604-BAF/0604-BAG  
110 mm

0604-BAH/0604-BAI  
110 mm

Con morso liscio  
Smooth jaws  
Glattes Maul  
A' mors lisses  
Mandibula lisa

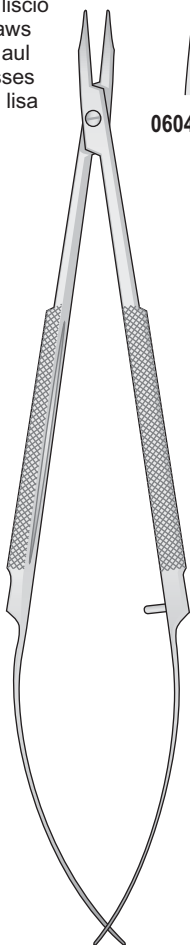

0604-BBD



0604-BBE

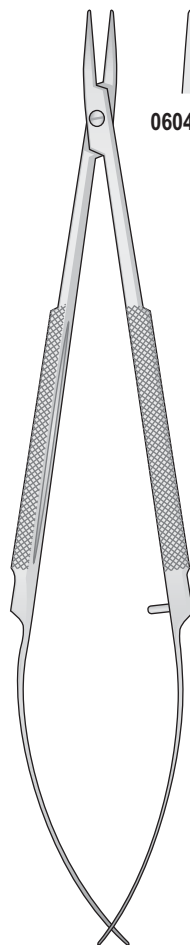

0604-BBF



0604-BBG

0604-BBD/0604-BBE  
150 mm

0604-BBF/0604-BBG  
150 mm

Con morso zigrinato fine  
Fine serrated jaws  
Feingerieftes Maul  
Mors stries fins  
Bocas estriadas finas

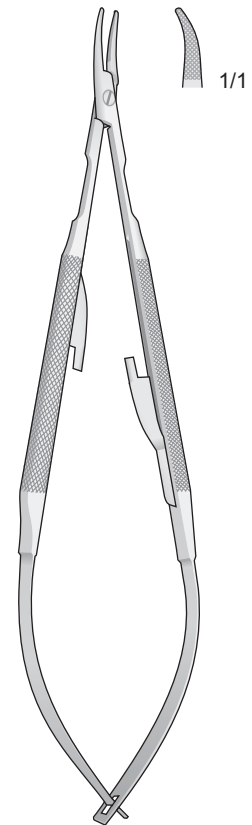

BARRAQUER  
0604-CE  
135 mm

Con morso liscio - Smooth jaws  
 Glattes Maul - A' mors lisses - Mandibula lisa

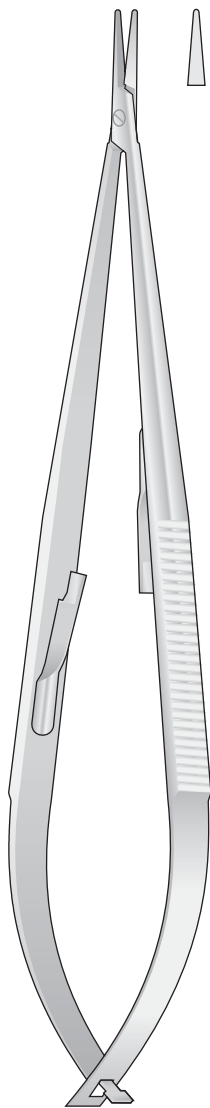

JACOBSON  
 0604-GD  
 180 mm

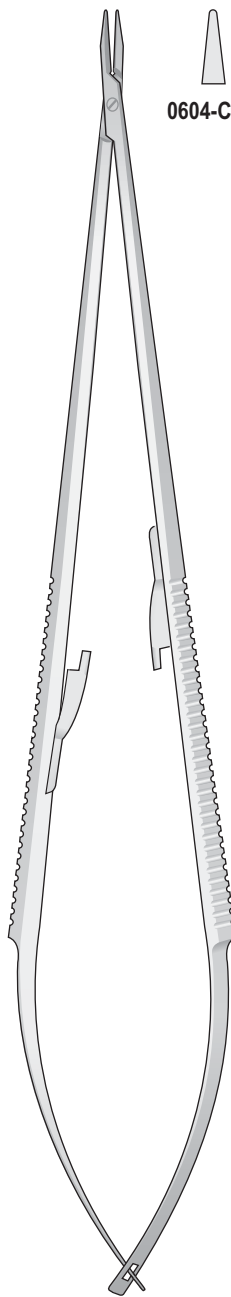

0604-CEG/0604-CEH  
 225 mm

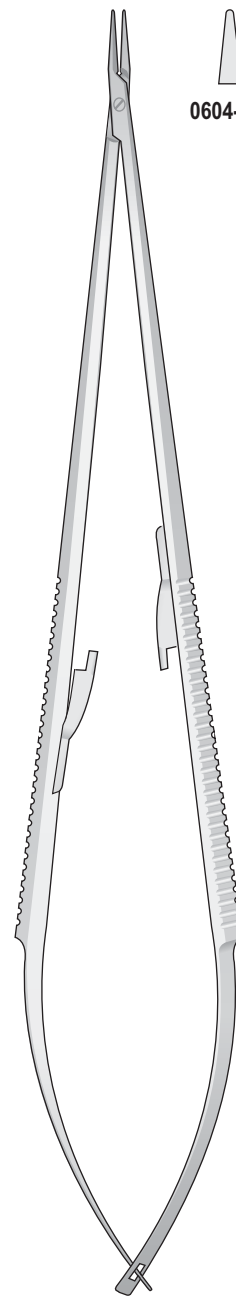

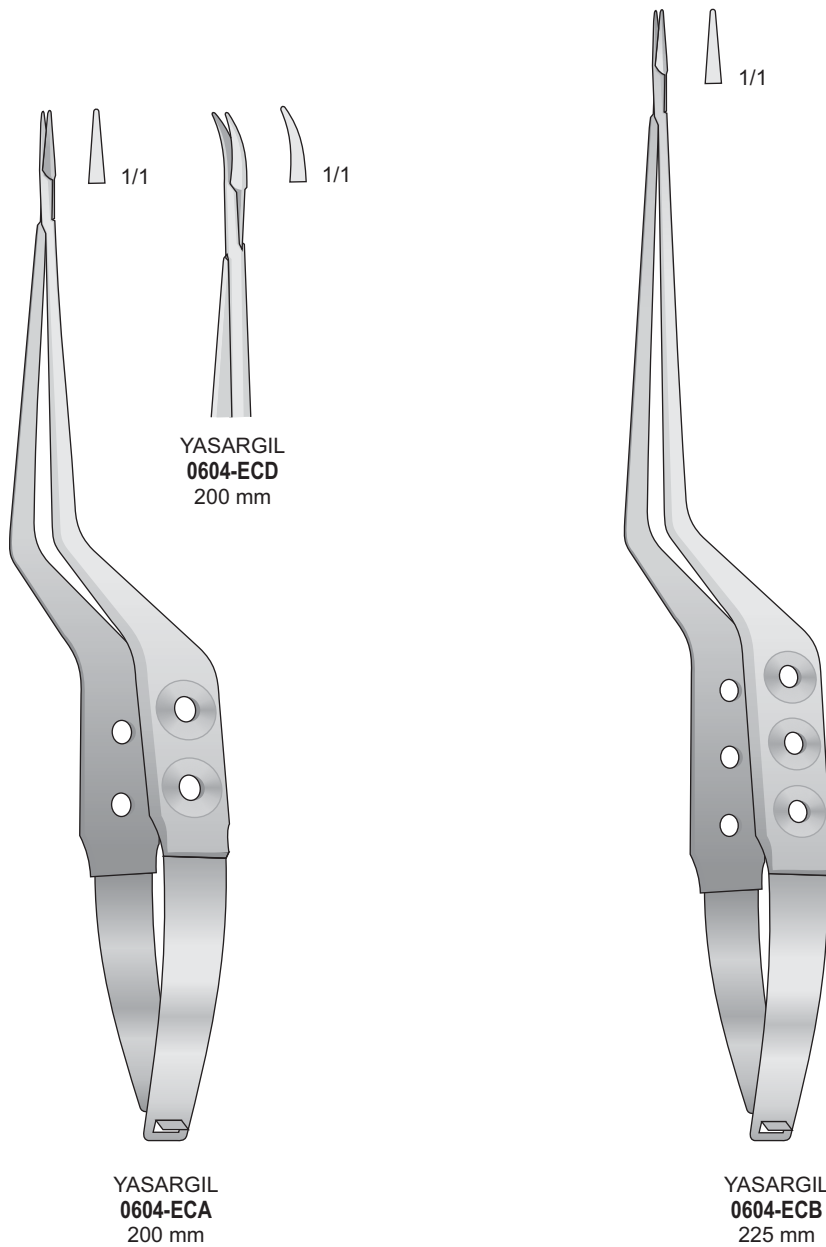

0604-CEI/0604-CEL  
 225 mm

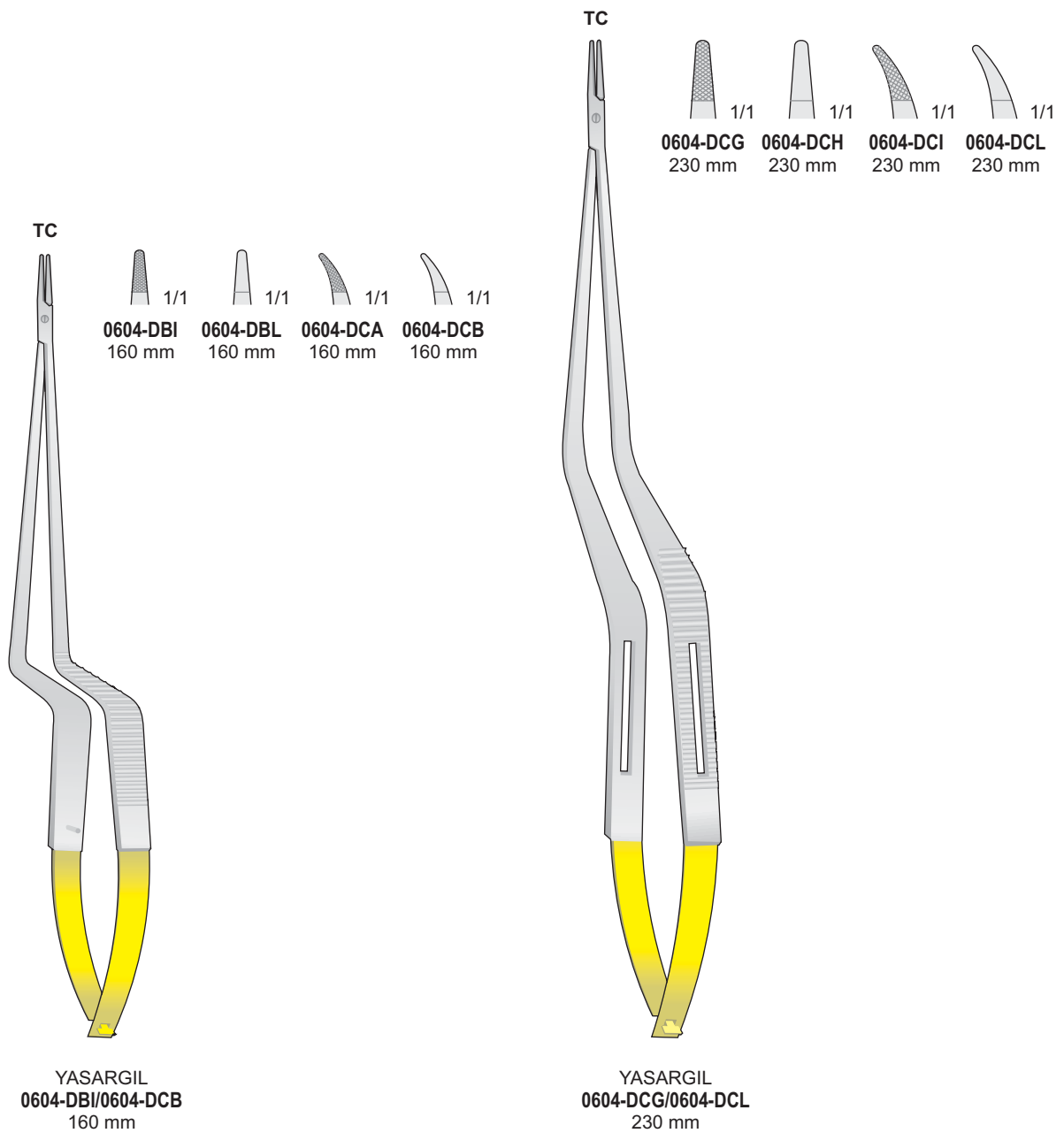

Portaghi con inserti al tungsteno  
 Needle Holders with tungsten-carbide inserts  
 Nadelhalter mit Hartmetalleinlagen  
 Porte aiguilles avec plaquettes en carbure de tungstène  
 Portaagujas con plaquitas de carburo de tungsteno

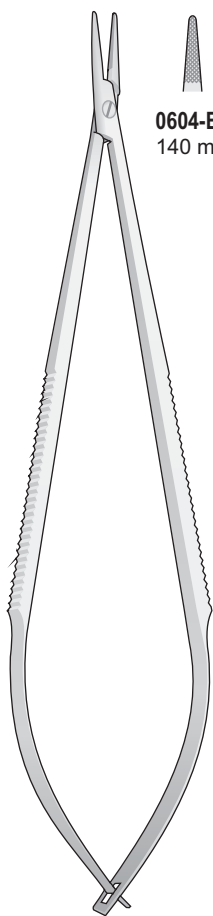



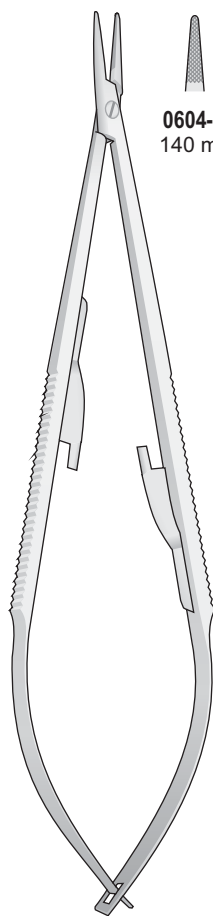

 1/1  
 1/1  
**0604-BE**  
140 mm  
**0604-BG**  
140 mm

**0604-BE/0604-BG**  
140 mm



 1/1  
 1/1  
**0604-BI**  
140 mm  
**0604-CA**  
140 mm

**CASTROVIEJO**  
**0604-BI/0604-CA**  
140 mm

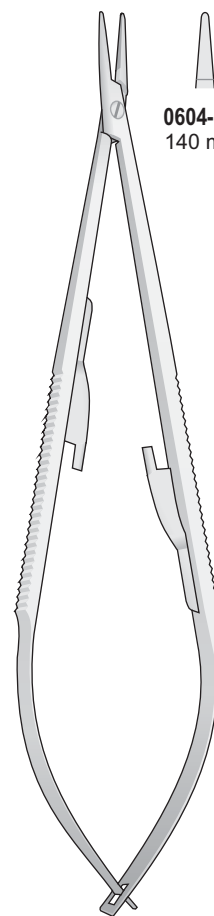

Con morso liscio  
 With smooth jaws  
 Mit Glatten maul  
 Avec mors lisses  
 Con mandibula lisa  
 1/1  
 1/1  
**0604-BH**  
140 mm  
**0604-BL**  
140 mm

**CASTROVIEJO**  
**0604-BH/0604-BL**  
140 mm



Portaghi con inserti al tungsteno  
 Needle Holders with tungsten-carbide inserts  
 Nadelhalter mit Hartmetalleinlagen  
 Porte aiguilles avec plaquettes en carbure de tungstène  
 Portaagujas con plaquitas de carburo de tungsteno

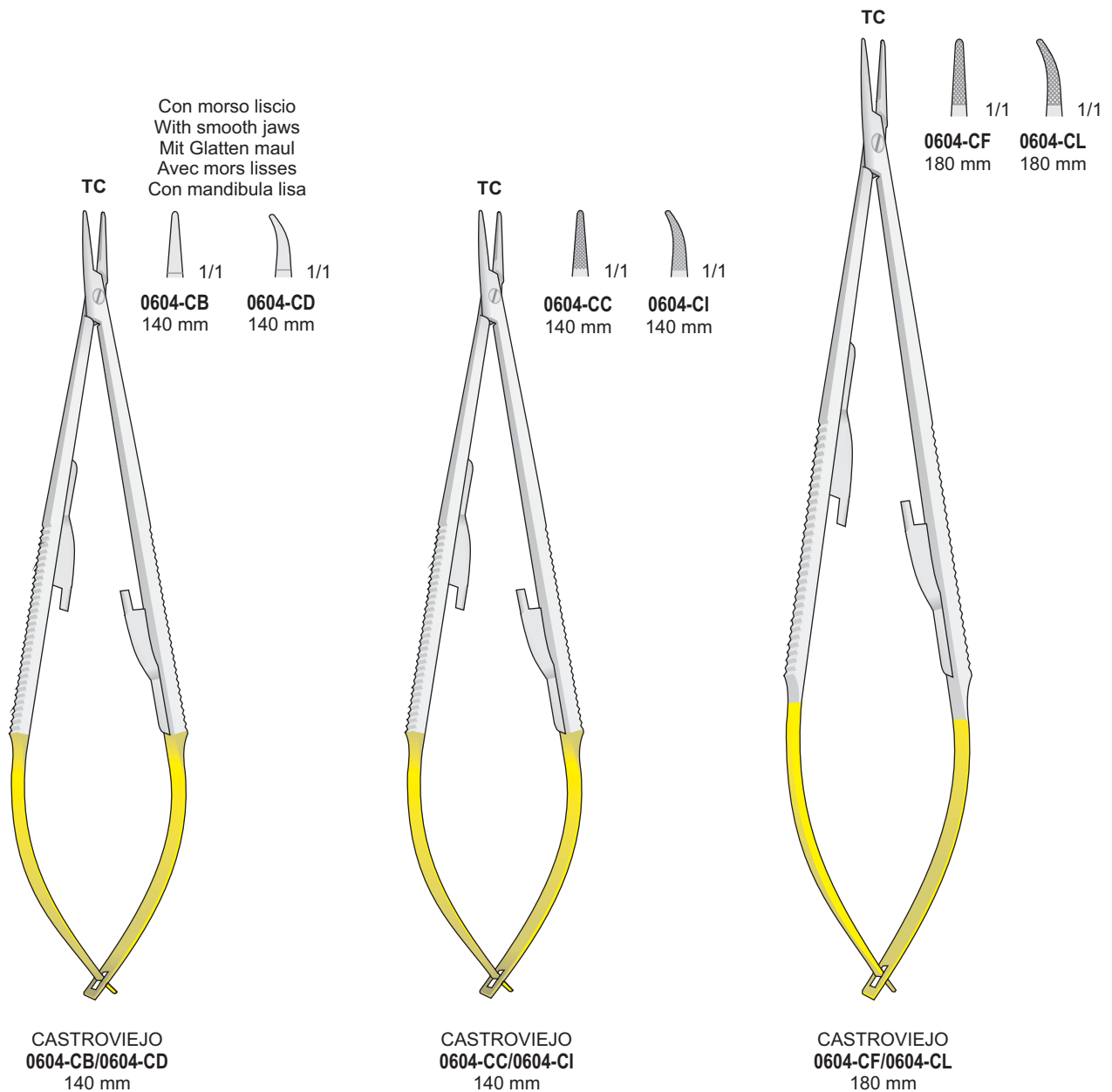

Portaghi con inserti al tungsteno  
 Needle Holders with tungsten-carbide inserts  
 Nadelhalter mit Hartmetalleinlagen  
 Porte aiguilles avec plaquettes en carbure de tungstène  
 Portaagujas con plaquitas de carburo de tungsteno

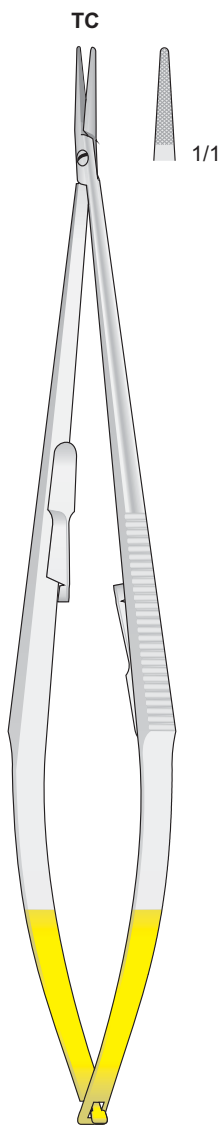

CASTROVIEJO  
 0604-CH  
 215 mm

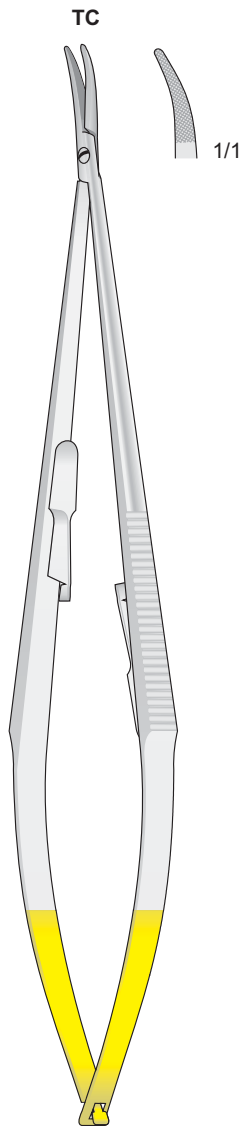

CASTROVIEJO  
 0604-BCI  
 215 mm

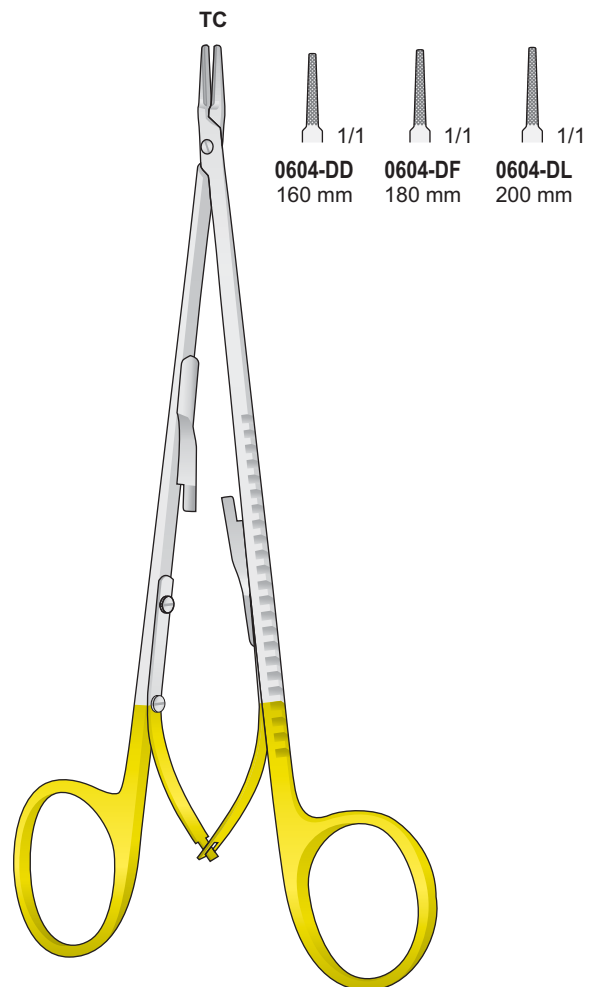

DIETRICH  
 0604-DD/0604-DL

Con morso liscio  
With smooth jaws  
Mit Glatten mau  
Avec mors lisses  
Con mandibula lisa

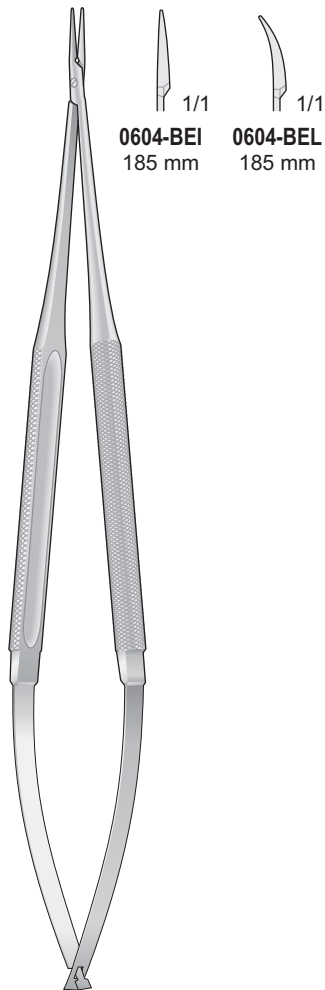

**0604-BEI** 185 mm  
**0604-BEL** 185 mm

**0604-BEI/0604-BEL**  
185 mm

Con morso liscio  
With smooth jaws  
Mit Glatten mau  
Avec mors lisses  
Con mandibula lisa

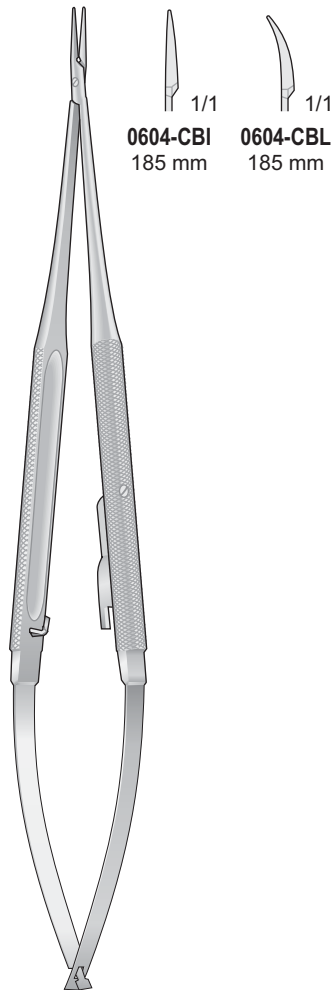

**0604-CBI** 185 mm  
**0604-CBL** 185 mm

**0604-CBI/0604-CBL**  
185 mm

Portaghi con inserti al tungsteno  
Needle Holders with tungsten-carbide inserts  
Nadelhalter mit Hartmetalleinlagen  
Porte aiguilles avec plaquettes en carbure de tungstène  
Portaagujas con plaquetas de carburo de tungsteno

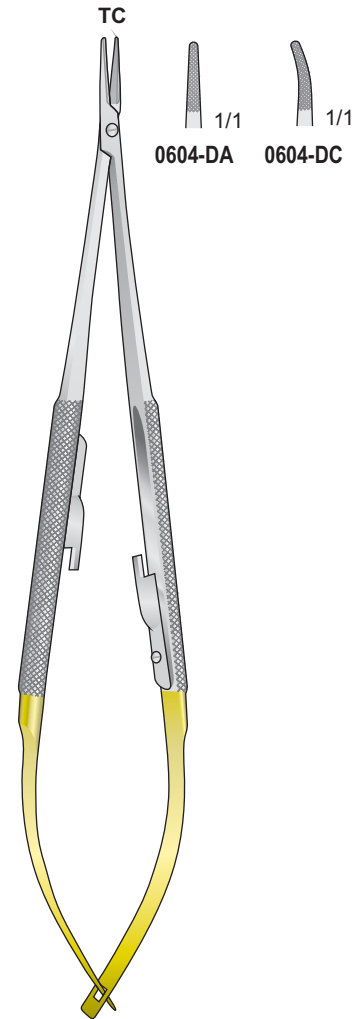

**0604-DA** 180 mm  
**0604-DC** 180 mm

**JACOBSON**  
**0604-DA/0604-DC**  
180 mm

Port'aghi

Needle Holders

Nadelhalter

Porte aiguilles

Portaagujas

Portaghi con inserti al tungsteno  
 Needle Holders with tungsten-carbide inserts  
 Nadelhalter mit Hartmetalleinlagen  
 Porte aiguilles avec plaquettes en carbure de tungstène  
 Portaagujas con plaquitas de carburo de tungsteno

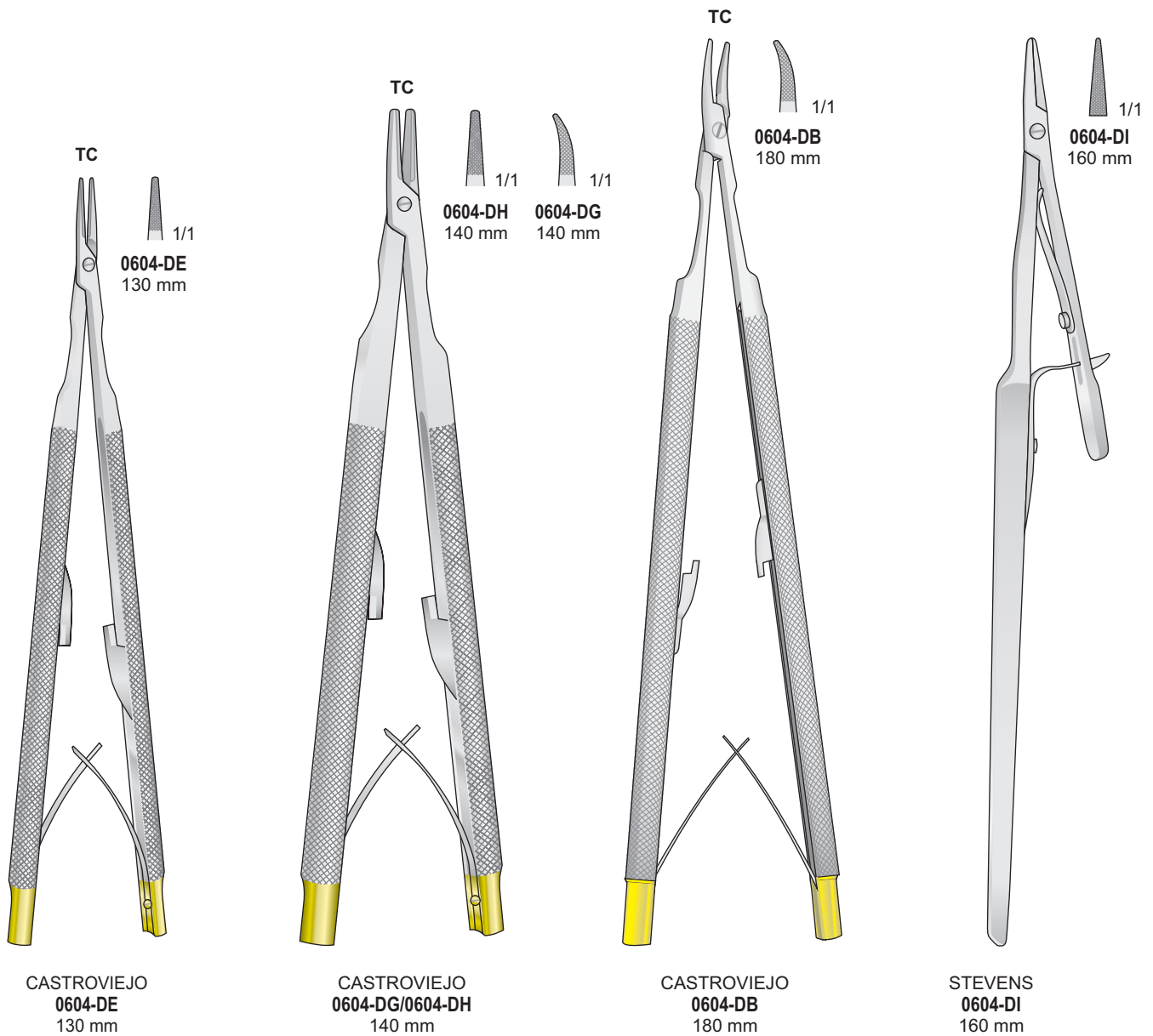

Port'aghi

Needle Holders

Nadelhalter

Porte aiguilles

Portaagujas

Con morso liscio  
With smooth jaws  
Mit Glatten maul  
Avec mors lisses  
Con mandibula lisa

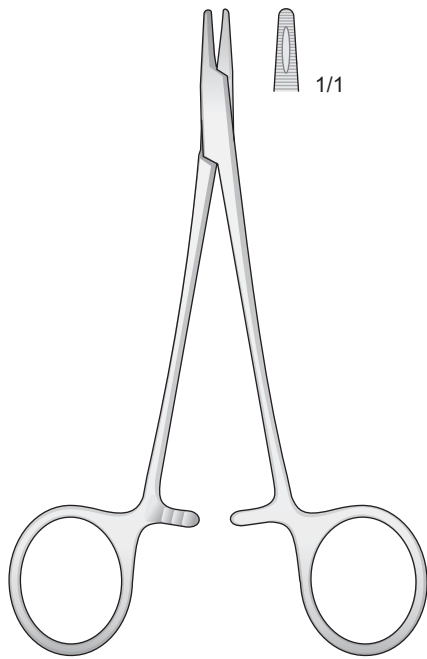

DERF  
1508-DL  
125 mm

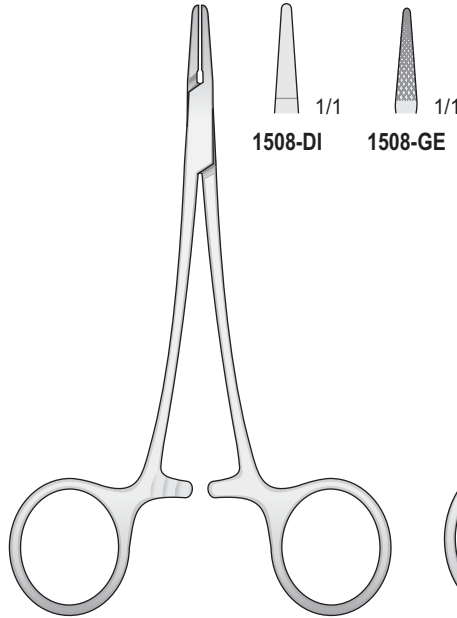

1508-DI/1508-GE  
120 mm

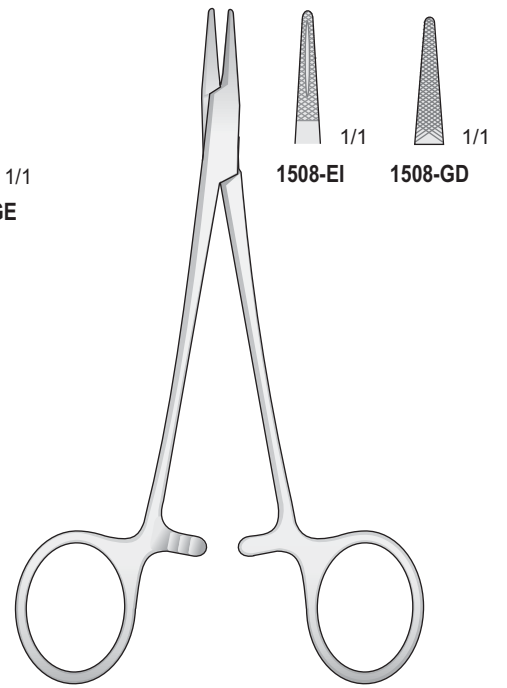

HALSEY  
1508-EI/1508-GD  
130 mm

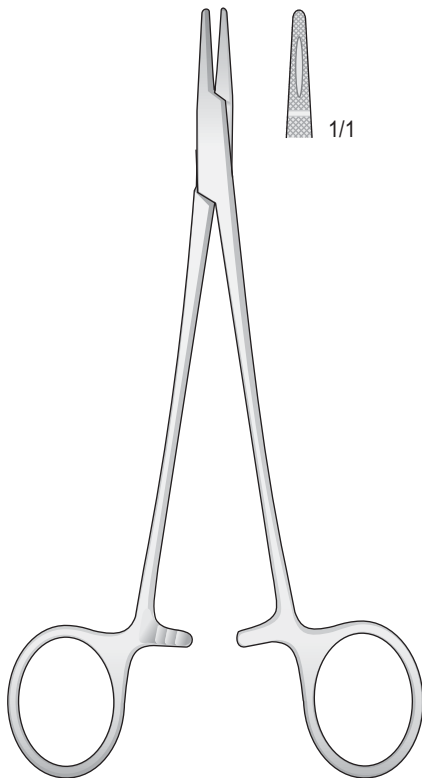

CRILE-WOOD  
1508-GB  
150 mm

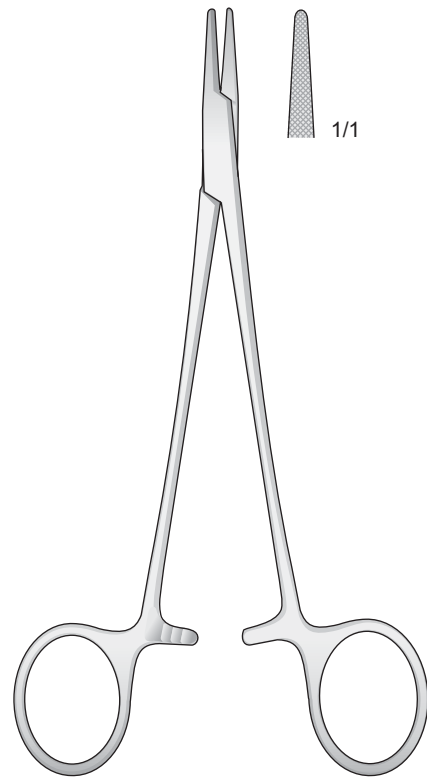

CRILE-MURRAY  
1508-GC  
150 mm

Port'aghi

Needle Holders

Nadelhalter

Porte aiguilles

Portaagujas

Modello fine - Delicate pattern - Schlankes Modell  
Modèle fin - Modelo delegado

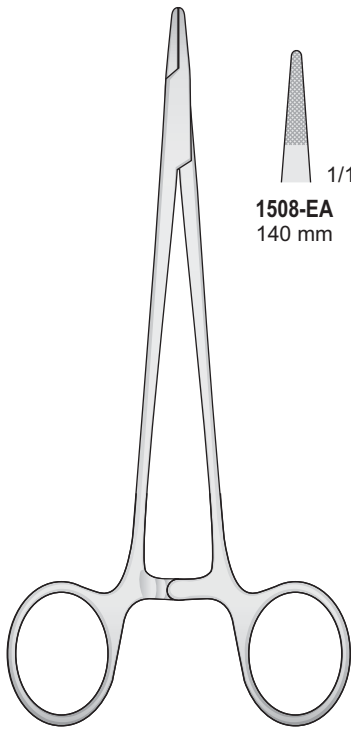

MAYO-HEGAR  
1508-EA/1508-EF

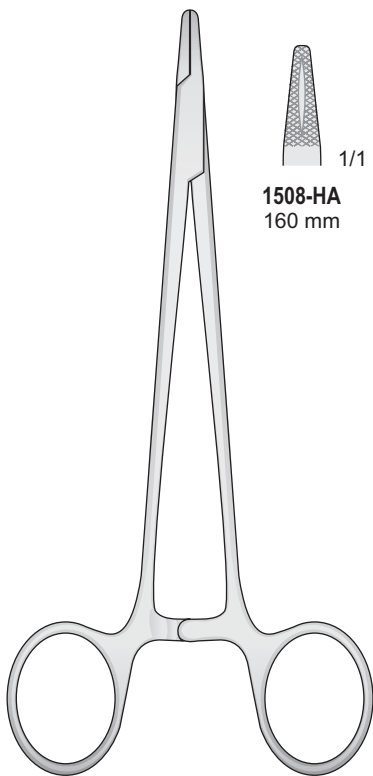
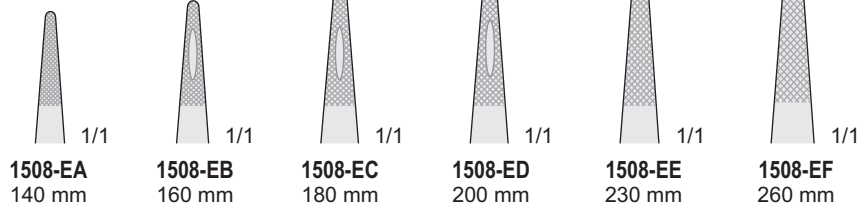

HEGAR  
1508-HA/1508-HI

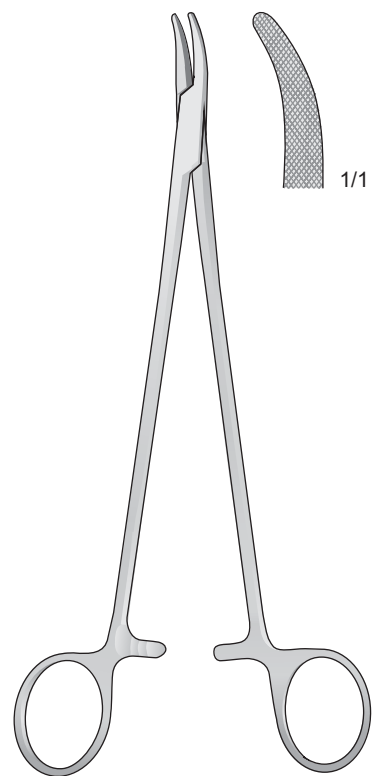
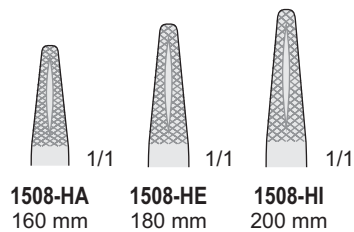

HEANEY (HEGAR)  
1508-FC  
200 mm

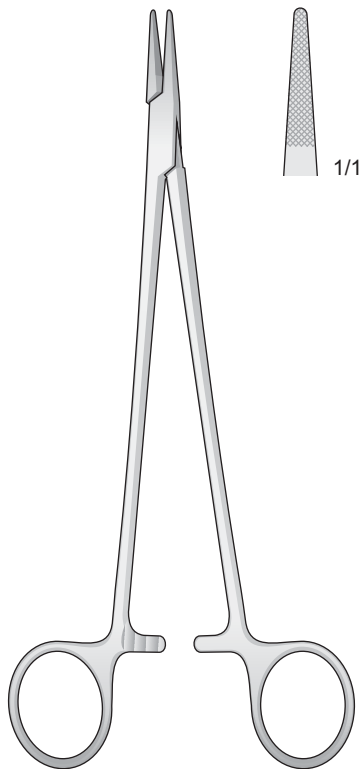

HEGAR-MAYO-SEELEY  
1508-EG  
200 mm

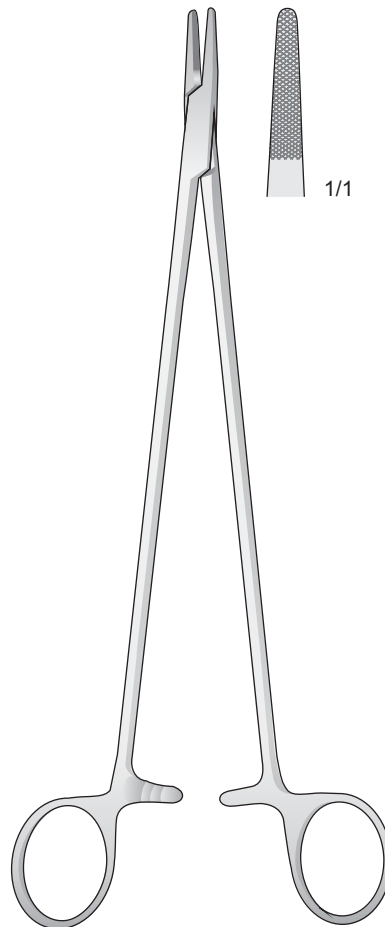

MASSON  
1508-EH  
270 mm

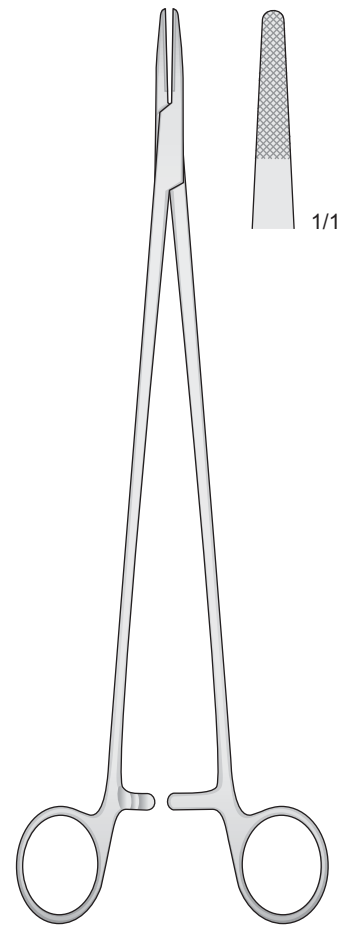

WANGENSTEEN  
1508-EL  
270 mm

Port'aghi con forbici - Needle holders with scissors - Nadelhalter mit Schere - Porte aiguilles avec ciseaux - Portaagujas con tijeras

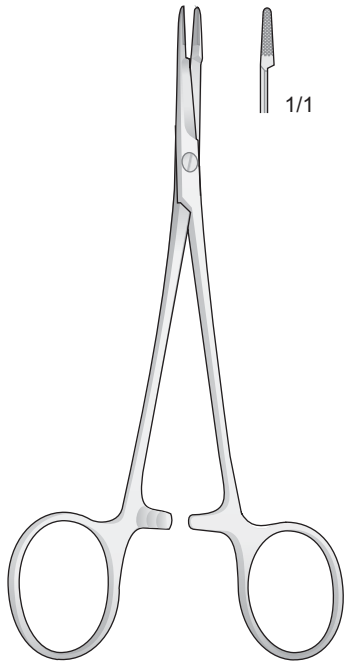

MINI-OLSEN-HEGAR  
0212-GB  
120 mm

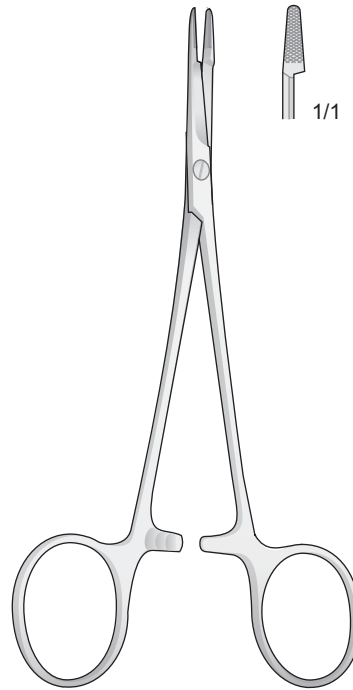

OLSEN-HEGAR  
0212-GC  
140 mm

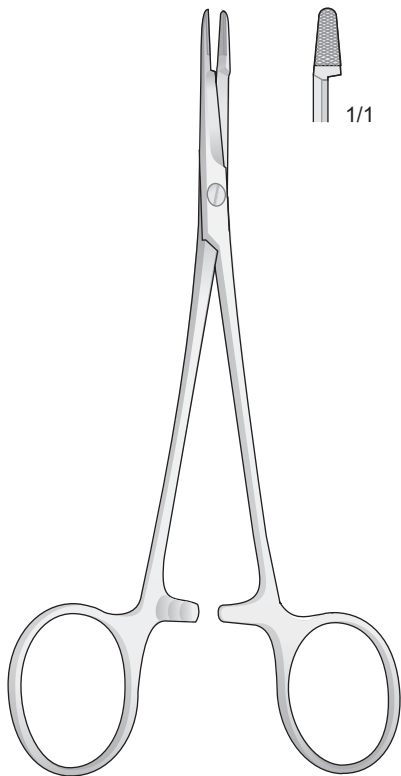

OLSEN-HEGAR  
0212-GD  
170 mm

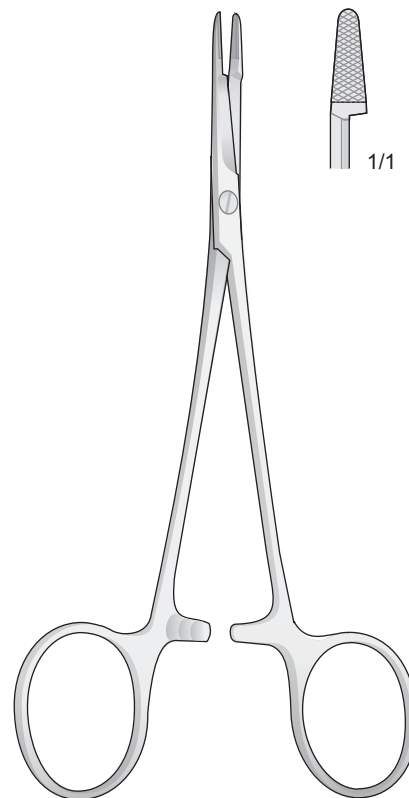

OLSEN-HEGAR  
0212-GE  
190 mm



Port'aghi

Needle Holders

Nadelhalter

Porte aiguilles

Portaagujas

Port'aghi con forbici - Needle holders with scissors - Nadelhalter mit Schere - Porte aiguilles avec ciseaux - Portaagujas con tijeras

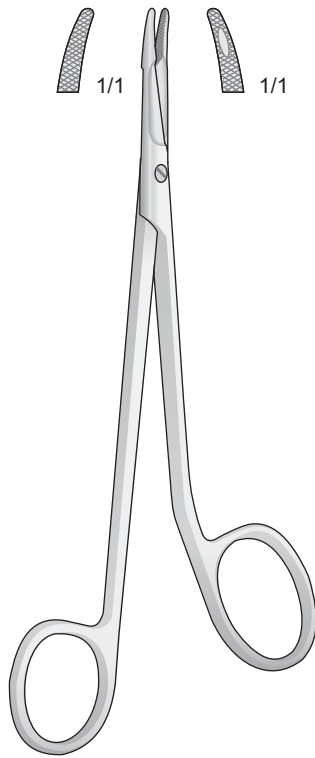

MINI-GILLIES  
1514-FL  
145 mm

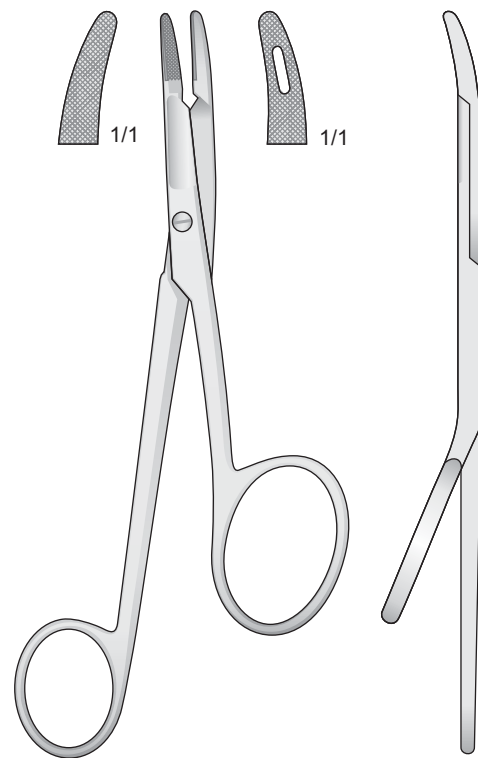

GILLIES  
1514-IL  
160 mm

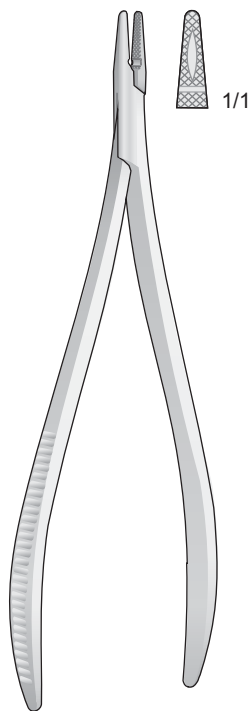

CRILE  
1514-DH  
150 mm

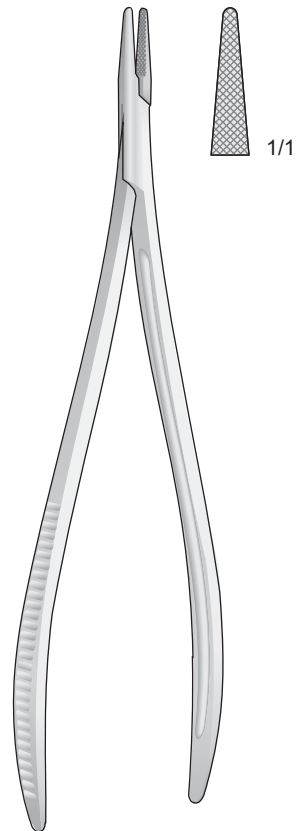

TÖNNIS  
1514-DI  
190 mm

Port'aghi

Needle Holders

Nadelhalter

Porte aiguilles

Portaagujas

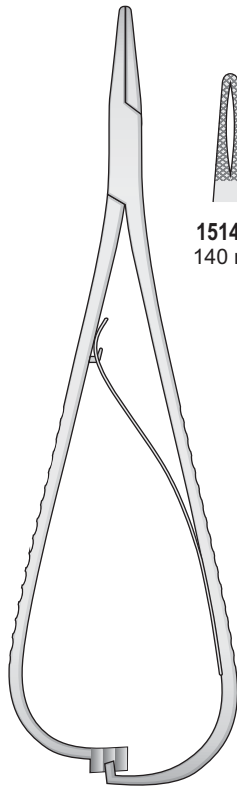

MATHIEU  
1514-HI/1514-LB

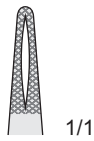

1514-HI  
140 mm

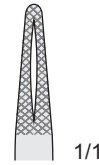

1514-IB  
170 mm

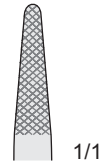

1514-GF  
170 mm

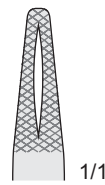

1514-LA  
200 mm

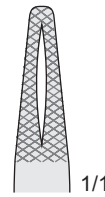

1514-LB  
240 mm

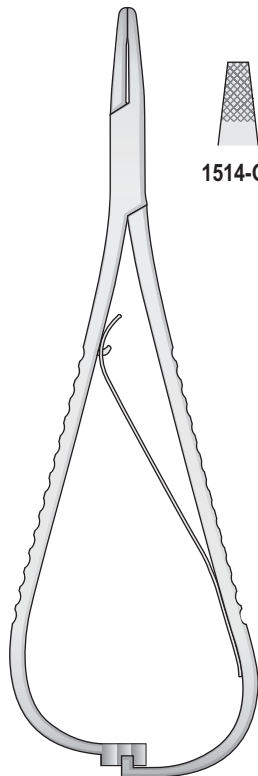

MATHIEU  
1514-GA/1514-IA  
140 mm



1514-GA

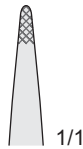

1514-HB

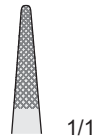

1514-HL

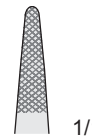

1514-IA

Port'aghi

Needle Holders

Nadelhalter

Porte aiguilles

Portaagujas

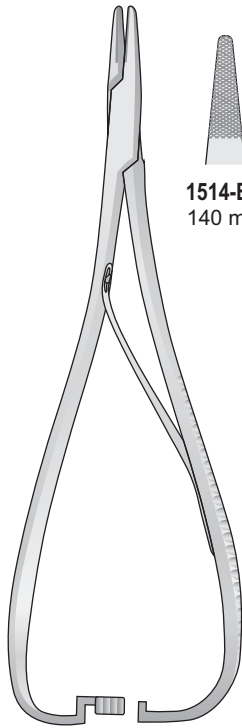

MATHIEU  
1514-EG/1514-EI

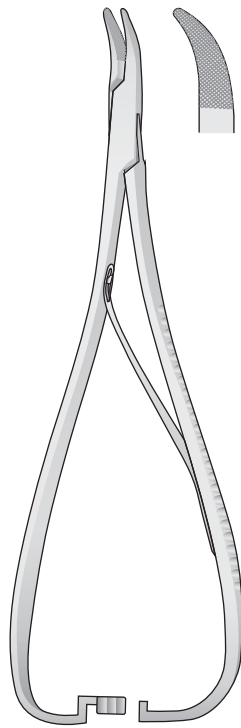
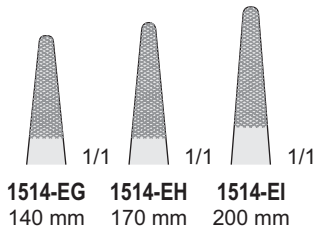

1514-EA  
140 mm

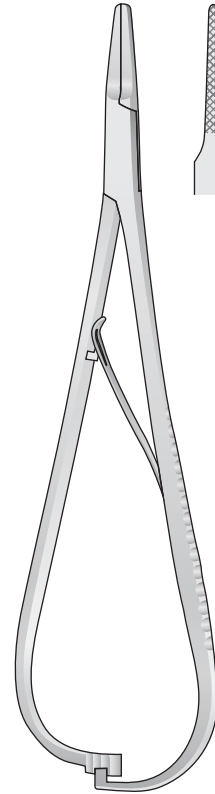
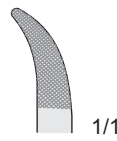

STILLE  
1514-HE  
170 mm

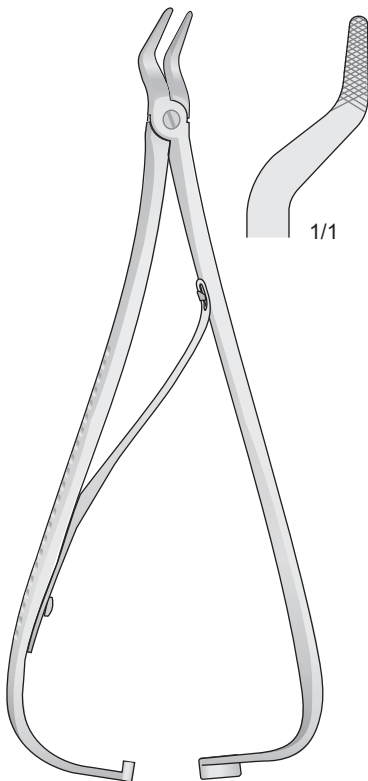
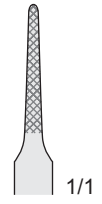

EISELBERG-MATHIEU  
1514-HF  
180 mm

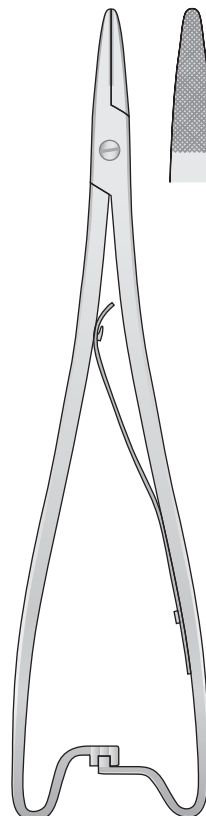
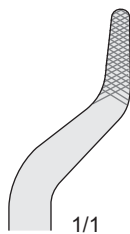

MATHIEU  
1514-GH  
200 mm

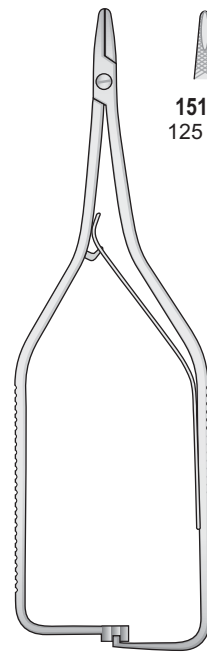
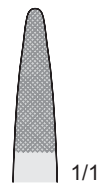

BOYNTON  
1514-II/1514-LE  
125 mm

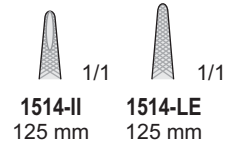

Port'aghi

Needle Holders

Nadelhalter

Porte aiguilles

Portaagujas

Portaghi con inserti al tungsteno - Needle Holders with tungsten-carbide inserts  
 Nadelhalter mit Hartmetalleinlagen - Porte aiguilles avec plaquettes en carbure de tungstène  
 Portaagujas con plaquitas de carburo de tungsteno

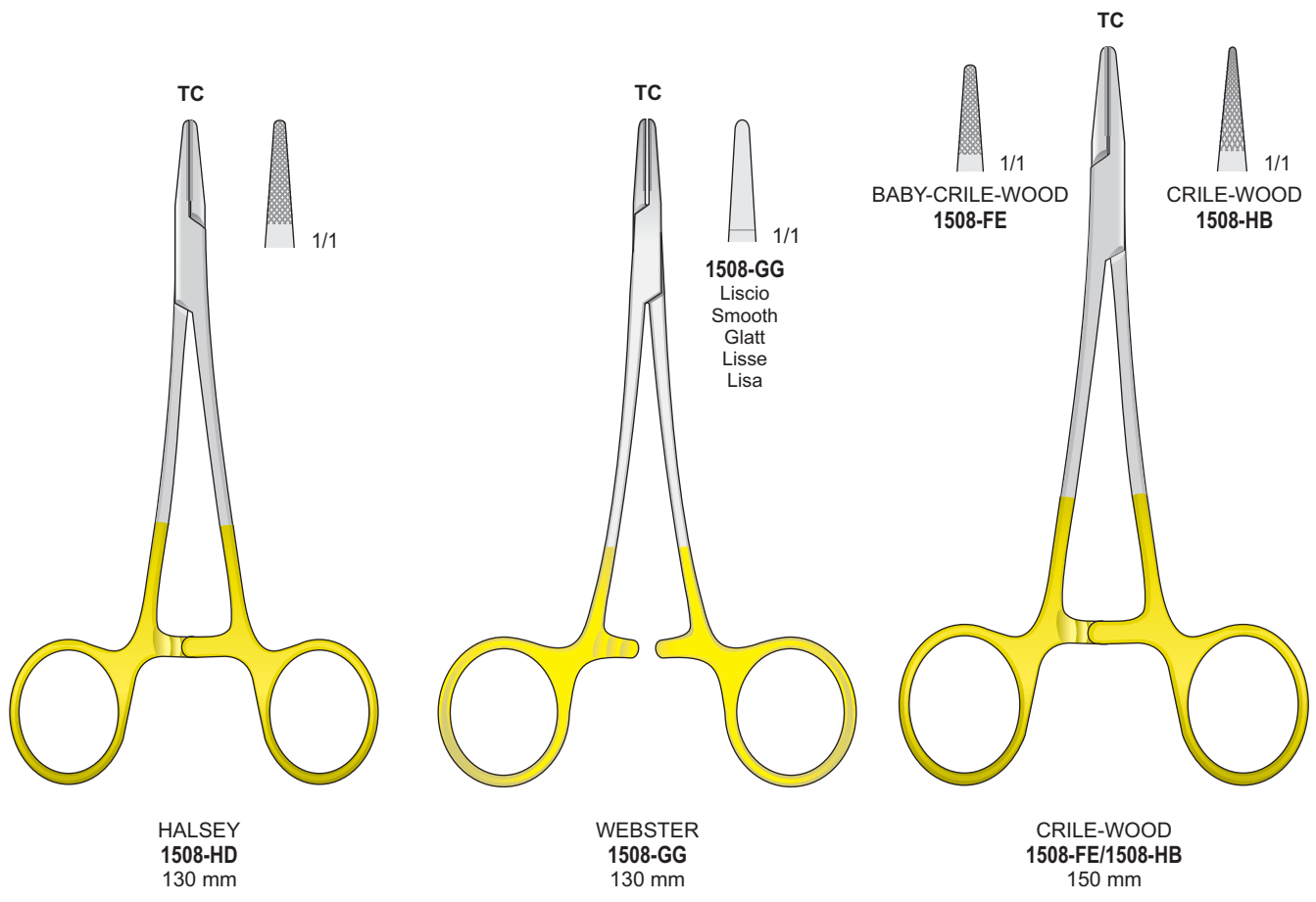
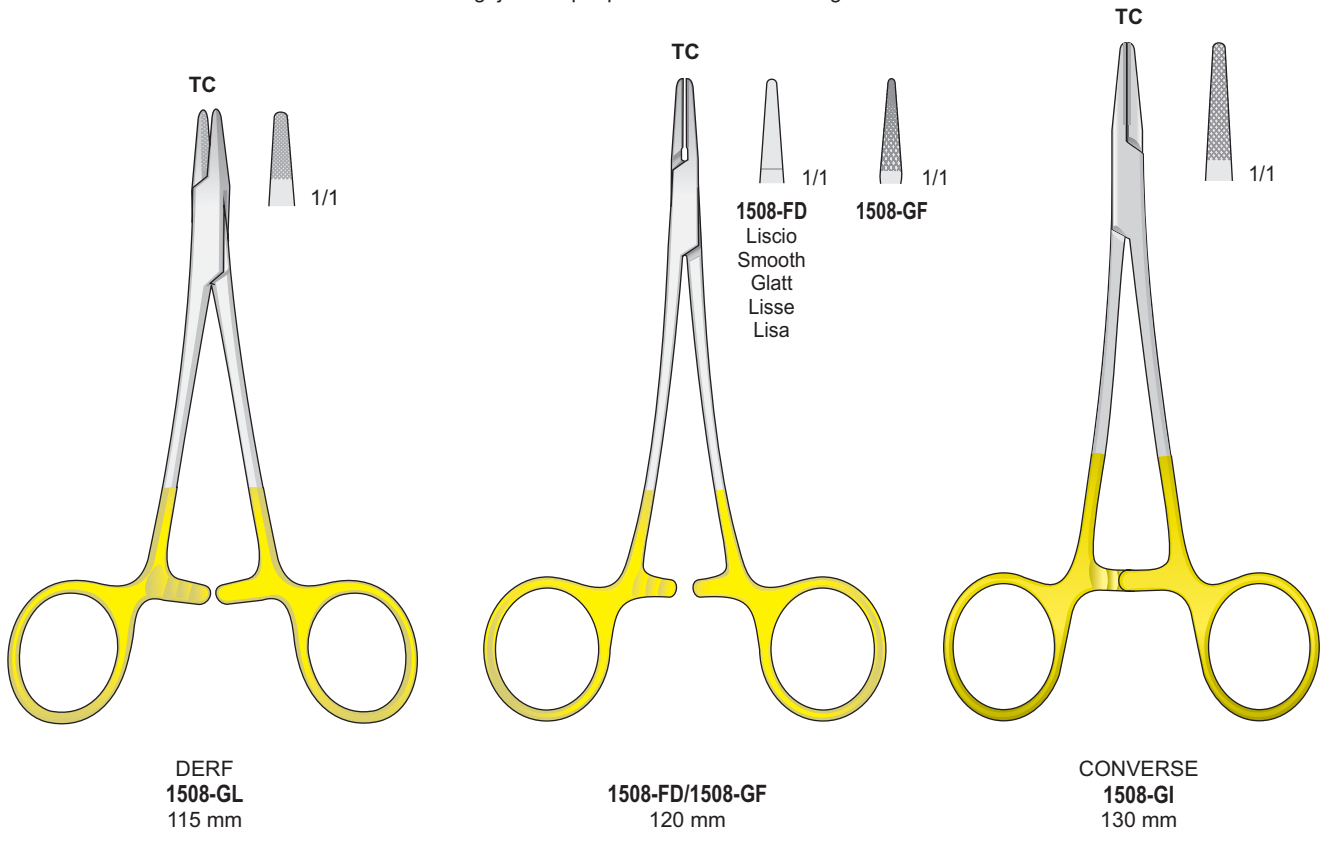

Port'aghi

Needle Holders

Nadelhalter

Porte aiguilles

Portaagujas

Portaghi con inserti al tungsteno - Needle Holders with tungsten-carbide inserts  
 Nadelhalter mit Hartmetalleinlagen - Porte aiguilles avec plaquettes en carbure de tungstène  
 Portaagujas con plaquitas de carburo de tungsteno

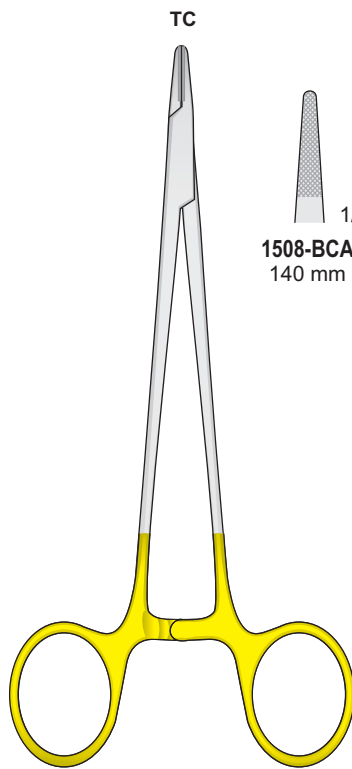

MAYO-HEGAR  
1508-BCA/1508-BCF

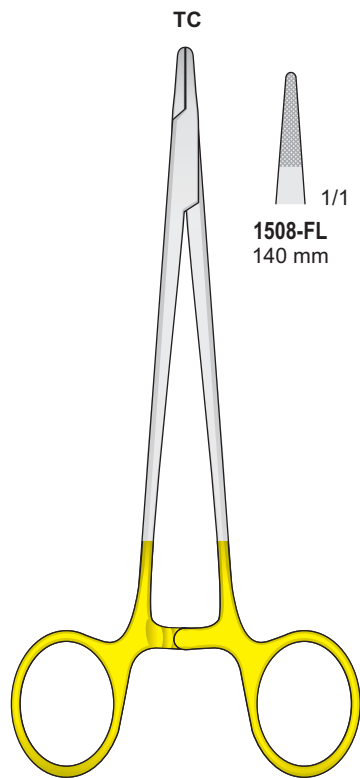
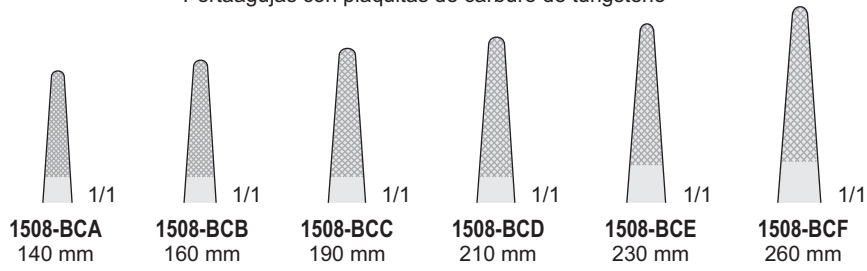

HEGAR  
1508-FL/1508-HG

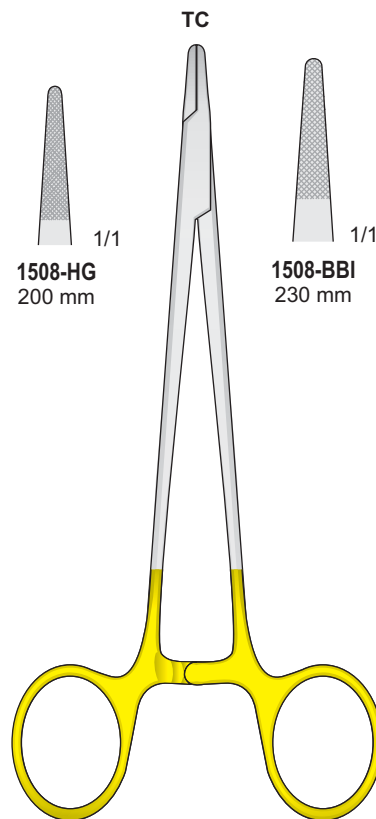
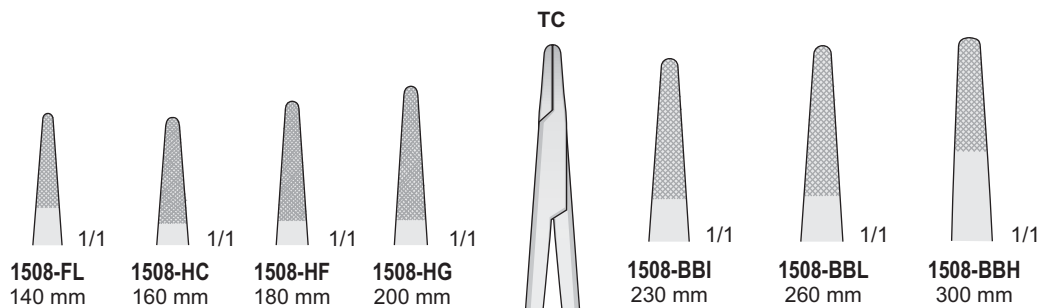

MAYO-HEGAR  
1508-BBH/1508-BBL

Port'aghi

Needle Holders

Nadelhalter

Porte aiguilles

Portaagujas

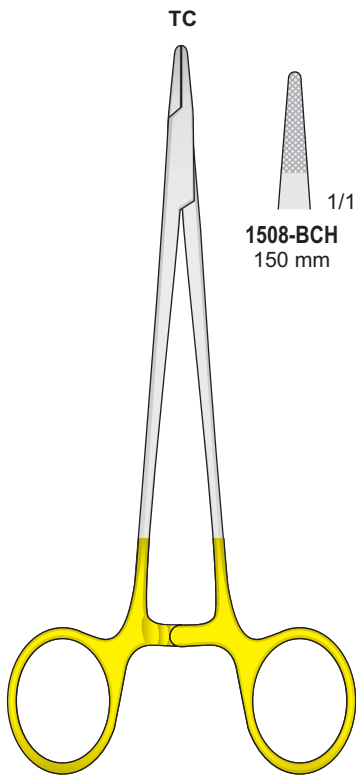

MAYO-HEGAR-FINO  
1508-BCH/1508-BCL

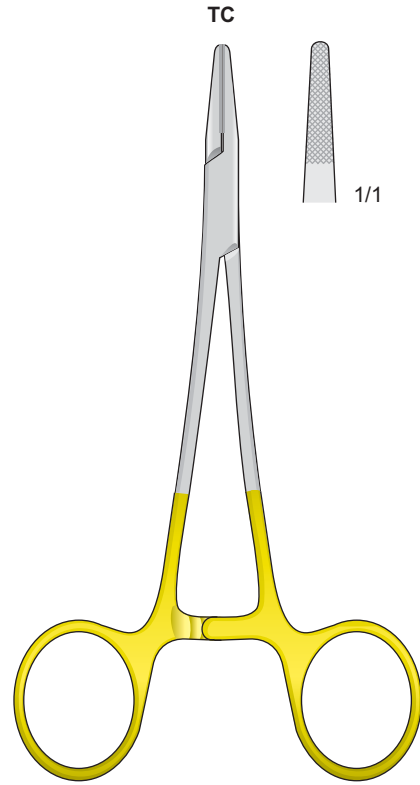
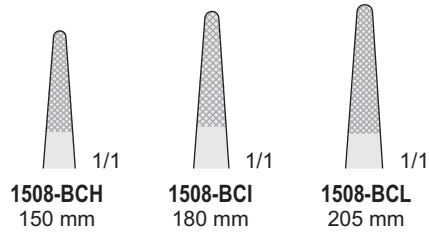

CRILE-WOOD  
1508-HH  
180 mm

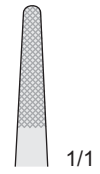

Port'aghi, pinze per fili d'acciaio  
Needle holder, wire forceps  
Nadelhalter, Draht-Zangen  
Porte-aiguilles, pinces à saisir  
Porta agujas, pinzas para hilos

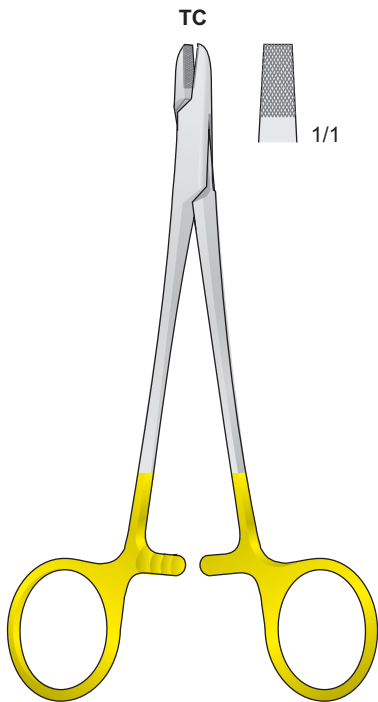

1508-FI  
150 mm

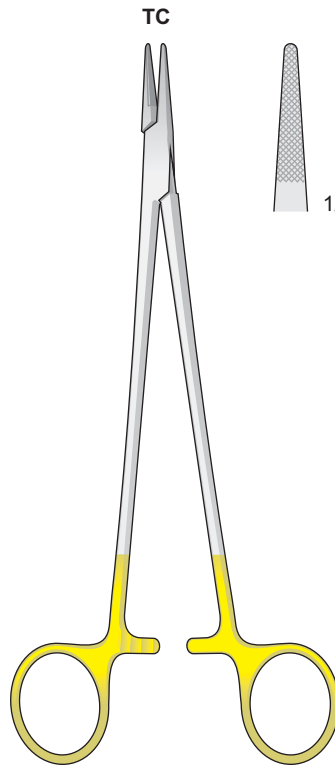
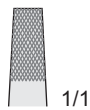

HEGAR-MAYO-SEELEY  
1508-BDA  
200 mm

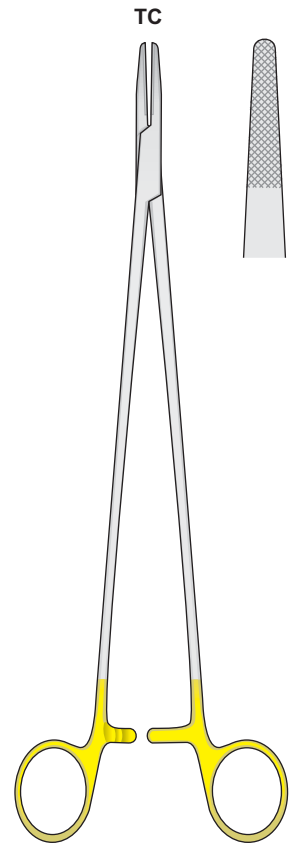
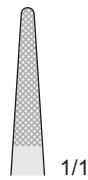

WANGENSTEEN  
1508-BDB  
270 mm

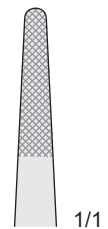

Port'aghi con forbici - Needle holders with scissors - Nadelhalter mit Schere - Porte aiguilles avec ciseaux - Portaagujas con tijeras

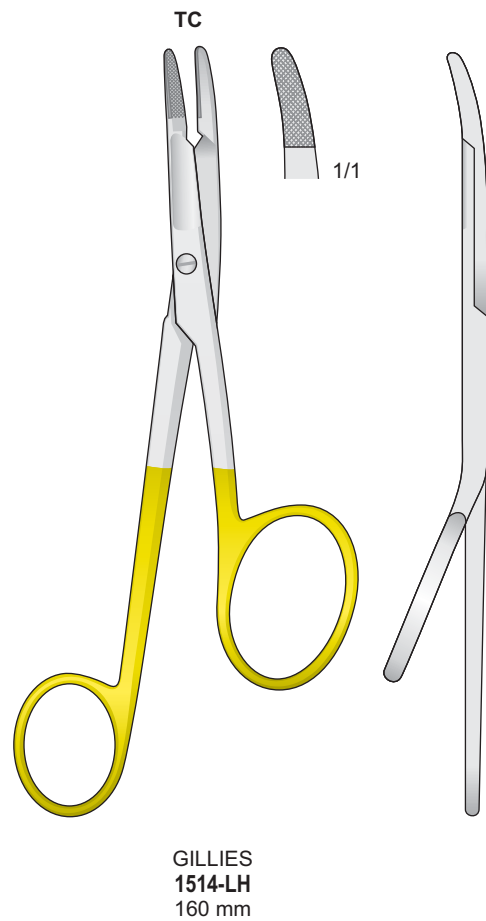
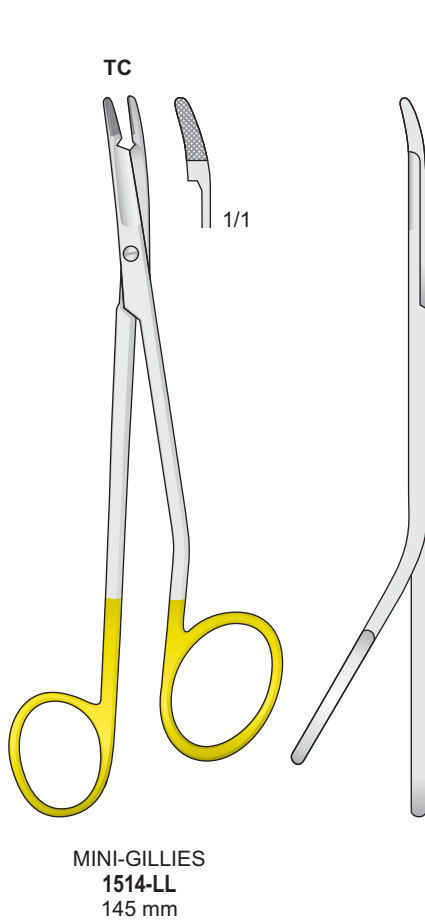
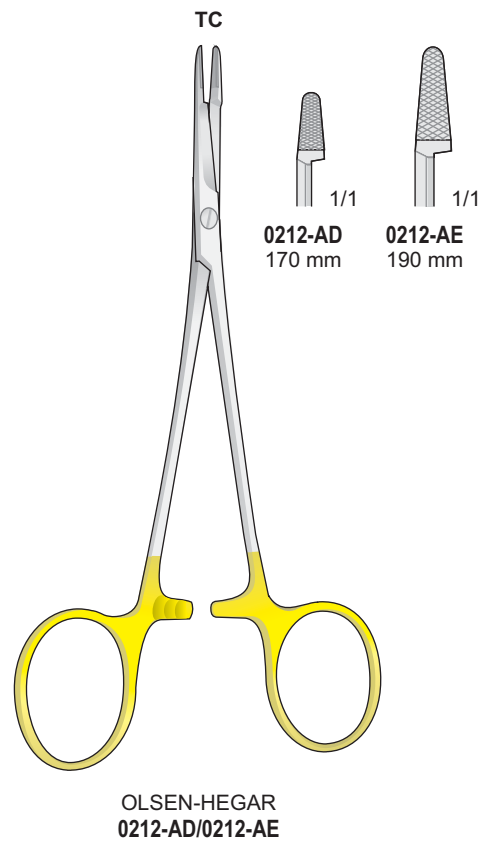
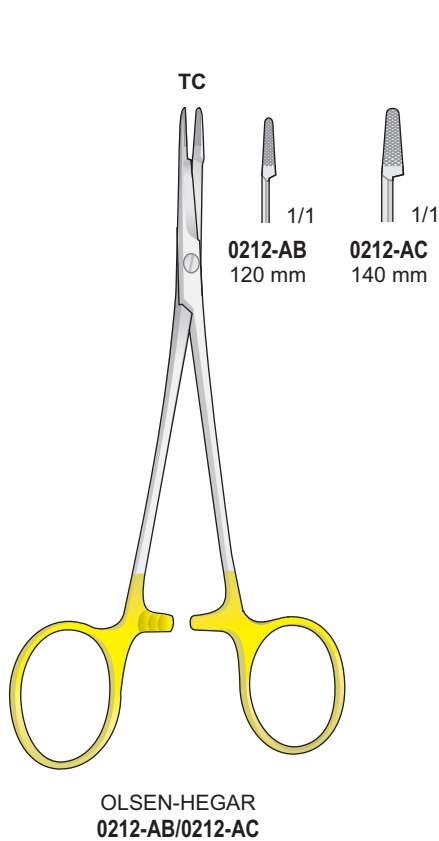

Port'aghi

Needle Holders

Nadelhalter

Porte aiguilles

Portaagujas

Portaghi con inserti al tungsteno - Needle Holders with tungsten-carbide inserts  
 Nadelhalter mit Hartmetalleinlagen - Porte aiguilles avec plaquettes en carbure de tungstène  
 Portaagujas con plaquitas de carburo de tungsteno

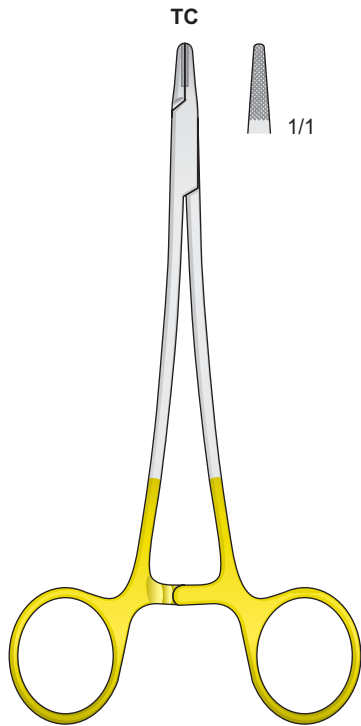

**1508-HL**  
145 mm

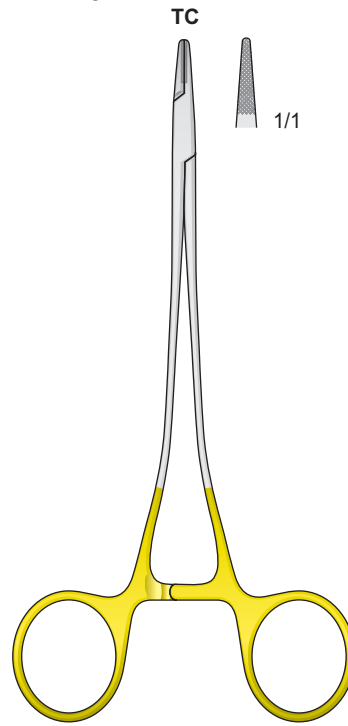

**1508-IF**  
150 mm

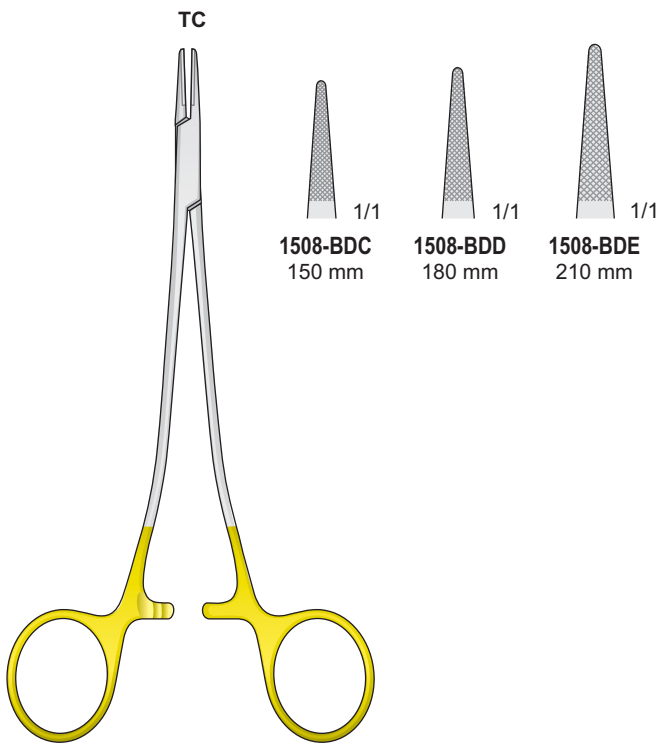

**SAROT**  
**1508-BDC/1508-BDE**

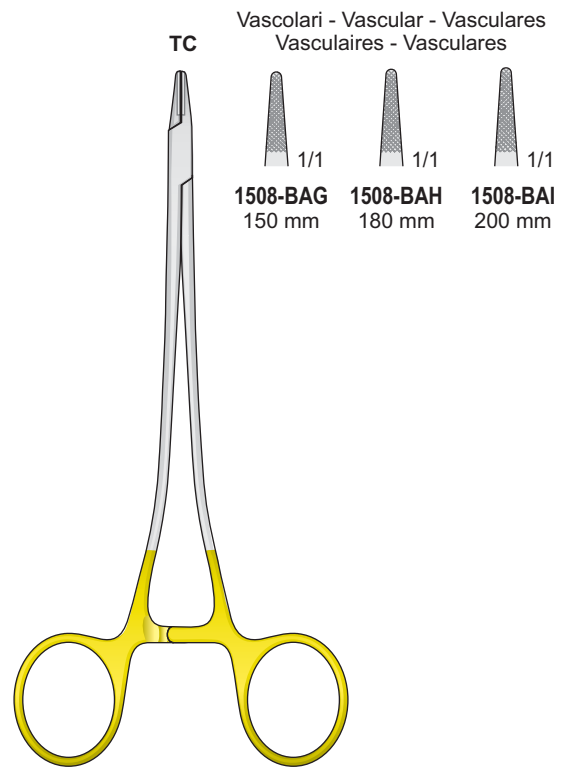

**SWEDISH MOD.**  
**1508-BAG/1508-BAI**



Portaghi con inserti al tungsteno - Needle Holders with tungsten-carbide inserts  
 Nadelhalter mit Hartmetalleinlagen - Porte aiguilles avec plaquettes en carbure de tungstène  
 Portaagujas con plaquitas de carburo de tungsteno

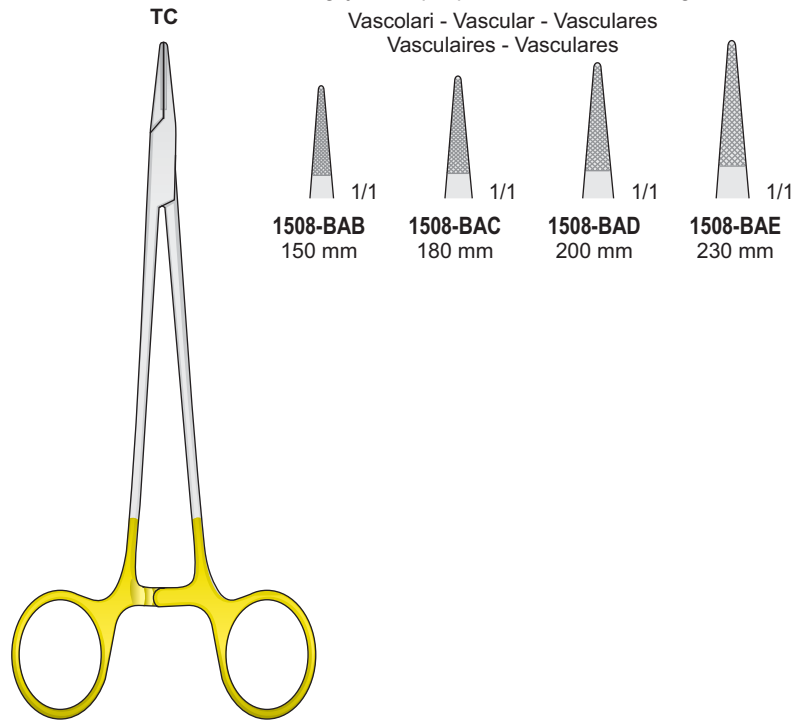

MICRO-VASCULAR  
 1508-BAB/1508-BAE

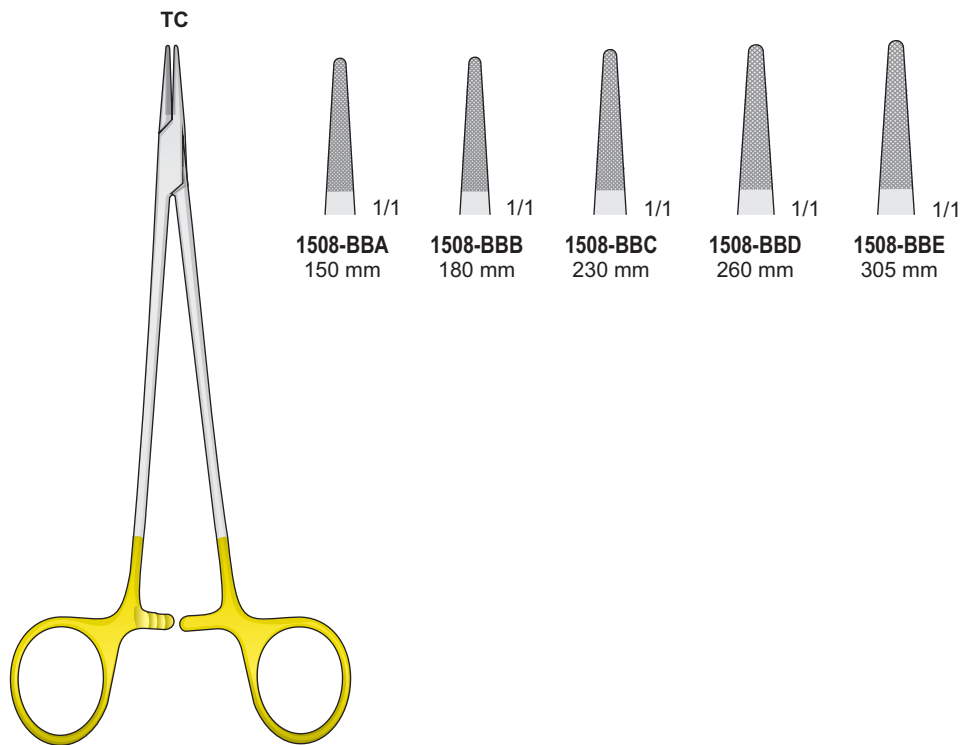

DE BAKEY  
 1508-BBA/1508-BBE

Port'aghi

Needle Holders

Nadelhalter

Porte aiguilles

Portaaguja

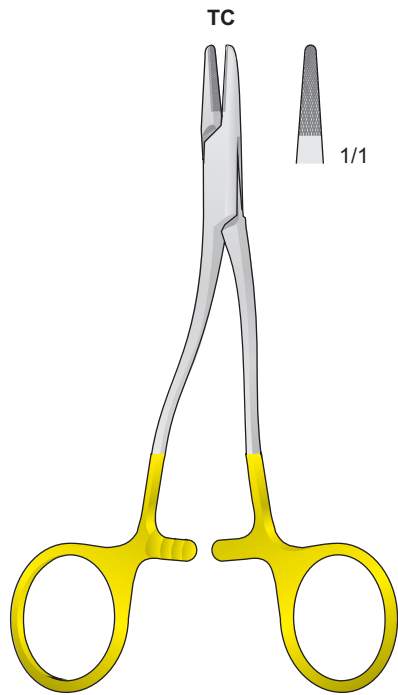

**KILNER**  
**1508-LI**  
130 mm

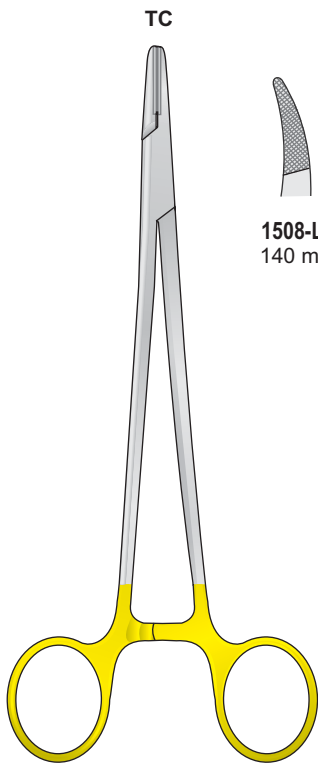

**MAYO-HEGAR-HEANEY**  
**1508-LF/1508-LH**

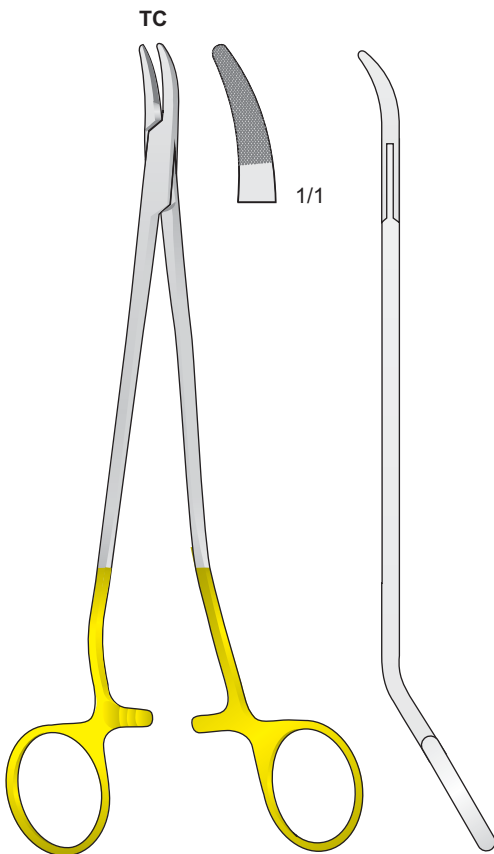
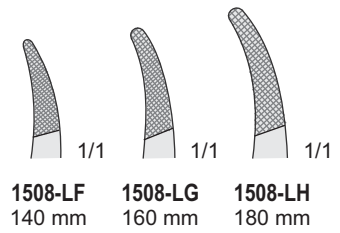

**S-FORMING**  
**1508-IL**  
200 mm

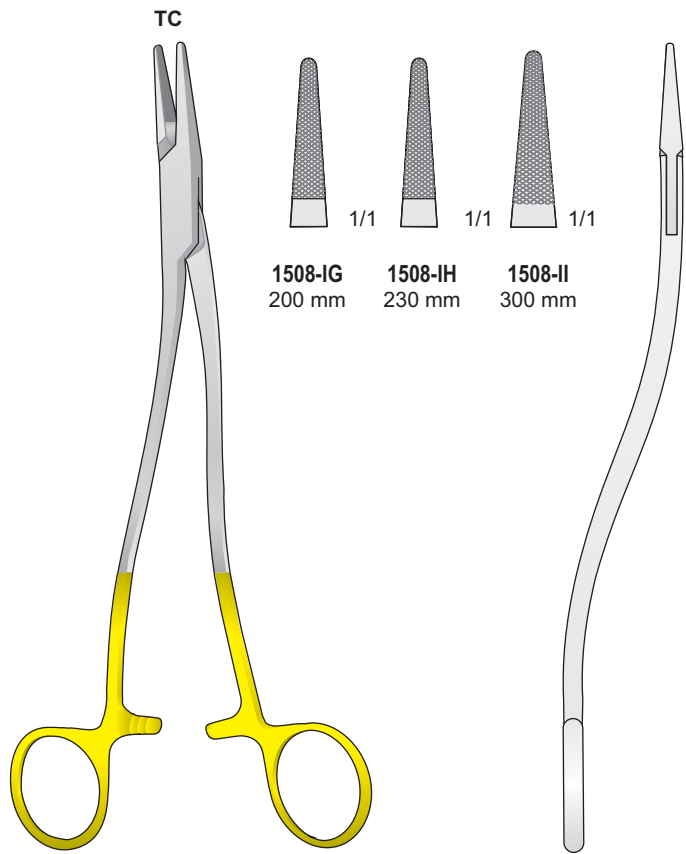

**WERTHEIM**  
**1508-IG/1508-II**

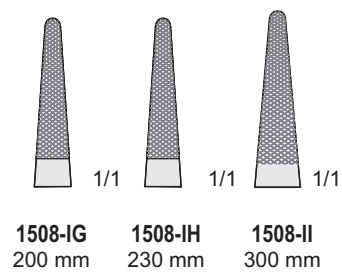

Portaghi con inserti al tungsteno - Needle Holders with tungsten-carbide inserts  
 Nadelhalter mit Hartmetalleinlagen - Porte aiguilles avec plaquettes en carbure de tungstène  
 Portaagujas con plaquitas de carburo de tungsteno

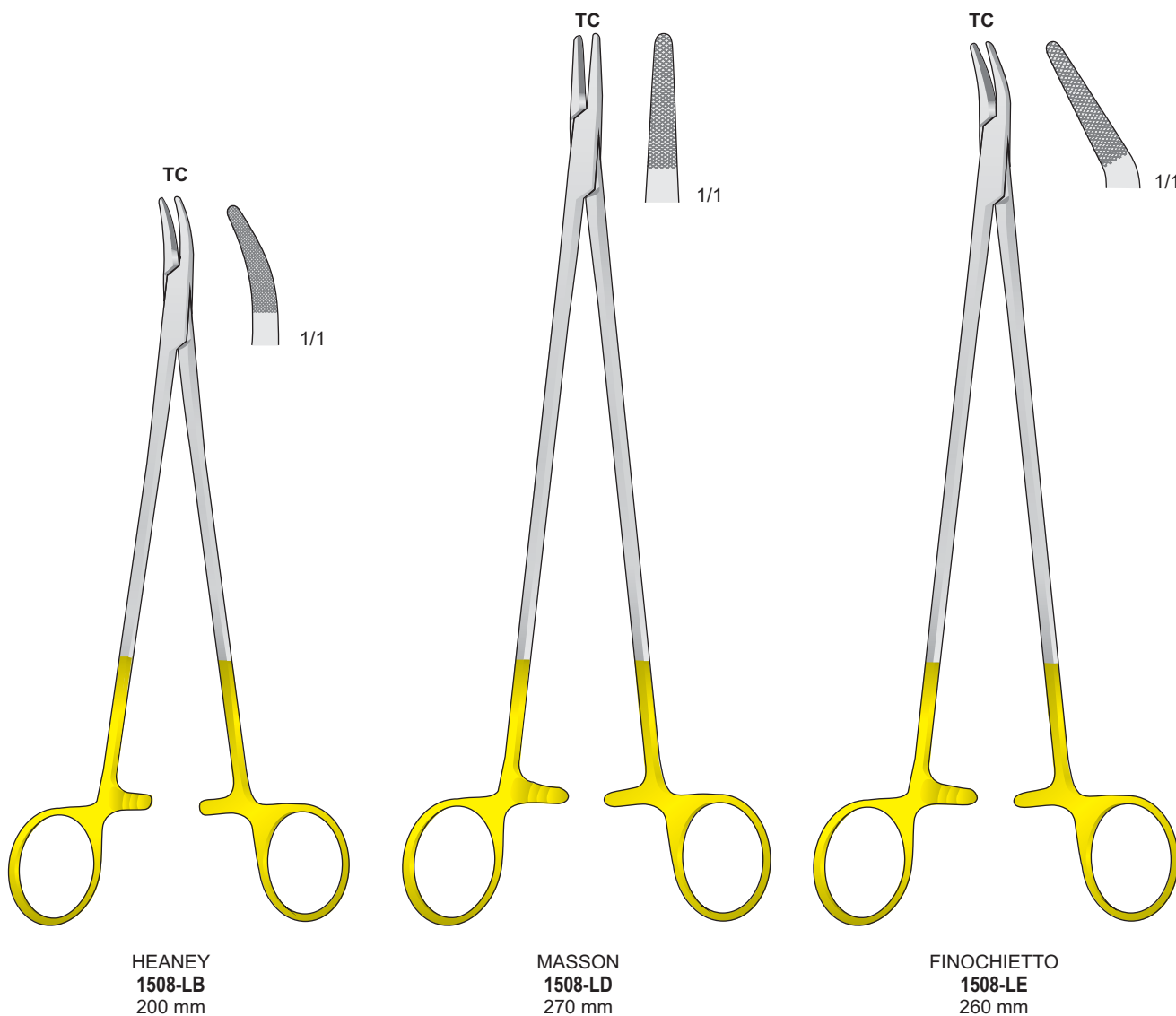

Port'aghi

Needle Holders

Nadelhalter

Porte aiguilles

Portaagujas

Portaghi con inserti al tungsteno - Needle Holders with tungsten-carbide inserts  
 Nadelhalter mit Hartmetalleinlagen - Porte aiguilles avec plaquettes en carbure de tungstène  
 Portaagujas con plaquitas de carburo de tungsteno

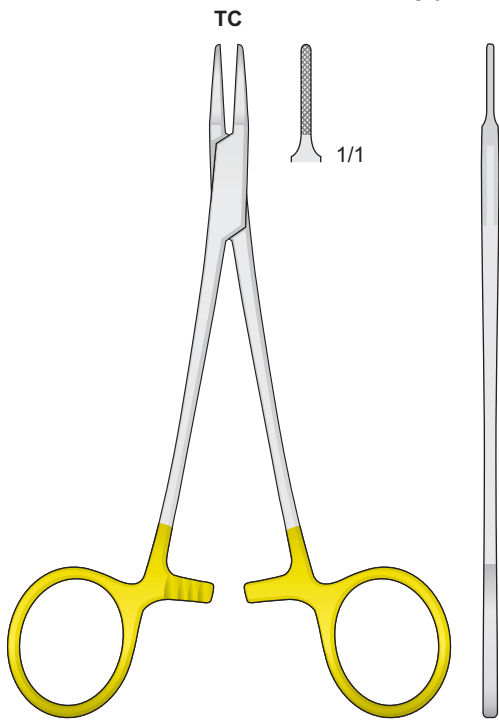

**MICRO-RYDER**  
**1508-ID**  
 140 mm

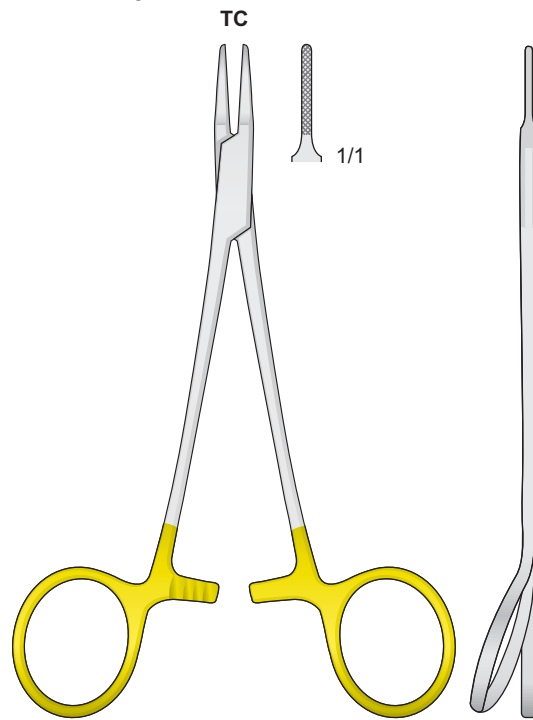

**1508-IE**  
 140 mm

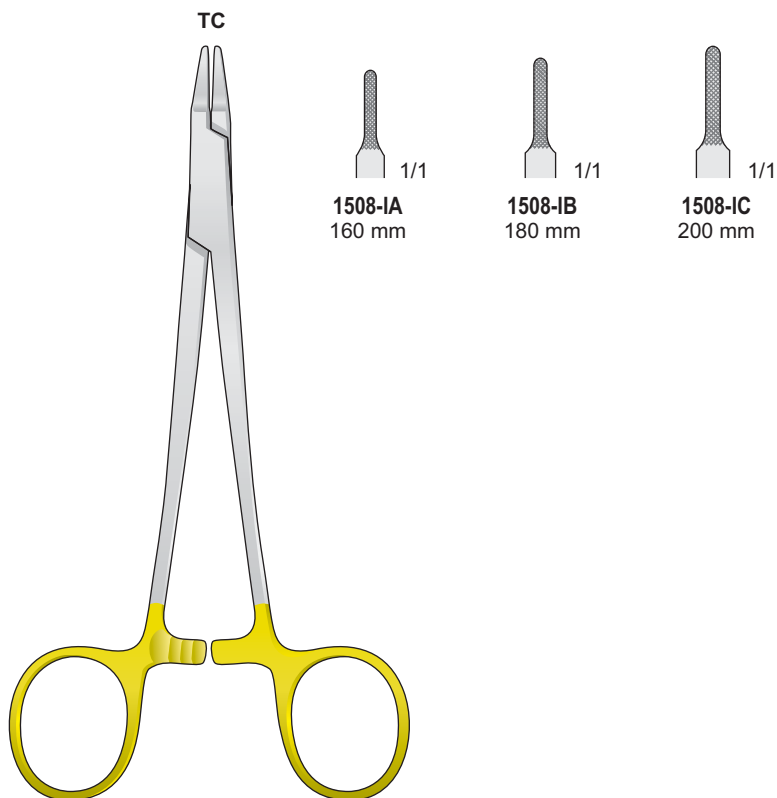

**RYDER**  
**1508-IA/1508-IC**

Port'aghi

Needle Holders

Nadelhalter

Porte aiguilles

Portaagujas

Portaghi con inserti al tungsteno - Needle Holders with tungsten-carbide inserts  
 Nadelhalter mit Hartmetalleinlagen - Porte aiguilles avec plaquettes en carbure de tungstène  
 Portaagujas con plaquitas de carburo de tungsteno

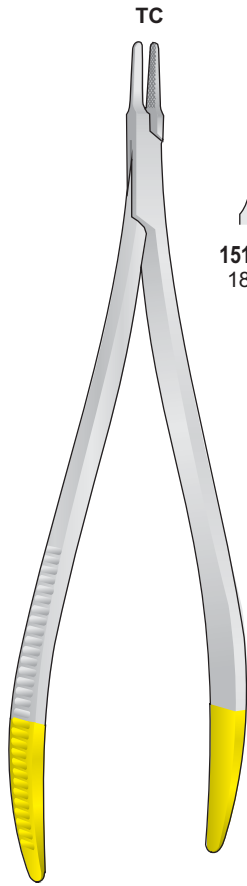

LANGENBECK-RYDER  
1514-BCA/1514-BCB

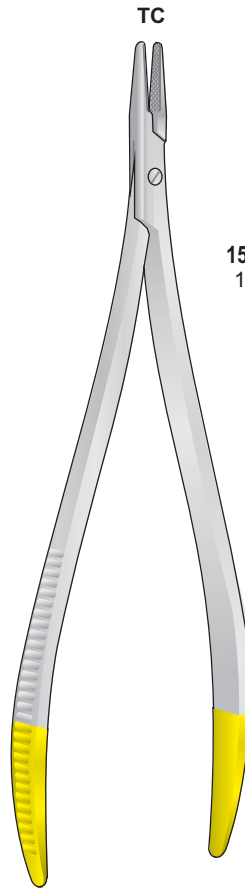
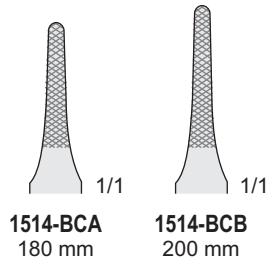

LANGENBECK  
1514-BCC/1514-BCF

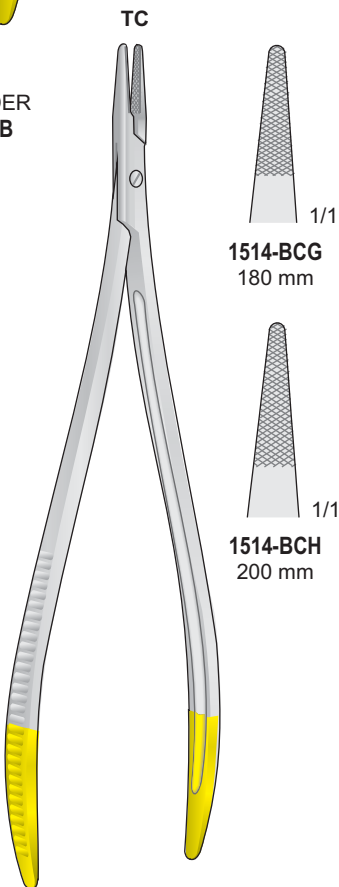
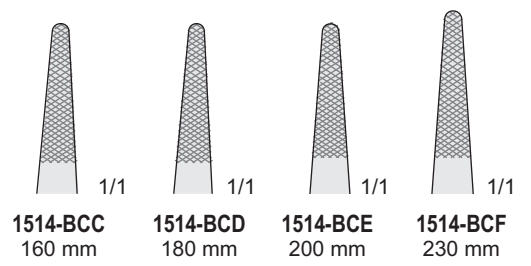

TÖNNIS  
1514-BCG/1514-BCH

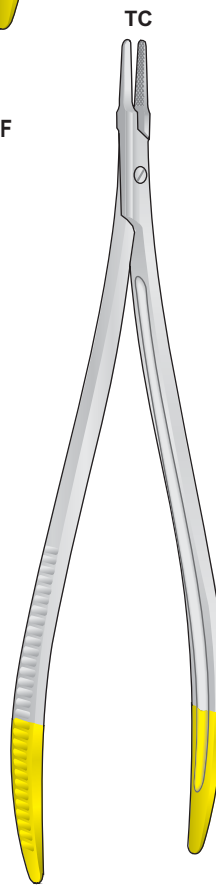

TÖNNIS-RYDER  
1514-BCI/1514-BCL

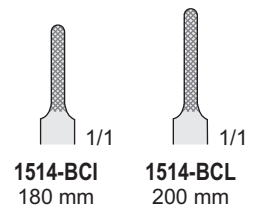

Port'aghi

Needle Holders

Nadelhalter

Porte aiguilles

Portaaguja

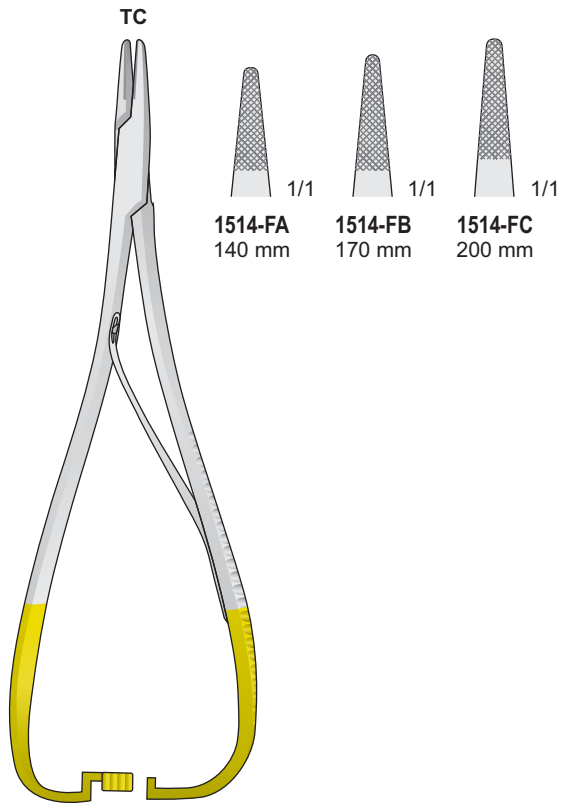

MATHIEU  
1514-FA/1514-FC

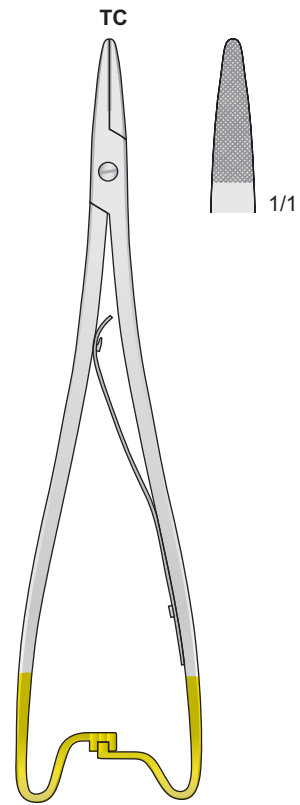

MATHIEU  
1514-GG  
200 mm

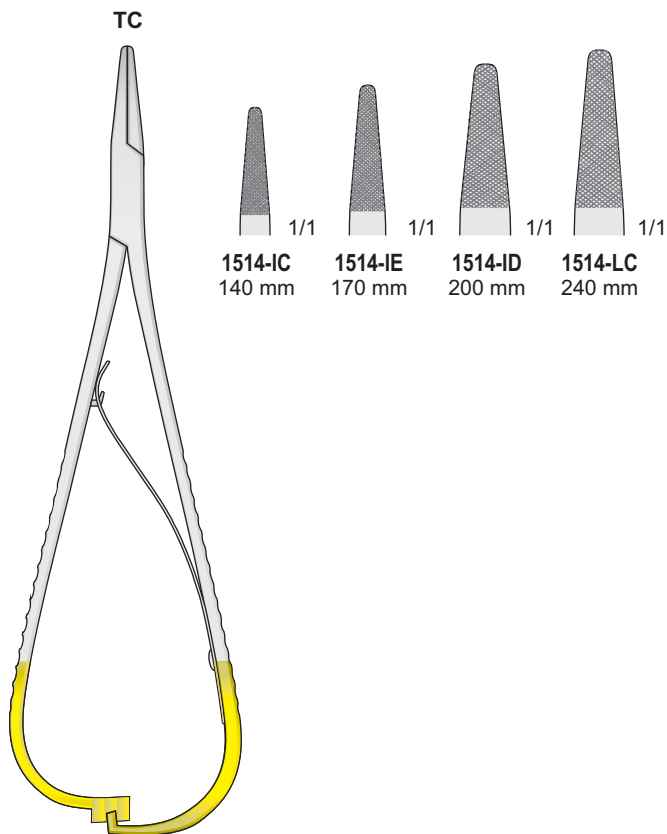

MATHIEU  
1514-IC/1514-LC

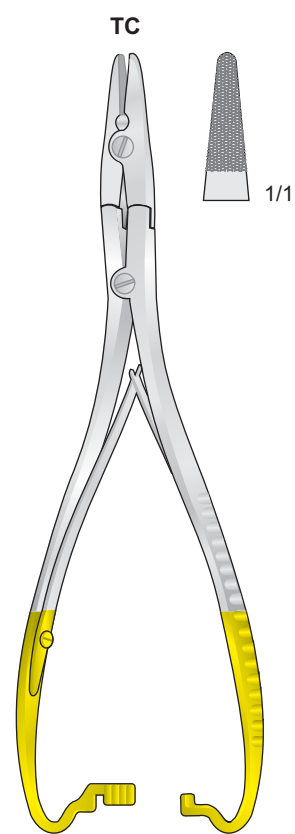

1514-BBA  
200 mm

Portaghi con inserti al tungsteno - Needle Holders with tungsten-carbide inserts  
 Nadelhalter mit Hartmetalleinlagen - Porte aiguilles avec plaquettes en carbure de tungstène  
 Portaagujas con plaquitas de carburo de tungsteno

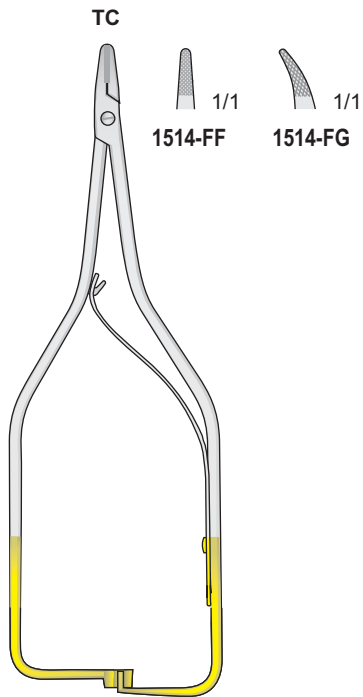

BOYNTON  
 1514-FF/1514-FG  
 120 mm

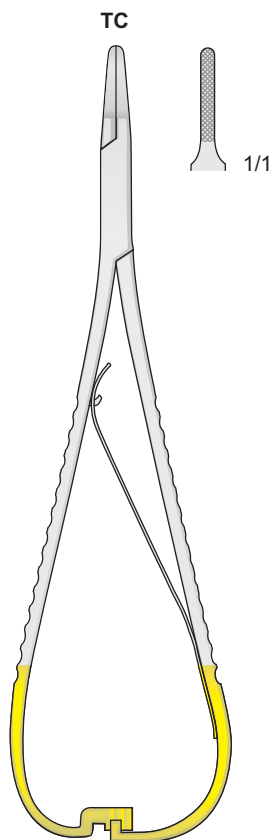

LICHTENBERG  
 1514-IG  
 175 mm

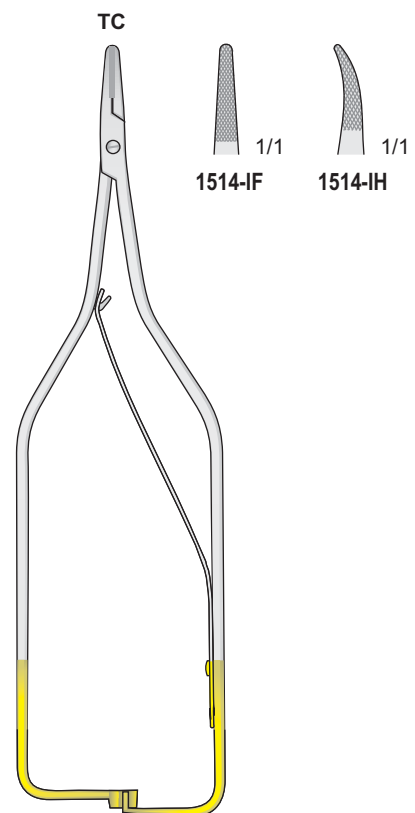

ARRUGA  
 1514-IF/1514-IH  
 160 mm

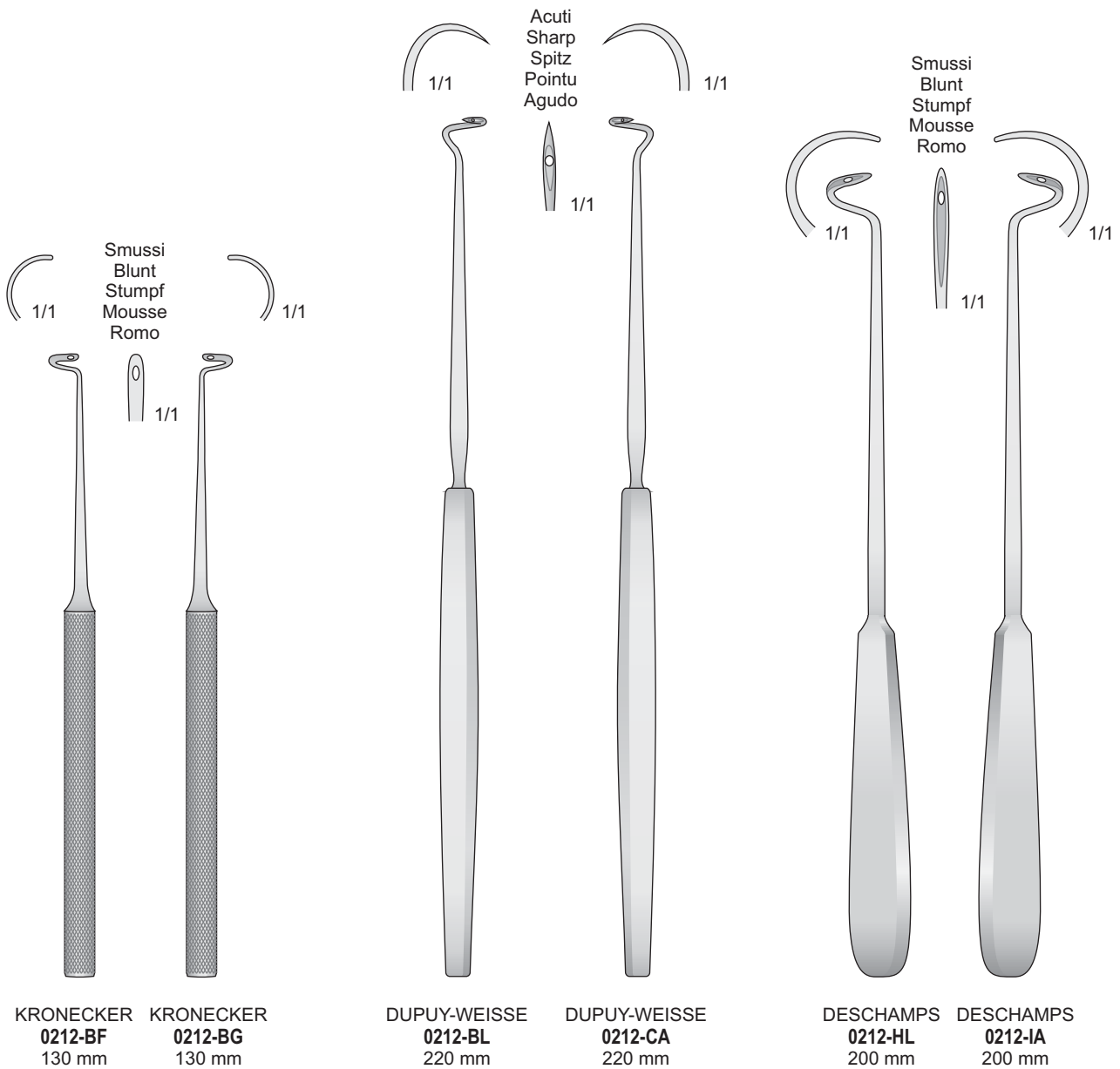



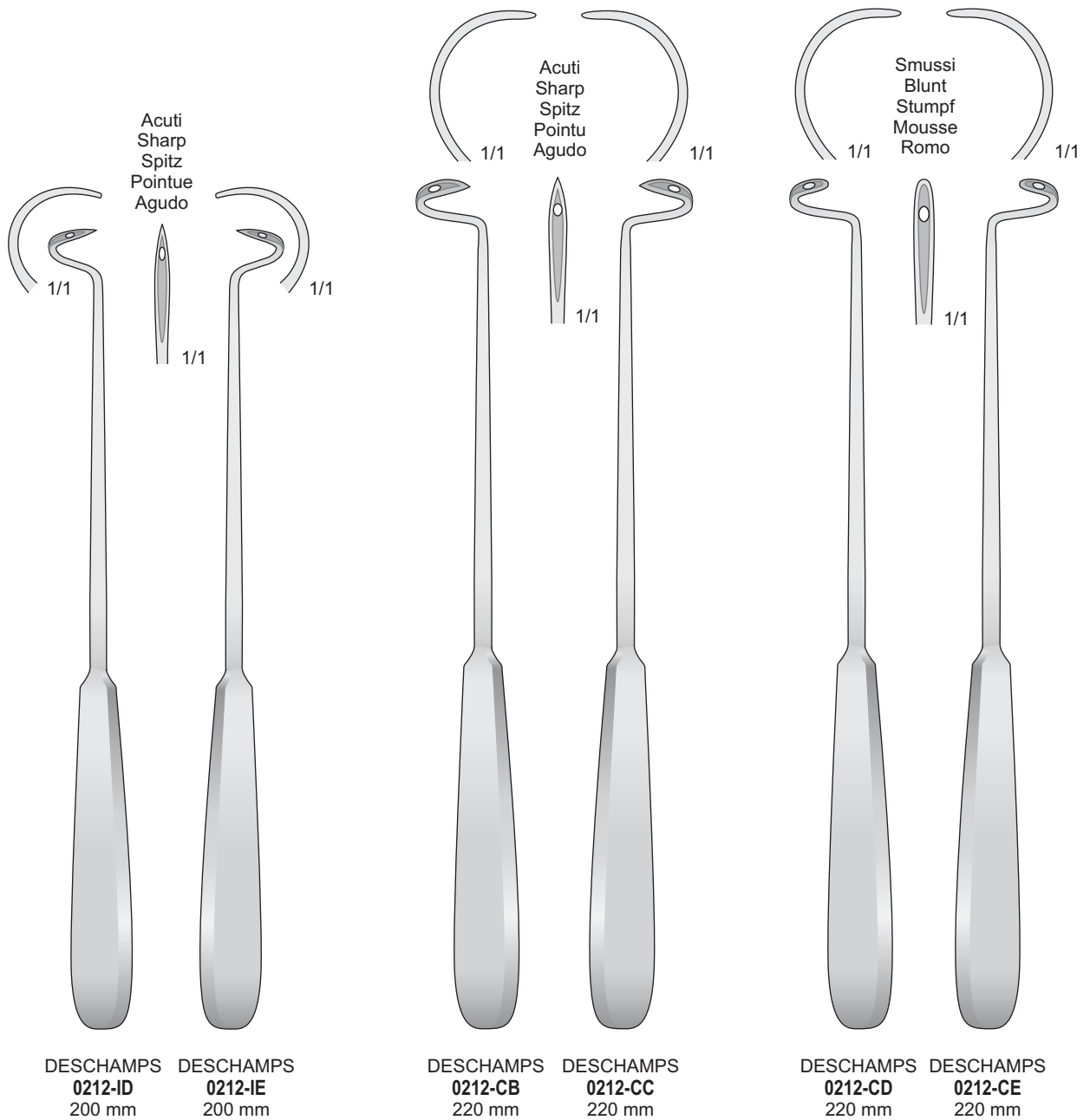

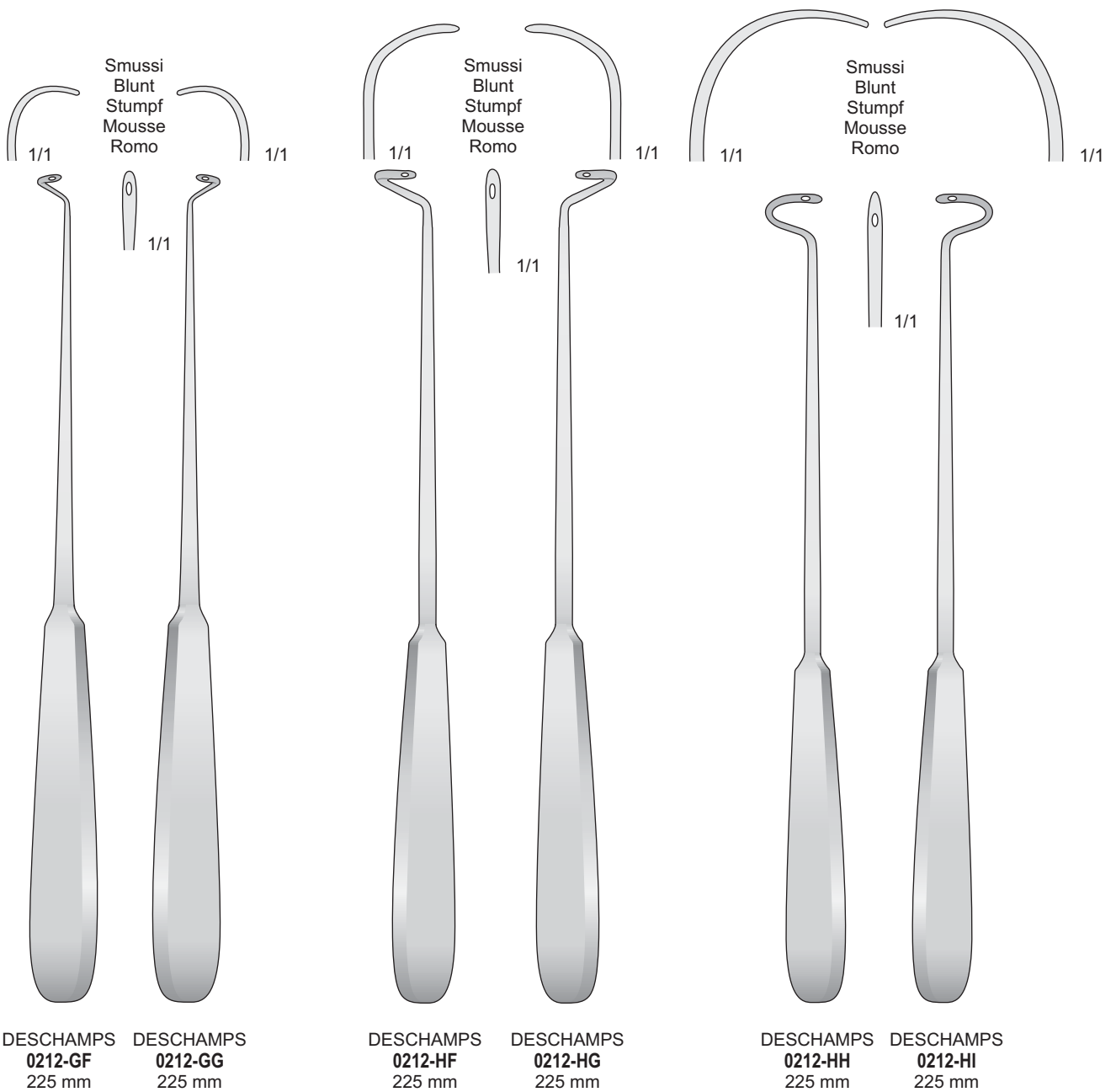

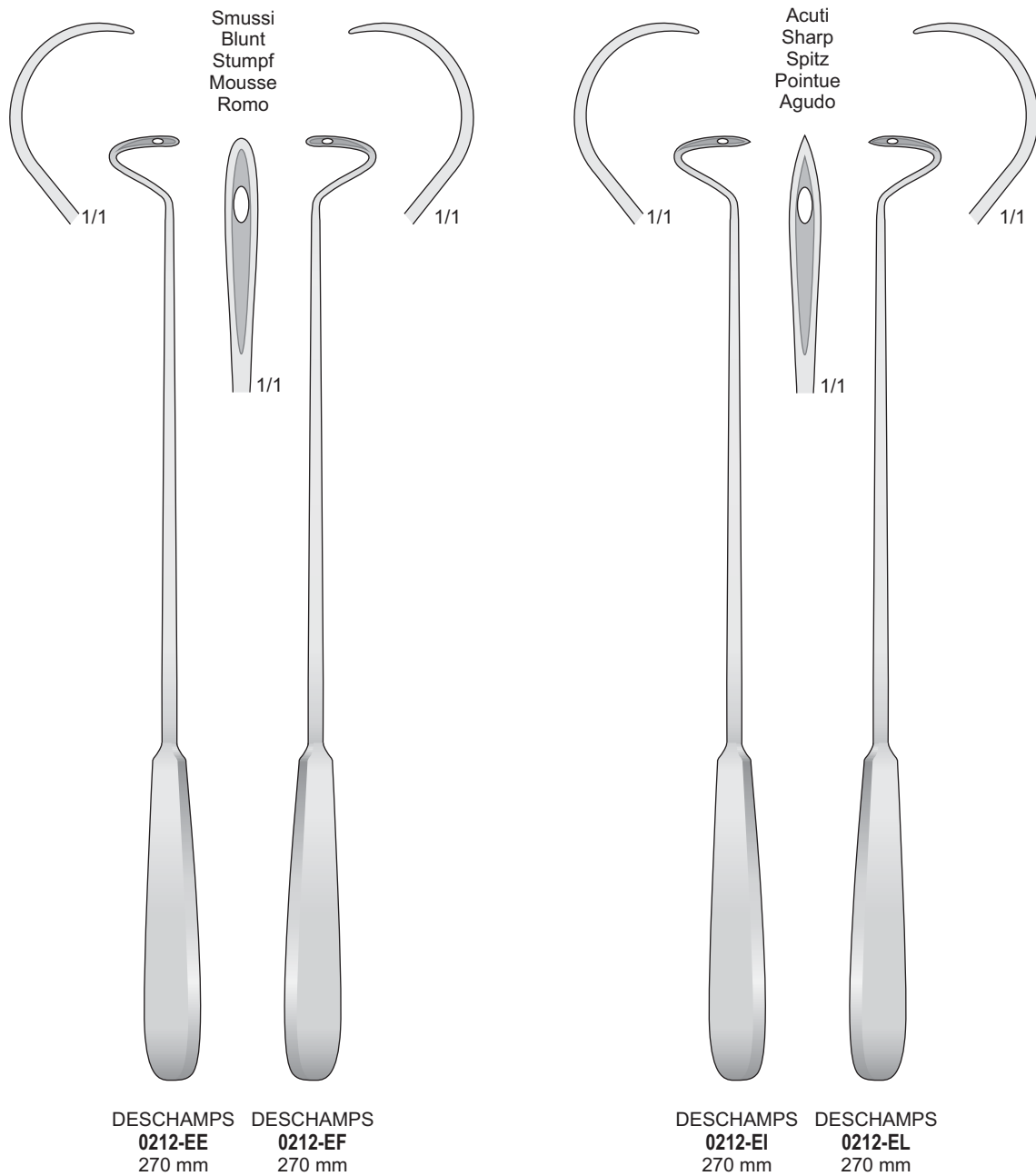

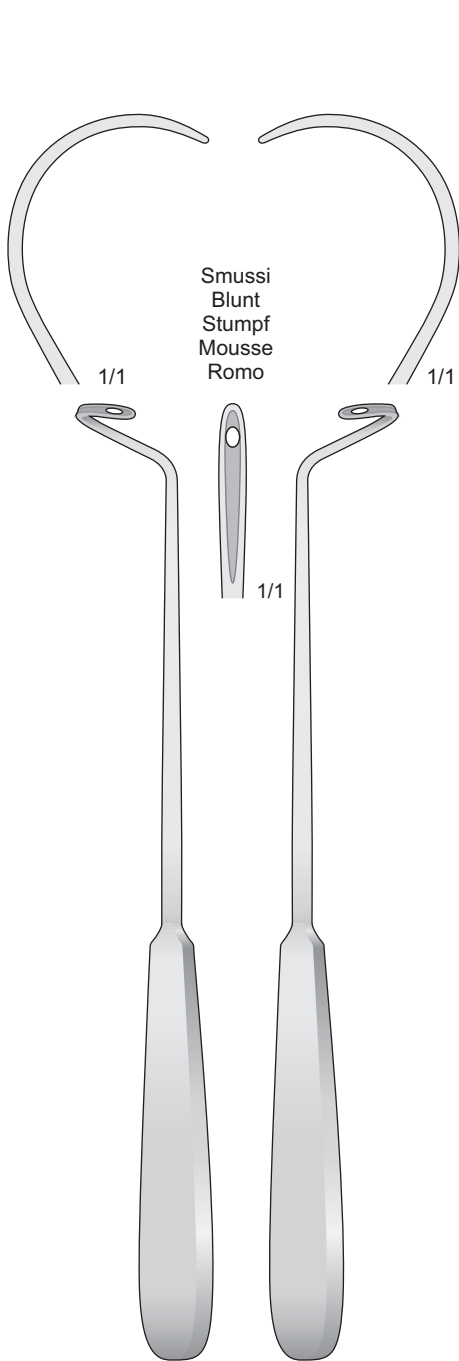

DESCHAMPS 0212-EG 240 mm  
 DESCHAMPS 0212-EH 240 mm

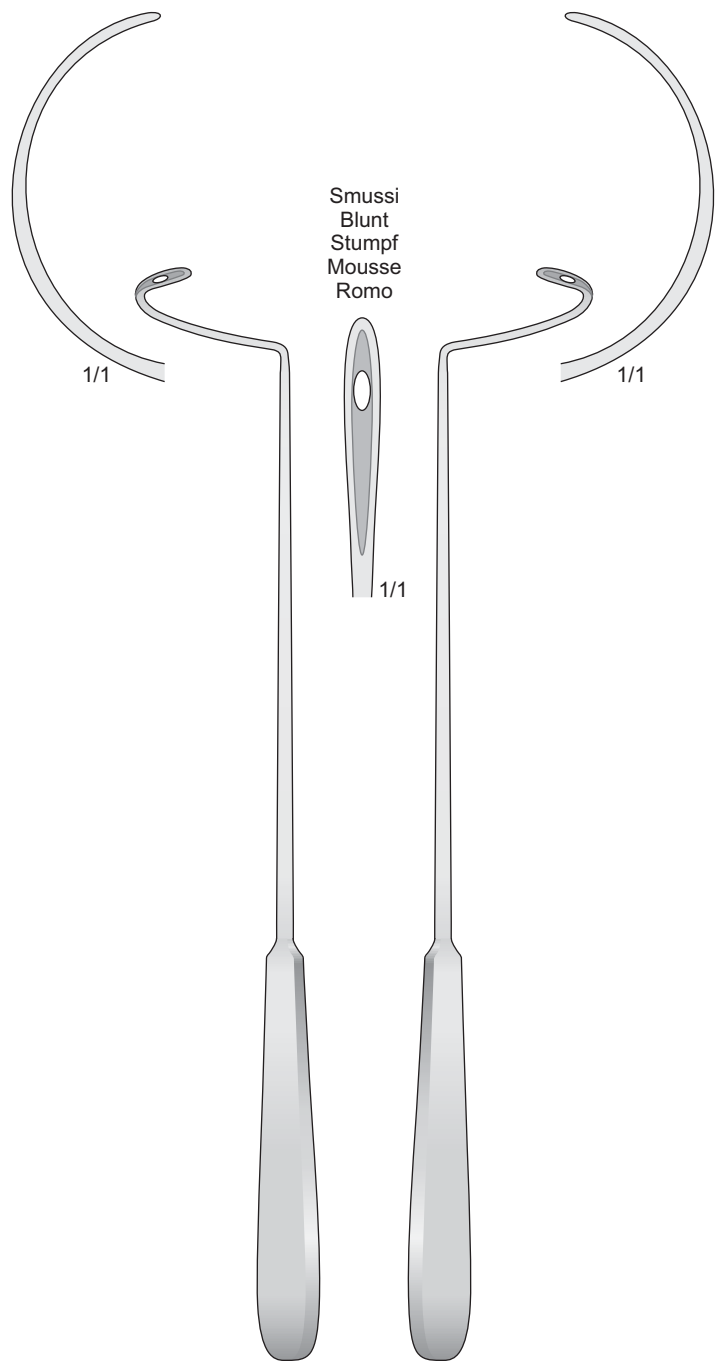

DESCHAMPS 0212-FC 280 mm  
 DESCHAMPS 0212-FD 280 mm

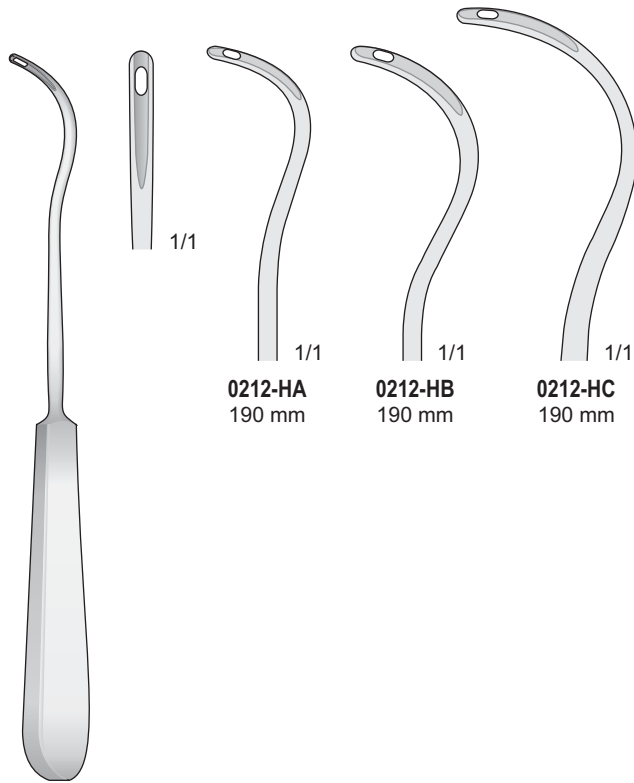

0212-HA  
190 mm

0212-HB  
190 mm

0212-HC  
190 mm

Malleabile  
Flexible  
Biegsam  
Souple  
Maleable

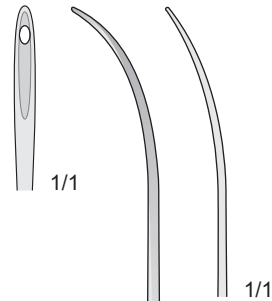

1/1

1/1

KOCHER  
0212-HA/0212-HC  
190 mm

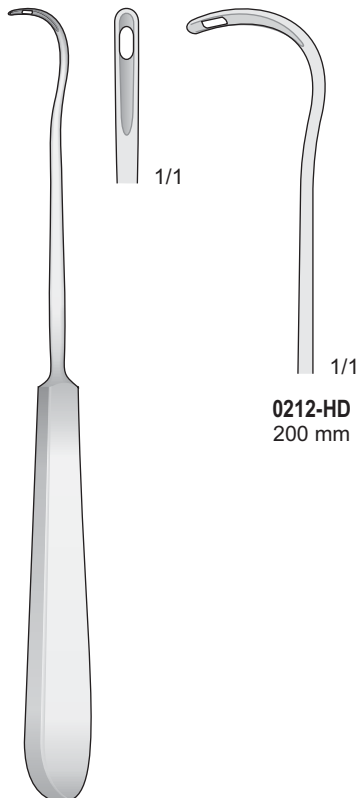

1/1

1/1

0212-HD  
200 mm

1/1

1/1

COOPER  
0212-HD  
200 mm

COOPER  
0212-CL  
190 mm

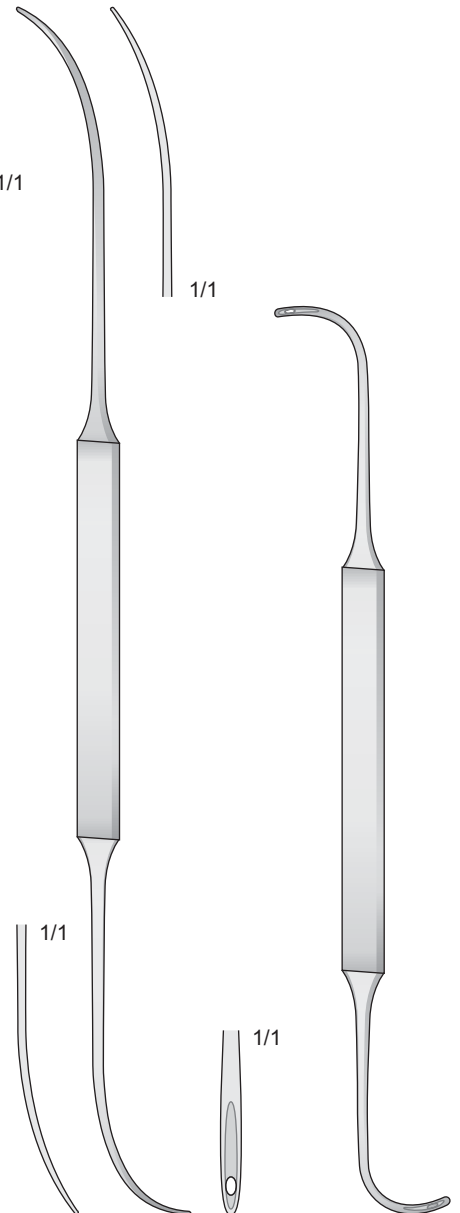

1/1

1/1

SCHMIEDEN-DICK  
0212-BH  
320 mm

SCHMIEDEN  
0212-BI  
210 mm

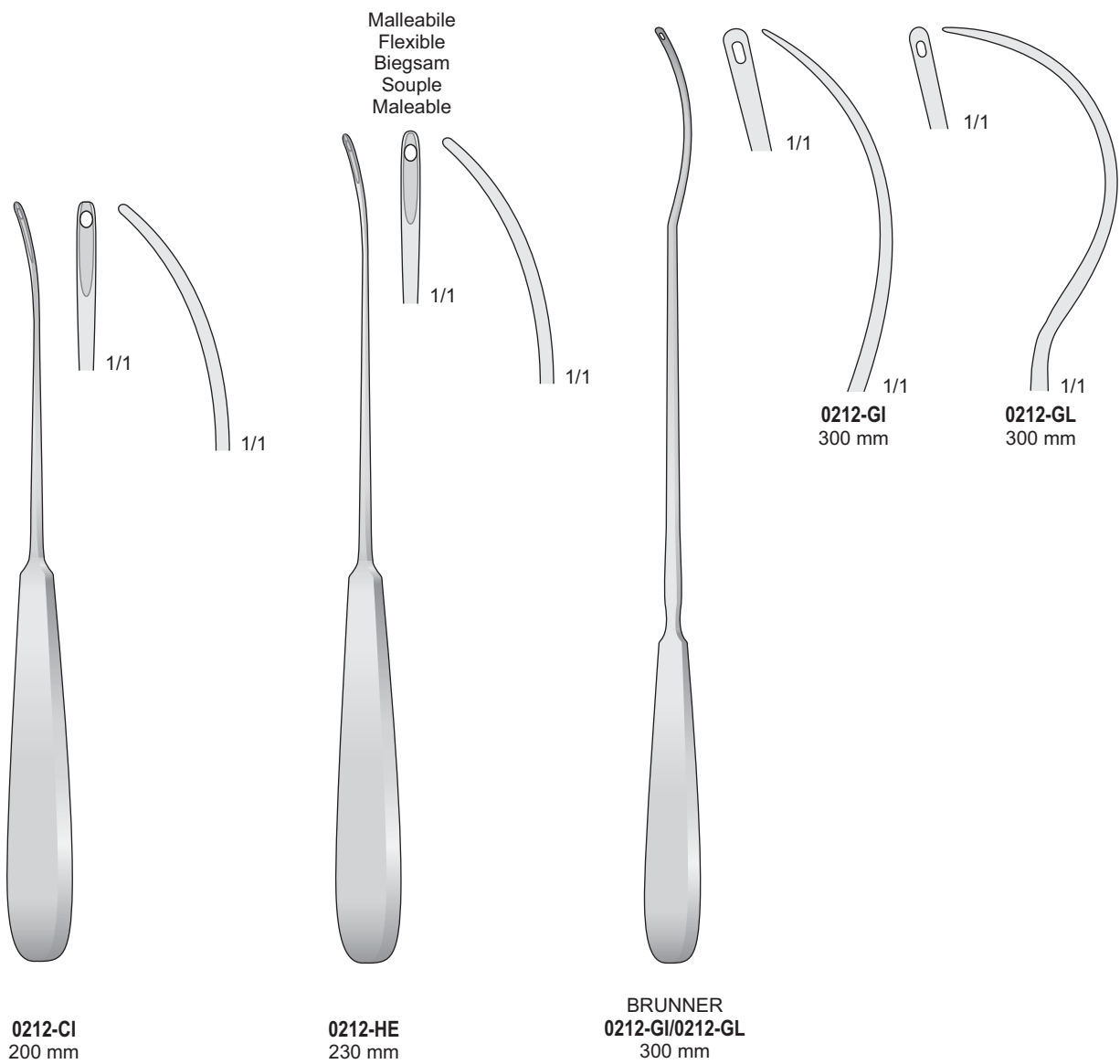

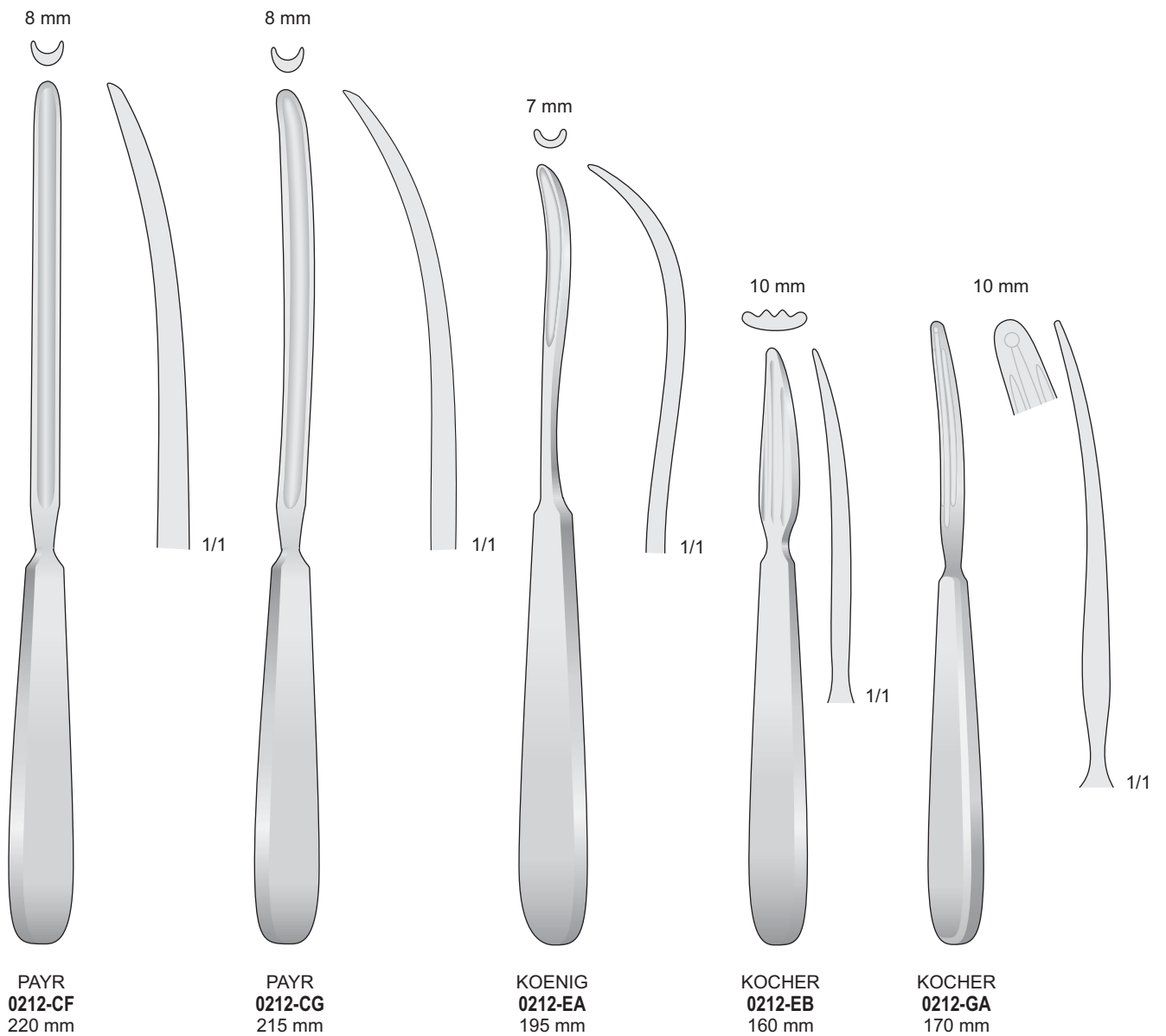

**Aghi guida  
REDON**

**REDON  
Guide needles**

**REDON  
Führungsnadeln**

**Aiguille  
d'introduction REDON**

**Aguja de  
guida REDON**

Char. 8	= 2,75 mm
Char 10	= 3,3 mm
Char 12	= 4 mm
Char 14	= 4,6 mm
Char 16	= 5,3 mm
Char 18	= 6 mm



Punta a coltello  
Messerspitze gebogen  
Knife tip curved

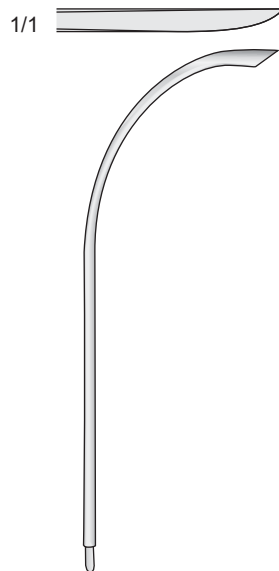

Punta a coltello  
Messerspitze gebogen  
Knife tip curved

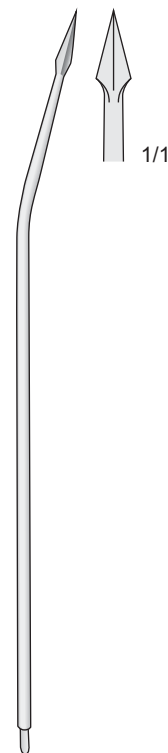

Punta a lancetta  
Lanzettenspitze gebogen  
Lancet tip curved

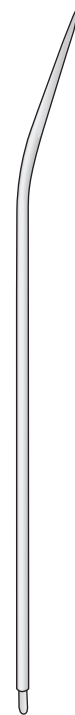

Punta Trocar  
Dreikanterspitze gebogen  
Trocar tip curved

Charr.

8	0212-BAC
10	0212-BAD
12	0212-BAE
14	0212-BAF
16	0212-BAG
18	0212-BAH

0212-BBC
0212-BBD
0212-BBE
0212-BBF
0212-BBG
0212-BBH

0212-BCC
0212-BCD
0212-BCE
0212-BCF
0212-BCG
0212-BCH

0212-BDC
0212-BDD
0212-BDE
0212-BDF
0212-BDG
0212-BDH



Pinze  
per agrafes

Clip applying  
forceps

Klammernanlegepinzetten

Pinces pour  
agrafes

Pinzas para  
agrafes

 1/1

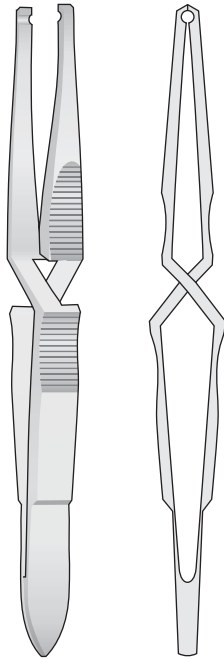

HEGENBARTH  
0204-FC  
125 mm

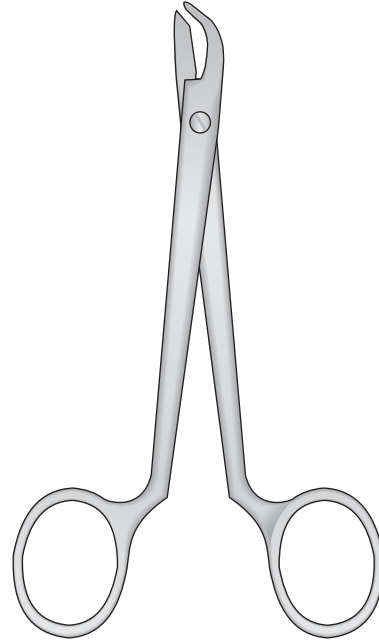

COLLIN  
0206-GF  
135 mm

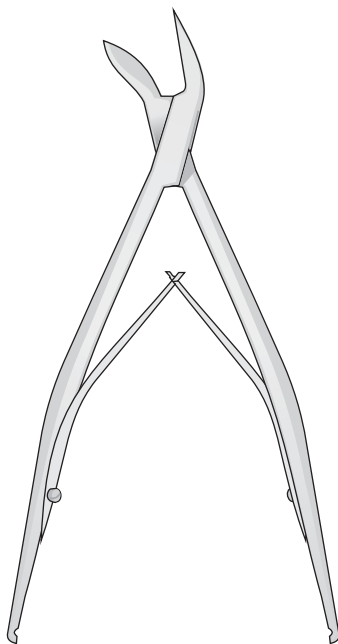

MICHEL  
0206-GI  
130 mm

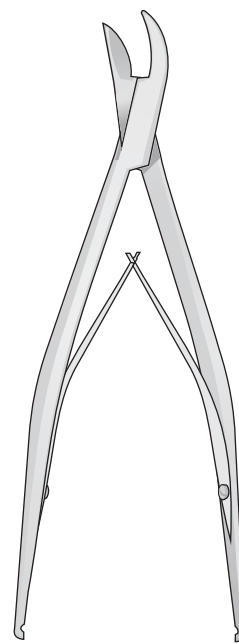

MICHEL  
0206-GL  
120 mm





ideal-tek  
manufacturer & supplier of precision instruments 

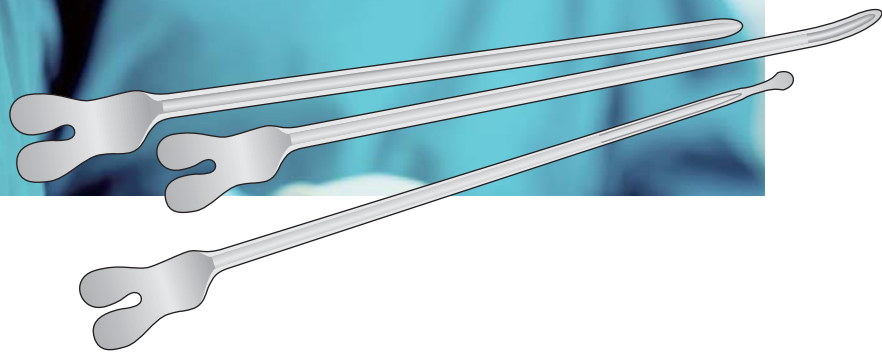

8

Sonde, Specilli, Portacotone  
Probes, Directors, Cotton Applicators  
Sonden, Watterträger  
Stylets, Sondes, Porte coton  
Sondas, Estiletas, Portaalgodòn



Sonde bottonute

Probes

Sonden

Sondes

Estiletos

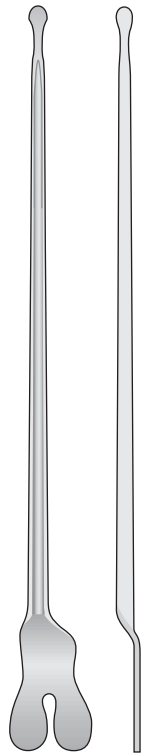

1506-FE 145 mm  
 1506-FF 160 mm  
 1506-BL 180 mm  
 1506-FG 200 mm

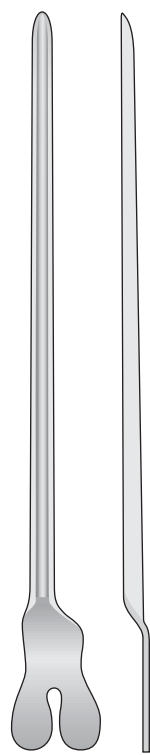

1506-FD 130 mm  
 1506-FH 145 mm  
 1506-FI 160 mm  
 1506-FL 180 mm  
 1506-BI 200 mm

Hohlsonde

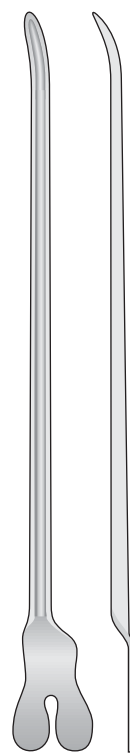

DOYEN  
 1506-CE  
 145 mm

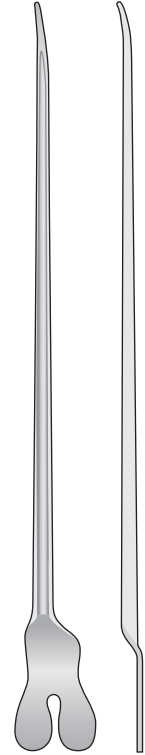

NELATON  
 1506-BH  
 160 mm

Sonde per fistole - Fistula probes - Fistelsonden - Sondes pour fistulas - Sondas para fistulas



LOCHART  
 1506-IA  
 170 mm

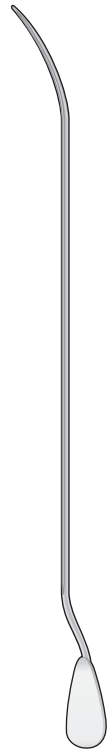

LOCHART  
 1506-IB  
 170 mm

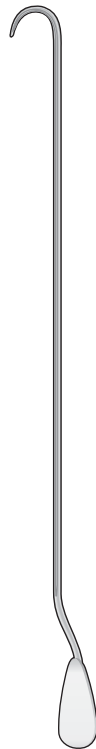

LOCHART  
 1506-IC  
 170 mm

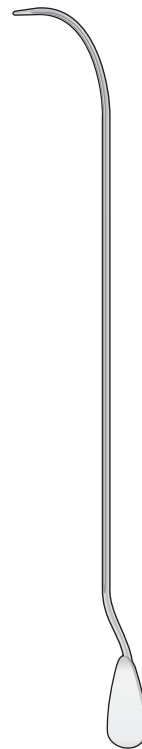

LOCHART  
 1506-ID  
 170 mm

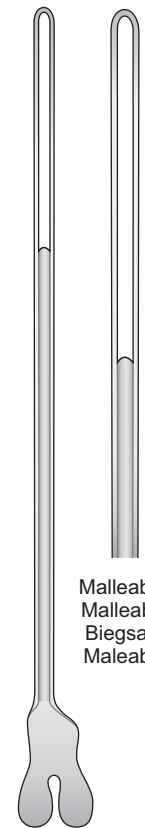

LOCHART  
 1506-IF  
 190 mm

1/1  
 Malleabile  
 Malleable  
 Biigsam  
 Maleable

Sonde bottonute

Probes

Sonden

Sondes

Estiletos

Ø 1 mm



Ø 1,5 mm



Ø 2 mm



Ø 2 mm



Ø 1,5 mm

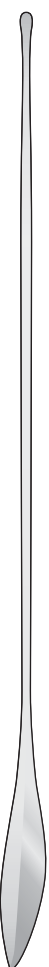

Ø 1,0 mm



**1506-CA** 145 mm  
**1506-CB** 160 mm

**1506-DC** 130 mm  
**1506-CC** 145 mm  
**1506-CF** 160 mm  
**1506-CG** 200 mm

**1506-CH** 145 mm  
**1506-CD** 160 mm  
**1506-CI** 200 mm  
**1506-EE** 250 mm

**1506-DG** 130 mm  
**1506-BF** 145 mm  
**1506-CL** 160 mm  
**1506-DI** 200 mm

**1506-H**  
145 mm

**STACKE**  
**1506-BE**  
110 mm

**BOWMAN**  
**1506-DA** 00/0  
**1506-DB** 1/2  
**1506-DD** 3/4  
**1506-DE** 5/6  
**1506-DF** 7/8  
**1506-DG** 6/7

Porta cotone

Cotton applicators

Watteträger

Porte cotons

Portaalgodòn

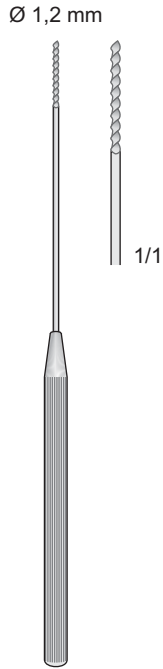

UNIVERSAL  
1506-EI 120 mm  
1506-EA 140 mm  
1506-FA 160 mm

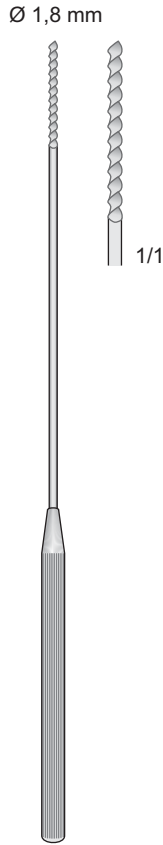

UNIVERSAL  
1506-GC 120 mm  
1506-GD 140 mm  
1506-GE 160 mm  
1506-EB 180 mm

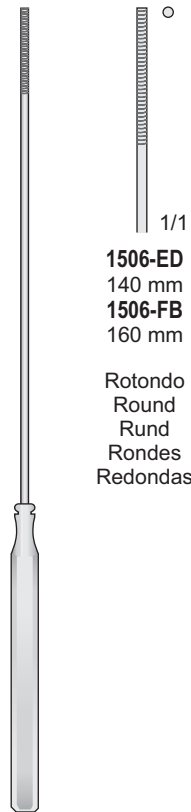

MOD. MARTIN  
1506-ED/1506-FC



<b>1506-ED</b> 140 mm <b>1506-FB</b> 160 mm	<b>1506-EG</b> 140 mm <b>1506-FC</b> 160 mm	<b>1506-EL</b> 180 mm
Rotondo Round Rund Rondes Redondas	Triangolare Triangular Dreikant Triangulaires Triangulares	Rotondo Round Rund Rondes Redondas

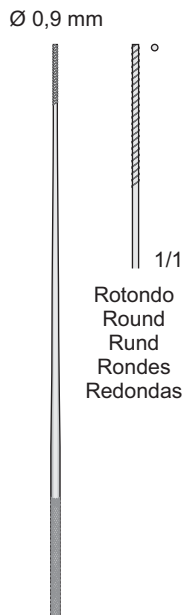

FARRELL  
1506-BA 120 mm

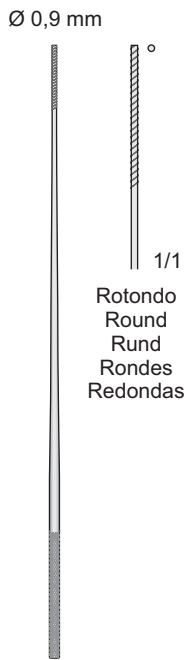

FARRELL  
1506-BD 140 mm  
1506-GG 160 mm  
1506-GH 180 mm

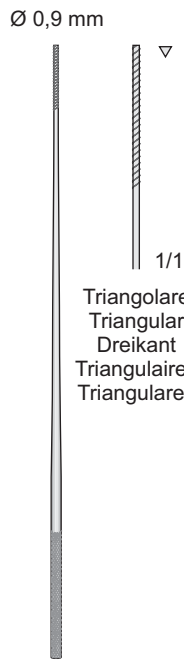

FARRELL  
1506-GI 140 mm  
1506-GL 160 mm

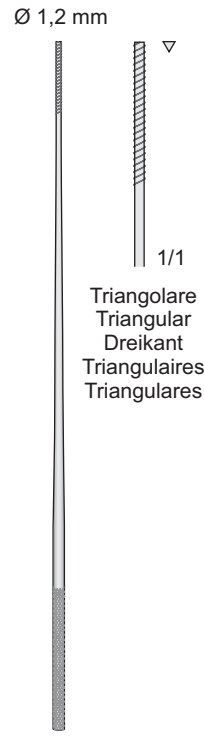

FARRELL  
1506-DL 180 mm

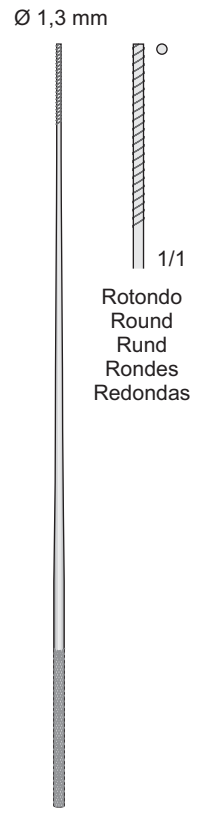

FARRELL  
1506-EC 230 mm

Porta cotone

Cotton applicators

Watteträger

Porte cotons

Portaalgodön

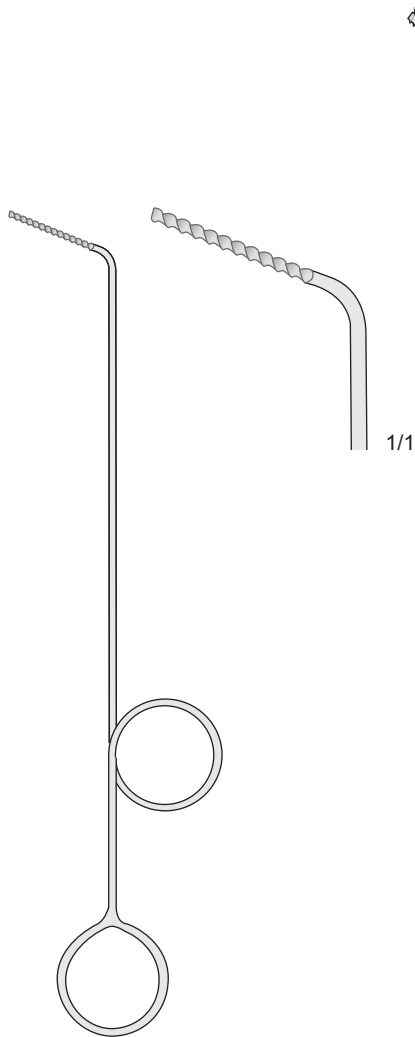
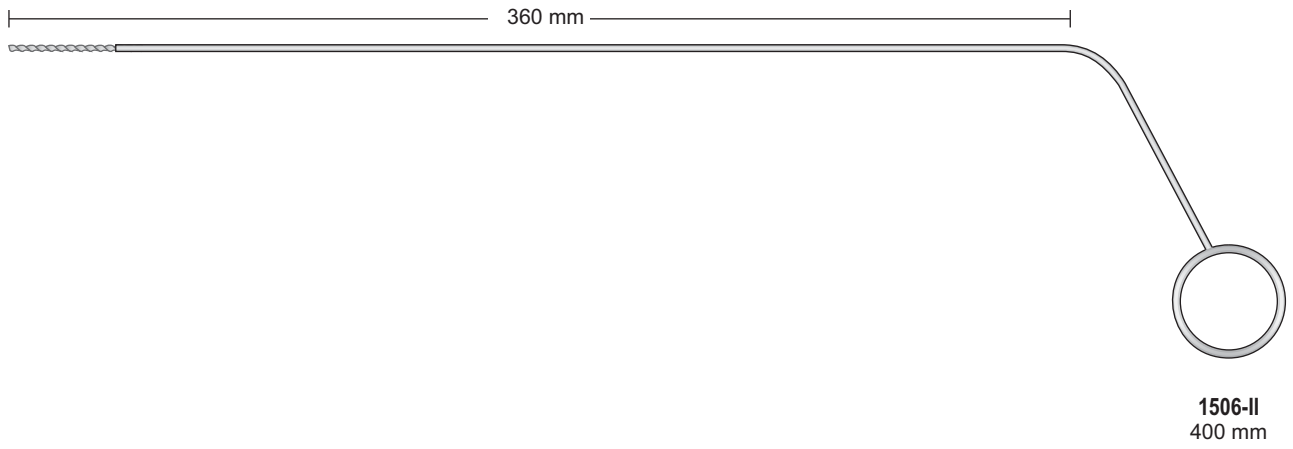

**HARTMANN**  
**1506-HD** - Ø 2,3 mm  
220 mm

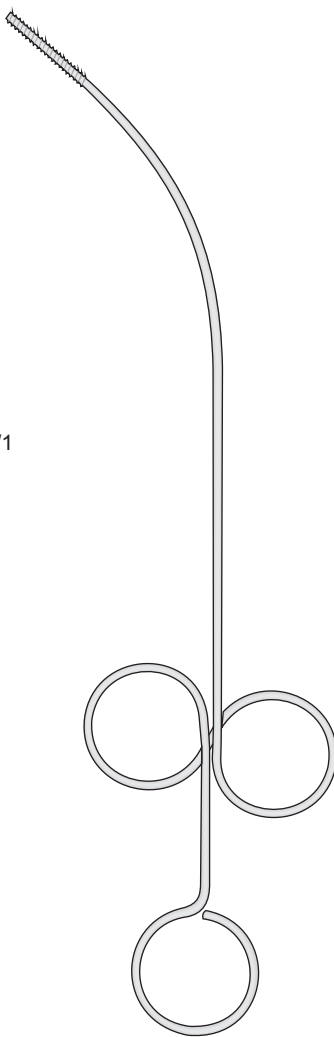

**FEIN**  
**1506-GF**  
250 mm

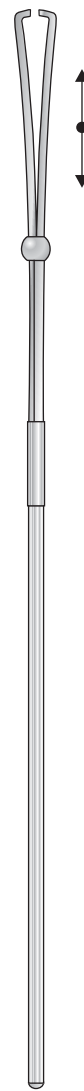

**HEILDELBERG**  
**1506-GA**  
180 mm

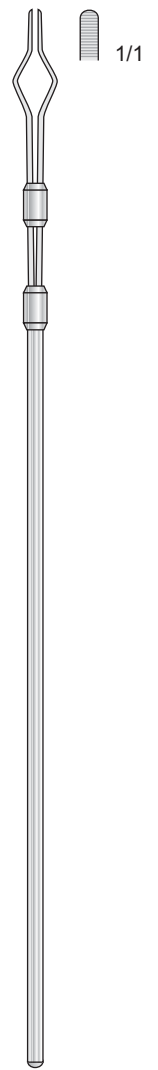

**HEILDELBERG**  
**1506-GB**  
170 mm



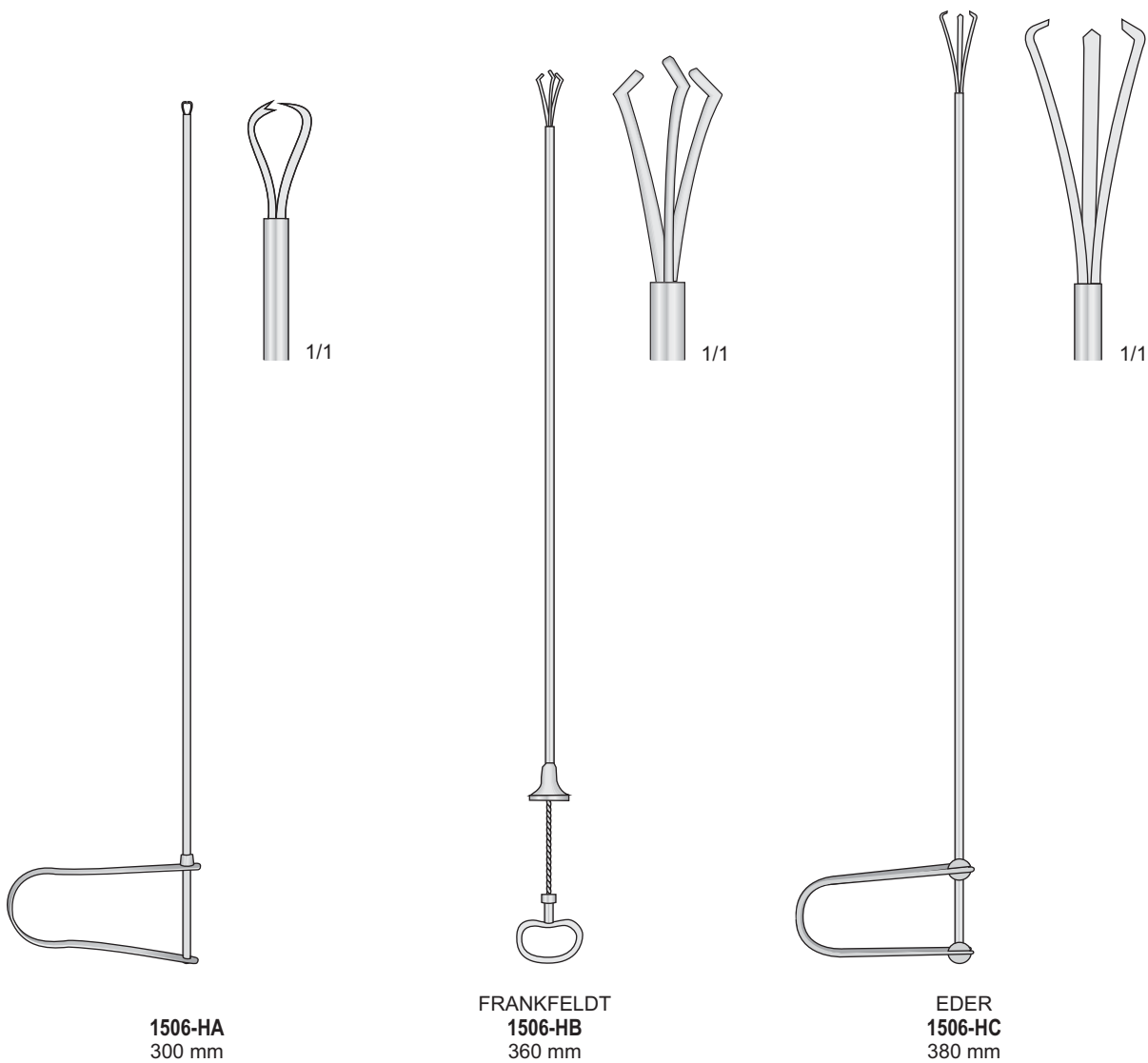





9

Divaricatori, Chirurgia Toracica  
Retractors  
Wundhaken  
Ecarteurs  
Separadores



Uncini cutanei - Cutaneous hook - Hauthäkchen - Erignes cutanées - Ganchos cutáneos

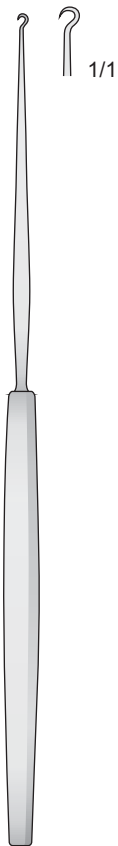

GILLIES  
0219-BF  
180 mm

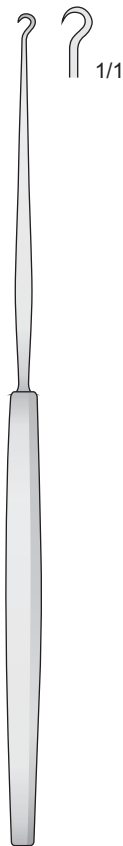

GILLIES  
0219-BG  
180 mm

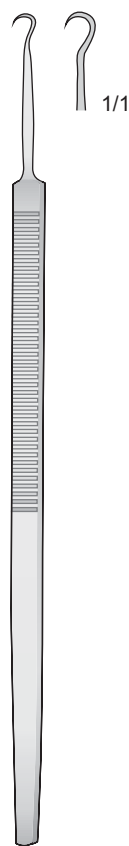

0219-CAH  
160 mm

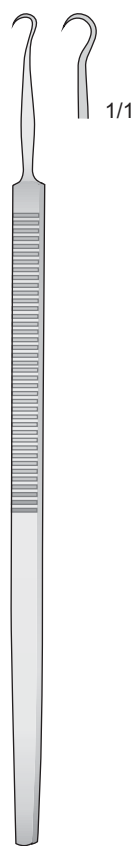

0219-CAI  
160 mm

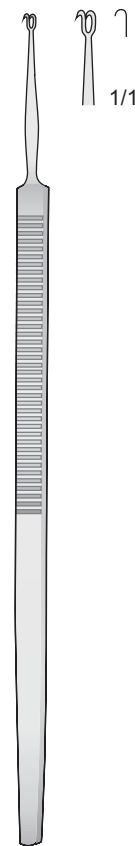

GUTHRIE  
0219-CAD  
160 mm

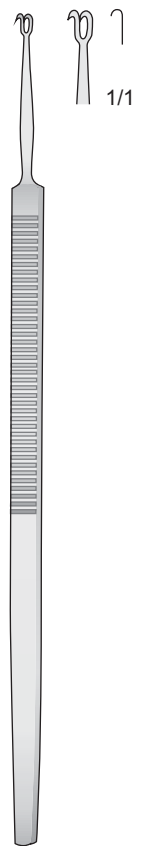

GUTHRIE  
0219-CAE  
160 mm

Divaricatori

Retractors

Wundhaken

Ecarteurs

Separadores

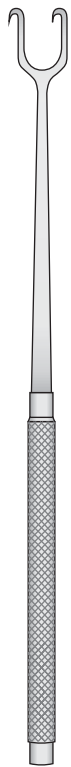

JOSEPH  
0219-CBA/0219-CBE  
160 mm

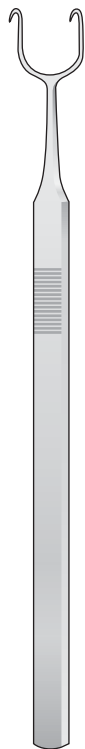
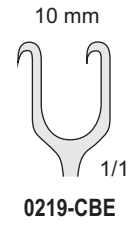
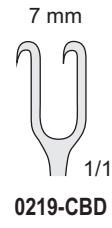
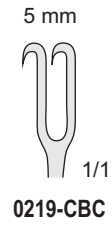
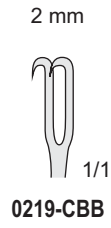
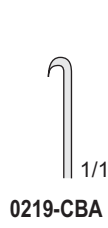

COTTLE  
0219-CBF/0219-CBH  
150 mm

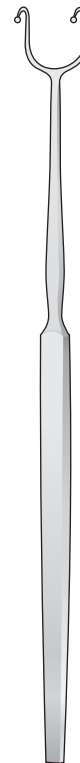
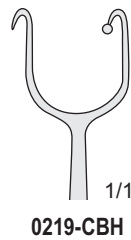
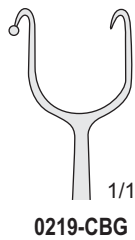
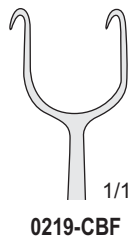

FOMON  
0219-CBI  
160 mm

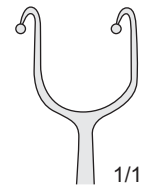

Divaricatori

Retractors

Wundhaken

Ecarteurs

Separadores

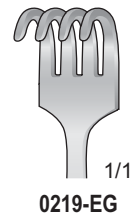
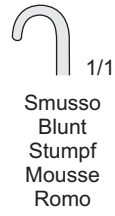
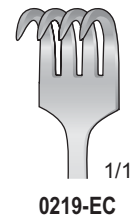
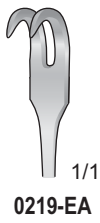

0219-EA/0219-EG  
160 mm

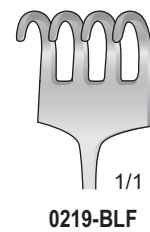
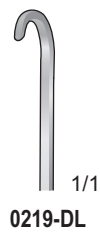
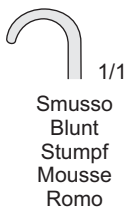
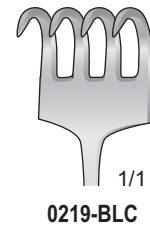
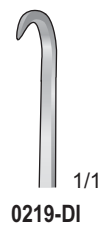
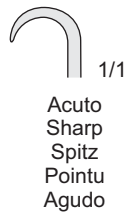
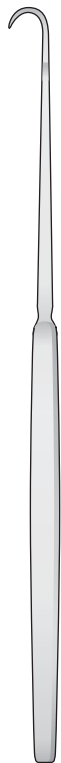

0219-DI/0219-BLF  
160 mm

Divaricatori delicati flessibili-acute  
 Feine wundhaken flexibel-spitz  
 Delicate retractors flexible-sharp  
 Separadores finos flexibles-agudas

Divaricatori delicati flessibili-smussi  
 Feine wundhaken flexibel-stumpf  
 Delicate retractors flexible-blunt  
 Separadores finos flexibles-romas

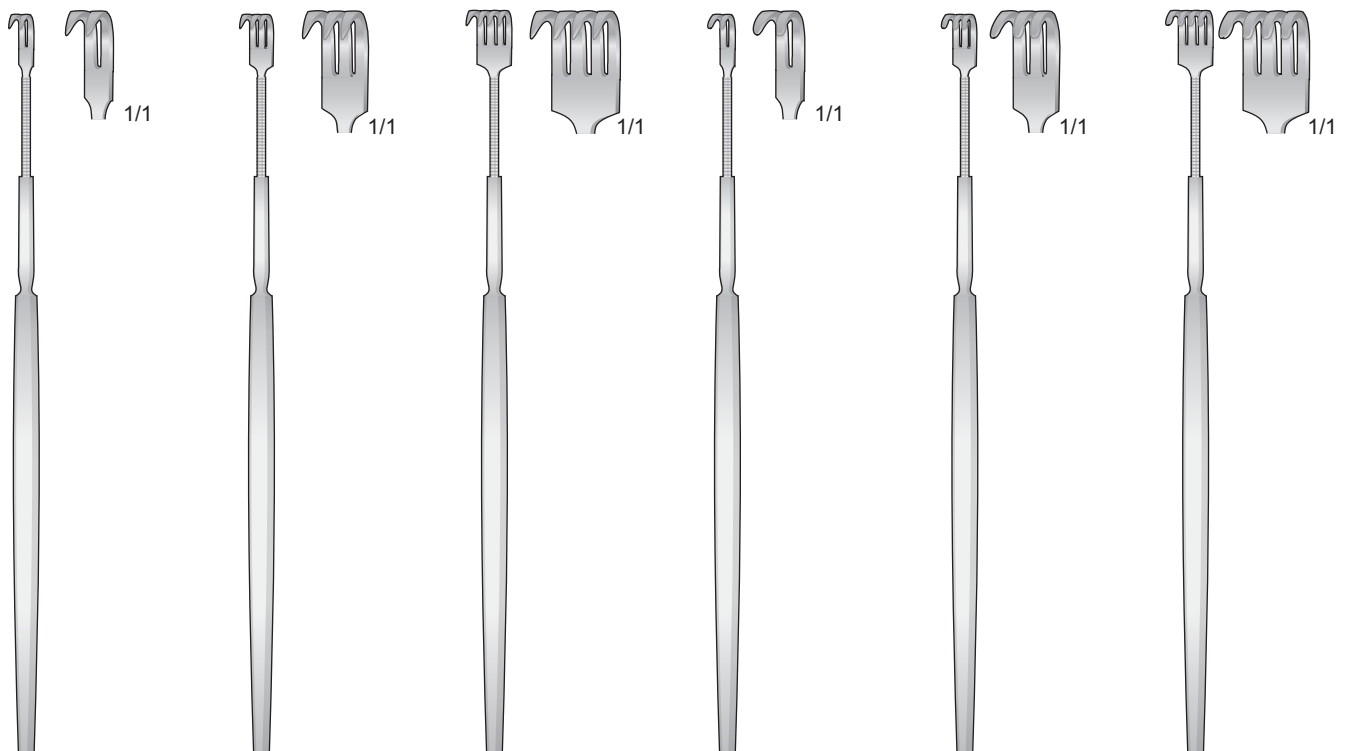

0219-FA  
150 mm

0219-FB  
150 mm

0219-FC  
150 mm

0219-FE  
150 mm

0219-FF  
150 mm

0219-FG  
150 mm



Divaricatori

Retractors

Wundhaken

Ecarteurs

Separadores

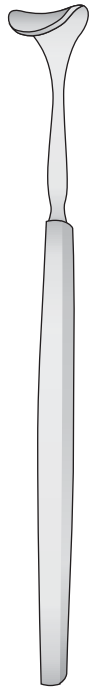

DESMARRES  
0219-HA/0219-HL  
140 mm



0219-HA  
10 mm

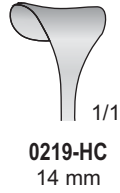

0219-HC  
14 mm

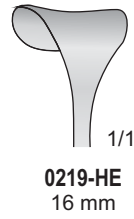

0219-HE  
16 mm

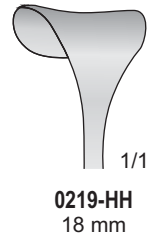

0219-HH  
18 mm



0219-HB  
12 mm



0219-HD  
14 mm

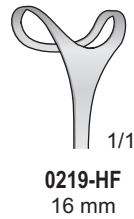

0219-HF  
16 mm



0219-HL  
18 mm

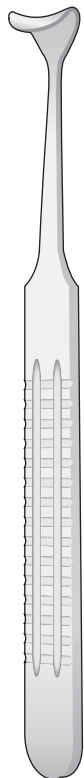

DESMARRES  
0219-CI  
160 mm

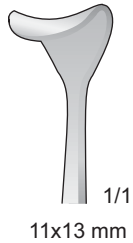

11x13 mm  
1/1



SENN GREEN  
0219-EI/0219-EL  
160 mm



0219-EI  
10 x 6 mm  
1/1



0219-EL  
20 x 6 mm  
1/1

Divaricatori

Retractors

Wundhaken

Ecarteurs

Separadores



LAHEY  
0219-BAL  
195 mm

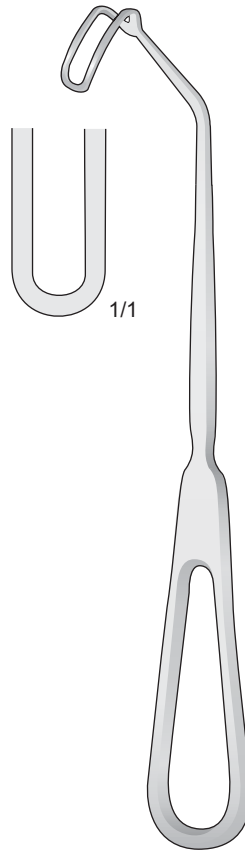

CUSHING  
0219-CL  
200 mm

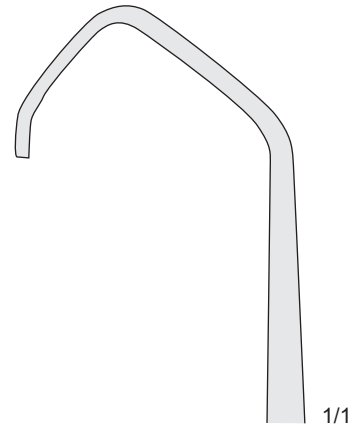

1/1

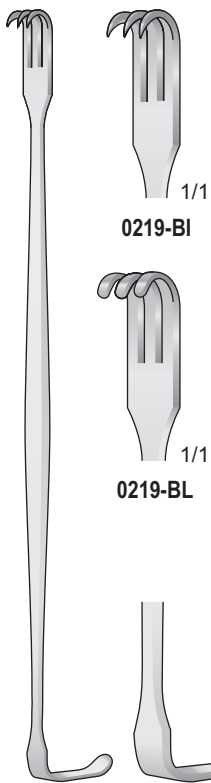

0219-BI

0219-BL

SENN-MILLER  
0219-BI/0219-BL  
160 mm

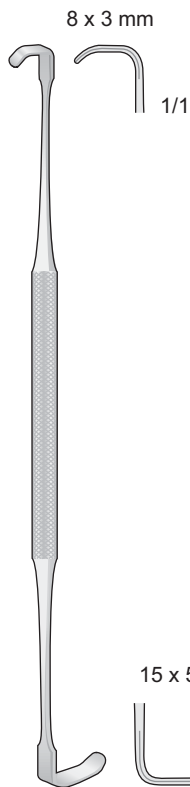

8 x 3 mm

1/1

15 x 5 mm

1/1

RAGNELL  
0219-CH  
140 mm

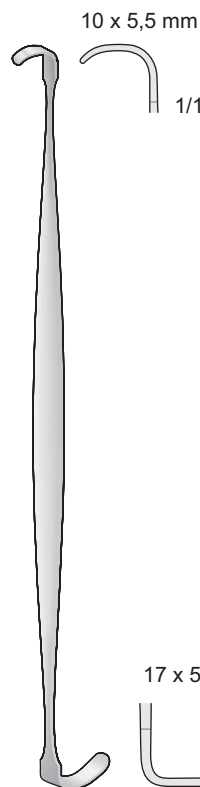

10 x 5,5 mm

1/1

17 x 5,5 mm

1/1

RAGNELL-DAVIS  
0219-CG  
140 mm

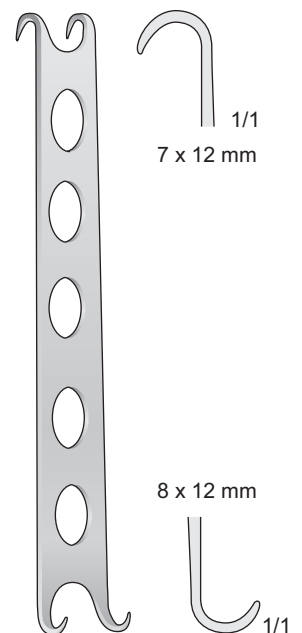

7 x 12 mm  
1/1

8 x 12 mm

1/1

CONVERSE  
0219-CC  
120 mm

Divaricatori

Dritto



LOVE  
0414-FG  
210 mm

Retractors

LOVE  
0414-FH



Wundhaken

45°

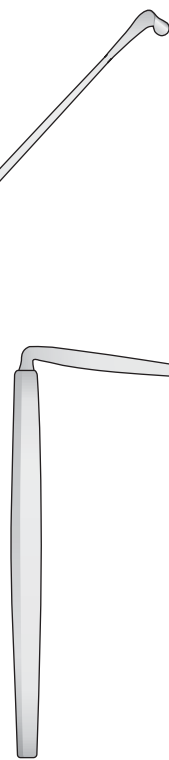

LOVE  
0414-FI

Ecarteurs

LOVE  
0414-BHE  
210 mm



Separadores

1/1

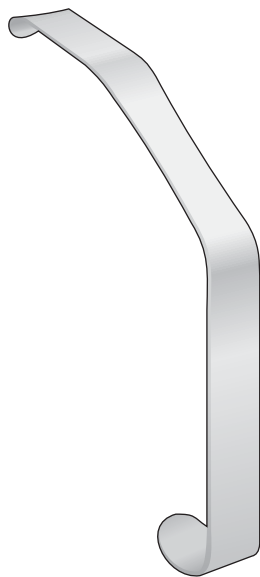

LOVE  
0414-CBD - 18 mm  
0414-CBE - 20 mm  
0414-CBF - 22 mm  
150 mm



0219-CLG  
1/1



0219-CLH  
1/1

CUSHING  
0219-CLG/0219-CLH  
190 mm



CUSHING  
0219-CLI/0219-CLL  
280 mm



0219-CLI  
1/1



0219-CLL  
1/1



LANGE  
1014-GA  
220 mm

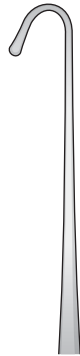

1/1

Divaricatori

Retractors

Wundhaken

Ecarteurs

Separadores

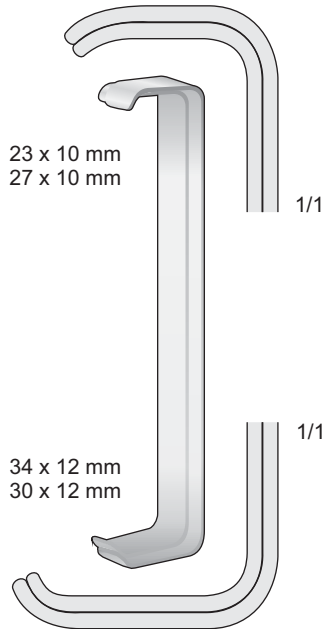

23 x 10 mm  
27 x 10 mm

34 x 12 mm  
30 x 12 mm

**FARABEU**  
**0219-CA**  
120 mm

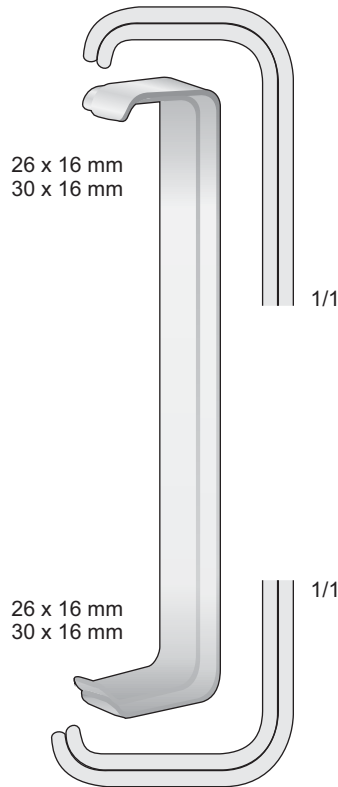

26 x 16 mm  
30 x 16 mm

26 x 16 mm  
30 x 16 mm

**FARABEU**  
**0219-CF**  
150 mm

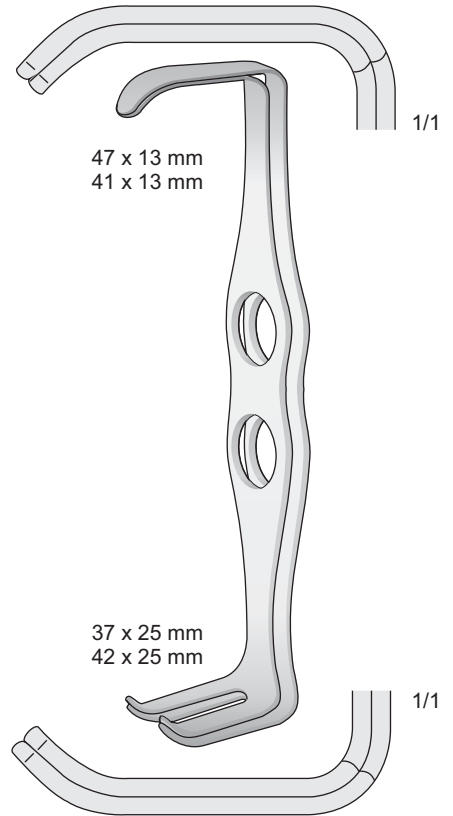

47 x 13 mm  
41 x 13 mm

37 x 25 mm  
42 x 25 mm

**MATHIEU**  
**0219-CLE**  
200 mm

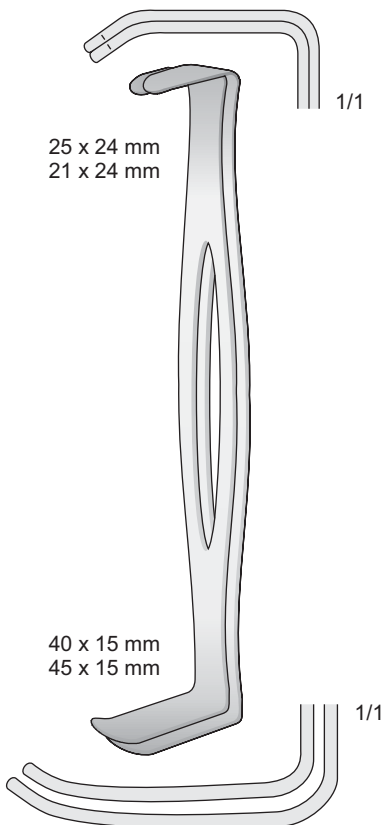

25 x 24 mm  
21 x 24 mm

40 x 15 mm  
45 x 15 mm

**PARKER-LANGENBECK**  
**0219-CLB**  
210 mm

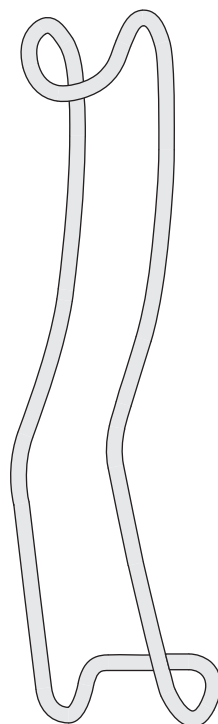

**STERNBERG**  
**1412-FA**  
160 mm

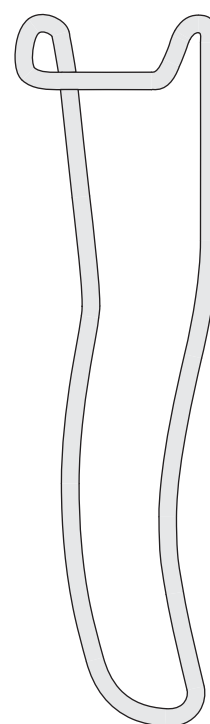

**STERNBERG**  
**1412-FC**  
160 mm

Divaricatori

Retractors

Wundhaken

Ecarteurs

Separadores

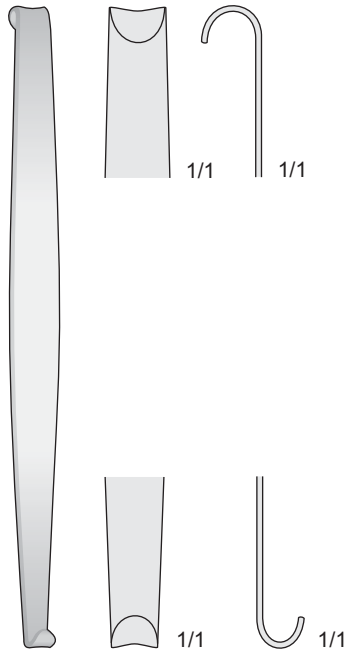

MINI-ROUX  
0219-CIC  
150 mm

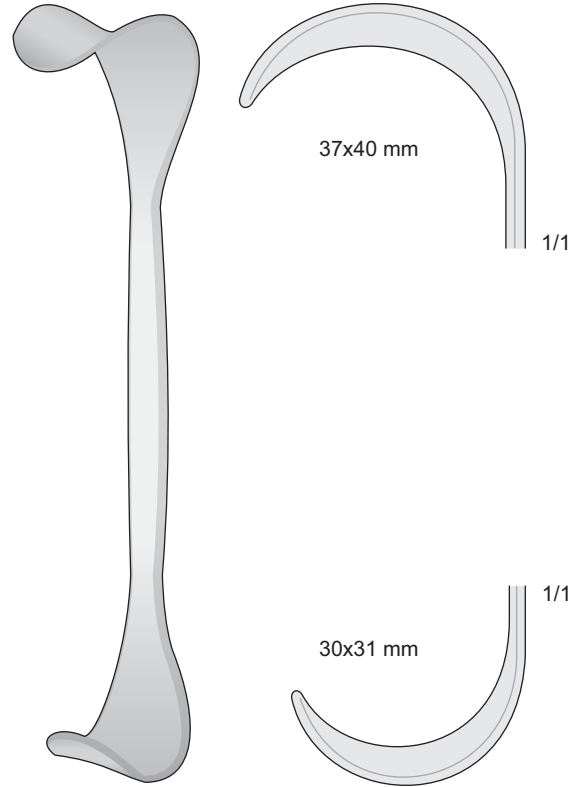

GOELET  
0219-ID  
190 mm

**0219-CID**  
Set completo  
Set complete  
Komplettsset  
Set complet  
Set completo

29 mm  
26 mm  
22 mm

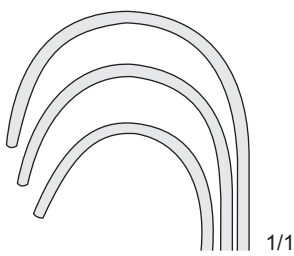

**0219-CIE** - 20x22 mm  
25x28 mm  
**0219-CIF** - 23x26 mm  
29x38 mm  
**0219-CIG** - 29x29 mm  
34x44 mm

28 mm  
38 mm  
44 mm

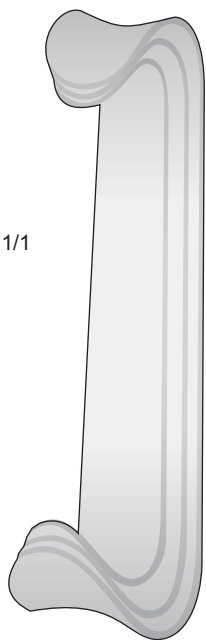

ROUX  
0219-CIE/0219-CIG  
165 mm

20x22 mm

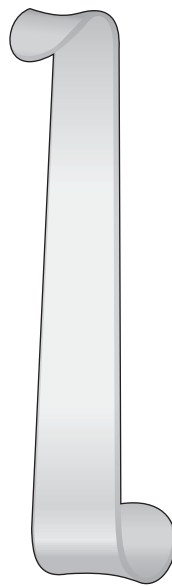

25x28 mm  
ROUX-MAGNUS  
0219-CIH  
150 mm

23x26 mm

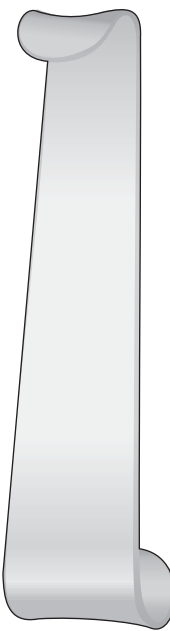

29x38 mm  
ROUX-MAGNUS  
0219-CII  
160 mm

29x29 mm

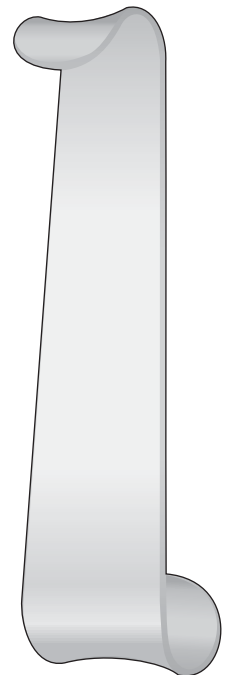

34x44 mm  
ROUX-MAGNUS  
0219-CIL  
170 mm

Divaricatori

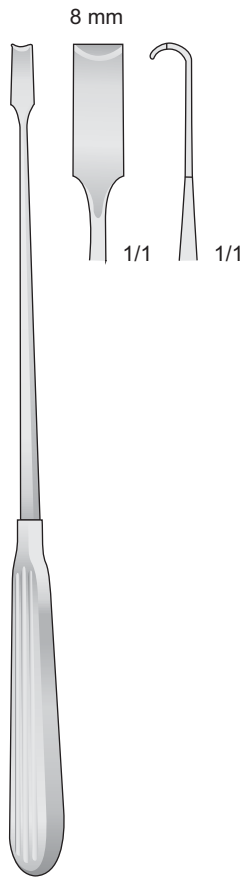

SCOVILLE  
0219-DBC  
230 mm

Retractors

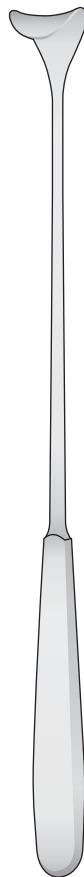

CUSHING  
0219-BBE/0219-BBG  
250 mm

Wundhaken

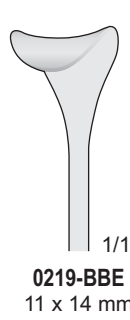

0219-BBE  
11 x 14 mm

Ecarteurs

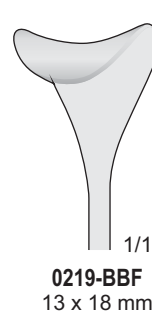

0219-BBF  
13 x 18 mm

Separadores

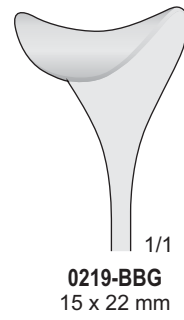

0219-BBG  
15 x 22 mm

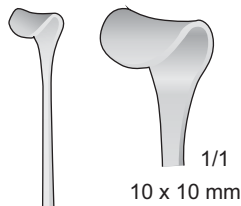

CUSHING-KOCHER  
0219-BBD  
180 mm



KOCHER  
0219-BBH/0219-BBI  
205 mm

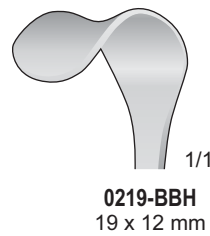

0219-BBH  
19 x 12 mm

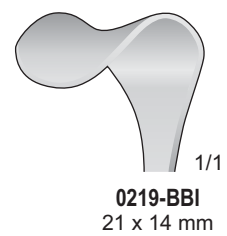

0219-BBI  
21 x 14 mm

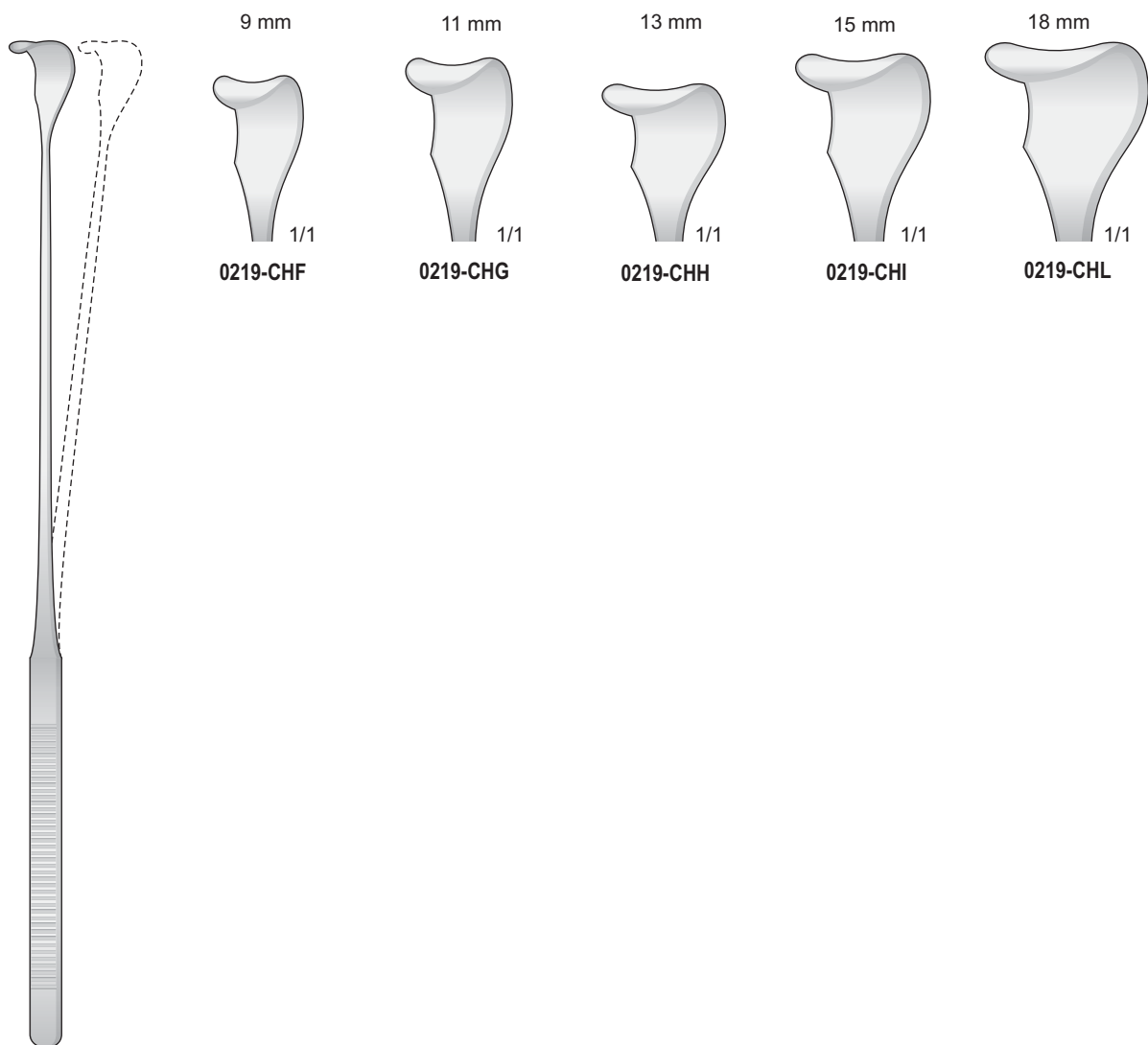

GIL-VERNET  
0219-CHF/0219-CHL  
280 mm

Divaricatori

Retractors

Wundhaken

Ecarteurs

Separadores

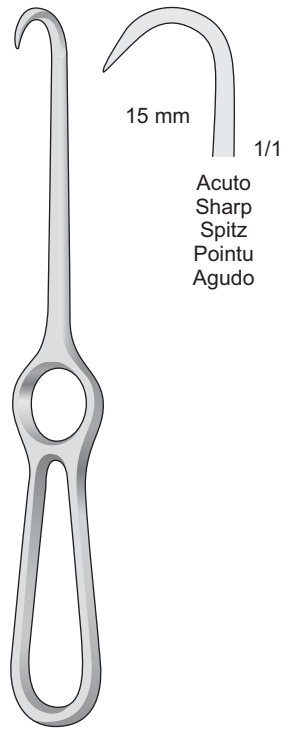

KOCHER  
0219-BDL  
205 mm

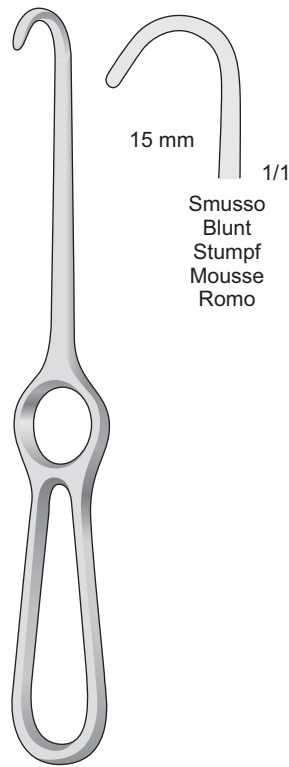

KOCHER  
0219-BEA  
220 mm

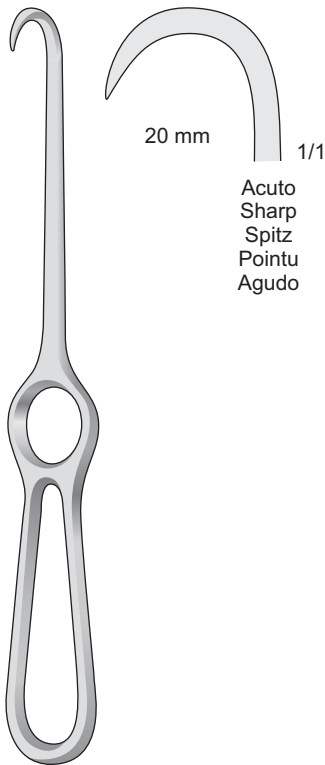

VOLKMANN  
0219-BCG  
220 mm

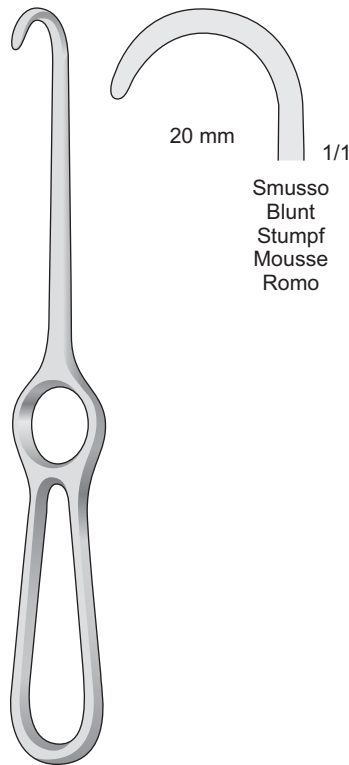

VOLKMANN  
0219-BCH  
220 mm

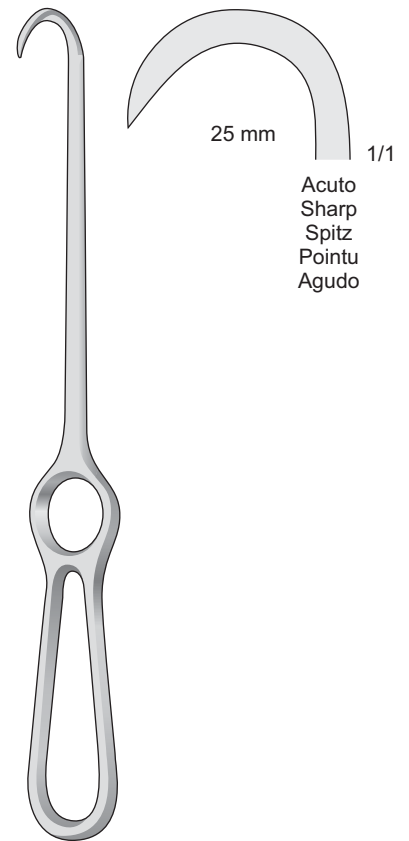

0219-BCI  
245 mm

15 mm 1/1  
Acuto  
Sharp  
Spitz  
Pointu  
Agudo

15 mm 1/1  
Smusso  
Blunt  
Stumpf  
Mousse  
Romo

20 mm 1/1  
Acuto  
Sharp  
Spitz  
Pointu  
Agudo

20 mm 1/1  
Smusso  
Blunt  
Stumpf  
Mousse  
Romo

25 mm 1/1  
Acuto  
Sharp  
Spitz  
Pointu  
Agudo



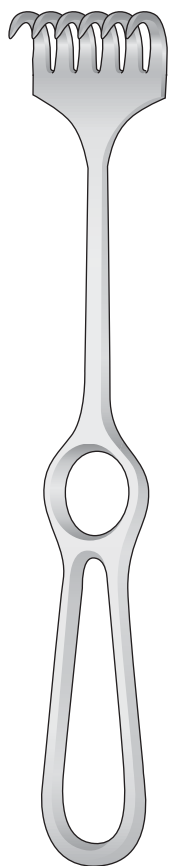

VOLKMANN  
0219-BAB/0219-BAI  
220 mm

Acuto  
Sharp  
Spitz  
Pointu  
Agudo

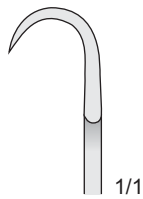

1/1



0219-BAB  
9 x 8 mm



0219-BAD  
9 x 13 mm



0219-BAF  
9 x 19 mm

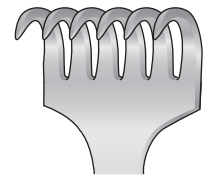

0219-BAH  
9 x 29 mm

Smusso  
Blunt  
Stumpf  
Mousse  
Romo

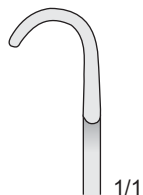

1/1



0219-BAC  
9 x 8 mm



0219-BAE  
9 x 13 mm



0219-BAG  
9 x 19 mm

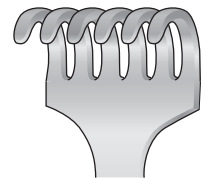

0219-BAI  
9 x 29 mm

Divaricatori

Retractors

Wundhaken

Ecarteurs

Separadores

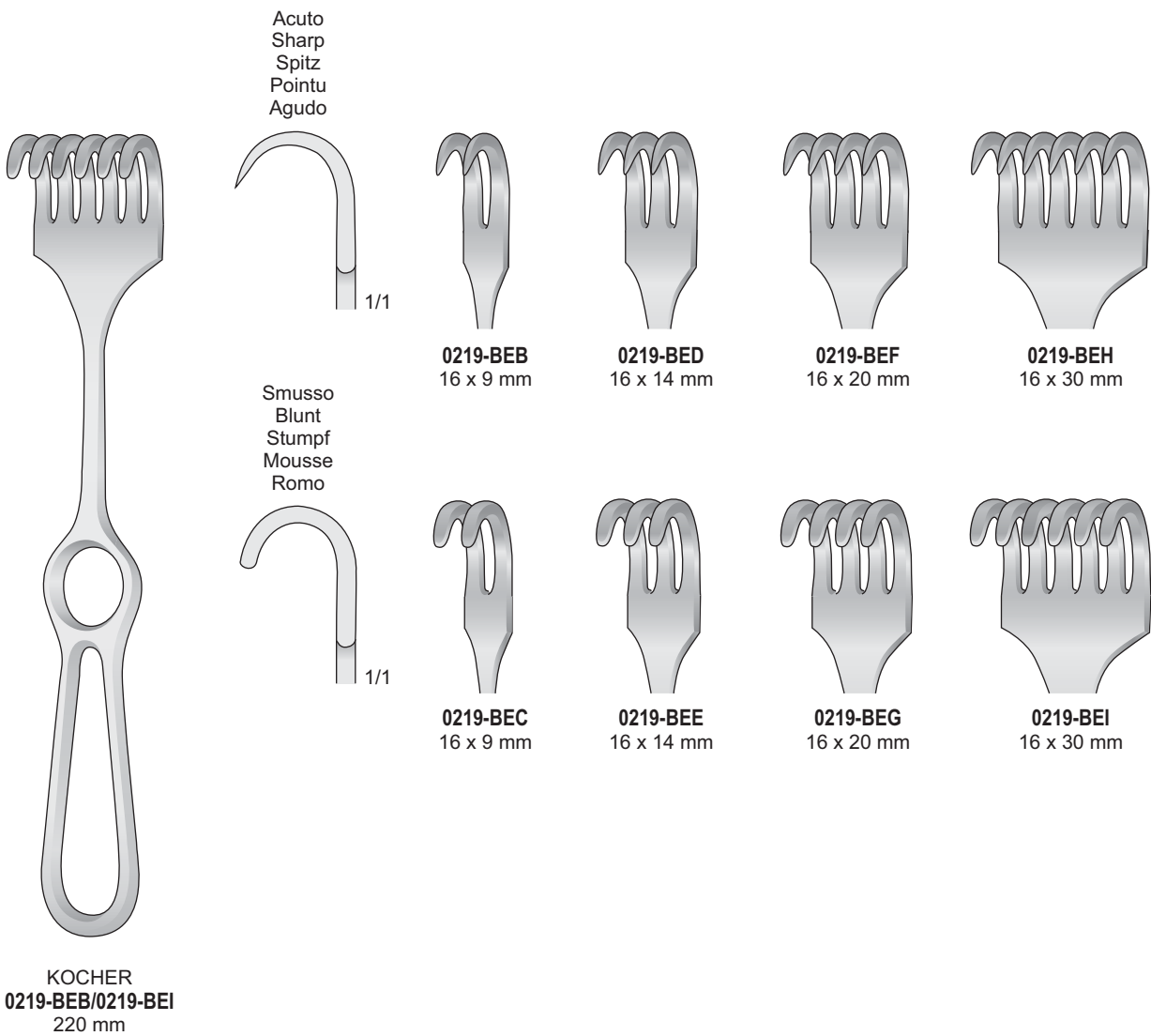

Divaricatori

Retractors

Wundhaken

Ecarteurs

Separadores

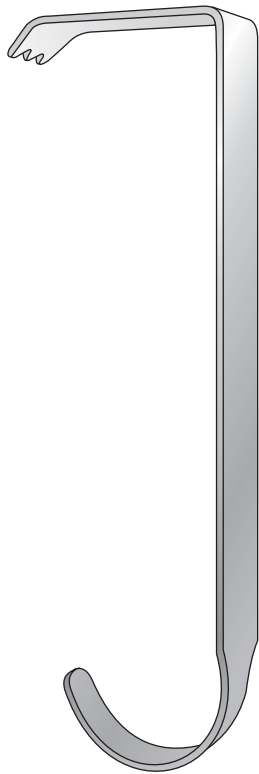

HIBBS  
0219-CD/0219-CE  
240 mm



1/1

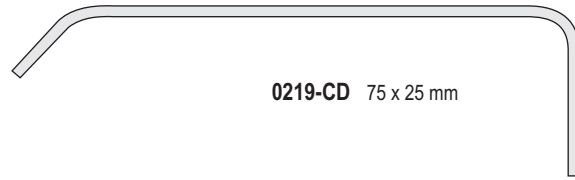

0219-CD 75 x 25 mm

1/1

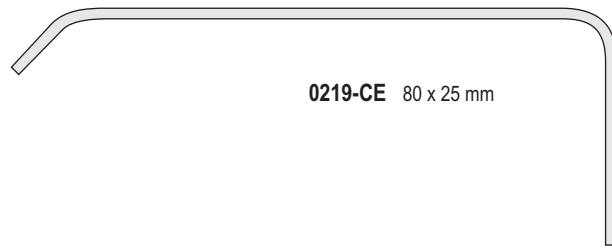

0219-CE 80 x 25 mm

1/1

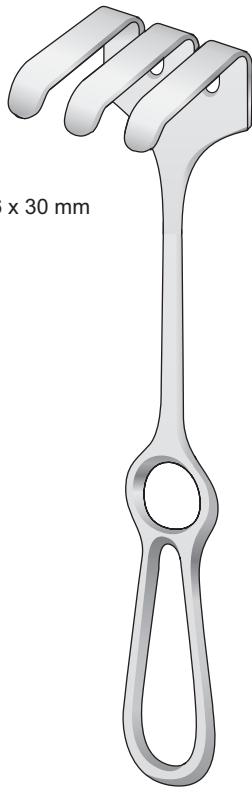

36 x 30 mm

OLLIER  
0219-BCE  
225 mm

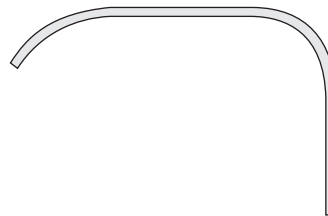

1/1

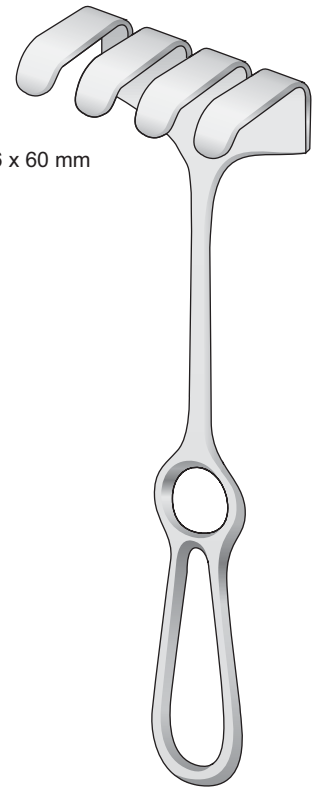

36 x 60 mm

OLLIER  
0219-BCF  
225 mm

40 x 40 mm

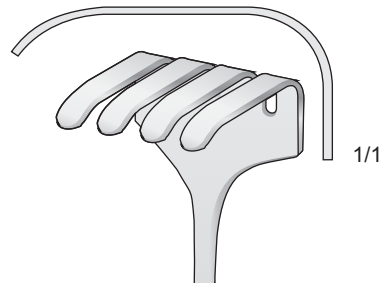

1/1

0219-BCA

45 x 50 mm

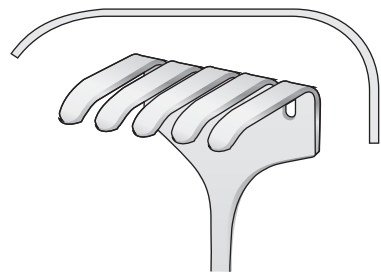

1/1

0219-BCB

50 x 60 mm

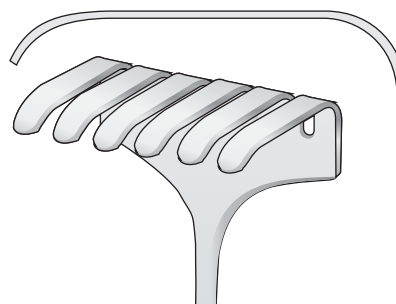

1/1

0219-BCC

70 x 70 mm

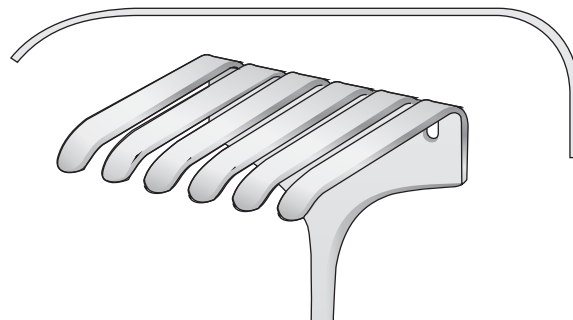

1/1

0219-BCD

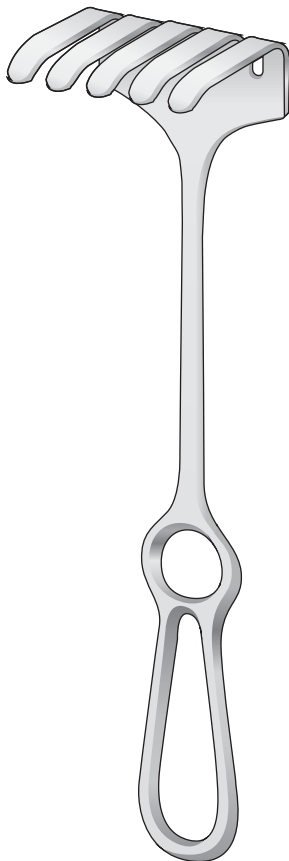

ISRAEL  
0219-BCA/0219-BCD  
250 mm

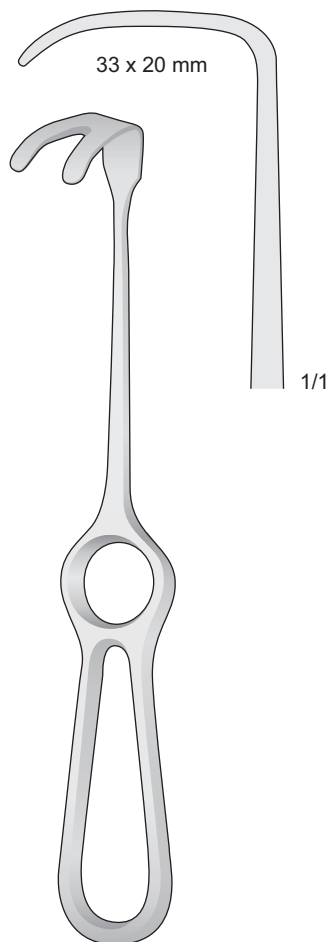

WASSMUND  
0219-GL  
220 mm

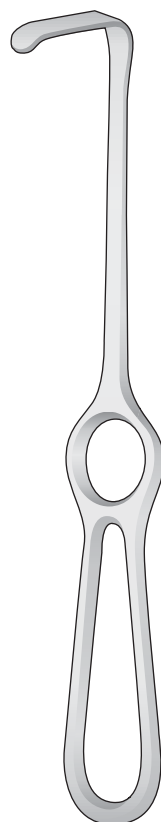

LANGENBECK  
0219-DD/0219-ED  
210 mm

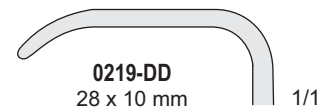

0219-DD  
28 x 10 mm



0219-DE  
30 x 14 mm

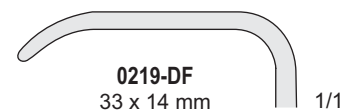

0219-DF  
33 x 14 mm

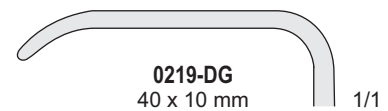

0219-DG  
40 x 10 mm

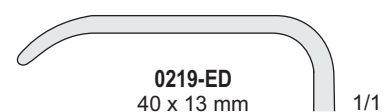

0219-ED  
40 x 13 mm

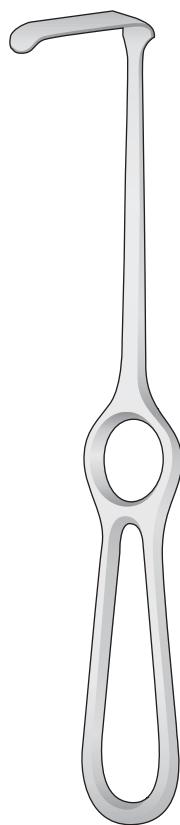

KOCHER-LANGENBECK  
0219-GA/0219-CGD  
215 mm

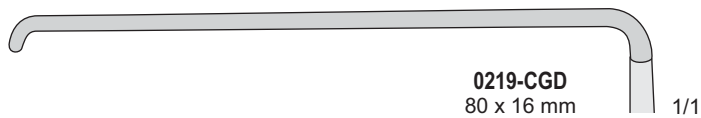
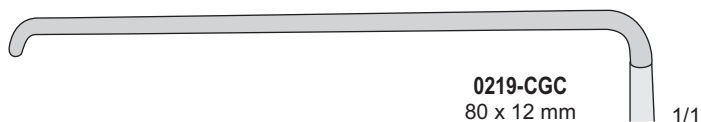
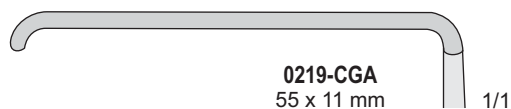
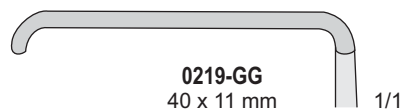
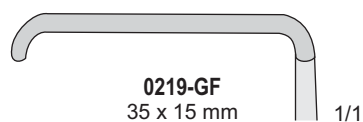
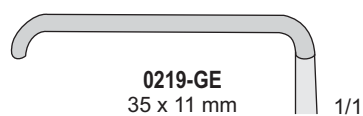
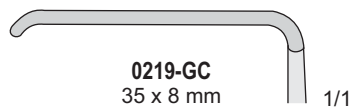
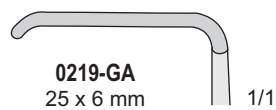

Divaricatori

Retractors

Wundhaken

Ecarteurs

Separadores

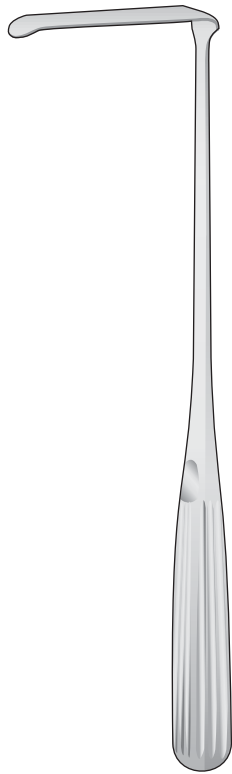

SAUERBRUCH  
0219-BBA/0219-BBC  
225 mm

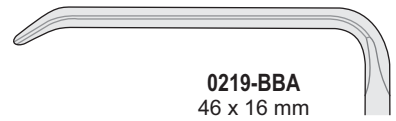

0219-BBA  
46 x 16 mm 1/1

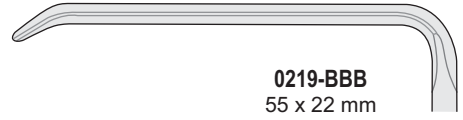

0219-BBB  
55 x 22 mm 1/1

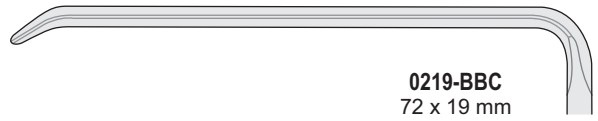

0219-BBC  
72 x 19 mm 1/1

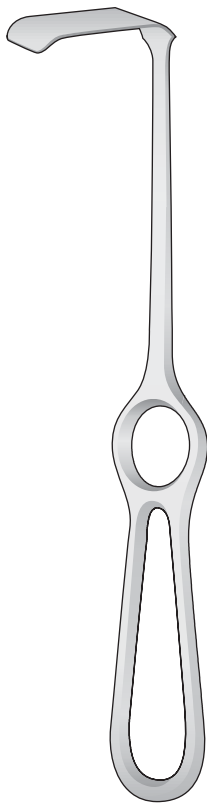

KOCHER  
0219-CFA/0219-CFE  
230 mm

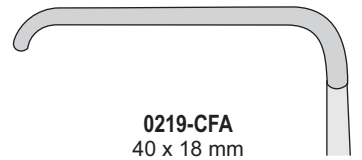

0219-CFA  
40 x 18 mm 1/1

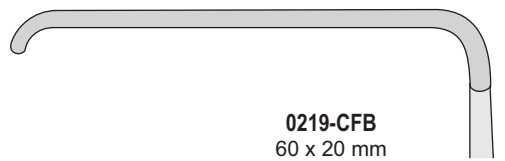

0219-CFB  
60 x 20 mm 1/1

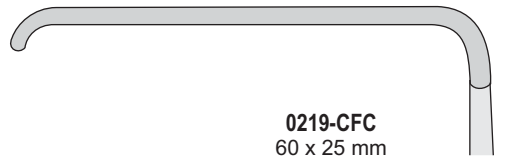

0219-CFC  
60 x 25 mm 1/1



0219-CFD  
75 x 30 mm 1/1

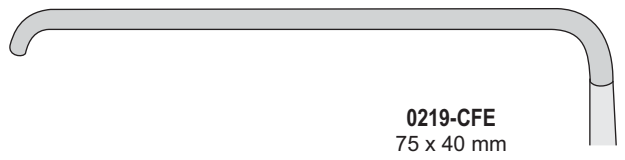

0219-CFE  
75 x 40 mm 1/1

Divaricatori

Retractors

Wundhaken

Ecarteurs

Separadores

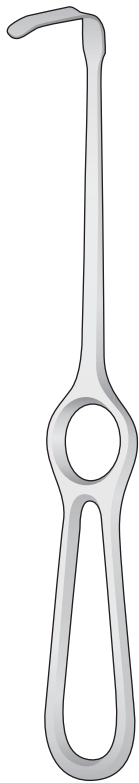

OBWEGESER  
0219-BFC/0219-BFH  
220 mm



OBWEGESER  
0219-LC/0219-BAA  
220 mm

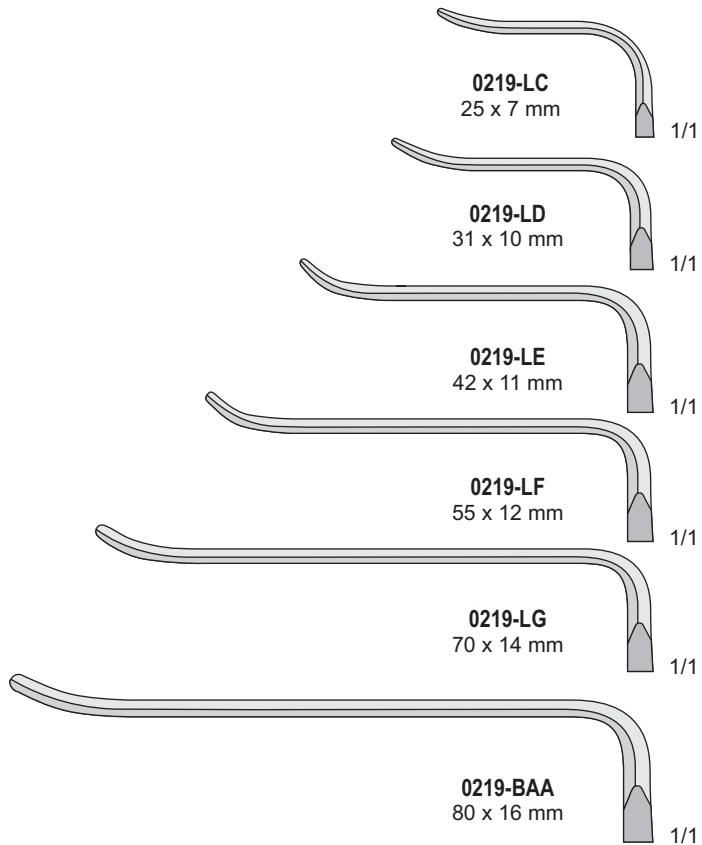
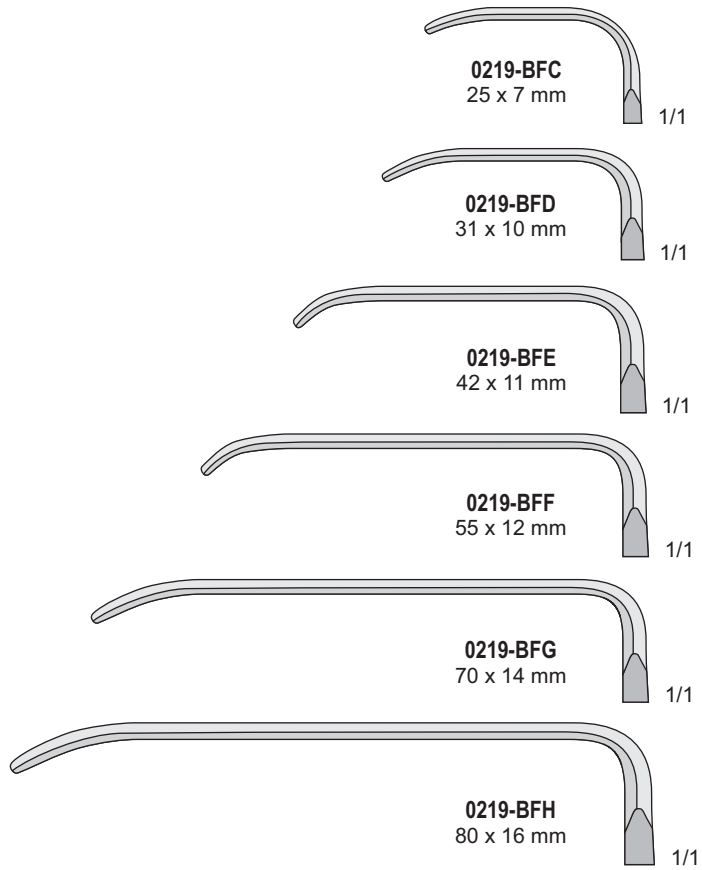



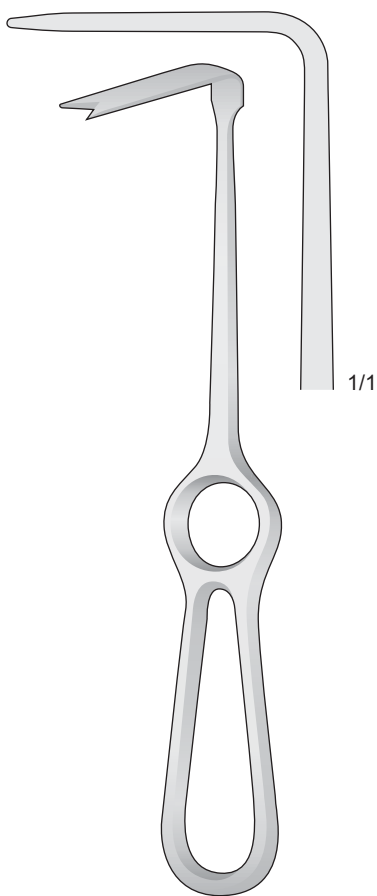
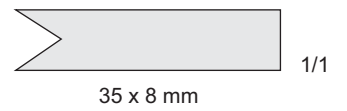
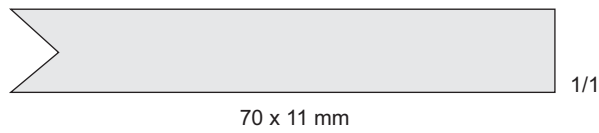
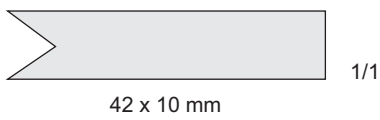

**OBWEGESER**  
**0219-GH**  
215 mm

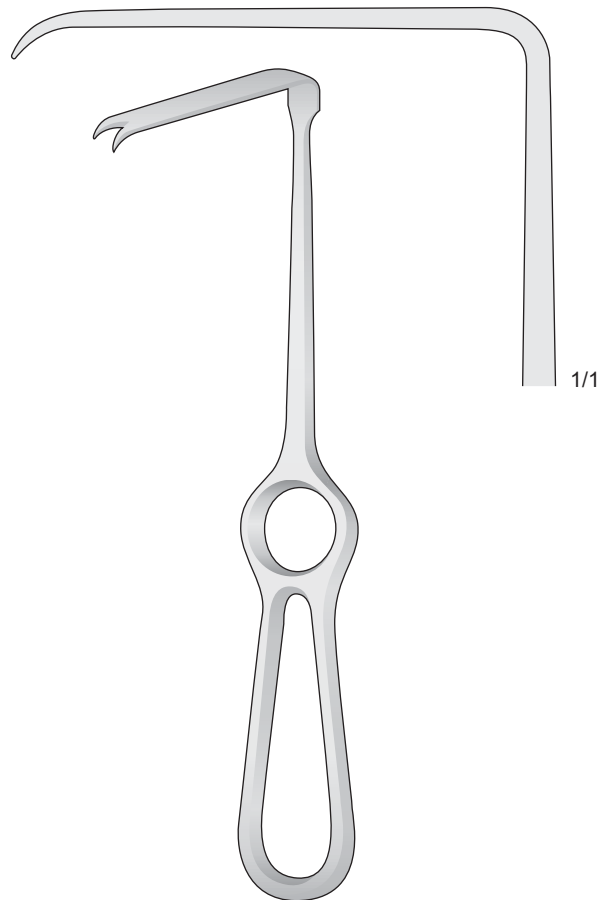

**0219-GI**  
220 mm

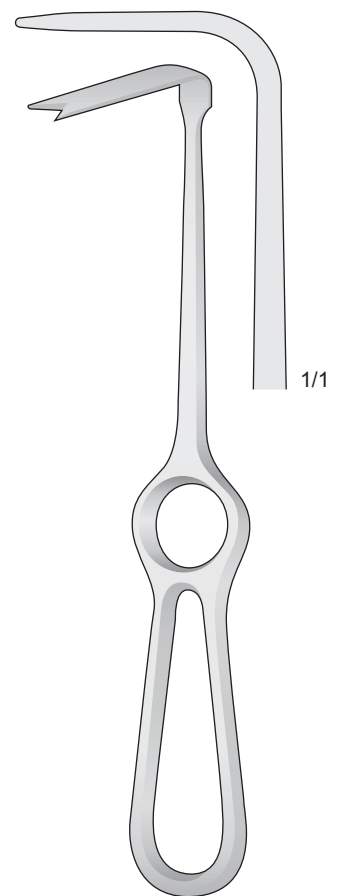

**0219-BDA**  
215 mm

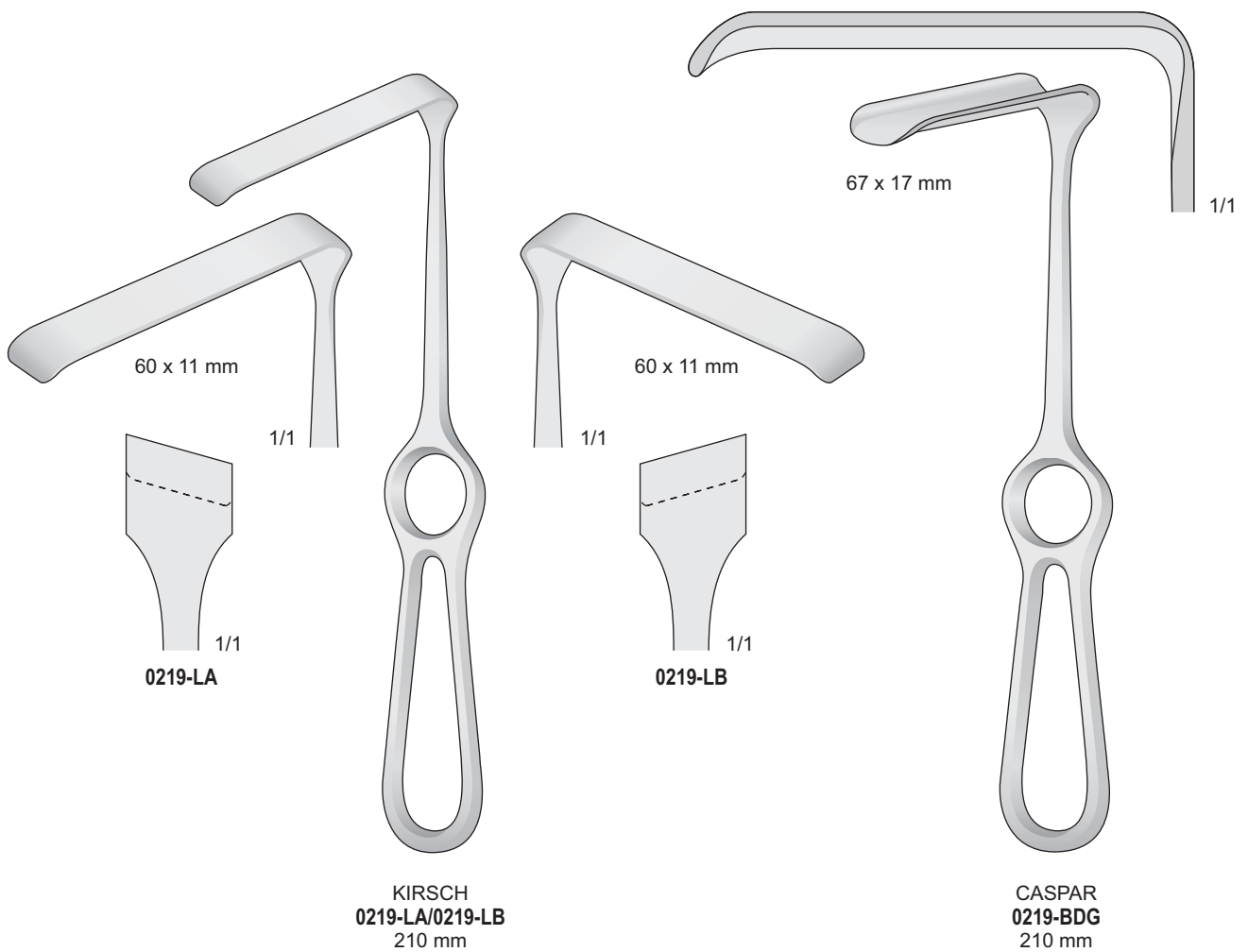

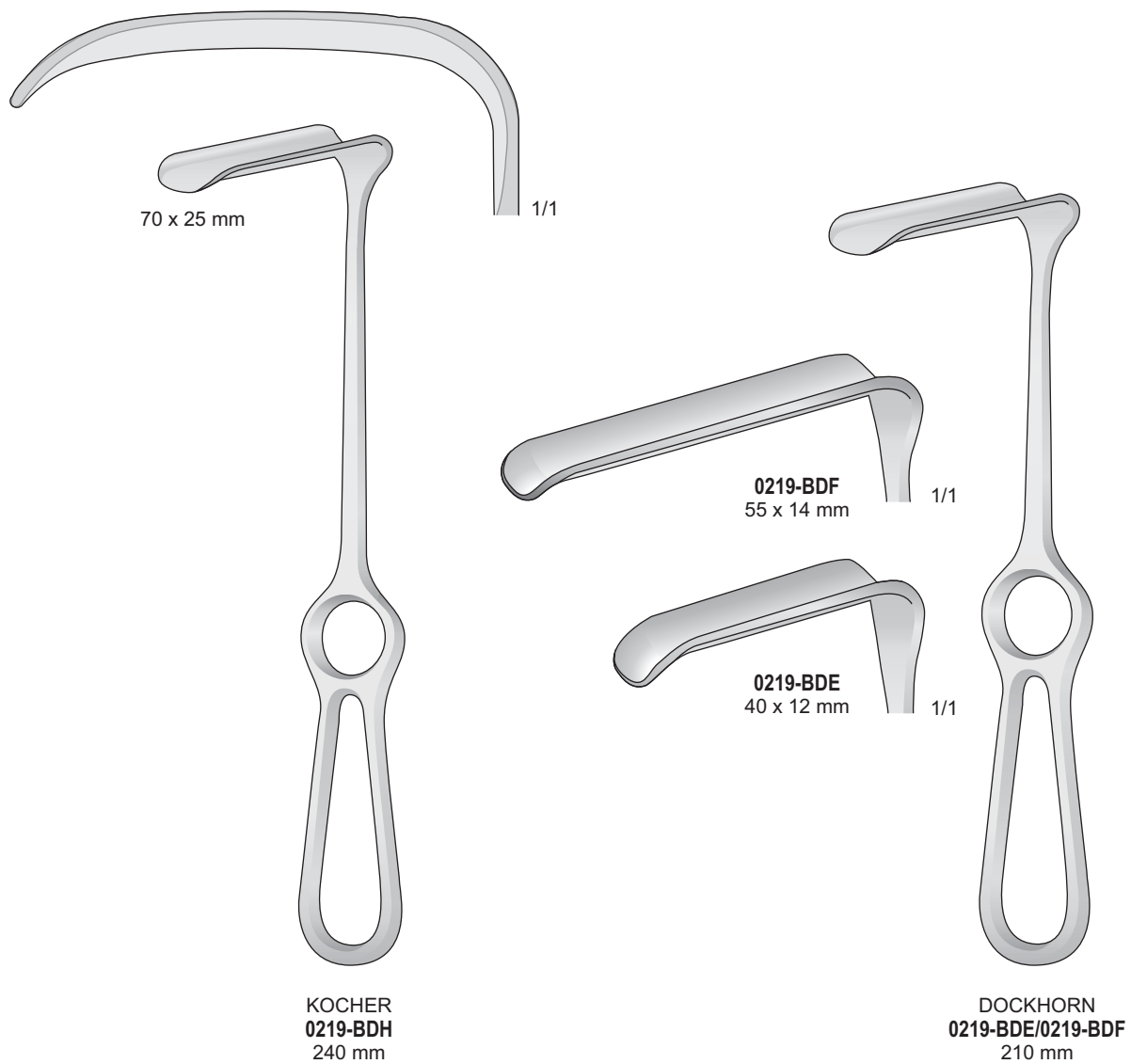

Divaricatori

Retractors

Wundhaken

Ecarteurs

Separadores

15 x 15 mm

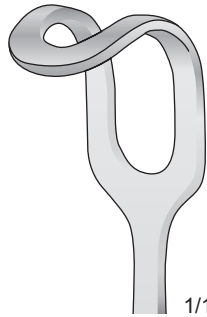

**0219-IA**  
225 mm

45 x 45 mm

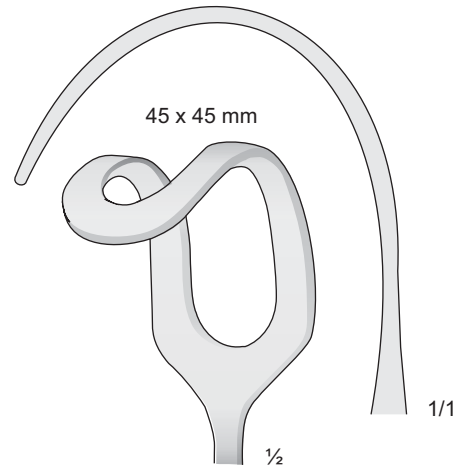

**0219-BIA**  
255 mm

20 x 22 mm

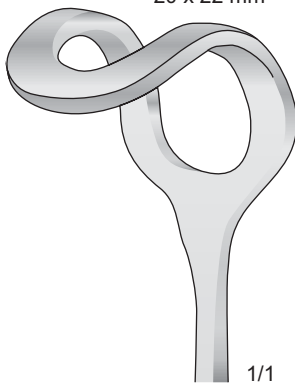

**0219-IB**  
225 mm

45 x 50 mm

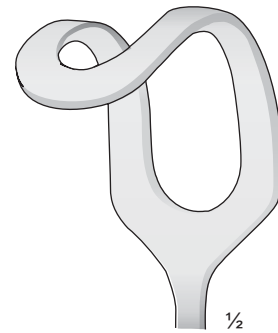

**0219-BIB**  
255 mm

28 x 28 mm

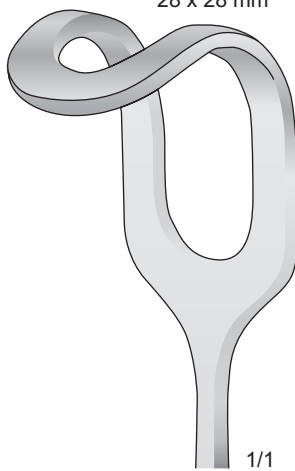

**0219-IC**  
225 mm

55 x 70 mm

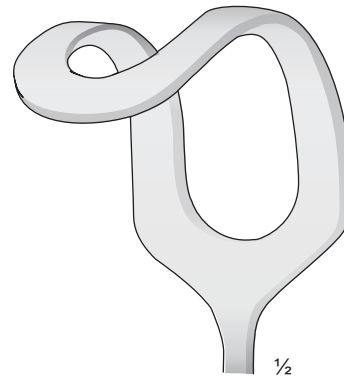

**0219-BIC**  
255 mm

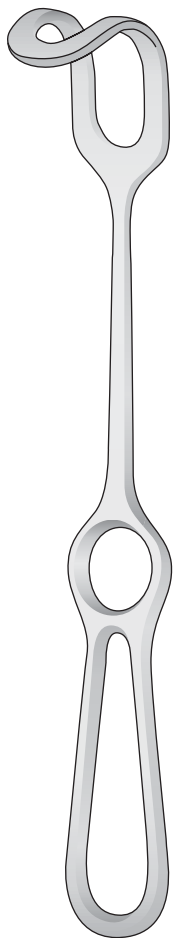

MIDDELDORPF  
**0219-IA/0219-IC**  
225 mm

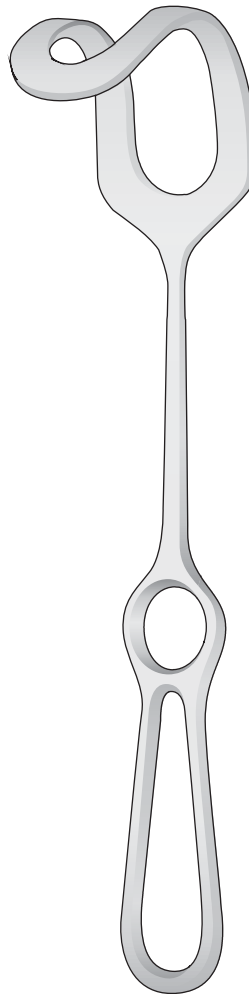

MIDDELDORPF  
**0219-BIA**  
255 mm

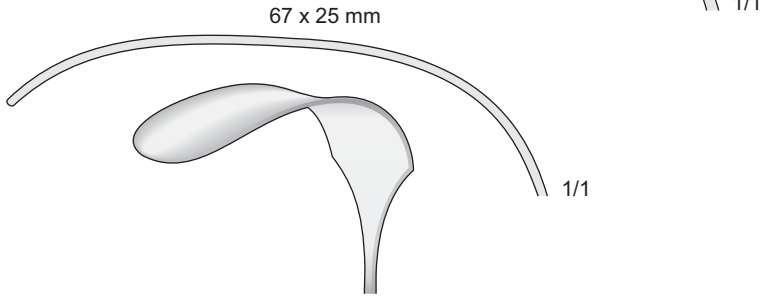
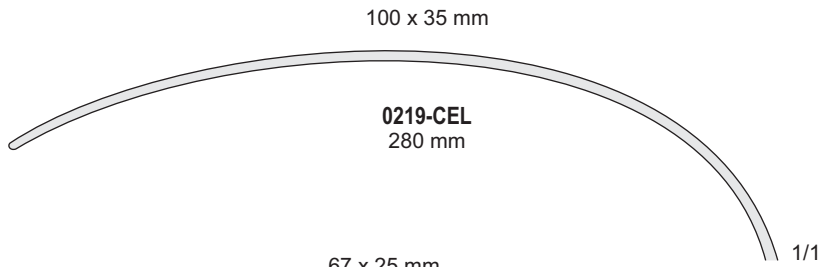

**0219-CHA** 80x42 mm  
**0219-CHB** 80x50 mm  
**0219-CHC** 80x60 mm

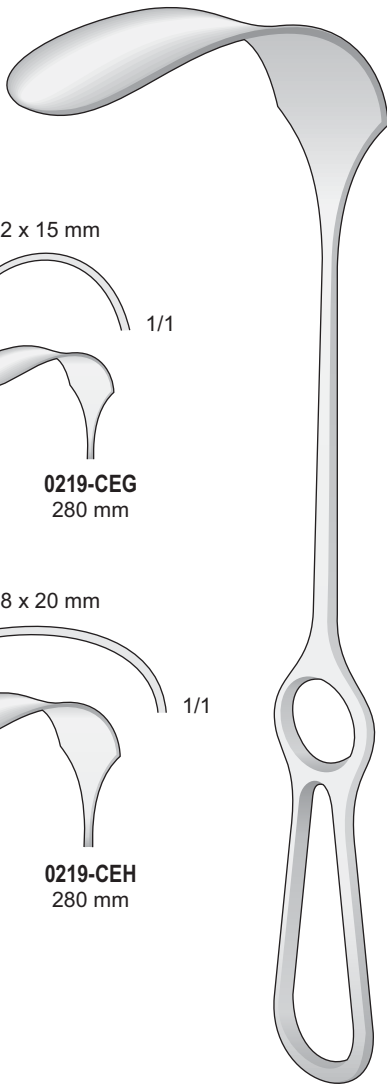

KOCHER  
**0219-CEG/0219-CEL**  
280 mm

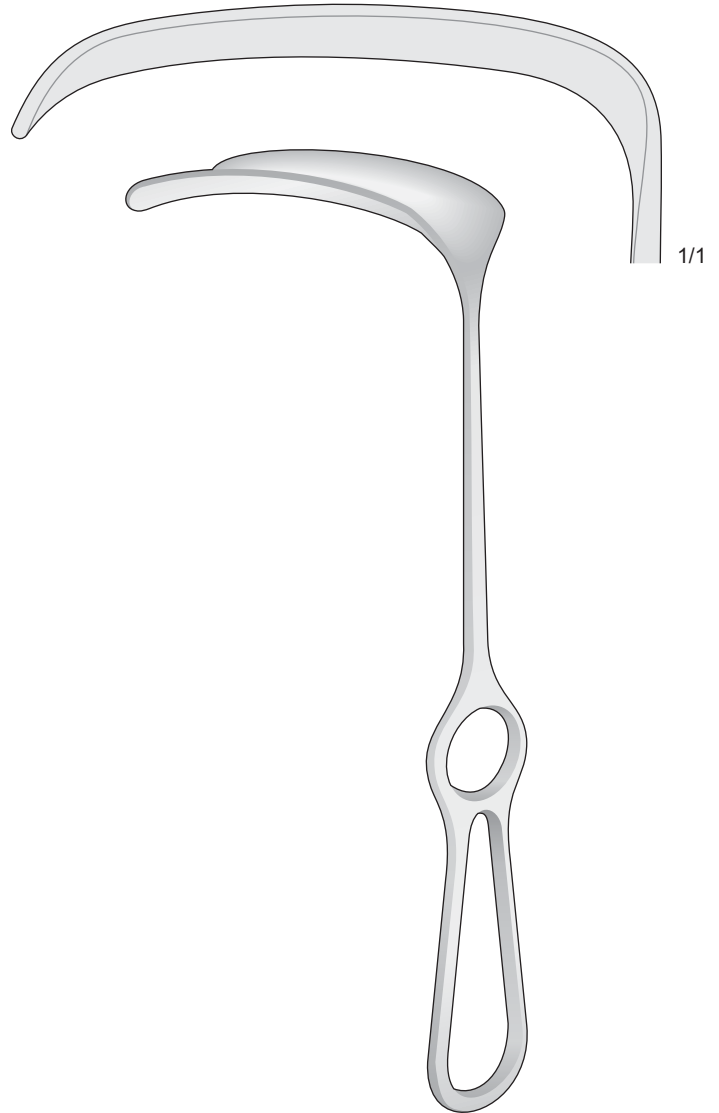

KOCHER  
**0219-CHA/0219-CHC**  
250 mm

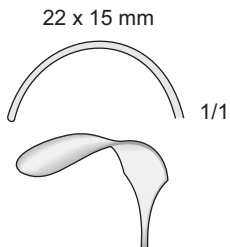

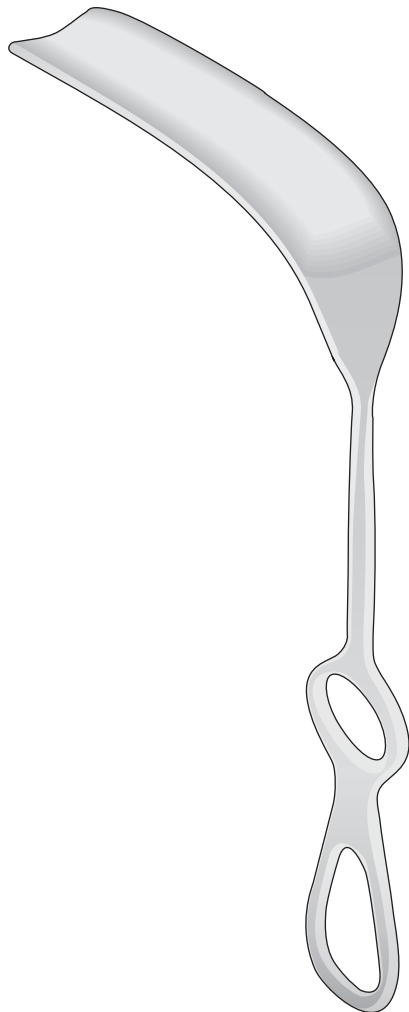
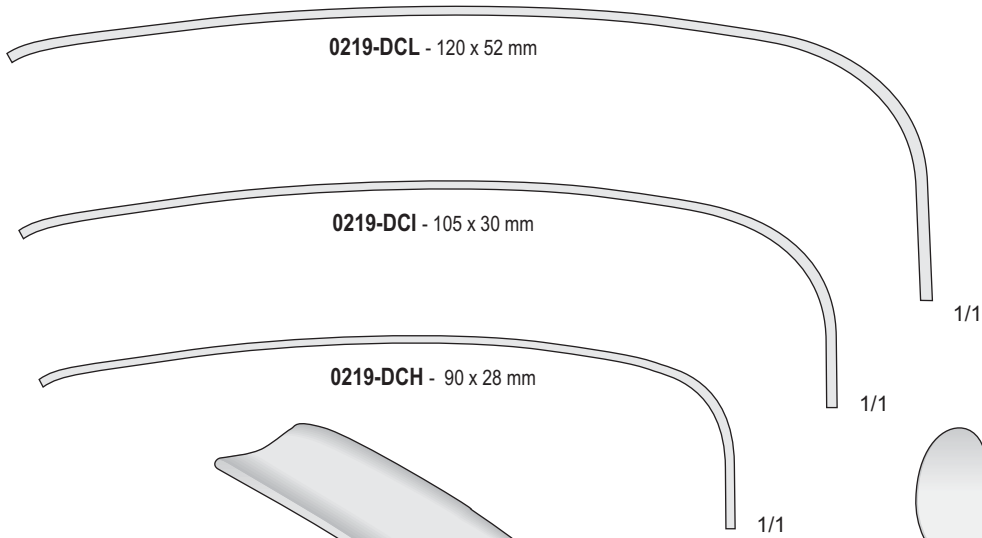

DOYEN-STILLE  
0219-DCH/0219-DCL  
220 mm



DOYEN  
0219-DDA  
250 mm

Divaricatori

Retractors

Wundhaken

Ecarteurs

Separadores

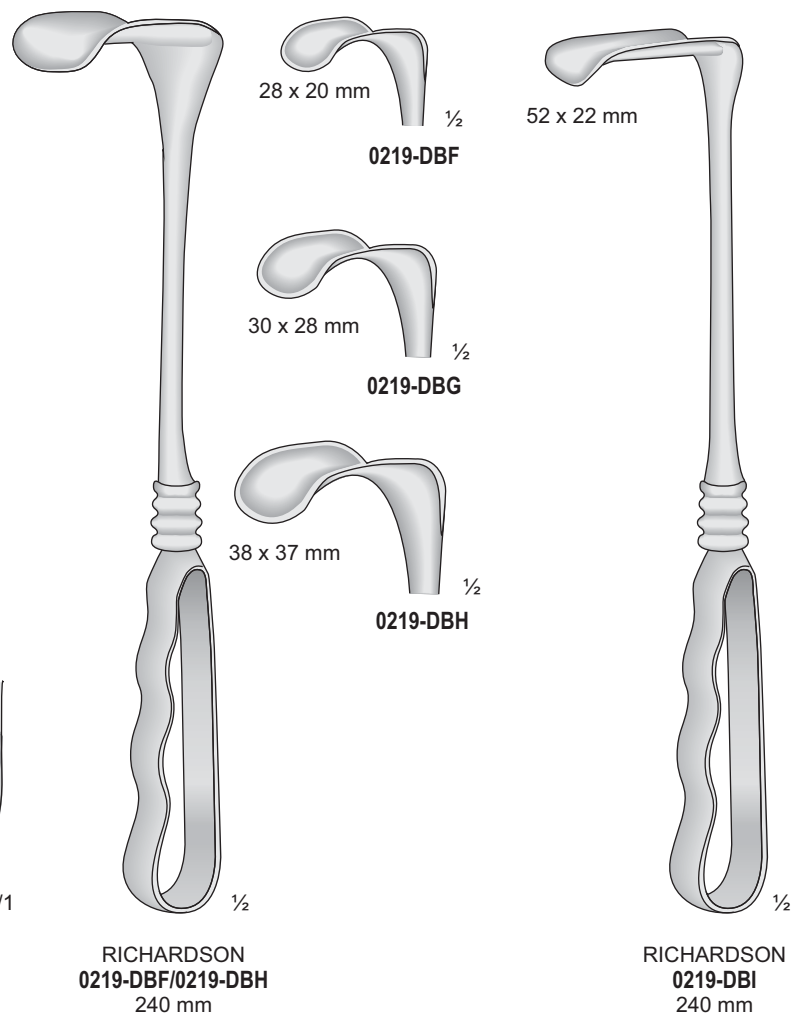
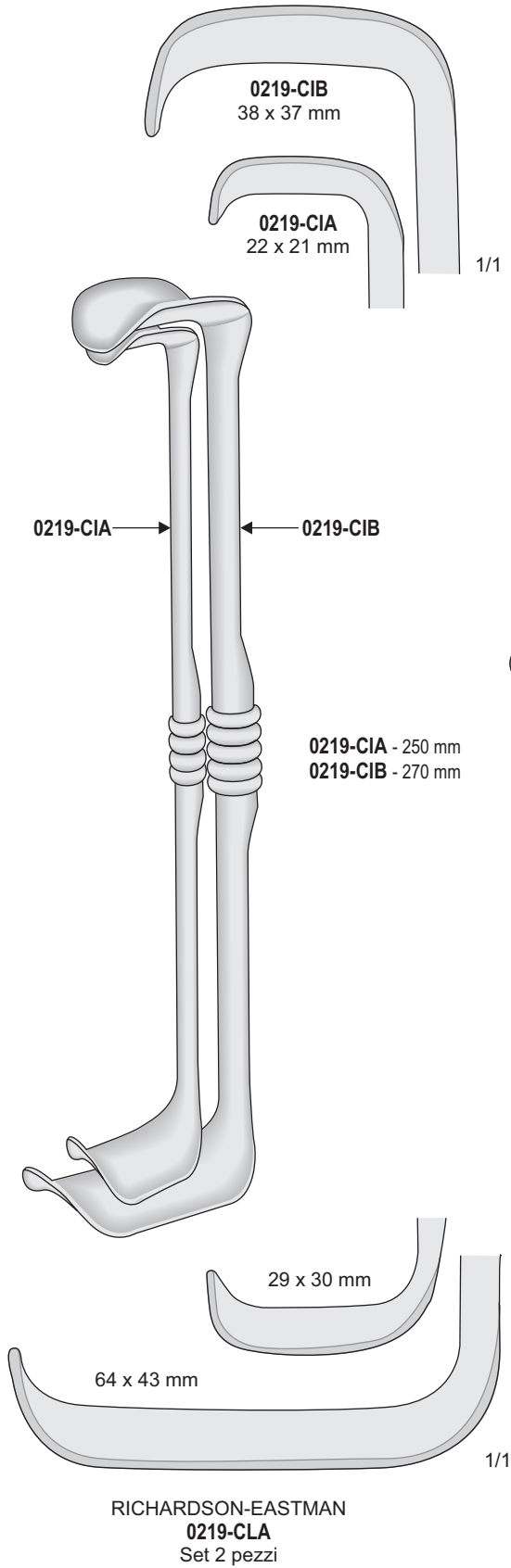

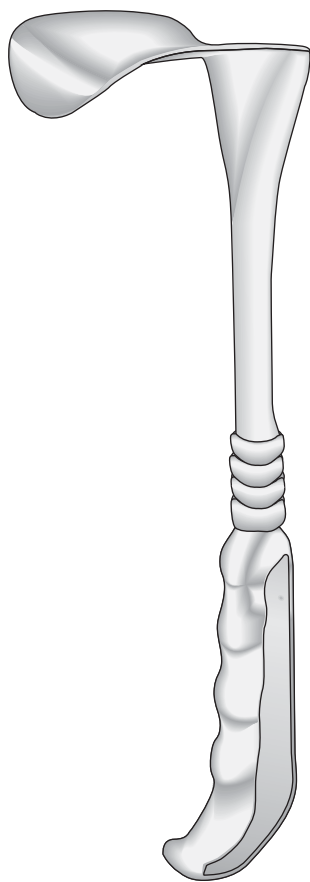

KELLY  
0219-DBL/0219-DCC  
260 mm

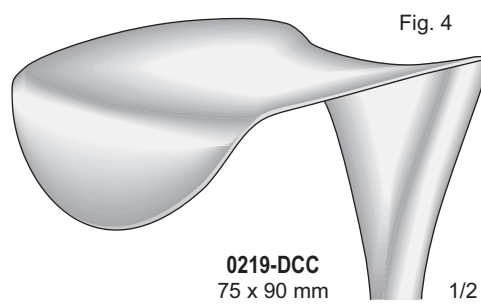
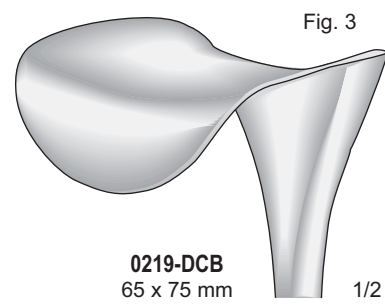
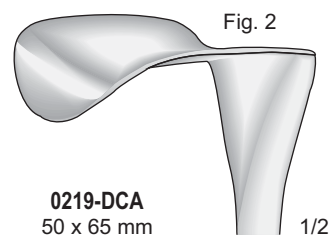
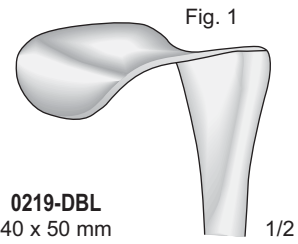



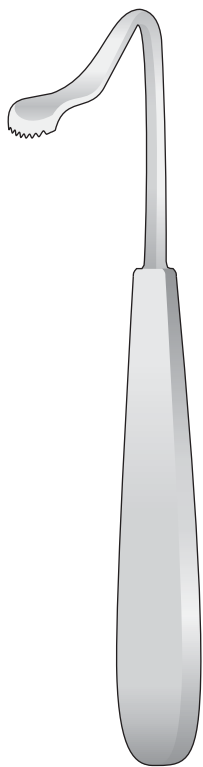

**BOWLED-HENRY**  
**0414-BHF**  
170 mm

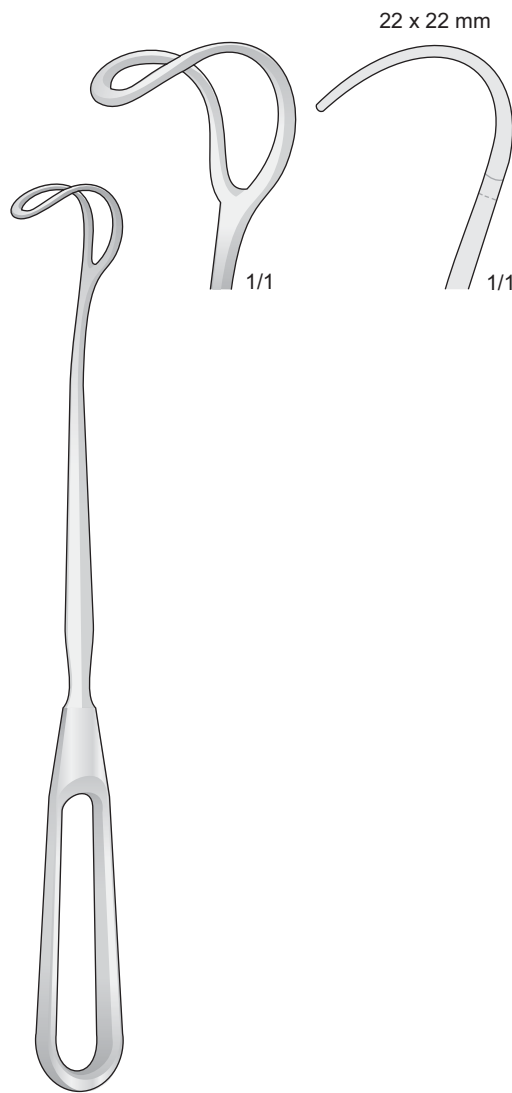

**GREENE**  
**0219-BDB**  
225 mm

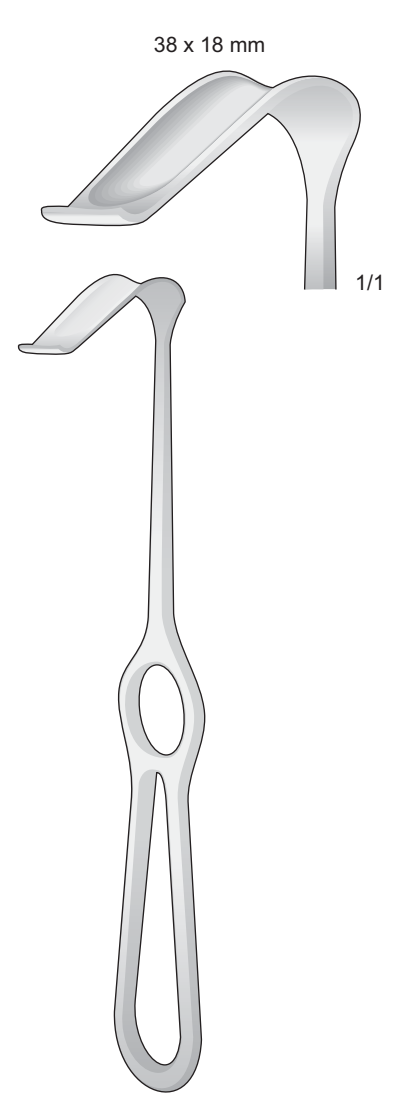

**BÜCHS**  
**0219-BDD**  
205 mm

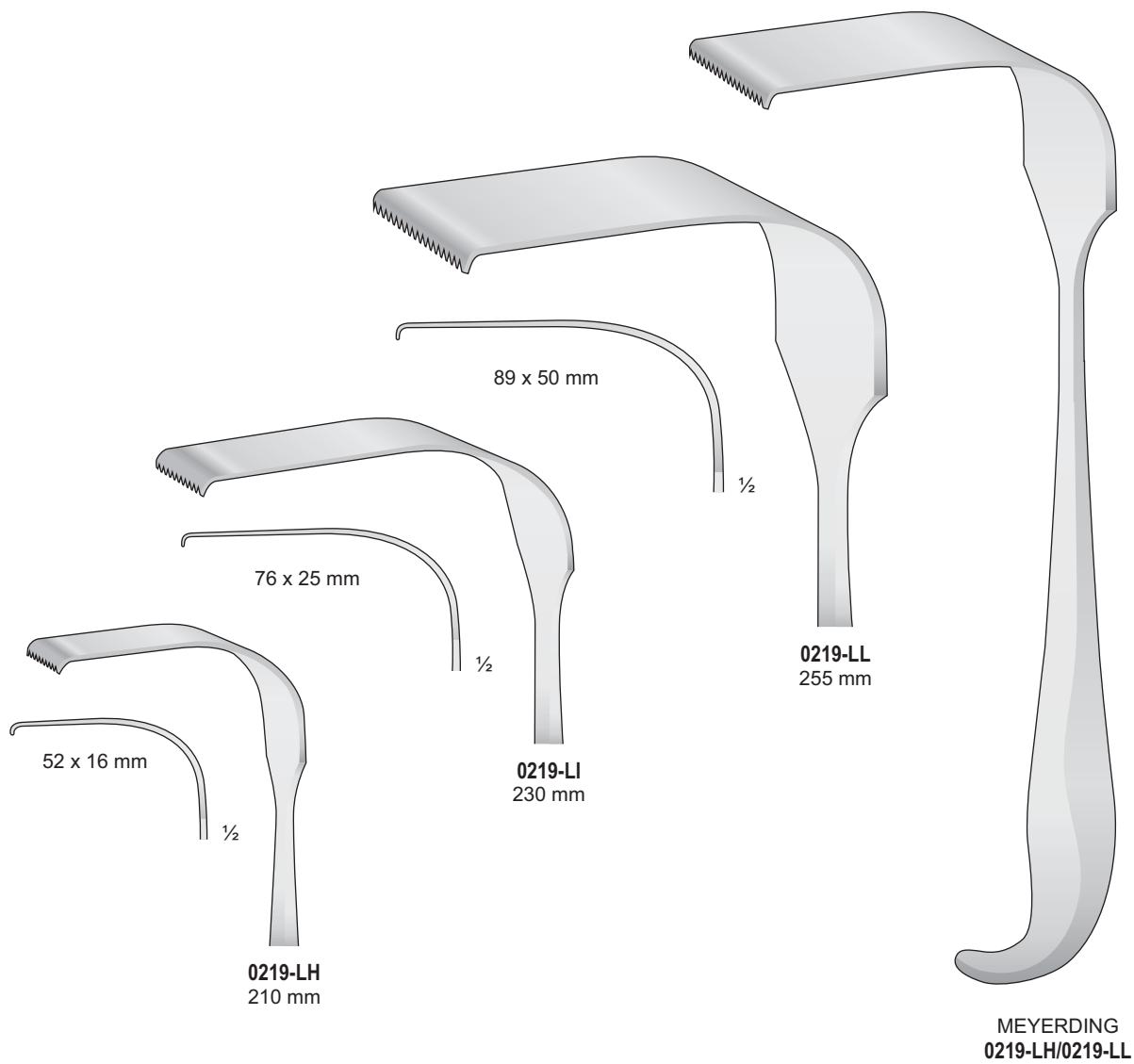

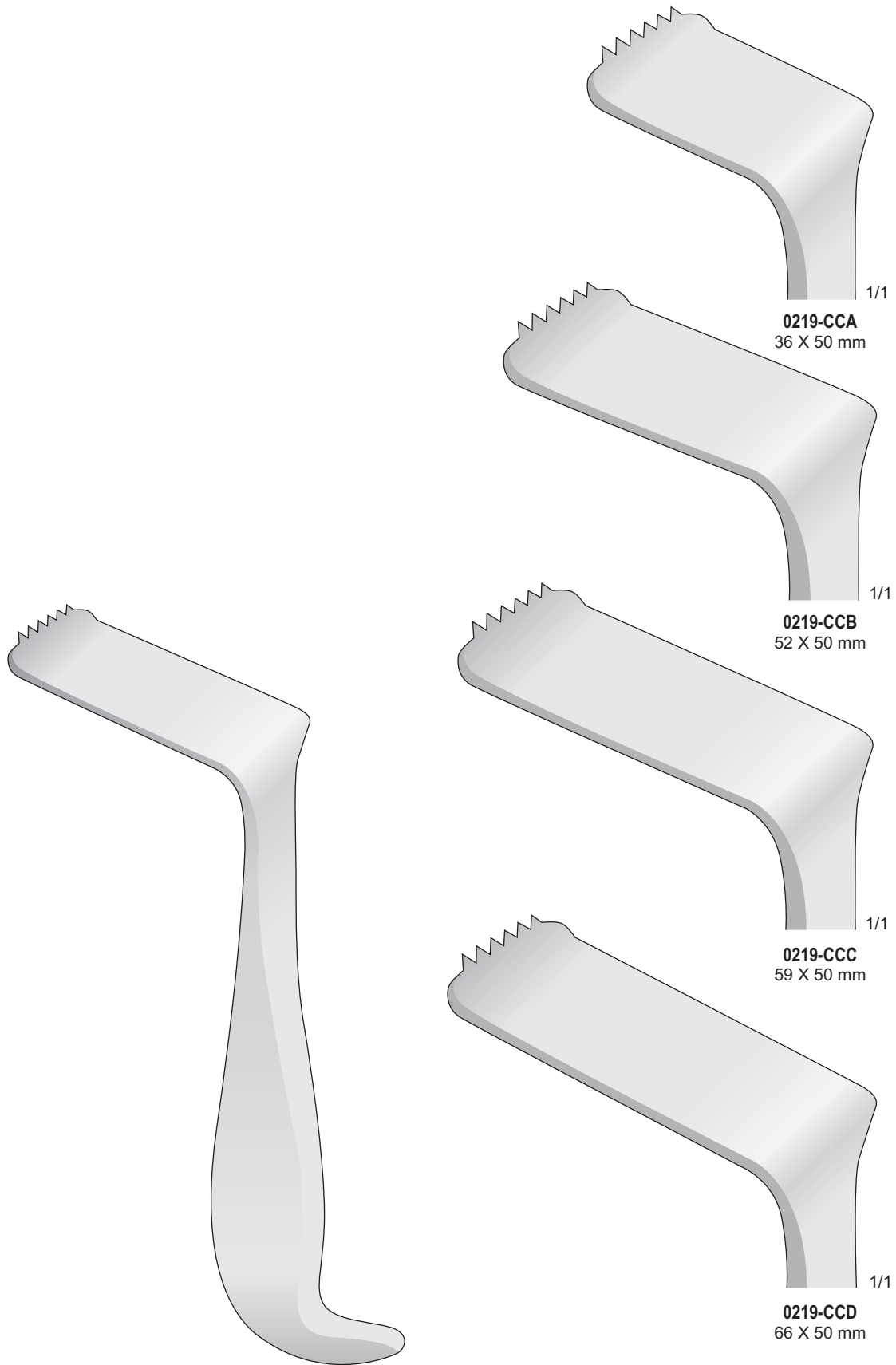

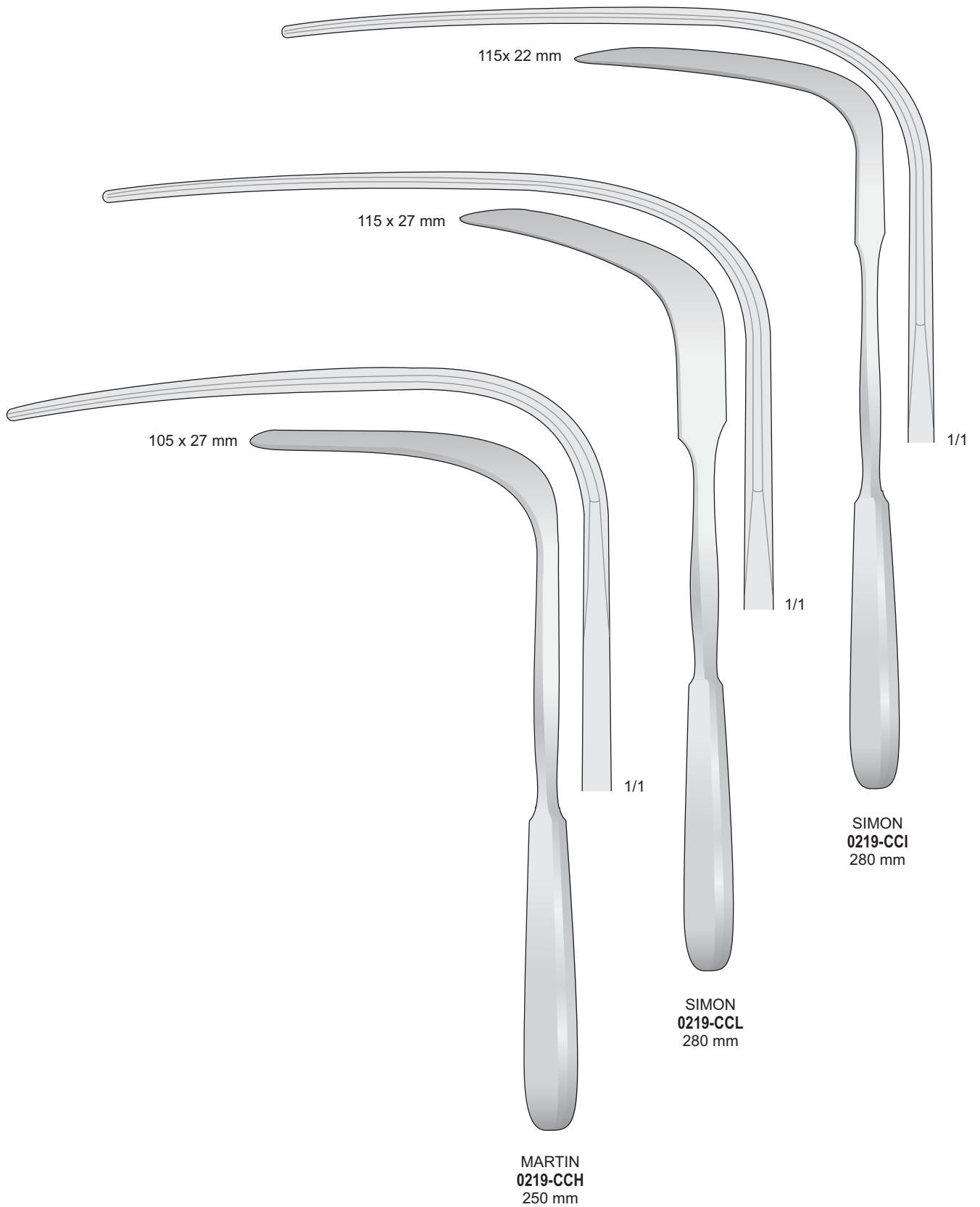

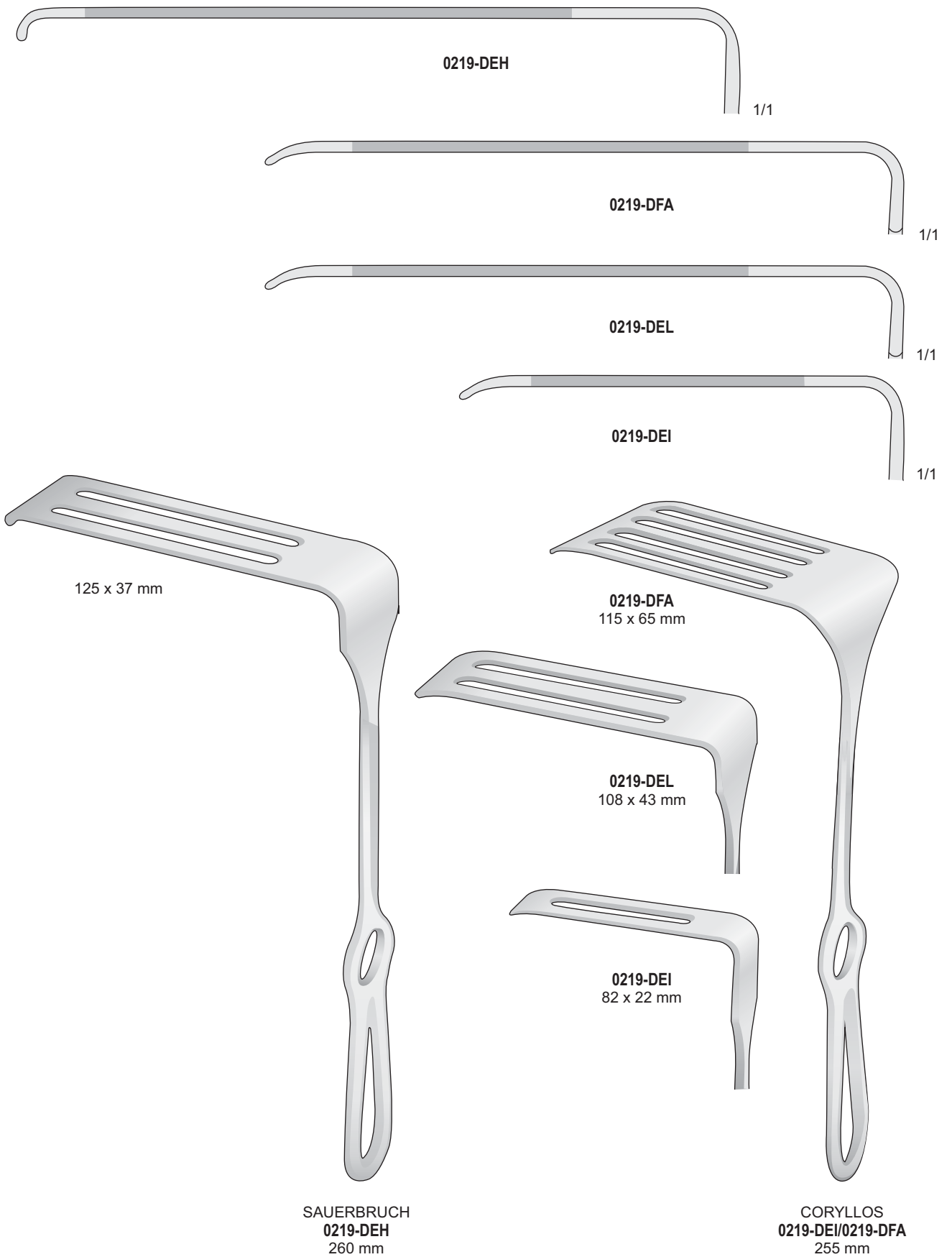

Retrattori per scapola  
 Scapula retractors  
 Scapula-Haken  
 Ecarteurs pour scapula  
 Separadores para scápula

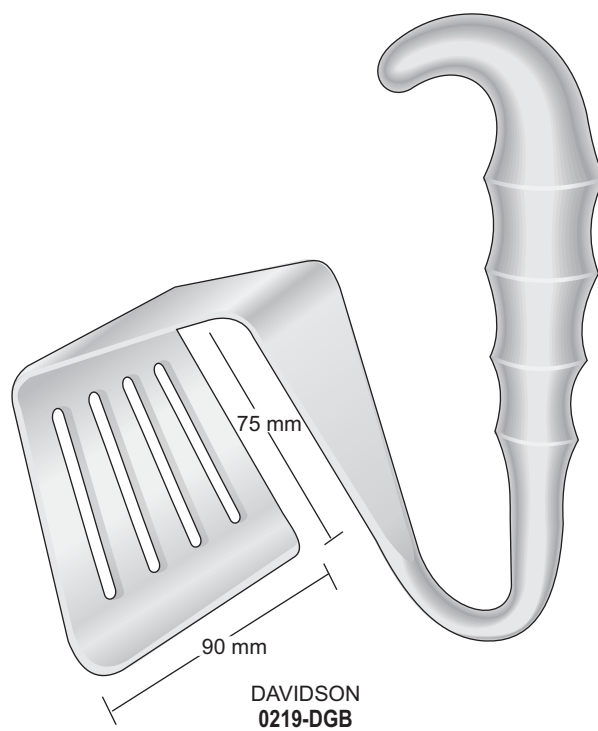
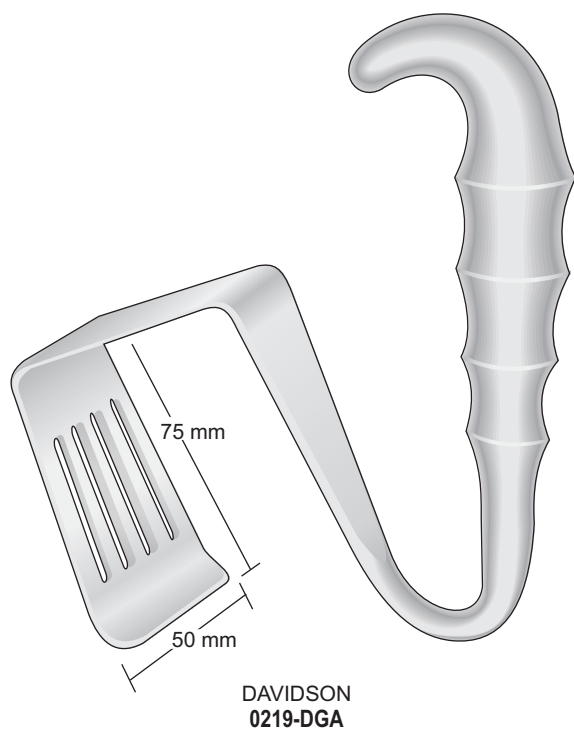

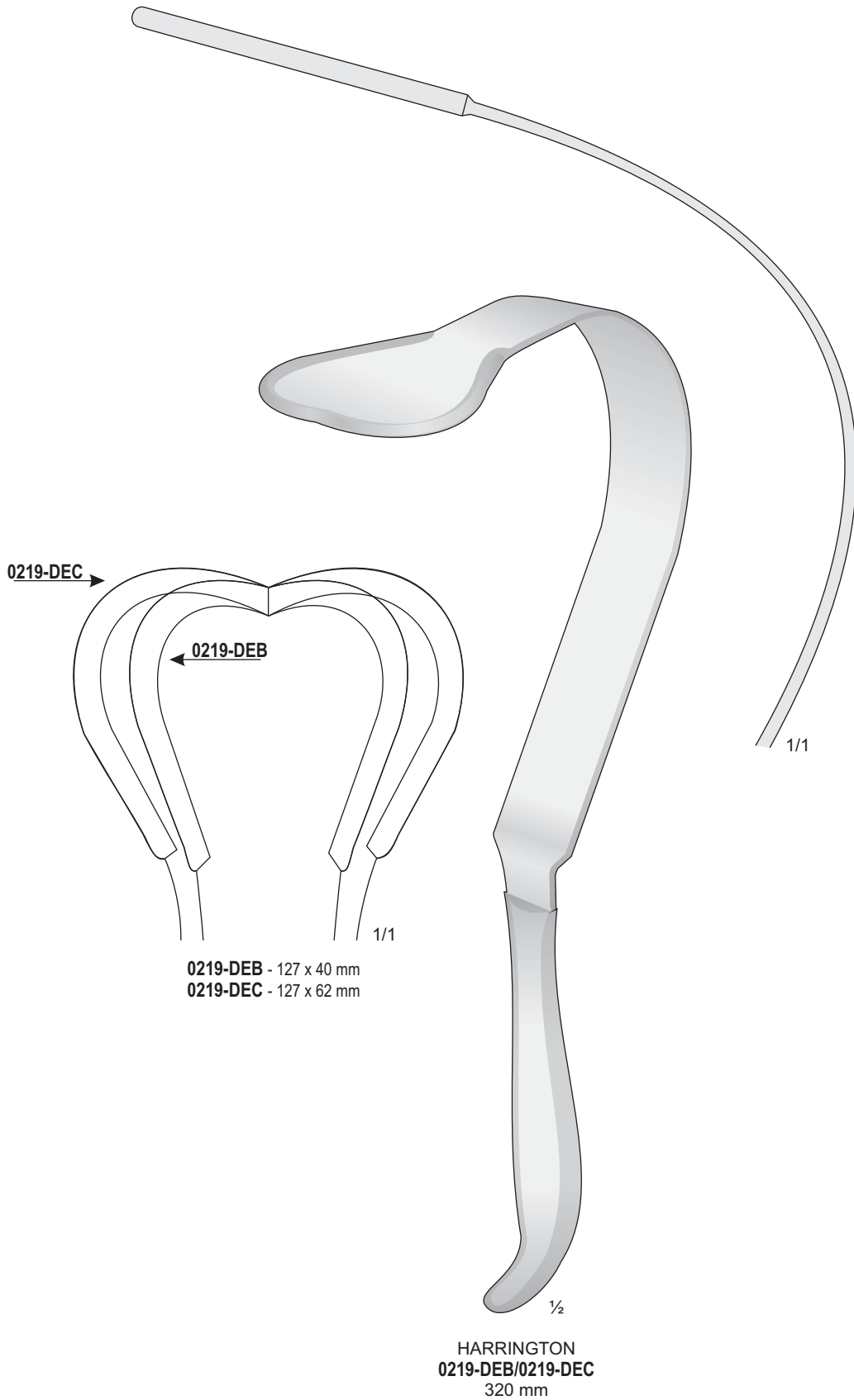

Spatole per polmone  
Lung spatulas  
Lungenspatel  
Spatules pulmonaires  
Espátulas pulmonares

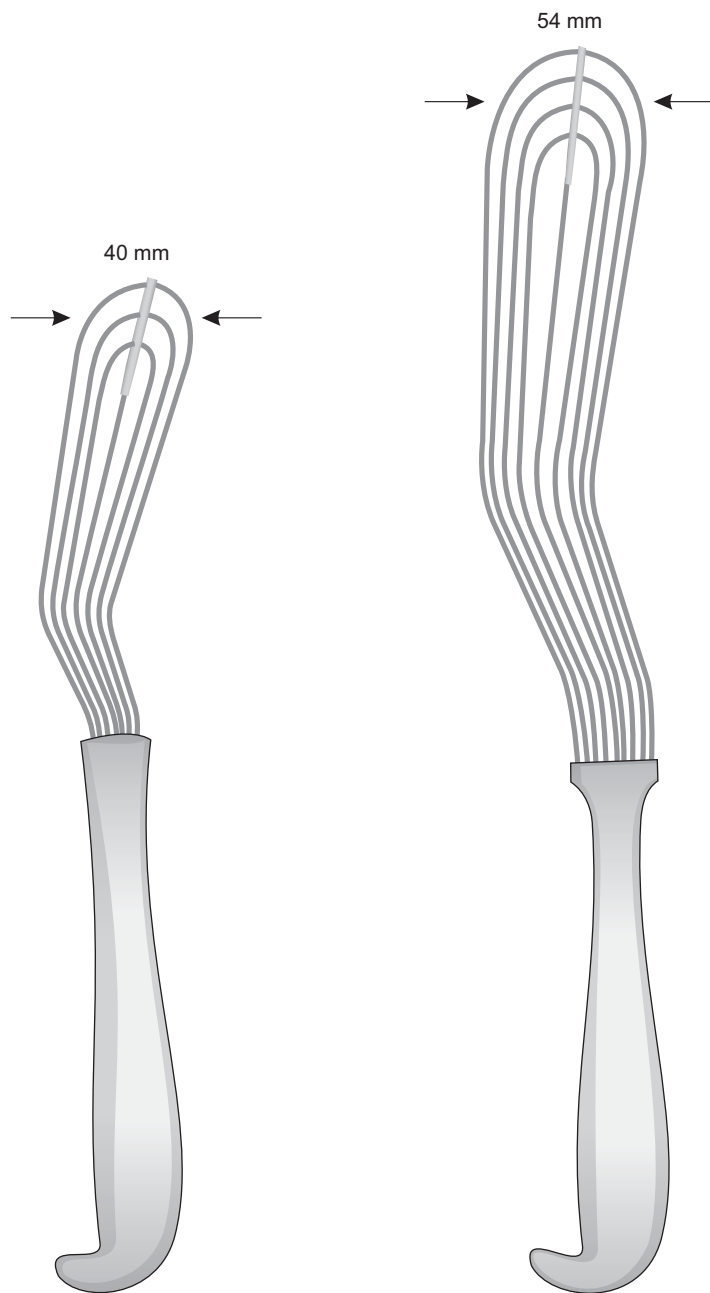

ALLISON  
0219-DEE  
255 mm

ALLISON  
0219-DEF  
320 mm



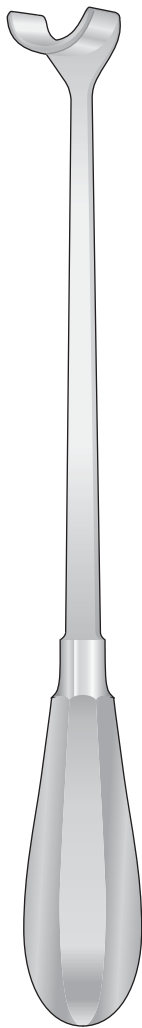
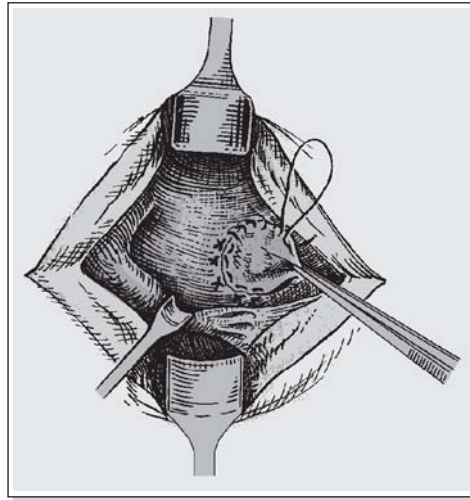

ROSS  
0219-DDB/0219-DDG  
270 mm

Fig. 1



Fig. 2



Fig. 3



Fig. 4



Fig. 5



Fig. 6

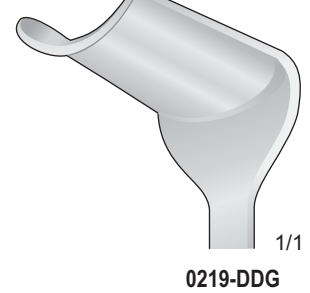

Divaricatori

Retractors

Wundhaken

Ecarteurs

Separadores

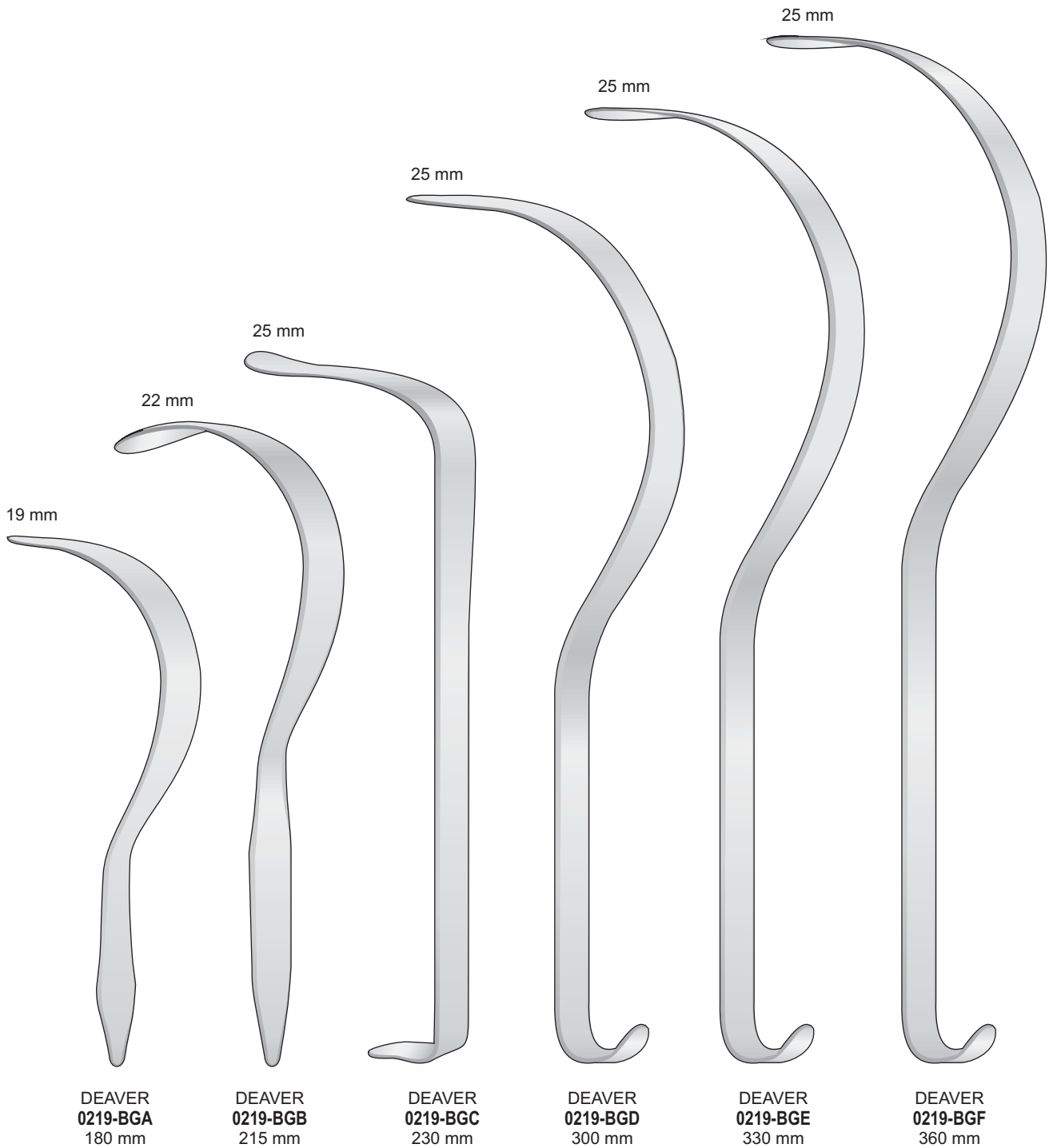

38 mm

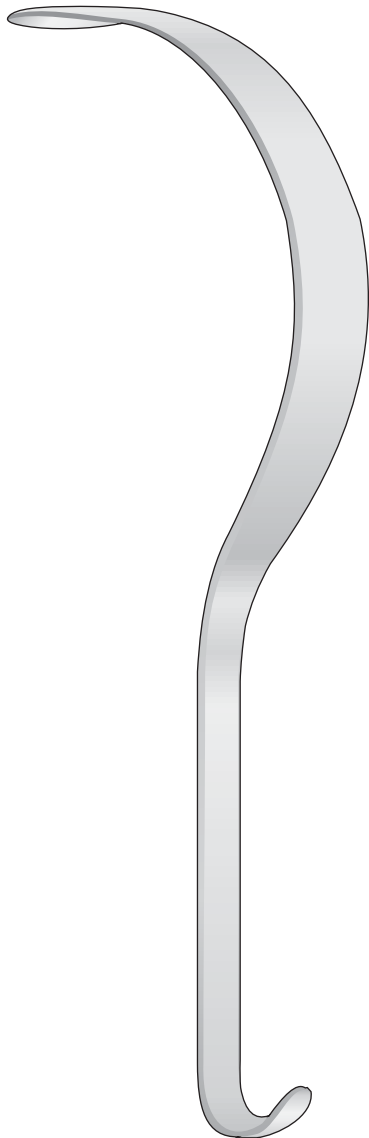

DEAVER  
0219-BGG  
300 mm

50 mm

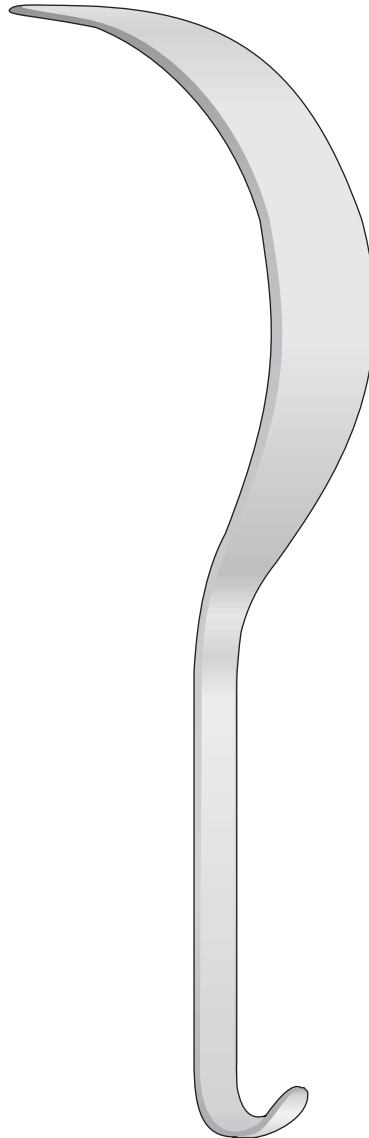

DEAVER  
0219-BGH  
300 mm

75 mm

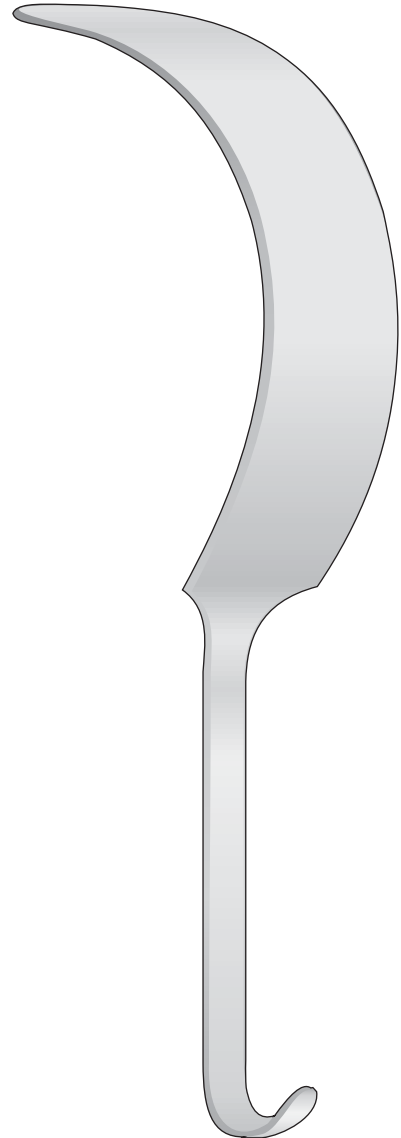

DEAVER  
0219-BGI  
300 mm

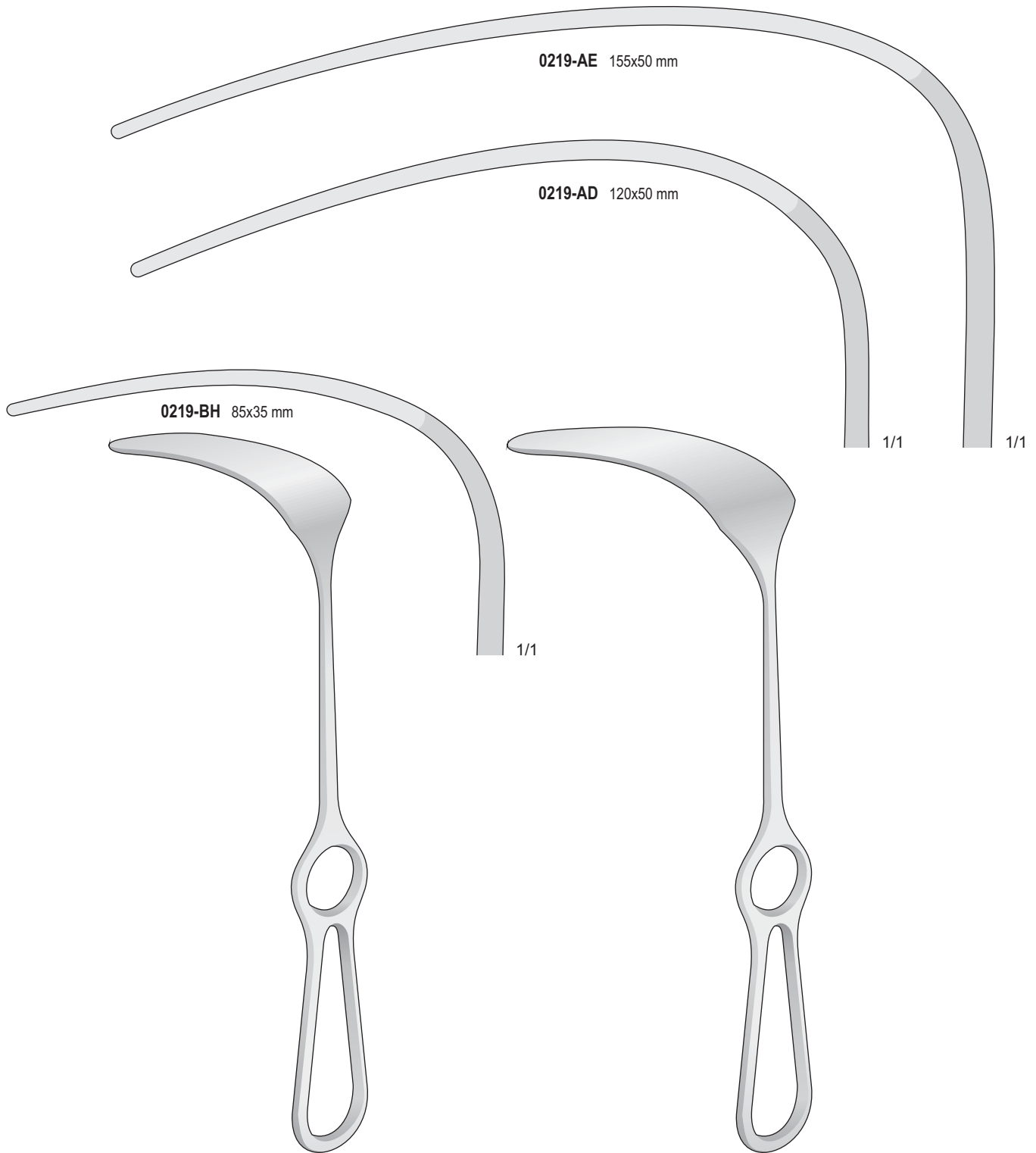

0219-AE 155x50 mm

0219-AD 120x50 mm

0219-BH 85x35 mm

1/1

1/1

1/1

MIKULICZ  
0219-BH  
260 mm

MIKULICZ  
0219-AD/0219-AE  
260 mm

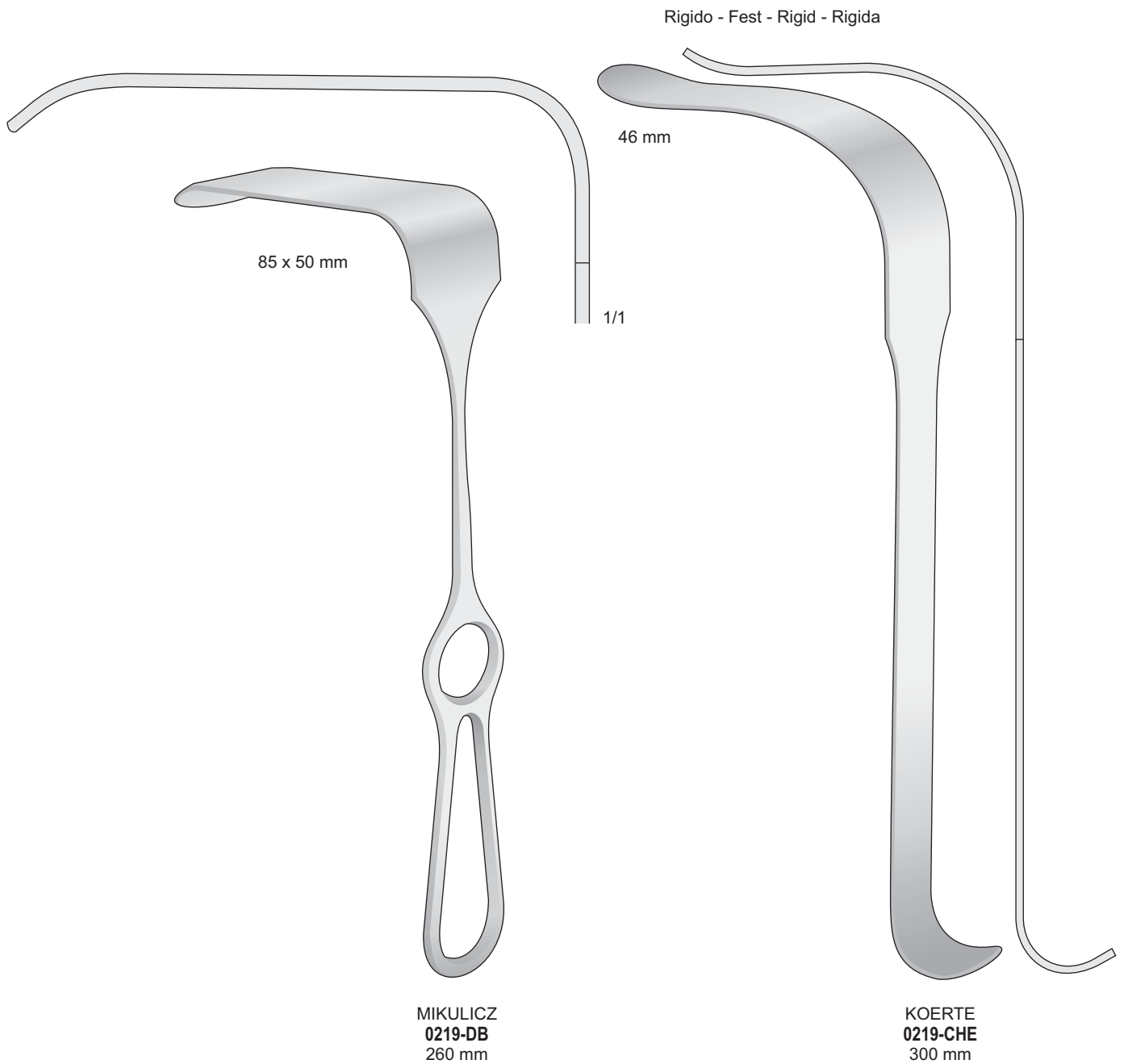

Divaricatori

Retractors

Wundhaken

Ecarteurs

Separadores

Destro  
Right  
Rechts  
Droite  
Derecha

45 mm  
48 mm

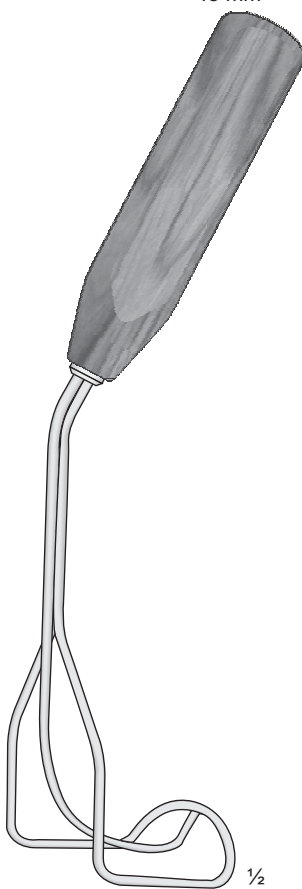

COOLEY  
0219-DFH  
215 mm

Destro, leggermente dentallato  
Right, slightly serrated  
Rechts, mit zahnriefen  
Droite, légèrement dentelé  
Derecha, legermente dentados

45 mm  
48 mm

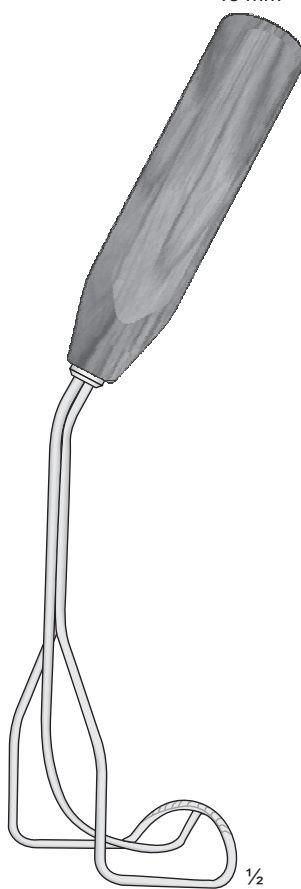

COOLEY  
0219-DFI  
215 mm

Sinistro  
Left  
Links  
Gauche  
Izquierda

24 mm  
48 mm

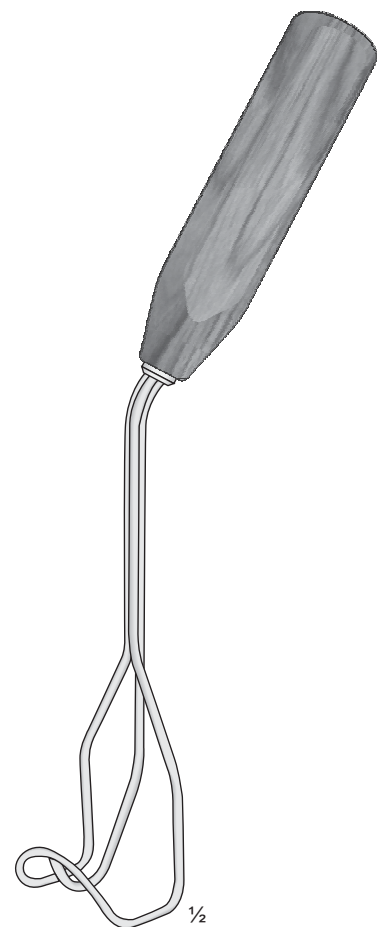

COOLEY  
0219-DFL  
230 mm

**1412-IF**

Set completo con 3 spatole  
 Set complete with 3 spatulas  
 Kompletset mit 3 Spatel  
 Set complete avec 3 spatules  
 Set completos con 3 espatulas

**1412-IA + 1412-IB + 1412-IC**

Spatole addominali e intestinali inox  
 Abdominal and intestinal spatulas  
 Bauch und Darmspatel  
 Ecarteurs abdominaux et intestinaux  
 Espátulas abdominales e intestinales

Malleabili - Malleable - Biegsam  
 Souples - Maleables

Spatole Inox malleabili antiriflesso nere  
 Spatulas malleable black anodized

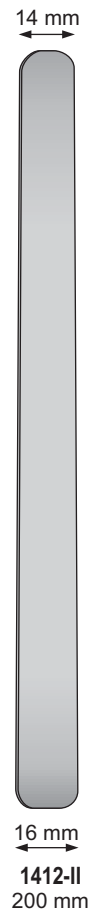
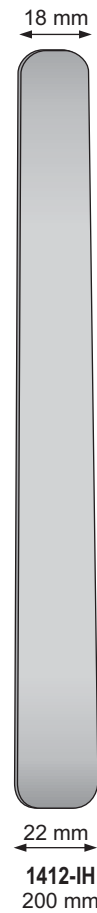
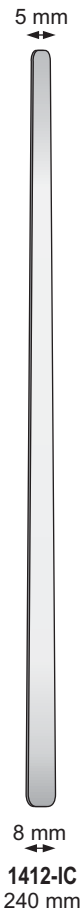
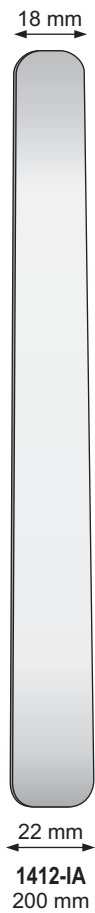

Divaricatori

Retractors

Wundhaken

Ecarteurs

Separadores



<b>1412-CAB</b>	7 mm + 9 mm
<b>1412-CAC</b>	11 mm + 13 mm
<b>1412-CAD</b>	15 mm + 18 mm
<b>1412-CAE</b>	18 mm + 22 mm

CUSHING  
1412-CAB/1412-CAE  
180 mm

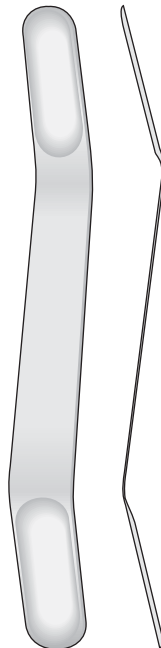

<b>1412-CAI</b>	7 mm + 9 mm
<b>1412-CAL</b>	11 mm + 13 mm
<b>1412-CBA</b>	15 mm + 18 mm
<b>1412-CBB</b>	18 mm + 22 mm

OLIVECRONA  
1412-CAI/1412-CBB  
180 mm

Malleabile - Malleable  
Biagsam - Souple - Maleable



**1412-BAB** 30 mm  
**1412-BAC** 40 mm  
**1412-BAD** 50 mm  
330 mm

Malleabile - Malleable  
Biagsam - Souple - Maleable



**HABERER**  
**1412-BAE**  
300 mm



**REVERDIN**  
**1412-BAF**  
285 mm

Malleabile - Malleable  
Biagsam - Souple - Maleable



**TUFFIER**  
**1412-LL**  
200 mm



Divaricatori

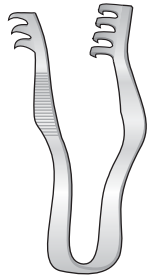

FINSEN  
0221-DG/0221-DL  
50 mm

Retractors

Acuto  
Sharp  
Spitz  
Pointù  
Agudas

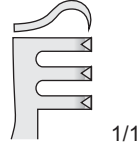

0221-DG

Wundhaken

Smusso  
Blunt  
Stumpf  
Mousse  
Romas

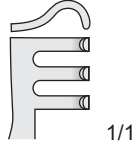

0221-DH

Ecarteurs

Acuto  
Sharp  
Spitz  
Pointù  
Agudas

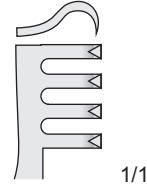

0221-DI

Separadores

Smusso  
Blunt  
Stumpf  
Mousse  
Romas

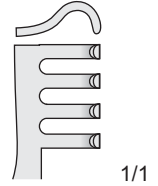

0221-DL

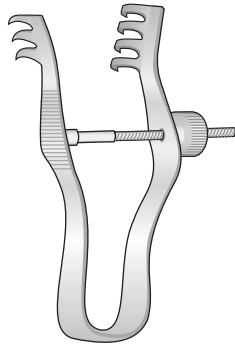

FINSEN  
0221-EH/0221-EI  
70 mm

Acuto  
Sharp  
Spitz  
Pointù  
Agudas

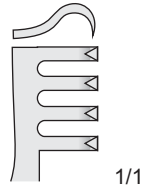

0221-EH

Smusso  
Blunt  
Stumpf  
Mousse  
Romas

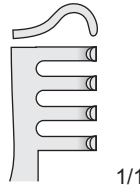

0221-EI

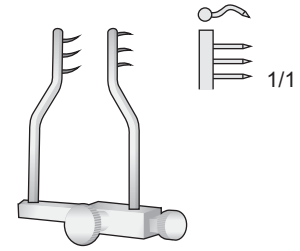

LOGAN  
0221-EF  
40 mm

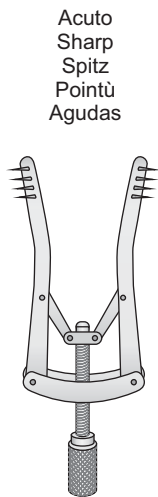

ALM  
0221-BC  
70 mm

Smusso  
Blunt  
Stumpf  
Mousse  
Romas

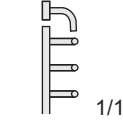

0221-EL  
70 mm

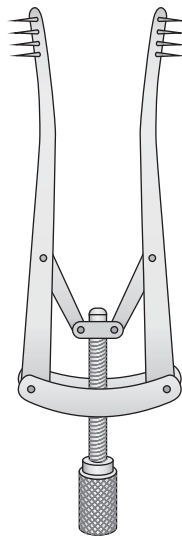

ALM  
0221-BA  
100 mm

Acuto  
Sharp  
Spitz  
Pointù  
Agudas

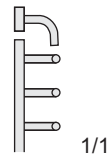

0221-FB  
100 mm

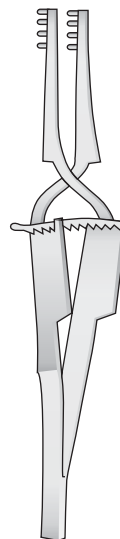

0221-AI  
100 mm

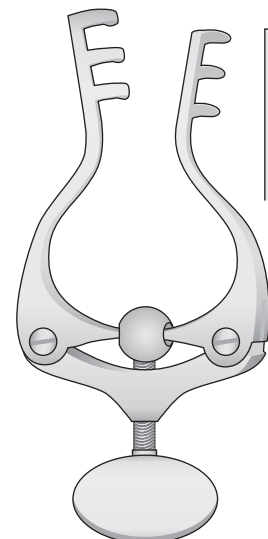

JANSEN  
0221-FC  
100 mm

Smusso  
Blunt  
Stumpf  
Mousse  
Romas

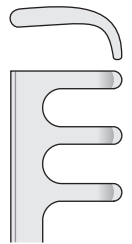

Divaricatori

Retractors

Wundhaken

Ecarteurs

Separadores

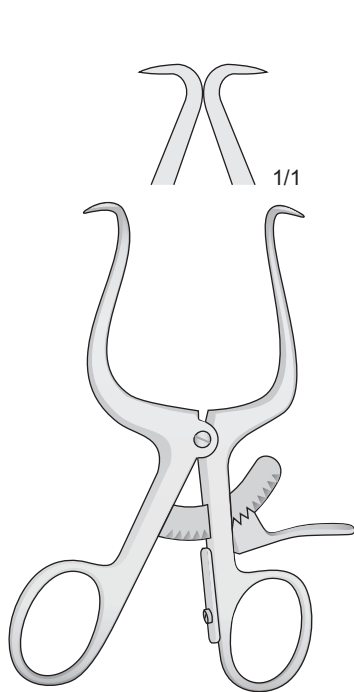

GELPI  
0221-BE  
90 mm

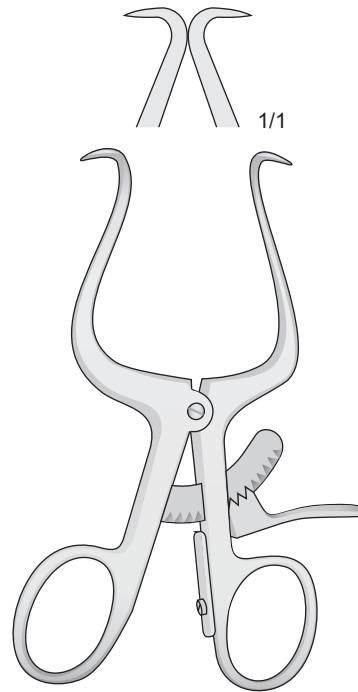

GELPI  
0221-BF  
110 mm

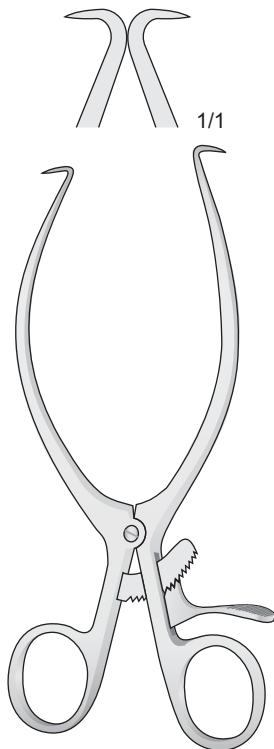

GELPI  
0221-BG  
140 mm

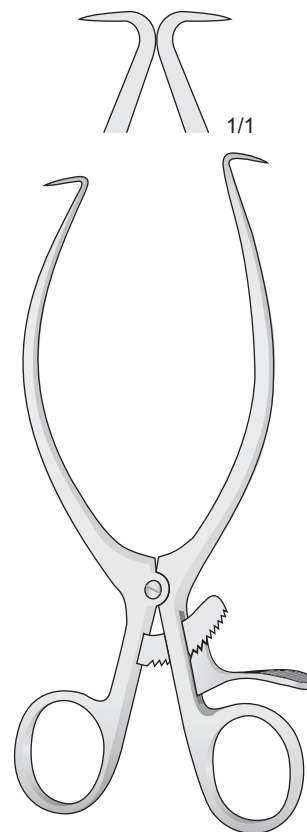

GELPI  
0221-BH  
180 mm

Divaricatori

Retractors

Wundhaken

Ecarteurs

Separadores

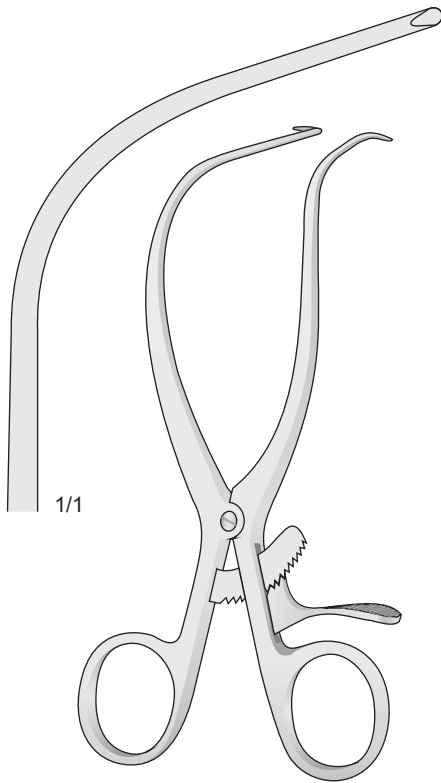

GELPI-SELETZ  
0221-BB  
165 mm

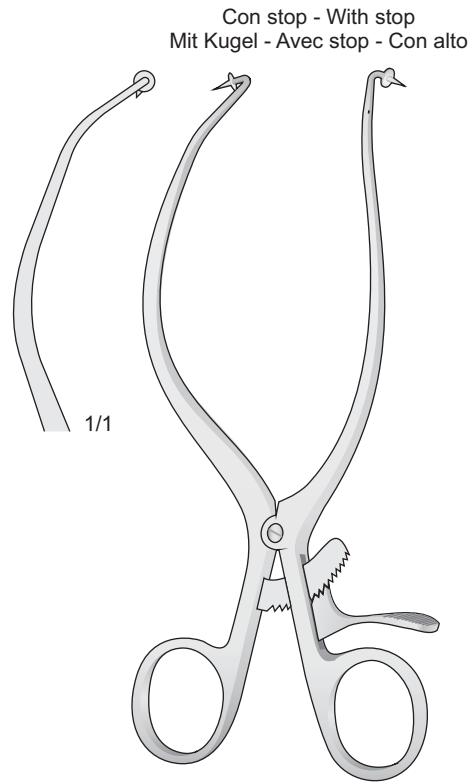

GELPI-LOKTITE  
0221-BD  
190 mm

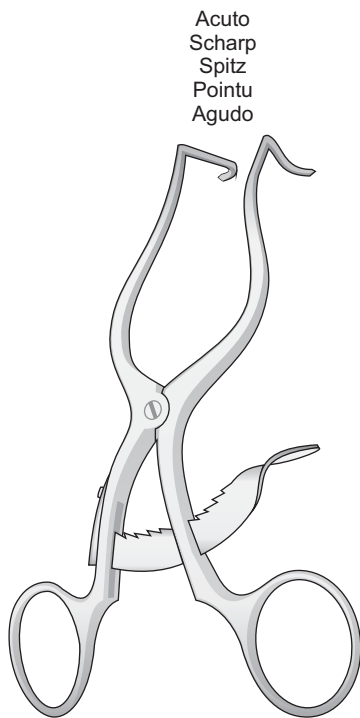

CLOWARD-CONTOUR  
0221-BAI  
140 mm

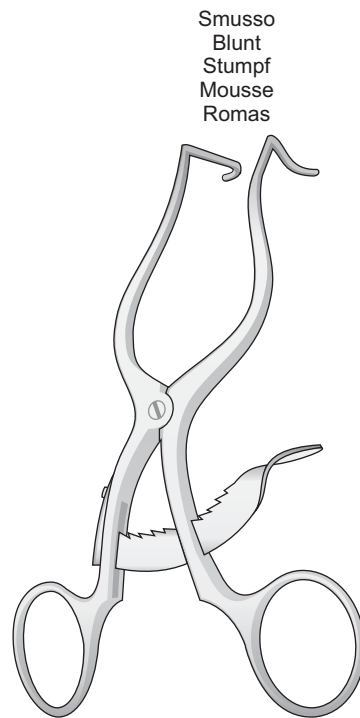

CLOWARD-CONTOUR  
0221-BAL  
140 mm

Divaricatori

Retractors

Wundhaken

Ecarteurs

Separadores

Acuto  
Sharp  
Spitz  
Pointu  
Agudo



1/1

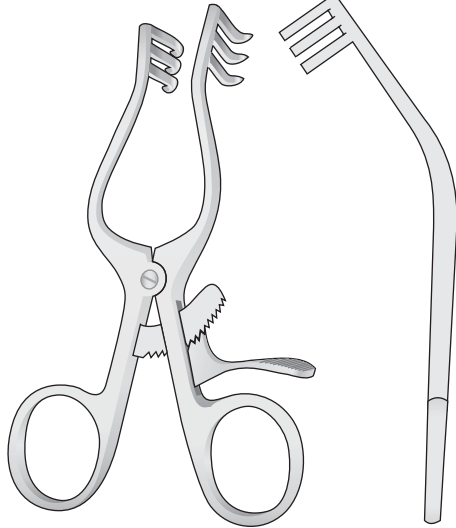

WULLSTEIN  
0221-BBB  
105 mm

Smusso  
Blunt  
Stumpf  
Mousse  
Romo



1/1

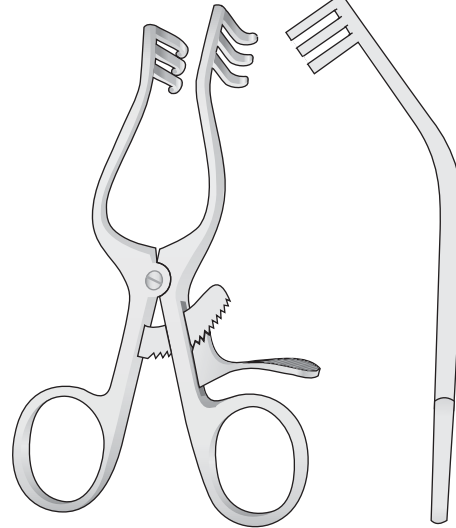

WULLSTEIN  
0221-BBC  
105 mm

Acuto  
Sharp  
Spitz  
Pointu  
Agudo



1/1

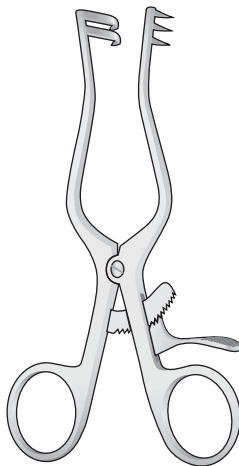

WEITLANER  
0221-AH  
110 mm

Smusso  
Blunt  
Stumpf  
Mousse  
Romo



1/1

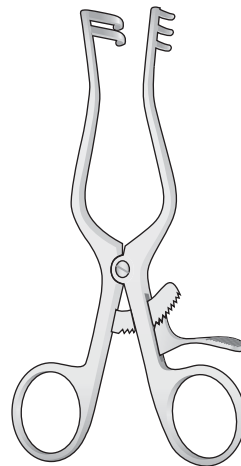

WEITLANER  
0221-AL  
110 mm

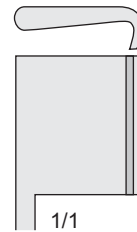

1/1

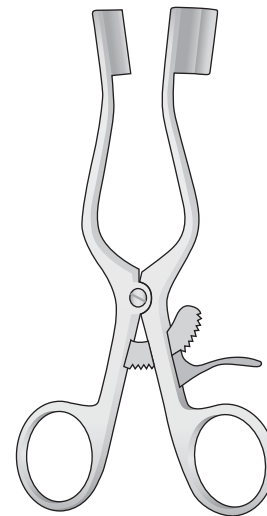

BABY-WEITLANER  
0221-CG  
140 mm

Divaricatori

Retractors

Wundhaken

Ecarteurs

Separadores

Semi acuto - Semi Sharp - Halbscharf  
Semi Pointu - Semi Agudas



1/1

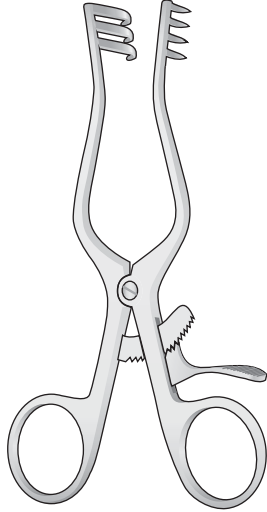

WEITLANER  
**0221-BI**  
135 mm

Acuto - Sharp - Spitz  
Pointu - Agudas



1/1

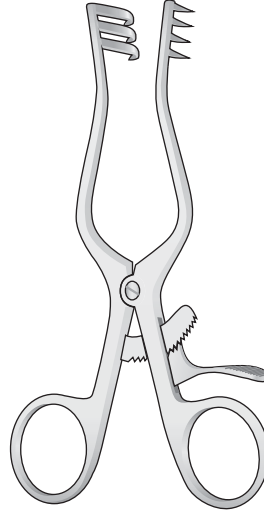

WEITLANER  
**0221-CA**  
135 mm

Smusso - Blunt - Stumpf  
Mousse - Romas

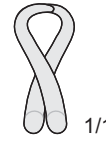

1/1

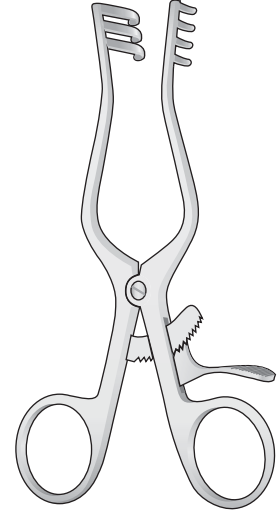

WEITLANER  
**0221-CC**  
135 mm

Acuto - Sharp - Spitz  
Pointu - Agudas

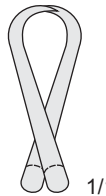

1/1

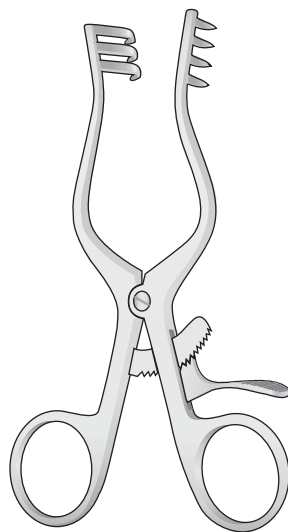

WEITLANER  
**0221-FF**  
135 mm

Smusso - Blunt - Stumpf  
Mousse - Romas



1/1

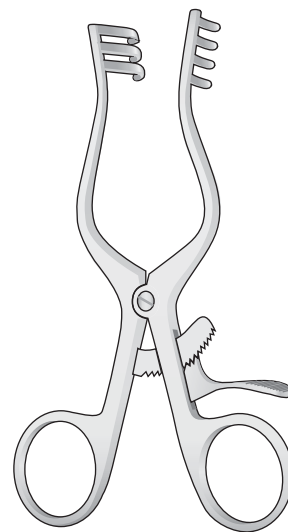

WEITLANER  
**0221-FG**  
135 mm

Divaricatori

Retractors

Wundhaken

Ecarteurs

Separadores

Semi acuto - Sharp - Halbscharf  
Semi Pointu - Agudas

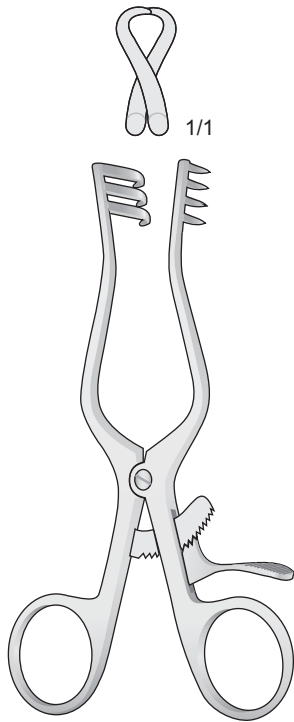

WEITLANER  
0221-BL  
165 mm

Acuto - Sharp - Spitz  
Pointu - Agudas

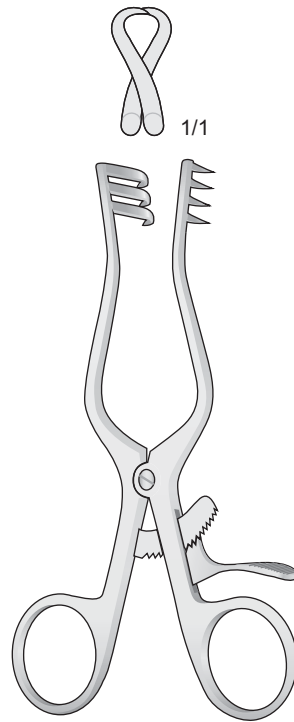

WEITLANER  
0221-CB  
165 mm

Smusso - Blunt - Stumpf  
Mousse - Romas

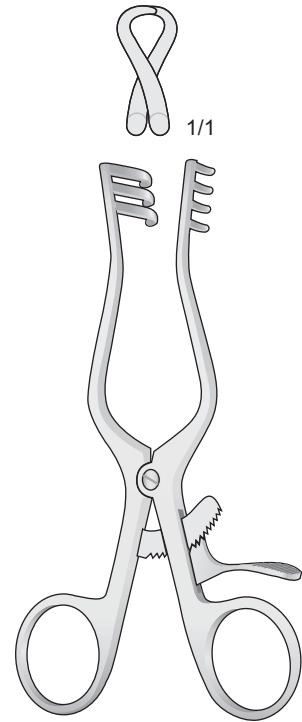

WEITLANER  
0221-CD  
165 mm

Acuto - Sharp - Spitz  
Pointu - Agudas

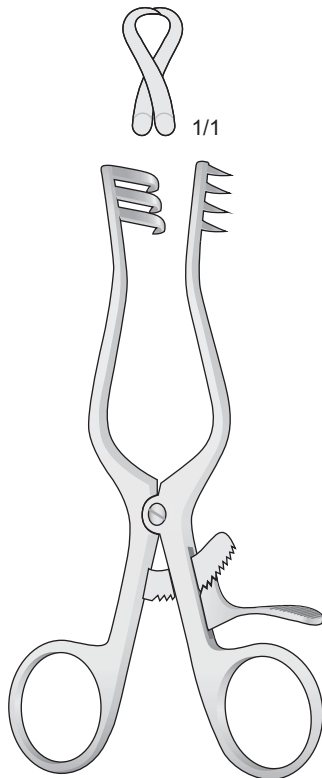

WEITLANER  
0221-CE  
200 mm

Smusso - Blunt - Stumpf  
Mousse - Romas

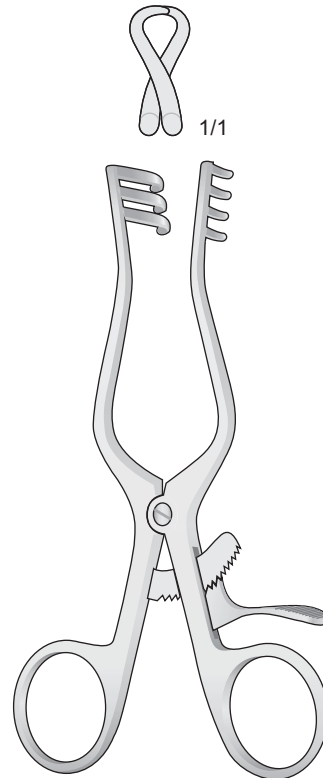

WEITLANER  
0221-CF  
200 mm

Acuto - Sharp - Spitz  
Pointu - Agudas

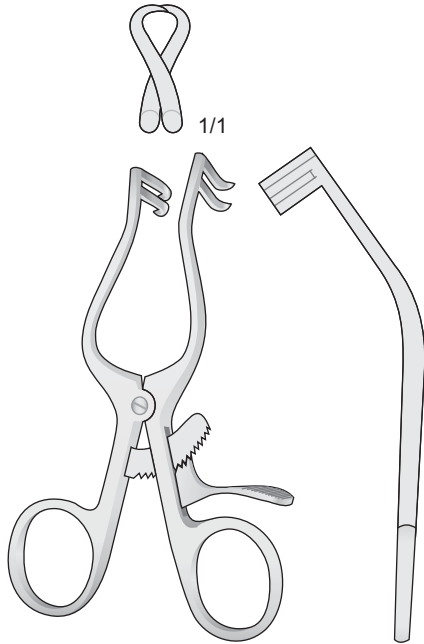

PLESTER  
0221-LA  
110 mm

Smusso - Blunt - Stumpf  
Mousse - Romas

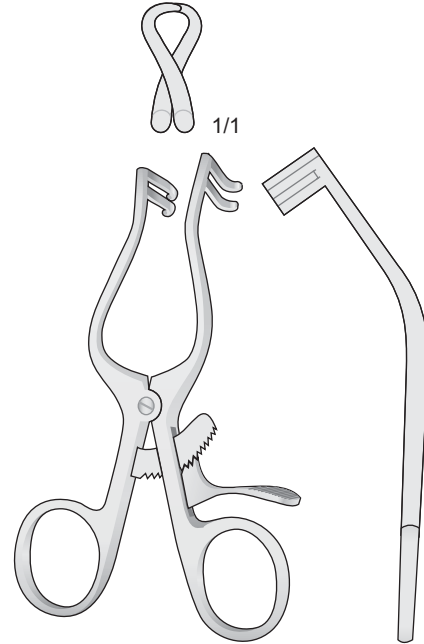

PLESTER  
0221-LB  
110 mm

Acuto - Sharp - Spitz  
Pointu - Agudas

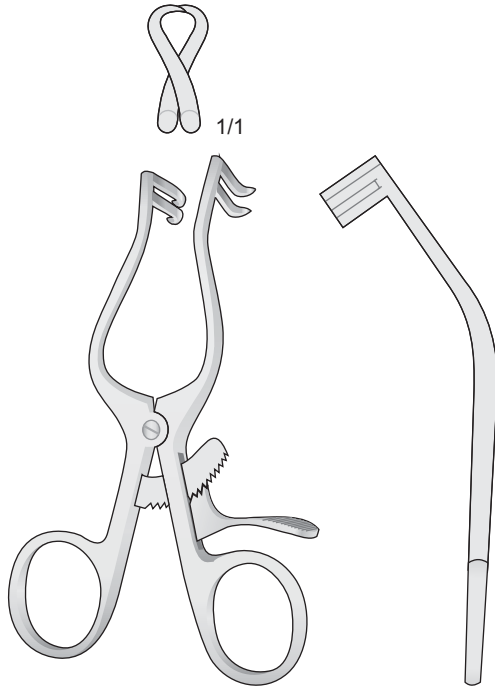

PLESTER  
0221-LC  
135 mm

Smusso - Blunt - Stumpf  
Mousse - Romas

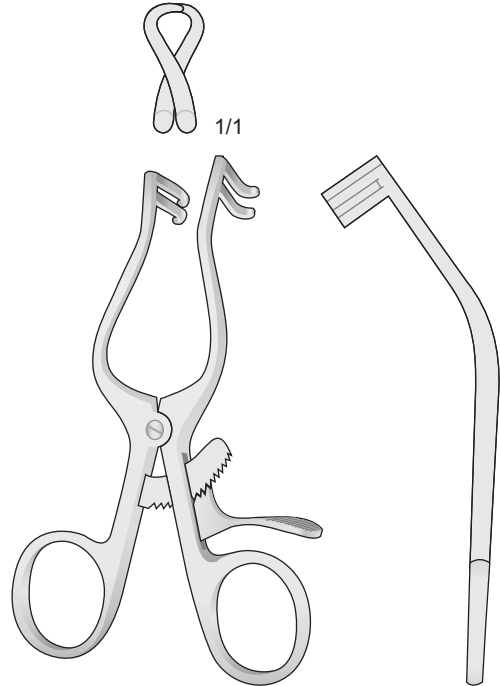

PLESTER  
0221-LD  
135 mm

Smusso - Blunt - Stumpf - Mousse - Rome

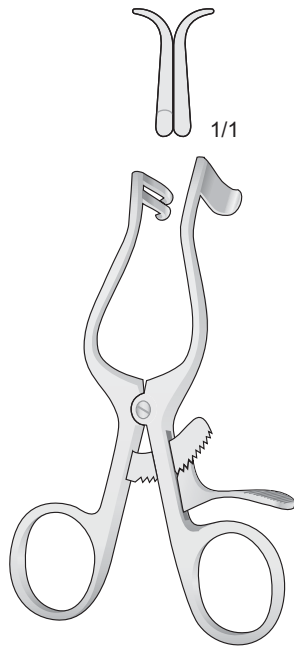

PLESTER  
0221-LE  
110 mm

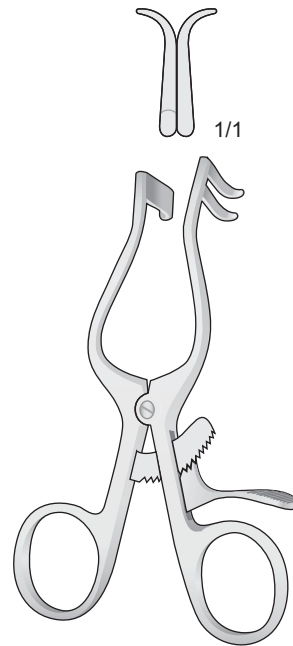

PLESTER  
0221-LF  
110 mm

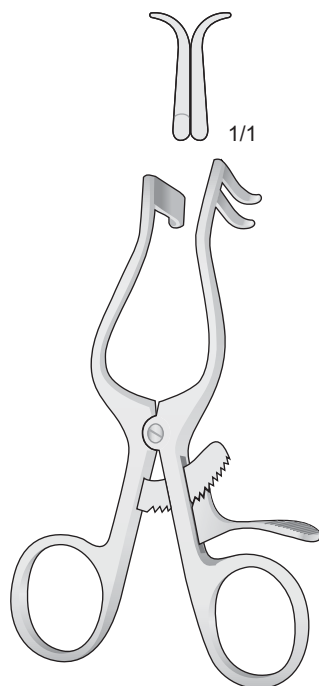

PLESTER  
0221-LG  
135 mm

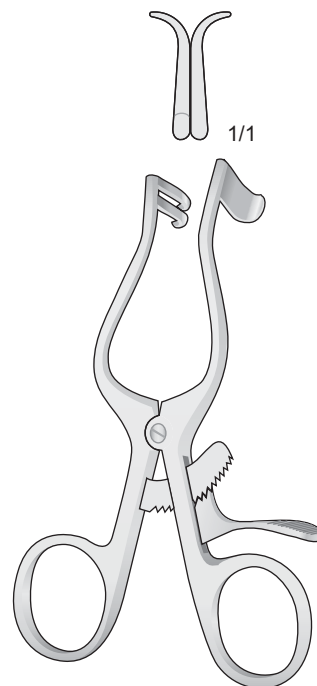

PLESTER  
0221-LH  
135 mm



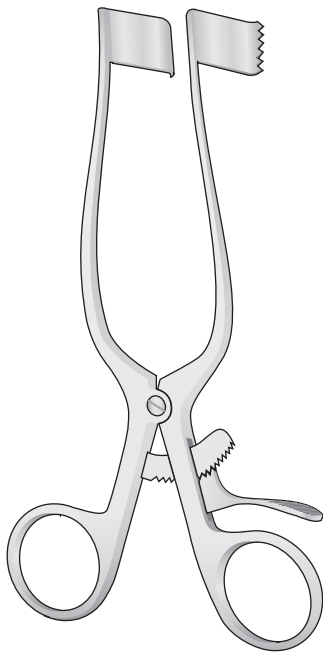

**MEYERDING**  
**0221-HG** - 32 x 25 mm  
**0221-HH** - 60 x 25 mm  
**0221-HI** - 54 x 25 mm  
**0221-HL** - 60 x 20 mm  
 180 mm

Acuto - Sharp - Spitz  
 Pointu - Agudo

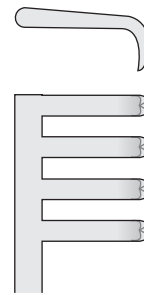

**0221-BBH**

Smusso - Blunt - Stumpf  
 Mousse - Rome

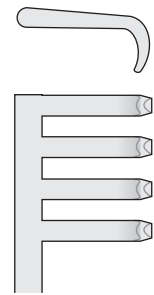

**0221-BBI**

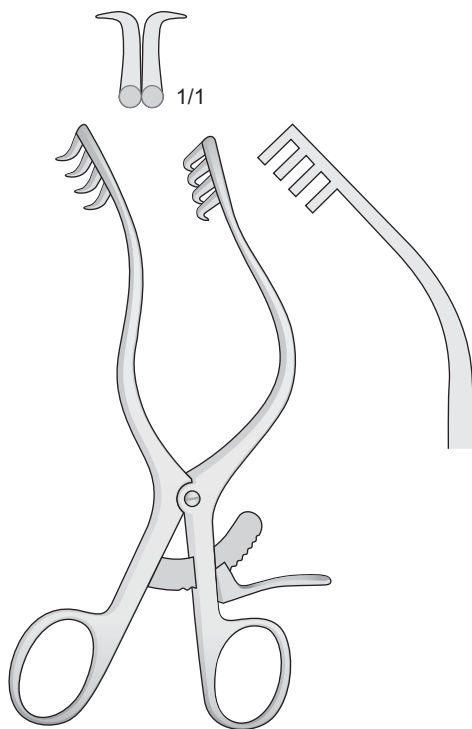

**MOLLISON**  
**0221-BBA**  
 160 mm

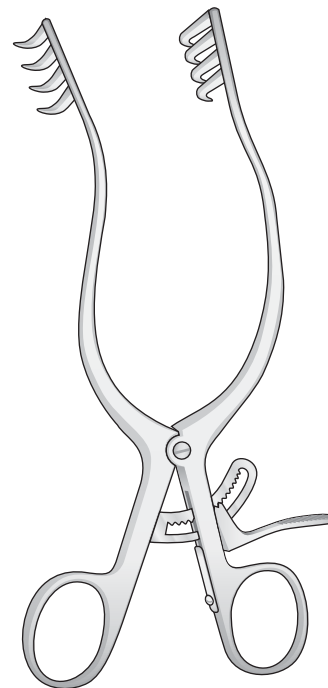

**ANDERSON-ADSON**  
**0221-BBH/0221-BBI**  
 200 mm

Divaricatori

Retractors

Wundhaken

Ecarteurs

Separadores



WALTON  
0221-II  
180 mm

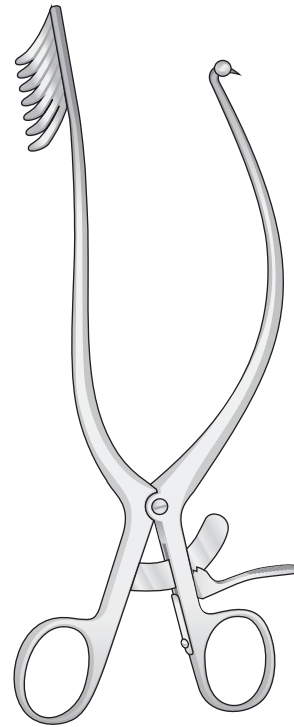

WALTON  
0221-IL  
180 mm

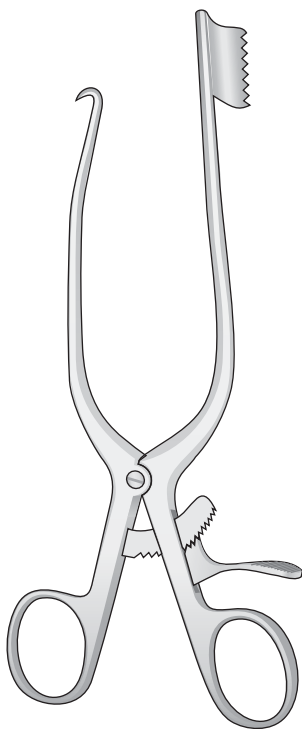

MARKHAM-MEYERDING  
0221-LI  
180 mm

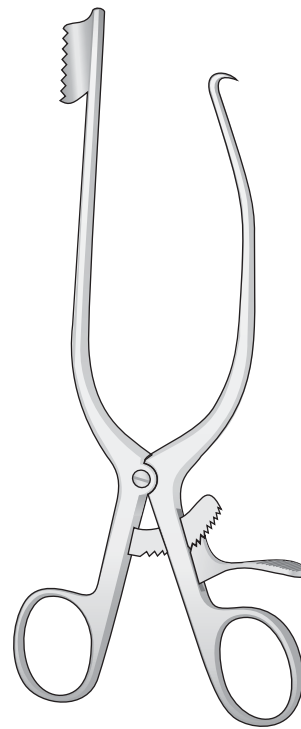

MARKHAM-MEYERDING  
0221-LL  
180 mm

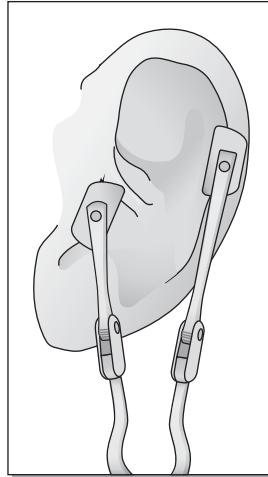

Lame, sinistro  
Blades, left  
Klingen, Link  
Lames, gauche  
Hojas, izquierda  
13 x 20 mm

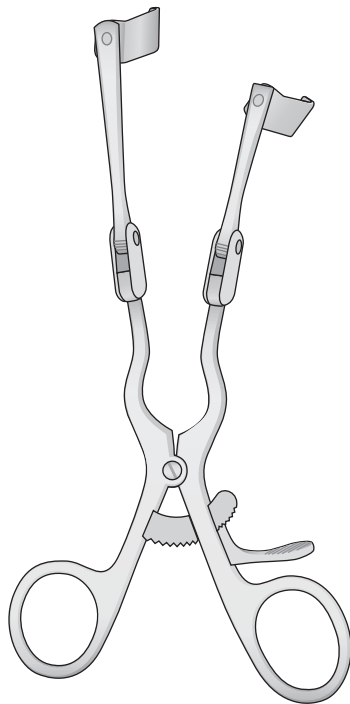

**DOLWICK-REICH**  
**0221-BAB**  
170 mm

Lame, destro  
Blades, right  
Klingen, Rechts  
Lames, droite  
Hojas, derecha  
13 x 20 mm

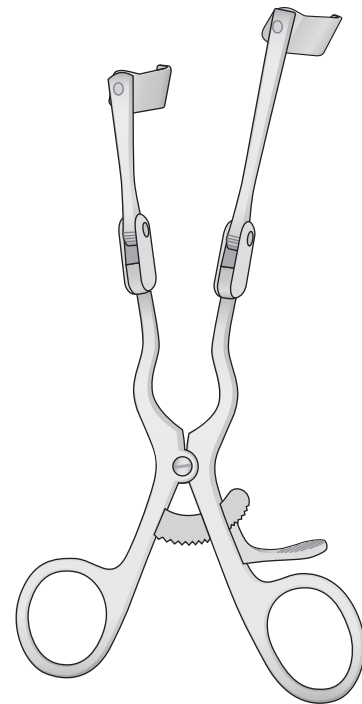

**DOLWICK-REICH**  
**0221-BAC**  
170 mm

Divaricatori

Retractors

Wundhaken

Ecarteurs

Separadores

Acuto - Sharp - Spitz  
Pointu - Agudo

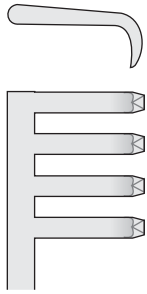

0221-BBL

Smusso - Blunt - Stumpf  
Mousse - Rome

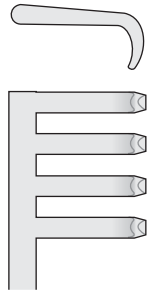

0221-BCA

4 x 4 Denti  
4 x 4 Teeth  
4 x 4 Zähne  
4 x 4 Dents  
4 x 4 Dientes

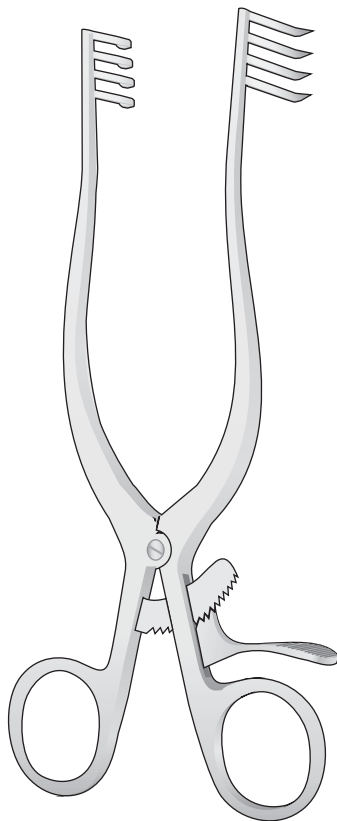

ADSON  
0221-BBL/0221-BCA  
200 mm

Acuto - Sharp - Spitz  
Pointu - Agudo

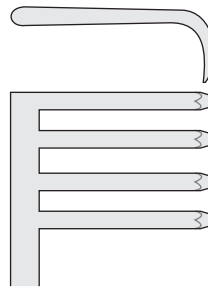

0221-CH

Smusso - Blunt - Stumpf  
Mousse - Rome

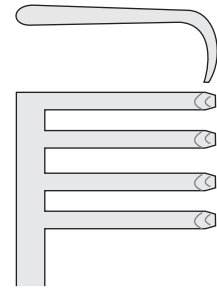

0221-CI

4 x 4 Denti  
4 x 4 Teeth  
4 x 4 Zähne  
4 x 4 Dents  
4 x 4 Dientes

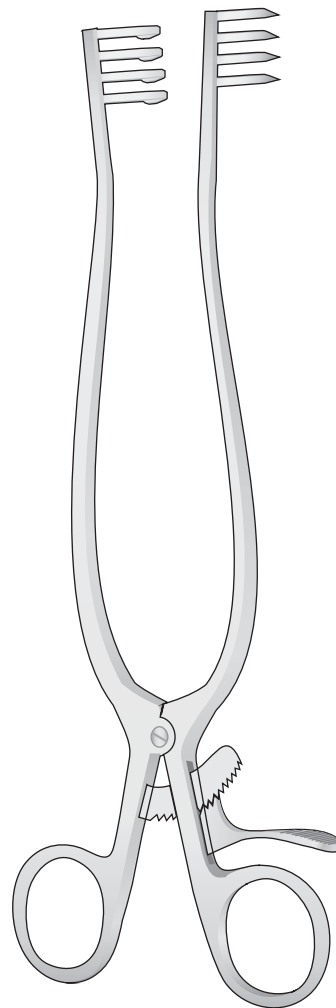

WEITLANER  
0221-CH/0221-CI  
250 mm

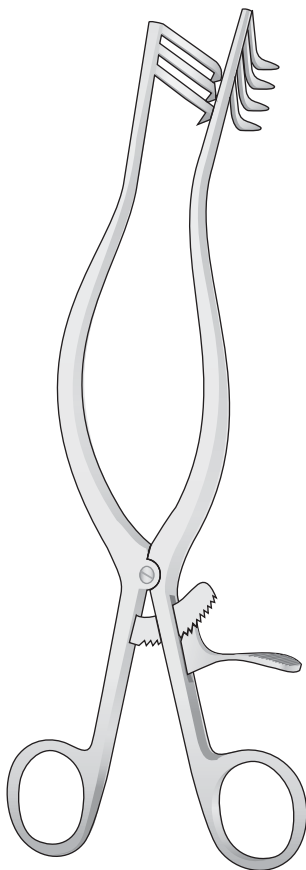

ADSON  
0221-BLA/0221-BLD  
265 mm

3 x 4 Denti  
3 x 4 Teeth  
3 x 4 Zähne  
3 x 4 Dents  
3 x 4 Dientes

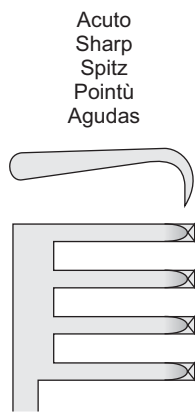

0221-BLA

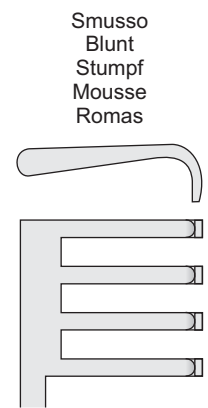

0221-BLB

6 x 6 Denti  
6 x 6 Teeth  
6 x 6 Zähne  
6 x 6 Dents  
6 x 6 Dientes

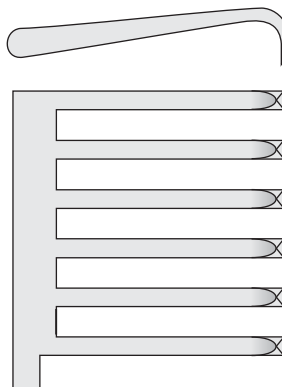

0221-BLC

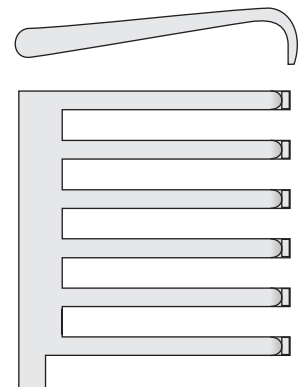

0221-BLD

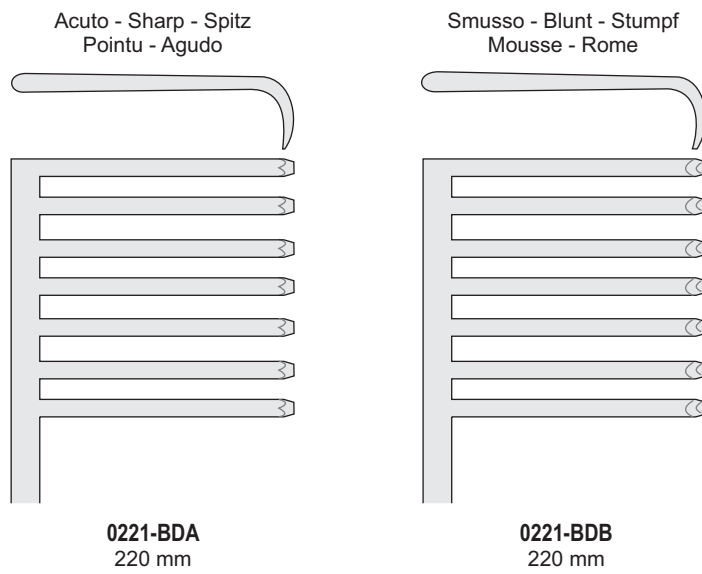

7 x 7 Denti  
7 x 7 Teeth  
7 x 7 Zähne  
7 x 7 Dents  
7 x 7 Dientes

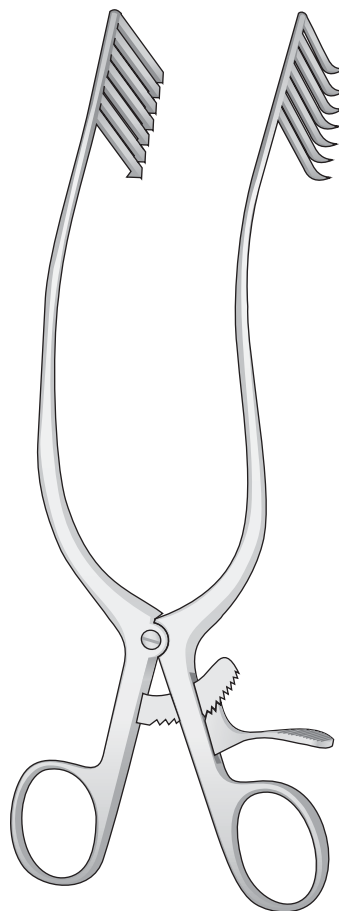

MISKIMON  
**0221-BDA/0221-BDB**  
220 mm

Divaricatori

Retractors

Wundhaken

Ecarteurs

Separadores

Acuto  
Scharp  
Spitz  
Pointu  
Agudo

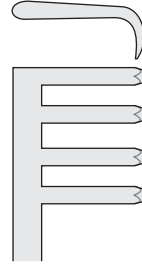

0221-GI  
140 mm

Smusso  
Blunt  
Stumpf  
Mousse  
Romos

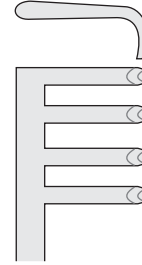

0221-HA  
140 mm

3 x 4 Denti  
3 x 4 Teeth  
3 x 4 Zähne  
3 x 4 Dents  
3 x 4 Dientes

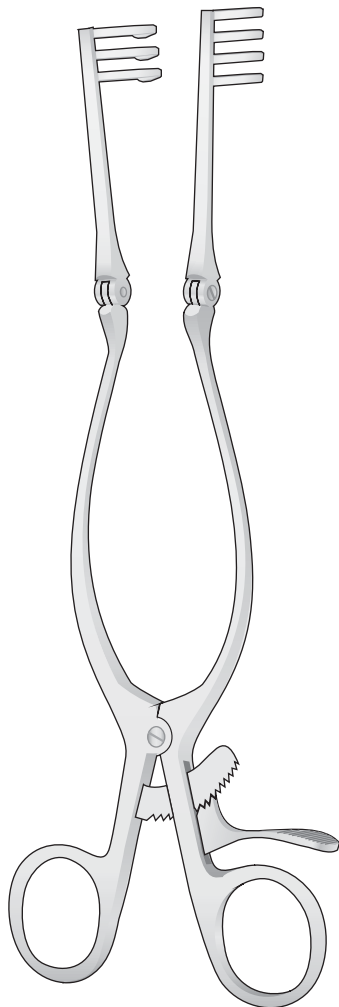

ADSON  
0221-GI/0221-HF

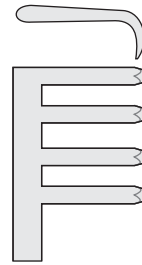

0221-GL  
165 mm

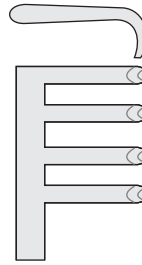

0221-HB  
165 mm

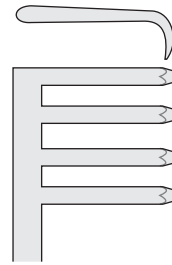

0221-HC  
200 mm

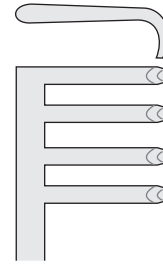

0221-HD  
200 mm

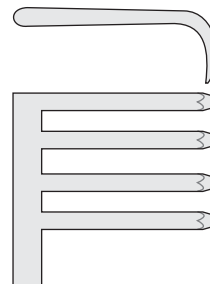

0221-HE  
250 mm

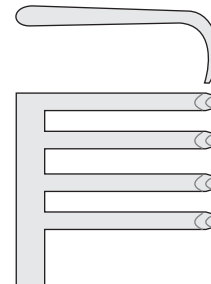

0221-HF  
250 mm

Acuto - Sharp  
Spitz - Pointu  
Agudas  
4 x 4 Denti  
4 x 4 Teeth  
4 x 4 Zähne  
4 x 4 Dents  
4 x 4 Dientes

Semi acuto -Sharp  
Halbscharf - Semi pointu  
Agudas  
4 x 4 Denti  
4 x 4 Teeth  
4 x 4 Zähne  
4 x 4 Dents  
4 x 4 Dientes

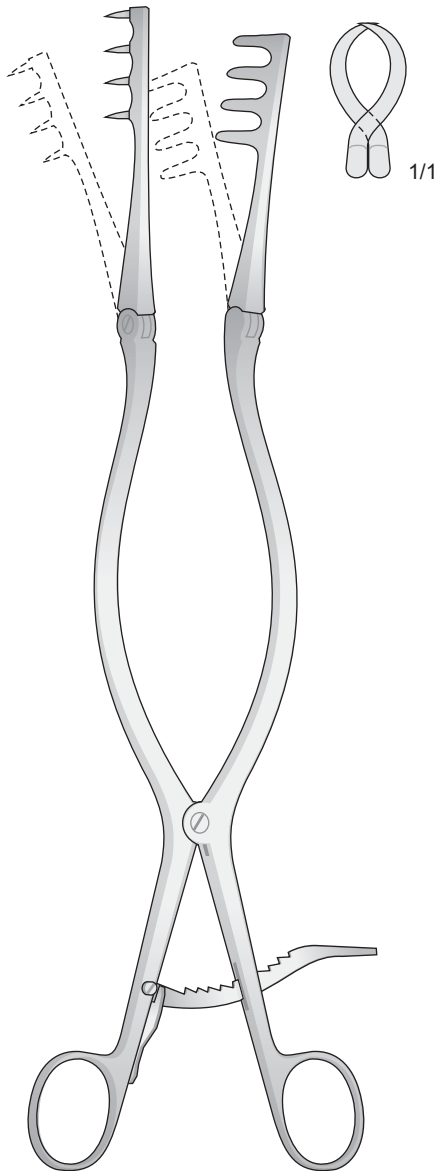

BECKMANN  
0221-BCB  
310 mm

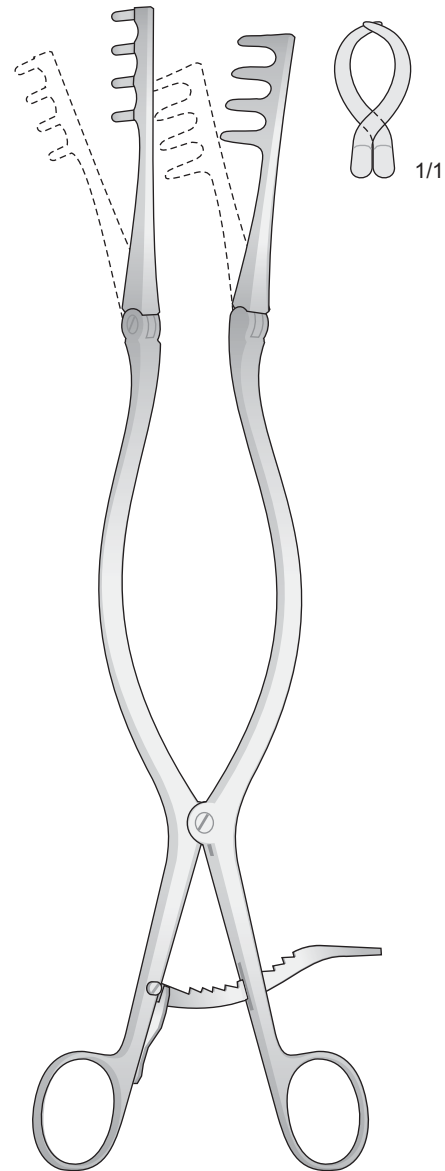

BECKMANN  
0221-BCC  
310 mm



Smusso - Blunt - Stumpf  
Mousse - Romas

5 x 4 Denti  
5 x 4 Teeth  
5 x 4 Zähne  
5 x 4 Dents  
5 x 4 Dientes

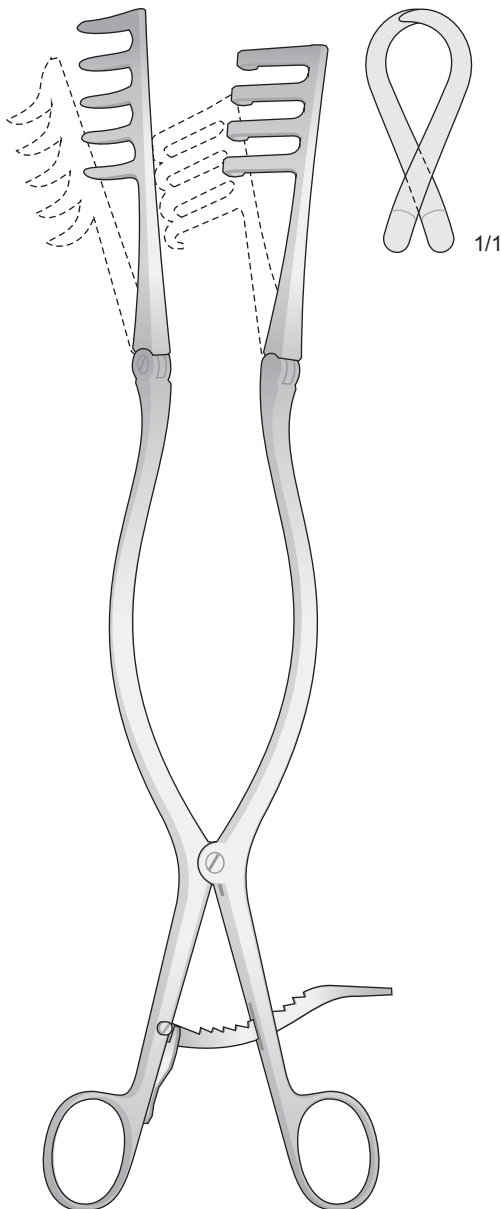

ADSON  
0221-BCD  
320 mm

Acuto-Sharp-Spitz  
Pointú-Agudas

7 x 7 Denti  
7 x 7 Teeth  
7 x 7 Zähne  
7 x 7 Dents  
7 x 7 Dientes

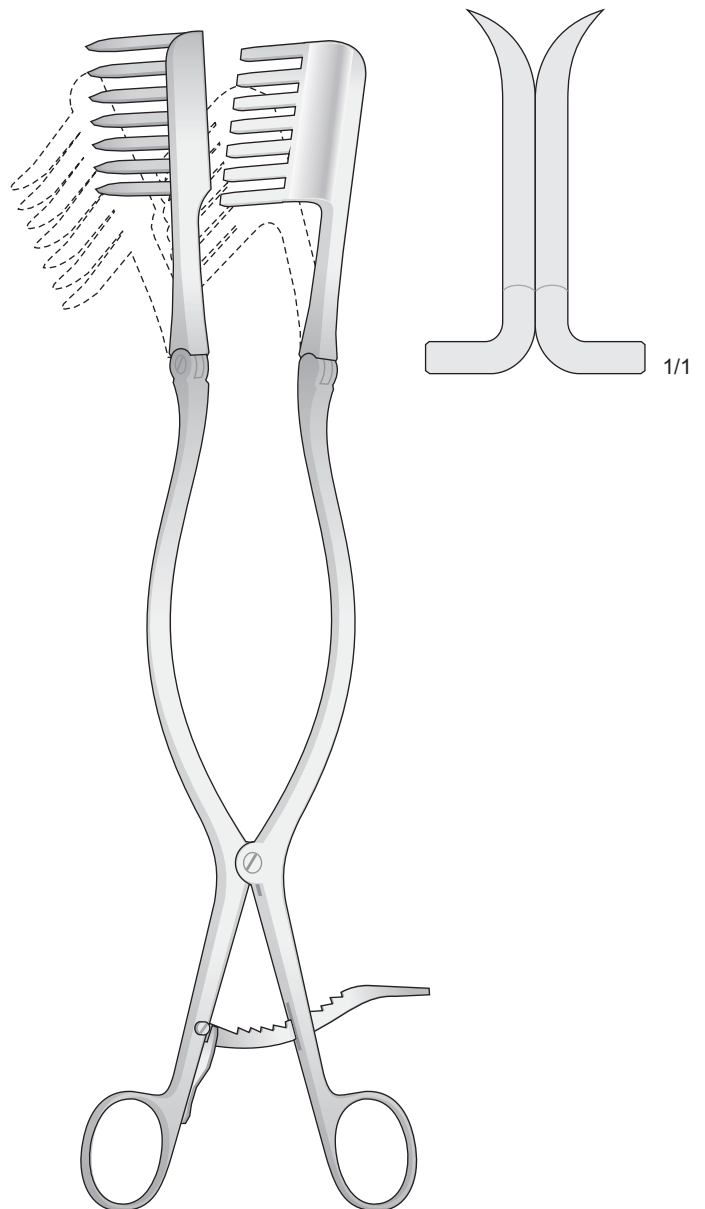

BECKMANN-EATON  
0221-BCE  
330 mm

Solo divaricatore senza valva  
 Retractor without blades  
 Spreizer allein  
 Separador sin valvas  
 Ecarteur sans valves

Acuto  
 Sharp  
 Spitz  
 Pointu  
 Agudas

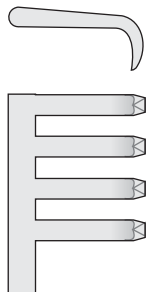

0221-BDF

Smusso  
 Blunt  
 Stumpf  
 Mousse  
 Romas

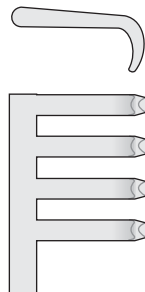

0221-BDG

3 x 4 Denti  
 3 x 4 Teeth  
 3 x 4 Zähne  
 3 x 4 Dents  
 3 x 4 Dientes

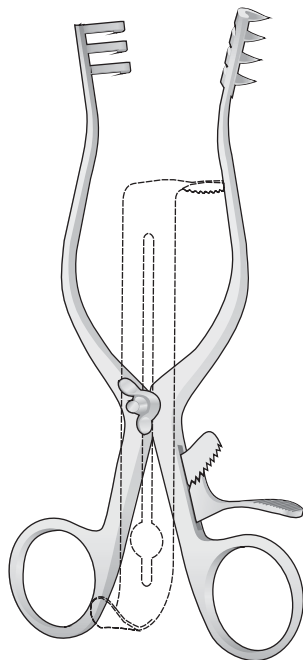

HENLEY  
 0221-BDF/0221-BDG  
 165 mm

Valve centrali  
 Center blades  
 Mittelblatt  
 Valves centrale  
 Valvas centrales

Fig. 1

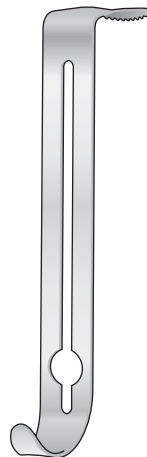

0221-BDH  
 16x19 mm

Fig. 2

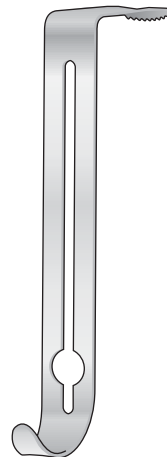

0221-BDI  
 16x25 mm

Fig. 3

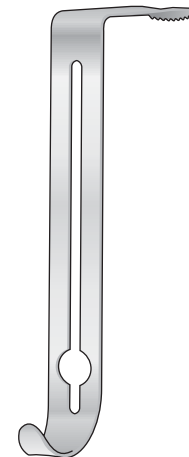

0221-BDL  
 16x32 mm

Divaricatori

Retractors

Wundhaken

Ecarteurs

Separadores

CLOWARD Modif.  
**0221-DBL**  
Divaricatore, solo  
Retractor, only  
Sperrer, allein  
Ecarteur, seul  
Separador, suelto

CLOWARD Modif.  
**0221-DBH**  
Divaricatore, solo  
Retractor, only  
Sperrer, allein  
Ecarteur, seul  
Separador, suelto

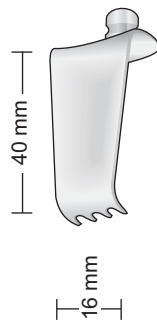

0221-DCB

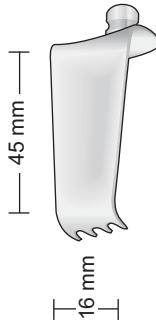

0221-DCC

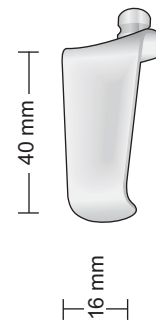

0221-DCG

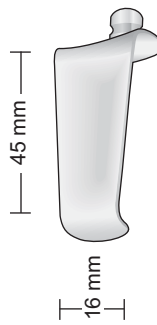

0221-DCH

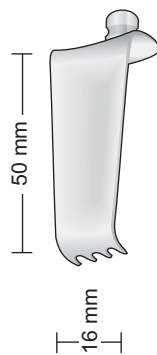

0221-DCD

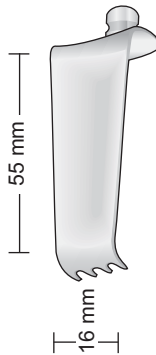

0221-DCE

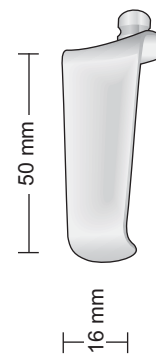

0221-DCI

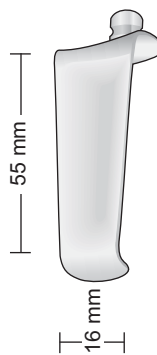

0221-DCL

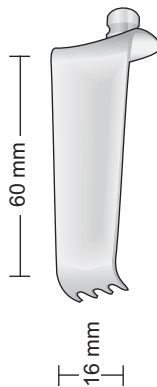

0221-DCF

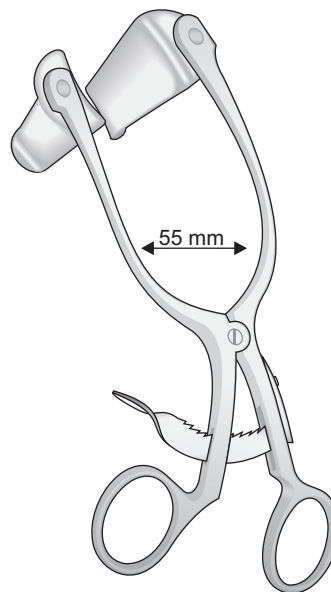

CLOWARD  
**0221-DBI**  
160 mm

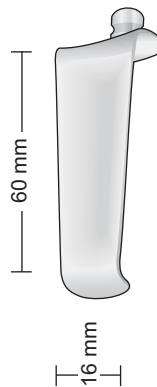

0221-DDA

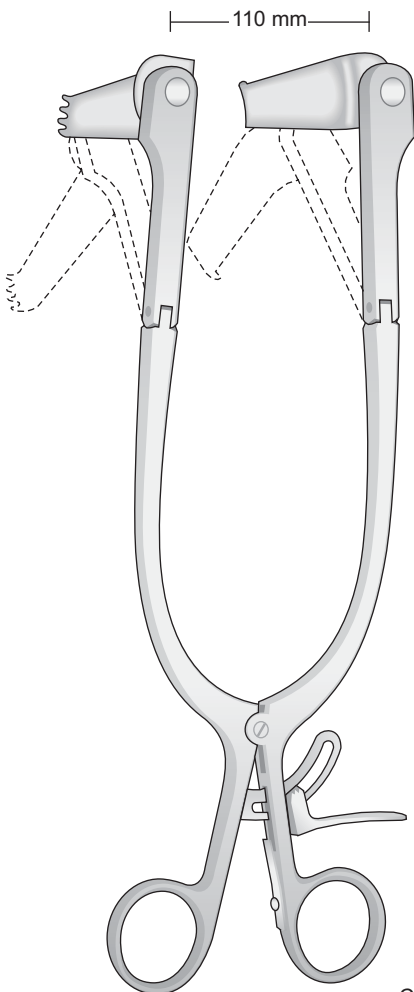

CLOWARD modif.  
**0221-DCA**  
250 mm

Completo di 5 valve  
Complete with 5 blades  
Komplett mit 5 Valven  
Complet avec 5 valves  
Completo con 5 valvas

Completo di 5 valve  
Complete with 5 blades  
Komplett mit 5 Valven  
Complet avec 5 valves  
Completo con 5 valvas

**0221-BEB**

Completo con un paio di valve  
Complete with 1 pairs of blades  
Komplett mit 1 Paar Valven  
Complete avec 1 paires de valves  
Completo con 1 pares de valvas

**0221-BEG**

Completo con due paia di valve  
Complete with 2 pairs of blades  
Komplett mit 2 paar valven  
Complete avec 2 paires de valves  
Completo con 2 pares de valvas

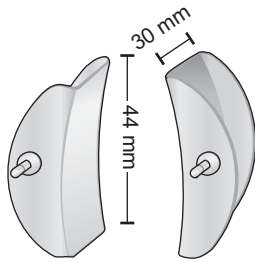

**0221-BEC** 20x44 mm

**0221-BED** 30x44 mm

Valve laterali - paia  
Lateral blades - pairs  
Seitl. Blätter - paar  
Valves latérales - paires  
Valvas laterales - pares

**0221-BEF**

Completo con un paio di valve  
Complete with 1 pairs of blades  
Komplett mit 1 Paar Valven  
Complete avec 1 paires de valves  
Completo con 1 pares de valvas

**0221-BEI**

Divaricatore solo  
Retractor only  
Sperrer allein  
Ecarteur seul  
Separador suelto

**0221-DHC**

32x62 mm

Valve laterali - paia  
Lateral blades - pairs  
Seitl.blätter - paar  
Valves latérales - paires  
Valvas laterales - pares

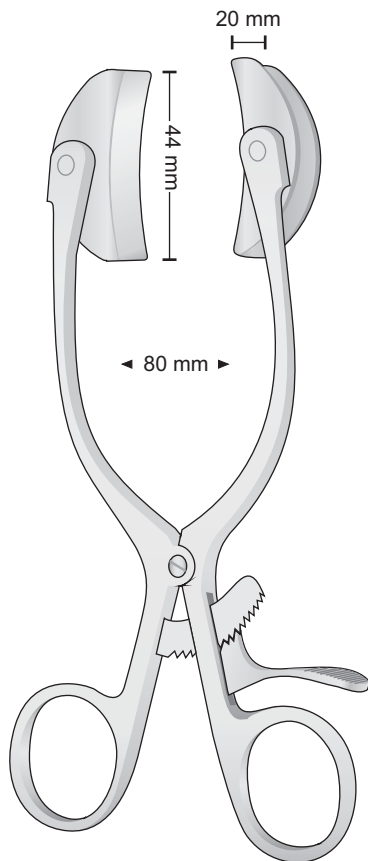

BABY-COLLIN

**0221-BEB**

180 mm

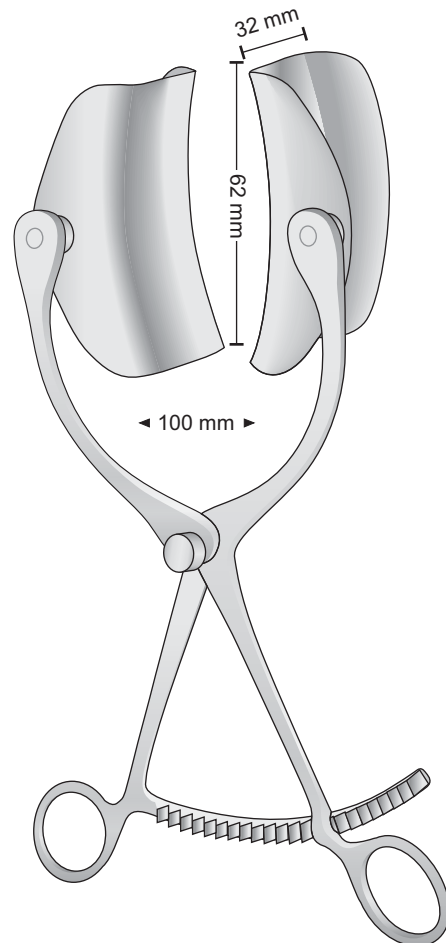

COLLIN

**0221-BEF**

220 mm

**COLLIN  
0221-DIA**  
Completo - Complete  
Komplett - Complets - Completos  
**0221-DHI + 0221-DHF + 0221-DHC**

**COLLIN  
0221-DIB**  
Completo - Complete  
Komplett - Complets - Completos  
**0221-DHL + 0221-DHG + 0221-DHD**

**COLLIN  
0221-DIC**  
Completo - Complete  
Komplett - Complets - Completos  
**0221-DHL + 0221-DHH + 0221-DHE**

**0221-DHI**  
Allargatore solo  
Spreader only  
Sperrer allein  
Ecarteur seul  
Separador suelto

**0221-DHL**  
Allargatore solo  
Spreader only  
Sperrer allein  
Ecarteur seul  
Separador suelto

**0221-DHL**  
Allargatore solo  
Spreader only  
Sperrer allein  
Ecarteur seul  
Separador suelto

**0221-DHF**  
Valva centrale  
Center blade  
Mittelblatt  
Valve centrale  
Valva central  
55 x 55 mm

**0221-DHG**  
Valva centrale  
Center blade  
Mittelblatt  
Valve centrale  
Valva central  
55 x 65 mm

**0221-DHH**  
Valva centrale  
Center blade  
Mittelblatt  
Valve centrale  
Valva central  
55 x 75 mm

**0221-DHC**  
Valve laterali  
Lateral blades  
Seitliche Blätter  
Valves latérales  
Valvas laterales  
32 x 62 mm

**0221-DHD**  
Valve laterali  
Lateral blade  
Seitliche Blätter  
Valves latérales  
Valvas laterales  
38 x 80 mm

**0221-DHE**  
Valve laterali  
Lateral blade  
Seitliche Blätter  
Valves latérales  
Valvas laterales  
38 x 100 mm

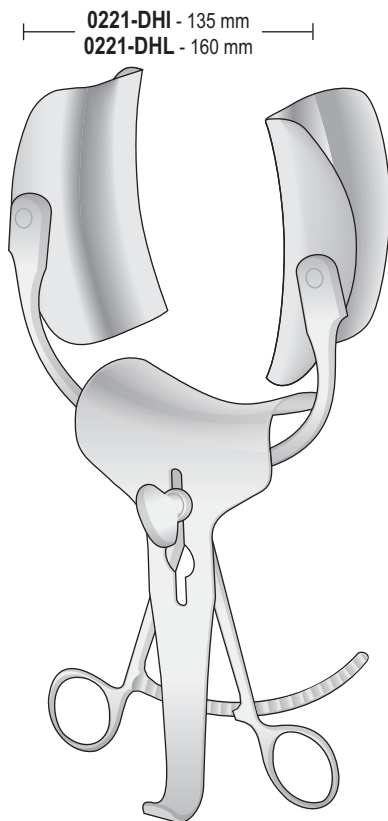

Unità di vendita delle valve: paio  
Sales Unit of blades: pair  
Bestelleinheit der Blätter: Paar  
Unité de commande pour les valves: paire

**COLLIN  
0221-DIA - 0221-DIB - 0221-DIC**  
Completo - Complete  
Komplett - Complets - Completos

**COLLIN**  
**0221-DHA**  
 Completo - Complete  
 Komplett - Complets - Completos  
**0221-DGL ÷ 0221-DGI ÷ 0221-DGG**

**COLLIN**  
**0221-DHB**  
 Completo - Complete  
 Komplett - Complets - Completos  
**0221-DGL ÷ 0221-DGI ÷ 0221-DGH**

**0221-DGG**  
 Valve laterali  
 Lateral blades  
 Seitliche Blätter  
 Valves latérales  
 Valvas laterales  
 50 x 58 mm

**0221-DGH**  
 Valve laterali  
 Lateral blades  
 Seitliche Blätter  
 Valves latérales  
 Valvas laterales  
 62 x 80 mm

**0221-DGI**  
 Valva centrale  
 Center blade  
 Mittelblatt  
 Valve centrale  
 Valva central  
 62 x 70 mm

**0221-DGL**  
 Allargatore solo  
 Spreader only  
 Sperrer allein  
 Ecarteur seul  
 Separador suelto

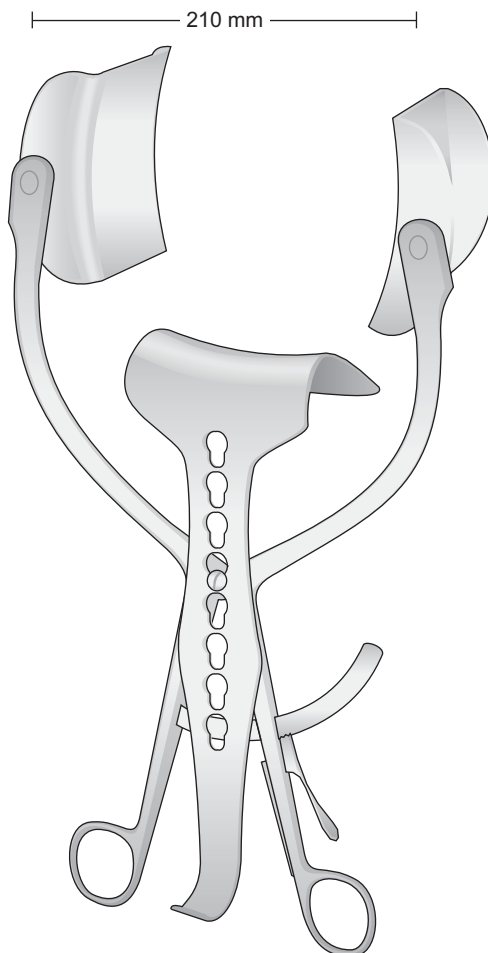

Unità di vendita delle valve: paio  
 Sales Unit of blades: pair  
 Bestelleinheit der Blätter: Paar  
 Unité de commande pour les valves: paire

**COLLIN**  
**0221-DHA/0221-DHB**  
 Completo - Complete  
 Komplett - Complets - Completos

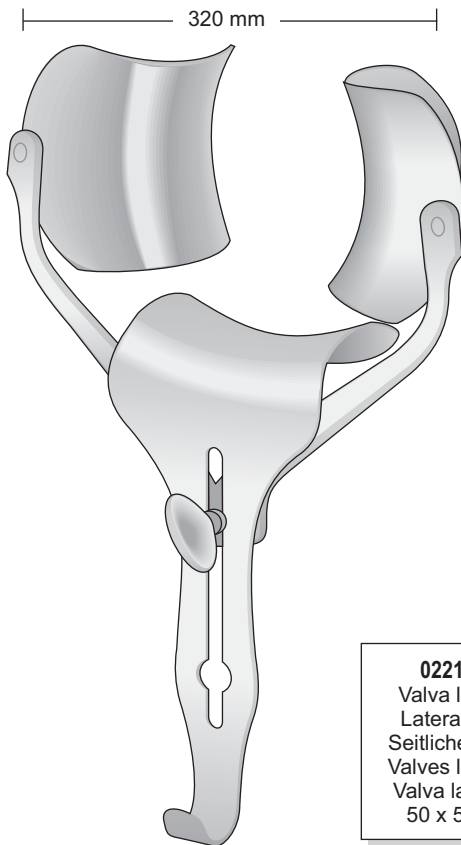

**RICARD  
0221-BLL**  
Completo - Complete  
Komplett - Complet - Completo  
**0221-BLE + 0221-BLF + 0221-BLH**

**RICARD  
0221-CAA**  
Completo - Complete  
Komplett - Complet - Completo  
**0221-BLE + 0221-BLG + 0221-BLI**

**0221-BLE**  
Divaricatore solo  
Retractor only  
Sperrer allein  
Ecarteur seul  
Separador suelto

**0221-BLF**  
Valva centrale  
Center blade  
Mittelblatt  
Valve centrale  
Valva central  
55 x 70 mm

**0221-BLG**  
Valva centrale  
Center blade  
Mittelblatt  
Valve centrale  
Valva central  
80 x 90 mm

**0221-BID**  
Valva laterale  
Lateral blade  
Seitliche Blätter  
Valves latérales  
Valva laterales  
50 x 58 mm

**0221-BLH**  
Valva laterale  
Lateral blade  
Seitliche Blätter  
Valves latérales  
Valva laterales  
60 x 80 mm

**0221-BLI**  
Valva laterale  
Lateral blade  
Seitliche Blätter  
Valves latérales  
Valva laterales  
72 x 85 mm

**RICARD**  
**0221-BLL** Completo - Complete  
Komplett - Complet - Completo  
**0221-CAA** Completo - Complete  
Komplett - Complet - Completo

Unità di vendita delle valve: paio  
Sales Unit of blades: pair  
Bestellereinheit der Blätter: Paar  
Unité de commande pour les valves: paire

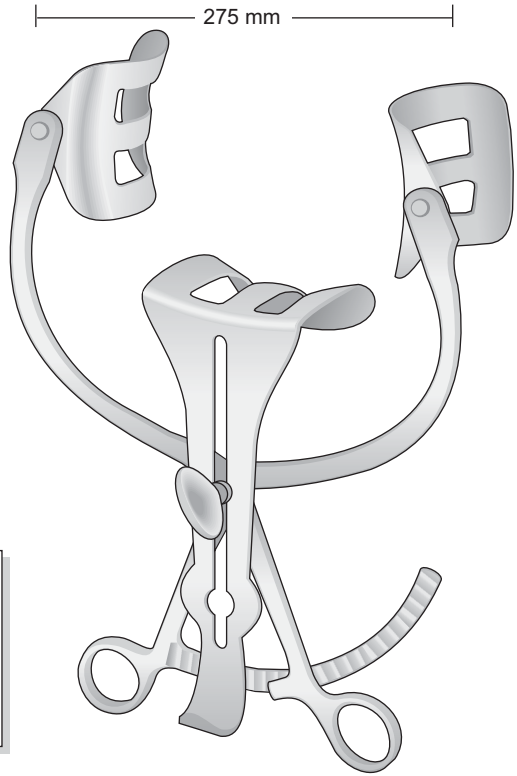

**0221-BGC**  
Divaricatore solo  
Retractor only  
Sperrer allein  
Ecarteur seul  
Separador suelto

**0221-BFL**  
Valve laterali  
Lateral blades  
Seitliche Blätter  
Valves latérales  
Valvas laterales  
59 x 80 mm

**0221-BEE**  
Valva centrale  
Center blade  
Mittelblatt  
Valve centrale  
Valva central  
74 x 82 mm

**HOLZBACH  
0221-BFI**  
Completo - Complete  
Komplett - Complet - Completos

Divaricatori  
per laminectomia

Laminectomy  
retractors

Laminektomiespreizer

Ecarteurs  
pour laminectomie

Separadores  
para laminectomia

Strumento solo, senza valve  
Frame only - Instrumente allein, ohne Blätter  
Cadre seul - Cuadro solo, no valvas

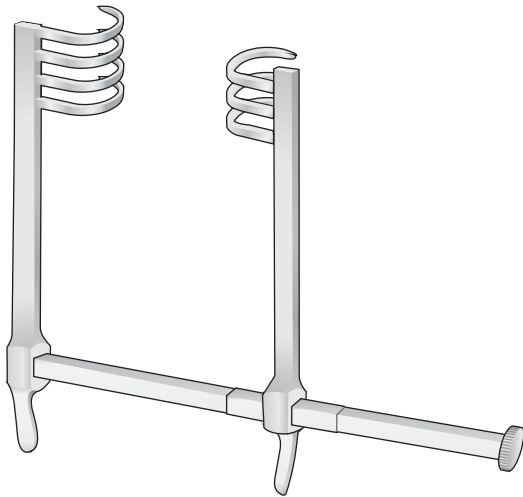

FRAZIER  
0221-DF

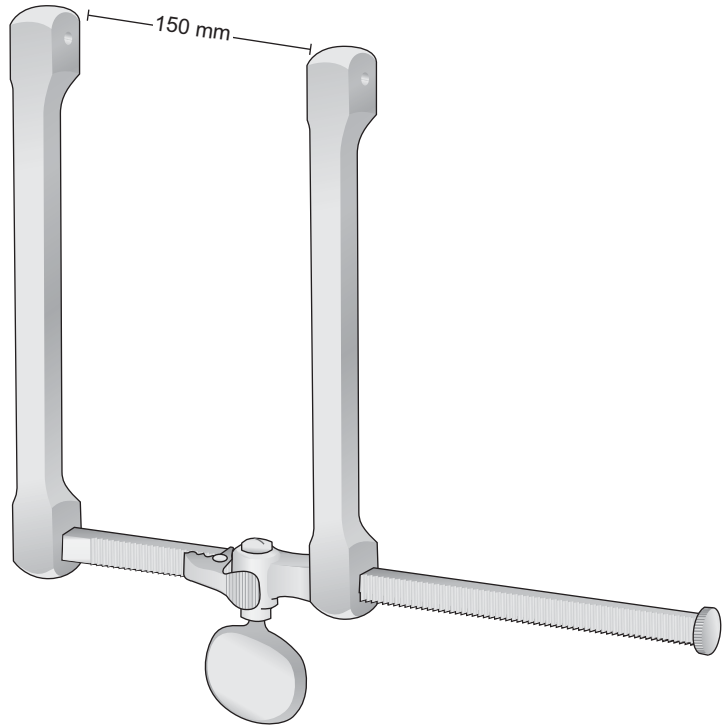

SCOVILLE  
0221-BGB

Strumento solo, senza valve  
Frame only, without blade  
Instrumente allein, ohne Blätter  
Cadre seul, sans valves  
Cuadro solo, no valvas

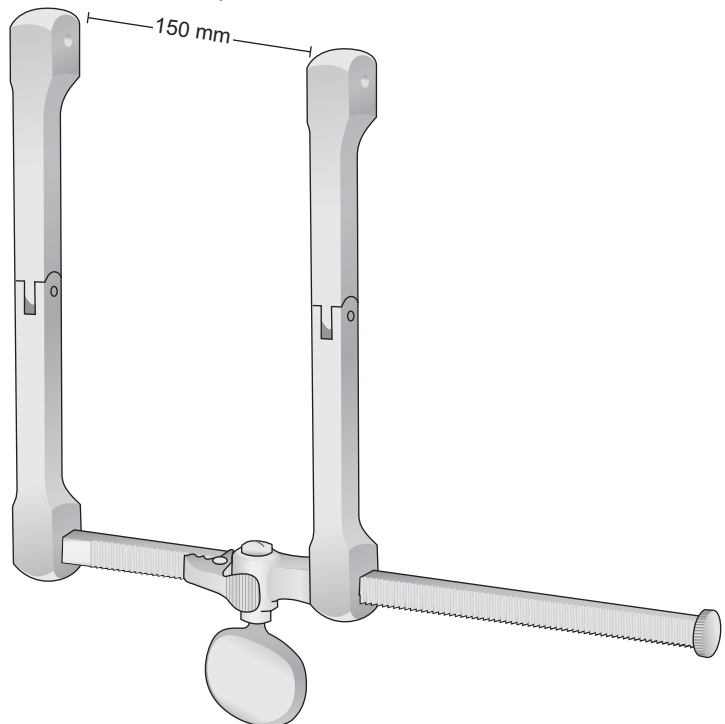

SCOVILLE-HAVERFIELD  
0221-BGA



**Divaricatori  
per laminectomia**

**Laminectomy  
retractors**

**Laminektomiespreizer**

**Ecarteurs  
pour laminectomie**

**Separadores  
para laminectomia**

Acuto  
Scharp  
Spitz  
Pointù  
Agudo

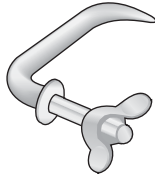

**SCOVILLE  
0221-BGD**  
50 mm

Acuto  
Scharp  
Spitz  
Pointù  
Agudo

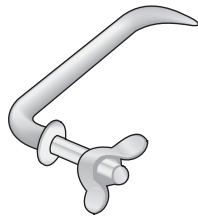

**SCOVILLE  
0221-BGE**  
70 mm

Smusso  
Blunt  
Stumpf  
Mousse  
Romo

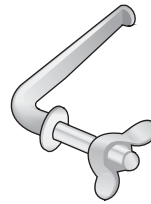

**SCOVILLE  
0221-BGF**  
50 mm

Smusso  
Blunt  
Stumpf  
Mousse  
Romo

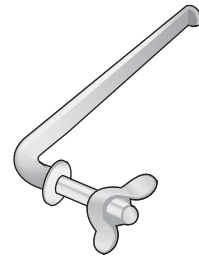

**SCOVILLE  
0221-BGG**  
70 mm

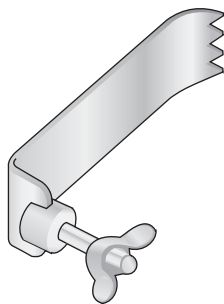

**SCOVILLE**  
**0221-BGH** 50x25 mm  
**0221-BGI** 50x50 mm  
**0221-BGL** 57x38 mm  
**0221-BHA** 64x25 mm  
**0221-BHB** 64x50 mm  
**0221-BHC** 67x30 mm  
**0221-BHD** 75x25 mm  
**0221-BHE** 75x50 mm  
**0221-BHF** 88x25 mm  
**0221-BHG** 100x50 mm

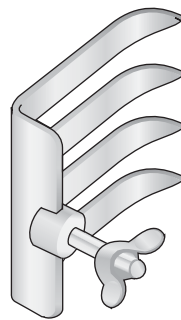

**TAYLOR**  
**0221-BHH** 48x50 mm  
**0221-BHI** 64x50 mm  
**0221-BHL** 64x64 mm  
**0221-BIA** 80x57 mm

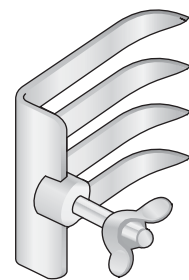

**SCOVILLE**  
**0221-BIB** 41x38 mm  
**0221-BIC** 67x44 mm

**Divaricatori per  
la colonna vertebrale**

**Retractors for lumbar  
vertebral column**

**Wundspreizer für die  
Lumbale Wirbelsäule**

**Ecarteurs pour  
la colonne cervicale**

**Separadores para  
columna espinal**

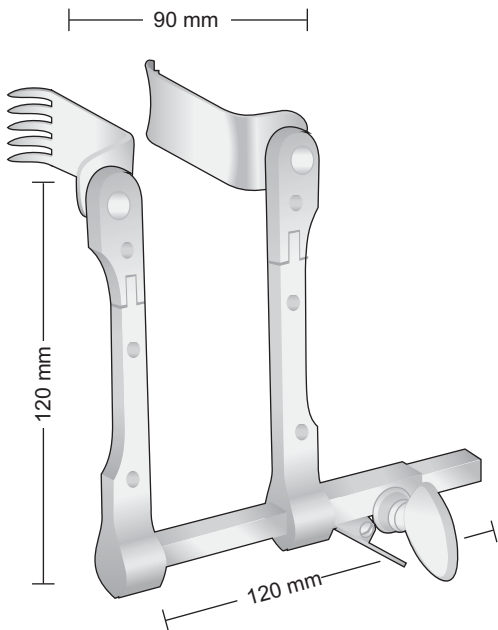

**CASPAR  
0221-CFA**  
Completo con 5 + 5 valve  
Complete with 5 + 5 blade  
Komplett mit 5 + 5 Blätter  
Complet avec 5 + 5 valves  
Completo con 5 + 5 valvas

**0221-CEL**  
Divaricatore solo  
Retractor only  
Sperrer allein  
Ecarteur seul  
Separador suelto

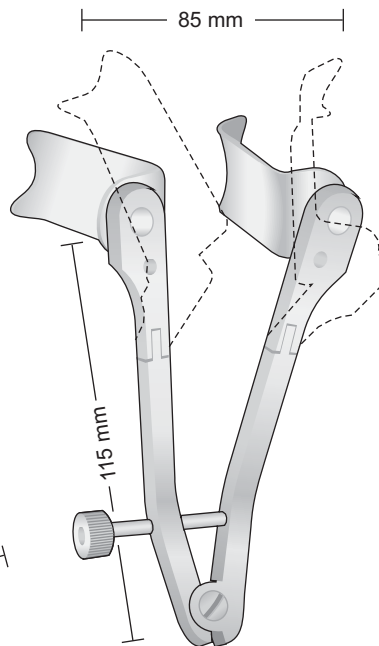

**CASPAR  
0221-CHA**  
Completo con 5 valve  
Complete with 5 blade  
Komplett mit 5 Blätter  
Complet avec 5 valves  
Completo con 5 valvas

**0221-CGL**  
Divaricatore solo  
Retractor only  
Sperrer allein  
Ecarteur seul  
Separador suelto

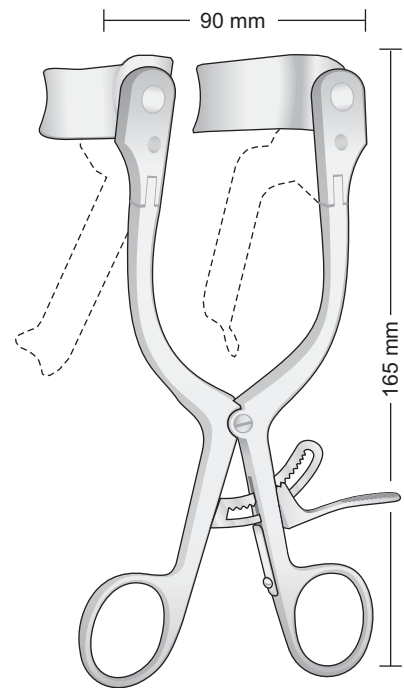

**CASPAR  
0221-CIA**  
Completo con 5 valve  
Complete with 5 blade  
Komplett mit 5 Blätter  
Complet avec 5 valves  
Completo con 5 valvas

**0221-CHL**  
Divaricatore solo  
Retractor only  
Sperrer allein  
Ecarteur seul  
Separador suelto

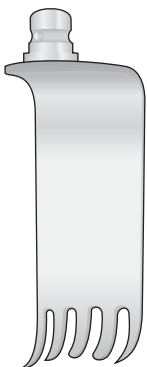

**0221-CFB**  
40 x 23 mm  
**0221-CFC**  
45 x 23 mm  
**0221-CFD**  
50 x 23 mm  
**0221-CFE**  
55 x 23 mm  
**0221-CFF**  
60 x 23 mm



**0221-CFG**  
40 x 23 mm  
**0221-CFH**  
45 x 23 mm  
**0221-CFI**  
50 x 23 mm  
**0221-CFL**  
55 x 23 mm  
**0221-CGA**  
60 x 23 mm



**0221-CHB**  
45 x 23 mm  
**0221-CHC**  
50 x 23 mm  
**0221-CHD**  
55 x 23 mm  
**0221-CHE**  
60 x 23 mm  
**0221-CHF**  
65 x 23 mm

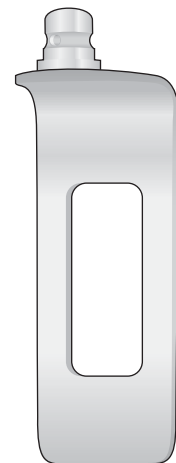

**0221-CHG**  
50 x 25 mm  
**0221-CHH**  
60 x 25 mm

Divaricatori per  
la colonna vertebrale

Retractors for lumbar  
vertebral column

Wundspreizer für die  
Lumbale Wirbelsäule

Ecarteurs pour  
la colonne cervicale

Separadores para  
columna espinal

Valve in titanio  
Titanium blades  
Titan-valven  
Valves en titane  
Valvas in titanio



- 0221-CIB19** 25 x 24 mm
- 0221-CIC19** 30 x 24 mm
- 0221-CID19** 35 x 24 mm
- 0221-CIE19** 40 x 24 mm
- 0221-CIF19** 45 x 24 mm
- 0221-CIG19** 25 x 24 mm
- 0221-CIH19** 30 x 24 mm
- 0221-CII19** 35 x 24 mm
- 0221-CIL19** 40 x 24 mm
- 0221-CLA19** 45 x 24 mm

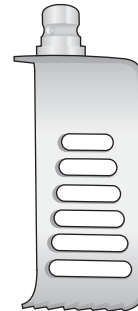

- 0221-CLB19** 25 x 24 mm
- 0221-CLC19** 30 x 24 mm
- 0221-CLD19** 35 x 24 mm
- 0221-CLE19** 40 x 24 mm
- 0221-CLF19** 45 x 24 mm
- 0221-CLG19** 50 x 24 mm
- 0221-CLH19** 55 x 24 mm
- 0221-CLI19** 60 x 24 mm
- 0221-CLL19** 65 x 24 mm
- 0221-DAA19** 70 x 24 mm



- 0221-DAB19** 30 x 24 mm
- 0221-DAC19** 35 x 24 mm
- 0221-DAD19** 40 x 24 mm
- 0221-DAE19** 45 x 24 mm
- 0221-DAF19** 50 x 24 mm
- 0221-DAG19** 55 x 24 mm
- 0221-DAH19** 60 x 24 mm
- 0221-DAI19** 65 x 24 mm
- 0221-DAL19** 70 x 24 mm
- 0221-DBA19** 75 x 24 mm

Pinzetta per la sostituzione delle valve  
con i bloccaggi rapidi a sfera  
Blade ejector for changing the blades  
with ball snap closure  
Pinzette zum wechseln der valven  
mit kugelschnellverschluss  
Pincas pour changer les valves munies  
du système de verrouillage rapide à billes

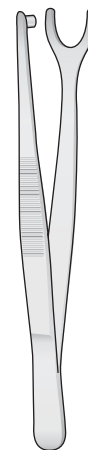

- 0221-CCL**  
115 mm

Divaricatori per  
microchirurgia lombare

Retractors for  
Micro-Lumbar Discectomy

Wundspreizer zur  
Mikrodiskektomie

Ecarteurs pour  
Micro chirurgie

Separadors para  
micro chirurgia

Oberfläche schwarz beschichtet  
Surface black-coated

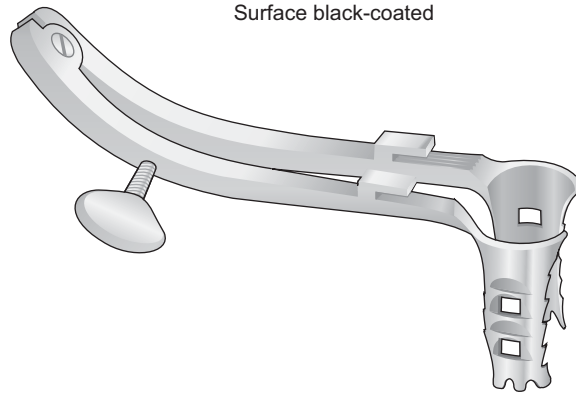

CASPAR  
0221-CAB/0221-CAI

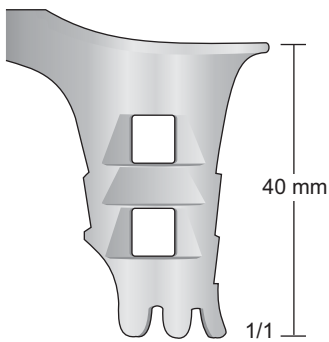

0221-CAB

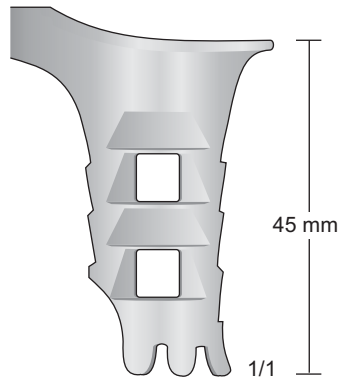

0221-CAC

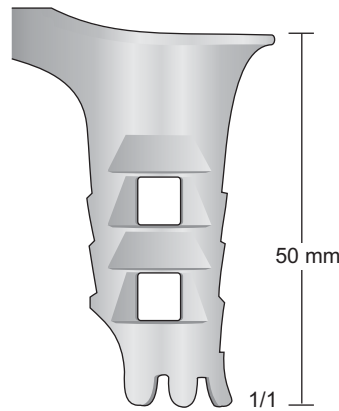

0221-CAD

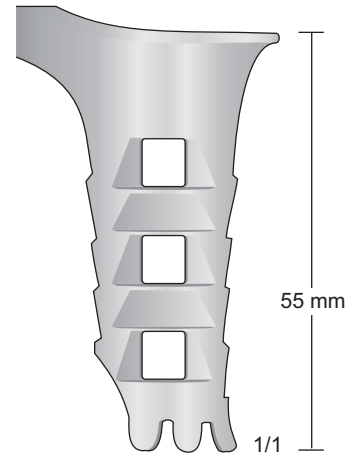

0221-CAE

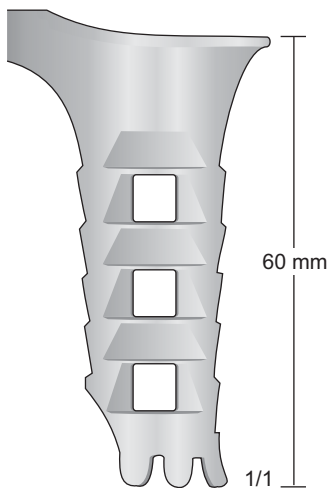

0221-CAF

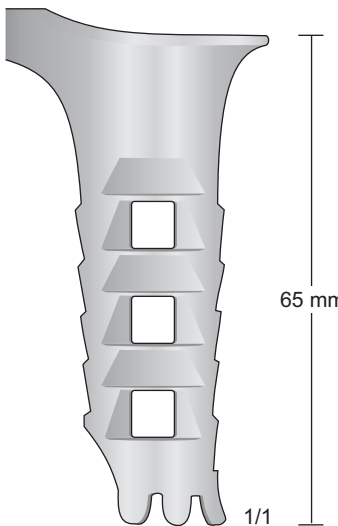

0221-CAG

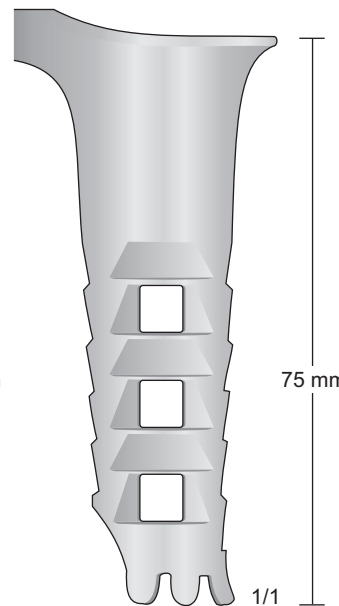

0221-CAH

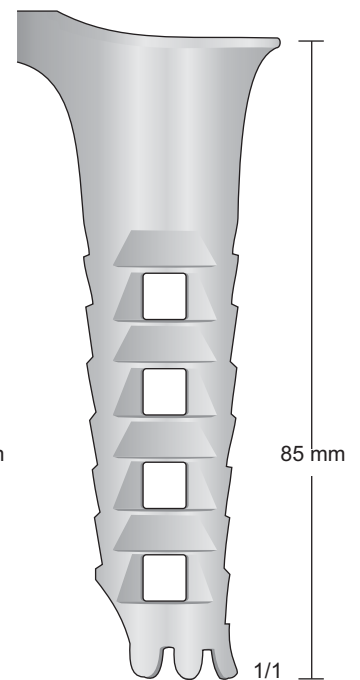

0221-CAI

Divaricatori per  
microchirurgia lombare

Retractors for  
Micro-Lumbar Discectomy

Wundspreizer zur  
Mikrodiskektomie

Ecarteurs pour  
Micro chirurgie

Separadors para  
micro chirurgia

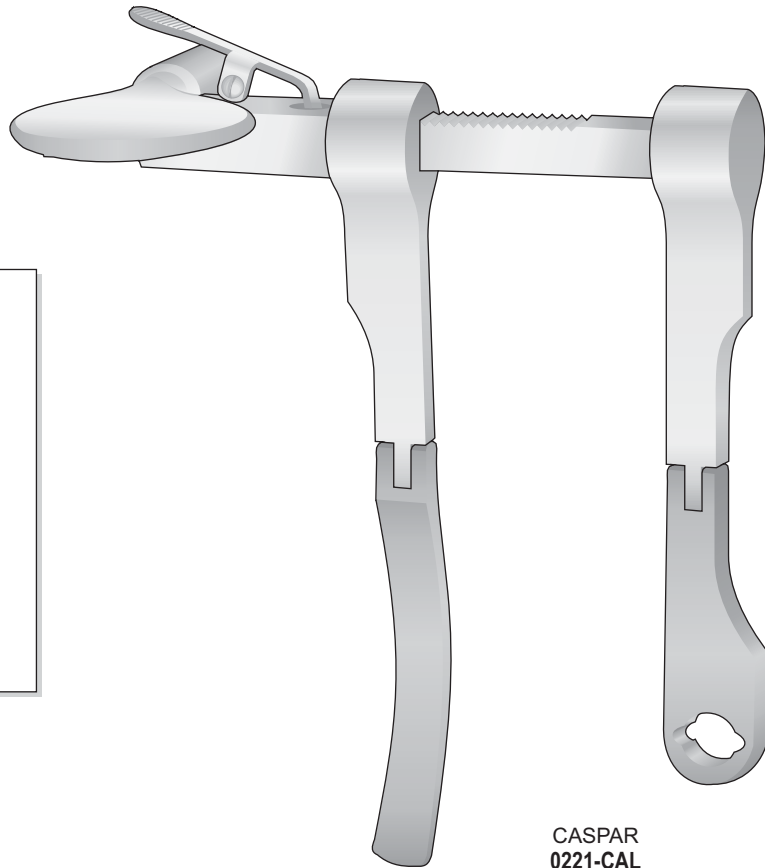

**CASPAR  
0221-CBA**

Divaricatore completo di  
Retractor complete with  
Sperrer komplett mit  
Ecarteur complet avec  
Separador completo con

- 0221-CBB** Valva anti-riflesso mm. 35
- 0221-CBC** Valva anti-riflesso mm. 40
- 0221-CBD** Valva anti-riflesso mm. 45
- 0221-CBE** Valva anti-riflesso mm. 50
- 0221-CBF** Valva anti-riflesso mm. 55
- 0221-CBG** Valva anti-riflesso mm. 60

**0221-CAL**

Divaricatore solo  
Retractor only  
Sperrer allein  
Ecarteur seul  
Separador suelto

CASPAR  
0221-CAL

Valve anti-riflesso  
Surface Black-coated  
Oberfläche schwarz Beschichtet  
Surface noircie

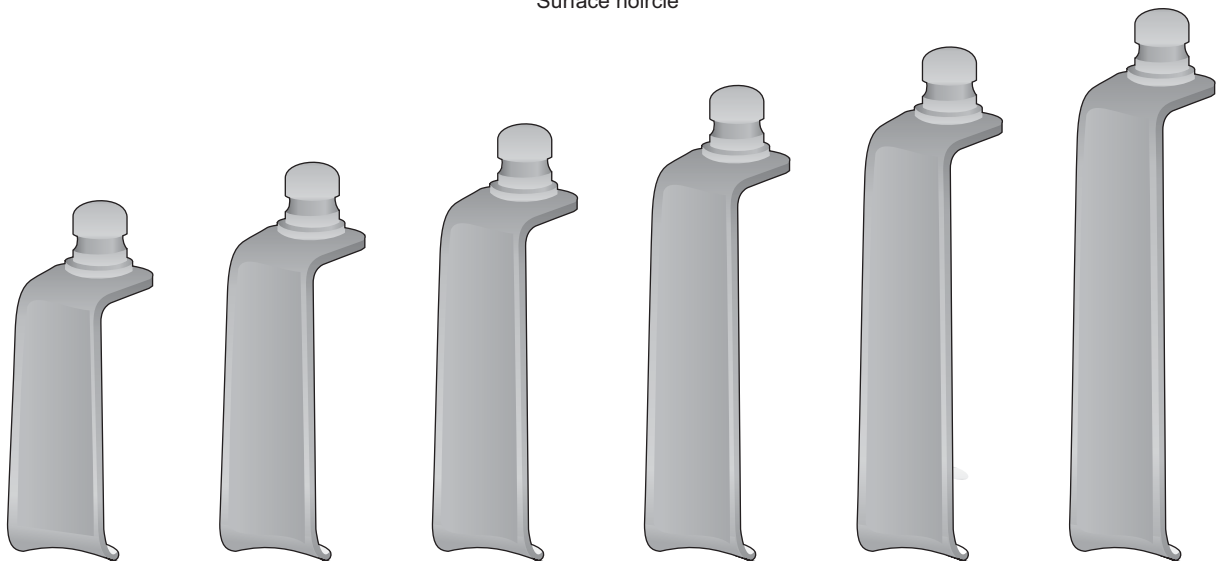

**0221-CBB**  
35 mm

**0221-CBC**  
40 mm

**0221-CBD**  
45 mm

**0221-CBE**  
50 mm

**0221-CBF**  
55 mm

**0221-CBG**  
60 mm

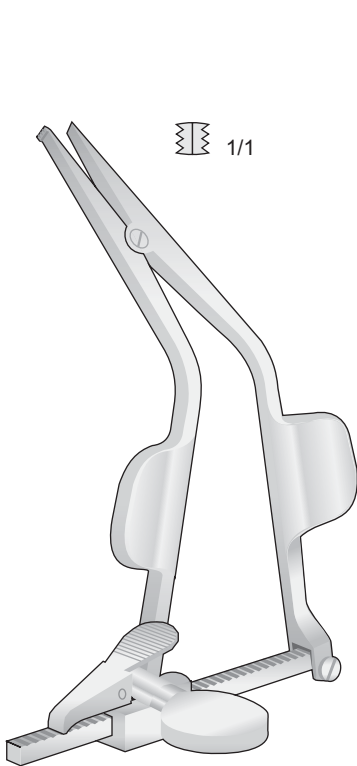

CLOWARD  
0221-IG  
150 mm

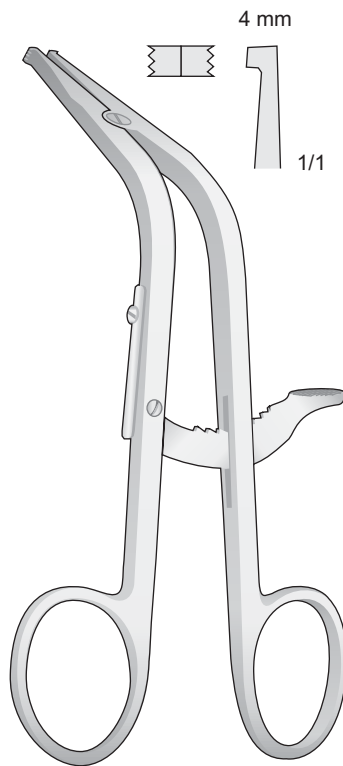

CLOWARD  
0221-IE  
160 mm

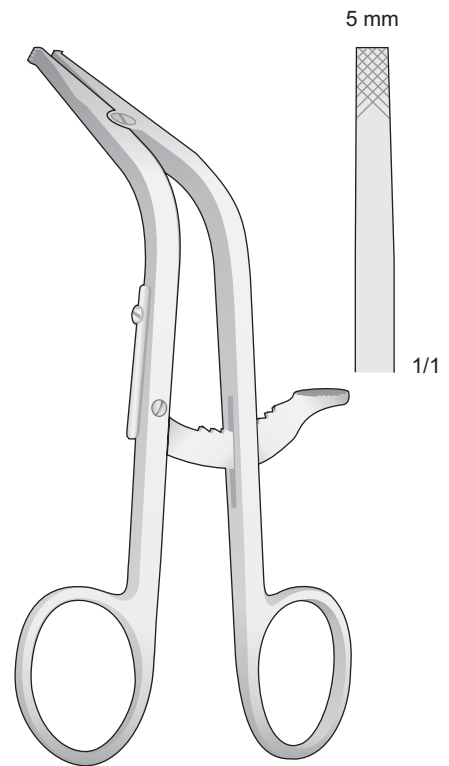

CLOWARD  
0221-IF  
160 mm

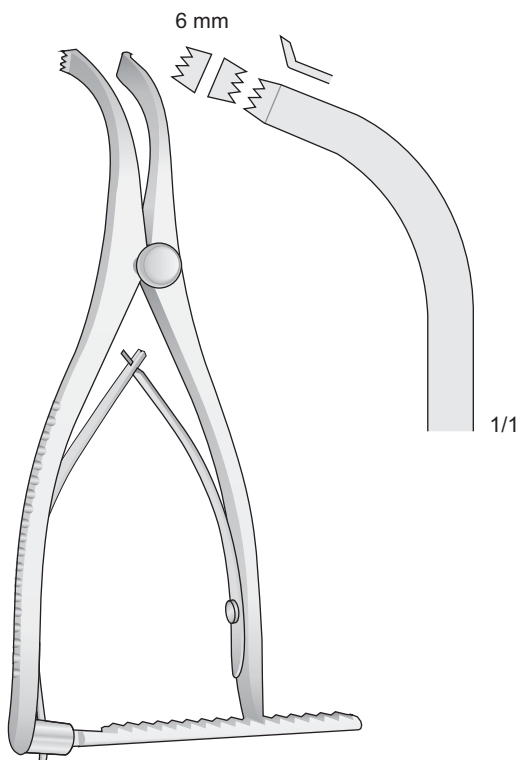

INGE  
0221-IA  
160 mm

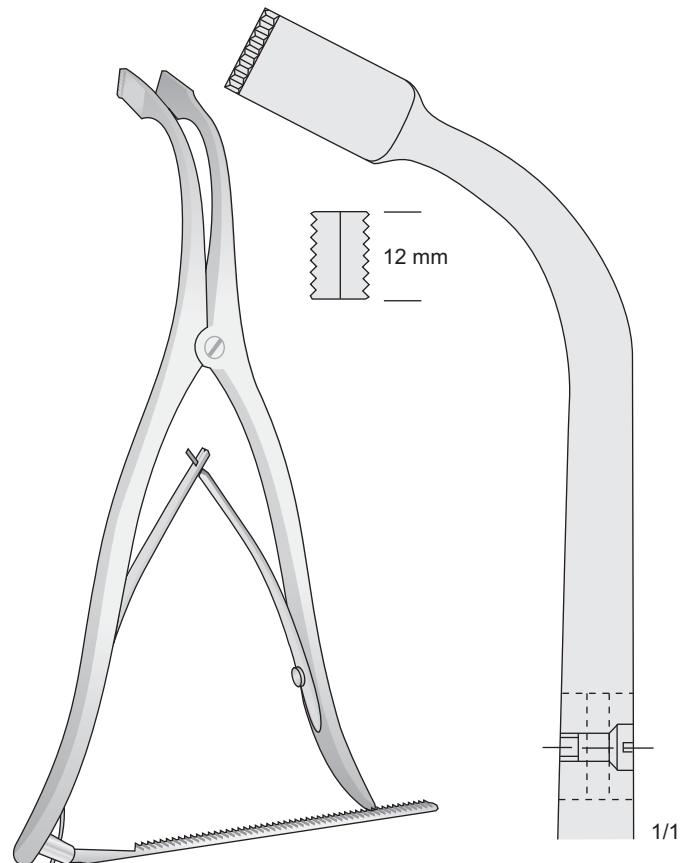

INGE  
0221-IC  
275 mm

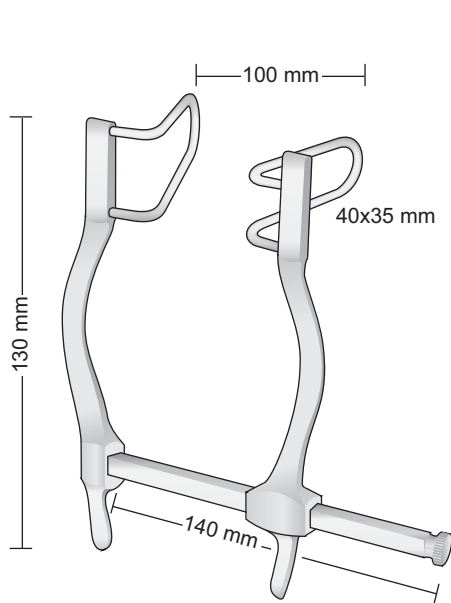

GOSSET  
0221-DB

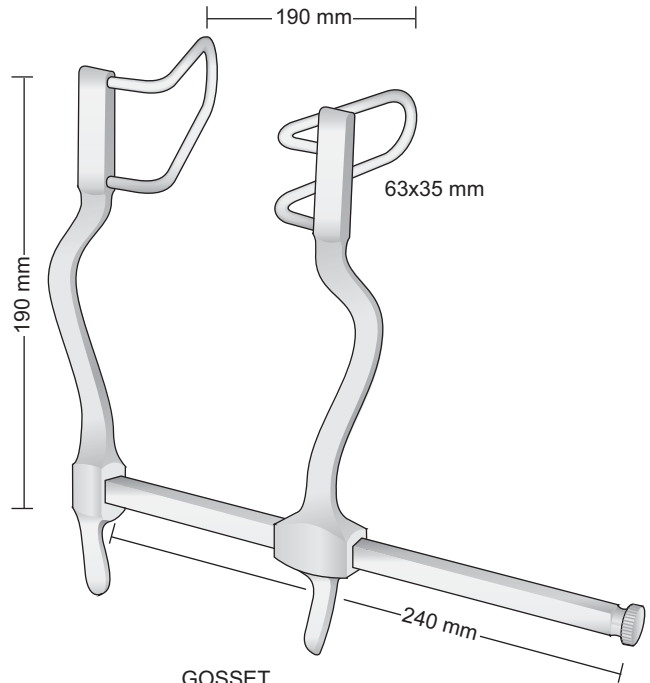

GOSSET  
0221-DA

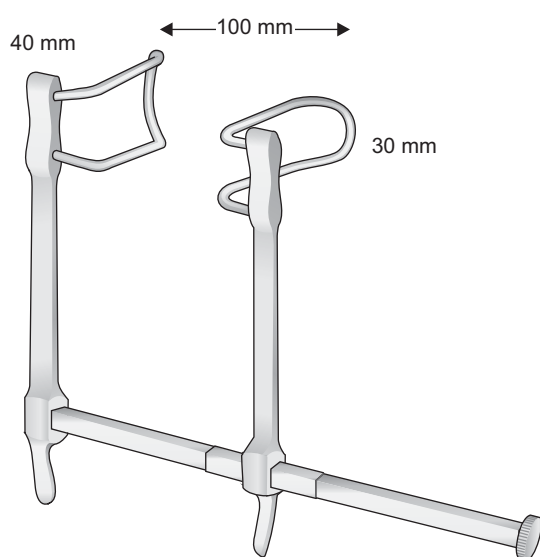

GOSSET  
0221-DD

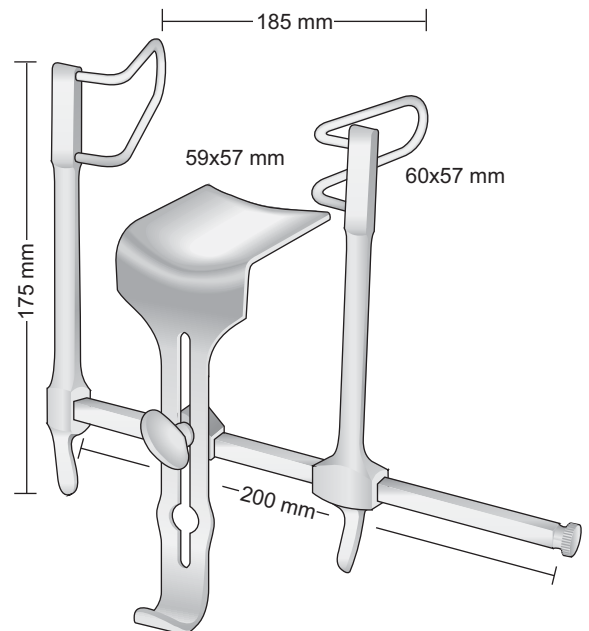

GOSSET  
0221-DC

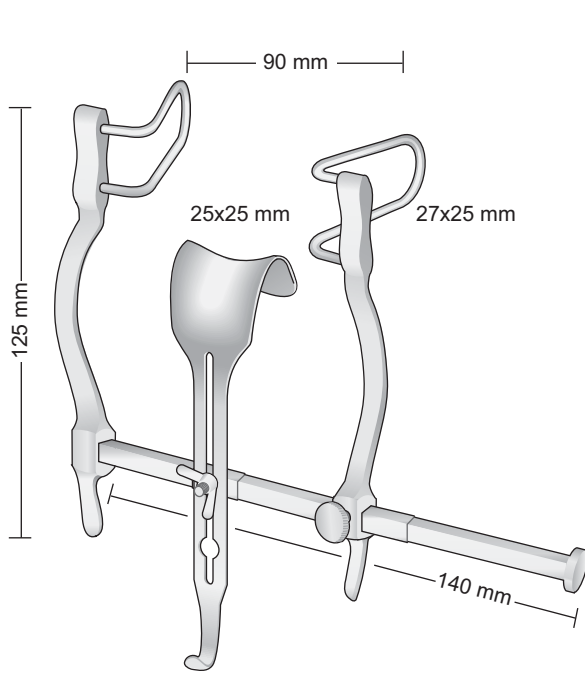

BALFOUR-BABY  
0221-EB

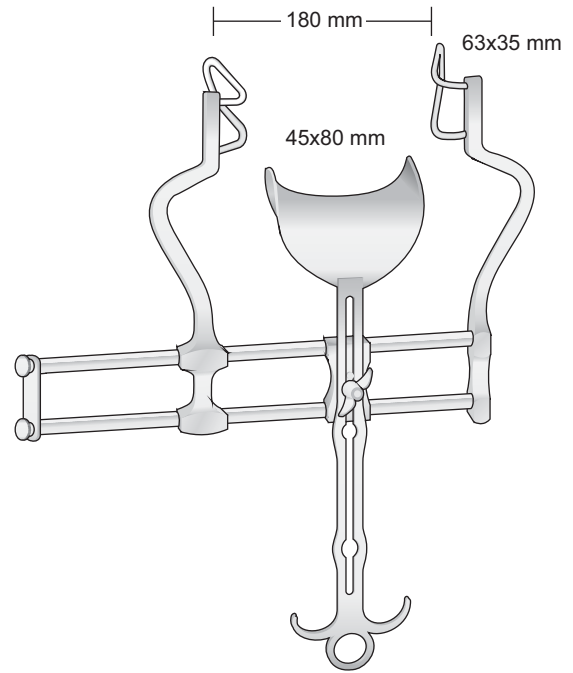

BALFOUR  
0221-EA

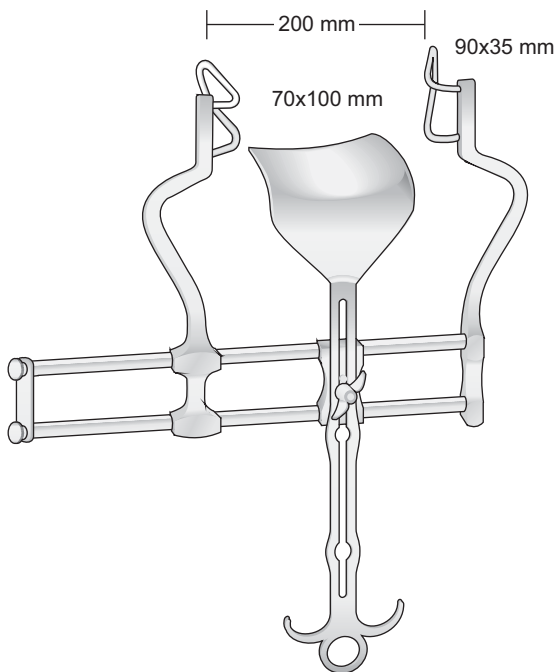

BALFOUR  
0221-EC

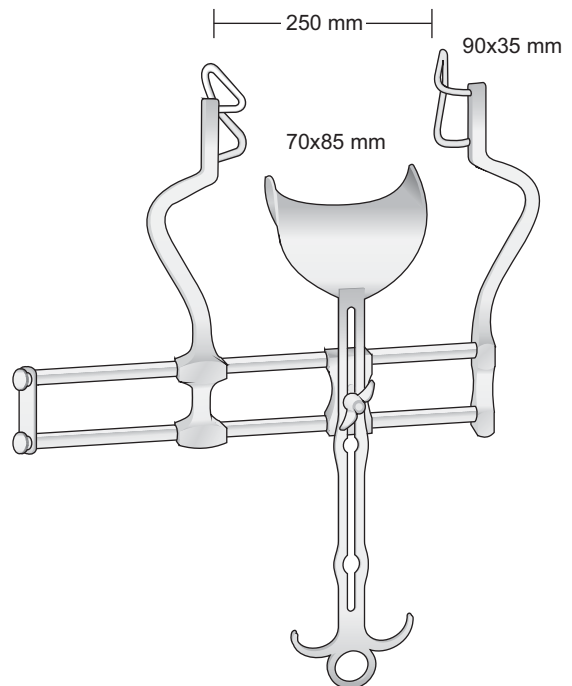

BALFOUR  
0221-ED



Valva centrale - Center blade  
Mittelblatt - Valve centrale - Valva central

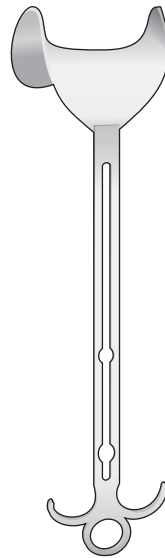

BALFOUR  
0221-BFD  
45 x 80 mm

Valve laterali - paio  
Lateral blades - pair  
Seitliche Blätter - Paar  
Valves latérales - paires  
Valvas laterales - pares

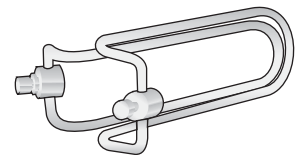

0221-BIG - 50 mm  
0221-BIH - 60 mm  
0221-BII - 75 mm  
0221-BIL - 90 mm

**0221-BIE**  
Completo con:  
Complete with:  
Komplett mit:  
Complet avec:  
Completo con:  
**0221-BIF - 0221-BFD - 0221-BIG**

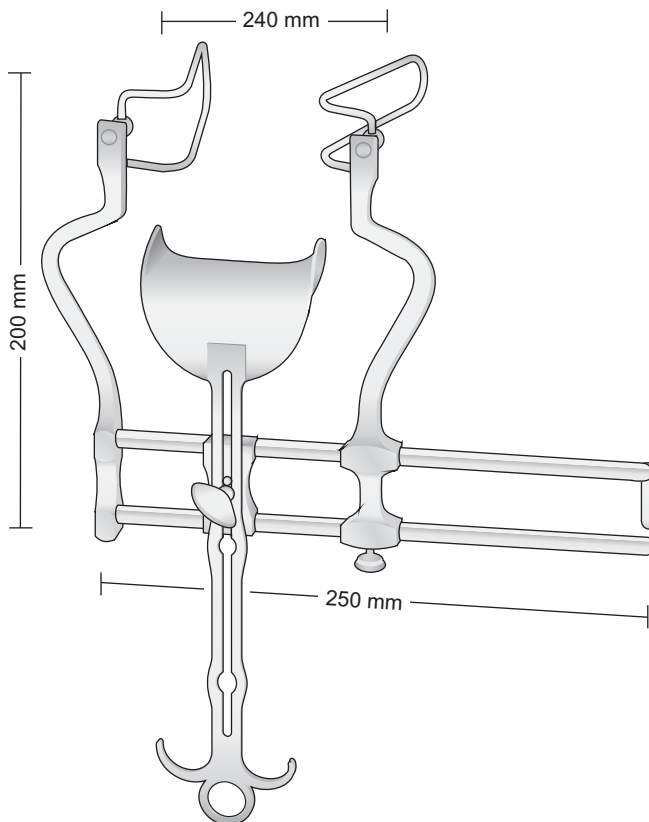

BALFOUR  
0221-BIE

**0221-BIF**  
BALFOUR  
Divaricatore solo  
Retractor only  
Sperrer allein  
Ecarteur seul  
Separador suelto

**0221-BFD**  
Valva centrale  
Center blade  
Mittelblatt  
Valve centrale  
Valva central  
45 x 80 mm

**0221-BFG**  
Valva centrale  
Center blade  
Mittelblatt  
Valve centrale  
Valva central  
60 x 80 mm

**0221-BFH**  
Valva centrale  
Center blade  
Mittelblatt  
Valve centrale  
Valva central  
80 x 80 mm

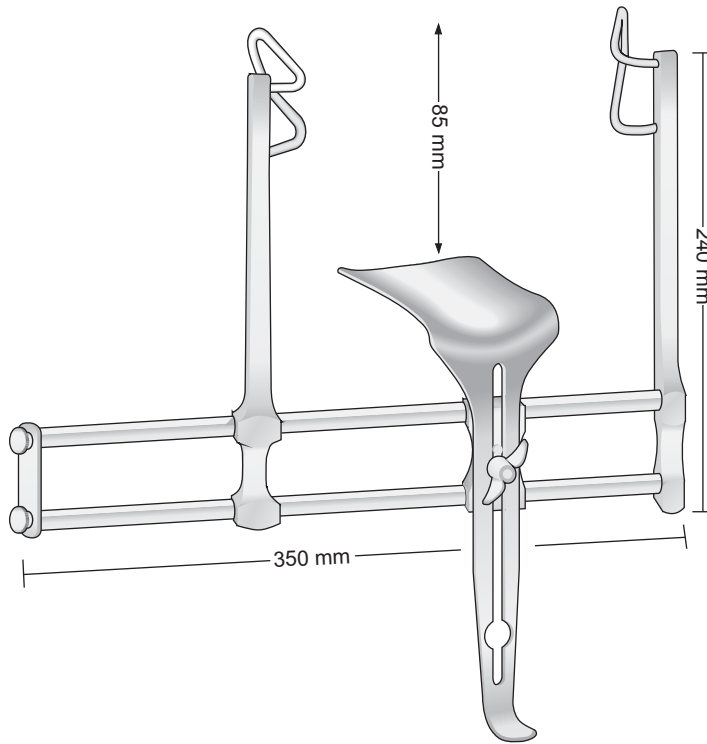

BALFOUR MODIF.  
0221-EG

45 X 85 mm

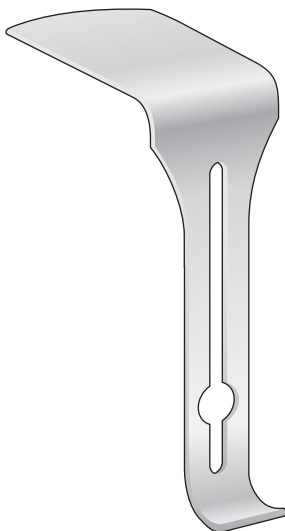

0221-BFA  
170 mm

75 X 65 mm

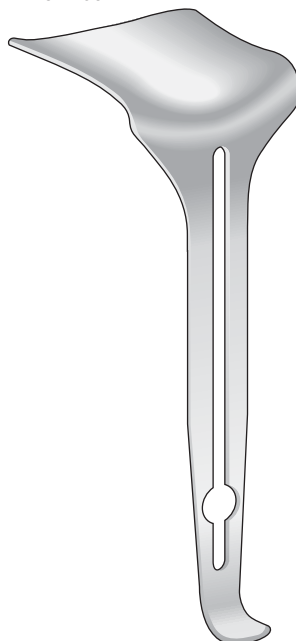

0221-BFB  
230 mm

70 X 100 mm



0221-BFC  
200 mm

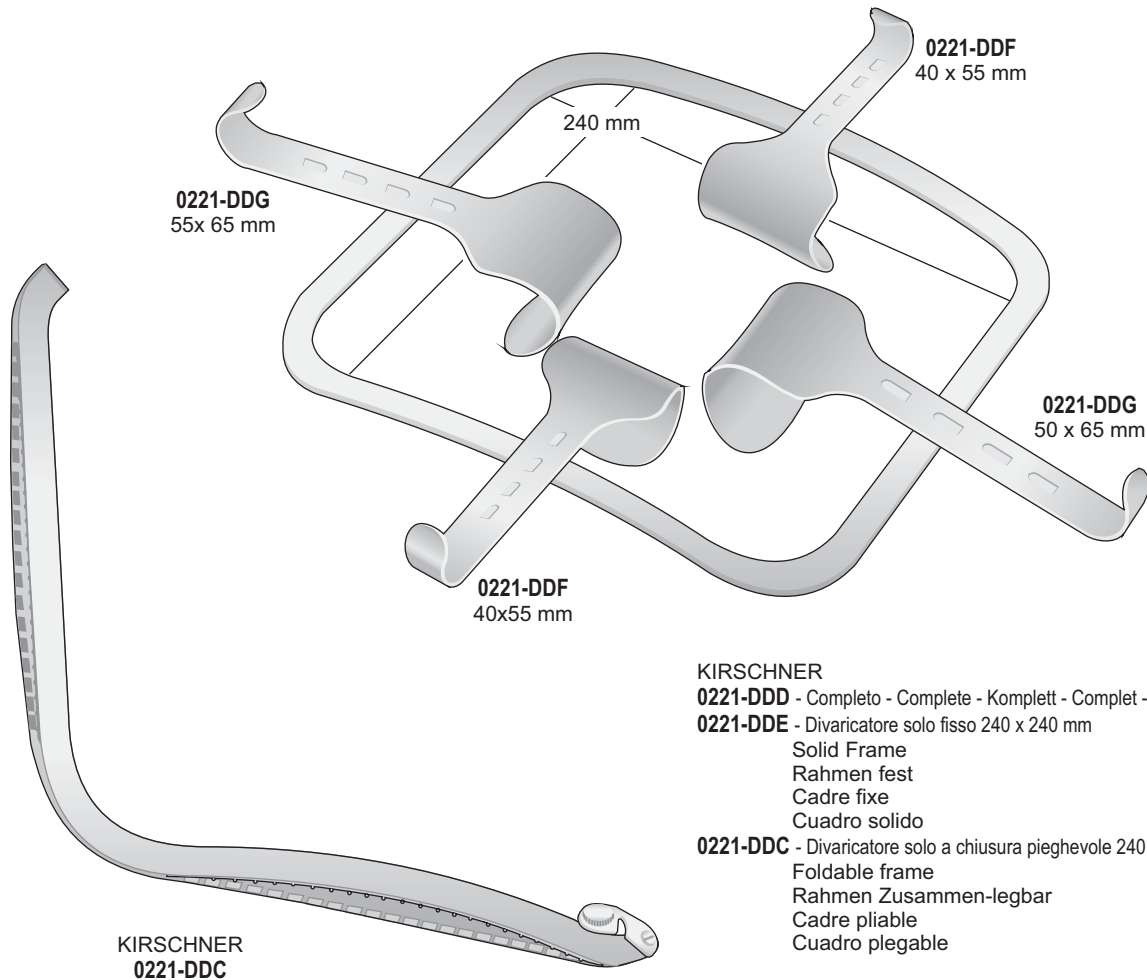

**KIRSCHNER**

**0221-DDD** - Completo - Complete - Komplett - Complet - Completo

**0221-DDE** - Divaricatore solo fisso 240 x 240 mm

Solid Frame

Rahmen fest

Cadre fixe

Cuadro solido

**0221-DDC** - Divaricatore solo a chiusura pieghevole 240 x 240 mm

Foldable frame

Rahmen Zusammen-legbar

Cadre pliable

Cuadro plegable

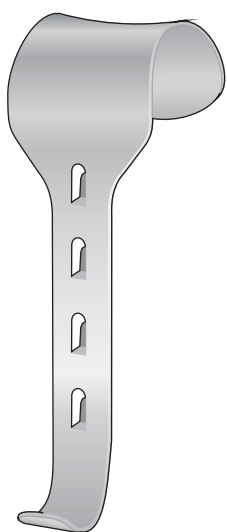

KIRSCHNER  
**0221-DDF**  
40 x 55 mm

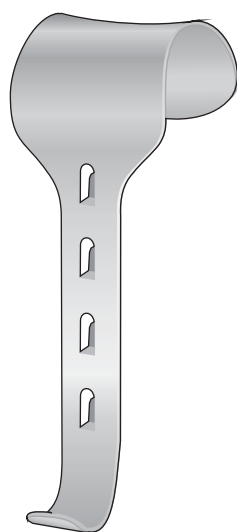

KIRSCHNER  
**0221-DDB** - 65 x 80 mm  
**0221-DDG** - 50 x 65 mm

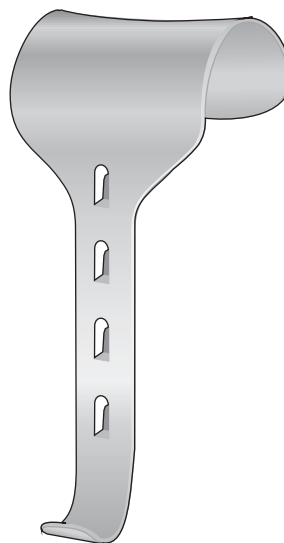

KIRSCHNER  
**0221-DDH** - 60 x 85 mm  
**0221-DDI** - 78 x 65 mm  
**0221-DDL** - 90 x 65 mm

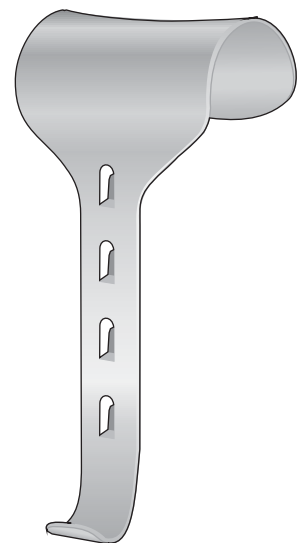

KIRSCHNER  
**0221-DEG** - 80 x 80 mm  
**0221-DEH** - 80 x 90 mm  
**0221-DEI** - 90 x 90 mm

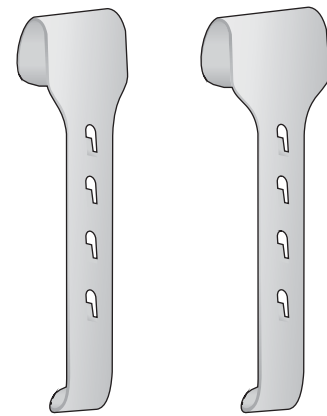
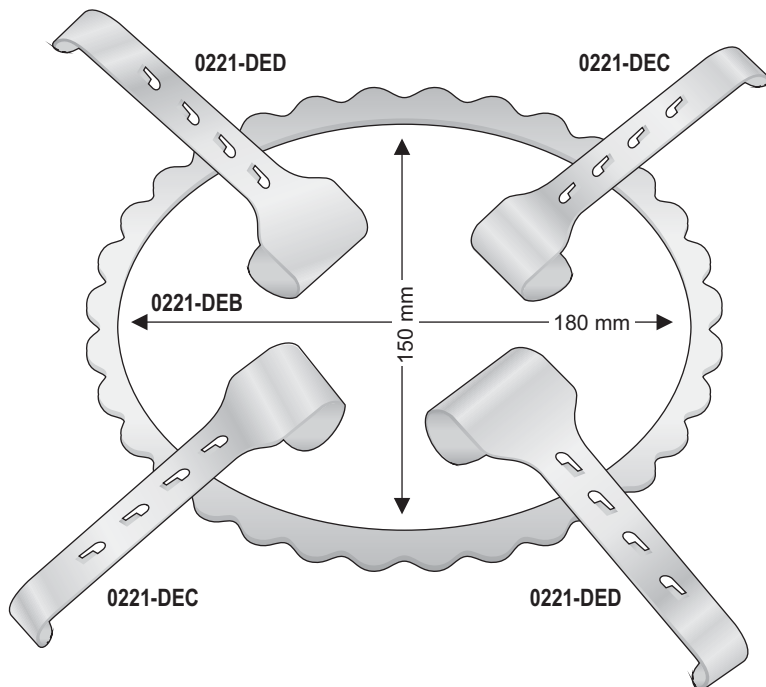

**0221-DEE**  
20 x 30 mm

**0221-DEF**  
20 x 40 mm

**DENIS-BROWNE**  
**0221-DEA**

Set completo per bambini  
Set complete for children  
Komplettset für Kinder  
Set complete pour enfants  
Set completo para niños

**0221-DEB** - 1 Cornice 180 x 150 mm  
**0221-DEE** - 2 Valve 20 x 30 mm  
**0221-DEF** - 2 Valve 20 x 40 mm

**0221-DEB**

180 x 150 mm  
Cornice sola  
Frame only  
Rahmen allein  
Ecarteur seul  
Separador suelto

Per bambini - For children  
Für Kinder - Pour enfants  
Para niños

**DENIS-BROWNE**  
**0221-DFA**

Set completo per adulti  
Set complete for adults  
Komplettset für Erwachsene  
Set complete pour adultes  
Set completo para adultos

**0221-DEL** - 1 Cornice 255 x 180 mm  
**0221-DEC** - 2 Valve 40 x 30 mm  
**0221-DED** - 2 Valve 40 x 40 mm

**0221-DEL**

255 x 180 mm  
Cornice sola  
Frame only  
Rahmen allein  
Ecarteur seul  
Separador suelto

Per adulti - For adults  
Für Erwachsene - Pour adultes  
Para adultos

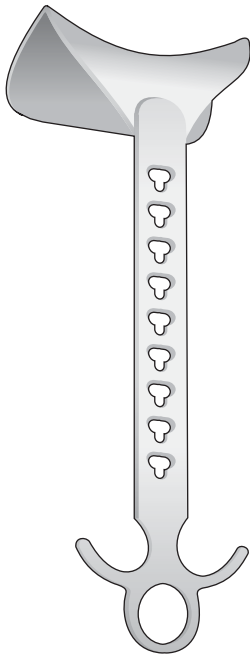

**ROCHARD**  
**0221-DID** - 60 x 95 mm  
**0221-DIE** - 60 x 105 mm  
**0221-DIF** - 60 x 120 mm  
**0221-DIG** - 60 x 135 mm  
**0221-DIH** - 60 x 155 mm  
 270 mm

Dispositivo di fissaggio  
 Fixation device  
 Fixiervorrichtung  
 Dispositif de fixation articulé  
 Dispositivo de fijación

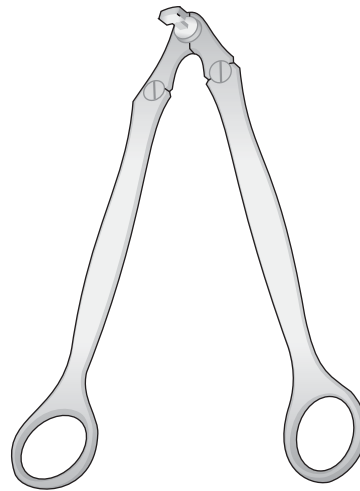

**ROCHARD**  
**0221-DII**  
 190 mm

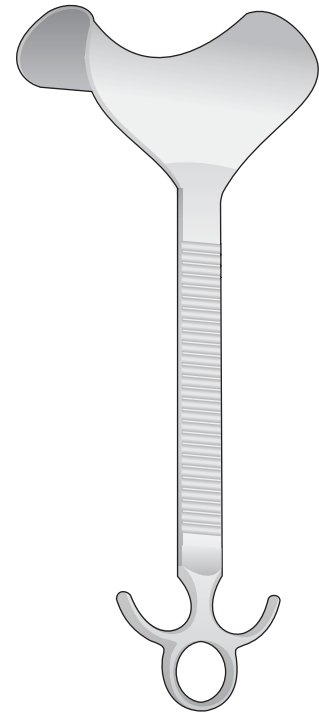

**DOYEN**  
**0219-CFF** - 50 x 85 mm  
**0219-CFG** - 48 x 90 mm  
**0219-CFH** - 48 x 105 mm  
**0219-CFI** - 48 x 120 mm  
**0219-CFL** - 48 x 135 mm  
 280 mm

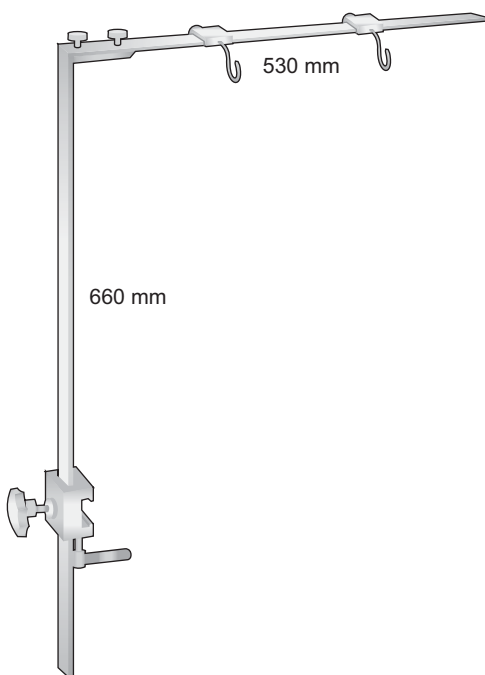

**ROCHARD**  
**0221-DIL**

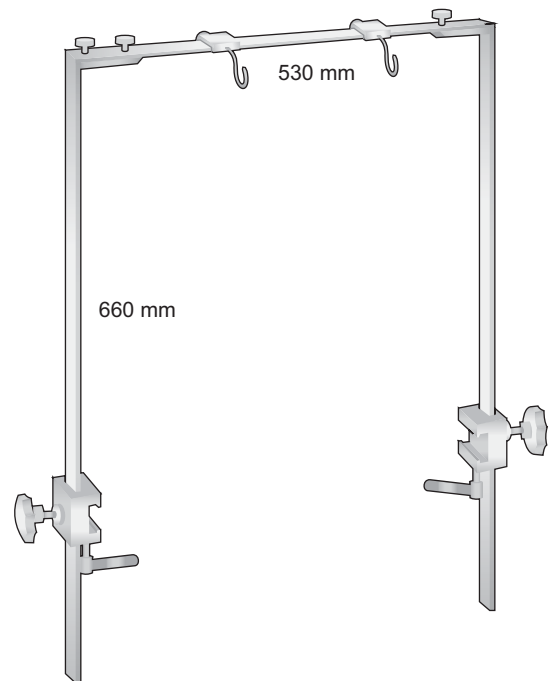

**ROCHARD**  
**0221-DLA**

**0221-CGD**  
Valva regolabile  
Large blade

**0221-CGE**  
Valva piccola  
Small blade

**0221-CGF**  
Contrappeso + catenella  
Weight with chain

Divaricatore per anca  
Retractor with chain  
Wundhaken mit Kette

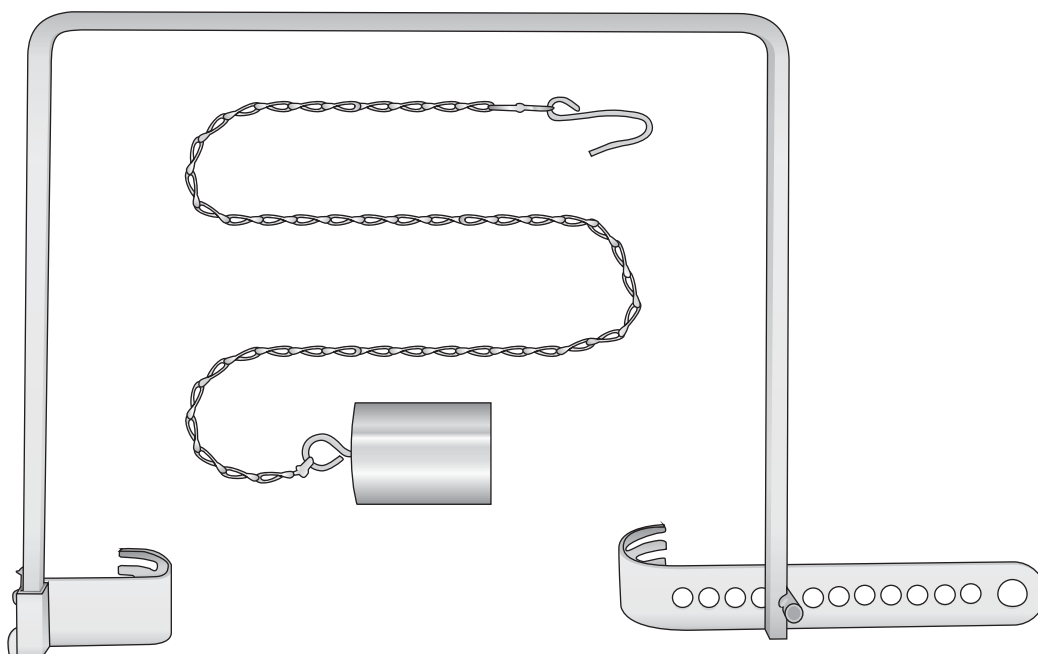

CHARNELY  
**0221-CGC**  
Completo - Complete - Komplett  
Complete - Completos

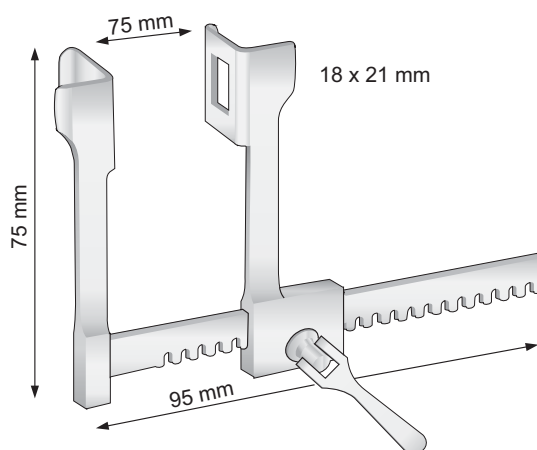
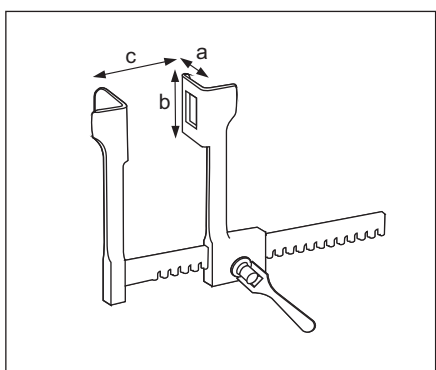

BABY FINOCCHIETTO  
 a b c  
**0221-GA** 18 x 21 mm 75 mm

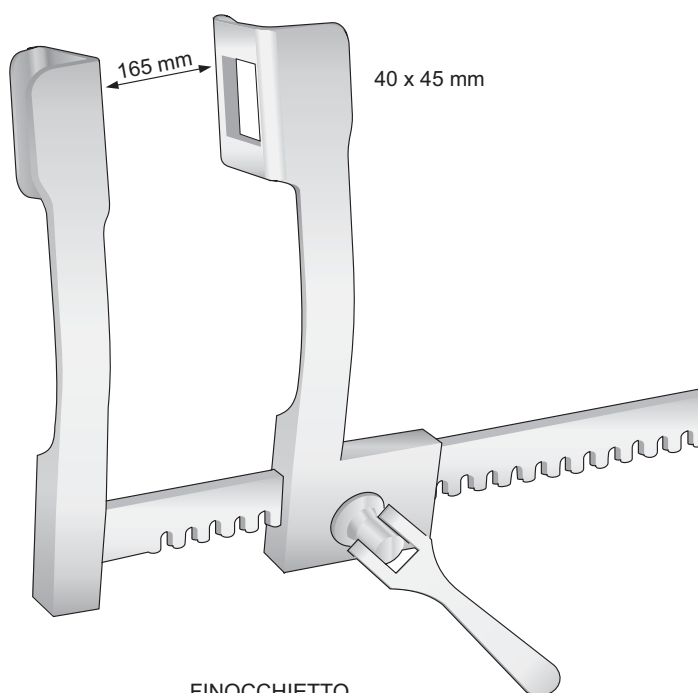

FINOCCHIETTO  
 a b c  
**0221-GC** 40 x 45 mm 165 mm  
**0221-GE** 45 x 65 mm 200 mm  
**0221-GG** 70 x 65 mm 250 mm

Divaricatori costali

Rib spreaders

Rippensperrer

Ecarteurs des cotes

Separadores costales

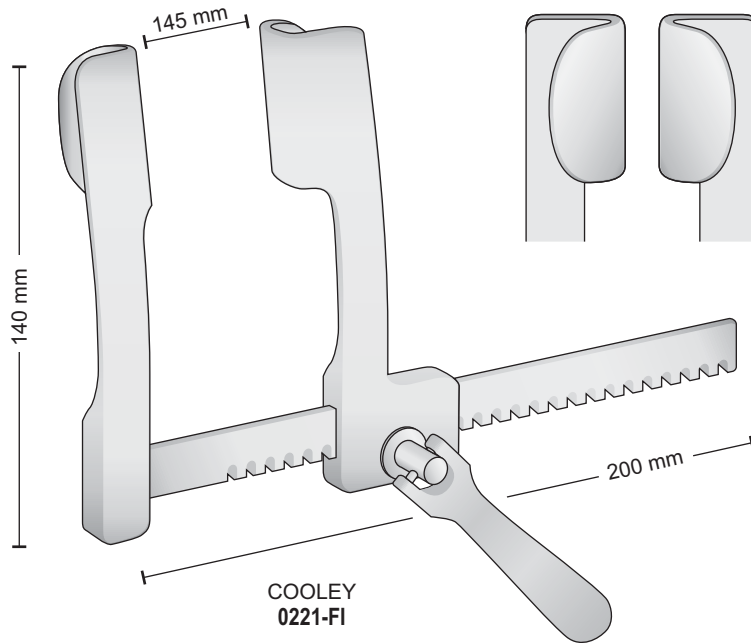

COOLEY  
0221-FI

Valve  
Blades  
Blätter  
Valves  
Valvas  
21 x 45 mm

Per bambini  
For children  
Für Kinder  
Pour enfants  
Para niños

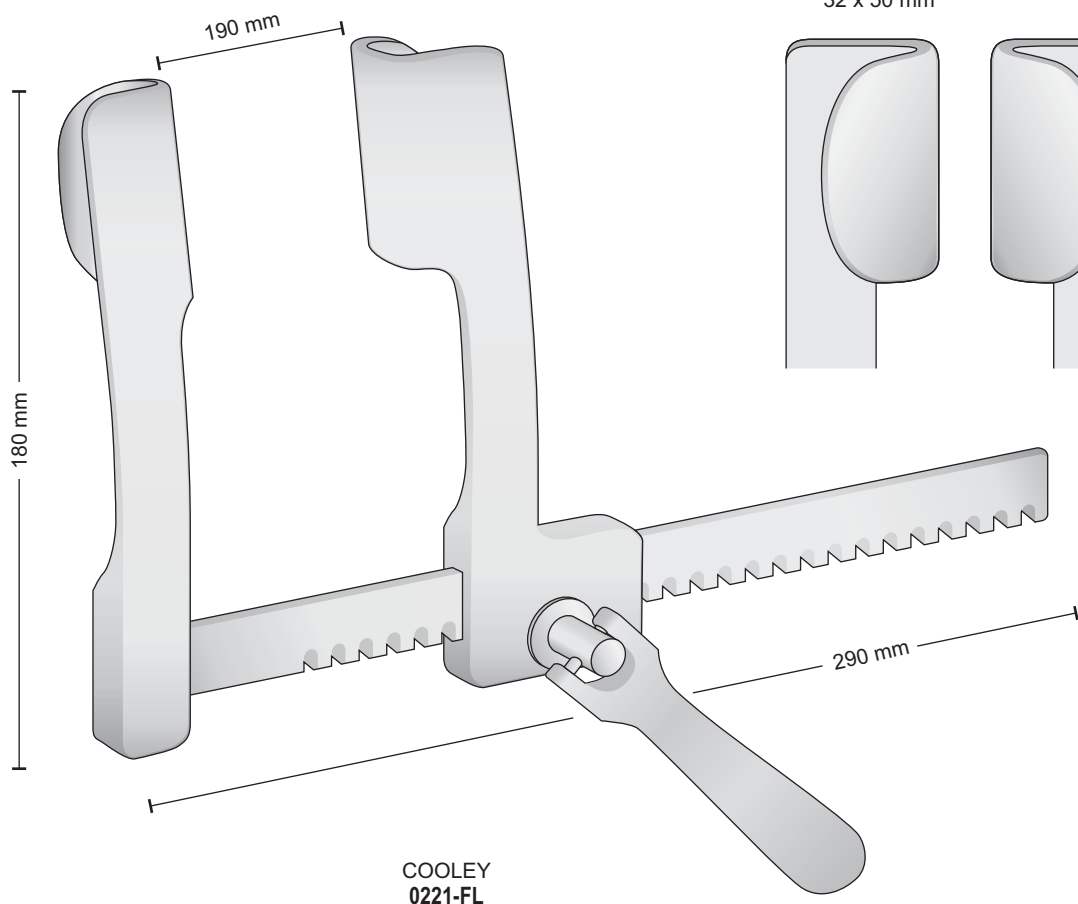

COOLEY  
0221-FL

Valve  
Blades  
Blätter  
Valves  
Valvas  
32 x 50 mm

Per adulti  
For adults  
Für Erwachsene  
Pour adultes  
Para adultos



Valve - Blade - Blätter  
Valve - Valvas  
50 x 43 mm

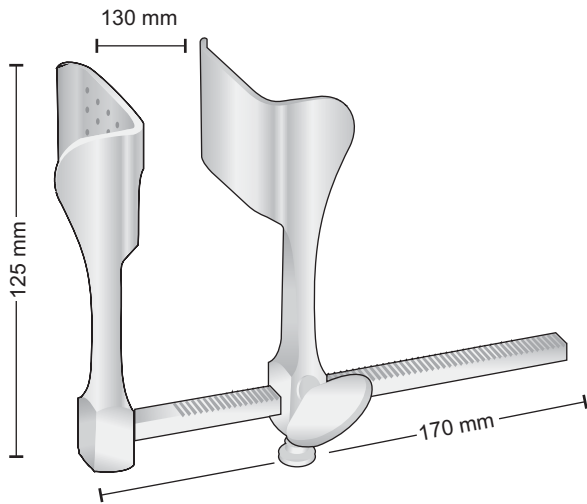

TUFFIER  
0221-FH

Divaricatori per sternotomia  
Sternotomy spreaders  
Sternotomie-Sperrer  
Ecarteurs à sternotomie  
Separador para sternotomia

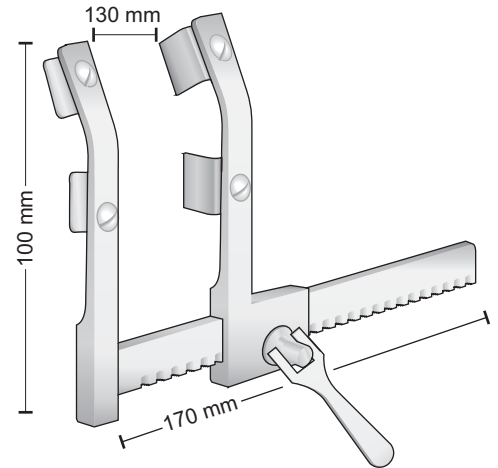

BABY-MORSE  
0221-BCF

Divaricatori per sternotomia - Sternotomy spreaders - Sternotomie-Sperrer  
Ecarteurs à sternotomie - Separador para sternotomia

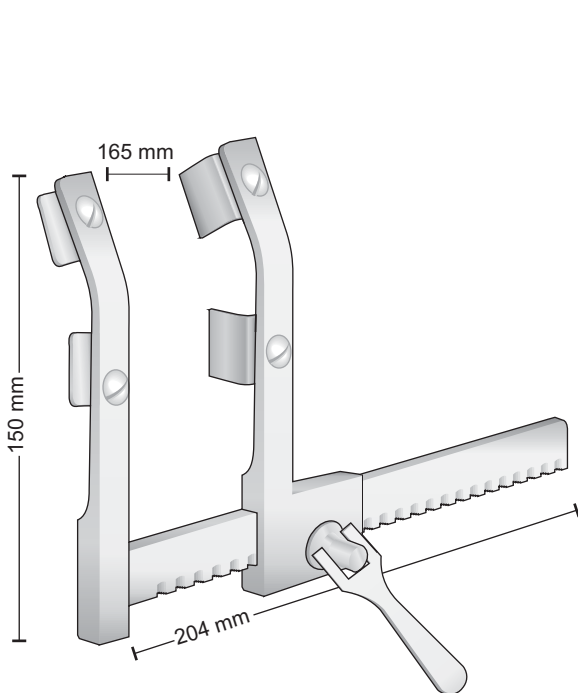

MORSE  
0221-BCG

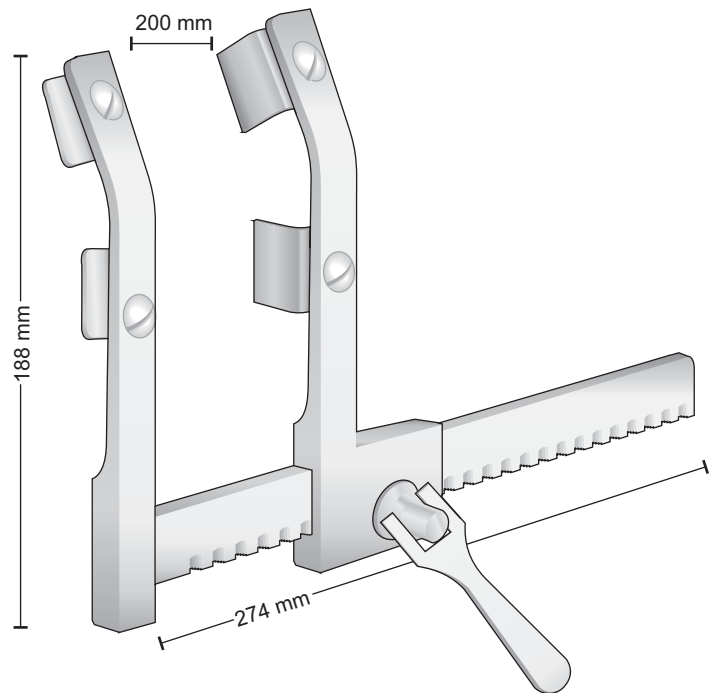

MORSE  
0221-BCI

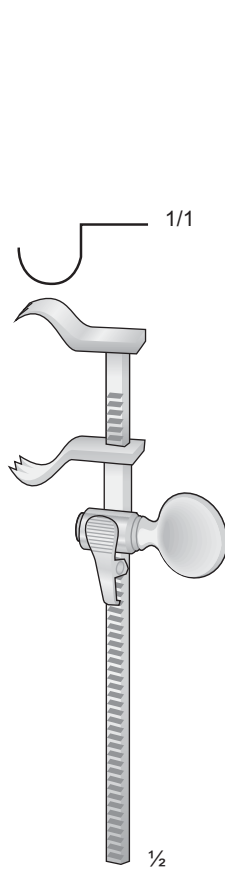

BAILEY  
0602-CLG  
160 mm

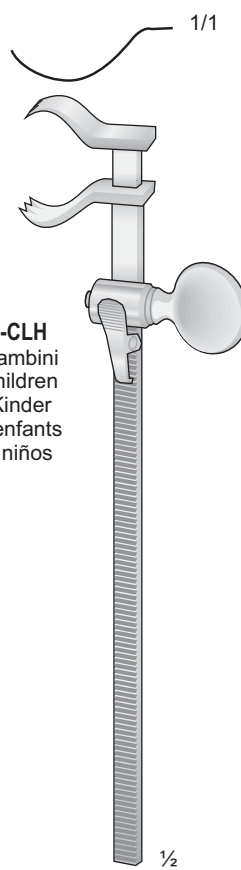

**0602-CLH**  
Per bambini  
For children  
Für Kinder  
Pour enfants  
Para niños

BAILEY  
0602-CLH/0602-CLI  
200 mm

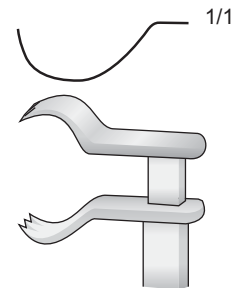

**0602-CLI**  
Per adulti  
For adults  
Für Erwachsene  
Pour adultes  
Para adultos

Divaricatori vescicali - Bladder retractors - Blasenwundspreizer  
Ecarteurs vésicaux - Separadores vesicales

Valva centrale - Center blade  
Mittelblatt - Valve centrale - Valva central

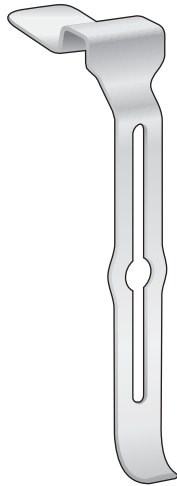

0221-DFE

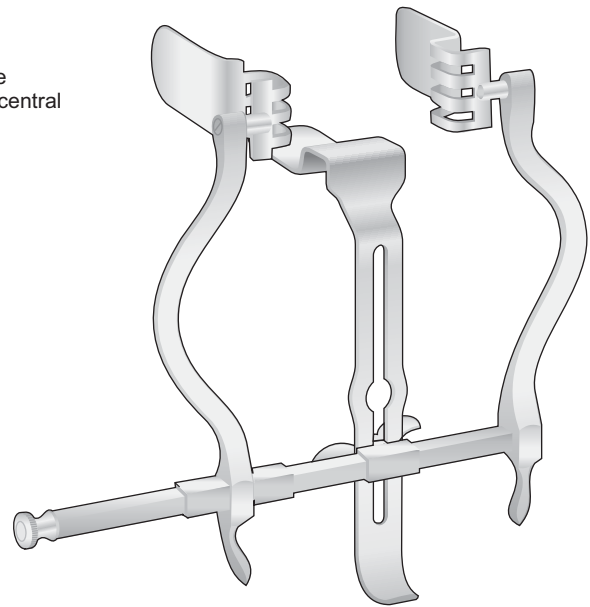

JUDD-MASSON  
0221-DFE

Speculum rettale  
Rectal Specula  
Mastdarm Rektum Spekula  
Spéculum rectaux  
Espéculos rectales

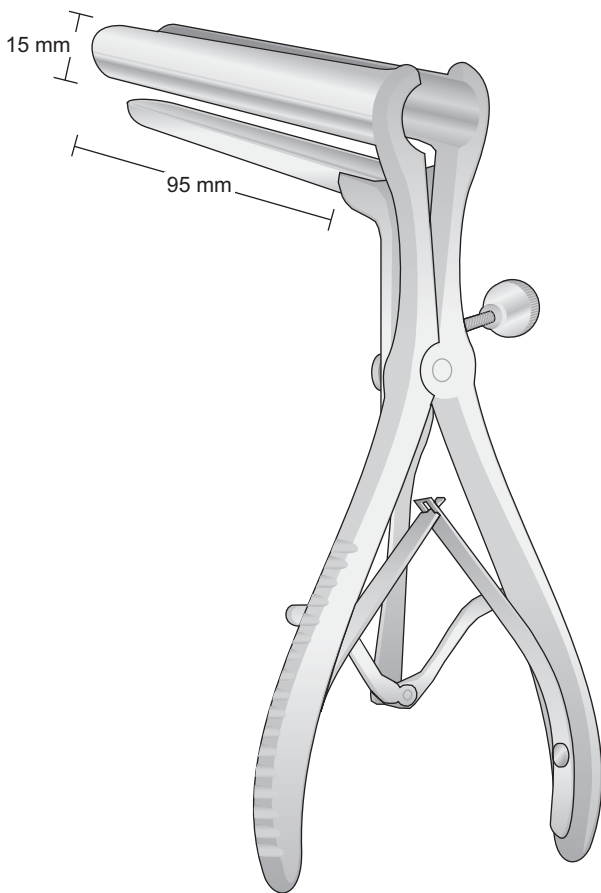

MATHIEU  
0501-EA  
215 mm

0221-DGA  
Valva laterale  
Lateral blade  
Seitliche Blätter  
Valves latérales  
Valva laterales  
80 x 25 mm

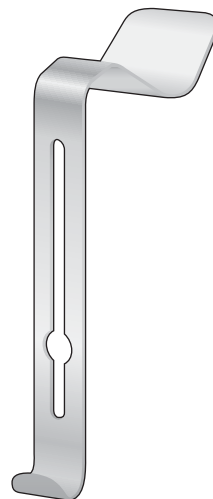

0221-DFL

Valva centrale - Center blade - Mittelblatt  
Valve centrale - Valva central

0221-DFI  
Divaricatore solo - Retractor only  
Sperrer allein - Ecarteur seul  
Separador suelto

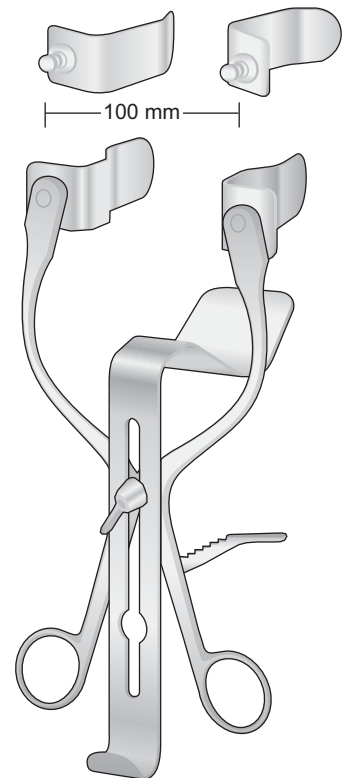

MILLIN  
0221-DFH

Completo - Complete - Komplett  
Complet - Completo

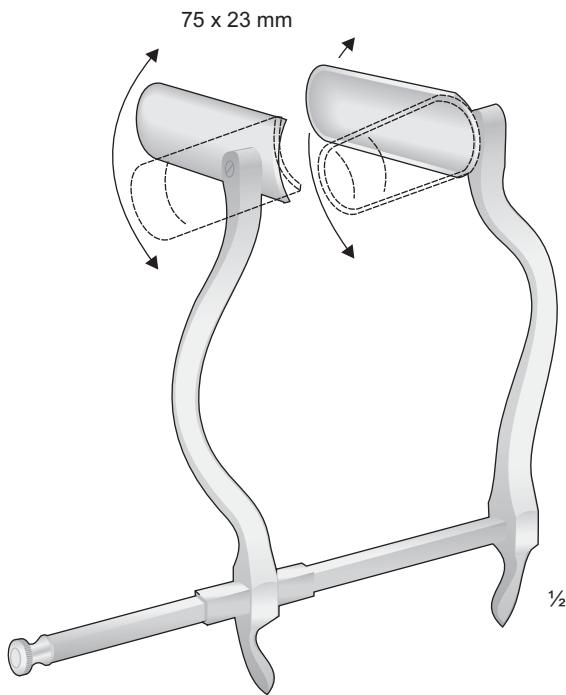

SMITH-BUIE  
0221-CEB  
150 mm

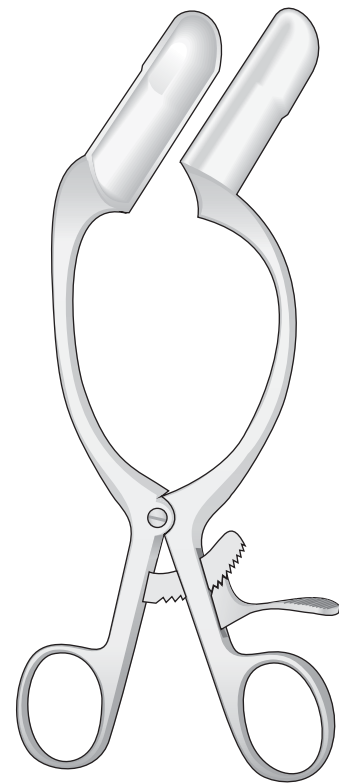

BARR  
0221-CEC  
170 mm

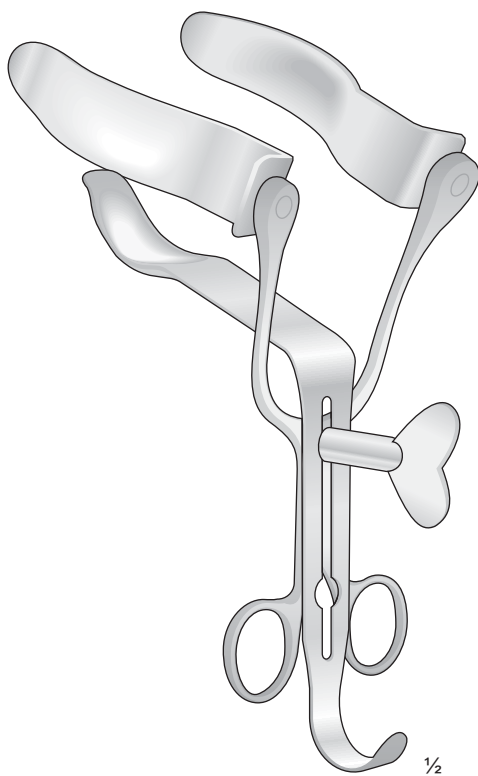

ALAN PARKS  
0221-CEF  
135 mm

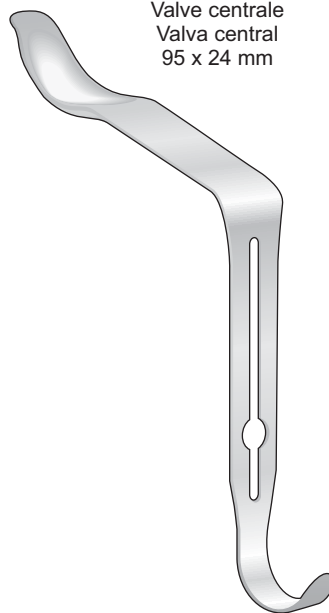

Valva centrale  
Center blade  
Mittelblatt  
Valve centrale  
Valva central  
95 x 24 mm

0221-CEI

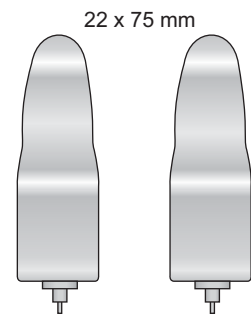

0221-CEG

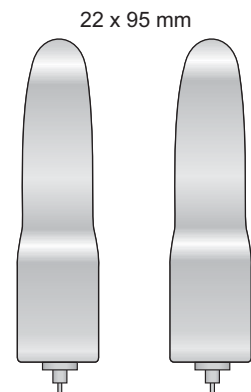

0221-CEH

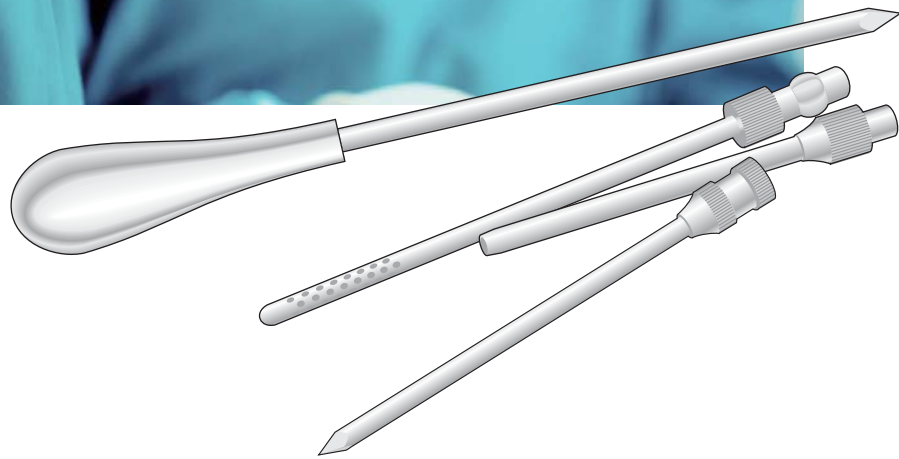

10

Trequarti  
Trocars  
Trokare  
Trocartis  
Trócares



Trequarti

Trocars

Trokare

Trocarts

Trócares

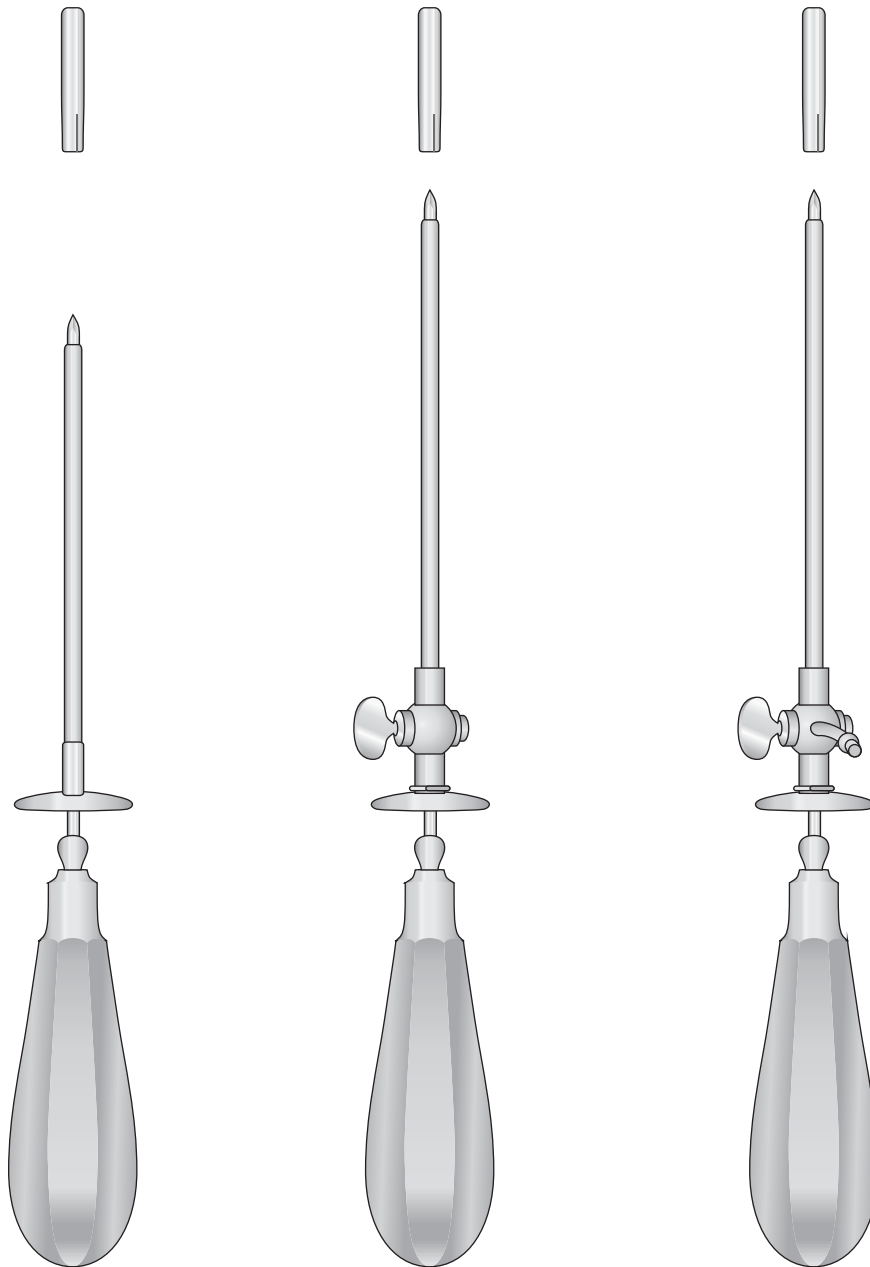

Ø mm Esterno  
 Outside Außen  
 Extérieur Exterior  
 Ø mm Interno  
 Inside Innen  
 Intérieur Interior

		STANDARD	STANDARD	STANDARD
3,0	2,0	<b>1917-EA</b>	<b>1917-CA</b>	<b>1917-FB</b>
3,5	2,5	<b>1917-EE</b>	<b>1917-CB</b>	<b>1917-FC</b>
4,0	3,0	<b>1917-EB</b>	<b>1917-CC</b>	<b>1917-FD</b>
4,5	3,5	<b>1917-EF</b>	<b>1917-CD</b>	<b>1917-FE</b>
5,0	4,0	<b>1917-EC</b>	<b>1917-CE</b>	<b>1917-FF</b>
5,5	4,5	<b>1917-EG</b>	<b>1917-CF</b>	<b>1917-FG</b>
6,0	5,0	<b>1917-ED</b>	<b>1917-CG</b>	<b>1917-FH</b>
		110 mm	120 mm	120 mm

Trequarti

Trocars

Trokare

Trocarts

Tròcares

Per vescica biliare - For gall bladder - Für die gallenblase  
 Pour la vésicule biliaire - Para vesícula biliar

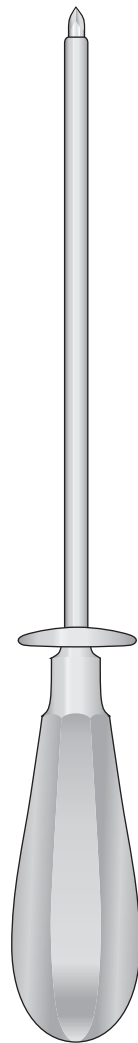
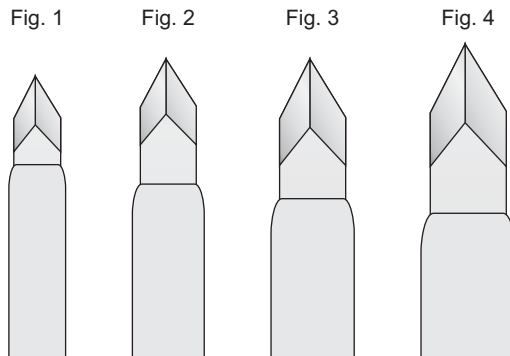

Ø mm Esterno Outside Außen Extérieur Exterior	Ø mm Interno Inside Innen Intérieur Interior		NELSON
7,5	6,0	Fig. 1	<b>1917-GB</b>
9,5	8,0	Fig. 2	<b>1917-GC</b>
11,0	9,5	Fig. 3	<b>1917-GD</b>
12,5	11,0	Fig. 4	<b>1917-GE</b>
210 mm			

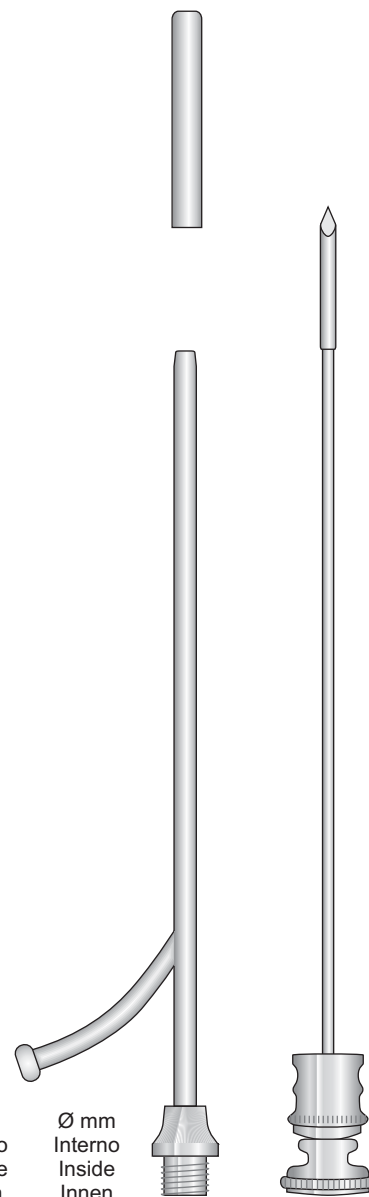

Ø mm Esterno Outside Außen Extérieur Exterior	Ø mm Interno Inside Innen Intérieur Interior	OCHSNER
4,0	3,0	<b>0706-BCA</b>
4,6	3,6	<b>0706-BCB</b>
5,3	4,3	<b>0706-BCC</b>
6,0	5,0	<b>0706-BCD</b>
210 mm		



Trequarti per seno mascellare  
 Antrum puncture trocars  
 Kieferhöhlentrokare  
 Trocarts pour sinus maxillaire  
 Trócares para punción del seno maxilar

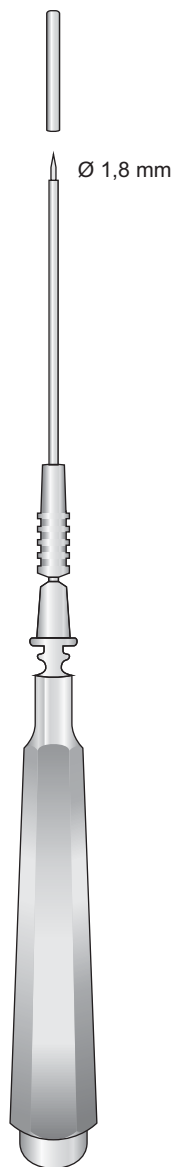

LICHTWITZ  
 1917-DA  
 190 mm

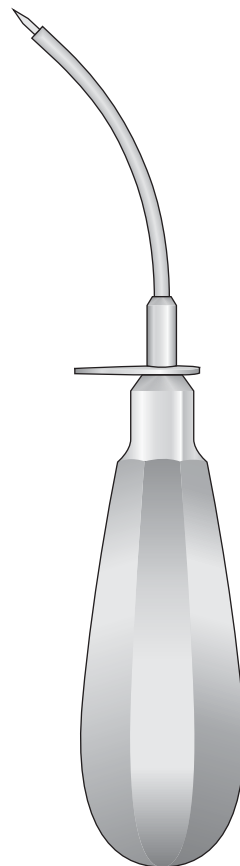
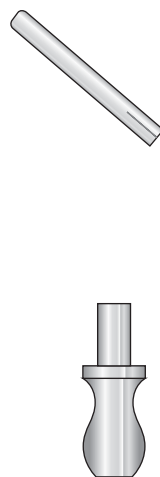

PIERCE  
 1917-DC Ø 3 mm  
 1917-DD Ø 4 mm  
 1917-DE Ø 5 mm  
 160 mm

Ø 5,5 mm

Set completo Krause  
 Krause set complete  
 Krause Kompletset  
 Set complet Krause  
 Set completo Krause

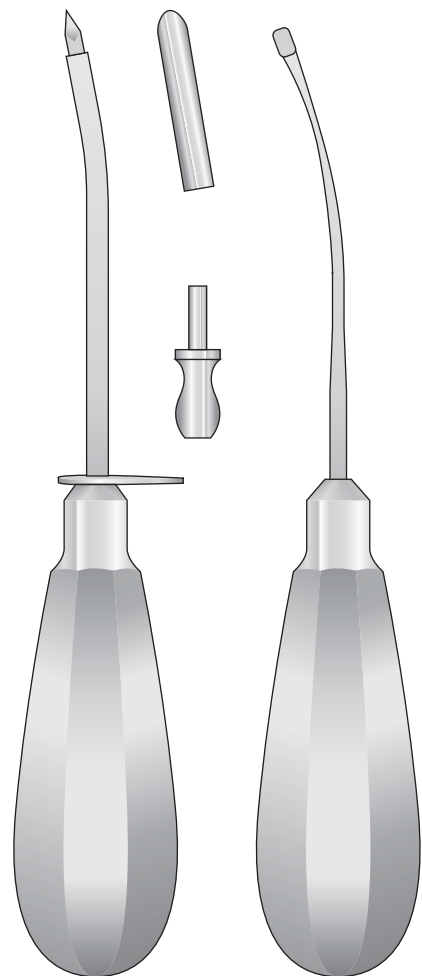

KRAUSE  
 1917-DF  
 160 mm

Trequarti

Trocars

Trokare

Trocarts

Tròcares

Universale completo con 3 punte  
Set of 3 pieces  
Satz zu 3 Stück  
Jeu de 3 pièces  
Juego de 3 piezas

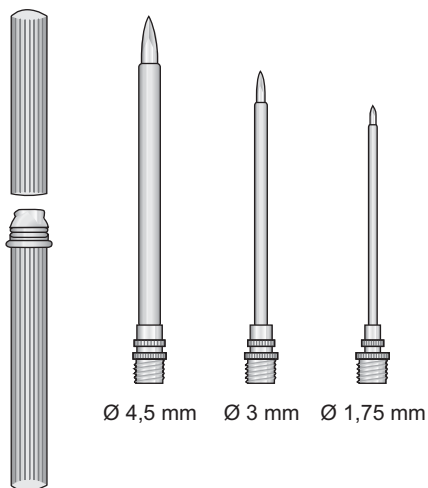

UNIVERSAL  
1917-EH

Universale completo con 4 punte  
Set of 4 pieces  
Satz zu 4 Stück  
Jeu de 4 pièces  
Juego de 4 piezas

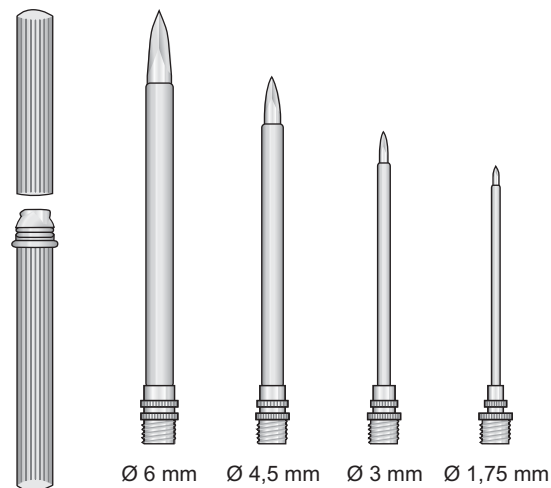

UNIVERSAL  
1917-EI

Universale completo con 3 punte  
Set of 3 pieces  
Satz zu 3 Stück  
Jeu de 3 pièces  
Juego de 3 piezas

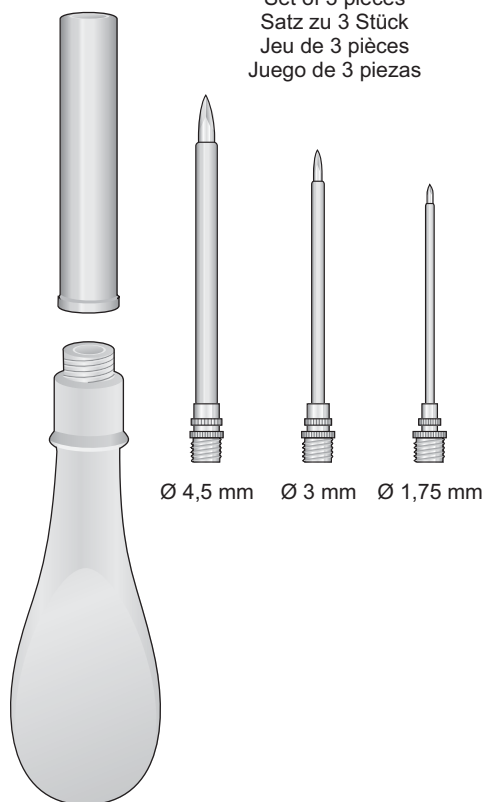

1917-EL  
130 mm

Universale completo con 4 punte  
Set of 4 pieces  
Satz zu 4 Stück  
Jeu de 4 pièces  
Juego de 4 piezas

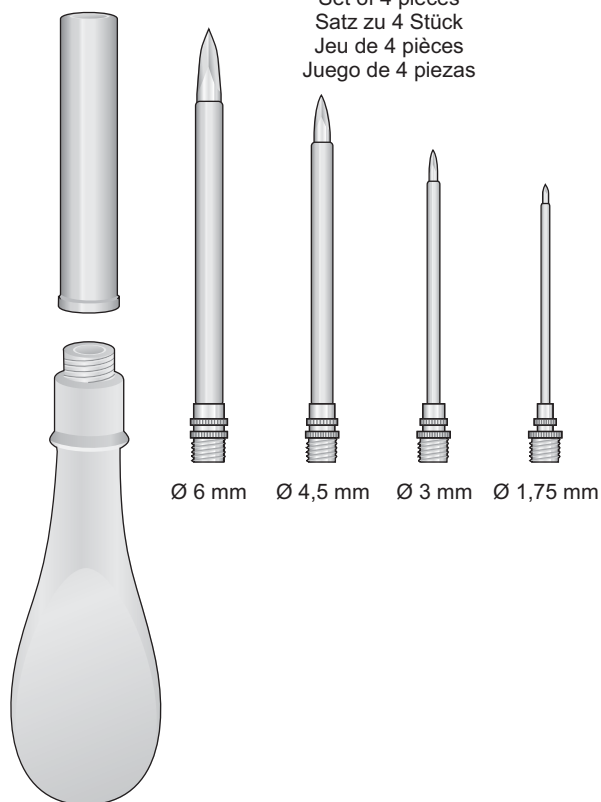

1917-FA  
130 mm

Trequarti

Trocars

Trokare

Trocarts

Tròcares

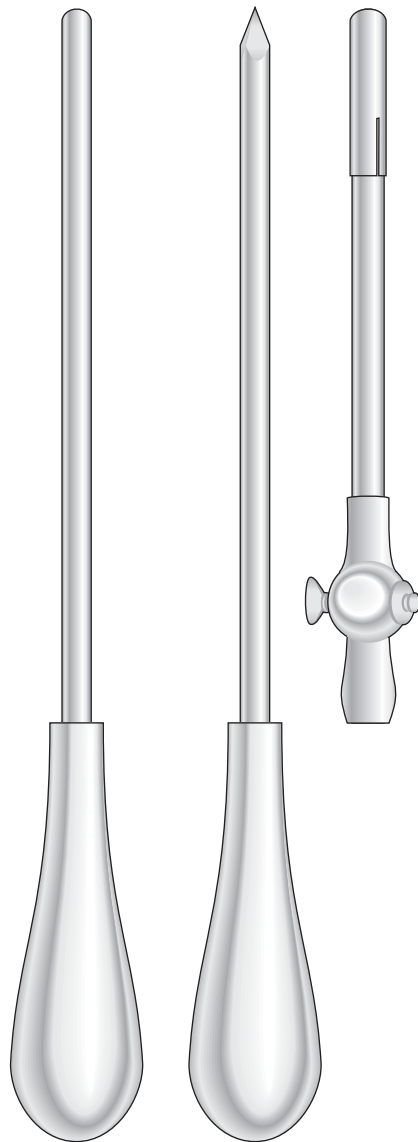

Ø mm	Ø mm
Esterno	Interno
Outside	Inside
Außen	Innen
Extérieur	Intérieur
Exterior	Interior

		BUELAU
8	6,5	<b>1917-GI</b>
10	8,5	<b>1917-GL</b>

240 mm

Ago per la puntura dello sterno  
 Sternal puncture needle  
 Sternal-Punktionskanülen  
 Aiguilles pour la ponction sternale  
 Agujas para punción esternal

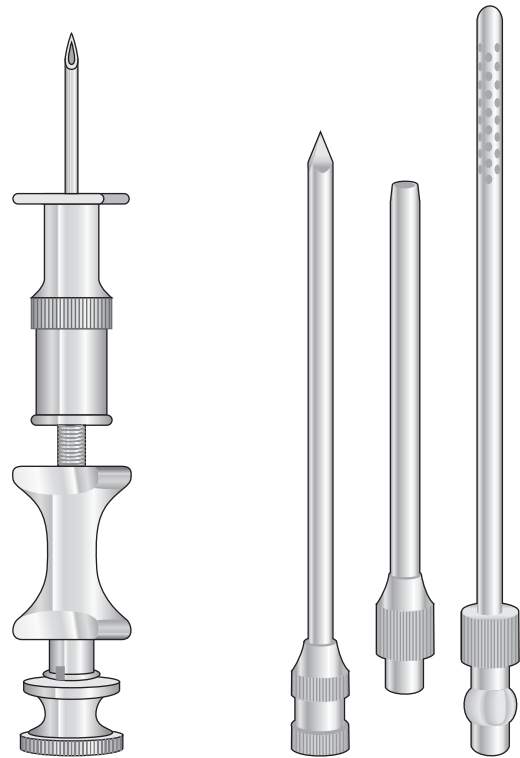

KLIMA-ROSEGGER  
**1411-EA**  
 1,80 x 35 mm

DUKE  
**0706-BAG**  
 110 mm - 5,5 mm

Aghi da biopsia

Biopsy needles

Nadel für Biopsie

Aiguilles pour Biopsie

Agujas para Biopsia

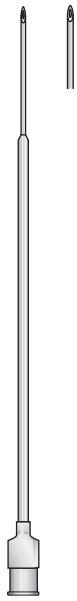

**1411-AB**  
120 mm

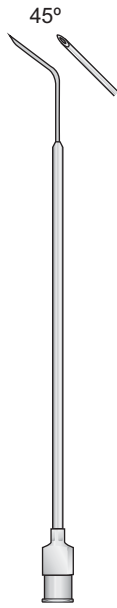

**1411-AC**  
110 mm

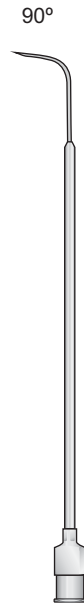

**1411-AD**  
110 mm

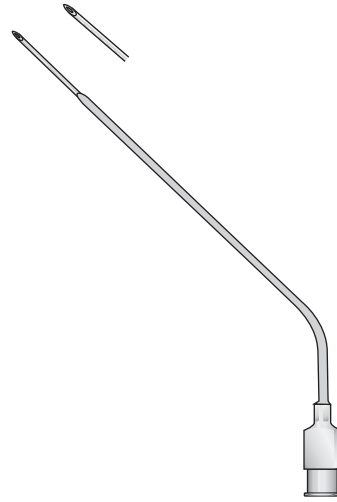

**1411-AE**  
110 mm

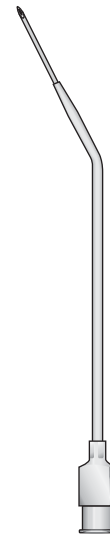

**1411-AF**  
110 mm

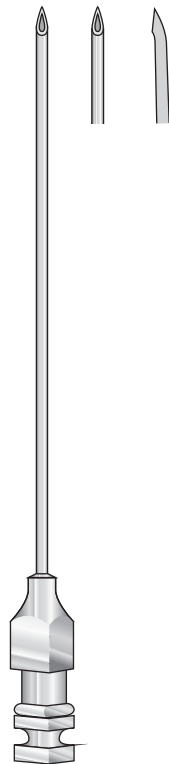

**TUOHY**  
**1411-EB** - 1,30 x 80 mm  
**1411-EC** - 1,50 x 80 mm  
**1411-ED** - 1,65 x 80 mm



**QUINKE**  
**1411-EE** - 0,70 x 80 mm  
**1411-EF** - 0,70 x 90 mm  
**1411-EG** - 1,00 x 80 mm  
**1411-EH** - 1,00 x 90 mm  
**1411-EI** - 1,20 x 90 mm  
**1411-EL** - 1,20 x 100 mm



ideal-tek

manufacturer & supplier of precision instruments 

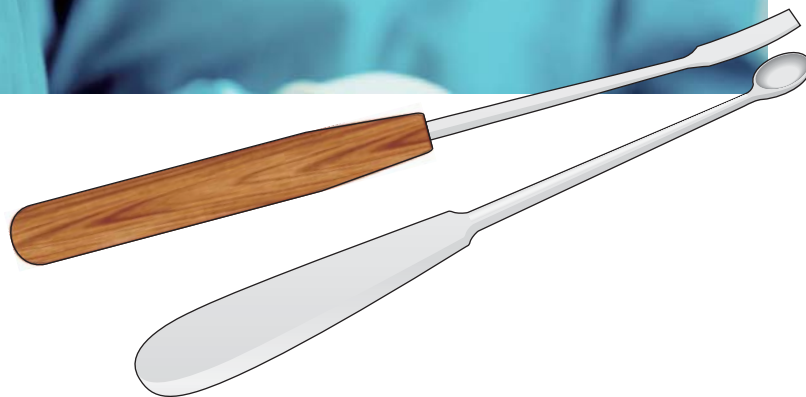

11

Elevatori, Raspatori, Cucchiali  
Periosteal Elevators, Curettes  
Raspatorien, Löffel  
Rugines, Raspatoires, Curettes  
Periostòtomos, Cucharillas



Elevatori

Elevators

Elevatoren

Elevateurs

Elevadores

6 mm



8 mm

**0414-CEC**  
135 mm

8 mm



10 mm

**0414-CED**  
135 mm

4,5 mm

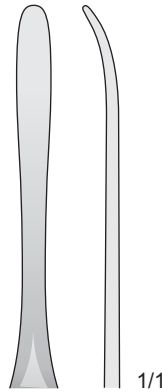

1/1

**KÖNIG**  
**1014-B**  
155 mm

4,5 mm

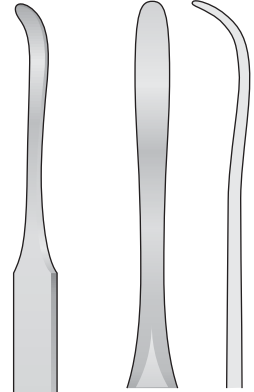

1/1

**KÖNIG**  
**1014-C**  
155 mm

5 mm

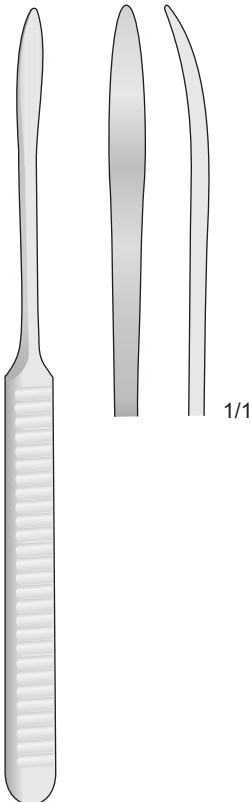

1/1

**WILLIGER**  
**2207-BA**  
165 mm

6 mm

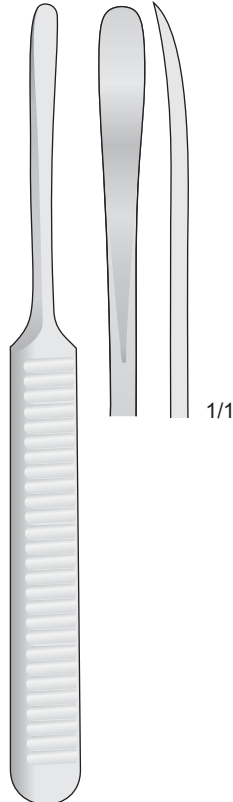

1/1

**WILLIGER**  
**2207-BC**  
160 mm

4 mm

Periostotomi  
Periosteal Raspatories  
Raspatorien  
Rugines à périostomie  
Legras periostotomos

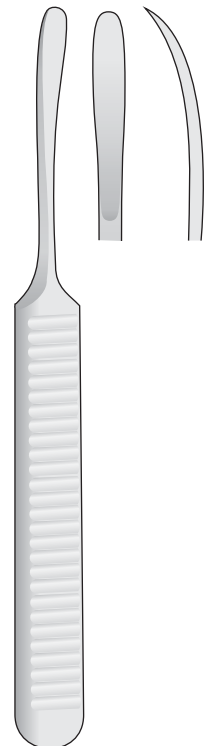

1/1

**WILLIGER**  
**2207-BE**  
140 mm

Dissettori  
Separatori

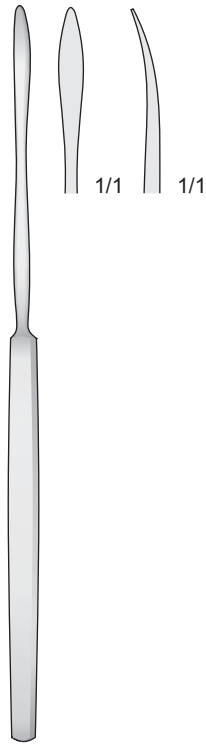

**1014-BI**  
175 mm

Dissectors  
Seperators

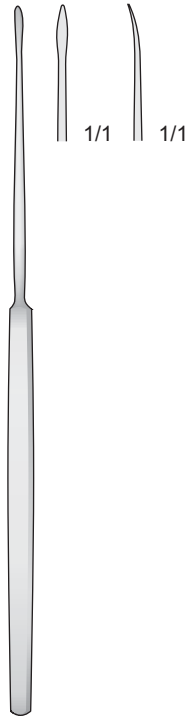

**1014-BL**  
160 mm

Dissektoren  
Separatoren

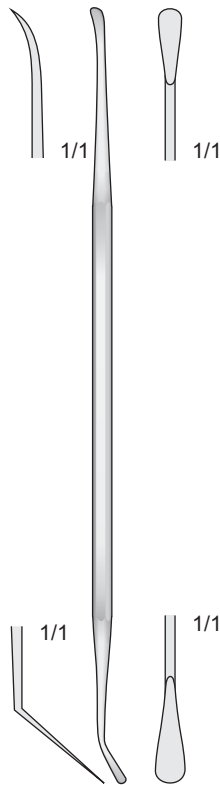

**MILLIGAN**  
**1014-CH**  
210 mm

Dissecteurs  
Separateurs

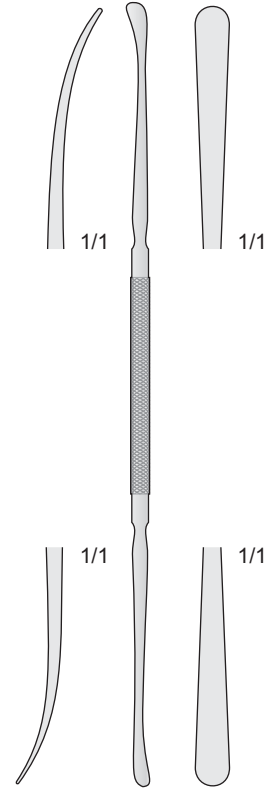

**DAVIS**  
**1014-CB**  
245 mm

Disectores  
Descoladores

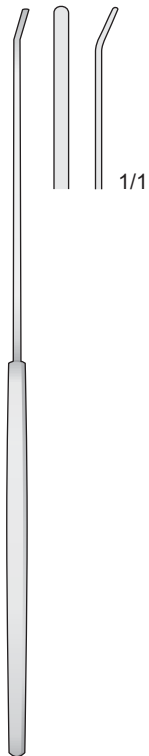

**FAGER**  
**1014-CE**  
200 mm

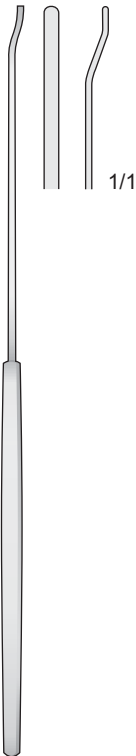

**FAGER**  
**1014-CF**  
200 mm

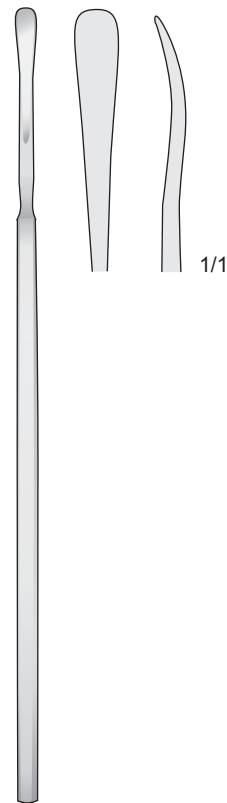

**SACHS**  
**1014-CG**  
210 mm

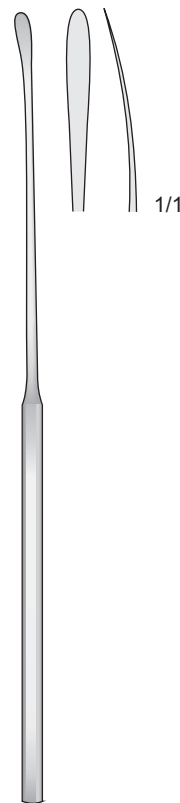

**SACHS**  
**1014-CI**  
210 mm

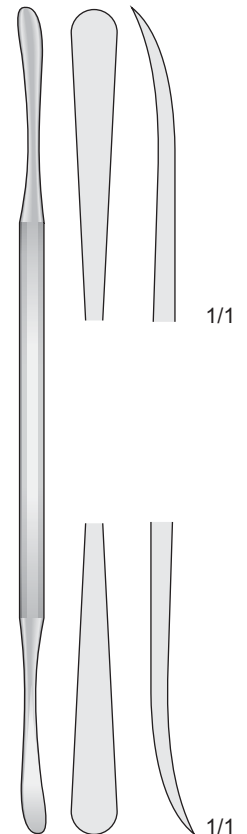

**1014-CL**  
220 mm



Dissettori  
Separatori

Dissectors  
Seperators

Dissektoren  
Separatoren

Dissecteurs  
Separateurs

Disecadores  
Descoladores

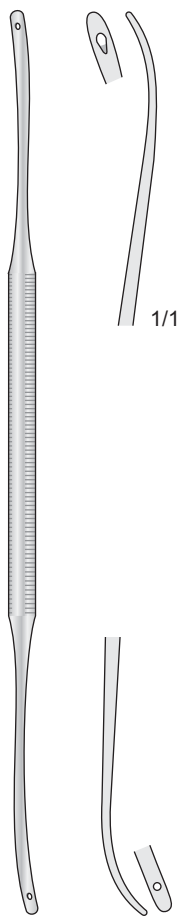

1014-BE - 180 mm  
1014-BF - 240 mm

Fine  
Fein  
Fin  
Fino  
Fin

1/1

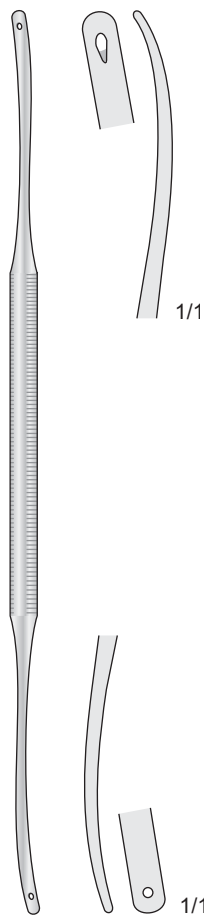

1014-BG - 180 mm  
1014-BH - 240 mm

1/1

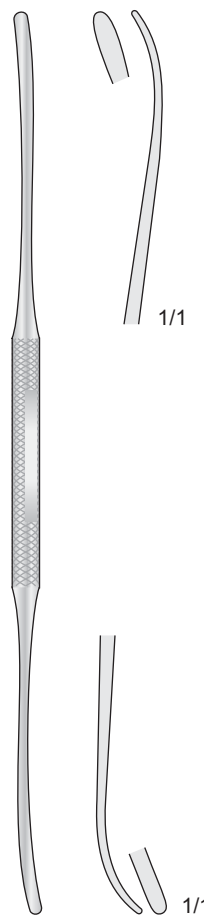

OLIVECRONA  
1014-EH - 180mm  
1014-EI - 240mm

1/1

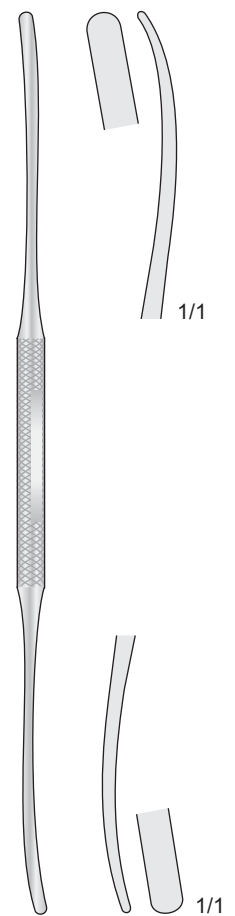

OLIVECRONA  
1014-EL - 195mm  
1014-FA - 240mm

1/1

Elevatori

Elevators

Elevatorien

Elevateurs

Elevadores

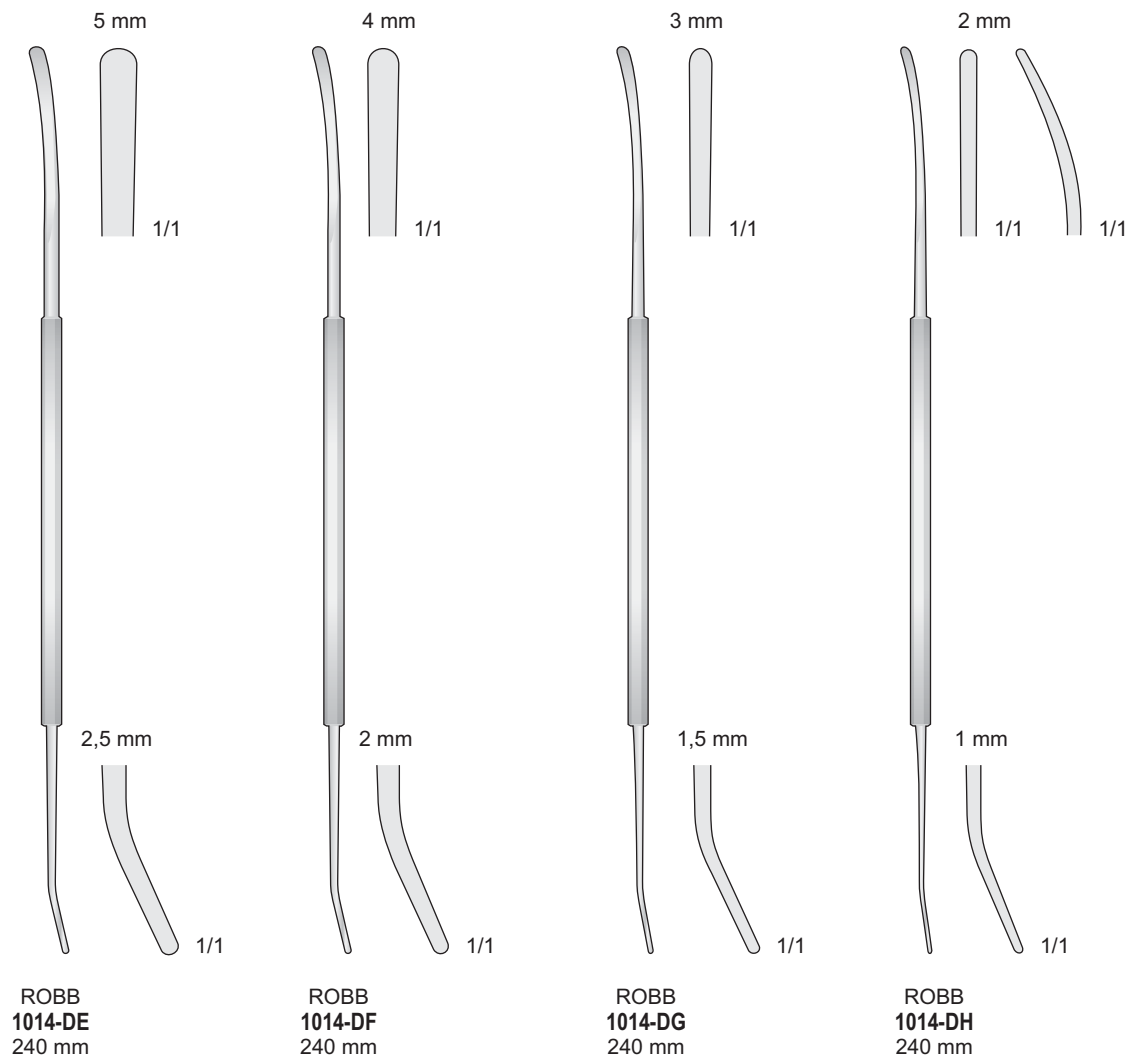

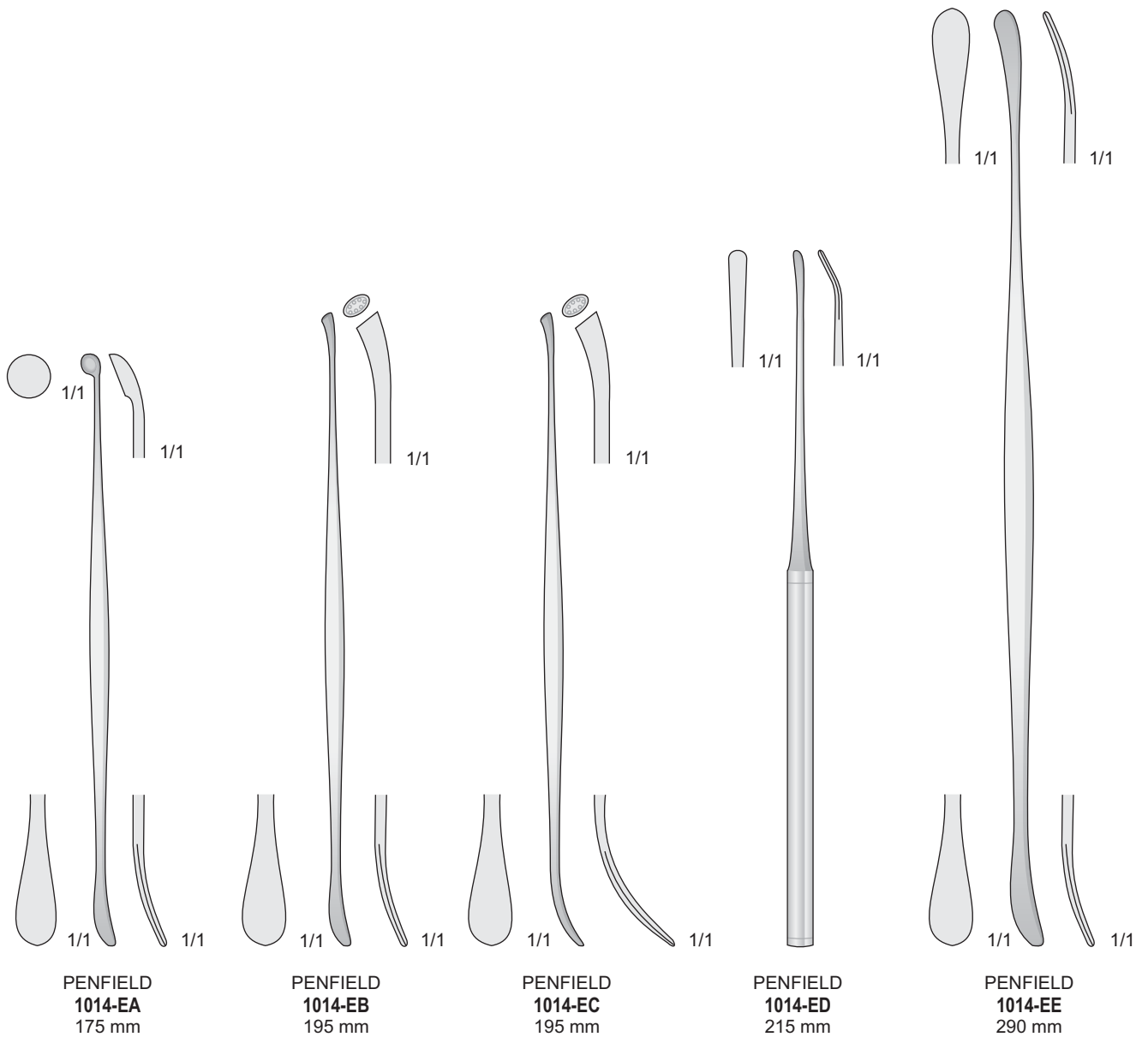

Divaricatori

Retractors

Wundhaken

Ecarteurs

Separadores

Nerve and Tissue protectors

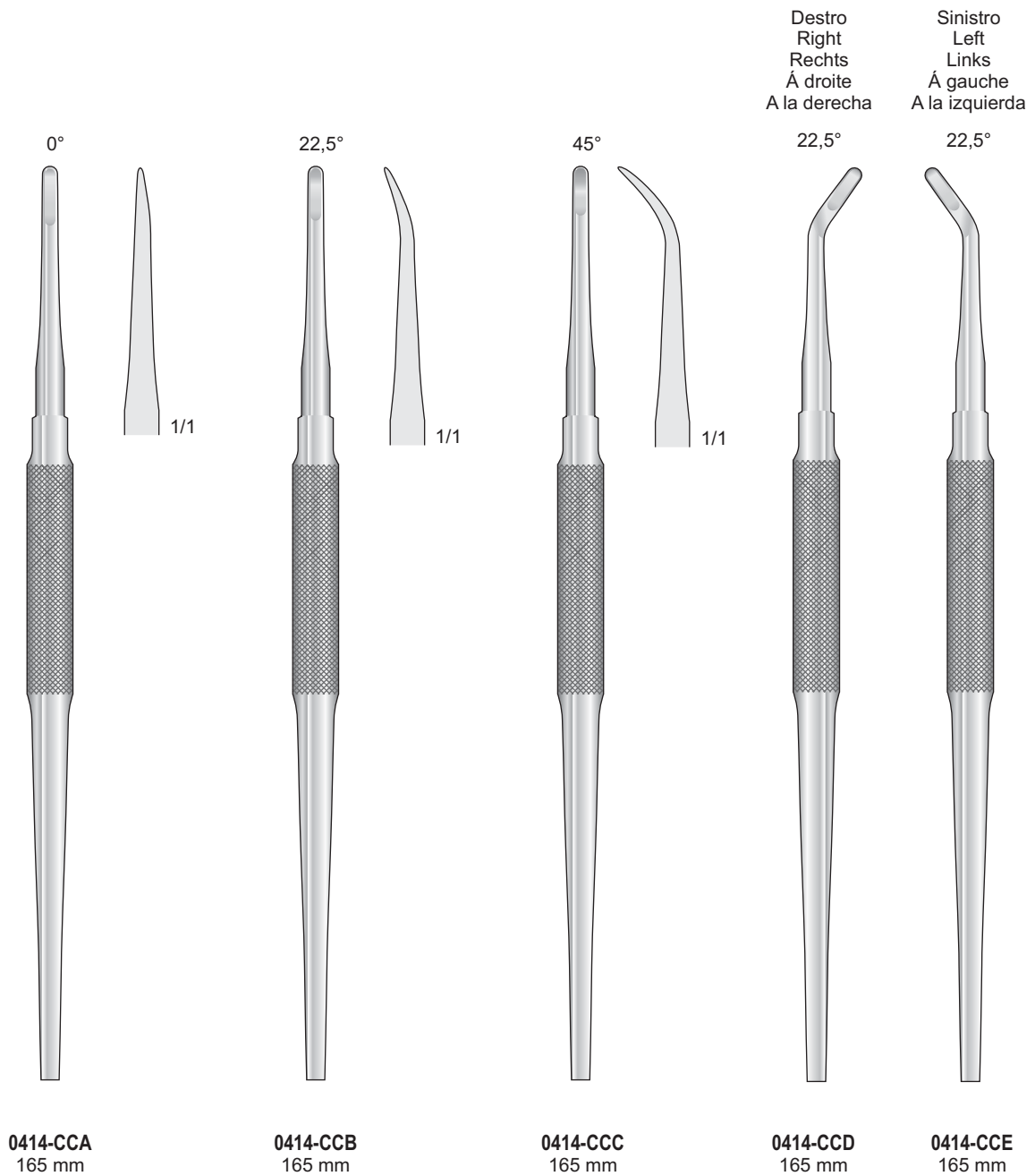

Periostotomi

Raspatories

Raspatorien

Rugines

Legras

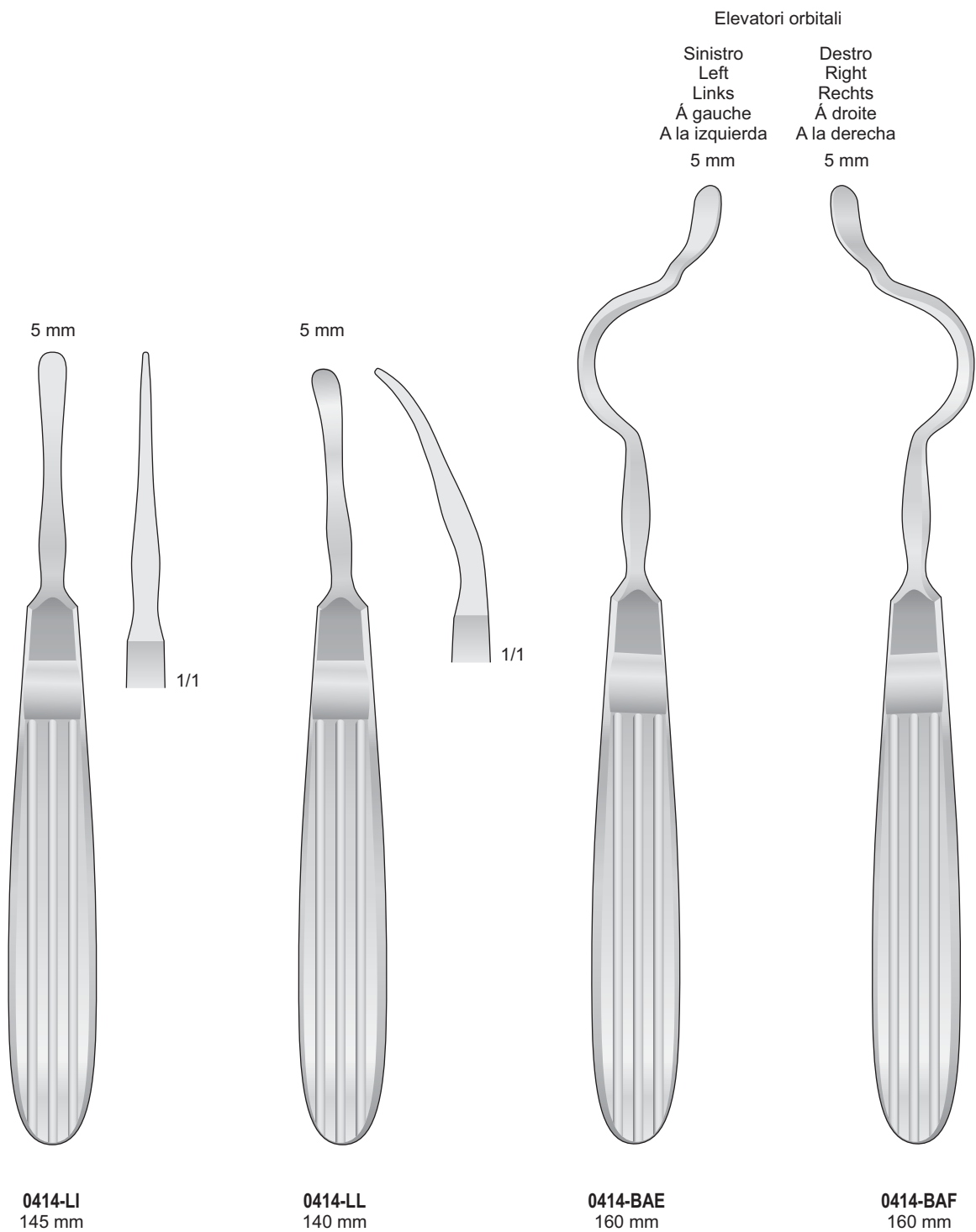

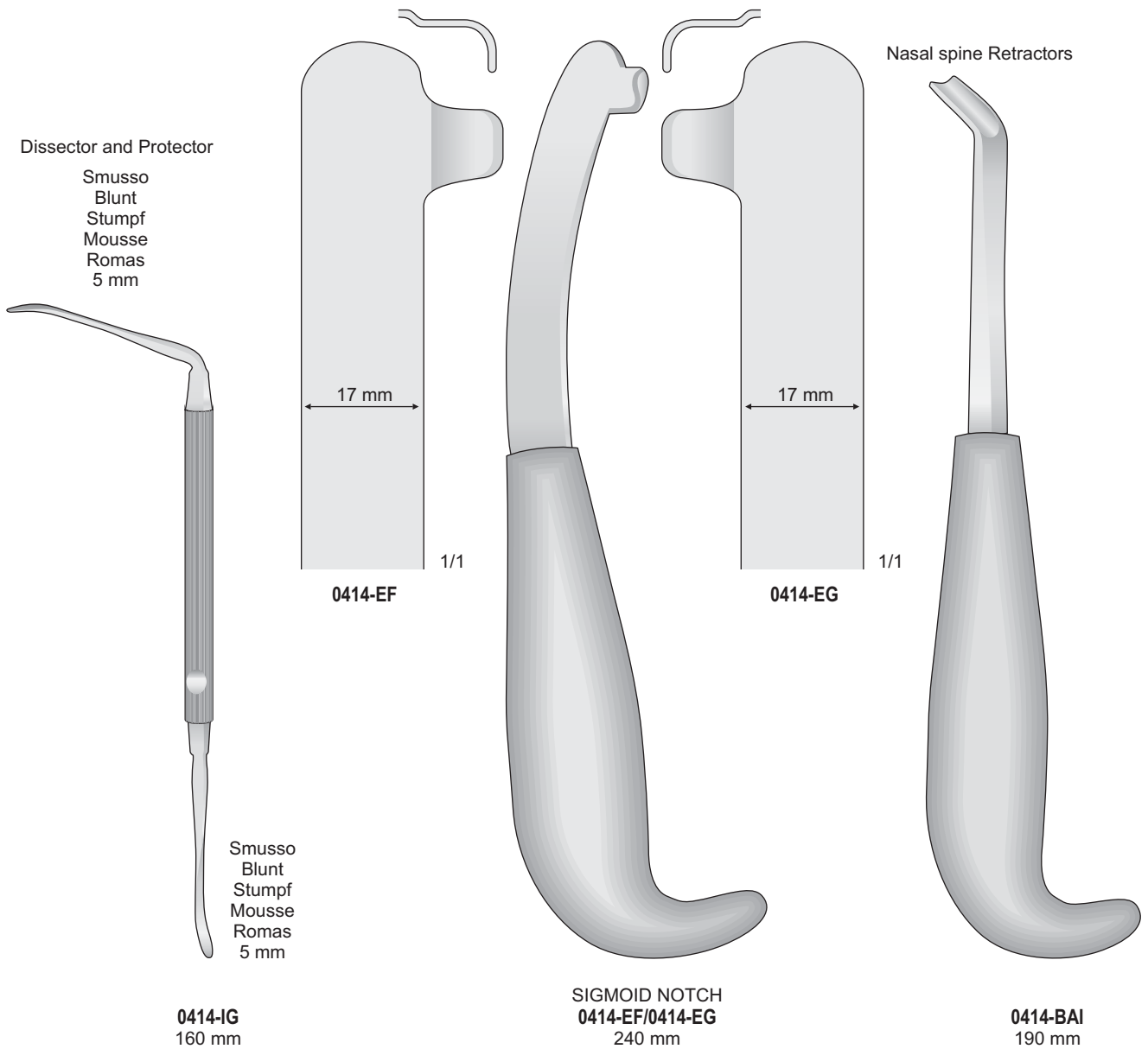

Elevatori

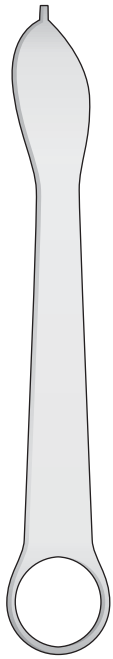

**0610-EF**  
120 mm

Elevators

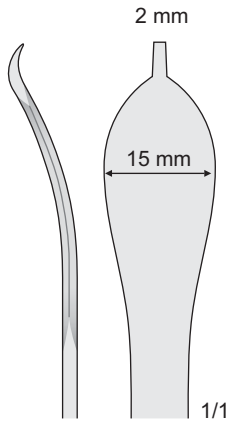

**0610-EG**  
140 mm

Elevatoren

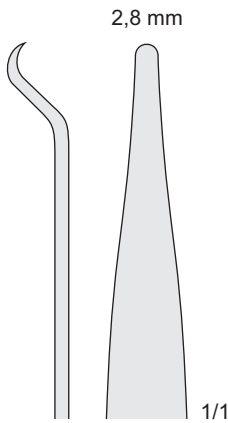

MINI-HOHMANN  
**0610-EI**  
160 mm

Elevateurs

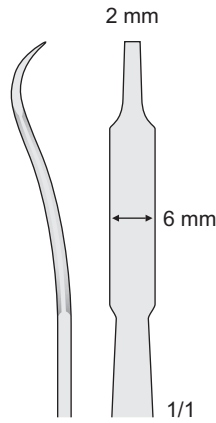

MINI-HOHMANN  
**0610-EL**  
160 mm

Elevadores

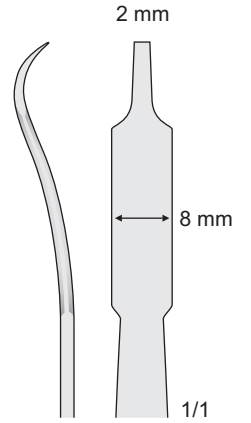

BLOUNT  
**0610-CH**  
175 mm

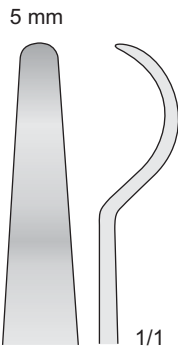

**0610-DA**  
150 mm

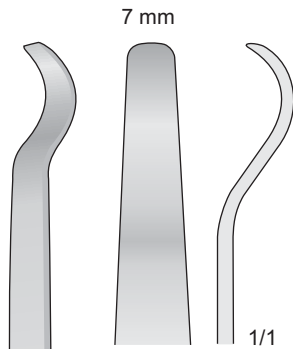

**0610-CI**  
150 mm

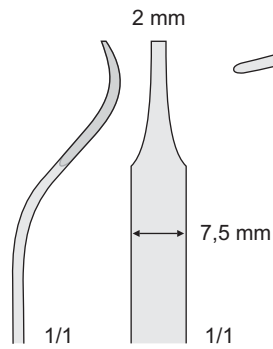

BUCK-GRAMCKO  
**0610-CA**  
150 mm

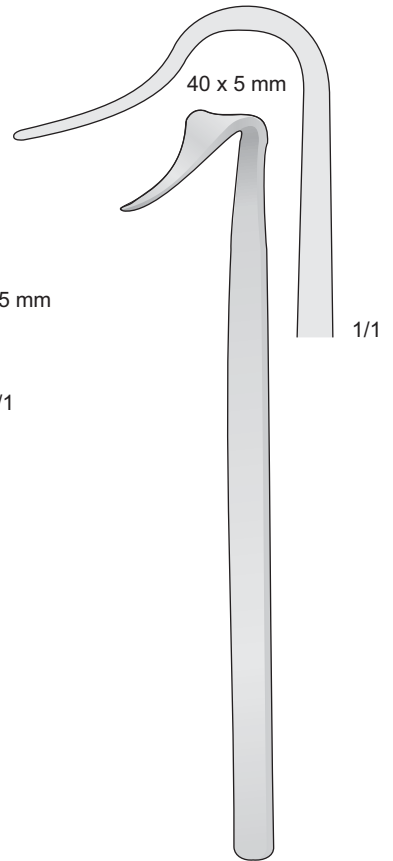

Elevatori

Elevators

Elevatorien

Elevateurs

Elevadores

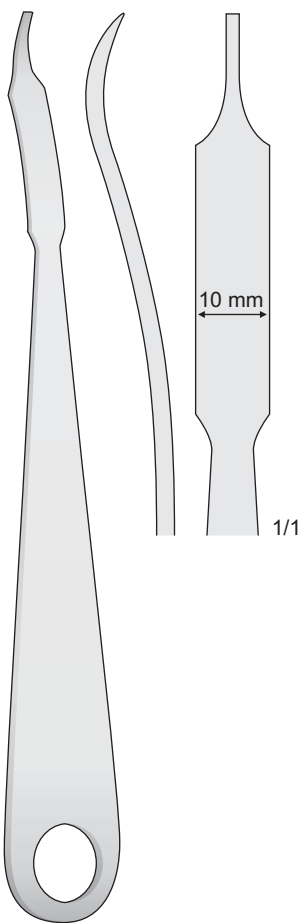

0610-FB  
220 mm

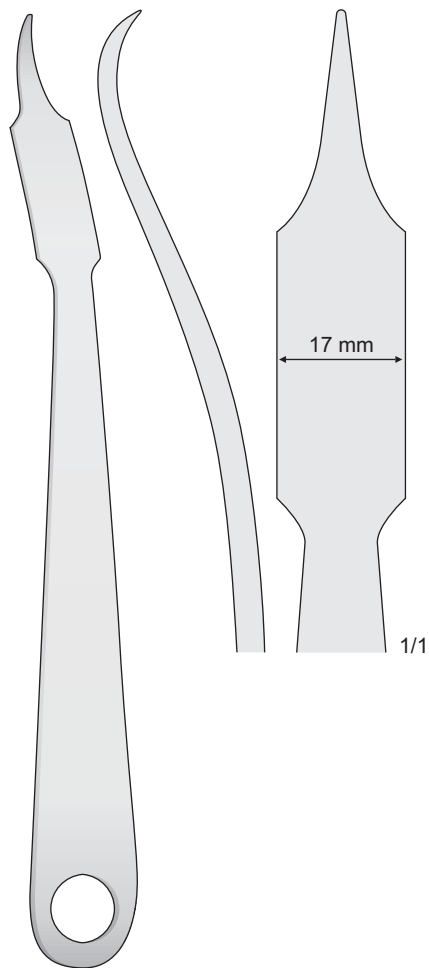

0610-FC  
240 mm

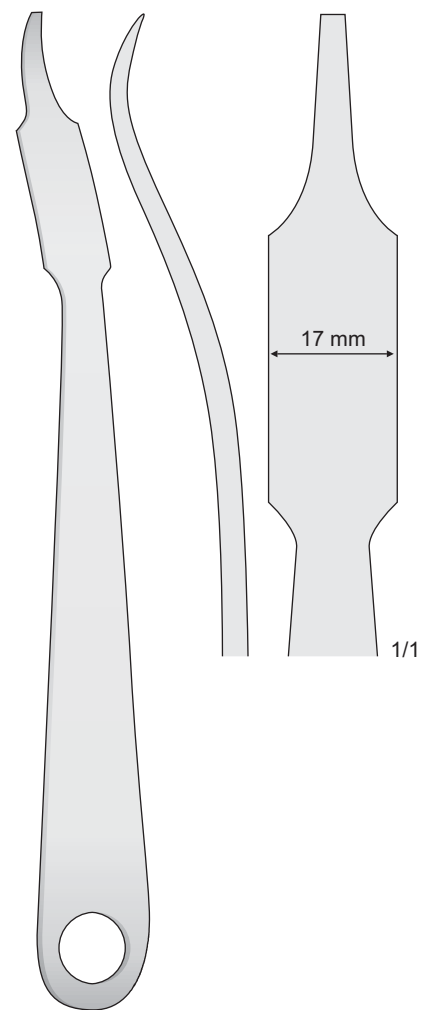

0610-FD  
240 mm



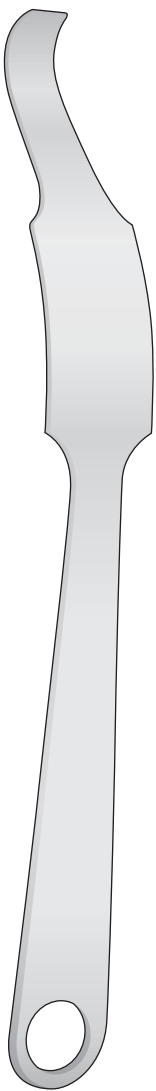

HOHMANN  
0610-FE/0610-FF

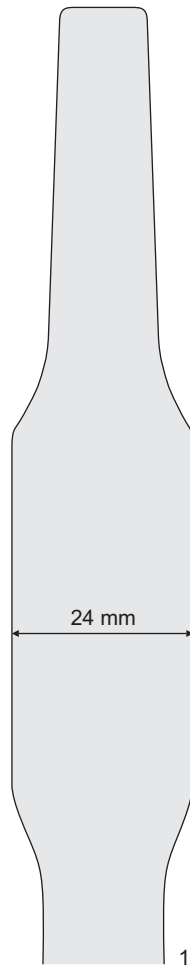

0610-FE  
260 mm

1/1

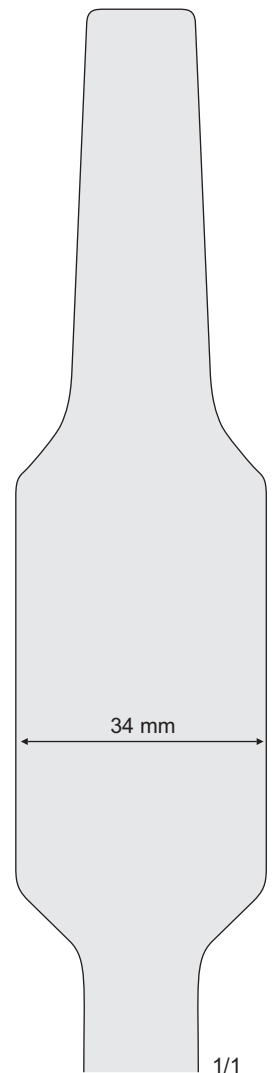

0610-FF  
285 mm

1/1

Elevatori

Elevators

Elevatorien

Elevateurs

Elevadores

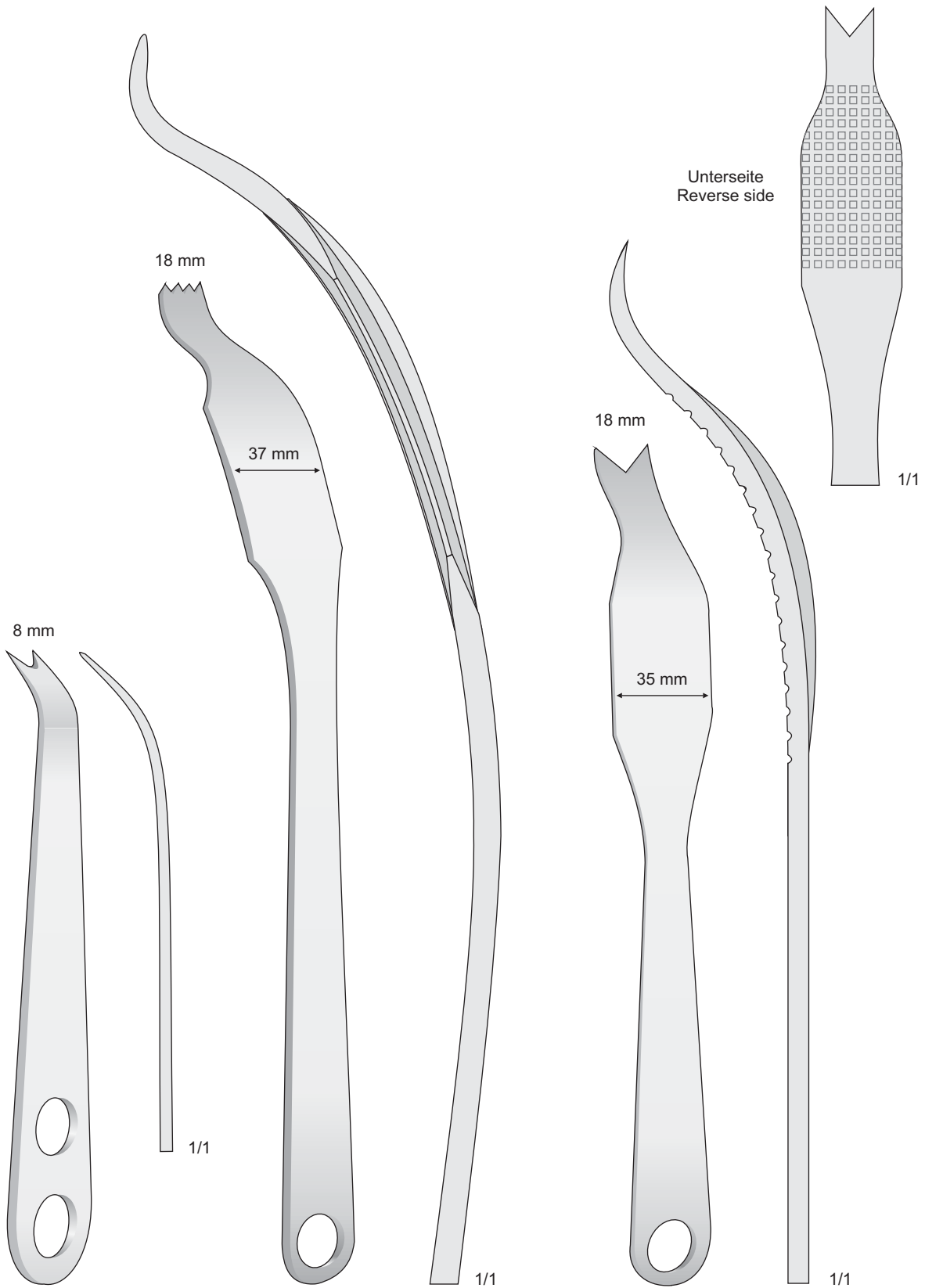

**0610-IB**  
140 mm

SCHUMACHER mod. WAGNER  
**0610-FI**  
345 mm

SCHUMACHER  
**0610-FL**  
285 mm

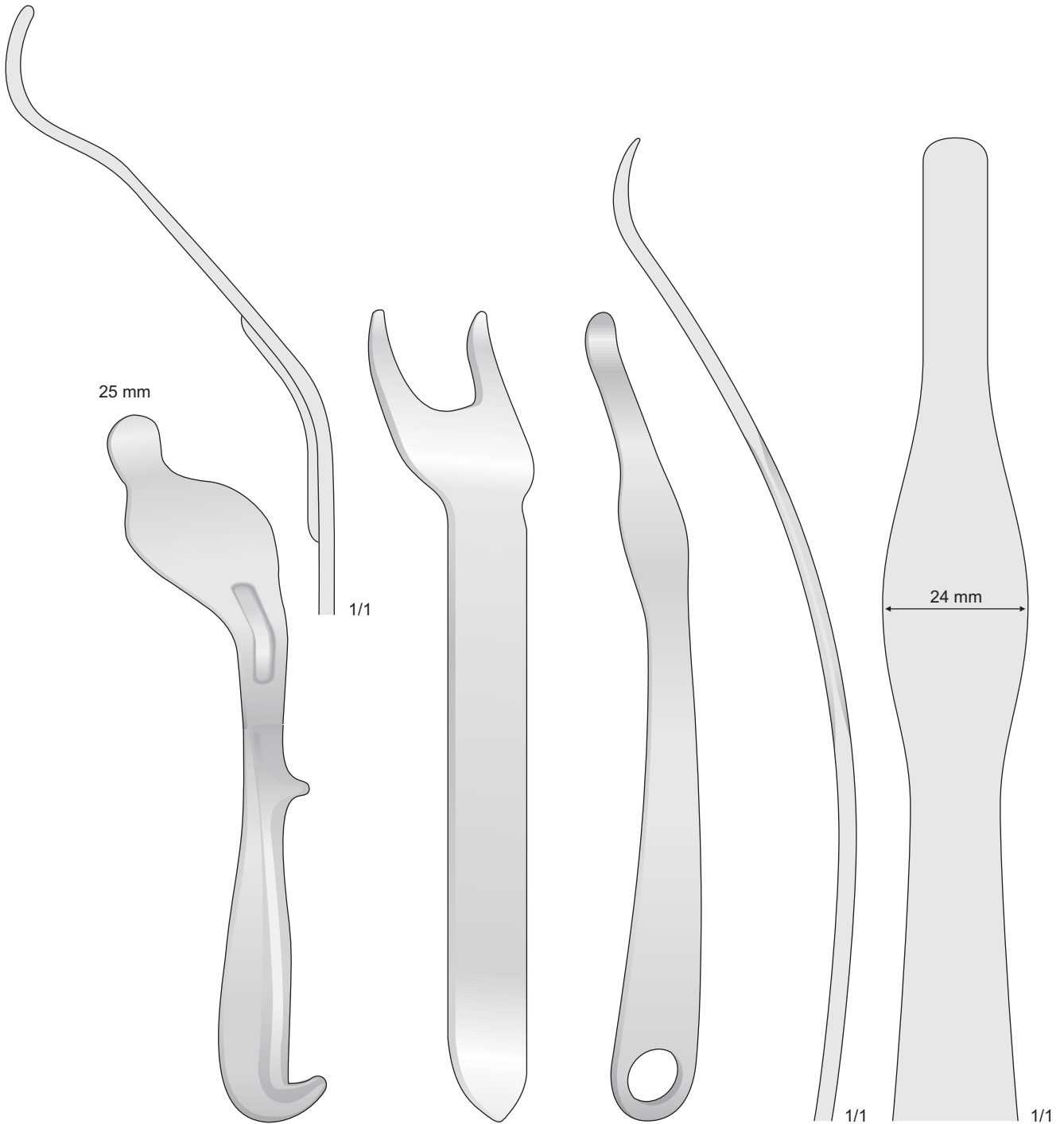

25 mm

1/1

24 mm

1/1

1/1

**BENNETT**  
**0610-BHG** 43 mm  
**0610-BHL** 60 mm  
 240 mm

**BLOUNT**  
**0610-LD**  
 260 mm

**0610-FG**  
 260 mm

Elevatori

Elevators

Elevatorien

Elevateurs

Elevadores

Divaricatore spinale  
Spinal Retractors  
Spinalhaken  
Ecarteurs spinaux  
Separadores espinales

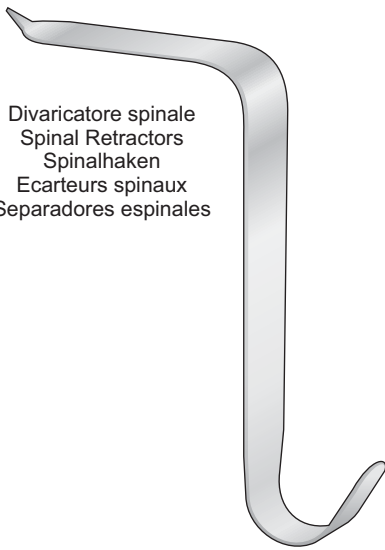

TAYLOR  
0610-BGI 75 x 30 mm  
0610-BGL 100 x 30 mm  
165 mm

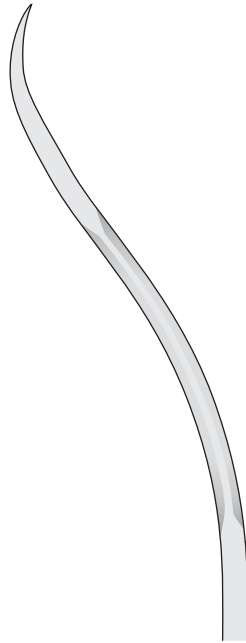

1/1

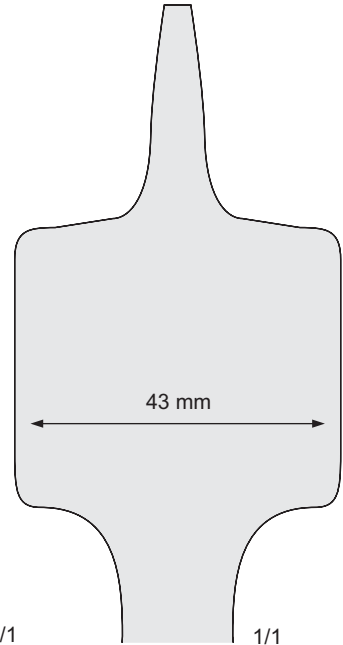

1/1

0610-FH  
240 mm

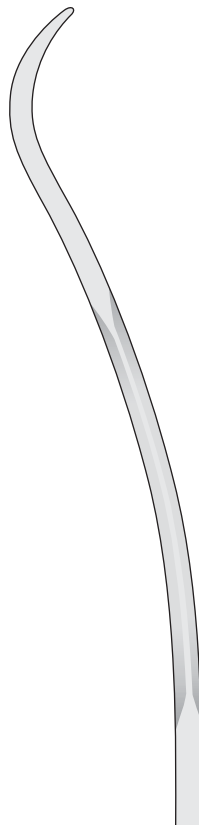
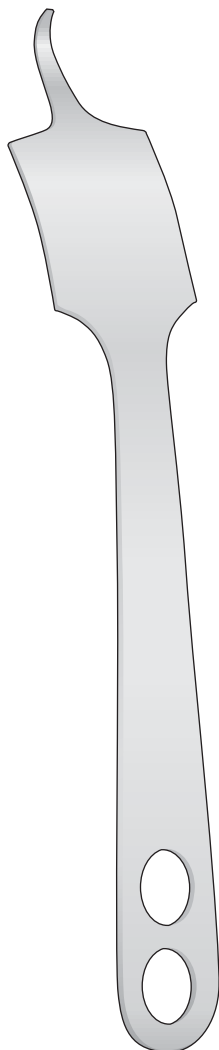
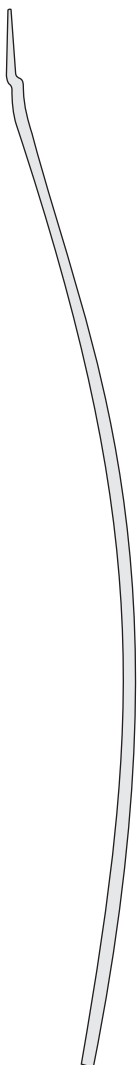

1/1

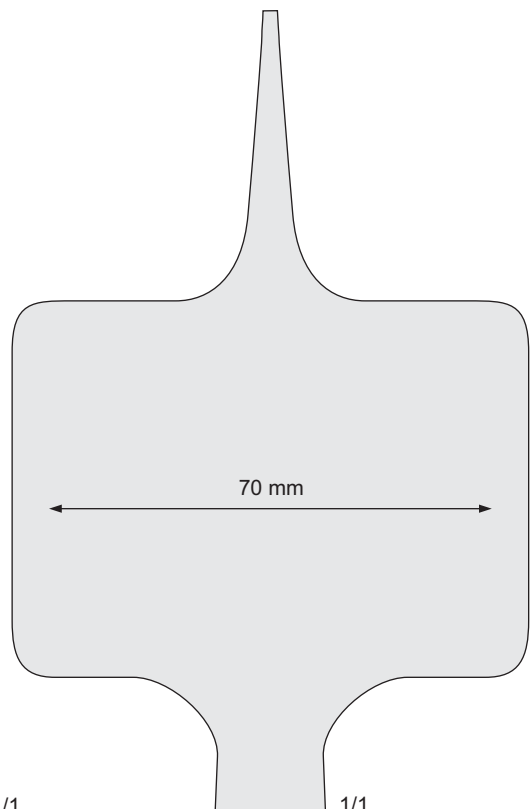

1/1

0610-BGE  
250 mm

HOHMANN  
0610-EH/0610-FH  
240 mm

0610-EH  
240 mm

Periostotomi



22051819  
185 mm

Periosteal Raspatories

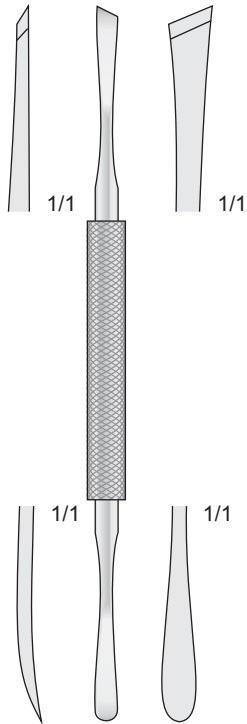

12050104  
165 mm

Raspatorien



ALDERDYCE  
1014-DL  
210 mm

Rugines à periostomie

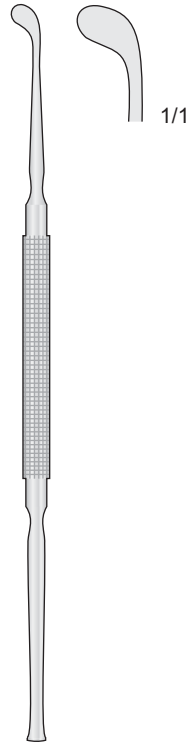

FREER  
0617-BF  
190 mm

Legras periostotomos

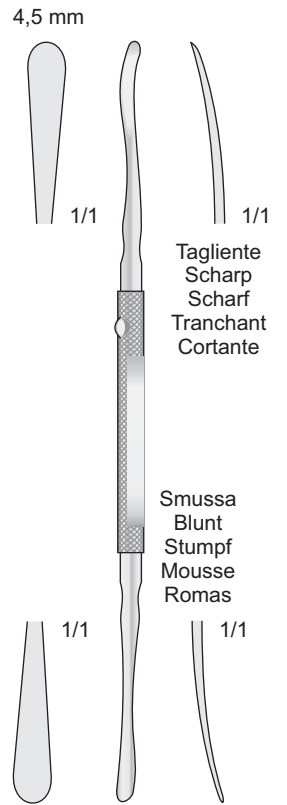

061705017  
180 mm

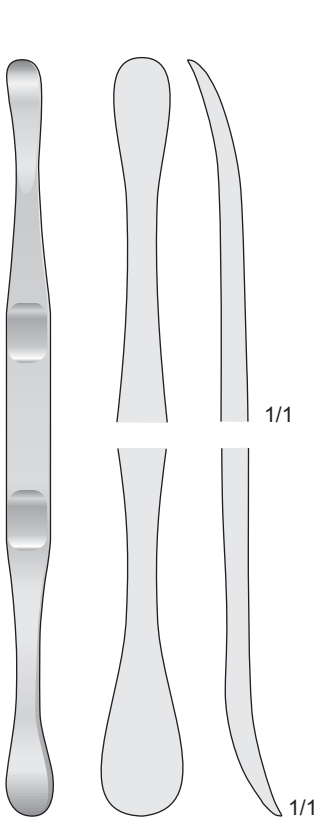

BABBUSH  
1014-CA  
180 mm

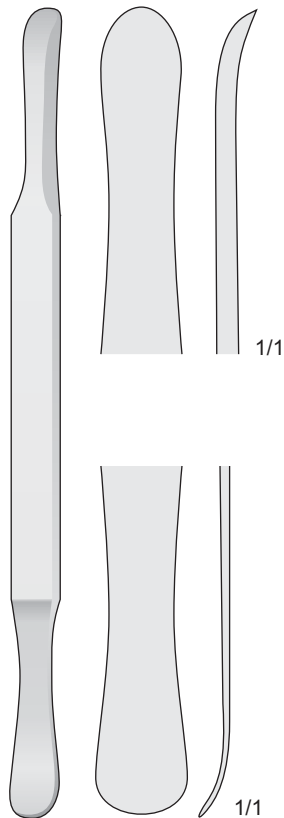

SELDIN  
1014-CD  
195 mm

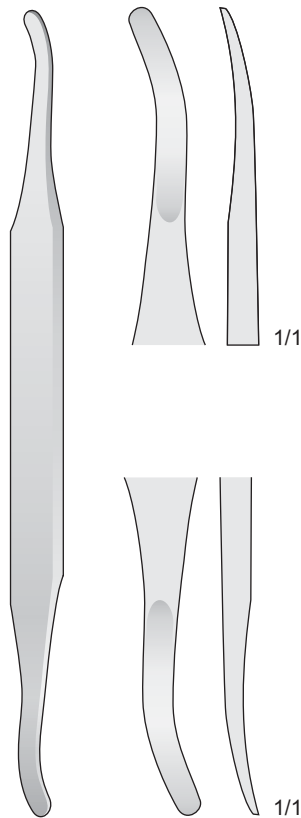

SELDIN  
1014-CC  
190 mm

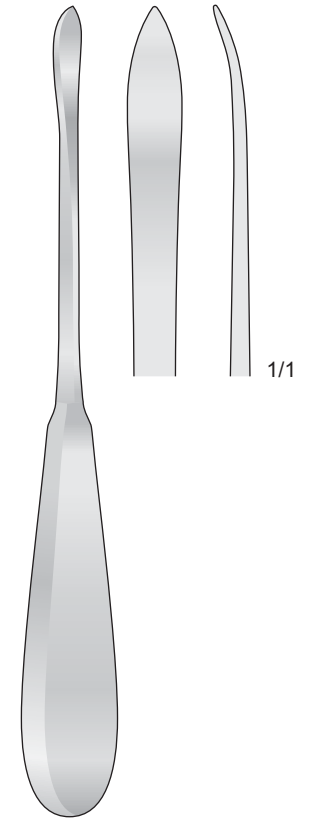

LANGENBECK  
0610-BC  
200 mm

Periostotomi

Raspatories

Raspatorien

Rugines

Legras

4 mm

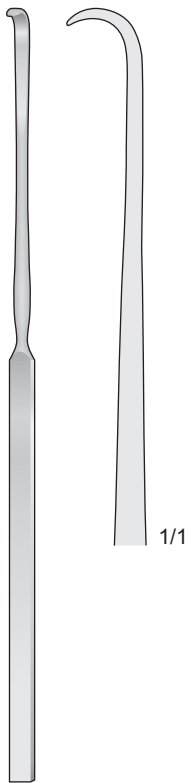

0414-CEE  
200 mm

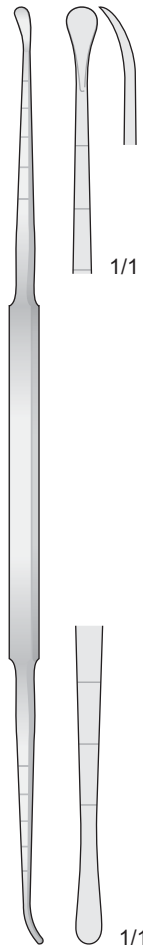

COTTLE  
0414-GA  
220 mm

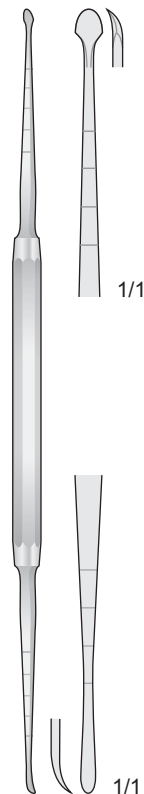

MASING  
0414-EH  
210 mm

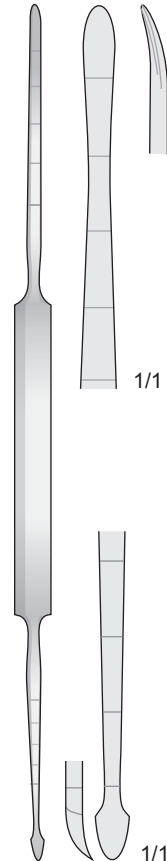

COTTLE  
0414-BBB  
210 mm



SALZBURG  
0414-CEA  
245 mm

Tagliente  
Sharp  
Scharf  
Tranchant  
Cortante

5 mm

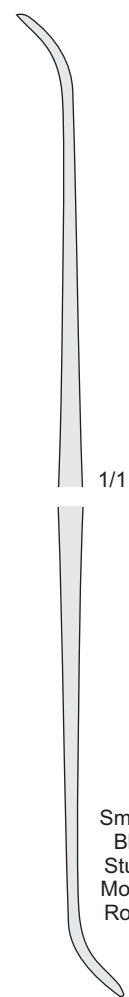

Smussa  
Blunt  
Stumpf  
Mousse  
Romas

SALZBURG  
0414-CEB  
245 mm

Tagliente  
Sharp  
Scharf  
Tranchant  
Cortante

5 mm

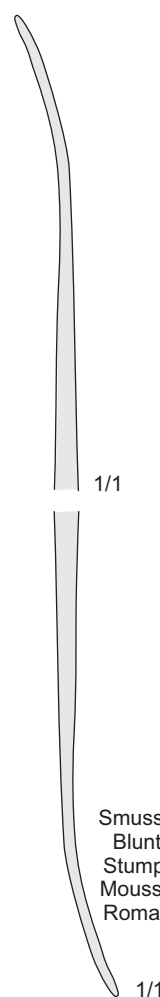

Smussa  
Blunt  
Stumpf  
Mousse  
Romas

1/1

Periostotomi

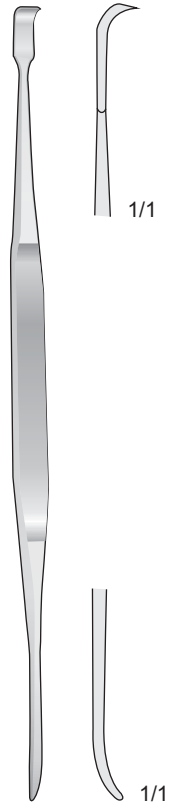

HOWARTH  
1014-DA  
210 mm

Raspatories

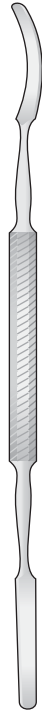

MC DONALD  
1014-DI  
190 mm

Raspatorien

Rugines

Legras

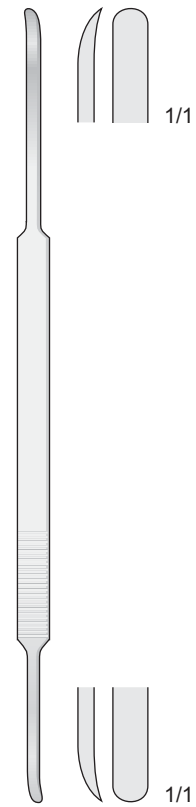

MCKENTY  
1014-EG  
220 mm

7 mm

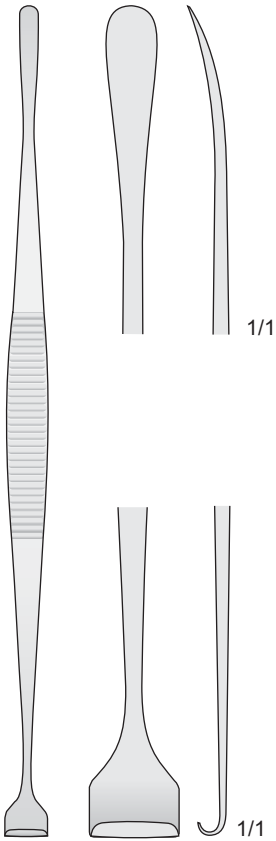

HURD  
0219-B  
220 mm

10 mm

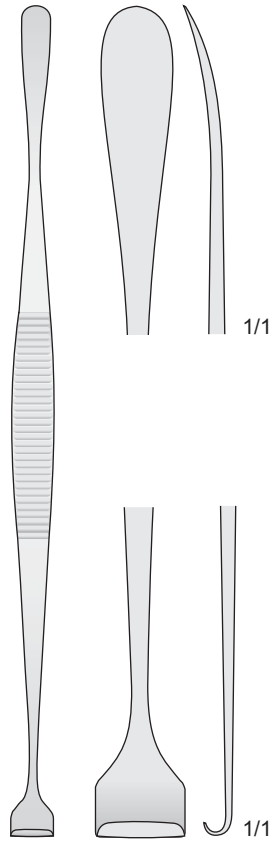

HURD  
0219-C  
220 mm

14 mm

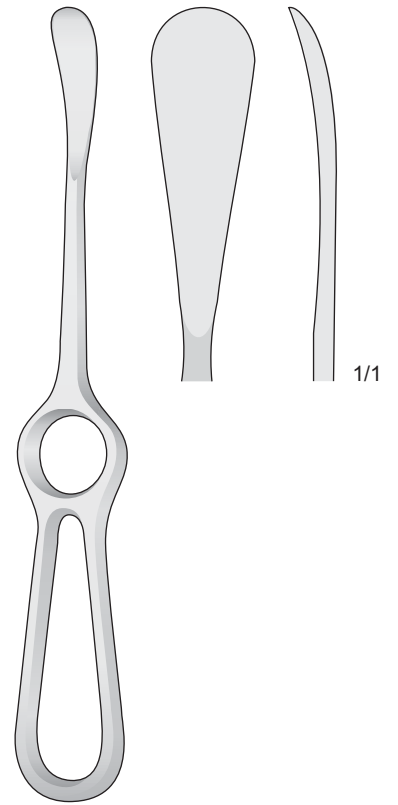

SEDILLOT  
0219-DH  
210 mm

Periostotomi

Raspatories

Raspatorien

Rugines

Legras

Periosteal elevators  
 Taglienti  
 Sharp  
 Scharf  
 Tranchant  
 Cortante

6 mm

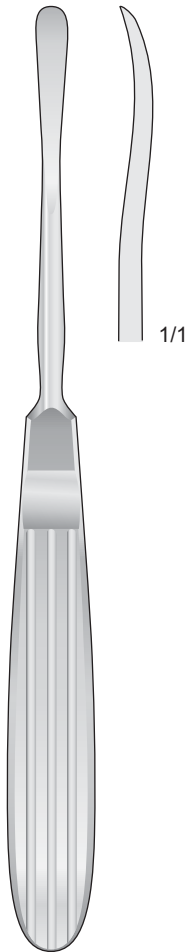

1/1

OBWEGESER  
 0414-FL  
 175 mm

7 mm

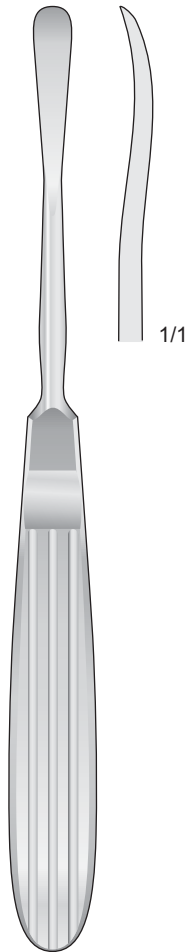

1/1

OBWEGESER  
 0414-GD  
 175 mm

9 mm

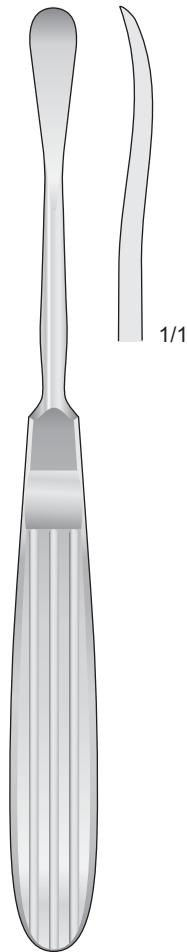

1/1

OBWEGESER  
 0414-GH  
 175 mm

11 mm

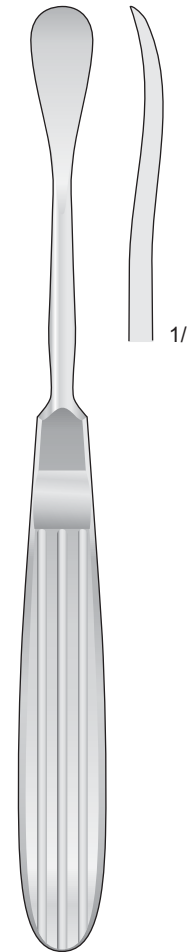

1/1

OBWEGESER  
 0414-GF  
 175 mm



Periostotomi

Raspatories

Raspatorien

Rugines

Legras

Sinistra, tagliente  
Left, sharp  
Links, Scharf  
À gauche, tranchant  
A la izquierda, cortante

Destra, tagliente  
Right, sharp  
Rechts, Scharf  
À droite, tranchant  
A la derecha, cortante



0414-GI



0414-GL

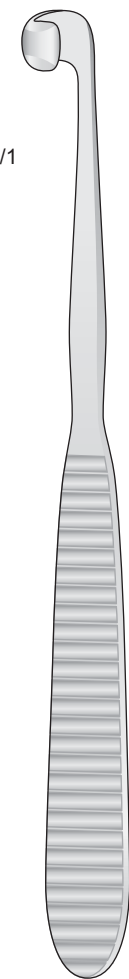

OBWEGESER  
0414-GI/0414-GL  
190 mm

5 mm

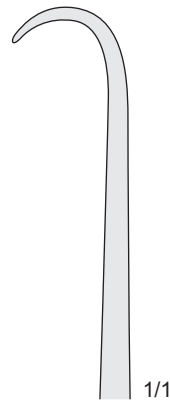

1/1



0414-LA  
200 mm

7 mm

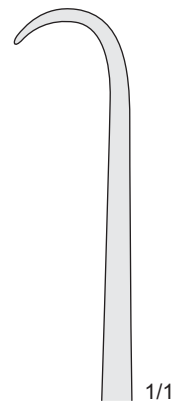

1/1



0414-BBH  
200 mm

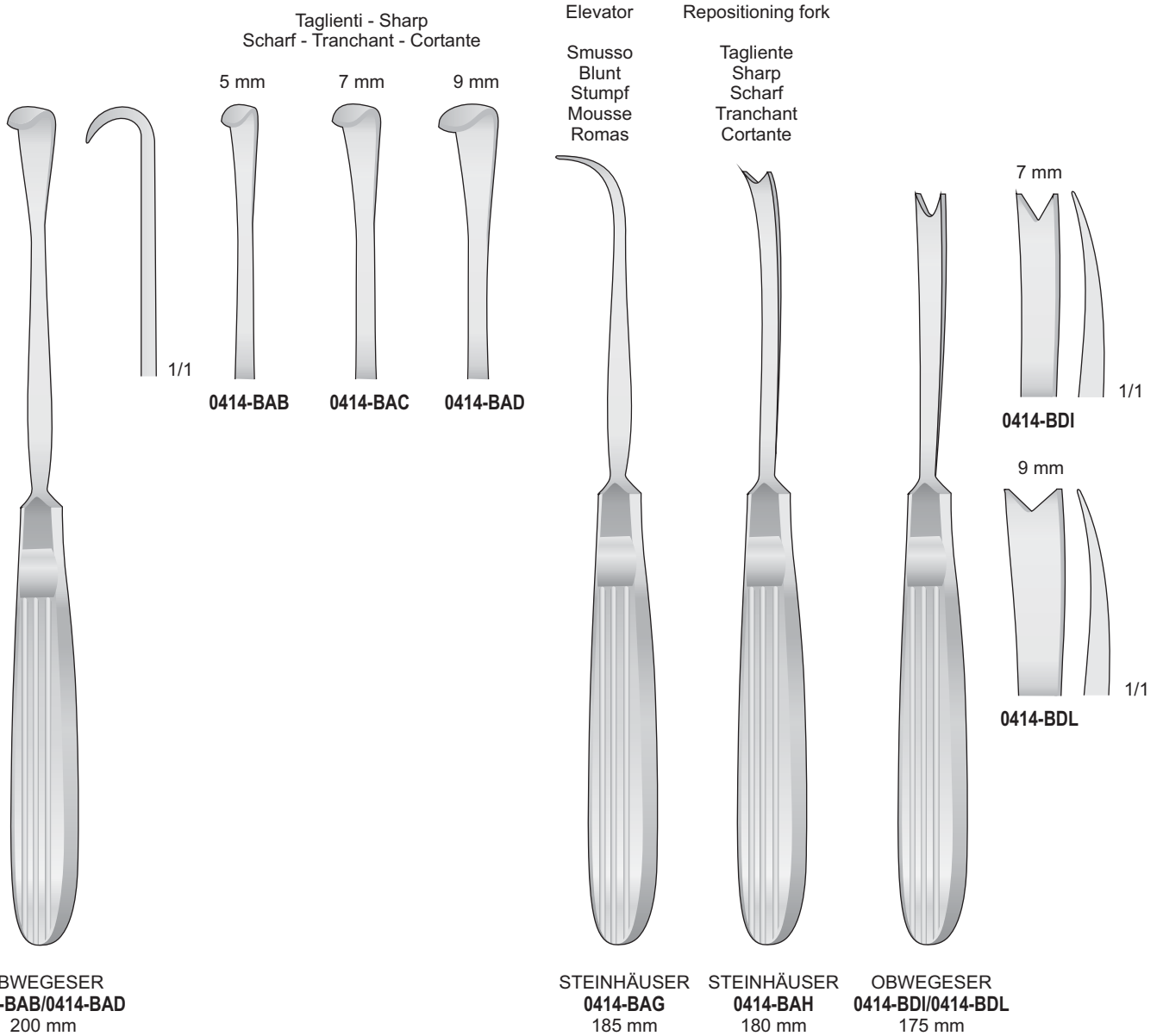

Periostotomi - Raspatori

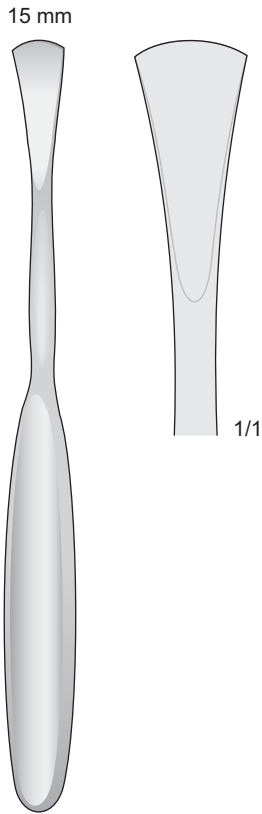

CUSHING  
0610-CFC  
190 mm

Periosteal Raspatories

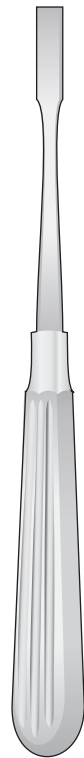

ADSON  
0610-CGA/0610-CGD  
170 mm

Raspatorien

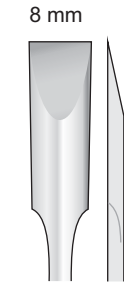

0610-CGA



0610-CGB



0610-CGC

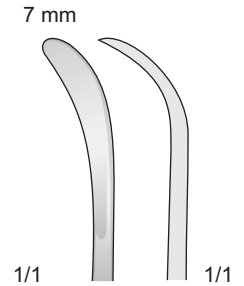

0610-CGD

1/1

1/1

1/1

1/1

Rugines à périostomie

Periostotomos - Legras

2,5 mm

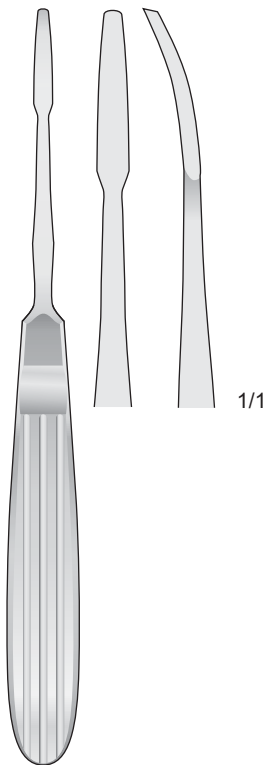

JOSEPH  
0610-IA  
170 mm

1/1

7 mm

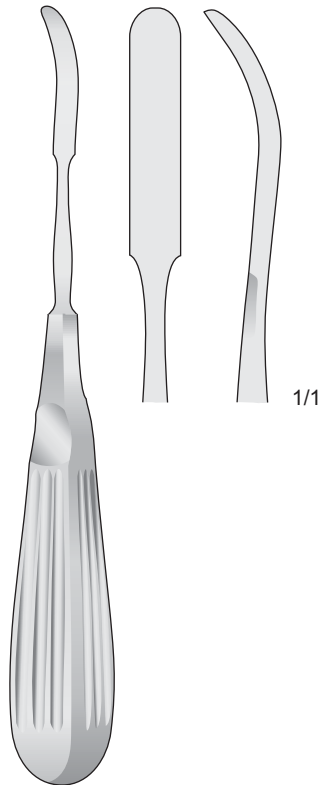

JOSEPH  
0610-IC  
180 mm

1/1

10 mm



MOLT  
1214-BF  
160 mm

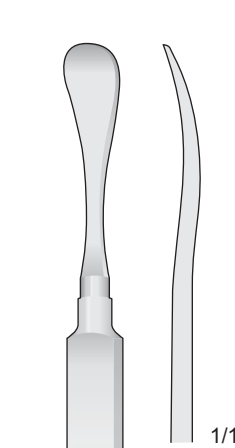

HENAHAN  
0219-AF/0219-AH  
175 mm

1/1

10 mm



0219-AF

1/1

12 mm



0219-AG

1/1

15 mm



0219-AH

1/1

Periostotomi - Raspatori

Periosteal Raspatories

Raspatorien

Rugines à périostomie

Periostotomos - Legras

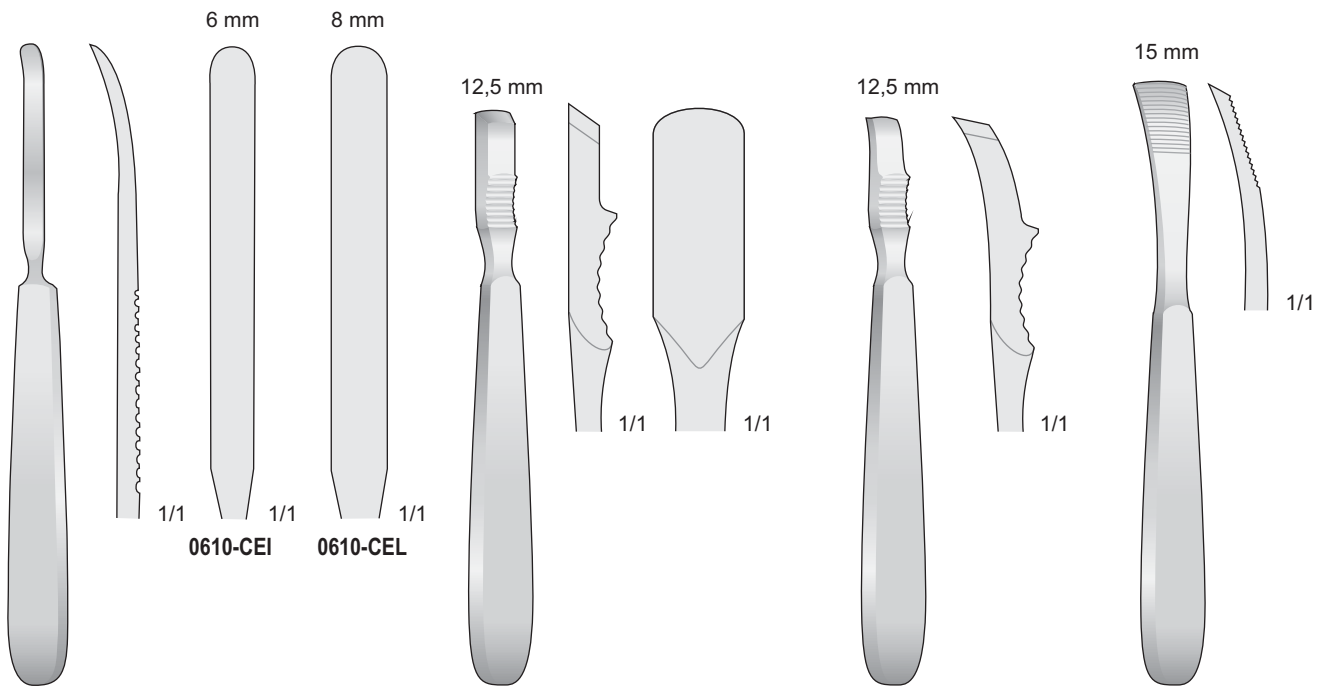

**0610-CEI/0610-CEL**  
170 mm

**FARABEUFF**  
**0610-CFA**  
150 mm

**FARABEUFF**  
**0610-CFB**  
150 mm

**JANSEN**  
**0610-CFF**  
165 mm

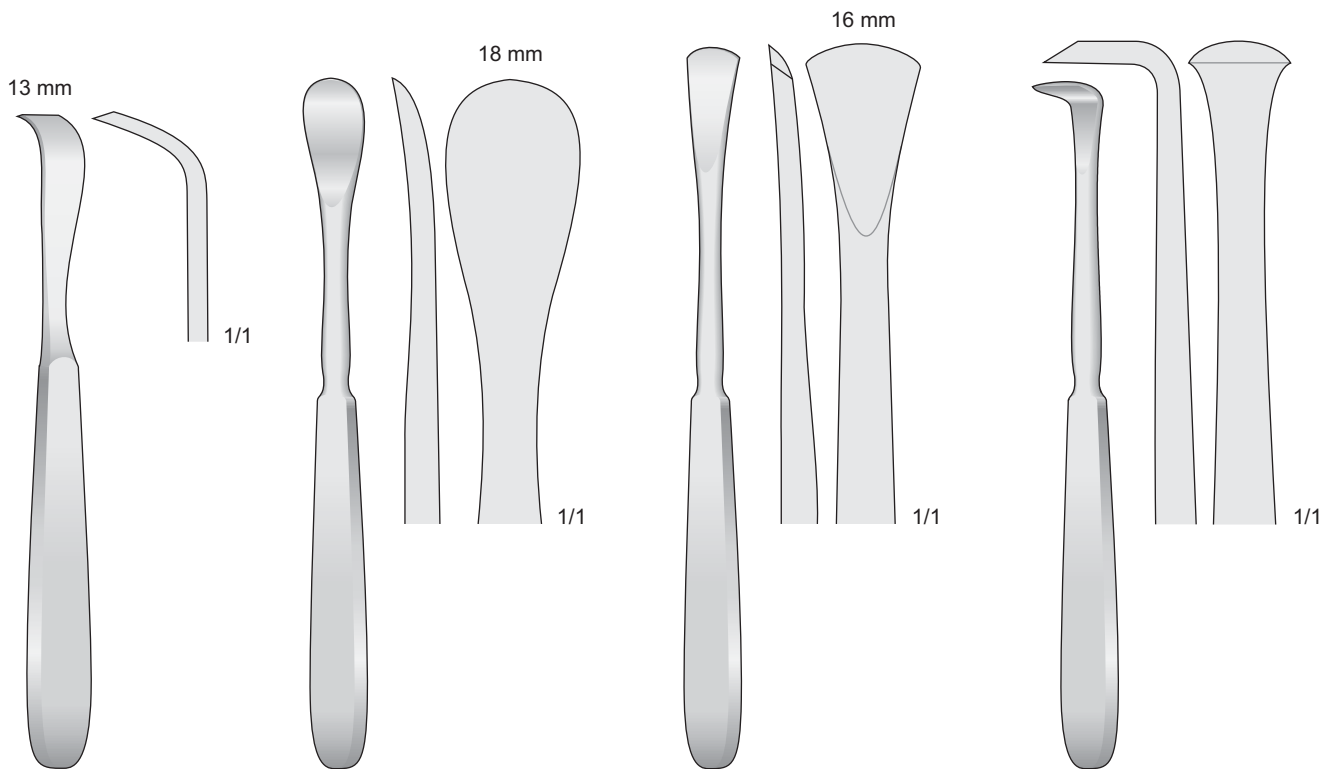

**SCHNEIDER**  
**0610-CFI**  
175 mm

**SEDILLOT**  
**0610-CFE**  
185 mm

**LANGENBECK**  
**0610-CFG**  
190 mm

**LANGENBECK**  
**0610-CFH**  
180 mm

Sinus  
Hipphisectomia

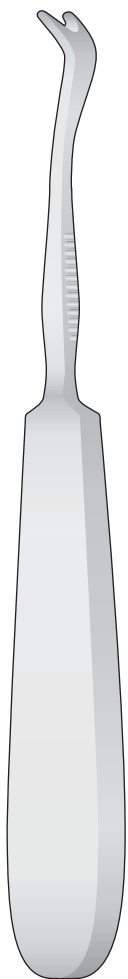

SEMB  
0610-EA/0610-EE

Sinus and  
Hypophysectomy

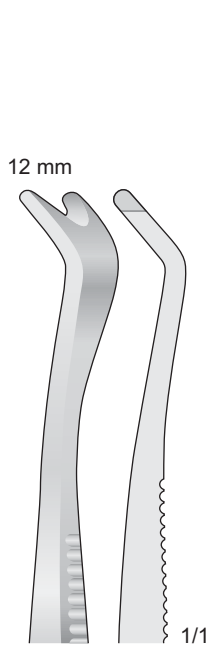

0610-EA  
190 mm

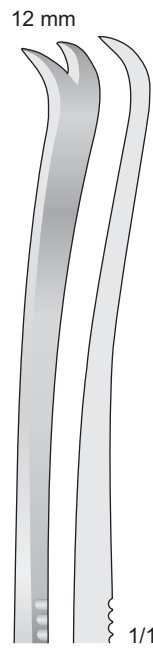

0610-EB  
230 mm

Sinus und  
Hypophysectomie

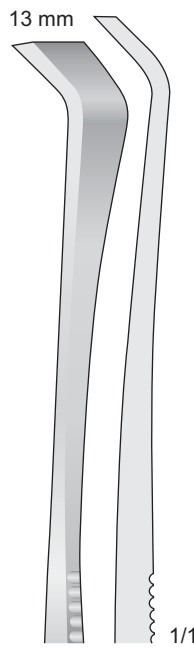

0610-EC  
230 mm



0610-ED  
230 mm

Elevation e dissezion  
de apofisi zigomatica

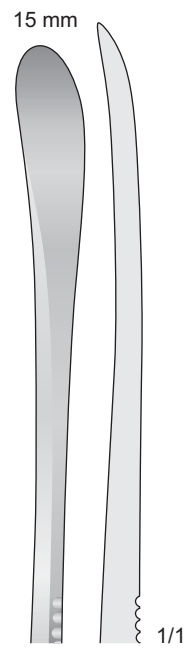

0610-EE  
230 mm

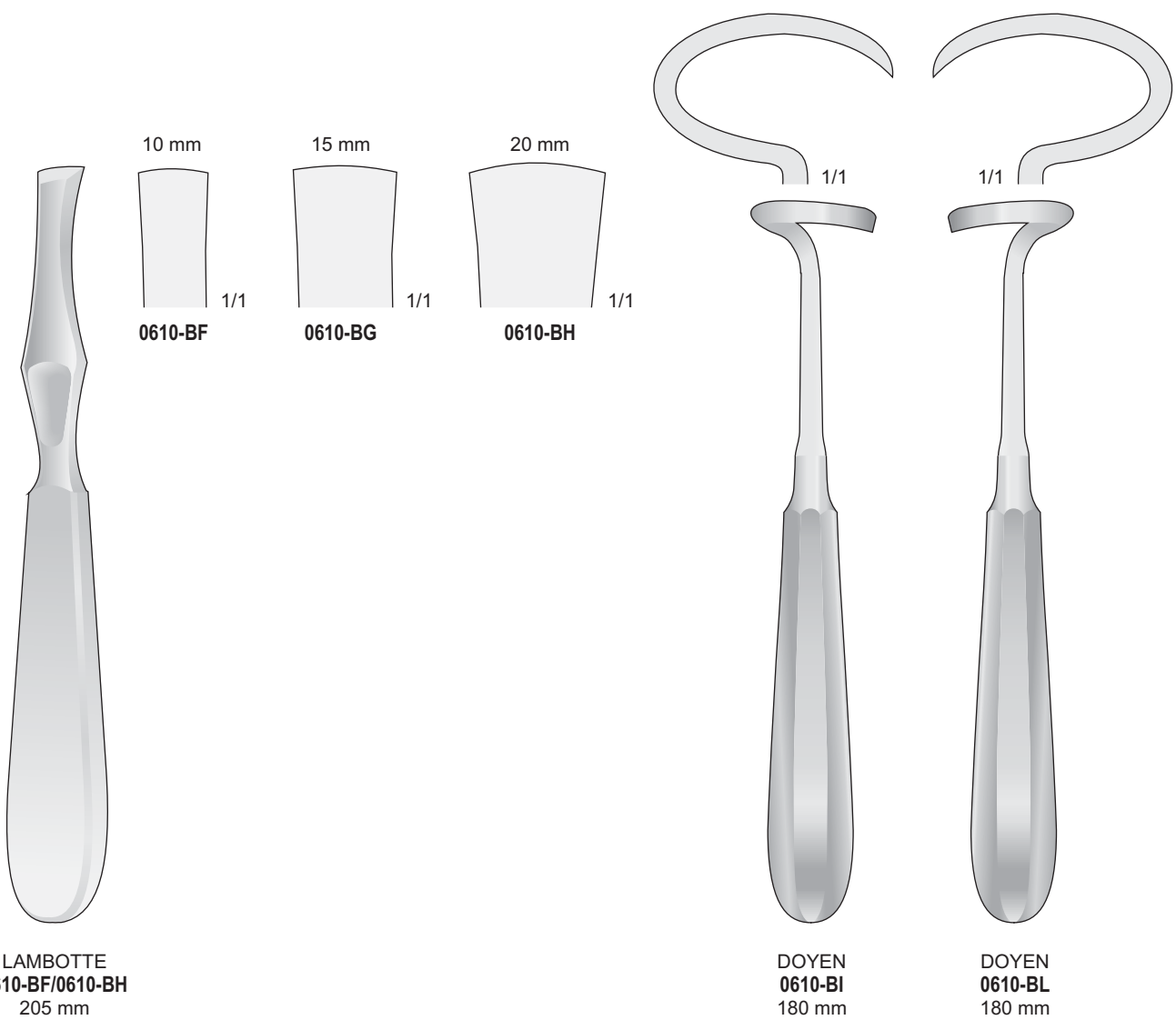

Con manico Ferrozell  
 With Ferrozell handle  
 Mit Ferrozellgriff  
 Avec poignée en Ferrozell  
 Con mango de Ferrozell



**0610-CDE**  
180 mm



**0610-CDA**  
190 mm



**0610-CDC**  
190 mm

Con manico Ferrozell  
 With Ferrozell handle  
 Mit Ferrozellgriff  
 Avec poignée en Ferrozell  
 Con mango de Ferrozell

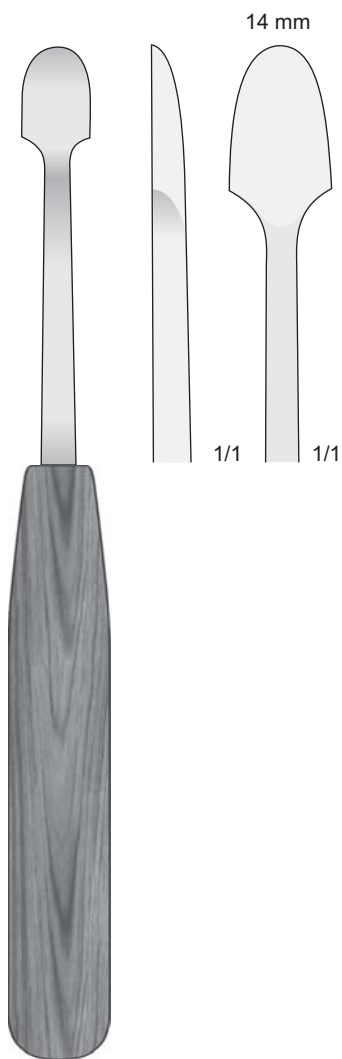

**0610-CDG**  
200 mm

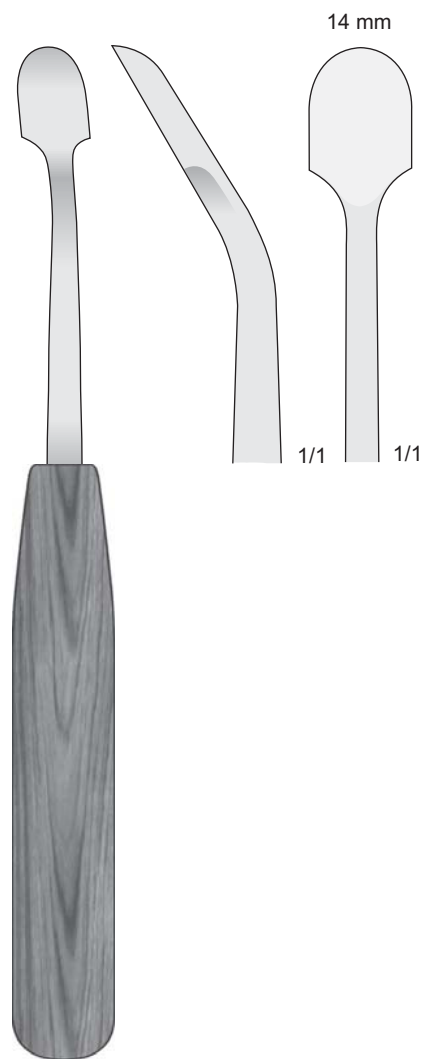

**0610-CDI**  
200 mm

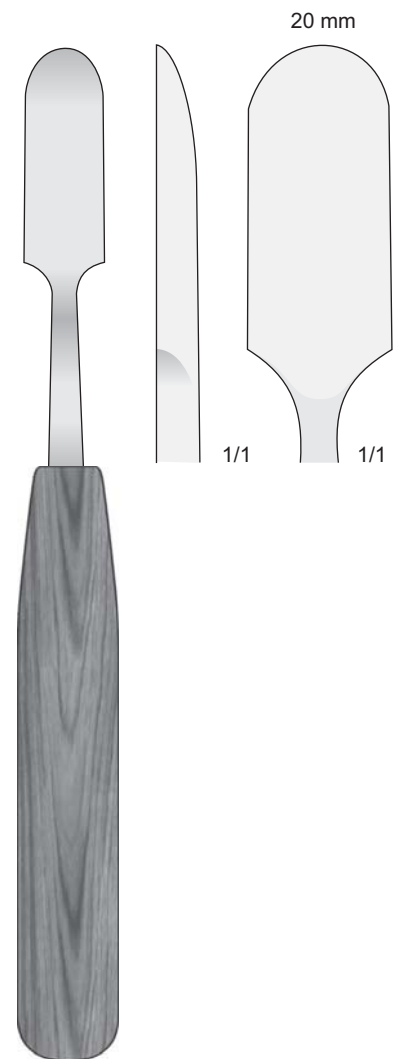

**0610-CEA**  
200 mm



Con manico Ferrozell  
 With Ferrozell handle  
 Mit Ferrozellgriff  
 Avec poignée en Ferrozell  
 Con mango de Ferrozell

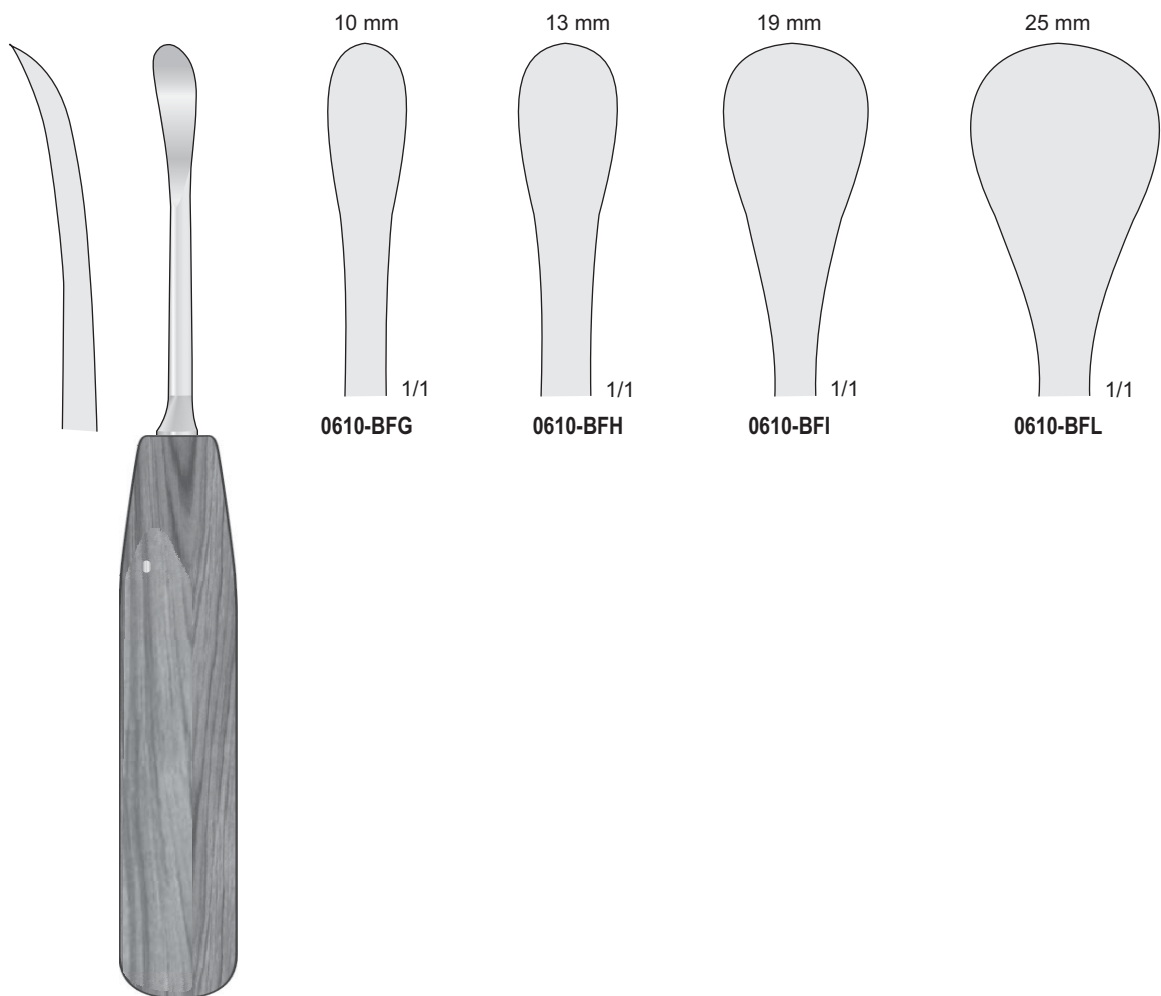

COBB  
 0610-BFG/0610-BFL  
 250 mm

Lime per osso

Bone files

Knochenfeilen

Limes à os

Limas para huesos

Fig. 67

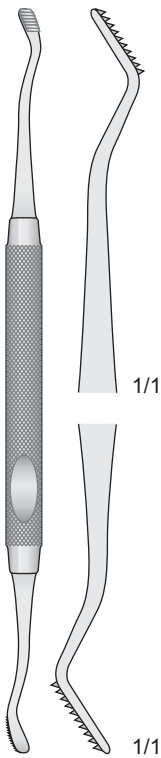

HOWARD  
0414-B  
180 mm

Fig. 45

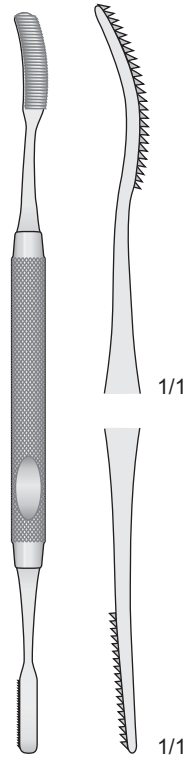

MILLER  
0414-C  
185 mm

Fig. 52

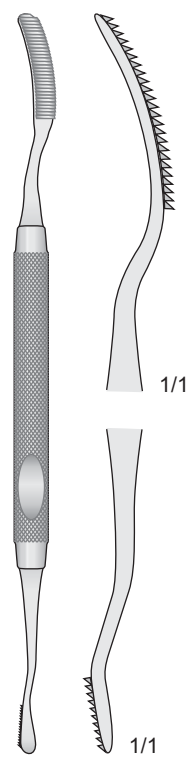

MILLER  
0414-D  
180 mm

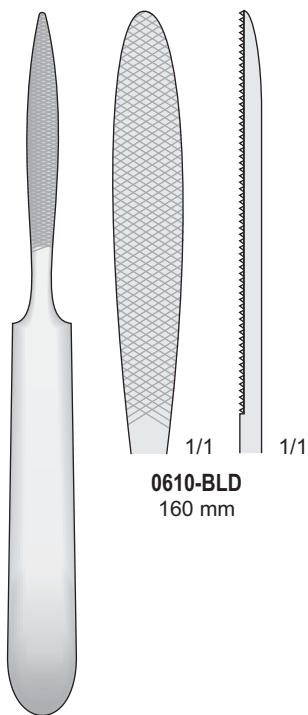

JOSEPH  
0610-BLD  
160 mm

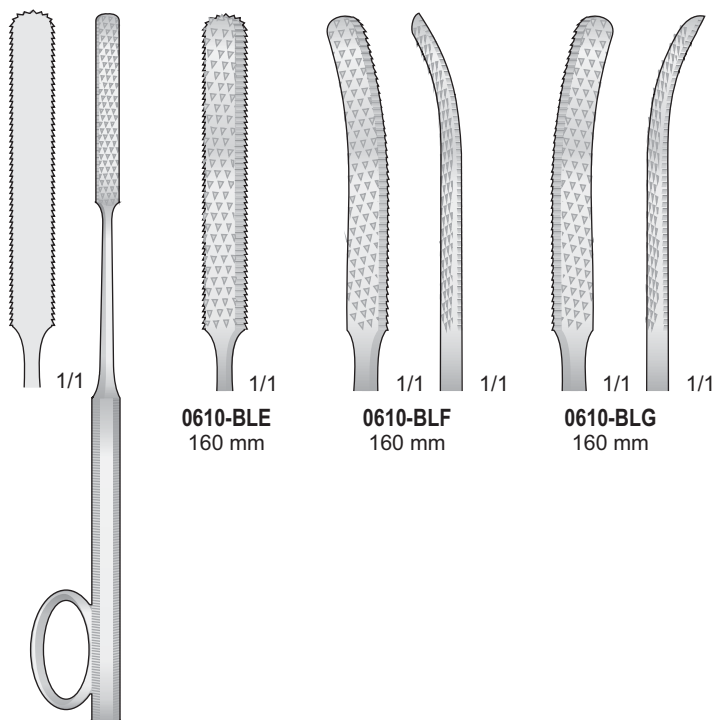

GALLAHER  
0610-BLE/0610-BLG  
160 mm

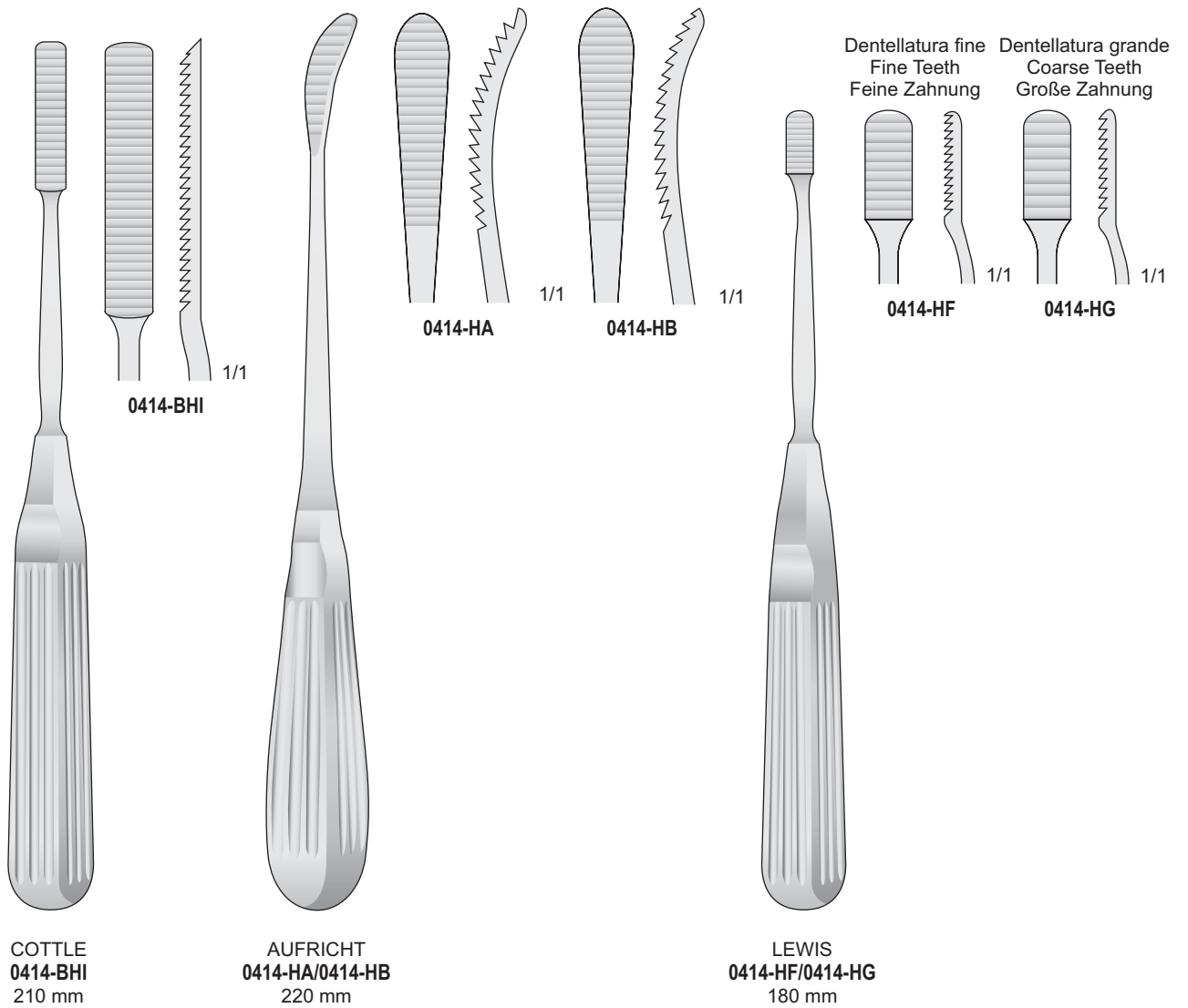

Lime per osso

Bone files

Knochenfeilen

Limes à os

Limas para huesos

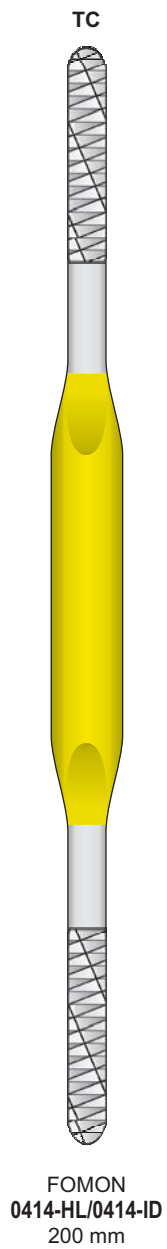

1



3



5



7

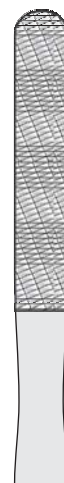

9

2



0414-HL

4



0414-IA

6



0414-IB

8



0414-IC

10

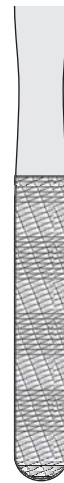

0414-ID

Lime per osso

Bone files

Knochenfeilen

Limes à os

Limas para huesos

8 mm



8 mm

**0610-LG**  
210 mm

2 mm



5 mm

**0610-LH**  
210 mm



1/1



1/1

8 mm



8 mm

**0610-LI**  
210 mm

8 mm

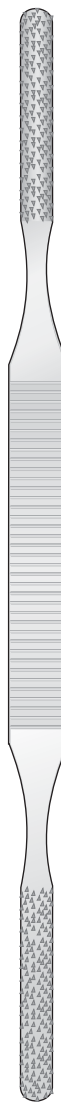

8 mm

**0610-LL**  
210 mm

Lime per osso

Bone files

Knochenfeilen

Limes à os

Limas para huesos

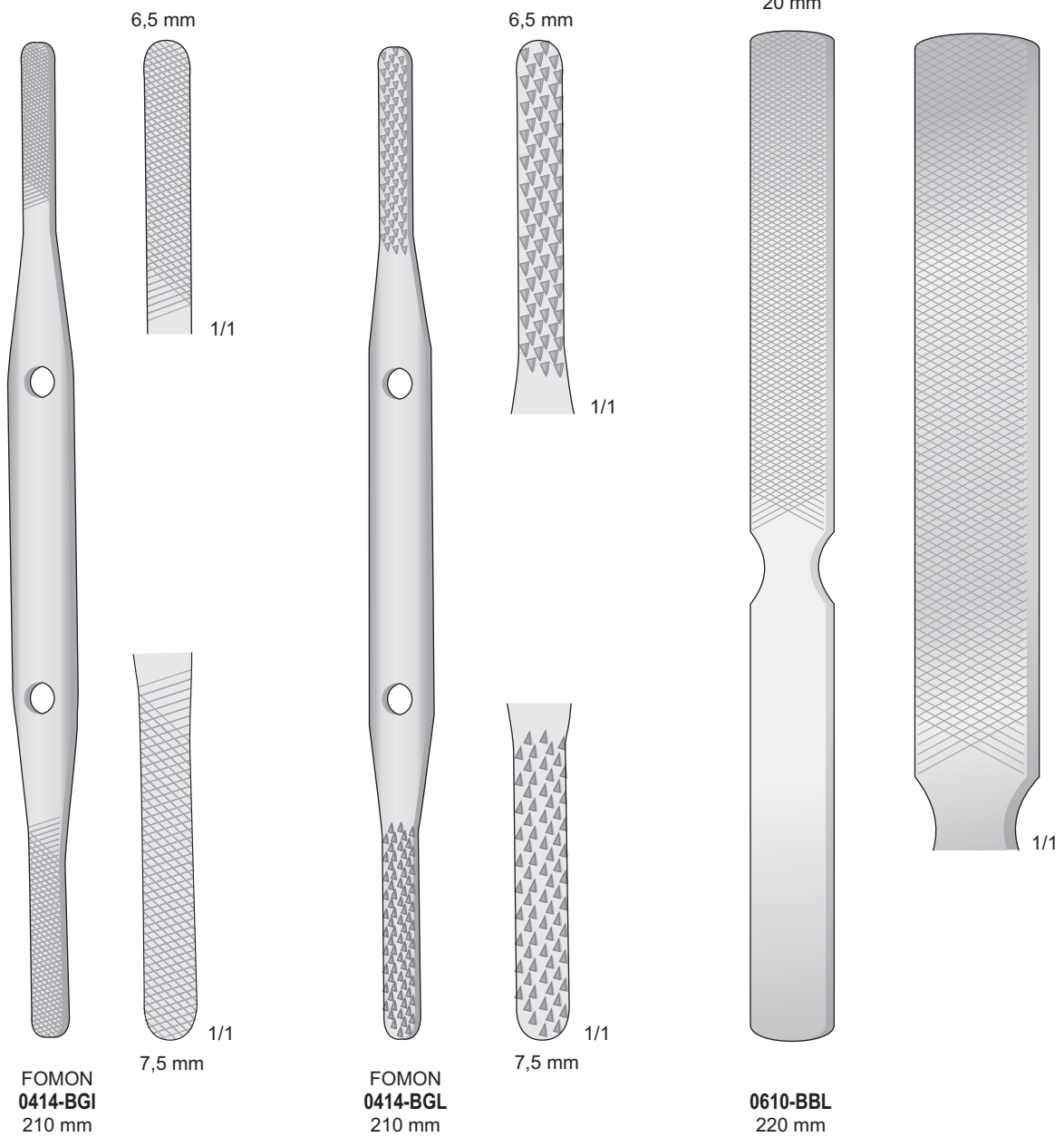

Lime per osso

Bone files

Knochenfeilen

Limes à os

Limas para huesos

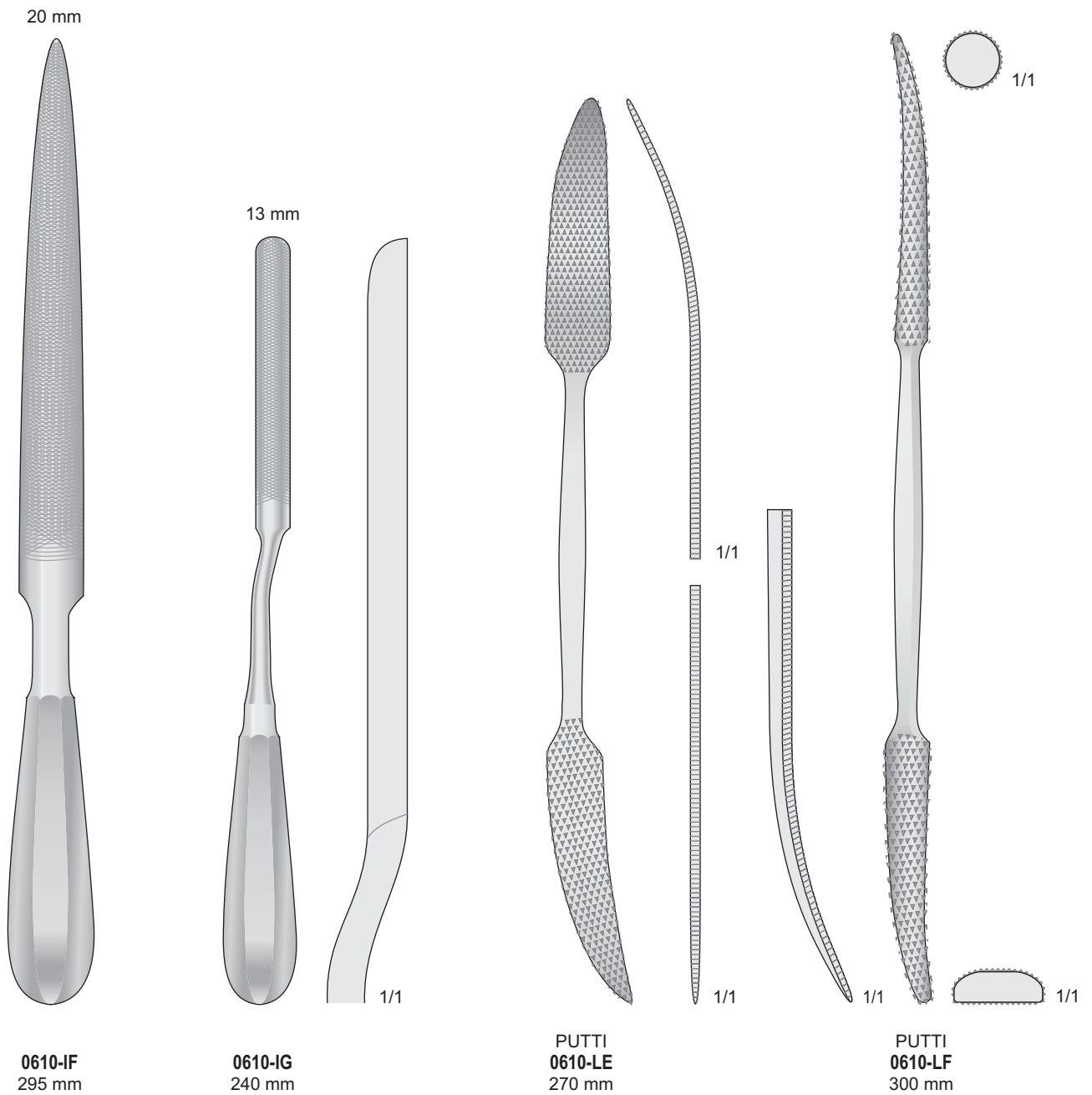

Lime per osso

Bone files

Knochenfeilen

Limes à os

Limas para huesos

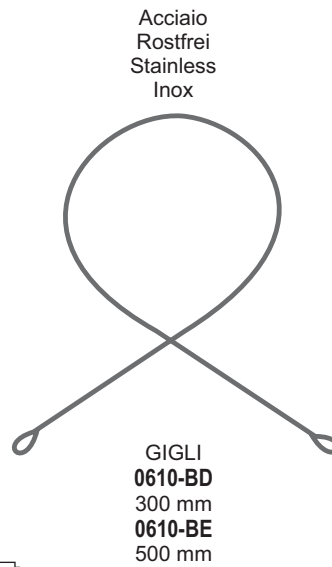
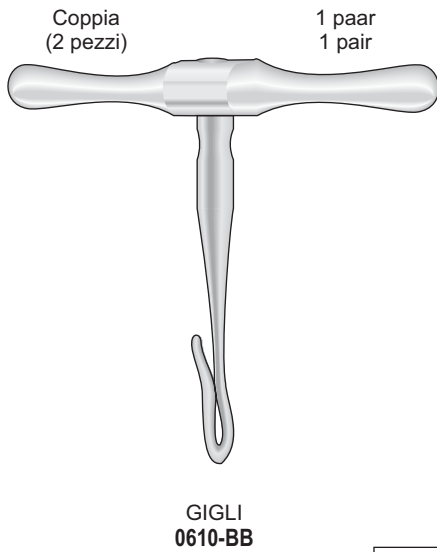

**1118-DAA**  
Completa con 3 seghe  
Complete with 3 saws  
Komplett mit 3 Sägen  
Complet avec 3 scies  
Completo con 3 sierras

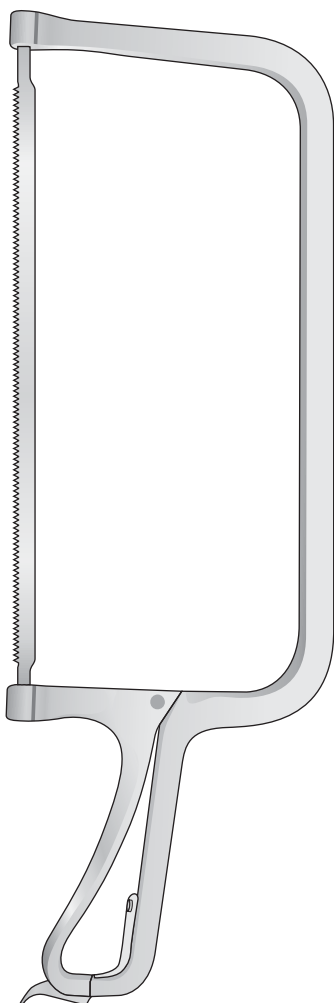

COLLIN  
1118-DAA  
390 mm

Fig.1



1118-DAB  
280 mm

Fig.2



1118-DAC  
280 mm

Fig.3



1118-DAD  
280 mm



LINDEMANN  
0610-CED  
200 mm



1/1



LANGENBECK  
0610-CEE  
235 mm



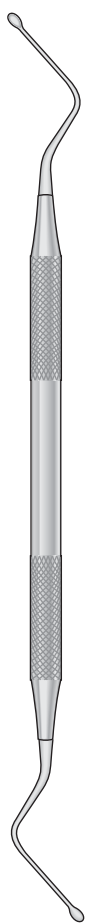

HEMINGWAY  
03-B  
175 mm

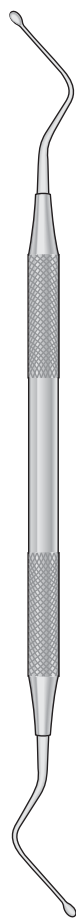

HEMINGWAY  
03-C  
175 mm

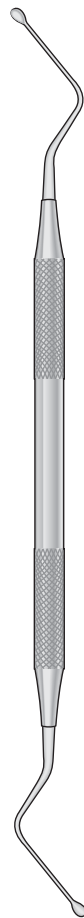

HEMINGWAY  
03-D  
175 mm

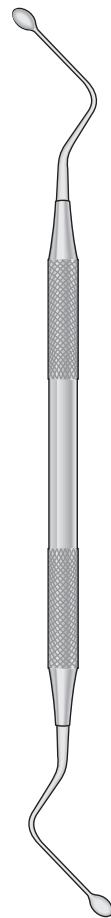

HEMINGWAY  
03-E  
175 mm

Fig. 1

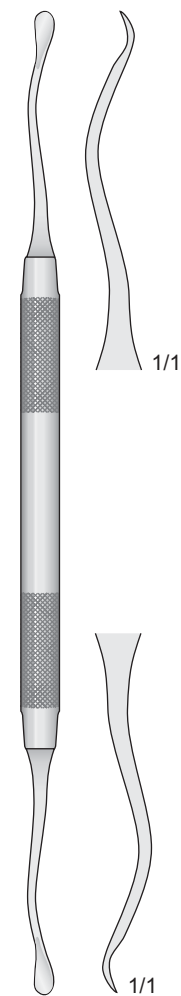

1811-B  
200 mm

Fig. 2

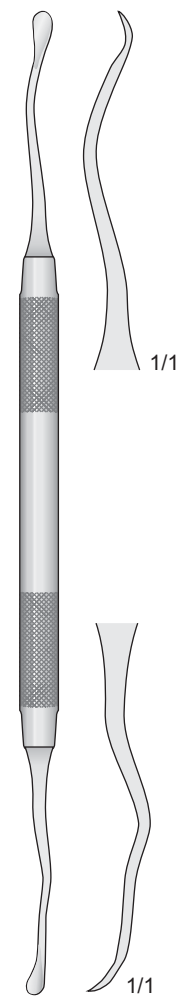

1811-C  
195 mm

Curette, Cucchiai taglienti

Sharp curettes

Scharfe Löffel

Curettes tranchantes

Cucharillas cortantes

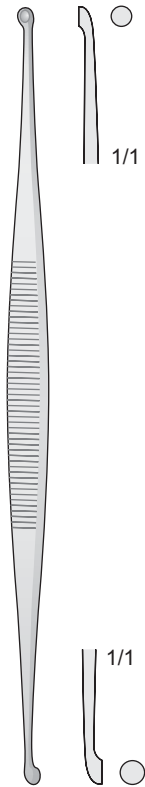

MARTINI  
0610-HA  
140 mm

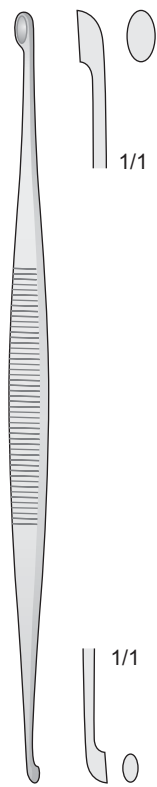

WILLIGER  
0610-HB  
145 mm

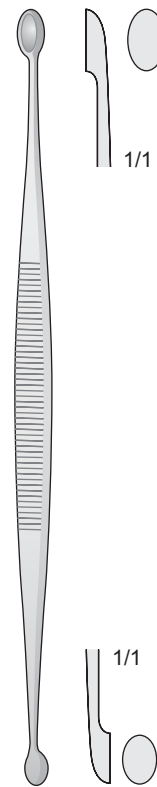

JACOBSON  
0610-HF  
140 mm

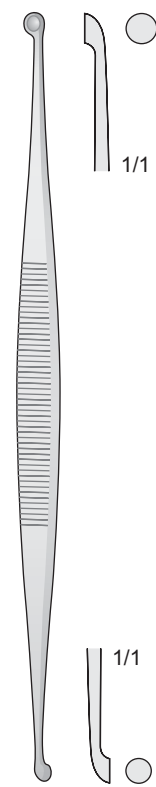

MARTINI  
0610-HG  
140 mm

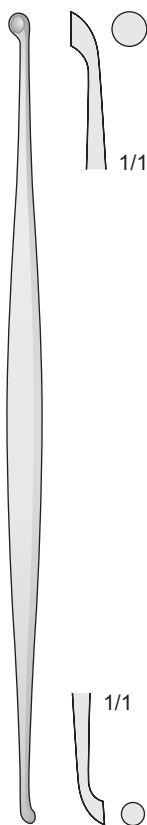

JANSEN  
0610-HH  
160 mm

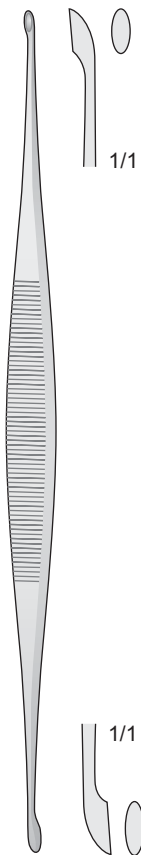

BARTH  
0610-HI  
180 mm

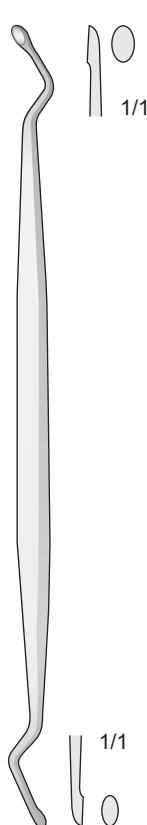

0610-ID  
160 mm

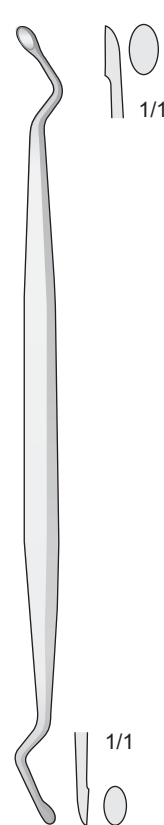

JANSEN  
0610-IE  
160 mm

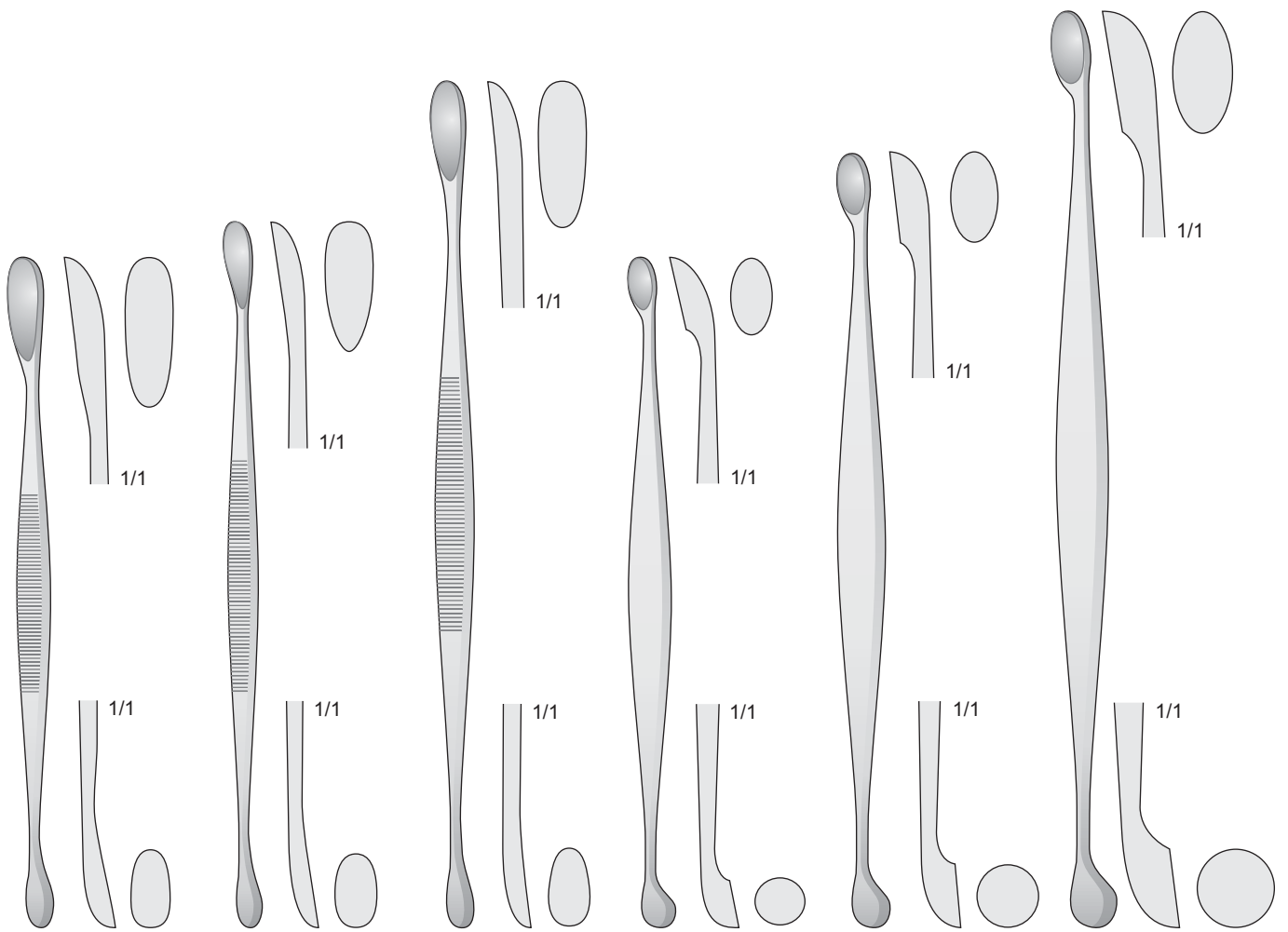

VOLKMANN  
0610-HL  
130 mm

VOLKMANN  
0610-HC  
145 mm

VOLKMANN  
0610-HD  
170 mm

0610-BHH  
130 mm

0610-HE  
160 mm

0610-BHI  
200 mm

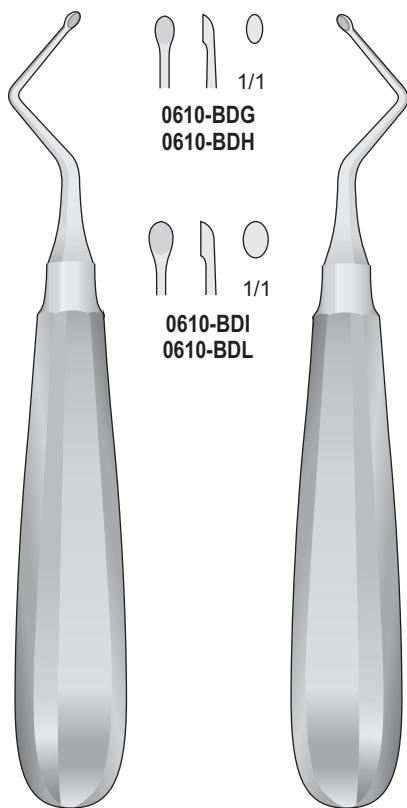

0610-BDG  
0610-BDH

0610-BDI  
0610-BDL

KERPEL  
0610-BDG  
0610-BDI  
145 mm

KERPEL  
0610-BDH  
0610-BDL  
145 mm

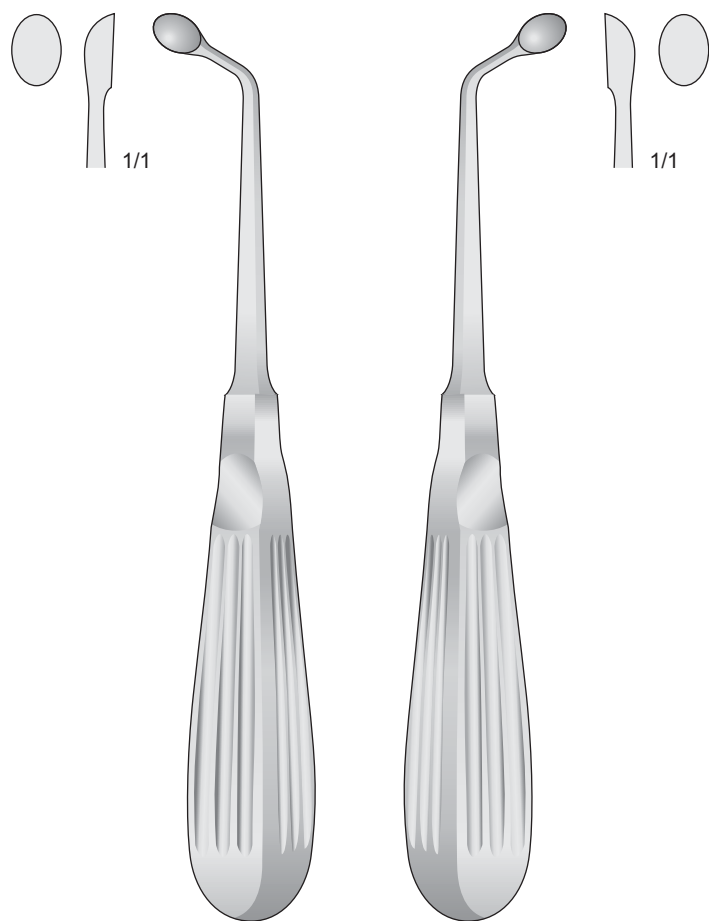

1/1

1/1

UFFENDORDE  
0610-BII  
170 mm

UFFENDORDE  
0610-BIL  
170 mm

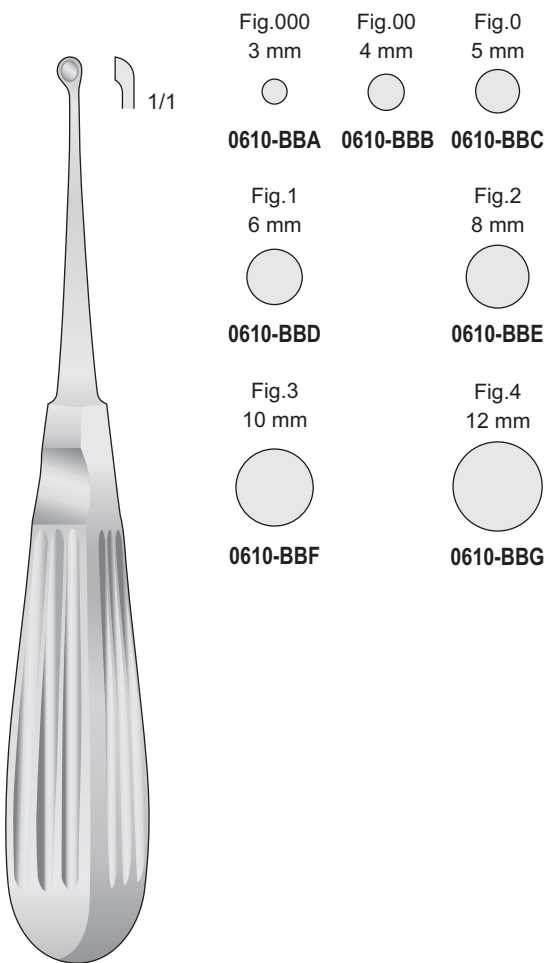

**BRUNS**  
0610-BBA/0610-BBG  
165 mm

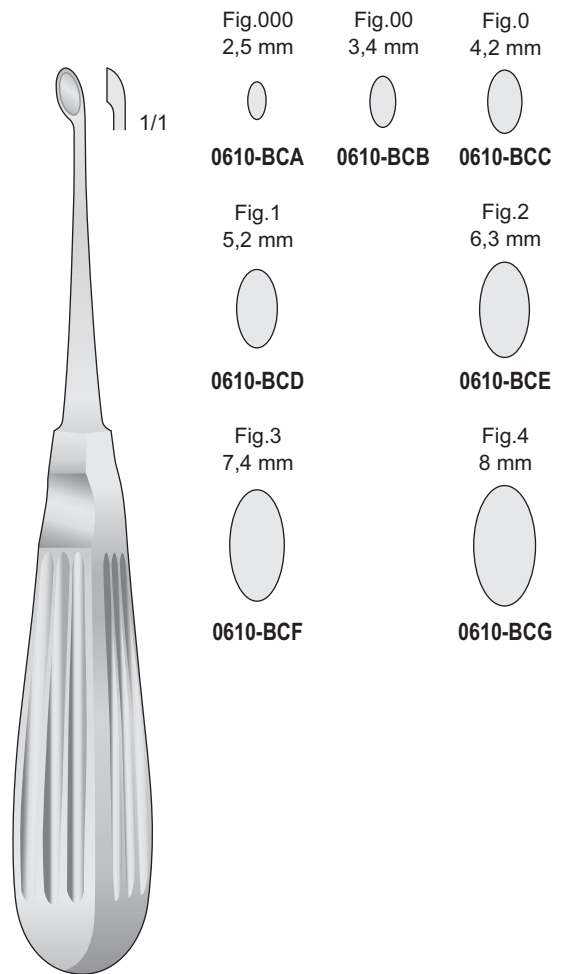

**SCHEDE**  
0610-BCA/0610-BCG  
170 mm

Curette, Cucchiai taglienti

Sharp curettes

Scharfe Löffel

Curettes tranchantes

Cucharillas cortantes

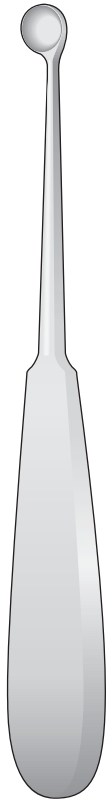

Fig.1  
○ 1/1  
**0610-AB**

Fig.2  
○ 1/1  
**0610-AC**

Fig.3  
○ 1/1  
**0610-AD**

Fig.4  
○ 1/1  
**0610-AE**

Fig.5  
○ 1/1  
**0610-AF**

Fig.6  
○ 1/1  
**0610-AG**

Fig.7  
○ 1/1  
**0610-AH**

Fig.8  
○ 1/1  
**0610-AI**

**0610-AB/0610-AI**  
180 mm

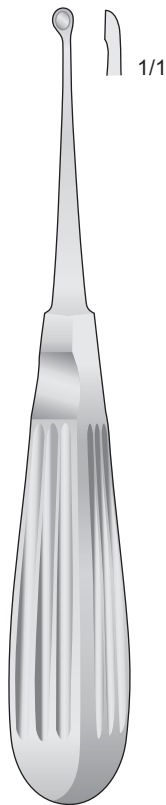

Fig.0000  
2,8 mm  
○ 1/1  
**0610-GA**

Fig.000  
3,6 mm  
○ 1/1  
**0610-GB**

Fig.00  
4,4 mm  
○ 1/1  
**0610-GC**

,Fig.0  
5,2 mm  
○ 1/1  
**0610-GD**

Fig.1  
6,8 mm  
○ 1/1  
**0610-GE**

Fig.2  
8,5 mm  
○ 1/1  
**0610-GF**

Fig.3  
10 mm  
○ 1/1  
**0610-GG**

Fig.4  
11,5 mm  
○ 1/1  
**0610-GH**

Fig.5  
13 mm  
○ 1/1  
**0610-GI**

Fig.6  
14,5 mm  
○ 1/1  
**0610-GL**

**VOLKMANN**  
**0610-GA/0610-GL**  
170 mm



Fig.1  
○ 1/1  
**0610-DB**

Fig.2  
○ 1/1  
**0610-DC**

Fig.3  
○ 1/1  
**0610-DD**

Fig.4  
○ 1/1  
**0610-DE**

Fig.5  
○ 1/1  
**0610-DF**

Fig.6  
○ 1/1  
**0610-DG**

Fig.7  
○ 1/1  
**0610-DH**

Fig.8  
○ 1/1  
**0610-DI**

Fig.9  
○ 1/1  
**0610-DL**

**0610-DB/0610-DL**  
210 mm

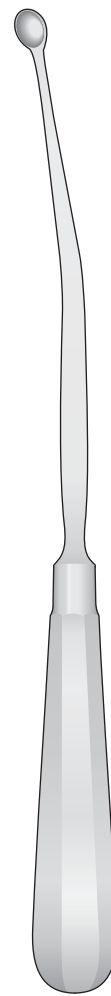

Fig. 1  
○ 1/1  
**0610-CB**

Fig. 2  
○ 1/1  
**0610-CC**

Fig. 3  
○ 1/1  
**0610-CD**

Fig. 4  
○ 1/1  
**0610-CE**

Fig. 5  
○ 1/1  
**0610-CF**

Fig. 6  
○ 1/1  
**0610-CG**

**0610-CB/0610-CG**  
260 mm

Malleabile  
Malleable  
Biegsam  
Souple  
Maleable

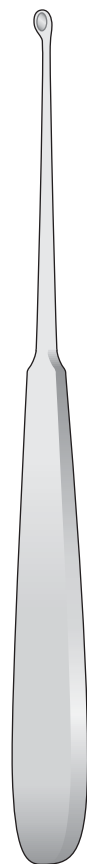

WILLIGER  
0610-BLH/0610-BLI  
170 mm



Fig. 00  
3,4 mm  
1/1  
**0610-BLH**

Fig. 1  
5,2 mm  
1/1  
**0610-BLI**

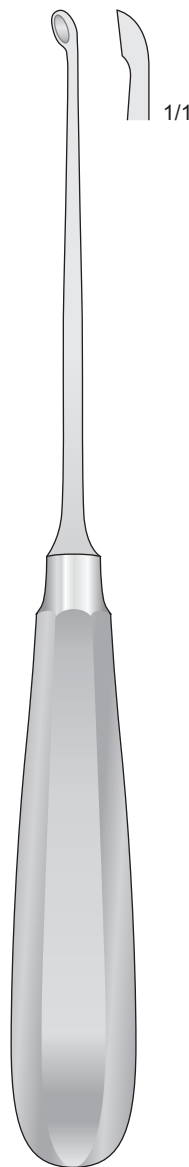

HALLE  
0610-BDA/0610-BDC  
215 mm

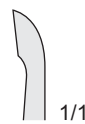
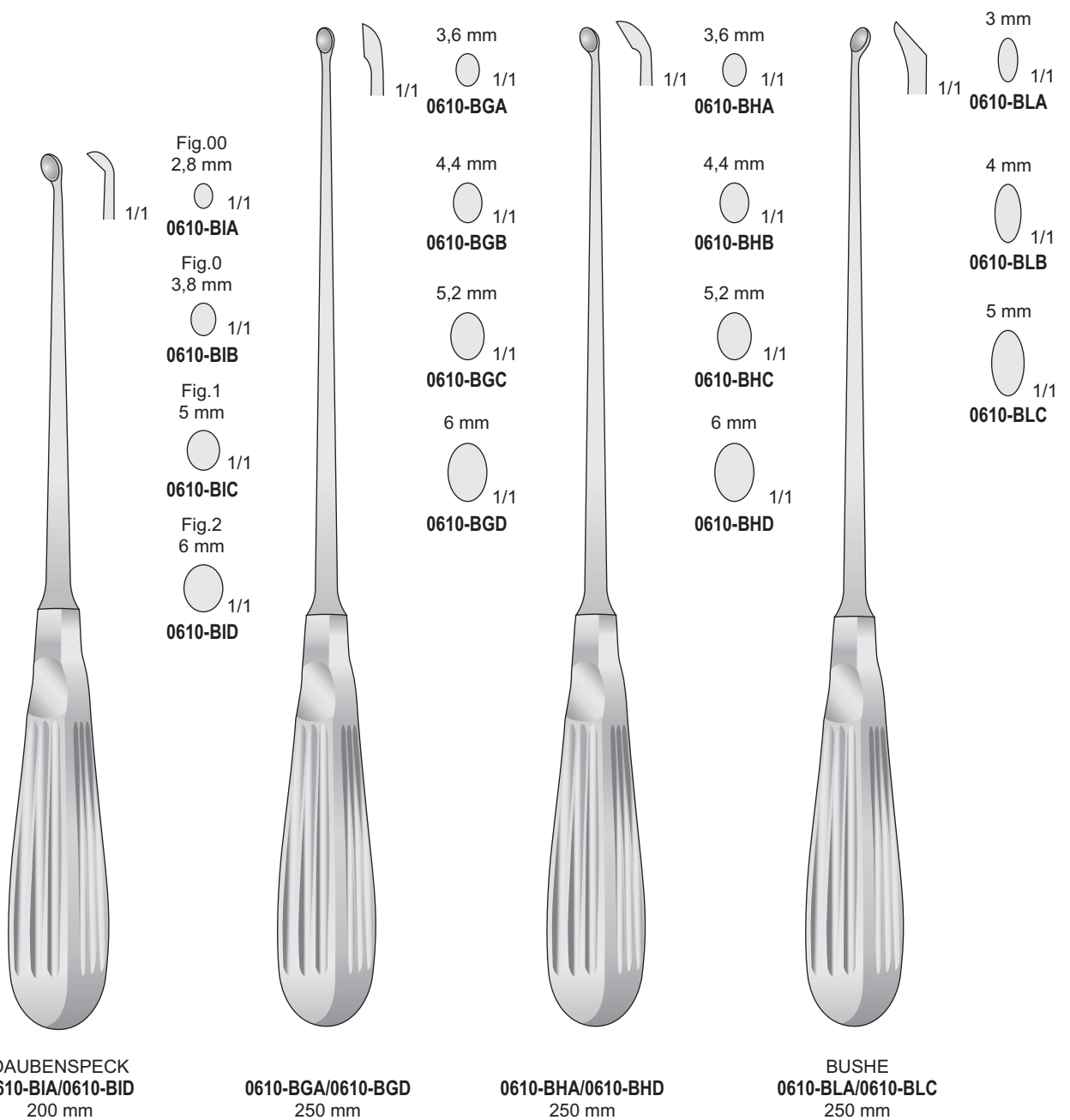

Fig.00  
4,4 mm  
1/1  
**0610-BDA**

Fig.0  
5,2 mm  
1/1  
**0610-BDB**

Fig.1  
6,8 mm  
1/1  
**0610-BDC**





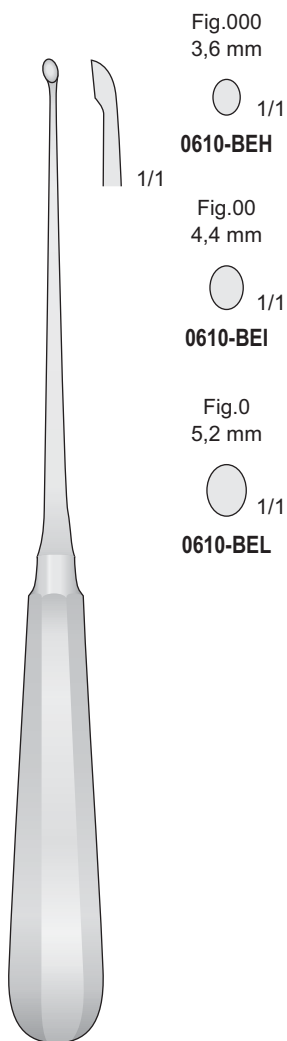

SIMON  
0610-BEH/0610-BEL  
235 mm

- Fig.000  
3,6 mm  
1/1  
**0610-BEH**
- Fig.00  
4,4 mm  
1/1  
**0610-BEI**
- Fig.0  
5,2 mm  
1/1  
**0610-BEL**

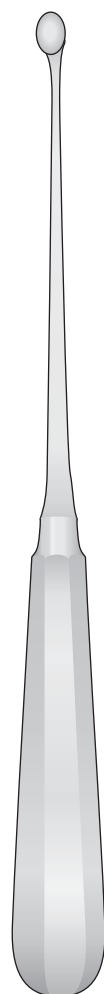

SIMON  
0610-BEA/0610-BEF  
240 mm

- Fig.1  
6,8 mm  
1/1  
**0610-BEA**
- Fig.2  
8,5 mm  
1/1  
**0610-BEB**
- Fig.3  
10 mm  
1/1  
**0610-BEC**
- Fig.4  
11,5 mm  
1/1  
**0610-BED**
- Fig.5  
13 mm  
1/1  
**0610-BEE**
- Fig.6  
14,5 mm  
1/1  
**0610-BEF**

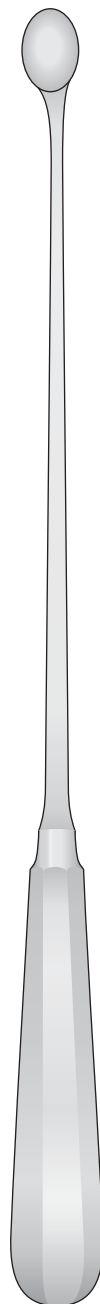

SCHRÖDER  
0610-BFA/0610-BFF  
310 mm

- Fig.1  
6,8 mm  
1/1  
**0610-BFA**
- Fig.2  
8,5 mm  
1/1  
**0610-BFB**
- Fig.3  
10 mm  
1/1  
**0610-BFC**
- Fig.4  
11,5 mm  
1/1  
**0610-BFD**
- Fig.5  
13 mm  
1/1  
**0610-BFE**
- Fig.6  
14,5 mm  
1/1  
**0610-BFF**

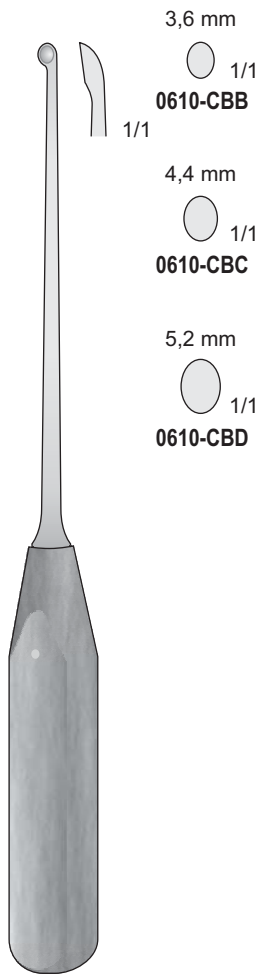

CASPAR  
0610-CBB/0610-CBD  
220 mm

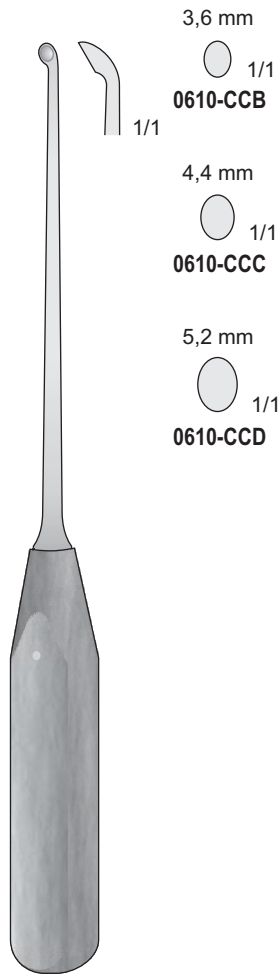

CASPAR  
0610-CCB/0610-CCD  
220 mm

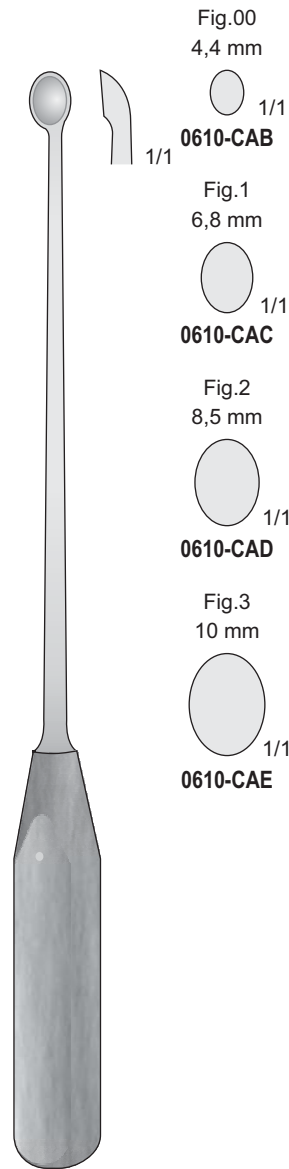

0610-CAB/0610-CAE  
270 mm

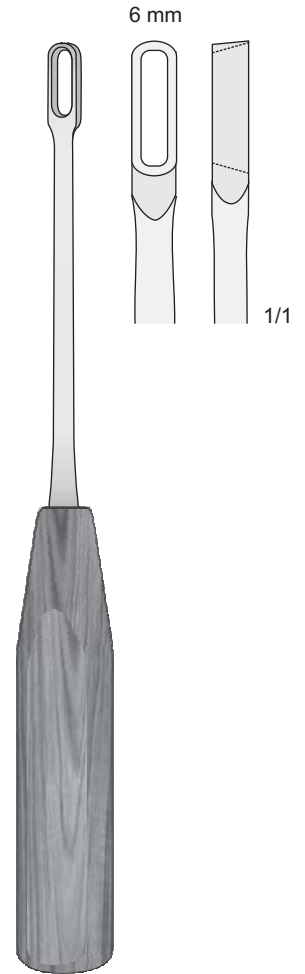

TESSIER  
0611-BLI  
220 mm

Strumentario per protesi femorale  
 Femoral prosthesis instrumentation  
 Instruments pour prothese femorale

Con manico Ferrozell  
 With Ferrozell handle  
 Mit Ferrozellgriff  
 Avec poignée en Ferrozell  
 Con mango de Ferrozell

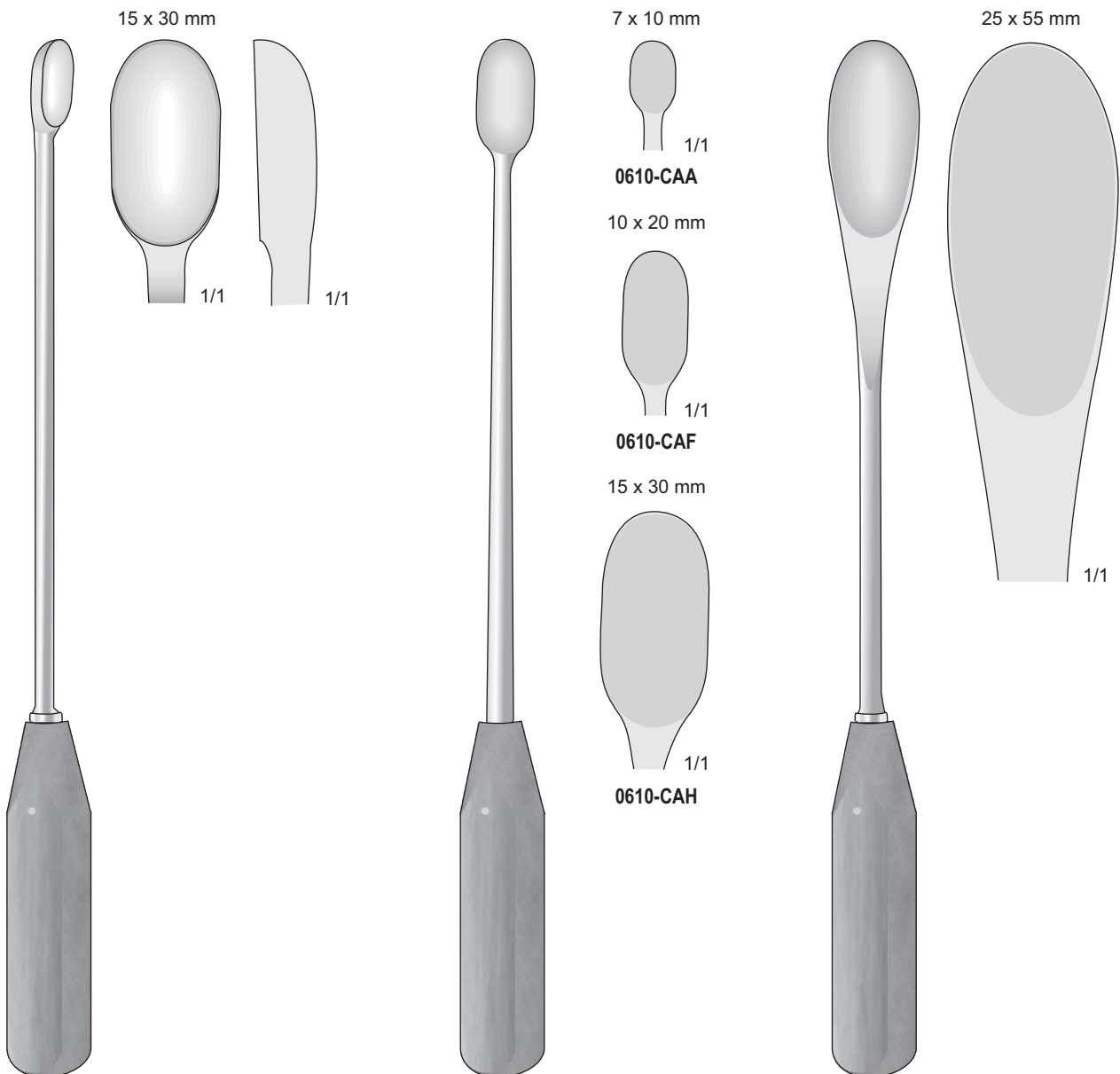

**0610-CAG**  
300 mm

**0610-CAA/0610-CAH**  
300 mm

**0610-CAI**  
300 mm

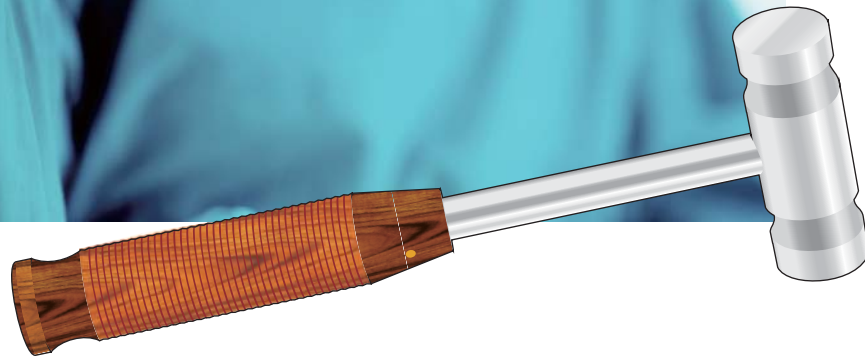

12

Martelli, Scalpelli  
Hammers, Bone chisels  
Hämmer, Knochenmeissel  
Maillets, Scalpel  
Martillos, Cinceles



Martelli chirurgici

Surgical mallets

Chirurgische Hämmer

Maillets chirurgicaux

Martillos quirurgicos

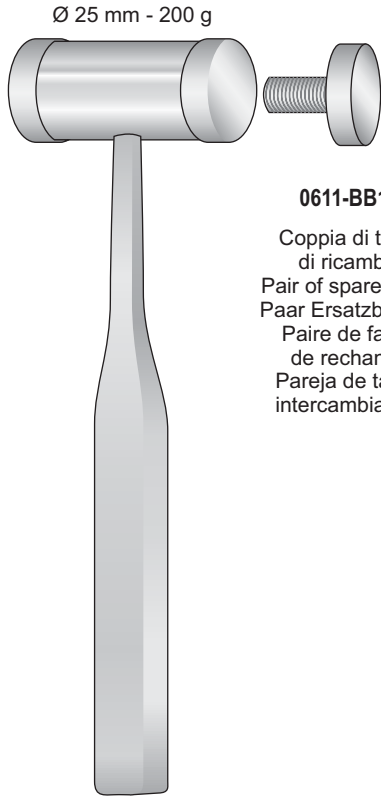

**0611-BB17**

Coppia di teste di ricambio  
 Pair of spare faces  
 Paar Ersatzbacken  
 Paire de faces de rechange  
 Pareja de tapas intercambiables

MEAD  
**0611-BB**  
 200 mm

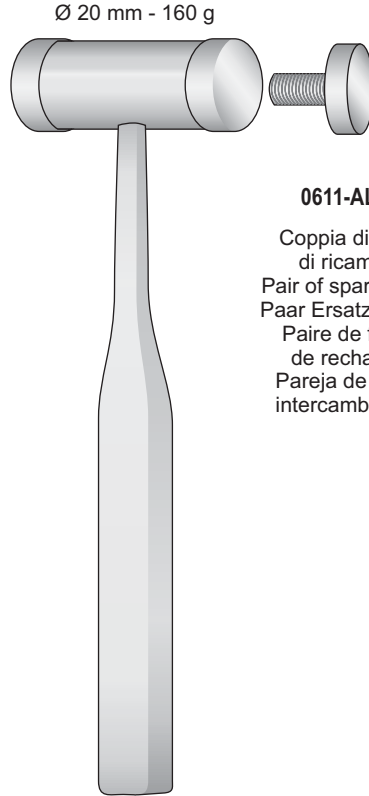

**0611-AL17**

Coppia di teste di ricambio  
 Pair of spare faces  
 Paar Ersatzbacken  
 Paire de faces de rechange  
 Pareja de tapas intercambiables

MEAD  
**0611-AL**  
 190 mm

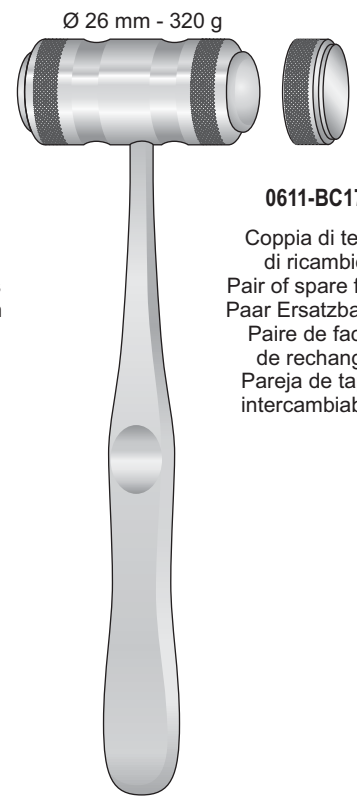

**0611-BC17**

Coppia di teste di ricambio  
 Pair of spare faces  
 Paar Ersatzbacken  
 Paire de faces de rechange  
 Pareja de tapas intercambiables

MEAD  
**0611-BC**  
 190 mm

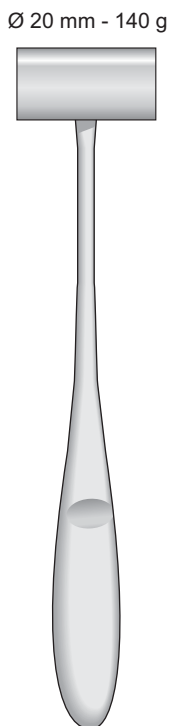

**0611-AB**  
 165 mm

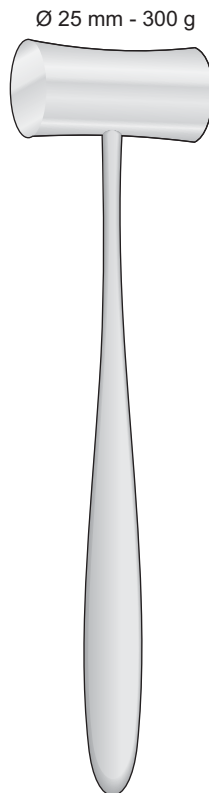

LUCAE  
**0611-BA12**  
 190 mm

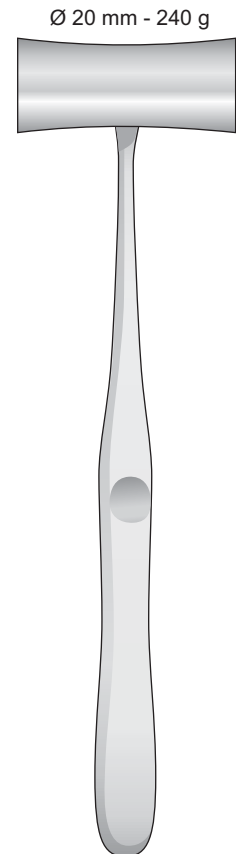

WILLIGER  
**0611-AC**  
 240 mm

1 Lato piatto - 1 Lato convesso  
 1 Side flat - 1 Side convex  
 1 Seite flach - 1 Seite convex  
 1 Face plate - 1 Face convexe  
 1 Parte plana - 1 Parte convexa

Ø 30 mm - 240 g

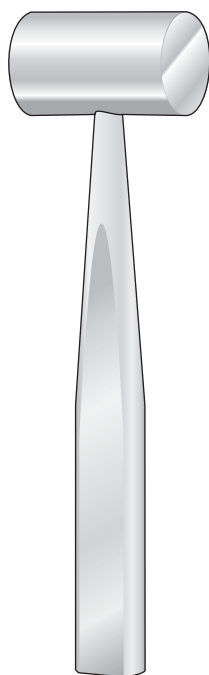

**COTTLE**  
**0611-BAE**  
 185 mm

Ø 30 mm - 300 g



**BERGMANN**  
**0611-BAF**  
 235 mm

Ø 45 mm - 300 g



**BERGMANN**  
**0611-BAG**  
 245 mm





**0611-BAH**  
240 mm



**OMBREDANNE**  
**0611-BAI**  
240 mm



**HEATH**  
**0611-BAL**  
185 mm

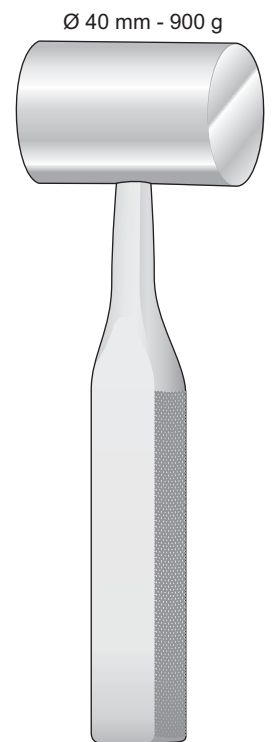

**0611-BBC**  
190 mm

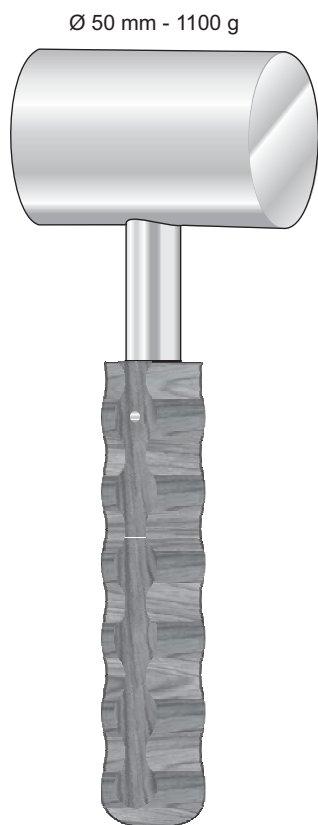

**0611-BBB**  
200 mm



**0611-AG**  
260 mm

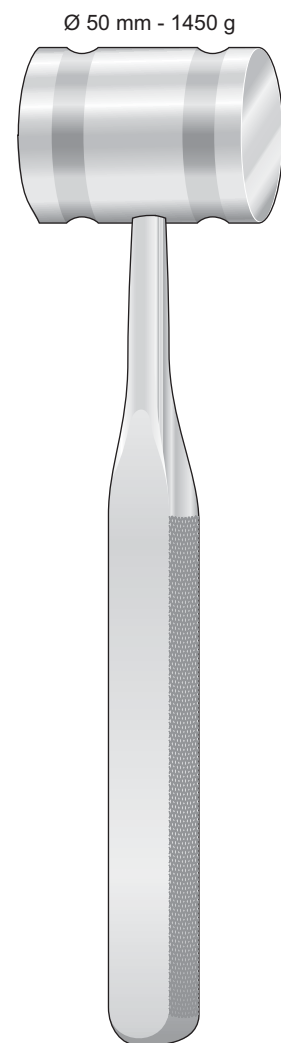

**0611-BBD**  
270 mm



-  **0606-BEH**  
Ø3 mm
-  **0606-BEI**  
Ø5 mm
-  **0606-BEL**  
Ø8 mm



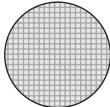
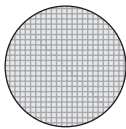

CASPAR  
0606-BEH/0606-BEL  
200 mm



-  **0611-CFD**  
Ø12 mm
-  **0611-CFE**  
Ø14 mm
-  **0611-CFF**  
Ø16 mm

0611-CFD/0611-CFF  
200 mm



-  **0611-CFG**  
3x8 mm
-  **0611-CFH**  
4x10 mm
-  **0611-CFI**  
5x15 mm
-  **0611-CFL**  
6x20 mm

SYPERT  
0611-CFG/0611-CFL  
290 mm

Battitori - Osteotomi

Tampers - Osteotomes

Stosser - Osteotome

Pilons - Ostéotomes

Batidor - Osteotomos

Ø 3 mm

Ø 5 mm

Ø 7 mm

Ø 2 mm

Ø 4 mm

Ø 3 mm

Ø 5 mm

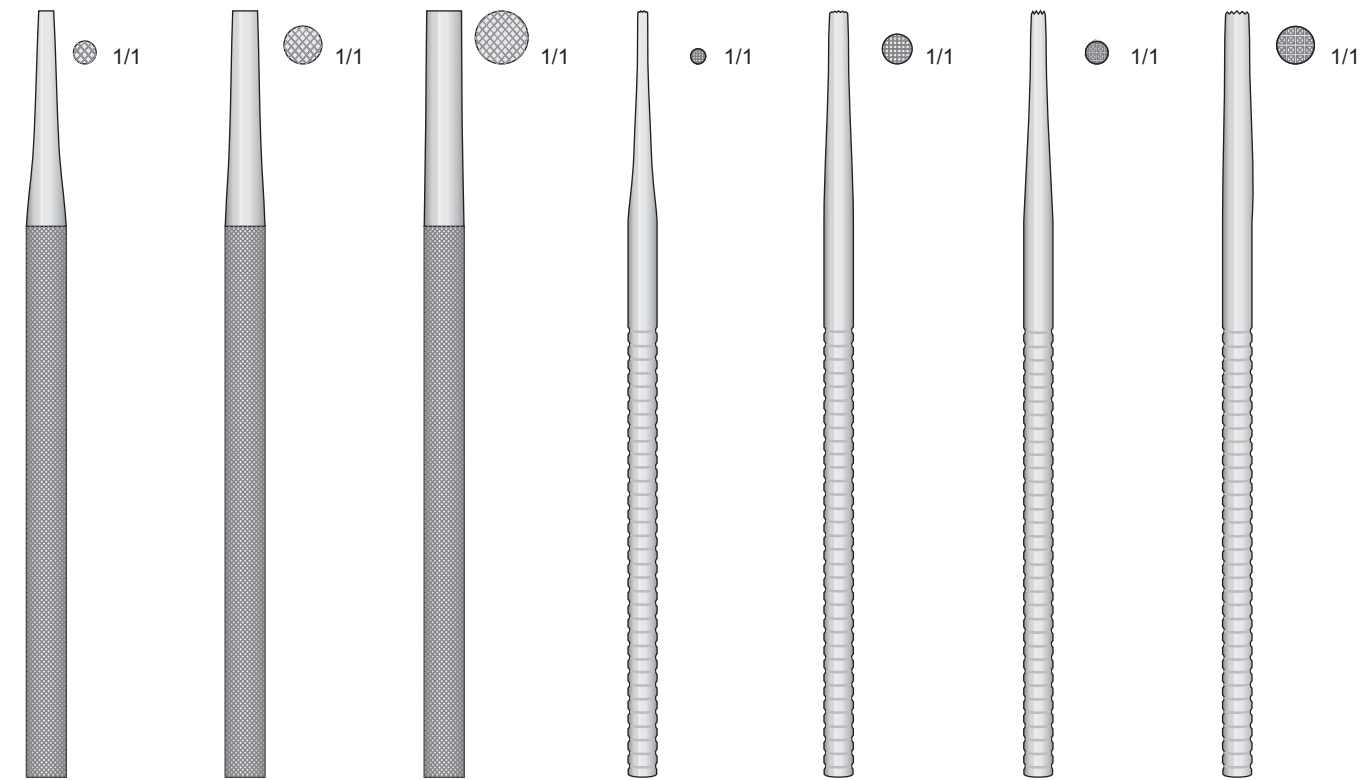

**0611-CA**  
155 mm

**0611-CB**  
155 mm

**0611-CC**  
155 mm

**0611-DA**  
155 mm

**0611-DB**  
155 mm

**0611-DD**  
155 mm

**0611-DF**  
155 mm

2 mm

4 mm

6 mm

2 mm

4 mm

6 mm

4 mm

4 mm

4 mm

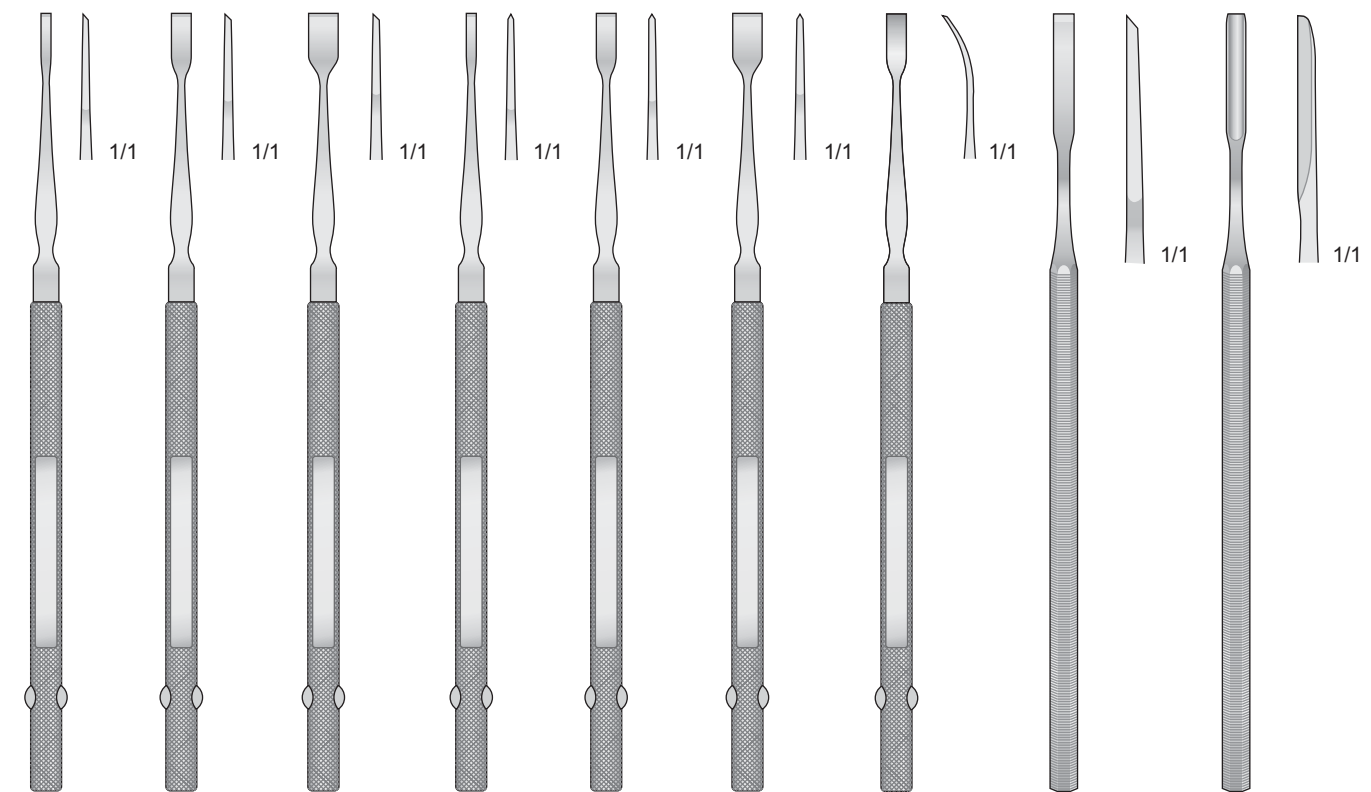

**1907-BA**  
160 mm

**1907-BB**  
160 mm

**1907-BC**  
160 mm

**1907-CA**  
160 mm

**1907-CB**  
160 mm

**1907-CC**  
160 mm

**FREER**  
**1907-CD**  
160 mm

**BUCKLEY**  
**1907-EA**  
160 mm

**BUCKLEY**  
**1907-EB**  
160 mm

Osteotomi - Osteotomes  
Osteotome - Ostéotomes - Osteótomos

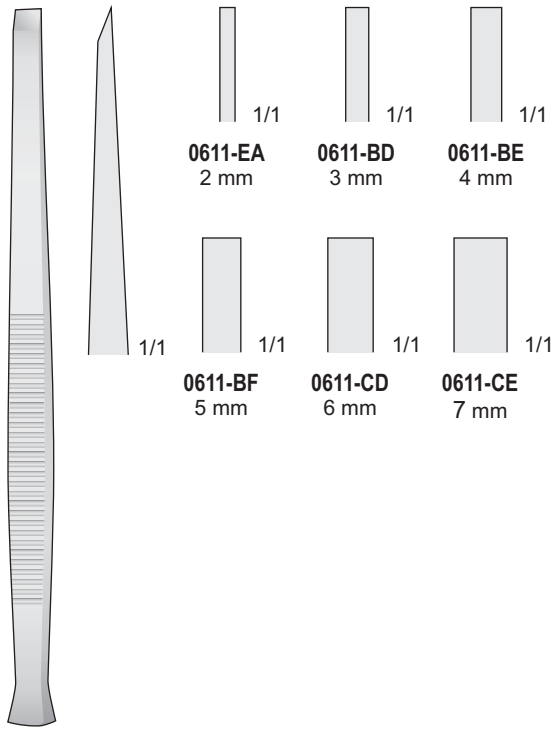

PARTSCH  
0611-BD/0611-EA  
140 mm

Sgorbie - Gouges  
Hohlmeissel - Gouges - Gubias

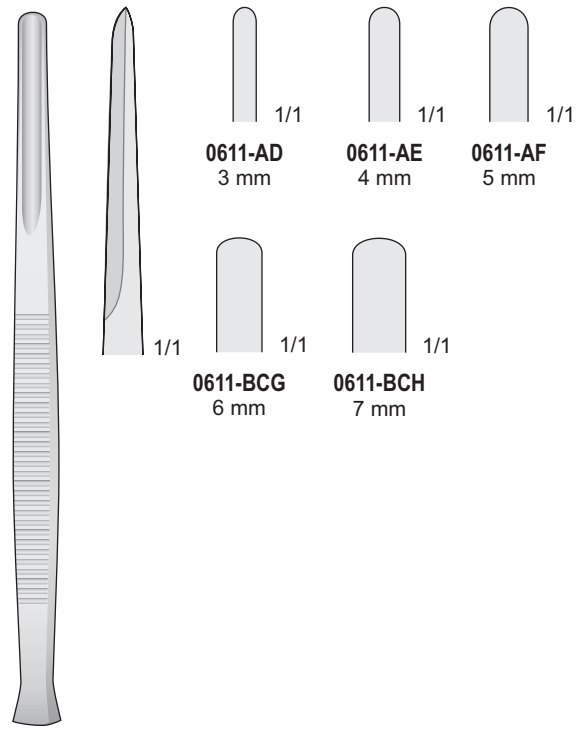

PARTSCH  
0611-AD/0611-BCH  
140 mm

Osteotomi - Osteotomes  
Osteotome - Ostéotomes - Osteótomos

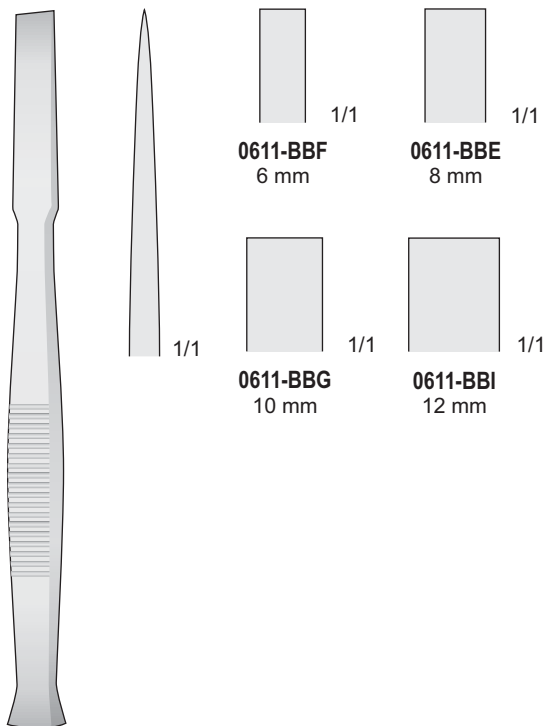

0611-BBE/0611-BBI  
140 mm

Sgorbie - Gouges  
Hohlmeissel - Gouges - Gubias

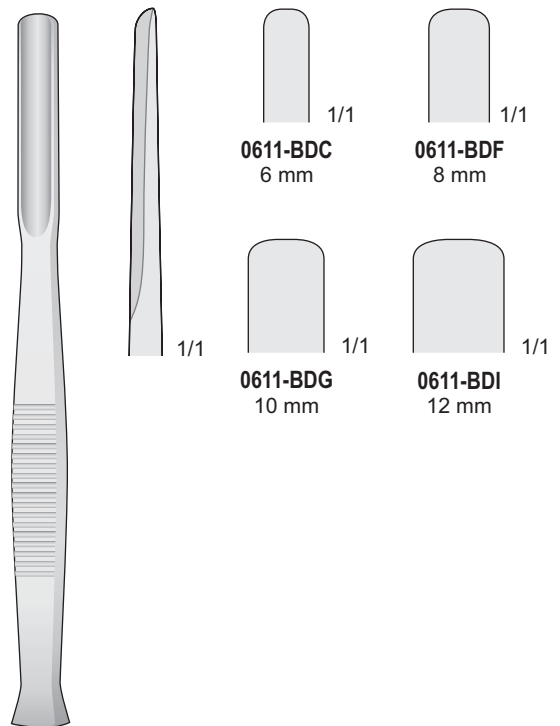

0611-BDC/0611-BDI  
140 mm

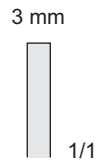

**0611-BHH**

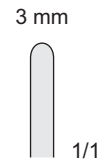

**0611-BIF**

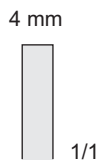

**0611-BHL**

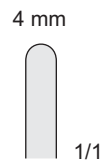

**0611-BIG**

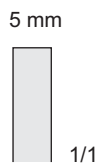

**0611-BIB**

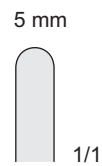

**0611-BIH**

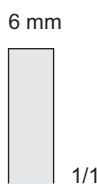

**0611-BID**

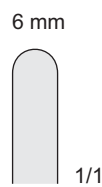

**0611-BII**

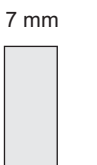

**0611-BIE**

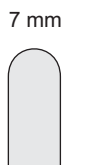

**0611-BIL**

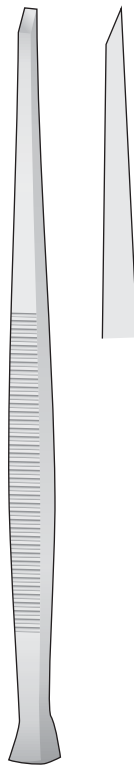

**PARTSCH**  
**0611-BHH/0611-BIE**  
170 mm

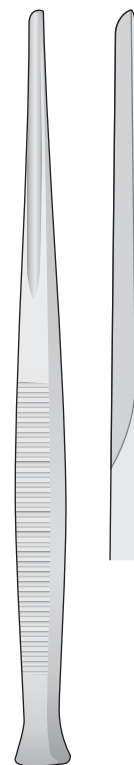

**PARTSCH**  
**0611-BIF/0611-BIL**  
170 mm

Osteotomi

Osteotomes

Osteotome

Ostéotomes

Osteótomos

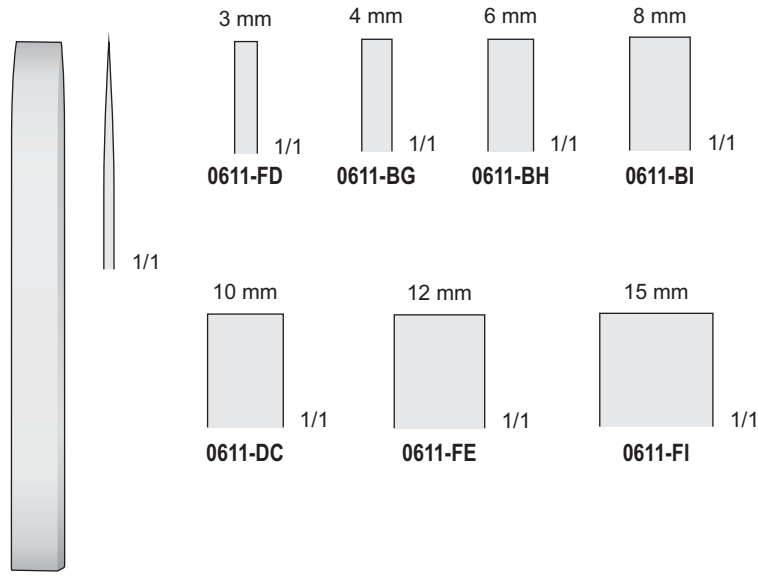

MINI-LAMBOTTE  
0611-BG/0611-FI  
125 mm

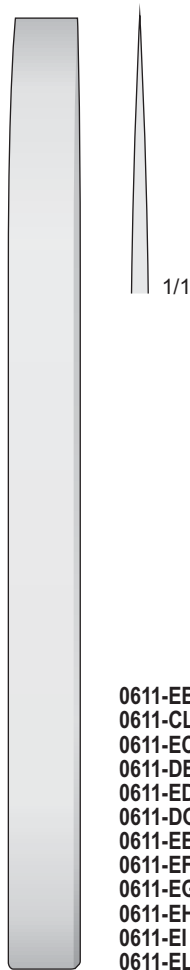

LAMBOTTE  
0611-EB/0611-EL  
250 mm

- 0611-EB 4 mm
- 0611-CL 8 mm
- 0611-EC 10 mm
- 0611-DE 13 mm
- 0611-ED 15 mm
- 0611-DG 18 mm
- 0611-EE 20 mm
- 0611-EF 25 mm
- 0611-EG 30 mm
- 0611-EH 38 mm
- 0611-EI 44 mm
- 0611-EL 50 mm

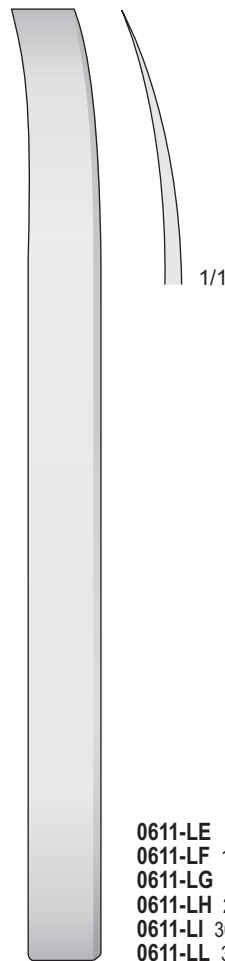

LAMBOTTE  
0611-LE/0611-LL  
250 mm

- 0611-LE 8 mm
- 0611-LF 13 mm
- 0611-LG 18 mm
- 0611-LH 25 mm
- 0611-LI 30 mm
- 0611-LL 38 mm

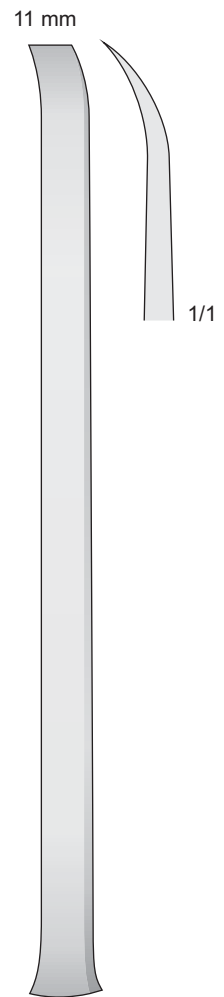

OBWEGESER  
0414-BI  
235 mm

Osteotomi

Osteotomes

Osteotome

Ostéotomes

Osteòtoms

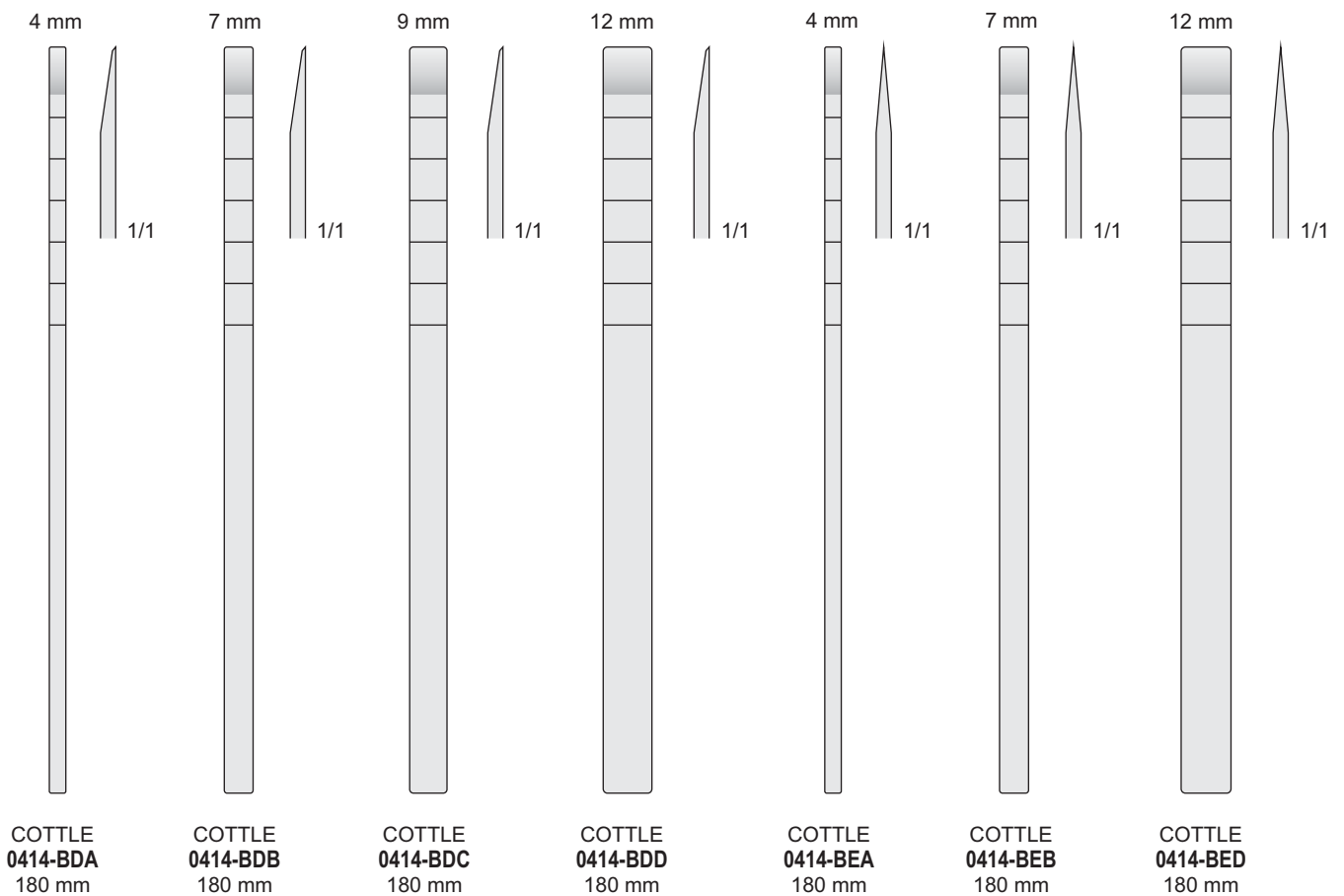
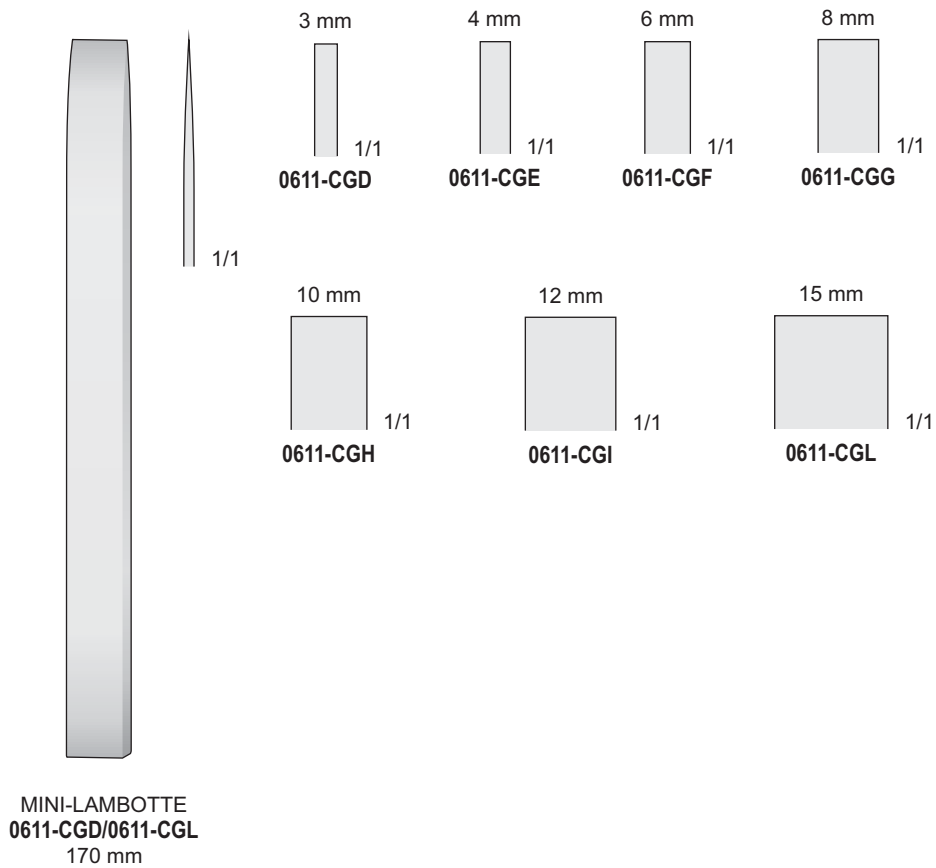



Osteotomi

Osteotomes

Osteotome

Ostéotomes

Osteotomos

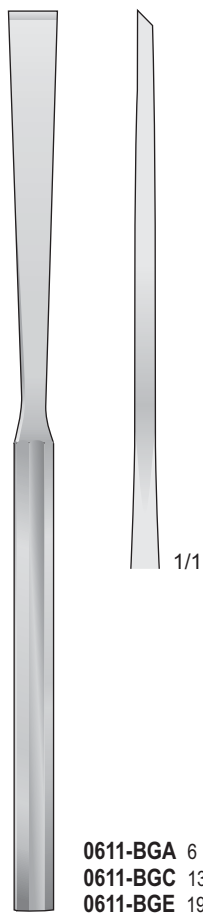

0611-BGA 6 mm  
0611-BGC 13 mm  
0611-BGE 19 mm

HIBBS  
0611-BGA/0611-BGE  
230 mm

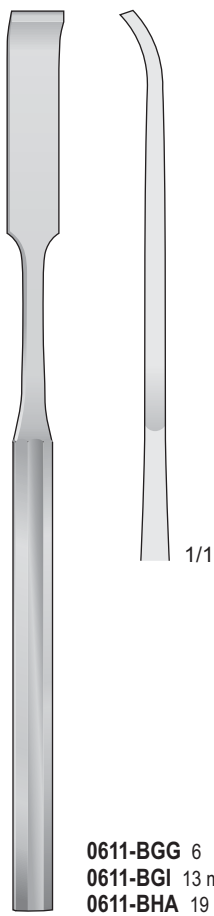

0611-BGG 6 mm  
0611-BGI 13 mm  
0611-BHA 19 mm

HIBBS  
0611-BGG/0611-BHA  
230 mm

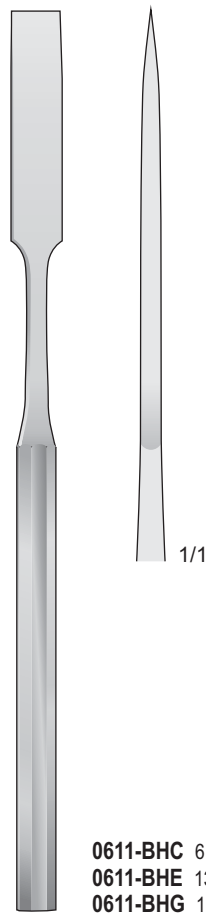

0611-BHC 6 mm  
0611-BHE 13 mm  
0611-BHG 19 mm

HIBBS  
0611-BHC/0611-BHG  
230 mm

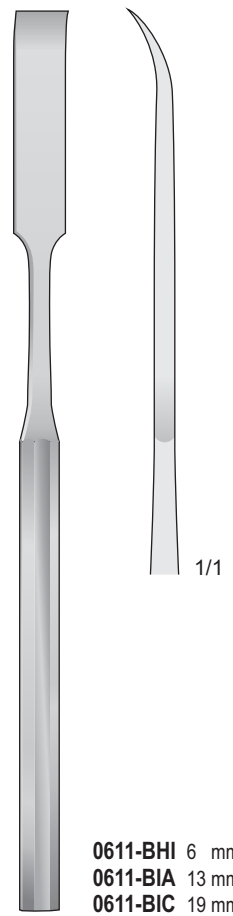

0611-BHI 6 mm  
0611-BIA 13 mm  
0611-BIC 19 mm

HIBBS  
0611-BHI/0611-BIC  
230 mm

Osteotomi

Osteotomes

Osteotome

Ostéotomes

Osteotomos



0414-BLA 4 mm  
0414-BLB 6 mm  
0414-BLC 8 mm

0414-BLD 4 mm  
0414-BLE 6 mm  
0414-BLF 8 mm

0414-BLG 6 mm  
0414-BLH 8 mm

2 mm 1/1  
0611-FL  
4 mm 1/1  
0611-GA  
6 mm 1/1  
0611-GB  
8 mm 1/1  
0611-GC

0414-BLA/0414-BLC  
180 mm

0414-BLD/0414-BLF  
180 mm

0414-BLG/0414-BLH  
180 mm

MINI-LEXER  
0611-FL/0611-GC  
200 mm

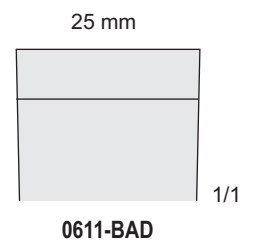
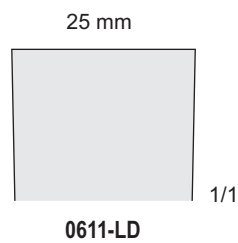
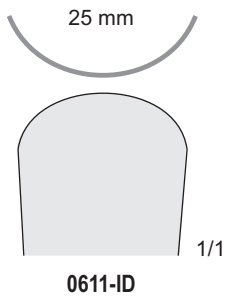
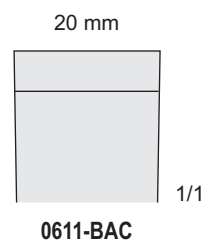
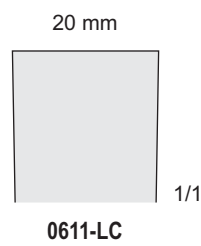
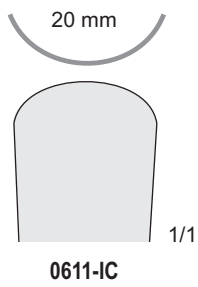
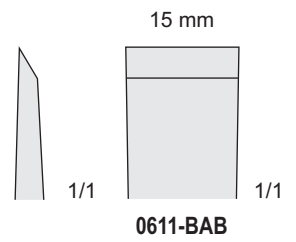
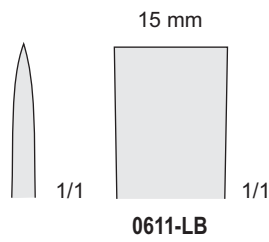
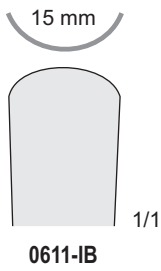
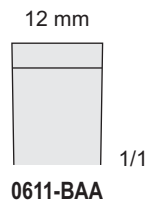
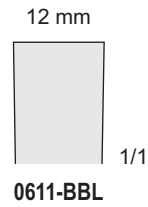
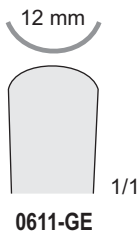
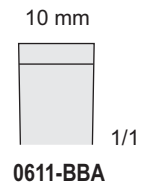
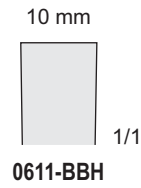
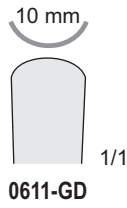

STILLE  
**0611-GD/0611-ID**  
200 mm



STILLE  
**0611-LB/0611-BBL**  
200 mm

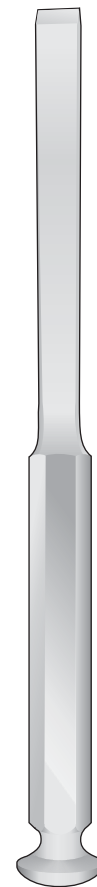

STILLE  
**0611-BAA/0611-BBA**  
200 mm

















Osteotomi

Osteotomes

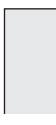
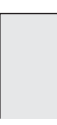
Osteotome

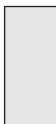
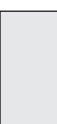
Ostéotomes

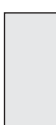
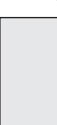
Osteótomos

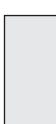
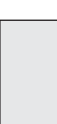
<p>6 mm</p>  <p>1/1</p> <p><b>0611-DEA</b></p>	<p>6 mm</p>  <p>1/1</p> <p><b>0611-DEH</b></p>		
<p>9 mm</p>  <p>1/1</p> <p><b>0611-DEB</b></p>	<p>9 mm</p>  <p>1/1</p> <p><b>0611-DEI</b></p>		
<p>13 mm</p>  <p>1/1</p> <p><b>0611-DEC</b></p>	<p>13 mm</p>  <p>1/1</p> <p><b>0611-DEL</b></p>	 <p>1/1</p>	 <p>1/1</p>
<p>16 mm</p>  <p>1/1</p> <p><b>0611-DED</b></p>	<p>16 mm</p>  <p>1/1</p> <p><b>0611-DFA</b></p>	<p>9 mm</p>  <p>1/1</p> <p><b>0611-DFE</b></p>	<p>9 mm</p>  <p>1/1</p> <p><b>0611-DFL</b></p>
<p>19 mm</p>  <p>1/1</p> <p><b>0611-DEE</b></p>	<p>19 mm</p>  <p>1/1</p> <p><b>0611-DFB</b></p>	<p>13 mm</p>  <p>1/1</p> <p><b>0611-DFE</b></p>	<p>13 mm</p>  <p>1/1</p> <p><b>0611-DFL</b></p>
<p>25 mm</p>  <p>1/1</p> <p><b>0611-DEF</b></p>	<p>25 mm</p>  <p>1/1</p> <p><b>0611-DFC</b></p>	<p>19 mm</p>  <p>1/1</p> <p><b>0611-DFE</b></p>	<p>19 mm</p>  <p>1/1</p> <p><b>0611-DFL</b></p>
<p>32 mm</p>  <p>1/1</p> <p><b>0611-DEG</b></p>	<p>32 mm</p>  <p>1/1</p> <p><b>0611-DFD</b></p>	<p>25 mm</p>  <p>1/1</p> <p><b>0611-DFE</b></p>	<p>25 mm</p>  <p>1/1</p> <p><b>0611-DFL</b></p>
<p>SMITH-PETERSEN 0611-DEA/0611-DEG 200 mm</p>	<p>SMITH-PETERSEN 0611-DEH/0611-DFD 200 mm</p>	<p>SMITH-PETERSEN 0611-DFE/0611-DFH 200 mm</p>	<p>SMITH-PETERSEN 0611-DFL/0611-DGC 200 mm</p>

Osteotomi

Osteotomes

Osteotome

Ostéotomes

Osteótomos

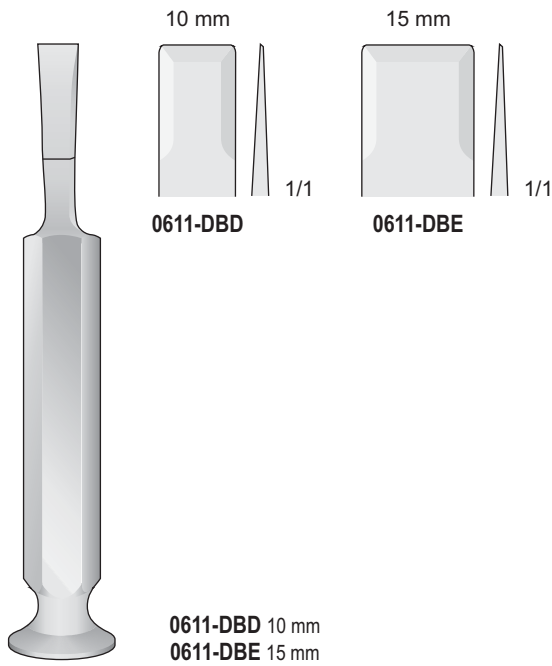

TESSIER  
0611-DBD/0611-DBE  
160 mm

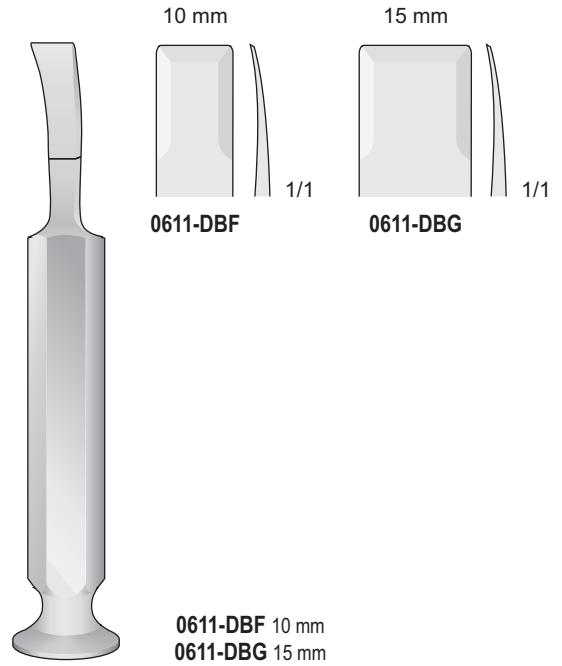

TESSIER  
0611-DBF/0611-DBG  
160 mm

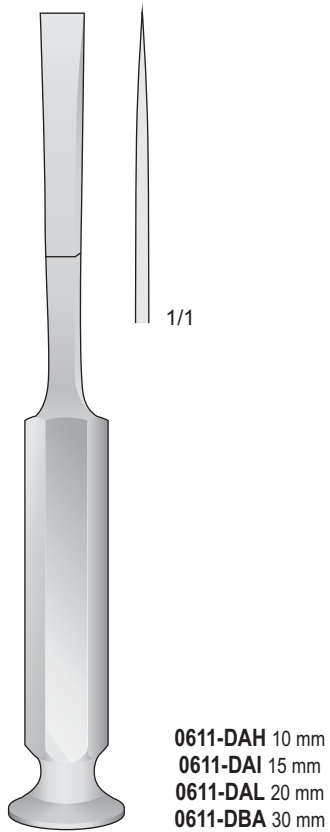

TESSIER  
0611-DAH/0611-DBA  
200 mm

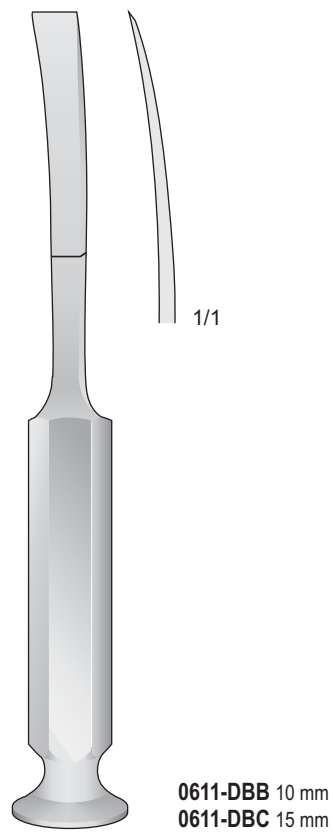

TESSIER  
0611-DBB/0611-DBC  
200 mm

**0611-LA**

Set completo di  
Set complete with  
Komplettset mit  
Set complet avec  
Set completo con

<p>1 Manico portalama in ferrozell 1 With Ferrozell handle 1 Mit Ferrozellgriff 1 Avec poignée en Ferrozell 1 Con mango de Ferrozell</p>	<p>4 Lame Fig. 1-2-3-4 4 Blades Fig. 1-2-3-4 4 Klingen Fig. 1-2-3-4 4 Lames Fig. 1-2-3-4 4 Hojas Fig. 1-2-3-4</p>	<p>1 Chiave ferma lama 1 Key to hold on blade 1 Schlüssel zum klingen anziehen 1 Clef ferme lame 1 Clave ferma hoja</p>
--	---	---

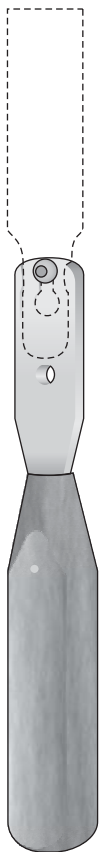

**0611-IF**  
190 mm

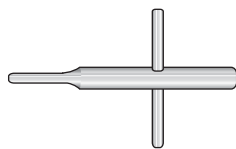

**0611-IE**  
90 mm

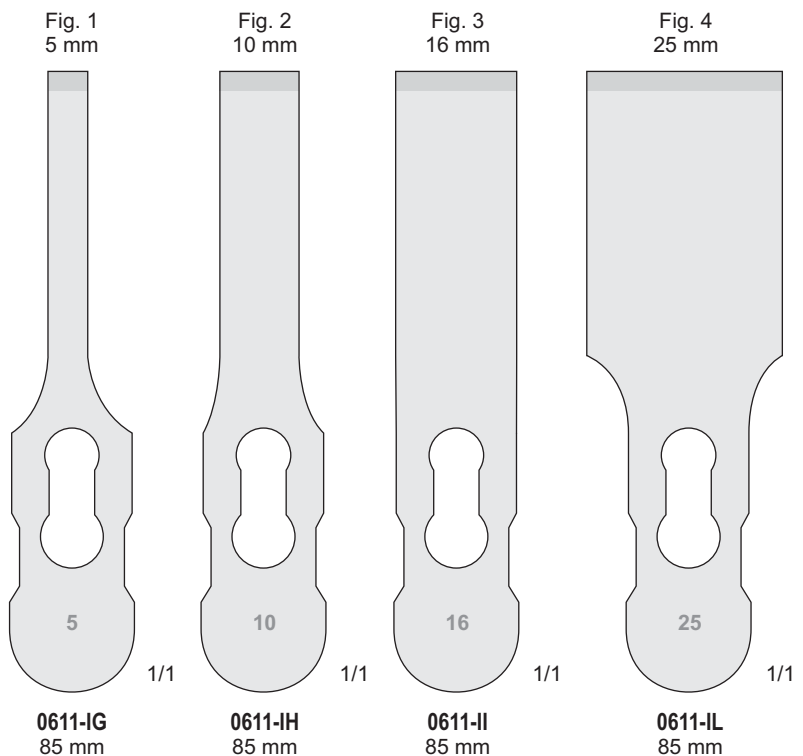

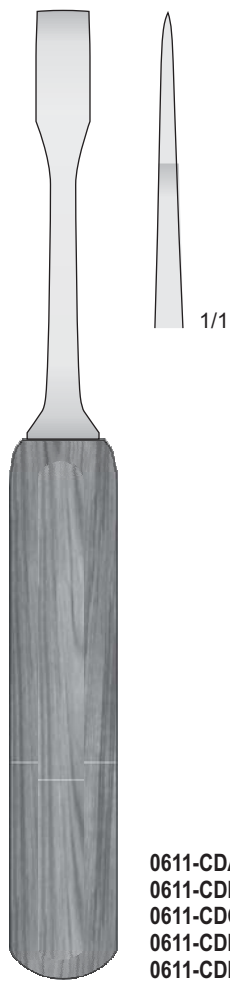

- 0611-CDA 4 mm
- 0611-CDB 6 mm
- 0611-CDC 8 mm
- 0611-CDD 10 mm
- 0611-CDE 12 mm

MINI-LEXER  
0611-CDA/0611-CDE  
180 mm

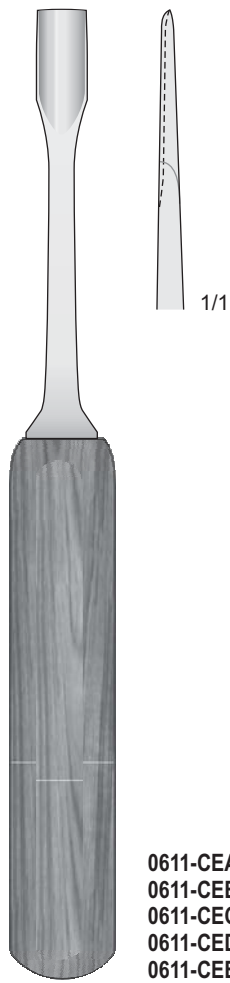

- 0611-CEA 4 mm
- 0611-CEB 6 mm
- 0611-CEC 8 mm
- 0611-CED 10 mm
- 0611-CEE 12 mm

MINI-LEXER  
0611-CEA/0611-CEE  
180 mm



- 0611-BLA 4 mm
- 0611-BLB 6 mm
- 0611-BLC 8 mm
- 0611-BLD 10 mm
- 0611-BLE 12 mm

LEXER  
0611-BLA/0611-BLE  
180 mm

Osteotomi

Osteotomes

Osteotome

Ostéotomes

Osteòtoms

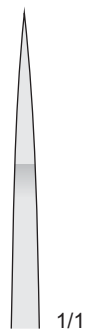

1/1

- 0611-CBA 5 mm
- 0611-CBB 7 mm
- 0611-CBC 10 mm
- 0611-CBD 15 mm
- 0611-CBE 20 mm
- 0611-CBF 25 mm
- 0611-CBG 30 mm

LEXER  
0611-CBA/0611-CBG  
220 mm

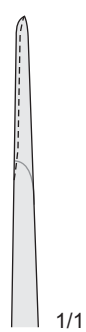

1/1

- 0611-CCA 5 mm
- 0611-CCB 7 mm
- 0611-CCC 10 mm
- 0611-CCD 15 mm
- 0611-CCE 20 mm
- 0611-CCF 25 mm
- 0611-CCG 30 mm

LEXER  
0611-CCA/0611-CCG  
220 mm

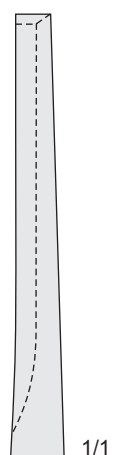
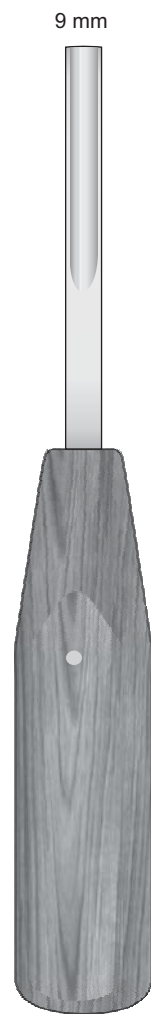

1/1

9 mm

0611-CHC  
220 mm



Osteotomi

Osteotomes

Osteotome

Ostéotomes

Osteòtomos

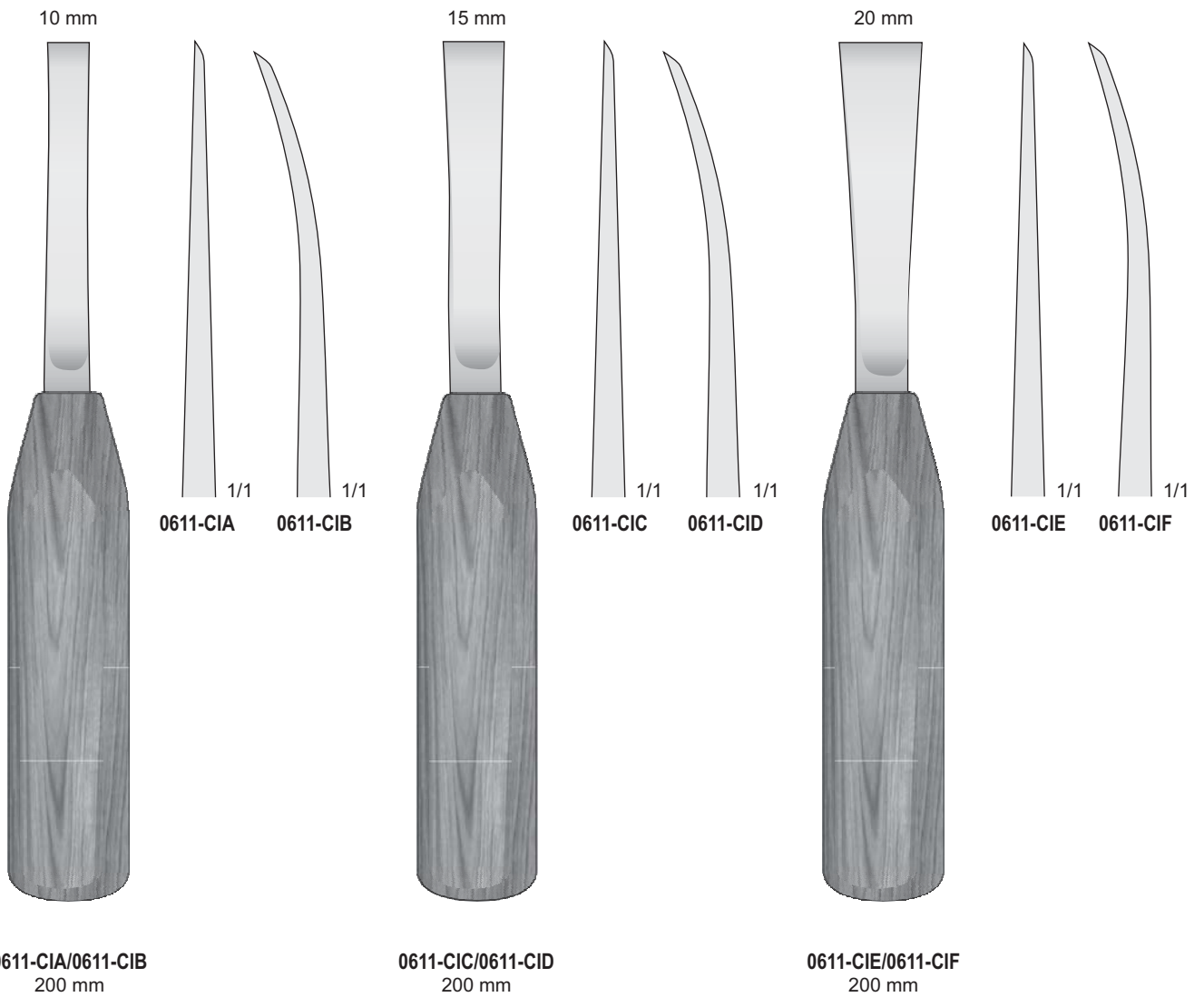

Osteotomi

Osteotomes

Osteotome

Ostéotomes

Osteótomos

Sgorbie - Gouges  
Hohlmeissel - Gouges - Gubias

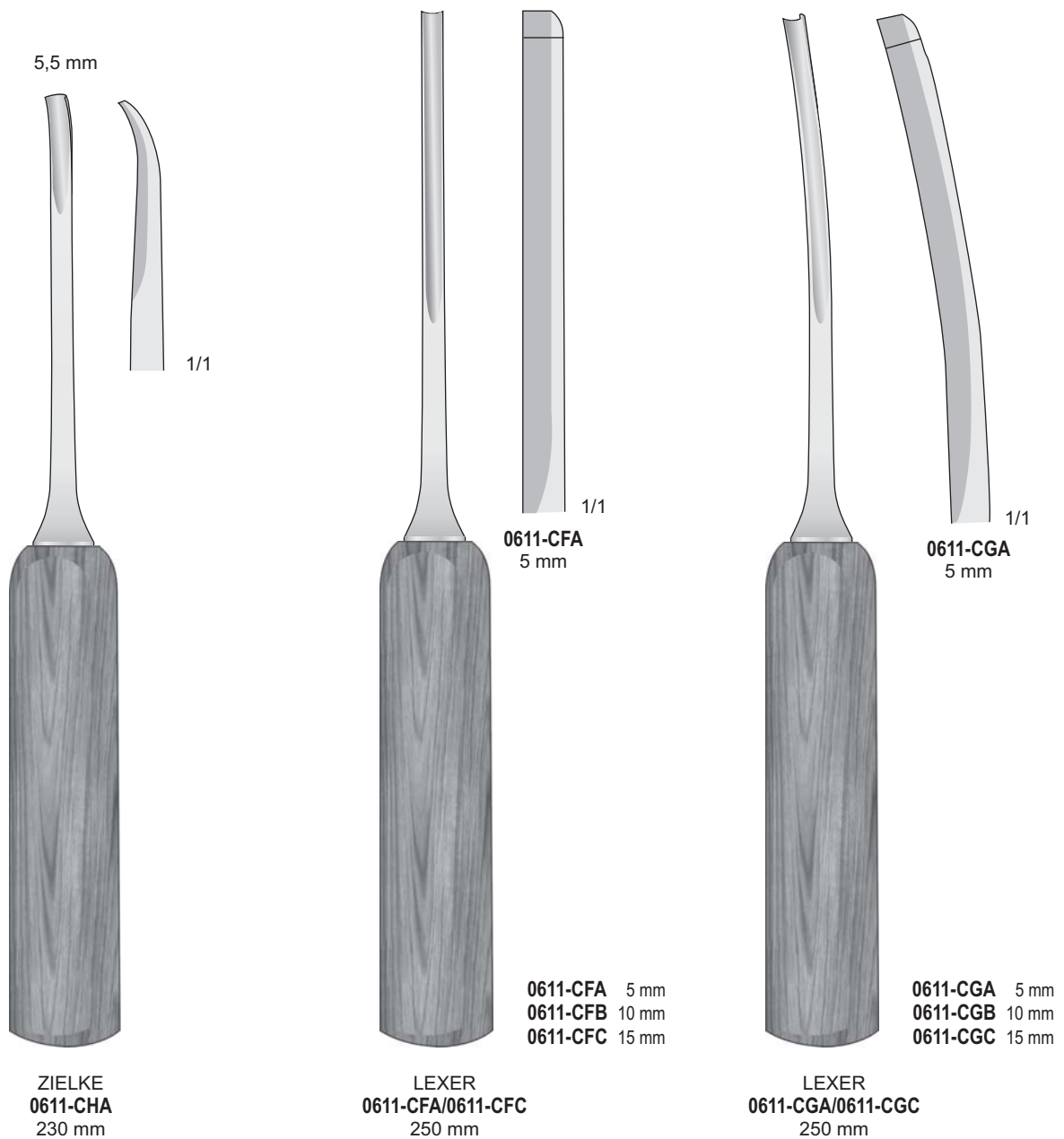

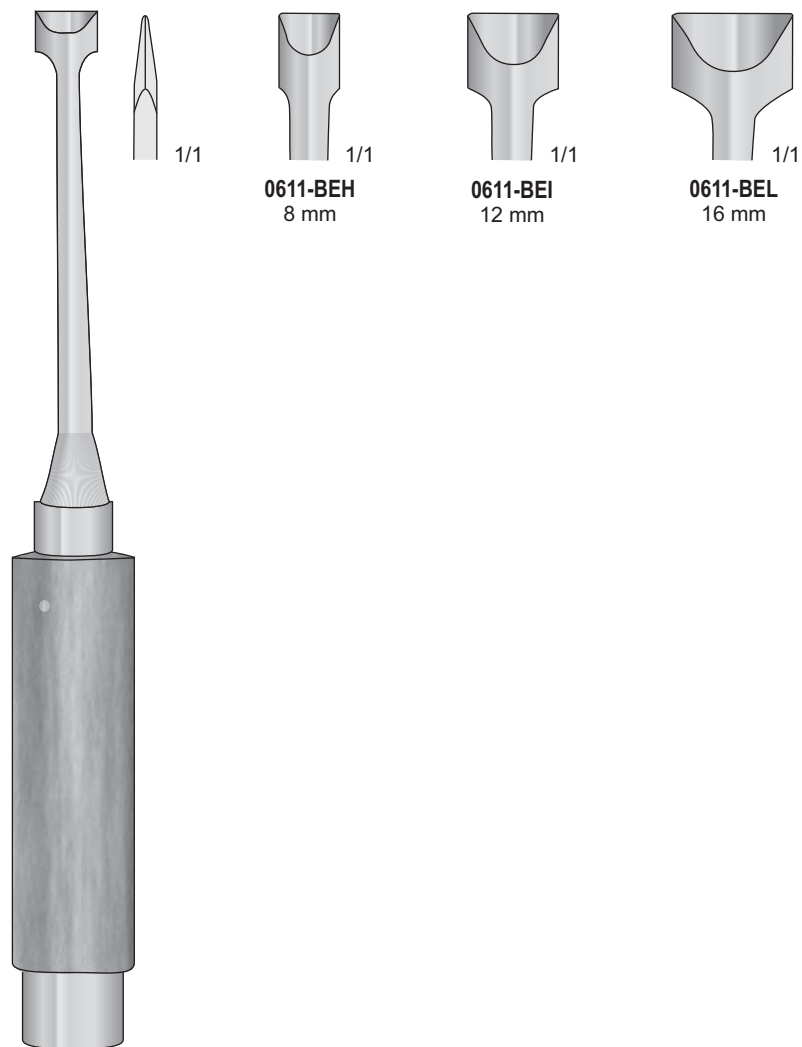

OBWEGESER  
0611-BEH/0611-BEL  
220 mm

Osteotomi

Osteotomes

Osteotome

Ostéotomes

Osteõtomas

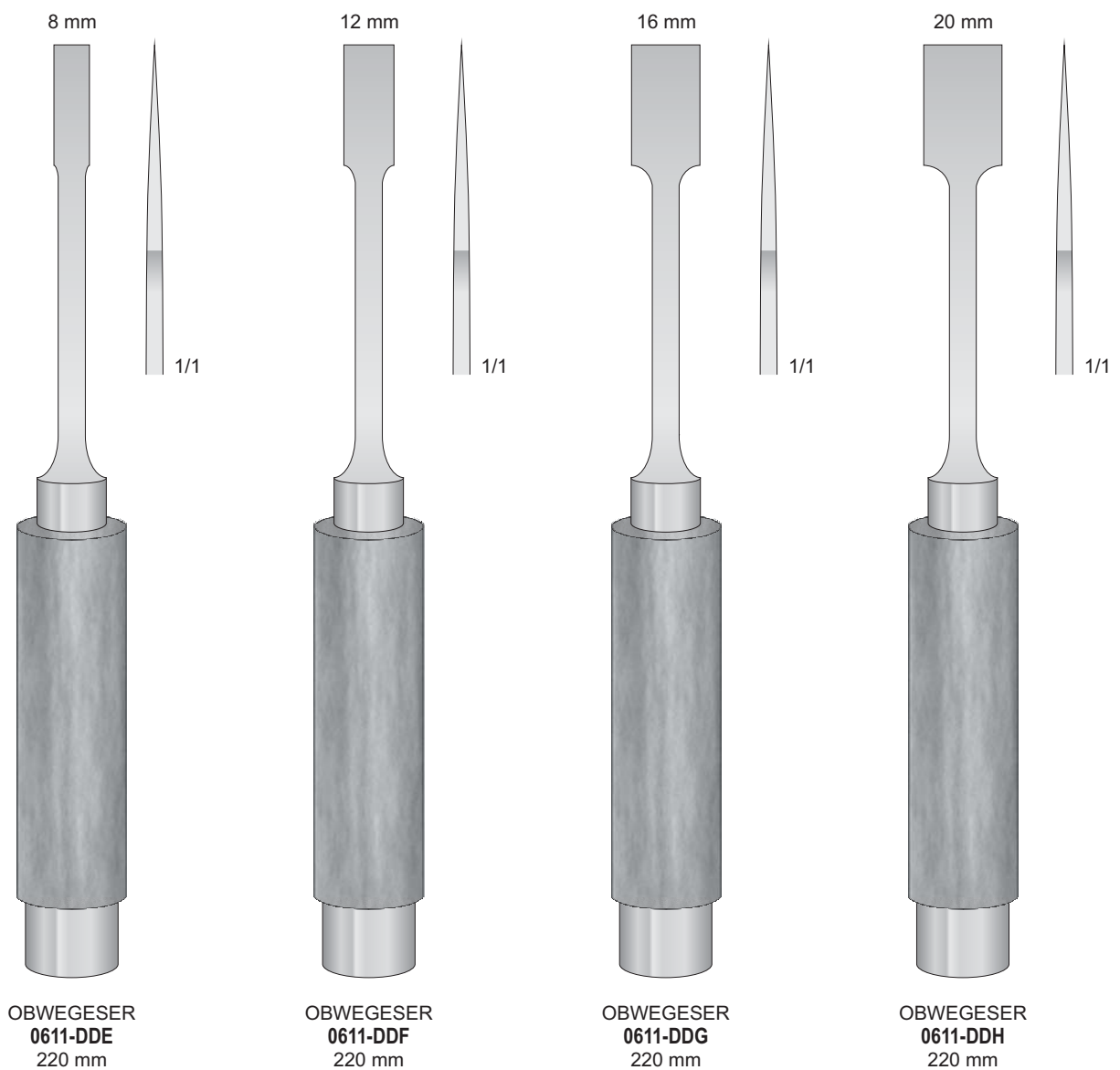



ideal-tek

manufacturer & supplier of precision instruments 



13

Laminotomi, Pinze ossivore  
Laminectomy, Bone rongeurs  
Laminektomie, Hohlmeisselzangen  
Laminectomy, Pincés Gouges  
Laminectomia, Pinzas Gubias



Punches - Stanzen

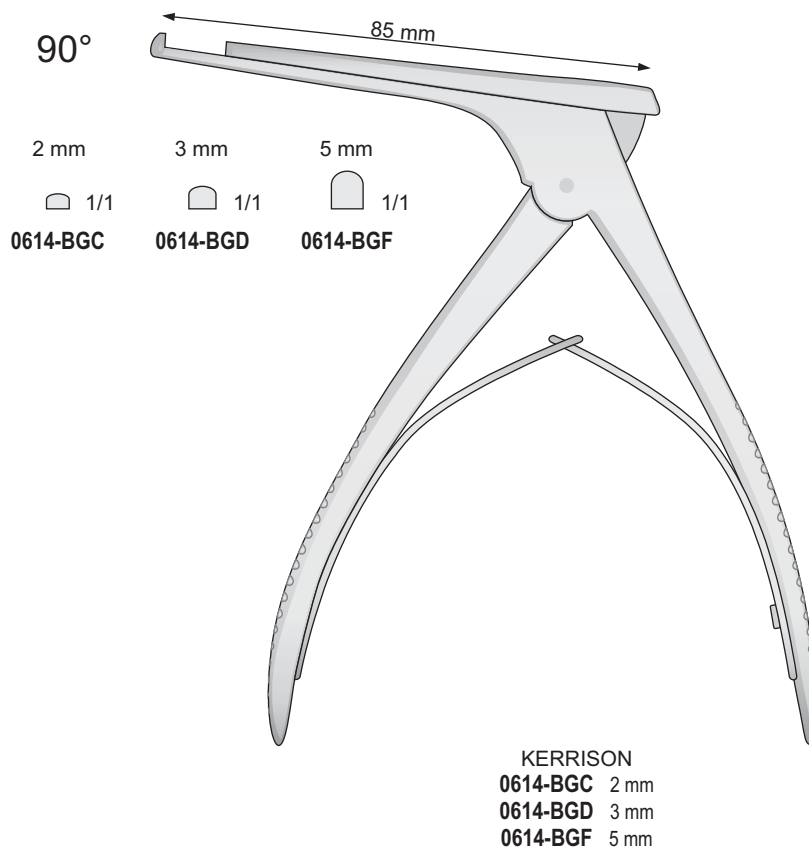
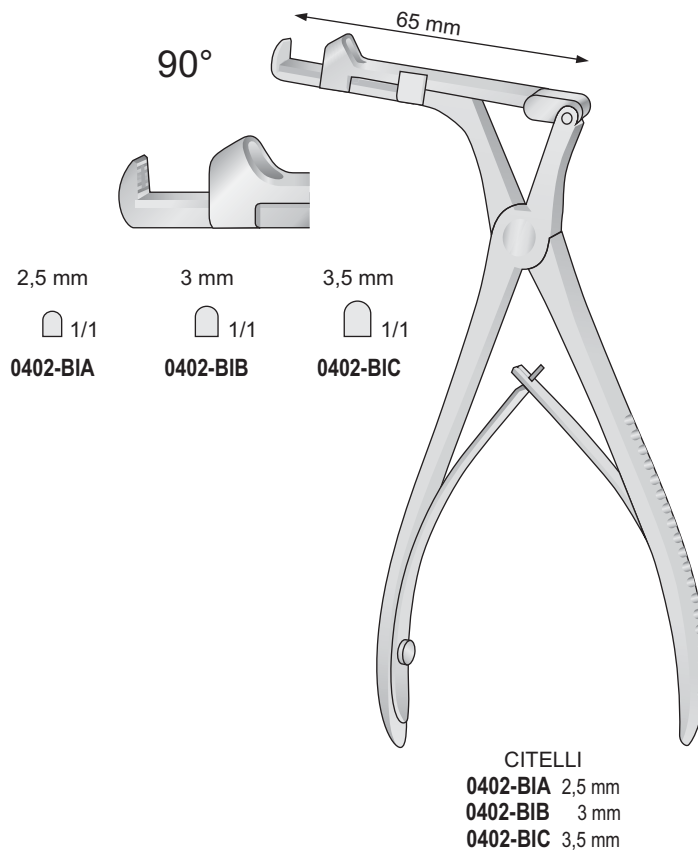

Laminectomia

Laminectomy

Laminektomie

Laminectomie

Laminectomia

Punches - Stanzen

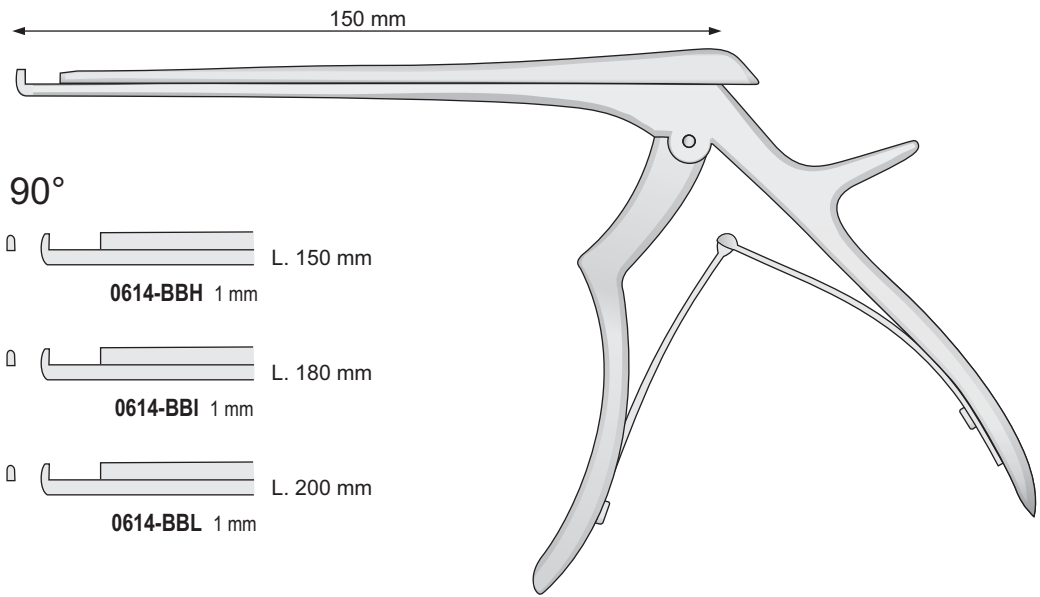

FERRIS-SMITH-KERRISON  
0614-BBH/0614-BBL

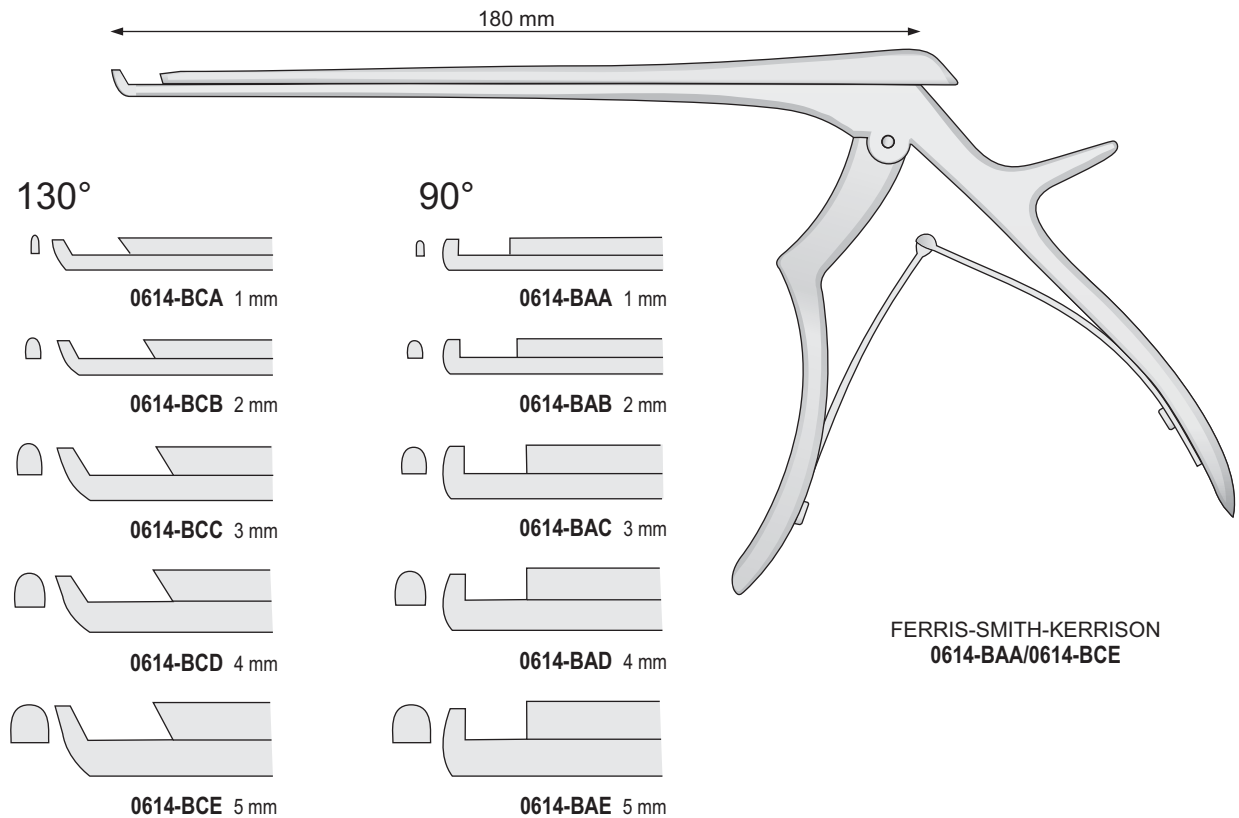

FERRIS-SMITH-KERRISON  
0614-BAA/0614-BCE



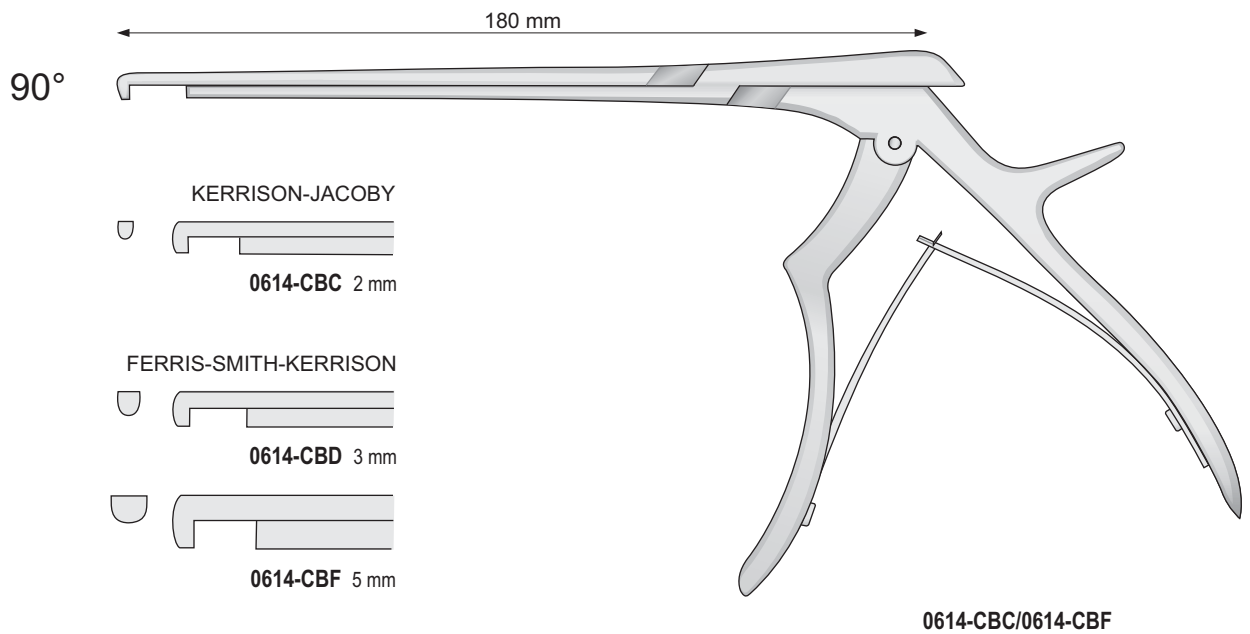
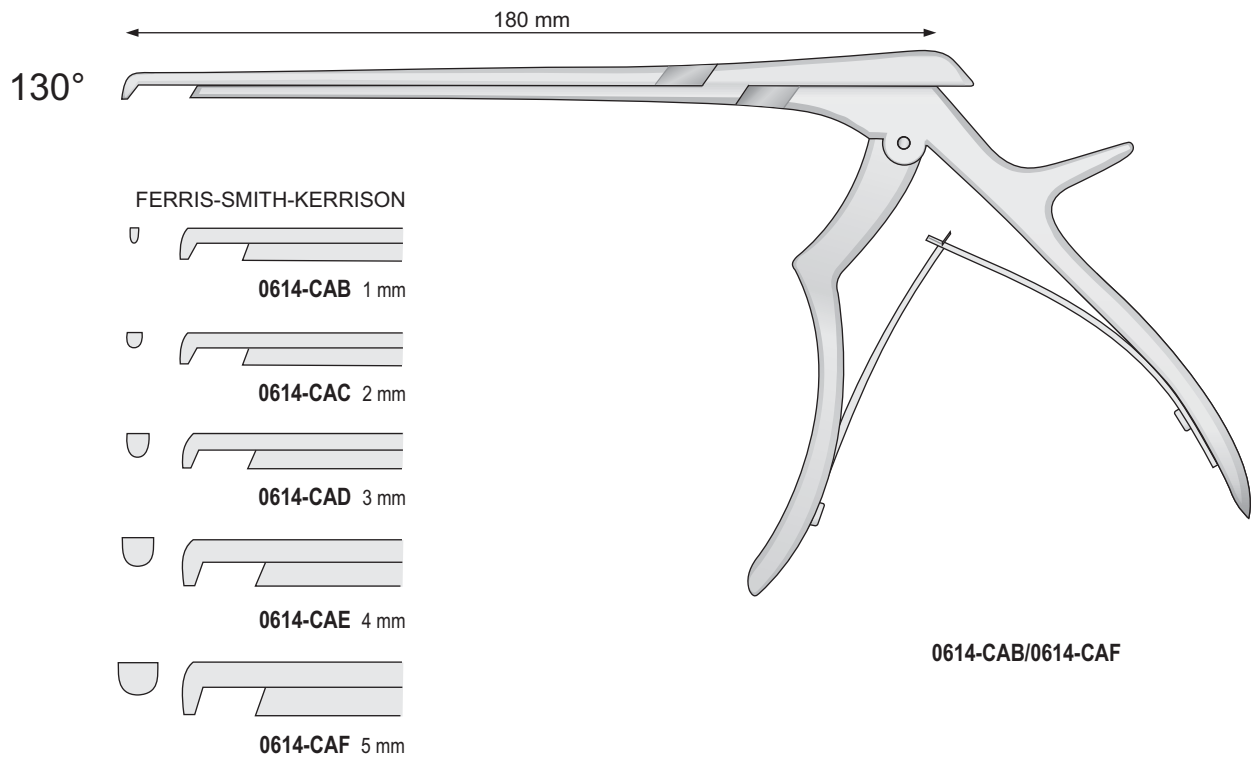

Laminectomia

Laminectomy

Laminektomie

Laminectomie

Laminectomia

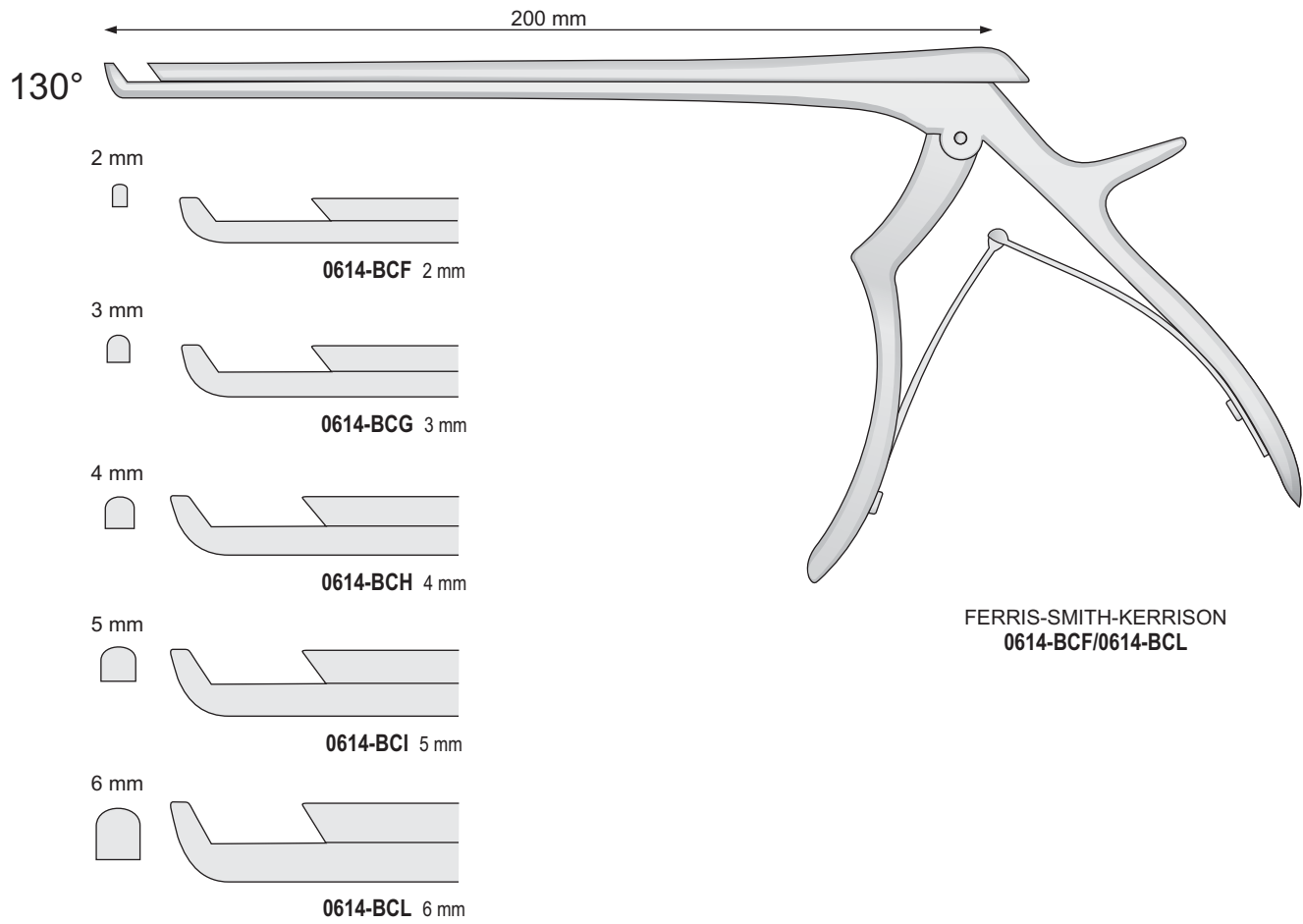

Laminotomo cervicale - Cervical Laminectomy

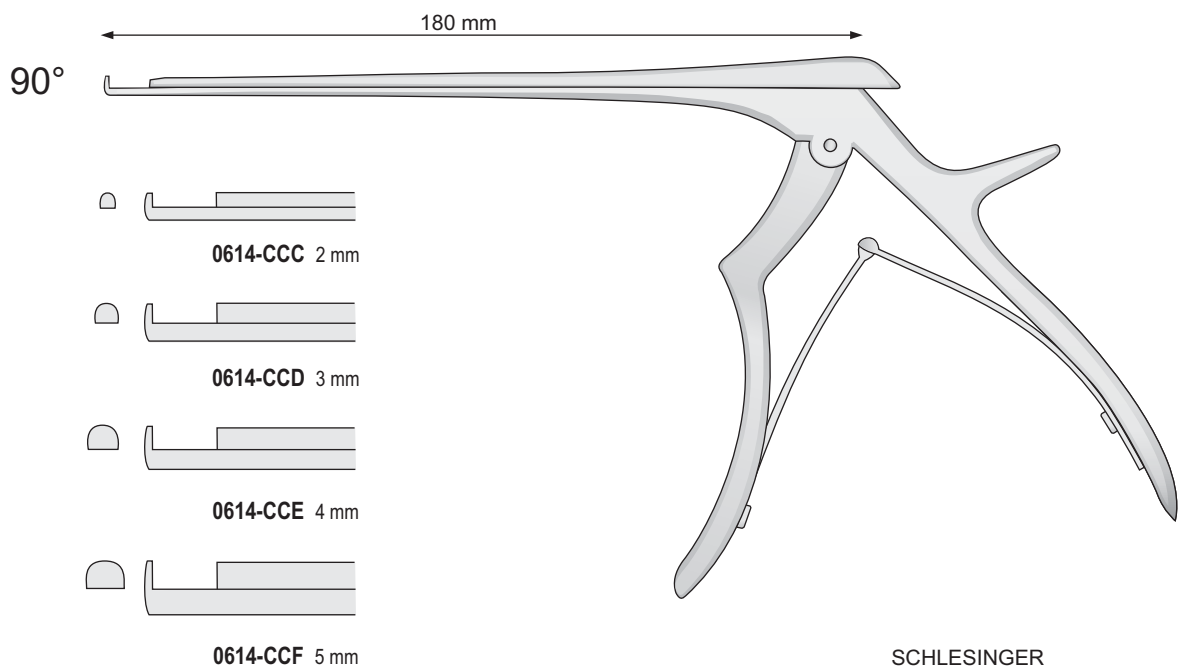

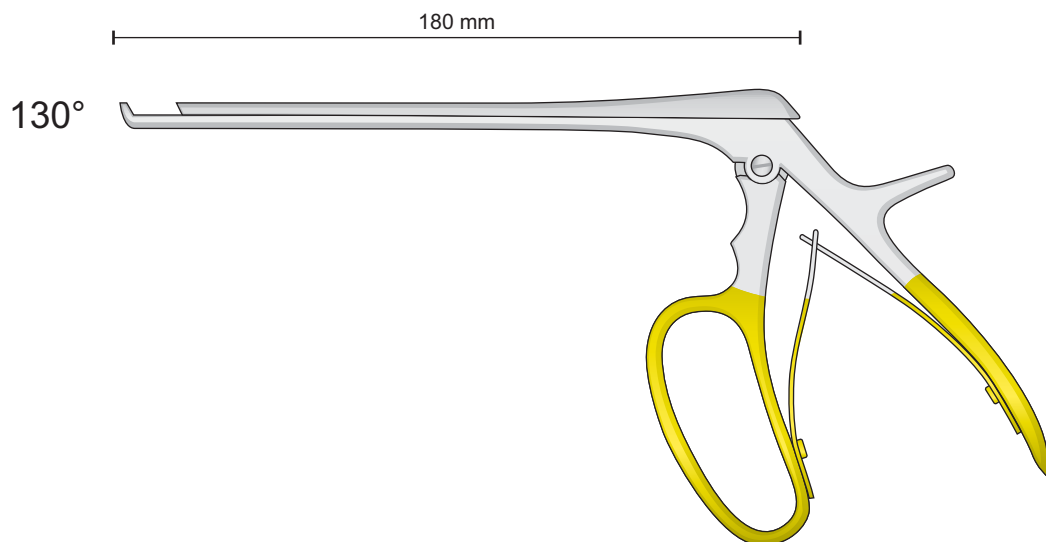
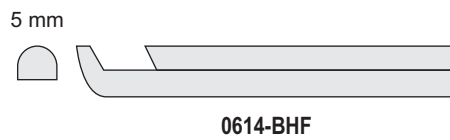
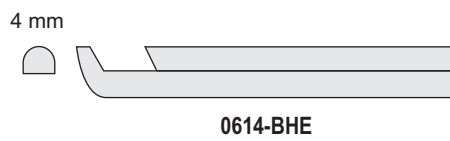
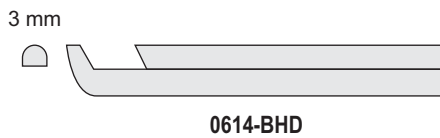
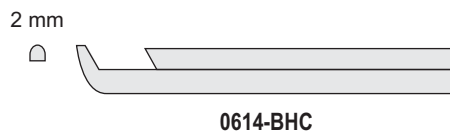
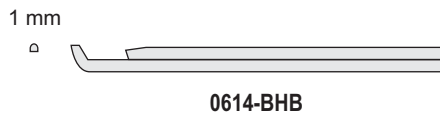

FERRIS - SMITH - KERRISON  
0614-BHB/0614-BHF

Laminectomia

Laminectomy

Laminektomie

Laminectomie

Laminectomia

Diritta  
Stright  
Gerade  
Droites  
Rectas

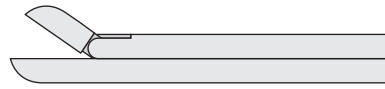

-  **0614-BIA** 2 x 10 mm
-  **0614-BIB** 3 x 10 mm
-  **0614-BIC** 4 x 10 mm
-  **0614-BID** 6 x 12 mm

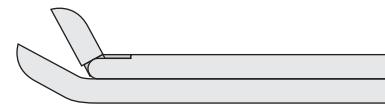

Curva verso l'alto  
Top curved  
Aufwärtsgebogen  
Courbe vers le haut  
Curvos

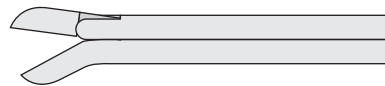

-  **0614-BIE** 2 x 10 mm
-  **0614-BIF** 3 x 10 mm
-  **0614-BIG** 4 x 10 mm

Curva verso il basso  
Bottom curved  
Abwärts gebogen  
Courbe vers le bas  
Curvos



-  **0614-BIH** 2 x 10 mm
-  **0614-BII** 3 x 10 mm
-  **0614-BIL** 4 x 10 mm

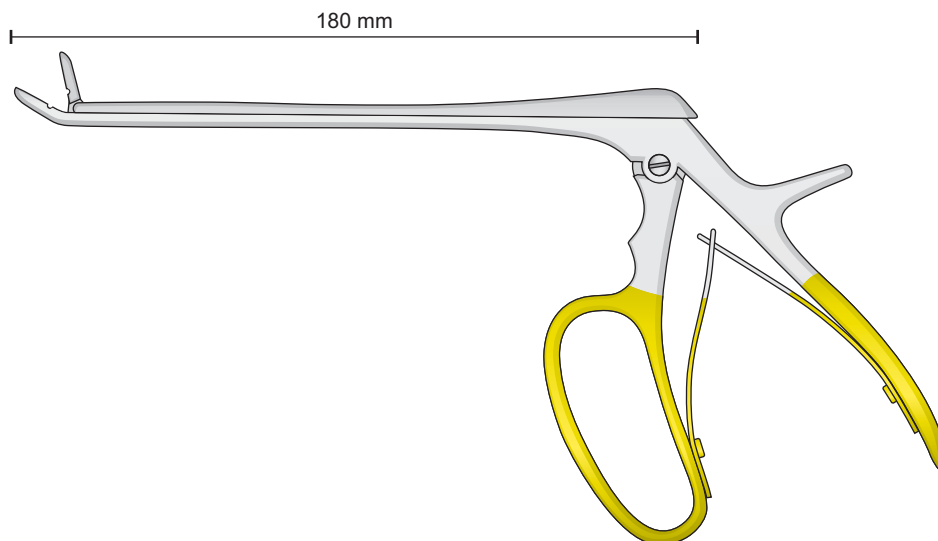

FERRIS - SMITH - CUSHING  
0614-BIA/0614-BIL

Pinze per biopsia

Laminectomy rongeurs

Laminectomy Rongeur

Pincas a laminectomia

Pinzas cortantes para laminectomia

Rongeurs - Rongeur

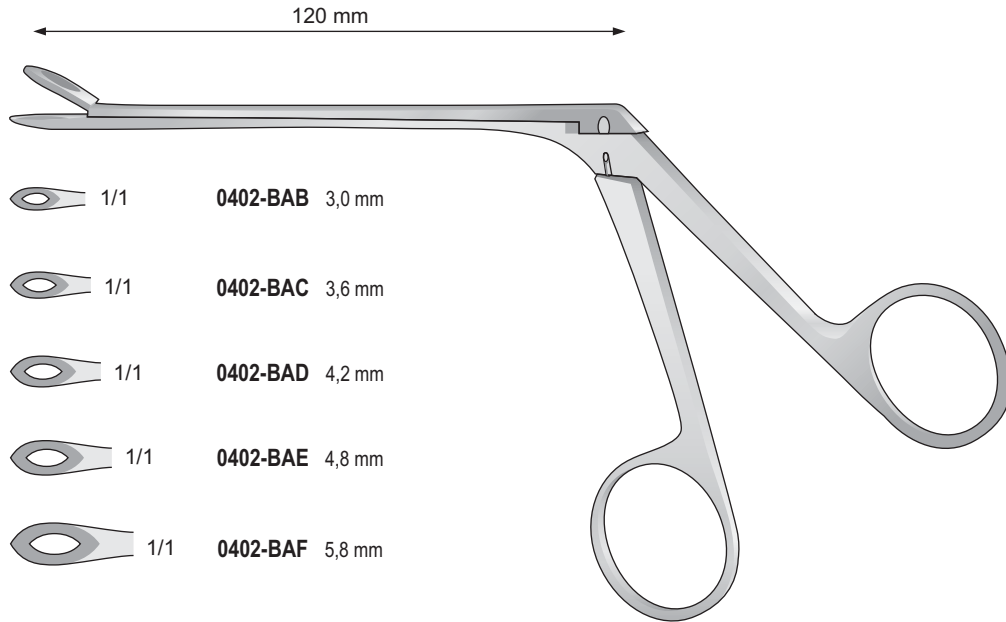

WEIL-BLAKESLEY  
0402-BAB/0402-BAF  
190 mm

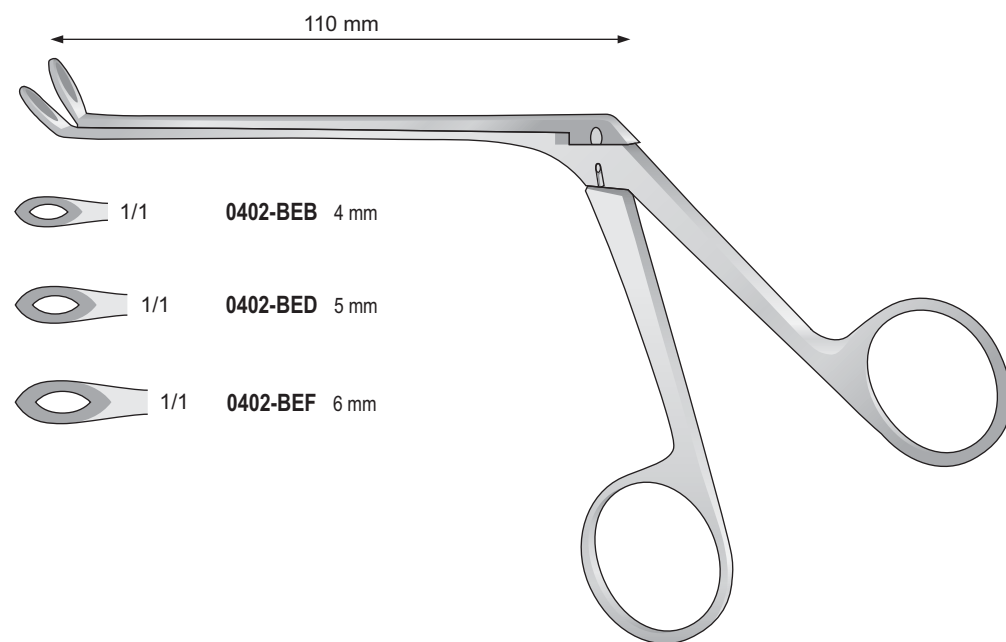

WEIL-BLAKESLEY  
0402-BEB/0402-BEF  
190 mm

Pinze  
per biopsia

Laminectomy  
rongeurs

Laminectomy  
Rongeur

Pinces a  
laminectomia

Pinzas cortantes  
para laminectomia

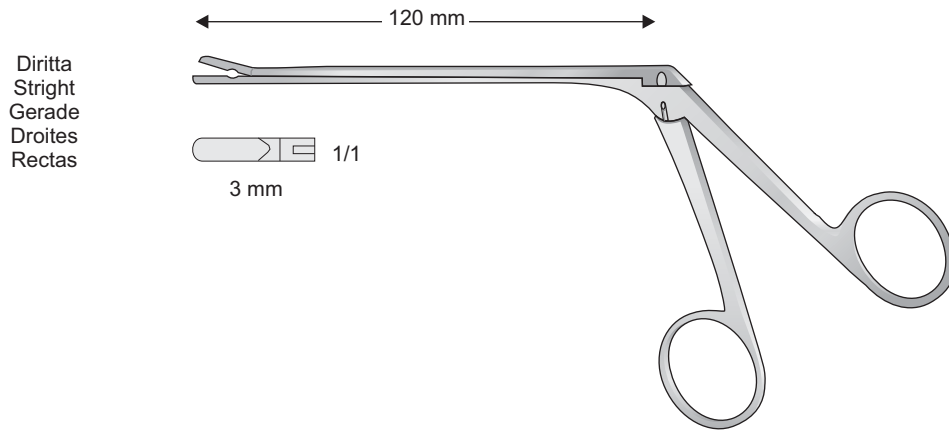

TAKAHASHI  
0606-HA

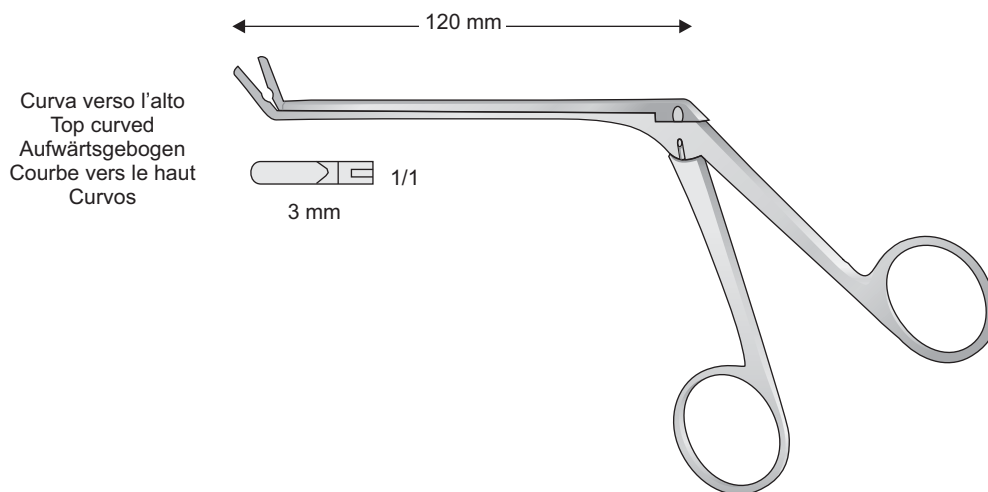

TAKAHASHI  
0606-HB

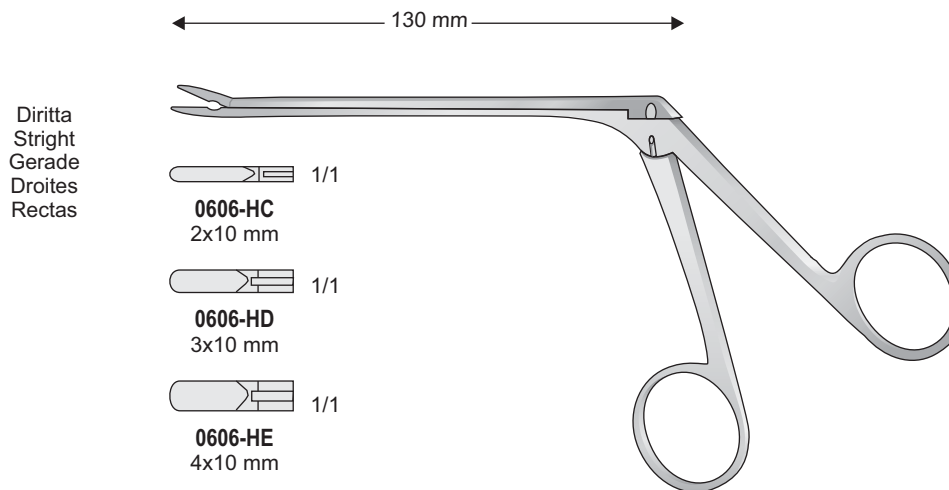

LOVE-GRUENWALD  
0606-HC/0606-HE

Pinze  
per biopsia

Laminectomy  
rongeurs

Laminectomy  
Rongeur

Pincas a  
laminectomia

Pinzas cortantes  
para laminectomia

Diritta  
Stright  
Gerade  
Droites  
Rectas

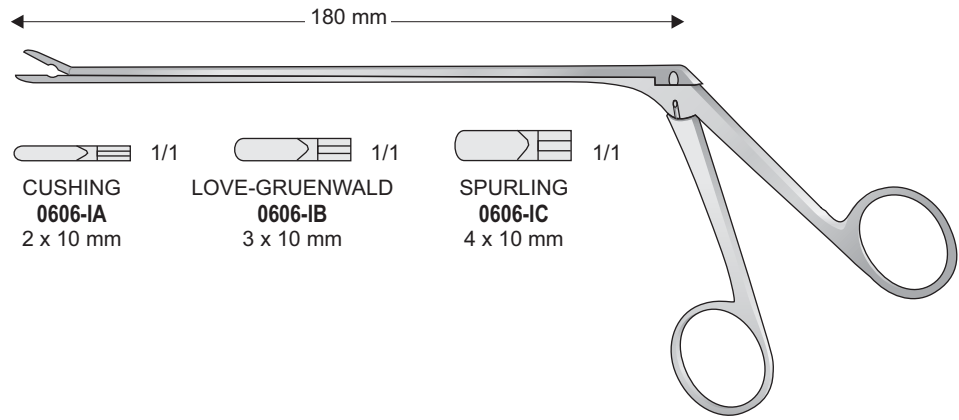

CUSHING  
**0606-IA**  
2 x 10 mm

LOVE-GRUENWALD  
**0606-IB**  
3 x 10 mm

SPURLING  
**0606-IC**  
4 x 10 mm

0606-IA/0606-IC

Curva verso l'alto  
Top curved  
Aufwärtsgebogen  
Courbe vers le haut  
Curvos

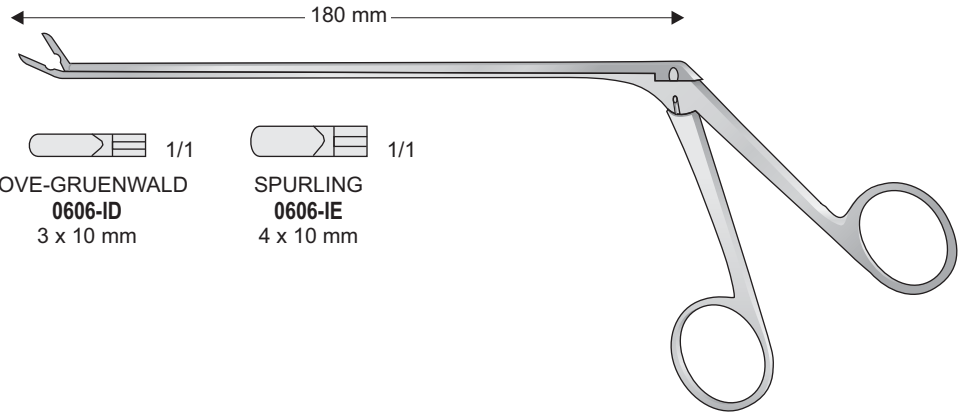

LOVE-GRUENWALD  
**0606-ID**  
3 x 10 mm

SPURLING  
**0606-IE**  
4 x 10 mm

0606-ID/0606-IE

Curva verso il basso  
Bottom curved  
Abwärts gebogen  
Courbe vers le bas  
Curvos

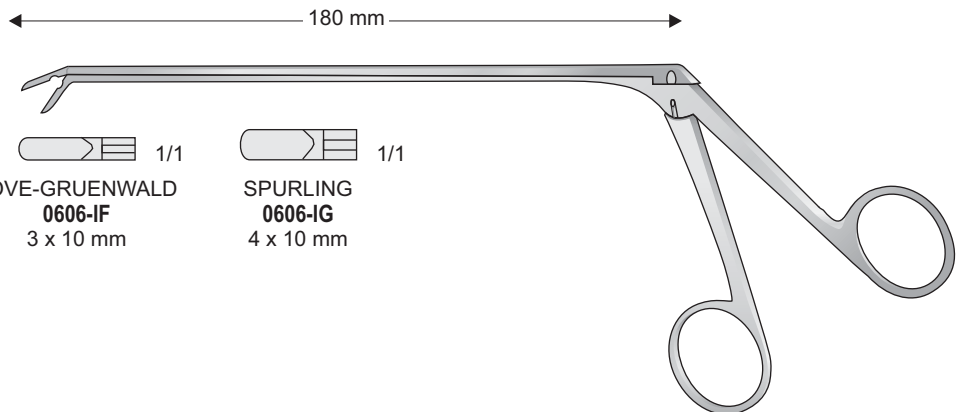

LOVE-GRUENWALD  
**0606-IF**  
3 x 10 mm

SPURLING  
**0606-IG**  
4 x 10 mm

0606-IF/0606-IG

Pinze  
per biopsia

Laminectomy  
rongeurs





Laminectomy  
Rongeur

Pincas a  
laminectomia

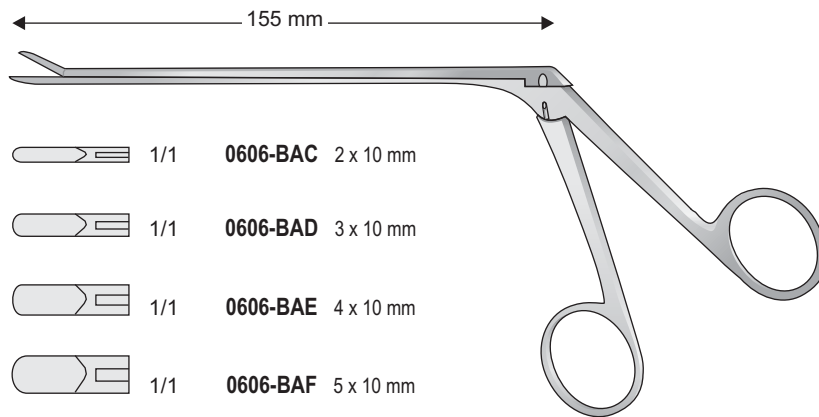
Pinzas cortantes  
para laminectomia

Diritta  
Stright  
Gerade  
Droites  
Rectas





-  1/1 **0606-BAC** 2 x 10 mm
-  1/1 **0606-BAD** 3 x 10 mm
-  1/1 **0606-BAE** 4 x 10 mm
-  1/1 **0606-BAF** 5 x 10 mm

CASPAR  
0606-BAC/0606-BAF

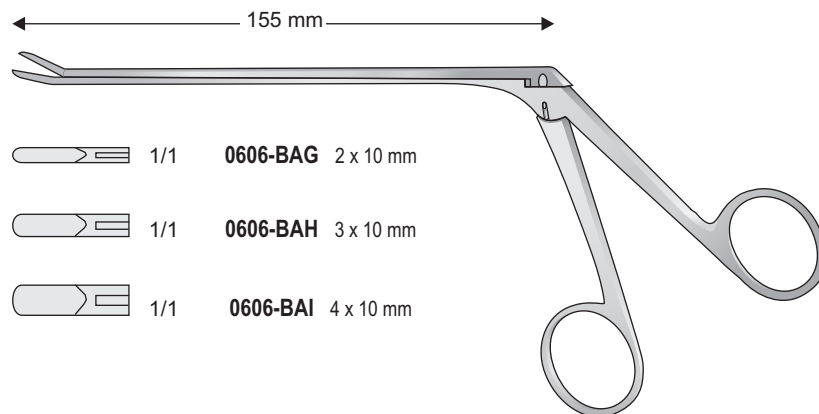
Curva verso l'alto  
Top curved  
Aufwärtsgebogen  
Courbe vers le haut  
Curvos



-  1/1 **0606-BAG** 2 x 10 mm
-  1/1 **0606-BAH** 3 x 10 mm
-  1/1 **0606-BAI** 4 x 10 mm

CASPAR  
0606-BAG/0606-BAI

Curva verso il basso  
Bottom curved  
Abwärts gebogen  
Courbe vers le bas  
Curvos

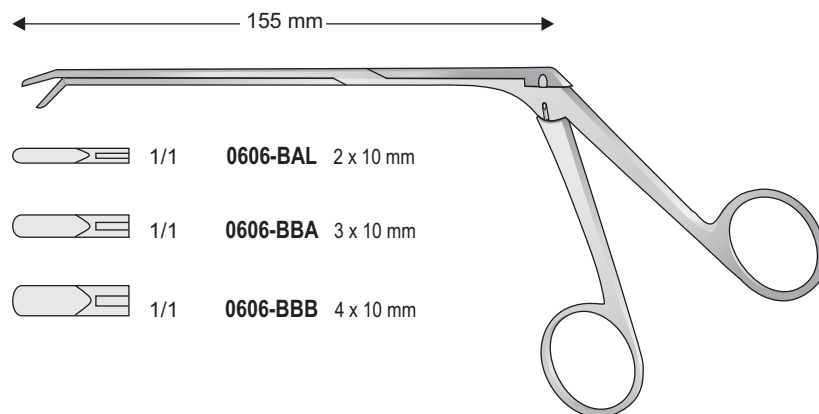

-  1/1 **0606-BAL** 2 x 10 mm
-  1/1 **0606-BBA** 3 x 10 mm
-  1/1 **0606-BBB** 4 x 10 mm

CASPAR  
0606-BAL/0606-BBB



Pinze per biopsia

Laminectomy rongeurs

Laminectomy Rongeur



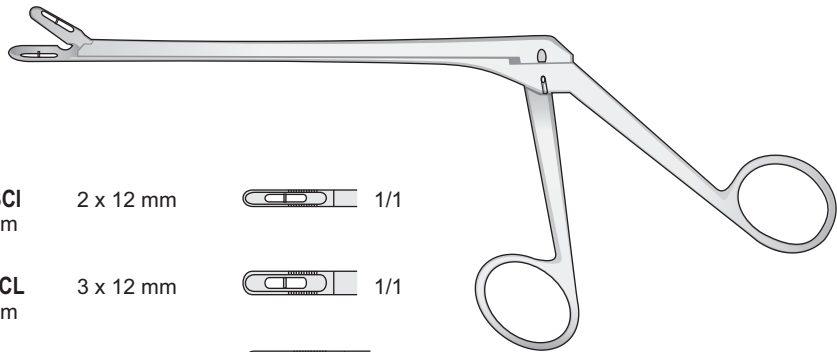

Pinces a laminectomia

Pinzas cortantes para laminectomia

Diritta  
Stright  
Gerade  
Droites  
Rectas



CASPAR

<b>0606-BCA</b> 140 mm	<b>0606-BCD</b> 160 mm	<b>0606-BCI</b> 185 mm	2 x 12 mm		1/1
<b>0606-BCB</b> 140 mm	<b>0606-BCE</b> 160 mm	<b>0606-BCL</b> 185 mm	3 x 12 mm		1/1
<b>0606-BCC</b> 140 mm	<b>0606-BCF</b> 160 mm	<b>0606-BDA</b> 185 mm	4 x 14 mm		1/1
	<b>0606-BCG</b> 160 mm	<b>0606-BDB</b> 185 mm	5 x 14 mm		1/1
	<b>0606-BCH</b> 160 mm	<b>0606-BDC</b> 185 mm	6 x 16 mm		1/1

CASPAR  
0606-BCA/0606-BDC

Curva verso l'alto  
Top curved  
Aufwärtsgebogen  
Courbe vers le haut  
Curvos

150°

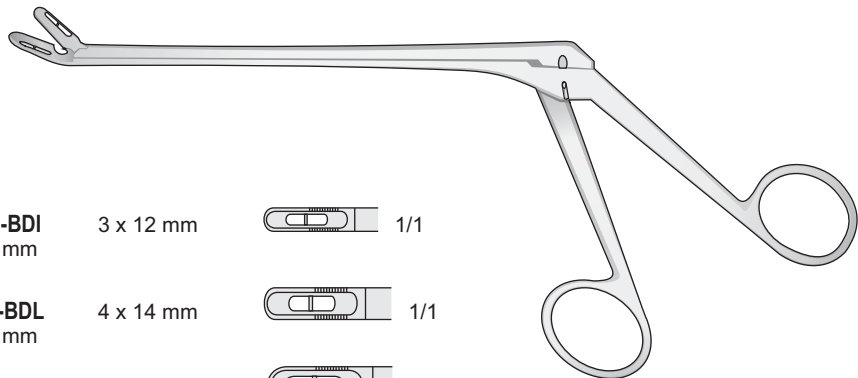

CASPAR

<b>0606-BDD</b> 140 mm	<b>0606-BDF</b> 160 mm	<b>0606-BDI</b> 185 mm	3 x 12 mm		1/1
<b>0606-BDE</b> 140 mm	<b>0606-BDG</b> 160 mm	<b>0606-BDL</b> 185 mm	4 x 14 mm		1/1
	<b>0606-BDH</b> 160 mm	<b>0606-BEA</b> 185 mm	5 x 14 mm		1/1

CASPAR  
0606-BDD/0606-BEA

Curva verso il basso  
Bottom curved  
Abwärts gebogen  
Courbe vers le bas  
Curvos

150°

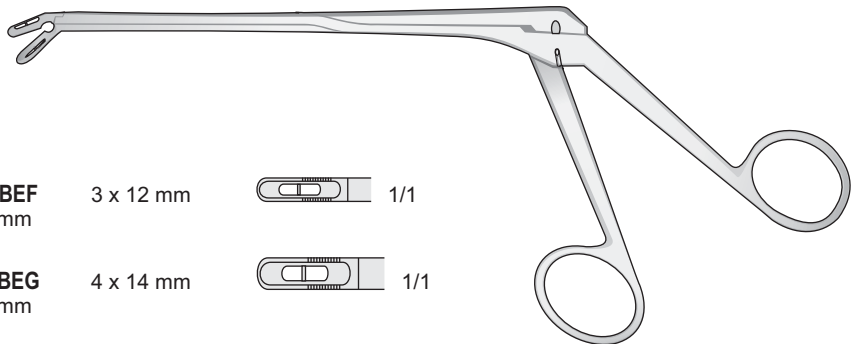

CASPAR

<b>0606-BEB</b> 140 mm	<b>0606-BED</b> 160 mm	<b>0606-BEF</b> 185 mm	3 x 12 mm		1/1
<b>0606-BEC</b> 140 mm	<b>0606-BEE</b> 160 mm	<b>0606-BEG</b> 185 mm	4 x 14 mm		1/1

CASPAR  
0606-BEB/0606-BEG

Pinze  
per biopsia

Laminectomy  
rongeurs

Laminectomy  
Rongeur

Pinces a  
laminectomia

Pinzas cortantes  
para laminectomia

Diritta  
Stright  
Gerade  
Droites  
Rectas

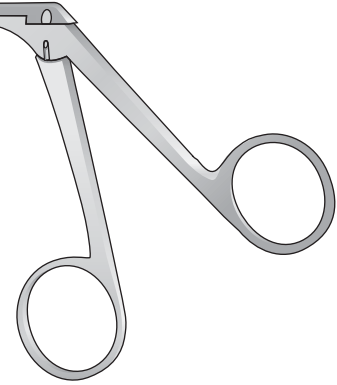
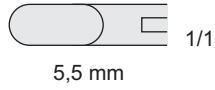
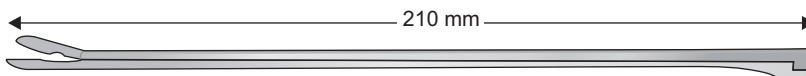

WAGNER  
0606-LA

Diritta  
Stright  
Gerade  
Droites  
Rectas

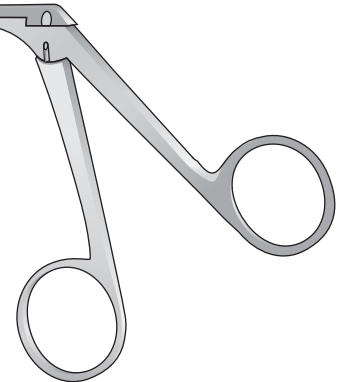
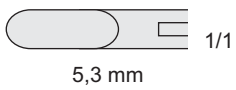
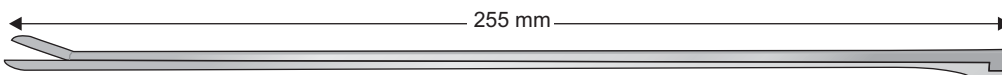

0606-LB

Curva verso l'alto  
Top curved  
Aufwärtsgebogen  
Courbe vers le haut  
Curvos

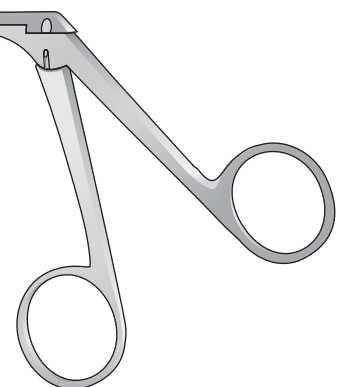
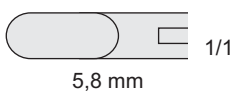
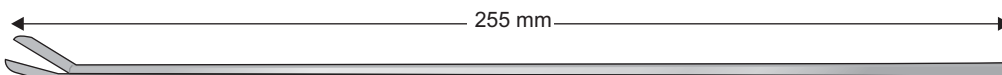

SYPERT  
0606-LC

Pinze per biopsia

Laminectomy rongeurs

Laminectomy Rongeur

Pincas a laminectomia

Pinzas cortantes para laminectomia

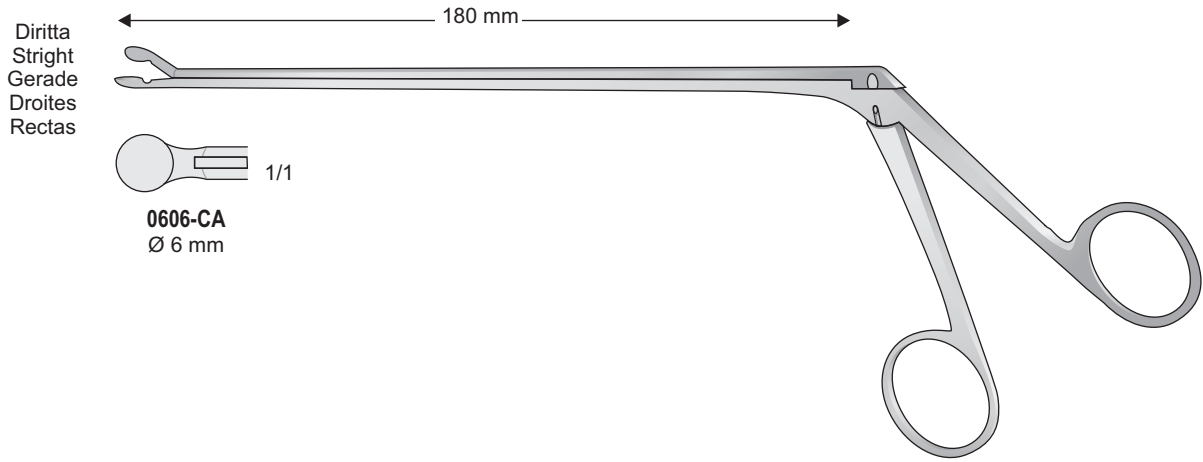

OLDBERG  
0606-CA

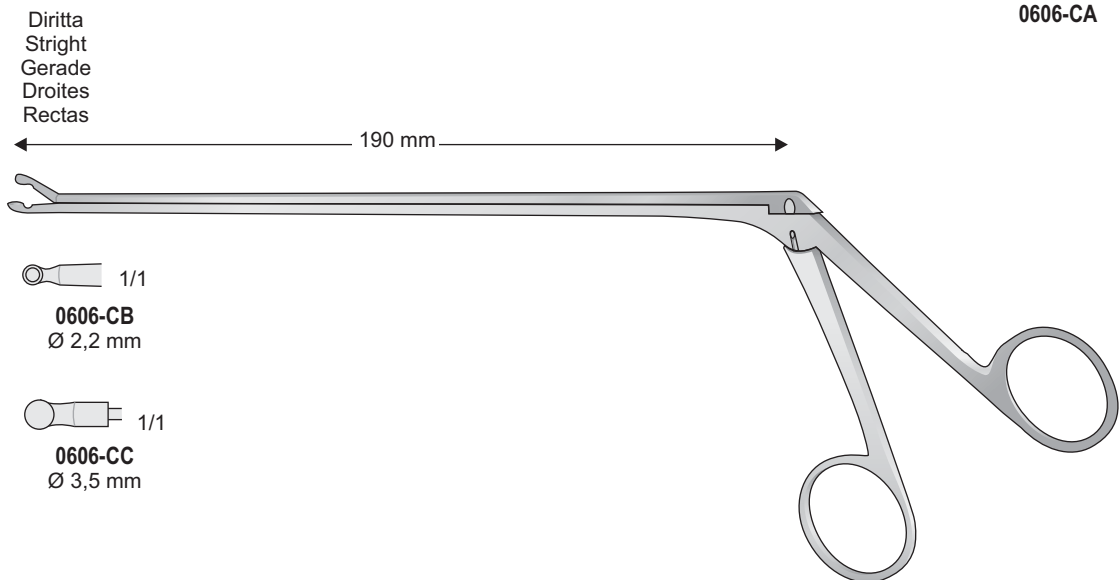

YASARGIL  
0606-CB/0606-CC

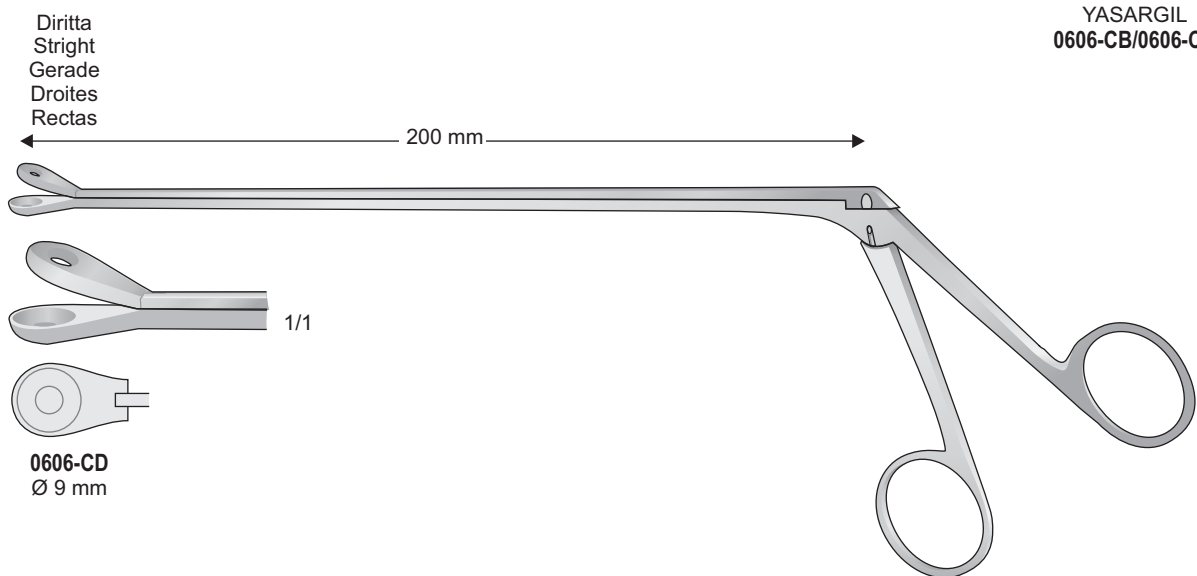

LANDOLT  
0606-CD

Pinze ossivore

Bone rongeurs

Hohlmeißelzangen

Pinces-gouges

Pinza-gubias

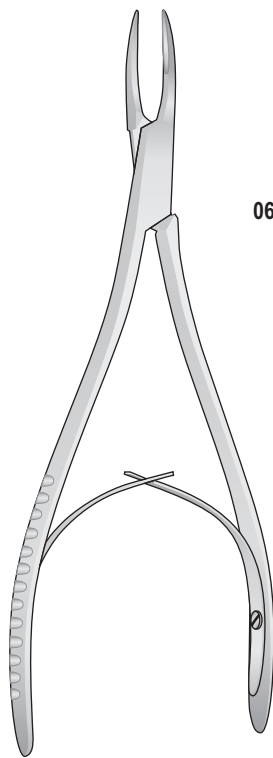

MINI-FRIEDMANN  
0614-CC/0614-CE  
150 mm

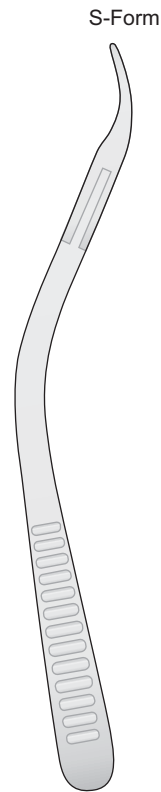
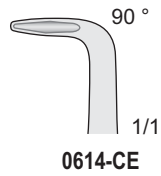
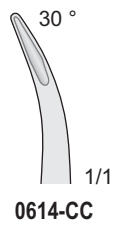
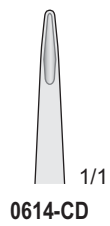

MINI-FRIEDMANN  
0614-IF  
145 mm

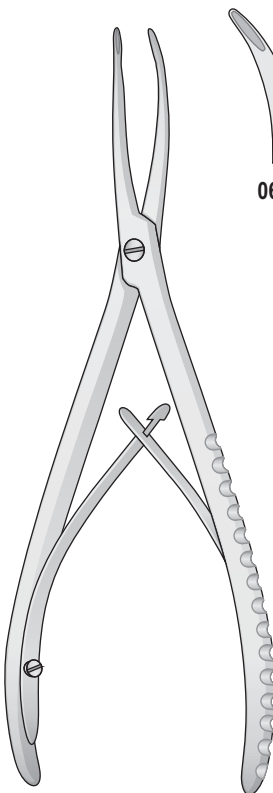
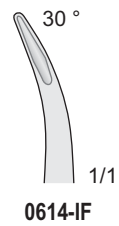

STELLBRINK  
0614-II/0614-IL  
170 mm

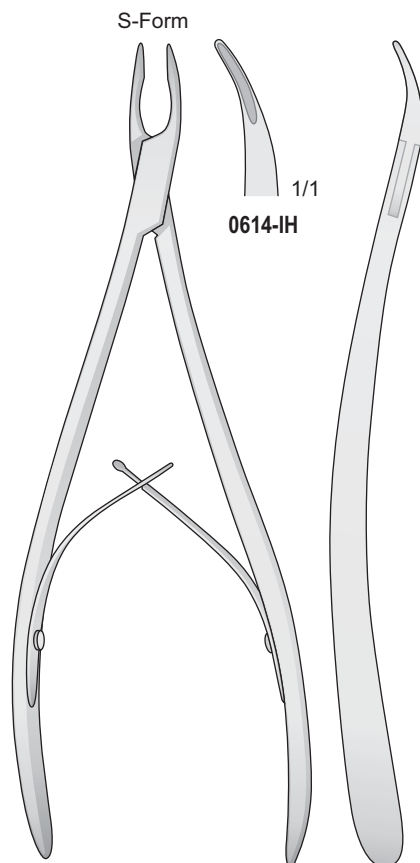
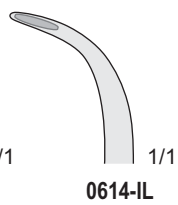
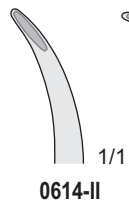

STELLBRINK  
0614-IH  
190 mm

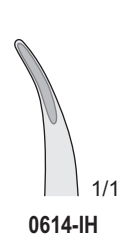

Pinze ossivore

Bone rongeurs

Hohlmeißelzangen

Pinces-gouges

Pinza-gubias

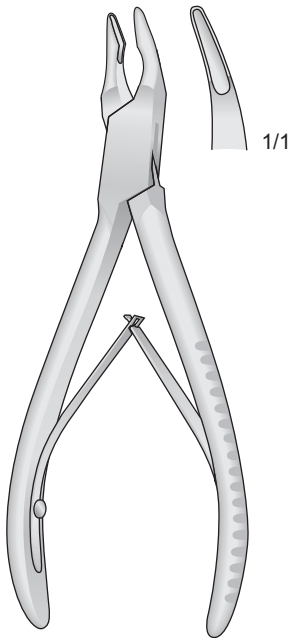

MINI FRIEDMANN  
0614-BF  
120 mm

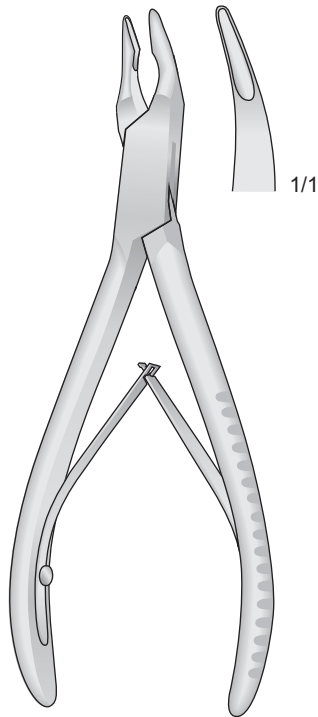

FRIEDMANN  
0614-BH  
140 mm

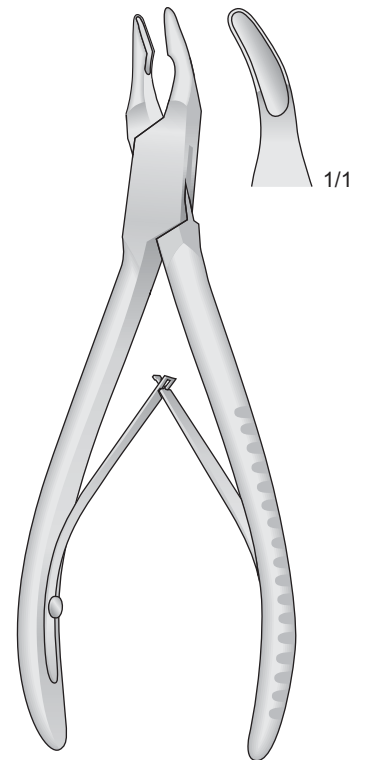

BLUMENTHAL  
0614-BL  
155 mm

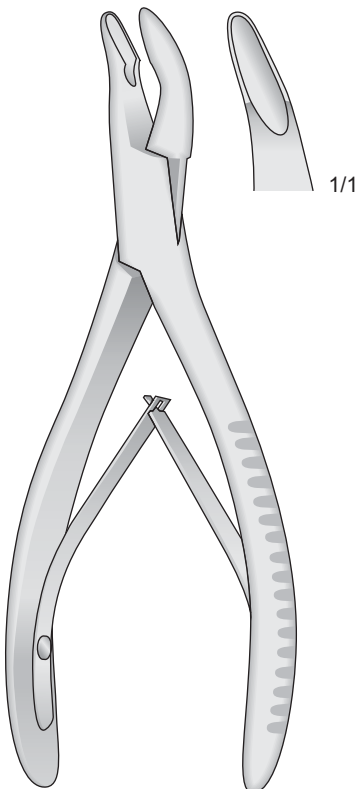

MEAD  
0614-CB  
165 mm

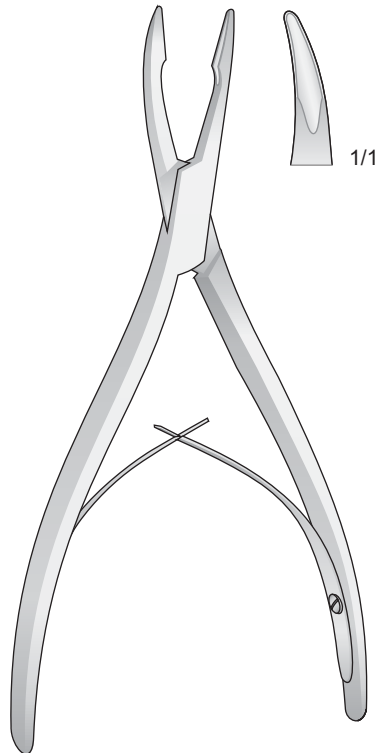

FRIEDMANN  
0614-BG  
160 mm

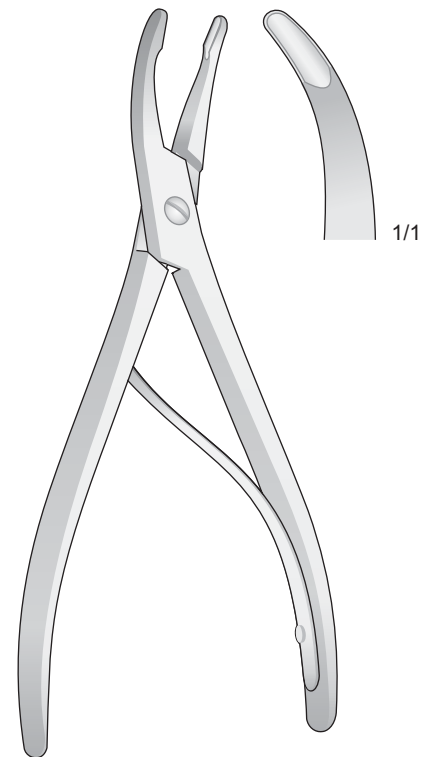

LUER  
0614-BI  
155 mm

Pinze ossivore

Bone rongeurs

Hohlmeißelzangen

Pinces-gouges

Pinza-gubias

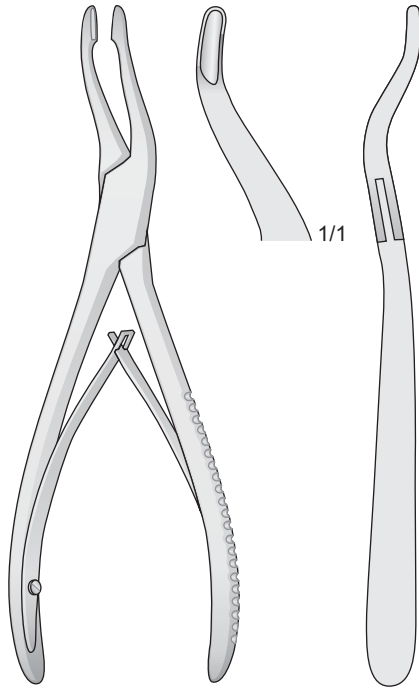

ALEXANDER  
0614-CH  
140 mm

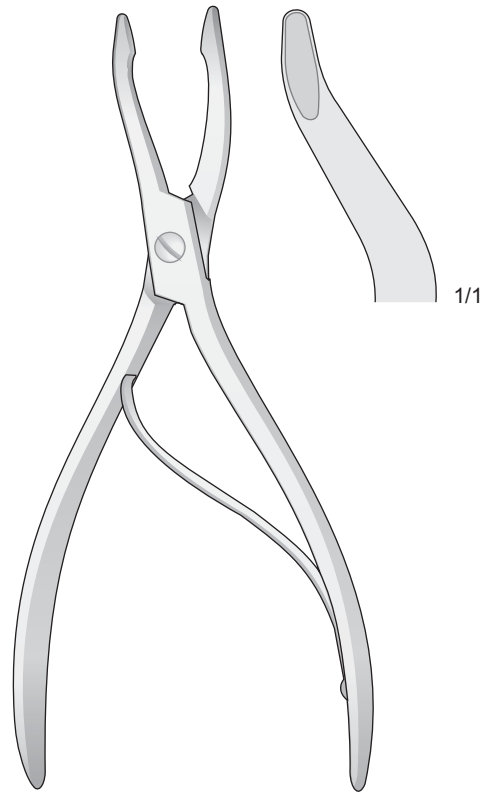

JANSEN-LEUER  
0614-BA  
180 mm

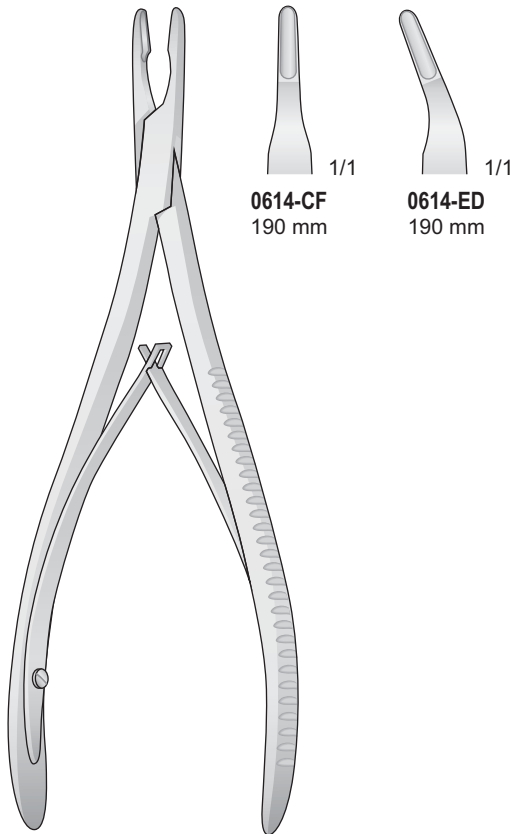

LEMPERT  
0614-CF/0614-ED  
190 mm

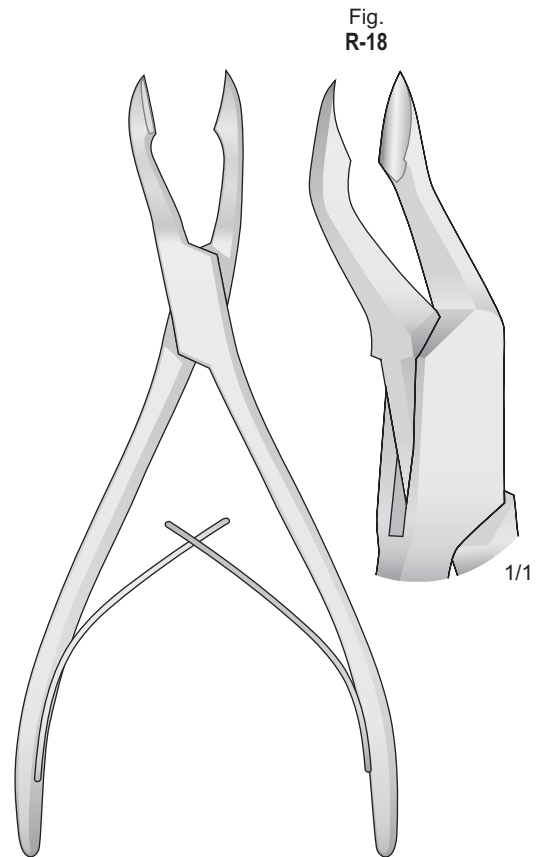

0614-DD  
175 mm

Pinze ossivore

Bone rongeurs

Hohlmeißelzangen

Pinces-gouges

Pinza-gubias

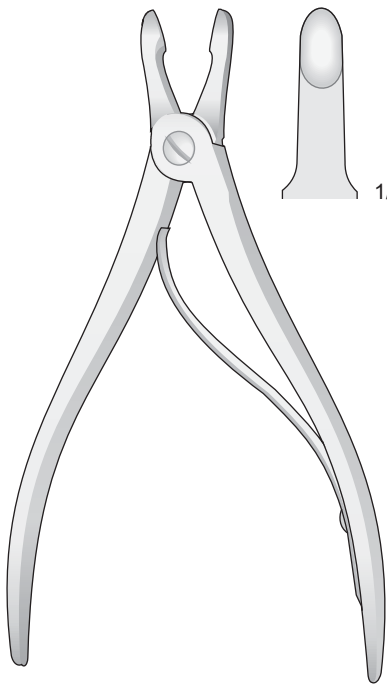

HARTMANN  
0614-BE  
155 mm

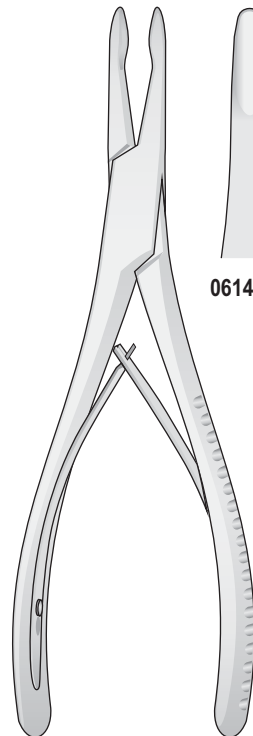
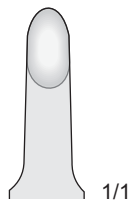

JANSEN  
0614-DH/0614-DL  
170 mm

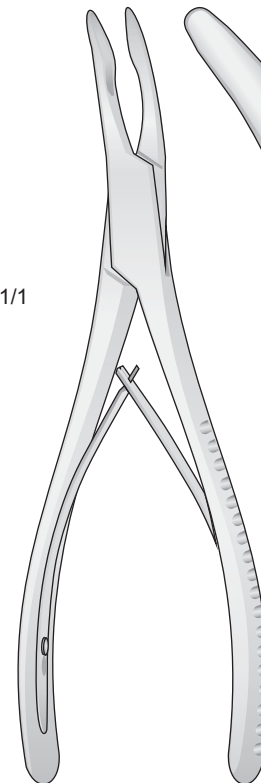
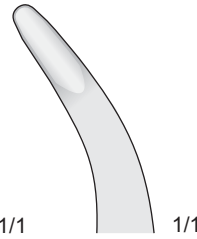
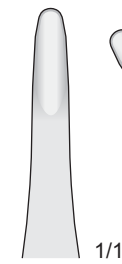

OLIVECRONA  
0614-EF  
190 mm

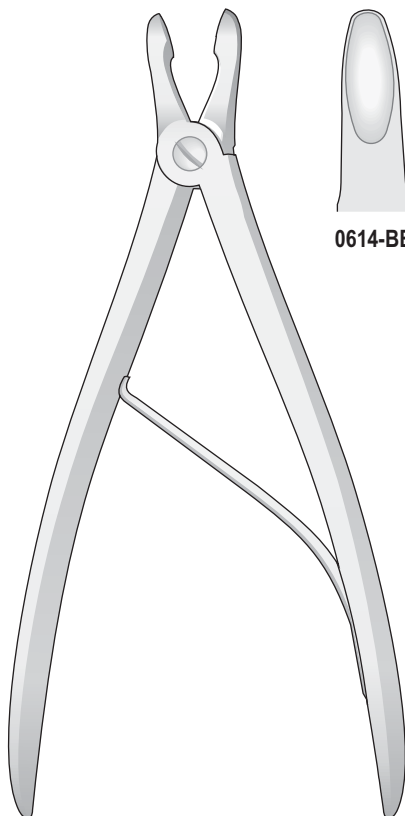
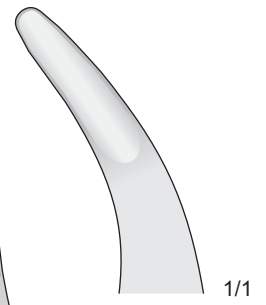

CUSHING  
0614-BB/0614-BC  
190 mm

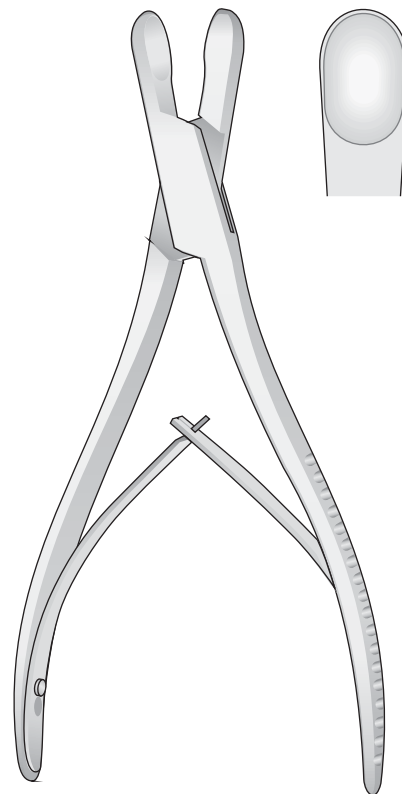
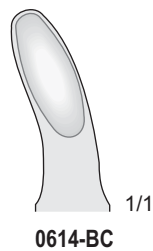
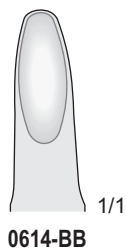

LUER-STILLE  
0614-BD  
185 mm

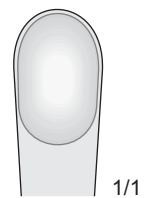

Pinze ossivore

Bone rongeurs

Hohlmeißelzangen

Pinces-gouges

Pinza-gubias

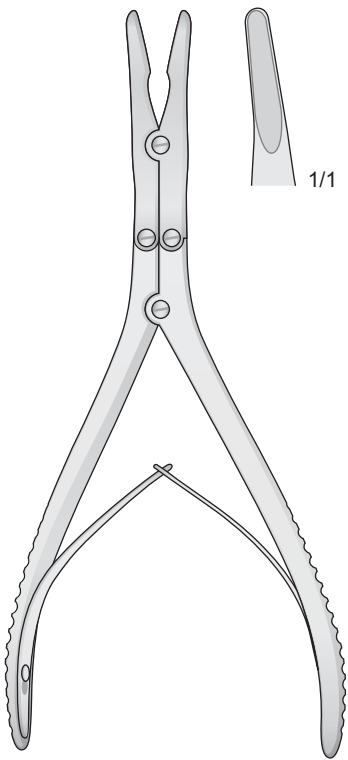

BEYER  
0614-CA  
180 mm

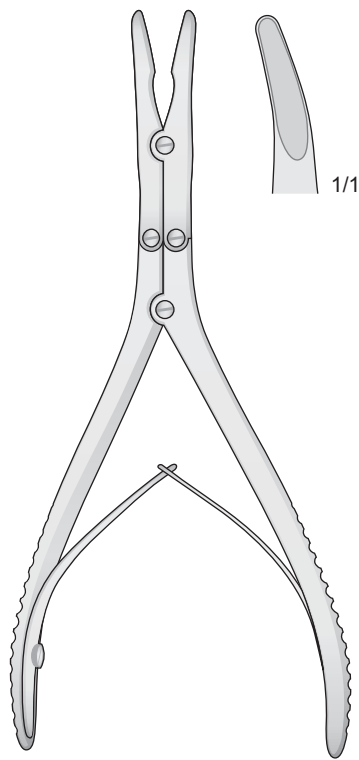

ZAUFGAL-JANSEN  
0614-DE  
180 mm

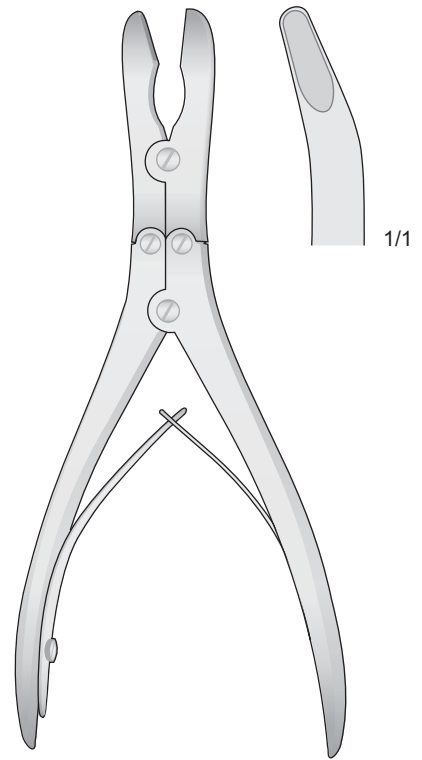

RUSKIN-STILLE  
0614-DF  
180 mm

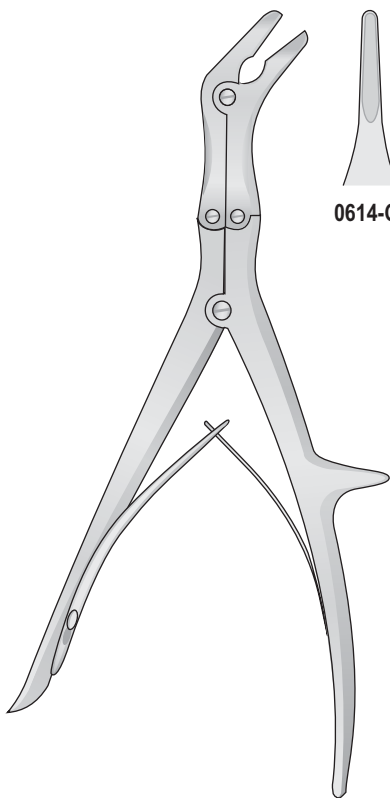

ECHLIN  
0614-CI/0614-DA  
230 mm

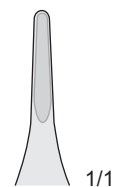

0614-CI

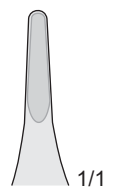

0614-CL

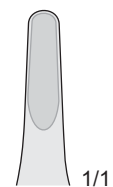

0614-DA

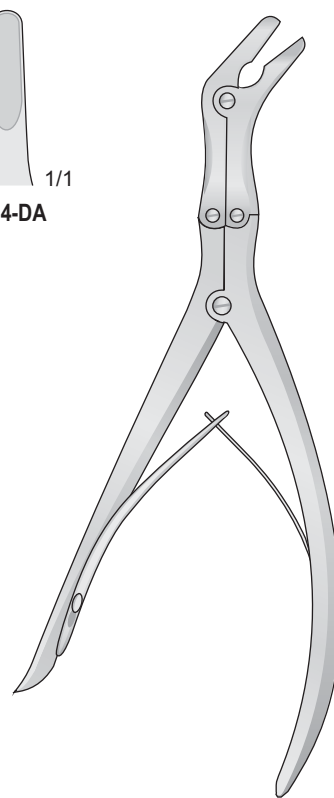

LEKSELL  
0614-DB/0614-DC

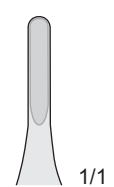

0614-DB  
240 mm

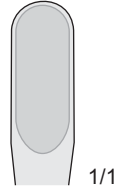

0614-DC  
250 mm



Pinze ossivore

Bone rongeurs

Hohlmeißelzangen

Pinces-gouges

Pinza-gubias

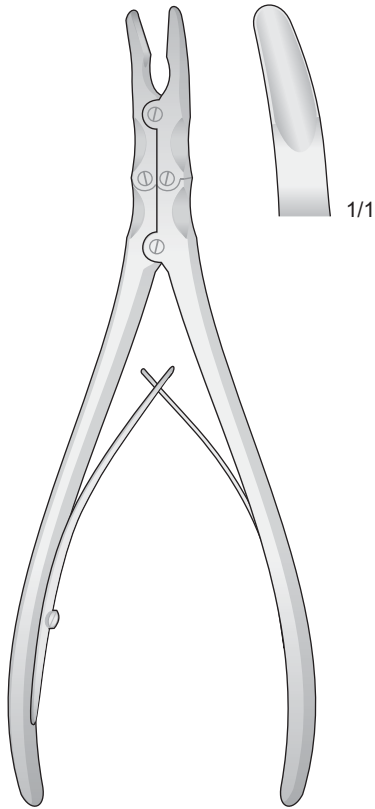

RÖTTGEN-RUSKIN  
0614-BLL  
240 mm

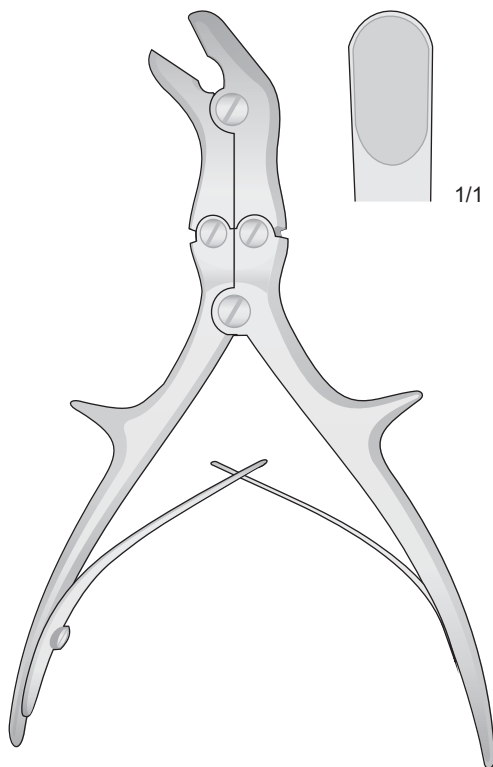

STILLE  
0614-DG  
210 mm

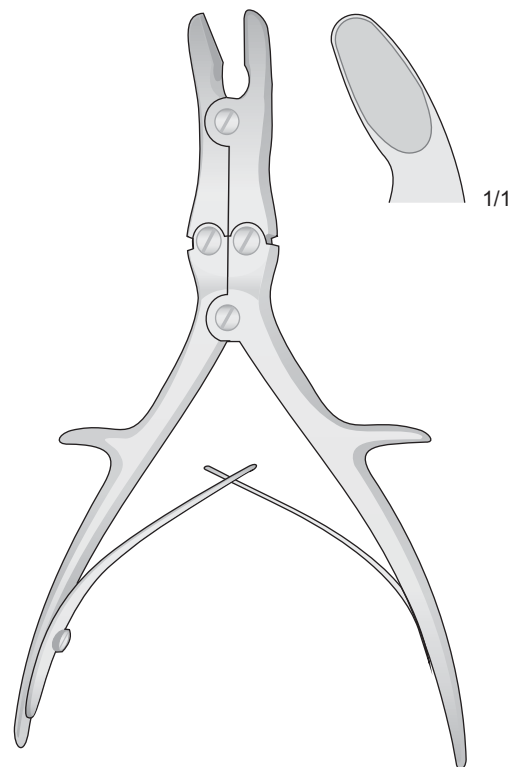

LUER-STILLE  
0614-DI  
210 mm

Pinze ossivore

Bone rongeurs

Hohlmeißelzangen

Pinces-gouges

Pinza-gubias

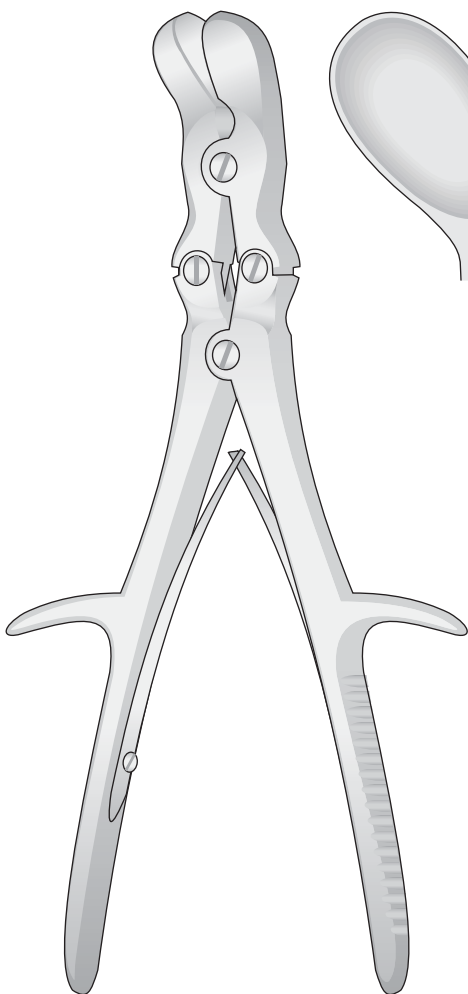

LUER-STILLE  
0614-CAA  
260 mm

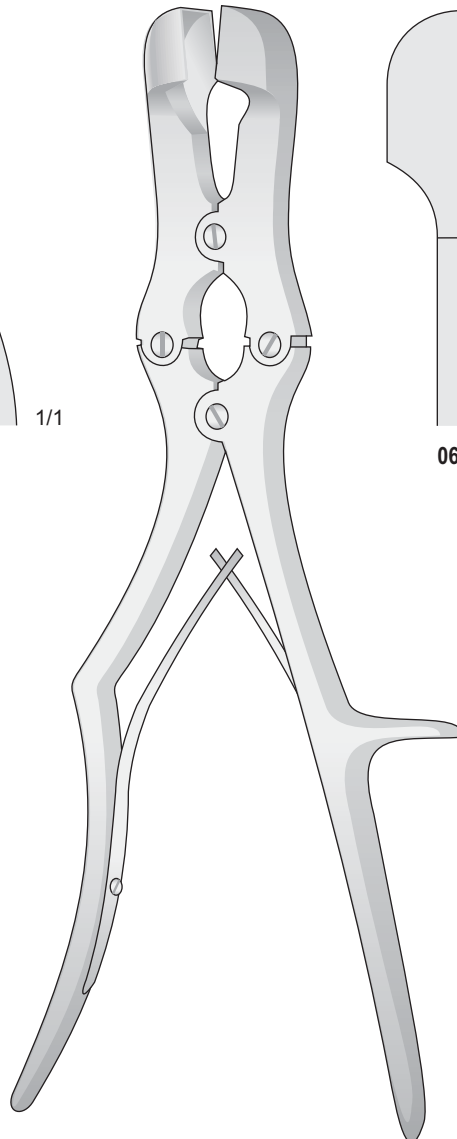
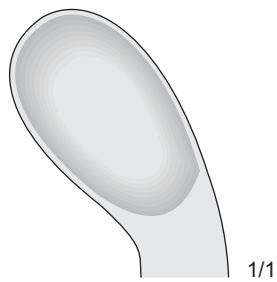

SAUERBRUCH  
0614-BGA/0614-BGB  
300 mm

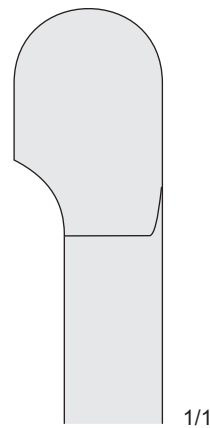

0614-BGA

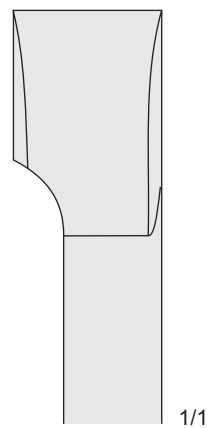

0614-BGB

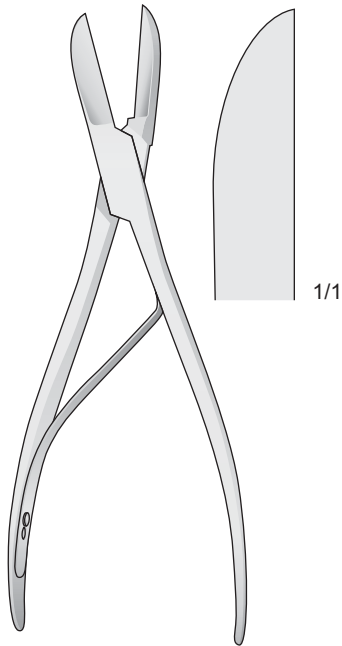

LISTON  
1123-BAI  
220 mm

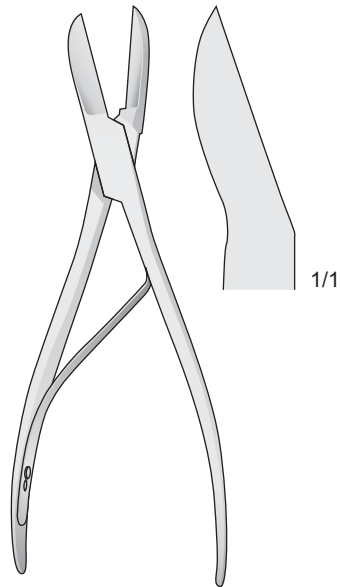

LISTON  
1123-BAL  
170 mm

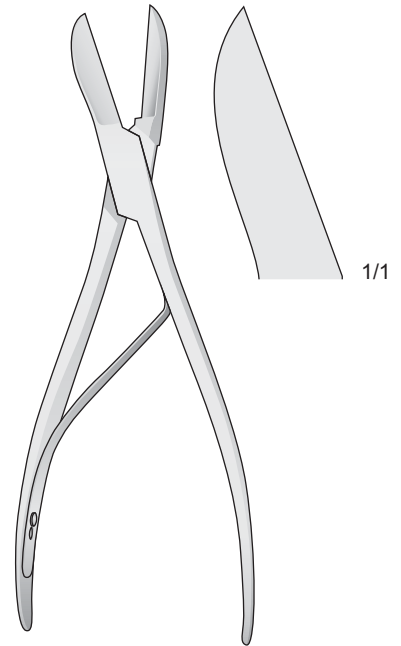

LISTON  
1123-BBA  
220 mm

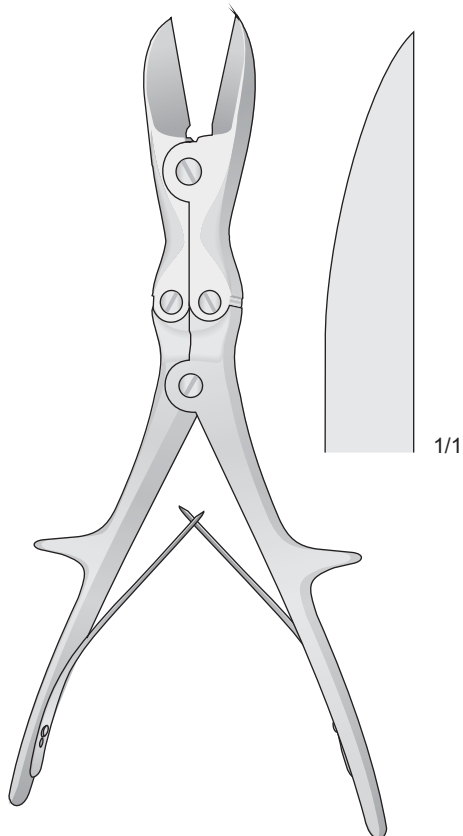

LISTON  
0614-EB  
270 mm

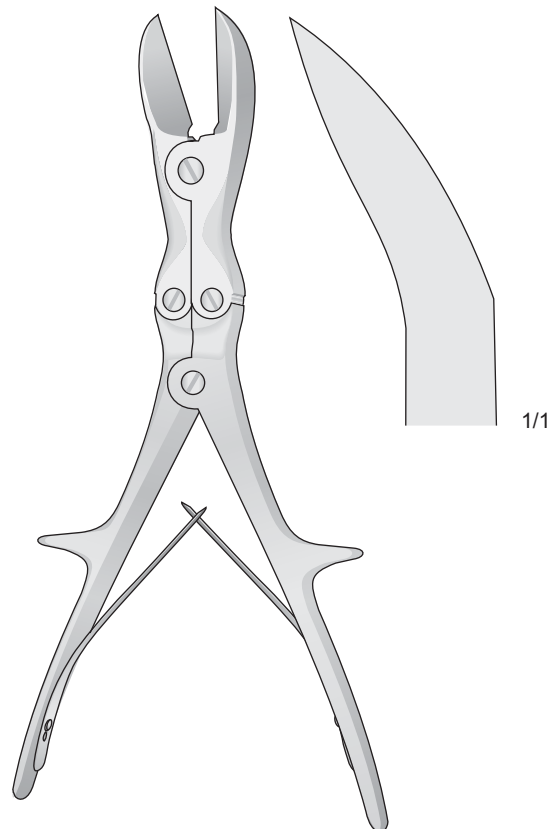

LISTON  
0614-EC  
270 mm

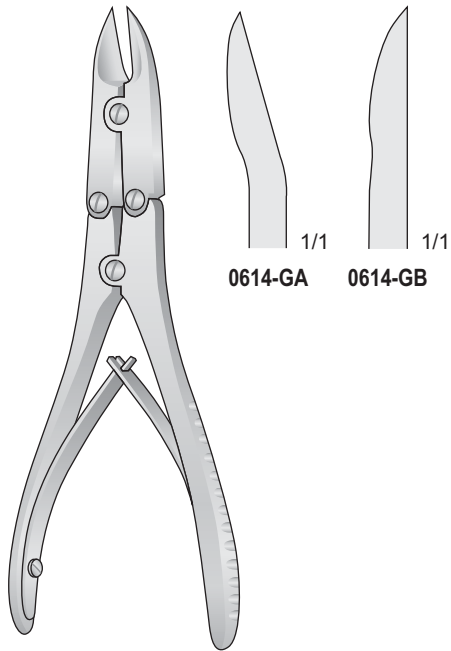

**BÖHLER**  
**0614-GA/0614-GB**  
150 mm

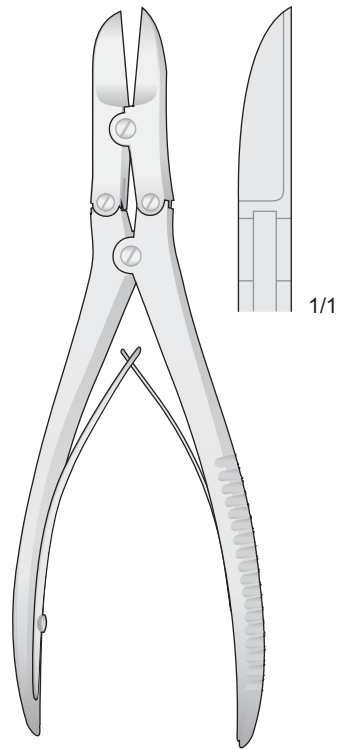

**RUSKIN-LISTON**  
**0614-BAI**  
190 mm

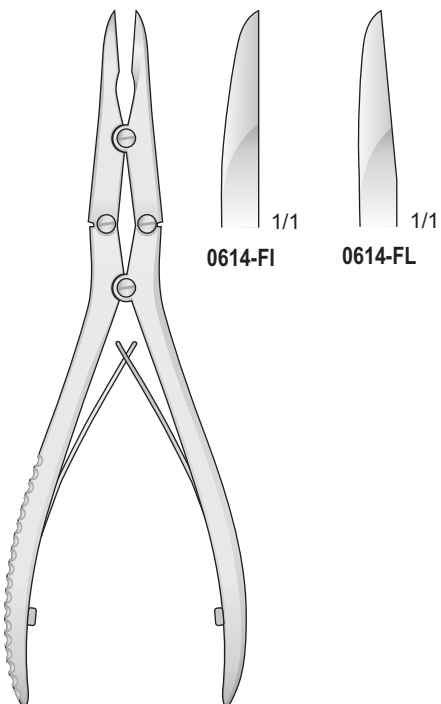

**0614-FI/0614-FL**  
180 mm

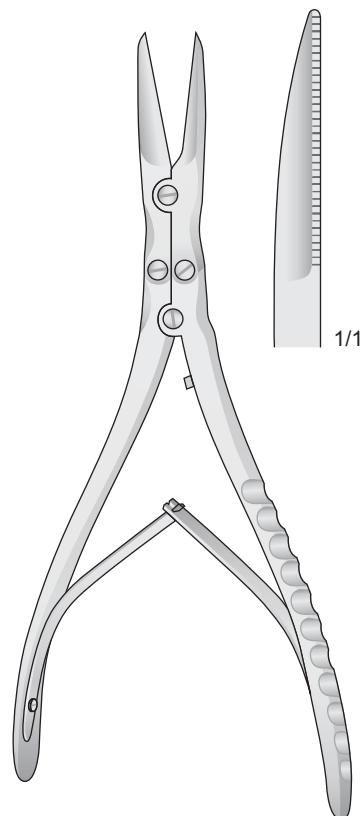

**0614-BEG**  
215 mm

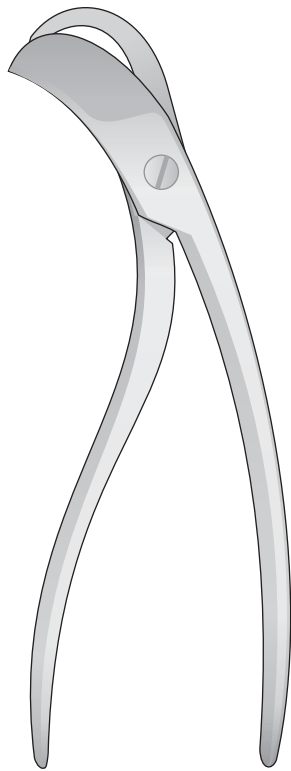

COLLIN  
1123-BBC  
195 mm

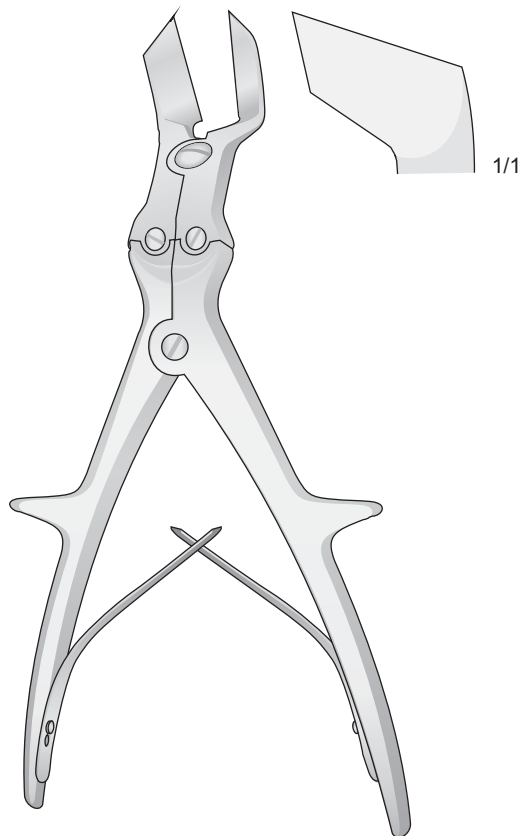

KEY-HORSLEY  
0614-EA  
235 mm

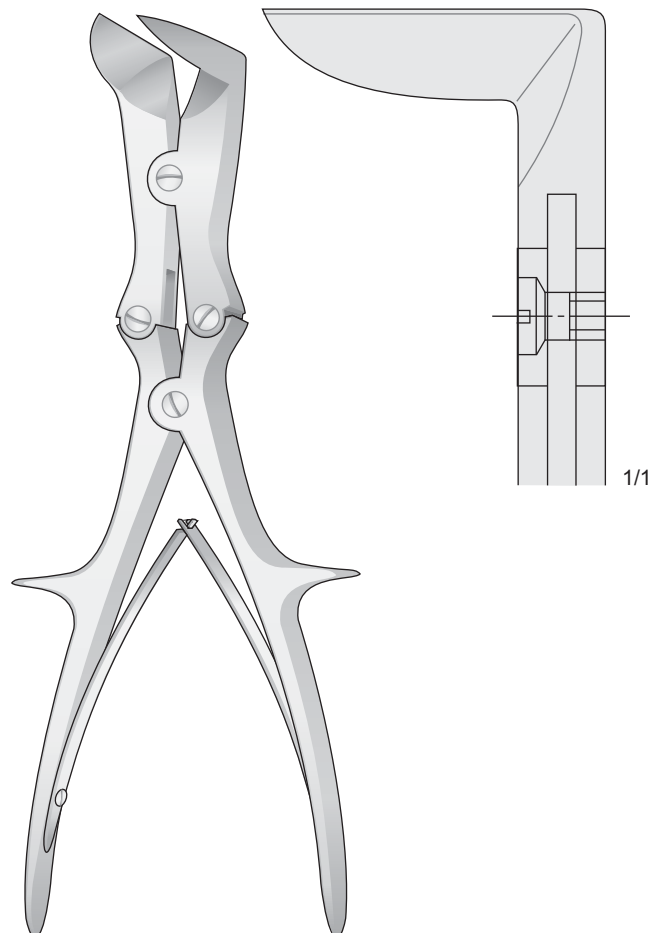

LISTON-STILLE  
0614-BFI  
265 mm

Forbici ossivore

Bone cutting scissors

Knochensplitterscheren

Ciseaux à os

Tijeras para huesos

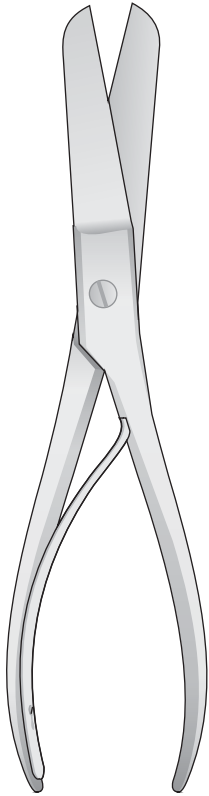

**0607-EA**  
230 mm



1/1

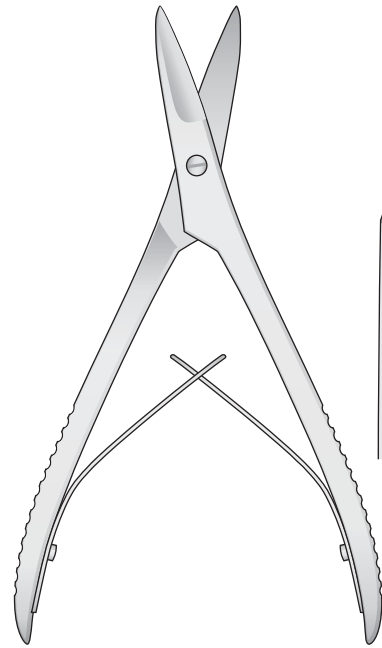

**0614-GD**  
160 mm



1/1

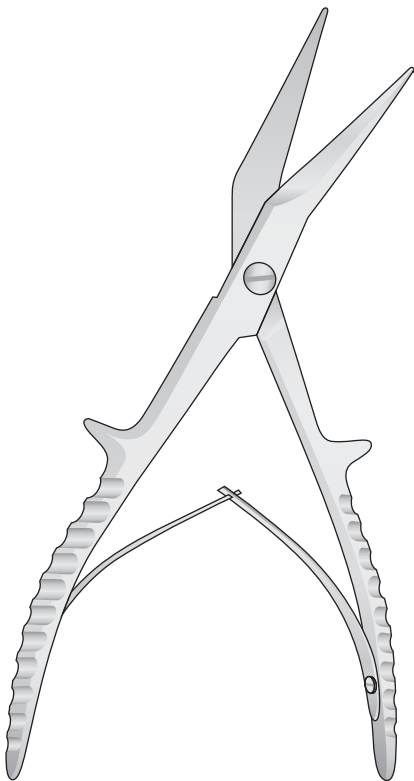

**0607-BBA**  
195 mm

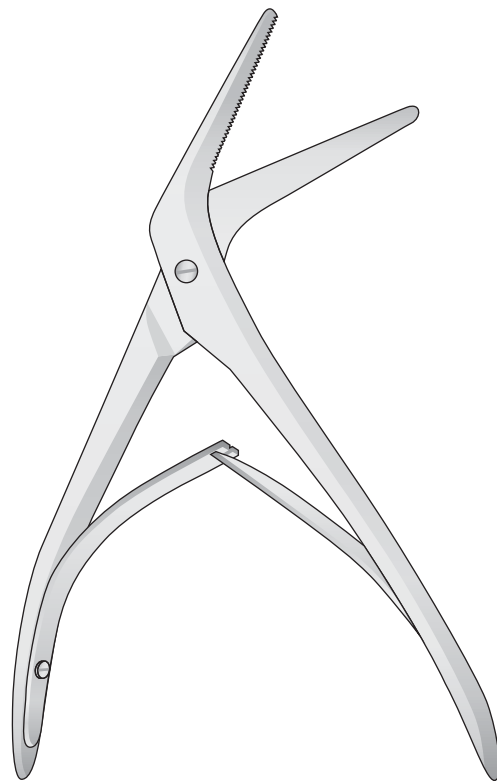

**JACKSON-TESSIER**  
**0607-BBB**  
190 mm

Costotomi, forbici  
per sterno

Rib shears  
Sternum Scissors

Rippenscheren,  
Sternumscheren

Costotomes et  
ciseau-burins à sternum

Costotómos  
Tijeras de esternón

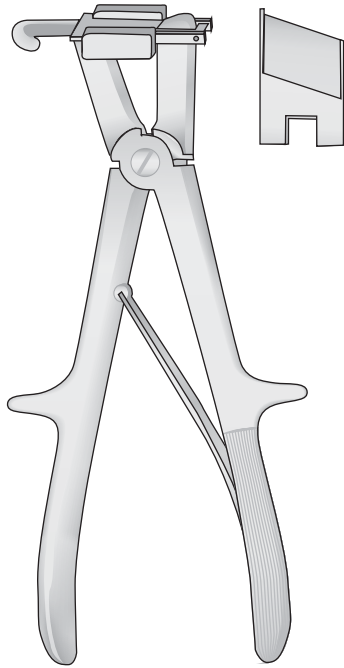

SAUERBRUCH  
1123-BGE - 230 mm  
1123-BGF - 260 mm

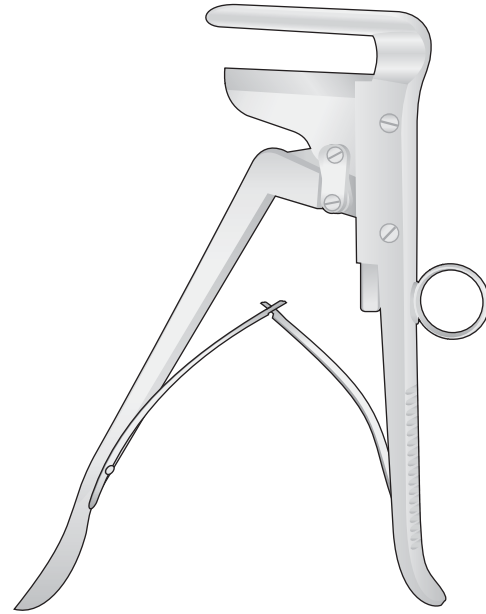

SCHUMACHER  
1123-BGG  
210 mm

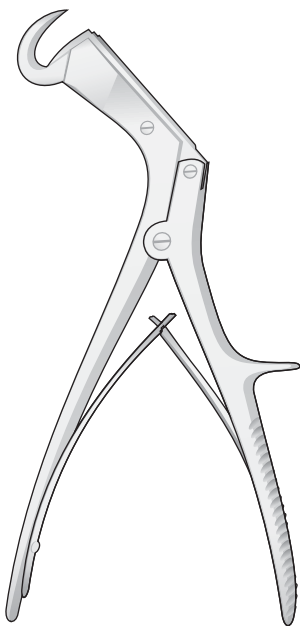

GIERTZ-STILLE  
1123-BGA  
250 mm

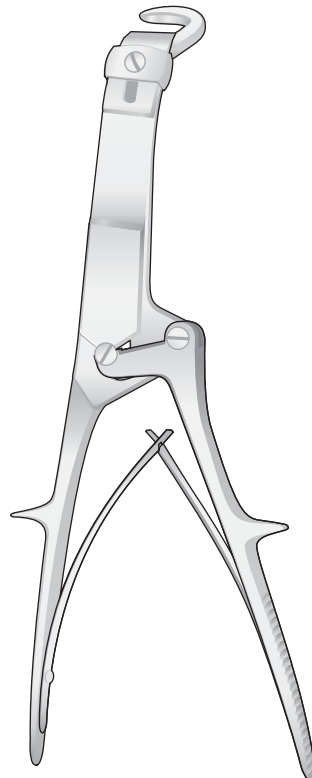

BRUNNER  
1123-BGB - Destro  
1123-BGD - Sinistro  
320 mm

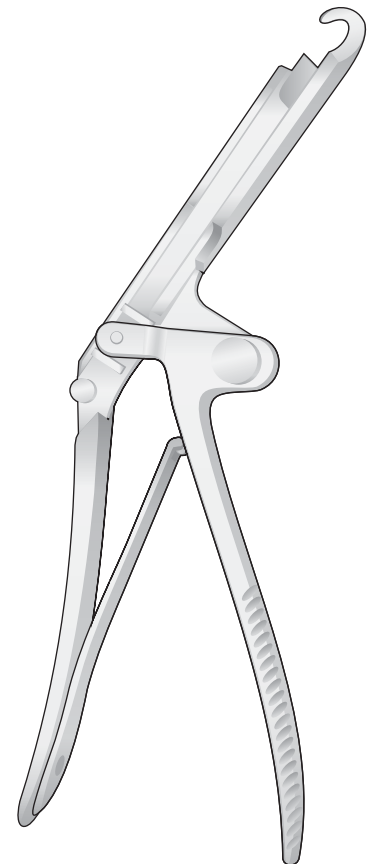

SAUERBRUCH-FREY  
1123-BGC  
370 mm

Pinze per ossa

Bone Holding Forceps

Knochenhaltenzangen

Daviers porte os

Pinzas para huesos

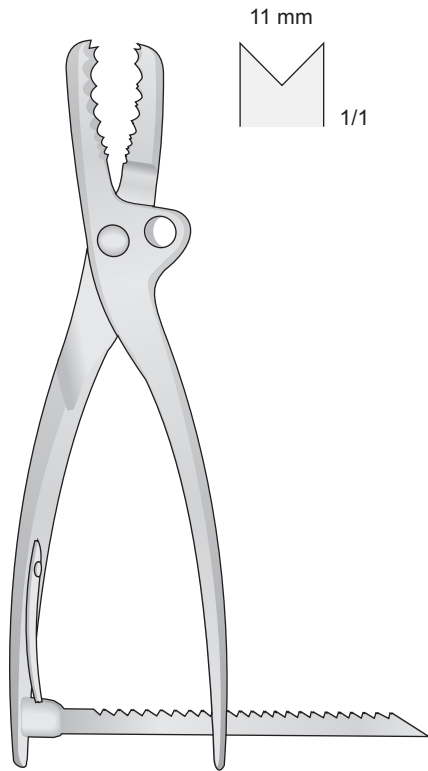

FARABEU-F-LAMBOTTE  
0614-FC  
250 mm

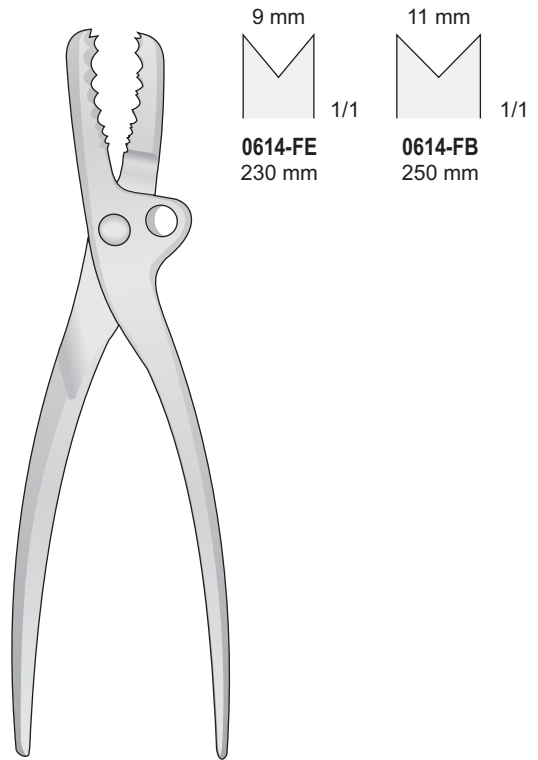

FARABEU  
0614-FB/0614-FE

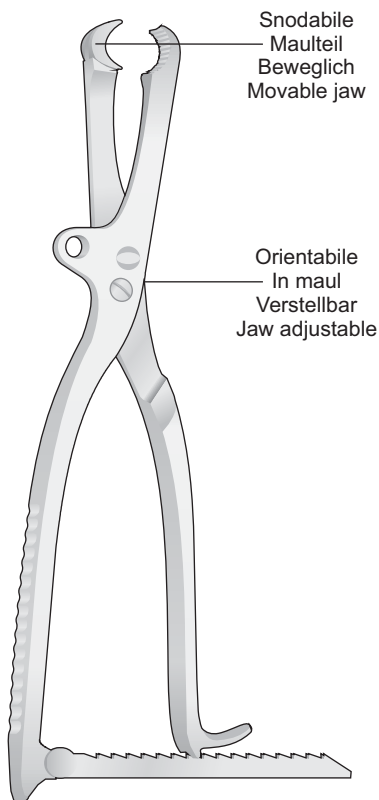

LAMBOTTE  
0614-EE  
265 mm

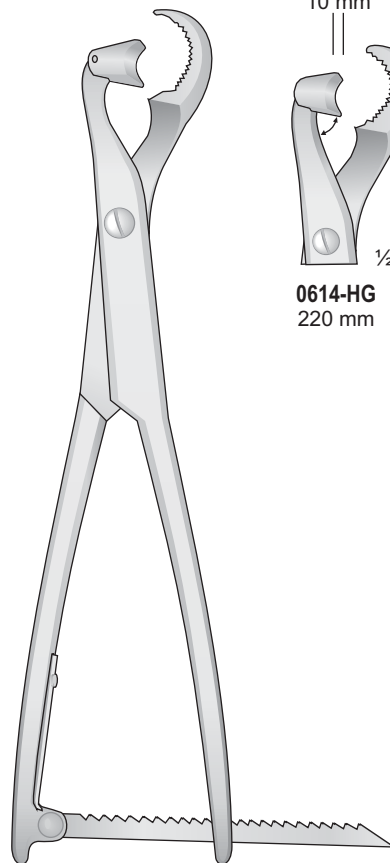

LAMBOTTE  
0614-HG/0614-FA

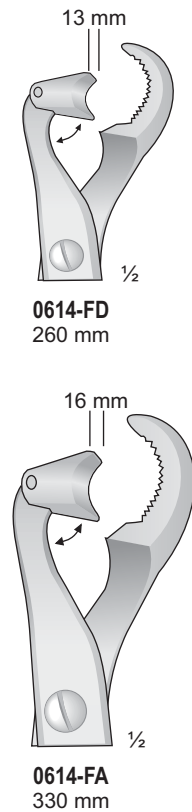

0614-FA  
330 mm



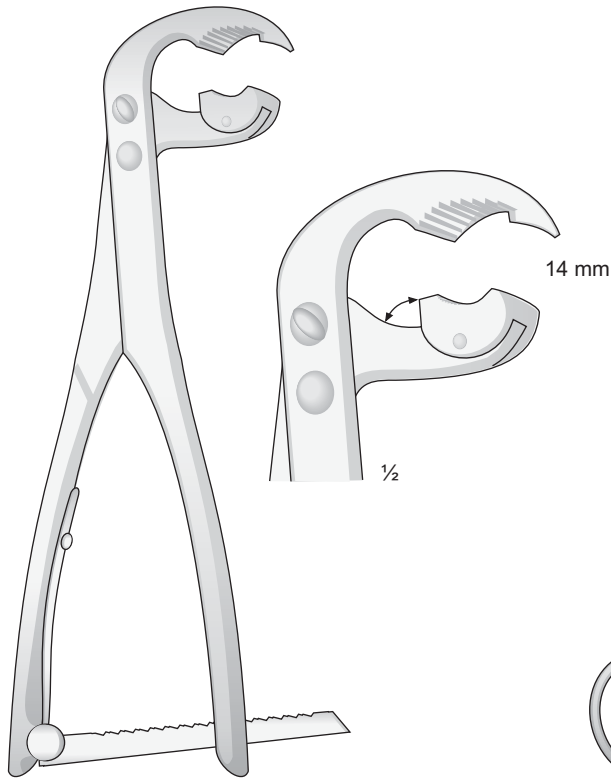

**0614-HI**  
215 mm

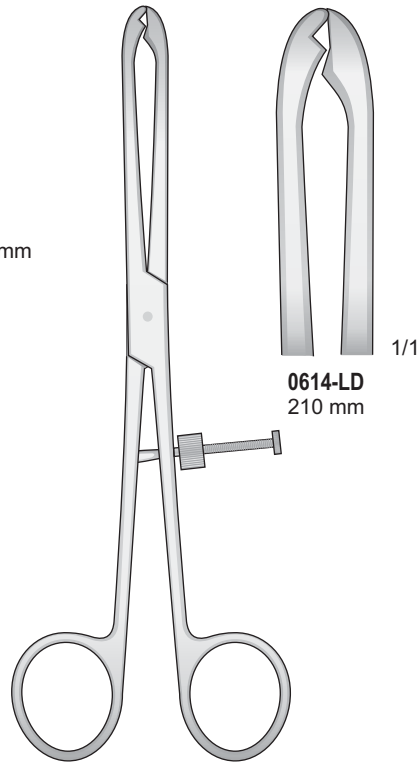

**FIBULA**  
**0614-LD/0614-LE**  
210 mm

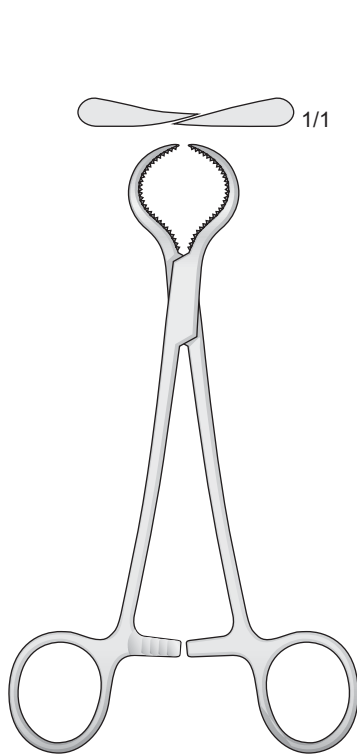

**LEWIN**  
**0614-GL**  
180 mm

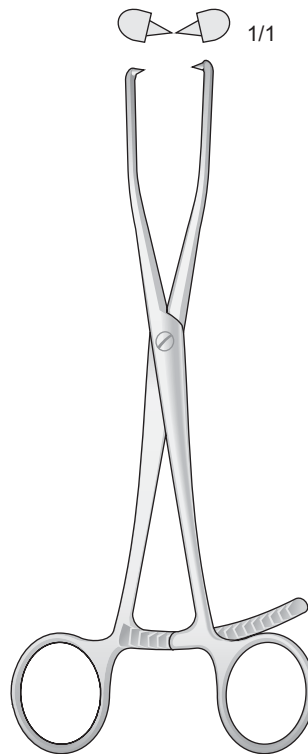

**0614-GH**  
210 mm

Pinze riposizionatrici di osso - Repositionszangen  
 Reposition forceps - Pinzas para la reducci3n de huesos

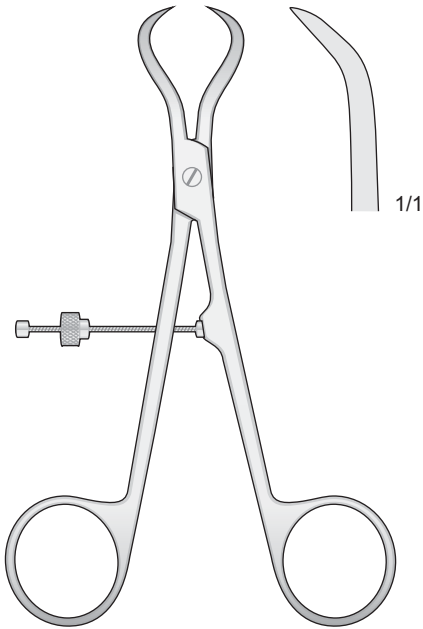

**0614-HL**  
140 mm

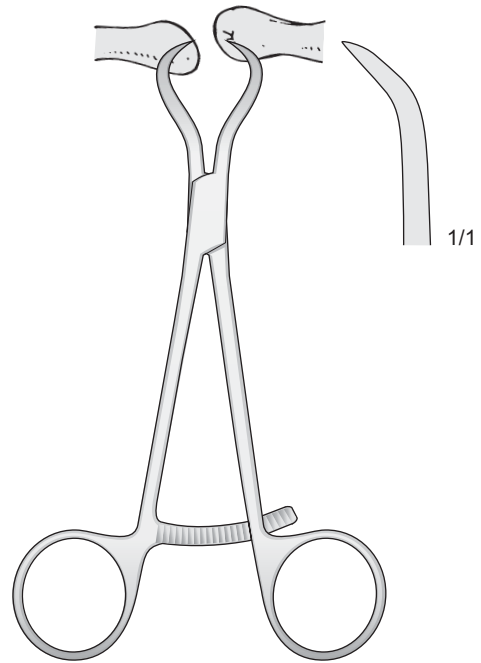

**0614-GG**  
135 mm

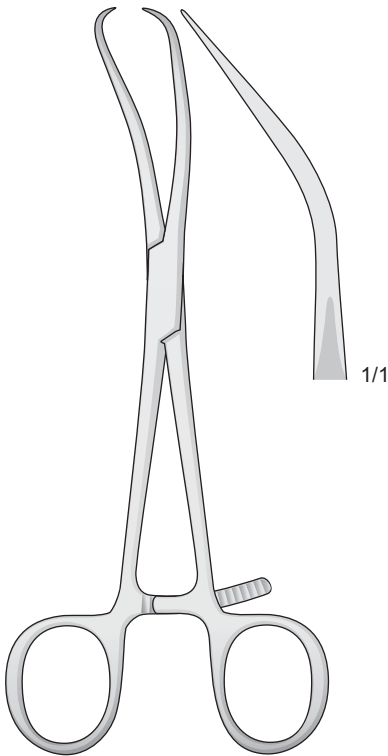

**REILL**  
**0614-GE**  
170 mm

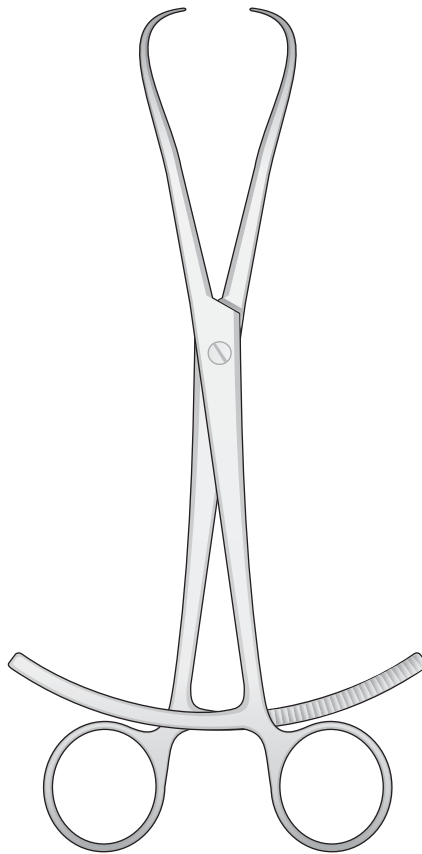

**0614-GI**  
200 mm

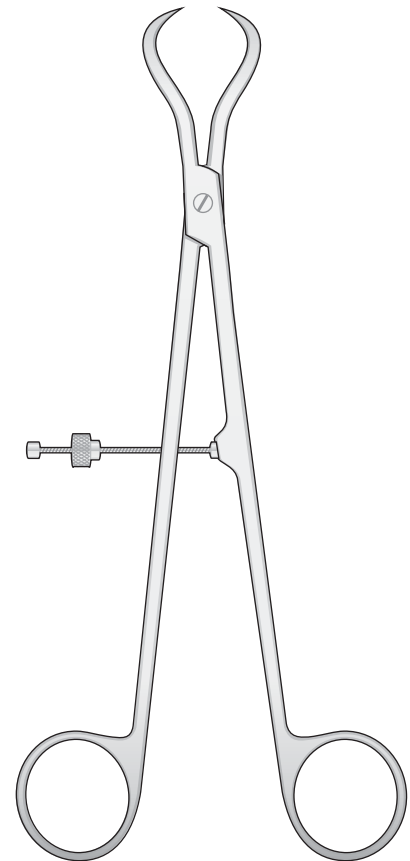

**0614-IB**  
210 mm

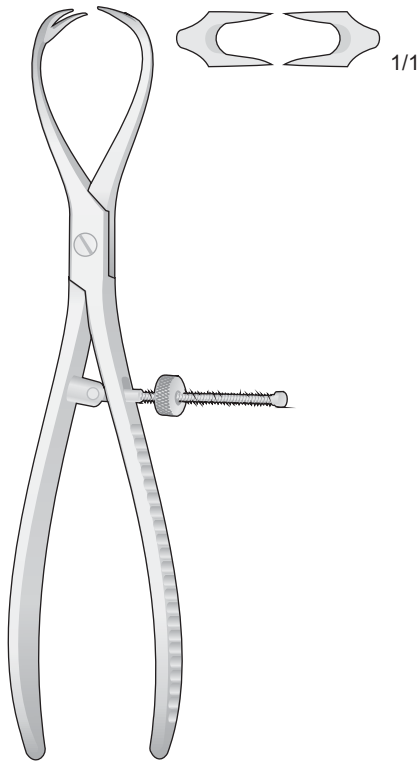

PATELLA  
0614-EG  
185 mm

Pinza con regolazione  
Forceps with thread fixation  
Zange mit Gewindsperre  
Davier avec système d'arrêt fileté

Pinza con cremagliera  
Forceps with ratchet fixation  
Zange mit Zahnsperre  
Davier à crémaillère

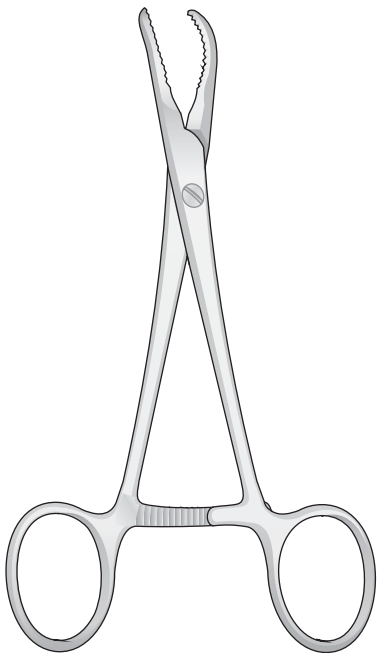

0614-EH  
140 mm

Pinza con regolazione  
Forceps with thread fixation  
Zange mit Gewindsperre  
Davier avec système d'arrêt fileté

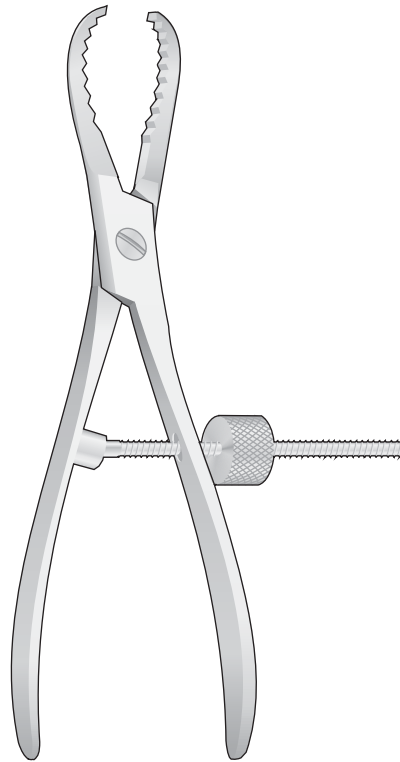

0614-EI  
170 mm

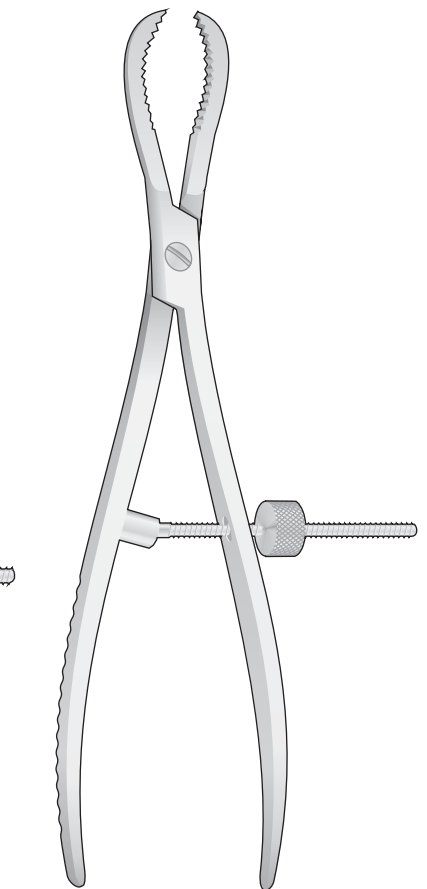

0614-EL  
235 mm

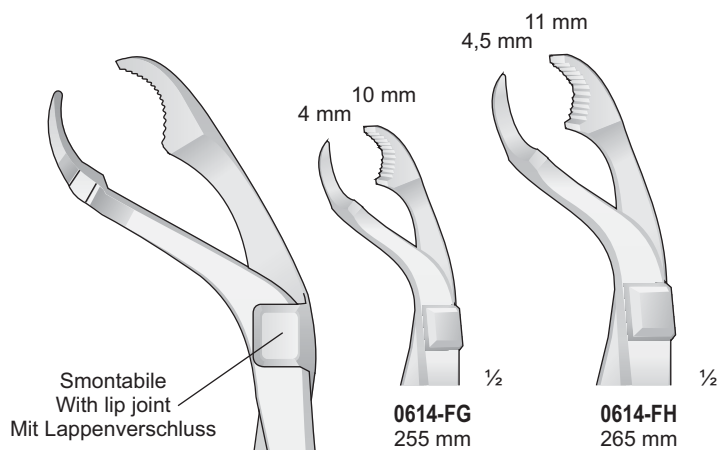

VERBRUGGE  
**0614-FG/0614-FH**

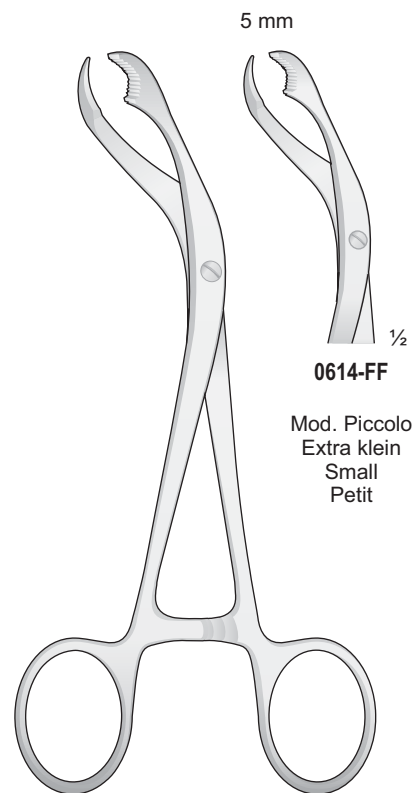

VERBRUGGE  
**0614-FF**  
175 mm

Autocentrante con blocco  
 Selbstzentrierend mit Gewindesperre  
 Self-centering bone holding forceps with thread lock  
 À centrage automatique avec arrêt de filetage

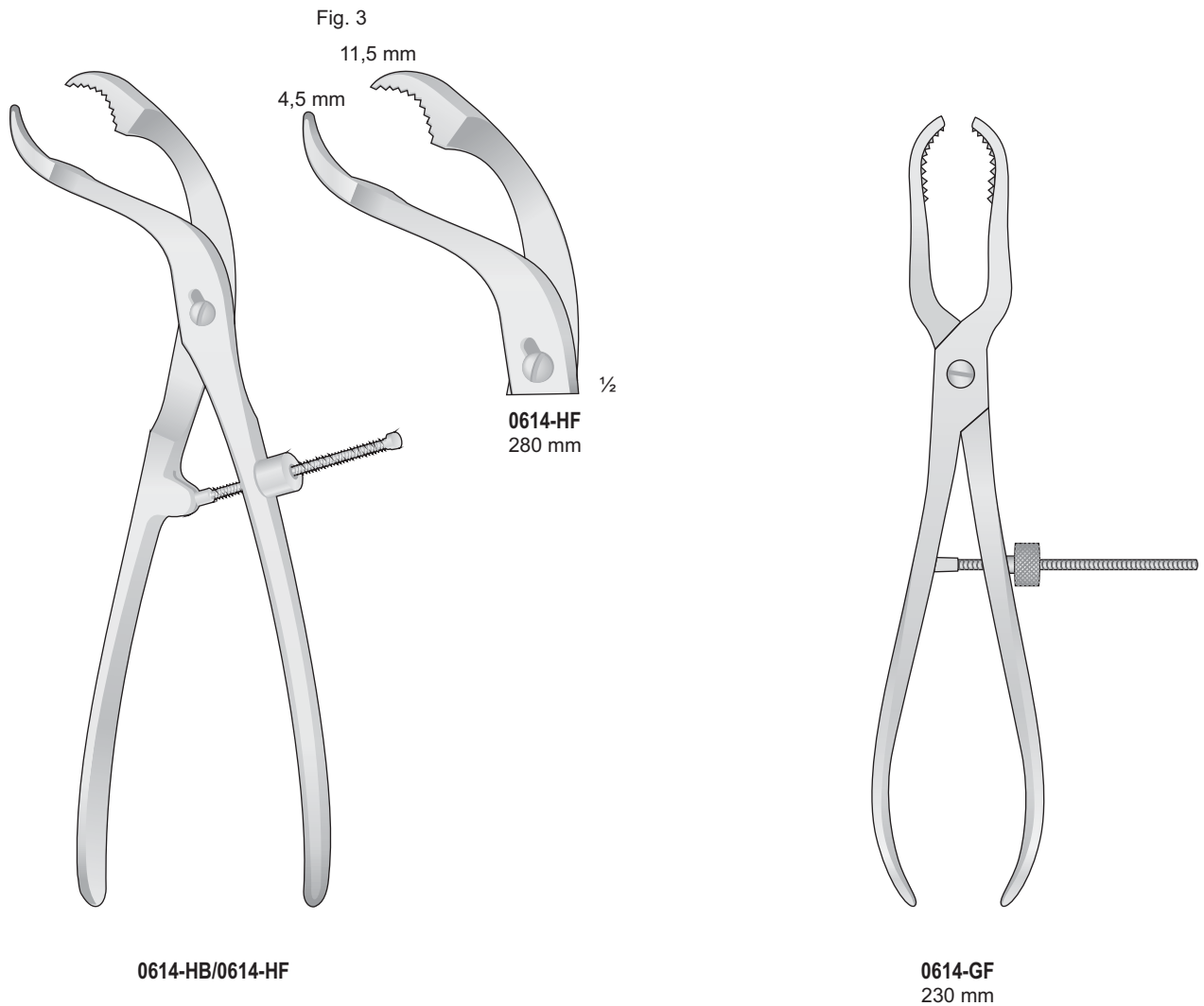
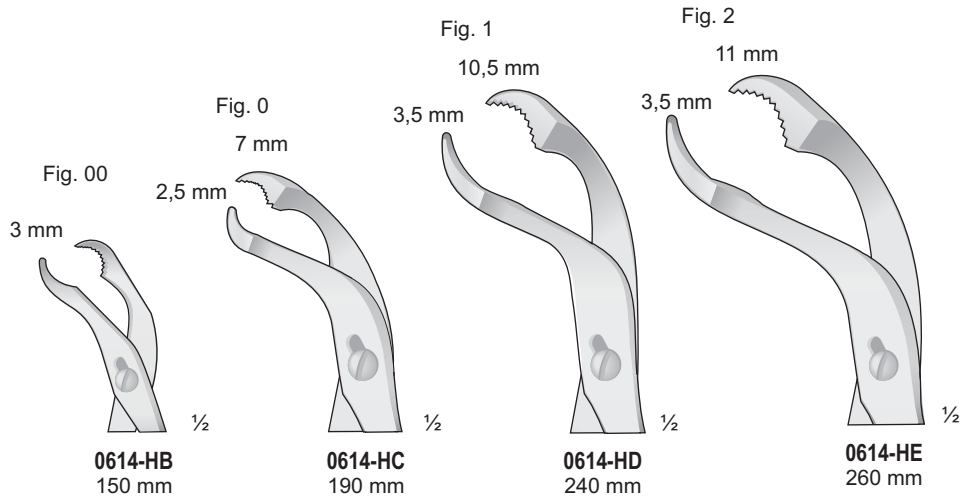

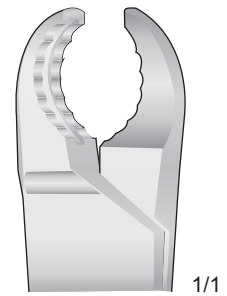

1/1

**0614-GC**  
230 mm

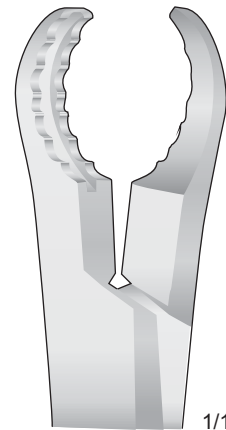

1/1

**0614-IC**  
250 mm

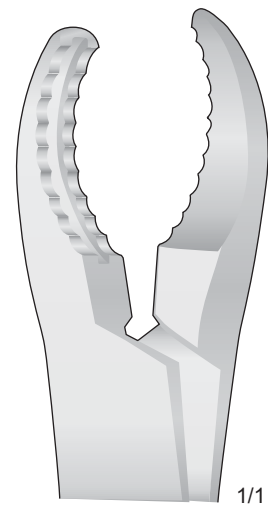

1/1

**0614-BAF**  
280 mm

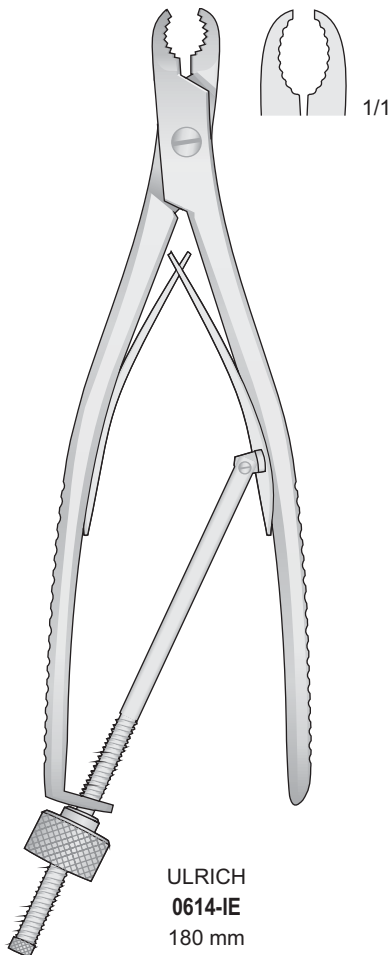

1/1

ULRICH  
**0614-IE**  
180 mm

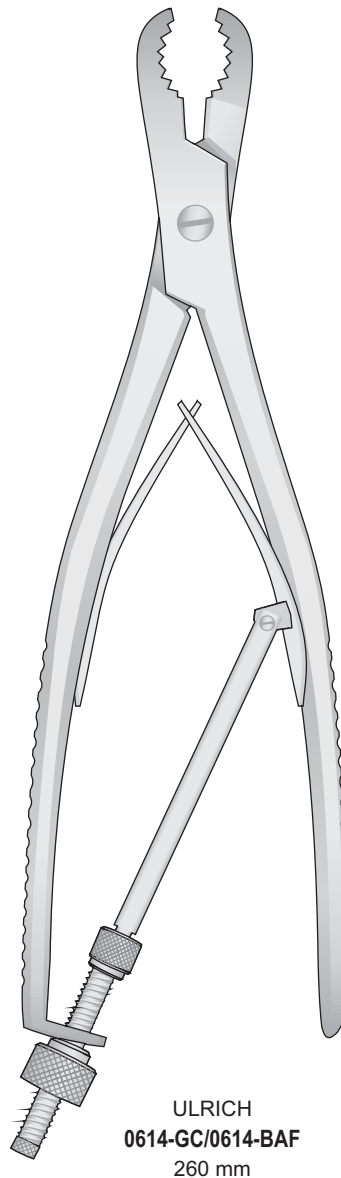

ULRICH  
**0614-GC/0614-BAF**  
260 mm

Pinze per menisco e cartilagine - Meniscus and cartilage clamp  
 Meniskus und Knorpelfasszangen - Pincès à saisir ménisque et cartilages

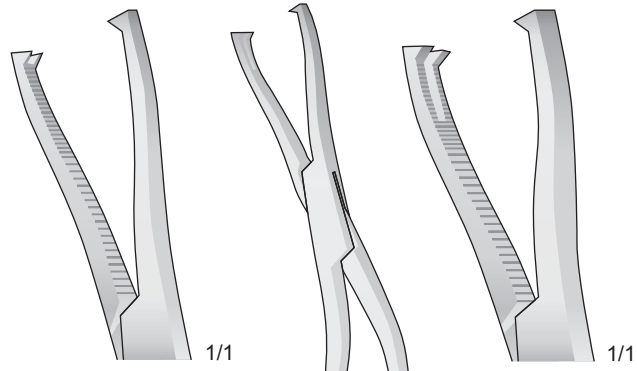

DINGMANN  
0614-BDA

DINGMANN MODIF.  
0614-BDB

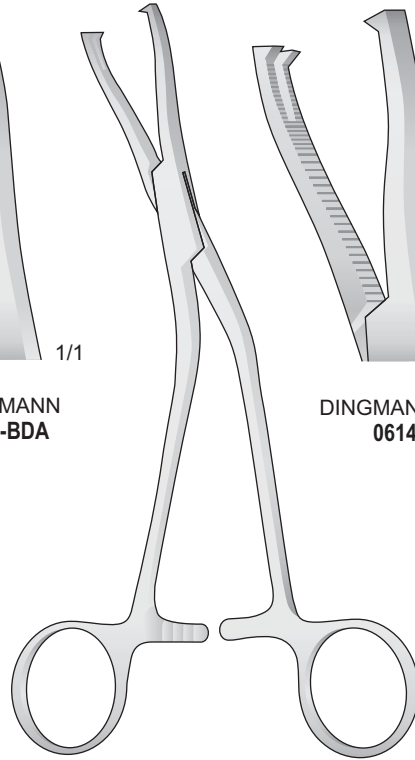

DINGMANN  
0614-BDA/0614-BDB  
190 mm



0614-BDE  
185 mm

MARTIN  
0614-BDD  
200 mm

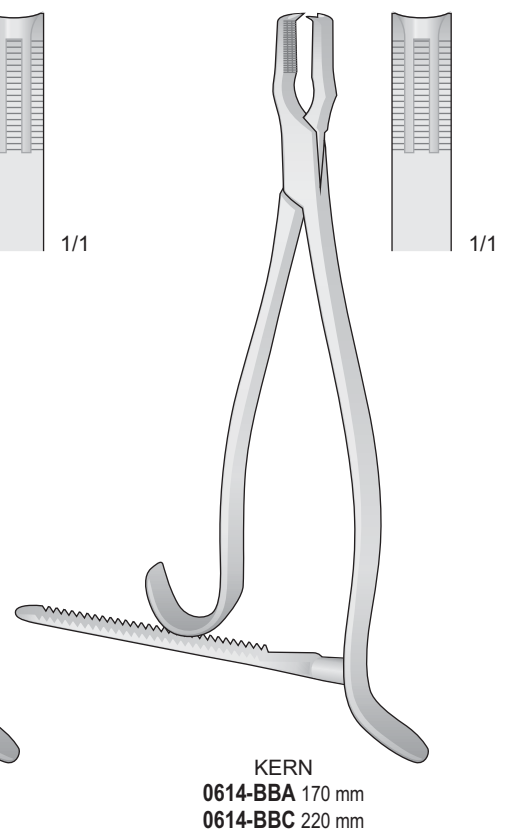
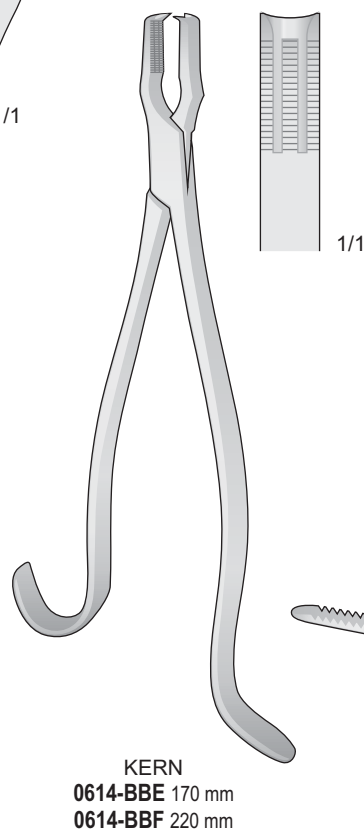
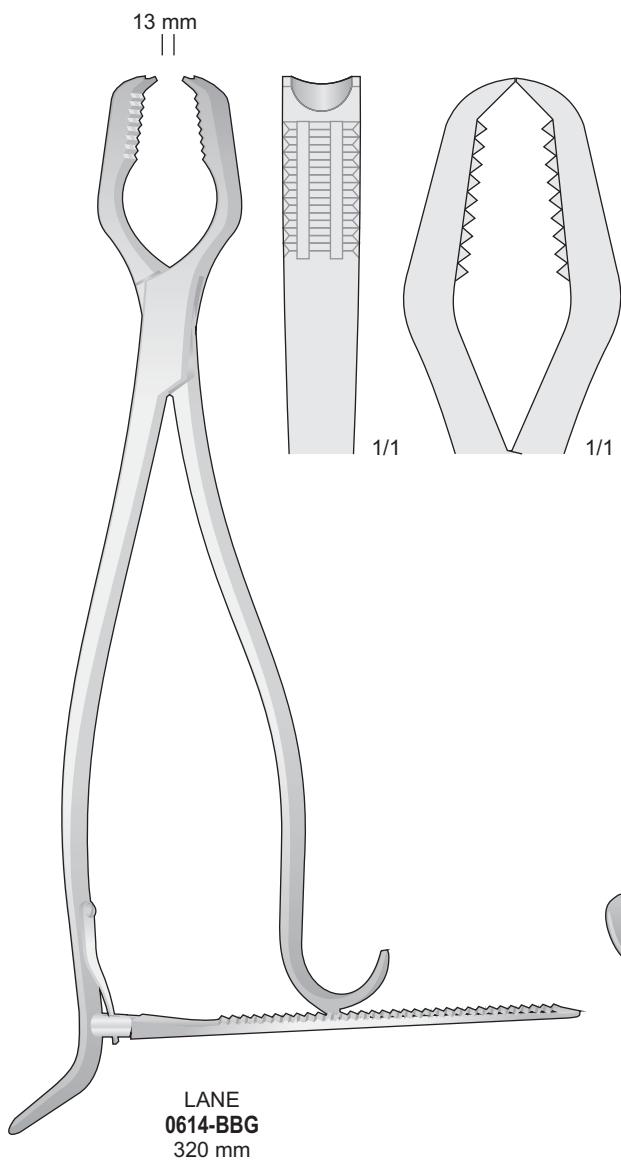



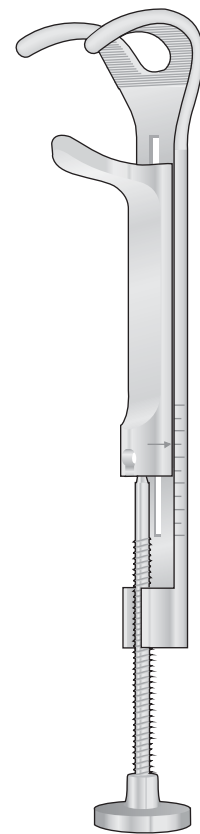
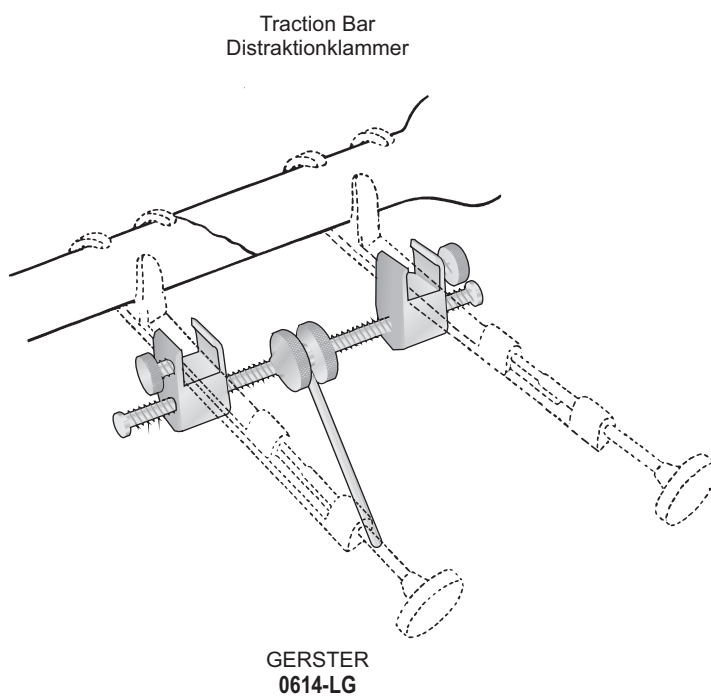

GERSTER-LOWMAN  
0614-LA 120 mm  
0614-LB 185 mm  
0614-LC 200 mm

Per bambini  
For children  
Für Kinder  
Pour enfants  
Para niños

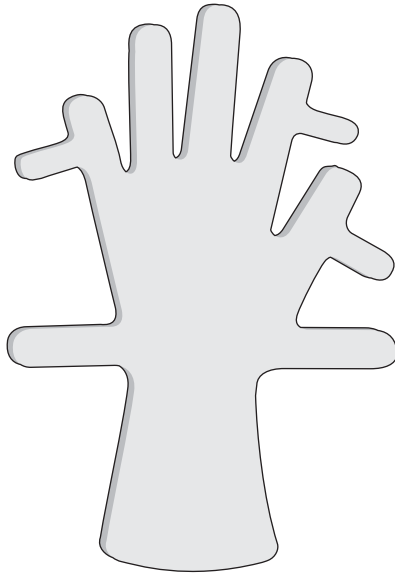

0614-CLL

Per adulti - For adults - Für Erwachsene  
Pour adultes - Para adultos

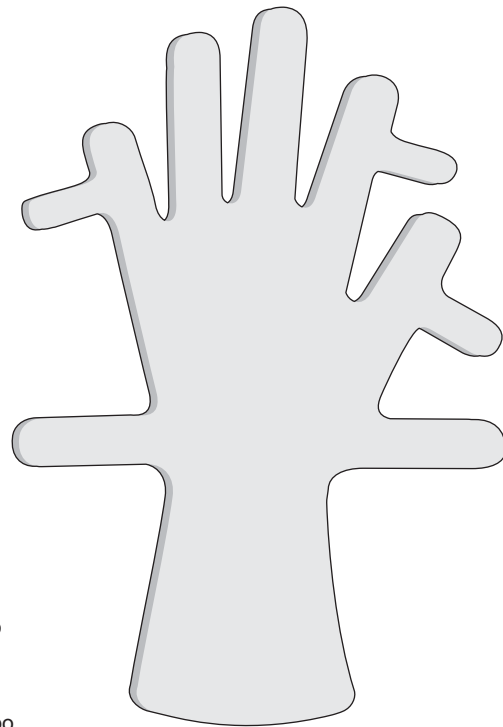

Mani di piombo  
Lead hands  
Bleihände  
Main de plomb  
Manos de plombo

0614-DAA

Pinza taglia anelli - Forceps for opening rings  
Fingerringssägen - Scies pour bagues - Sierra para anillos

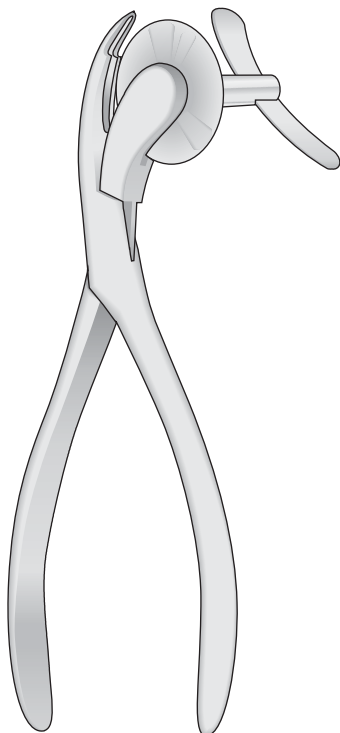

0614-IA  
170 mm

Pinza per estrazione delle unghie  
Nail extracting forceps  
Nagel -Ausreisszange  
Pince pour extraire les ongles  
Pinzas para arrancar uñas

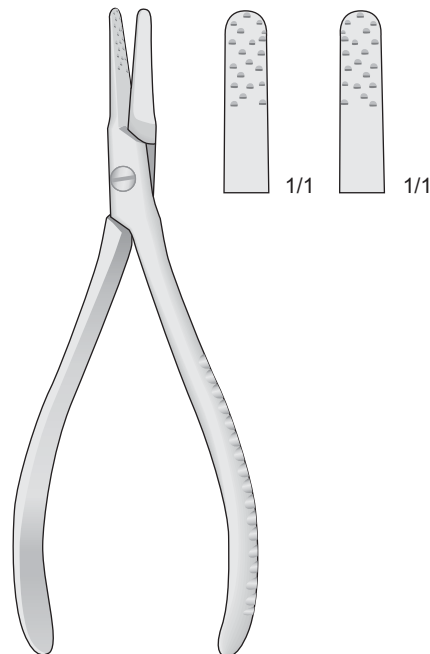

RADOLF  
0614-BFL  
135 mm

Pinza per unghie  
Nail nipper  
Nagelspaltzange  
Pince à ongles  
Pinzas corta uñas

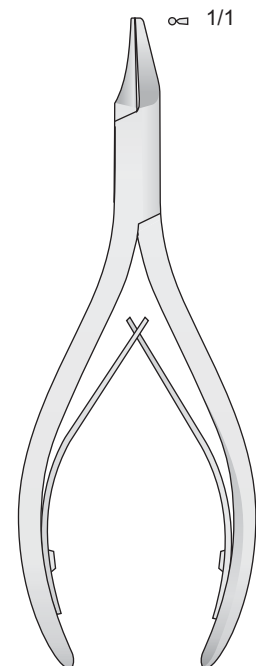

0415-AL  
135 mm

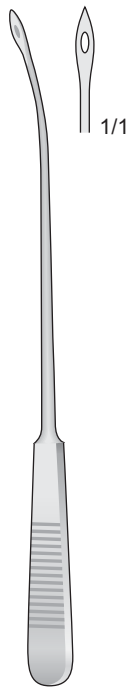

OBWEGESER  
**0414-DA**  
140 mm

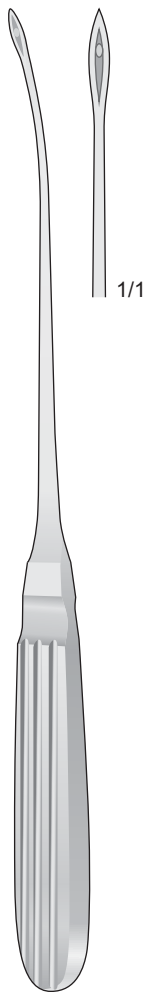

OBWEGESER  
**0414-DB**  
230 mm

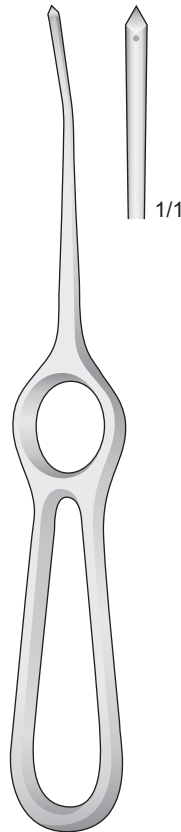

**0414-DC**  
180 mm

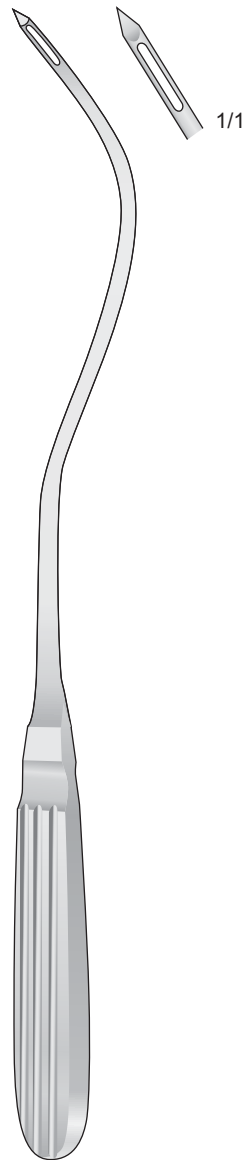

SANDERS-BROWN  
**0414-EE**  
290 mm

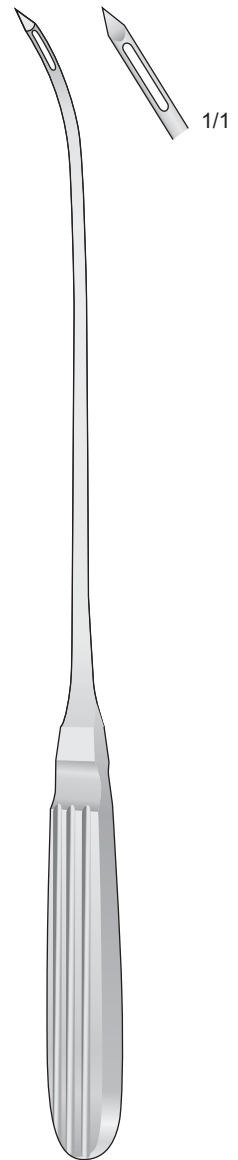

SANDERS-BROWN  
**0414-EL**  
300 mm

Perforatori  
a mano

Boring  
instruments

Bohrinstrumente  
Pfrieme

Instruments à perforer  
alènes

Perforadores  
para huesos

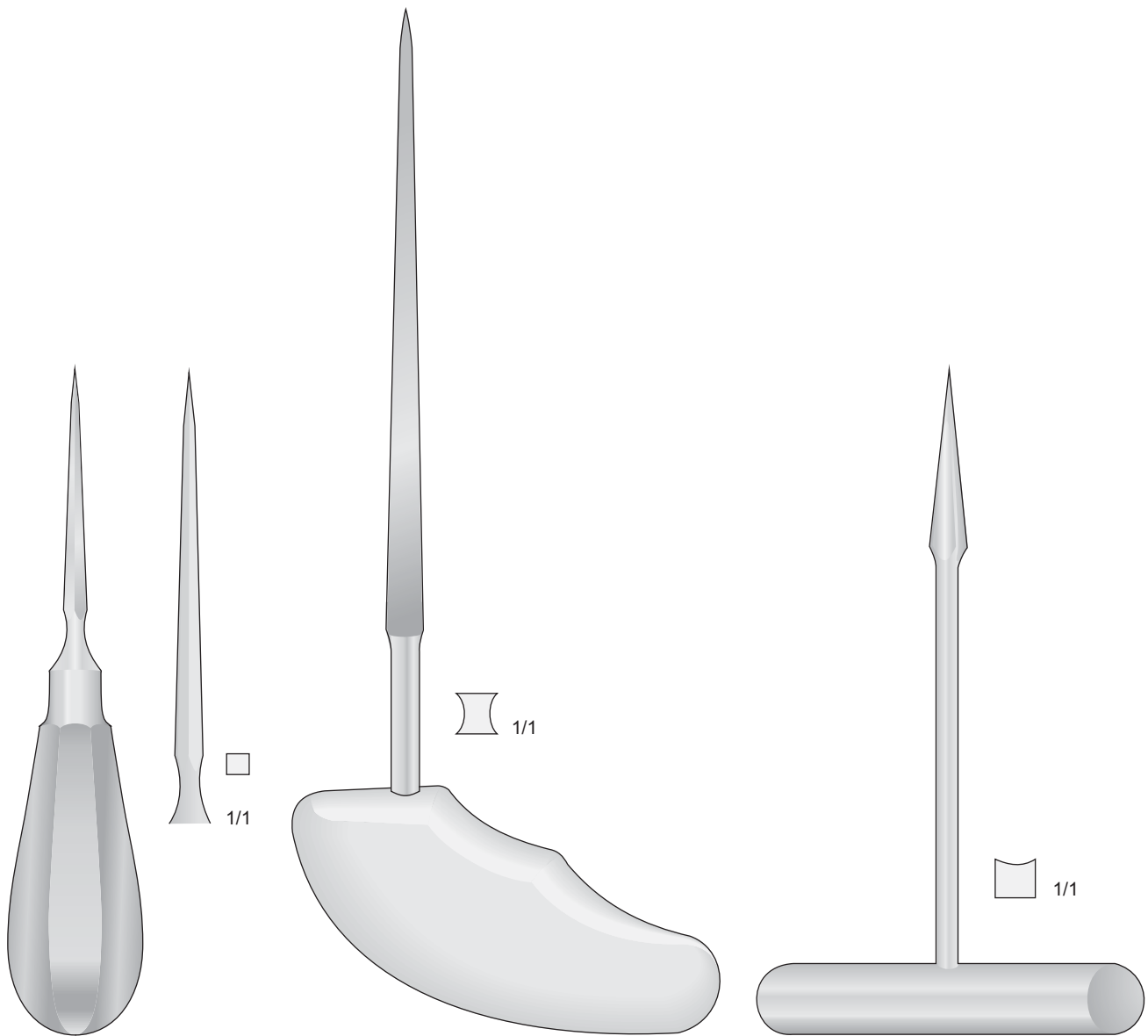





1917-HH  
140 mm

PERTHES  
1917-HI  
210 mm

1917-HG  
140 mm



Punche da biopsia - Hautstanzen  
 Dermal punches - Trépan cutané - Trépanos cutáneos

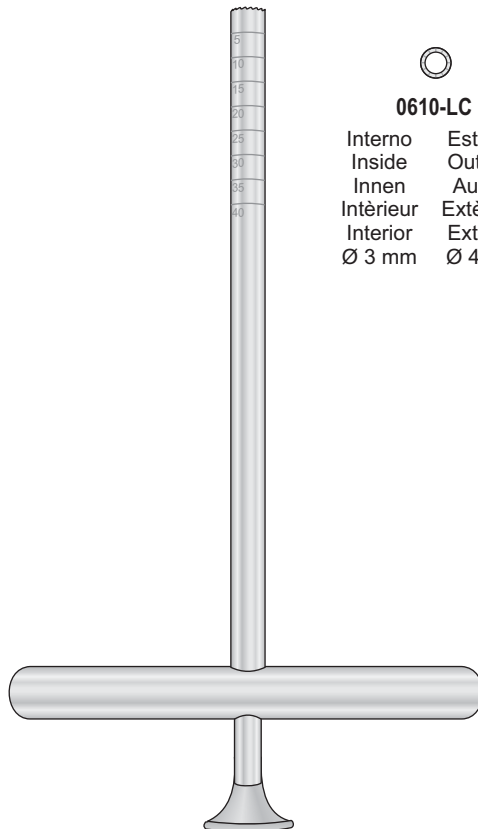

-   
**0611-BFA**  
 3 mm
-   
**0611-BFB**  
 4 mm
-   
**0611-BFC**  
 5 mm
-   
**0611-BFD**  
 6 mm

KEYES  
 0611-BFA/0611-BFD  
 100 mm



- |   |           |         |        |         |       |       |           |           |          |          |        |        |   |         |         |        |         |       |       |           |           |          |          |          |        |   |         |         |        |         |       |       |           |           |          |          |          |        |
|---|-----------|---------|--------|---------|-------|-------|-----------|-----------|----------|----------|--------|--------|---|---------|---------|--------|---------|-------|-------|-----------|-----------|----------|----------|----------|--------|---|---------|---------|--------|---------|-------|-------|-----------|-----------|----------|----------|----------|--------|
| <br><b>0610-LC</b><br><table border="0" style="margin: auto;"> <tr><td>Interno</td><td>Esterno</td></tr> <tr><td>Inside</td><td>Outside</td></tr> <tr><td>Innen</td><td>Außen</td></tr> <tr><td>Intérieur</td><td>Extérieur</td></tr> <tr><td>Interior</td><td>Exterior</td></tr> <tr><td>Ø 3 mm</td><td>Ø 4 mm</td></tr> </table> | Interno   | Esterno | Inside | Outside | Innen | Außen | Intérieur | Extérieur | Interior | Exterior | Ø 3 mm | Ø 4 mm | <br><b>0610-LA</b><br><table border="0" style="margin: auto;"> <tr><td>Interno</td><td>Esterno</td></tr> <tr><td>Inside</td><td>Outside</td></tr> <tr><td>Innen</td><td>Außen</td></tr> <tr><td>Intérieur</td><td>Extérieur</td></tr> <tr><td>Interior</td><td>Exterior</td></tr> <tr><td>Ø 3,9 mm</td><td>Ø 5 mm</td></tr> </table> | Interno | Esterno | Inside | Outside | Innen | Außen | Intérieur | Extérieur | Interior | Exterior | Ø 3,9 mm | Ø 5 mm | <br><b>0610-LB</b><br><table border="0" style="margin: auto;"> <tr><td>Interno</td><td>Esterno</td></tr> <tr><td>Inside</td><td>Outside</td></tr> <tr><td>Innen</td><td>Außen</td></tr> <tr><td>Intérieur</td><td>Extérieur</td></tr> <tr><td>Interior</td><td>Exterior</td></tr> <tr><td>Ø 6,4 mm</td><td>Ø 8 mm</td></tr> </table> | Interno | Esterno | Inside | Outside | Innen | Außen | Intérieur | Extérieur | Interior | Exterior | Ø 6,4 mm | Ø 8 mm |
| Interno   | Esterno   |         |        |         |       |       |           |           |          |          |        |        |   |         |         |        |         |       |       |           |           |          |          |          |        |   |         |         |        |         |       |       |           |           |          |          |          |        |
| Inside  | Outside   |         |        |         |       |       |           |           |          |          |        |        |   |         |         |        |         |       |       |           |           |          |          |          |        |   |         |         |        |         |       |       |           |           |          |          |          |        |
| Innen   | Außen     |         |        |         |       |       |           |           |          |          |        |        |   |         |         |        |         |       |       |           |           |          |          |          |        |   |         |         |        |         |       |       |           |           |          |          |          |        |
| Intérieur   | Extérieur |         |        |         |       |       |           |           |          |          |        |        |   |         |         |        |         |       |       |           |           |          |          |          |        |   |         |         |        |         |       |       |           |           |          |          |          |        |
| Interior  | Exterior  |         |        |         |       |       |           |           |          |          |        |        |   |         |         |        |         |       |       |           |           |          |          |          |        |   |         |         |        |         |       |       |           |           |          |          |          |        |
| Ø 3 mm  | Ø 4 mm    |         |        |         |       |       |           |           |          |          |        |        |   |         |         |        |         |       |       |           |           |          |          |          |        |   |         |         |        |         |       |       |           |           |          |          |          |        |
| Interno   | Esterno   |         |        |         |       |       |           |           |          |          |        |        |   |         |         |        |         |       |       |           |           |          |          |          |        |   |         |         |        |         |       |       |           |           |          |          |          |        |
| Inside  | Outside   |         |        |         |       |       |           |           |          |          |        |        |   |         |         |        |         |       |       |           |           |          |          |          |        |   |         |         |        |         |       |       |           |           |          |          |          |        |
| Innen   | Außen     |         |        |         |       |       |           |           |          |          |        |        |   |         |         |        |         |       |       |           |           |          |          |          |        |   |         |         |        |         |       |       |           |           |          |          |          |        |
| Intérieur   | Extérieur |         |        |         |       |       |           |           |          |          |        |        |   |         |         |        |         |       |       |           |           |          |          |          |        |   |         |         |        |         |       |       |           |           |          |          |          |        |
| Interior  | Exterior  |         |        |         |       |       |           |           |          |          |        |        |   |         |         |        |         |       |       |           |           |          |          |          |        |   |         |         |        |         |       |       |           |           |          |          |          |        |
| Ø 3,9 mm  | Ø 5 mm    |         |        |         |       |       |           |           |          |          |        |        |   |         |         |        |         |       |       |           |           |          |          |          |        |   |         |         |        |         |       |       |           |           |          |          |          |        |
| Interno   | Esterno   |         |        |         |       |       |           |           |          |          |        |        |   |         |         |        |         |       |       |           |           |          |          |          |        |   |         |         |        |         |       |       |           |           |          |          |          |        |
| Inside  | Outside   |         |        |         |       |       |           |           |          |          |        |        |   |         |         |        |         |       |       |           |           |          |          |          |        |   |         |         |        |         |       |       |           |           |          |          |          |        |
| Innen   | Außen     |         |        |         |       |       |           |           |          |          |        |        |   |         |         |        |         |       |       |           |           |          |          |          |        |   |         |         |        |         |       |       |           |           |          |          |          |        |
| Intérieur   | Extérieur |         |        |         |       |       |           |           |          |          |        |        |   |         |         |        |         |       |       |           |           |          |          |          |        |   |         |         |        |         |       |       |           |           |          |          |          |        |
| Interior  | Exterior  |         |        |         |       |       |           |           |          |          |        |        |   |         |         |        |         |       |       |           |           |          |          |          |        |   |         |         |        |         |       |       |           |           |          |          |          |        |
| Ø 6,4 mm  | Ø 8 mm    |         |        |         |       |       |           |           |          |          |        |        |   |         |         |        |         |       |       |           |           |          |          |          |        |   |         |         |        |         |       |       |           |           |          |          |          |        |

0610-LA/0610-LC  
 170 mm

**0610-BAA**

Set completo di 4 pezzi  
 Set complete with 4 pieces  
 Kompletset mit 4 Teilen  
 Set complet avec 4 pièces  
 Set completo con 4 piezas

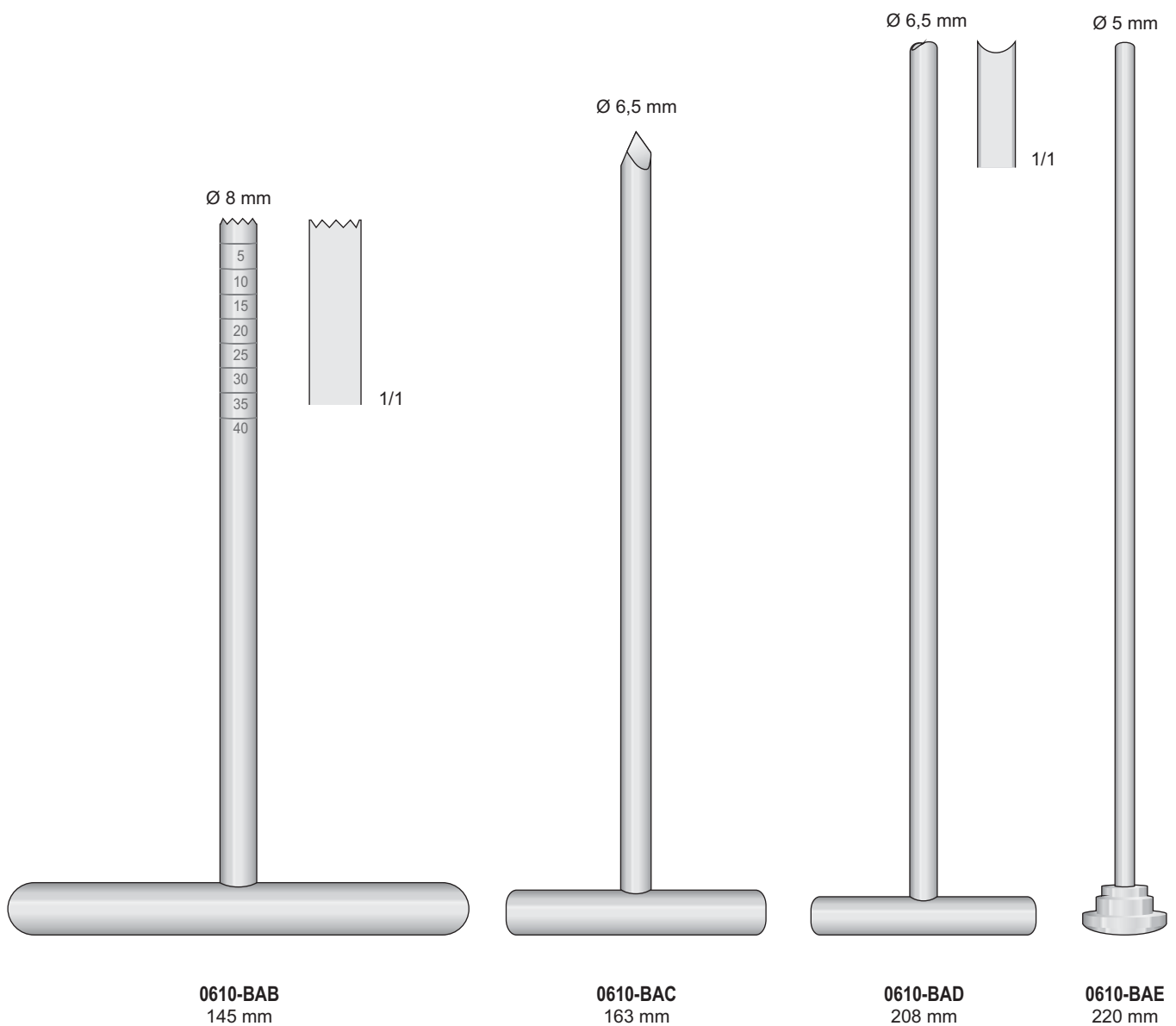

**0610-BAF**

Set completo di 4 pezzi  
 Set complete with 4 pieces  
 Kompletset mit 4 Teilen  
 Set complet avec 4 pièces  
 Set completo con 4 piezas

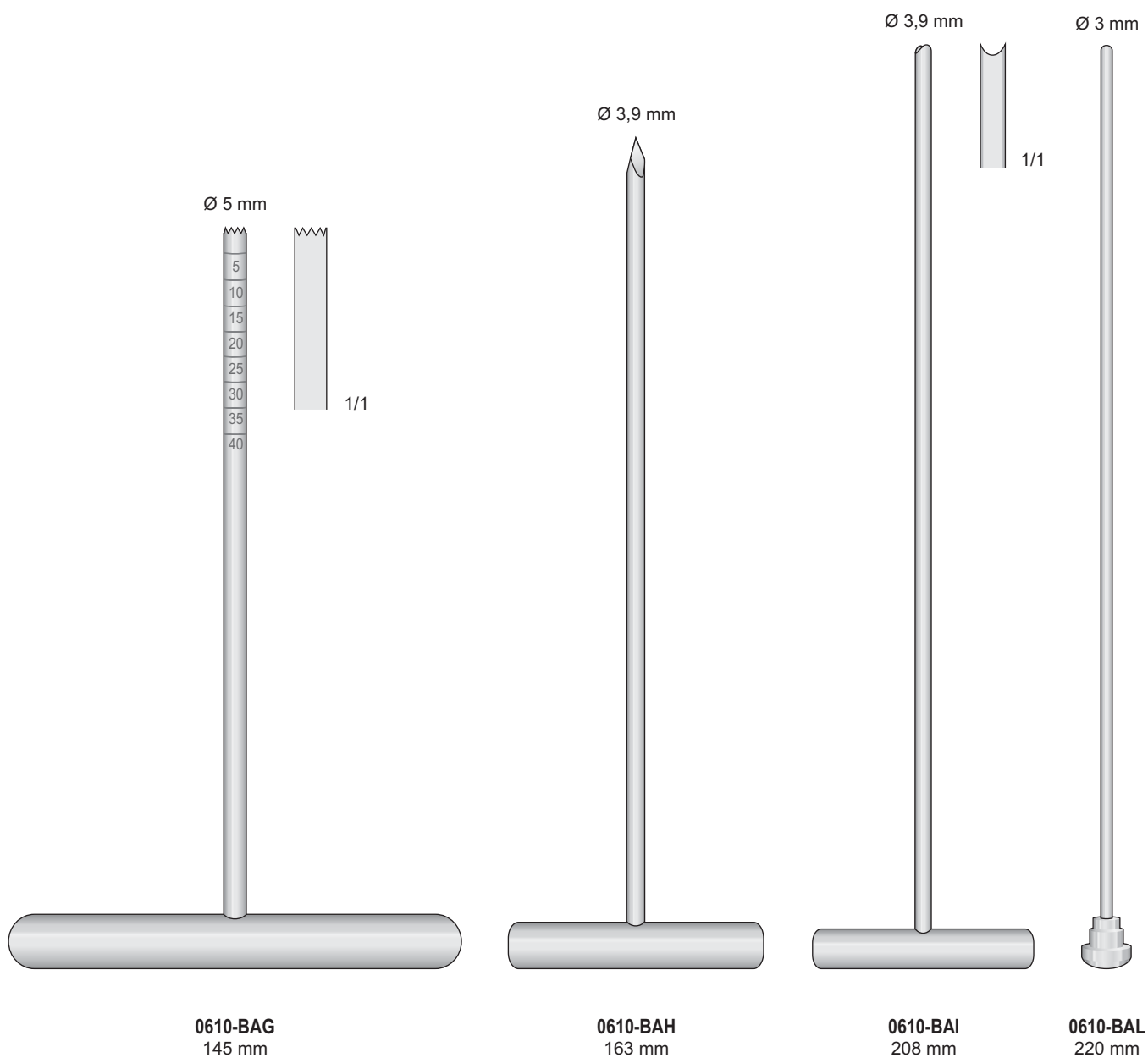

**Chiodi Kirschner**
**Wires extension**
**Bohrdrahte**
**Broches filiformes**
**Taladros filiformes**



**KIRSCHNER**  
 Punta trequarti  
 Trocar point  
 Trokarspitze  
 Pointe de Trocart  
 Punta de trocar



**KIRSCHNER**  
 Punta trequarti  
 Trocar point  
 Trokarspitze  
 Pointe de Trocart  
 Punta de trocar

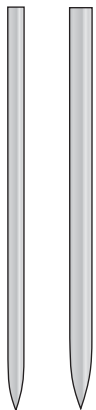

**KIRSCHNER**  
 Punta lanceolate  
 Lance point  
 Lanzenspitze  
 Pointe lancette  
 Punta lanceolar



Punta trequarti  
 Trocar point  
 Trokarspitze  
 Pointe de Trocart  
 Punta de trocar

310 mm

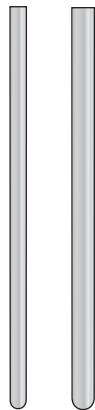

Punta rotonda  
 Round shaft  
 Rundes ende  
 Pointe ronde  
 Punta redonda

310 mm

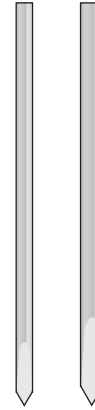

Punta lanceolate  
 Lance point  
 Lanzenspitze  
 Pointe lancette  
 Punta lanceolar

310 mm

Ø/Diam.	Pack. 10 pcs
0,8 mm	<b>1009-LL</b>
1,0 mm	<b>1009-BAA</b>
1,2 mm	<b>1009-BAC</b>
1,4 mm	<b>1009-BBE</b>
1,5 mm	<b>1009-BBF</b>
1,6 mm	<b>1009-BBG</b>
1,7 mm	<b>1009-BBH</b>
1,8 mm	<b>1009-BBI</b>
2,0 mm	<b>1009-BCA</b>
2,2 mm	<b>1009-BCC</b>
2,5 mm	<b>1009-BCF</b>
3,0 mm	<b>1009-BDA</b>

Ø/Diam.	Pack. 10 pcs
0,8 mm	<b>1009-AA</b>
1,0 mm	<b>1009-AB</b>
1,2 mm	<b>1009-AC</b>
1,4 mm	<b>1009-BE</b>
1,5 mm	<b>1009-BF</b>
1,6 mm	<b>1009-BG</b>
1,7 mm	<b>1009-BH</b>
1,8 mm	<b>1009-BI</b>
2,0 mm	<b>1009-CA</b>
2,2 mm	<b>1009-CC</b>
2,5 mm	<b>1009-CF</b>
3,0 mm	<b>1009-DA</b>

Ø/Diam.	Pack. 10 pcs
0,8 mm	<b>1009-EA</b>
1,0 mm	<b>1009-EB</b>
1,2 mm	<b>1009-EC</b>
1,5 mm	<b>1009-ED</b>
1,6 mm	<b>1009-EE</b>
1,8 mm	<b>1009-EF</b>
2,0 mm	<b>1009-EG</b>
2,2 mm	<b>1009-EH</b>
2,5 mm	<b>1009-EI</b>
3,0 mm	<b>1009-EL</b>





**KIRSCHNER**  
 Punta trequarti  
 Trocar point  
 Trokarspitze  
 Pointe de Trocart  
 Punta de trocar



**KIRSCHNER**  
 Punta trequarti  
 Trocar point  
 Trokarspitze  
 Pointe de Trocart  
 Punta de trocar



15 mm

Con filettatura  
 With thread  
 Mit Gewinde  
 Avec filetage  
 Con rosca

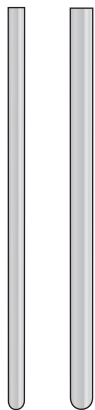

Punta rotonda  
 Round shaft  
 Rundes ende  
 Pointe ronde  
 Punta redonda

150 mm



Punta trequarti  
 Trocar point  
 Trokarspitze  
 Pointe de Trocart  
 Punta de trocar

150 mm



Rotonda  
 Round  
 Runde  
 Ronde  
 Redonda

○

Ø/Diam.	Pack. 10 pcs
0,8 mm	<b>1009-GL</b>
1,0 mm	<b>1009-HA</b>
1,2 mm	<b>1009-HC</b>
1,4 mm	<b>1009-HE</b>
1,5 mm	<b>1009-HF</b>
1,6 mm	<b>1009-HG</b>
1,7 mm	<b>1009-HH</b>
1,8 mm	<b>1009-HI</b>
2,0 mm	<b>1009-IA</b>
2,2 mm	<b>1009-IC</b>
2,5 mm	<b>1009-IF</b>
3,0 mm	<b>1009-LA</b>

Ø/Diam.	Pack. 10 pcs
0,8 mm	<b>1009-GA</b>
1,0 mm	<b>1009-GB</b>
1,2 mm	<b>1009-GC</b>
1,4 mm	<b>1009-GD</b>
1,6 mm	<b>1009-GE</b>

KIRSCHNER			
Code	Ø mm	Lenght	Wire Len.
<b>1009-CCA</b>	1,5	150	5
<b>1009-CCB</b>	1,6	150	15
<b>1009-CCC</b>	2	150	15
<b>1009-CCD</b>	2	200	15

KIRSCHNER

Bundel-Nagel

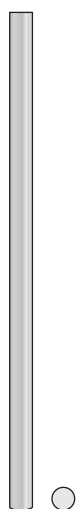
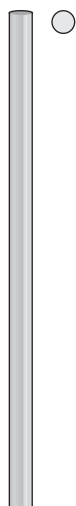

500 mm

Steinmann pins



310 mm

Küntscher



400 mm



Threaded Steinmann Pins



230 mm

Runde



Ø/Diam.	Pack. 10 pcs
2,0 mm	<b>1009-FA</b>
2,5 mm	<b>1009-FB</b>
3,0 mm	<b>1009-FC</b>
3,5 mm	<b>1009-FD</b>
4,0 mm	<b>1009-FE</b>
4,5 mm	<b>1009-FF</b>
5,0 mm	<b>1009-FG</b>
5,5 mm	<b>1009-FH</b>
6,0 mm	<b>1009-FI</b>

Ø/Diam.	Pack. 1 pc
3,5 mm	<b>1009-CIA</b>
4,0 mm	<b>1009-CIC</b>
4,5 mm	<b>1009-CIE</b>
5,0 mm	<b>1009-CIG</b>
6,0 mm	<b>1009-CII</b>
6,5 mm	<b>1009-CLA</b>

Ø/Diam.	Pack. 1 pc
6,0 mm	<b>1009-CFC</b>
7,0 mm	<b>1009-CFE</b>
8,0 mm	<b>1009-CFG</b>
9,0 mm	<b>1009-CFI</b>
10 mm	<b>1009-CGA</b>
11 mm	<b>1009-CGC</b>
12 mm	<b>1009-CGE</b>

Ø/Diam.	Pack. 1 pc
2,0 mm	<b>1009-BGA</b>
2,5 mm	<b>1009-BGB</b>

Steinmann Pins with Central Thread with Trocar Point

Contenitore per  
sterilizzazione Kirschner  
Bohrdrahtspender

Positivo  
Thread - Ø is 0,5 mm  
more than pin - Ø

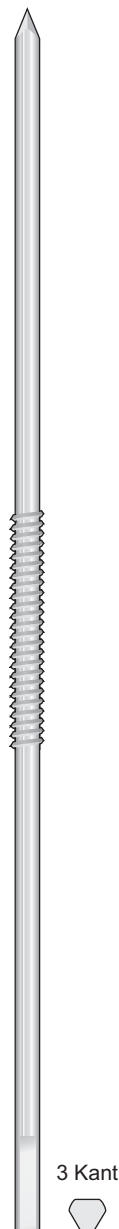

STEINMANN PINS			
Code	Ø mm	Lenght	Wire Len. mm
1009-BHF	3	150	37
1009-BHG	3	180	48
1009-BHH	3	200	50
1009-BHI	3	230	52
1009-BHL	3,5	150	37
1009-BIA	3,5	180	52
1009-BIB	3,5	200	52
1009-BIC	3,5	230	52
1009-BID	4	150	37
1009-BIE	4	180	52
1009-BIF	4	200	50
1009-BIG	4	230	52
1009-BIH	4	250	52
1009-BII	4,5	150	37
1009-BIL	4,5	180	52
1009-BLA	4,5	200	52
1009-BLB	4,5	230	52
1009-BLC	4,5	250	52
1009-BLD	4,5	300	52
1009-BLE	5	150	37
1009-BLF	5	180	52
1009-BLG	5	200	50
1009-BLH	5	230	52
1009-BLI	5	250	52
1009-BLL	5	300	52

Ø 10 mm

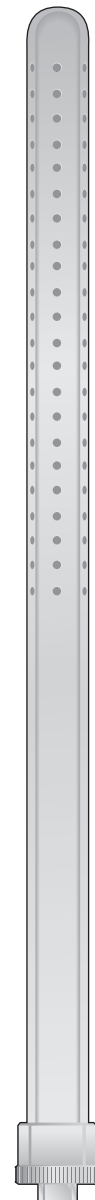

1009-BHF/1009-BLL

1009-DAA - 320 mm  
1009-DAB - 190 mm

**Chiodi filettati  
Schanz**

**Threaded Wires  
and pines**

**Bohrdrähte und  
knochennägel mit Gewinde**

**Broches et clous  
avec filetage**

**Agujas y clavos  
con rosca**

Viti di Schanz  
Schanz screws  
Schanz'sche Schrauben  
Vis de Schanz

Negative

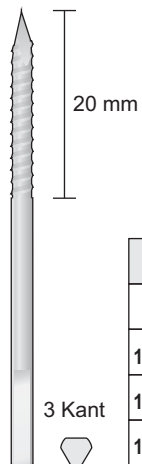

SCHANZ			
Code	Ø mm	Lenght	Wire Len.
1009-CDA	3	60	20
1009-CDB	3	80	20
1009-CDC	4	60	25

Negative

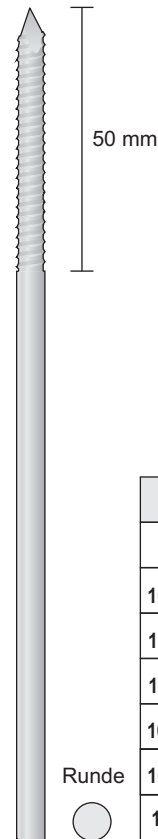

SCHANZ			
Code	Ø mm	Lenght	Wire Len.
1009-CLD	2	150	50
1009-CLE	3	150	50
1009-CLF	3,5	150	50
1009-CLG	4	150	50
1009-CLH	4,5	150	50
1009-CLI	5	150	50

Negative

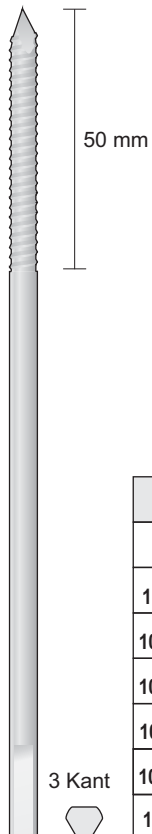

SCHANZ			
Code	Ø mm	Lenght	Wire Len.
1009-CDI	2	150	50
1009-CEA	3	150	50
1009-CEC	3,5	150	50
1009-CEE	4	150	50
1009-CEG	4,5	150	50
1009-CEI	5	150	50

Positive

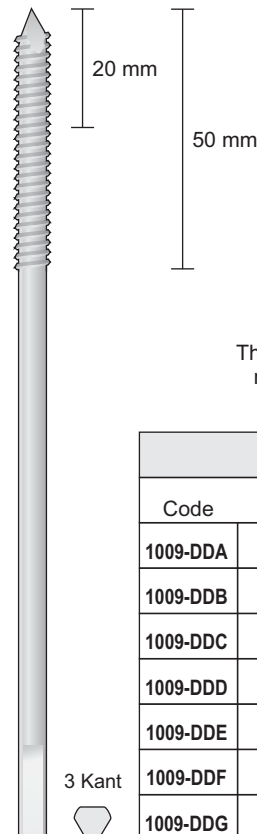

Thread - Ø is 0,5 mm  
more than pin - Ø

SCHANZ			
Code	Ø mm	Lenght	Wire Len.
1009-DDA	2	150	20
1009-DBB	3	150	20
1009-DDC	3,5	150	50
1009-DDD	4	150	25
1009-DDE	4	150	50
1009-DDF	4,5	150	50
1009-DDG	5	150	50

Strumenti per filo di cerchiaggio  
Wire instrument set  
Drahtinstrumentarium  
Instruments à fil  
Instrumental para cerclaje

Filo malleabile  
per compattare l'osso  
Wire soft  
Draht weich  
Fil à os  
Alambre ligadura

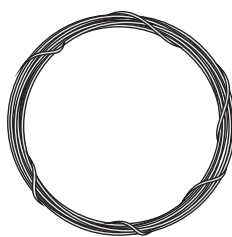

10 mt.

Ø/Diam.	Code
0,2 mm	<b>1009-CAC</b>
0,3 mm	<b>1009-CAD</b>
0,4 mm	<b>1009-CAE</b>
0,5 mm	<b>1009-CAF</b>
0,6 mm	<b>1009-CAG</b>
0,7 mm	<b>1009-CAH</b>
0,8 mm	<b>1009-CAI</b>
0,9 mm	<b>1009-CAL</b>
1,0 mm	<b>1009-CBA</b>
1,2 mm	<b>1009-CBB</b>
1,5 mm	<b>1009-CBC</b>

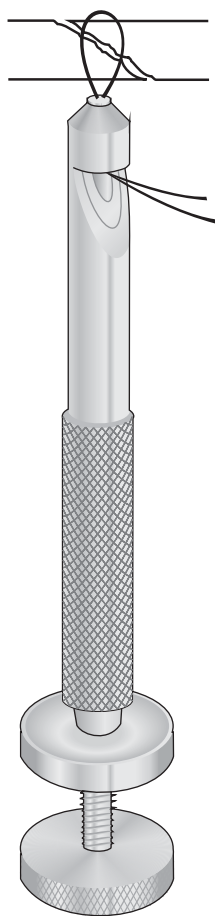

LOUTE  
**1009-DCC**  
220 mm

Strumenti tendifili  
Bone wire tighteners  
Drahtspanninstrument  
Tendeur serre fils  
Tensor cierra-hilos

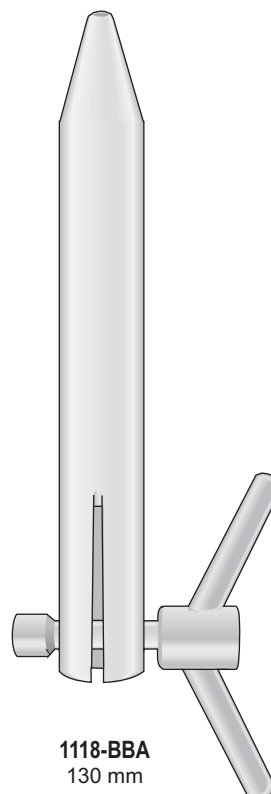

**1118-BBA**  
130 mm

Fino a Ø 3 mm  
Bis Ø 3 mm  
Up to Ø 3 mm

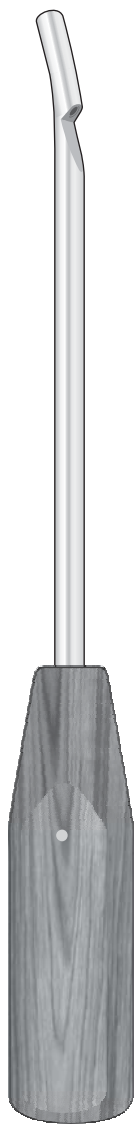

WAGNER  
1118-BAG  
300 mm

Gancio d'estrazione  
Extraction hooks  
Extraktionshaken  
Crochets d'extraction  
Ganchos extractores

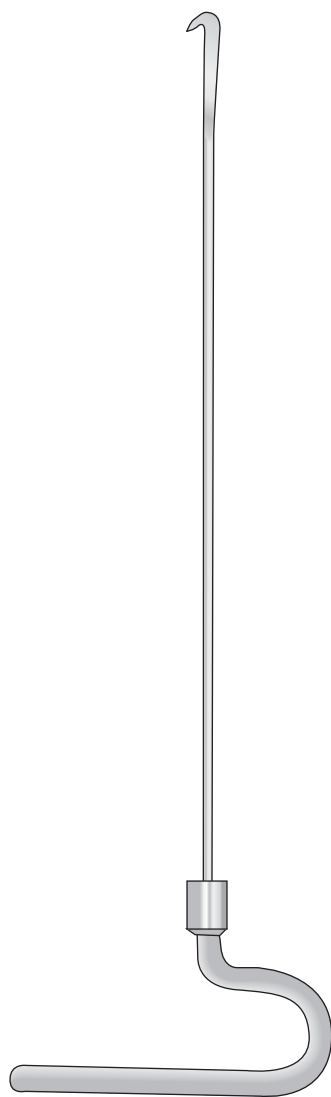

1009-DAG - 290 mm  
1009-DAH - 370 mm  
1009-DAI - 420 mm



1118-BAA  
120 mm



KÜNTSCHER  
0610-AL  
210 mm

**1118-CDD**  
 Completo con - Complete with  
 Komplett mit - Completes avec  
 Completos con:  
 1 **1118-CDG**  
 1 **1118-CCL**  
 1 **1118-CEB**

Attacco AO

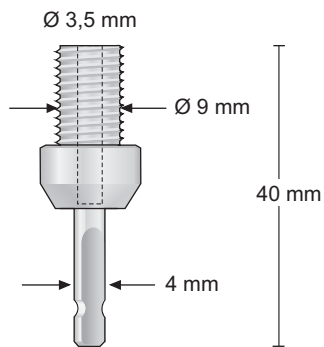

**1118-CCH**  
40 mm

Inox  
 ORIGINAL JACOBS

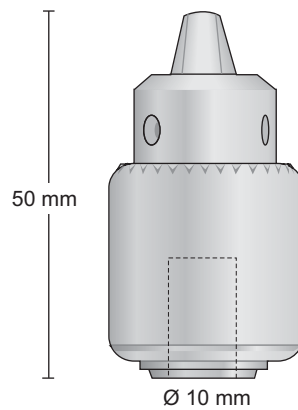

**1118-CDG**  
50 mm

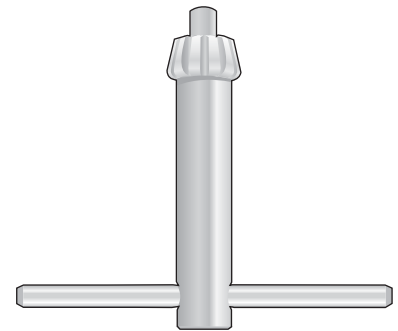

**1118-CEB**  
52 mm

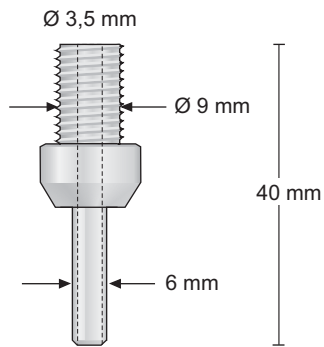

**1118-CCI**  
40 mm

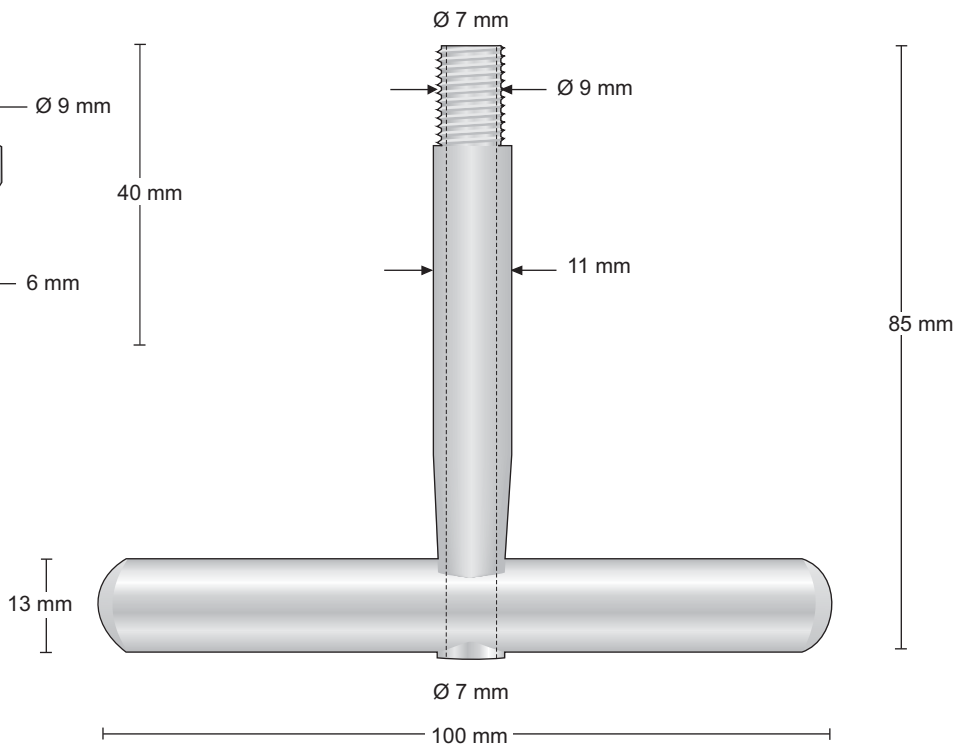

**1118-CCL**  
85 mm

**1118-CDL**  
 Completo con - Complete with  
 Komplett mit - Completes avec  
 Completos con:  
 1 **1118-CDG**  
 1 **1118-CDH**  
 1 **1118-CDI**  
 1 **1118-CEB**

Inox  
 ORIGINAL JACOBS

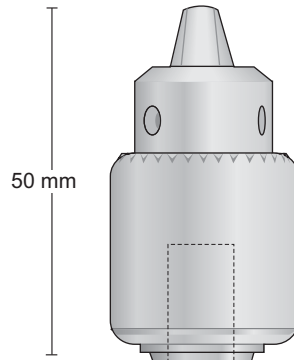

Ø 10 mm

**1118-CDG**  
 50 mm

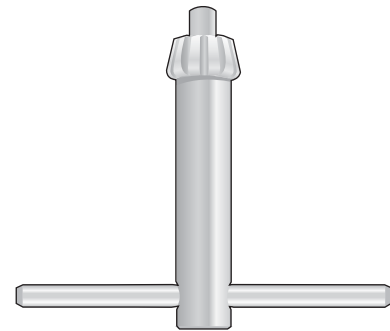

**1118-CEB**  
 52 mm

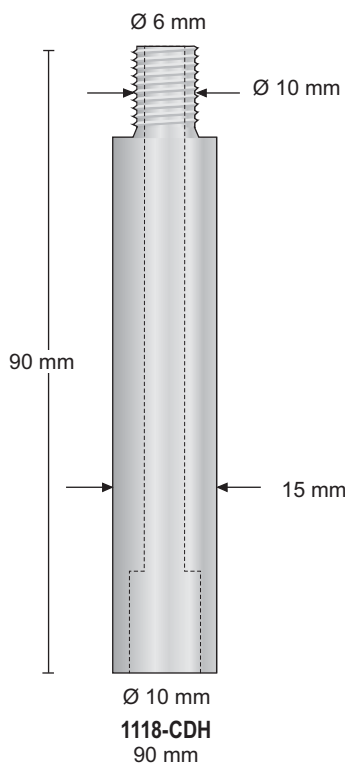

Ø 10 mm  
**1118-CDH**  
 90 mm

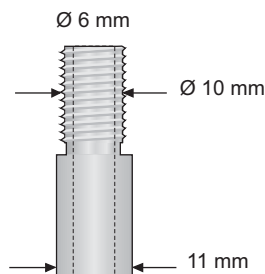

**1118-CDI**  
 130 mm

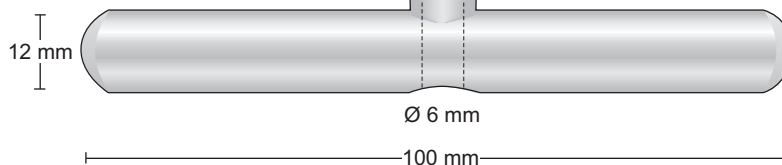

130 mm



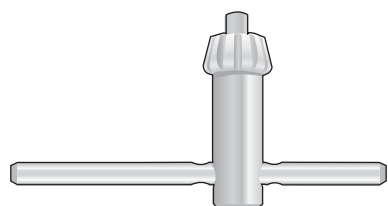

**1118-CDB**  
32 mm

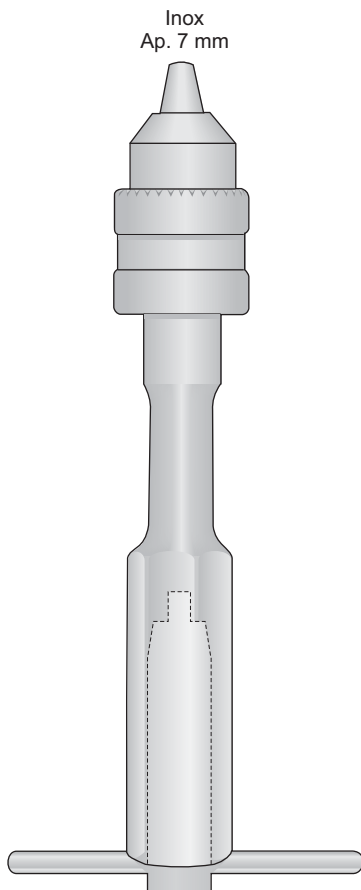

**1118-CDC**  
130 mm

Con chiusura a mano  
Von Handt zu spannen  
Tightened by hand

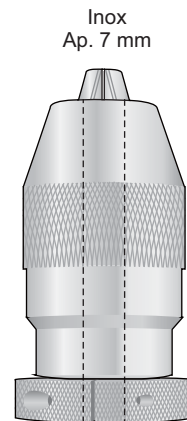

**1118-CCE**  
Mandrino solo

Con chiusura a mano  
Von Handt zu spannen  
tightened by hand

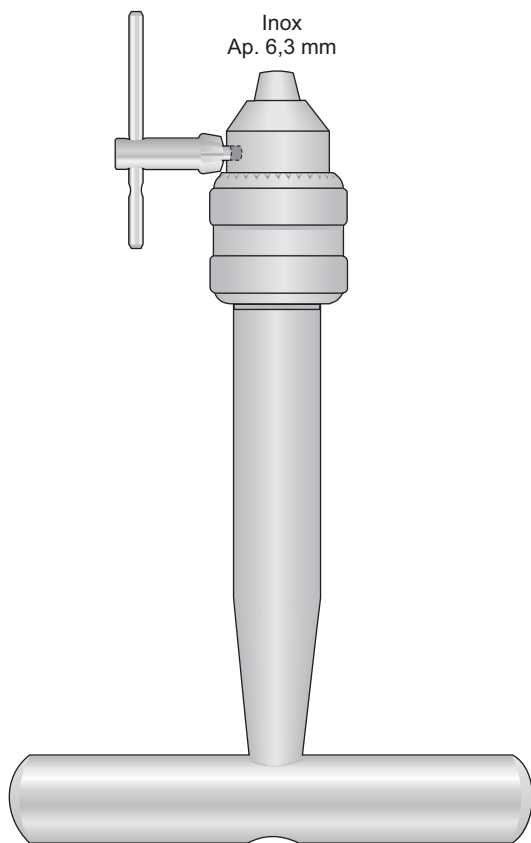

**1118-CDA**  
130 mm

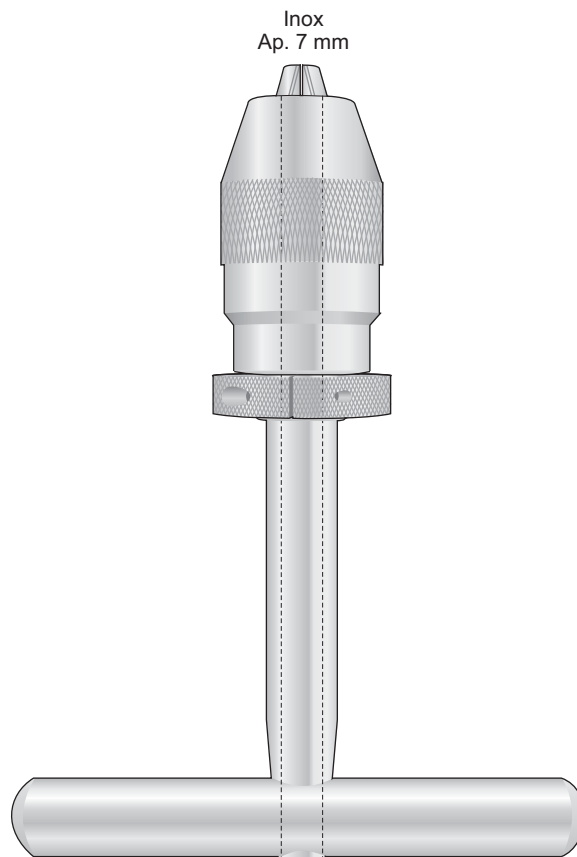

**1118-CDE**  
135 mm

Passafili

Wire guides

Drahtumföhrungsnadel

Aiguilles passe-fils

Agujas pasa hilos

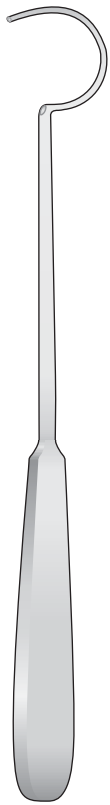

DEMEL  
0212-BC/0212-BE

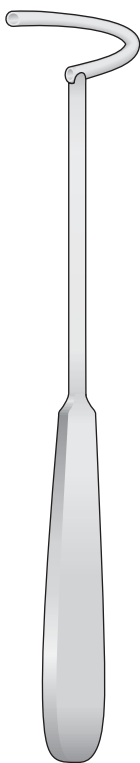
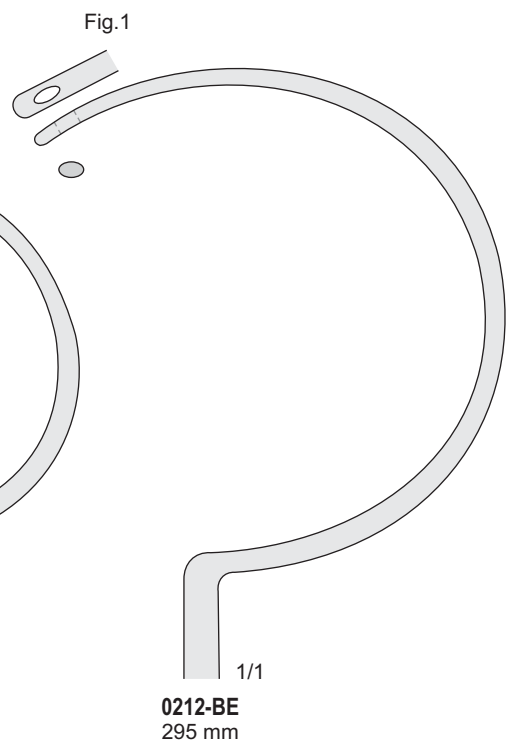
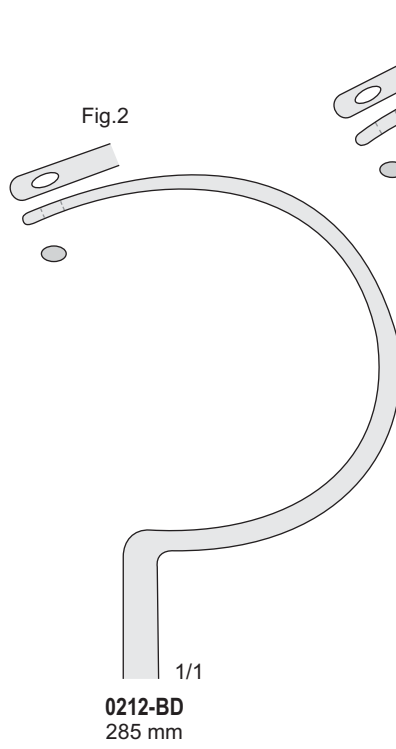
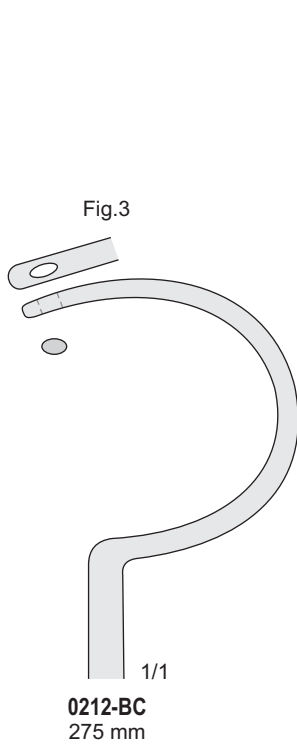

**0212-BA**  
225 mm

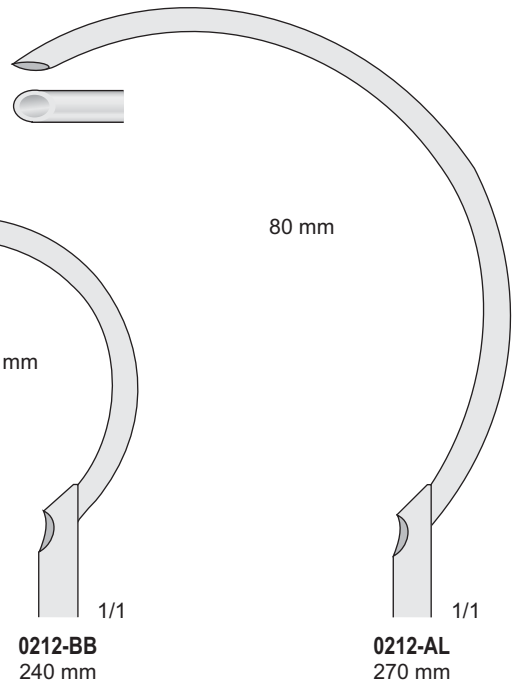
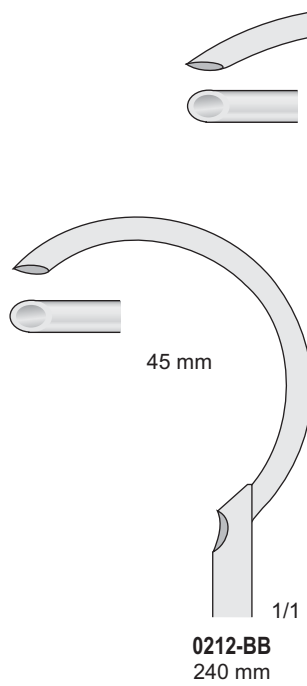
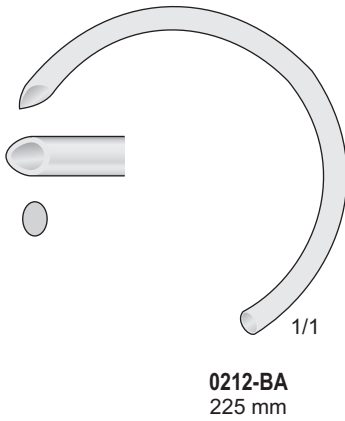

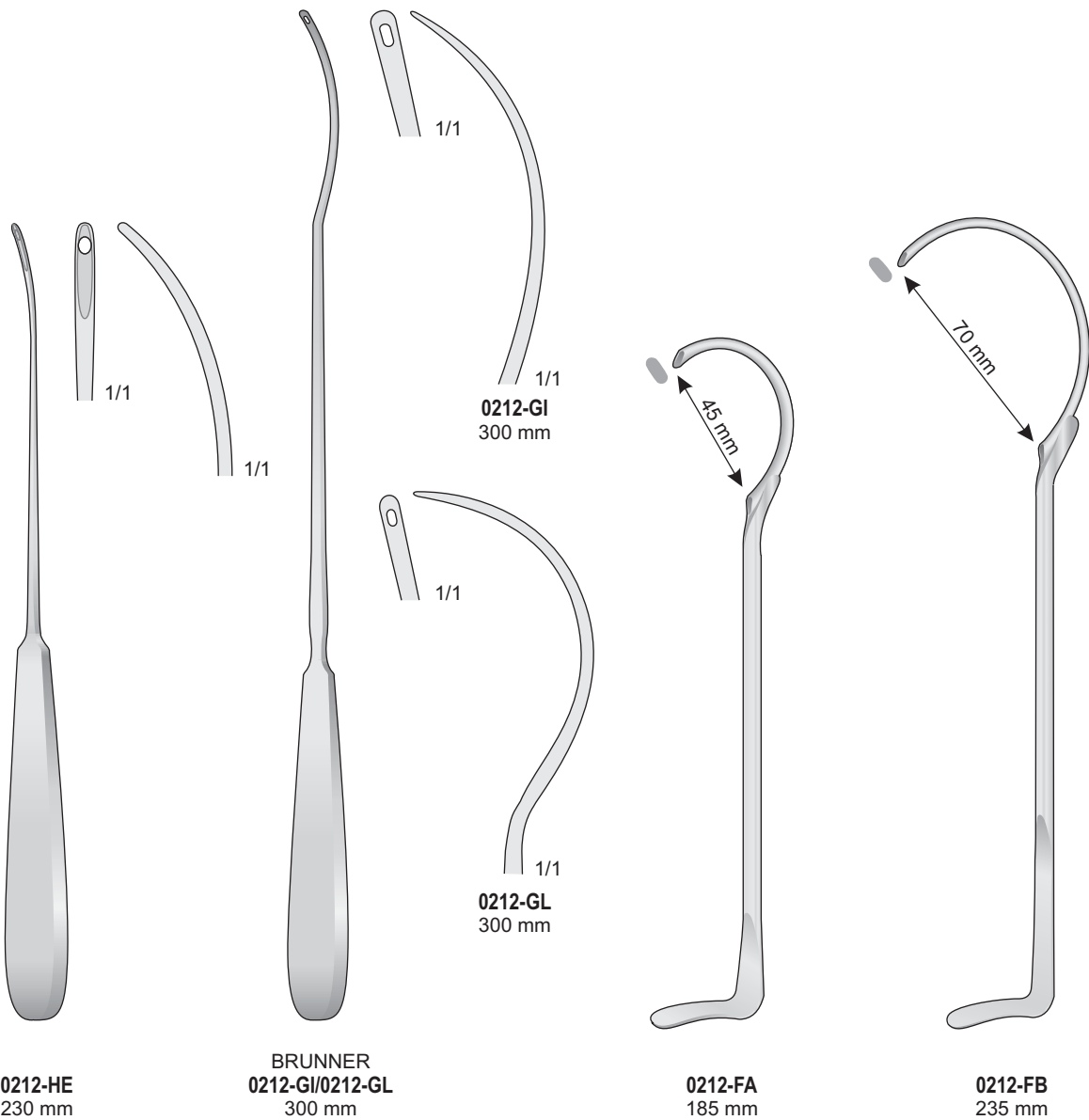

Pinze per estrazione  
fili metallici

Extraction pliers  
for boring wires

Extraktionszangen  
für Bohrdrähte

Pinces pour  
l'extraction des broches

Pinzas para extracción  
de hilo metálico

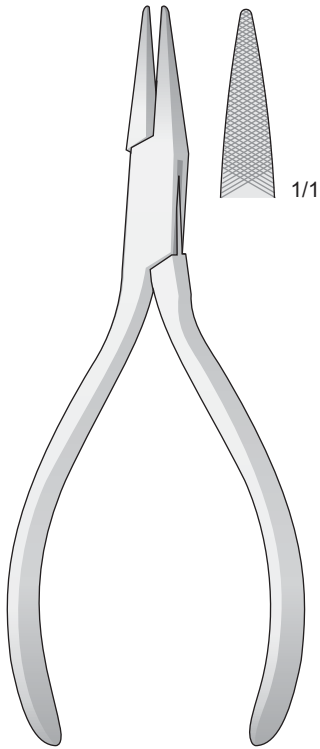

0415-AI  
140 mm

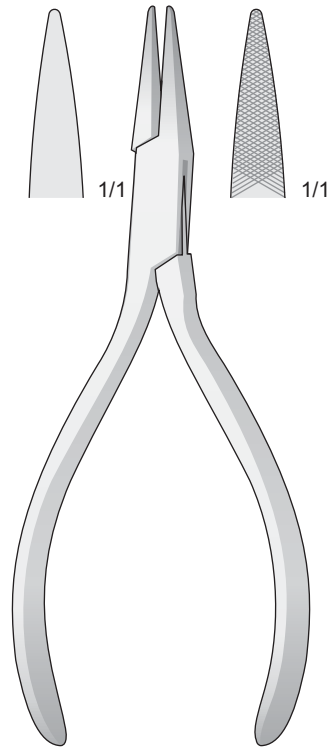

0415-BI  
140 mm

Per filo duro ø 1 mm  
For hard wire ø 1 mm  
Für harten Draht ø 1 mm  
Pour fil dur ø 1 mm  
Para alambres duro ø 1 mm

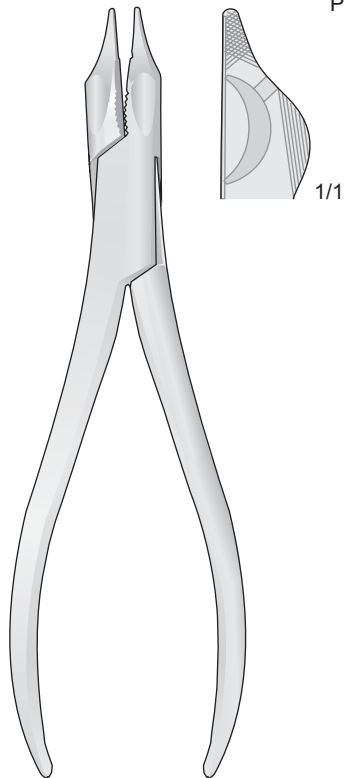

0415-HB  
150 mm

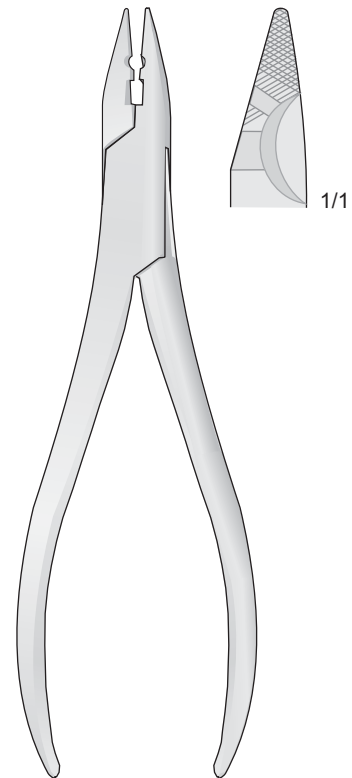

0415-HF  
160 mm

Pinze per estrazione  
fili metallici

Extraction pliers  
for boring wires

Extraktionszangen  
für bohrdrähte

Pinces pour  
l'extraction des broches

Pinzas para extracción  
de hilo metálico

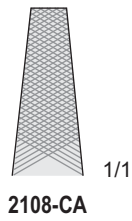

2108-CA

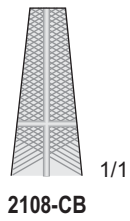
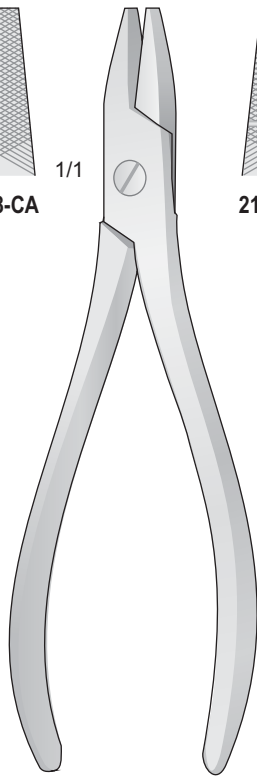

2108-CB

2108-CA/2108-CB  
175 mm

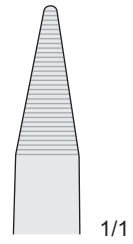
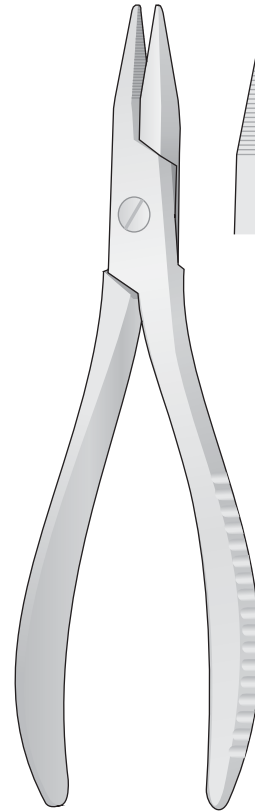

2108-CD  
190 mm

Pinza a branche parallele - Flat-nosed pliers, parallel  
Parallel-Flachzange - Pincas plates - Alicates planos

Pinza a branche parallele con tronchese  
Flat-nose pliers parallel with lateral wire cutter  
Parallel-Flachzange mit Seitenschneider

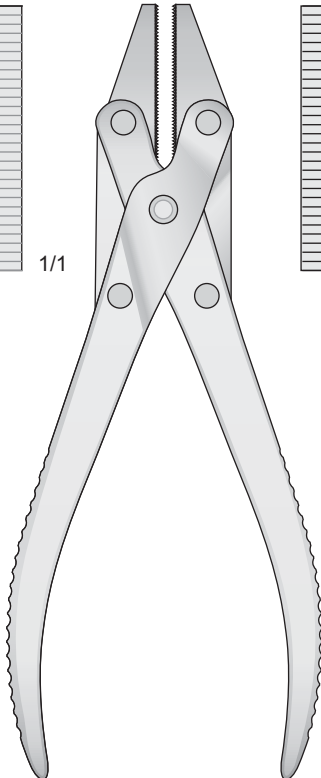
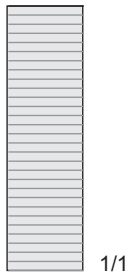

2108-CF  
185 mm

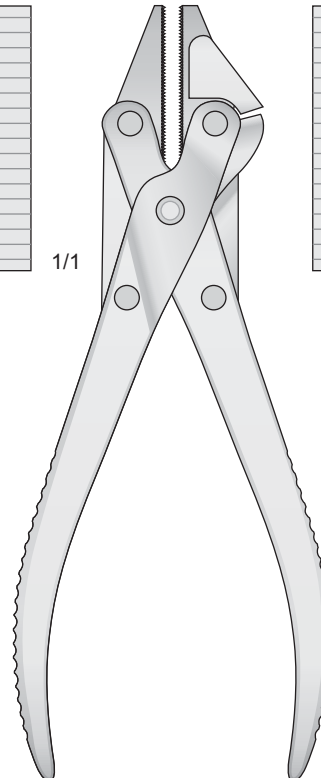
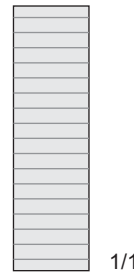
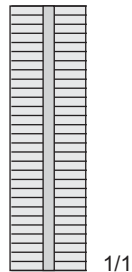

1123-IA  
185 mm

Inox  
Stainless Steel  
Rostfrei

Inox  
Stainless Steel  
Rostfrei

Pinze per estrazione  
fili metallici

Extraction pliers  
for boring wires

Extraktionszangen  
für bohrdrähte

Pinces pour  
l'extraction des broches

Pinzas para extracción  
de hilo metálico

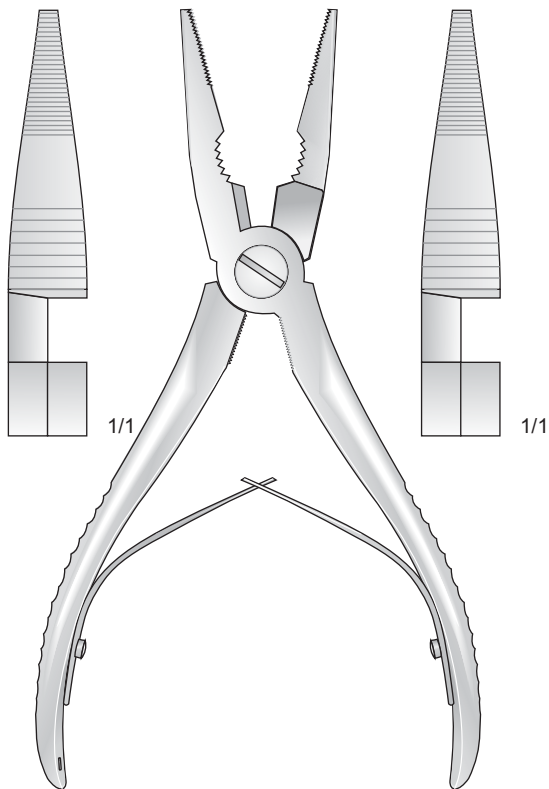

1123-BDF  
175 mm

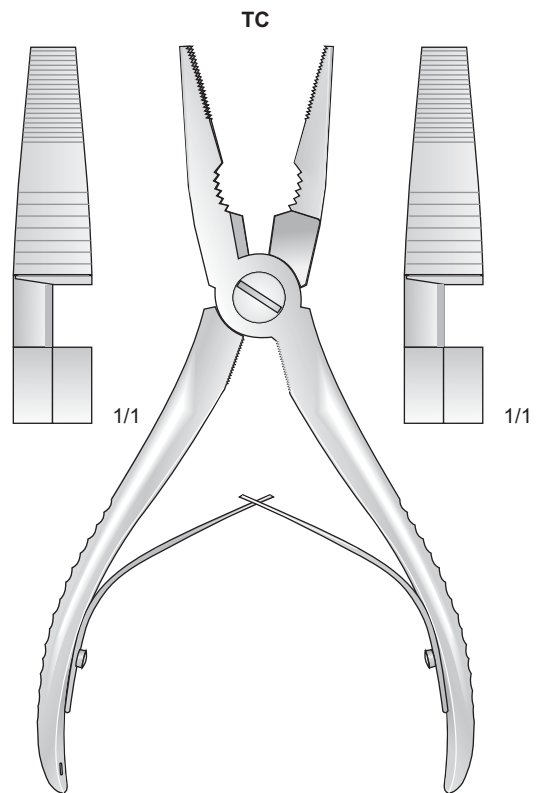

1123-BDG  
165 mm

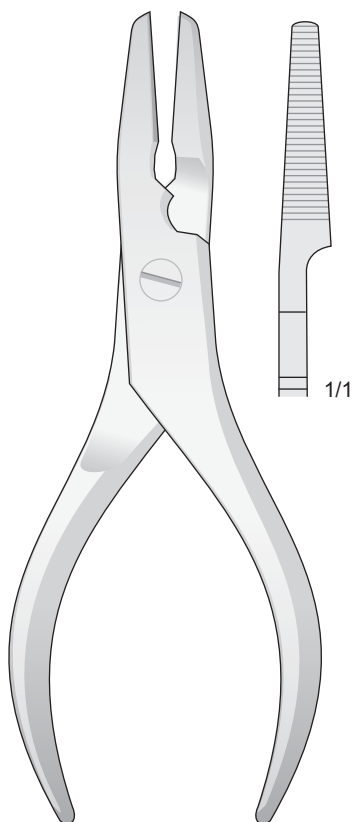

1123-BDE  
160 mm

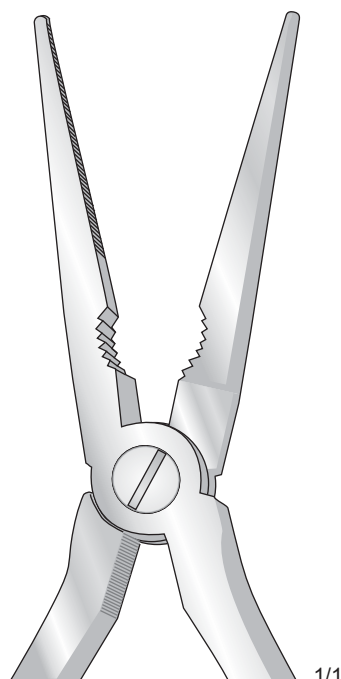

1123-BDH  
200 mm

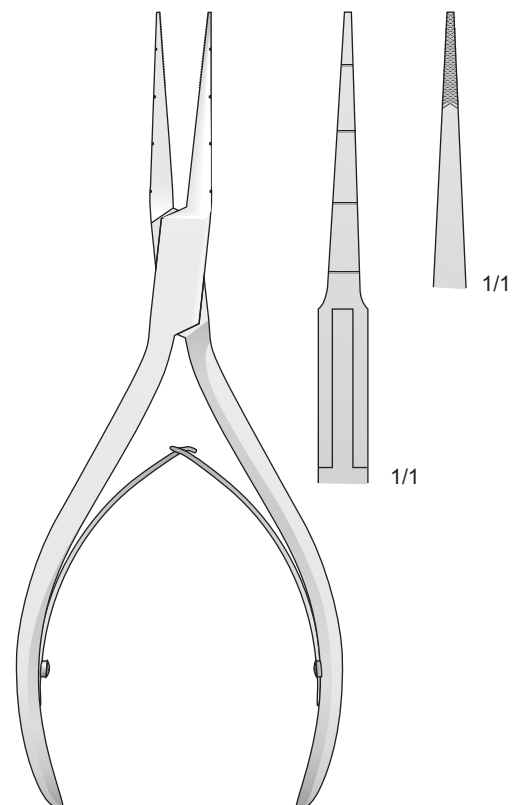

0415-LG  
150 mm

Pinze per estrazione  
fili metallici

Extraction pliers  
for boring wires

Extraktionszangen  
für Bohrdrähte

Pinces pour  
l'extraction des broches

Pinzas para extracción  
de hilo metálico

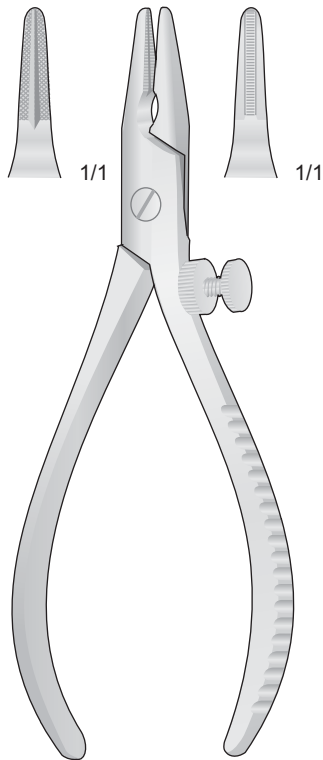

1123-BDA  
140 mm

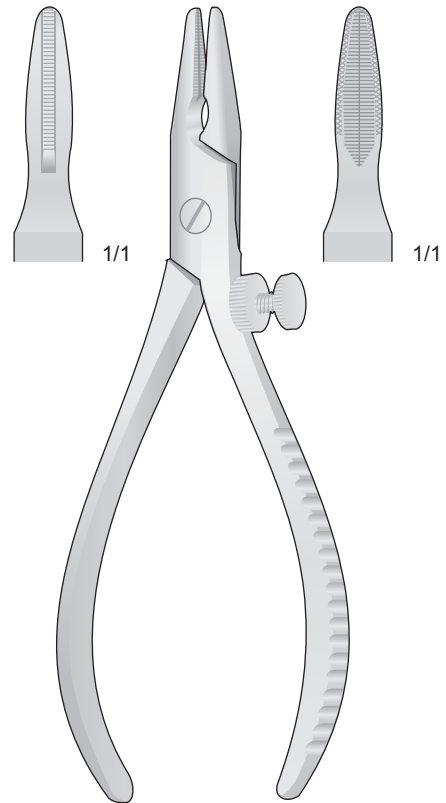

1123-BDB  
180 mm

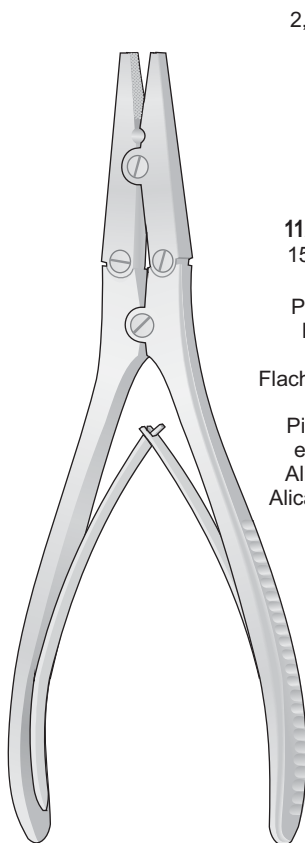

1123-BDI/1123-BDL

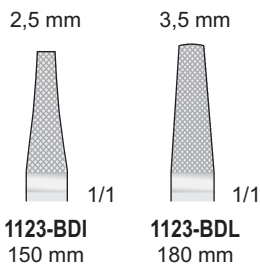

Pinze per estrazione fili  
Flat pliers, Extraction  
pliers for wires  
Flachzange, Extraktionszange  
für Bohrdrähte  
Pince plate, Pinces pour  
extraction des broches  
Alicates para extracción,  
Alicates para sacar alambre

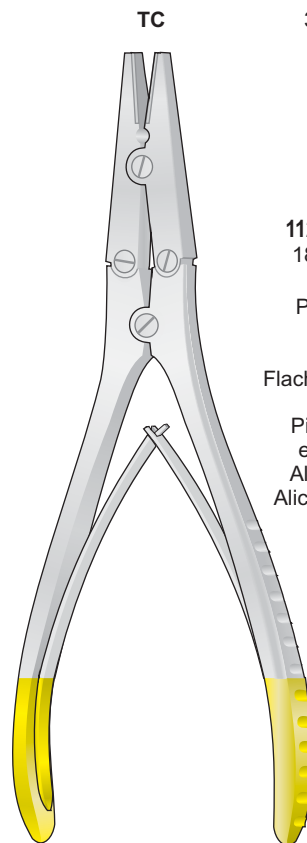

1123-BEA/1123-BEB

TC  
3 mm  
6 mm  
Pinze per estrazione fili  
Flat pliers, Extraction  
pliers for wires  
Flachzange, Extraktionszange  
für Bohrdrähte  
Pince plate, Pinces pour  
extraction des broches  
Alicates para extracción,  
Alicates para sacar alambre

**Tronchesi per fili metallici Wire cutting pliers Drahtschneidezangen Pincas à couper le fil Alicates para cortar alambre**

Per fili duri di  $\varnothing$  0,4 mm - For hard wire with  $\varnothing$  0,4 mm  
 Für harten Draht bis  $\varnothing$  0,4 mm - Pour fils durs avec  $\varnothing$  0,4 mm  
 Para alambres duros de  $\varnothing$  0,4 mm

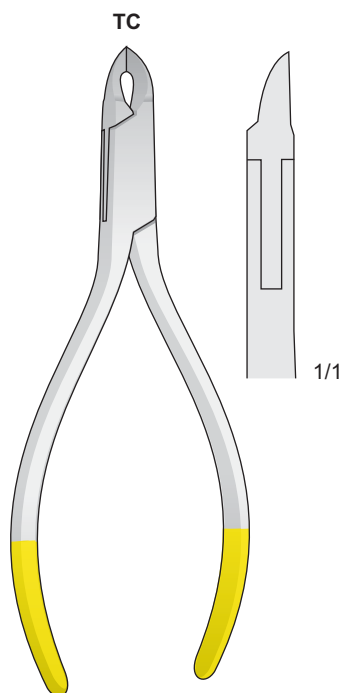

**ANGLE**  
**1123-LF1903**  
 130 mm

Per filo duro  $\varnothing$  1 mm - For hard wire with  $\varnothing$  1 mm  
 Für harten Draht bis  $\varnothing$  1 mm - Pour fil dur avec  $\varnothing$  1 mm  
 Para alambres duro  $\varnothing$  1 mm

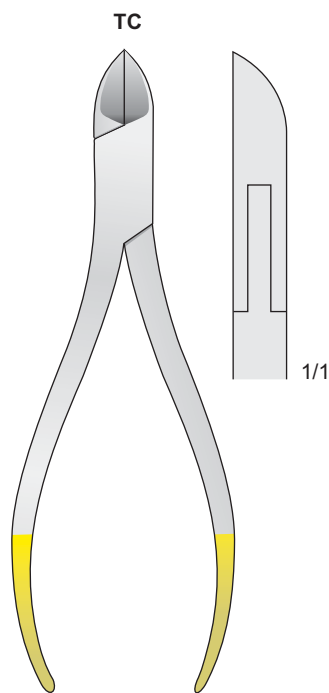

**1123-LL**  
 130 mm

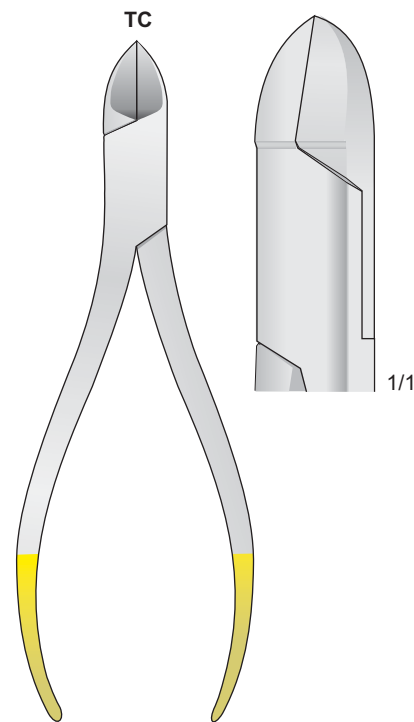

**1123-LG1903**  
 150 mm

Per filo duro  $\varnothing$  1 mm - For hard wire with  $\varnothing$  1 mm  
 Für harten Draht bis  $\varnothing$  1 mm - Pour fil dur avec  $\varnothing$  1 mm  
 Para alambres duro  $\varnothing$  1 mm

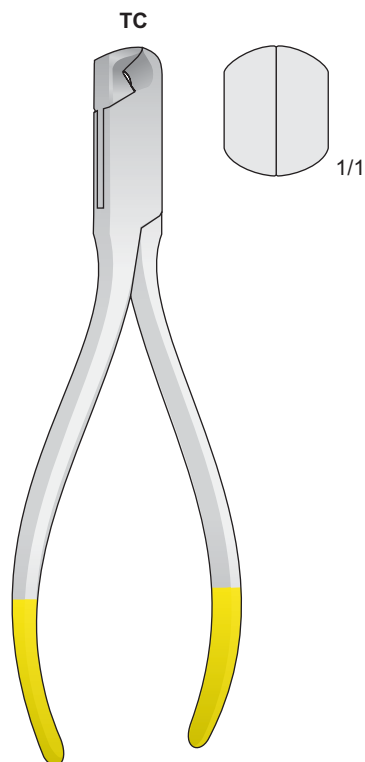

**1123-LC1903**  
 145 mm

Per filo duro  $\varnothing$  1,7 mm  
 For hard wire with  $\varnothing$  1,7 mm  
 Für harten Draht bis  $\varnothing$  1,7 mm  
 Pour fil dur avec  $\varnothing$  1,7 mm  
 Para alambres duro  $\varnothing$  1,7 mm



**1123-IC**  
 185 mm



Port'aghi, pinze per fili d'acciaio - Needle holders, steel wire forceps  
 Nadelhalter, Stahldrahtzangen - Porte aiguilles, pinces à saisir fils d'acier  
 Porta agujas, pinzas para hilos de acero

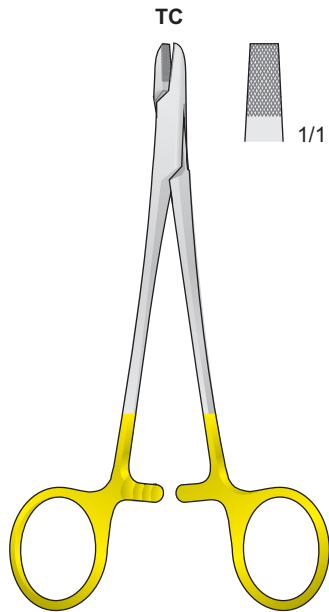

**1508-FI**  
150 mm

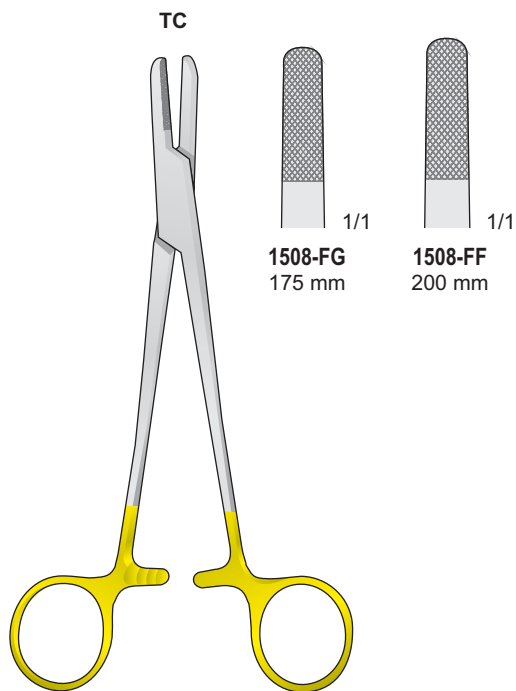

**1508-FF/1508-FG**

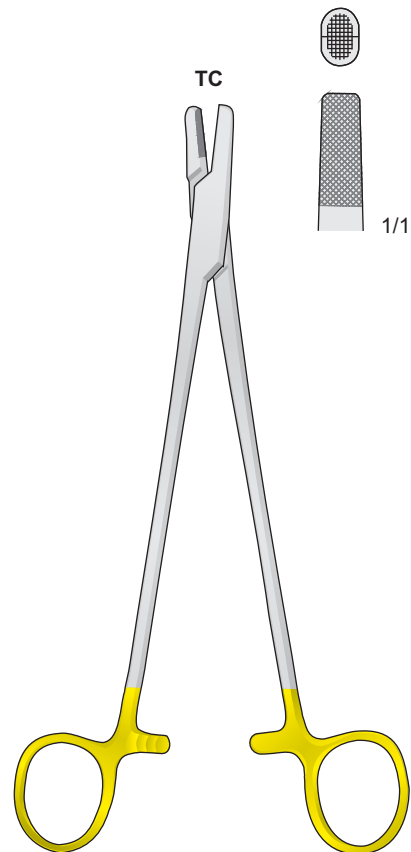

**BAUMGARTNER**  
**1508-FH**  
200 mm

Pinze per estrazione  
fili metallici

Extraction pliers  
for boring wires

Extraktionszangen  
für bohrdrähte

Pinces pour  
l'extraction des broches

Pinzas para extracción  
de hilo metálico

Forbice universale dentellata - Draht-und Blechschere gezahnt  
Wire cutting scissor serrated - Ciseaux à couper les fils métalliques  
Tijeras para cortar hilo de acero dentadas

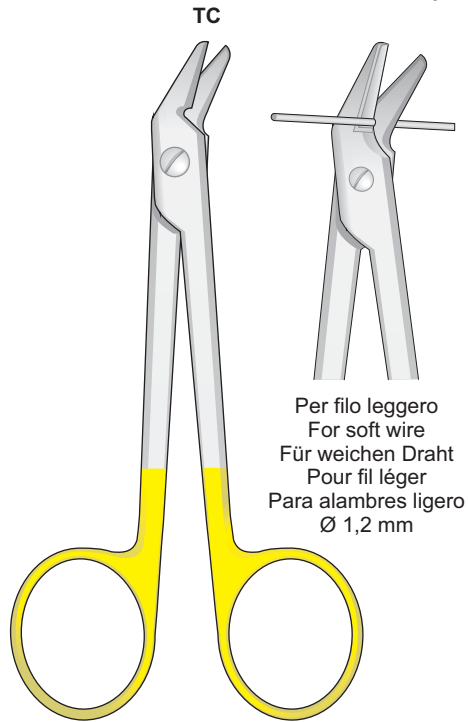

0415-BCA  
120 mm

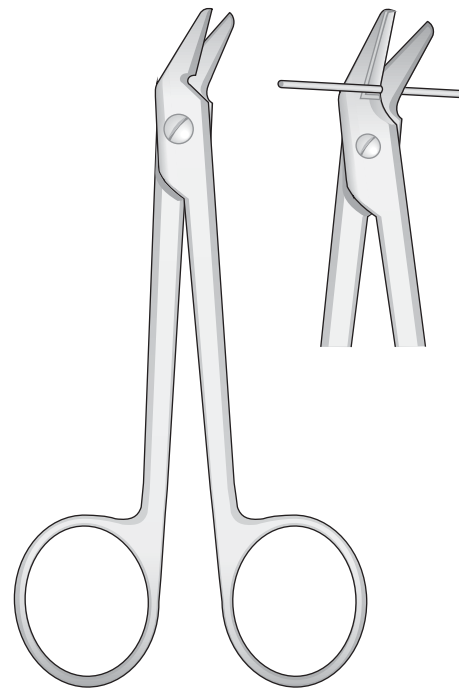

0415-LA  
120 mm

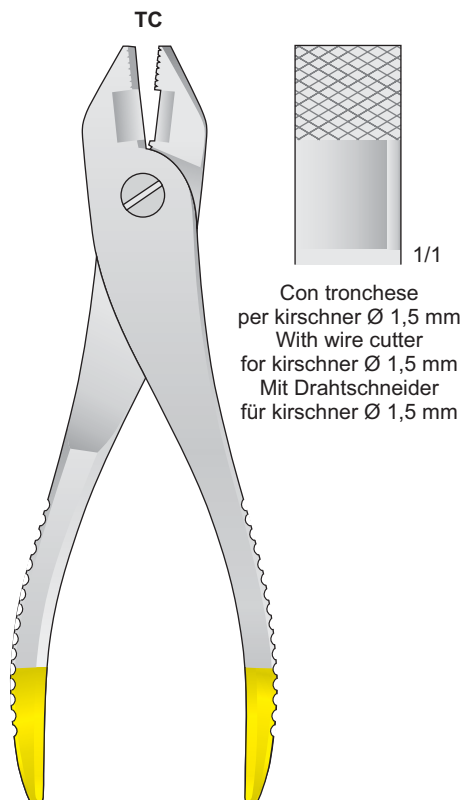

1123-BCF  
220 mm

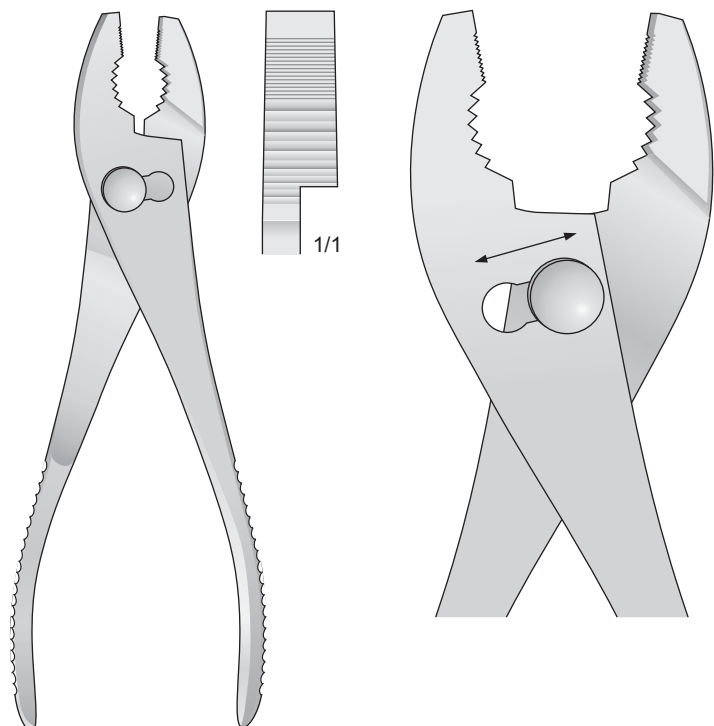

2108-EA  
200 mm

Per filo leggero Ø 2 mm  
 Per filo duro Ø 1,5 mm  
 For soft wire Ø 2 mm  
 For hard wire Ø 1,5 mm  
 Für weichen Draht Ø 2 mm  
 Für harten Draht Ø 1,5 mm  
 Pour fil léger Ø 2 mm  
 Pour fil dur Ø 1,5 mm  
 Para alambres ligero Ø 2 mm  
 Para alambres duro Ø 1,5 mm

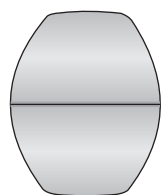

TC

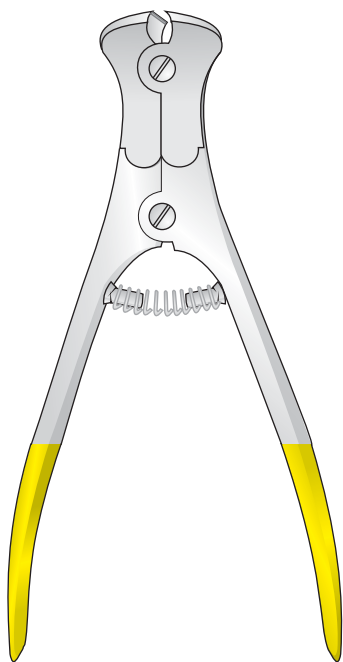

1123-BAC  
145 mm

Per filo leggero Ø 2 mm  
 Per filo duro Ø 1,6 mm  
 For soft wire Ø 2 mm  
 For hard wire Ø 1,6 mm  
 Für weichen Draht Ø 2 mm  
 Für harten Draht Ø 1,6 mm  
 Pour fil léger Ø 2 mm  
 Pour fil dur Ø 1,6 mm  
 Para alambres ligero Ø 2 mm  
 Para alambres duro Ø 1,6 mm

TC

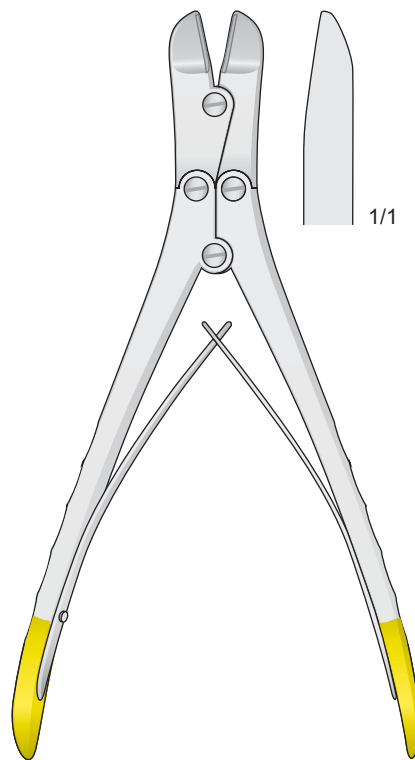

1123-BAD  
170 mm

Per filo leggero Ø 3,5 mm  
 Per filo duro Ø 2,5 mm  
 For soft wire Ø 3,5 mm  
 For hard wire Ø 2,5 mm  
 Für weichen Draht Ø 3,5 mm  
 Für harten Draht Ø 2,5 mm  
 Pour fil léger Ø 3,5 mm  
 Pour fil dur Ø 2,5 mm  
 Para alambres ligero Ø 3,5 mm  
 Para alambres duro Ø 2,5 mm

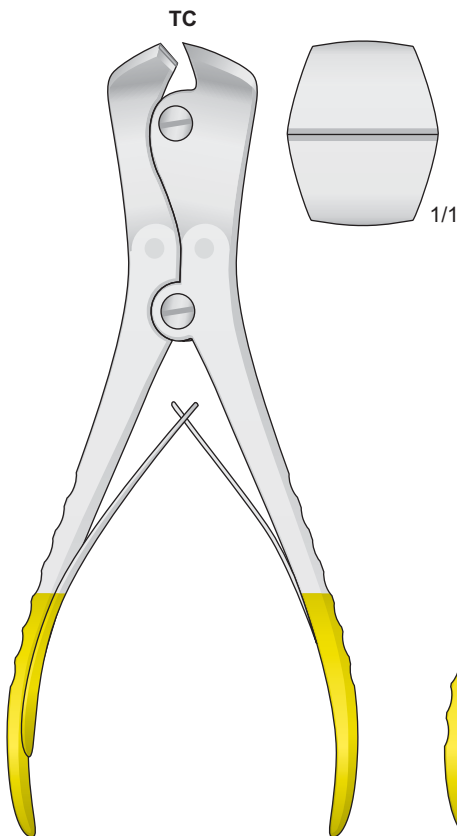

**1123-BAE**  
215 mm

Per filo leggero Ø 3 mm  
 Per filo duro Ø 2,2 mm  
 For soft wire Ø 3 mm  
 For hard wire Ø 2,2 mm  
 Für weichen Draht Ø 3 mm  
 Für harten Draht Ø 2,2 mm  
 Pour fil léger Ø 3 mm  
 Pour fil dur Ø 2,2 mm  
 Para alambres ligero Ø 3 mm  
 Para alambres duro Ø 2,2 mm

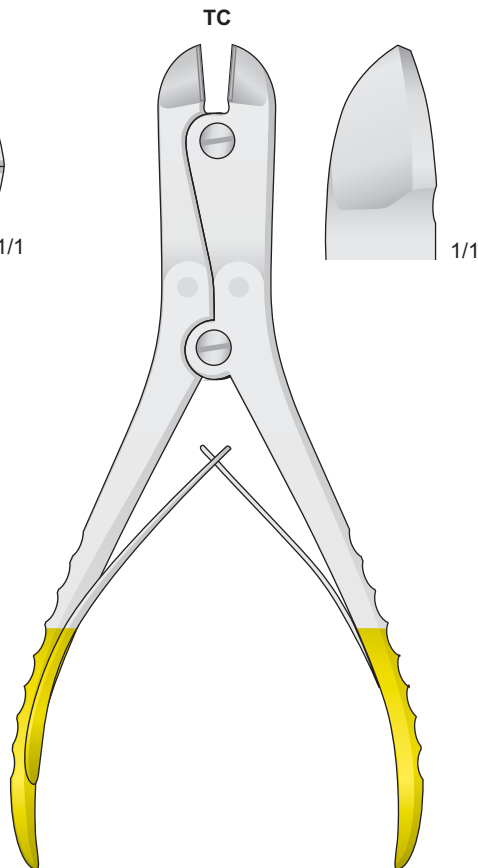

**1123-BAG**  
230 mm

Per filo leggero Ø 2,5 mm  
 Per filo duro Ø 2 mm  
 For soft wire Ø 2,5 mm  
 For hard wire Ø 2 mm  
 Für weichen Draht Ø 2,5 mm  
 Für harten Draht Ø 2 mm  
 Pour fil léger Ø 2,5 mm  
 Pour fil dur Ø 2 mm  
 Para alambres ligero Ø 2,5 mm  
 Para alambres duro Ø 2 mm

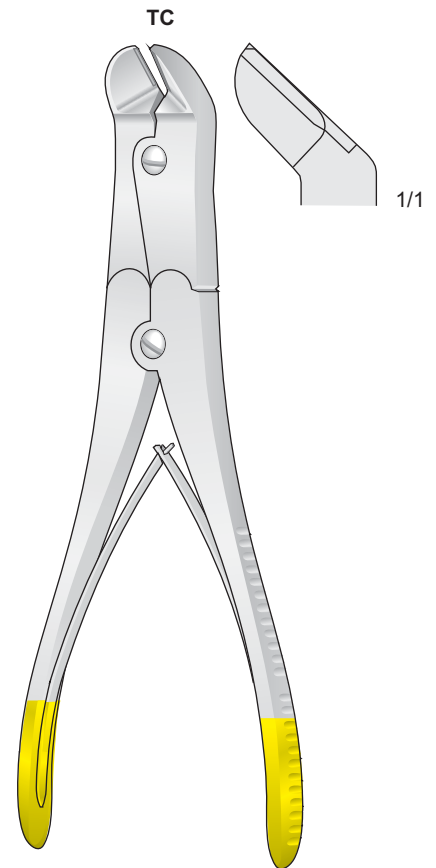

**1123-BAF**  
230 mm

Per filo leggero Ø 7 mm  
 Per filo duro Ø 6 mm  
 For soft wire Ø 7 mm  
 For hard wire Ø 6 mm  
 Für weichen Draht Ø 7 mm  
 Für harten Draht Ø 6 mm  
 Pour fil léger Ø 7 mm  
 Pour fil dur Ø 6 mm  
 Para alambres ligero Ø 7 mm  
 Para alambres duro Ø 6 mm

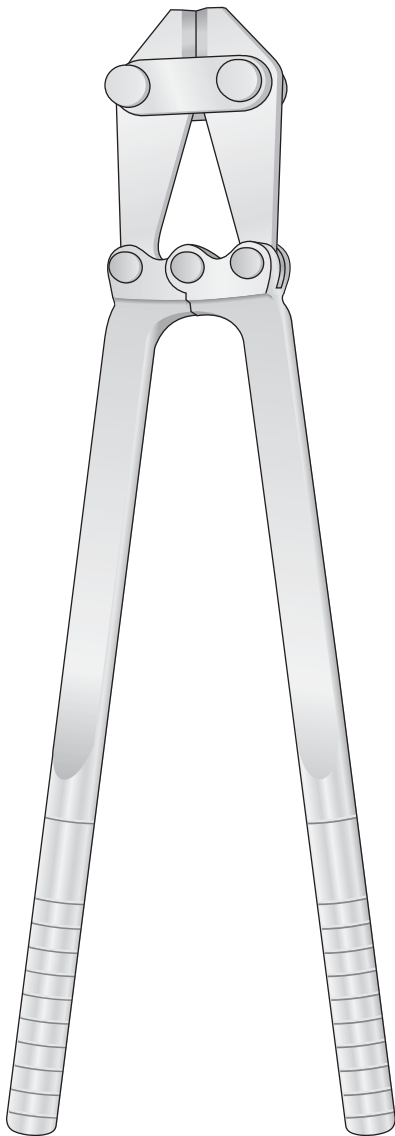

2106-LI  
480 mm

Per filo leggero Ø 7 mm  
 Per filo duro Ø 6 mm  
 For soft wire Ø 7 mm  
 For hard wire Ø 6 mm  
 Für weichen Draht Ø 7 mm  
 Für harten Draht Ø 6 mm  
 Pour fil léger Ø 7 mm  
 Pour fil dur Ø 6 mm  
 Para alambres ligero Ø 7 mm  
 Para alambres duro Ø 6 mm

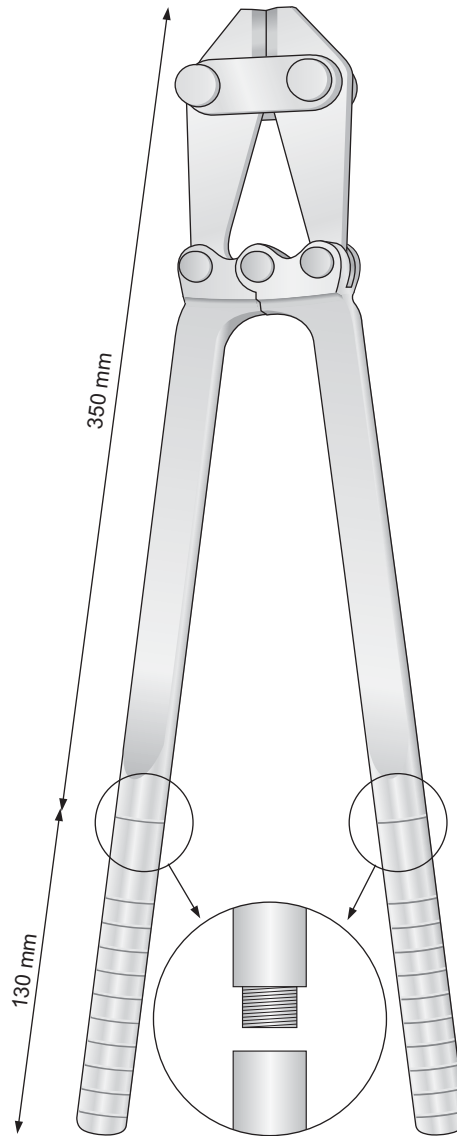

2106-LI12  
480 mm

Per filo leggero Ø 5 mm  
 Per filo duro Ø 4,5 mm  
 For soft wire Ø 5 mm  
 For hard wire Ø 4,5 mm  
 Für weichen Draht Ø 5 mm  
 Für harten Draht Ø 4,5 mm  
 Pour fil léger Ø 5 mm  
 Pour fil dur Ø 4,5 mm  
 Para alambres ligero Ø 5 mm  
 Para alambres duro Ø 4,5 mm

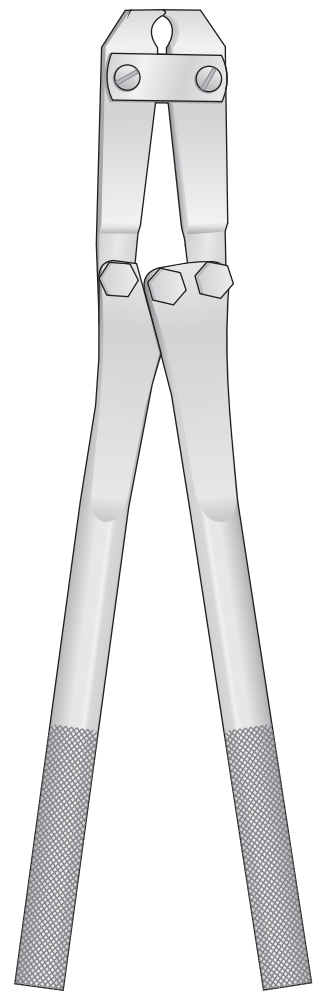

1123-BAH  
375 mm

Misuratore per chiodi Kirschner  
 Measuring Gauge for nails  
 Meßlehre für Kirschnerdrähte



1009-BA

0,5 mm



0,5 mm



0,5 mm



0,5 mm



1118-AH  
50 mm

1118-AI  
120 mm

1118-AL  
150 mm

1118-AG  
300 mm

Misuratore di lunghezza per viti  
 Screw depth gauges, to select proper length of screw  
 Instruments de mesure de profondeur pour déterminer la longueur de vis requise



**1118-CAA**  
165 mm

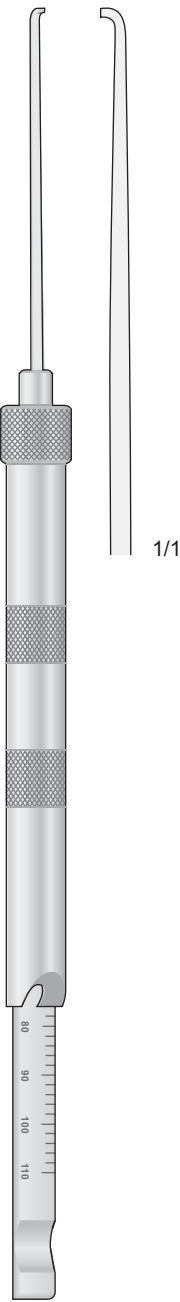

**1118-CAB**  
265 mm

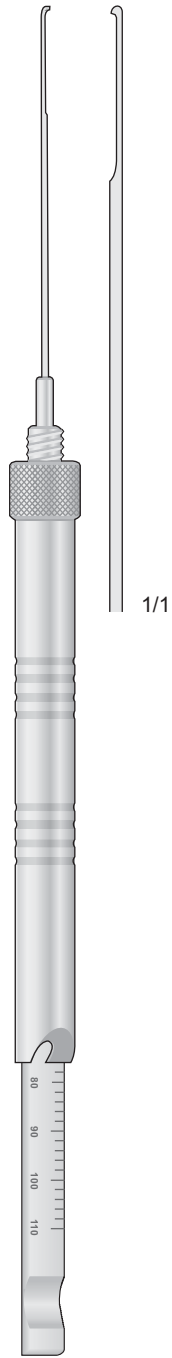

**1118-CAC**  
280 mm

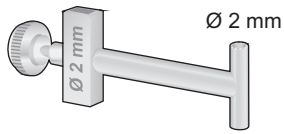

1118-LG

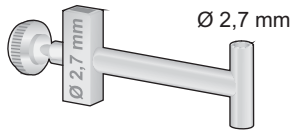

1118-LH

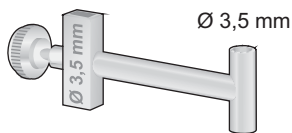

1118-LI

**1118-LF**  
Completo di 3 guide  
Complete with 3 guide  
**1118-LE+1118-LG+1118-LH+1118-LI**

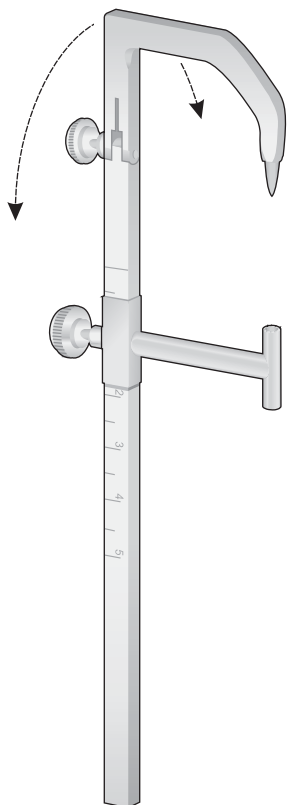

1118-LF  
145 mm

**1118-LE**  
Centratore solo  
Drill guide only

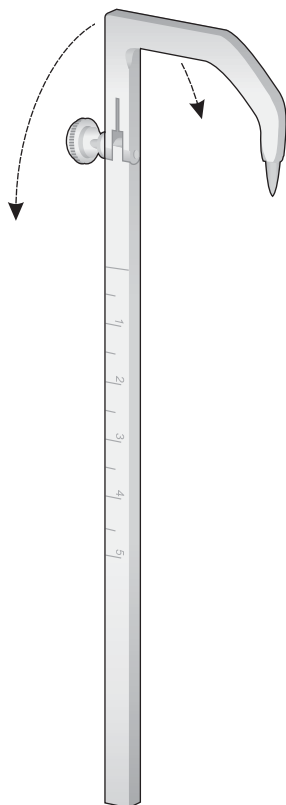

1118-LE  
145 mm

Centrapunte  
Manicotto dentato  
Steckbohrbüchsen  
Insert-drill

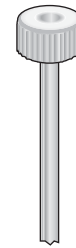

Ø Esterno	Ø Per punte
Ø Outside	Ø For drills
Ø Außen	Ø Für Bohrer
Ø Extérieur	Ø Pour Mèches
Ø Exterior	Ø Para agujas

Cod. Art.	Ø Esterno	Ø Per punte
1118-BBD	4,5 mm	3,2 mm
1118-BBE	3,5 mm	2 mm
1118-BBF	3,5 mm	2,7 mm

Guida per punte elicoidali  
Gewebeschutzhülsen

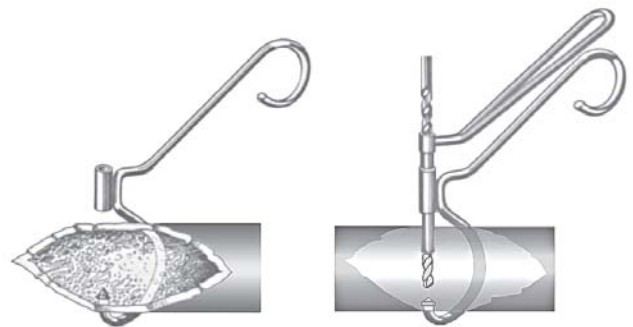

Interno Ø 6,5 mm  
Inside Ø 6,5 mm  
Innen Ø 6,5 mm  
Intérieur Ø 6,5 mm  
Interior Ø 6,5 mm

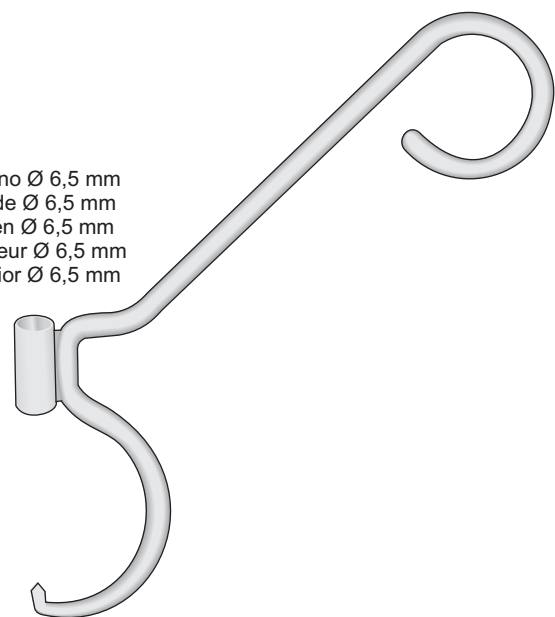

1118-BBC



Attacco Dentale  
Dental schaft

Ø 1,5 mm



**1118-DC**  
50 mm

Ø 2,0 mm



**1118-DD**  
55 mm

Attacco AO  
Mit AO schaft

Ø 1,5 mm



**1118-BA**  
65 mm

Ø 2 mm



**1118-BB**  
70 mm

Ø 2,7 mm



**1118-BC**  
100 mm

Passo della vite  
a 1,25 mm

Ø 3,5 mm



**1118-BD**  
110 mm

Passo della vite  
a 1,75 mm

Ø 3,5 mm



**1118-BE**  
110 mm

Ø 4,5 mm



**1118-BF**  
130 mm

Ø 4,5 mm



**1118-BG**  
130 mm

Ø 6,5 mm



**1118-BH**  
170 mm

Punte elicoidali con innesto rapido

Attacco AO  
Mit AO schaft  
Drill bits

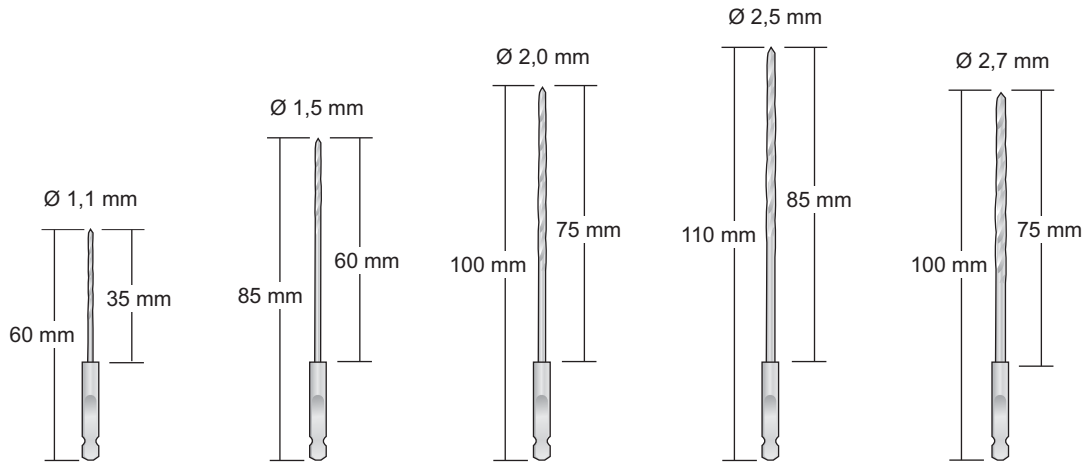

1118-CA

1118-CB

1118-CC

1118-CD

1118-CE

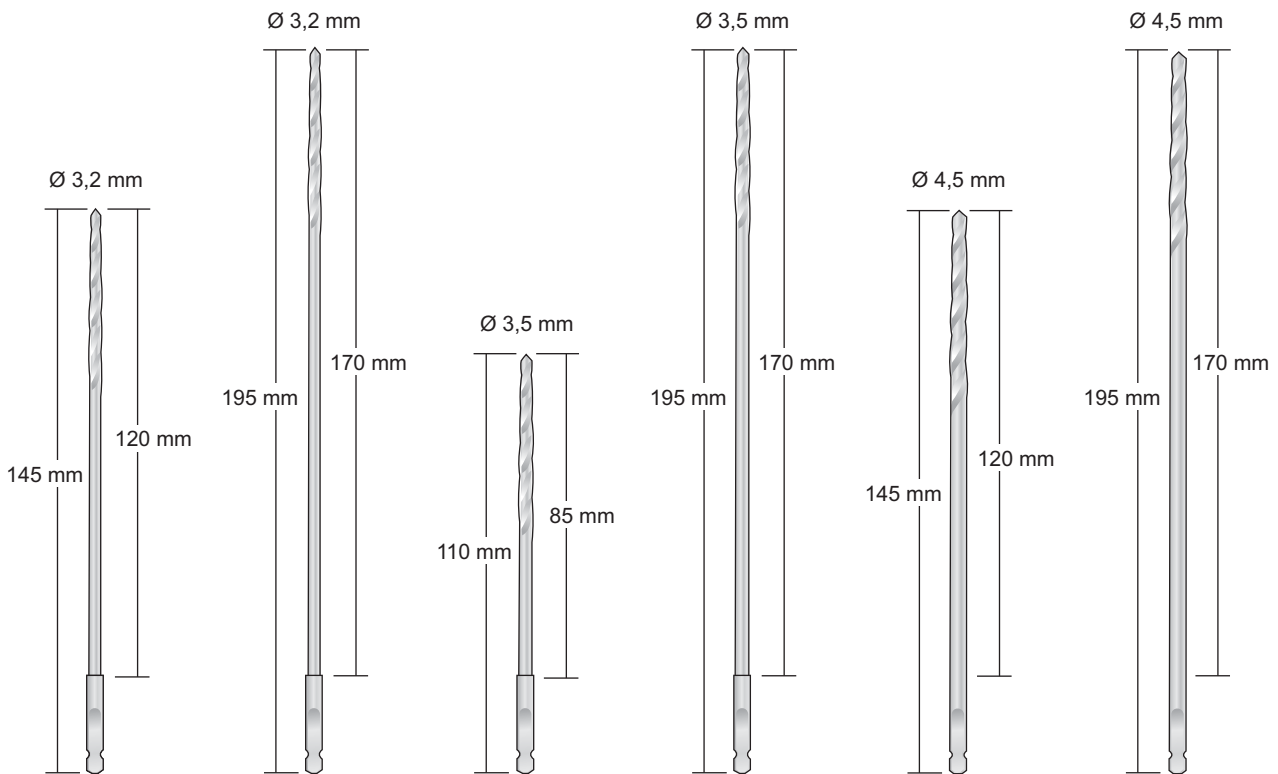

1118-CF

1118-CG

1118-CH

1118-CI

1118-CL

1118-DA

Punte elicoidali

Con attacco rotondo  
Mit rundschaft  
Drill bits

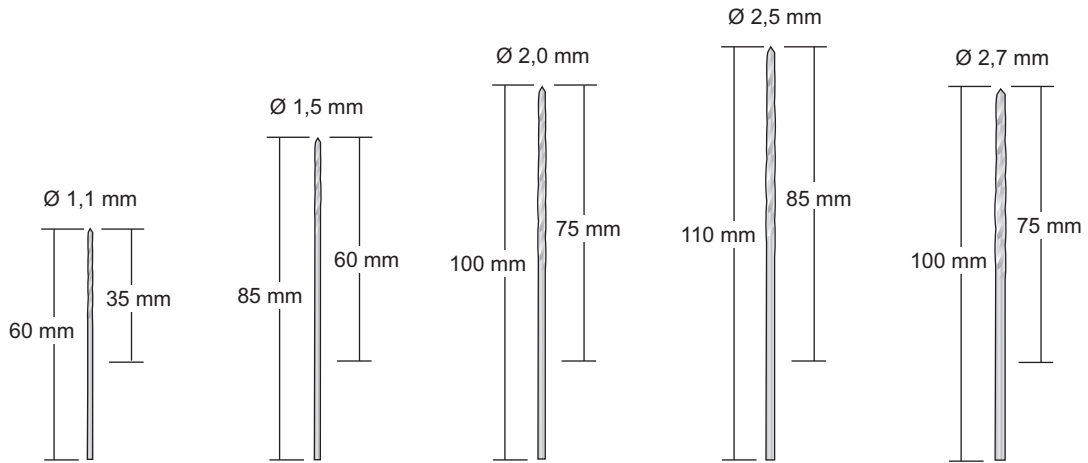

1118-EA

1118-EB

1118-EC

1118-ED

1118-EE

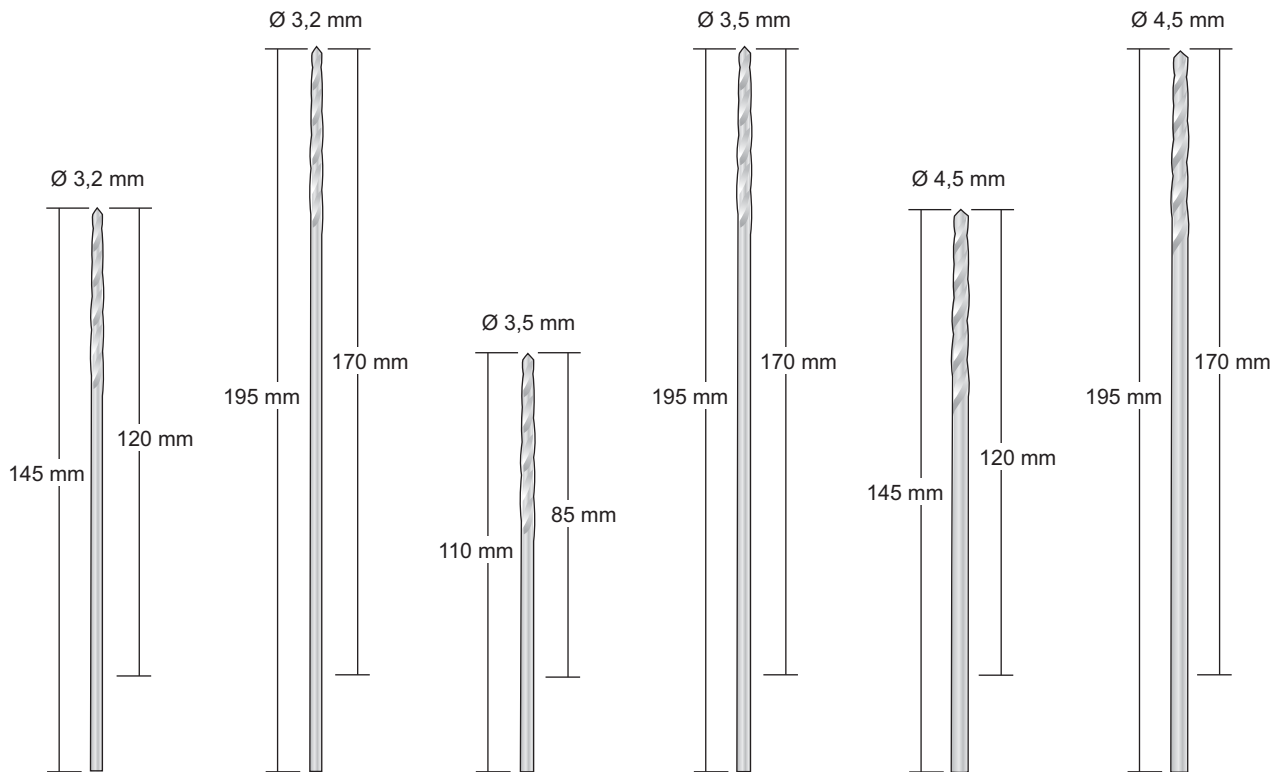

1118-EF

1118-EG

1118-EH

1118-EI

1118-EL

1118-FA

Ortopedia  
Osteosintesi

Bone Surgery  
Osteosynthesis

Orthopädie  
Osteosinthese

Orthopédie  
Ostéosynthèse

Cirurgia ósea  
Osteosintesis

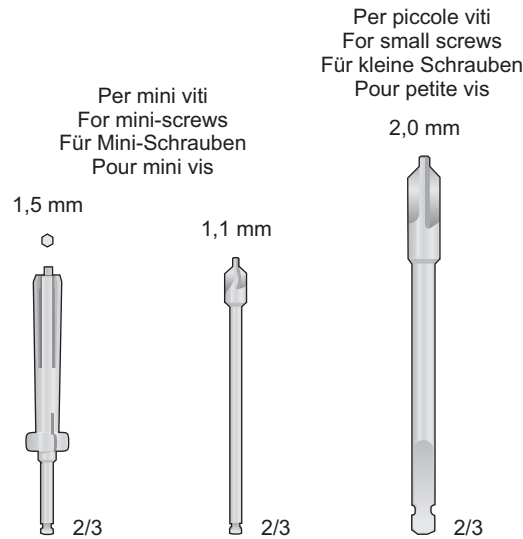

**1118-BDF**  
55 mm

**1118-BDG**  
55 mm

**1118-BDH**  
70 mm

Per viti malleolari  
For malleolar screws  
Für Malleolarschrauben  
Pour vis à malléole

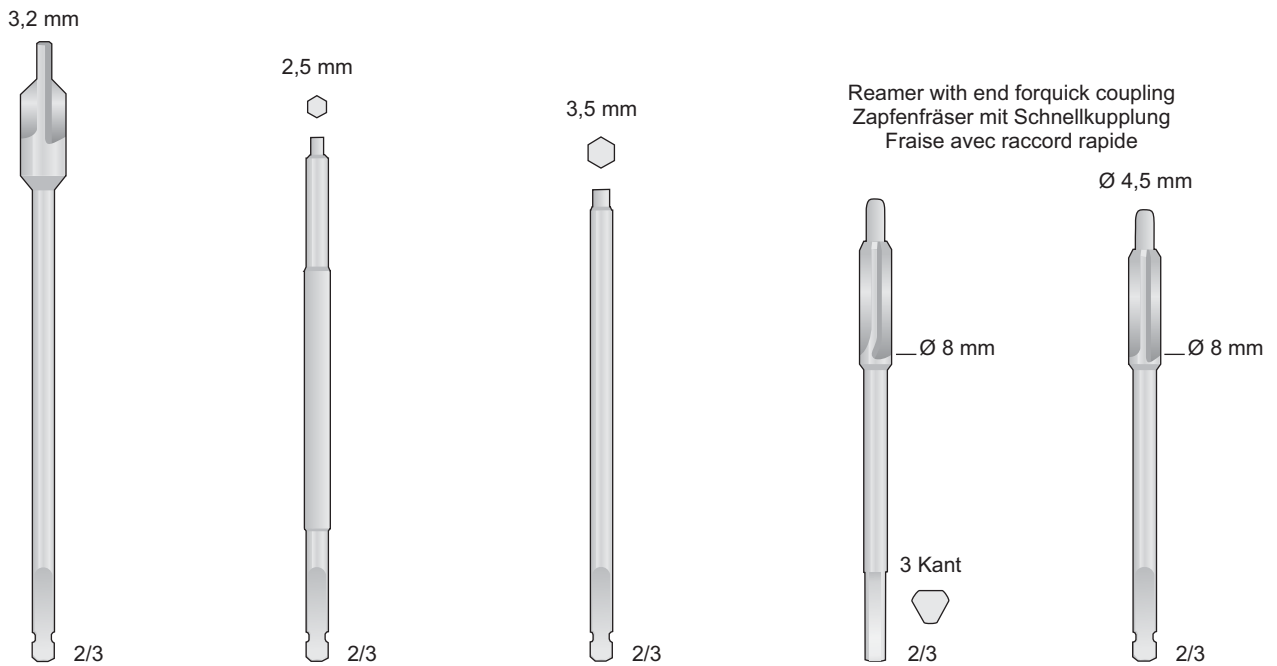

**1118-BDI**  
120 mm

**1118-BCF**  
100 mm

**1118-BCG**  
90 mm

**1118-BDL**  
90 mm

**1118-BEA**  
90 mm

Manico con mandrino rapido  
Handles with quick-action chuck  
Handgriffe mit schnellspann futter  
Poignées avec mandrins rapides

Ø 4 mm

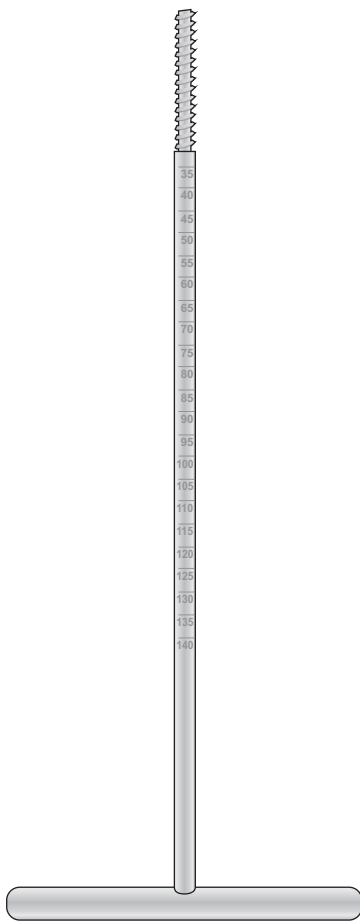

**1118-BCA**  
260 mm

AO-Schaft



Dental-Schaft



4kant-Schaft

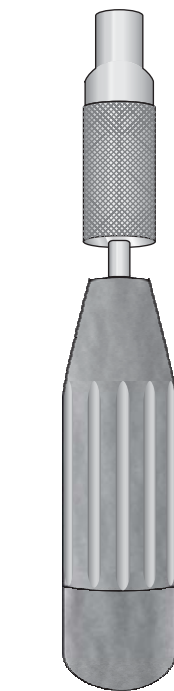

**MANICO FERROZELL**  
**1118-CEC**  
125 mm



**1118-CEE**  
110 mm

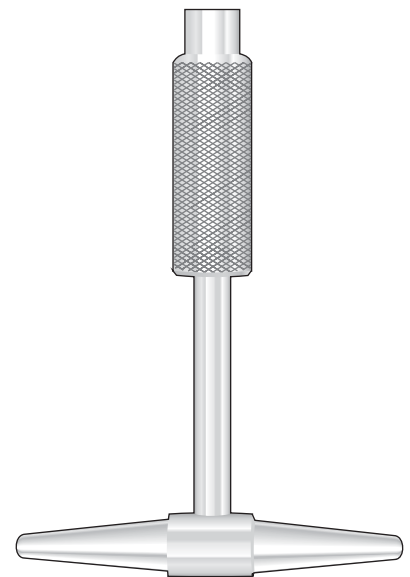

**1118-CEA**  
80 mm

Strumenti per  
osteosintesi

Osteosynthesis  
Instruments

Osteosynthese  
Schränkeisen

Instruments pour  
Ostéosynthèse

Instrumentos para  
Osteosintesis

Centratori guida punte - Drill guides - Bohrbüchsen zu Knochenplatten - Guide méche

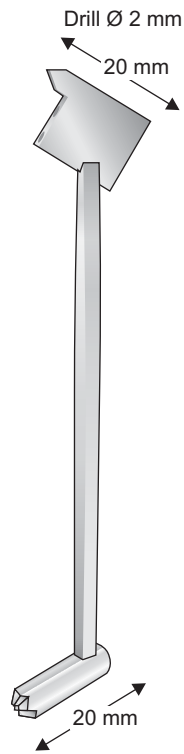

**1118-IA**  
110 mm

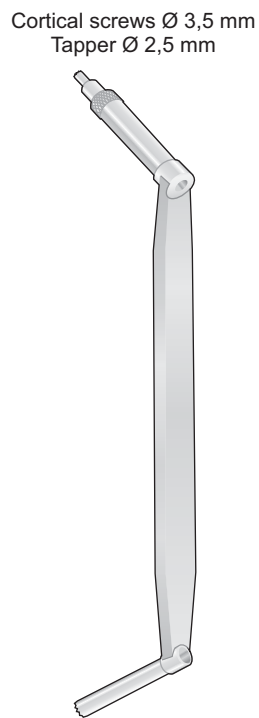

**1118-IB**

Cortical screws  
Ø 6,5 mm  
Tapper  
Ø 3,2 mm



**1118-IC**

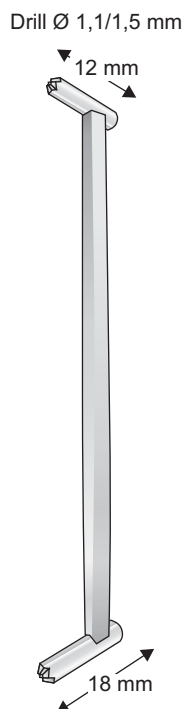

**1118-ID**  
105 mm

Per trapano Ø 2,5 mm  
Cortical screws Ø 3,5 mm  
Tapper Ø 3,5 mm

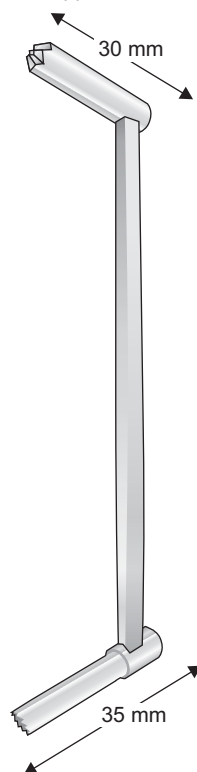

**1118-IE**  
125 mm

Cortical screws Ø 4,5 mm  
Tapper Ø 3,2 mm

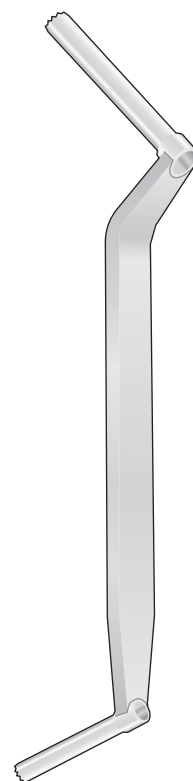

**1118-IF**

Centratori guida punte - Drill guides - Bohrbüchsen zu Knochenplatten - Guide méche

**Color codification**  
green = centric  
gold = eccentric

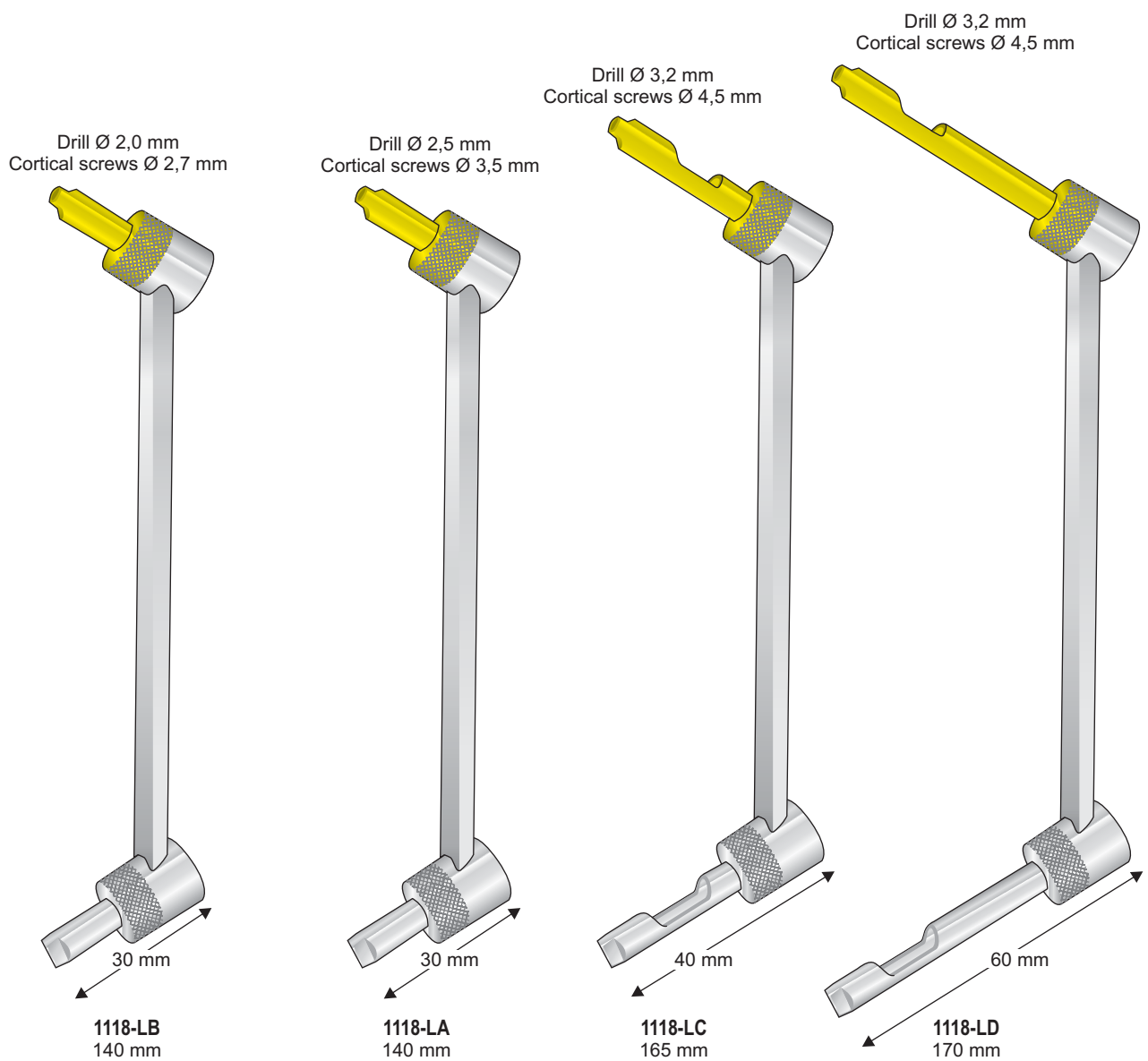

Strumenti per  
osteosintesi

Osteosynthesis  
Instruments

Osteosynthese  
Schränkeisen

Instruments pour  
Ostéosynthèse

Instrumentos para  
Osteosintesis

Centratori guida punte - Drill guides - Bohrbüchsen zu Knochenplatten - Guide méche

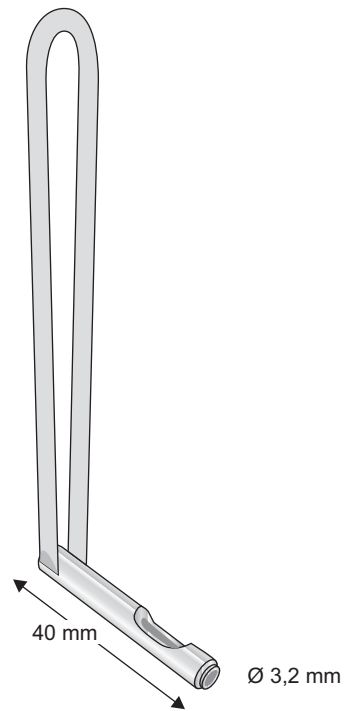

**1118-BBH**  
125 mm

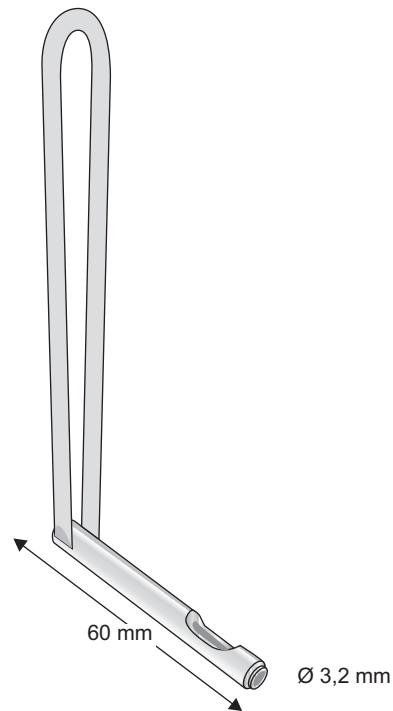

**1118-BCE**  
125 mm

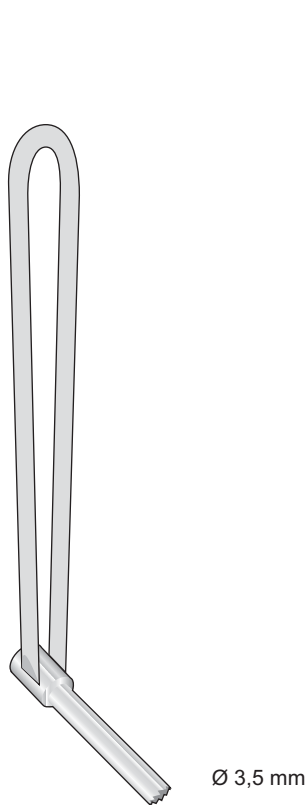

**1118-BBG**  
125 mm

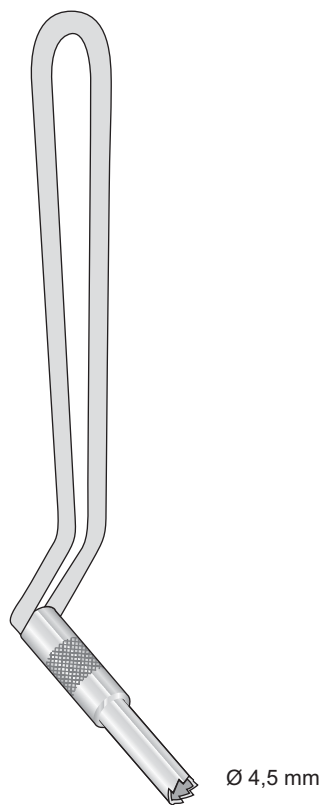

**1118-BBL**  
150 mm

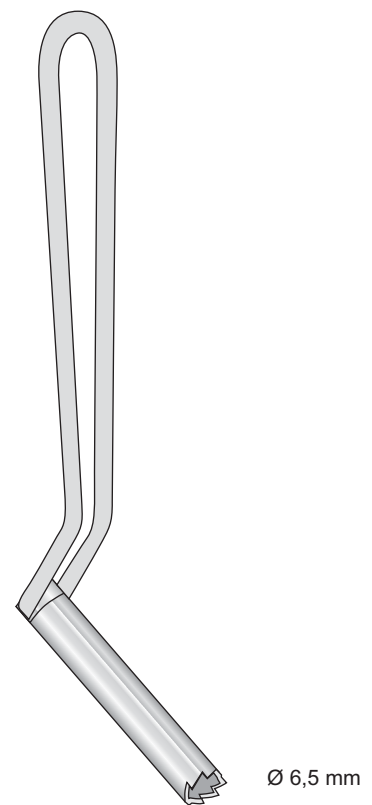

**1118-BCB**  
150 mm



Ortopedia  
Osteosintesi

Bone Surgery  
Osteosynthesis

Orthopädie  
Osteosinthese

Orthopédie  
Ostéosynthèse

Cirurgia òsea  
Osteosintesis

Scatola con set giraviti - Box with screws driver - Schraubenzieher, Set mit Etui  
Jeu de tournevis, en boîte - Set destornilladores

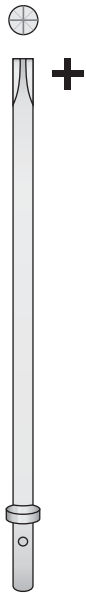

1118-DCB  
140 mm

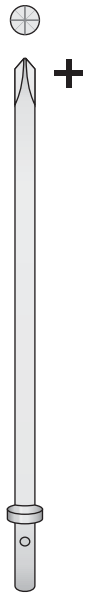

1118-DCC  
140 mm



1118-DCD  
140 mm

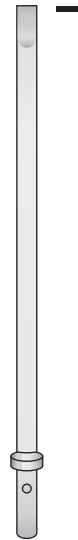

1118-DCE  
140 mm

2,5 mm

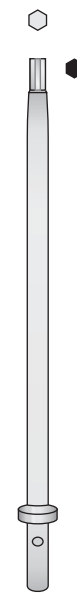

1118-DCF  
140 mm

3,5 mm

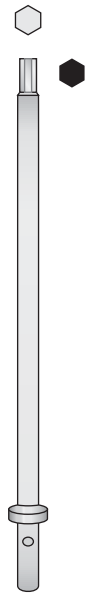

1118-DCG  
140 mm

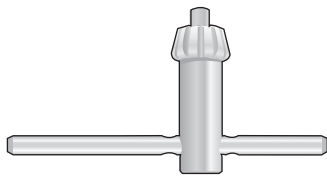

1118-CDB  
32 mm

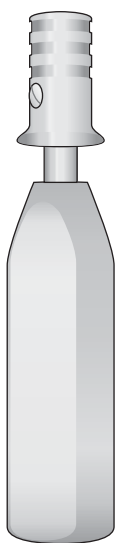

1118-DCA  
145 mm

Max. Ø 6,3 mm

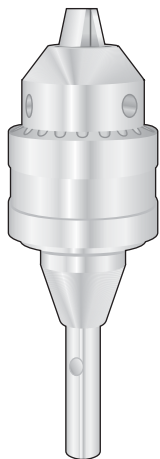

UNIVERSAL  
1118-CDF  
75 mm

1118-DDA

Scatola con set giraviti - Completo  
Box with screws driver - Complete  
Schraubenzieher, Set mit Etui - Komplett  
Jeu de tournevis, en boîte - Complete  
Set destornilladores - Completos

Solo scatola  
Box only  
Etui allein  
Seul boîte

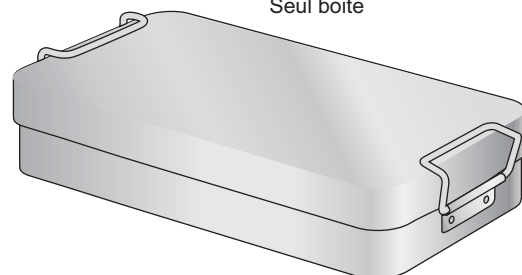

1118-DCL  
200x100x40 mm

Cacciaviti

Screw drivers

Schraubendreher

Tourne-vis

Destornilladores

Giraviti con manico di Ferrozell  
 Screws driver with Ferrozell handle  
 Schraubenzieher mit Ferrozellgriff  
 Jeu de tournevis avec poignée en Ferrozell  
 Destornilladores con mango de Ferrozell

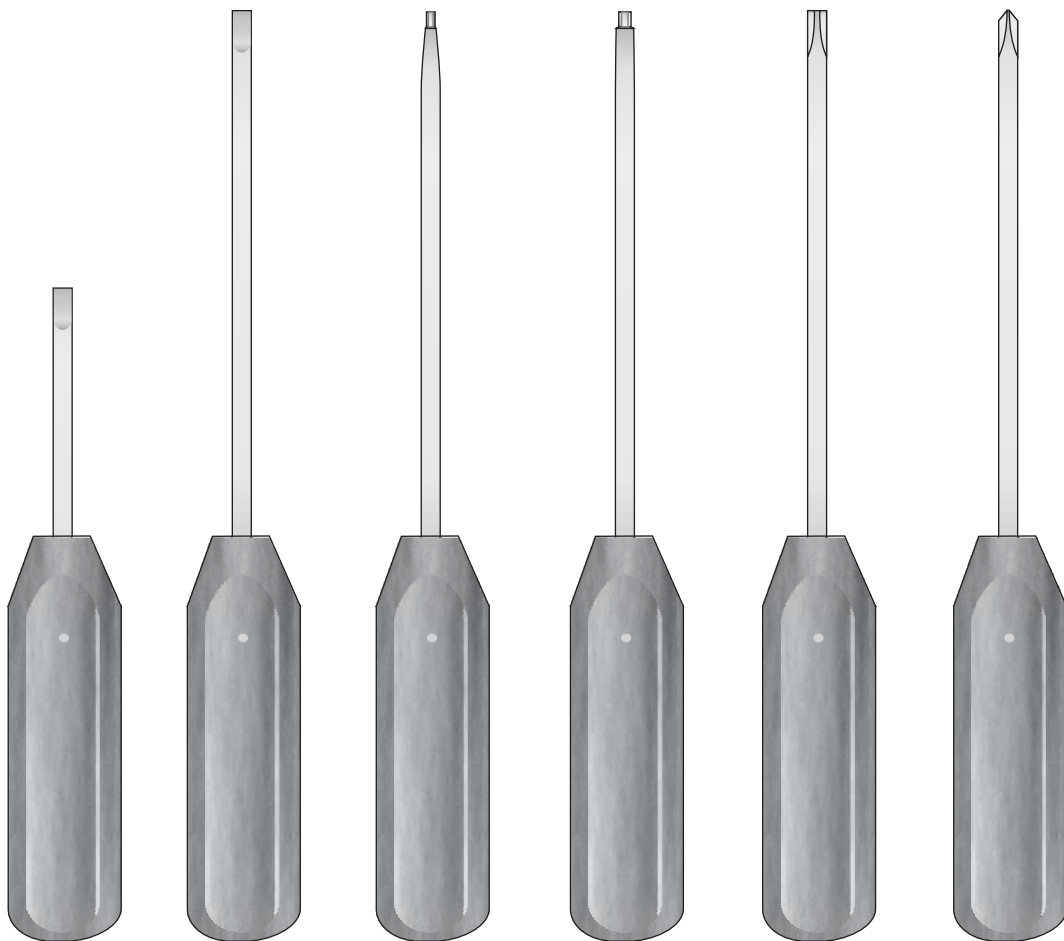
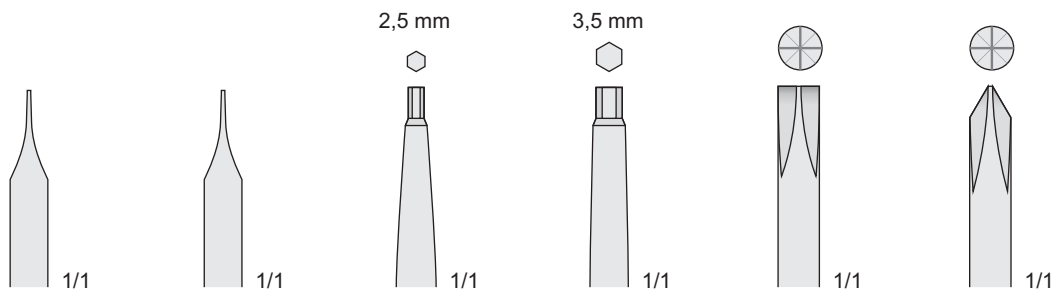

1118-DBA  
170 mm

LANE  
1118-DBB  
250 mm

1118-DBC  
250 mm

1118-DBD  
250 mm

1118-DBE  
250 mm

PHILIPS  
1118-DBF  
250 mm

Giraviti con manico di Ferrozell  
Screws driver with Ferrozell handle  
Schraubenzieher mit Ferrozellgriff  
Jeu de tournevis avec poignée en Ferrozell  
Destornilladores con mango de Ferrozell

1,5 mm



**1118-BCH**  
35 mm

2,5 mm

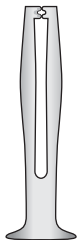

**1118-BCI**  
50 mm

+ 1,5 -2,5 mm

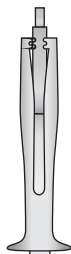

**1118-DBG**  
195 mm

o 1,5 mm

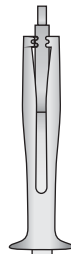

**1118-DBH**  
195 mm

o 2,5 mm

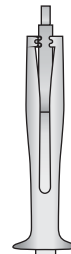

**1118-DBI**  
195 mm

Pinze e chiavi  
per placche

Biege und  
schränkhebel

Forceps  
for plattes

Pinces à courber  
pour plaques

Pinzas  
para placas

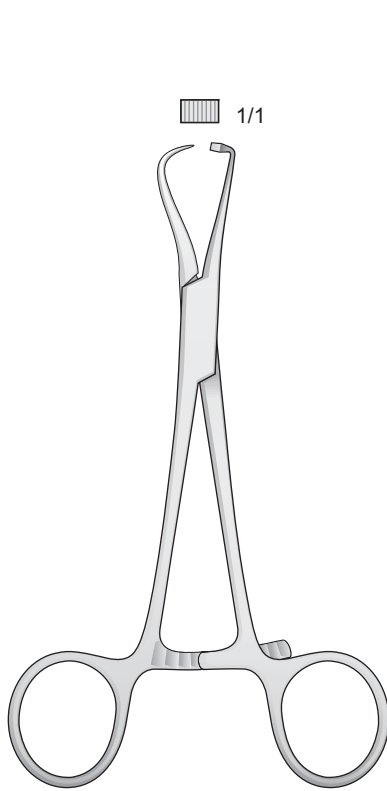

1118-HG  
120 mm

Holding forceps for plattes  
Haltezange für platten

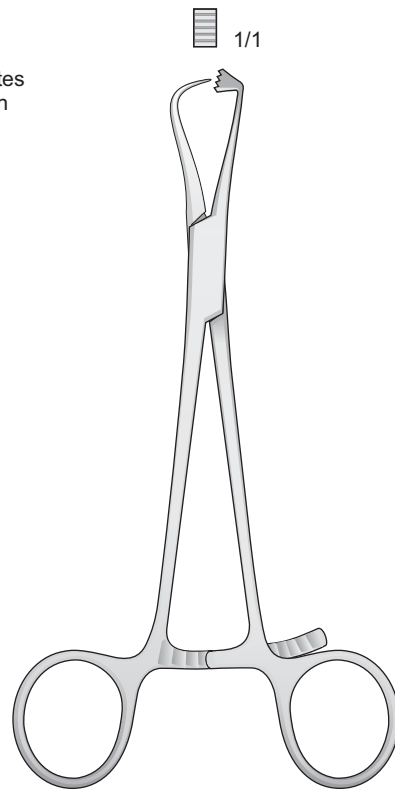

1118-HI  
125 mm

For standard plates  
Für Standard-Platten

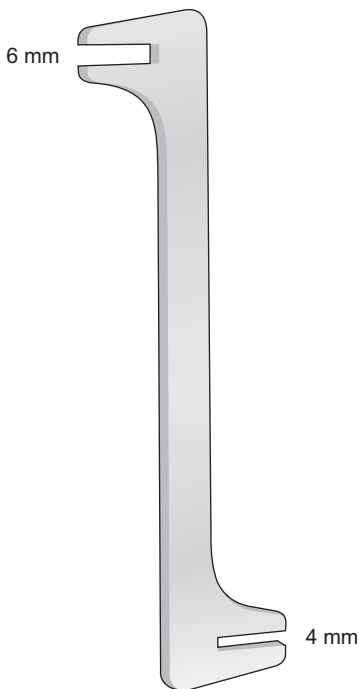

1118-BAB  
180 mm

Bending irons, for small plates  
Biege und Schränkhebel für kleine platten

Per placche da  
2,7 mm e 3,5 mm



1118-BAD 100 mm  
1118-BAC 140 mm



1118-BCD 100 mm  
1118-BCC 140 mm

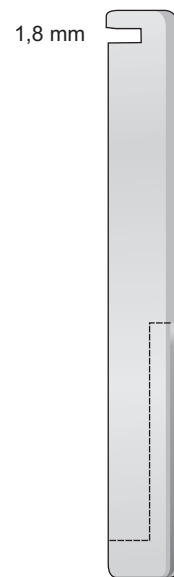

1118-BAE  
100 mm

**Pinze  
per placche**

**Zangen für  
schränkhebel platten**

**Forceps  
for plattes**

**Pinces à courber  
pour plaques**

**Pinzas  
para placas**

Pinze piegaplacche - Bending pliers - Biegezange - Pinces à plier



**1118-EAF**  
200 mm



**1118-EAG**  
240 mm

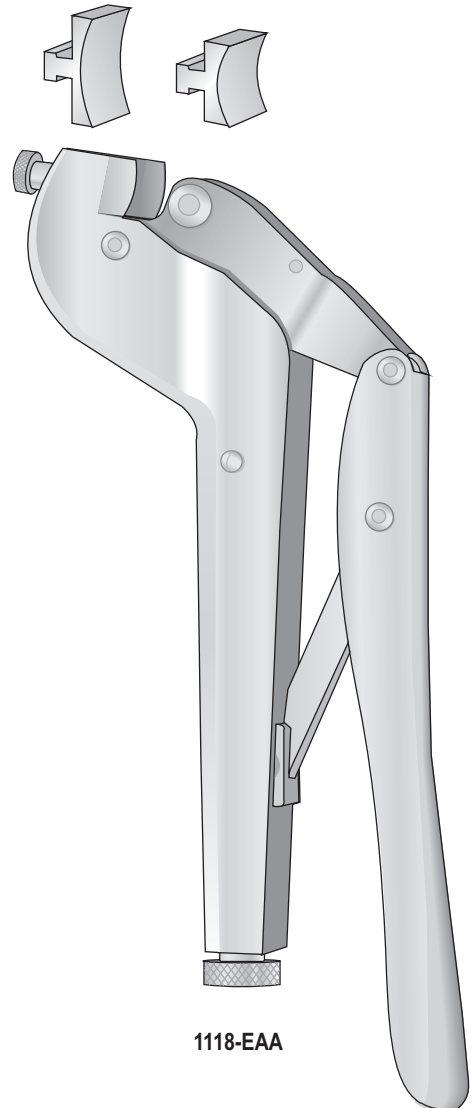

**1118-EAA**

Pressa piegaplacche - Bending press - Biegepresse - Presse pour plier

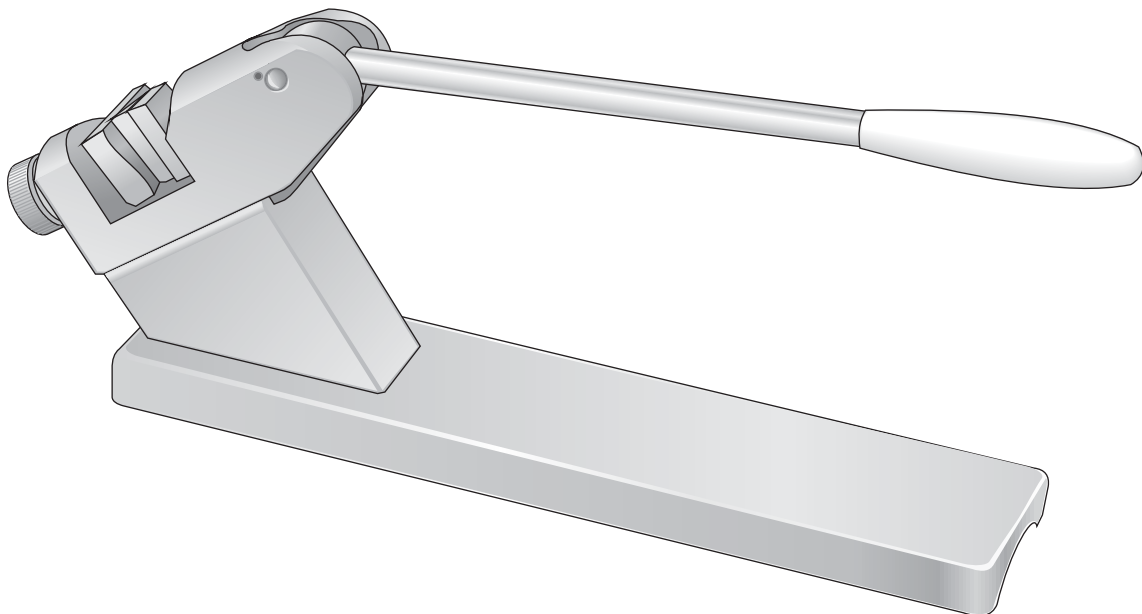

**1118-EBA**

Strumenti  
per gesso

Plaster spreader  
Plaster cast breakers

Gipsspreizer  
Gipsabreisszangen

Pinces pour  
appareils plâtrés

Pinza para  
arrancar vendajes

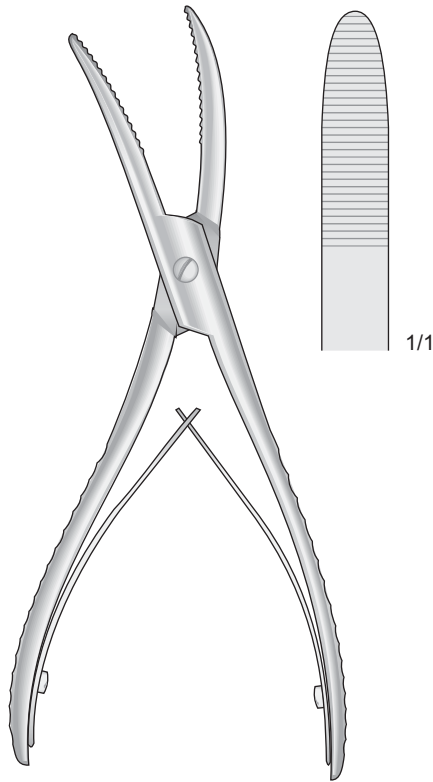

WOLFF  
1123-BBD  
180 mm

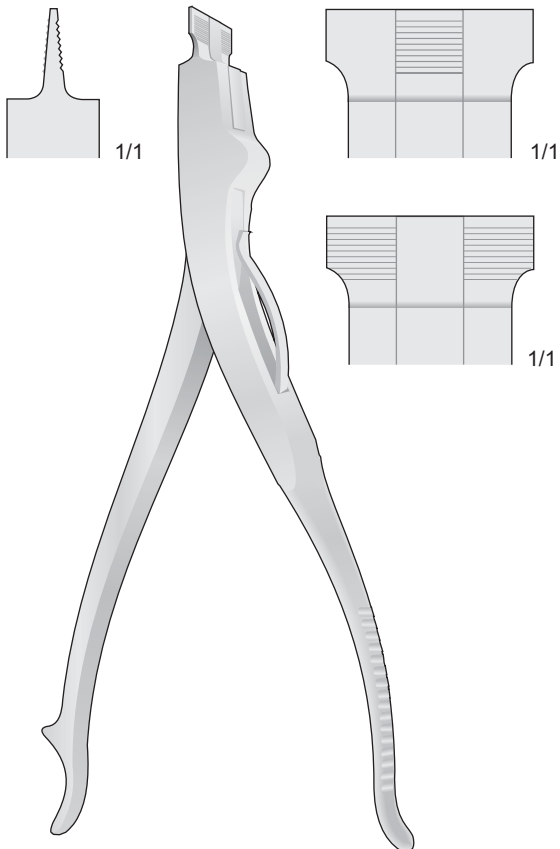
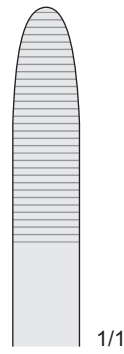

1123-BBF  
220 mm

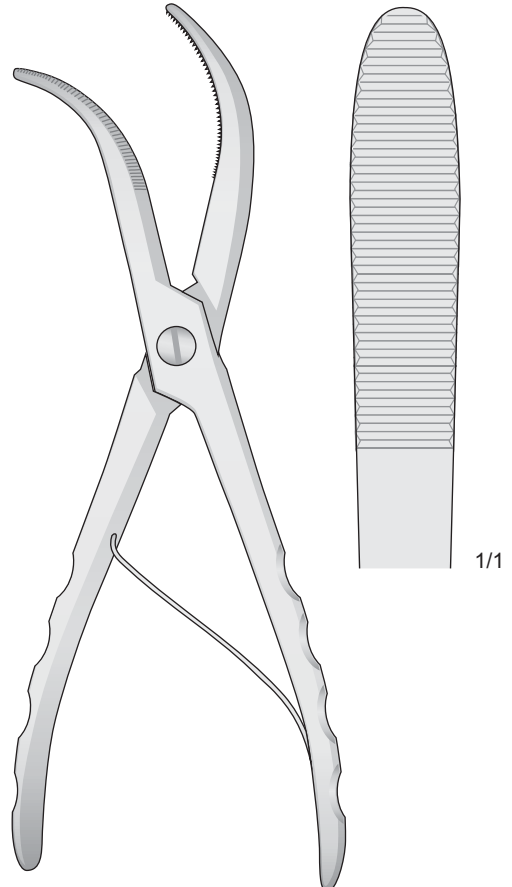

WOLFF  
1123-BBE  
250 mm

Cesoie per gesso  
Gips - Schneidezangen

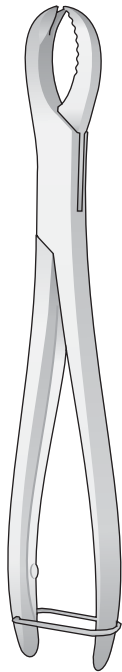

0210-DA  
210 mm

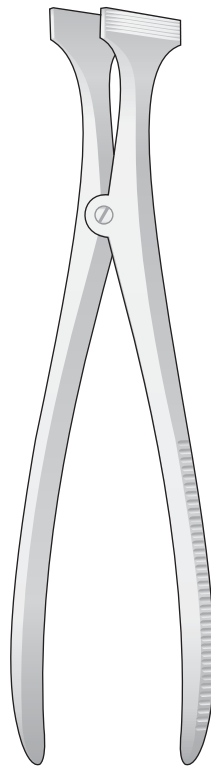

HENNIG  
1123-BCD  
270 mm

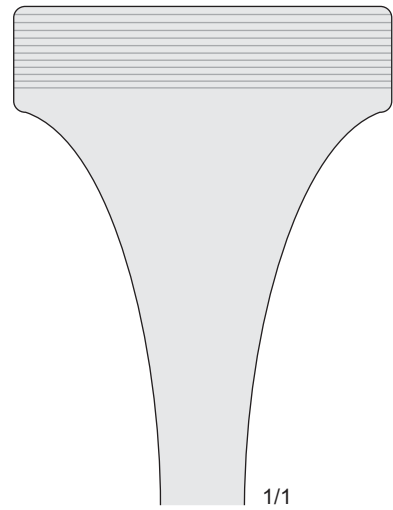

1/1

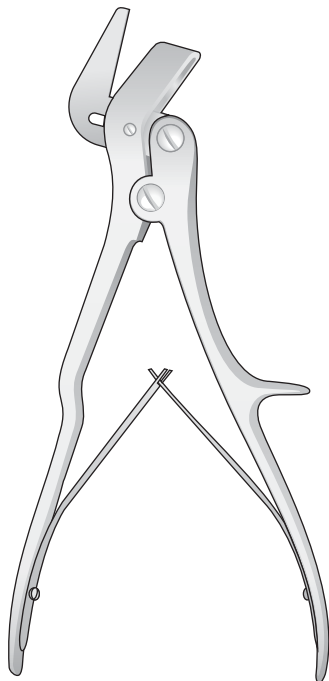

STILLE  
1123-BCA  
230 mm

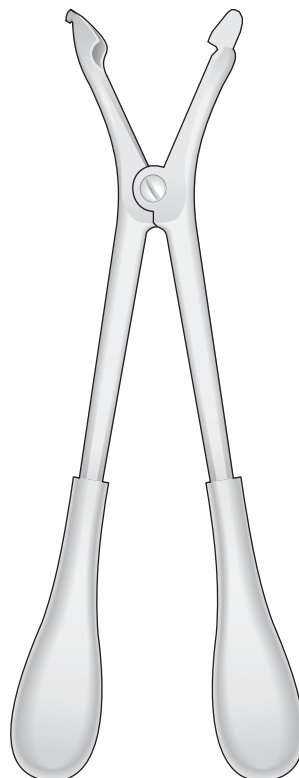

HAGLUND  
1123-BCB  
280 mm

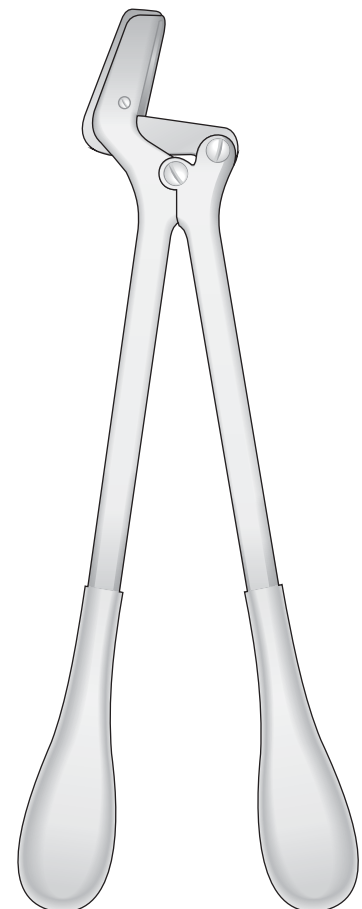

STILLE  
1123-BCC  
370 mm







14

O.R.L. - H.N.O. - E.N.T.  
O.R.L. - H.N.O. - E.N.T.  
O.R.L. - H.N.O. - E.N.T.  
O.R.L. - H.N.O. - E.N.T.  
O.R.L. - H.N.O. - E.N.T.



Per adulti - For adults  
Für Erwachsene - Pour adultes  
Para adultos

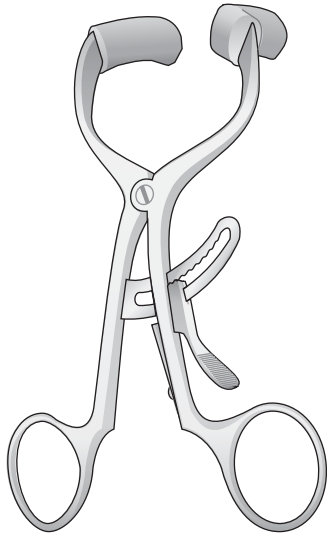

DOYEN-JANSEN  
1412-EB  
140 mm

Per adulti - For adults  
Für Erwachsene - Pour adultes  
Para adultos

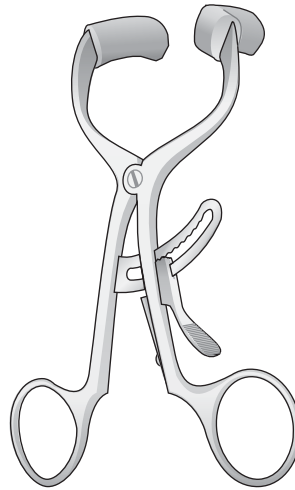

DOYEN-COLLIN  
1412-EA  
120 mm

Per bambini  
For children  
Für kinder  
Pour enfants  
Para niños

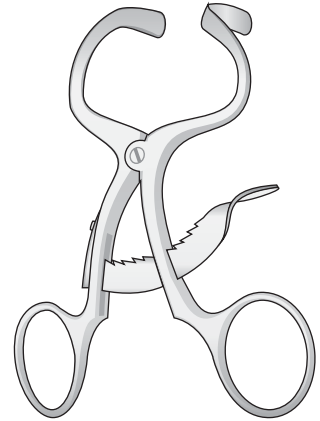

MOLT  
1412-EC  
100 mm

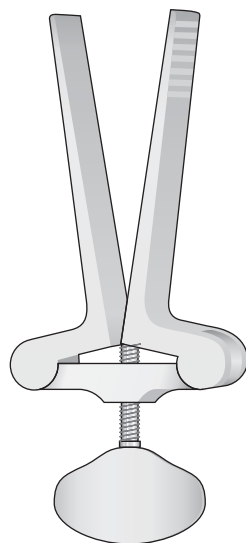

HEISTER  
1412-GC  
135 mm

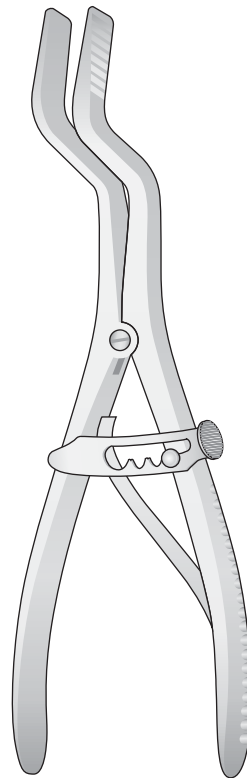

ROSER KÖNIG  
1412-GA  
185 mm

Apribocca

Mouth gags

Mundsperrer

Ecarteur buccal

Abrebocas

Apribocca con aspirazione  
Mouth gag with suction  
Mundsperrer mit Absauger

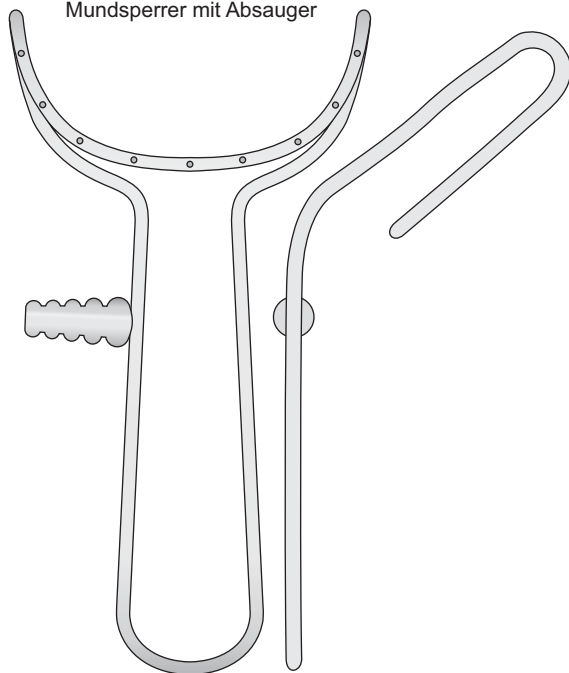

**1412-LC**  
140 mm

Apribocca senza aspirazione  
Mouth gag without suction  
Mundsperrer ohne Absauger

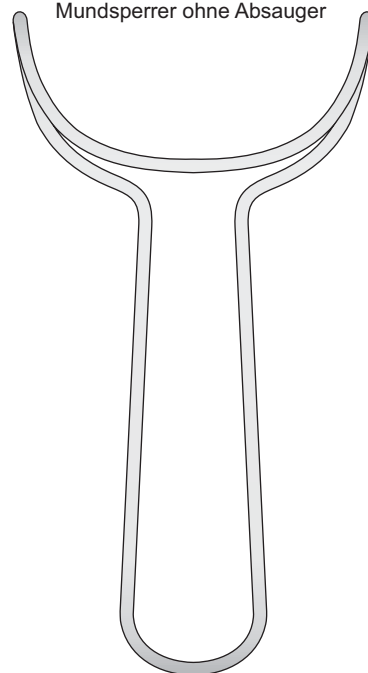

**1412-LA**  
150 mm

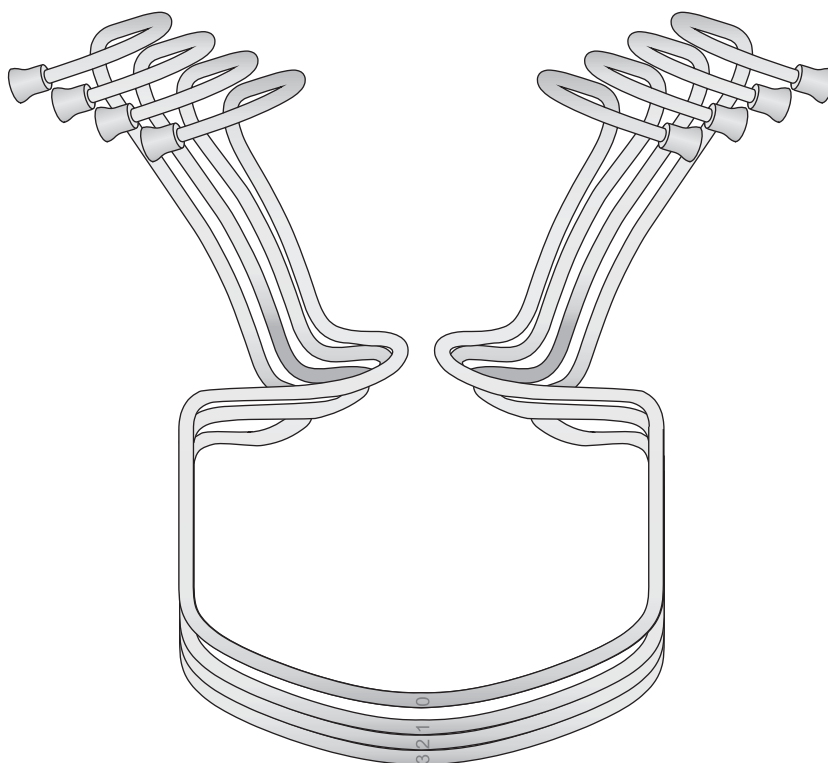
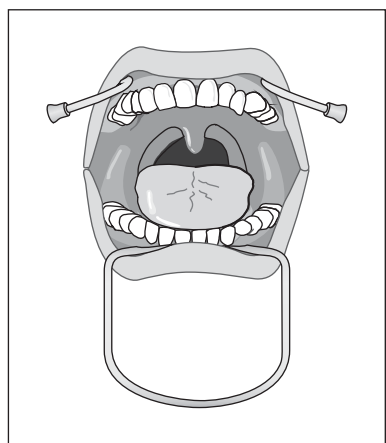

**ORINGER**

- 1412-HE** Fig. 0 100 x 95 mm Per bambini
- 1412-HF** Fig. 1 115 x 105 mm Per adulti
- 1412-HG** Fig. 2 115 x 110 mm Per adulti
- 1412-HH** Fig. 3 125 x 115 mm Per adulti

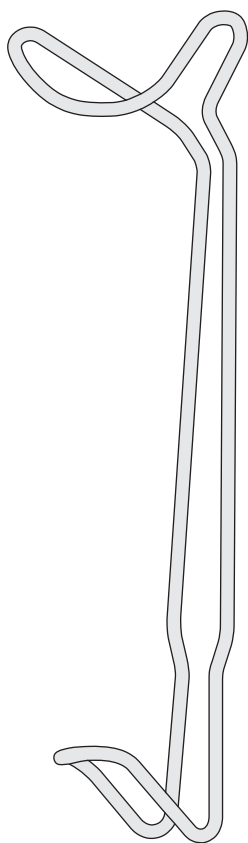

1412-FI  
210 mm

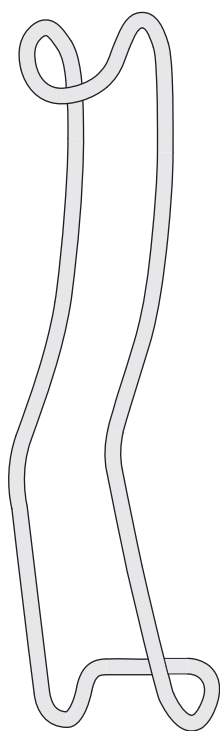

STERNBERG  
1412-FA  
160 mm

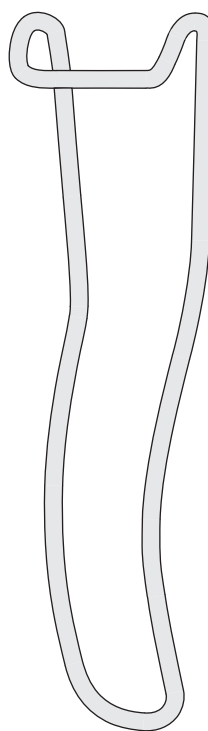

STERNBERG  
1412-FC  
160 mm

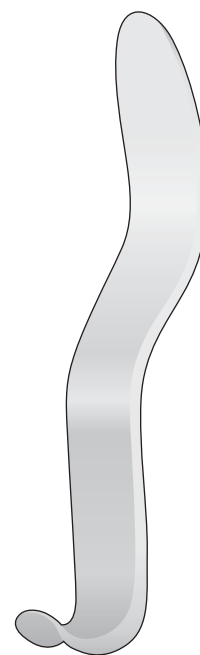

MINNESOTA  
1412-FF  
140 mm

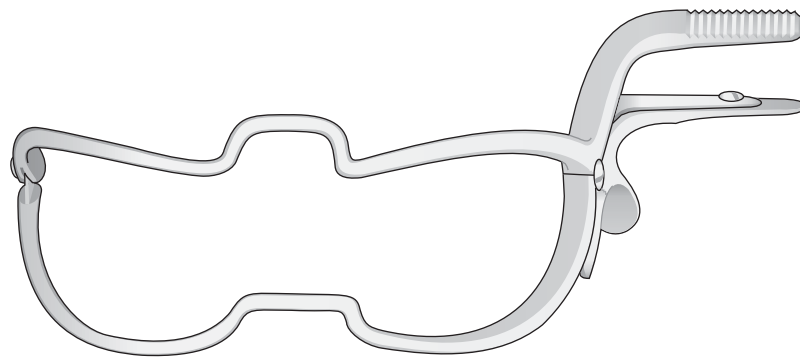

WHITEHEAD-JENNINGS

- 1412-BDG** 90 mm
- 1412-BDH** 110 mm
- 1412-BDI** 130 mm
- 1412-BDL** 150 mm

Apribocca solo  
Gag only  
Sperrer allein  
Manche et cadreseuls  
Apre-boca suelto

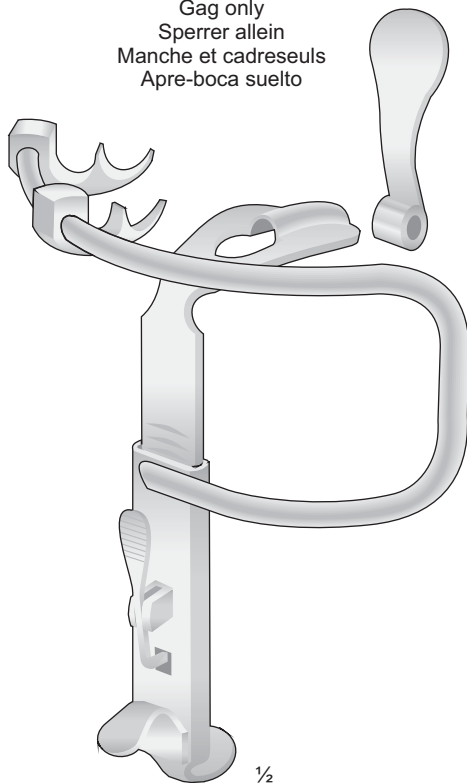

KILNER-DOUGHTY  
**1412-BGB**

Fig. 1

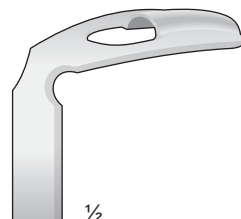

**1412-BGC**  
28 x 65 mm

Fig. 2

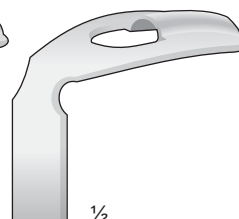

**1412-BGD**  
32 x 75 mm

Fig. 3

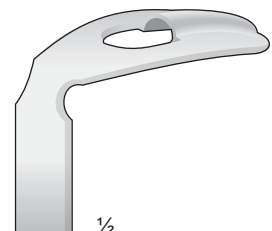

**1412-BGE**  
37 x 80 mm

KILNER-DOUGHTY  
**1412-BGA**

Completo con 3 abbassalingua  
Complete with 3 tongue depressors  
Komplet mit 3 Zungenspatel  
Complet avec 3 abaisse-langues  
Completo con 3 abaja lengua

Apribocca

Mouth gags

Mundsperrer

Ecarteur buccal

Abrebocas

Apribocca solo  
Gag only  
Sperrer allein  
Manche et cadreseuls  
Apre-boca suelto

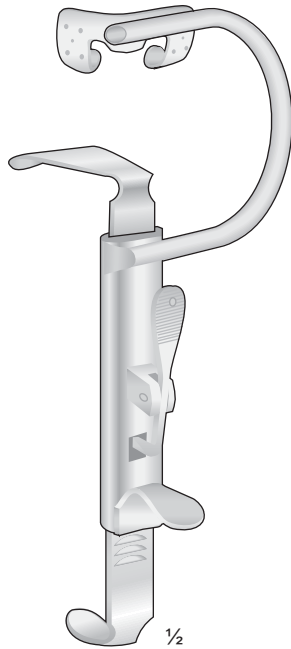

DAVIS-BOYLE  
1412-BEB

DAVIS-BOYLE  
1412-BEA  
Completo con 5 abbassalingua  
Complete with 5 tongue depressors  
Komplet mit 5 Zungenspatel  
Complet avec 5 abaisse-langues  
Completo con 5 abaja lengua

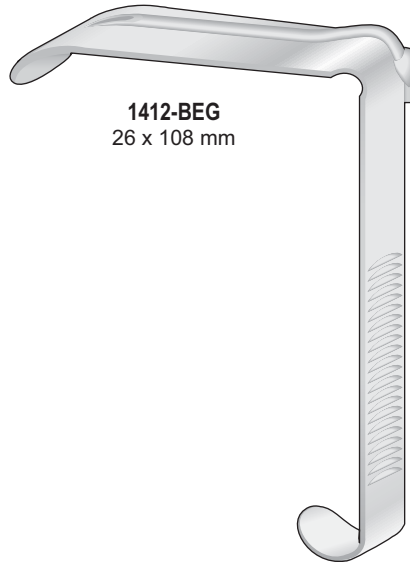

1412-BEG  
26 x 108 mm

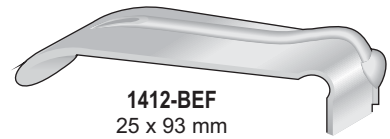

1412-BEF  
25 x 93 mm

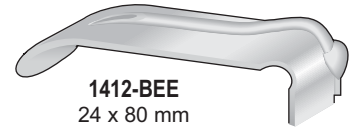

1412-BEE  
24 x 80 mm

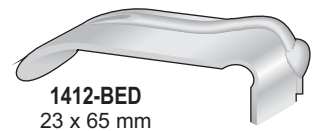

1412-BED  
23 x 65 mm



1412-BEC  
21 x 30 mm

Mc-IVOR  
1412-BHA  
Completo di 3 abbassalingua  
Complete with 3 tongue depressors  
Komplet mit 3 Zungenspatel  
Complet avec 3 abaisse-langues  
Completo con 3 abaja lengua

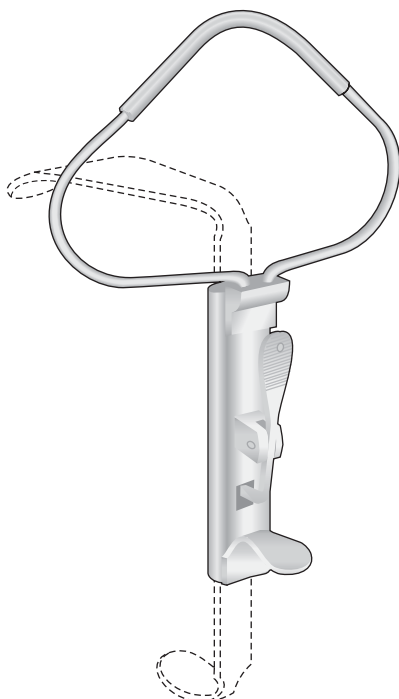

Mc-IVOR  
1412-BHB



1412-BHE  
26 x 100 mm

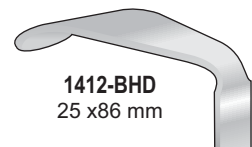

1412-BHD  
25 x 86 mm

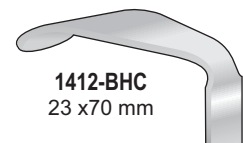

1412-BHC  
23 x 70 mm

Telaio Dingmann con  
due apriguancia

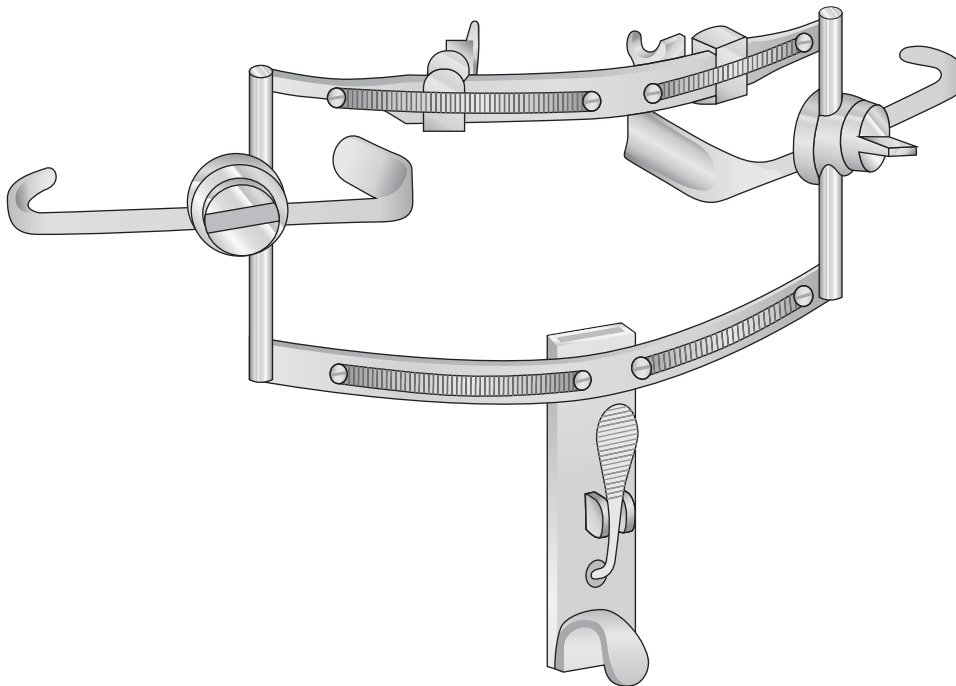

1412-BBB

Abbassalingua  
Tongue depressor  
Zungenspatel  
Abaisse langues  
Bejalenguas

Fig. 1

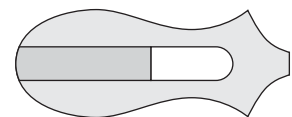

1412-BBC  
piccolo

Fig. 2

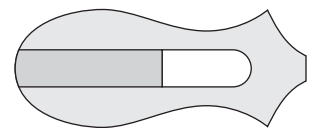

1412-BBD  
medio

Fig. 3

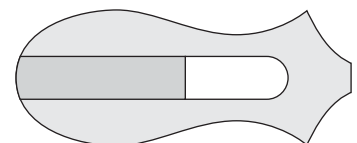

1412-BBE  
grande

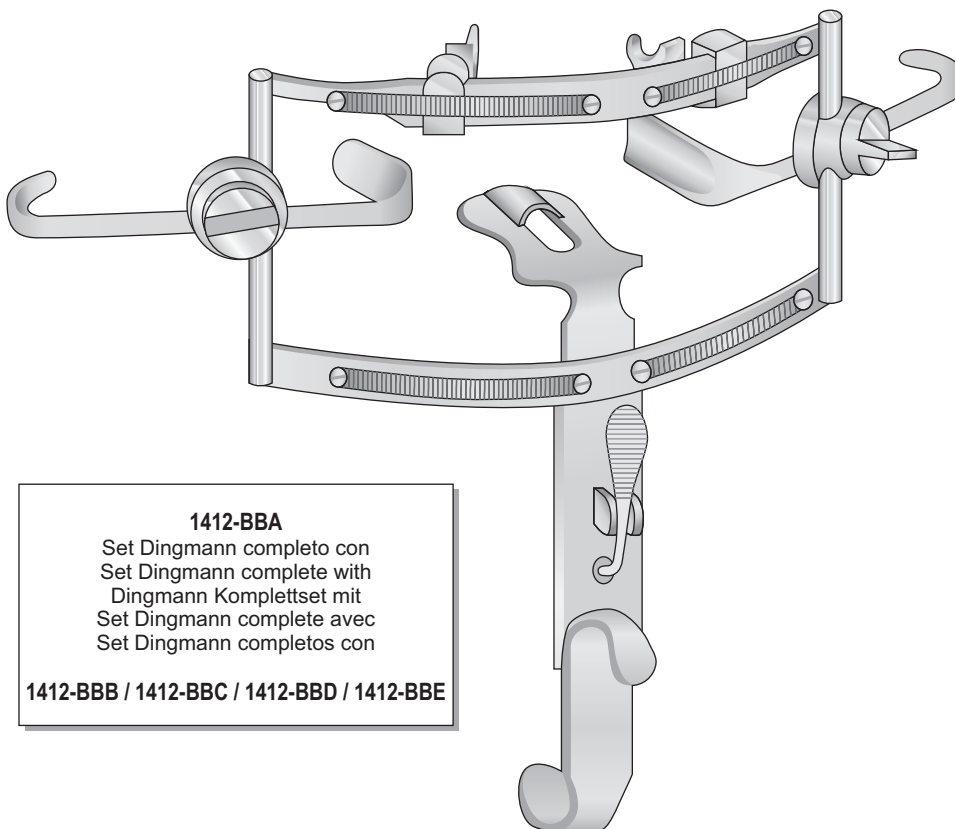

**1412-BBA**

Set Dingmann completo con  
Set Dingmann complete with  
Dingmann Kompletset mit  
Set Dingmann complete avec  
Set Dingmann completos con

1412-BBB / 1412-BBC / 1412-BBD / 1412-BBE

DINGMANN  
1412-BBA  
Set completo



Spatole malleabili

Spatulas malleable

Biegsame Spatel

Spatules flexible

Espatulas flexible



**0418-AB**  
110 mm

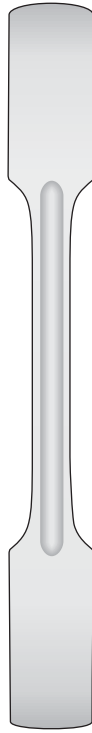

**0418-AC**  
160 mm



**1412-LI**  
195 mm

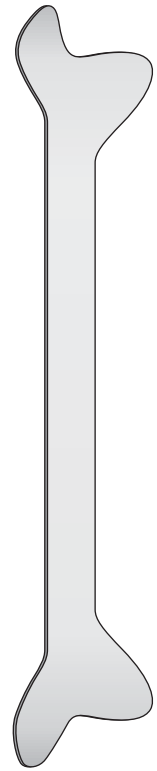

**1412-BAA**  
180 mm

Spatole inox malleabili  
Spatulas malleable

Spatole Inox malleabili antiriflesso nere  
Spatulas malleable black anodized

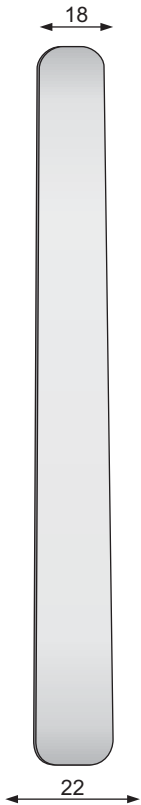

**1412-IA**  
200 mm

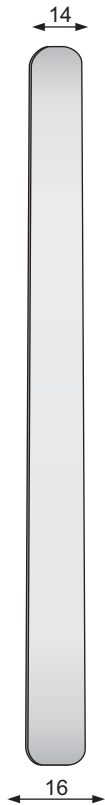

**1412-IB**  
200 mm



**1412-IC**  
240 mm



**1412-IH**  
200 mm

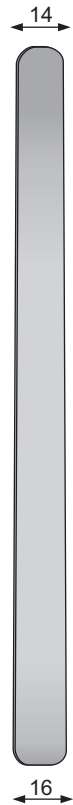

**1412-II**  
200 mm

Abbassalingua

Tongue depressor

Zungendrucker

Abaisse-langues

Bejalenguas

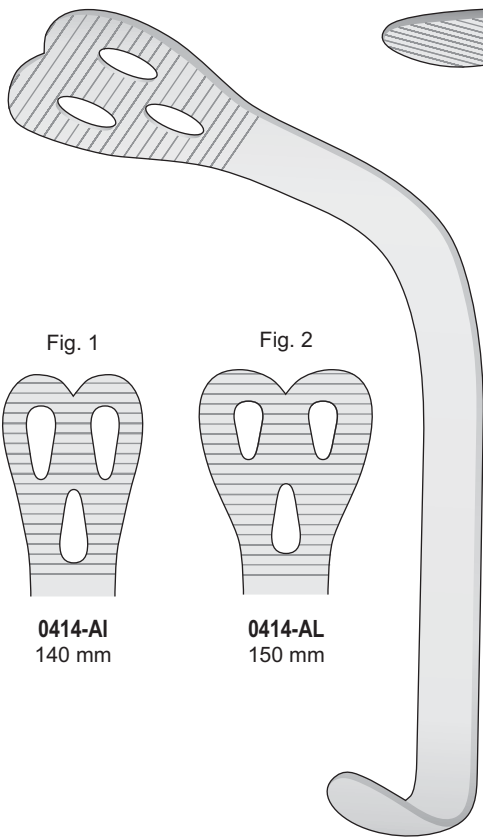
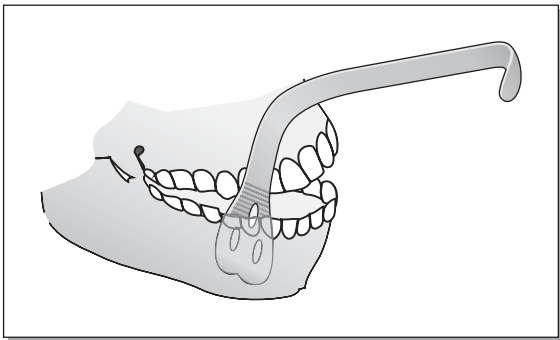

Fig. 1

Fig. 2

**0414-AI**  
140 mm

**0414-AL**  
150 mm

WIEDER  
**0414-AI/0414-AL**

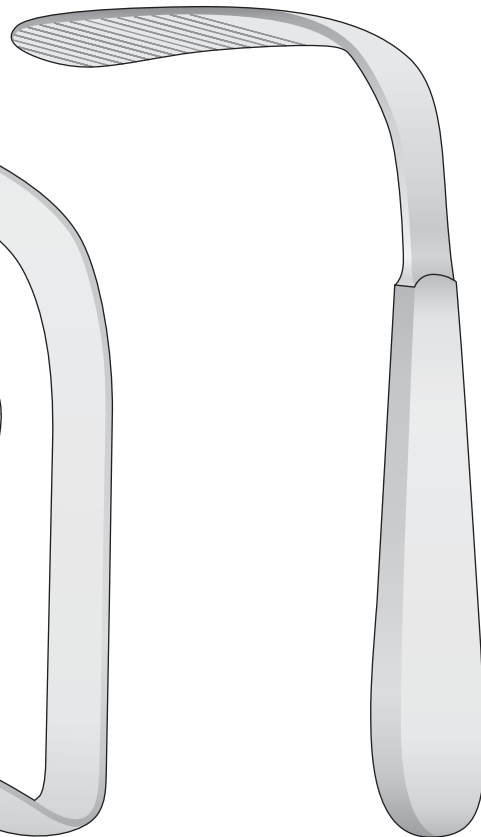

TOBOLD  
**1412-AI**  
145 mm

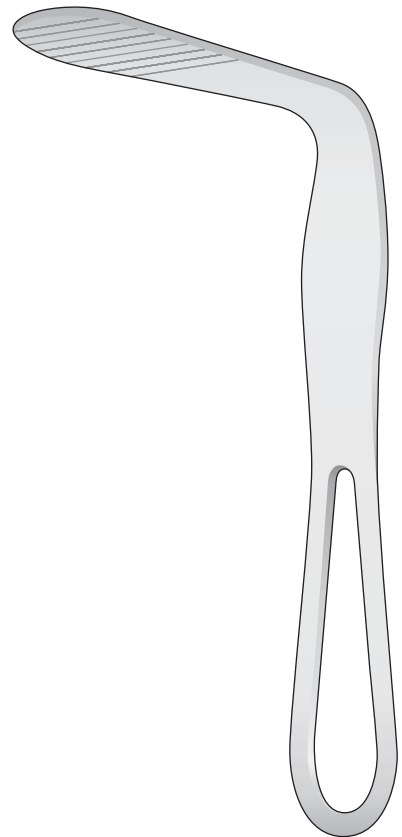

HARTMANN  
**1412-AG**  
150 mm

Divaricatori

Retractors

Wundhaken

Ecarteurs

Separadores

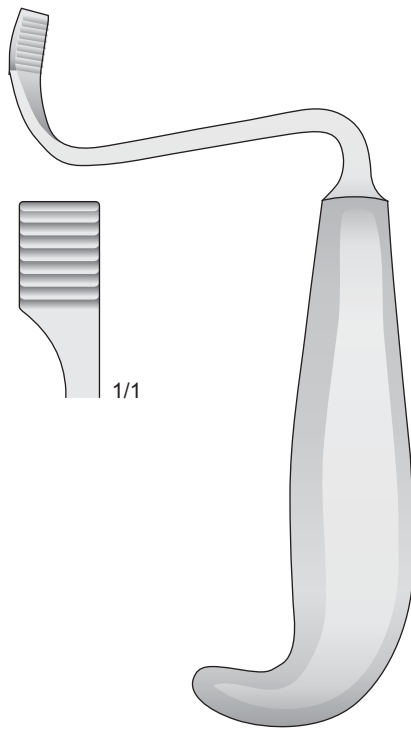

TESSIER  
0414-EC  
150 mm

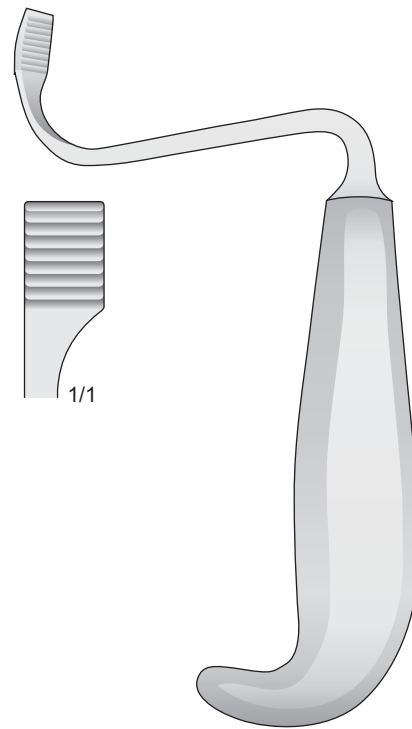

TESSIER  
0414-ED  
150 mm

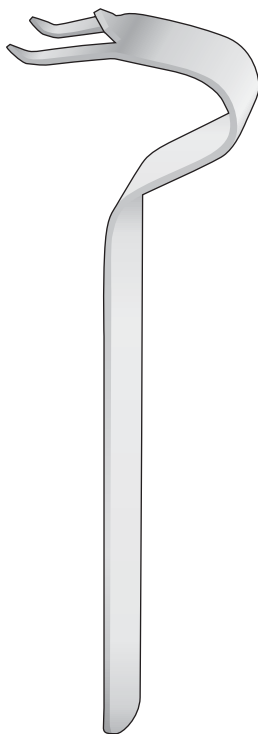

OBWEGESER  
0414-EA  
155 mm

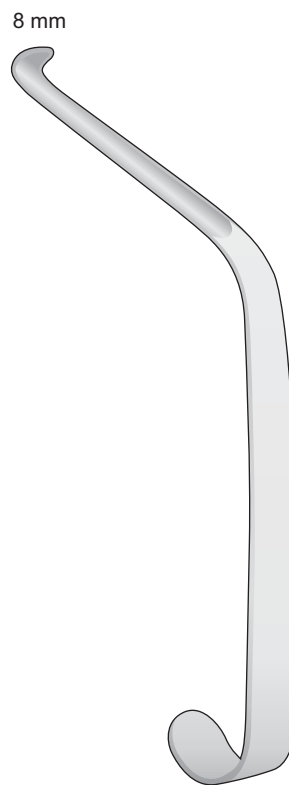

OBWEGESER  
0414-EB  
165 mm

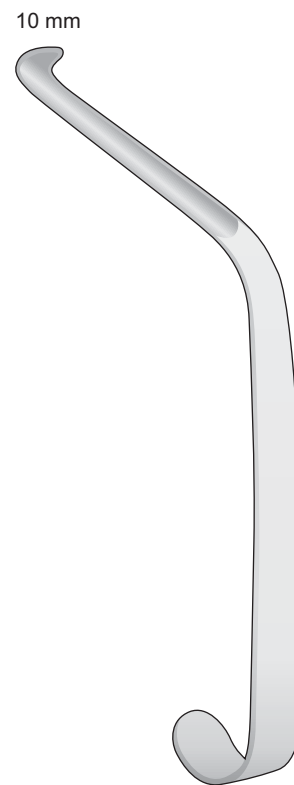

OBWEGESER  
0414-BEC  
165 mm

Divaricatori

Retractors

Wundhaken

Ecarteurs

Separadores

6 x 13 mm

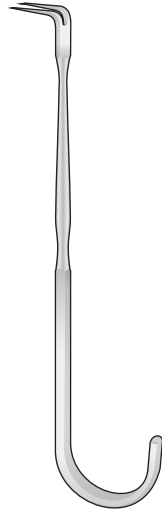

DUNN-DAUTREY  
0414-BLI  
130 mm

8 x 18 mm

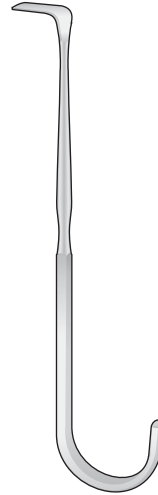

DUNN-DAUTREY  
0414-BLL  
125 mm

Posteriore  
Posterior

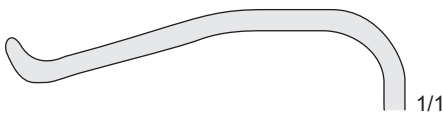

1/1

Anteriore  
Anterior

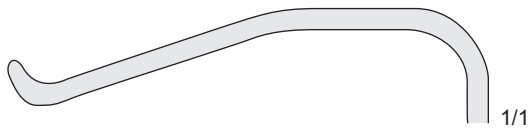

1/1

Superiore  
Superior

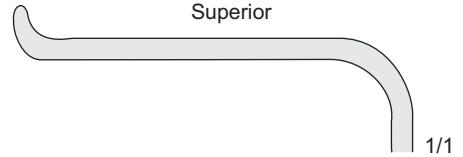

1/1

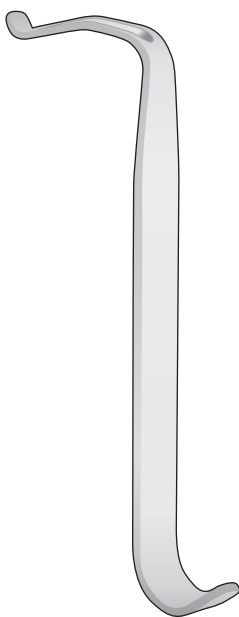

DUNN-DAUTREY  
0414-LE 6,5 x 50 mm  
140 mm

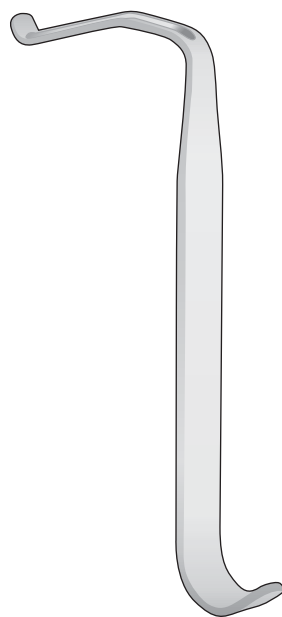

DUNN-DAUTREY  
0414-LF 6,5 x 60 mm  
140 mm

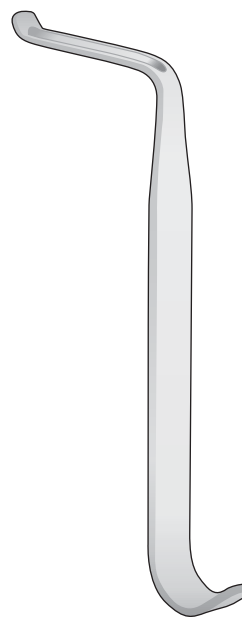

DUNN-DAUTREY  
0414-LG 8 x 50 mm  
140 mm

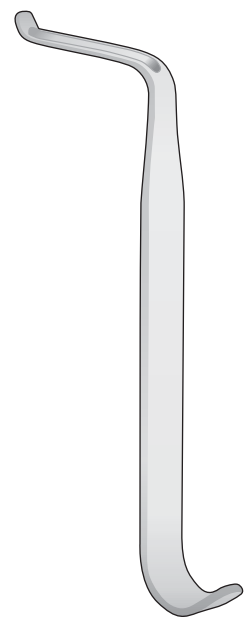

DUNN-DAUTREY  
0414-LH 6,5 x 50 mm  
140 mm

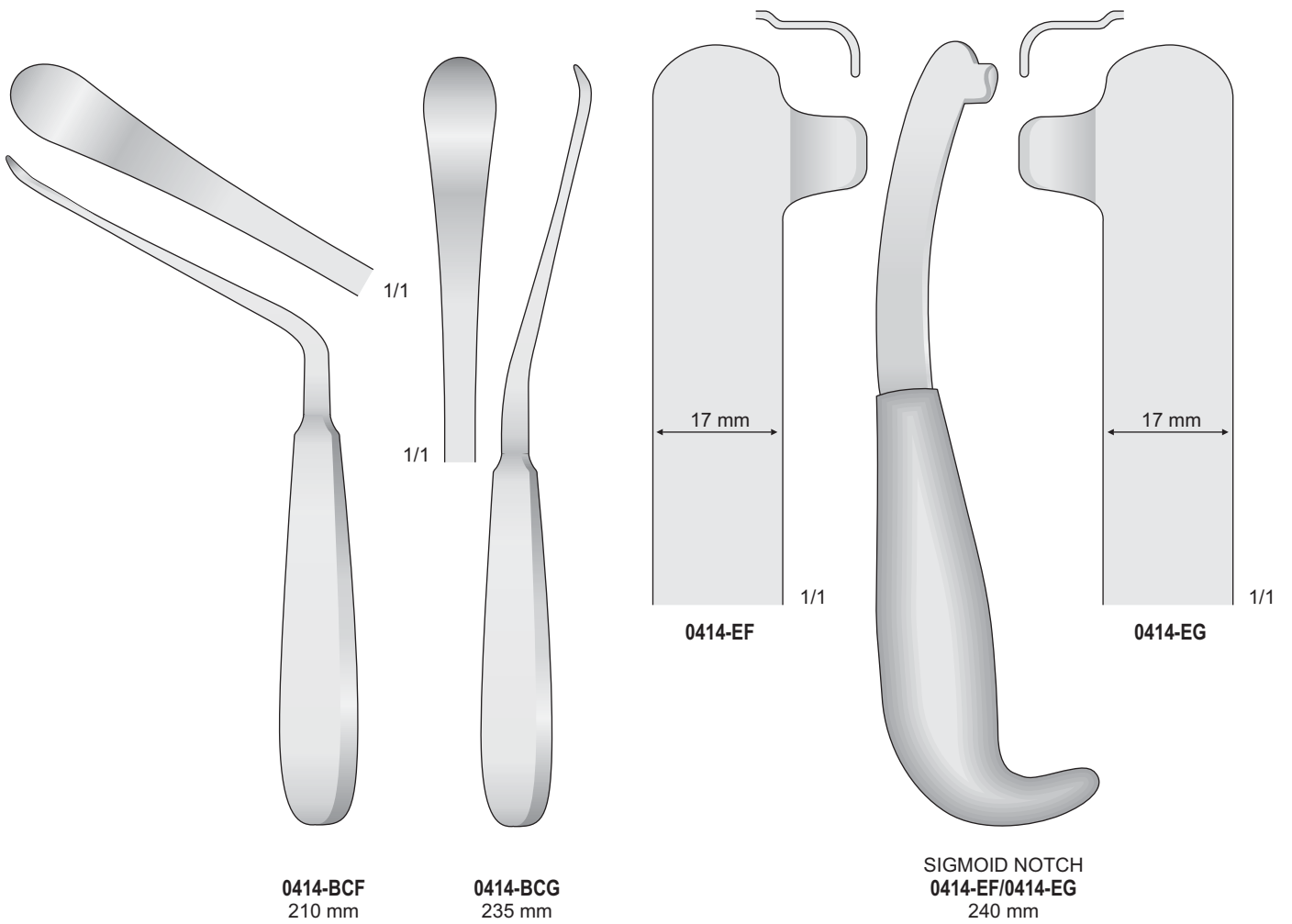

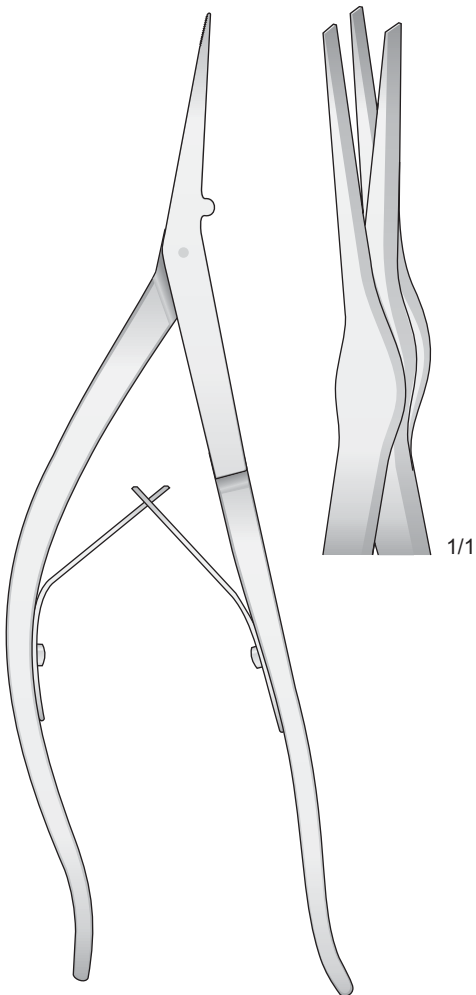
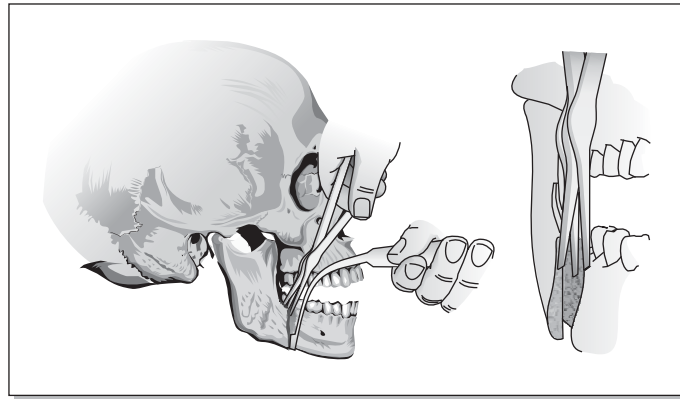

RAMUS  
0414-CEH  
230 mm

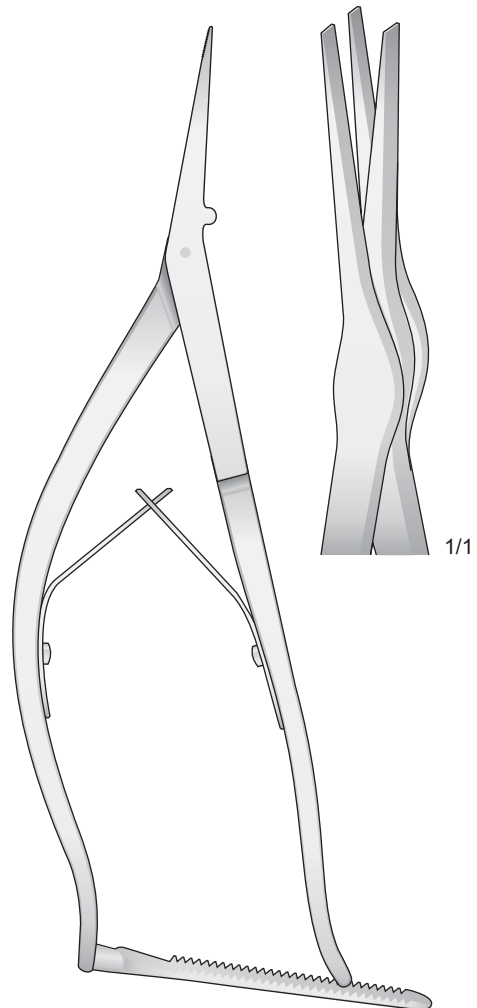

RAMUS  
0414-CEI  
230 mm

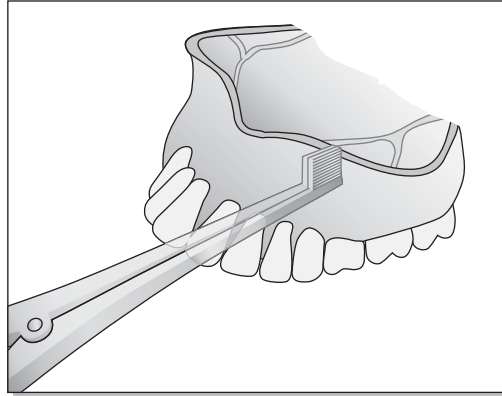

Bone spreaders

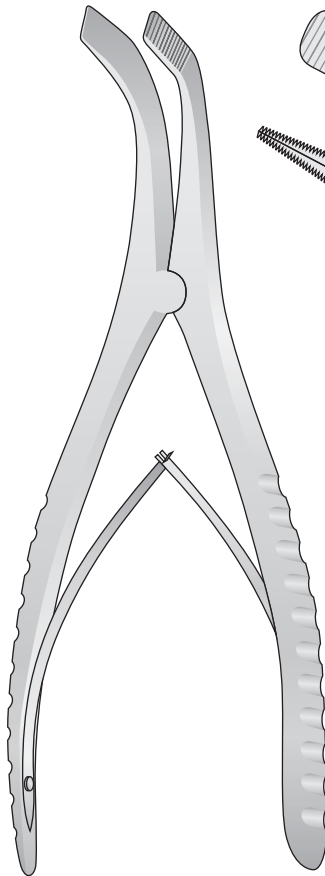

TESSIER  
0414-BL  
180 mm

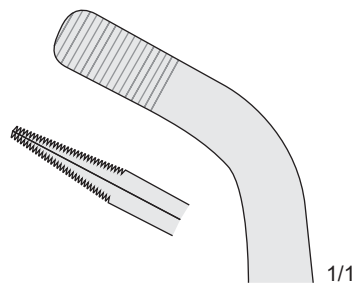

Maxillary palatal

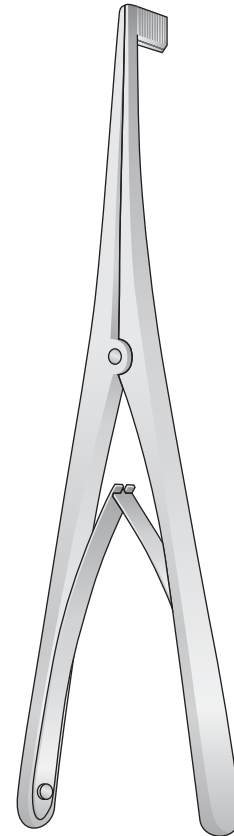

0414-CL  
170 mm

Pinze per riposizione

Reposition forceps

Repositionszangen

Pinces de reposition

Pinzas para la reducción

Lattanti  
For juveniles  
Für Jugendliche

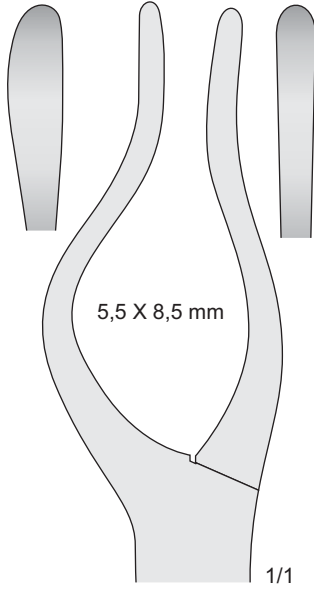

5,5 X 8,5 mm

0414-BA  
0414-BB  
225 mm

Per bambini  
For children  
Für Kinder  
Pour enfants  
Para niños

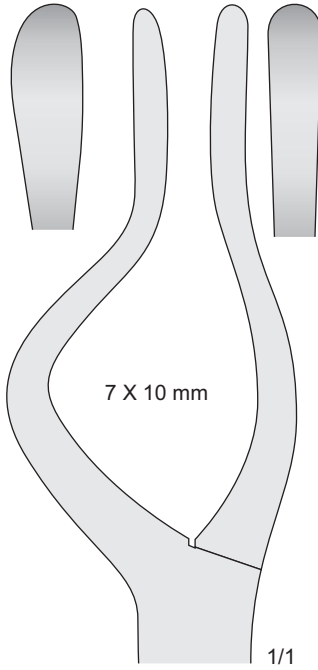

7 X 10 mm

0414-BC  
0414-BD  
235 mm

Per adulti  
For adults  
Für Erwachsene  
Pour adultes  
Para adultos

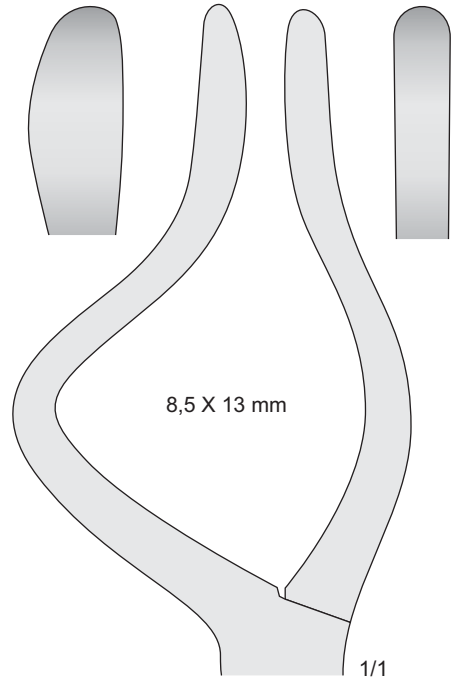

8,5 X 13 mm

0414-BE  
0414-BF  
240 mm

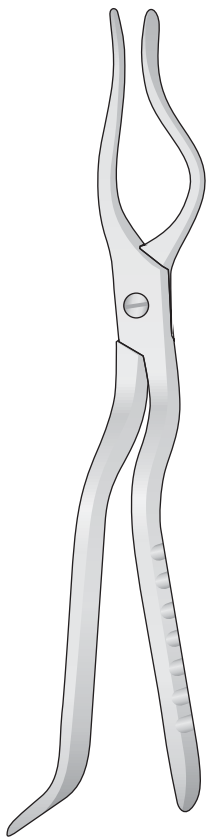

ROWE



ROWE

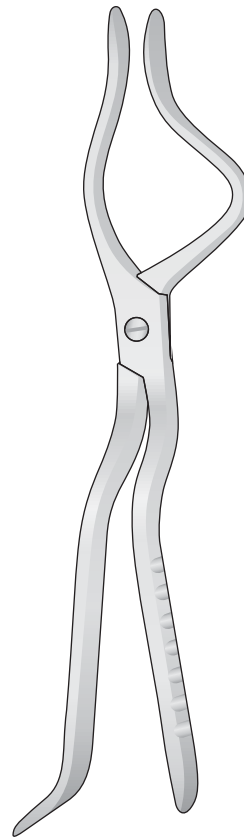

ROWE

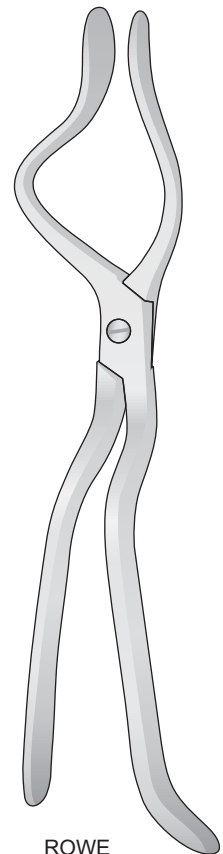

ROWE



Strumenti per otologia

Otology instruments

Instrumente für Otologie

Instrumentes pour l'otologie

Instrumentos auriculares

Uncini - Ear hooks - Ohrhebel

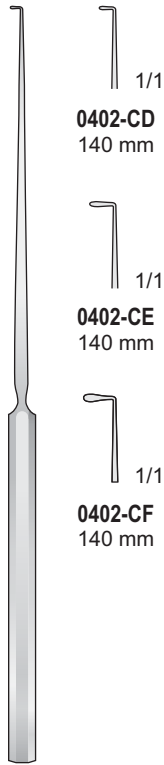

1/1  
**0402-CD**  
140 mm

1/1  
**0402-CE**  
140 mm

1/1  
**0402-CF**  
140 mm

LUCAE  
**0402-CD/0402-CF**  
140 mm

Curette - Curettes - Löffel - Curettes - Curetas

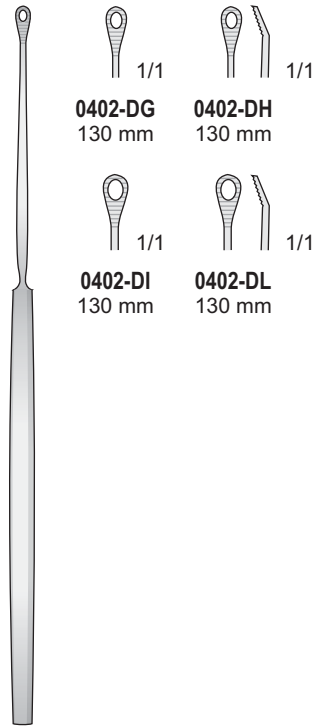

1/1  
**0402-DG**  
130 mm

1/1  
**0402-DH**  
130 mm

1/1  
**0402-DI**  
130 mm

1/1  
**0402-DL**  
130 mm

SHAPLEIGH  
**0402-DG/0402-DL**  
130 mm

Uncini - Ear hooks - Ohrhebel

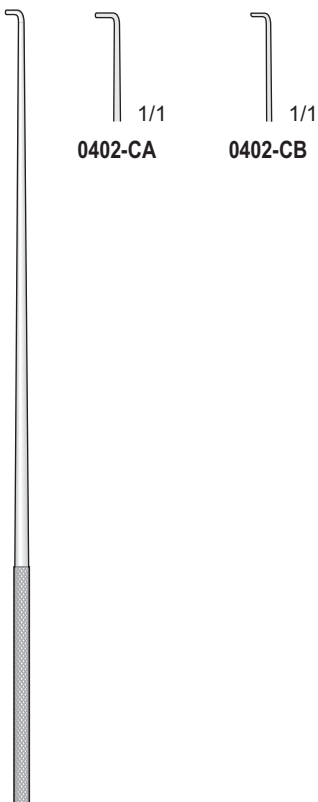

1/1  
**0402-CA**

1/1  
**0402-CB**

DAY  
**0402-CA/0402-CB**  
160 mm

Anse auricolari - Ear loops anses - Ohrschlingen - Ansas auriculares

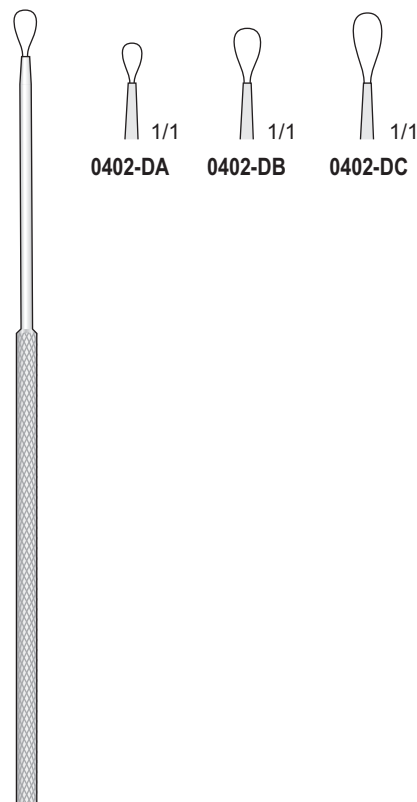

1/1  
**0402-DA**

1/1  
**0402-DB**

1/1  
**0402-DC**

BILLEAU  
**0402-DA/0402-DC**  
160 mm

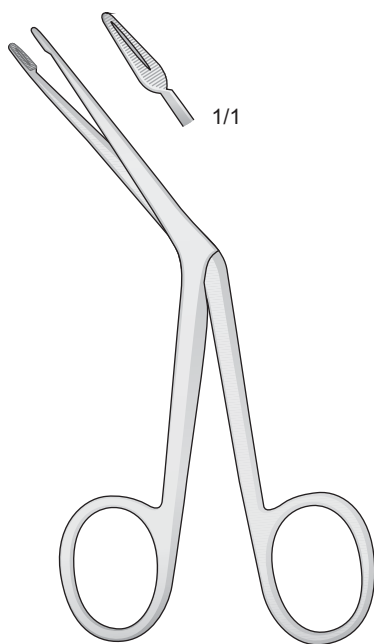
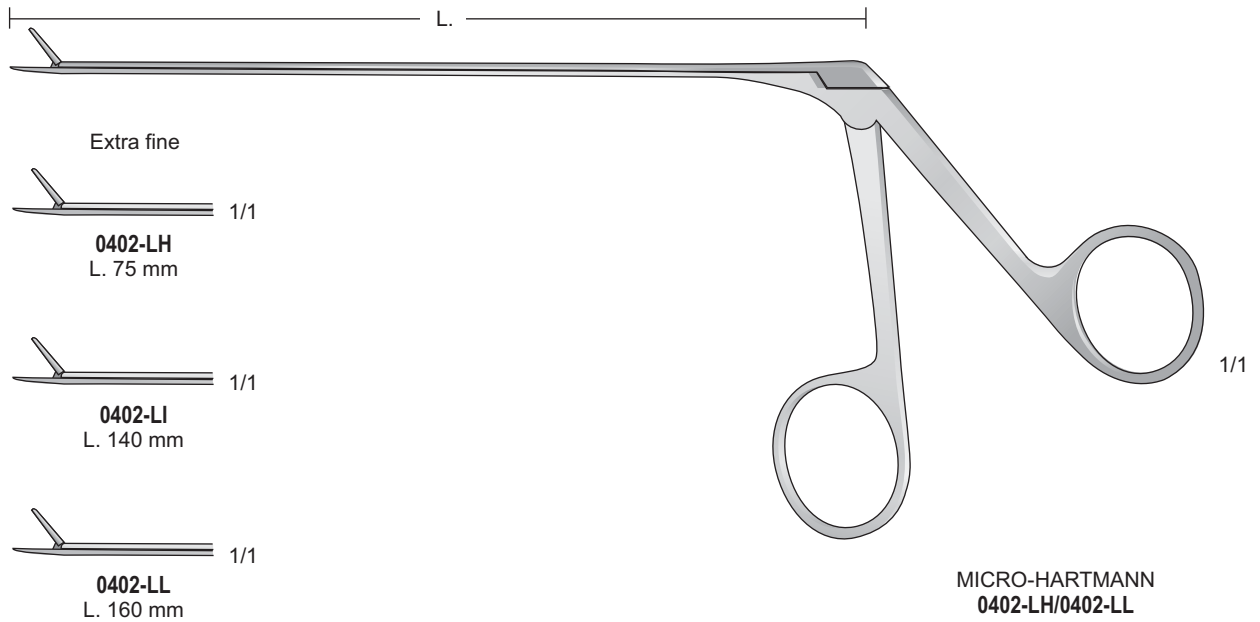

LITTAUER  
0402-BBB  
120 mm

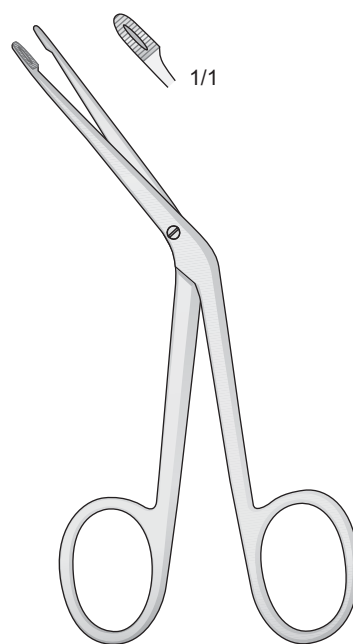

HARTMANN  
0402-BBD  
120 mm

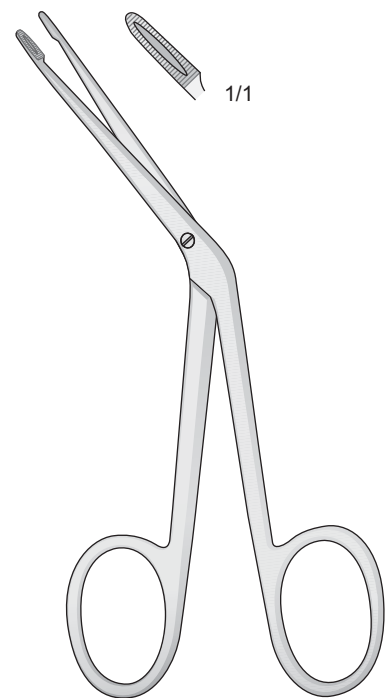

HARTMANN  
0402-BBE  
140 mm

Pinze auricolari  
Ear Forceps  
Ohr-Polypenzangen  
Pinces pour polypes auriculaires  
Pinzas auricolares

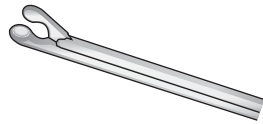

**0402-BCE**  
L.85 mm

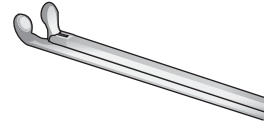

**0402-BCF**  
L.85 mm

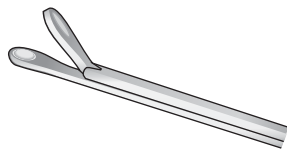

**0402-BCL**  
L.85 mm

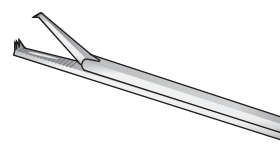

**0402-BCD**  
L.85 mm

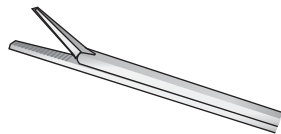

**0402-BCA**  
L.85 mm

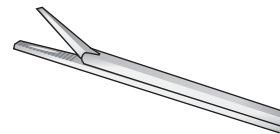

**0402-BCB**  
L.140 mm  
**0402-BCC**  
L.165 mm

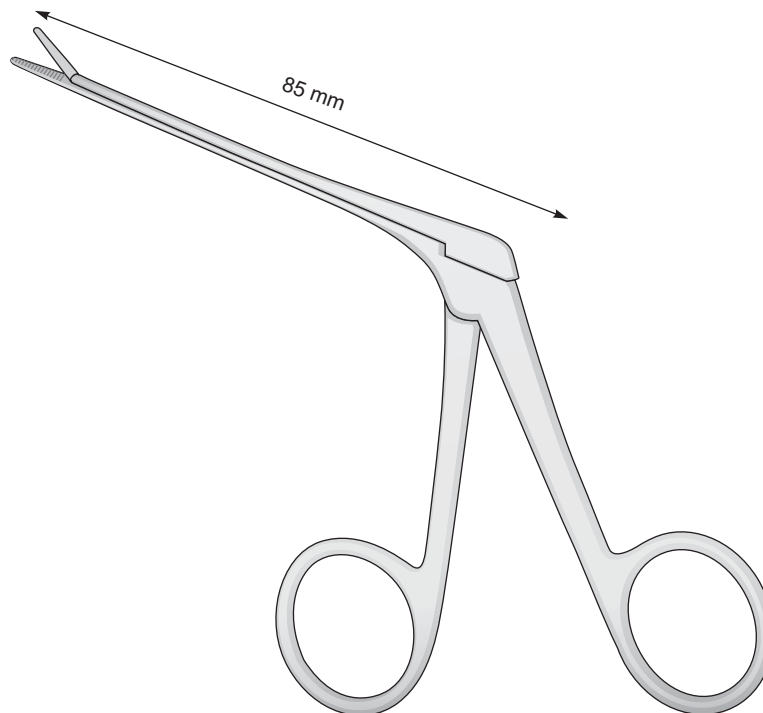

**0402-BCA/0402-BCL**  
L. 85 mm

Micro forbice  
Micro scissor  
Mikro Scheren  
Micro ciseaux  
Micro tijeras

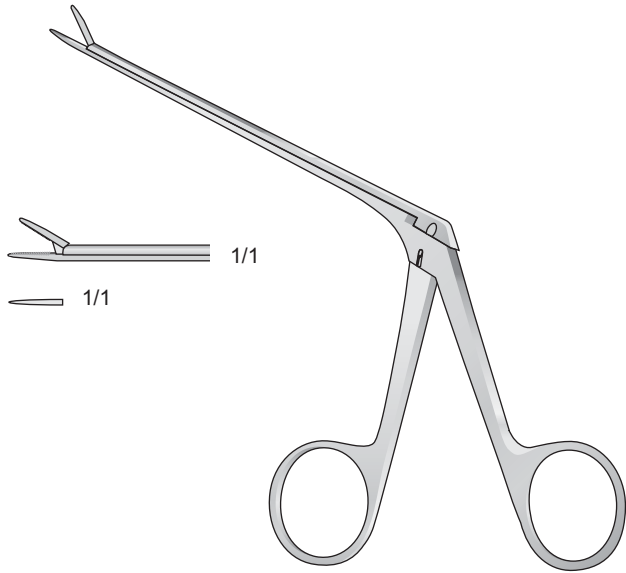

**0402-BAA**  
80 mm

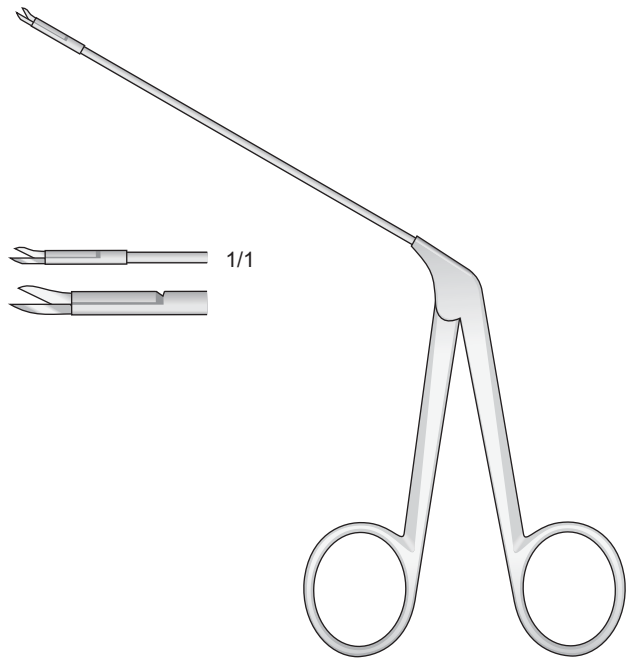

**BELLUCCI**  
**0402-BAG**  
80 mm

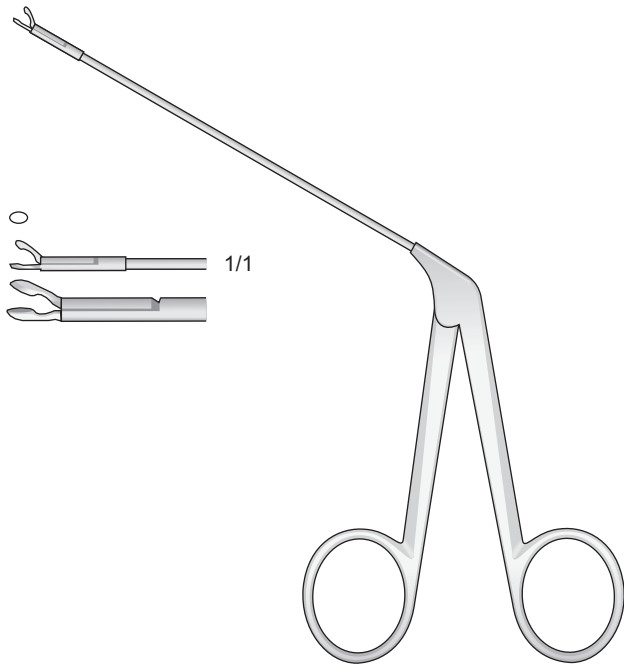

**WULLSTEIN**  
**0402-BAH**  
80 mm

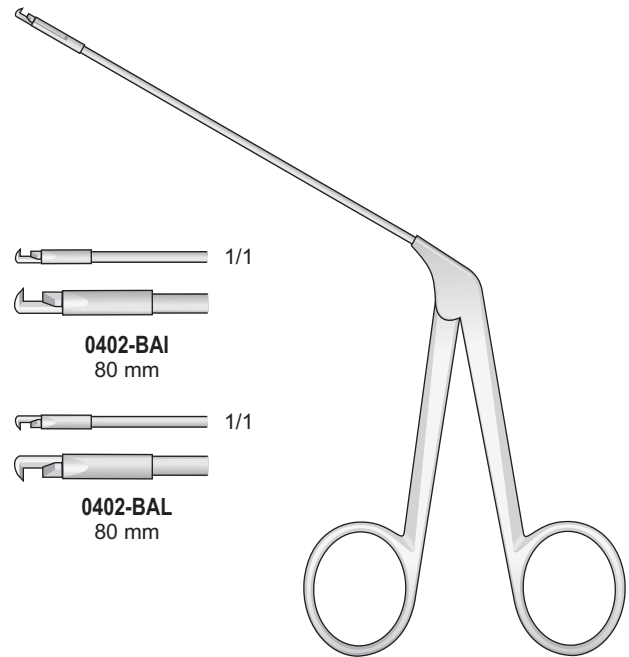

**DIETER**  
**0402-BAI/0402-BAL**  
80 mm

Mikro-Schere

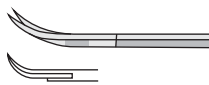

FAHLBUSCH  
**0606-EAB**  
165 mm

FAHLBUSCH  
**0606-EBB**  
230 mm

Scharfe Zange

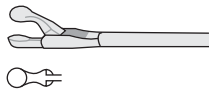

NICOLA  
**0606-EAC**  
165 mm

NICOLA  
**0606-EBC**  
230 mm

Mikro-Schere

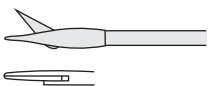

NICOLA  
**0606-EAD**  
165 mm

NICOLA  
**0606-EBD**  
230 mm

Faßzange

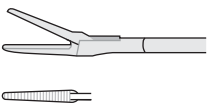

YASARGIL-NICOLA  
**0606-EAE**  
165 mm

YASARGIL-NICOLA  
**0606-EBE**  
230 mm

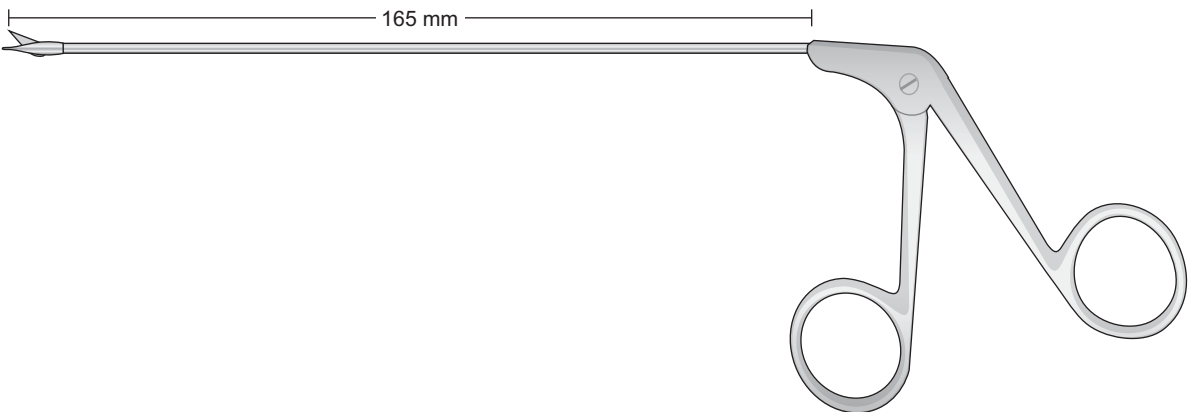

NICOLA  
**0606-EAD**  
165 mm

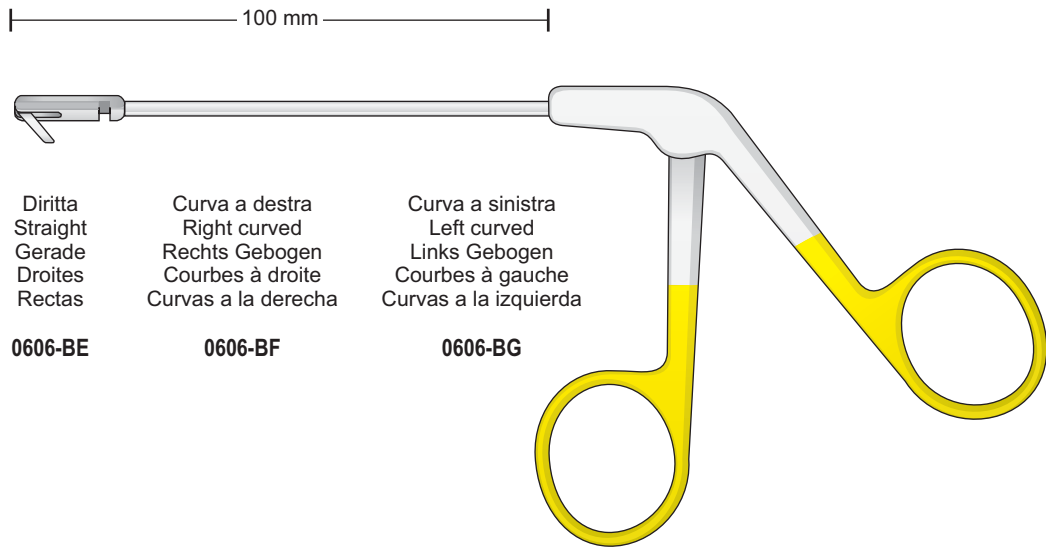

STAMBERGER  
0606-BE/0606-BG

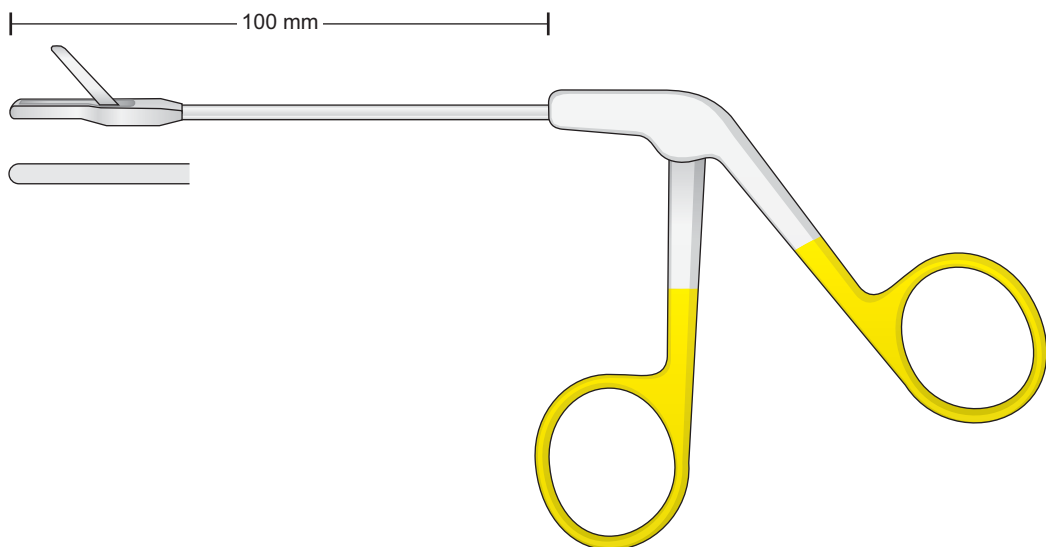

STRUYCKEN  
0606-BH

130 mm

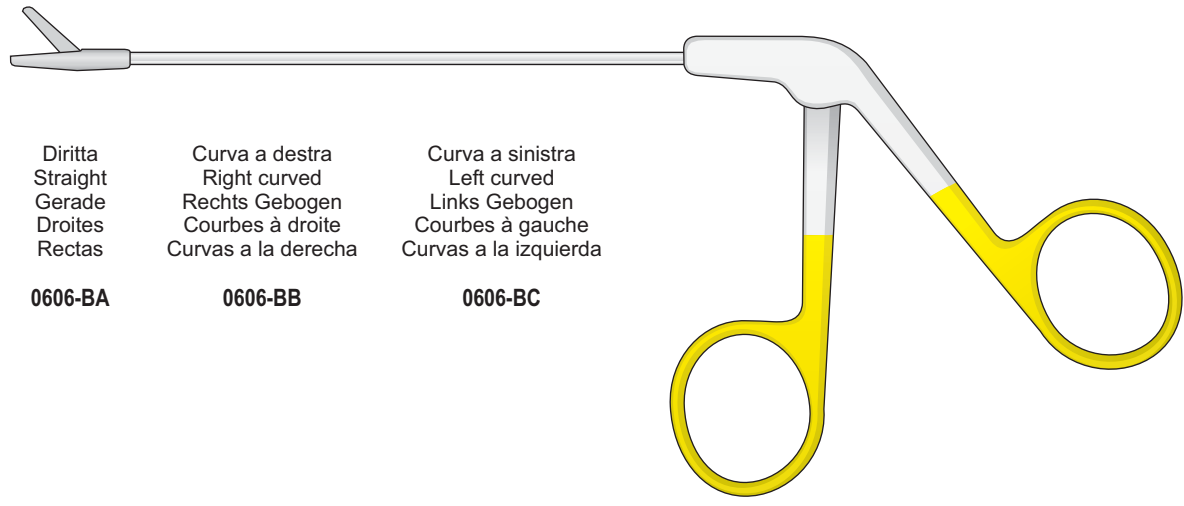

Diritta  
Straight  
Gerade  
Droites  
Rectas

**0606-BA**

Curva a destra  
Right curved  
Rechts Gebogen  
Courbes à droite  
Curvas a la derecha

**0606-BB**

Curva a sinistra  
Left curved  
Links Gebogen  
Courbes à gauche  
Curvas a la izquierda

**0606-BC**

**0606-BA/0606-BC**

140 mm

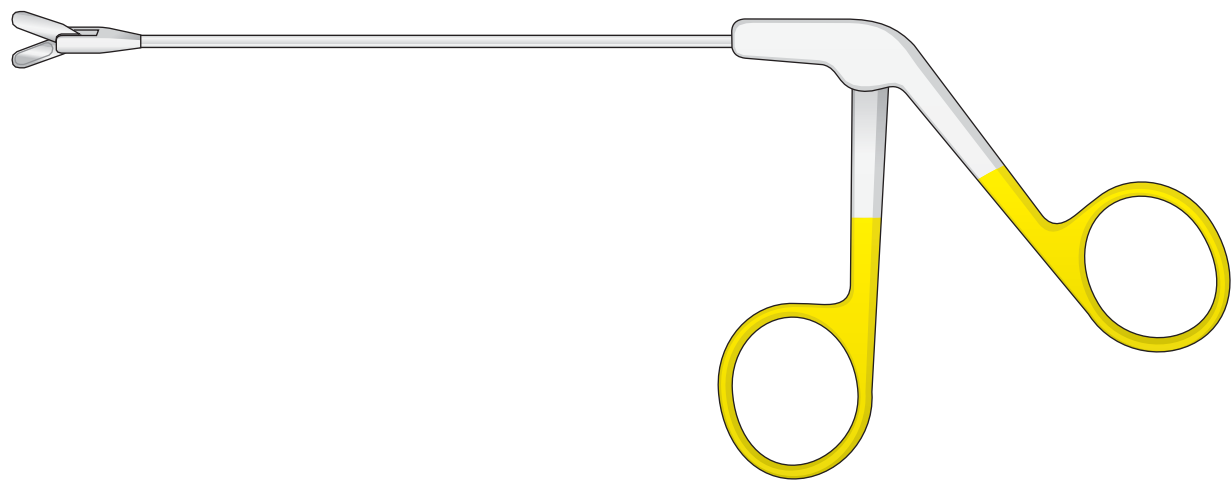

**0606-BD**

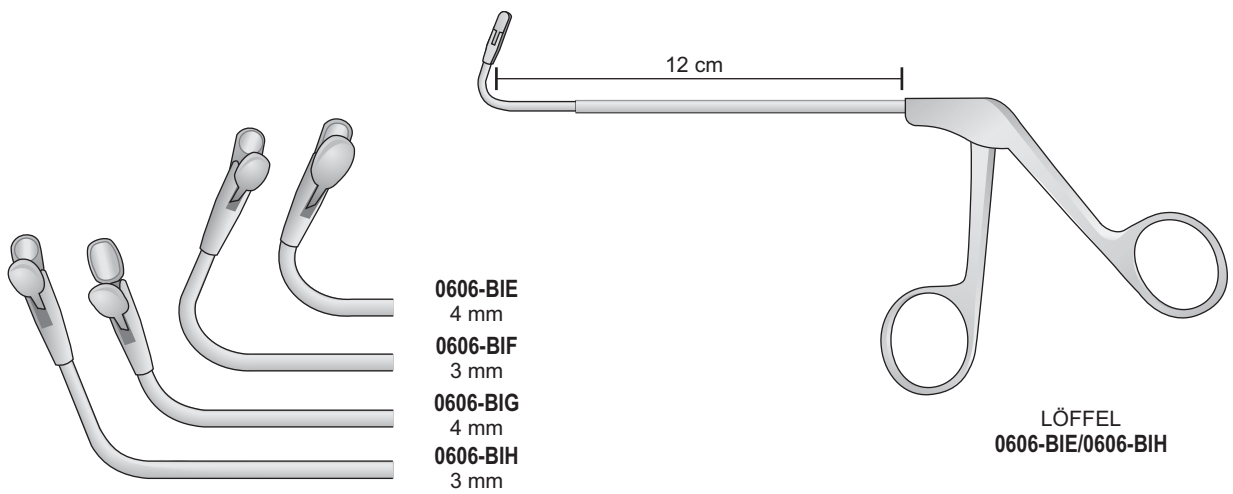
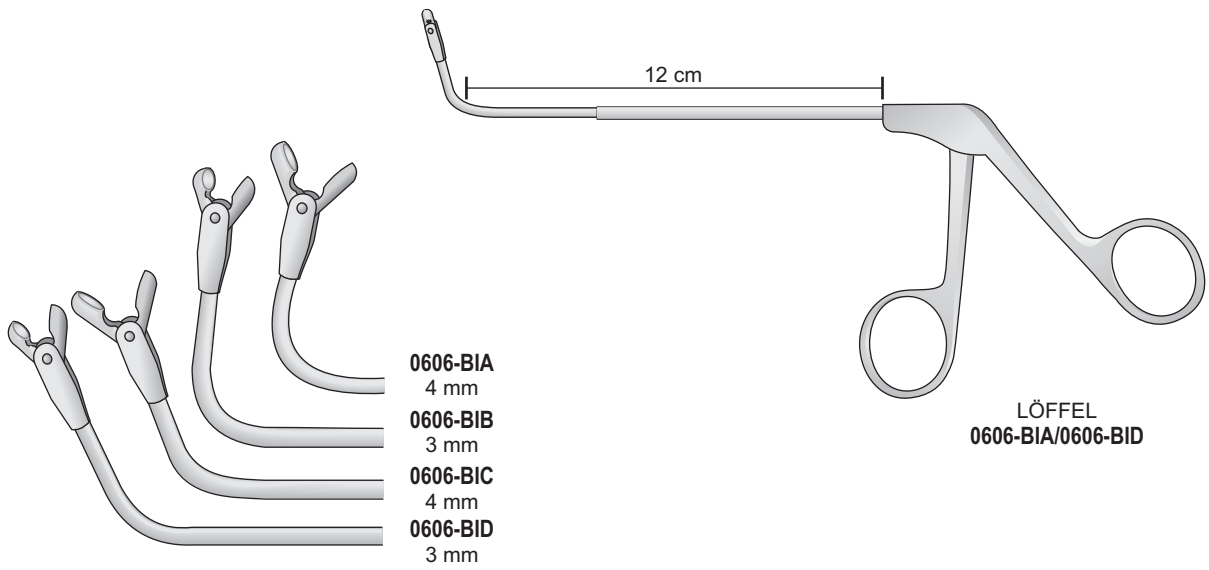



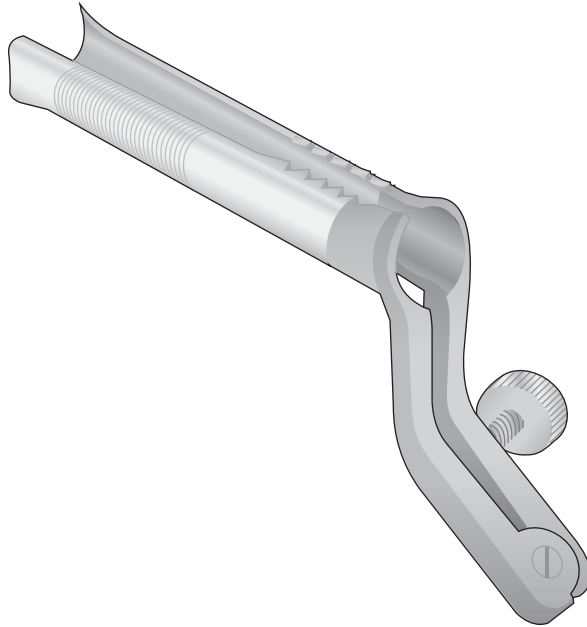

PAPAVERO-CASPAR  
**0606-CBE** 80 x 11 mm  
**0606-CBF** 90 x 13 mm  
**0606-CBG** 100 x 15 mm

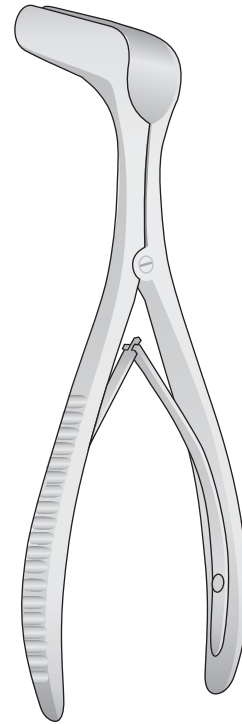

PAPAVERO-HARTMANN  
**1412-DL**  
 140 mm

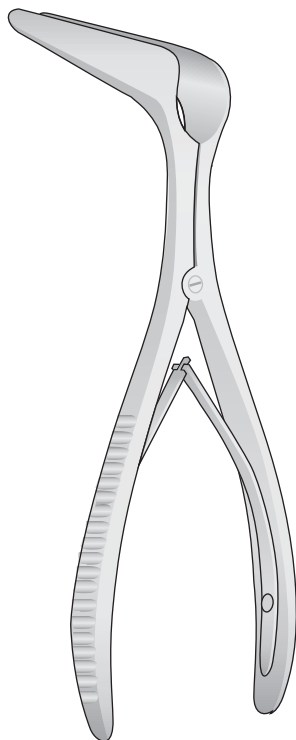

COTTLE  
**1412-CF/1412-CL**  
 150 mm

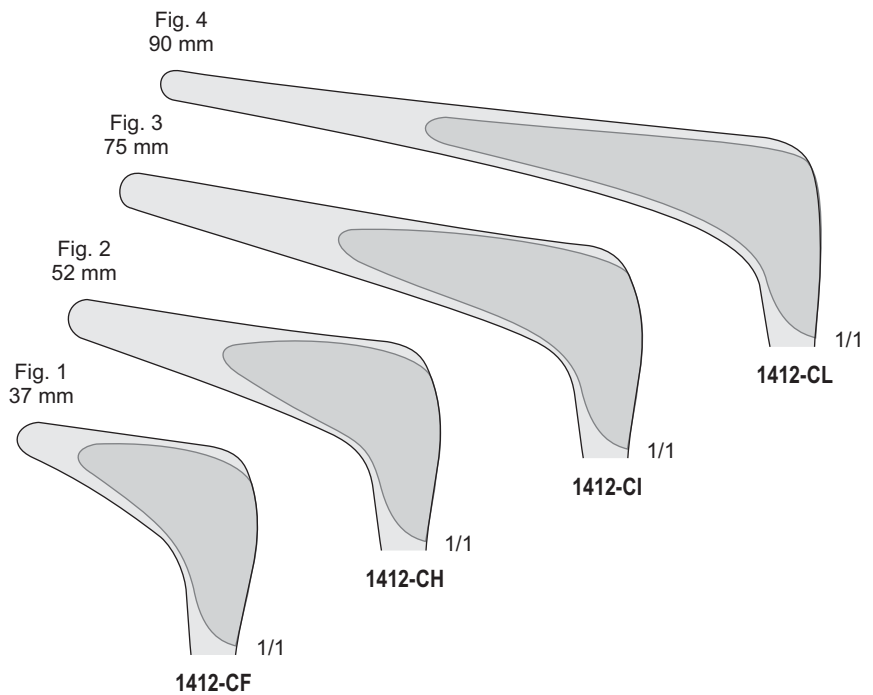

Speculum nasali  
Nasal specula  
Nasen Spekula  
Spéculums nasaux  
Espéculos nasales

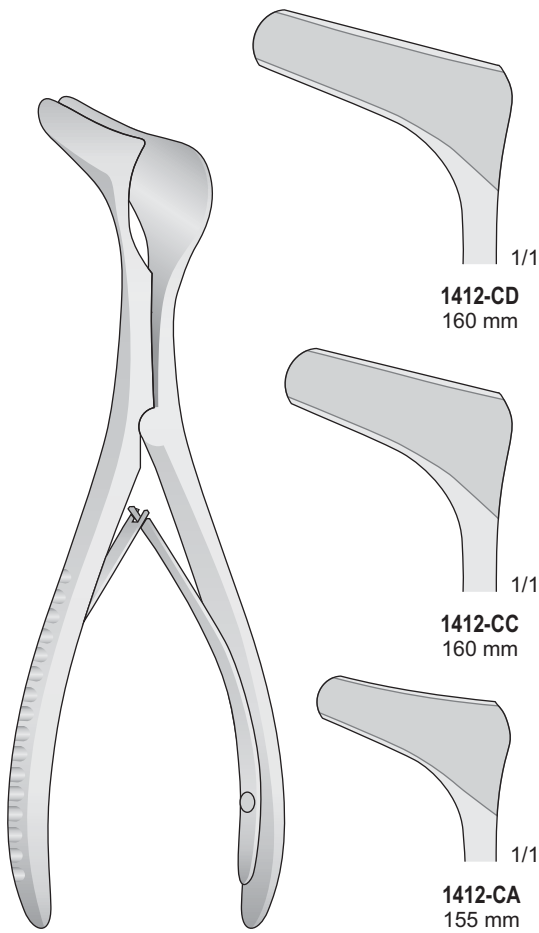

HARTMANN  
1412-CA/1412-CD

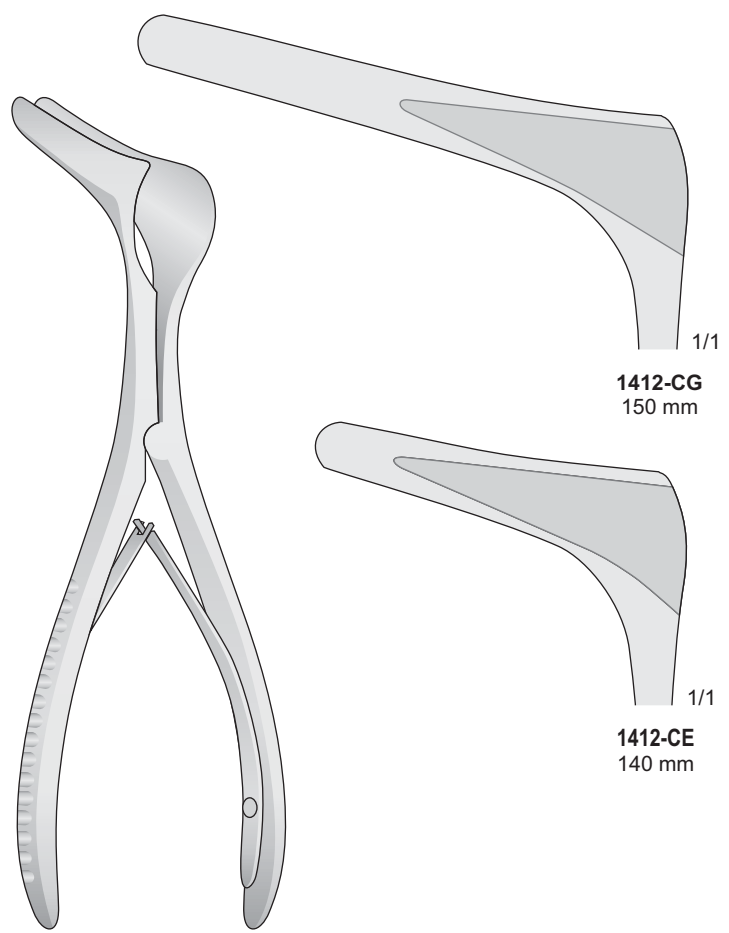

KILLIAN  
1412-CE/1412-CG

Speculum nasali  
 Nasal specula  
 Nasen Spekula  
 Spéculums nasaux  
 Espéculos nasales

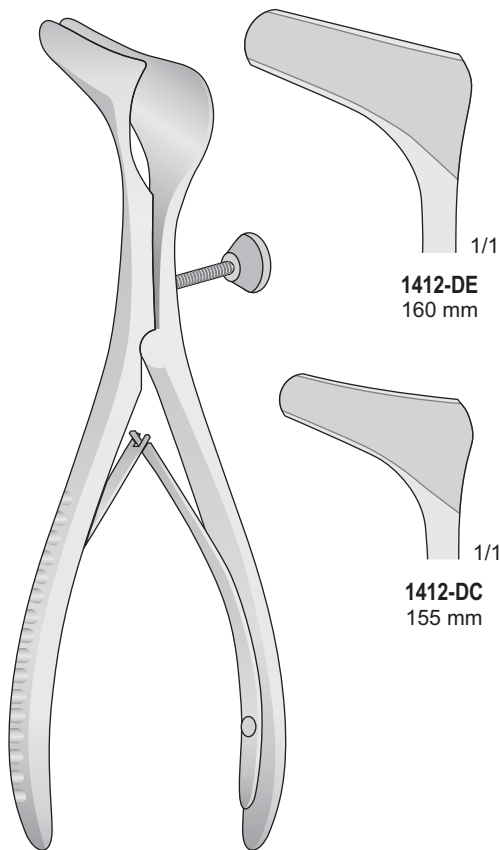

HARTMANN  
 1412-DC/1412-DE

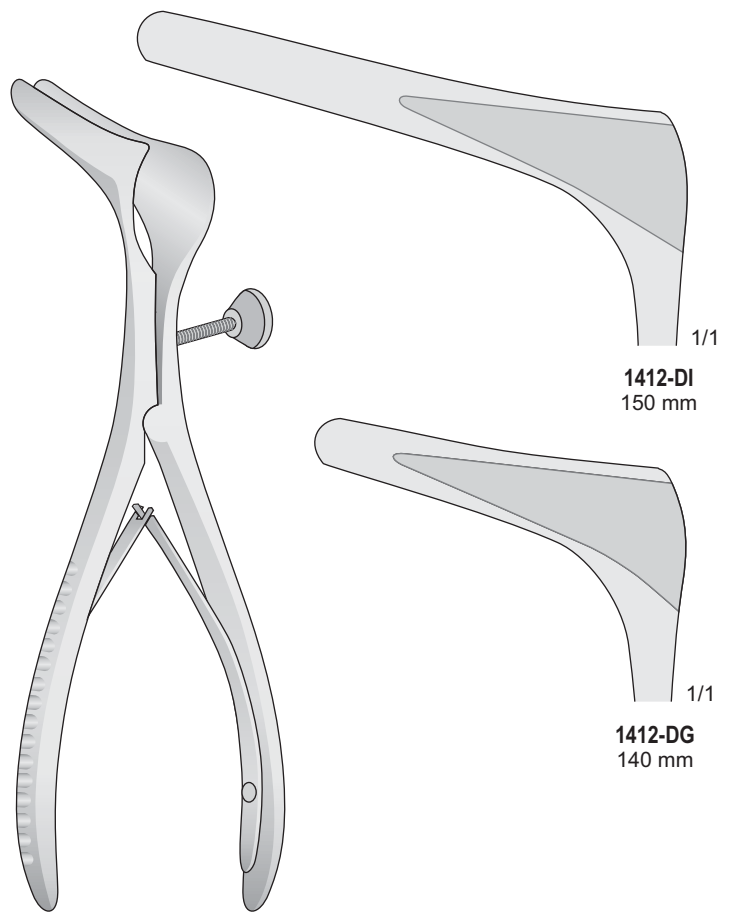

KILLIAN  
 1412-DG/1412-DI

Pinza serranodi  
 Ear polypus snares  
 Polypenschnürer  
 Serre noeuds  
 Polipòtomos

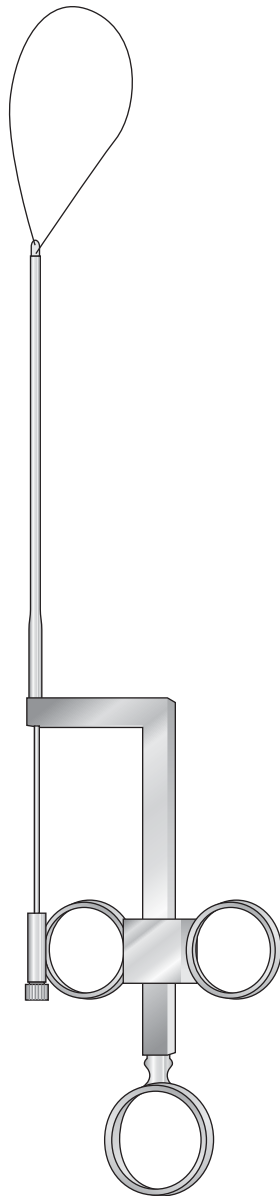

**WILDE**  
**0414-BG**  
 240 mm

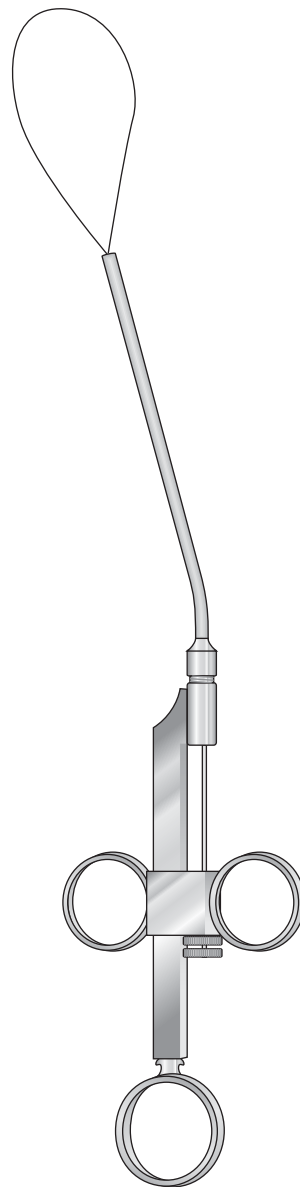

**KRAUSE**  
**0414-BH**  
 260 mm

Rinologia

Rhinology

Rhinologie

Rhinologie

Rinologia

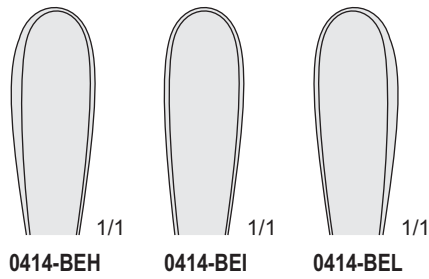
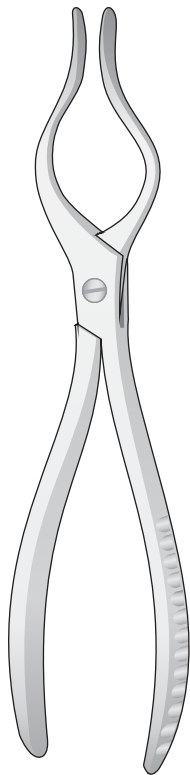

**COTTLE-WALSHAM**  
0414-BEH/0414-BEL  
230 mm

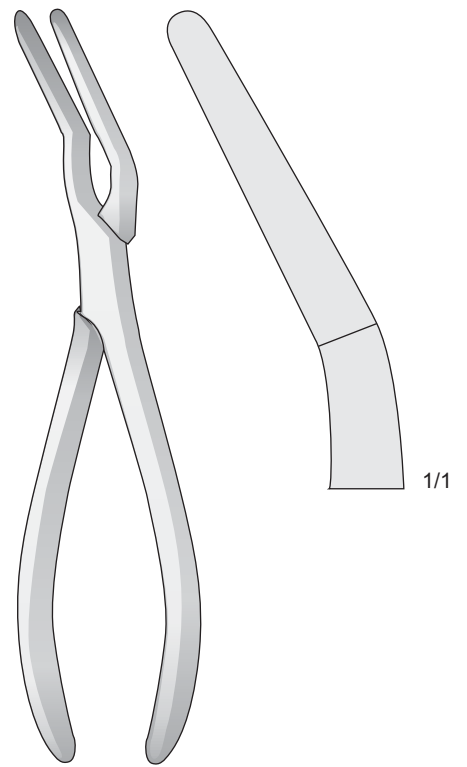

**ASH**  
0414-BFH  
230 mm

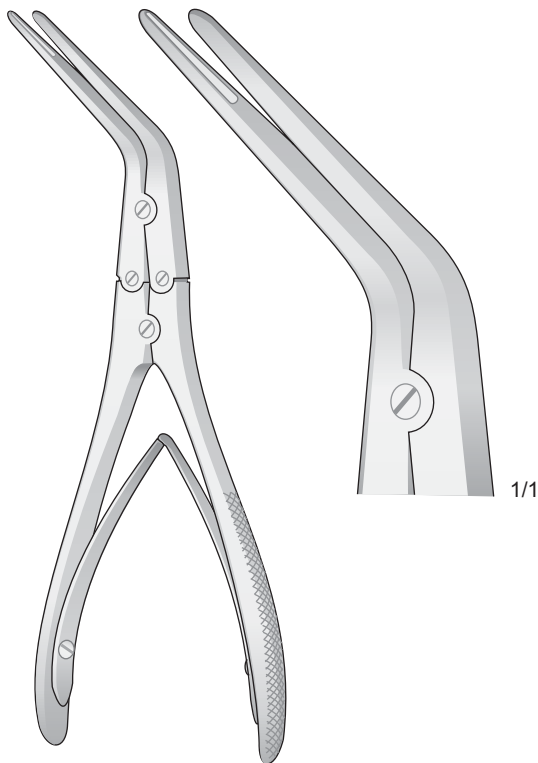

**KRESSNER**  
0614-BEB  
200 mm

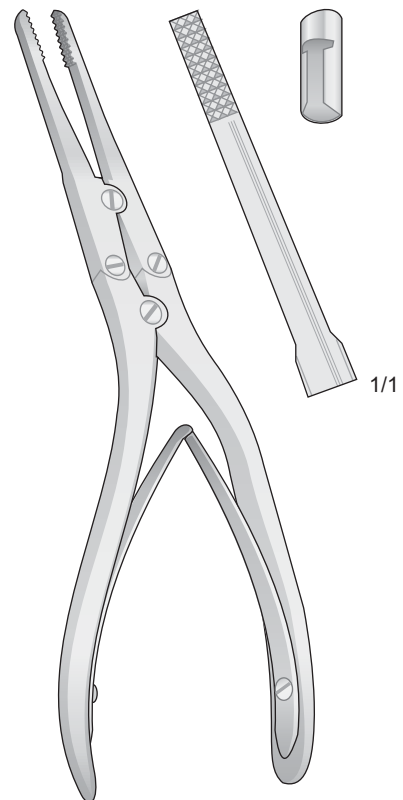

**RUBIN**  
0614-BEC  
210 mm

Strumento per rotture e asportazione frammenti ossei e cartilagine  
 Bone crusher  
 Knochen-Knorpelquetsche  
 Instrument à écraser le cartilage  
 Instrumento para magullar carilagos

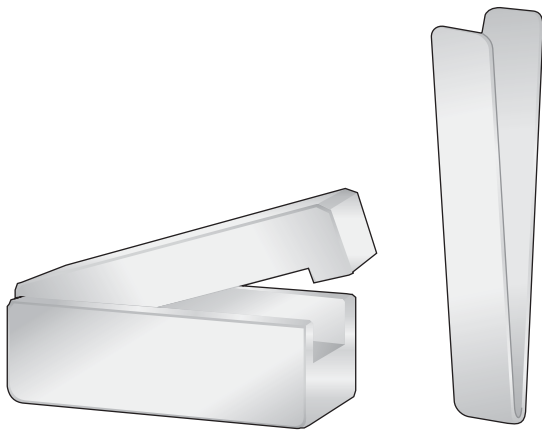

**COTTLE  
0414-CGE**

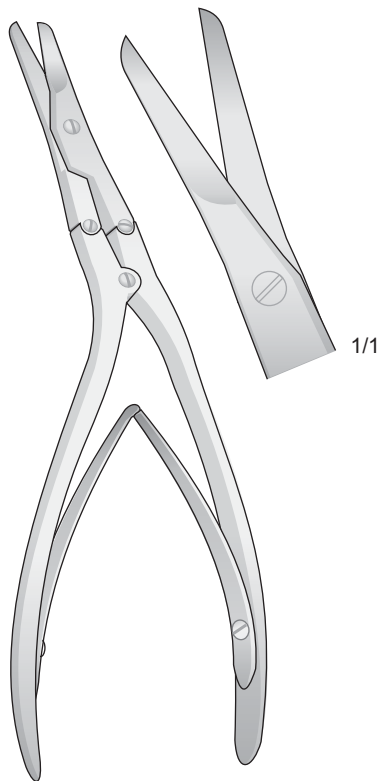

**CAPLAN  
0614-BEE  
200 mm**

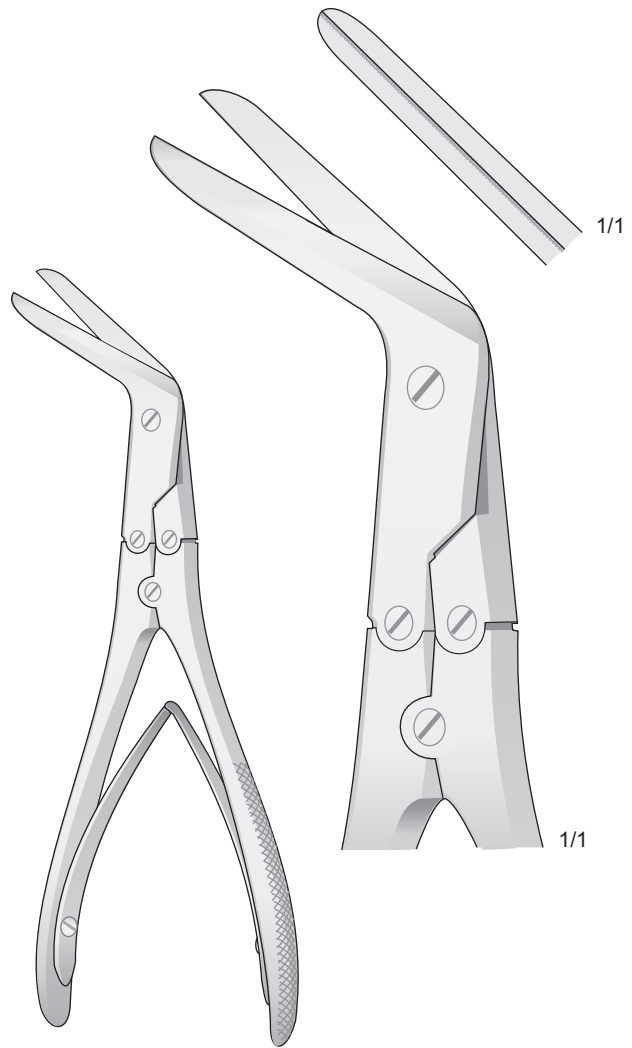

**KILLIAN  
0614-BED  
210 mm**

Rinologia

Rhinology

Rhinologie

Rhinologie

Rinologia

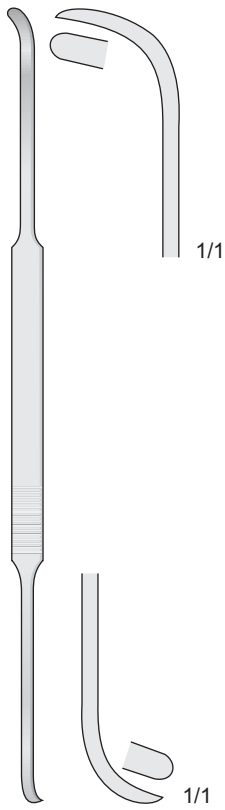

**COTTLE**  
**1014-BC**  
230 mm

Tagliente/Smusso - Sharp/Blunt  
Scharf/Stumpf - Tranchant/Mousse  
Cortante/Romo

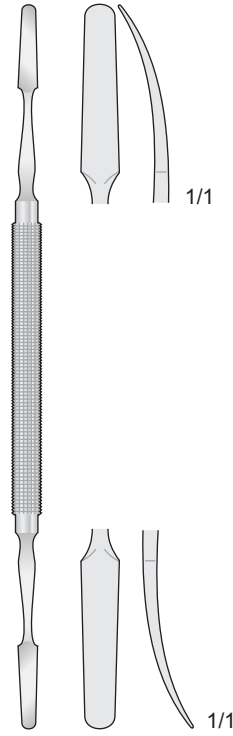

**KILIAN**  
**1014-BB**  
180 mm

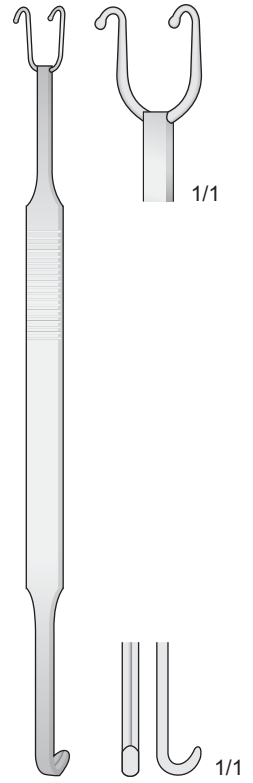

**COTTLE-NEIVERT**  
**0219-FH**  
200 mm

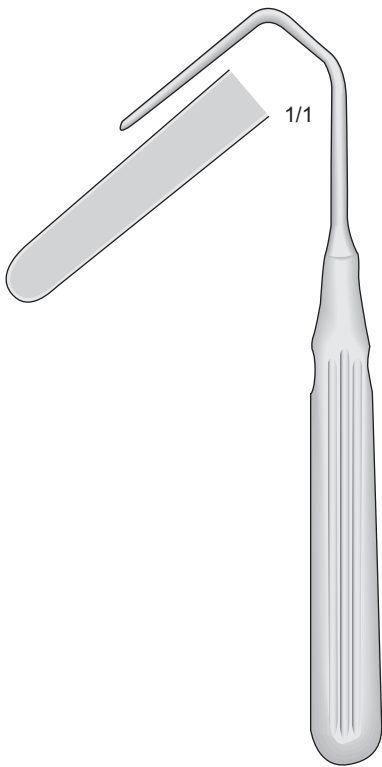

**AUFRICHT**  
**0414-EI**  
175 mm

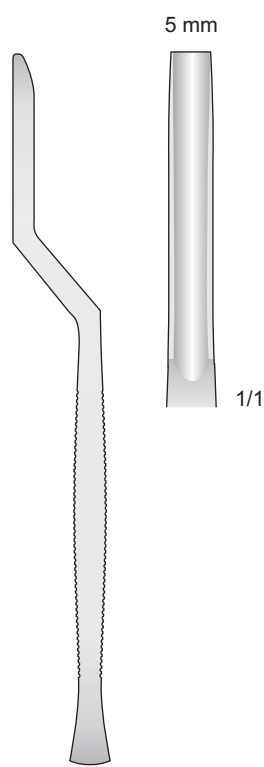

**KILIAN**  
**0414-LB**  
160 mm

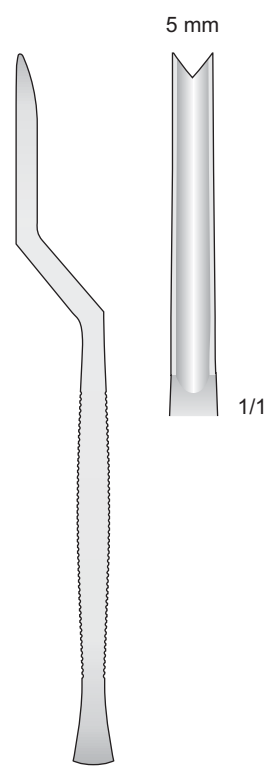

**KILIAN-KLAUS**  
**0414-LC**  
160 mm

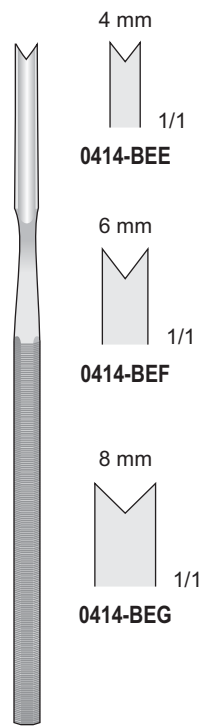

**BALLENGER**  
**0414-BEE/0414-BEG**  
150 mm

Rinologia

Rhinology

Rhinologie

Rhinologie

Rinologia

Diritta  
Straight  
Gerade  
Droites  
Rectas



SILVER  
0414-DE  
180 mm

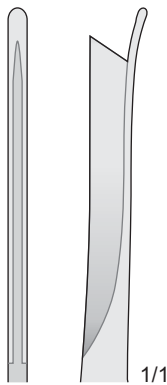

Curva, sinistra  
Curved, left  
Gebogen, links  
Courbes à gauche  
Curvas a la izquierda



SILVER  
0414-DF  
180 mm

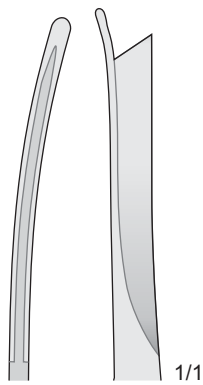

Curva, destra  
Curved, right  
Gebogen, rechts  
Courbes à droite  
Curvas a la derecha



SILVER  
0414-DG  
180 mm

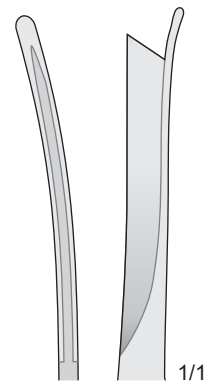



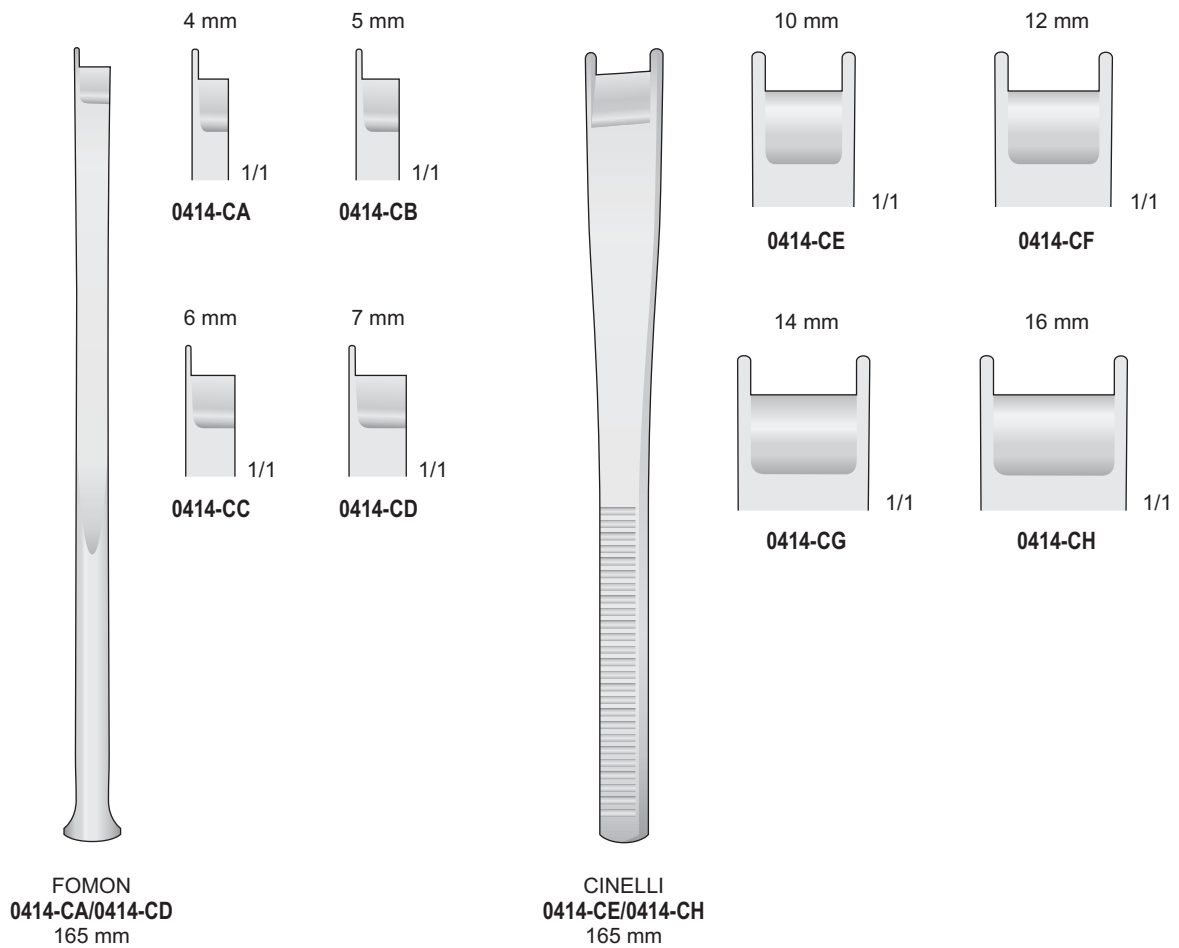

Rinologia

Rhinology

Rhinologie

Rhinologie

Rinologia

Nasal septum  
Osteotomes, graduated

U form

V form

4 mm

6 mm

8 mm

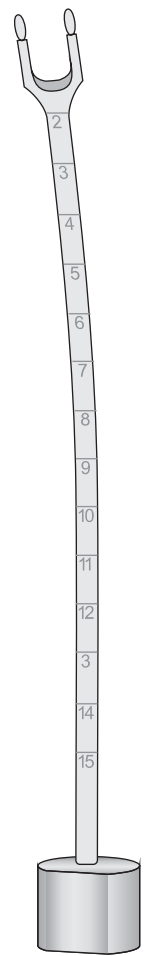
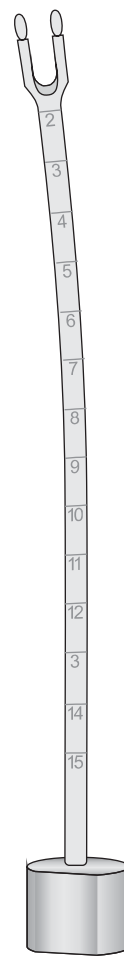
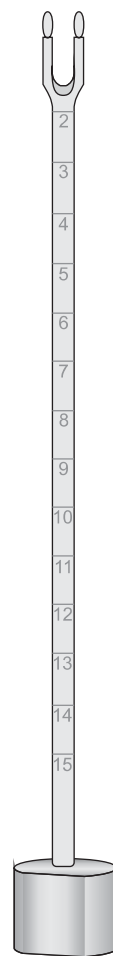
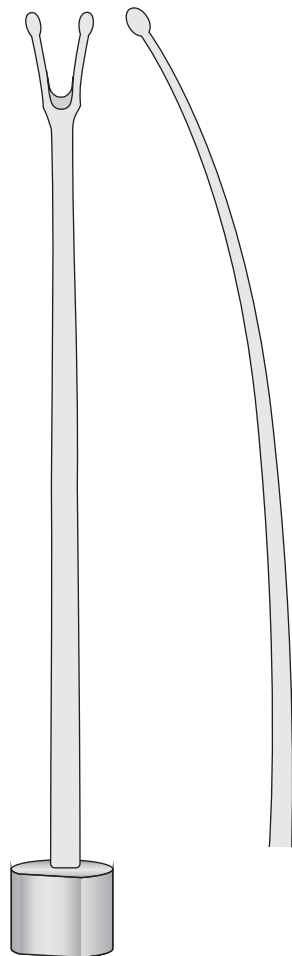
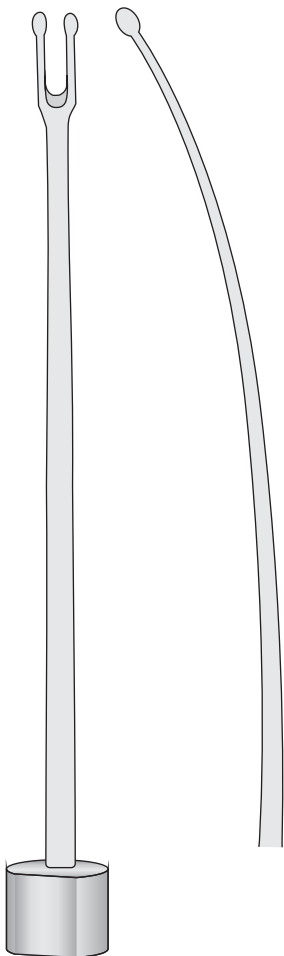

OBWEGESER  
0414-BBA  
185 mm

OBWEGESER  
0414-BBC  
185mm

OBWEGESER  
0414-BCA  
185 mm

OBWEGESER  
0414-BCB  
185 mm

OBWEGESER  
0414-BCC  
185 mm

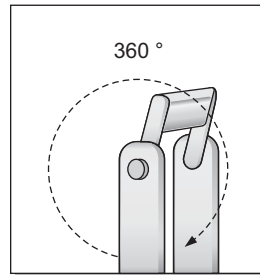

BALLENGER  
0414-FA/0414-FC  
200 mm



0414-FA  
3 mm



0414-FB  
4 mm

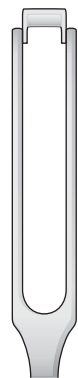

0414-FC  
5 mm

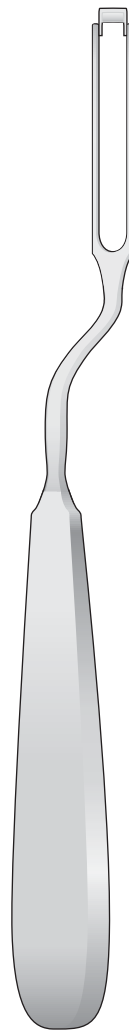

BALLENGER  
0414-FD/0414-FF  
200 mm

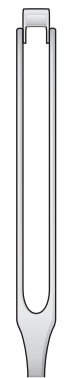

0414-FD  
3 mm



0414-FE  
4 mm



0414-FF  
5 mm

Fig. 67

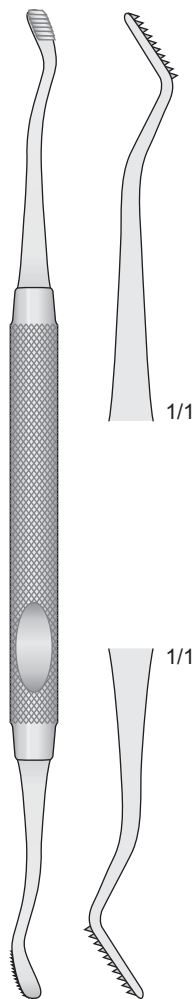

HOWARD  
0414-B  
180 mm

Fig. 45

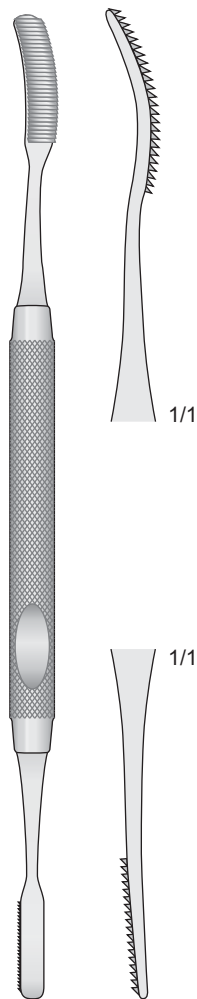

MILLER  
0414-C  
185 mm

Fig. 52

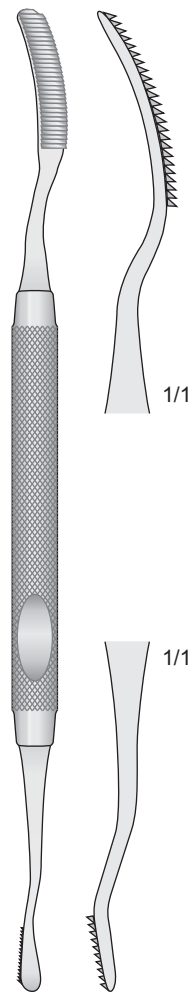

MILLER  
0414-D  
180 mm

Lime per osso

Bone files

Knochenfeilen

Limes à os

Limas para huesos

Lime nasali  
Nasal Files  
Nasenfeilen  
Limes nasales  
Limas nasales

Raspe nasali  
Nasal Rasp  
Nasenraspel  
Râpe nasales  
Raspador nasal

8 mm



8 mm

**0610-LG**  
210 mm

2 mm



5 mm

**0610-LH**  
210 mm



1/1



1/1

8 mm



8 mm

**0610-LI**  
210 mm

8 mm



8 mm

**0610-LL**  
210 mm

Lime per osso

Bone files

Knochenfeilen

Limes à os

Limas para huesos

Lima nasale  
Nasal File  
Nasenfeilen  
Lime nasales  
Lima nasales

Raspa nasale  
Nasal Rasp  
Nasenraspel  
Râpe nasale  
Raspador nasal

Bisturi per mucosa  
Mucous knife  
Mukosamesser  
Septotome  
Cuchillo para mucosa

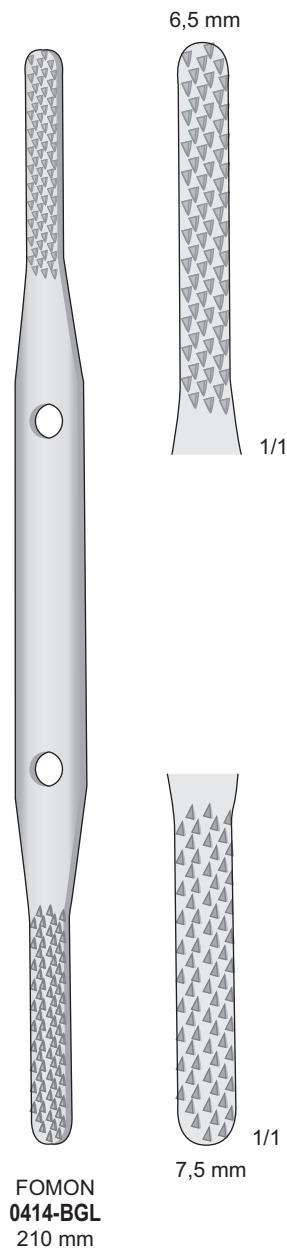
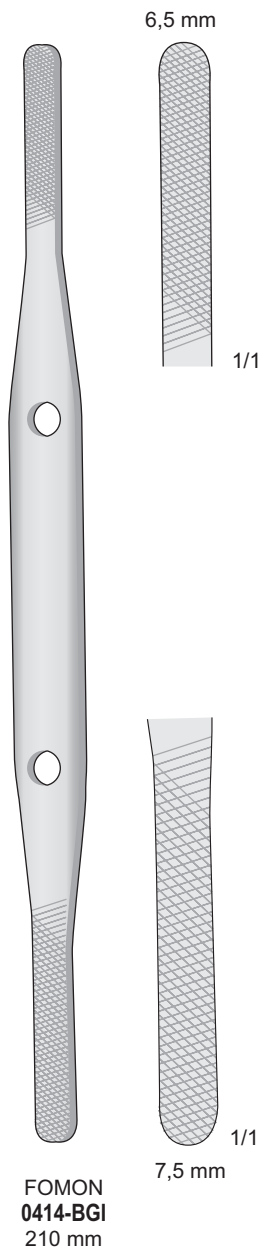

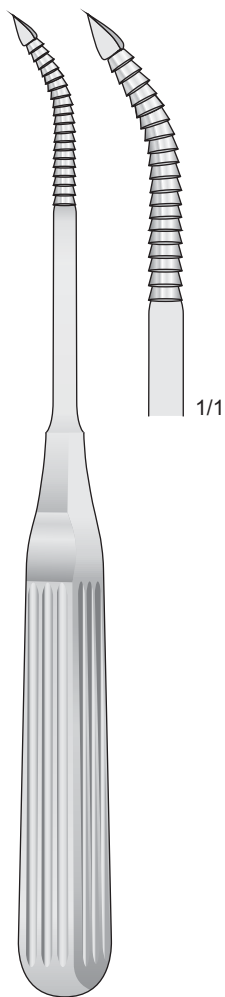

LEWIS  
0414-HH  
180 mm

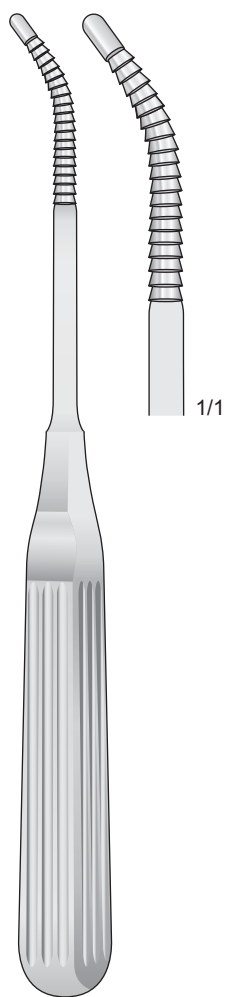

LEWIS  
0414-HI  
180 mm



JOSEPH  
0414-HC/0414-BAL  
190 mm

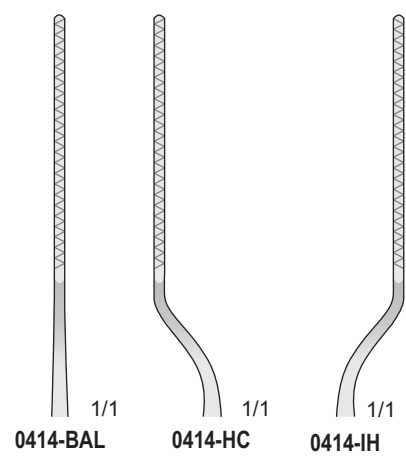

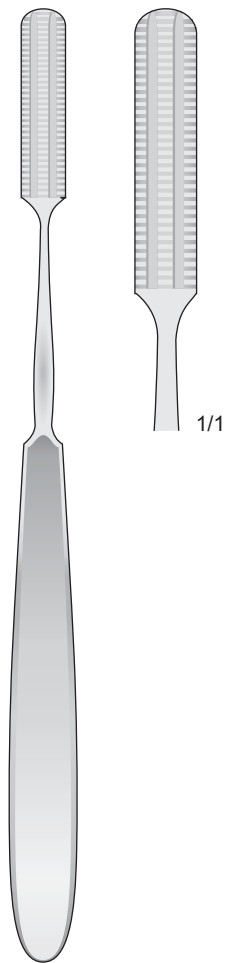

MALTZ  
0414-BHL  
180 mm

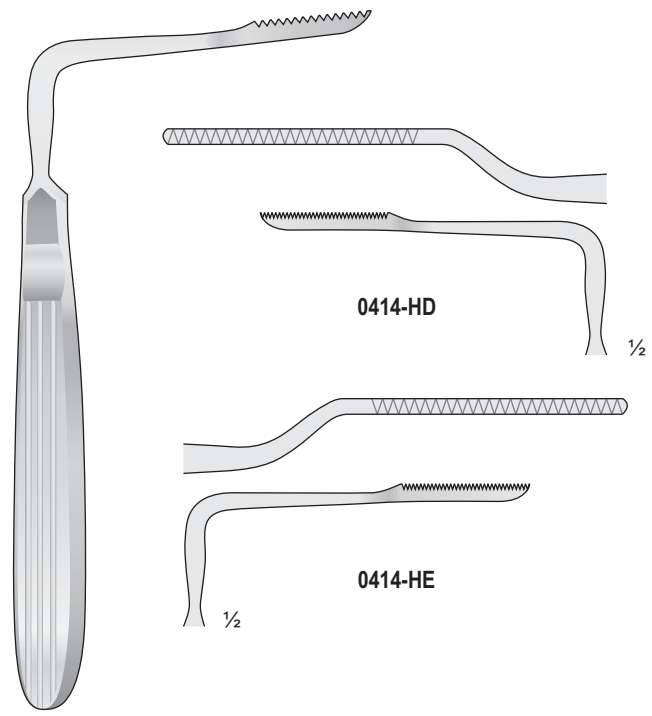

JOSEPH  
0414-HD/0414-HE  
135 mm



Uncino per arco zigomato  
Zigoma hook  
Haken-Jochbogenahle

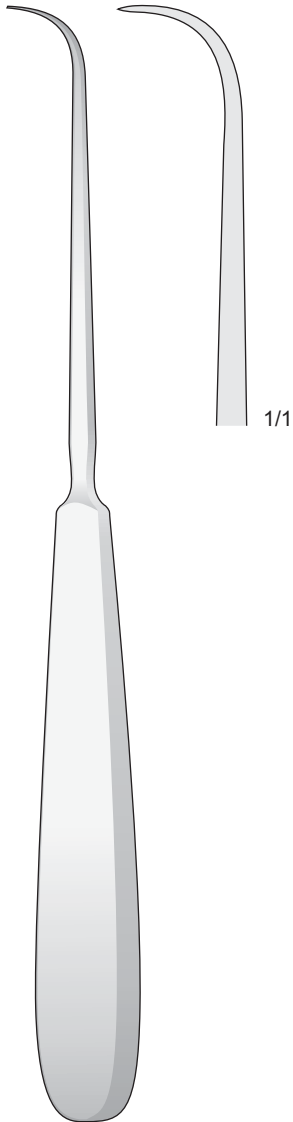

**0414-CHE**  
200 mm

Curette taglienti  
Scharfe Küretten  
Curettes Tranchantes

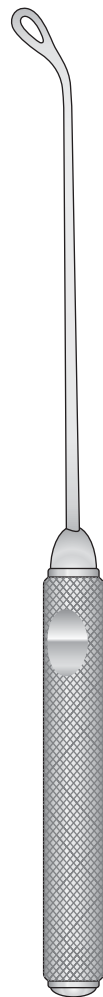

COAKLEY  
**0414-CIF/0414-CLA**  
170 mm

Fig. 1



1/1  
**0414-CIF**

Fig. 2



1/1  
**0414-CIG**

Fig. 3



1/1  
**0414-CIH**

Fig. 4



1/1  
**0414-II**

Fig. 5



1/1  
**0414-IL**

Fig. 6



1/1  
**0414-CLA**

Adenotomi - Adenotomie - Adenoidectomy  
Adénoïdes - Adenoides

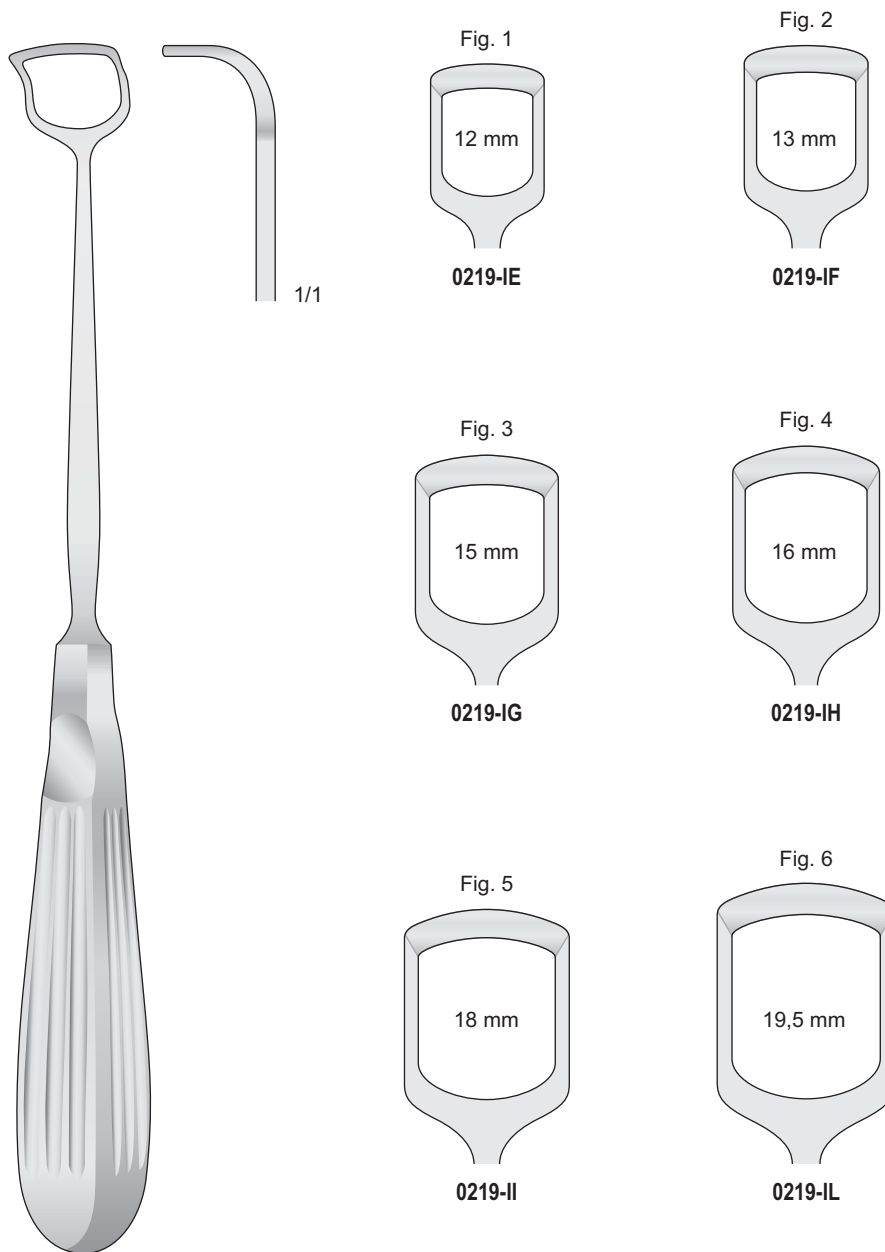

BECKMANN  
0219-IE/0219-IL  
220 mm

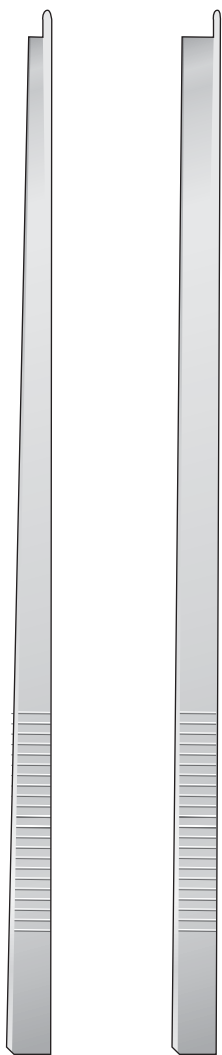

**0414-BBI**  
200 mm

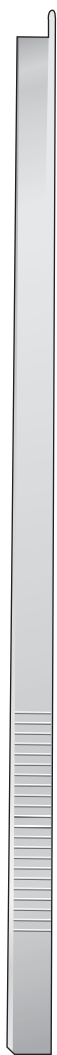

**0414-BBL**  
200 mm

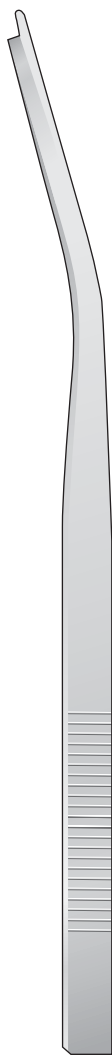

**0414-IE**  
200 mm



**0414-IF**  
200 mm

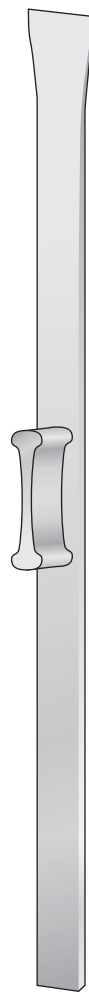

**RUBIN**  
**0414-BHA/0414-BHC**  
180 mm

Osteotomi, Osteotomes  
Osteotome, Ostéotomes, Osteótomos



**0414-BHA**  
10 mm



**0414-BHB**  
12 mm



**0414-BHC**  
14 mm

Osteotomi

Osteotomes

Osteotome

Ostéotomes

Osteòtoms

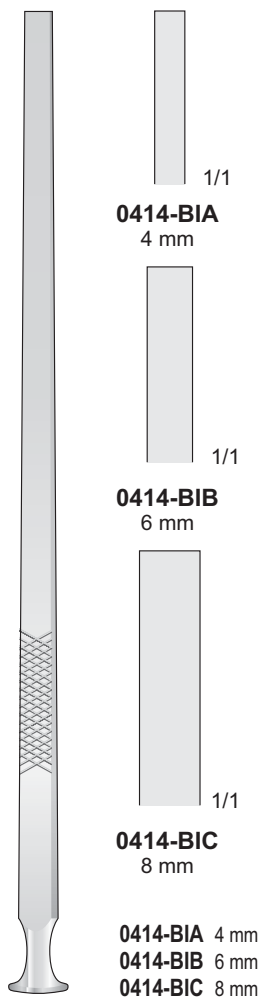

EPKER  
0414-BIA/0414-BIC  
180 mm

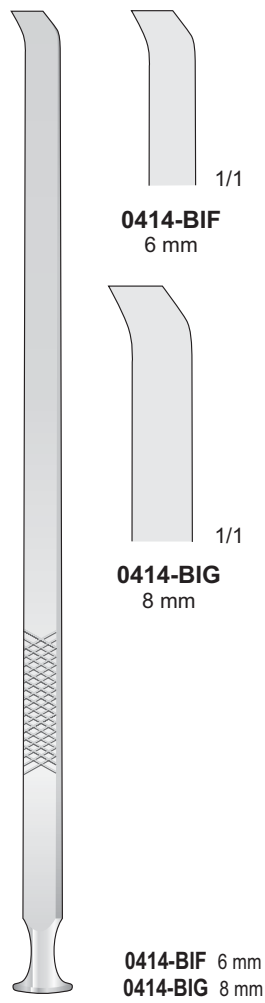

EPKER  
0414-BIF/0414-BIG  
180 mm

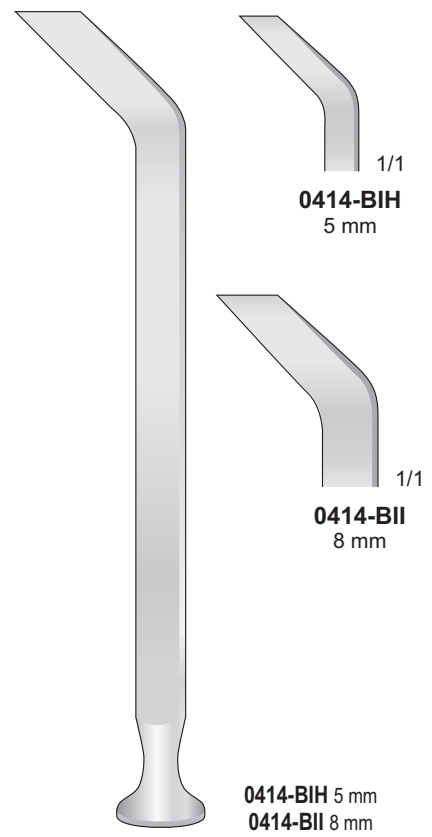

SPLIT  
0414-BIH/0414-BII  
150 mm

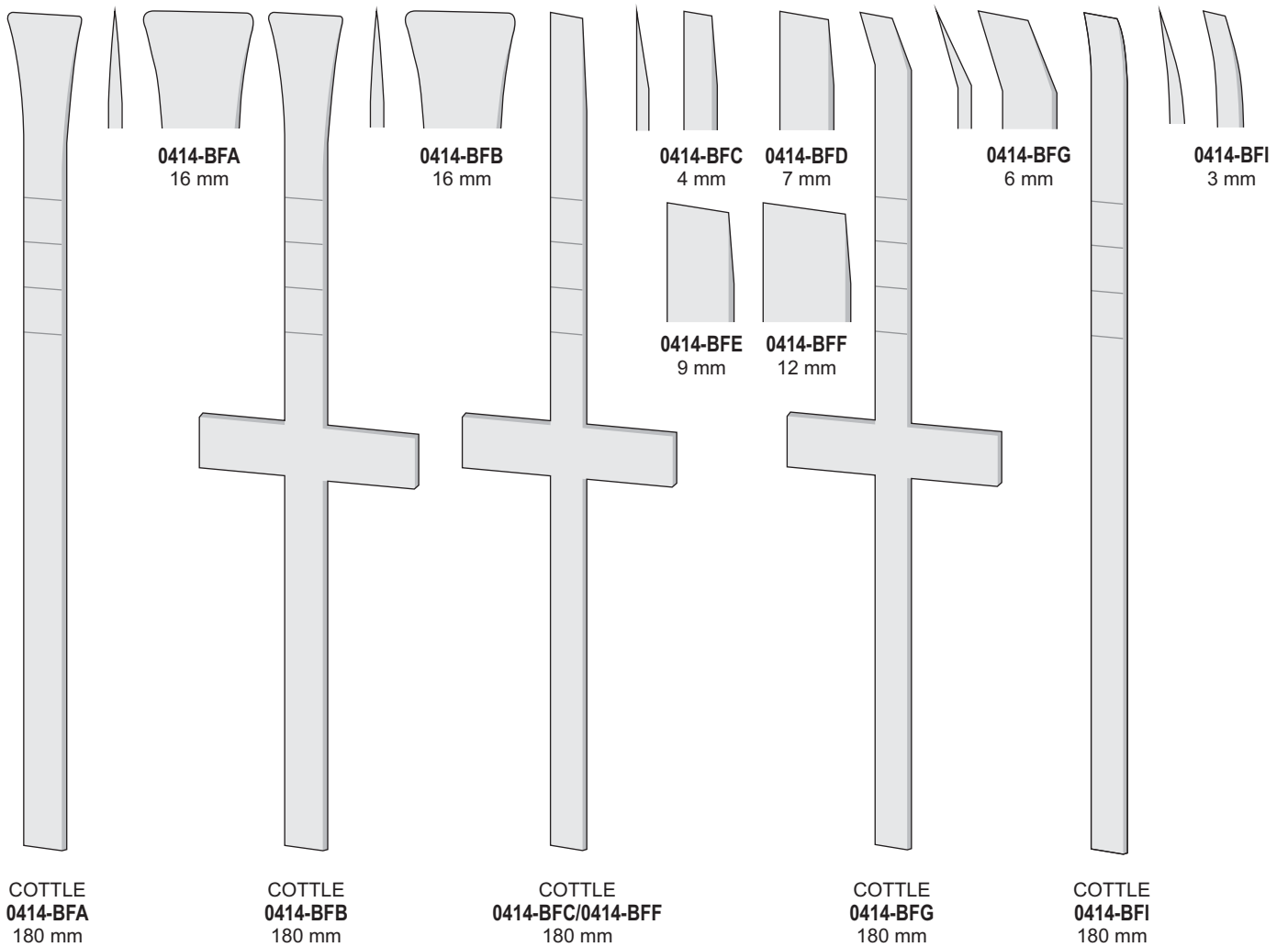

Osteotomi

Osteotomes

Osteotome

Ostéotomes

Osteòtomas

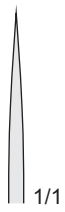

**0414-BGB**  
3 mm

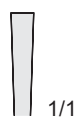

**0414-BGC**  
4 mm

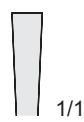

**0414-BGD**  
7 mm

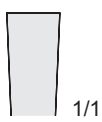

**0414-BGE**  
9 mm

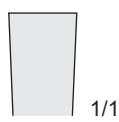

**0414-BGF**  
12 mm

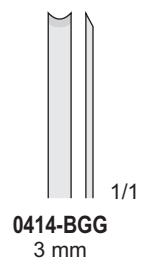
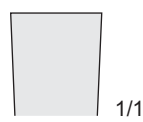

**0414-BGG**  
3 mm

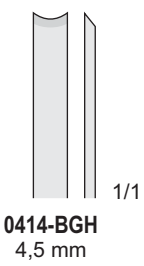

**0414-BGH**  
4,5 mm

**0414-BGB/0414-BGF**  
190 mm

**0414-BGG/0414-BGH**  
190 mm

Osteotomi

Osteotomes

Osteotome

Ostéotomes

Osteòtomos

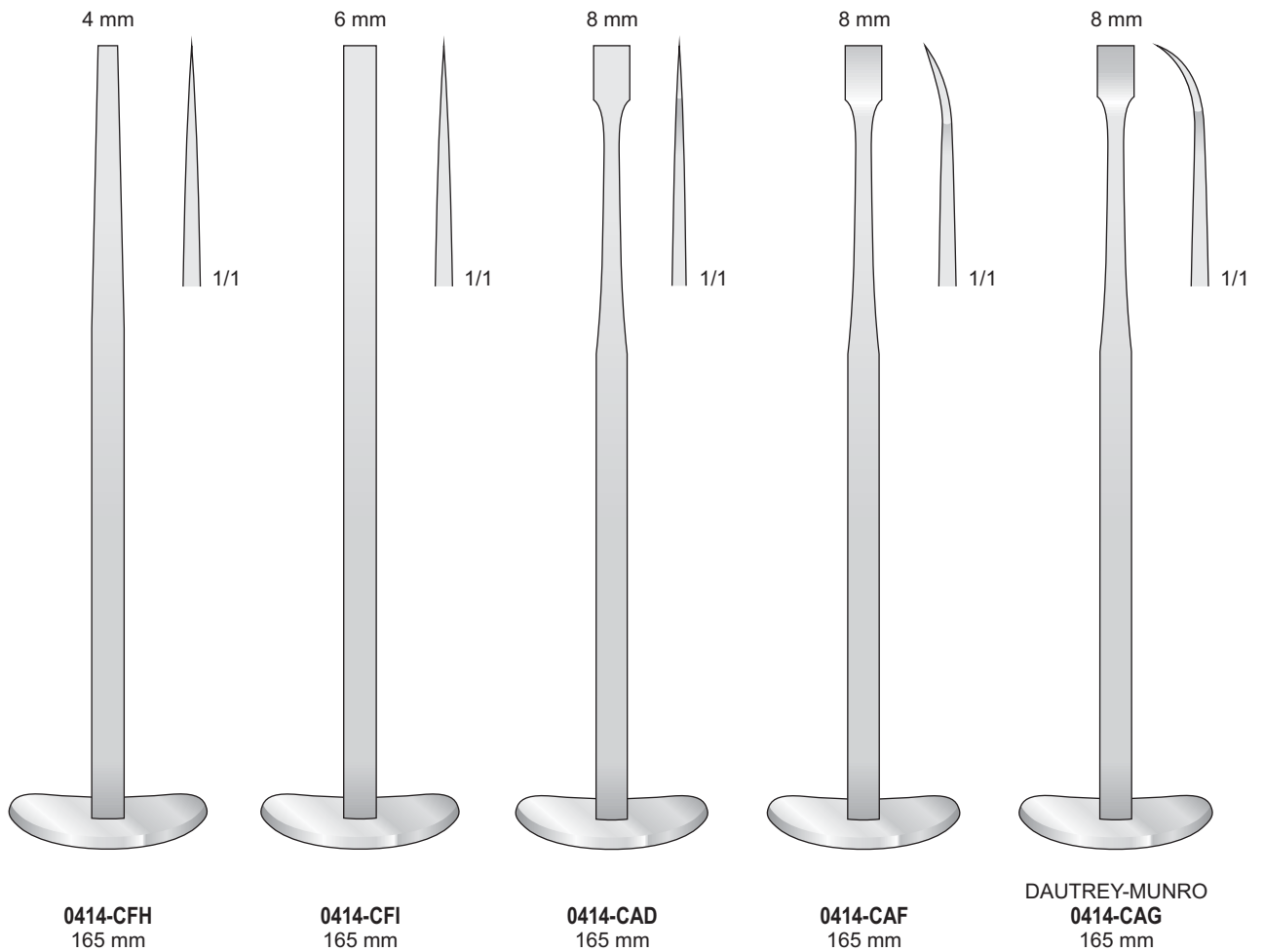

Osteotomi

Osteotomes

Osteotome

Ostéotomes

Osteòtoms

Osteotomi graduati - Osteotomes graduated - Osteotome graduiert  
 Ostéotomes graduée - Osteòtoms graduada

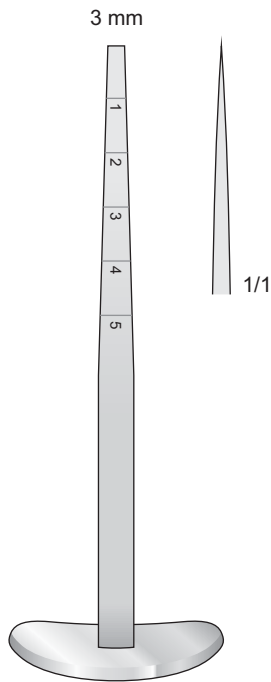

**0414-CFA**  
115 mm

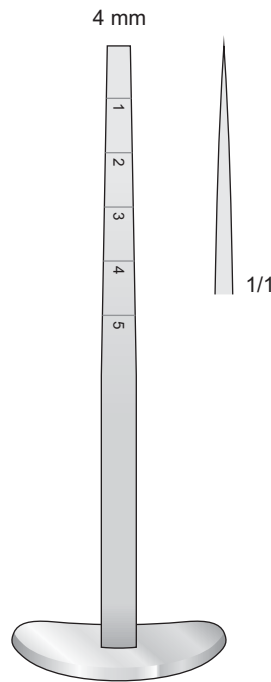

**0414-CFB**  
115 mm

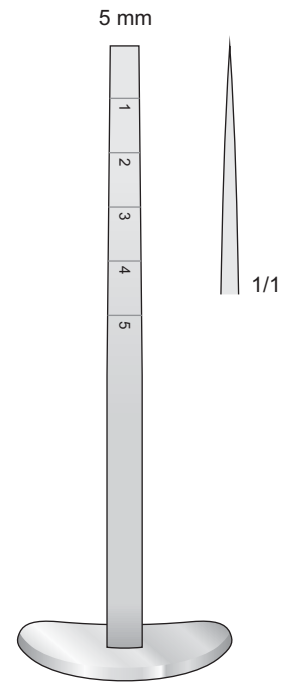

**0414-CFC**  
115 mm

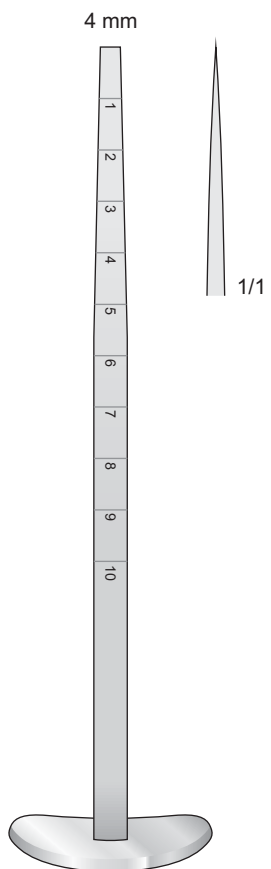

**0414-CGA**  
160 mm

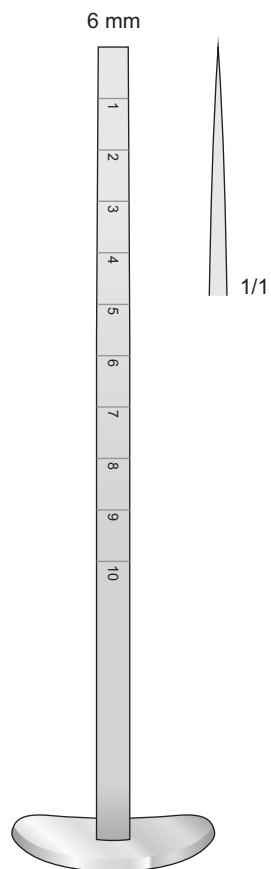

**0414-CGB**  
160 mm

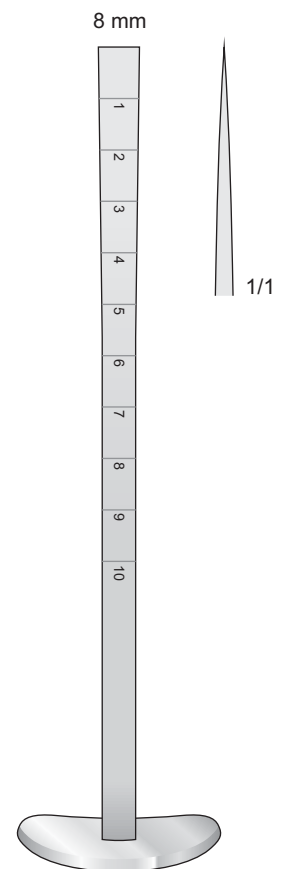

**0414-CGC**  
160 mm



Osteotomi

Osteotomes

Osteotome

Ostéotomes

Osteòtomos

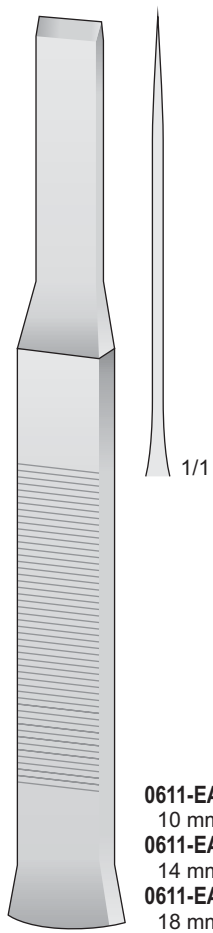

**0611-EAB**  
10 mm  
**0611-EAC**  
14 mm  
**0611-EAD**  
18 mm

TESSIER  
**0611-EAB/0611-EAD**  
160 mm

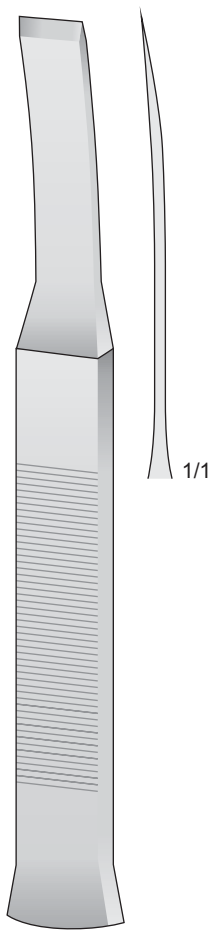

TESSIER  
**0611-EAE** 10 mm  
160 mm

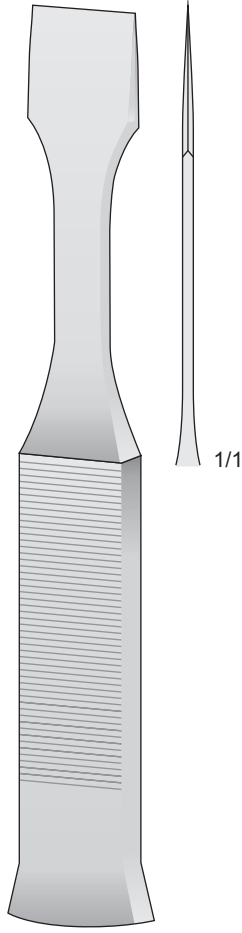

TESSIER  
**0611-EAF** 18 mm  
160 mm

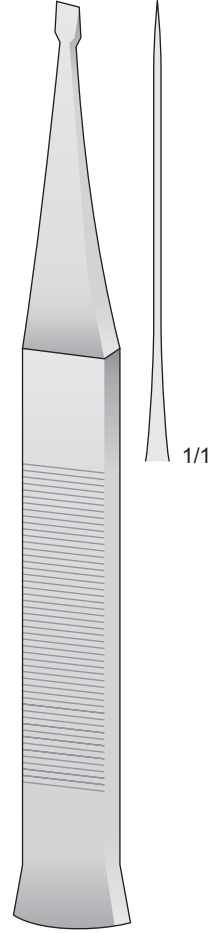

TESSIER  
**0611-EBA** 3,5 mm  
160 mm

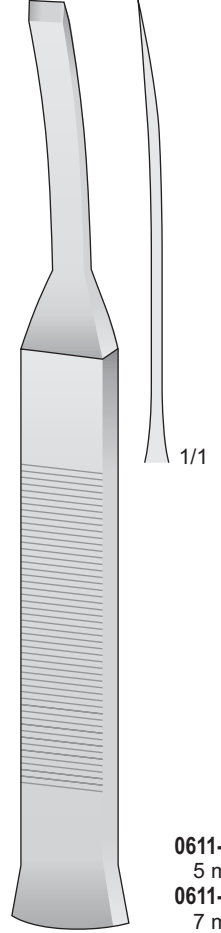

**0611-EBB**  
5 mm  
**0611-EBC**  
7 mm

TESSIER  
**0611-EBB/0611-EBC**  
160 mm

Osteotomi

Osteotomes

Osteotome

Ostéotomes

Osteòtoms

Manico in ferrozell  
 With Ferrozell Handle  
 Mit Ferrozell-Griff  
 Avec poignée en Ferrozell  
 Con mango de Ferrozell

Osteotomi nasali  
 Nasal Osteotomes  
 Nasen Osteotome  
 Ostéotomes nasaux  
 Osteotomos nasales

Pterygomaxillary osteotome

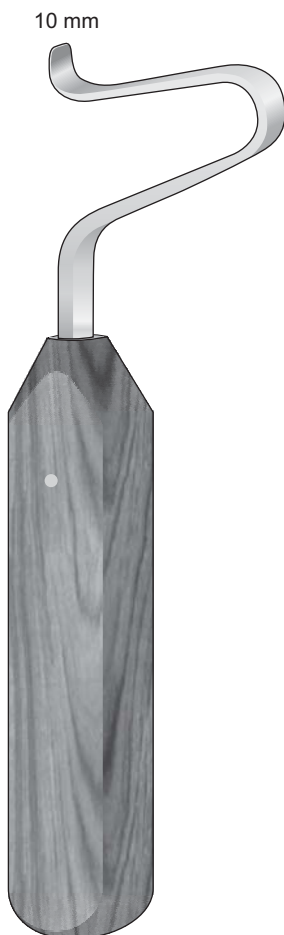

**0611-DCA**  
170 mm



**0611-DCC**  
190 mm

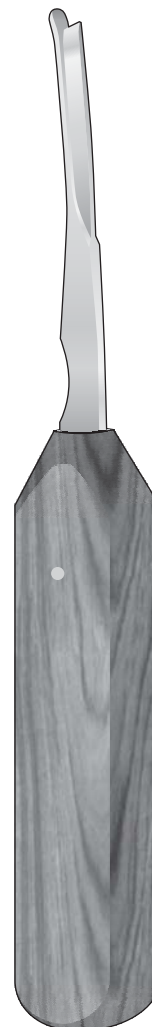

**0611-DCD** destro - Right R  
**0611-DCE** sinistro - Left L  
 205 mm

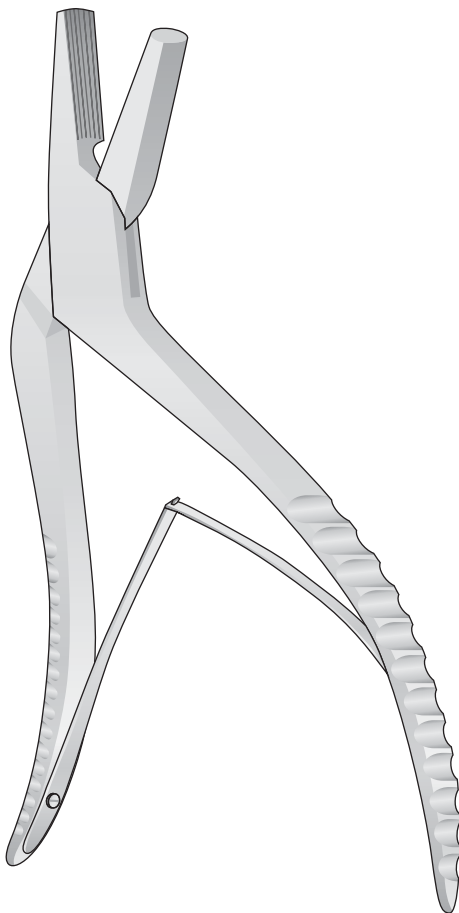

TESSIER  
0614-BDG  
195 mm

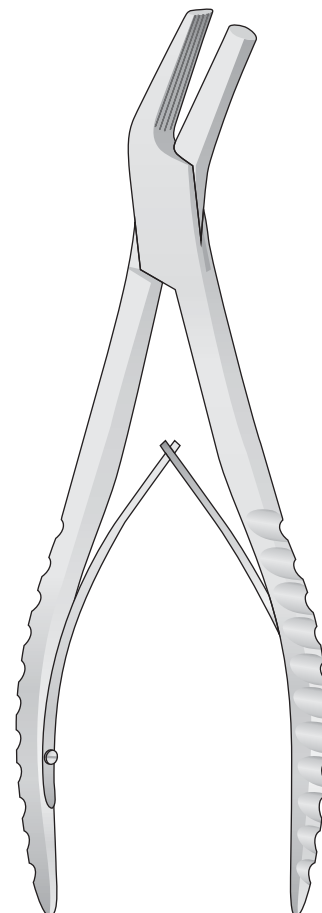

TESSIER  
0614-BDH  
220 mm

Macinino per osso - GABON  
 Micro bone mill - GABON  
 Mikro-Knochenmühle - GABON

**0701-LF** - Manico ad innesto cm. 19,5  
 Flexible handle  
 Abnehmbarer Griff

**0701-LG** - Vaschetta porta-osso con presa  
 Knochenbehälter  
 Container for bone

**0701-LH** - Tassello spingi-osso superiore  
 Plug CHIPS  
 Oberer Knochen-drücker

**0701-LI** - Grattugia per CHIPS fine #1  
 Reibe für CHIPS, fein #1  
 Cutting cylinder for CHIPS fine #1

**0701-LL** - Grattugia per CHIPS grossi #2  
 Reibe für CHIPS, gross #2  
 Cutting cylinder for CHIPS big #2

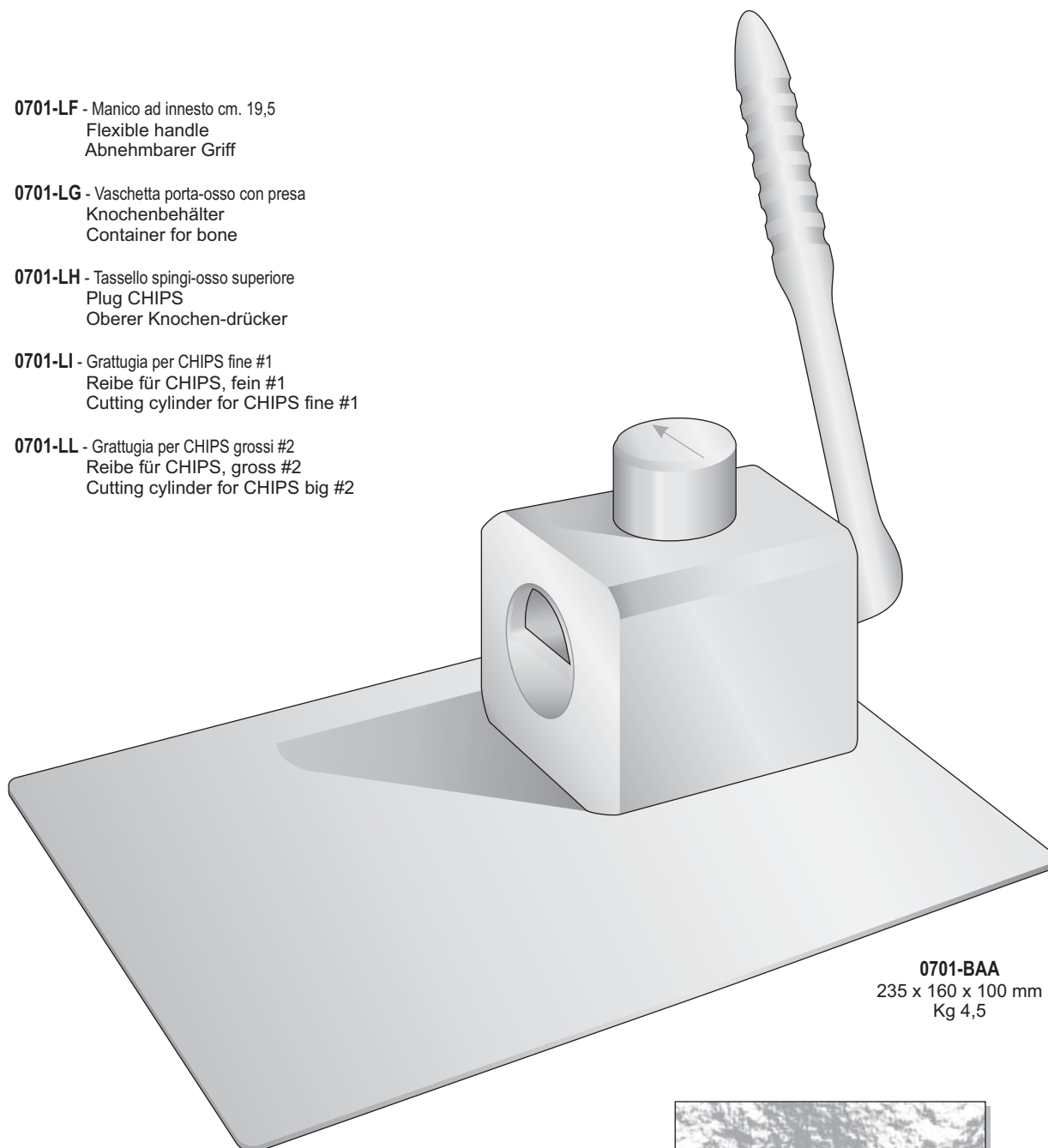

**0701-BAA**  
 235 x 160 x 100 mm  
 Kg 4,5

**0701-BAA**  
 Comprende una sola grattugia - **0701-LL**  
 With only one cutting cylinder - **0701-LL**  
 Mit nur eine Reibe - **0701-LL**

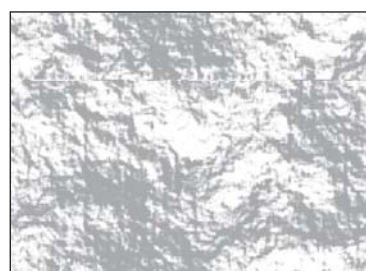

Chips macinato  
 Bone Chips



ideal-tek

manufacturer & supplier of precision instruments 

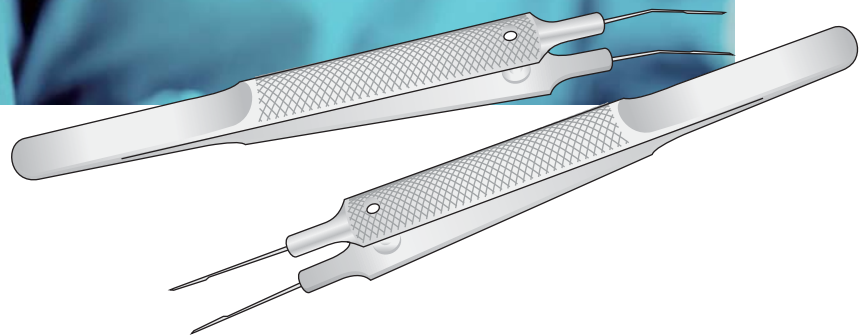

15

Oftalmologia  
Ophthalmology  
Ophthalmologie  
Ophtalmologie  
Oftalmologia



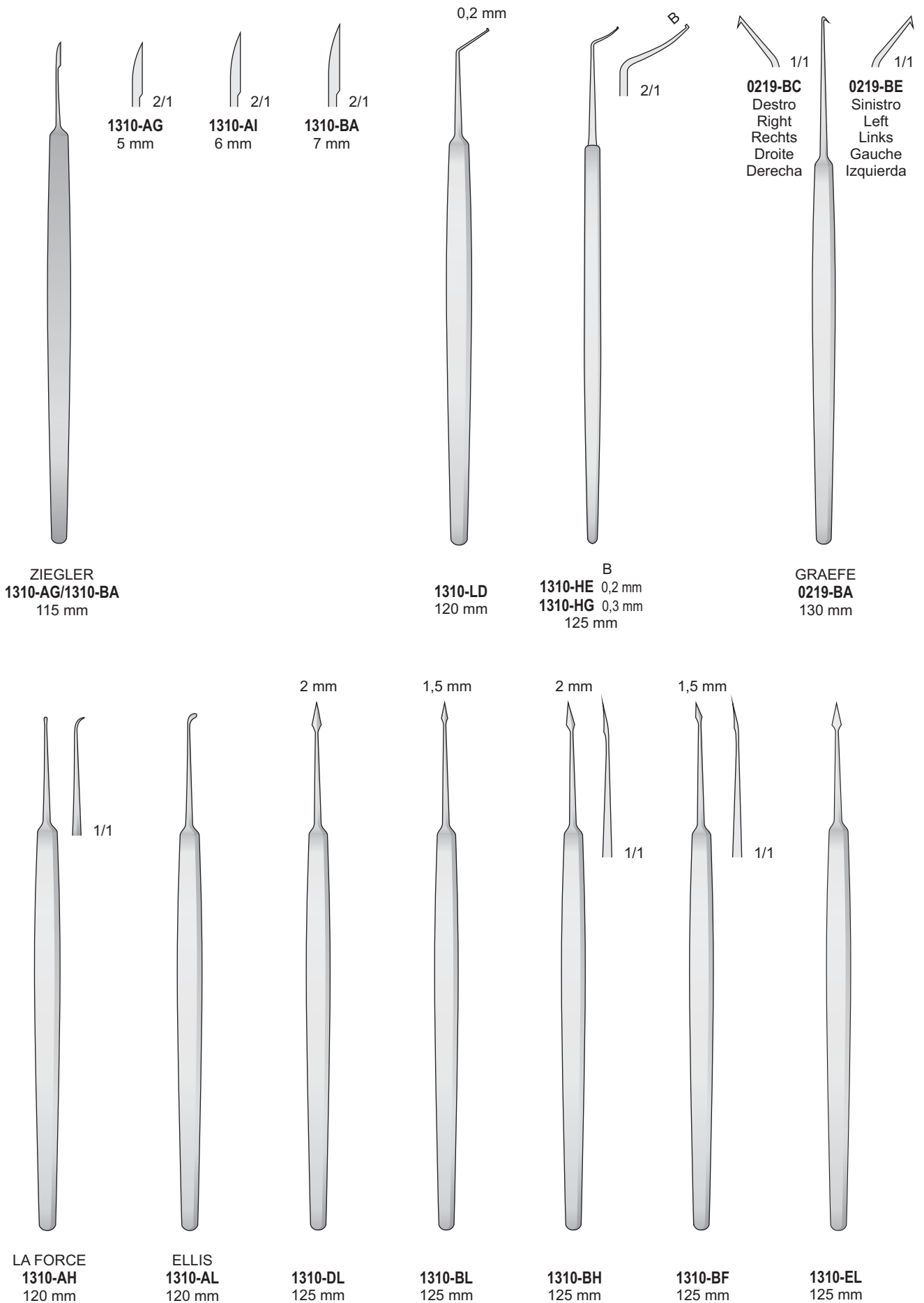

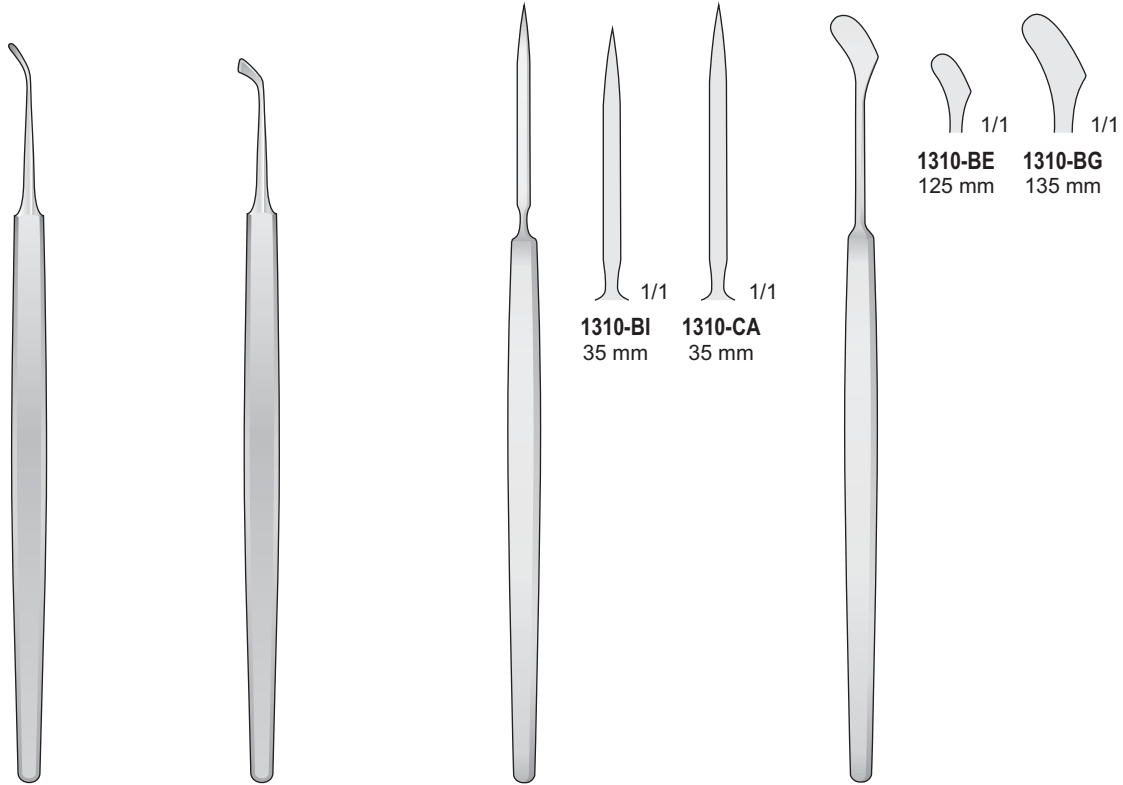

GRAEFE  
1310-BI/1310-CA  
140 mm

GRAEFE  
1310-BE/1310-BG

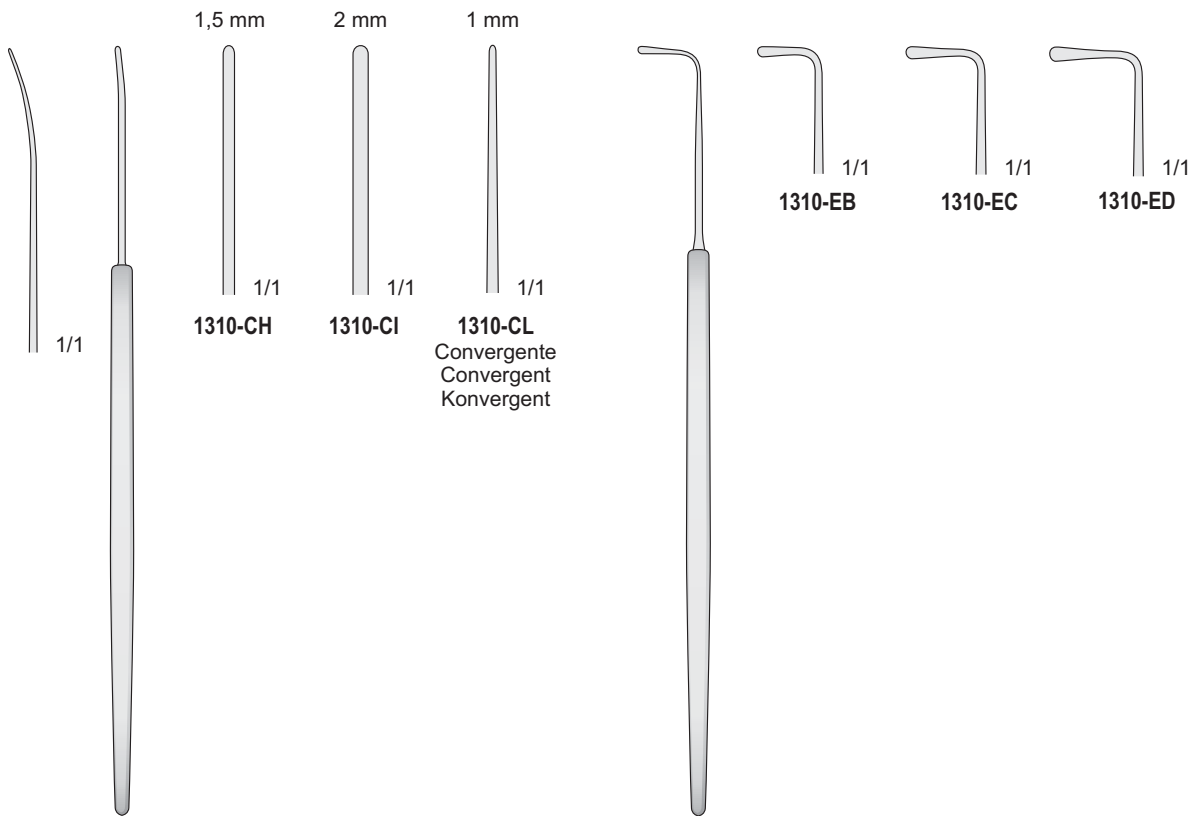

WECKER  
1310-CH/1310-CL  
130 mm

GRAEFE  
1310-EB/1310-ED  
130 mm



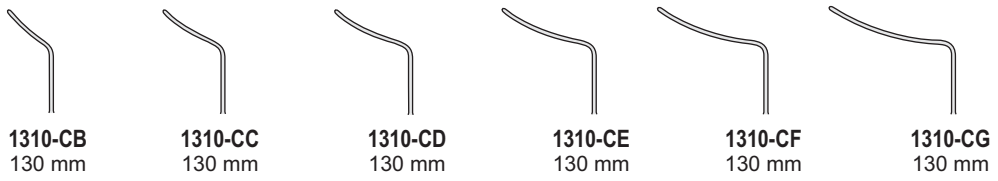

**1310-CB**  
130 mm

**1310-CC**  
130 mm

**1310-CD**  
130 mm

**1310-CE**  
130 mm

**1310-CF**  
130 mm

**1310-CG**  
130 mm

**CASTROVIEJO**  
**1310-CB/1310-CG**

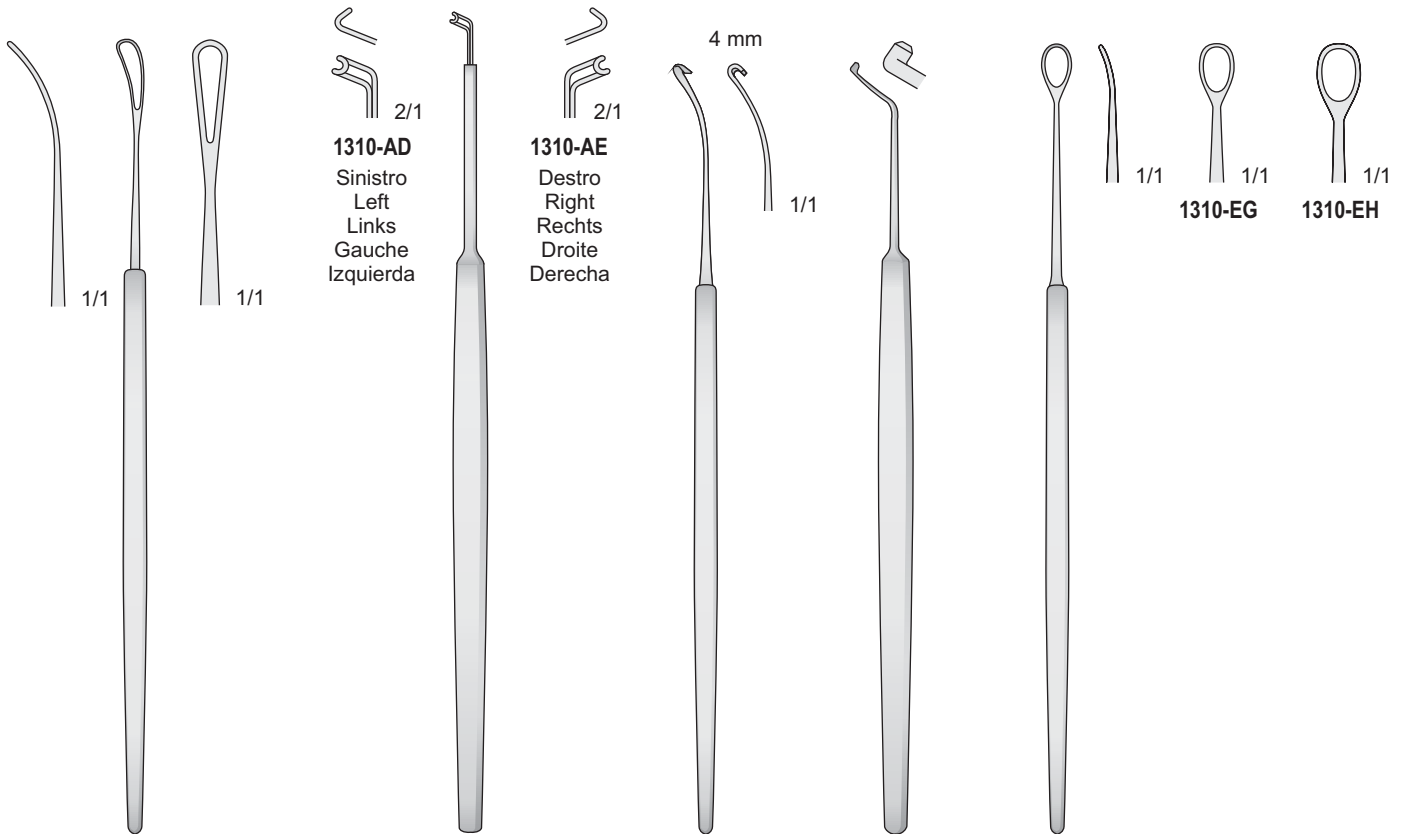

**1310-AD**  
Sinistro  
Left  
Links  
Gauche  
Izquierda

**1310-AE**  
Destro  
Right  
Rechts  
Droite  
Derecha

**SNELLEN**  
**1310-EF**  
135 mm

**1310-AD/1310-AE**  
140 mm

**1310-EE**  
130 mm

**1310-HF**  
130 mm

**WEBER**  
**1310-EG/1310-EH**  
135 mm

Strumenti per oftalmologia Eye instruments Augeninstrumente Instrumentes pour l'oftalmologie Instrumentos oculares

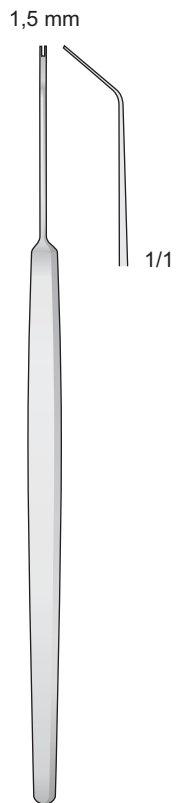

**1310-BAL**  
130 mm

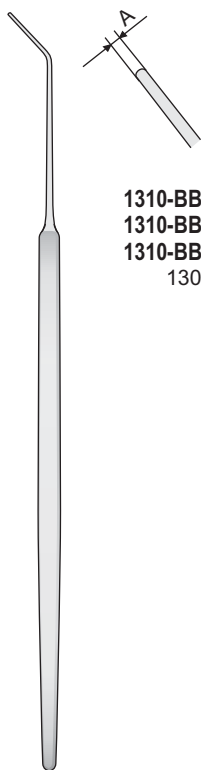

**A**  
**1310-BBA** 0,6 mm  
**1310-BBB** 1,0 mm  
**1310-BBC** 1,5 mm  
 130 mm

**CASTROVIEJO**  
**1310-BBA/1310-BBB**  
 130 mm



**1310-AF**  
140 mm



**1310-LE**  
165 mm



**KIMURA**  
**1310-EI**  
 150 mm

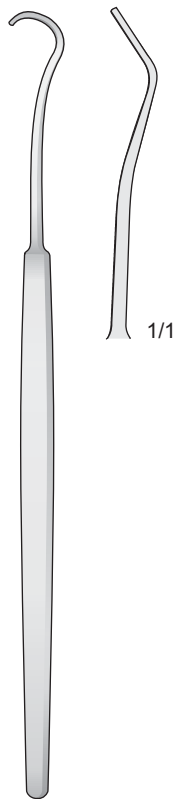

**ARRUGA**  
**1310-FL**  
 140 mm

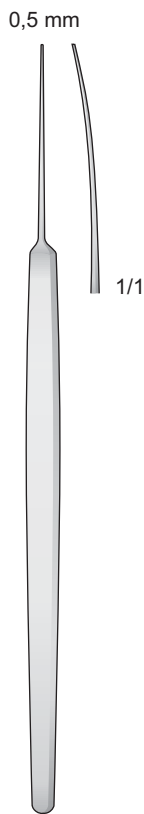

**1310-BAH**  
130 mm

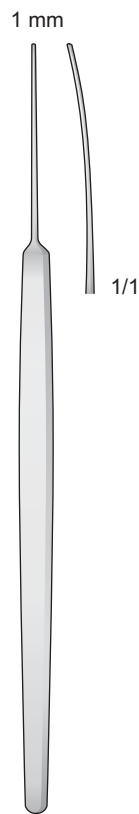

**1310-BAI**  
130 mm

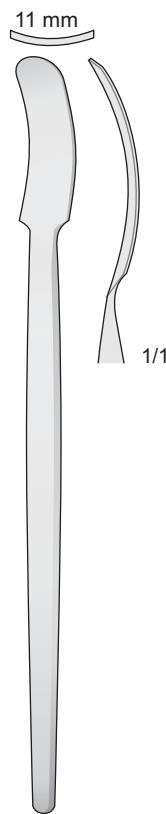

**1310-BAF**  
125 mm

Dilatatori lacriminali  
 Tränenkanal Dilatatoren  
 Lacrymal dilators  
 Dilatadores lacrimales

Fig.1 Fig.2 Fig.3



**WILDER**  
**1310-LH**  
 100 mm



**WILDER**  
**1310-LI**  
 100 mm



**WILDER**  
**1310-LL**  
 100 mm

Cannule di irrigazione  
Irrigating cannulas  
Spülkanülen  
Canules d'irrigation  
Cánulas de irrigación

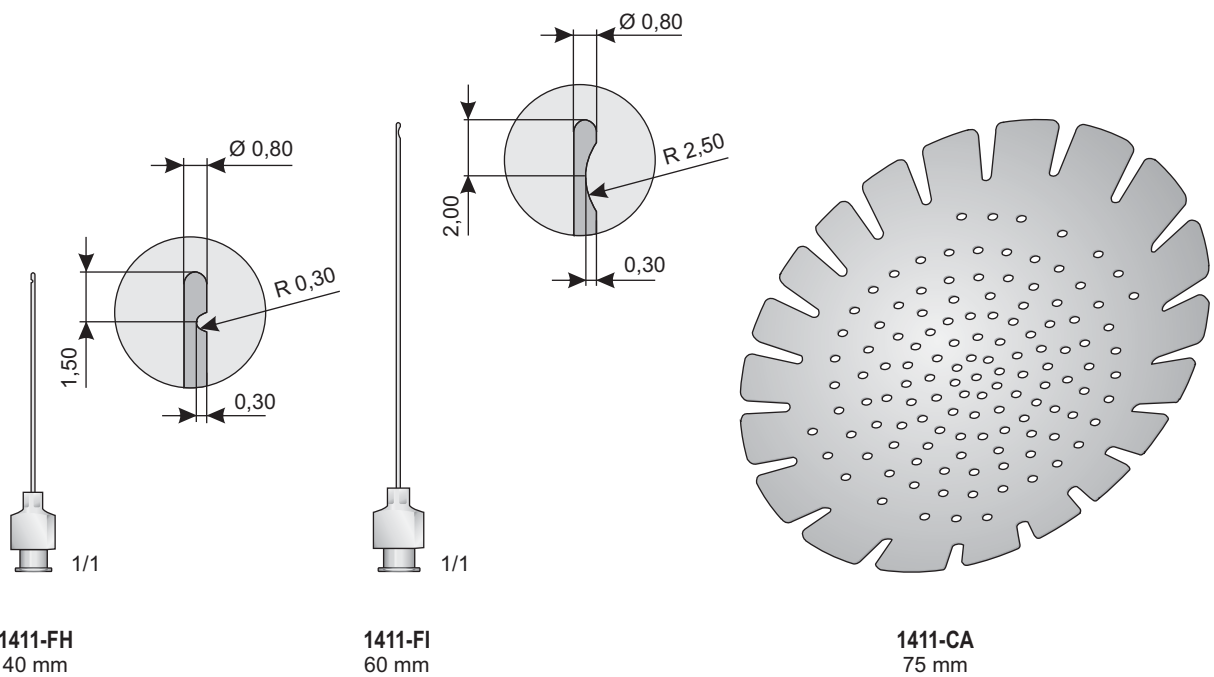
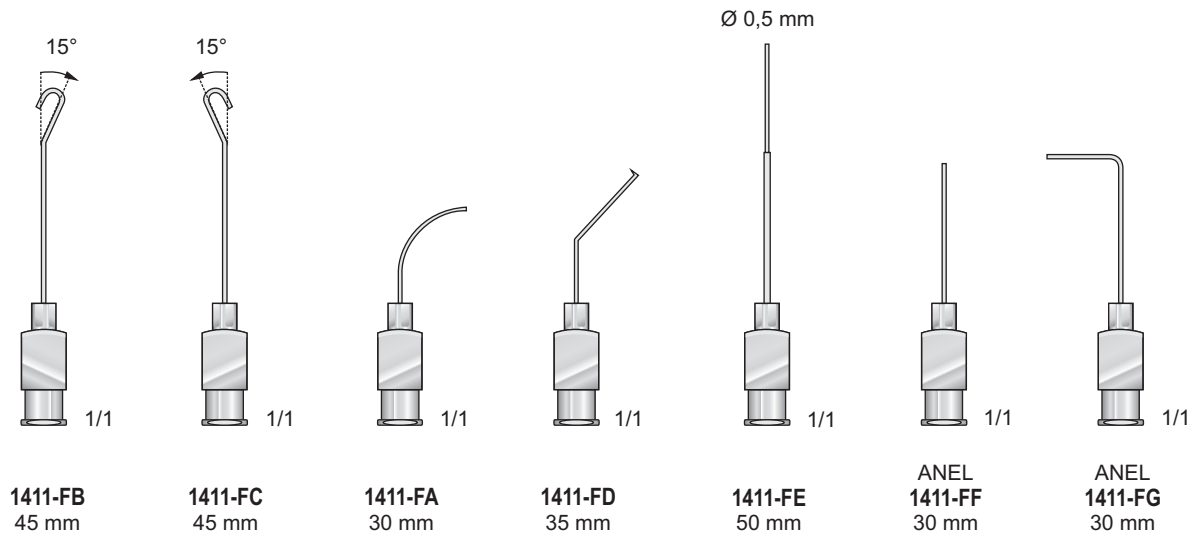

Micro Pinzette - Micro Forceps - Mikro Pinzetten - Micro pinces - Pinzas finos

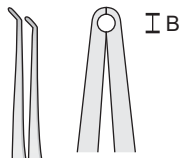

**B**  
**1310-GB** 0,2 mm  
**1310-GC** 0,3 mm  
**1310-GD** 0,4 mm

**PIERSE**  
**1310-GB/1310-GD**  
 80 mm

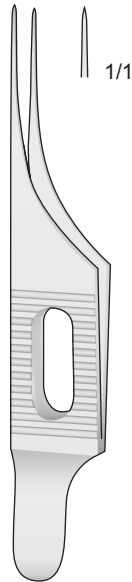

**COLIBRI**  
**1310-GE**  
 80 mm



**A**  
**1310-GF** 0,25 mm  
**1310-GG** 0,4 mm  
**1310-GH** 0,6 mm

**COLIBRI**  
**1310-GF/1310-GH**  
 75 mm

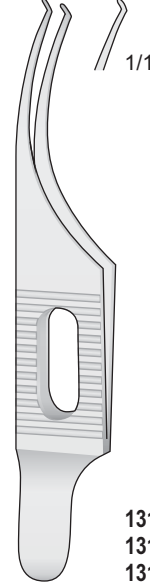

**A**  
**1310-GL** 0,25 mm  
**1310-HA** 0,4 mm  
**1310-HB** 0,6 mm

**COLIBRI**  
**1310-GL/1310-HB**  
 80 mm

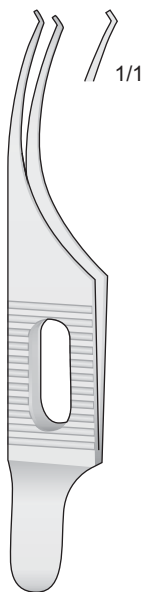

**COLIBRI**  
**1310-GA**  
 80 mm



**1310-HD**  
 70 mm

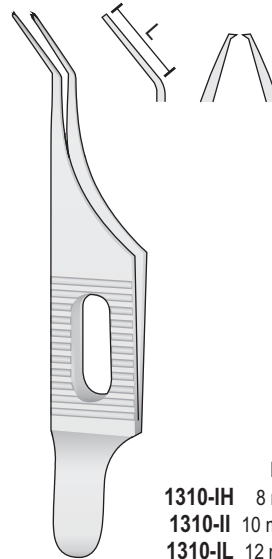

**L**  
**1310-IH** 8 mm  
**1310-II** 10 mm  
**1310-IL** 12 mm

**1310-IH/1310-IL**  
 70 mm

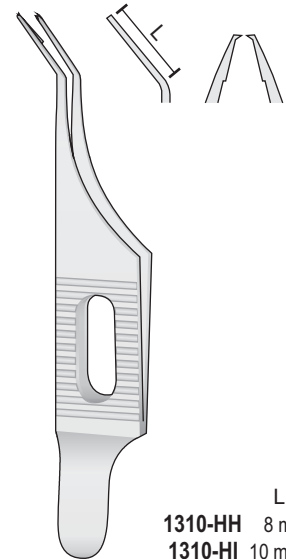

**L**  
**1310-HH** 8 mm  
**1310-HI** 10 mm

**1310-HH/1310-HI**  
 70 mm

Micro Pinzette

Micro Forceps

Mikro Pinzetten

Micro pinces

Pinzas finos

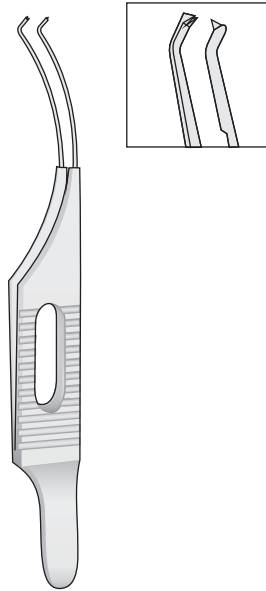

BARRAQUER  
1310-EAB  
75 mm

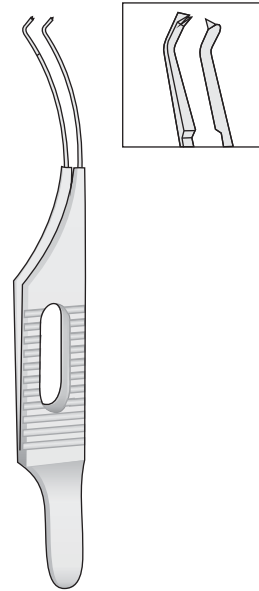

BARRAQUER  
1310-EAD  
75 mm

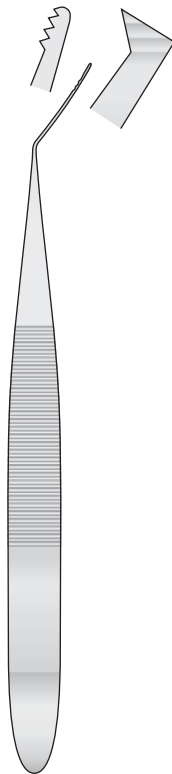

0604-BBI  
95 mm

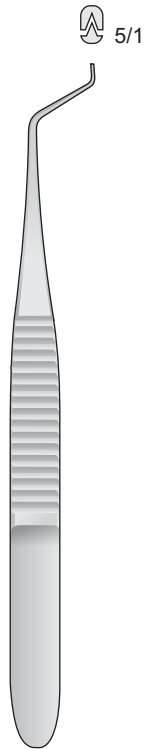

0604-BBL  
90 mm

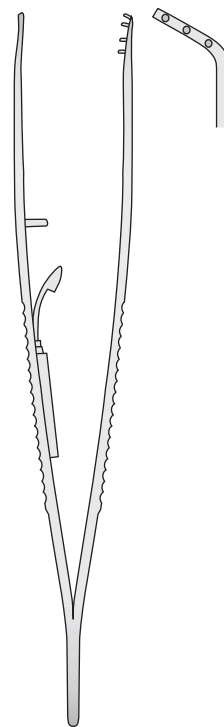

0604-BCA  
95 mm

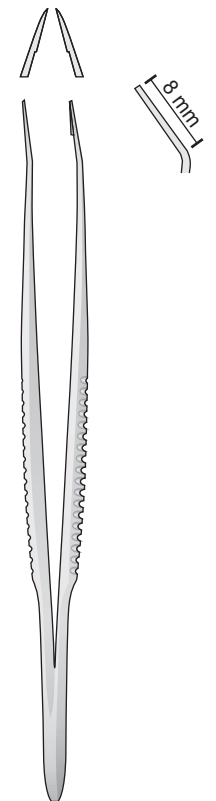

Mc PHERSON  
0604-BCD  
95 mm

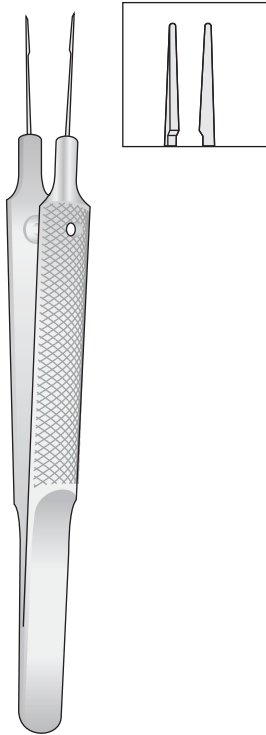

**1206-BFA**  
100 mm

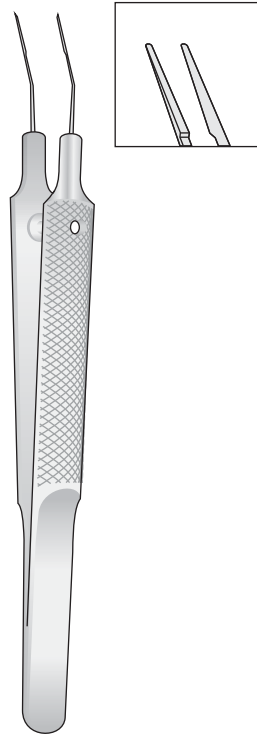

**1206-BFB**  
100 mm



**CASTROVIEJO**  
**1206-CEF**  
110 mm

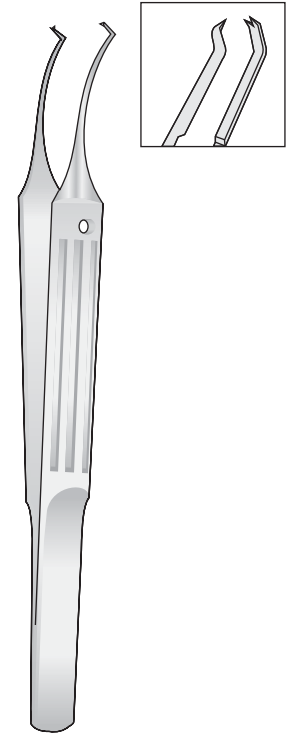

**TROUTMAN**  
**1206-CEG**  
110 mm

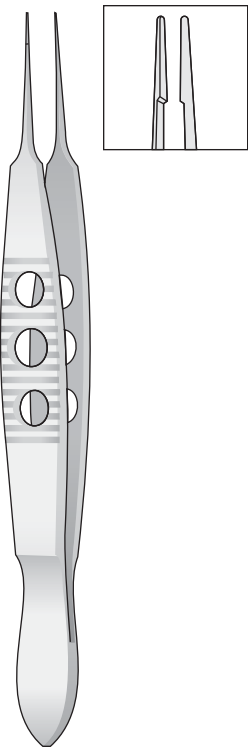

**MC PHERSON**  
**1206-CDB**  
105 mm

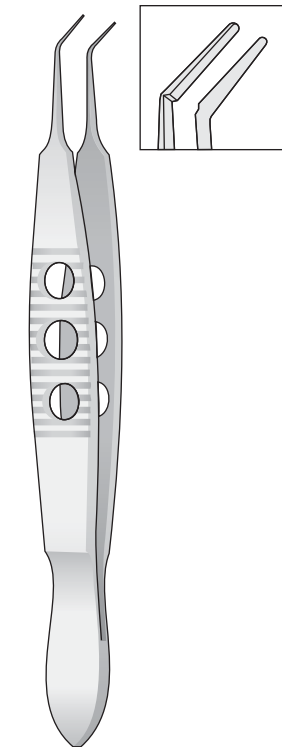

**MC PHERSON**  
**1206-CDC**  
105 mm

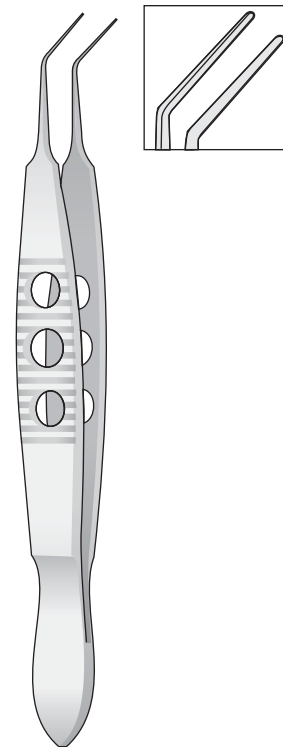

**FAULKNER**  
**1206-CHI**  
105 mm

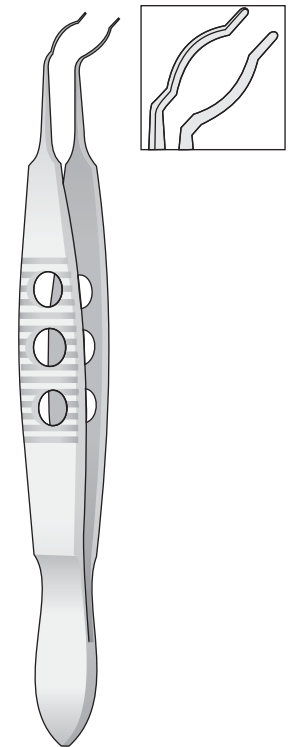

**OSHIKA-FAULKNER**  
**1206-CHL**  
105 mm

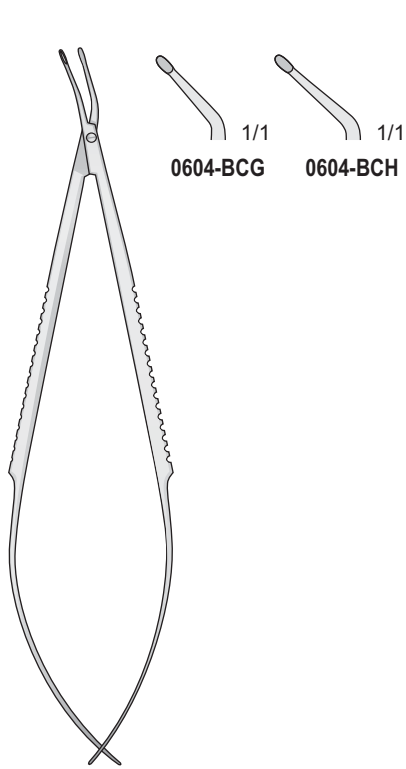

0604-BCG/0604-BCH  
110 mm

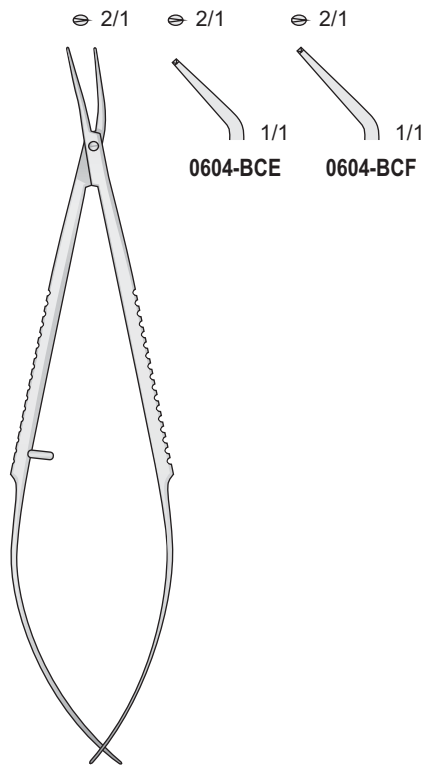

0604-BCE/0604-BCF  
110 mm

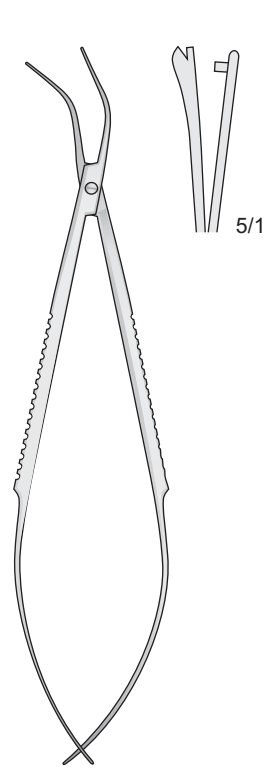

0604-BDA  
110 mm

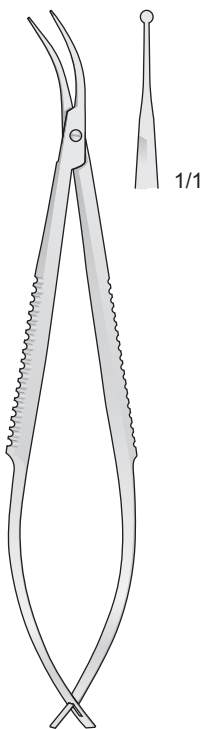

0604-BDC  
110 mm

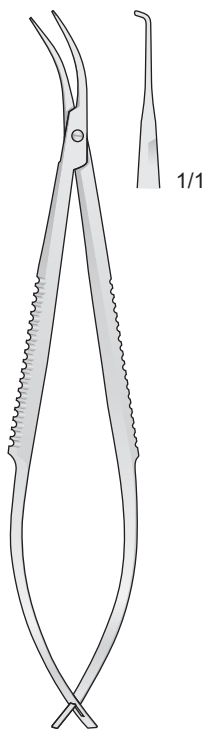

0604-BDE  
110 mm

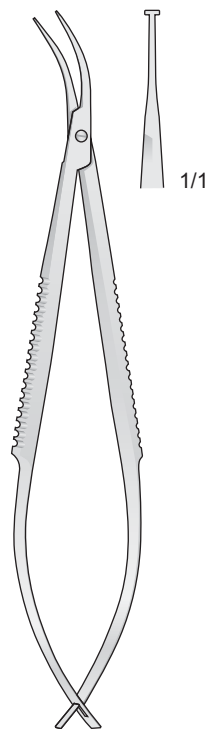

0604-BDG  
110 mm

Blefarostati - Eye specula - Sperrelevatoren  
Blèpharostats - Blefarostatos

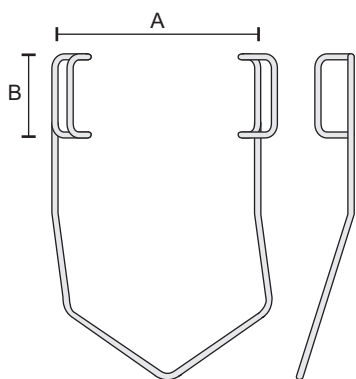

A B  
**1310-HL** 27 mm 11 mm



**BARRAQUER**  
**1310-ID**

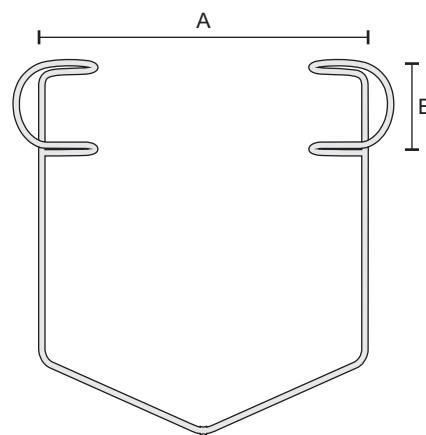

A B  
**1310-IA** 27 mm 5 mm  
**1310-IC** 34 mm 9 mm  
**1310-IE** 42 mm 12 mm  
**1310-IG** 42 mm 14 mm

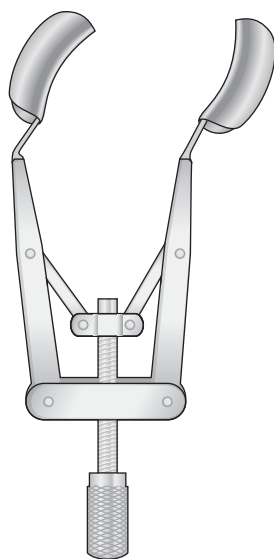

**KERSHNER**  
**1310-ECA**

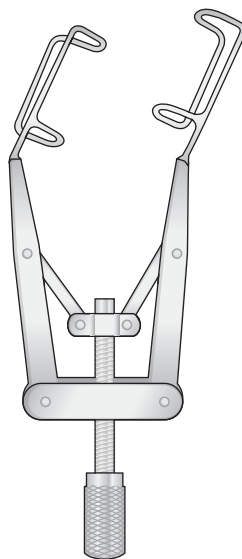

**KERSHNER**  
**1310-ECB**

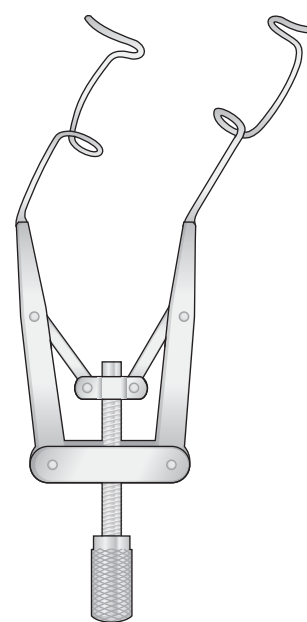

**LIEBERMANN-TENNANT**  
**1310-ECC**



Blefarostati - Eye specula - Sperrelevatoren  
Blèpharostats - Blefarostatos

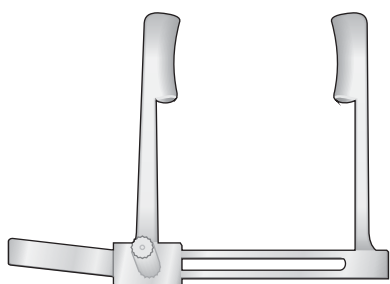

PROST  
1310-LC

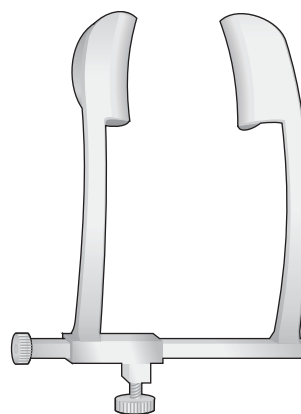

COOK  
1310-BDB

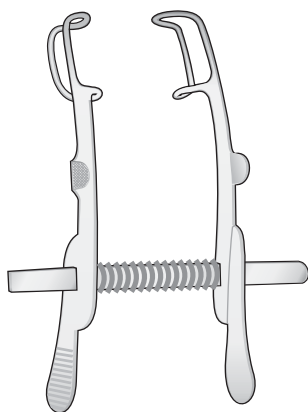

MELLINGER  
0221-AC  
70 mm

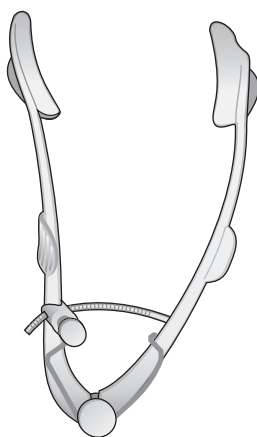

LISTER-BURCH  
0221-AE  
80 mm

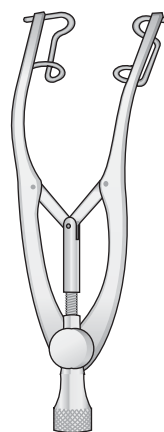

CASTROVIEJO  
0221-AF  
80 mm

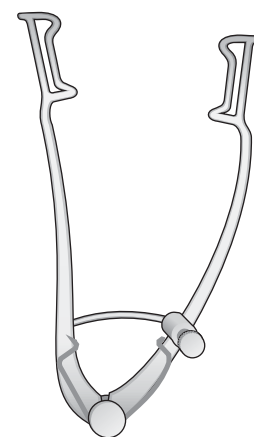

WILLIAMS  
0221-AG  
80 mm

Micro forbici

Micro scissors

Micro Scheren

Micro ciseaux

Micro tijeras

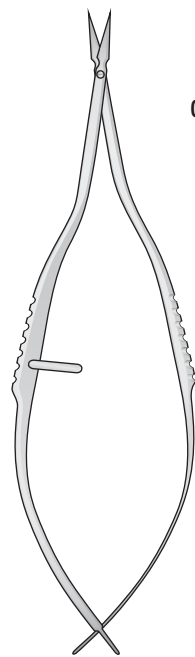

VANNAS  
0604-HL/0604-IB  
85 mm

Iris Scissors

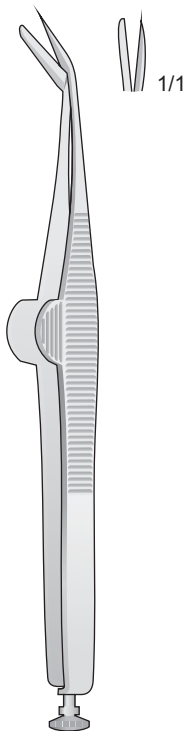

WECKER  
0604-CDB  
110 mm

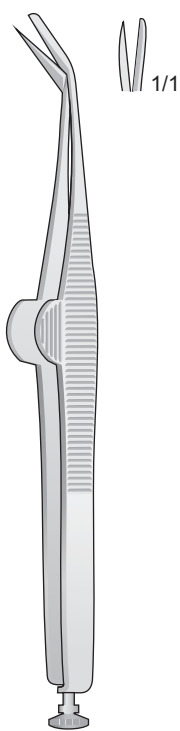

WECKER  
0604-CDC  
110 mm

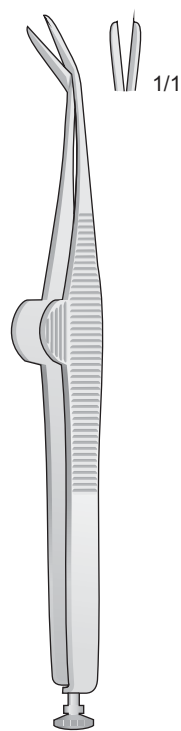

WECKER  
0604-CDD  
110 mm

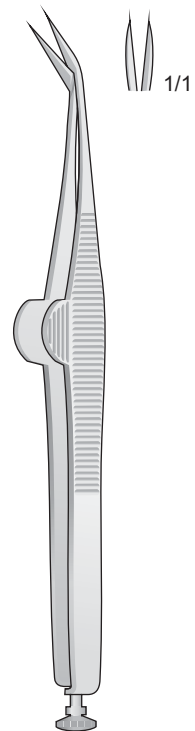

WECKER  
0604-CDE  
110 mm

Micro forbici

Micro scissors

Micro Scheren

Micro ciseaux

Micro tijeras

Acuta - Sharp - Spitz  
Pointu - Agudas

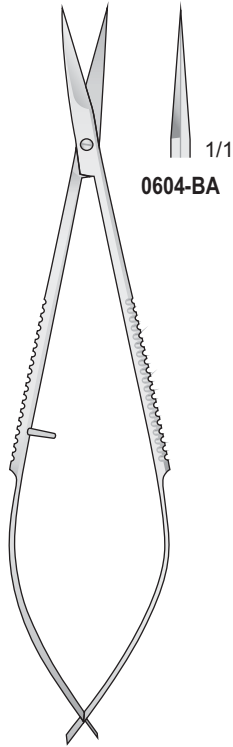

0604-BA

NOYES  
0604-BA  
120 mm

Acuta - Sharp - Spitz  
Pointu - Agudas

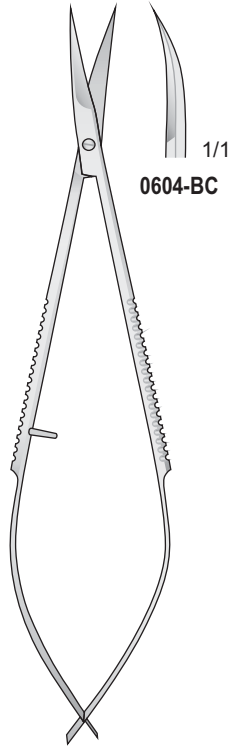

0604-BC

NOYES  
0604-BC  
120 mm

Acuta - Sharp - Spitz  
Pointu - Agudas

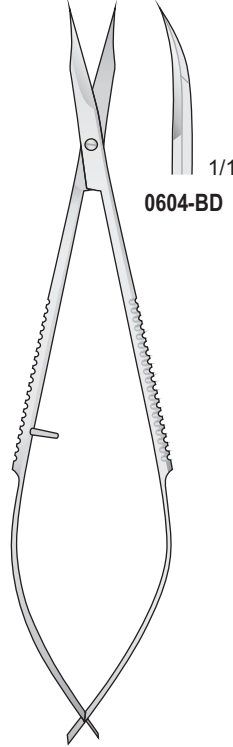

0604-BD

WESTCOTT  
0604-BD  
120 mm

Acuta - Sharp - Spitz  
Pointu - Agudas

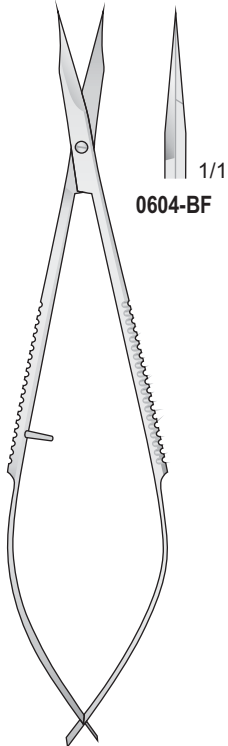

0604-BF

WESTCOTT  
0604-BF  
120 mm

Smussa - Blunt - Stumpf  
Mousse - Romas

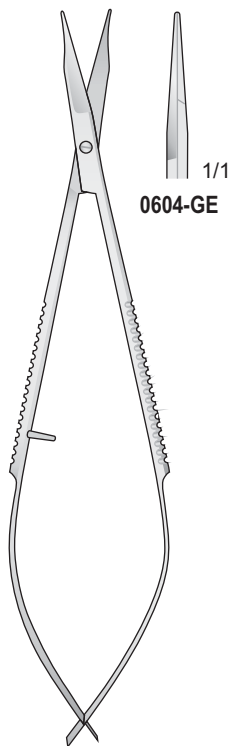

0604-GE

WESTCOTT  
0604-GE  
120 mm

Smussa - Blunt - Stumpf  
Mousse - Romas

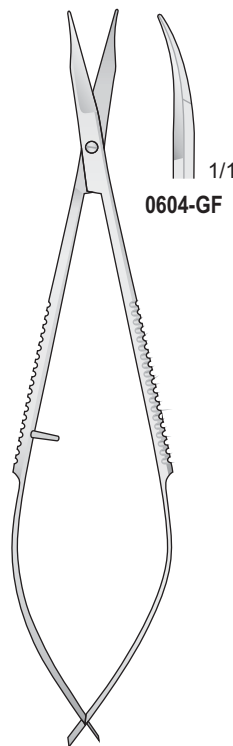

0604-GF

WESTCOTT  
0604-GF  
120 mm

Micro forbici

Micro scissors

Micro Scheren

Micro ciseaux

Micro tijeras

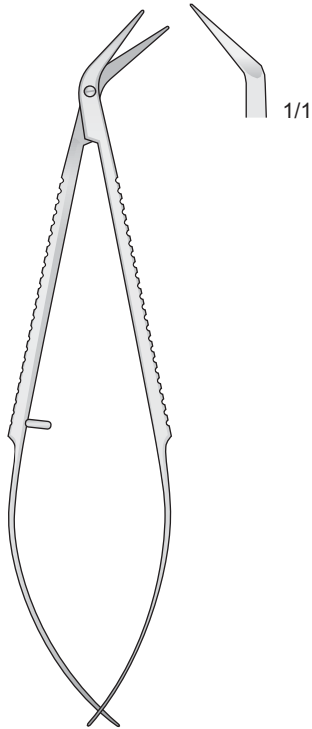

**0604-AD**  
110 mm

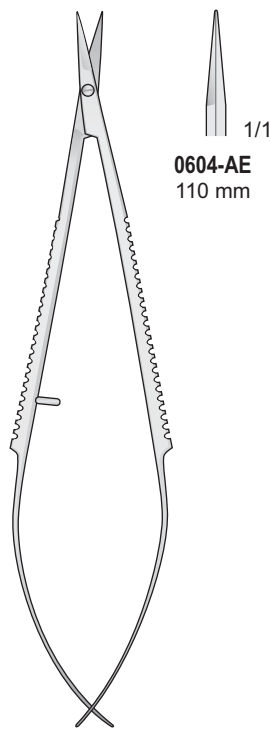

Acuta - Sharp  
Spitz - Pointu - Agudas

**0604-AE**  
110 mm

**0604-AF**  
110 mm

**0604-AE/0604-AF**  
110 mm

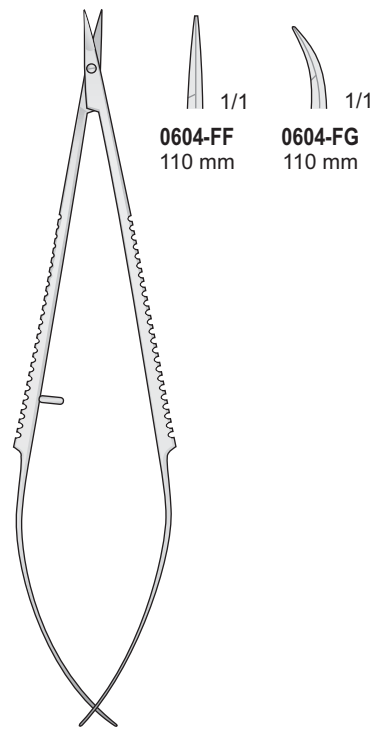

Acuta - Sharp  
Spitz - Pointu - Agudas

**0604-FF**  
110 mm

**0604-FG**  
110 mm

**0604-FF/0604-FG**  
110 mm

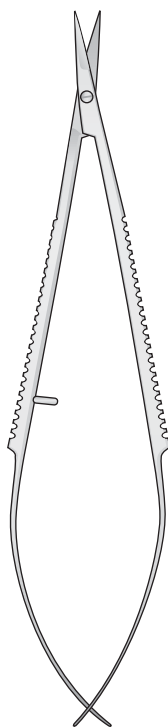

Smussa - Blunt  
Stumpf - Mousse - Romas

**0604-EL**  
110 mm

**0604-FA**  
110 mm

**0604-EL/0604-FA**  
110 mm

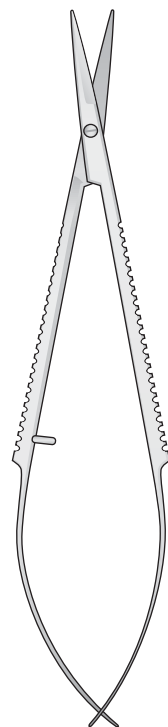

Smussa - Blunt  
Stumpf - Mousse - Romas

**0604-EB**  
120 mm

**0604-EC**  
120 mm

**0604-EB/0604-EC**  
120 mm

Micro forbici

Micro scissors

Micro Scheren

Micro ciseaux

Micro tijeras

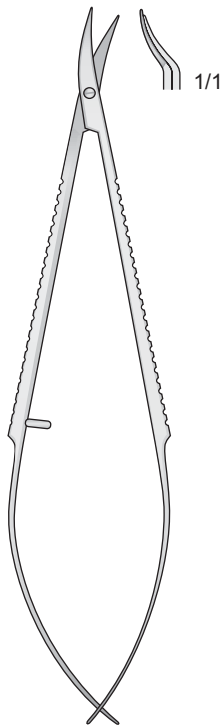

TROUTMAN  
0604-GL  
110 mm

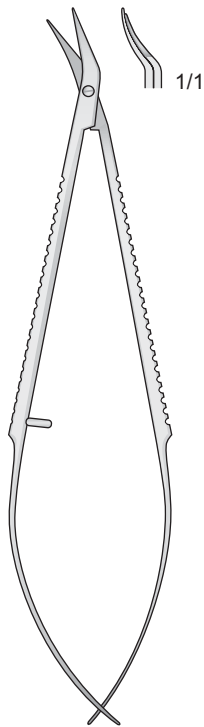

TROUTMAN  
0604-HA  
110 mm

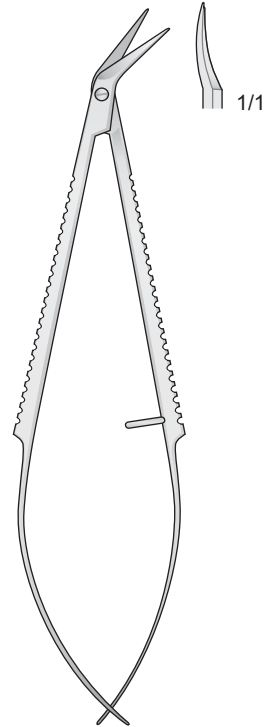

CASTROVIEJO  
0604-GG  
110 mm

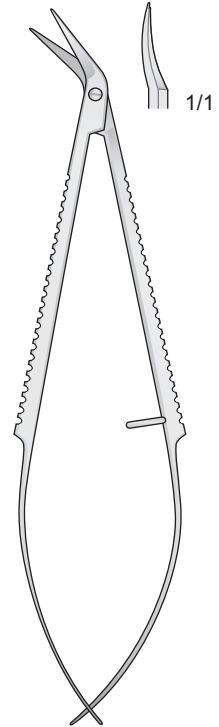

CASTROVIEJO  
0604-GH  
110 mm

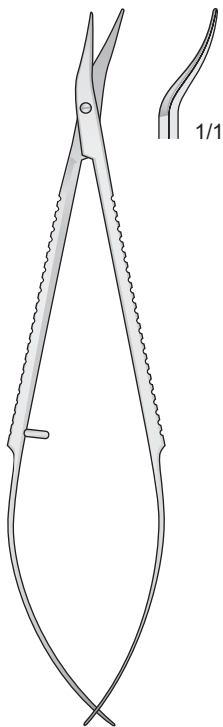

CASTROVIEJO  
0604-GI  
110 mm

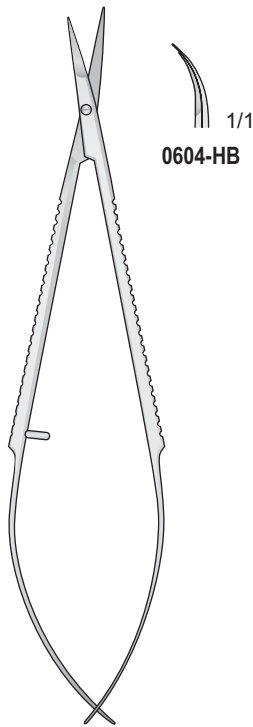

0604-HB/0604-HC  
110 mm

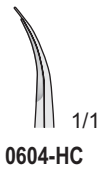

0604-HC

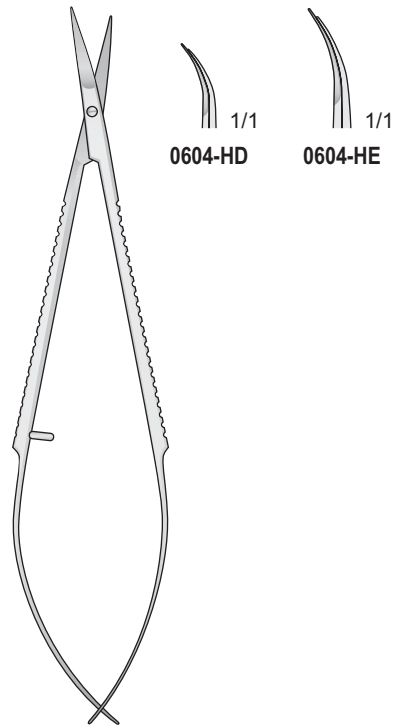

0604-HD/0604-HE  
110 mm



0604-HD



0604-HE

Micro forbici

Micro scissors

Micro Scheren

Micro ciseaux

Micro tijeras

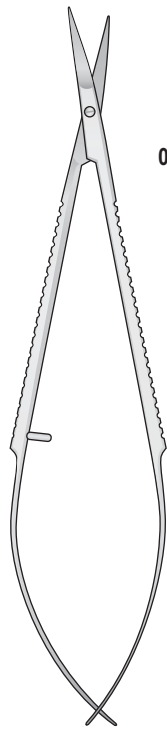

0604-BEG/0604-BEH

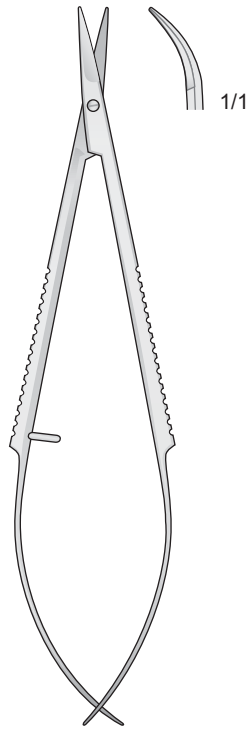

0604-GC  
110 mm

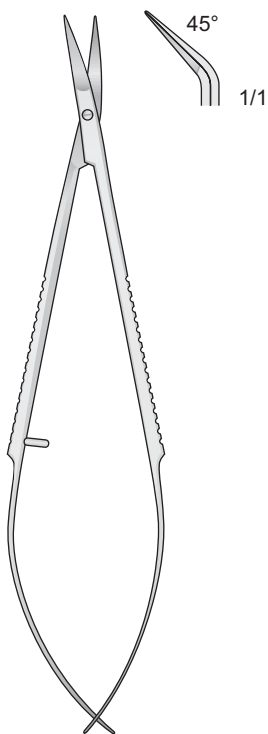

0604-BB  
110 mm

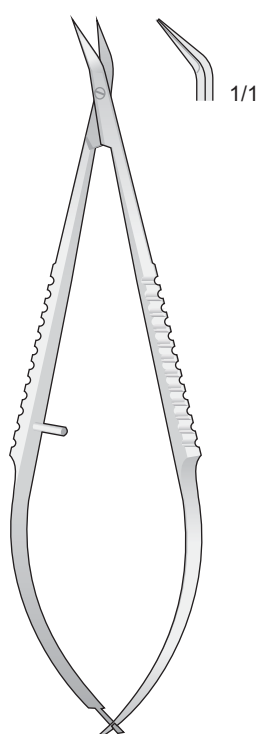

0604-CDF  
110 mm

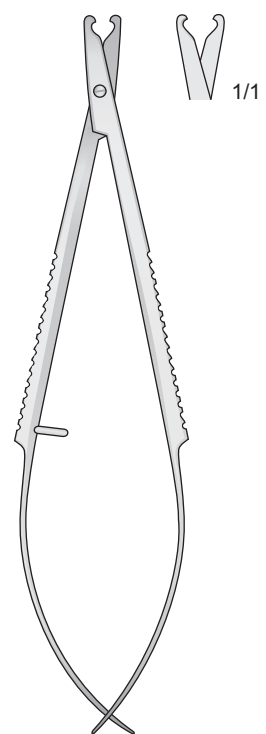

0604-GB  
110 mm

Micro forbici

Micro scissors

Micro Scheren

Micro ciseaux

Micro tijeras

Acuta - Sharp - Spitz - Pointu - Agudas

Acuta - Sharp - Spitz - Pointu - Agudas

Smussa - Blunt - Stumpf - Mousse - Romas

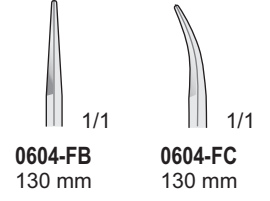
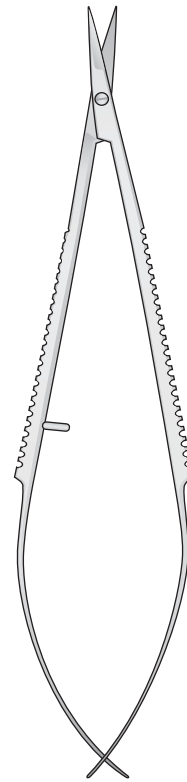
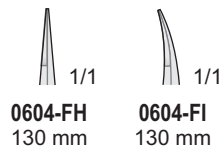
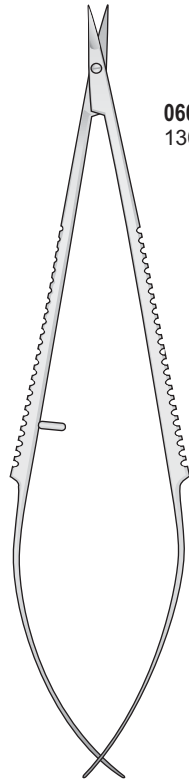
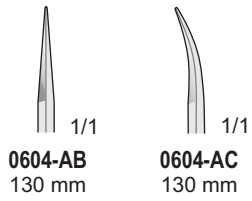
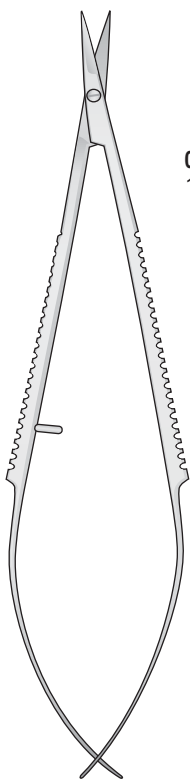

**0604-AB/0604-AC**  
130 mm

**0604-FH/0604-FI**  
130 mm

**0604-FB/0604-FC**  
130 mm

Acuta - Sharp - Spitz - Pointu - Agudas

Smussa - Blunt - Stumpf - Mousse - Romas

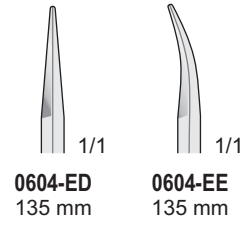
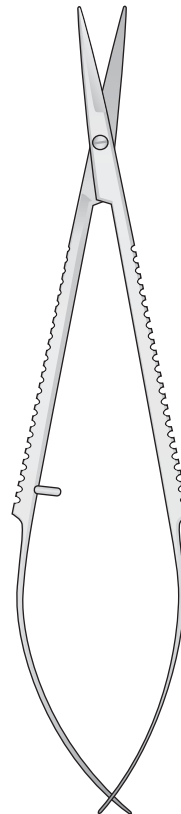
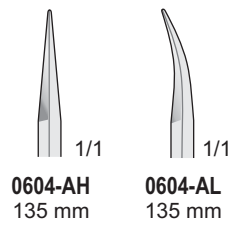
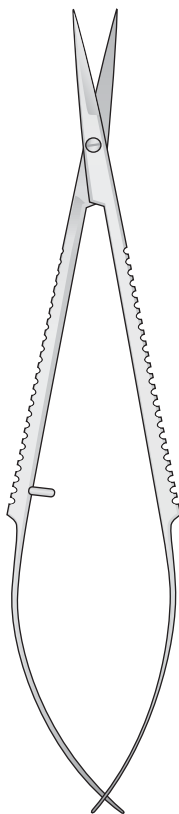

**0604-AH/0604-AL**  
135 mm

**0604-ED/0604-EE**  
135 mm

Micro forbici

Micro scissors

Micro Scheren

Micro ciseaux

Micro tijeras

Acuta - Sharp  
Spitz - Pointu - Agudas

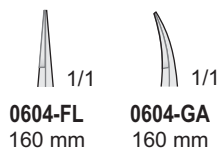
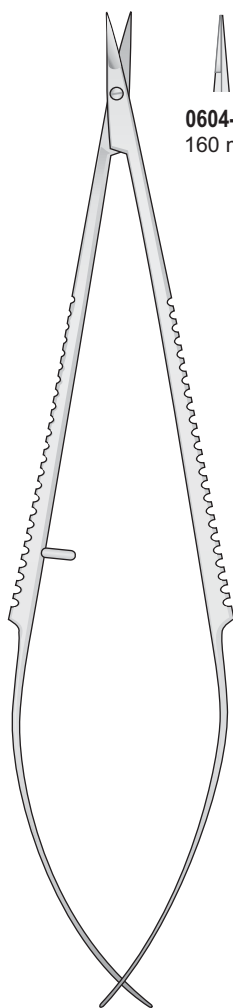

0604-FL  
160 mm

0604-GA  
160 mm

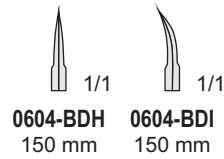
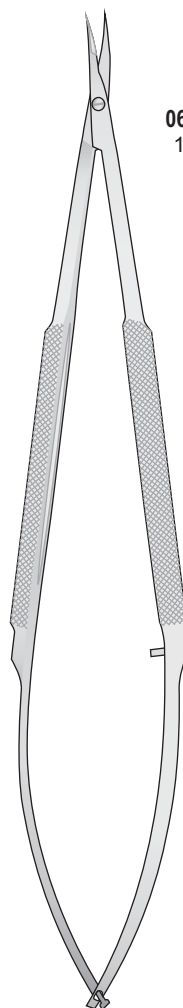

0604-BDH  
150 mm

0604-BDI  
150 mm

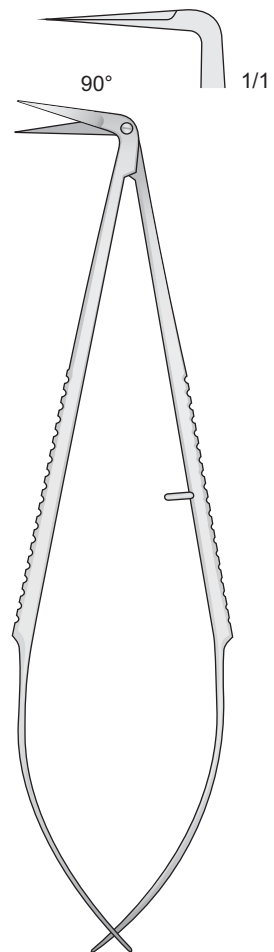

90°

1/1

0604-FL/0604-GA  
160 mm

0604-BDH/0604-BDI  
150 mm

0604-EA  
150 mm



Micro port'aghi

Micro needle holders

Micro Nadelhalter

Micro porte aiguilles

Micro portaagujas

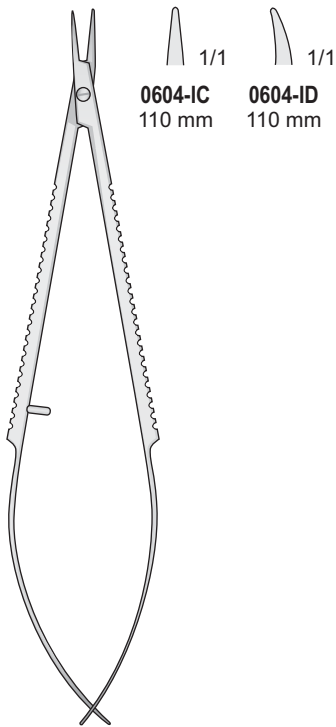

0604-IC/0604-ID  
110 mm

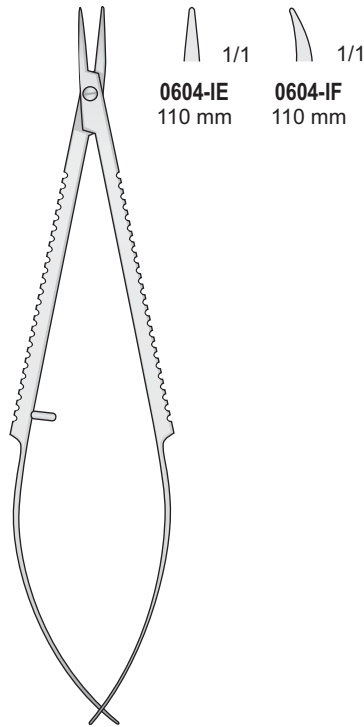

0604-IE/0604-IF  
110 mm

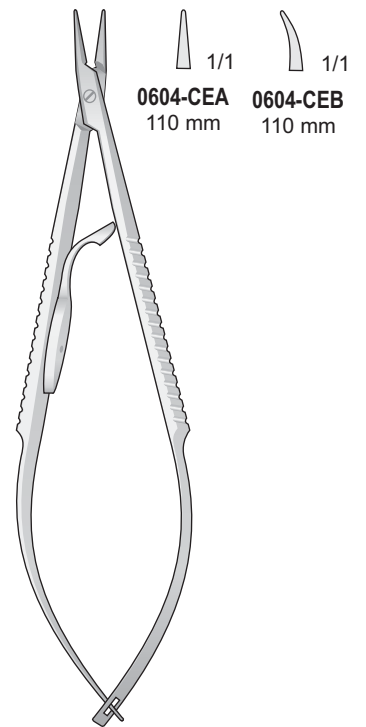

0604-CEA/0604-CEB  
110 mm

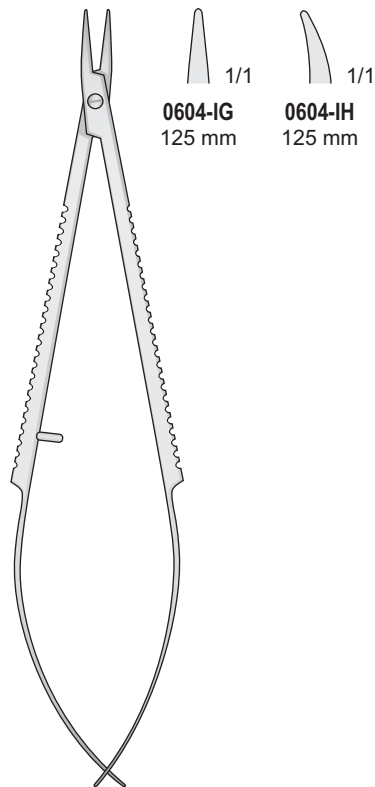

0604-IG/0604-IH  
125 mm

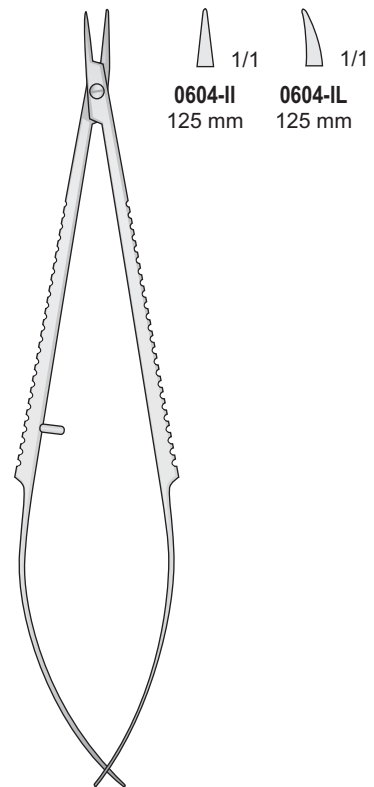

0604-II/0604-IL  
125 mm

Micro port'aghi

Micro needle holders

Micro Nadelhalter

Micro porte aiguilles

Micro portaagujas

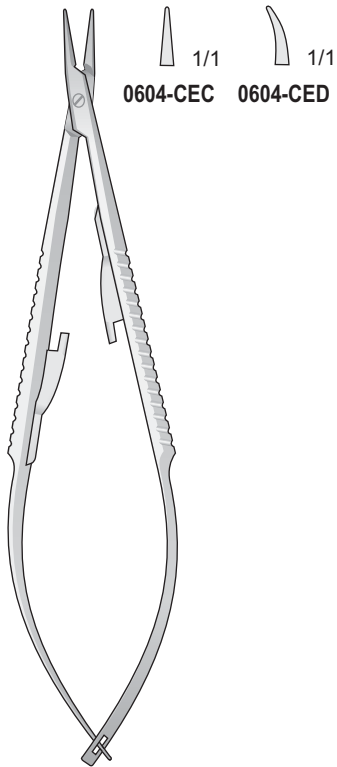

0604-CEC/0604-CED  
125 mm

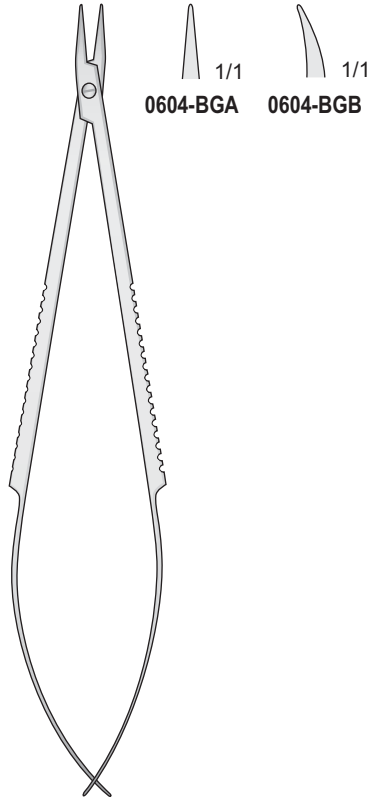

0604-BGA/0604-BGB  
135 mm

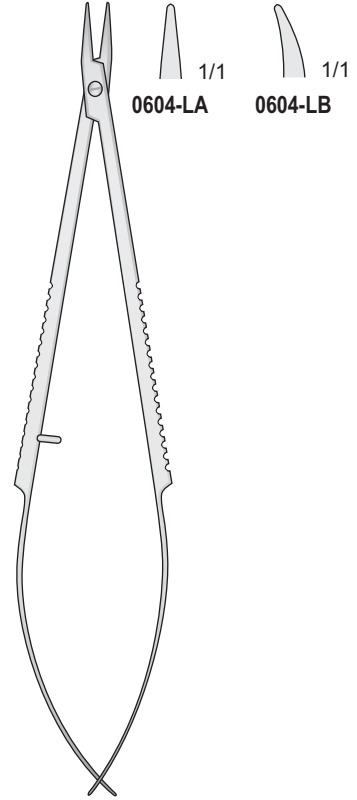

0604-LA/0604-LB  
135 mm

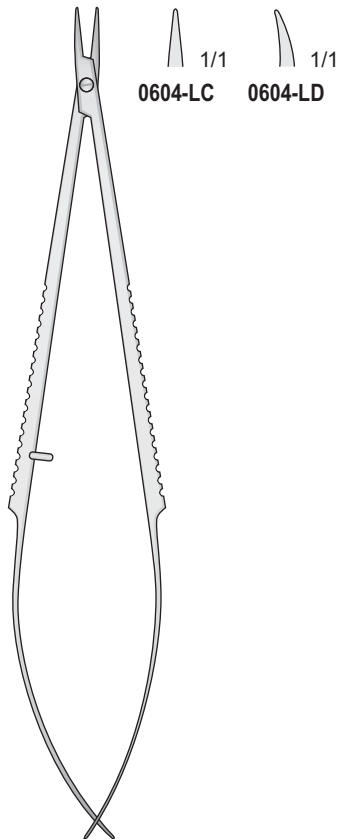

0604-LC/0604-LD  
135 mm

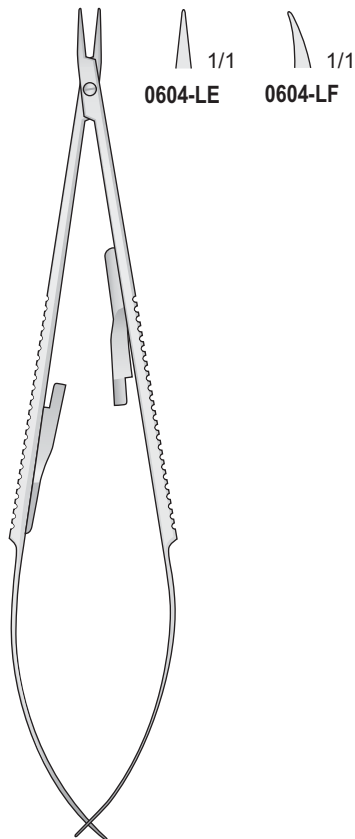

0604-LE/0604-LF  
135 mm

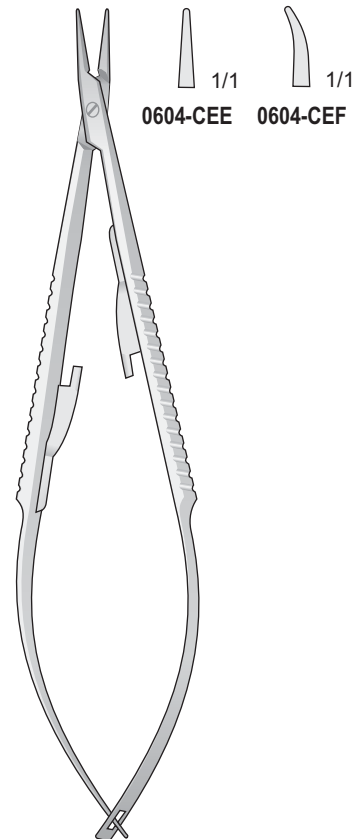

0604-CEE/0604-CEF  
135 mm

Micro port'aghi

Micro needle holders

Micro Nadelhalter

Micro porte aiguilles

Micro portaagujas

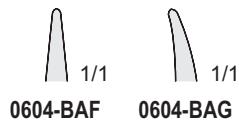
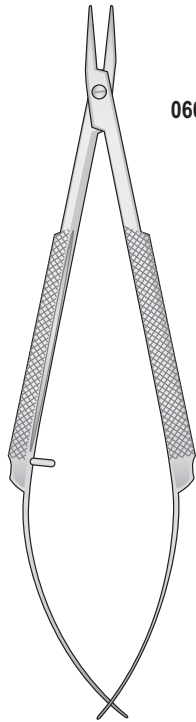

0604-BAF/0604-BAG  
110 mm

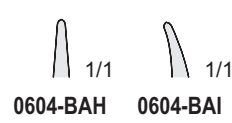
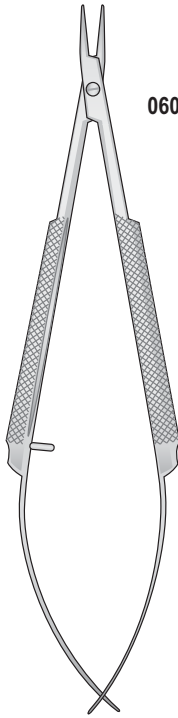

0604-BAH/0604-BAI  
110 mm

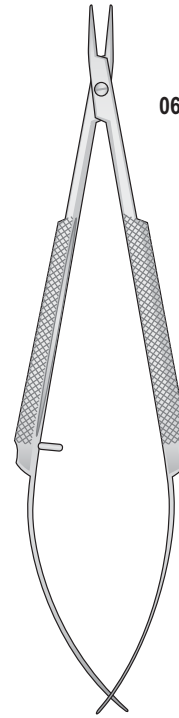

0604-BGC  
110 mm

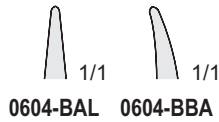
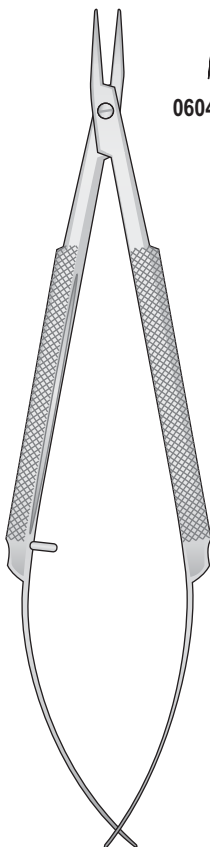

0604-BAL/0604-BBA  
125 mm

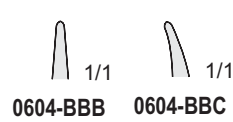
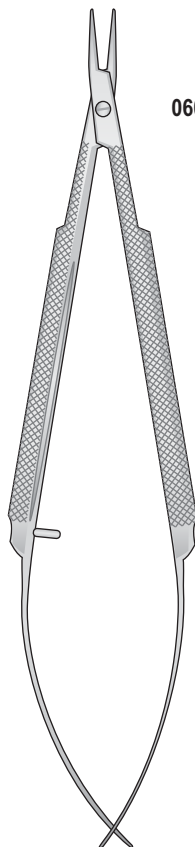

0604-BBB/0604-BBC  
125 mm

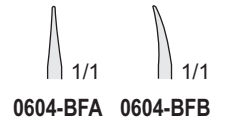
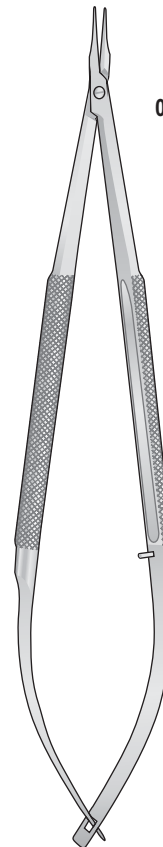

BARRAQUER  
0604-BFA/0604-BFB  
125 mm

Micro port'aghi

Micro needle holders

Micro Nadelhalter

Micro porte aiguilles

Micro portaagujas

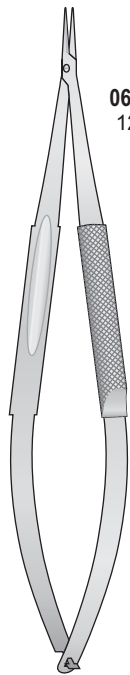

1/1  
0604-BFE  
125 mm

1/1  
0604-BFF  
125 mm

BARRAQUER  
0604-BFE/0604-BFF  
125 mm

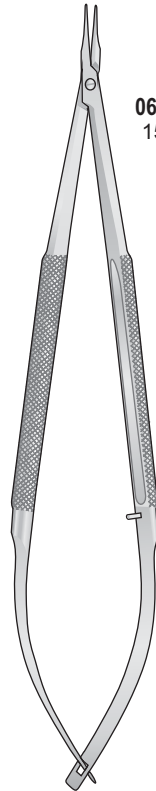

1/1  
0604-BFC  
150 mm

1/1  
0604-BFD  
150 mm

BARRAQUER  
0604-BFC/0604-BFD  
150 mm

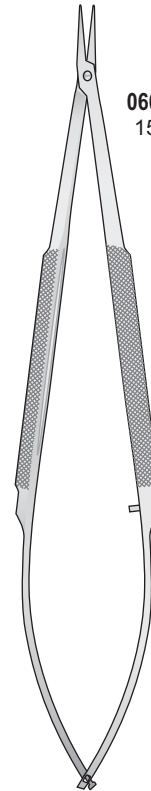

1/1  
0604-BFG  
150 mm

1/1  
0604-BFH  
150 mm

REILL  
0604-BFG/0604-BFH  
150 mm

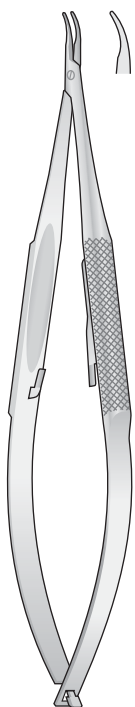

1/1

BARRAQUER  
0604-CBF  
120 mm

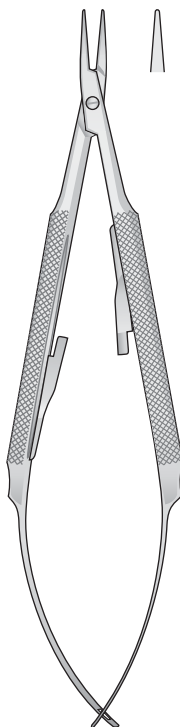

1/1

BARRAQUER  
0604-CBE  
125 mm

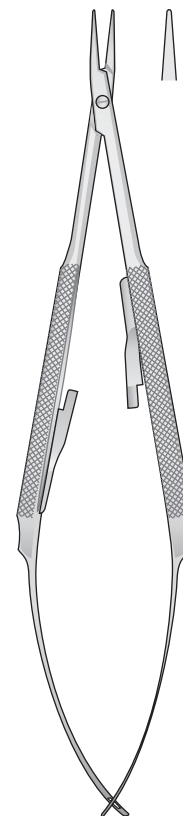

1/1

BARRAQUER  
0604-CBG  
150 mm

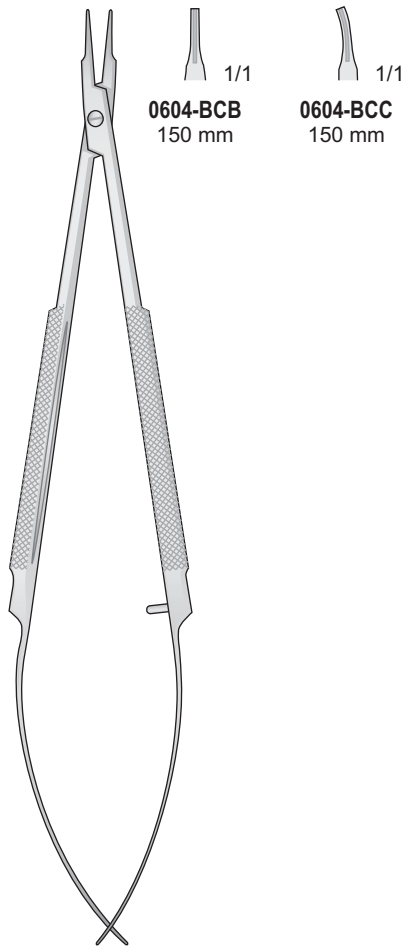

**0604-BCB**  
150 mm

**0604-BCC**  
150 mm

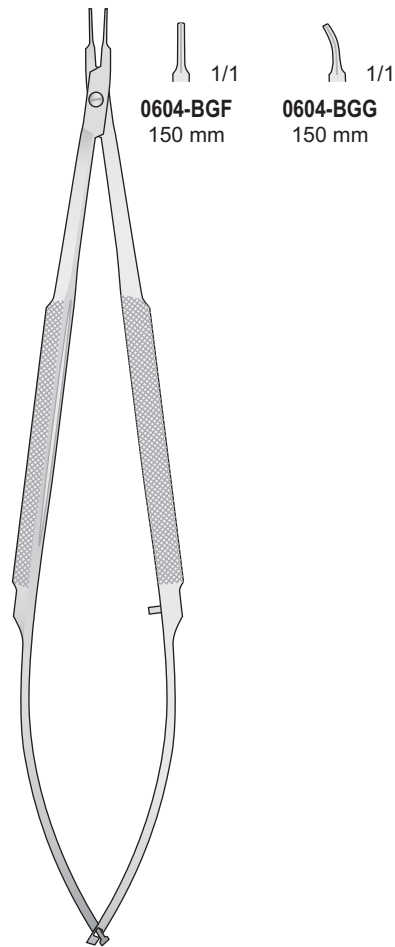

**0604-BGF**  
150 mm

**0604-BGG**  
150 mm

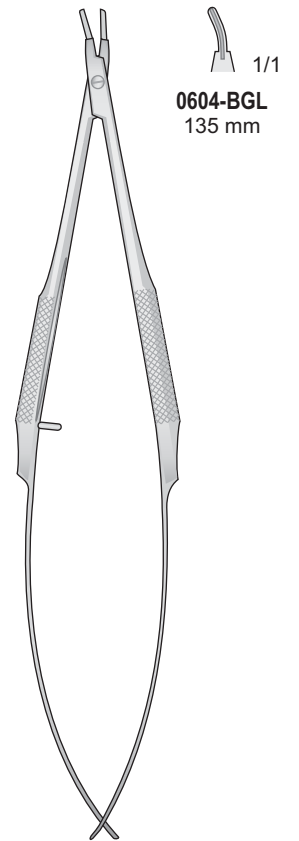

**0604-BGL**  
135 mm

**BARRAQUER**  
**0604-BCB/0604-BCC**  
150 mm

**BARRAQUER**  
**0604-BGF/0604-BGG**  
150 mm

**BARRAQUER**  
**0604-BGL**  
135 mm

Micro pinzette  
Micro forceps  
Mikro Pinzetten  
Micro pincés  
Pinzas finos

1 x 2 Denti  
1 x 2 Teeth  
1 x 2 Zähne  
1 x 2 Dents  
1 x 2 Dientes

1 x 2 Denti  
1 x 2 Teeth  
1 x 2 Zähne  
1 x 2 Dents  
1 x 2 Dientes

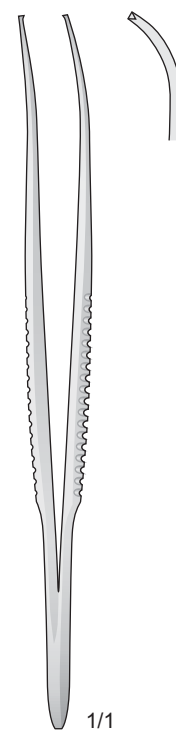
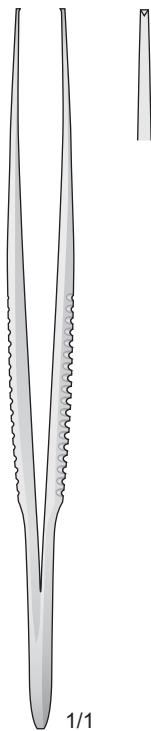
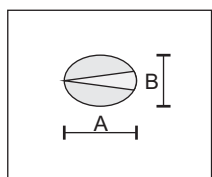

A	B		
0,4	0,25	<b>1206-DE</b>	<b>1206-EA</b>
0,5	0,35	<b>1206-DF</b>	<b>1206-EB</b>
0,7	0,55	<b>1206-DG</b>	<b>1206-EC</b>
1	0,8	<b>1206-DH</b>	<b>1206-ED</b>
1,2	0,9	<b>1206-DI</b>	<b>1206-EE</b>
		95 mm	95 mm

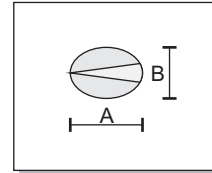

Micro pinzette  
Micro forceps  
Mikro Pinzetten  
Micro pincés  
Pinzas finos

1 x 2 Denti  
1 x 2 Teeth  
1 x 2 Zähne  
1 x 2 Dents  
1 x 2 Dientes

1 x 2 Denti  
1 x 2 Teeth  
1 x 2 Zähne  
1 x 2 Dents  
1 x 2 Dientes

Acuta  
Sharp  
Spitz  
Pointu  
Agudas



Smussa  
Blunt  
Stumpf  
Mousse  
Romas

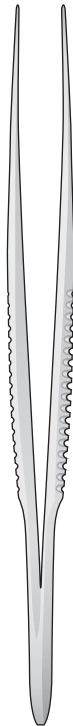

1/1 1/1  
1206-HD 1206-HE

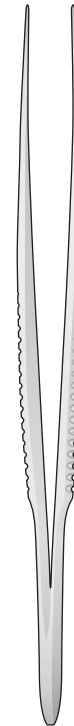

1/1 1/1  
1206-HF 1206-HG

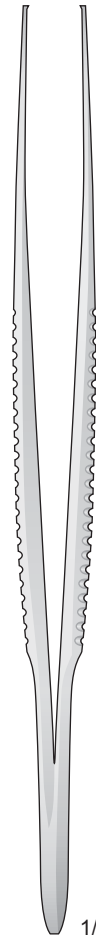

1/1

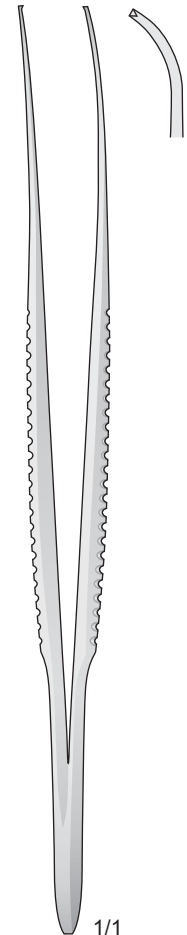

1/1

1206-HD/1206-HE  
95 mm

1206-HF/1206-HG  
95 mm

A	B		
0,4	0,25	1206-EG	1206-FC
0,5	0,35	1206-EH	1206-FD
0,7	0,55	1206-EI	1206-FE
1	0,8	1206-EL	1206-FF
1,2	0,9	1206-FA	1206-FG
		125 mm	125 mm

Micro Pinzette  
anatomiche

Dressing  
Micro Forceps

Anatomische  
Mikro Pinzetten

Micro pinces  
anatomiques

Pinzas finas  
de diseccion

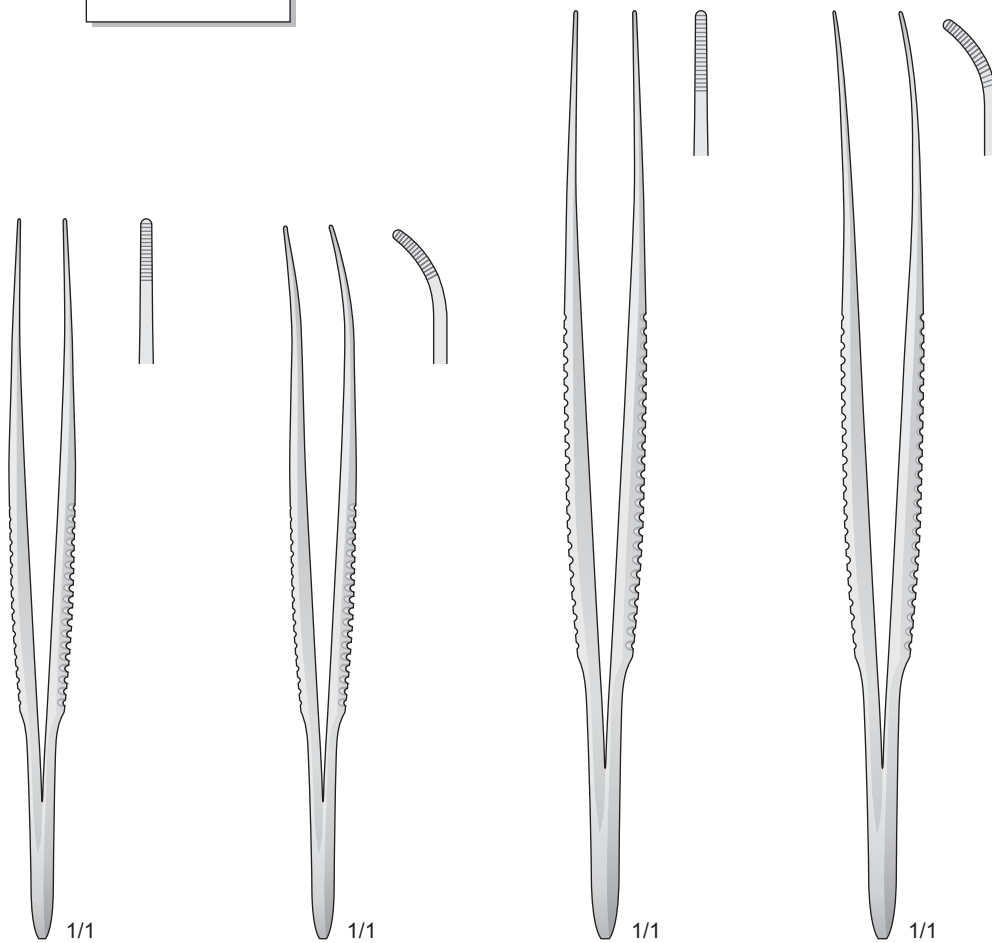
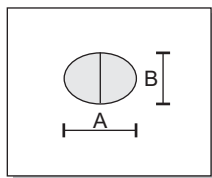

A	B				
0,5	0,4	<b>1206-CE</b>	<b>1206-CL</b>	<b>1206-BL</b>	<b>1206-BD</b>
0,6	0,5	<b>1206-CF</b>	<b>1206-DA</b>	<b>1206-CA</b>	<b>1206-BE</b>
0,9	0,7	<b>1206-CG</b>	<b>1206-DB</b>	<b>1206-CB</b>	<b>1206-BF</b>
1,3	1	<b>1206-CH</b>	<b>1206-DC</b>	<b>1206-CC</b>	<b>1206-BG</b>
1,6	1,3	<b>1206-CI</b>	<b>1206-DD</b>	<b>1206-CD</b>	<b>1206-BH</b>
		95 mm	95 mm	125 mm	125 mm



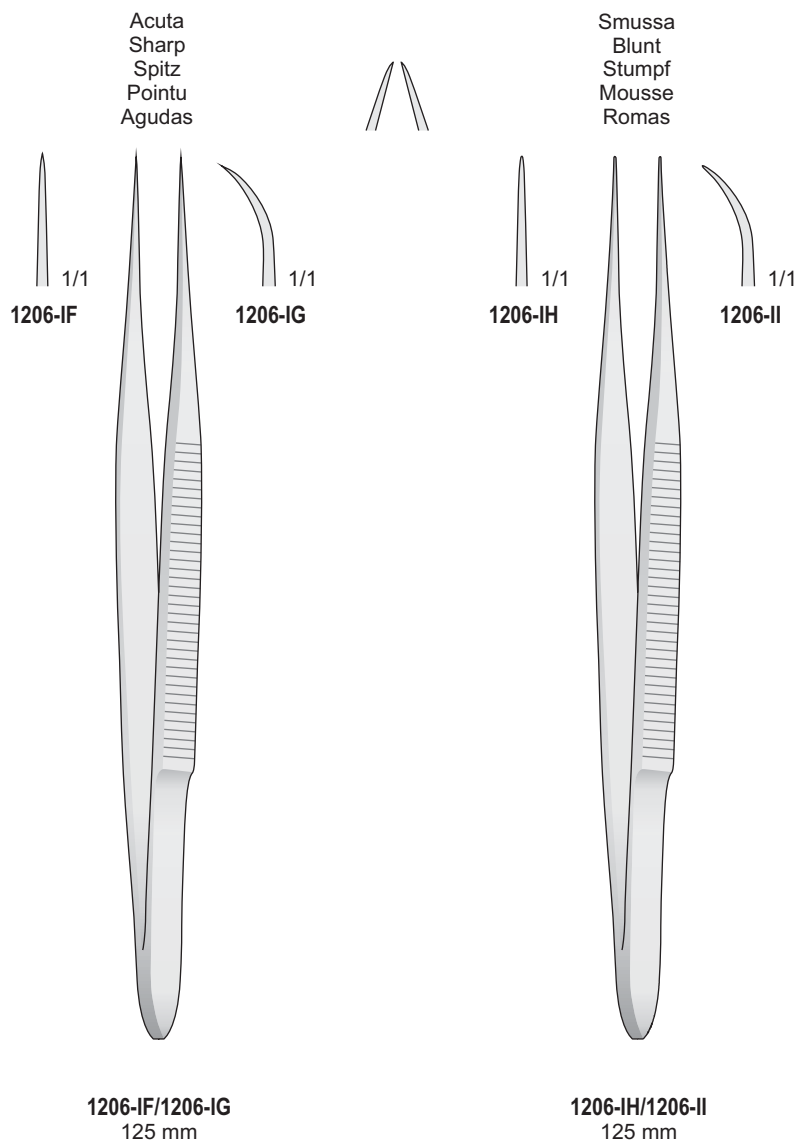

Micro Pinzette  
anatomiche

Dressing  
Micro Forceps

Anatomische  
Mikro Pinzetten

Micro pinces  
anatomiques

Pinzas finas  
de diseccion

Acuta  
Sharp  
Spitz  
Pointu  
Agudas

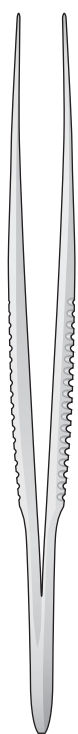

1206-HH 1206-HI

1206-HH/1206-HI  
95 mm

Smussa  
Blunt  
Stumpf  
Mousse  
Romas

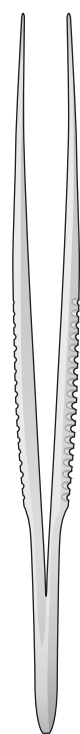

1206-HL 1206-IA

1206-HL/1206-IA  
95 mm

Acuta  
Sharp  
Spitz  
Pointu  
Agudas



1206-IB/1206-IC  
125 mm



1206-IB 1206-IC

Smussa  
Blunt  
Stumpf  
Mousse  
Romas



1206-ID/1206-IE  
125 mm

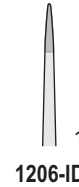

1206-ID 1206-IE

Set microchirurgia oftalmica  
Instrument sets  
Operationsbestecke

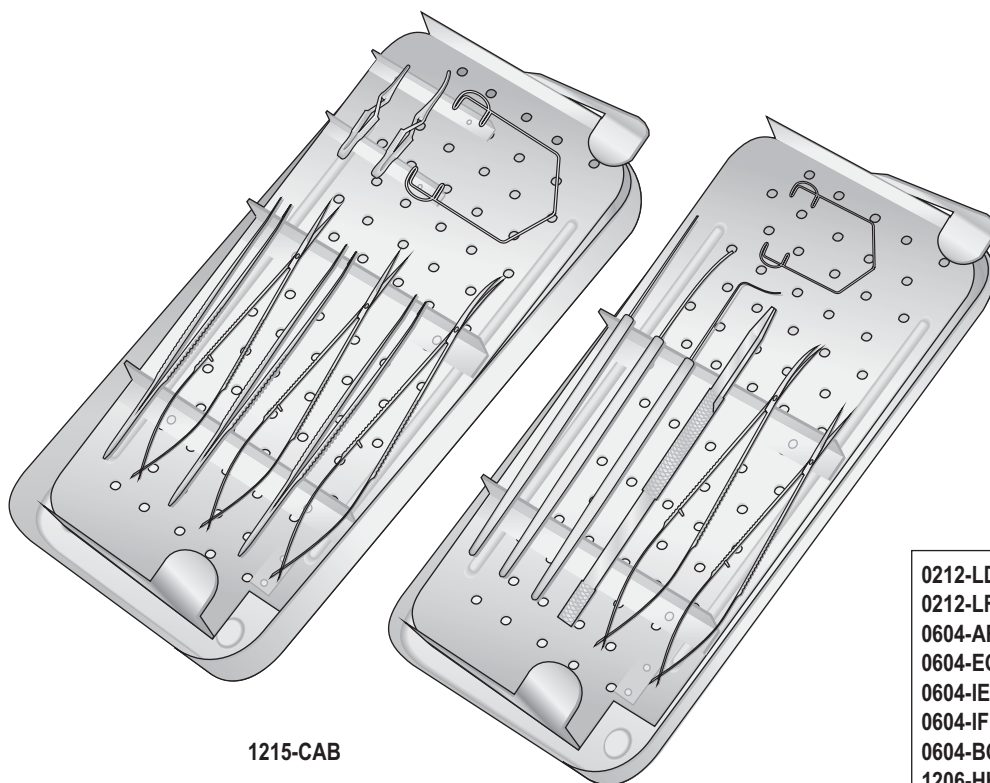

1215-CAB

**1215-CAB**  
Consisting

- 0212-LD - Bulldog diritta cm. 4
- 0212-LF - Bulldog diritta cm. 4,5
- 0604-AF - Micro forbice curva cm. 11
- 0604-EC - Micro forbice curva cm. 12
- 0604-IE - Micro pinzetta diritta cm. 11
- 0604-IF - Micro pinzetta curva cm. 11
- 0604-BCE - Micro pinzetta 1x2 denti cm. 11
- 1206-HH - Micro pinzetta diritta cm. 9,5
- 1206-HL - Micro pinzetta diritta cm. 9,5
- 1310-BC - Porta lame per micro cm. 12
- 1310-BI - Micro bisturi Graefe cm. 13
- 1310-CD - Micro divar. Castrovejo cm. 13
- 1310-CI - Micro spatole Wecker cm. 13
- 1310-GA - Micro pinzetta Colibri cm. 8
- 1310-IA - Blefarostato Barraquer mm. 27x5



1215-CBA

**1215-CBA**  
Consisting

- 0219-BG - Micro divar. Gillies # 2
- 0402-CB - Curette Day cm. 16
- 0604-FE - Micro forbice curva cm. 16
- 0504-BDF - Micro forbice diritta cm. 16
- 0604-BFI - Micro port'aghi dir. cm. 15
- 0604-BFL - Micro port'aghi curvo cm. 15
- 1206-FI - Micro pinzetta 1x2 denti cm. 15
- 1206-GE - Micro pinzetta 1x2 denti cm. 15
- 1206-LD - Micro pinzetta diritta cm. 15
- 1206-LE - Micro pinzetta curva cm. 15

Set microchirurgia oftalmica  
Instrument sets  
Operationsbestecke

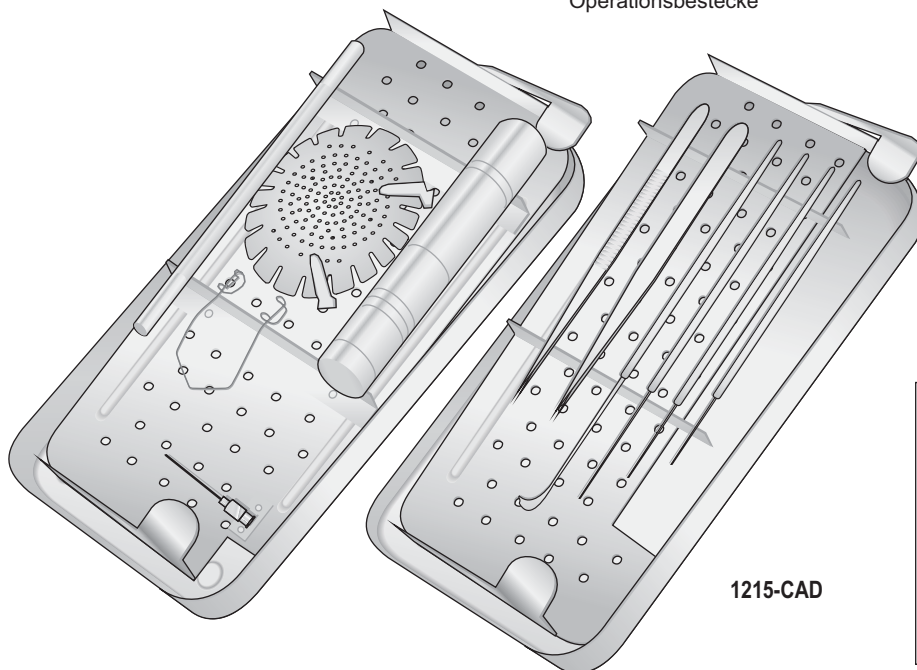

1215-CAD

**1215-CAD**  
Consisting

- 0204-CAE - Micro pinzetta cm. 12
- 0219-HA - Div. Desmarres mm. 10
- 1206-LH - Micro pinzetta cm. 8,5
- 1310-AL - Bisturi Ellis cm. 12
- 1310-EI - Spatola Kimura cm. 15
- 1310-HL - Blefarostato Barraquer mm.27
- 1310-LH - Dilatatore Wilder #1
- 1310-DLI - Pseudo sfera piombo
- 1411-CA - Occlusore alluminio mm. 75

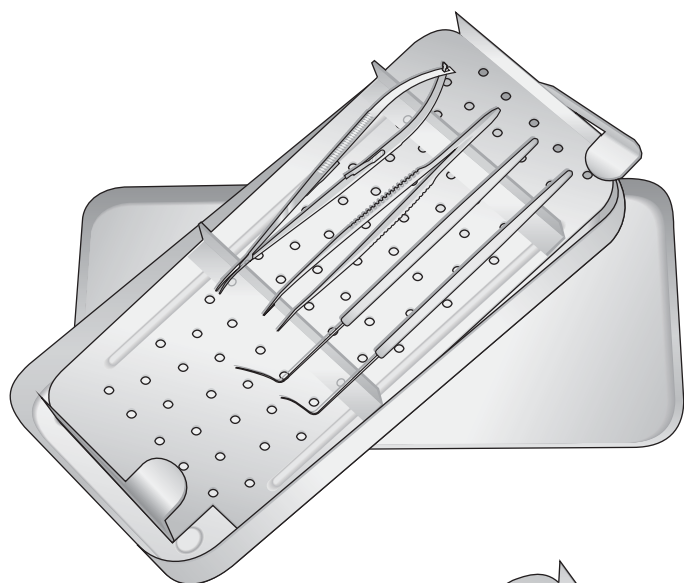

1215-CAE

**1215-CAE**  
Consisting

- 0204-CDF - Micro pinzetta cm. 12
- 0604-BDC - Micro pinzetta cm. 11
- 1310-HE - Micro divaricatore mm. 0,2
- 1310-HF - Uncino angolato cm. 13

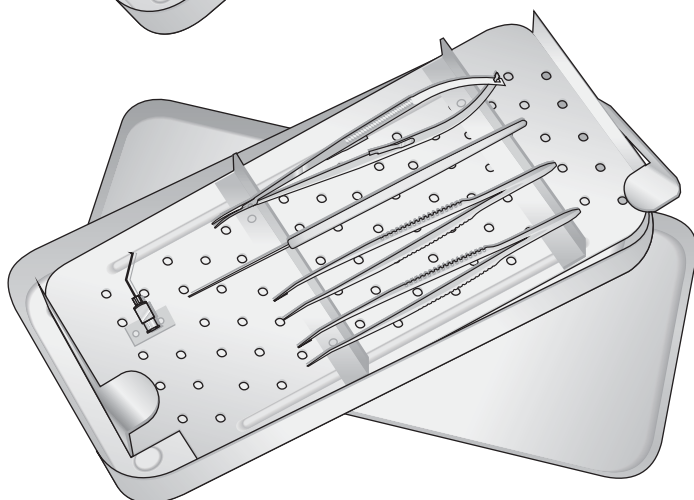

1215-CAG

**1215-CAG**  
Consisting

- 0604-BBI - Micro pinzetta 1x2 denti cm. 9,5
- 0604-BCD - Micro pinzetta McPerson cm. 9,5
- 0604-BDC - Micro pinzetta cristallino cm. 11
- 1310-LD - Micro spatola mm. 0,2
- 1411-FD - Ago lacrimale curvo mm. 35

Set microchirurgia oftalmica  
Instrument sets  
Operationsbestecke

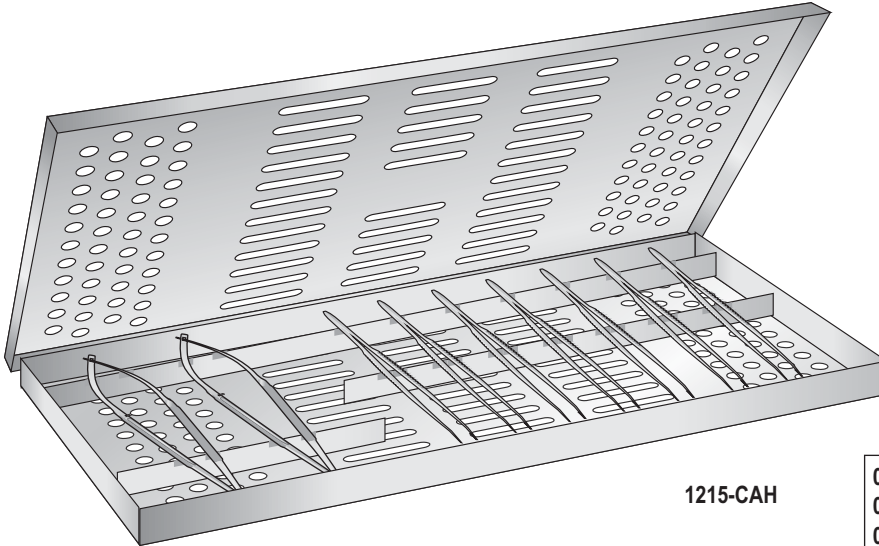

1215-CAH

**1215-CAH**  
Consisting

- 0604-BBI- Micro pinzetta 1x2 denti cm. 9,5
- 0604-BCD Micro pinzetta McPherson cm. 9,5
- 0604-BDG Micro pinzetta cristallino cm. 11
- 0604-BDG Micro pinzetta angolata cm. 11
- 1206-DE - Micro pinzetta 1x2 denti cm. 9,5
- 1206-EA - Micro pinzetta 1x2 denti cm. 9,5
- 1206-HL - Micro pinzetta diritta cm. 9,5
- 1206-IA - Micro pinzetta curva cm. 9,5
- 1310-GL - Micro pinzetta Colibri cm. 9,5

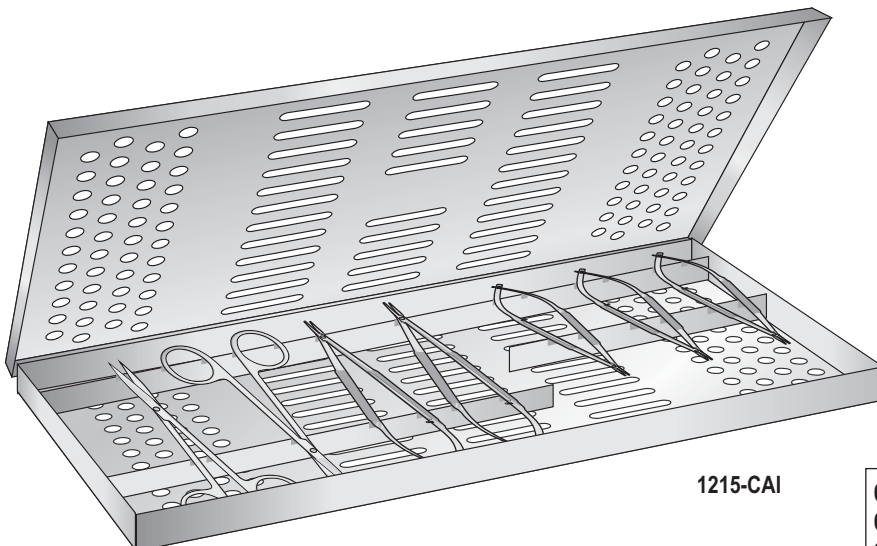

1215-CAI

**1215-CAI**  
Consisting

- 0604-GL - Micro forbice Troutmann dx. cm. 11
- 0604-HA - Micro forbice Troutmann sx. cm. 11
- 0604-HL - Micro forbice Vannas cm. 8,5
- 0604-IA - Micro forbice Vannas cm. 8,5
- 0604-IB - Micro forbice Vannas cm. 8,5
- 0607-B - Forbice Iris diritta cm. 11
- 0607-C - Forbice Iris curva cm. 11

Set microchirurgia oftalmica  
Instrument sets  
Operationsbestecke

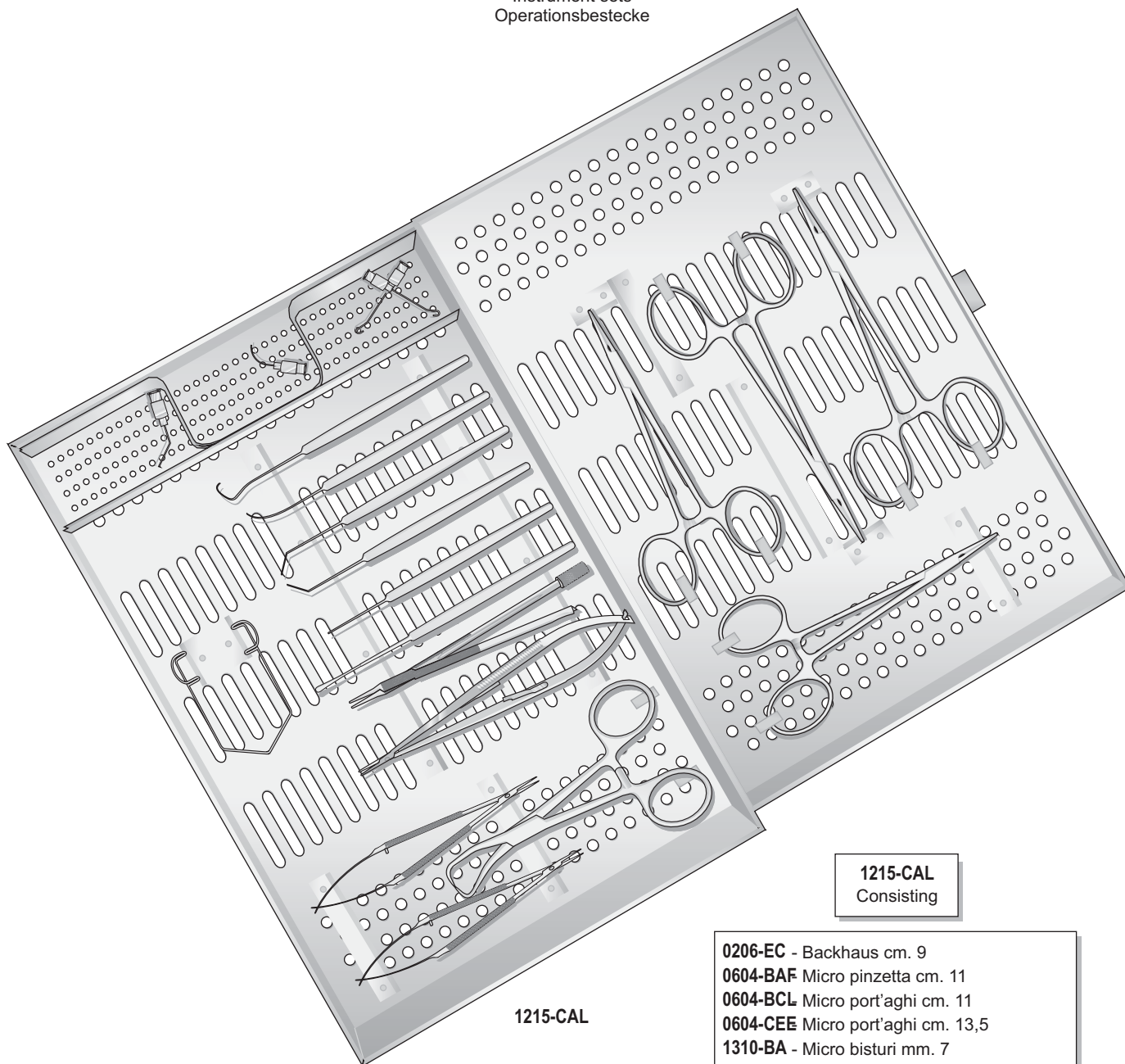

1215-CAL

**1215-CAL**  
Consisting

- 0206-EC - Backhaus cm. 9
- 0604-BAF Micro pinzetta cm. 11
- 0604-BCL Micro port'aghi cm. 11
- 0604-CEE Micro port'aghi cm. 13,5
- 1310-BA - Micro bisturi mm. 7
- 1310-BC - Portalame per micro cm. 12
- 1310-EF - Micro divaricatore Snellen cm. 12
- 1310-FL - Uncino Arruga cm. 14
- 1310-IE - Blefarostato Barraquer mm. 42x12
- 1310-LD - Micro spatola mm. 0,2
- 1310-BBA Micro spatola mm. 0,6
- 1310-BBB Micro spatola mm. 1
- 1411-FB - Ago lacrimale curvo mm. 30
- 1411-FC - Ago lacrimale 15° Sx.
- 1411-FD - Ago lacrimale 15° Dx.
- 1411-FA - Ago lacrimale curvo mm. 35
- 15-LB - Halstead diritta cm. 12,5
- 15-BBB - Pinza Anat. Diritta cm. 14



ideal-tek

manufacturer & supplier of precision instruments 

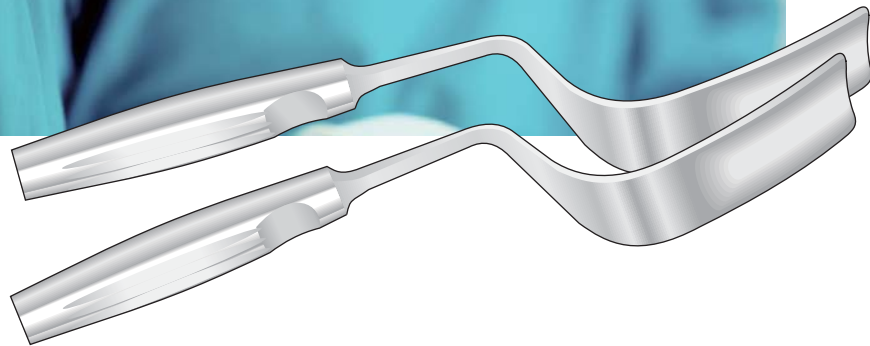

16

Urologia, Ginecologia  
Urology, Gynecology  
Urologie, Gynäkologie  
Urologie, Gynécologie  
Urologia, Ginecologia





Pinze per  
calcoli renali

Kidney stone  
forceps

Nierensteinzangen

Pinces pour  
les calculs renaux

Pinzas para  
cálculos renales

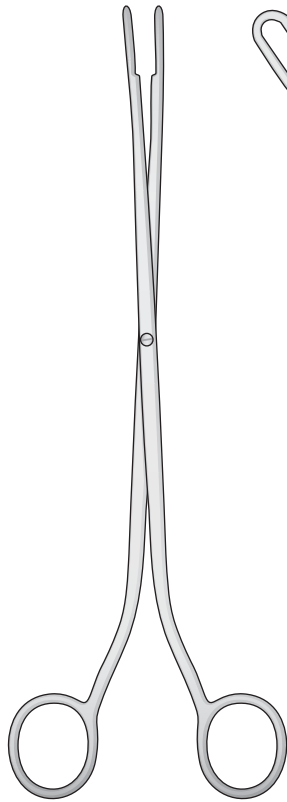

DESJARDINS  
0502-BB/0502-BE  
225 mm

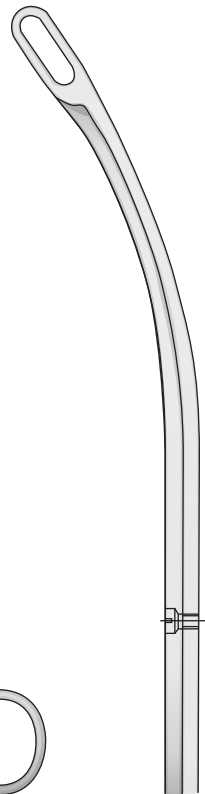

Fig. 1



0502-BB

Fig. 2



0502-BC

Fig. 3



0502-BD

Fig. 4



0502-BE

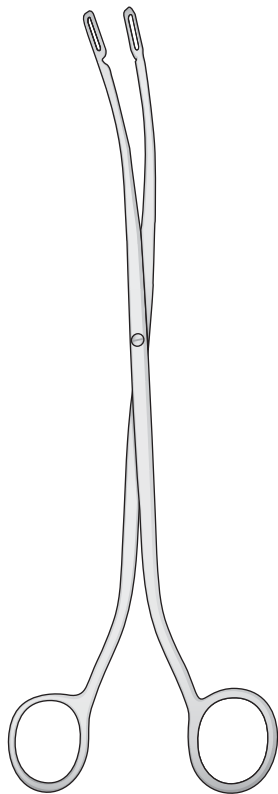

RANDALL  
0502-DG/0502-DL  
225 mm

Fig. 1

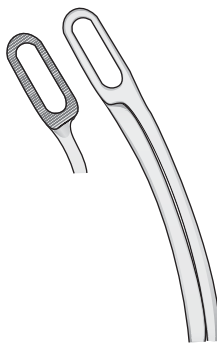

0502-DG

Fig. 2



0502-DH

Fig. 3

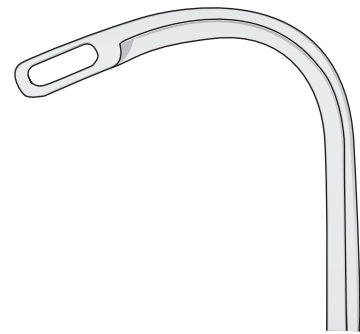

0502-DI

Fig. 4



0502-DL

**Cateteri**  
**Sonde metalliche**

**Catheters metal**

**Katheterspanner**  
**Metallkatheter**

**Sondes métalliques**

**Catéteres**  
**Sondas metálicas**

Strumenti per tendere ed introdurre i cateteri  
Catheter introducing instruments  
Katheter-Einführungsinstrumente  
Mandrin pour introduire les sondes  
Instrumentos para introducir catéteres

Ø 1,2 mm

Ø 3 mm

Ø 3 mm

Ø 2,7 mm

Per uomini  
For men  
Für Männer  
Pour hommes  
Para hombres

Charr.

<b>0501-GA</b>	8
<b>0501-GC</b>	10
<b>0501-GD</b>	12
<b>0501-GE</b>	14
<b>0501-GF</b>	16
<b>0501-GG</b>	18
<b>0501-GH</b>	20

Per donne  
For woman  
Für Frauen  
Pour femmes  
Para mujeres

Charr.

<b>0501-HA</b>	6
<b>0501-HC</b>	8
<b>0501-HE</b>	10
<b>0501-HG</b>	12
<b>0501-HH</b>	14
<b>0501-HI</b>	16
<b>0501-HL</b>	18

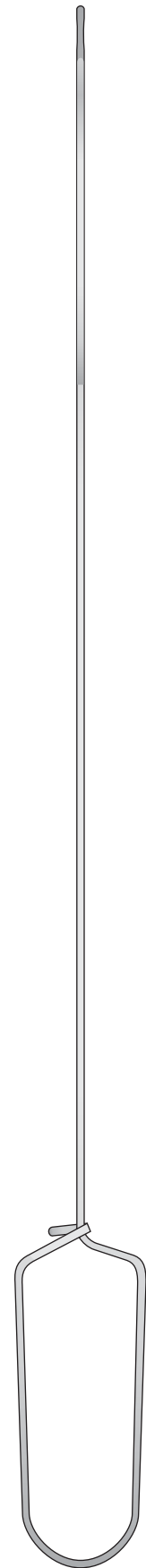
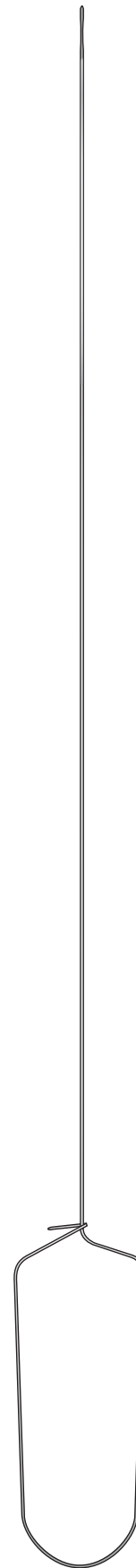
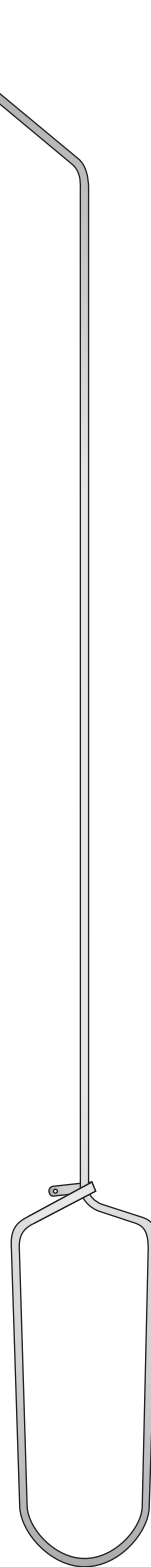
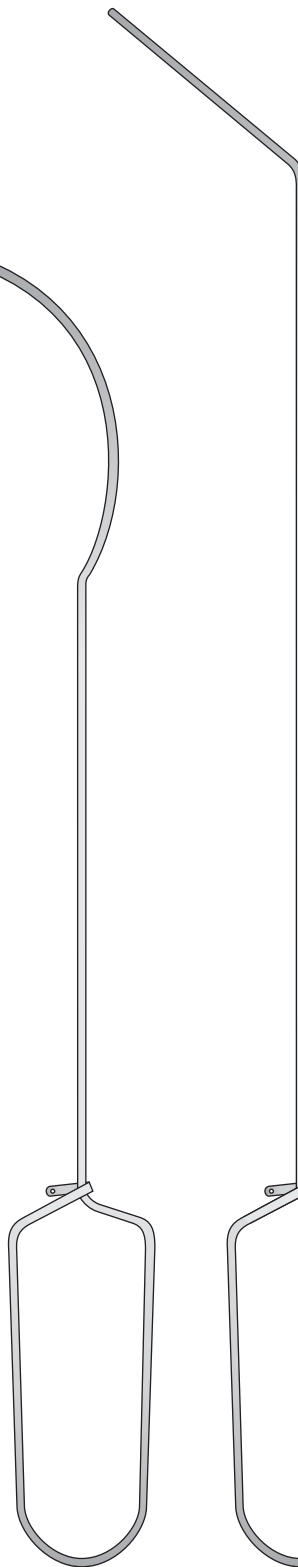
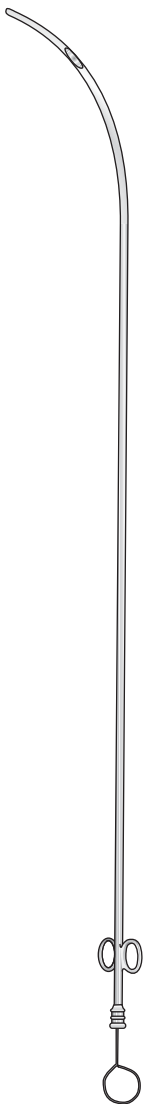

**0501-GA/0501-GH**  
290 mm

**0501-HA/0501-HL**  
160 mm

**GUYON**  
**0501-LA**  
365 mm

**BENIQUE**  
**0501-LB**  
410 mm

**0501-LD**  
460 mm

**0501-LC**  
460 mm

Dilatatori per  
vie biliari

Gall duct  
dilators

Gallengang-  
Dilatatoren

Dilatateurs pour  
les voies biliaires

Dilatadores para  
conductos biliares

0602-DCB - 190 mm - Ø 3 mm  
 0602-DCC - 190 mm - Ø 4 mm  
 0602-DCD - 190 mm - Ø 5 mm  
 0602-DCE - 190 mm - Ø 6 mm  
 0602-DCF - 190 mm - Ø 7 mm  
 0602-DCG - 190 mm - Ø 8 mm  
 0602-DCH - 190 mm - Ø 9 mm  
 0602-DCI - 190 mm - Ø 10 mm  
 0602-DCL - 190 mm - Ø 11 mm

0602-DDB - 300 mm - Ø 1 mm  
 0602-DDC - 300 mm - Ø 2 mm  
 0602-DDD - 300 mm - Ø 3 mm  
 0602-DDE - 300 mm - Ø 4 mm  
 0602-DDF - 300 mm - Ø 5 mm  
 0602-DDG - 300 mm - Ø 6 mm  
 0602-DDH - 300 mm - Ø 7 mm  
 0602-DDI - 300 mm - Ø 8 mm  
 0602-DDL - 300 mm - Ø 9 mm  
 0602-DEA - 300 mm - Ø 10 mm  
 0602-DEB - 300 mm - Ø 11 mm  
 0602-DEC - 300 mm - Ø 12 mm  
 0602-DED - 300 mm - Ø 13 mm

**0602-DCA**

Set di 9 pezzi con custodia  
 Set of 9 pieces in canvas pocket  
 Satz à 9 Stück in Leinentuchtasche  
 Jeu de 9 pièces dans une poche en toile  
 Juego de 9 unidades en bolsa de tela

**0602-DDA**

Set di 13 pezzi  
 Set of 13 pieces  
 Satz à 13 Stück  
 Jeu de 13 pièces  
 Juego de 13 unidades

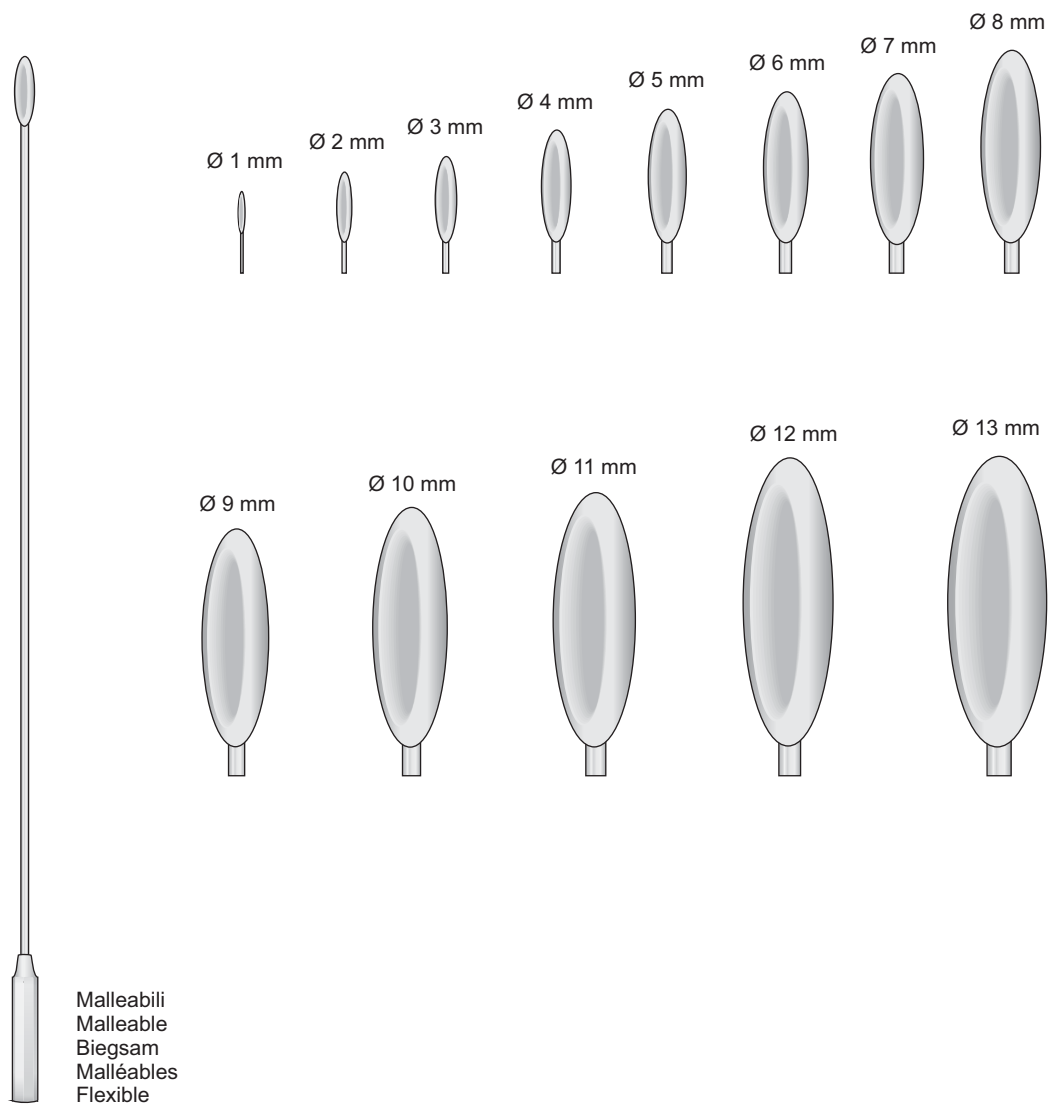

BAKES  
 0602-DCB/0602-DED

Dilatatori per  
vie biliari

Gall duct  
dilators

Gallengang-  
Dilatatoren

Dilateurs pour  
les voies biliaires

Dilatadores para  
conductos biliares



DITTEL  
0502-CFB/0502-CGH  
220 mm

	Charr.
0502-CFB	8
0502-CFC	9
0502-CFD	10
0502-CFE	11
0502-CFF	12
0502-CFG	14
0502-CFH	16
0502-CFI	18
0502-CFL	20
0502-CGA	22
0502-CGB	24
0502-CGC	25
0502-CGD	26
0502-CGE	27
0502-CGF	28
0502-CGG	29
0502-CGH	30

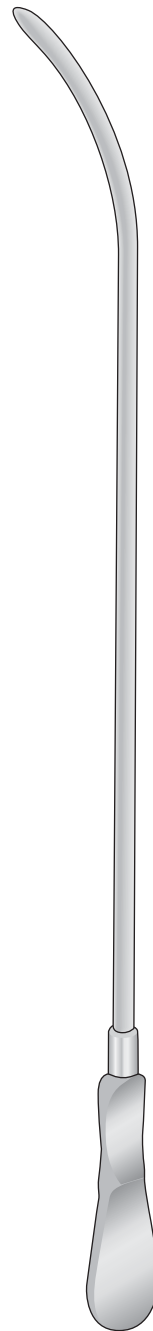

DITTEL  
0502-CAB/0502-CCD  
345 mm

	Charr.
0502-CAB	8
0502-CAC	9
0502-CAD	10
0502-CAE	11
0502-CAF	12
0502-CAG	13
0502-CAH	14
0502-CAI	15
0502-CAL	16
0502-CBA	17
0502-CBB	18
0502-CBC	19
0502-CBD	20
0502-CBE	21
0502-CBF	22
0502-CBG	23
0502-CBH	24
0502-CBI	25
0502-CBL	26
0502-CCA	27
0502-CCB	28
0502-CCC	29
0502-CCD	30

Dilatatori per  
vie biliari

Gall duct  
dilators

Gallengang-  
Dilatatoren

Dilateurs pour  
les voies biliaires

Dilatadores para  
conductos biliares

0502-EL - Ø 10 mm  1/1

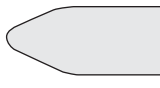
0502-EI - Ø 9 mm  1/1

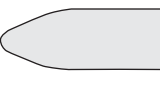
0502-EH - Ø 8 mm  1/1

0502-EG - Ø 7 mm  1/1

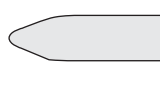
0502-EF - Ø 6 mm  1/1

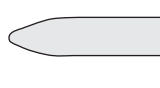
0502-EE - Ø 5 mm  1/1

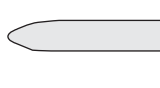
0502-ED - Ø 4 mm  1/1

0502-EC - Ø 3 mm  1/1

0502-EC/0502-EL  
190 mm

**0502-CFA**

Set completo con 19 pezzi  
 Set complete with 19 pieces  
 Kompletset mit 19 Stück  
 Set complet avec 19 pièces  
 Set completo con 19 piezas

da Ch.12 a Ch.30

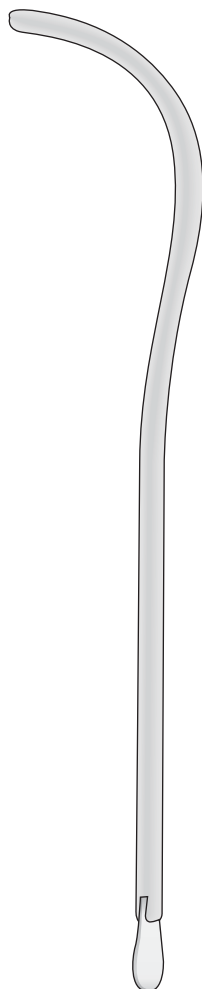

GUYON  
 0502-CDB/0502-CEL  
 255 mm

Ben. Charr.

0502-CDB	24	12
0502-CDC	26	13
0502-CDD	28	14
0502-CDE	30	15
0502-CDF	32	16
0502-CDG	34	17
0502-CDH	36	18
0502-CDI	38	19
0502-CDL	40	20
0502-CEA	42	21
0502-CEB	44	22
0502-CEC	46	23
0502-CED	48	24
0502-CEE	50	25
0502-CEF	52	26
0502-CEG	54	27
0502-CEH	56	28
0502-CEI	58	29
0502-CEL	60	30

Sonde per dotto biliare, Elastiche  
 Gall Stone Probes, Elastic  
 Gallensteinsonden, Federnd  
 Explorateurs pour calculs biliaires, Élastiques  
 Exploradores para cálculos biliares, Elásticos

Ø 4,3 mm

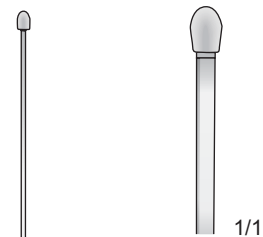

1/1

**0502-BI**

Ø 6,0 mm

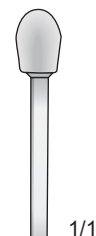

1/1

**0502-BL**

Ø 7,0 mm

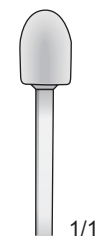

1/1

**0502-CA**



DESJARDINS  
 0502-BI/0502-CA  
 280 mm

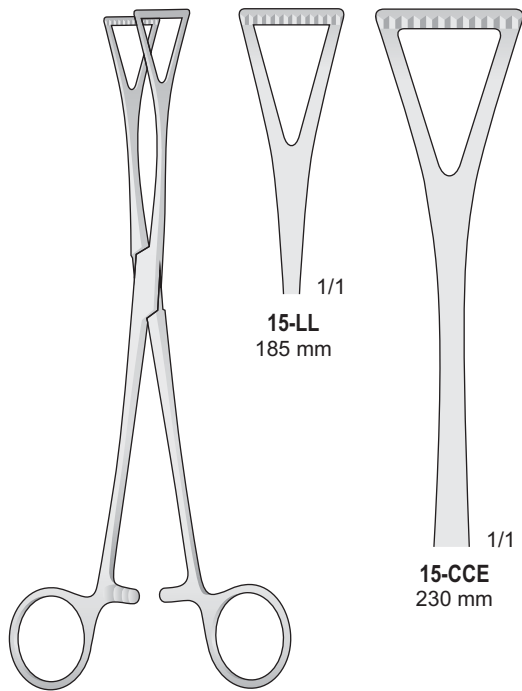

DUVAL  
15-LL/15-CCE

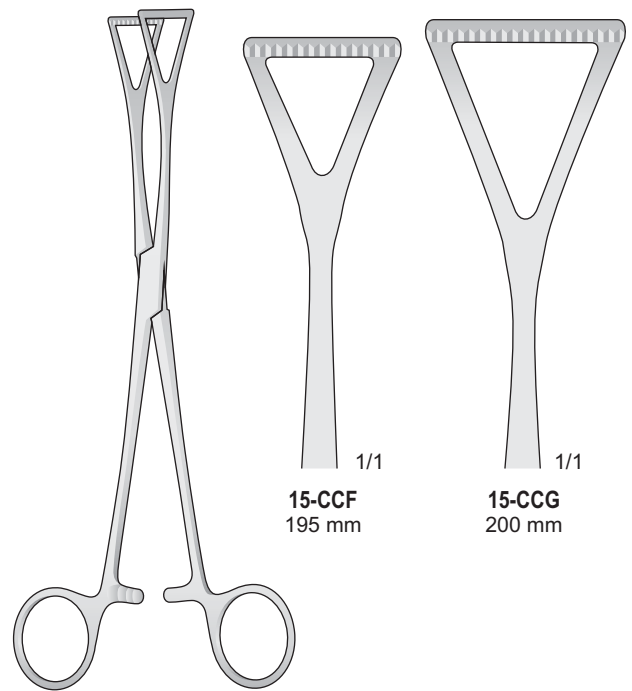

DUVAL-COLLIN  
15-CCF/15-CCG

Pinze per peduncoli renali - Kidney pedicle clamp forceps - Nierenstielklemmen  
Pincas-clamps pour pédicules rénaux - Pinzas-clamps para pedúncolos renales

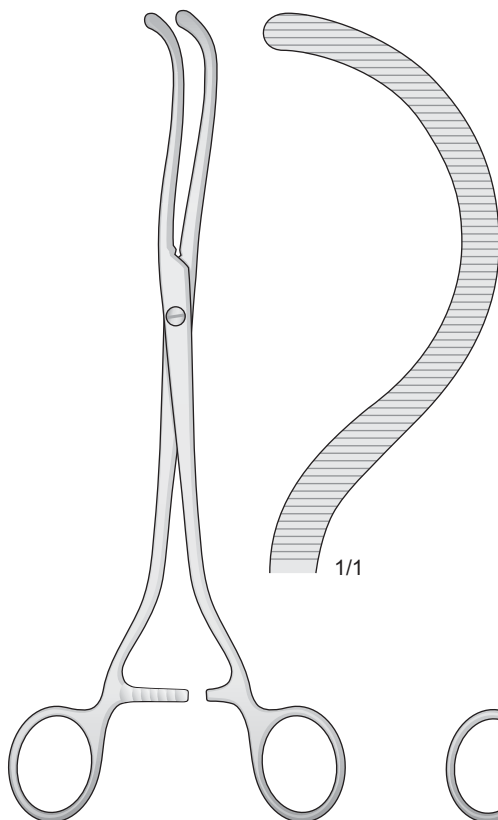

BRAUN  
0502-DA  
245 mm

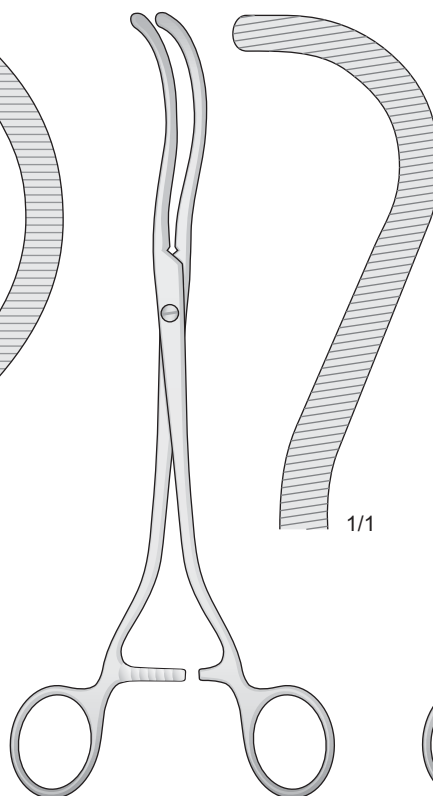

GUYON  
0502-DB  
235 mm

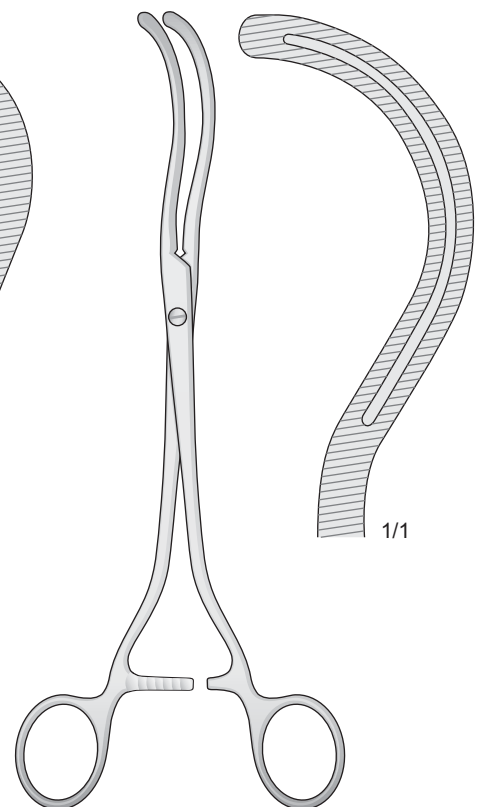

STILLE  
0502-DC  
240 mm

Pinze per  
peduncoli renali

Kidney pedicle  
forceps

Nierenklemmen

Pinces-clamps pour  
pédicules rénaux

Pinzas para  
pedúnculos renales

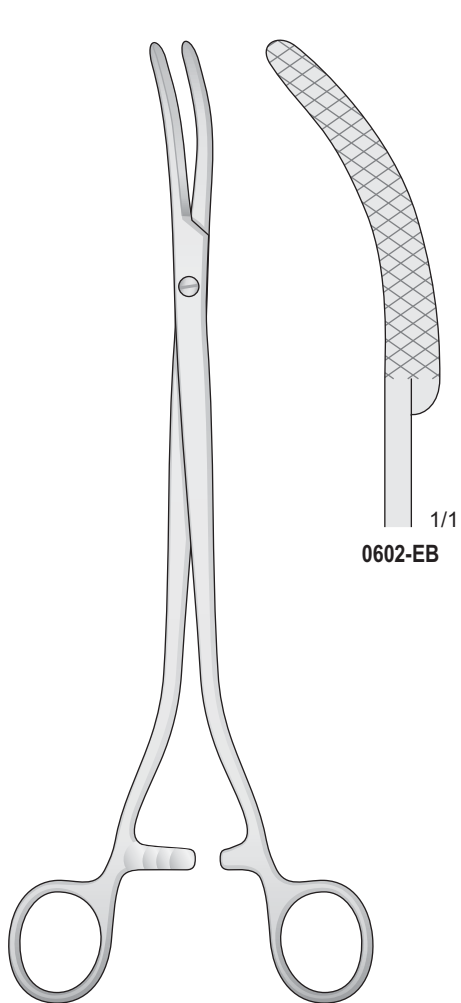

WERTHEIM  
0602-EB  
260 mm

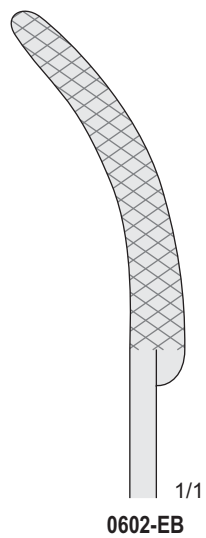

0602-EB

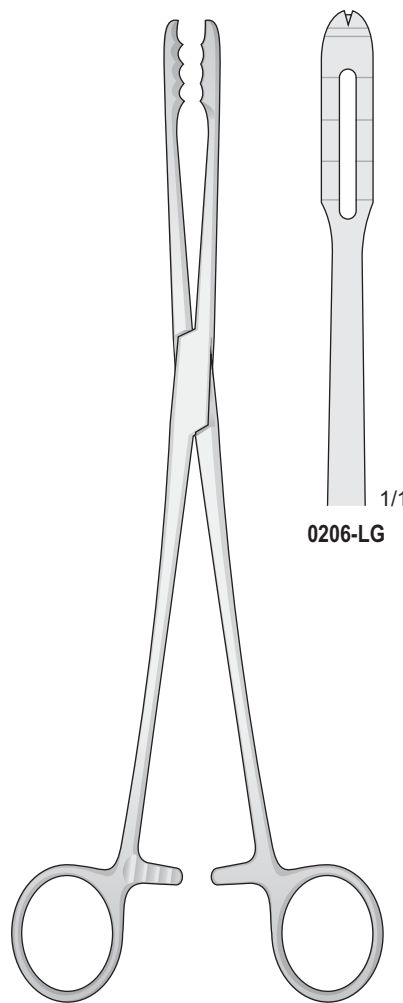

0206-LG/0206-LH  
265 mm

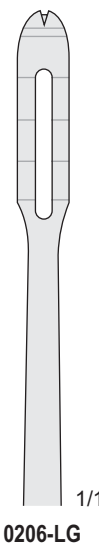

0206-LG

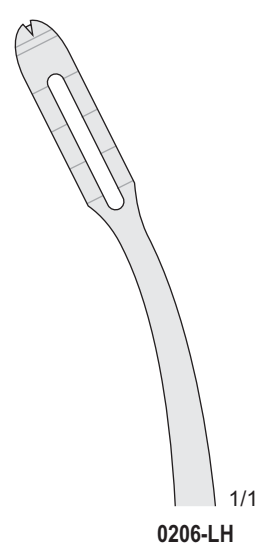

0206-LH



Pinze per  
peduncoli renali

Kidney pedicle  
forceps

Nierenklemmen

Pinces-clamps pour  
pédicules rénaux

Pinzas para  
pedúnculos renales

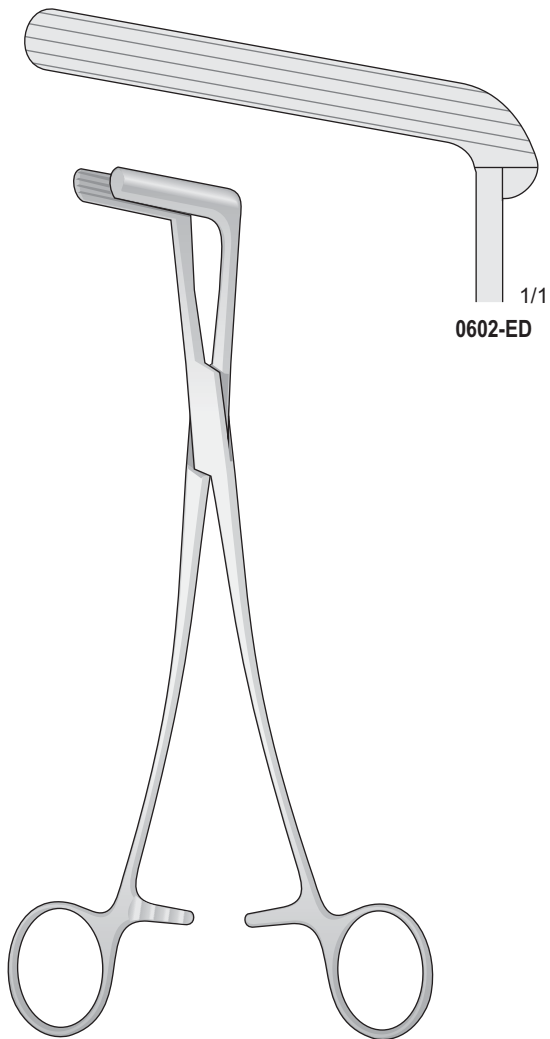

WERTHEIM  
0602-ED  
235 mm

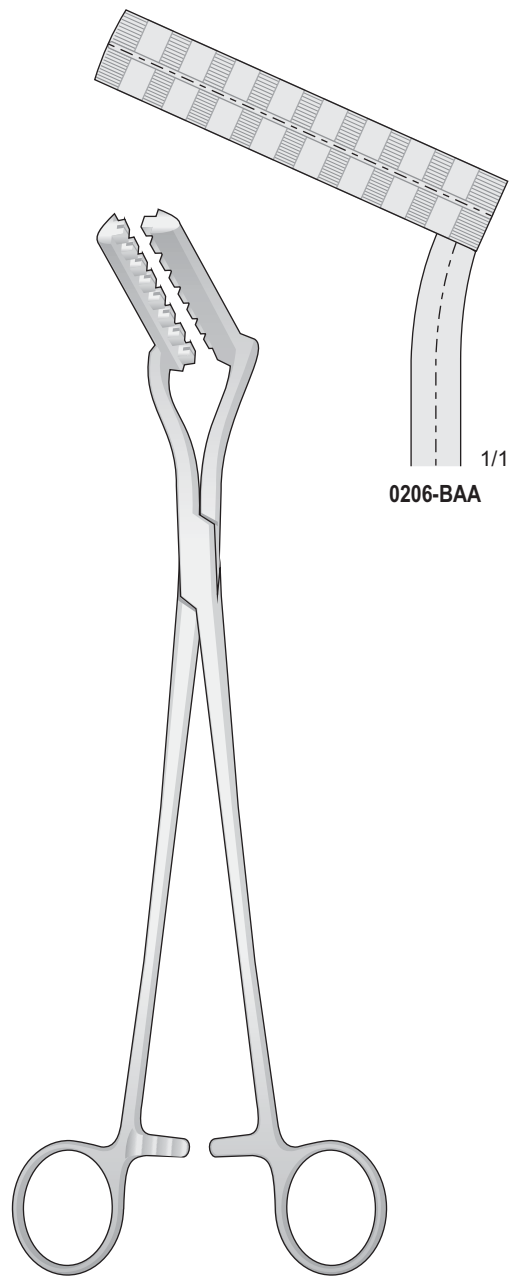

0206-BAA  
280 mm

Pinze da placenta e aborto

Placenta and ovum forceps

Placentar und Abortuszangen

Pinces à faux germes

Pinzas para aborte

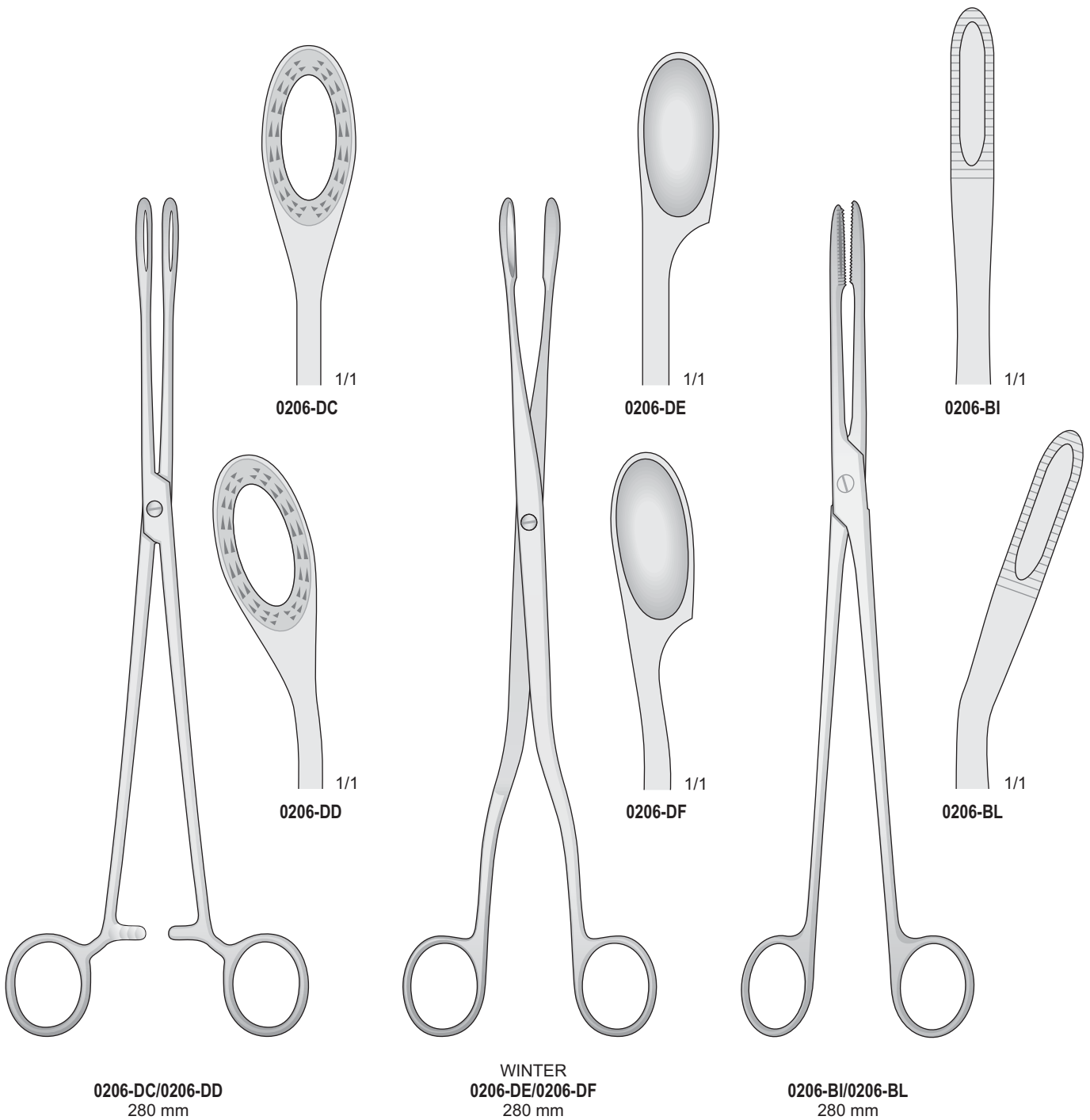

Pinze per tamponi  
Pinze emostatiche

Cotton Swab forceps  
Artery forceps

Tupferzangen  
Arterienklemmen

Pinces à tampons  
Pinces hemostâtiques

Pinzas para tampones  
Pinzas hemostáticas

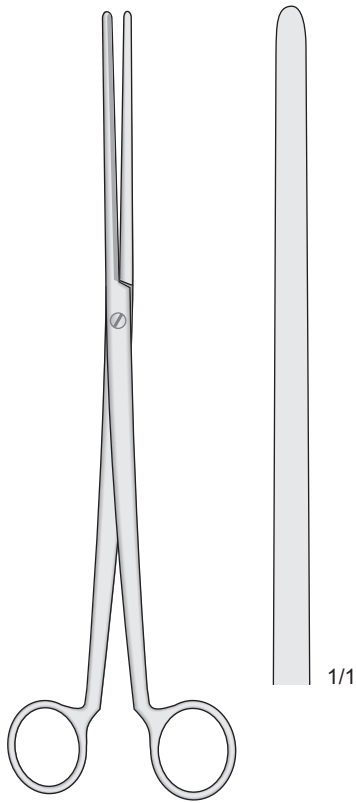

COLLIN  
0206-AD  
260 mm

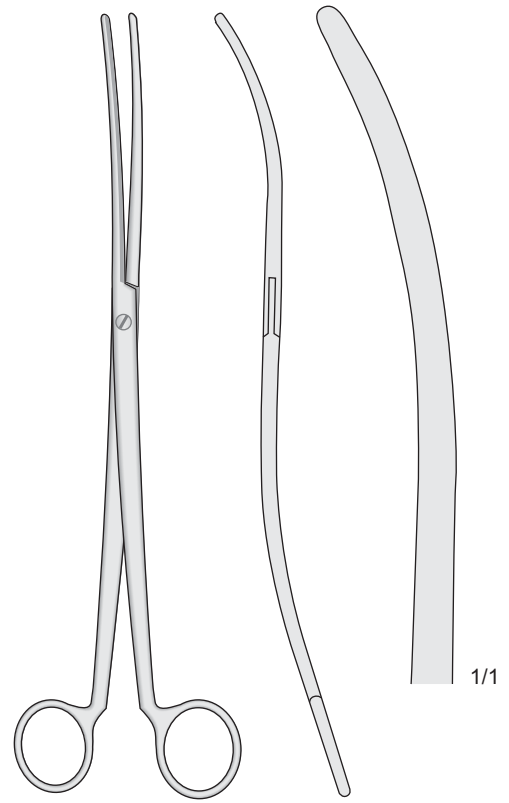

COLLIN  
0206-AE  
260 mm

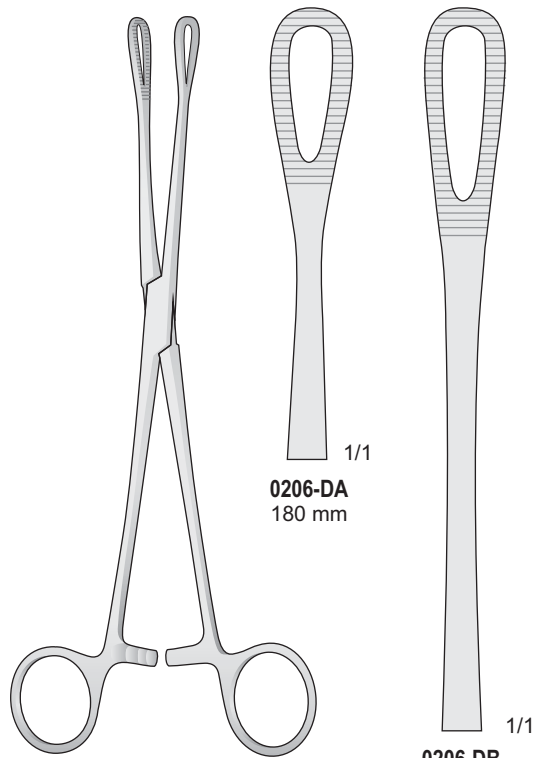

RAMPLEY  
0206-DA/0206-DB

0206-DA  
180 mm

0206-DB  
245 mm

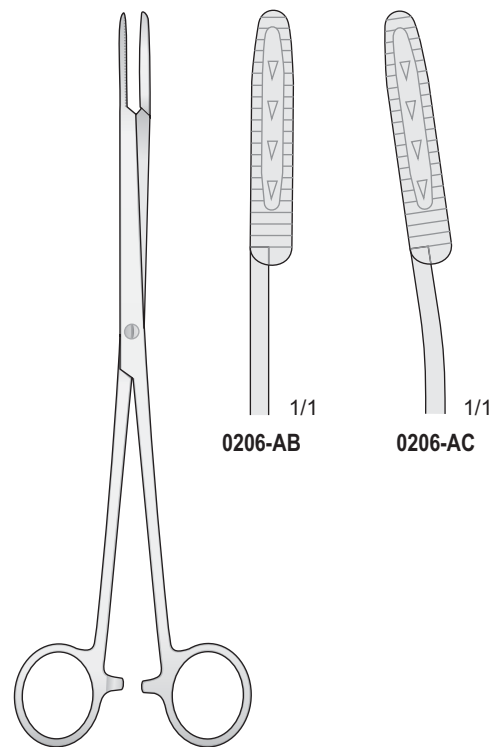

MAIER  
0206-AB/0206-AC  
245 mm

0206-AB

0206-AC

Speculum vaginali

Vaginal specula

Scheidenspekula

Spéculums vaginaux

Espéculos vaginales

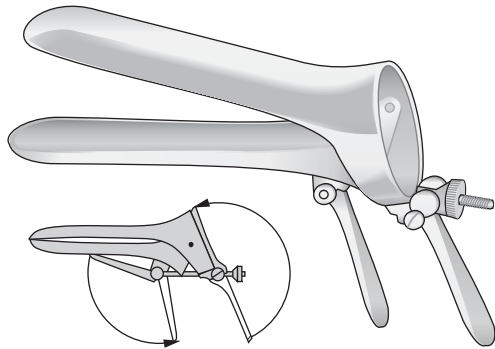

**CUSCO**  
**0517-EL** Fig. 0 77x17 mm  
**0517-EI** Fig. 1 75x33 mm  
**0517-EH** Fig. 2 86x36 mm  
**0517-EG** Fig. 3 97x36 mm

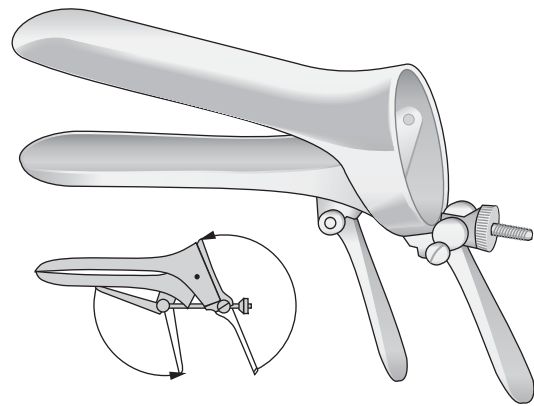

**CUSCO**  
**SCHWEIZER MODELL**  
**0517-GB** Fig.1 90x23 mm  
**0517-GC** Fig.2 100x24 mm  
**0517-GD** Fig.3 105x27 mm

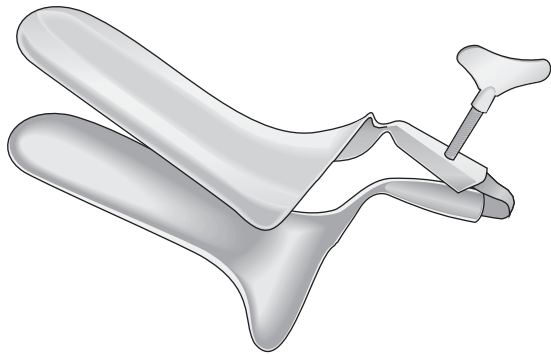

**COLLIN-STANDARD**  
**0517-HC** Fig. 1 90x29 mm  
**0517-HD** Fig. 2 95x35 mm  
**0517-HE** Fig. 3 110x40 mm

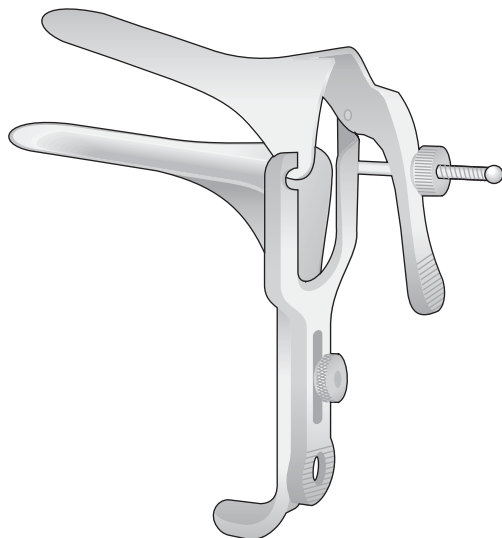

**GRAVE**  
**0517-LB** 75x20 mm  
**0517-LC** 95x30 mm  
**0517-LD** 105x33 mm

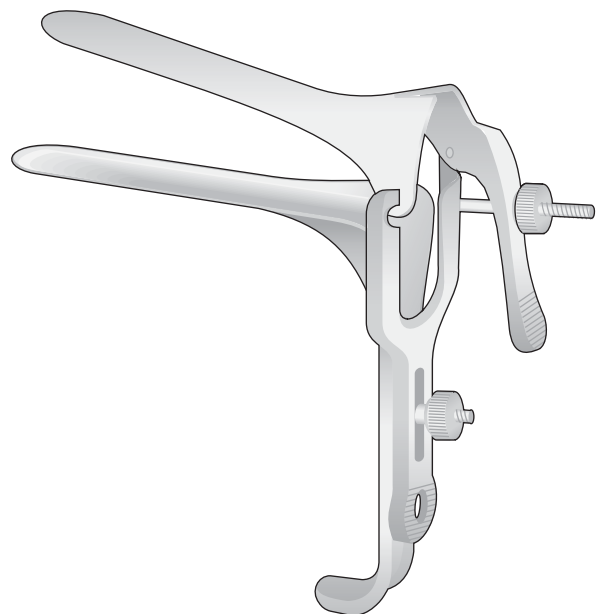

**PEDERSON**  
**0517-LG** 100x22 mm  
**0517-LH** 120x25 mm

Speculum e valve vaginali

Vaginal specula

Scheidenspekula und halter

Spéculums et valves vaginaux

Espéculos vaginales



KALLMORGEN  
0502-BAB - 70 x 40 mm  
170 mm

0502-BAC - 70 x 33 mm  
170 mm

**0502-BAA**  
Set 2 pezzi - Set 2 pieces  
Set 2 stück - Set 2 pièces  
Set 2 piezas  
70 x 40 mm  
70 x 33 mm

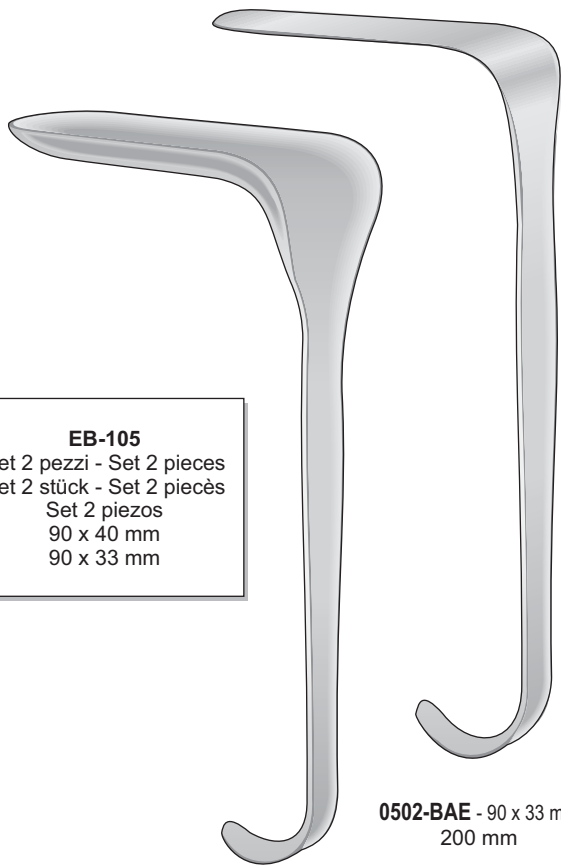

KALLMORGEN  
0502-BAD - 90 x 40 mm  
200 mm

0502-BAE - 90 x 33 mm  
200 mm

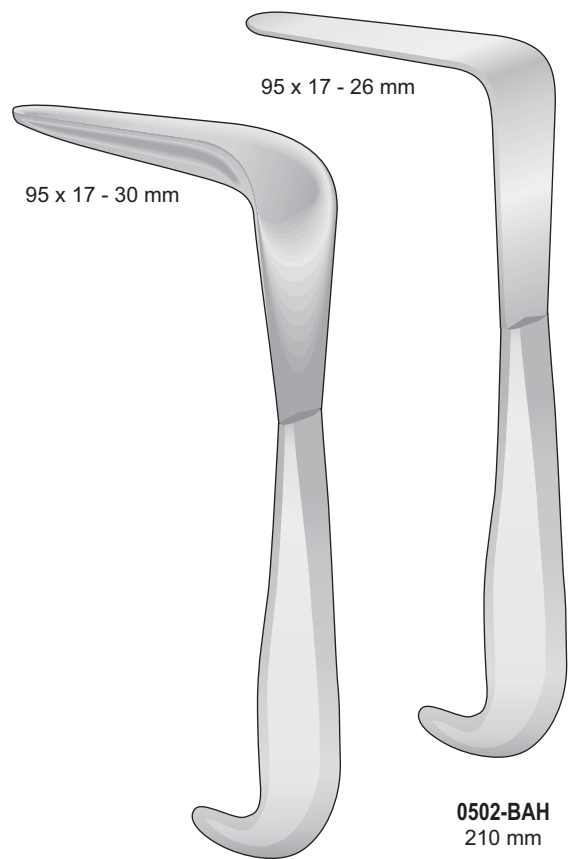

MATHIEU  
0502-BAG  
210 mm

0502-BAH  
210 mm

**EB-105**  
Set 2 pezzi - Set 2 pieces  
Set 2 stück - Set 2 pièces  
Set 2 piezas  
90 x 40 mm  
90 x 33 mm

95 x 17 - 30 mm  
95 x 17 - 26 mm

**Speculum e valve vaginali**

**Vaginal specula**

**Scheidenspekula und halter**

**Spéculums et valves vaginaux**

**Espéculos vaginales**

Speculum  
Spekula  
Specula  
Spéculums  
Espéculos



**KRISTELLER**

- Fig. 1 **0502-BCA** - 70 x 27 mm
- Fig. 2 **0502-BCB** - 75 x 30 mm
- Fig. 3 **0502-BCC** - 90 x 36 mm

Valva  
Halter  
Retractors  
Valves  
Valvas



**KRISTELLER**

- Fig. 1 **0502-BCD** - 75 x 23 mm
- Fig. 2 **0502-BCE** - 80 x 26 mm
- Fig. 3 **0502-BCF** - 95 x 32 mm

Speculum + Valva  
Specula + Retractor  
Spekula + Halter  
Spéculum + Valve  
Espéculo + Valva



- Fig. 1 **0502-BCG**
- Fig. 2 **0502-BCH**
- Fig. 3 **0502-BCI**

Speculum  
Spekula  
Specula  
Spéculums  
Espéculos



**KRISTELLER**

- Fig. 00 **0502-BDA** - 110 x 18 mm
- Fig. 0 **0502-BDB** - 110 x 21 mm
- Fig. 1 **0502-BDC** - 110 x 27 mm
- Fig. 2 **0502-BDD** - 110 x 30 mm
- Fig. 3 **0502-BDE** - 110 x 36 mm

Valva  
Halter  
Retractors  
Valves  
Valvas



**KRISTELLER**

- Fig. 00 **0502-BDF** - 115 x 14 mm
- Fig. 0 **0502-BDG** - 115 x 17 mm
- Fig. 1 **0502-BDH** - 115 x 23 mm
- Fig. 2 **0502-BDI** - 115 x 26 mm
- Fig. 3 **0502-BDL** - 115 x 32 mm

Speculum + Valva  
Specula + Retractor  
Spekula + Halter  
Spéculum + Valve  
Espéculo + Valva



- Fig. 00 **0502-BEA**
- Fig. 0 **0502-BEB**
- Fig. 1 **0502-BEC**
- Fig. 2 **0502-BED**
- Fig. 3 **0502-BEE**

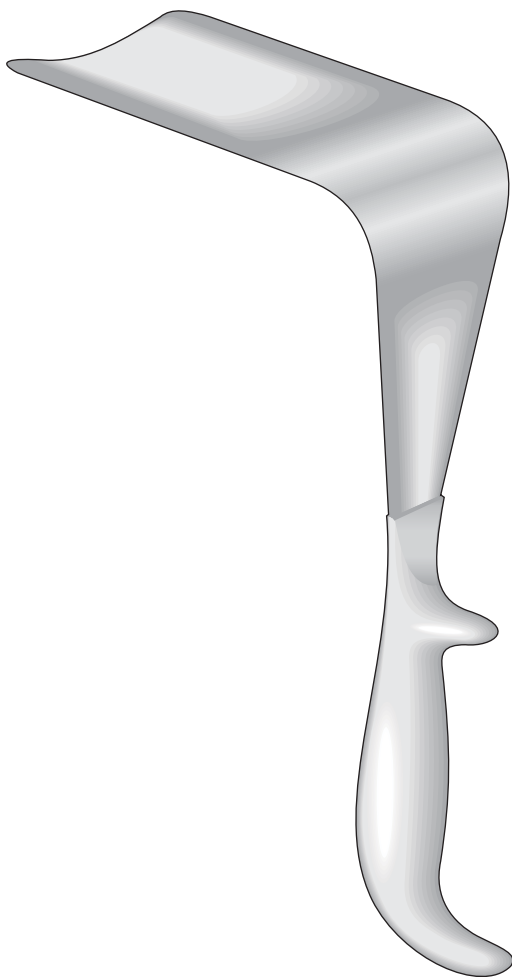

DOYEN  
0502-BFA/0502-BGG  
240 mm

- |        |                               |
|--------|-------------------------------|
| Fig. 1 | <b>0502-BFA</b> - 60 x 35 mm  |
| Fig. 2 | <b>0502-BFB</b> - 90 x 35 mm  |
| Fig. 3 | <b>0502-BFC</b> - 120 x 35 mm |
| Fig. 1 | <b>0502-BFG</b> - 60 x 45 mm  |
| Fig. 2 | <b>0502-BFH</b> - 90 x 45 mm  |
| Fig. 3 | <b>0502-BFI</b> - 120 x 45 mm |
| Fig. 4 | <b>0502-BGA</b> - 160 x 45 mm |
| Fig. 1 | <b>0502-BGC</b> - 60 x 60 mm  |
| Fig. 2 | <b>0502-BGD</b> - 90 x 60 mm  |
| Fig. 3 | <b>0502-BGE</b> - 120 x 60 mm |
| Fig. 4 | <b>0502-BGG</b> - 160 x 60 mm |



LANDAU  
0502-BLA/0502-BLB  
290 mm

- |                               |
|-------------------------------|
| <b>0502-BLA</b> - 100 x 28 mm |
| <b>0502-BLB</b> - 100 x 38 mm |



**BREISKY**

- 0502-BHA** - 100 x 20 mm
- 0502-BHB** - 100 x 25 mm
- 0502-BHC** - 100 x 30 mm
- 0502-BHD** - 100 x 35 mm
- 0502-BHE** - 100 x 40 mm
- 290 mm

**BREISKY**

- 0502-BHF** - 130 x 20 mm
- 0502-BHG** - 130 x 25 mm
- 0502-BHH** - 130 x 30 mm
- 0502-BHI** - 130 x 35 mm
- 0502-BHL** - 130 x 40 mm
- 320 mm

**BREISKY**

- 0502-BIE** - 160 x 40 mm
- 350 mm

**BREISKY**

- 0502-BIL** - 180 x 40 mm
- 370 mm



Dilatatori uterini

Uterine dilators

Uterus-Dilatatoren

Dilateurs du col de l'utérus

Dilatadores uterinos

Hegar Dilatatori - Hegar Dilators - Hegar Dilatatoren - Hegar Dilateur - Hegar Dilatadores

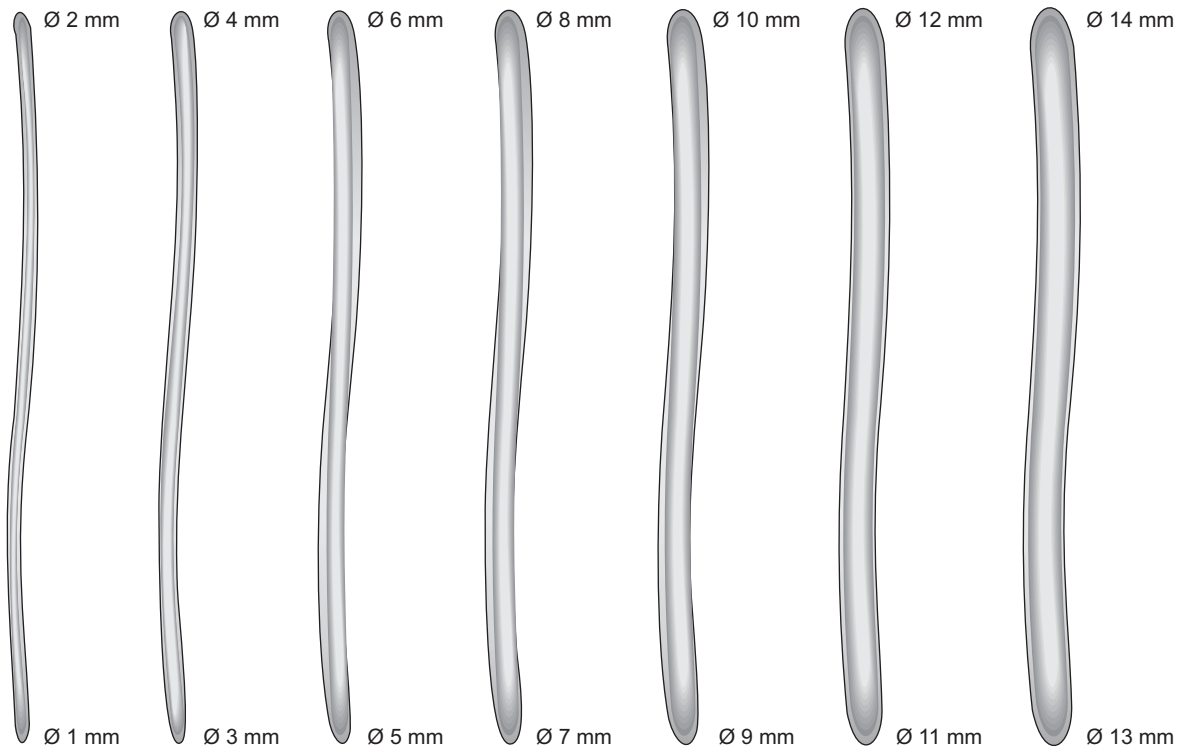

0517-BCA  
200 mm

0517-BCB  
200 mm

0517-BCC  
200 mm

0517-BCD  
200 mm

0517-BCE  
200 mm

0517-BCF  
200 mm

0517-BCG  
200 mm

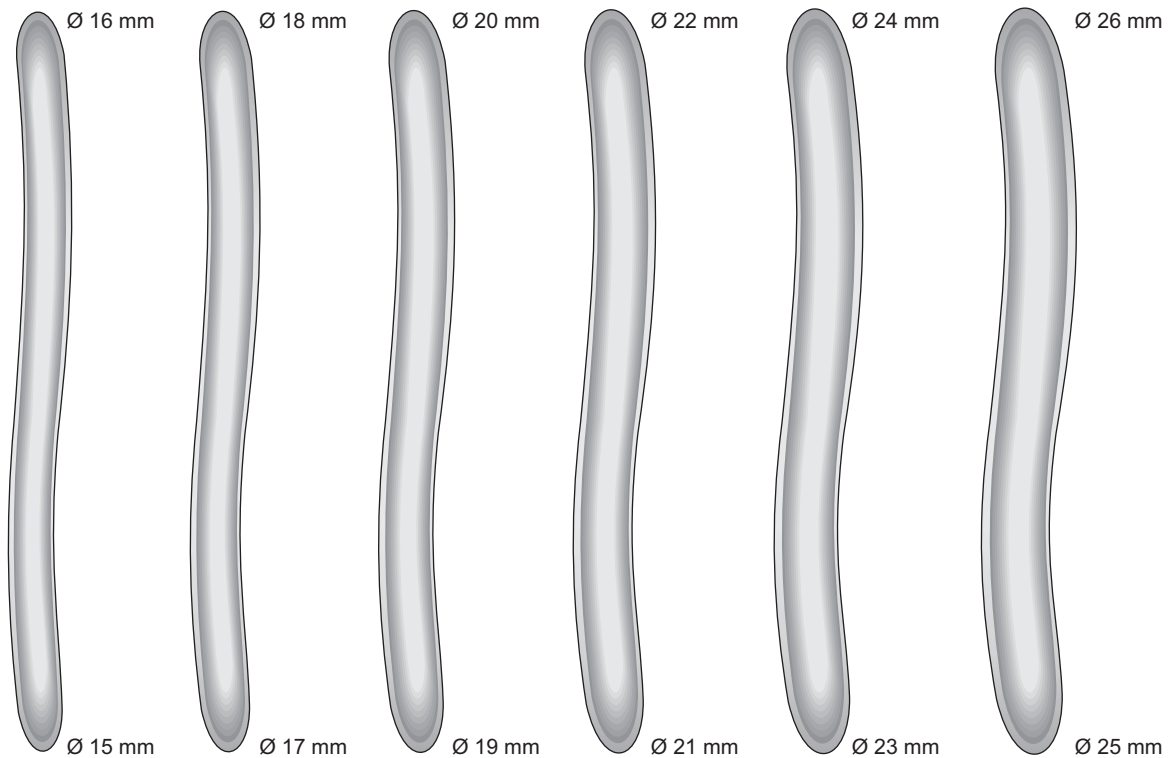

0517-BCH  
200 mm

0517-BCI  
200 mm

0517-BCL  
200 mm

0517-BDA  
200 mm

0517-BDB  
200 mm

0517-BDC  
200 mm

Pratt Dilatori - Pratt Dilators - Pratt Dilatoren  
Pratt Dilateur - Pratt Diladores

**0517-BBA**  
Set completo dilatatori 8 pezzi  
Set complete with 8 pieces  
Satz-Dilatator, komplett, 8 Stück  
Jeu complet avec 8 pieces  
Juego completo con 8 piezas

Fig.	mm
13/15	4,5/5,0
17/19	5,6/6,3
21/23	7,0/7,6
25/27	8,3/9,0
29/31	9,6/10,3
33/35	11,0/11,6
37/39	12,3/13,0
41/43	13,6/14,3

La misura è in French  
Breite in French

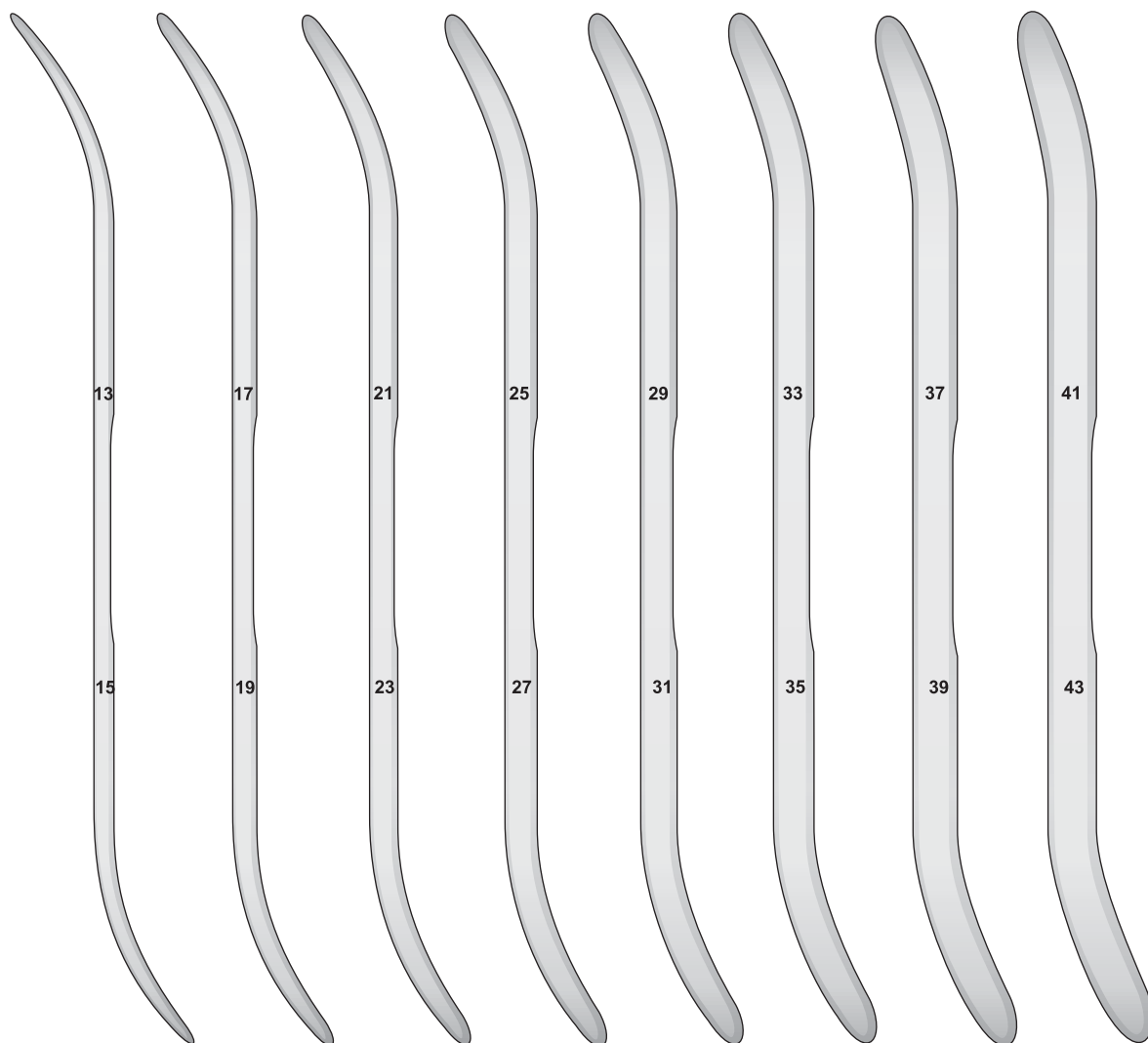

0517-BBB  
260 mm

0517-BBC  
260 mm

0517-BBD  
260 mm

0517-BBE  
260 mm

0517-BBF  
260 mm

0517-BBG  
260 mm

0517-BBH  
260 mm

0517-BBI  
260 mm

Dilatatori uterini

Uterine dilators

Uterus-Dilatatoren

Dilatateurs du col de l'utérus

Dilatadores uterinos



- 0502-FB 1 mm
- 0502-FC 2 mm
- 0502-FD 3 mm
- 0502-FE 4 mm
- 0502-FF 5 mm
- 0502-FG 6 mm
- 0502-FH 7 mm
- 0502-FI 8 mm
- 0502-FL 9 mm
- 0502-GA 10 mm
- 0502-GB 11 mm
- 0502-GC 12 mm
- 0502-GD 13 mm

- 0502-GE 14 mm
- 0502-GF 15 mm
- 0502-GG 16 mm
- 0502-GH 17 mm
- 0502-GI 18 mm
- 0502-GL 19 mm
- 0502-HA 20 mm
- 0502-HB 21 mm
- 0502-HC 22 mm
- 0502-HD 23 mm
- 0502-HE 24 mm
- 0502-HF 25 mm
- 0502-HG 26 mm

- 0502-HH 1½ mm
- 0502-HI 2½ mm
- 0502-HL 3½ mm
- 0502-IA 4½ mm
- 0502-IB 5½ mm
- 0502-IC 6½ mm
- 0502-ID 7½ mm
- 0502-IE 8½ mm
- 0502-IF 9½ mm
- 0502-IG 10½ mm
- 0502-IH 11½ mm
- 0502-II 12½ mm
- 0502-IL 13½ mm

- 0502-LA 14½ mm
- 0502-LB 15½ mm
- 0502-LC 16½ mm
- 0502-LD 17½ mm

HEGAR  
0502-FB/0502-LD  
185 mm

Fig. 9/10  
Ø 4,5/5,0 mm

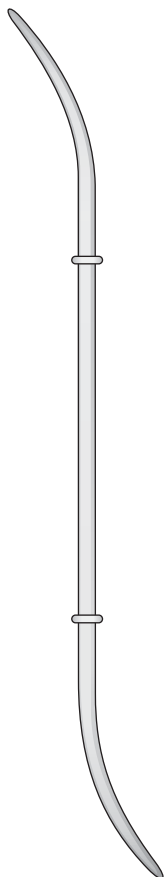

HANK  
0517-BGB  
260 mm

Fig. 11/12  
Ø 5,5/6,0 mm

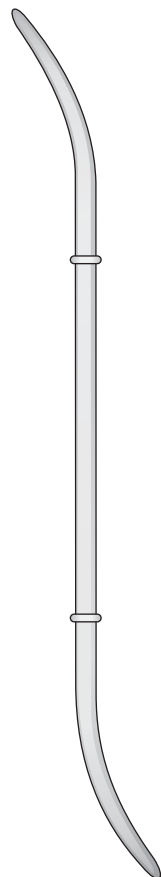

HANK  
0517-BGC  
260 mm

Fig. 13/14  
Ø 6,5/7,0 mm

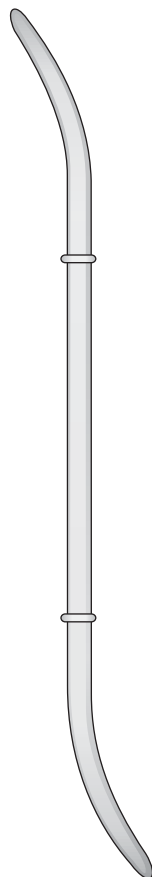

HANK  
0517-BGD  
260 mm

Fig. 15/16  
Ø 7,5/8,0 mm

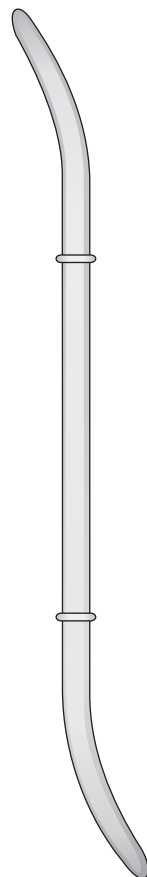

HANK  
0517-BGE  
260 mm

Fig. 17/18  
Ø 8,5/9,0 mm

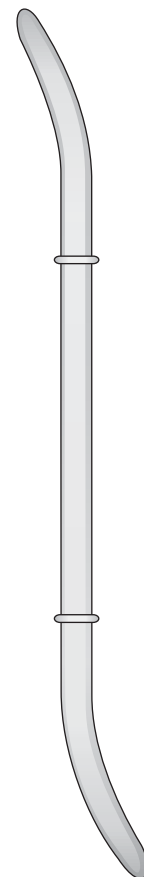

HANK  
0517-BGF  
260 mm

Fig. 19/20  
Ø 9,5/10 mm

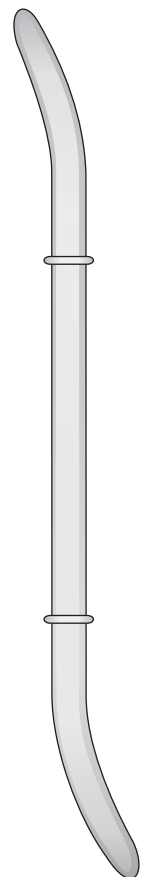

HANK  
0517-BGG  
260 mm

Isterometri

Uterine sounds

Uterussonden

Hystéromètres

Histerómetros

Graduati in centimetri  
 Graduated in centimeters  
 Zentimetereinteilung  
 Gradué en centimètres  
 Graduado en centímetros

Malleabile  
 Malleable  
 Biigsam  
 Malléables  
 Maleables

Malleabile  
 Malleable  
 Biigsam  
 Malléables  
 Maleables

Rigido  
 Rigid  
 Fest  
 Rigides  
 Rígidos

Malleabile  
 Malleable  
 Biigsam  
 Malléables  
 Maleables

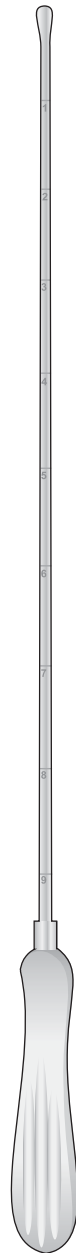
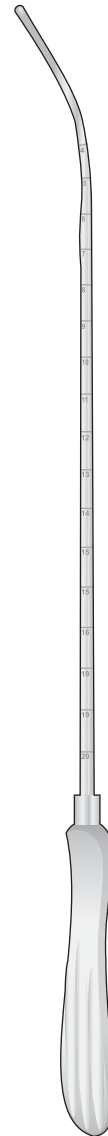
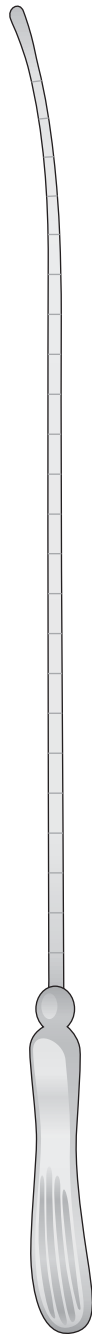
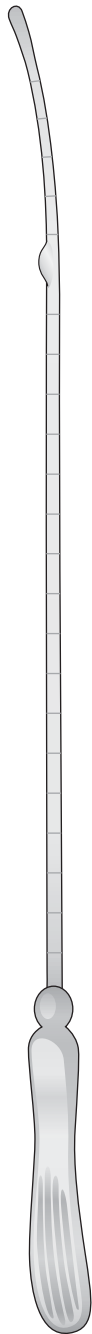
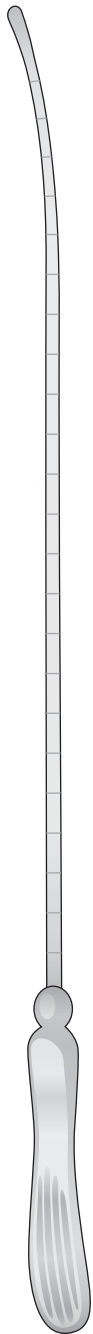

**0517-BAA**  
 Ø 2 mm  
**0517-BAB**  
 Ø 3 mm  
**0517-BAC**  
 Ø 4 mm

**0517-BAE**  
 Ø 3 mm  
**0517-BAF**  
 Ø 4 mm

SIMS  
**0517-BAA/0517-BAC**  
 320 mm

SIMPSON  
**0517-BAD** Ø 3 mm  
 320 mm

SIMS  
**0517-BAE/0517-BAF**  
 320 mm

VALLEIX  
**0517-BAH** Ø 4 mm  
 265 mm

MARTIN  
**0517-BAG** Ø 3 mm  
 300 mm

MAYO  
**0517-BAI** Ø 5 mm  
 330 mm

Amniotomo per la  
vescica amniotica  
Amniotome for the  
amnion bladder  
Amniotom für die  
Amnionblase  
Amniotome pour la  
vésicule amniotique  
Amniõtomo para la  
vesicula amniõtica

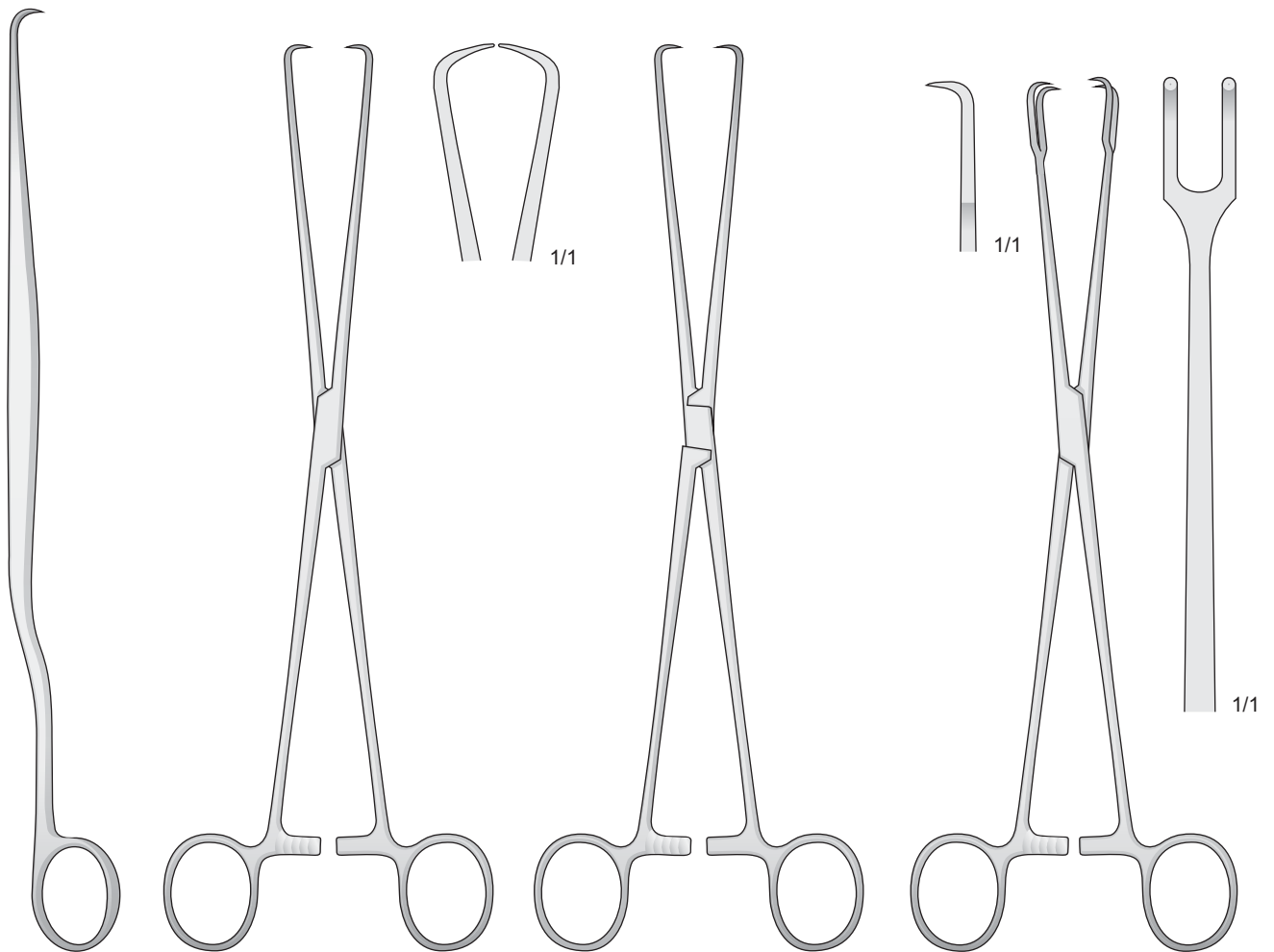

BEACHAM  
0206-FF  
260 mm

BRAUN  
0206-EL  
250 mm

POZZI  
0206-GA  
250 mm

SCHROEDER  
0206-FL  
240 mm

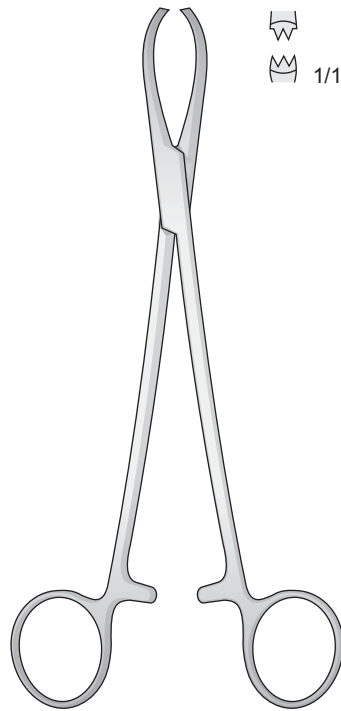

LITTLEWOOD  
0502-CF  
185 mm

Con curvatura laterale  
Curved Sideway  
Seitwärts Gebogen  
Courbes sur le côté  
Curvas laterales

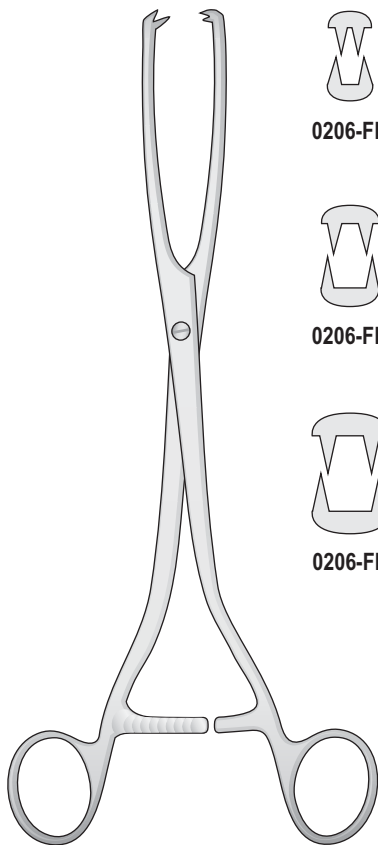

0206-FB

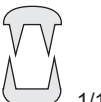

0206-FD

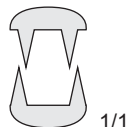

0206-FE

MUSEUX  
0206-FB/0206-FE  
240 mm

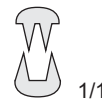
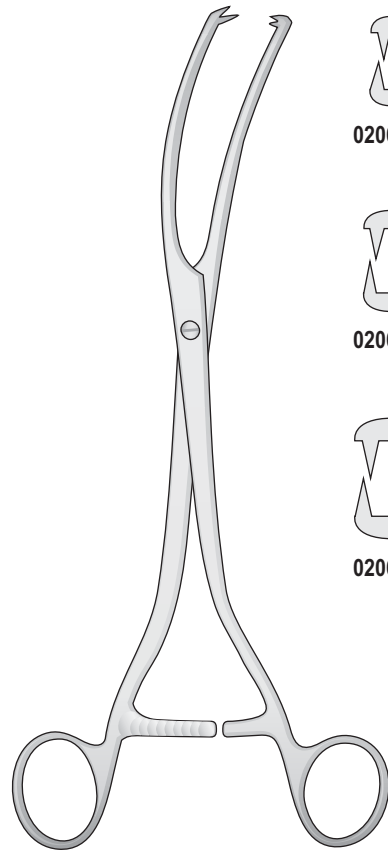

0206-GB

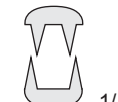

0206-GC

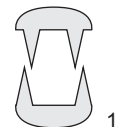

0206-GD

MUSEUX  
0206-GB/0206-GD  
240 mm

Strumenti per fibromi  
Strumenti per oper. Micro-tube

Myoma instruments  
Instruments for  
Micro tubal operation

Myom Instrumente  
Instrumente für  
Mikro-Tubenoperationen

Instruments  
pour fibromes  
Myomes

Instrumentos  
para fibroma

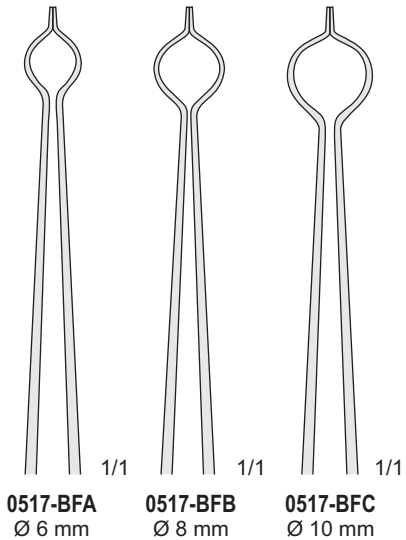
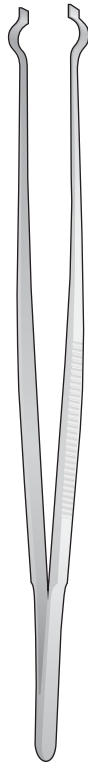

Pinzette per la presa delle tube  
Tubal seizing forceps  
Tubenfasspinzetten  
Pinces pour saisir les tubes

NEUBÜSER  
0517-BFA/0517-BFC  
200 mm

Elevatori per miomi  
Myoma screw  
Myomheber  
Tracteur pour fibromes  
Tiramiomas para fibromas



DOYEN  
0502-BF  
150 mm

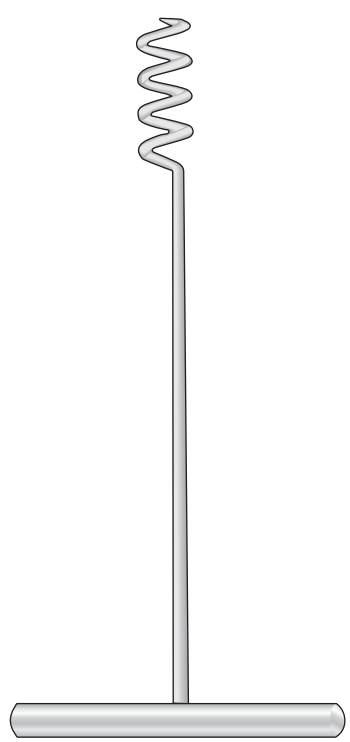

DOYEN  
0502-BG  
170 mm

Curette di aspirazione  
per biopsia

Uterine biopsy  
aspirating curettes

Uterus Biopsie  
Saugküretten

Curettes aspirantes  
à biopsie de l'utérus

Curetas aspiradoras para  
la biopsia uterina

Curette per biopsia endouterina  
Endometrial Biopsy curette  
Endometrium-Strickkürette  
Curette pour biopsie intra-utérines  
Cureta para biopsia endo-uterina

Curette per biopsia endocervicale  
Endocervical Biopsy Curettes  
Endocervix-Biopsieküretten  
Curettes pour biopsies  
endo-cervicales

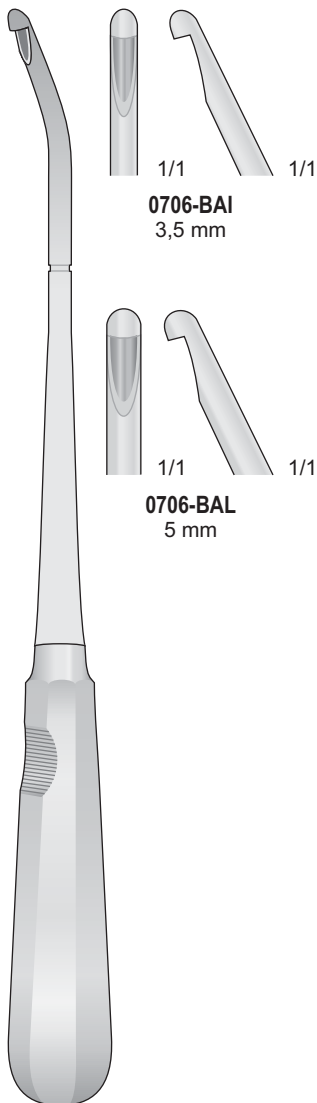

MÜNCHEN  
0706-BAI/0706-BAL  
270 mm

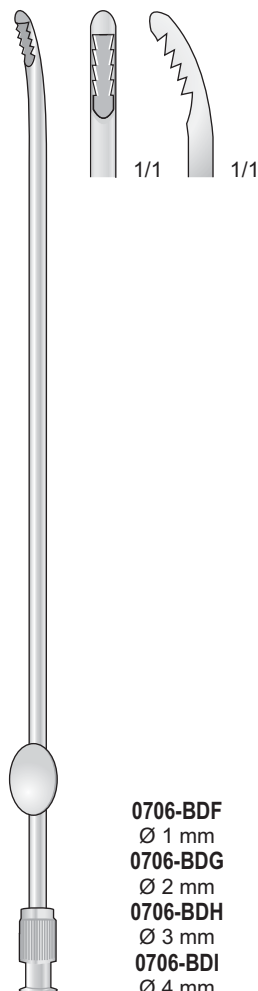

NOVAK  
0706-BDF/0706-BDI  
230 mm

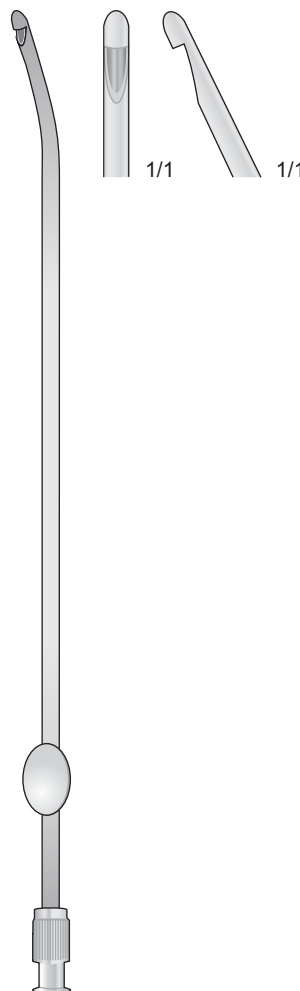

RANDALL  
0706-BDL  
230 mm

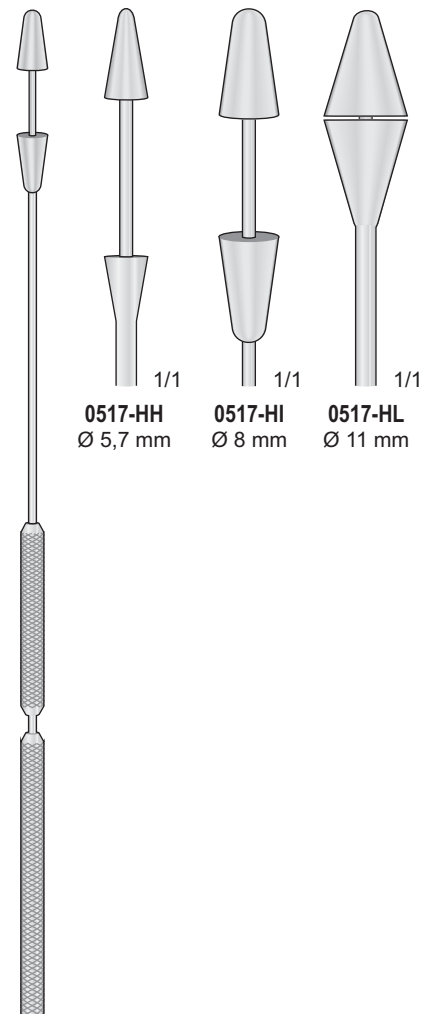

GUSBERG  
0517-HH/0517-HL  
240 mm



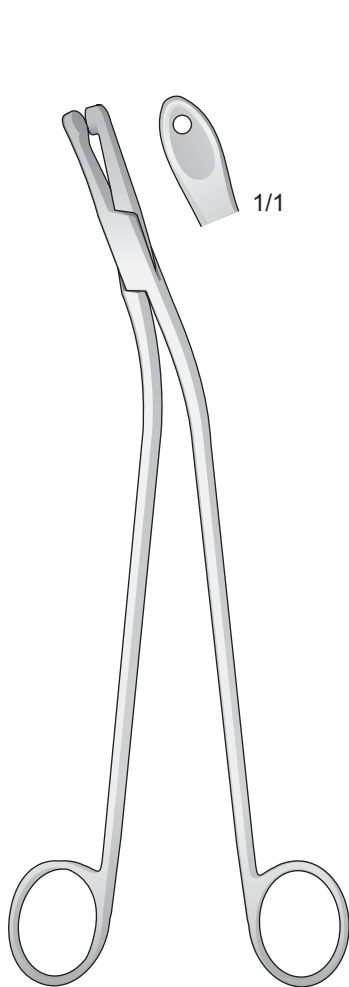

GELLHORN  
0606-DA  
230 mm

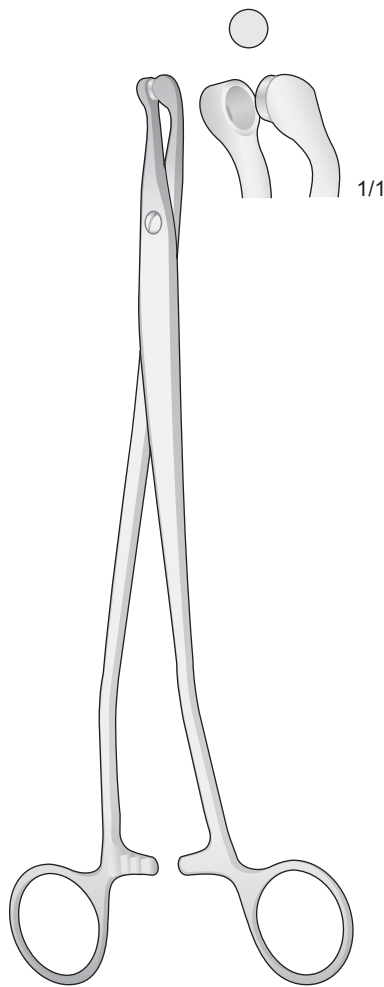

THOMS-GAYLOR  
0606-DC  
240 mm

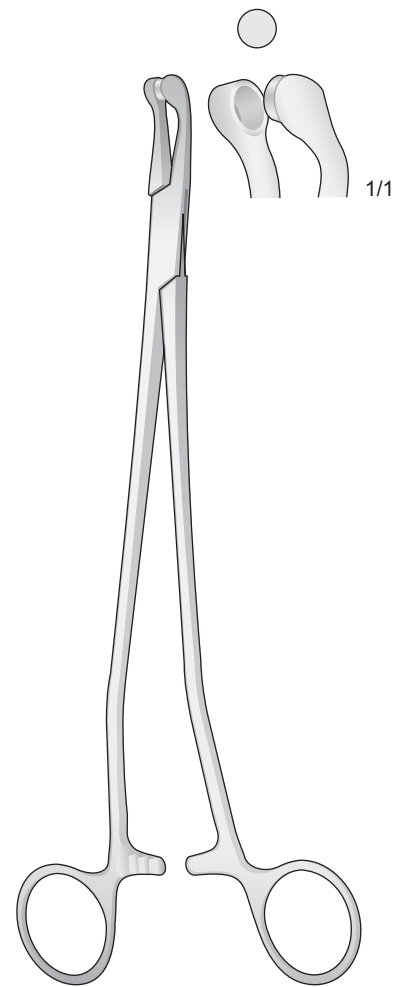

THOMS-GAYLOR  
0606-DD 220 mm  
0606-DE 240 mm

Pinze per biopsie

Biopsy forceps

Biopsiezangen

Pinces à biopsies

Pinzas para biopsia

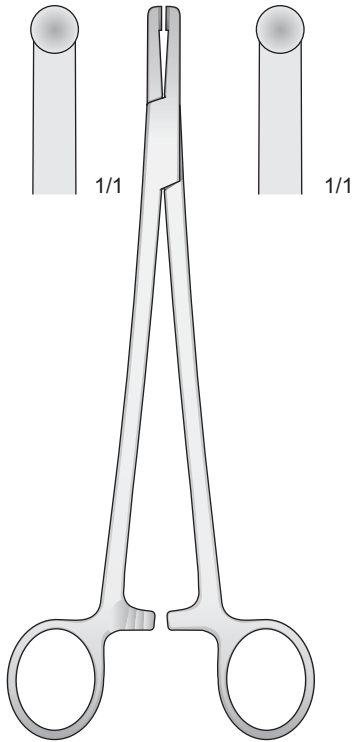

**0402-BFA**  
205 mm

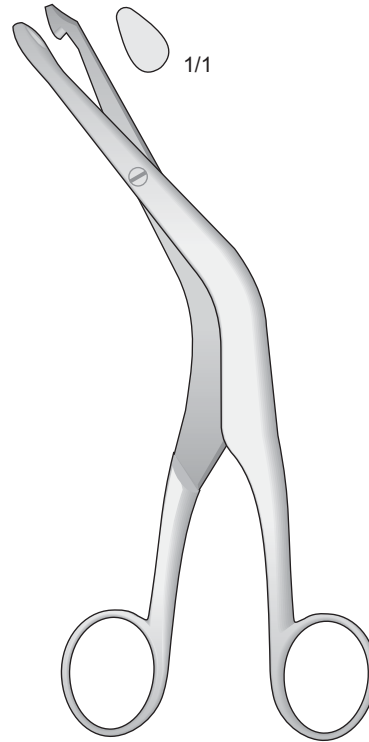

**FAURE**  
**0606-DB**  
210 mm

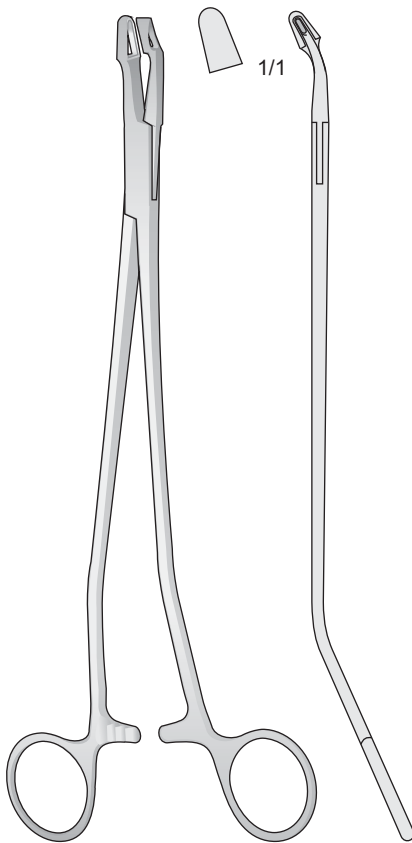

**VAN DOREN**  
**0606-DL**  
250 mm

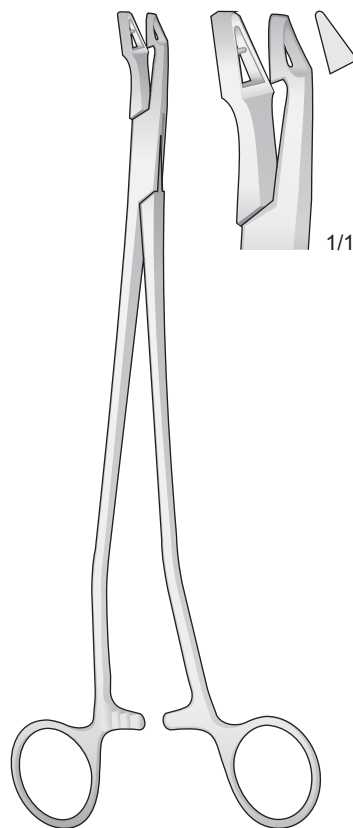

**VAN DOREN**  
**0606-DI**  
240 mm

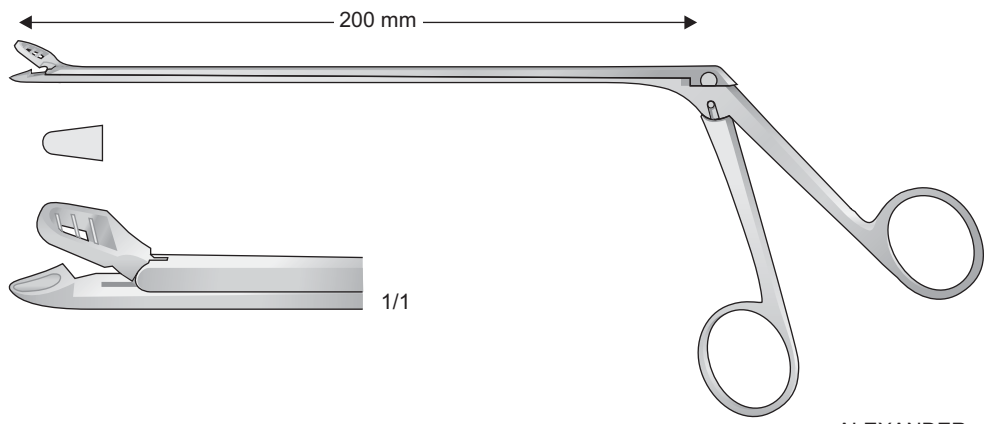

ALEXANDER  
0606-GE

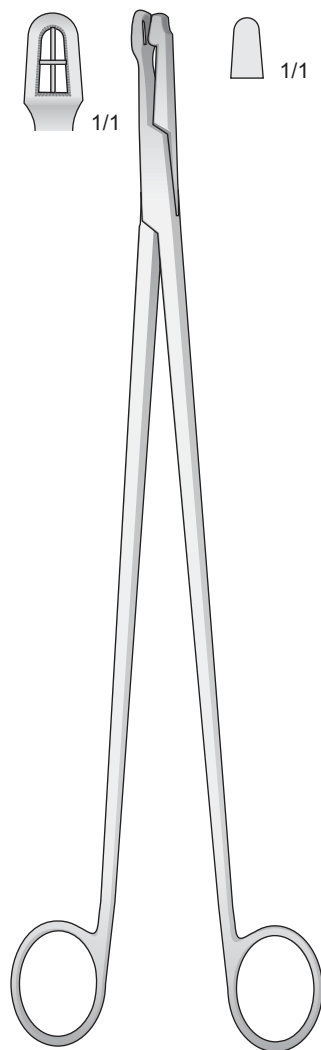

SCHUBERT  
0606-DF 210 mm  
0606-DG 290 mm

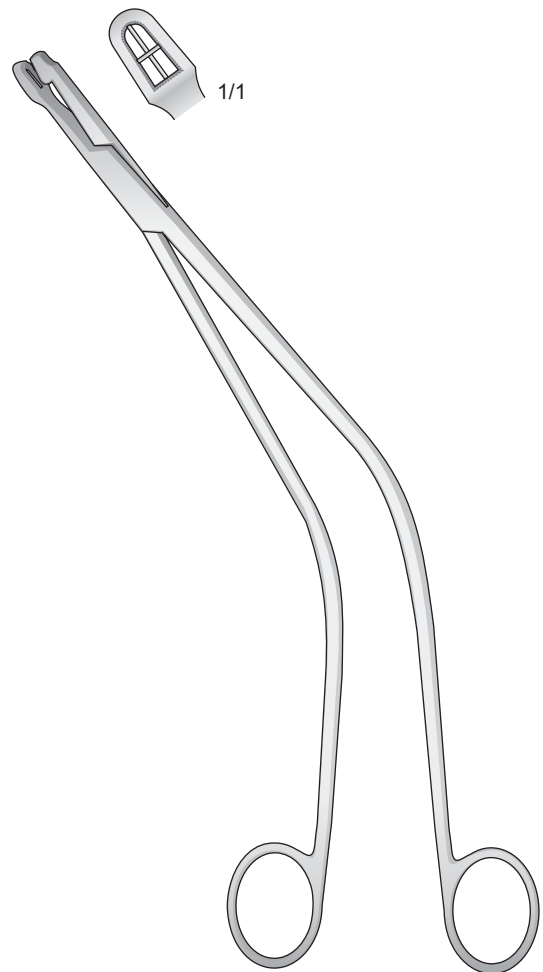

SCHUBERT  
0606-DH  
260 mm

Pinze per biopsie

Biopsy forceps

Biopsiezangen

Pinces à biopsies

Pinzas para biopsia

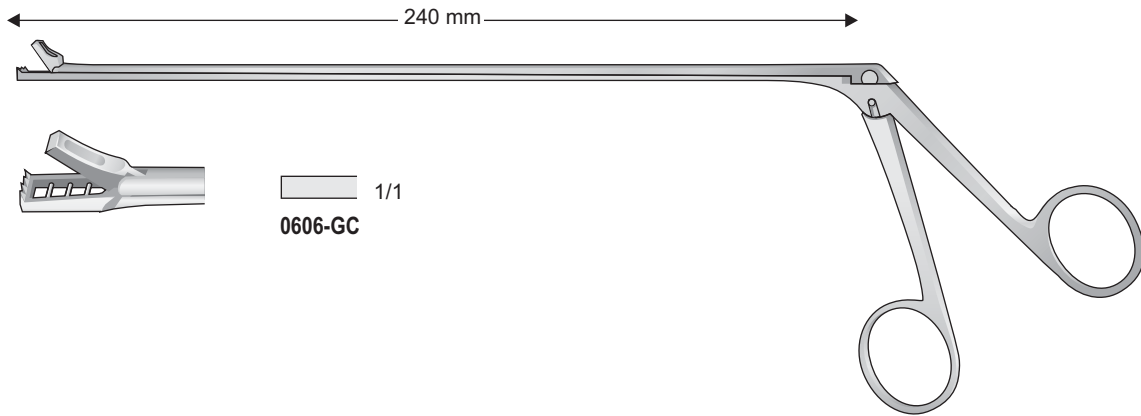

KEVORKIAN  
0606-GC

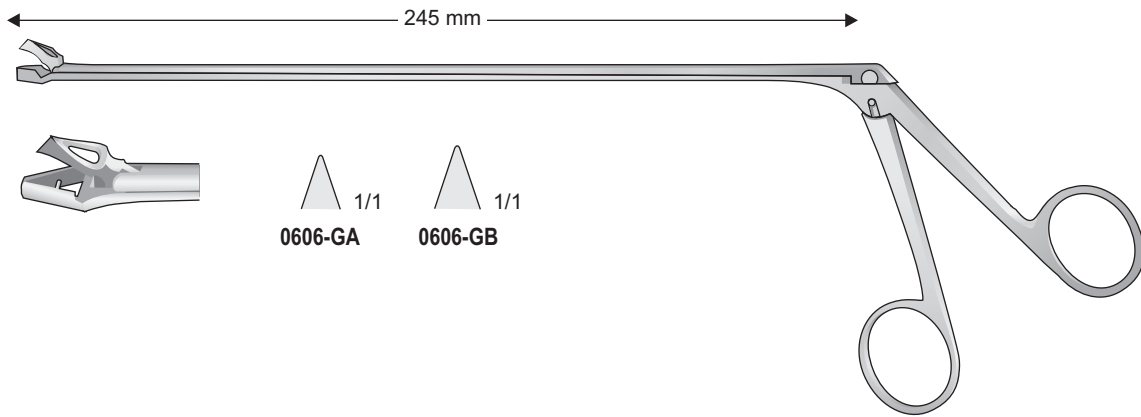

SCHUMACHER  
0606-GA/0606-GB

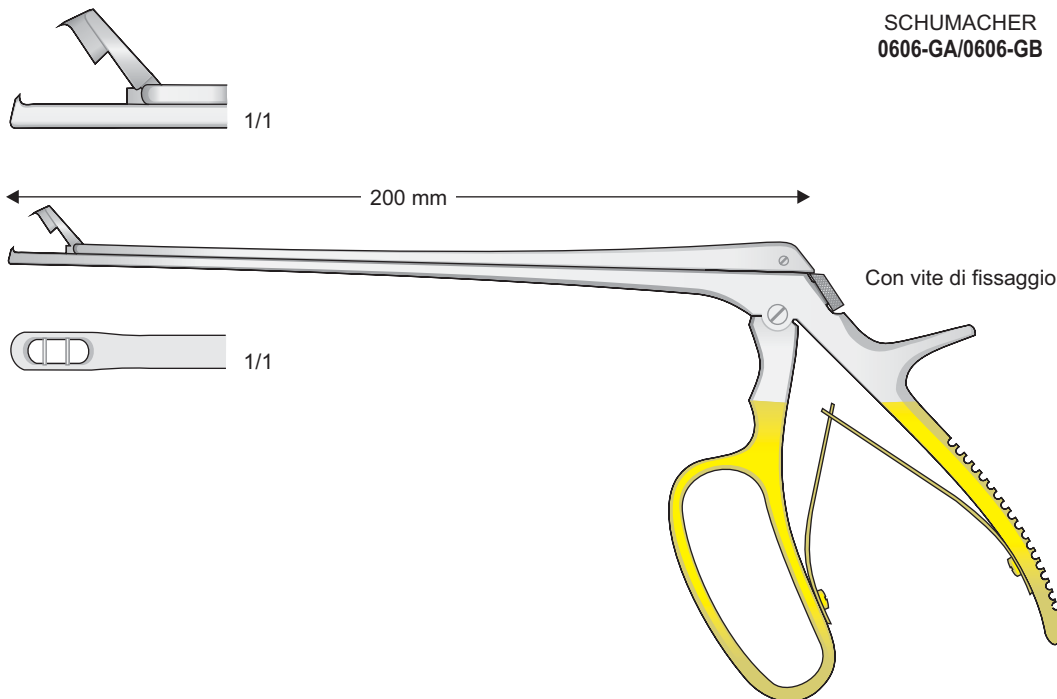

TISCHLER-MORGAN  
0606-FL



LUER-KÖRTE  
0502-CB/0502-CD  
260 mm

5,5 mm

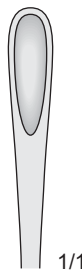

0502-CB 1/1

7 mm



0502-CC 1/1

11 mm



0502-CD 1/1

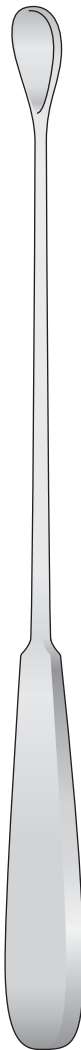

GOURDET  
0517-IA/0517-IE  
280 mm

Smusse - Blunt  
Stumpf - Mousset  
Romo

6 mm

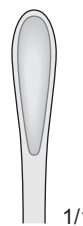

0517-IA 1/1

8 mm



0517-IB 1/1

10 mm



0517-IC 1/1

12 mm



0517-ID 1/1

14 mm



0517-IE 1/1

Curette uterine

Uterine curettes

Uterusküretten

Utérines curettes

Curetas uterinas

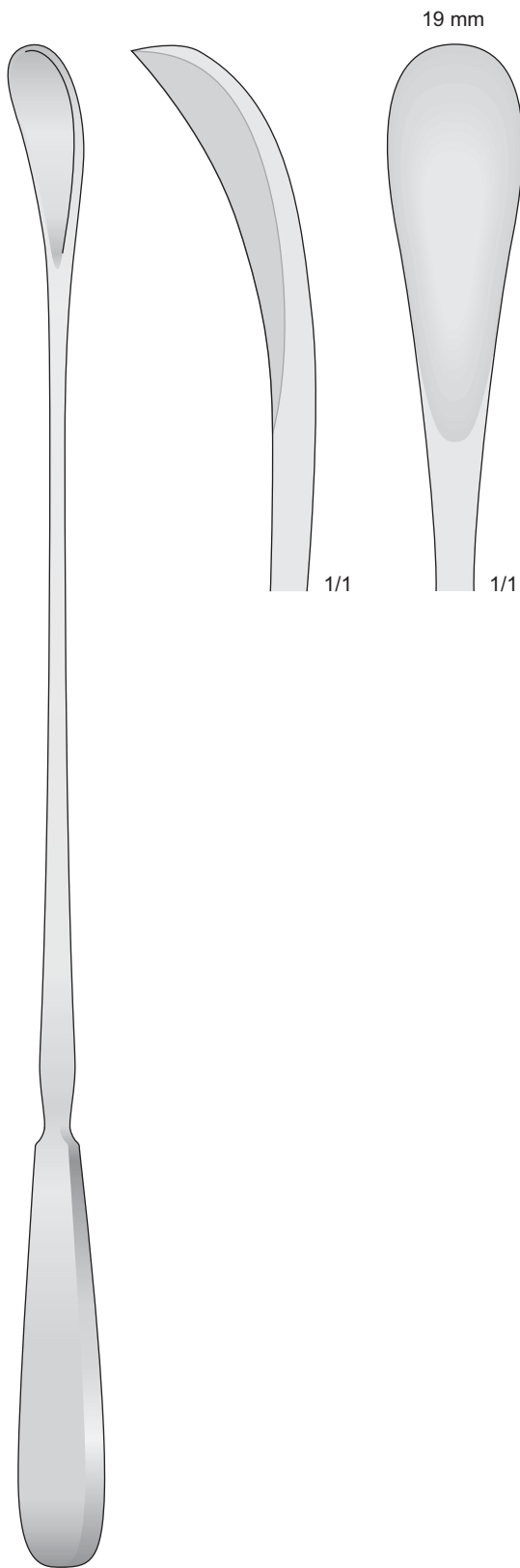

WALLICH  
0517-LA  
420 mm

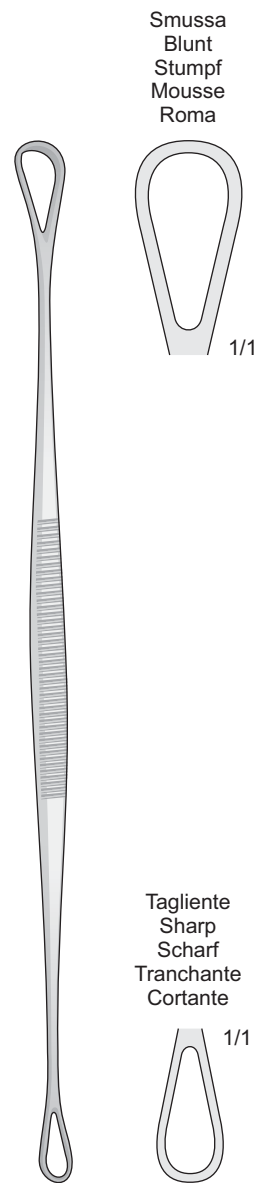

BLAKE  
0517-II  
275 mm

Taglienti  
Scharp  
Scharf  
Tranchantes  
Cortantes

Smussa  
Blunt  
Stumpf  
Mousse  
Romas

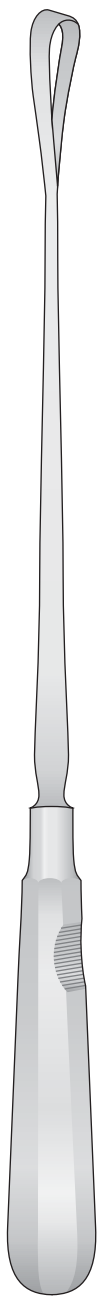

RECAMIER  
0517-BB/0517-CI  
310 mm

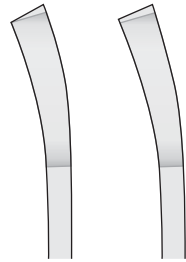
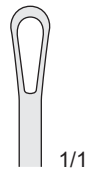

Fig. 1



1/1

Fig. 2



1/1

Fig. 3



1/1

Fig. 4



1/1

Fig. 5

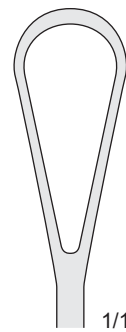

1/1

Fig. 6

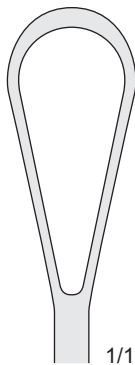

1/1

Fig. 7

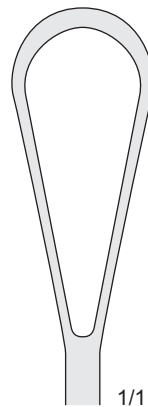

1/1

Fig. 8

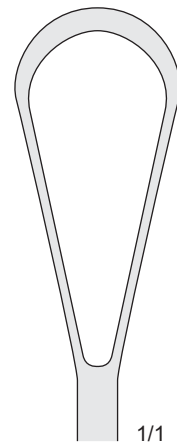

1/1

Fig.	Larghezza Width Breite	Taglienti-rigide Sharp-rigid Scharf-fest Tranchantes-rigides Cortantes-rigidas	Smusse-rigide Blunt-rigid Stumpf-fest Mousse-rigides Romas-rigidas
1	4 mm	0517-BB	0517-CB
2	6 mm	0517-BC	0517-CC
3	8 mm	0517-BD	0517-CD
4	10 mm	0517-BE	0517-CE
5	12 mm	0517-BF	0517-CF
6	14 mm	0517-BG	0517-CG
7	16 mm	0517-BH	0517-CH
8	18 mm	0517-BI	0517-CI

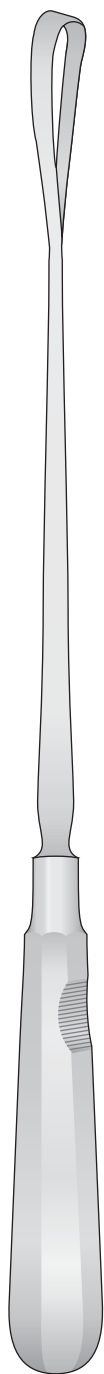

BUMM  
0517-DB/0517-EC  
310 mm

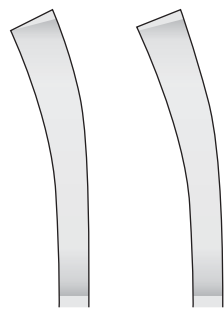

Tagliente  
Scharp  
Scharf  
Tranchantes  
Cortantes

Smussa  
Blunt  
Stumpf  
Mousse  
Romas

Malleabile  
Malleable  
Biegsam  
Souples  
Maleables

Fig. 3

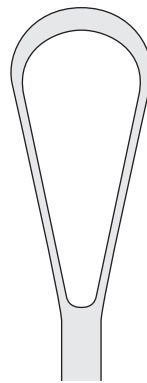
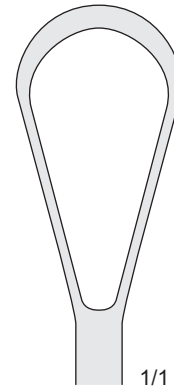

Fig. 4



1/1

Fig.	Larghezza Width Breite	Taglienti Sharp Scharf Tranchantes Cortantes	Smusse Blunt Stumpf Mousse Romas
3	18 mm	<b>0517-DB</b>	<b>0517-EB</b>
4	20 mm	<b>0517-DC</b>	<b>0517-EC</b>



Fig.	Larghezza Breite Width	Smusse malleabili - Blunt malleable Stumpf biegsam - Mousse malléables Romos maleables
0	16 mm	<b>0517-BEA</b>
1	18 mm	<b>0517-BEB</b>
2	19,5 mm	<b>0517-BEC</b>
3	21,5 mm	<b>0517-BED</b>
4	23,5 mm	<b>0517-BEE</b>
5	26 mm	<b>0517-BEF</b>
6	28,5 mm	<b>0517-BEG</b>

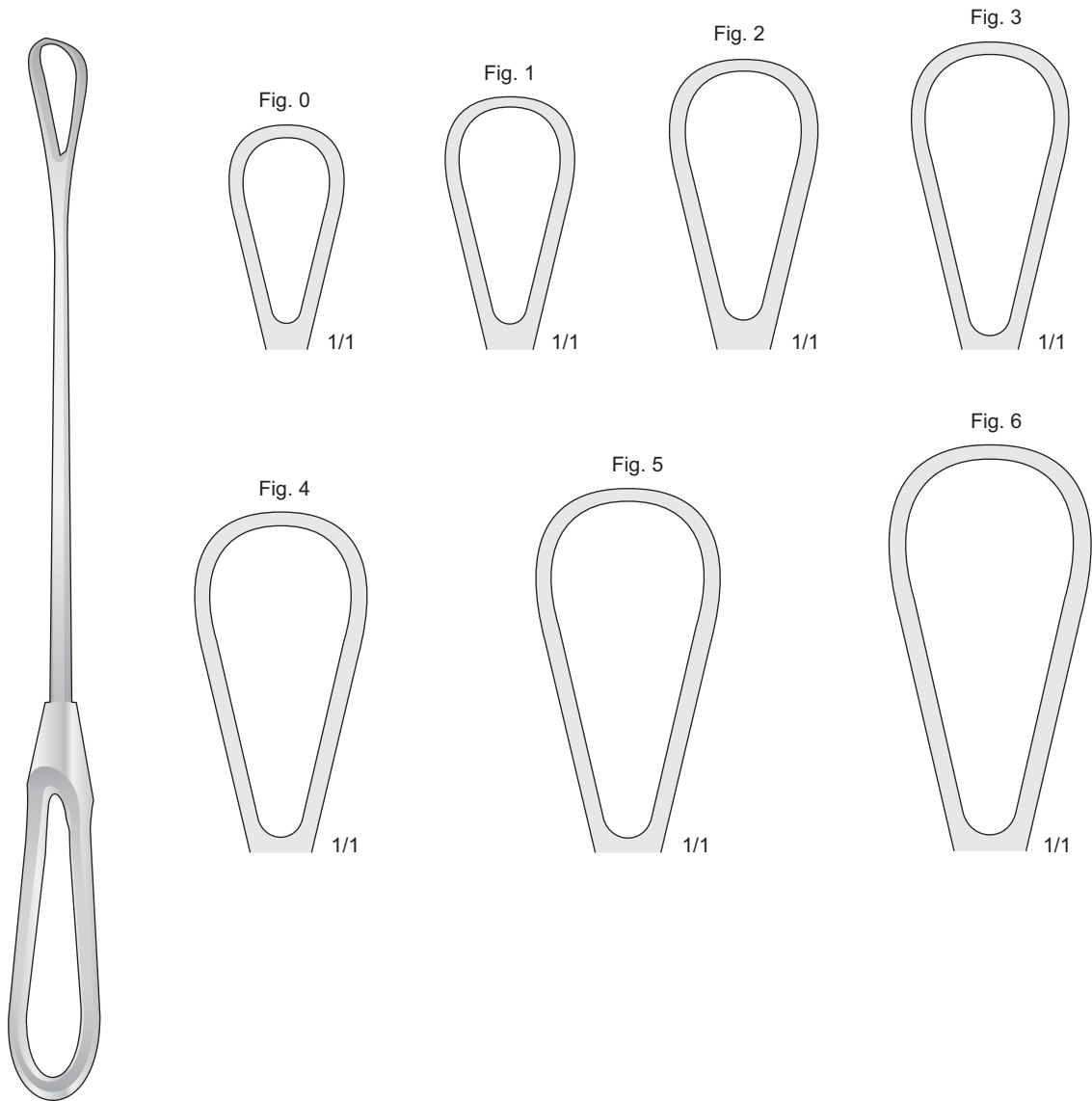

BUMM  
0517-BEA/0517-BEG  
290 mm

Speculum vaginali  
e forcipe

Vaginal specule  
and Midwifery forceps

Scheidenspekulum  
und Geburtszange

Speculum  
et forceps

Pinzas para el utero  
y obstétricos

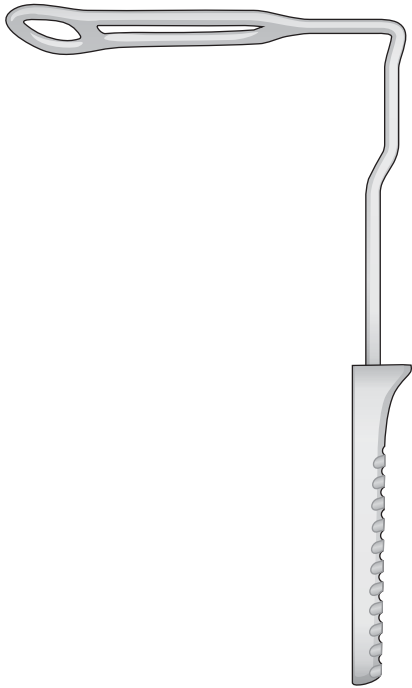

GENTOFT  
0517-FA  
210 mm

Set 2 pezzi  
Set 2 pieces  
Set 2 Stück  
Set 2 pièces  
Set 2 piezas  
0517-FA + 0517-FB

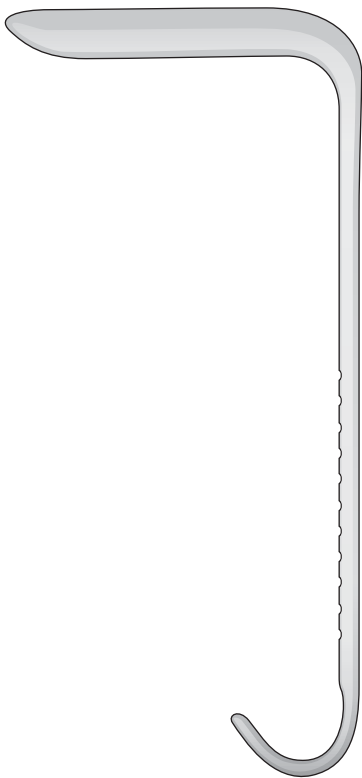

FENO  
0517-FB  
230 mm

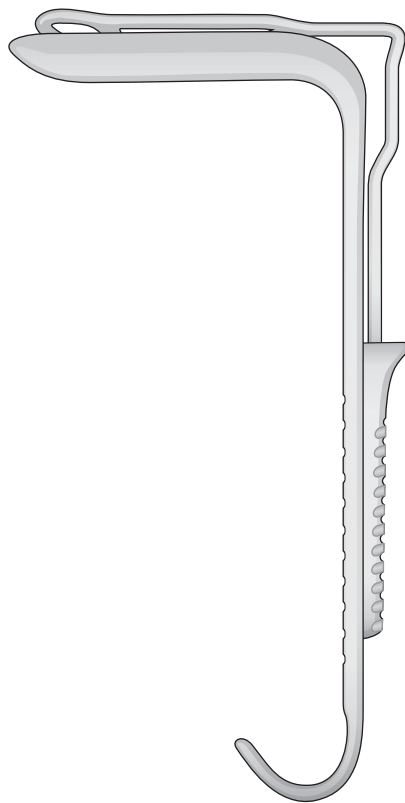

0517-FD  
230 mm

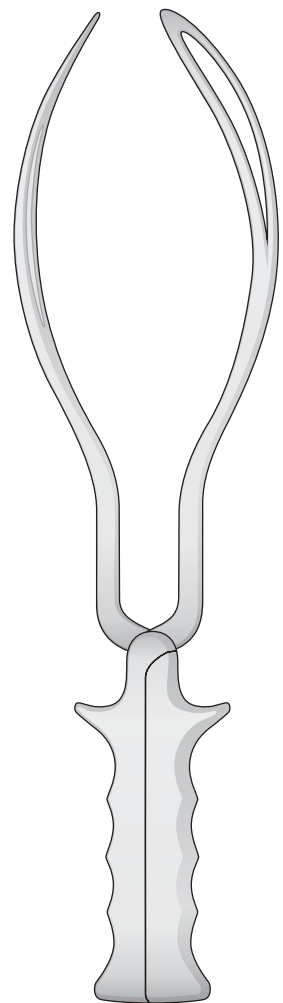

SIMPSON-BRAUN  
0517-FC  
365 mm

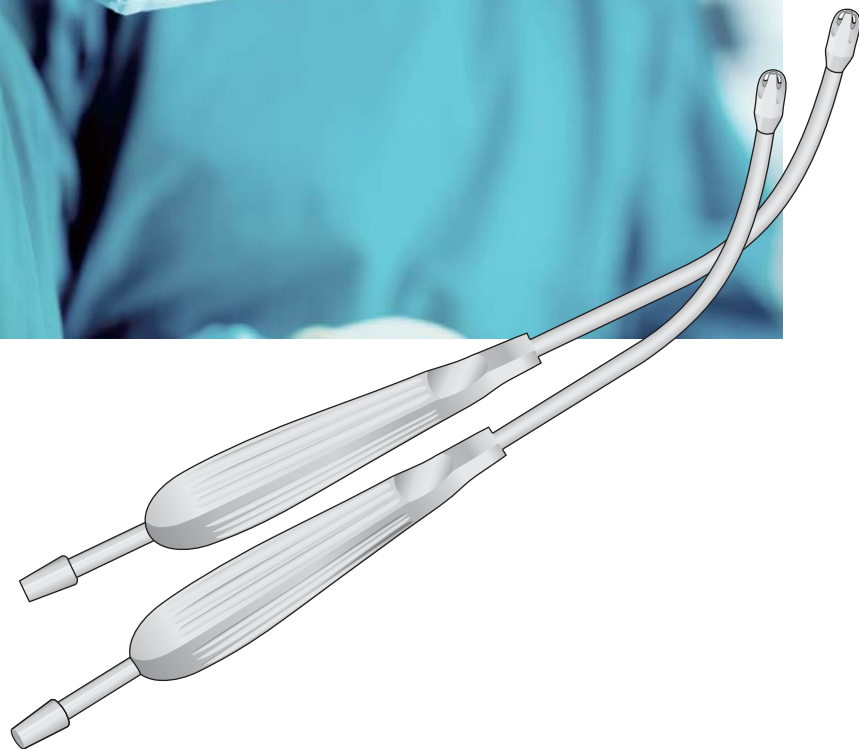

17

Cannule per aspirazione  
Suctions tubes  
Absaugkanülen  
Canules aspiratrices  
Cánulas aspiradoras



Cannule per aspirazione

Suctions tubes

Absaugkanülen

Canules aspiratrices

Cànulas aspiradoras

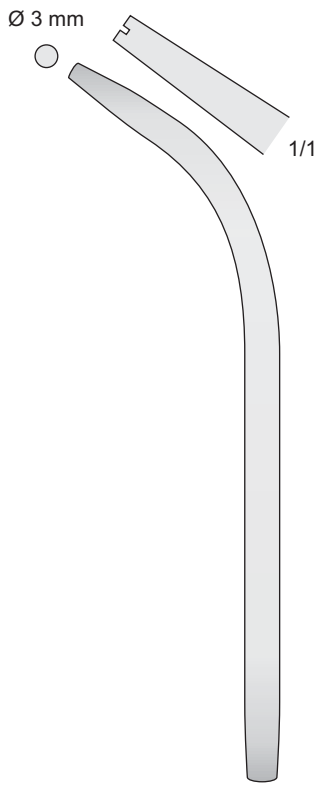

**0706-DA**  
140 mm

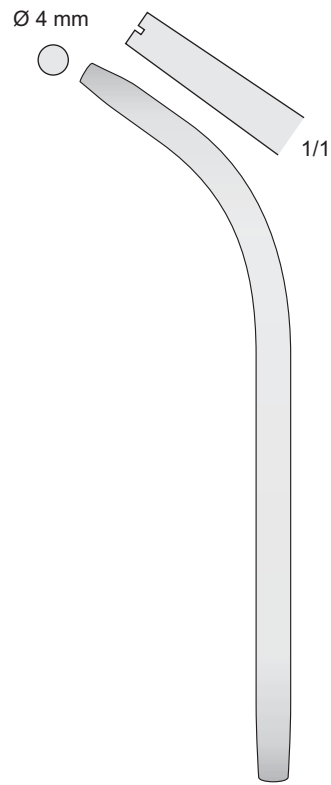

**0706-DB**  
140 mm

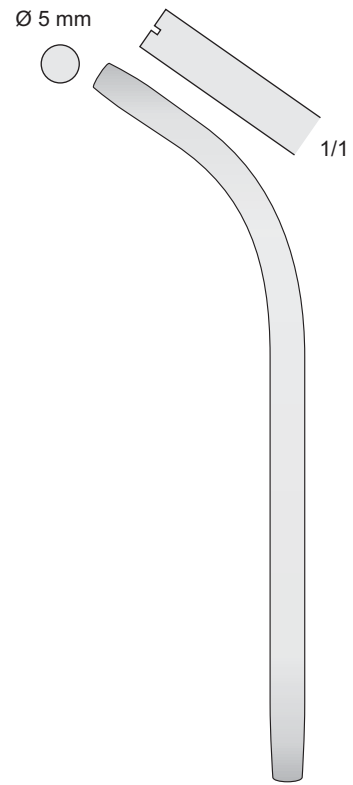

**0706-DC**  
140 mm

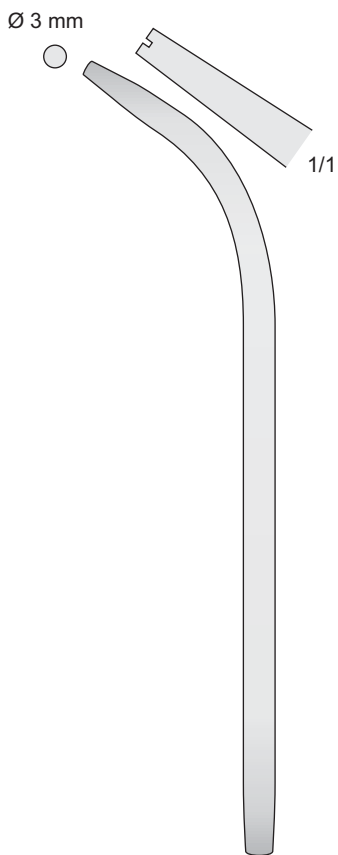

**0706-DD**  
170 mm

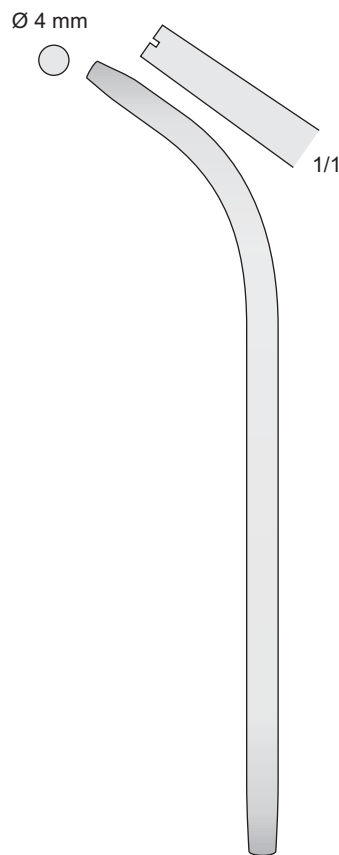

**0706-DE**  
170 mm

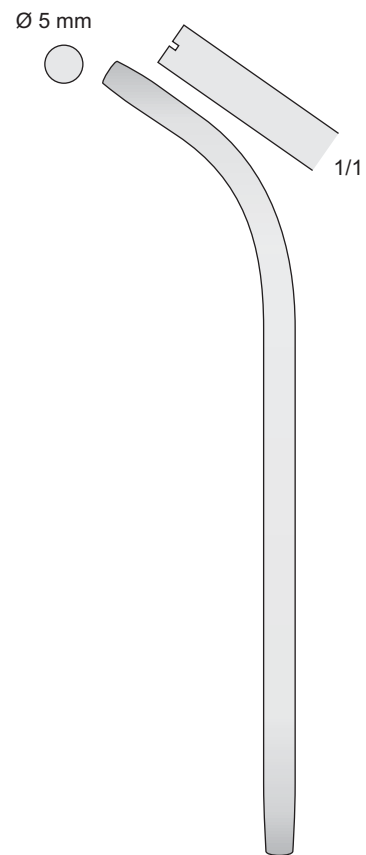

**0706-DF**  
170 mm

Ø 2 mm int.

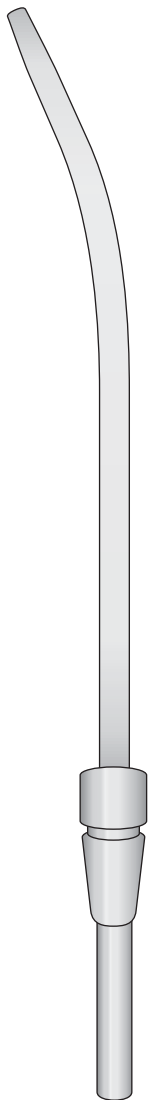

Mc KESSON  
0706-BD  
180 mm

Ø 3 mm int.

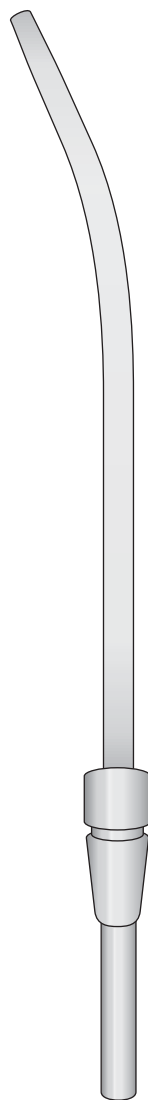

Mc KESSON  
0706-BE  
180 mm

Ø 4 mm int.

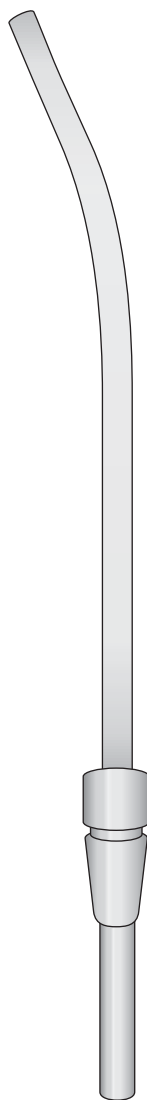

Mc KESSON  
0706-BF  
180 mm

Ø 4 mm int.

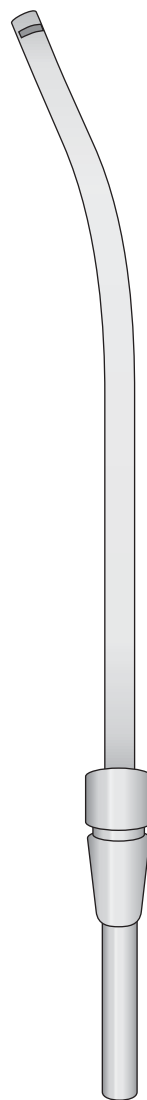

Mc KESSON  
0706-BG  
180 mm

Ø 3 mm

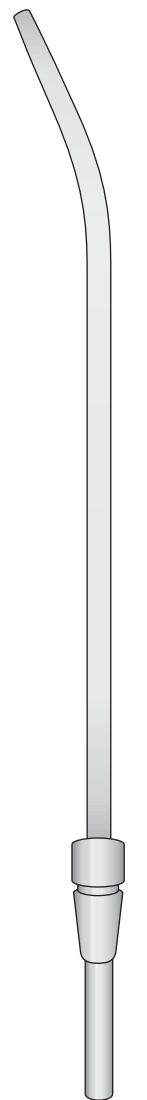

Mc KESSON  
0706-BH  
230 mm

Ø 4 mm

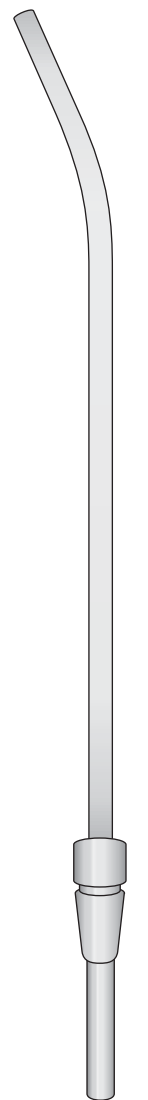

Mc KESSON  
0706-BI  
230 mm

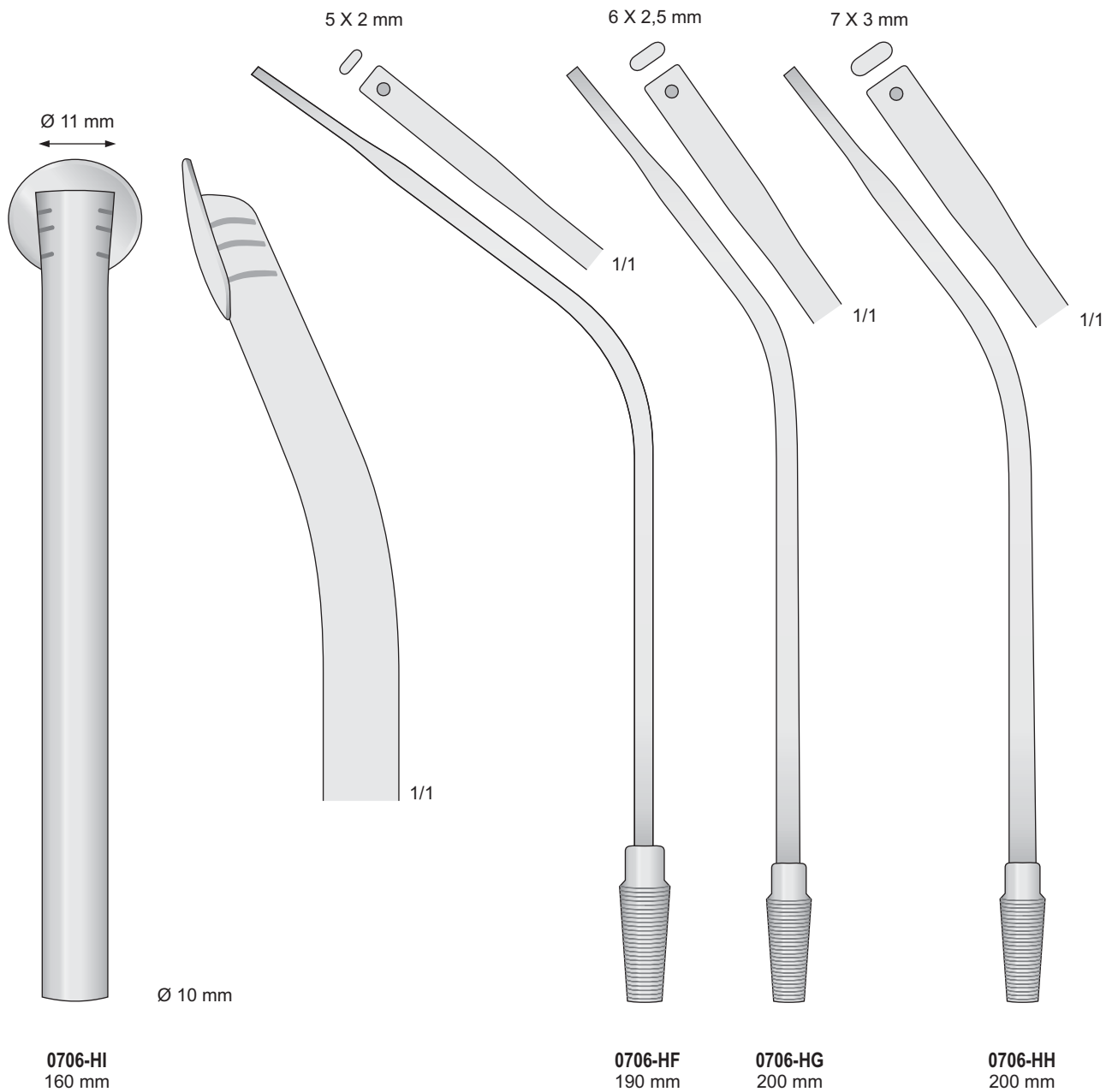

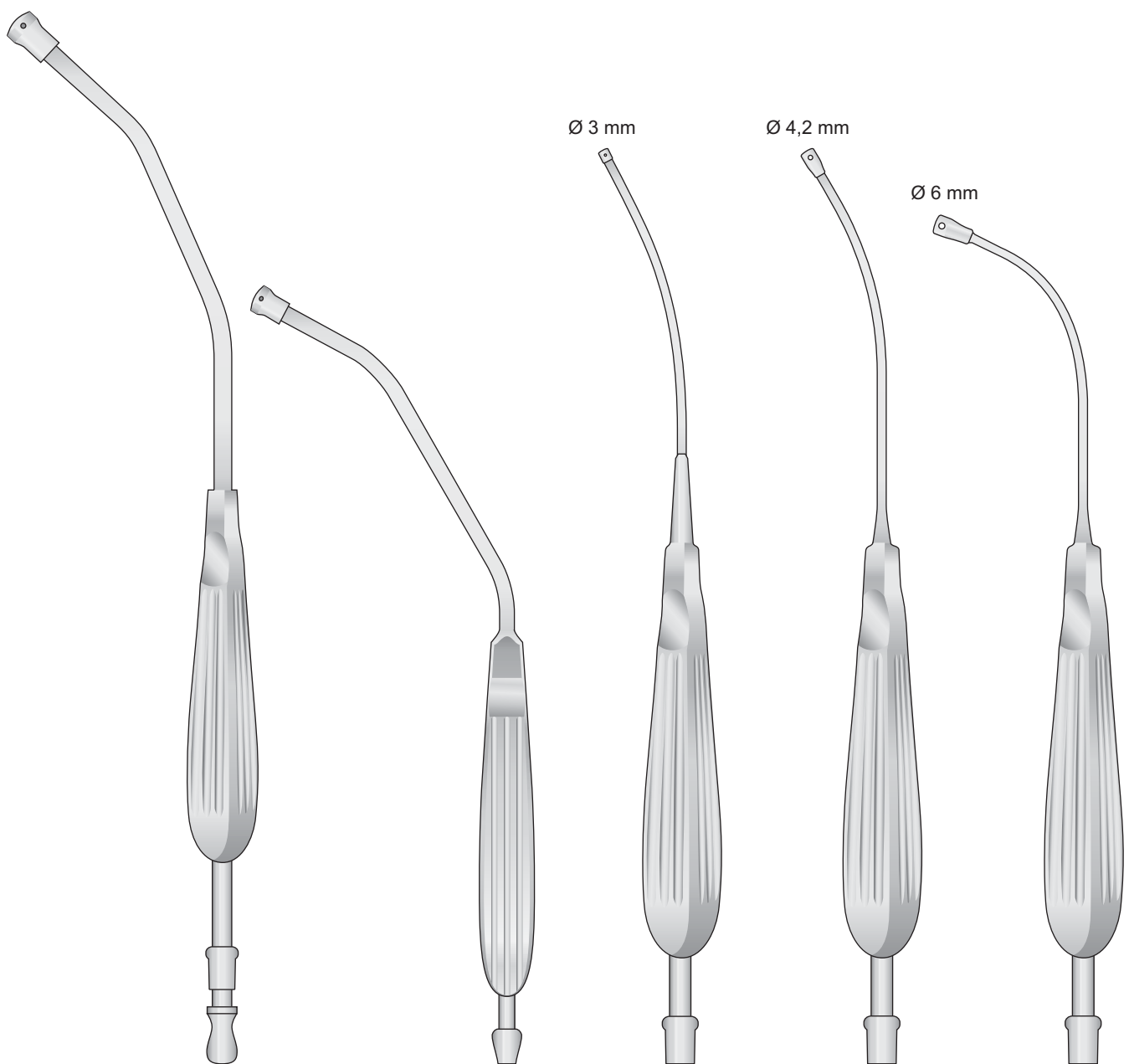

**YANKAUER**  
**0706-BC**  
310 mm

**BABY-YANKAUER**  
**0706-BA**  
200 mm

**ANDREWS-PYNCHON**  
**0706-AG**  
250 mm

**ANDREWS-PYNCHON**  
**0706-AH**  
250 mm

**ANDREWS-PYNCHON**  
**0706-FE**  
230 mm



**0706-BCL**  
 Manico portacannule  
 Set - Satz - Jeu - Jeugo  
  
 Completo con 4 cannule  
 Complet with 4 tubes  
 Komplett mit 4 kanülen  
 Complete avec 4 canules  
 Completo con 4 cànulas

**0706-BLH**  
 Manico portacannule  
 Set - Satz - Jeu - Jeugo  
  
 Completo con 3 cannule  
 Complet with 3 tubes  
 Komplett mit 3 kanülen  
 Complete avec 3 canules  
 Completo con 3 cànulas

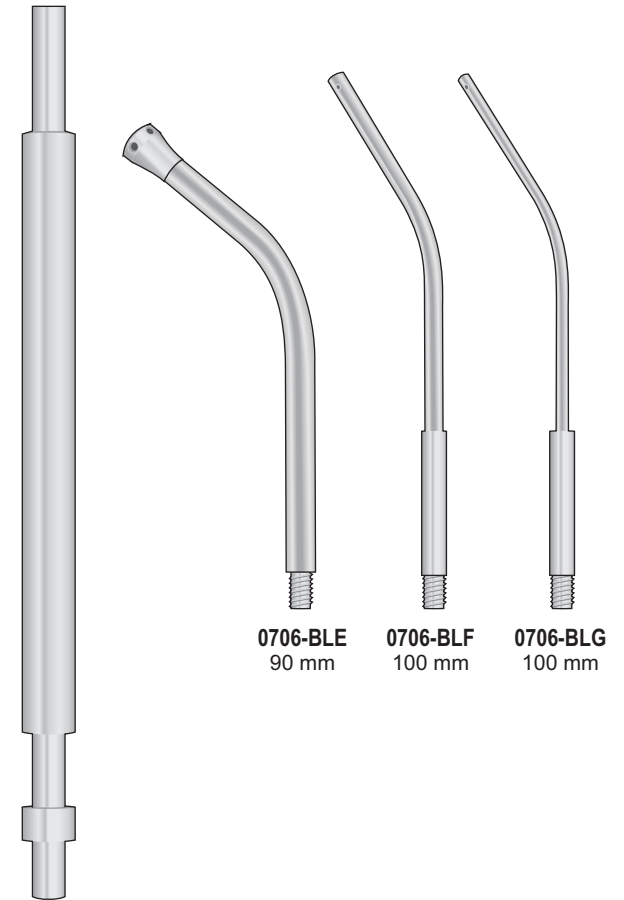
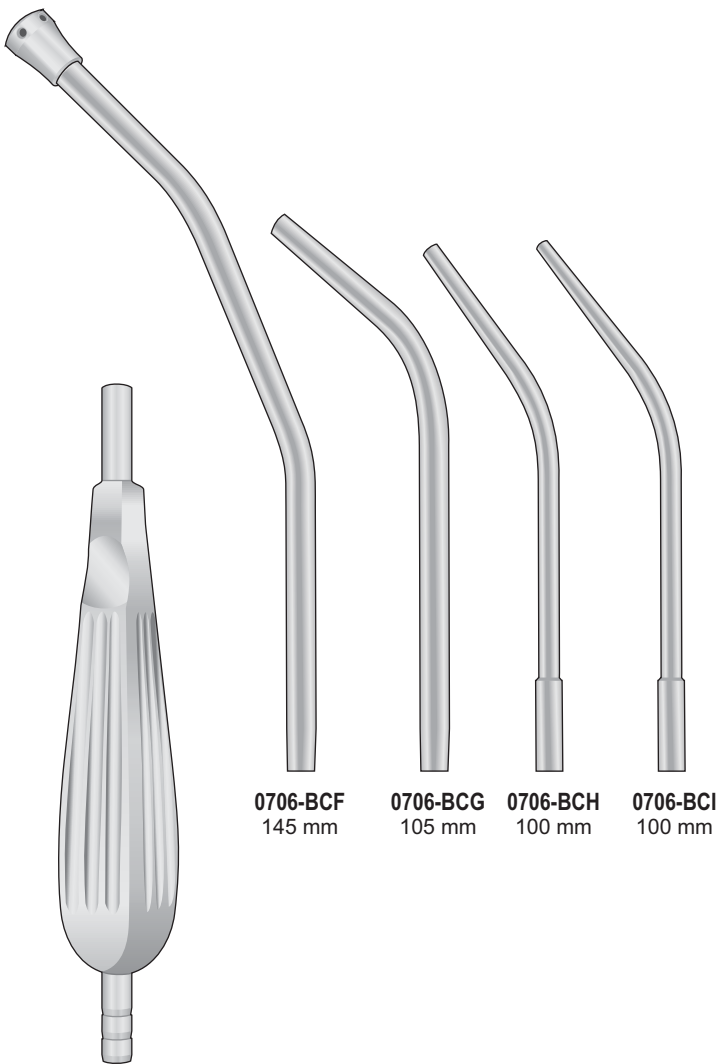

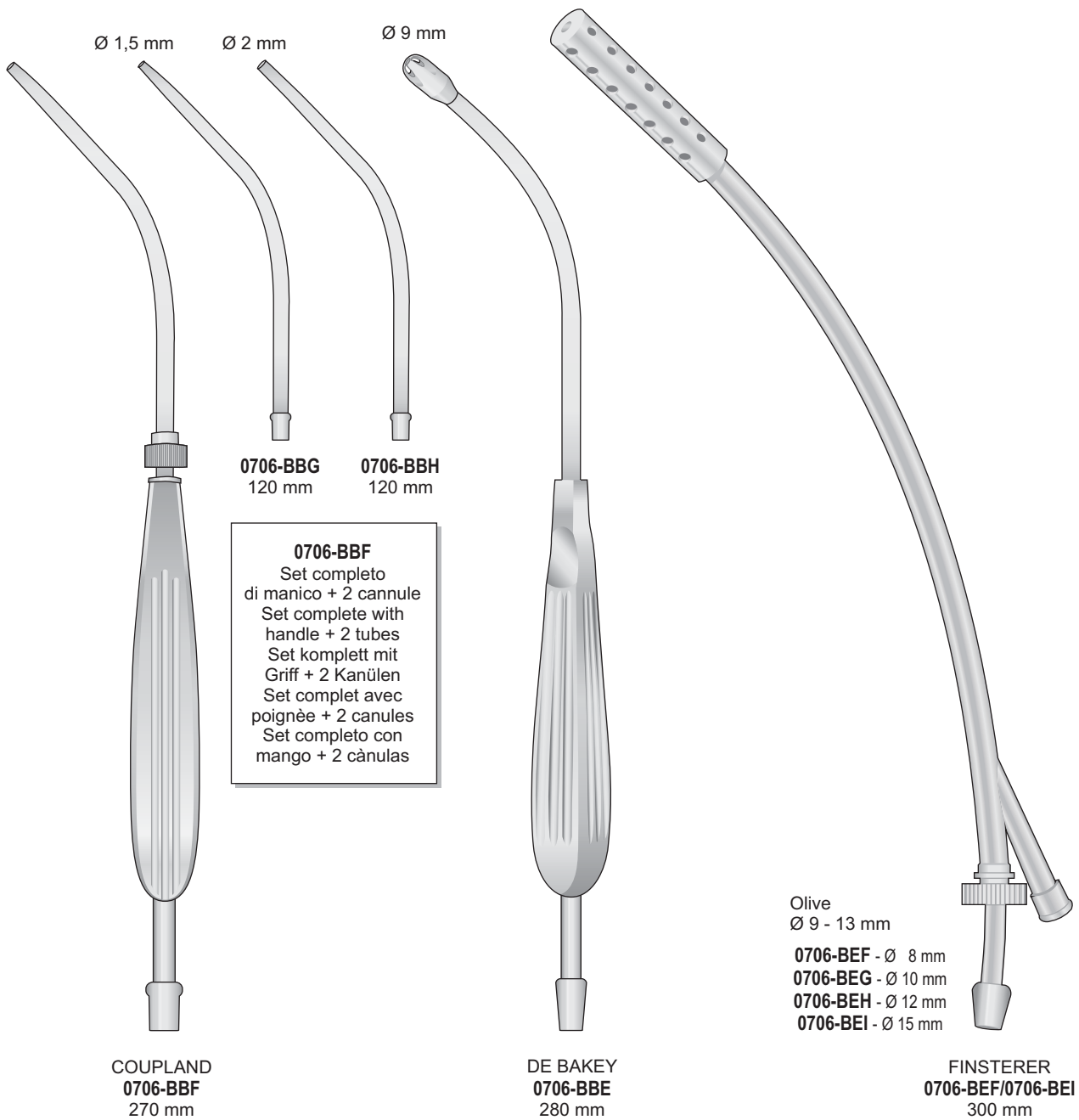

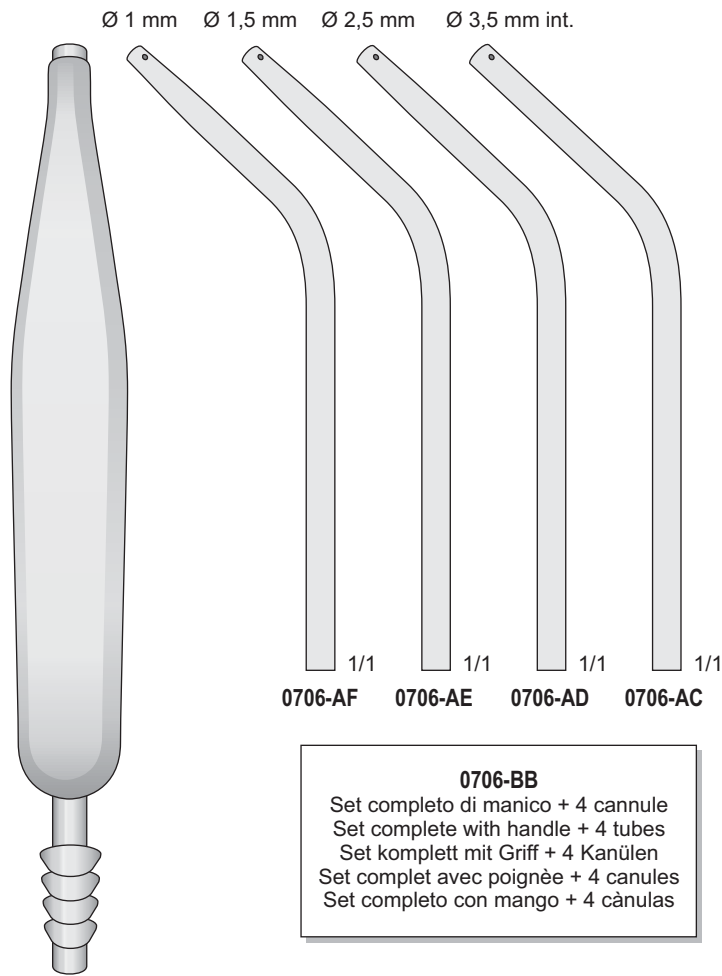

COUPLAND  
**0706-AB**  
 150 mm

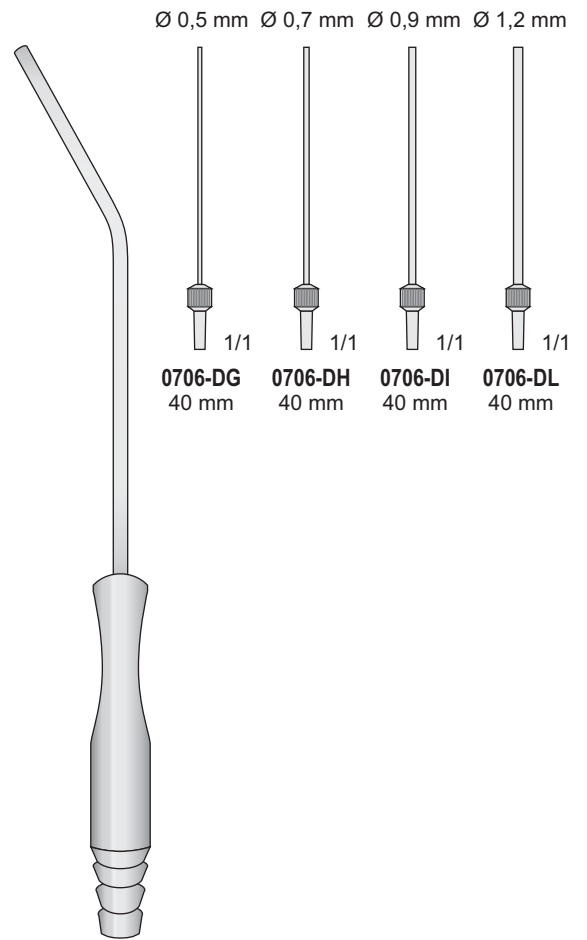

WULLSTEIN  
**0706-EE**  
 140 mm

Cannule per aspirazione

Suctions tubes

Absaugkanülen

Canules aspiratrices

Cánulas aspiradoras

Acciaio chirurgico - Stainless steel - Rostfrei - Acier - Acero

1/1

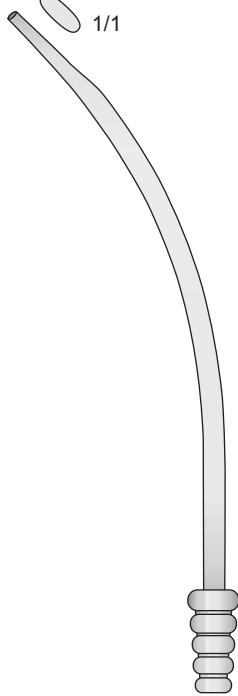

**0706-CA**  
180 mm

Ø 6 mm

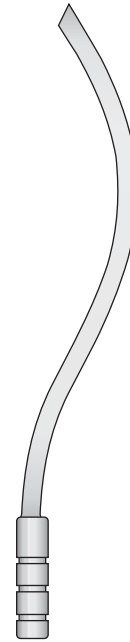

**0706-AL02**  
175 mm

Ø 9 mm

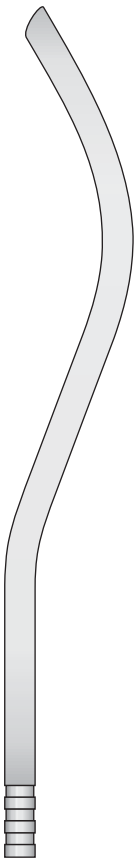

**0706-AL**  
230 mm

Ø 6 mm

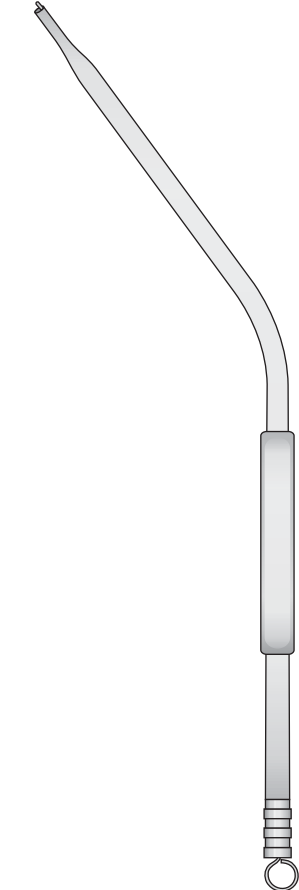

**0706-BAE**  
240 mm

Ø 4 mm



**0706-BBA**  
230 mm

6 mm



Rotondo  
Round  
Rund  
Ronde  
Redonda



**NUBOER**  
**0706-LI**  
210 mm

6 mm



Ovale  
Oval  
Ovale  
Ovale  
Ovalada

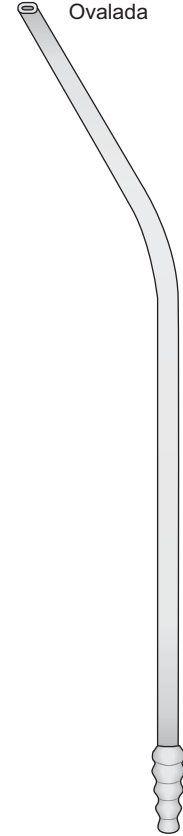

**NUBOER**  
**0706-LL**  
210 mm

Raschietti taglienti - Raspatories, Scharp  
 Saugraspatorium Scharf - Ruginie tranchante - Raspador cortante

Smussa  
 Blunt  
 Stumpf  
 Mousse  
 Romo

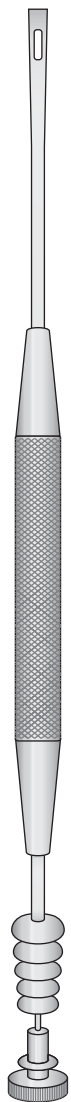

GORNEY  
 0706-HB  
 180 mm

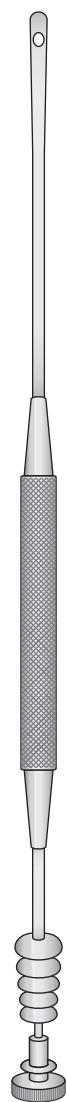

GORNEY  
 0706-HC  
 200 mm

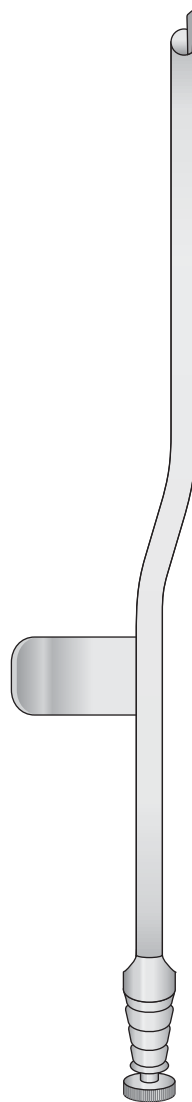

SAUG-RASPATORIUM  
 0706-EI Ø 4 mm  
 0706-EL Ø 5 mm  
 200 mm

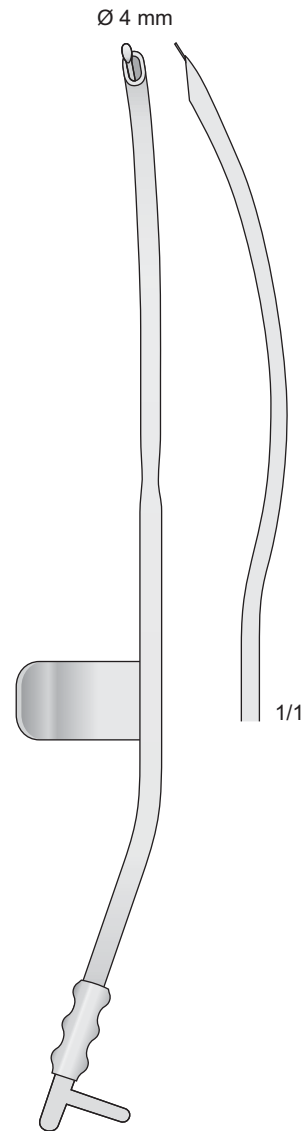

GUILLIEN  
 0706-FA  
 200 mm

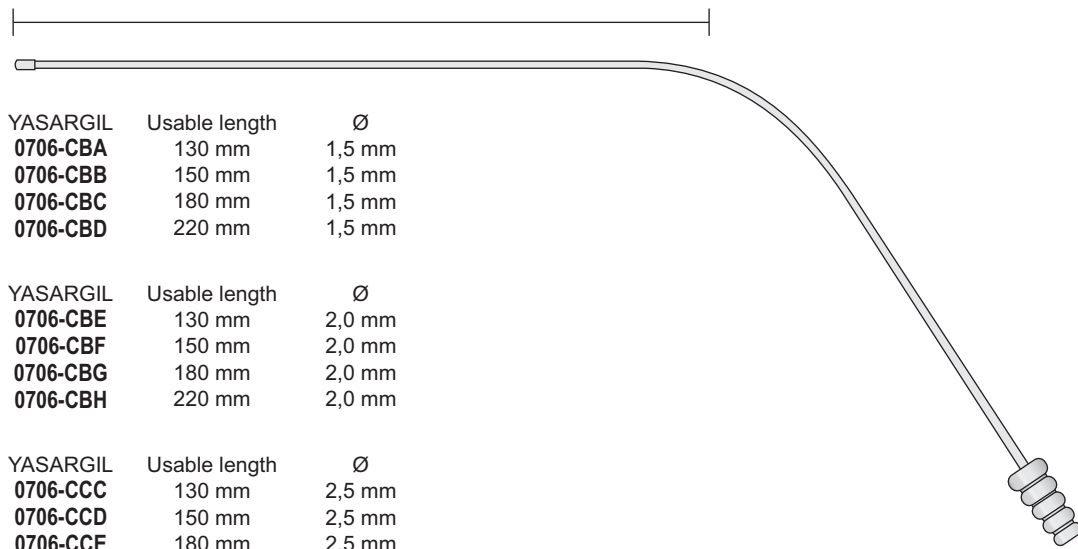

YASARGIL	Usable length	Ø
<b>0706-CBA</b>	130 mm	1,5 mm
<b>0706-CBB</b>	150 mm	1,5 mm
<b>0706-CBC</b>	180 mm	1,5 mm
<b>0706-CBD</b>	220 mm	1,5 mm

YASARGIL	Usable length	Ø
<b>0706-CBE</b>	130 mm	2,0 mm
<b>0706-CBF</b>	150 mm	2,0 mm
<b>0706-CBG</b>	180 mm	2,0 mm
<b>0706-CBH</b>	220 mm	2,0 mm

YASARGIL	Usable length	Ø
<b>0706-CCC</b>	130 mm	2,5 mm
<b>0706-CCD</b>	150 mm	2,5 mm
<b>0706-CCE</b>	180 mm	2,5 mm
<b>0706-CCF</b>	220 mm	2,5 mm

YASARGIL	Usable length	Ø
<b>0706-CCG</b>	130 mm	3,5 mm
<b>0706-CCH</b>	150 mm	3,5 mm
<b>0706-CCI</b>	180 mm	3,5 mm
<b>0706-CCL</b>	220 mm	3,5 mm

YASARGIL	Usable length	Ø
<b>0706-CDA</b>	180 mm	4,5 mm

YASARGIL  
0706-CBA/0706-CDA

Nasensauger

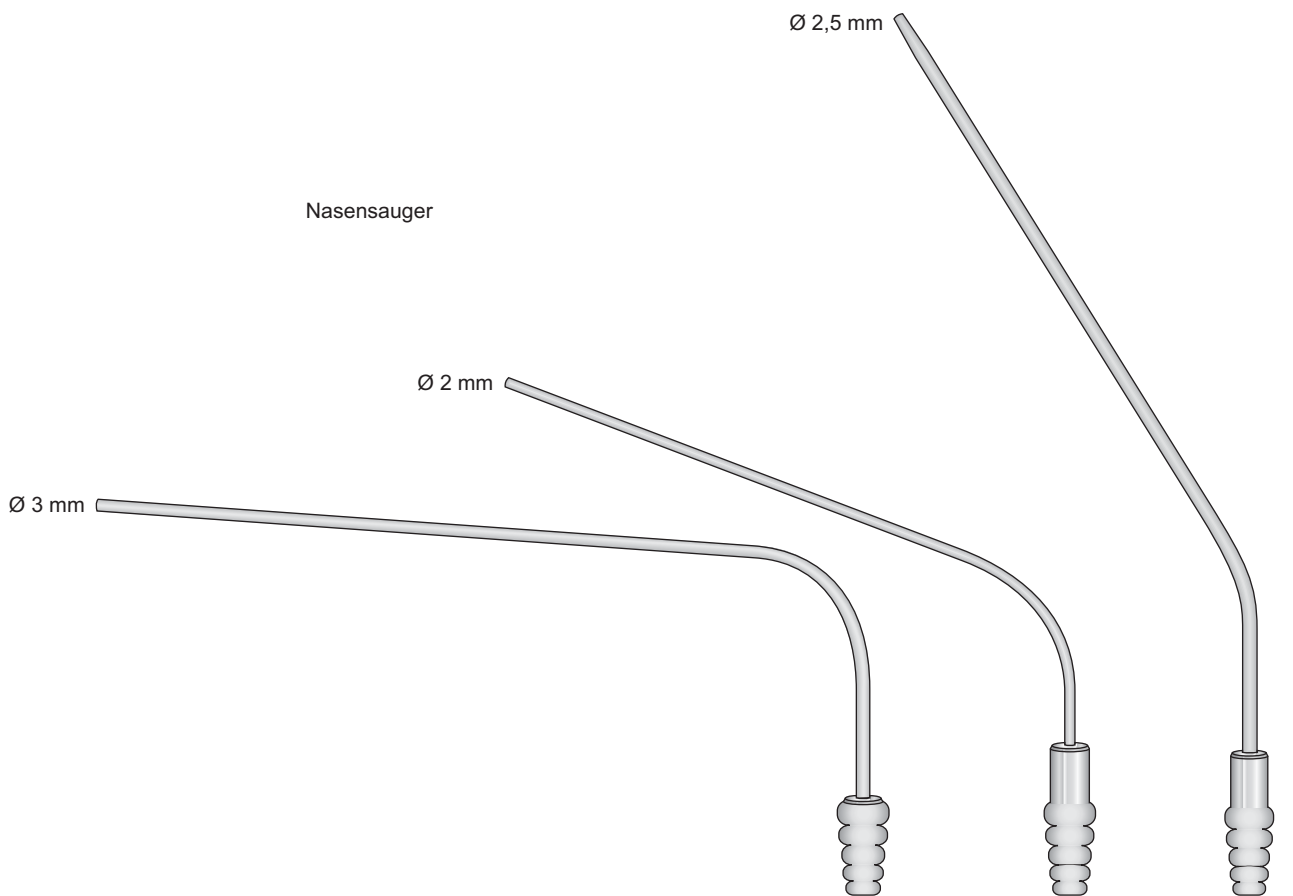

**0706-AI**  
160 mm

**0706-FB**  
130 mm

**0706-FC**  
170 mm

Char. 6	= 2 mm
Char 7	= 2,5 mm
Char 9	= 3 mm
Char 10	= 3,3 mm
Char 12	= 4 mm
Char 15	= 5 mm

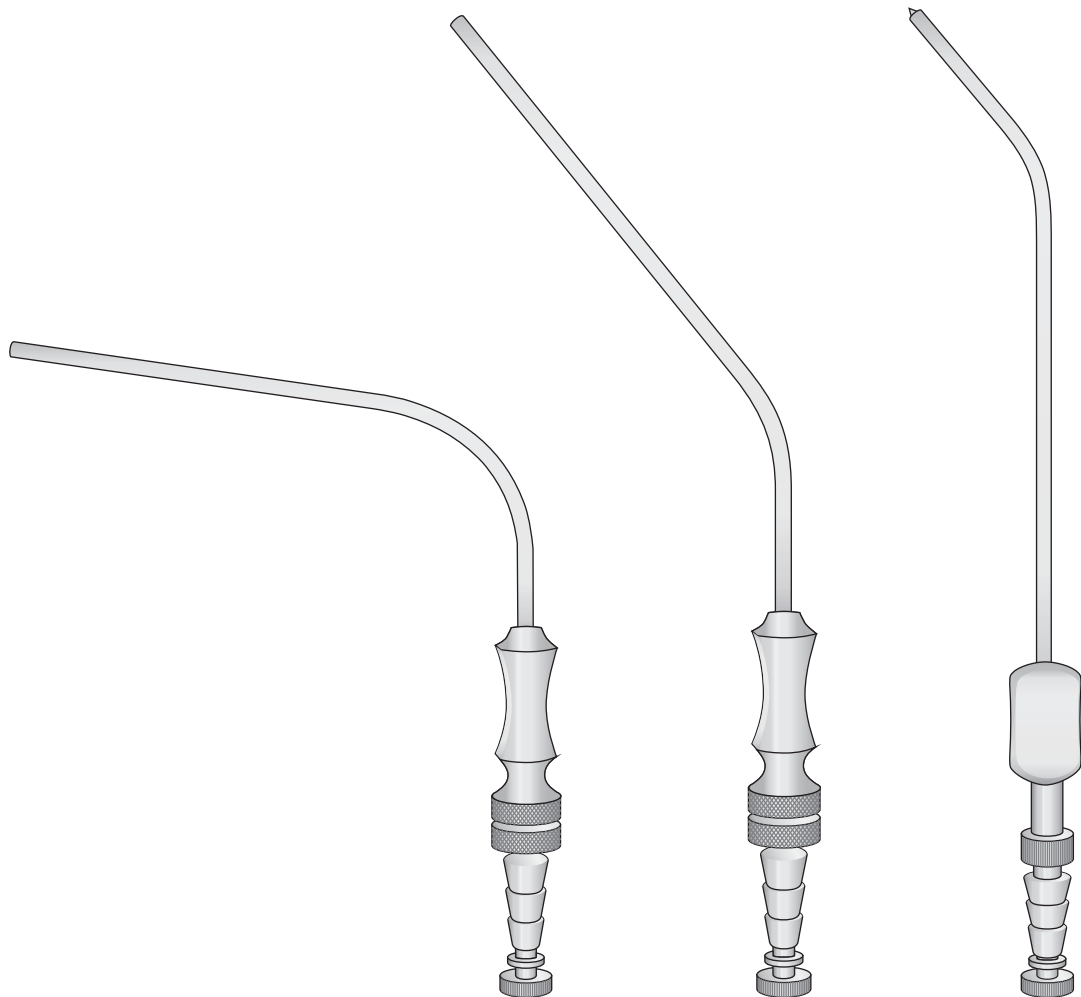

**FERGUSON**  
**0706-BEA** Ch. 6  
**0706-BEB** Ch. 7  
**0706-BEC** Ch. 9  
**0706-BED** Ch. 12  
**0706-BEE** Ch. 15  
 180 mm

**FRAZIER**  
**0706-CEA** Ch. 6  
**0706-CEB** Ch. 7  
**0706-CEC** Ch. 9  
**0706-CED** Ch. 12  
**0706-CEE** Ch. 15  
 180 mm

**PLESTER**  
**0706-BFA** Ch. 6  
**0706-BFB** Ch. 7  
**0706-BFC** Ch. 9  
**0706-BFD** Ch. 12  
**0706-BFE** Ch. 15  
 200 mm

Char. 3	= 1 mm
Char 5	= 1,7 mm
Char 7	= 2,5 mm
Char 10	= 3,3 mm
Char 12	= 4 mm

Con placca d'interruzione  
 With finger cut-off  
 Mit Unterbrecherplatte  
 Avec plaque interruptrice  
 Con placa desconectadora

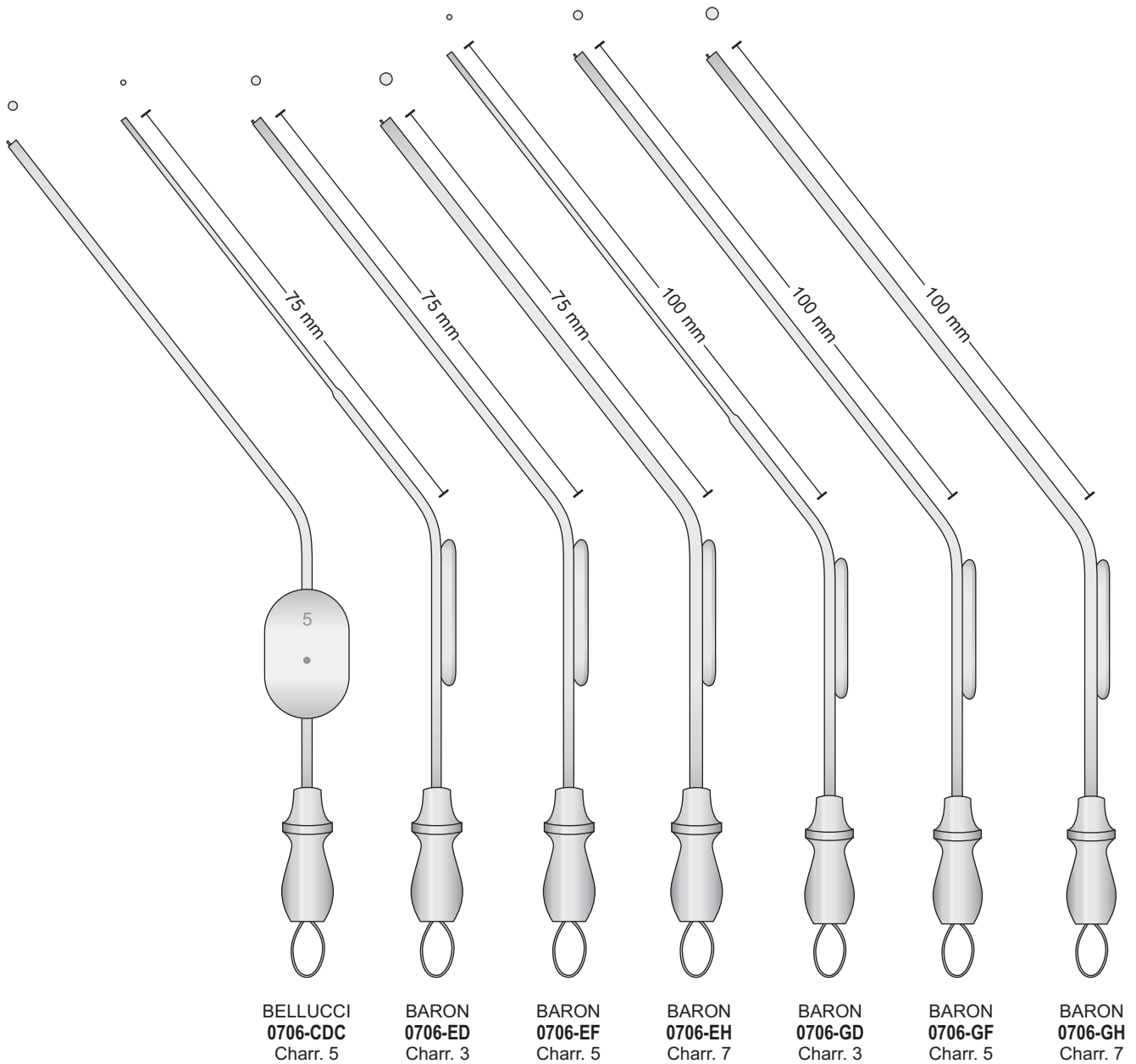



Char. 3	= 1 mm
Char 5	= 1,7 mm
Char 7	= 2,5 mm
Char 10	= 3,3 mm
Char 12	= 4 mm

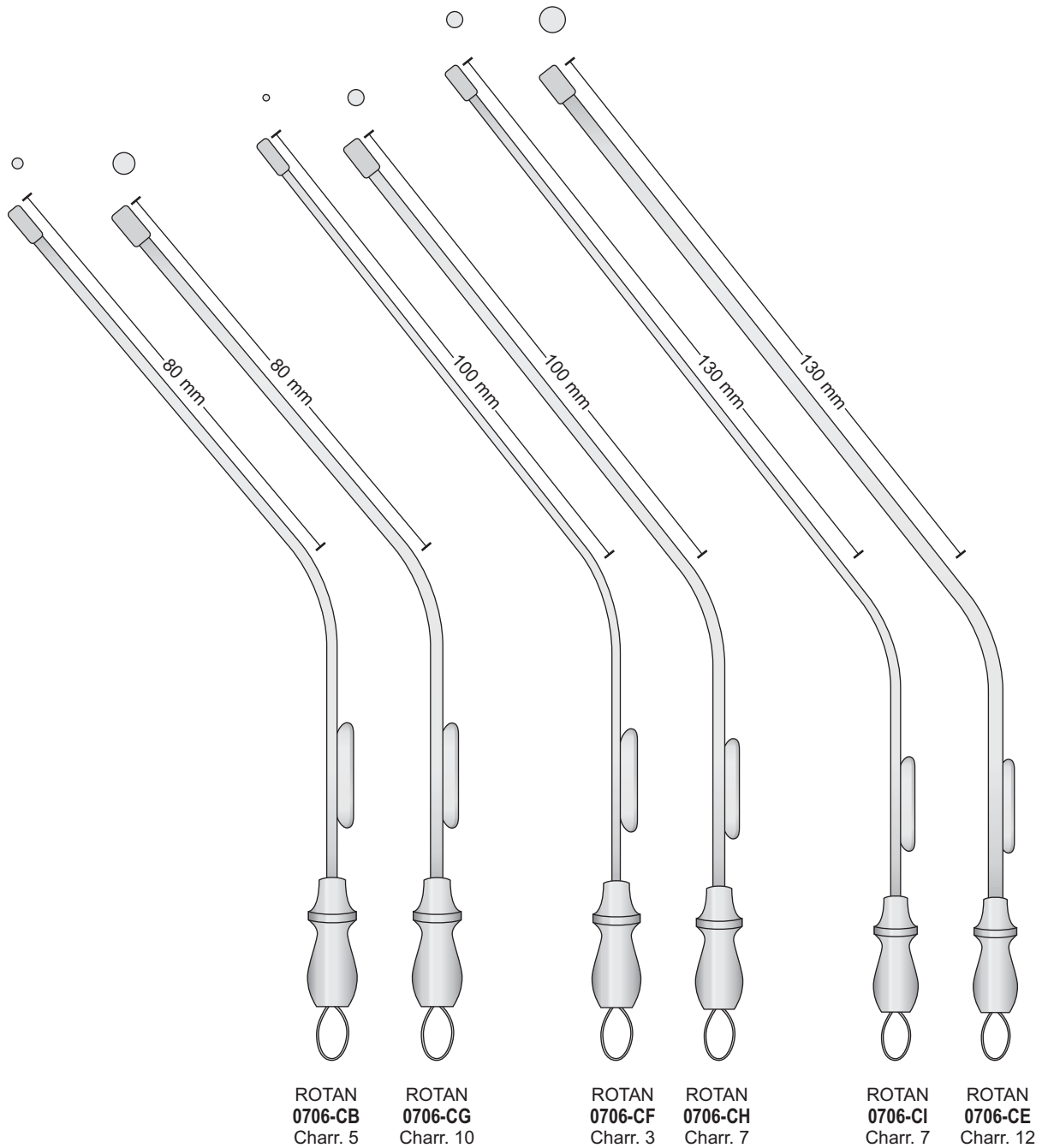

House Saug- und Spülrohr, Luer Konus

Tubo per aspirazione  
Suction tube  
Saugrohr  
Tube d'aspiration

Tubo per irrigazione  
Irrigation tube  
Spülrohr  
Tube d'irrigation

Char. 3	= 1 mm
Char 5	= 1,7 mm
Char 7	= 2,5 mm
Char 10	= 3,3 mm
Char 12	= 4 mm
Char 14	= 4,6 mm

Char. 2	= 0,6 mm
Char 4	= 1,21 mm
Char 5	= 1,7 mm
Char 7	= 2,5 mm
Char 8	= 2,4 mm
Char 12	= 4 mm

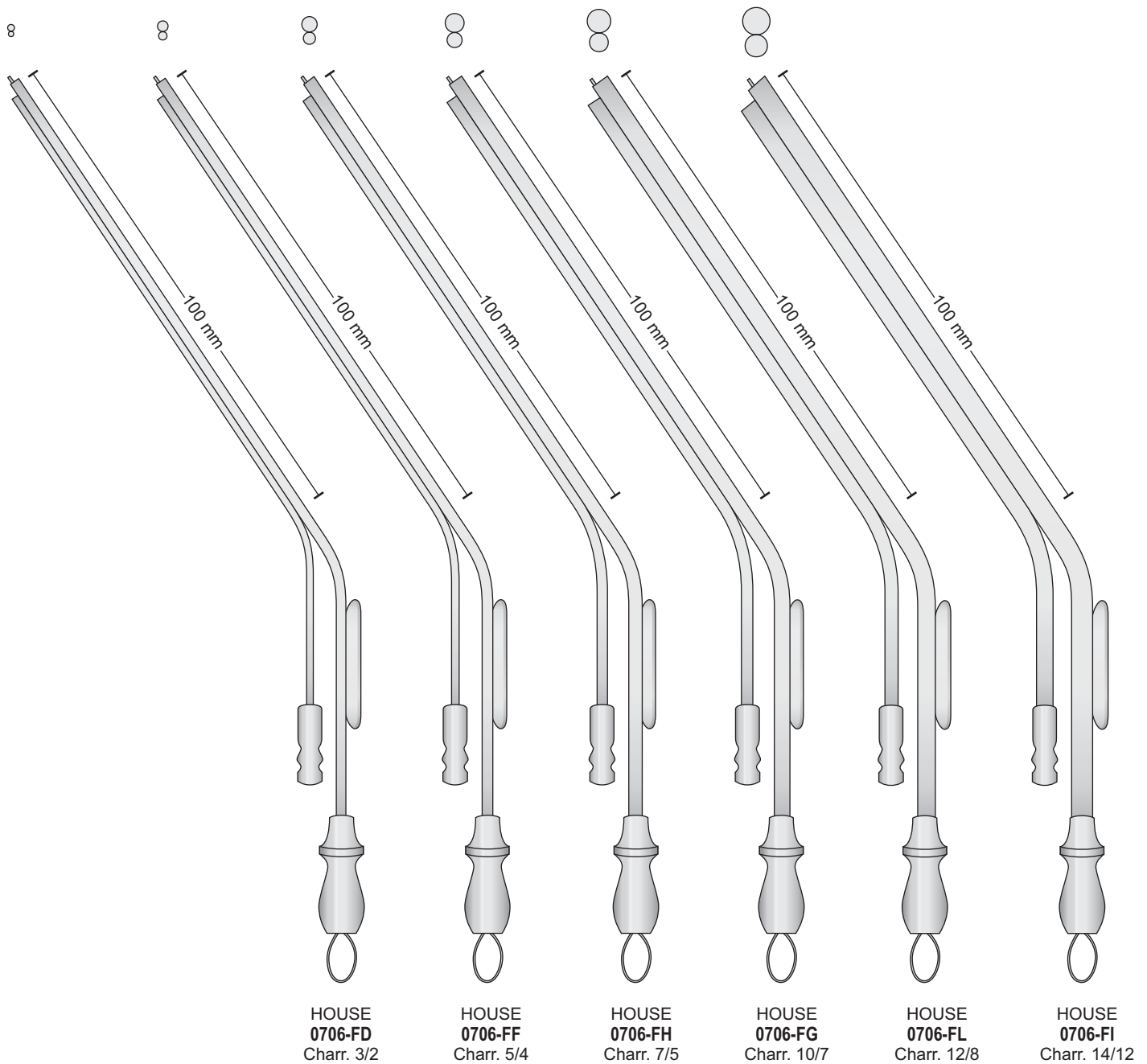

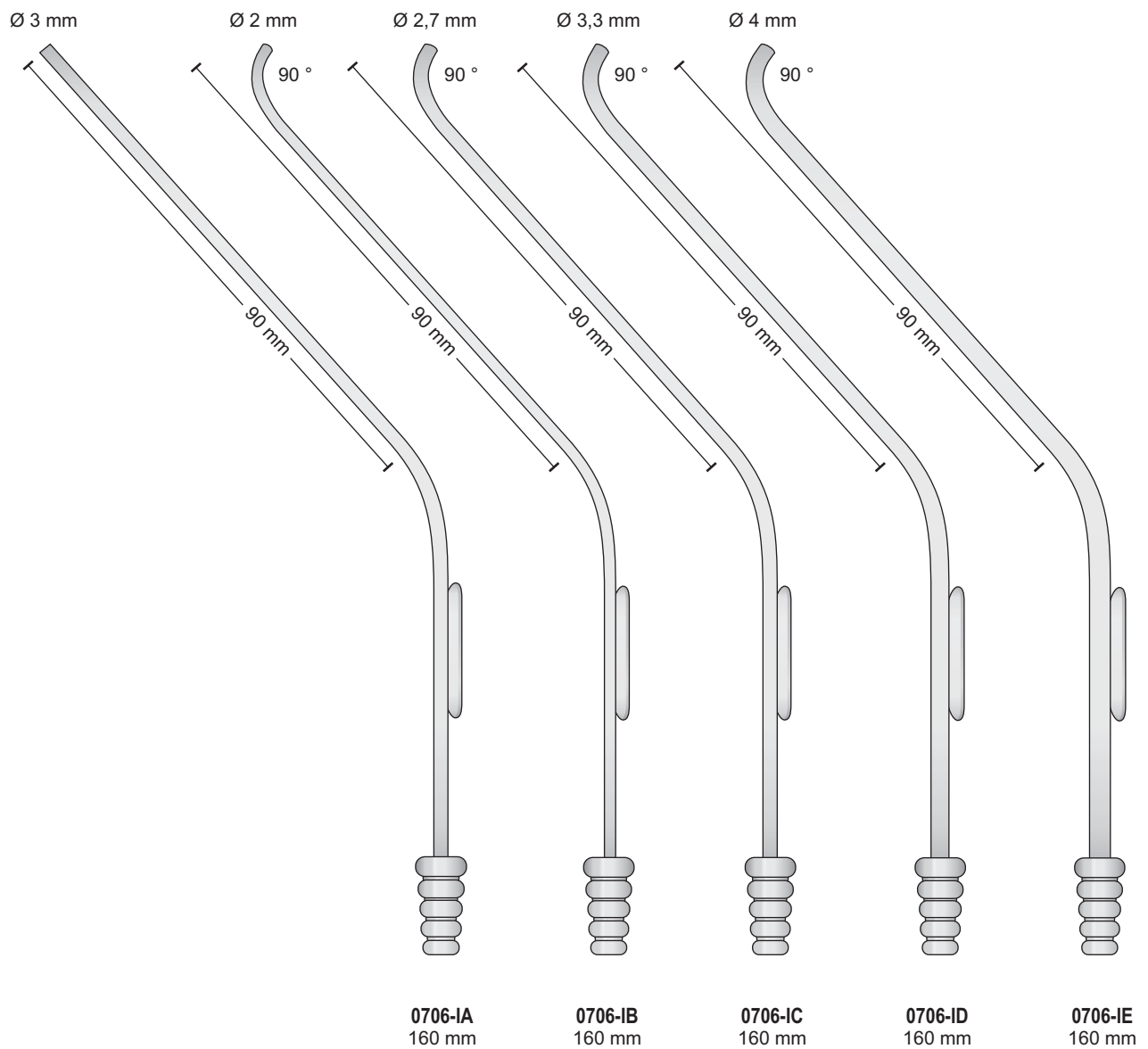

Superficie colorata nera  
Surface Black-finish  
Oberfläche Geschwärzt  
Surface noircie

Superficie colorata nera  
Surface Black-finish  
Oberfläche Geschwärzt  
Surface noircie

Malleabile  
Malleable  
Biegsam  
Malléables  
Malleable  
Ø 3 mm

Malleabile  
Malleable  
Biegsam  
Malléables  
Malleable  
Ø 3 mm

Malleabile  
Malleable  
Biegsam  
Malléables  
Malleable  
Ø 3 mm

Malleabile  
Malleable  
Biegsam  
Malléables  
Malleable  
Ø 3 mm

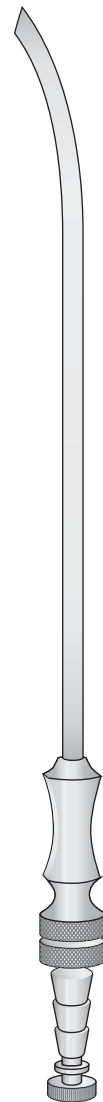
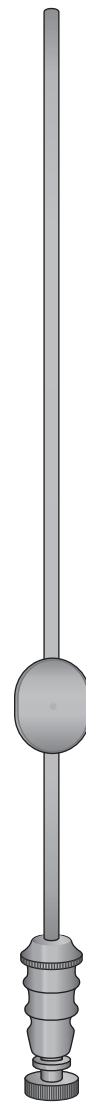
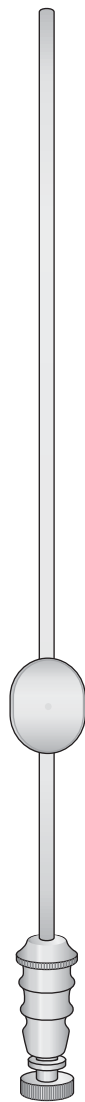
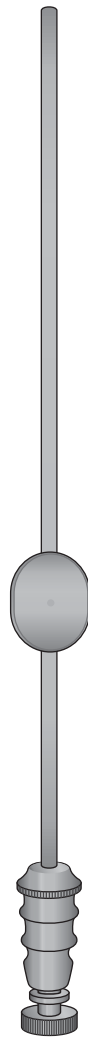
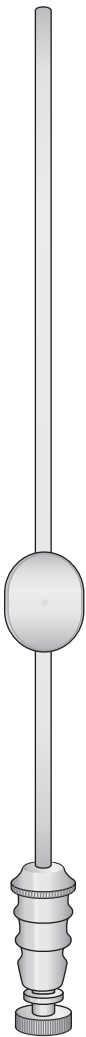

WERTHEIMER  
**0706-GL**  
160 mm

FRAZIER  
**0706-HA**  
160 mm

WERTHEIMER  
**0706-GA**  
200 mm

FRAZIER  
**0706-GB**  
200 mm

ADSON  
**0706-EB** ch. 12 = Ø 4 mm  
**0706-EC** ch. 15 = Ø 5 mm  
210 mm

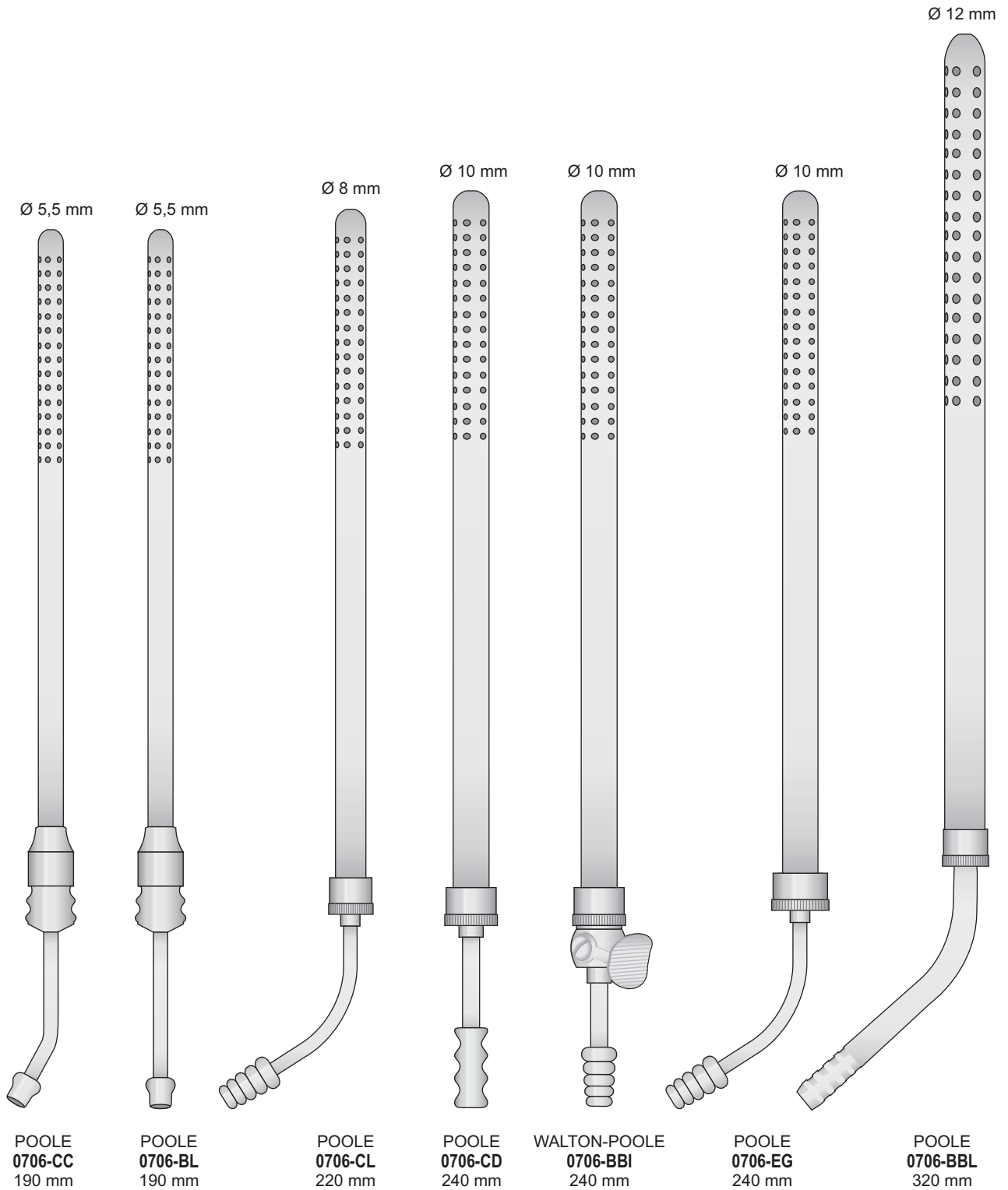

**0706-LH**  
 Set completo con:  
 Set complete with:  
 Komplettsset mit:  
 Set complet avec:  
 Set completos con:  
**0706-LC - 0706-LD - 0706-LE - 0706-LG**

Pompetta in gomma - Rubber bulb  
 Gummiball - Poire en caoutchouc  
 Pera de goma

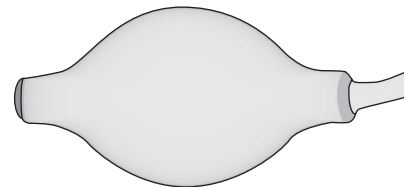

**0706-LG**

Raccordo in silicone per cannule  
 Autoclavabile  
 Flexible tube - Silicone  
 Schlauch - Silikon  
 Tuyau - Silicone  
 Tubo flexible de silicona

2 mt.

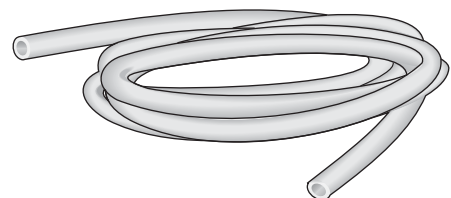

**1918-FA**  
 2 mt.

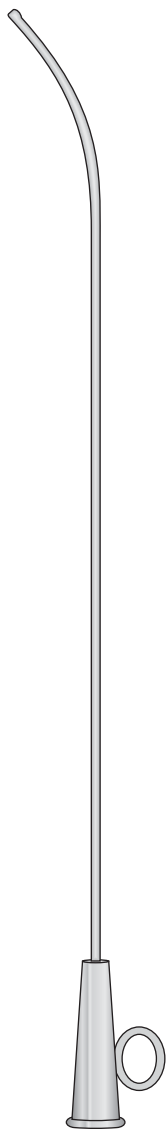

**0706-BBB** - Ø 1,5 mm  
**0706-BBC** - Ø 2 mm  
**0706-BBD** - Ø 2,5 mm

**HARTMANN**  
**0706-BBB/0706-BBD**  
 170 mm

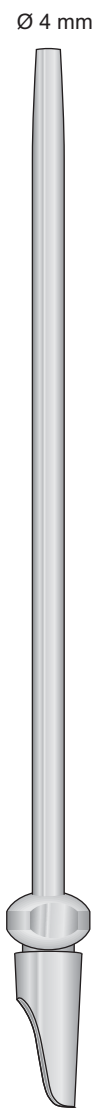

**0706-LE**  
 160 mm

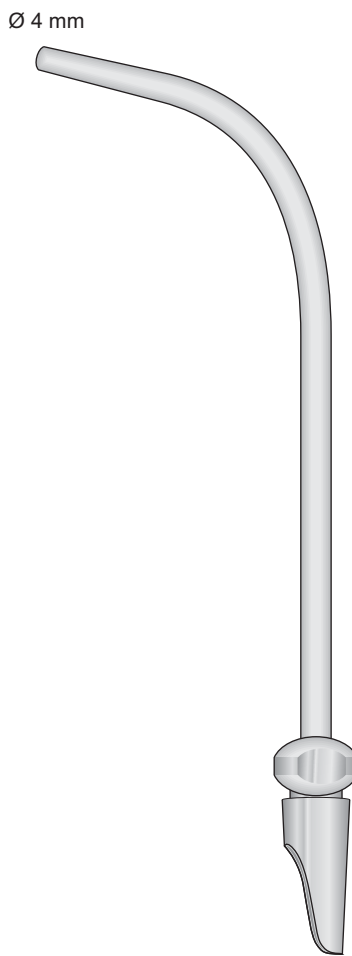

**0706-LD**  
 145 mm

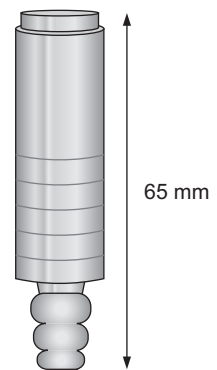

**0706-LC**  
 65 mm

Cannule per aspirazione

Suctions tubes

Absaugkanülen

Canules aspiratrices

Cánulas aspiradoras

Sonde auricolari  
Ear Catheters  
Ohrkatheter  
Sondes auriculaires  
Sondas auriculares

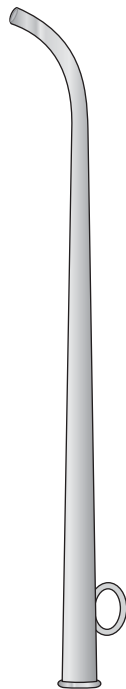

ITARD  
0706-BFG/0706-BGA  
145 mm

- 0706-BFG Ø 3,0 mm
- 0706-BFH Ø 3,5 mm
- 0706-BFI Ø 4,0 mm
- 0706-BFL Ø 4,5 mm
- 0706-BGA Ø 5,0 mm

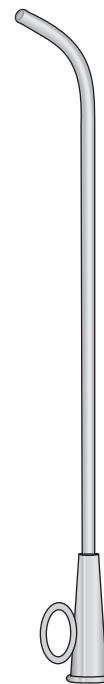

HARTMANN  
0706-BGB/0706-BGH  
150 mm



0706-BGI

- 0706-BGB Ø 2,0 mm
- 0706-BGC Ø 2,5 mm
- 0706-BGD Ø 3,0 mm
- 0706-BGE Ø 3,5 mm
- 0706-BGF Ø 4,0 mm
- 0706-BGG Ø 4,5 mm
- 0706-BGH Ø 5,0 mm

Cannule per lavaggio dei seni frontali e mascellari  
Antrum and frontal sinus wash cannulas  
Kiefer und Stirnhöhlen-Spülkanülen  
Canules pour le lavage du sinus maxillaire et frontal  
Cánulas lavadores para seno maxilar y seno frontal

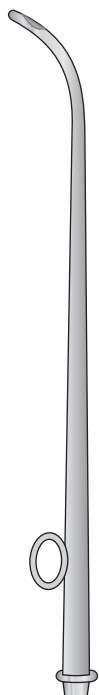

SIEBENMANN  
0706-BGL/0706-BHD  
150 mm

- 0706-BGL Ø 1,5 mm
- 0706-BHA Ø 1,7 mm
- 0706-BHB Ø 2,0 mm
- 0706-BHC Ø 2,5 mm
- 0706-BHD Ø 3,0 mm

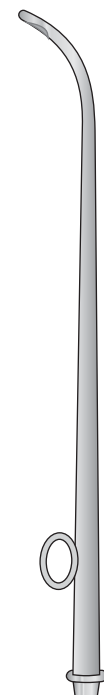

SIEBENMANN  
0706-BHE/0706-BHI  
150 mm

- 0706-BHE Ø 1,5 mm
- 0706-BHF Ø 1,7 mm
- 0706-BHG Ø 2,0 mm
- 0706-BHH Ø 2,5 mm
- 0706-BHI Ø 3,0 mm



0706-BHL

Cannule per lavaggio dei seni frontali e mascellari  
 Antrum and frontal sinus wash cannulas  
 Kiefer und Stirnhöhlen-Spülkanülen  
 Canules pour le lavage du sinus maxillaire et frontal  
 Cánulas lavadores para seno maxilar y seno frontal

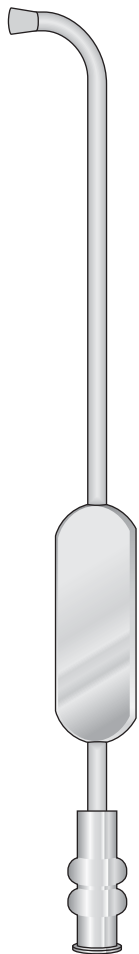

**KILLIAN**  
**0706-IF** Ø 3 mm  
**0706-IH** Ø 4 mm  
 145 mm

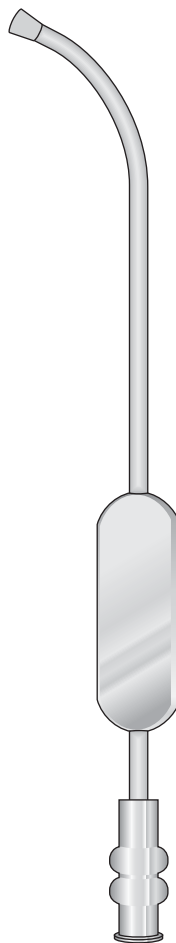

**KILLIAN**  
**0706-IG** Ø 3 mm  
**0706-II** Ø 4 mm  
 145 mm

Ø Interno  
 Ø Inside  
 Ø Innen  
 Ø Intérieur  
 Ø Interior



**MAGILL**  
**0706-BAA** Ø 1 mm  
 200 mm

Ø Interno  
 Ø Inside  
 Ø Innen  
 Ø Intérieur  
 Ø Interior



**MAGILL**  
**0706-BAB** Ø 1 mm  
**0706-BAC** Ø 2 mm  
**0706-BAD** Ø 3 mm  
 200 mm



Scovolini per pulizia cannule - Cleaning brush for tubes  
 Kanülenreinigungs-bürsten - Brosse de nettoyage pour canules  
 Cepillo para limpiar cánulas

Autoclavabile  
 Autoclavable  
 Sterilisier bar  
 Stérilisable  
 Esterilizable

Spazzola per unghie  
 Nail brushes  
 Handwaschbürste  
 Brosse à ongles  
 Cepillos de uñas



**0706-CAA**  
 4 x 11 cm

Ø Est. 8 mm  
 Ø Int. 6 mm



1/1

Ø Est. 5 mm  
 Ø Int. 2,5 mm



1/1

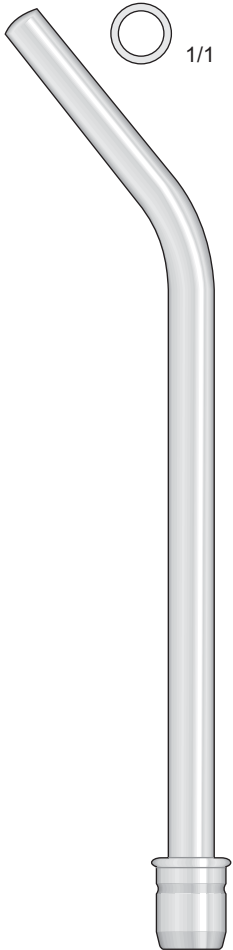

PELTON-CRANE  
**0706-BIE**  
 140 mm

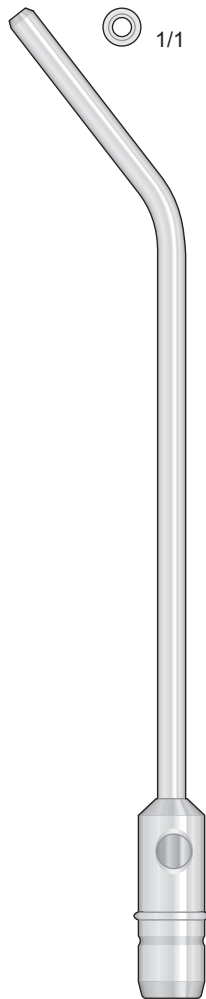

PELTON-CRANE  
**0706-BIA**  
 160 mm

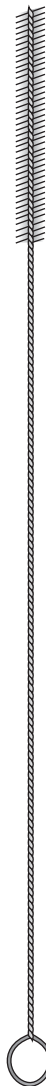

**0706-EA**  
 235 mm



**0706-BII**  
 220 mm

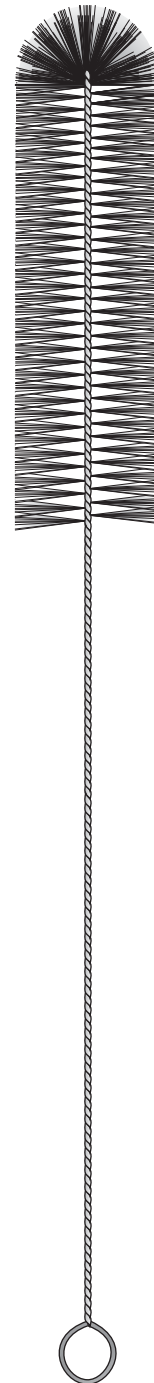

**0706-BIH**  
 300 mm

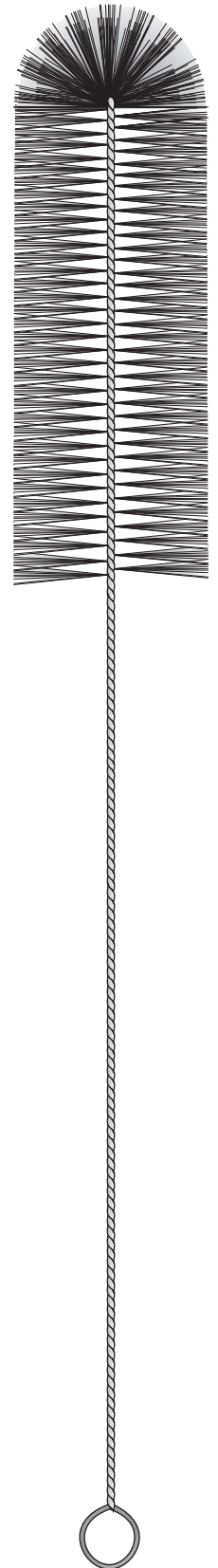

**0706-BIL**  
 360 mm

Sonde per varici, malleabili - Probe for varicose veins, malleable  
 Krampfadersonden, biegsam - Sondes pour varices, malléables  
 Sondas para vârices, maleables

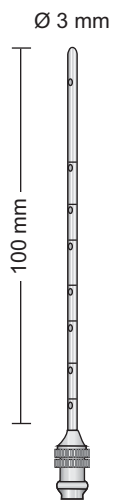

FRAZIER  
0706-BLA

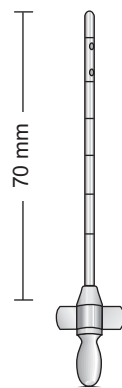

0706-BLB - Ø 2 mm  
0706-BLC - Ø 2,5 mm

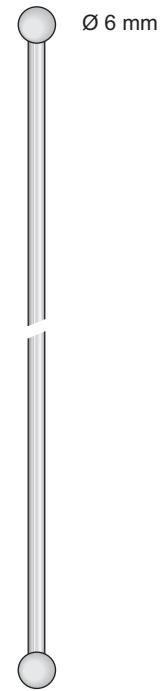

BABCOCK  
1411-GG - 400 mm  
1411-GH - 500 mm  
1411-GI - 650 mm  
1411-GL - 800 mm

Aghi per tonsille  
Tonsil needles  
Tonsillenkanülen  
Aiguilles pour les amygdales  
Agujas para amígdalas



1411-AB  
120 mm

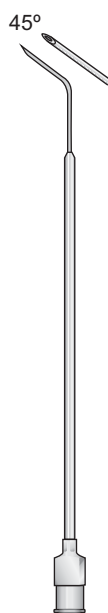

1411-AC  
110 mm



1411-AD  
110 mm

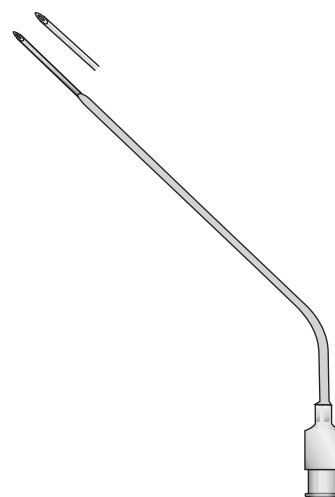

SEPTUN-NADEL  
1411-AE  
110 mm

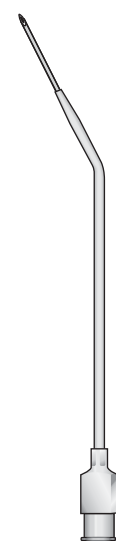

1411-AF  
110 mm

Strumenti per aspirazione e lavaggio  
 Aspirating and Irrigating instruments  
 Saug- und Spülinstrumente  
 Instruments à aspiration et à irrigation  
 Instrumentos de aspiración y de lavado

Ø 1 mm

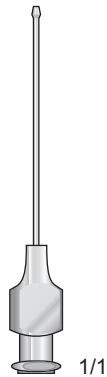

1411-CC  
50 mm

Ø 2 mm

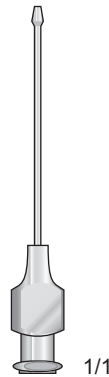

1411-CD  
50 mm

Ø 3 mm

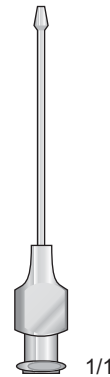

1411-CE  
50 mm

WULLSTEIN manico per aspirazione e lavaggio, con cono Luer, per cannule per aspirazione e lavaggio di WULLSTEIN  
 WULLSTEIN Irrigating suction handle, with Luer cone, for WULLSTEIN irrigating or Suction tubes  
 WULLSTEIN Spül- und Saughandgriff mit Luer-Konus, passend für WULLSTEIN Spül- oder Saugrohre  
 WULLSTEIN manche aspirateur et irrigateur, à cône Luer, s'adaptant aux tubes aspirateurs/irrigateurs de WULLSTEIN  
 WULLSTEIN mango irrigador y ispirador, con cono Luer, apropiado para los tubos de lavado y de aspiración según WULLSTEIN

Cannule per irrigazione dei vasi, malleabili  
 Vessel irrigating cannulas, malleable  
 Gefäß-spülkanülen, biegsam  
 Canules d'irrigation pour vaisseaux, malléables  
 Cánulas de irrigacion para vasos, maleables

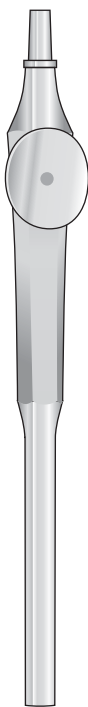

WULLSTEIN  
0706-GE  
120 mm



0706-GG  
110 mm



0706-GC  
65 mm

Con cono LUER-LOCK  
 With LUER-LOCK attachment  
 Mit LUER-LOCK-Ansatz  
 Avec cône LUER-LOCK  
 Con cono LUER-LOCK

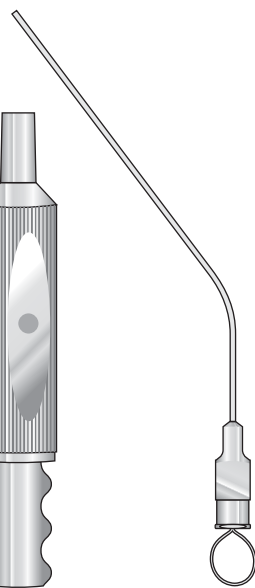

ROSEN  
1411-BG Ø 0,70 mm  
1411-BH Ø 0,90 mm  
1411-BI Ø 1,25 mm  
95 mm



ROSEN  
1411-BD Ø 0,70 mm  
1411-BE Ø 0,90 mm  
1411-BF Ø 1,25 mm  
95 mm

Ø 3 mm



SCHMID  
1411-DA  
150 mm

Ø 4 mm



SCHMID  
1411-DB  
150 mm

Ø 5 mm



SCHMID  
1411-DC  
150 mm

Ø 6 mm



SCHMID  
1411-DD  
150 mm

Cannule per aspirazione

Suctions tubes

Absaugkanülen

Canules aspiratrices

Cánulas aspiradoras

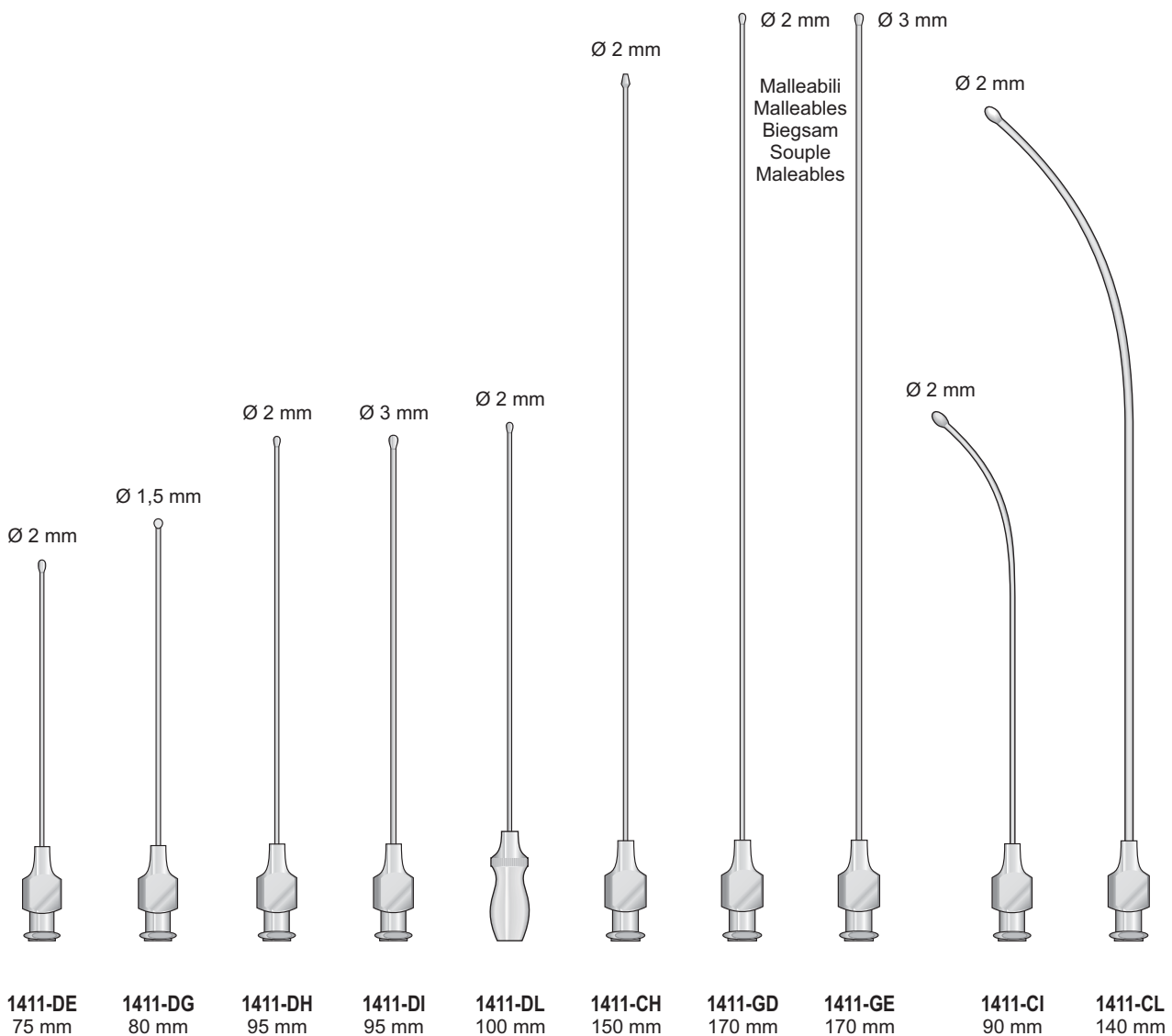
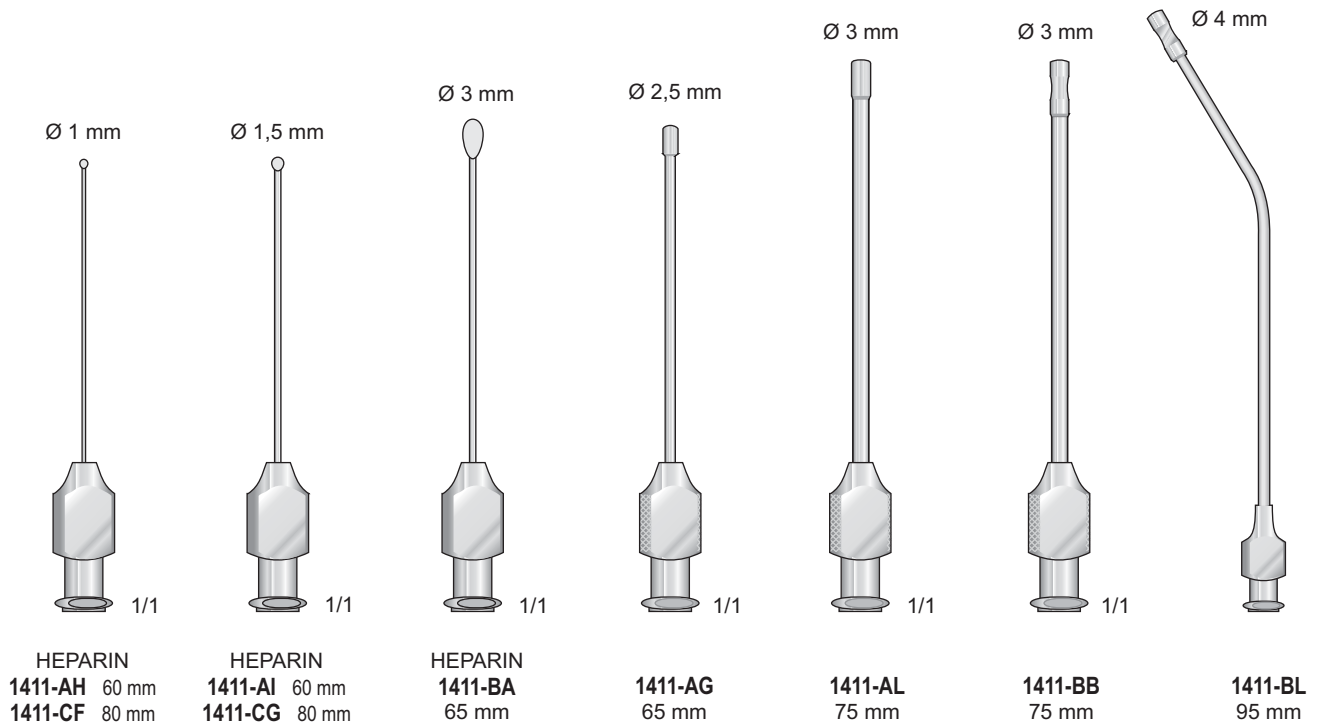

Cannule per aspirazione

Suctions tubes

Absaugkanülen

Canules aspiratrices

Cànulas aspiradoras

Malleable needles

0,5 mm

0,7 mm

1 mm

1,5 mm

2 mm

2,5 mm

3 mm



1411-IG  
150 mm



1411-IH  
150 mm



1411-II  
150 mm



1411-IL  
150 mm



1411-LA  
150 mm



1411-LB  
150 mm



1411-LC  
150 mm

Two hole malleable needles

0,5 mm

0,7 mm

1 mm

1,5 mm

2 mm

2,5 mm

3 mm



1411-LD  
150 mm



1411-LE  
150 mm



1411-LF  
150 mm



1411-LG  
150 mm



1411-LH  
150 mm



1411-LI  
150 mm



1411-LL  
150 mm

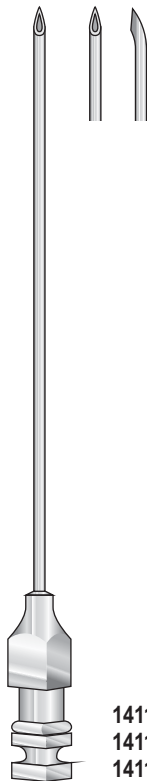

1411-EB - 1,30 x 80 mm  
 1411-EC - 1,50 x 80 mm  
 1411-ED - 1,65 x 80 mm

TUOHY  
 1411-EB/1411-ED



1411-EE - 0,70 x 80 mm  
 1411-EF - 0,70 x 90 mm  
 1411-EG - 1,00 x 80 mm  
 1411-EH - 1,00 x 90 mm  
 1411-EI - 1,20 x 90 mm  
 1411-EL - 1,20 x 100 mm

QUINKE  
 1411-EE/1411-EL

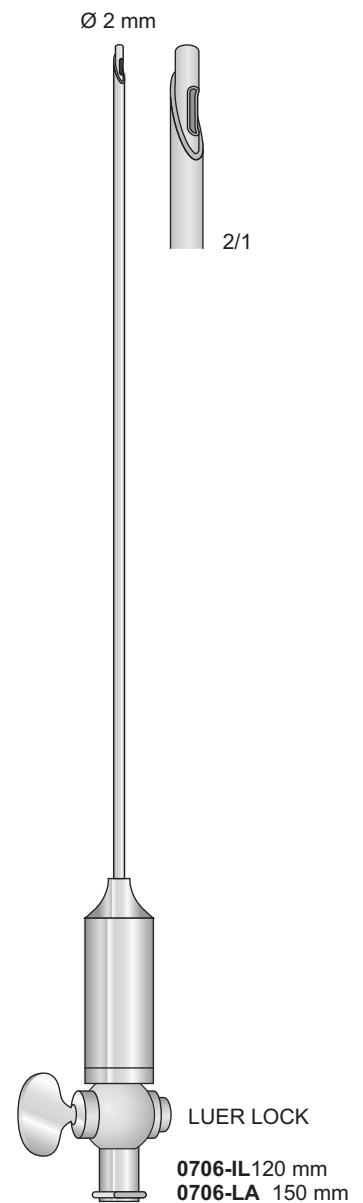

VERESS  
 0706-IL/0706-LA



18

Mantenimento strumenti  
Maintaining of instruments  
Erhaltung für instrumente  
Nettoyage d'instruments  
Mantenimiento del instrumental





**RODHOIL**

Lubrificante ad alta densità. Assicura la perfetta funzionalità e scorrevolezza di tutti gli strumenti chirurgici. Da applicare negli snodi, giunture e in tutte le parti in movimento soggette ad attrito.

**RODHOIL**

Lubrificant to high density. It assures the perfect utility and fluency of all the surgical instruments. For apply in to loosens, join and in all the parts in subject movement subject to attrition.

**RODHOIL**

Schmiermittel mit hoher Dichte. Es sichert den perfekten Gebrauch und die Leichtgängigkeit aller chirurgischen Instrumente. Man gibt es auf die Verbindungen und Gelenke und in alle Beweglichen Teile, die Reibungen unterworfen sind.

Olio lubrificante per  
strumenti chirurgici



**0402-141117**  
50 cc

**CLEANLACT**

Prodotto concentrato per strumenti chirurgici. Esplica un azione anticorrosiva batteriostatica e lubrificante. Garantisce il perfetto mantenimento di tutti gli strumenti in acciaio eliminando eventuali macchie, aloni e bruniture dovute a sterilizzazioni, disinfezioni e a lavaggi con acque dure. Va usato periodicamente.

**CLEANLACT**

Product concentrated for surgical instruments. It explains an action anti-corrosive, antibacterium and lubricant. It guarantees the perfect maintenance of all the instruments in steel eliminating eventual stains and burnishes to sterilization, disinfection and to washings with hard waters. It used periodically.

**CLEANLACT**

Reinigungskonzentrat für chirurgische Instrumente. Es wirkt antibakteriell, nicht-ätzend und schmierig. Es garantiert die perfekte Erhaltung aller Instrumente aus Stahl, entfernt eventuelle Flecken, Ränder, und Bräunungen von Sterilisationen, Desinfektionen und Reinigungen mit hartem Wasser. Es sollte regelmäßig verwendet werden.

Lubrificante anticorrosivo e detergente per strumenti chirurgici  
Soluble lubricant extends useful life of surgical instruments  
Das wasserlösliche Schmiermittel verlängert die Lebensdauer  
von chirurgischen Instrumenten  
Lubrifiant soluble dans l'eau prolonge la vie des instruments chirurgicaux  
Lubrificante soluble en agua,  
so uso prolonga la duración de los instrumentos quirúrgicos



**0402-B11** - 1000 cc  
**0402-F11** - 5000 cc

Pietre ed accessori

Accessories for re-sharpening

Abziehsteine zum schärfen

Pierre et accessoires

Accesorios para el reafilado

Pietre di Arkansas per affilatura strumenti  
Sharpening stones  
Schleifsteine  
Pierres d'affutage  
Materiales para afilar

Olio per affilatura strumenti  
Oil for grinding stones  
Schleifstein-Öl  
Huile d'affutage



**0402-CLL**  
ARKANSAS  
conica n° 299



**0402-1411**  
30 cc



**0402-LG**  
ARKANSAS  
piatta n° 8



**0402-G01**  
ARKANSAS n° 6A



**0402-E**  
ARKANSAS  
piatta n° 4

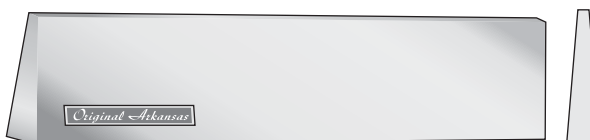

**0402-CC01**  
ARKANSAS

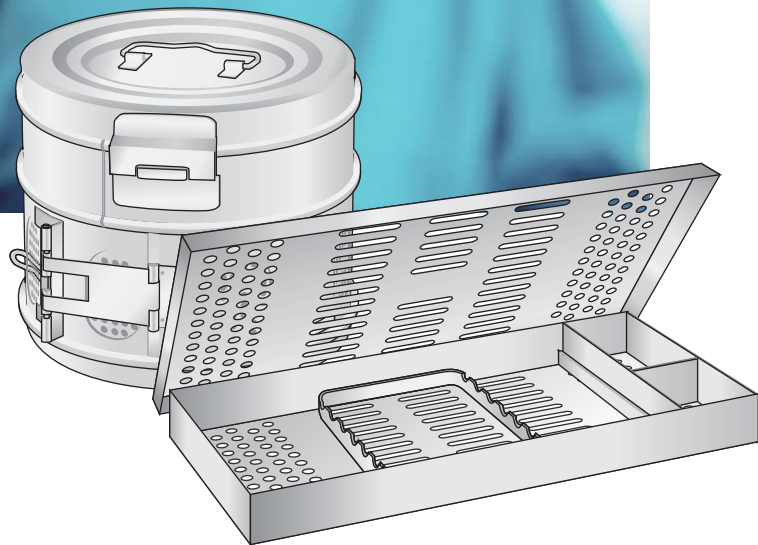

19

Bacinelle, Scatole per sterilizzazione  
Sterilizing containers  
Steril-Container  
Containers pour stérilizer  
Contenedores para esterilizaciòn



**Contenitori  
per sterilizzare**

**Sterilizing  
containers**

**Steril  
Container**

**Containers  
pour stérilizer**

**Contenedores  
para esterilizaciòn**

Scatola per sterilizzazione aghi da sutura - Box for needles  
Sterilbehälter für Nadeln - Boite pour aiguilles de suture  
Estuche para agujas

Vaso in vetro con coperchio in acciaio inox  
Jar in glass with lid in stainless steel  
Pot en verre avec couvercle en acier inox

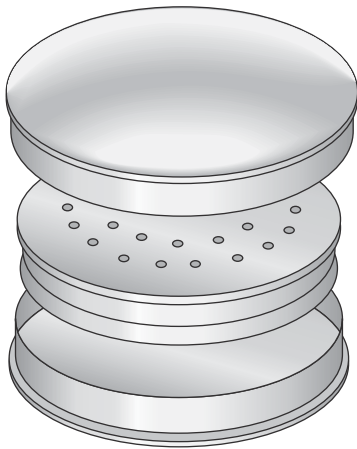

**0218-B**  
Ø 78 mm h 15 mm

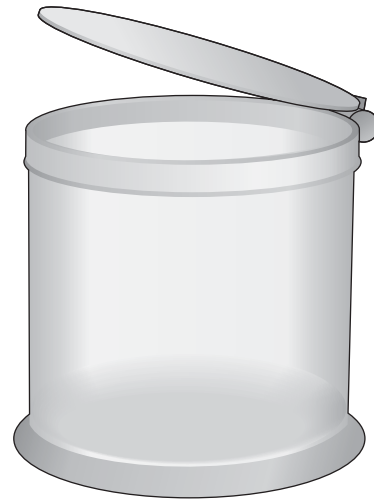

**211503-G** Ø 100x100 mm  
**211503-I** Ø 120x120 mm

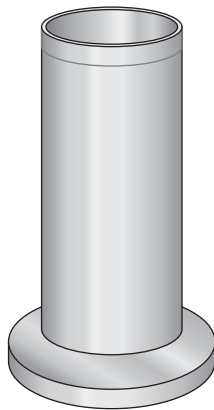

**0318-FB** Ø 50 mm h 100 mm  
**0318-FC** Ø 50 mm h 150 mm  
**0318-FF** Ø 80 mm h 180 mm



**211503-BA** Ø 100x100 mm  
**211503-BC** Ø 120x120 mm

Capsule inox con fondo piano e becco  
Lotion bowls capsules  
Runder Sterilbehälter mit Ausguss  
Capsule en acier inox

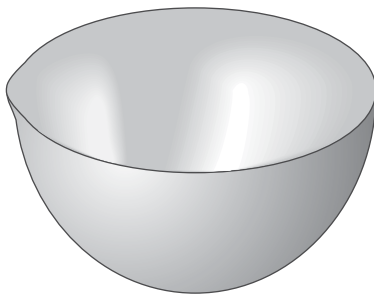

**0318-AB** Ø 40 mm 15 cc  
**0318-AC** Ø 60 mm 75 cc  
**0318-AD** Ø 80 mm 225 cc  
**0318-AE** Ø 100 mm 325 cc  
**0318-AF** Ø 120 mm 500 cc  
**0318-AG** Ø 150 mm 600 cc

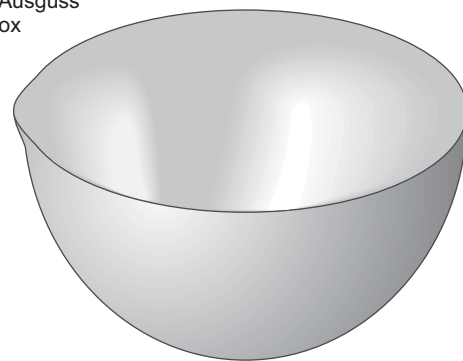

**0318-IA** Ø 180 mm 1000 cc  
**0318-IB** Ø 200 mm 1450 cc  
**0318-IC** Ø 220 mm 2000 cc  
**0318-ID** Ø 240 mm 3300 cc

Contenitori per  
sterilizzare

Sterilizing  
containers

Steril  
Container

Containers  
pour stérilizer

Contenedores  
para esterilizaciòn

Inox - Stainless steel - Rostfrei  
Inoxidable

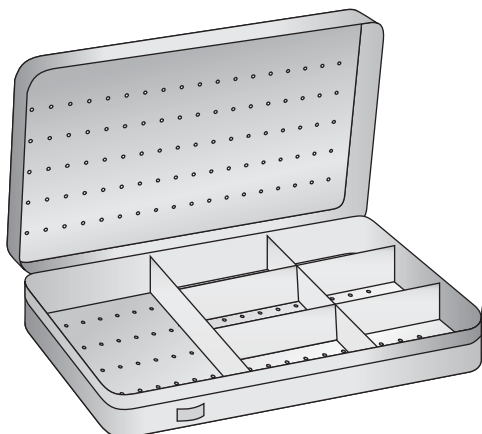

**0218-CH**  
150 x 90 x 20 mm

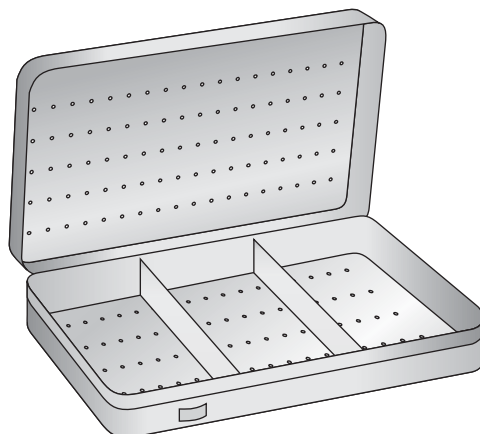

**0218-CD**  
150 x 90 x 20 mm

Bacinella a 10 scomparti

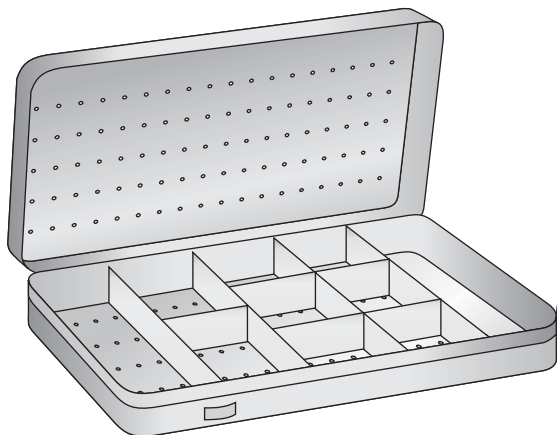

**0218-CI**  
220 x 120 x 20 mm

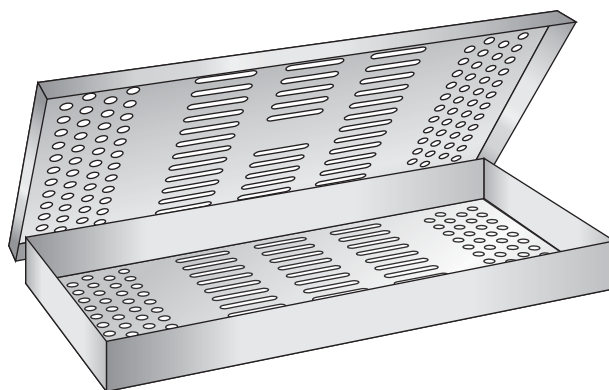

**0218-EB**  
275 x 130 x 25 mm

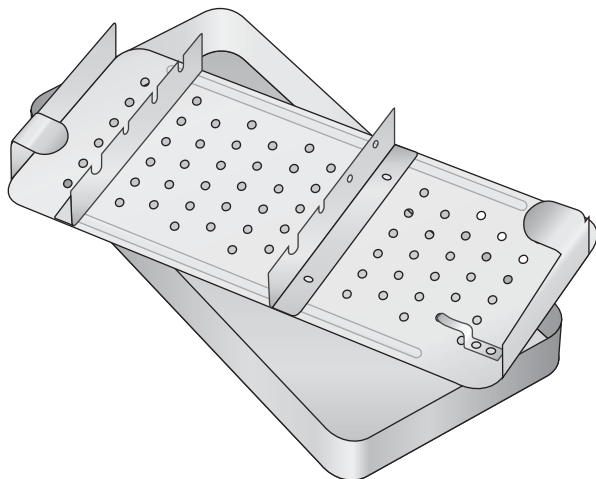

**0218-DA**  
180 x 90 x 35 mm 2 ripiani

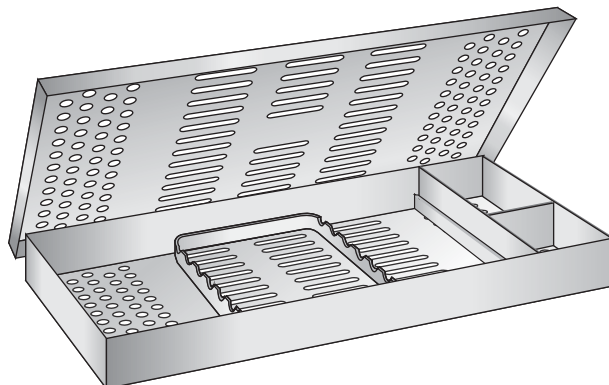

**0218-EA** 275 x 130 x 25 mm Con griglia e scomparti  
**0218-EC** 285 x 190 x 25 mm Con griglia e scomparti

**Contenitori per sterilizzare**

**Sterilizing containers**

**Steril Container**

**Containers pour stérilizer**

**Contenedores para esterilización**

Bacinelle reniformi  
Kidney bowls  
Nierenschalen  
Bassins réniformes  
Riñoneras

Vassoi porta-strumenti  
Trays  
Schalen  
Bassins  
Bandejas



**0217-CA** 200 mm  
**0217-CF** 250 mm  
**0217-CI** 280 mm

**2118-CA** 210 x 110 x 25 mm  
**2118-CG** 250 x 180 x 30 mm  
**2118-DA** 300 x 220 x 30 mm

Bacinella in vetro con coperchio e pomolo in acciaio inox  
Container in glass with lid and knob in stainless steel  
Cuvette en verre avec couvercle et pommeau en acier inox

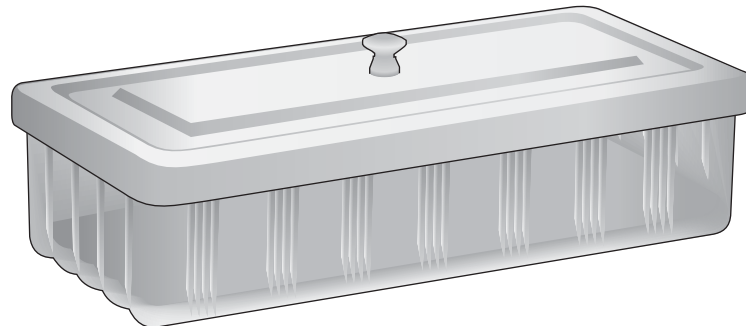

**021518-BA** 140 x 80 x 50 mm  
**021518-BC** 200 x 60 x 40 mm  
**021518-BE** 220 x 100 x 50 mm  
**021518-BF** 220 x 140 x 60 mm  
**021518-BH** 300 x 180 x 65 mm

Scatole per sterilizzazione a secco  
Instrument boxes  
Instrumentenkästen  
Boites pour instruments  
Cajas para instrumentos

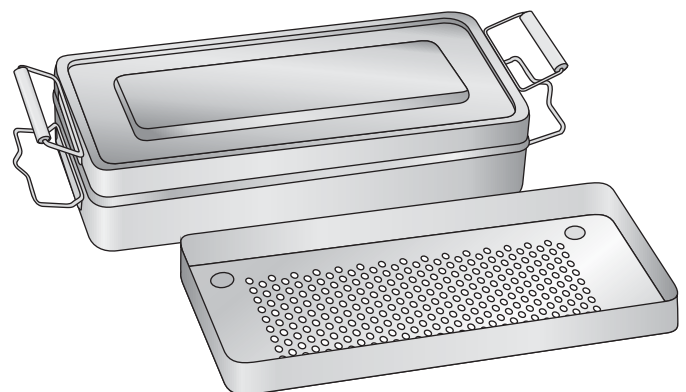
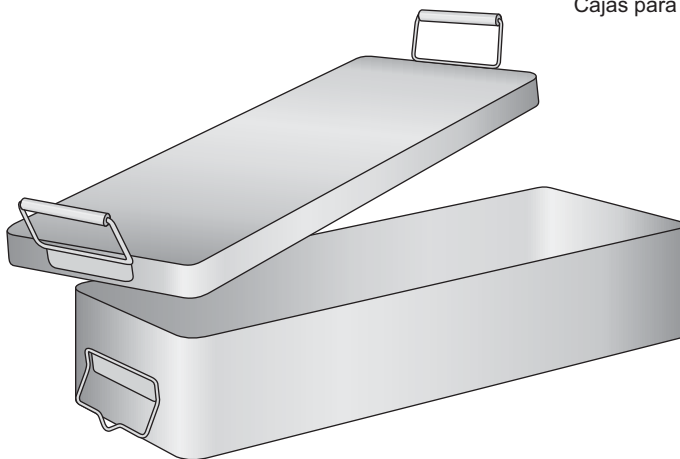

**0318-AH** 280 x 140 x 60 mm  
**0318-AI** 300 x 140 x 60 mm  
**0318-AL** 360 x 160 x 70 mm

**0318-GB** 150 x 90 x 40 mm  
**0318-GD** 200 x 100 x 60 mm  
**0318-GF** 250 x 120 x 60 mm  
**0318-GG** 280 x 140 x 60 mm  
**0318-GH** 320 x 150 x 60 mm

Contenitori per  
sterilizzare

Sterilizing  
containers

Steril  
Container

Containers  
pour stériliser

Contenedores  
para esterilización

Cestelli rettangolari con filtro  
Mit filter  
Whith filter  
Avec filtre  
Con filtros

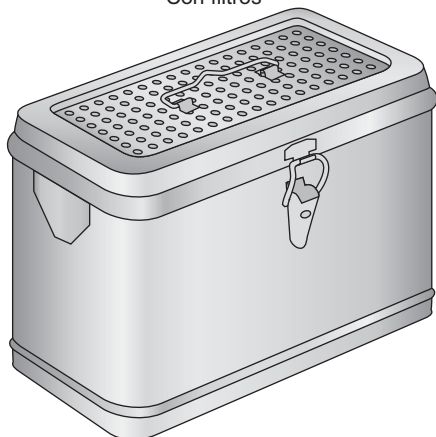

**0318-EA** 200 x 180 x 120 mm  
**0318-EB** 200 x 180 x 180 mm  
**0318-EC** 250 x 250 x 250 mm  
**0318-ED** 270 x 160 x 160 mm  
**0318-EE** 290 x 290 x 290 mm  
**0318-EF** 350 x 230 x 200 mm

Cestelli cilindrici  
Dressing sterilizing drums  
Verbandstoffrommeln  
Boites à stérilisation  
Cajas para esterilización

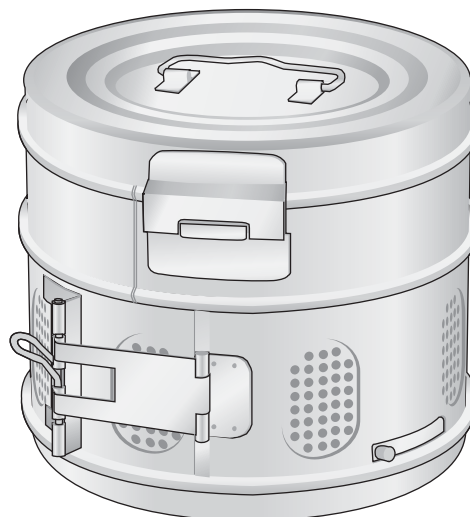

**0318-BC** 125x125 mm  
**0318-BF** 150x150 mm  
**0318-BL** 190x145 mm  
**0318-DA** 290x240 mm

Cestelli rettangolari  
Rectengular drum  
Panier rectangulaire

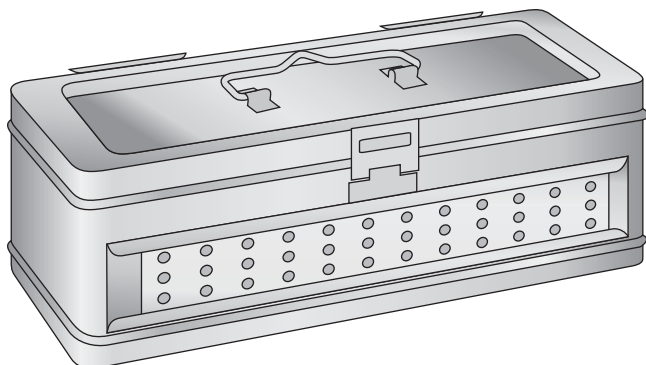

**0318-dc** 300 x 150 x 60 mm  
**0318-DD** 300 x 150 x 90 mm  
**0318-DE** 300 x 150 x 180 mm

Cestelli rettangolari  
Rectengular drum  
Panier rectangulaire

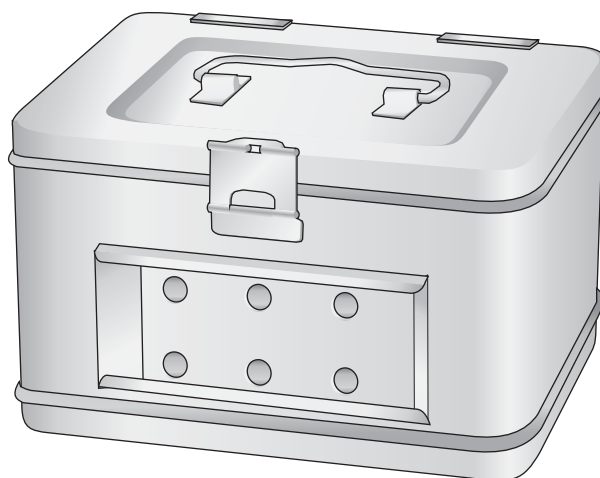

**0318-CB** 190x110x120 mm  
**0318-CA** 200x180x120 mm  
**0318-CC** 200x180x180 mm  
**0318-CF** 250x200x200 mm



Autoclavabili  
Autoclavable  
Sterilisierbar

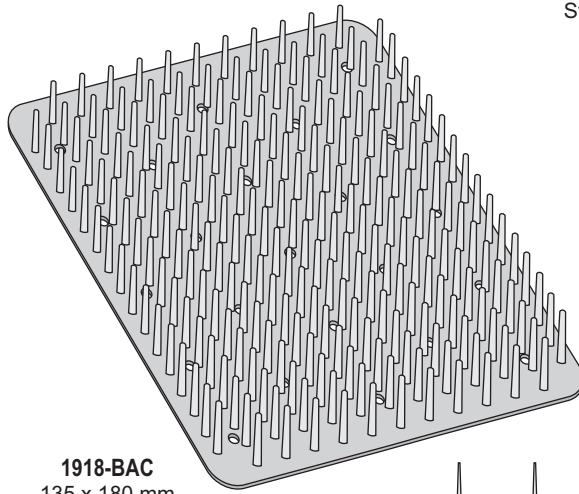

**1918-BAC**  
135 x 180 mm

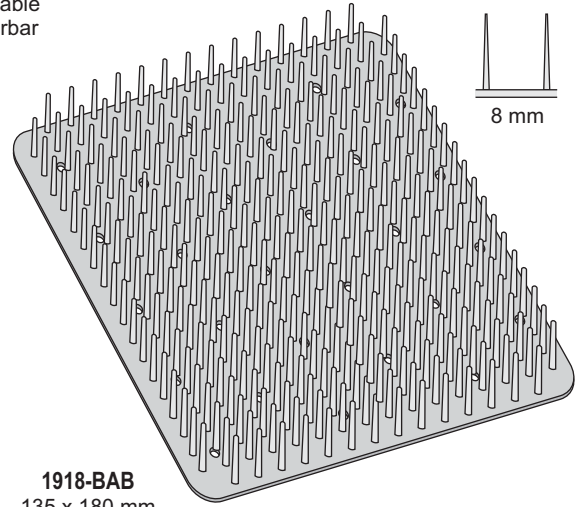
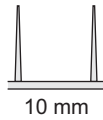

**1918-BAB**  
135 x 180 mm

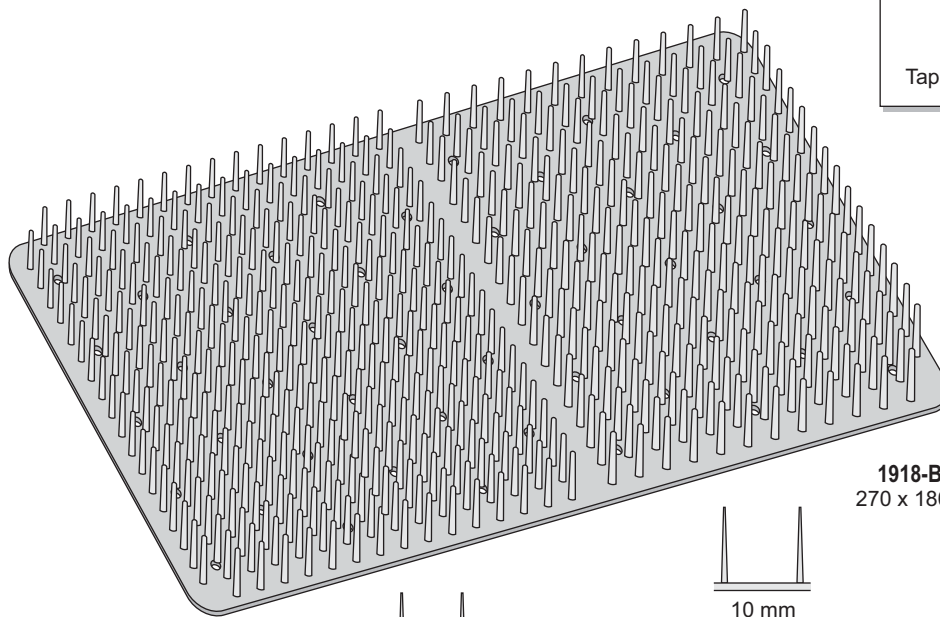
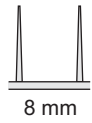

**1918-BAE**  
270 x 180 mm

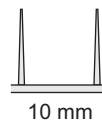
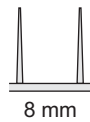

Tappeti in aghi di silicone  
Silikon matte  
Matte en silicone  
Tapis en Silicone  
Tapete en agujas de silicona

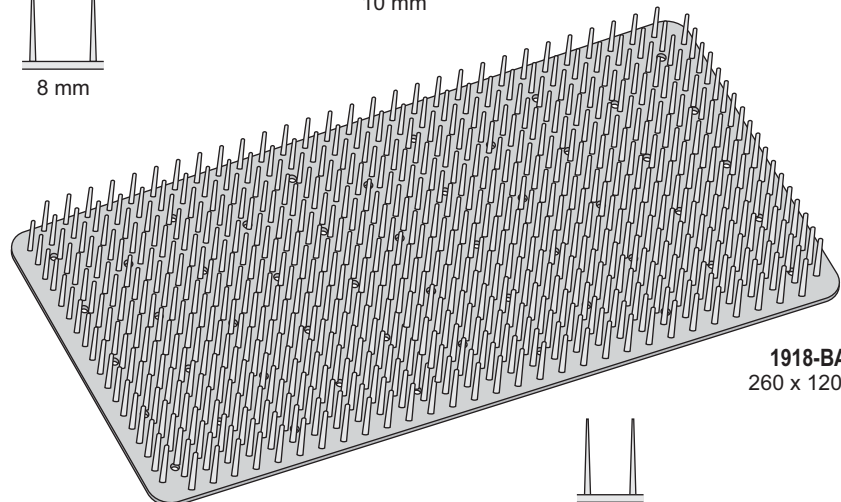

**1918-BAD**  
260 x 120 mm



Pinze per prelevare strumenti sterilizzati  
 Sterilizing forceps for picking up and holding of sterile instruments  
 Sterilisierzangen zum Fassen und Halten Steriler Instrumente



**0718-AC**  
145 mm

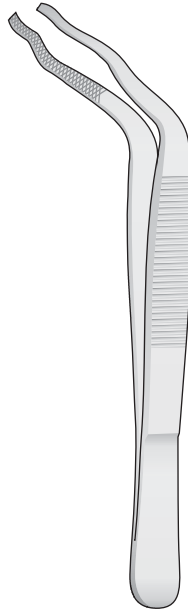

DAVIS  
**0718-AD**  
160 mm



DAVIS  
**0718-AE**  
200 mm

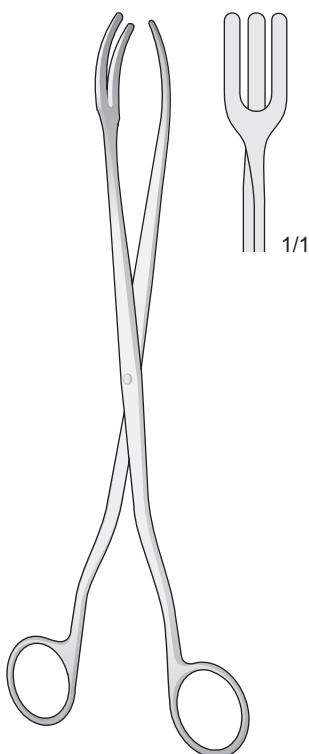

**0718-BA**  
200 mm

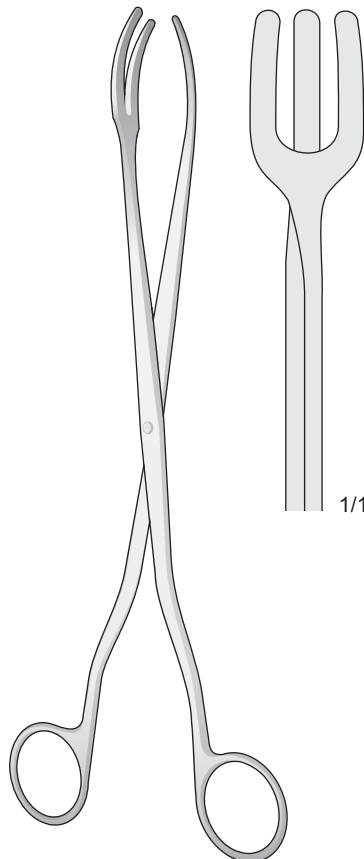

**0718-BB**  
300 mm

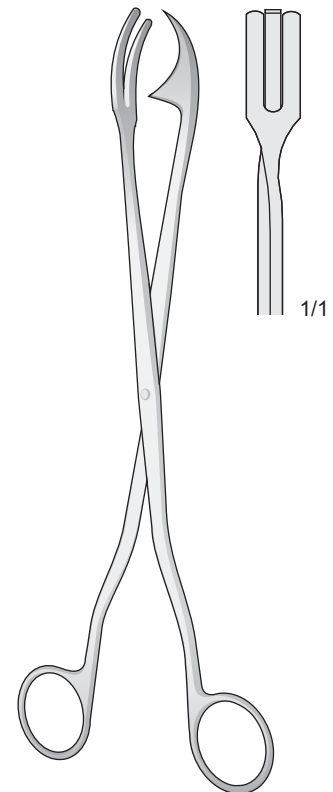

ROGGE  
**0718-AG**  
230 mm

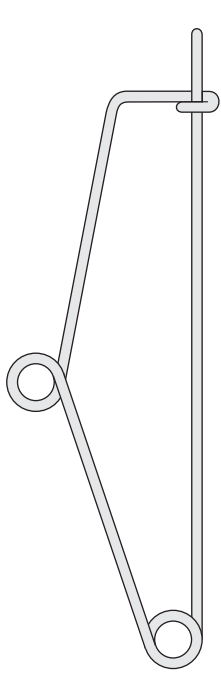

MAYO  
0718-AB  
140 mm

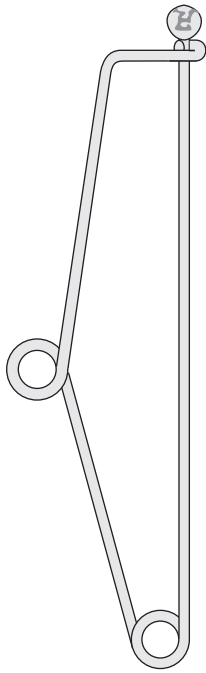

MAYO  
0718-AH  
140 mm

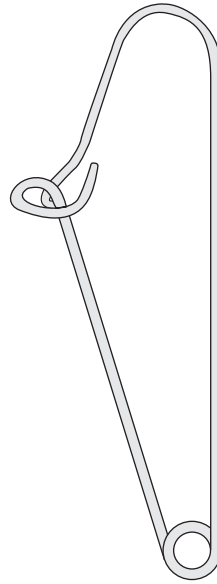

BUNT  
0718-AL  
110 mm

Pinza per materiali da medicazione  
e tamponi usati  
Operating room pick-up forceps  
for used tampons and dressings  
Fasszange für verbrauchtes  
verbandmaterial und Tupfer  
Pince pour pansements  
et tampons souillés  
Pinzas para desechos

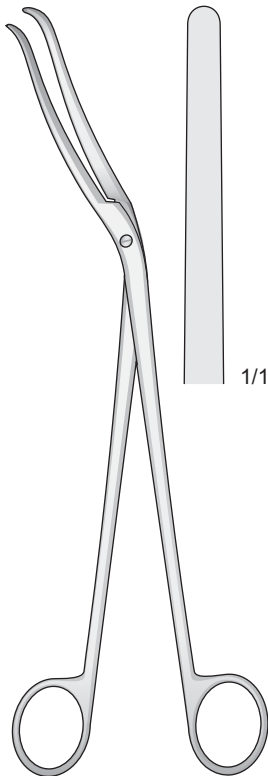

CHEATTLE  
0718-AF  
265 mm

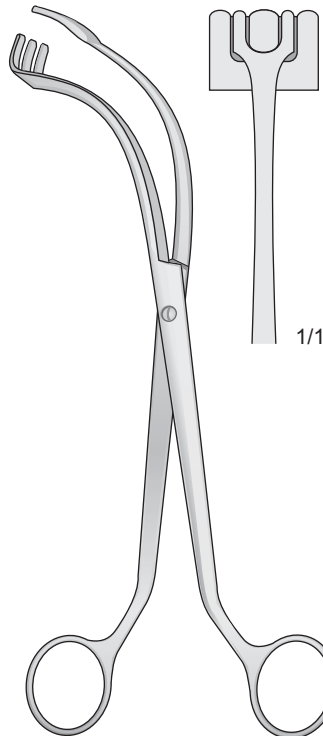

COLLIN  
0718-DA  
250 mm

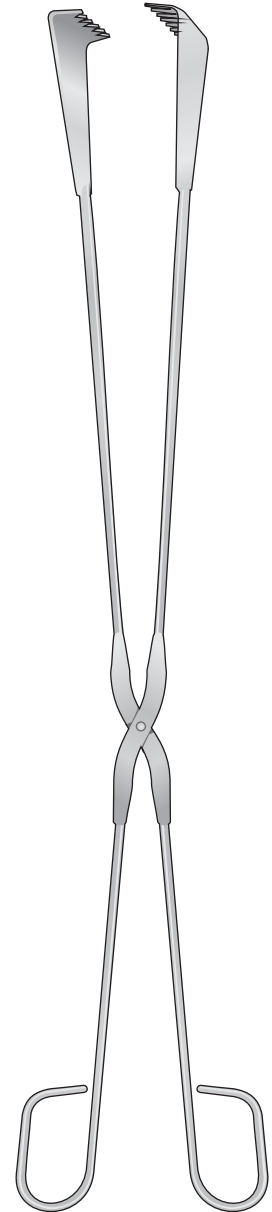

SAUERBRUCH  
0718-DB  
530 mm



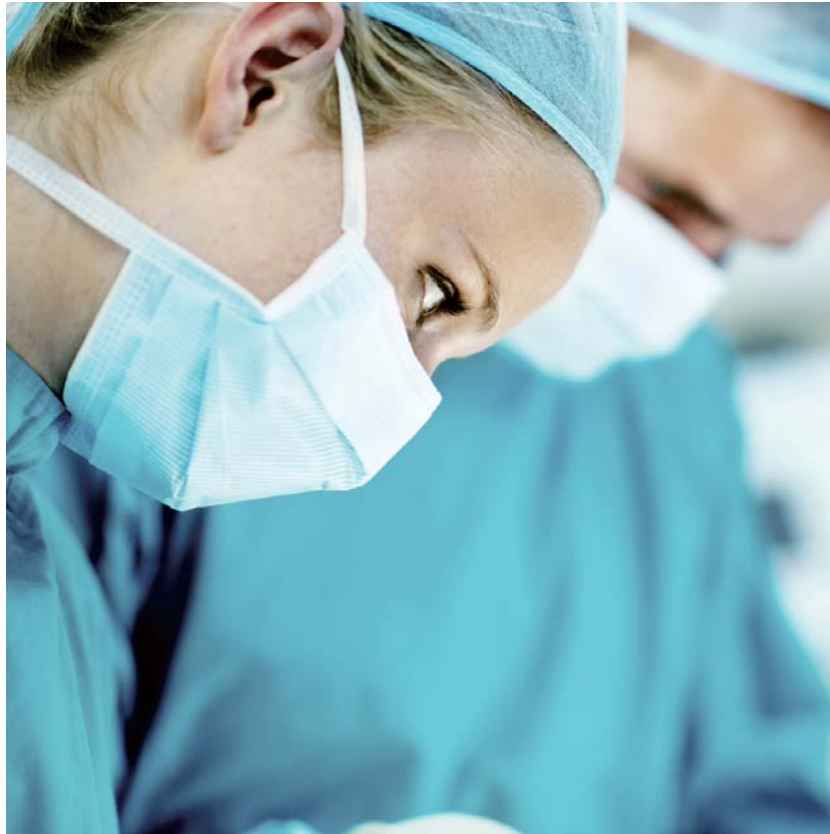

20

Indice alfabetico  
Alphabetical index  
Alphabetisches Inhaltsverzeichnis  
Index alphabétique  
Indice alfabetico



## A

<b>ADLERKREUTZ</b> , Pinzette chirurgiche	124
<b>ADSON</b> , Cannule per aspirazione	674
- Divaricatori	338, 339, 341, 343
- Periostotomi	401
- Pinzette anatomiche chirurgiche	116, 130
<b>ADSON-BROWN</b> , Pinzette chirurgiche	116
<b>ALAN-PARKS</b> , Divaricatore	370
<b>ALDERDYCE</b> , Periostotomo	395
<b>ALEXANDER</b> , Pinza ossivora	468
- Pinza per biopsia	649
<b>ALLIS</b> , Pinze per tessuti	145, 223
<b>ALLISON</b> , Divaricatori	318
<b>ALM</b> , Divaricatori	327
<b>ANDERSON-ADSON</b> , Divaricatori	335
<b>ANDREWS-PYNCHON</b> , Cannule per aspirazione	662
<b>ANEL</b> , Aghi lacrimali	593
<b>ANGLE</b> , Tronchese per fili metallici	510
<b>ARKANSAS</b> , Pietre per affilatura strumenti	688
<b>ARRUGA</b> , Port'aghi	261
- Uncino intracapsulare	592
<b>ASH</b> , Pinze nasali	563
<b>AUFRICHT</b> , Elevatore del setto nasale	565
- Lime per osso	409
<b>AUSTIN</b> , Pinzette chirurgiche	115

## B

<b>BABBUSH</b> , Elevatori	395
<b>BABCOCK</b> , Pinze intestinali	144, 223
- Sonde doppie malleabili	680
<b>BABINSKY</b> , Martello percussore	3
<b>BABY-ADSON</b> , Pinze emostatiche e legature	160
<b>BABY-ALLIS</b> , Pinze per tessuti	145
<b>BABY-CRILE</b> , Pinze emostatiche	152
<b>BABY-CRILE-WOOD</b> , Port'aghi	250
<b>BABY-COLLIN</b> , Divaricatori	346
<b>BABY-FINOCCHIETTO</b> , Divaricatore	365
<b>BABY-METZENBAUM</b> , Forbici chirurgiche	59
<b>BABY-MIXTER</b> , Pinze emostatiche	160
<b>BABY-MORSE</b> , Divaricatore costale	367
<b>BABY-WEITLANER</b> , Divaricatori	330
<b>BABY-YANKAUER</b> , Cannule per aspirazione	662
<b>BACKHAUS</b> , Fissateli	146
<b>BAILEY</b> , Divaricatori costali	368
<b>BAINBRIDGE</b> , Pinze intestinali	166
<b>BAKES</b> , Dilatatori per vie biliari	625
<b>BALFOUR</b> , Divaricatori addominali	358, 359, 360
<b>BALFOUR-BABY</b> , Divaricatore addominale	358
<b>BALLENGER</b> , Coltelli per setto nasale	569
- Scalpelli	565
<b>BARON</b> , Cannule per aspirazione	670
<b>BARR</b> , Divaricatore anale	370
<b>BARRAQUER</b> , Blefarostati	598
- Micro Pinzette oftalmiche	595
- Micro Port'aghi	609, 610, 611
- Pinzette	135
- Port'aghi	234
<b>BARTH</b> , Cucchiali taglienti	416
<b>BAUMGARTNER</b> , Port'aghi per legature	511
<b>BEACHAM</b> , Amniotomo	643
<b>BECK</b> , Pinza vascolare	207
<b>BECKMANN</b> , Adenotomi	576
- Divaricatori	342
<b>BECKMANN-EATON</b> , Divaricatore	343
<b>BEEBE</b> , Forbici per fili metallici	103
<b>BEER</b> , Pinzetta da depilazione	135
<b>BELLUCCI</b> , Cannula per aspirazione	670
- Micro forbice	554
<b>BENGOLEA</b> , Pinze emostatiche	159
<b>BENIQUE</b> , Mandrino per introduzione sonde	624
<b>BENNET</b> , Elevatori	393
<b>BERGH</b> , Pinzetta da depilazione	135
<b>BERGMANN</b> , Martelli chirurgici	430
<b>BERNHARD</b> , Pinze fissateli	148
<b>BEYER</b> , Pinza ossivora	470
<b>BILLEAU</b> , Anse auricolari	551

<b>BIRKETT</b> , Pinze emostatiche	158
<b>BLAKE</b> , Curette uterina	652
<b>BLOHMKE</b> , Pinza da intestino	174
<b>BLOUNT</b> , Elevatore	389, 393
<b>BLUMENTHAL</b> , Pinza ossivora	467
<b>BÖHLER</b> , Pinze ossivore	474
<b>BONNEY</b> , Pinzetta chirurgica	131
<b>BOWLED-HENRY</b> , Divaricatore	311
<b>BOWMAN</b> , Sonde bottonute	276
<b>BOYNTON</b> , Port'aghi	249, 261
<b>BRAUN</b> , Forbice chirurgica	
- Pinze per peducolo renale	629
<b>BRAUN-STADLER</b> , Forbice chirurgica	77
<b>BREISKY</b> , Valve vaginali	638
<b>BROCK</b> , Forbici	41
- Pinzette	109
- Port'aghi	233
<b>BROWN</b> , Pinzette chirurgiche	125
<b>BRUENINGS</b> , Abbassalingua	4
<b>BRUNNER</b> , Aghi per legature	268, 505
- Costotomi	477
<b>BRUNS</b> , Cucchiali taglienti	419
- Forbice per bendaggi	101
<b>BUCHWALD</b> , Abbassalingua	4
<b>BÜCHS</b> , Divaricatore	311
<b>BUCK</b> , Martello percussore	3
<b>BUCK-GRAMCKO</b> , Elevatore	389
<b>BUCKLEY</b> , Osteotomi	434
<b>BUELAU</b> , Trokare	377
<b>BUMM</b> , Curette uterine	654, 655
<b>BUNT</b> , Spillone per sterilizzazione	697
<b>BUSHE</b> , Cucchiali taglienti	423

## C

<b>CAPLAN</b> , Forbice per rinologia	564
<b>CASPAR</b> , Cucchiali taglienti	425
- Divaricatori	304, 352, 353
- Divaricatori lombari	354, 355
- Misuratore	22
- Battitore	433
- Pinze per biopsia	462, 463
<b>CASTANEDA</b> , Pinze vascolari	182
<b>CASTROVIEJO</b> , Blefarostati	599
- Micro divaricatori	591
- Micro forbici oftalmiche	603
- Micro pinzette oftalmiche	596
- Micro spatole	592
- Port'aghi	238, 239, 240, 241, 242
- Strumenti per misura	19, 20, 21
<b>CHADWICK</b> , Forbici delicate	46
<b>CHARNELY</b> , Divaricatore	364
<b>CHEATTLE</b> , Pinze per sterilizzazione	697
<b>CHILD</b> , Pinza per tamponi	8, 143
<b>CINELLI</b> , Scalpelli nasali	567
<b>CITELLI</b> , Pinza ossivora	453
<b>CLEANLACT</b> , Lubrificante per strumenti chirurgici	687
<b>CLOWARD</b> , Divaricatori	345
- Divaricatori vertebrali	356
<b>CLOWARD-CONTOUR</b> , Divaricatori	329
<b>COAKLEY</b> , Curette taglienti	575
<b>COBB</b> , Raspatori	407
<b>COLIBRI</b> , Micro pinzette	594
<b>COLLIN</b> , Costotomo	475
- Divaricatori	346, 347, 348
- Pinze emostatiche	139, 143, 633
- Pinza tira-lingua	7
- Pinze per agrafes	271
- Pinze per sterilizzazione	697
- Segna per amputazione	414
<b>COLLIN-Standard</b> , Speculum vaginali	634
<b>CONVERSE</b> , Divaricatori	288
- Port'aghi	250
- Tenotomo	28
<b>COOLEY</b> , Dilatatori per valvola mitralica	229
- Divaricatori costali	324, 366
- Pinze vascolari	212, 213, 214, 215, 216
<b>COOPER</b> , Aghi per legature	267
<b>COOK</b> , Blefarostati	599

Indice alfabetico	Alphabetical index	Alphabetisches Inhaltsverzeichnis	Index alphabétiques	Indice alfabetico
<b>CORYLLOS</b> , Divaricatori		315	<b>DOCKHORN</b> , Divaricatori	305
<b>COTTLE</b> , Divaricatori		284	<b>DOLWICK-REICH</b> , Divaricatori	337
- Periostotomo		396	<b>DOYEN</b> , Fissateli	146
- Forbici delicate		71	- Divaricatore	308, 363
- Lime per osso		409	- Pinze atraumatiche	171
- Martello chirurgico		430	- Raspatori	404
- Osteotomi	438, 579		- Sonde	275
- Pinzette, columella		129	- Strumenti per fibromi	645
- Raspatore-Elevatore nasale		565	- Valve vaginali	637
- Speculum nasali		559	<b>DOYEN-COLLIN</b> , Apribocca	6, 537
- Strumento per cartilagine		564	<b>DOYEN-JANSEN</b> , Apribocca	6, 537
<b>COTTLE-MASING</b> , Forbici delicate		46	<b>DOYEN-STILLE</b> , Divaricatori	308
<b>COTTLE-NEIVERT</b> , Divaricatore doppio		565	<b>DUBOIS</b> , Forbici chirurgiche	77
<b>COTTLE-WALSHAM</b> , Pinze nasali		563	<b>DUKE</b> , Trokare	377
<b>COUPLAND</b> , Cannule per aspirazione	664, 665		<b>DUNN-DAUTREY</b> , Divaricatori-Retrattori	546
<b>CRAFOORD</b> , Pinze per legature		163	<b>DUPLAY</b> , Speculum nasale	18
<b>CRILE</b> , Pinze emostatiche		151, 152	<b>DUPUY-WEISSE</b> , Aghi per legature	262
<b>CRILE-WOOD</b> , Port'aghi	243, 250, 252		<b>DURANTE</b> , Pinzette	125
<b>CRILE-MURRAY</b> , Port'aghi		243	<b>DUVAL</b> , Pinzette chirurgiche	129
<b>CUSCO</b> , Speculum vaginali		634	- Pinza atraumatica	223
<b>CUSHING</b> , Divaricatore	288, 289, 292		- Pinze emostatiche	145, 629
- Periostotomo		401	<b>DUVAL-COLLIN</b> , Pinze intestinali	629
- Pinze per biopsia		461		
- Pinze ossivore		469	<b>E</b>	
- Pinzette	121, 131		<b>ECHLIN</b> , Pinze ossivore	470
- Spatole cerebrali		326	<b>EDER</b> , Porta cotone	279
<b>CUSHING-KOCHER</b> , Divaricatore		292	<b>EISELBERG-MATHIEU</b> , Port'aghi	249
			<b>ELLIS</b> , Micro bisturi	589
<b>D</b>			<b>EPKER</b> , Osteotomi	578
<b>DALE</b> , Pinze vascolari	217		<b>ESMARCH</b> , Forbice per bendaggi	101
<b>DANDY</b> , Forbice delicate	70			
- Pinza chirurgica	151		<b>F</b>	
- Pinza emostatica	151		<b>FAGER</b> , Elevatori	382
<b>DAUBENSPECK</b> , Cucchiari taglienti	423		<b>FAHLBUSCH</b> , Micro forbici per rinologia	555
<b>DAUTREY-MUNRO</b> , Osteotomi	581		<b>FARABEUF</b> , Divaricatori	290
<b>DAVIDSON</b> , Divaricatori	316		- Pinze ossivore	478
<b>DAVIS</b> , Elevatore	382		- Raspatori	402
- Pinze per sterilizzazione	696		<b>FARABEUF-LAMBOTTE</b> , Pinze ossivore	478
<b>DAVIS-BOYLE</b> , Apribocca	541		<b>FARREL</b> , Porta cotone	277
<b>DAY</b> , Uncini per otologia	551		<b>FAULKNER</b> , Micro pinzetta oftalmica	596
<b>DE BAKEY</b> , Cannule per aspirazione	664		<b>FAURE</b> , Fissateli	146
- Dilatatori vascolari	226		- Pinza per biopsia	648
- Forbici	73		<b>FEICHENFELD</b> , Pinzette chirurgiche	134
- Port'aghi	255		<b>FEIN</b> , Porta cotone	278
<b>DE BAKEY-BAHNSON</b> , Pinze vascolari	193		<b>FENO</b> , Speculum vaginale	656
<b>DE BAKEY-BAINBRIDGE</b> , Pinze vascolari	187		<b>FERGUSON</b> , Cannule per aspirazione	669
<b>DE BAKEY-CAROTIS</b> , Pinze vascolari	180		- Pinze per angiotribi	166
<b>DE BAKEY-MOSQUITO</b> , Pinze vascolari	185		<b>FERRIS-SMITH-KERRISON</b> , Laminotomi	454, 455, 456, 457
<b>DE BAKEY-HARKEN</b> , Pinze vascolari	200		<b>FERRIS-SMITH-CUSHING</b> , Laminotomi	458
<b>DE BAKEY-PEAN</b> , Pinze vascolari	186		<b>FIBULA</b> , Pinze per chirurgia ossea	479
<b>DE BAKEY (POTTS-SMITH)</b> , Forbici	73		<b>FINOCCHIETTO</b> , Divaricatori	365
- Pinzette	126, 127, 128, 132		- Port'aghi	257
- Pinze vascolari	183, 203		<b>FINSEN</b> , Divaricatori	327
<b>DE BAKEY-RANKIN</b> , Pinze vascolari	185		<b>FINSTERER</b> , Cannule per aspirazione	664
<b>DE BAKEY-SATINSKY</b> , Pinze vascolari	180, 198		<b>FOERSTER-BALLENGER</b> , Pinze per tamponi	141
<b>DEAN</b> , Forbice dentellata	70		<b>FOMON</b> , Divaricatori	284
<b>DEAVER</b> , Forbici chirurgiche	57		- Forbici curve	59, 70, 71
- Divaricatori	320, 321		- Lime per osso	410, 412, 572
<b>DEJERINE</b> , Martello percussore	3		- Scalpelli nasali	567
<b>DEMEL</b> , Passafili	504		<b>FRANKFELDT</b> , Porta cotone	279
<b>DENIS-BROWN</b> , Divaricatori	362		<b>FRAZIER</b> , Cannule per aspirazione	669, 674, 680
<b>DERF</b> , Port'aghi	243, 250		- Divaricatore	350
<b>DERRA</b> , Pinze vascolari	189		<b>FREER</b> , Periostotomo	395
<b>DESCHAMPS</b> , Aghi per legature	262, 263, 264, 265, 266		- Scalpelli	434
<b>DESJARDINS</b> , Dilatatori per calcoli renali	623		- Bisturi per mucosa	572
- Dilatatori per calcoli biliari	628		<b>FRENZEL</b> , Abbassalingua	4
<b>DESMARRES</b> , Bisturi	28		<b>FRIEDMANN</b> , Pinze ossivore	467
- Divaricatori	287			
- Pinzette	129		<b>G</b>	
<b>DIETER</b> , Micro ossivora	554		<b>GABON</b> , Macinino per osso	586
<b>DIETRICH</b> , Forbici	74		<b>GALLAHER</b> , Lime per osso	408
- Pinze vascolari	205		<b>GARRETT</b> , Dilatatori vascolari	227
- Port'aghi Micro	240		<b>GELLHORN</b> , Pinza per biopsia	647
<b>DIFFENBACH</b> , Pinze bulldog clamps	177		<b>GELPI</b> , Divaricatori	328
<b>DIXON-LOVELACE</b> , Pinze emostatiche	158			
<b>DINGMANN</b> , Apribocca	542			
- Pinze per chirurgia ossea	485			
<b>DITTEL</b> , Dilatatori per calcoli biliari	626			



<b>GELPI-LOKTITE</b> , Divaricatore	329
<b>GELPI-SELETZ</b> , Divaricatore	329
<b>GEMINI</b> , Pinze emostatiche e legature	162
<b>GENTOFT</b> , Speculum vaginale	656
<b>GERALD</b> , Pinzette chirurgiche	123
<b>GERALD-BROWN</b> , Pinzetta chirurgica	123
<b>GERSTER</b> , Riposizionatori ossei	487
<b>GERSTER-LOWMAN</b> , Riposizionatori ossei	487
<b>GIDEF</b> , Pinze emostatiche	150
<b>GIERTZ-STILLE</b> , Costotomo	477
<b>GIGLI</b> , Seghe per amputazione	414
<b>GIL-VERNET</b> , Divaricatori	293
<b>GILLIES</b> , Divaricatori	283
- Port'aghi	253, 274
<b>GLASSMAN</b> , Forbici chirurgiche	52
<b>GLOVER</b> , Pinze bulldog	179, 180
- Pinze vascolari	207
<b>GOLDMAN-FOX</b> , Forbici chirurgiche	49, 50, 80, 84
<b>GOELET</b> , Divaricatore	291
<b>GORNEY</b> , Forbici chirurgiche	68
- Raschietti con aspirazione	667
<b>GOSSET</b> , Divaricatori addominali	357
<b>GOURDET</b> , Curette uterine	651
<b>GRAEFE</b> , Forbici delicate	46
- Pinzette per micro chirurgia	114, 129
- Micro divaricatori	589, 590
- Micro Bisturi	27, 590
<b>GRAY</b> , Pinze per legature	164
<b>GRAVE</b> , Speculum vaginali	634
<b>GREGORY</b> , Pinze vascolari	207
<b>GREENE</b> , Divaricatore	311
<b>GROSS</b> , Pinze emostatiche	139, 141
<b>GRUENWALD</b> , Pinzette chirurgiche	133
<b>GUILLIEN</b> , Cannula per aspirazione	667
<b>GUSBERG</b> , Curette per biopsia endocervicale	646
<b>GUTHRIE</b> , Divaricatori	283
<b>GUYON</b> , Dilatatori per calcoli biliari	628
- Mandrino per introduzione sonde	624
- Pinze per peduncoli renali	175
- Pinze renali	629

## H

<b>HABERER</b> , Spatole malleabili	326
<b>HAGLUND</b> , Pinze per gesso	533
<b>HALLE</b> , Cucchiari taglienti	422
<b>HALSEY</b> , Port'aghi	243, 250
<b>HALSTED</b> , Pinze emostatiche	150, 152
<b>HALSTED-MOSQUITO</b> , Pinze emostatiche	149, 152
<b>HANK</b> , Dilatatori uterini	641
<b>HARRINGTON</b> , Divaricatori	317
<b>HARTMANN</b> , Abbassalingua	544
- Cannule per aspirazione	676, 677
- Diaphason	5
- Porta cotone	278
- Pinza ossivora	469
- Pinze auricolari	552, 553
- Speculum nasali	18, 560, 561
<b>HARTMANN-BABY-MOSQUITO</b> , Pinze emostatiche	149
<b>HAYES</b> , Pinze atraumatiche	218
<b>HEANEY</b> , Port'aghi	257
<b>HEANEY-HEGAR</b> , Port'aghi	244
<b>HEAT</b> , Martello chirurgico	431
<b>HEGAR</b> , Dilatatori uterini	639, 641
- Port'aghi	244, 251
<b>HEGAR-MAYO-SEELEY</b> , Port'aghi	245, 252
<b>HEGENBARTH</b> , Pinzetta chirurgica	271
<b>HEILDELBERG</b> , Porta cotone	278
<b>HEISS</b> , Pinze emostatiche	158
<b>HEISTER</b> , Apribocca	6, 537
<b>HEMINGWAY</b> , Cucchiari taglienti	415
<b>HENAHAN</b> , Periostotomi	401
<b>HENLEY</b> , Divaricatori	344
<b>HENNIG</b> , Pinze per gesso	533
<b>HEPARIN</b> , Aghi malleabili	682
<b>HEYMANN</b> , Forbici angolate	71
<b>HEYMANN-KNIGHT</b> , Forbice angolata	71
<b>HIBBS</b> , Divaricatori	297
- Osteotomi	439

<b>HOHMANN</b> , Elevatori	391, 394
<b>HOLZBACH</b> , Divaricatori	349
<b>HÖPFNER</b> , Pinze per intestino	174
<b>HOPT</b> , Pinze vascolari	219
<b>HOUSE</b> , Cannule per aspirazione	672
<b>HOWARD</b> , Lime per osso	408, 570
<b>HOWARTH</b> , Periostotomi	397
<b>HUNTER</b> , Pinze per frammenti	134
<b>HURD</b> , Periostotomi	397

## I

<b>INGE</b> , Divaricatori vertebrali	356
<b>IRIS</b> , Forbici delicate	44, 81, 83, 84, 99
<b>ISRAEL</b> , Divaricatori	298
<b>ITARD</b> , Cannule per aspirazione	677

## J

<b>JACKSON-TESSIER</b> , Forbice ossivora	476
<b>JACOBSON</b> , Cucchiari taglienti	416
- Micro Forbice	40
- Mandrini	501, 502, 503, 527
- Port'aghi	235, 241
<b>JACOBSON-UNIVERSAL</b> , Mandrino	527
<b>JAMESON</b> , Forbici delicate	47
<b>JAMESON-WERBER</b> , Forbici delicate	47
<b>JANSEN</b> , Cucchiari taglienti	416
- Divaricatore	327
- Pinze ossivore	469
- Pinzetta	133
- Raspatore	402
<b>JANSEN-LEUER</b> , Pinza ossivora	468
<b>JAVID</b> , Pinze vascolari	222
<b>JONES</b> , Fissateli	146
- Pinza emostatica	139
<b>JOSEPH</b> , Divaricatori	284
- Forbici chirurgiche	58
- Lime per osso	408
- Lime nasali	573, 574
- Periostotomi	401
<b>JUDD-MASSON</b> , Divaricatori da prostata	369

## K

<b>KALLMORGEN</b> , Valve vaginali	635
<b>KELLY</b> , Divaricatori	310
- Forbici chirurgiche	53, 85
- Pinze emostatiche	155
<b>KERN</b> , Pinze per chirurgia ossea	486
<b>KERPEL</b> , Cucchiari taglienti	418
<b>KERSHNER</b> , Divaricatori oftalmici	598
<b>KERRISON</b> , Laminotomi	453
<b>KERRISON-JACOBY</b> , Laminotomi	455
<b>KEVORKIAN</b> , Pinza per biopsia	650
<b>KEY-HORSLEY</b> , Pinze ossivore	475
<b>KEYES</b> , Punche da biopsia	28, 491
<b>KILLIAN</b> , Cannule per aspirazione	678
- Forbice nasale	72
- Forbice per rinologia	564
- Scalpelli	565
- Speculum nasali	560, 561
<b>KILLIAN-KLAUS</b> , Osteotomo	565
<b>KILNER</b> , Forbici	47, 52, 85
- Port'aghi	256
<b>KILNER-DOUGHTY</b> , Apribocca	540
<b>KIMURA</b> , Micro spatola	592
<b>KIRSCH</b> , Divaricatori	304
<b>KIRSCHNER</b> , Divaricatori	361
<b>KLIMA-ROSEGGER</b> , Ago da biopsia	377
<b>KOCHER</b> , Aghi per legature	267
- Divaricatori	292, 294, 296, 301, 305, 307
- Pinze emostatiche	153, 155, 157
- Pinze intestinali	172, 173
- Sonde conduttrici	269
<b>KOCHER-LANGENBECK</b> , Divaricatori	300
<b>KOCHER-OCHSNER</b> , Pinze chirurgiche	154

Indice alfabetico	Alphabetical index	Alphabetisches Inhaltsverzeichnis	Index alphabétiques	Indice alfabetico
<b>KOENIG</b> , Sonda conduttrice		269		
<b>KOERTE</b> , Divaricatore		323		
<b>KÖNIG</b> , Elevatori		381		
<b>KRAUSE</b> , Strumento per tonsille		562		
- Trokare		375		
<b>KRESSNER</b> , Pinze nasali		563		
<b>KRISTELLER</b> , Speculum e valve vaginali		636		
<b>KROENIG</b> , Abbassalingua		4		
<b>KRONECKER</b> , Aghi per legature		262		
<b>KÜHNE</b> , Pinzette		135		
<b>KÜNTSCHER</b> , Chiodi		496		
- Piega chiodi		500		
<b>L</b>				
<b>LA FORCE</b> , Micro bisturi		589		
<b>LA GRANGE</b> , Forbici chirurgiche	50, 80			
<b>LAHEY</b> , Divaricatore		288		
<b>LAMBERT-KAY</b> , Pinze vascolari		210		
<b>LAMBOTTE</b> , Osteotomi		437		
- Pinze ossivore		478		
- Raspatori		404		
<b>LANDAU</b> , Valve vaginali		637		
<b>LANDOLT</b> , Manici per bisturi		34		
- Pinze per biopsia		465		
<b>LANE</b> , Giravite		528		
- Pinza per chirurgia ossea		486		
<b>LANGE</b> , Retrattore		289		
<b>LANGENBECK</b> , Divaricatori		299		
- Elevatore		395		
- Port'aghi		259		
- Raspatori		402		
- Segna per osso		414		
<b>LANGENBECK-RYDER</b> , Port'aghi		259		
<b>LAWRENCE</b> , Pinze emostatiche e passafili		165		
<b>LEES</b> , Pinze vascolari		209		
<b>LEKSELL</b> , Pinze ossivore		470		
<b>LELAND-JONES</b> , Pinze vascolari		215		
<b>LEMPERT</b> , Pinze ossivore		468		
<b>LERICHE</b> , Pinze emostatiche		151		
<b>LEWIN</b> , Pinza riposizionatrice		479		
<b>LEWIS</b> , Lime per osso		409		
- Lime nasali		573		
<b>LEXER</b> , Forbici chirurgiche		66, 95		
- Osteotomi		446, 448		
- Scalpelli		445, 446		
<b>LEVIS</b> , Fonendoscopi		10		
<b>LICHTENBERG</b> , Port'aghi		261		
<b>LICHTWITZ</b> , Trokare		375		
<b>LIEBERMANN-TENNANT</b> , Divaricatore oftalmico		598		
<b>LINDEMANN</b> , Segna per osso		414		
<b>LISTER</b> , Forbici per bendaggi		101		
- Pinza emostatica		139		
<b>LISTER-BURCH</b> , Blefarostati		599		
<b>LISTON</b> , Pinze ossivore		473		
<b>LISTON-STILLE</b> , Pinza ossivora		475		
<b>LITTAUER</b> , Pinze auricolari		552		
- Pinzette per cilia		135		
<b>LITTLER</b> , Forbice delicata		59		
<b>LITTLEWOOD</b> , Pinza uterina		644		
<b>LOCHART</b> , Sonda		275		
<b>LOCKLIN</b> , Forbici delicate	48, 53			
<b>LÖFFEL</b> , Pinze a cucchiaio per rinologia		558		
<b>LOGAN</b> , Divaricatore		327		
<b>LORENZ</b> , Forbice da bendaggio		101		
<b>LORNA</b> , Fissateli		147		
<b>LOUTE</b> , Tendifilo per chirurgia ossea		499		
<b>LOVE</b> , Divaricatori		289		
<b>LOVE-GRUENWALD</b> , Pinze per biopsia	460, 461			
<b>LUCAE</b> , Diaphason		5		
- Martello chirurgico		429		
- Pinzette chirurgiche		133		
- Uncini per otologia		551		
<b>LUER</b> , Pinza ossivora		467		
<b>LUER-KÖRTE</b> , Curette uterine		651		
<b>LUER-LOCK</b> , Manici porta-canule		681		
<b>LUER-STILLE</b> , Pinze ossivore	469, 471, 472			
		<b>M</b>		
		<b>MAGILL</b> , Cannule per aspirazione		678
		- Pinze da intubazione		7
		<b>MAIER</b> , Pinze per tamponi		142, 633
		<b>MALTZ</b> , Lima nasale		574
		<b>MARKHAM-MEYERDING</b> , Divaricatori		336
		<b>MARTIN</b> , Divaricatore		314
		- Pinza per chirurgia ossea		485
		- Porta cotone		277
		- Isterometro		642
		<b>MARTINI</b> , Cucchiari taglienti		416
		<b>MASING</b> , Periostotomo		396
		<b>MASSON</b> , Port'aghi		245, 257
		<b>MATHIEU</b> , Divaricatori		290
		- Divaricatore anale		369
		- Port'aghi		248, 249, 260
		- Valve vaginali		635
		<b>MAYO</b> , Forbici chirurgiche		64, 65, 82, 96
		- Isterometro malleabile		642
		- Spatola		4
		- Spilloni per sterilizzazione		697
		<b>MAYO-HARRINGTON</b> , Forbici		75
		<b>MAYO-HEGAR</b> , Port'aghi		244, 251, 252
		<b>MAYO-HEGAR-HEANEY</b> , Port'aghi		256
		<b>MAYO-LEXER</b> , Forbici chirurgiche		96
		<b>MAYO-NOBLE</b> , Forbici chirurgiche		64
		<b>MAYO-RUSSIAN</b> , Pinzette		125
		<b>MAYO-STILLE</b> , Forbici		67, 94
		<b>MC DONALD</b> , Periostotomo		397
		<b>MC INTOSH</b> , Laringoscopi		11, 14, 16
		<b>MC IVOR</b> , Apribocca		541
		<b>MC KENTY</b> , Periostotomo		397
		<b>MC KESSON</b> , Cannule per aspirazione		660
		<b>MC PHERSON</b> , Micro pinzette		595, 596
		<b>MEAD</b> , Periostotomo		395
		- Martelli chirurgici		429
		- Pinze ossivore		467
		<b>MEEKER</b> , Pinze emostatiche e legature		165
		<b>MELLINGER</b> , Blefarostati		599
		<b>METZENBAUM</b> , Forbici	59, 60, 61, 81, 84, 89, 90, 91, 92, 99	
		<b>MEYERDING</b> , Divaricatori		312, 335
		<b>MICHEL</b> , Pinze per agrafes		271
		<b>MICRO-HALSTEAD</b> , Pinze emostatiche		149
		<b>MICRO-HARTMANN</b> , Pinze per otologia		552
		<b>MICRO-IRIS</b> , Forbici delicate		44
		<b>MICRO-RYDER</b> , Port'aghi		258
		<b>MICRO-VASCULAR</b> , Port'aghi		255
		<b>MIDDLELDORPF</b> , Divaricatori		306
		<b>MIKULICZ</b> , Divaricatori		322, 323
		- Pinza emostatica		158
		<b>MILLER</b> , Laringoscopi		12, 15, 16
		- Lime per osso		408, 570
		<b>MILLIGAN</b> , Elevatore		382
		<b>MILLIN</b> , Divaricatori da prostata		369
		<b>MINI-FRIEDMANN</b> , Pinze ossivore		466, 467
		<b>MINI-GILLIES</b> , Port'aghi forbice		247, 253
		<b>MINI-HOHMANN</b> , Elevatori		389
		<b>MINI-LAMBOTTE</b> , Osteotomi		437, 438
		<b>MINI-LEXER</b> , Osteotomi		440, 445
		<b>MINI-OLSEN-HEGAR</b> , Port'aghi forbice		246
		<b>MINI-ROUX</b> , Divaricatore		291
		<b>MINNESOTA</b> , Divaricatore		539
		<b>MISKIMON</b> , Divaricatori		340
		<b>MIXTER</b> , Pinze emostatiche		162, 164
		<b>MOLLISON</b> , Divaricatori		335
		<b>MOLT</b> , Apribocca per bambini		537
		- Periostotomo		401
		<b>MORRIS-DE BAKEY</b> , Pinze vascolari		195
		<b>MORSE</b> , Divaricatori costali		367
		<b>MÜNCHEN</b> , Curette per biopsia		646
		<b>MUSEUX</b> , Pinze uterine		644
		<b>N</b>		
		<b>NEGUS</b> , Pinze emostatiche e legature		165
		<b>NEGUS-GUEDEL</b> , Laringoscopi		13, 16
		<b>NELATON</b> , Sonda		275

Indice alfabetico	Alphabetical index	Alphabetisches Inhaltsverzeichnis	Index alphabétiques	Indice alfabetico
<b>NELSON</b> , Trokare		374	<b>RANKIN</b> , Pinze emostatiche	155
<b>NELSON-METZENBAUM</b> , Forbici chirurgiche		62, 93	<b>RECAMIER</b> , Curette uterine	653
<b>NEUBÜSER</b> , Pinzette per tube		645	<b>REDON</b> , Aghi guida	270
<b>NEUMANN</b> , Forbici angolate		50	<b>REILL</b> , Micro port'aghi	610
<b>NICOLA</b> , Micro pinze per rinologia		555	- Pinza riposizionatrice	480
<b>NOVAK</b> , Curette da aspirazione		646	<b>REVERDIN</b> , Spatola	326
<b>NOYES</b> , Micro forbici		39, 601	<b>REYNOLDS</b> , Forbici chirurgiche	51
<b>NUBOER</b> , Cannule per aspirazione		666	<b>RICARD</b> , Divaricatori	349
<b>O</b>				
<b>OBWEGESER</b> , Aghi per legature		489	<b>RICHARDSON</b> , Divaricatori	309
- Divaricatori		302, 303, 545	<b>RICHARDSON-EASTMAN</b> , Divaricatori	309
- Osteotomi		437, 449, 450, 568	<b>ROBB</b> , Elevatori	384
- Periostotomi		398, 399, 400	<b>ROBIN</b> , Fissateli	147
<b>OCHSNER</b> , Pinza vascolare		205	<b>ROCHARD</b> , Divaricatori	363
- Tre quarti		374	<b>ROCHESTER-CARMALT</b> , Pinze emostatiche	171
<b>OLDBERG</b> , Pinze per biopsia		465	<b>ROCHESTER-PEAN</b> , Pinze emostatiche	154, 162
<b>OLIVECRONA</b> , Dissettori		383	<b>RODHOIL</b> , Lubrificante per strumenti	687
- Pinza ossivora		469	<b>ROGGE</b> , Pinze per sterilizzazione	696
- Spatole cerebrali		326	<b>ROSEN</b> , Aghi-cannula aspiranti	681
<b>OLLIER</b> , Divaricatori		297	<b>ROSER-KÖNIG</b> , Apribocca	6, 537
<b>OLSEN-HEGAR</b> , Port'aghi con forbice		246, 253	<b>ROSS</b> , Divaricatori aortici	319
<b>OMBREDANNE</b> , Martello chirurgico		431	<b>ROTAN</b> , Cannule per aspirazione	671
<b>ORINGER</b> , Apribocca		538	<b>RÖTTGEN-RUSKIN</b> , Pinza ossivora	471
<b>OSHIKA-FAULKNER</b> , Micro pinzette oftalmiche		596	<b>ROUX</b> , Divaricatori	291
<b>OVERHOLT</b> , Pinze per legature		161	<b>ROUX-MAGNUS</b> , Divaricatori	291
<b>OVERHOLT-GEISSENDORFER</b> , Pinze per legature		161	<b>ROWE</b> , Pinze riposizionatrici	550
<b>P</b>				
<b>PAPAVERO-CASPAR</b> , Speculum nasali		559	<b>RUBIN</b> , Pinze nasali	563
<b>PAPAVERO-HARTMANN</b> , Speculum nasali		559	<b>RUMEL</b> , Pinze emostatiche e passafilo	163
<b>PARAMETRIUM</b> , Forbice chirurgica		97	<b>RUSKIN-STILLE</b> , Pinze ossivore	470
<b>PARKER-LANGENBECK</b> , Divaricatori		290	<b>RUSKIN-LISTON</b> , Pinze ossivore	474
<b>PARTSCH</b> , Osteotomi, scalpelli, sgorbie		435, 436	<b>RUSSIAN</b> , Pinzette chirurgiche	125
<b>PATELLA</b> , Pinza riposizionatrice		481	<b>RYDER</b> , Port'aghi	258
<b>PAYR</b> , Pinze per intestino		174	<b>RYDEL-SEIFER</b> , Diaphason	5
- Sonde conduttrici		269	<b>S</b>	
<b>PEAN</b> , Pinze emostatiche		150, 153, 156	<b>SACHS</b> , Elevatori	382
<b>PEAN-MURPHY</b> , Pinze emostatiche		140	<b>SALZBURG</b> , Periostotomi	396
<b>PECK-JOSEPH</b> , Forbici chirurgiche		84	<b>SANDERS-BROWN</b> , Aghi per lagature	489
<b>PEDERSON</b> , Speculum vaginali		634	<b>SANTULLI</b> , Bulldog clamps	180
<b>PELTON-CRANE</b> , Cannule per aspirazione		679	<b>SAROT</b> , Port'aghi	254
<b>PENFIELD</b> , Dissettori		385	<b>SATINSKY</b> , Forbice	69
<b>PERRY</b> , Pinzette chirurgiche		115	- Pinze vascolari	225
<b>PERTHES</b> , Perforatori a mano		490	<b>SAUERBRUCH</b> , Costotomi	477
<b>PHILIPS</b> , Giravite universale		528	- Divaricatori	301, 315
<b>PIERCE</b> , Trokare		375	- Pinza ossivora	472
<b>PIERSE</b> , Micro pinzette		594	- Pinze per sterilizzazione	697
<b>PLESTER</b> , Cannule per aspirazione		669	<b>SAUERBRUCH-FREY</b> , Costotomo	477
- Divaricatori		333, 334	<b>SAUG-RASPATORIUM</b> , Cannule per aspirazione	667
<b>POOLE</b> , Cannule per aspirazione		675	<b>SCHAEDEL</b> , Fissateli	146
<b>POTTS</b> , Pinze vascolari		206, 208	<b>SCHAEDE</b> , Cucchiari taglienti	419
<b>POTTS-SMITH</b> , Forbici vascolari		73	<b>SCHLESINGER</b> , Laminotomi cervicali	456
- Pinzette chirurgiche		120, 131	<b>SCHMID</b> , Aghi vascolari malleabili	228, 681
<b>POTTS-YASARGIL</b> , Micro forbici		40	<b>SCHMIEDEN</b> , Aghi per legature	267
<b>POZZI</b> , Pinza uterina		643	<b>SCHMIEDEN-DICK</b> , Aghi per legature	267
<b>PRATT</b> , Dilatatori uterini		640	<b>SCHMIEDEN-TAYLOR</b> , Forbici chirurgiche	70
<b>PRICE-THOMAS</b> , Pinze vascolari		224	<b>SCHNEIDER</b> , Raspatore	402
<b>PROST</b> , Blearostati		599	<b>SCHRÖDER</b> , Cucchiari taglienti	424
<b>PUTTI</b> , Lime per osso		413	- Pinza uterina	643
<b>Q</b>				
<b>QUINBY</b> , Forbici		46	<b>SCHUBERT</b> , Pinze per biopsia	649
<b>QUINKE</b> , Aghi da biopsia		378, 684	<b>SCHUMACHER</b> , Elevatori	392
<b>R</b>				
<b>RADOLF</b> , Pinza per unghie		488	- Costotomo	477
<b>RAGNEL-DAVIS</b> , Divaricatore		288	- Pinze per biopsia	650
<b>RAMPLEY</b> , Pinze per tamponi		142, 633	<b>SCOVILLE</b> , Divaricatore	292, 350, 351
<b>RAMUS</b> , Pinze per chirurgia ossea		548	<b>SCOVILLE-HAVERFIELD</b> , Divaricatore	350
<b>RANDALL</b> , Curette da aspirazione		646	<b>SEDILLOT</b> , Periostotomo	397
- Pinze per calcoli renali		623	- Raspatore	402
			<b>SELDIN</b> , Periostotomo	395
			<b>SELMAN</b> , Pinzette emostatiche	125
			<b>SEMB</b> , Raschiatori	403
			<b>SEMKEN</b> , Pinzette chirurgiche	115, 120, 130
			<b>SENN-GREEN</b> , Divaricatori	287
			<b>SENN-MILLER</b> , Divaricatori	288
			<b>SEPTUN-NADEL</b> , Aghi-cannula angolati	680
			<b>SHAPLEIGH</b> , Curette per otologia	551
			<b>SIEBENMANN</b> , Cannule per aspirazione	677
			<b>SIEBOLD</b> , Forbici chirurgiche	78
			<b>SIGMOID-NOTCH</b> , Periostotomi-Divaricatori	388, 547
			<b>SILVER</b> , Scalpelli nasali	566
			<b>SIMON</b> , Cucchiari taglienti	424

- Divaricatori	314
<b>SIMPSON</b> , Isterometri	642
<b>SIMPSON-BRAUN</b> , Forcipe uterino	656
<b>SIMS</b> , Forbici chirurgiche	75, 76, 98
- Isterometri	642
<b>SINGLEY-TUTTLE</b> , Pinzette anatomiche	125
<b>SMITH</b> , Forbici per fili metallici	102
<b>SMITH-BUIE</b> , Divaricatori	370
<b>SMITH-PETERSEN</b> , Osteotomi	442
<b>SNELLEN</b> , Anse per oftalmologia	591
<b>SPENCER</b> , Forbici togliapunti	100
<b>SPLIT</b> , Osteotomi curvi	578
<b>SPURLING</b> , Pinze per biopsia	461
<b>STACKE</b> , Sonda bottonuta	276
<b>STAMMBERGER</b> , Pinze per rinologia	556
<b>STEINHÄUSER</b> , Periototomi	400
<b>STEINMANN</b> , Chiodi filettati	496, 497
<b>STELLBRINK</b> , Pinze ossivore	466
<b>STERNBERG</b> , Divaricatori	290, 539
<b>STEVENS</b> , Forbici delicate	51
- Port'aghi	242
<b>STIEGLITZ</b> , Pinze per frammenti	134
<b>STILLE</b> , Forbici chirurgiche	67
- Osteotomi, Scalpelli	441
- Pinza ossivora	471
- Pinzette chirurgiche	118
- Pinze per gesso	533
- Pinze renali	175
- Port'aghi	249
- Pinze renali	629
- Scalpelli	441
<b>STILLE-BARRAYA</b> , Pinzette chirurgiche	124
<b>STRULLY</b> , Forbici chirurgiche	69
<b>STRUYCKEN</b> , Pinza per rinologia	556
<b>SUBRAMANIAN</b> , Pinze vascolari	221
<b>SUBRAMANIAN-MINIATURE</b> , Pinze vascolari	221
<b>SWEDESH mod.</b> , Port'aghi	254
<b>SYPERT</b> , Battitore	433
- Pinze per biopsia	464

## T

<b>TAKAHASHI</b> , Pinze per biopsia	460
<b>TAYLOR</b> , Divaricatori	351
- Elevatori	394
- Martello percussore	3
- Pinzette chirurgiche	131
<b>TERRIER</b> , Pinza emostatica	139
<b>TESSIER</b> , Cucchiali taglienti	425, 583
- Divaricatori	313, 545
- Osteotomi	443, 583
- Pinze per osso	585
- Pinza palatale	549
<b>THOMS-GAYLOR</b> , Pinze per biopsia	647
<b>TISCHLER-MORGAN</b> , Pinza per biopsia	650
<b>TOBOLD</b> , Abbassalingua	544
<b>TÖNNIS</b> , Forbici chirurgiche	63
- Port'aghi	247, 259
<b>TÖNNIS-ADSON</b> , Forbici chirurgiche	63, 97
<b>TÖNNIS-RYDER</b> , Port'aghi	259
<b>TROELTSCH</b> , Pinzette anatomiche	133
<b>TROEMNER</b> , Martelli percussori	3
<b>TROUTMAN</b> , Micro pinzette oftalmiche	596
- Micro forbici oftalmiche	603
<b>TUBBS</b> , Dilatatori	229
<b>TUFFIER</b> , Divaricatore costale	367
- Spatola malleabile	326
<b>TUOHY</b> , Aghi da biopsia	378, 684

## U

<b>UFFENORDE</b> , Cucchiali taglienti	418
<b>ULRICH</b> , Pinze per fissazione ossea	484
<b>UNIVERSAL</b> , Porta cotone	277
- Trokare	376
<b>URO-TANGENTIAL</b> , Pinze vascolari	220

## V

<b>VALLEIX</b> , Isterometro	642
<b>VAN DOREN</b> , Pinze per biopsia	648
<b>VANNAS</b> , Micro forbici	39, 43
<b>VARADAY</b> , Strumenti per vene varicose	228
<b>VERBRUGGE</b> , Pinze per osso	482
<b>VERES</b> , Aghi per biopsia	684
<b>WISE</b> , Micro pinzette	107
<b>VOLKMANN</b> , Cucchiali taglienti	417, 420
- Divaricatori	294, 295
<b>VOLLMAR</b> , Stripper	228

## W

<b>WAGNER</b> , Piegia chiodi	500
- Pinze per biopsia	464
<b>WALDMANN</b> , Forbice per episiotomia	79
<b>WALLICH</b> , Curette uterine	652
<b>WALTON</b> , Divaricatori	336
<b>WALTON-POOLE</b> , Cannula per aspirazione	675
<b>WANGENSTEEN</b> , Pinzette chirurgiche	131
- Port'aghi	245, 252
<b>WASSMUND</b> , Divaricatore	299
<b>WEBER</b> , Anse per oftalmologia	591
- Pinze vascolari	204
<b>WEBSTER</b> , Port'aghi	250
<b>WECKER</b> , Micro spatole	590
- Micro forbici	600
<b>WEIL-BLAKESLEY</b> , Pinze per biopsia	459
<b>WEITLANER</b> , Divaricatori	330, 331, 332, 338
<b>WELLER</b> , Forbici chirurgiche	78
<b>WERTHEIM</b> , Forbice chirurgiche	58, 98
- Pinze renali	176, 630, 631
- Port'aghi	256
<b>WEST</b> , Periototomo	395
<b>WESTCOTT</b> , Micro forbici	39, 601
<b>WHERTEIMER</b> , Cannule per aspirazione	674
<b>WHITEHEAD-JENNINGS</b> , Apribocca	6, 540
<b>WIEDER</b> , Abbassalingua	544
<b>WIKSTROEM</b> , Pinze per legature	164
<b>WILDE</b> , Strumento per tonsille	562
<b>WILDER</b> , Dilatatori lacrimali	592
<b>WILLIAMS</b> , Blefarostati	599
<b>WILLIGER</b> , Cucchiali taglienti	416, 422
- Elevatori	381
- Martello chirurgico	429
<b>WINTER</b> , Pinza da placenta e aborto	632
<b>WOLFF</b> , Pinze per gesso	532
<b>WULLSTEIN</b> , Cannule per aspirazione	665, 681
- Divaricatori	330
- Micro cucchiaino ovale	554

## Y

<b>YANKAUER</b> , Cannule per aspirazione	662
<b>YASARGIL</b> , Cannule per aspirazione	668
- Micro Forbici	40, 43
- Pinze per biopsia	465
- Micro Pinzette	110
- Port'aghi	236, 237
<b>YASARGIL-NICOLA</b> , Micro pinza per rinologia	555
<b>YOUNG</b> , Pinza tiralingua	8, 143

## Z

<b>ZAUFAL-JANSEN</b> , Pinza ossivora	470
<b>ZIEGLER</b> , Micro bisturi	27, 589
<b>ZIELINSKY</b> , Compasso da misurazione	22
<b>ZIELKE</b> , Osteotomo	448

## A

<b>ADLERKREUTZ</b> , Tissue forceps	124
<b>ADSON</b> , Suction tubes	674
- Retractors	338, 339, 341, 343
- Periosteal	401
- Tissue forceps	116, 130
<b>ADSON-BROWN</b> , Tissue forceps	116
<b>ALAN-PARKS</b> , Retractors	370
<b>ALDERDYCE</b> , Elevators	395
<b>ALEXANDER</b> , Bone cutting forceps	468
- Biopsy specimen forceps	649
<b>ALLIS</b> , Gum and Tissue forceps	145, 223
<b>ALLISON</b> , Retractors	318
<b>ALM</b> , Retractors	327
<b>ANDERSON-ADSON</b> , Retractors	335
<b>ANDREWS-PYNCHON</b> , Suction tubes	662
<b>ANEL</b> , Eye instruments	593
<b>ANGLE</b> , Wire cutting pliers	510
<b>ARKANSAS</b> , Accessories for re-sharpening	688
<b>ARRUGA</b> , Needle holders	261
- Eye instruments	592
<b>ASH</b> , Rhinology	563
<b>AUFRICHT</b> , Rhinology	565
- Bone files	409
<b>AUSTIN</b> , Tissue forceps	115

## B

<b>BABBUSH</b> , Elevators	395
<b>BABCOCK</b> , Intestinal forceps	144, 223
- Double probe malleable	680
<b>BABINSKY</b> , Percussion hammer	3
<b>BABY-ADSON</b> , Artery forceps and ligature	160
<b>BABY-ALLIS</b> , Gum and tissue forceps	145
<b>BABY-CRILE</b> , Hemostatic forceps	152
<b>BABY-CRILE-WOOD</b> , Needle holders	250
<b>BABY-COLLIN</b> , Retractors	346
<b>BABY-FINOCCHIETTO</b> , Retractors	365
<b>BABY-METZENBAUM</b> , Operating scissors	59
<b>BABY-MIXTER</b> , Hemostatic forceps	160
<b>BABY-MORSE</b> , Rib spreaders	367
<b>BABY-WEITLANER</b> , Retractors	330
<b>BABY-YANKAUER</b> , Suction tubes	662
<b>BACKHAUS</b> , Towel clamps	146
<b>BAILEY</b> , Rib spreaders	368
<b>BAINBRIDGE</b> , Intestinal forceps	166
<b>BAKES</b> , Gall duct dilators	625
<b>BALFOUR</b> , Abdominal retractors	358, 359, 360
<b>BALFOUR-BABY</b> , Abdominal retractors	358
<b>BALLENGER</b> , Rhinology	569
- Rhinology	565
<b>BARON</b> , Suction tubes	670
<b>BARR</b> , Anal retractors	370
<b>BARRAQUER</b> , Eye specula	598
- Micro Forceps	595
- Micro Needle holders	609, 610, 611
- Forceps	135
- Needle holders	234
<b>BARTH</b> , Sharp curettes	416
<b>BAUMGARTNER</b> , Needle holders for ligature	511
<b>BEACHAM</b> , Uterine amniotome	643
<b>BECK</b> , Vessel clamps	207
<b>BECKMANN</b> , Adenotomie	576
- Retractors	342
<b>BECKMANN-EATON</b> , Retractors	343
<b>BEEBE</b> , Wire and plate cutting scissors	103
<b>BEER</b> , Cilia forceps	135
<b>BELLUCCI</b> , Suction tubes	670
- Micro scissors	554
<b>BENGOLEA</b> , Hemostatic forceps	159
<b>BENIQUE</b> , Catheters	624
<b>BENNET</b> , Elevators	393
<b>BERGH</b> , Cilia forceps	135
<b>BERGMANN</b> , Surgical mallets	430
<b>BERNHARD</b> , Gum and Tissue forceps	148
<b>BEYER</b> , Bone rongeurs	470
<b>BILLEAU</b> , Ear loops anses	551

<b>BIRKETT</b> , Hemostatic forceps	158
<b>BLAKE</b> , Uterine curettes	652
<b>BLOHMKE</b> , Intestinal forceps	174
<b>BLOUNT</b> , Elevator	389, 393
<b>BLUMENTHAL</b> , Bone rongeurs	467
<b>BÖHLER</b> , Bone cutting forceps	474
<b>BONNEY</b> , Tissue forceps	131
<b>BOWLED-HENRY</b> , Retractors	311
<b>BOWMAN</b> , Probes	276
<b>BOYNTON</b> , Needle holders	249, 261
<b>BRAUN</b> , Operating scissors	
- Uterine forceps	629
<b>BRAUN-STADLER</b> , Operating scissors	77
<b>BREISKY</b> , Vaginal specula	638
<b>BROCK</b> , Scissors	41
- Forceps	109
- Needle holders	233
<b>BROWN</b> , Tissue forceps	125
<b>BRUENINGS</b> , Tongue depressor	4
<b>BRUNNER</b> , Wire guides	268, 505
- Costotome	477
<b>BRUNS</b> , Sharp curettes	419
- Bandage scissors	101
<b>BUCHWALD</b> , Tongue depressor	4
<b>BÜCHS</b> , Retractors	311
<b>BUCK</b> , Percussion hammer	3
<b>BUCK-GRAMCKO</b> , Elevator	389
<b>BUCKLEY</b> , Osteotome	434
<b>BUELAU</b> , Trocars	377
<b>BUMM</b> , Uterine curettes	654, 655
<b>BUNT</b> , Sterilizing instruments	697
<b>BUSHE</b> , Sharp curettes	423

## C

<b>CAPLAN</b> , Rhinology	564
<b>CASPAR</b> , Sharp curettes	425
- Retractors	304, 352, 353
- Lamina spreaders	354, 355
- Measuring instruments	22
- Osteotome	433
- Biopsy forceps	462, 463
<b>CASTANEDA</b> , Atraumatic vessel clamps	182
<b>CASTROVIEJO</b> , Eye specula	599
- Micro Retractors	591
- Micro scissors	603
- Micro forceps	596
- Eye instruments	592
- Needle holders	238, 239, 240, 241, 242
- Measuring instruments	19, 20, 21
<b>CHADWICK</b> , Delicate scissors	46
<b>CHARNELY</b> , Retractors	364
<b>CHEATTLE</b> , Sterilizing forceps	697
<b>CHILD</b> , Tongue forceps	8, 143
<b>CINELLI</b> , Rhinology	567
<b>CITELLI</b> , Bone cutting forceps	453
<b>CLEANLACT</b> , Soluble lubricant for surgical instruments	687
<b>CLOWARD</b> , Retractors	345
- Lamina spreaders	356
<b>CLOWARD-CONTOUR</b> , Retractors	329
<b>COAKLEY</b> , Sharp curettes	575
<b>COBB</b> , Raspatories	407
<b>COLIBRI</b> , Micro forceps	594
<b>COLLIN</b> , Costotome	475
- Retractors	346, 347, 348
- Hemostatic forceps	139, 143, 633
- Tongue forceps	7
- Clip applying forceps	271
- Sterilizing forceps	697
- Amputations	414
<b>COLLIN-Standard</b> , Vaginal specula	634
<b>CONVERSE</b> , Retractors	288
- Needle holders	250
- Tenotome	28
<b>COOLEY</b> , Dilator for mitral valve	229
- Rib spreaders	324, 366
- Atraumatic vessel clamps	212, 213, 214, 215, 216
<b>COOPER</b> , Ligature needles	267
<b>COOK</b> , Eye specula	599

<b>CORYLLOS</b> , Retractors	315
<b>COTTLE</b> , Retractors	284
- Elevators	396
- Delicate scissors	71
- Bone files	409
- Surgical mallets	430
- Osteotome	438, 579
- Atraumatic Tissue forceps	129
- Nasal Raspatories-Elevator	565
- Nasal specula	559
- Bone crusher	564
<b>COTTLE-MASING</b> , Delicate scissors	46
<b>COTTLE-NEIVERT</b> , Double Retractors	565
<b>COTTLE-WALSHAM</b> , Nasal forceps	563
<b>COUPLAND</b> , Suction tubes	664, 665
<b>CRAFOORD</b> , Ligature forceps	163
<b>CRILE</b> , Hemostatic forceps	151, 152
<b>CRILE-WOOD</b> , Needle holders	243, 250, 252
<b>CRILE-MURRAY</b> , Needle holders	243
<b>CUSCO</b> , Vaginal specula	634
<b>CUSHING</b> , Retractors	288, 289, 292
- Periostotome	401
- Biopsy forceps	461
- Bone cutting forceps	469
- Forceps	121, 131
- Spatulas malleable	326
<b>CUSHING-KOCHER</b> , Retractors	292

## D

<b>DALE</b> , Atraumatic vessel clamps	217
<b>DANDY</b> , Delicate scissors	70
- Tissue forceps	151
- Hemostatic forceps	151
<b>DAUBENSPECK</b> , Sharp curettes	423
<b>DAUTREY-MUNRO</b> , Osteotome	581
<b>DAVIDSON</b> , Retractors	316
<b>DAVIS</b> , Elevator	382
- Sterilizing forceps	696
<b>DAVIS-BOYLE</b> , Mouth gags	541
<b>DAY</b> , Otology instruments	551
<b>DE BAKEY</b> , Suction tubes	664
- Vascular dilator	226
- Scissors	73
- Needle holders	255
<b>DE BAKEY-BAHNSON</b> , Atraumatic vessel clamps	193
<b>DE BAKEY-BAINBRIDGE</b> , Atraumatic vessel clamps	187
<b>DE BAKEY-CAROTIS</b> , Atraumatic vessel clamps	180
<b>DE BAKEY-MOSQUITO</b> , Atraumatic vessel clamps	185
<b>DE BAKEY-HARKEN</b> , Atraumatic vessel clamps	200
<b>DE BAKEY-PEAN</b> , Atraumatic vessel clamps	186
<b>DE BAKEY (POTTS-SMITH)</b> , Scissors	73
- Forceps	126, 127, 128, 132
- Atraumatic vessel clamps	183, 203
<b>DE BAKEY-RANKIN</b> , Atraumatic vessel clamps	185
<b>DE BAKEY-SATINSKY</b> , Atraumatic vessel clamps	180, 198
<b>DEAN</b> , Serrated scissors	70
<b>DEAVER</b> , Operating scissors	57
- Retractors	320, 321
<b>DEJERINE</b> , Percussion mallets	3
<b>DEMEL</b> , Wire guides	504
<b>DENIS-BROWN</b> , Retractors	362
<b>DERF</b> , Needle holders	243, 250
<b>DERRA</b> , Atraumatic vessel clamps	189
<b>DESCHAMPS</b> , Ligature needle	262, 263, 264, 265, 266
<b>DESJARDINS</b> , Kidney stone dilator	623
- Gall duct dilators	628
<b>DESMARRES</b> , Knives	28
- Retractors	287
- Forceps	129
<b>DIETER</b> , Ear instruments	554
<b>DIETRICH</b> , Scissors	74
- Atraumatic vessel clamps	205
- Micro needle holders	240
<b>DIFFENBACH</b> , Bulldog clamps	177
<b>DIXON-LOVELACE</b> , Hemostatic forceps	158
<b>DINGMANN</b> , Mouth gags	542
- Bone surgery	485
<b>DITTEL</b> , Gall duct dilators	626

<b>DOCKHORN</b> , Retractors	305
<b>DOLWICK-REICH</b> , Retractors	337
<b>DOYEN</b> , Towel clamps	146
- Retractor	308, 363
- Atraumatic forceps	171
- Raspatories	404
- Probes	275
- Myom instruments	645
- Vaginal specula	637
<b>DOYEN-COLLIN</b> , Mouth gags	6, 537
<b>DOYEN-JANSEN</b> , Mouth gags	6, 537
<b>DOYEN-STILLE</b> , Retractors	308
<b>DUBOIS</b> , Operating scissors	77
<b>DUKE</b> , Trocars	377
<b>DUNN-DAUTREY</b> , Retractors	546
<b>DUPLAY</b> , Otology specula	18
<b>DUPUY-WEISSE</b> , Ligature needle	262
<b>DURANTE</b> , Forceps	125
<b>DUVAL</b> , Tissue forceps	129
- Atraumatic vessel clamps	223
- Hemostatic forceps	145, 629
<b>DUVAL-COLLIN</b> , Intestinal forceps	629

## E

<b>ECHLIN</b> , Bone cutting forceps	470
<b>EDER</b> , Cotton applicators	279
<b>EISELBERG-MATHIEU</b> , Needle holders	249
<b>ELLIS</b> , Micro Knives	589
<b>EPKER</b> , Osteotome	578
<b>ESMARCH</b> , Bandage scissors	101

## F

<b>FAGER</b> , Elevator	382
<b>FAHLBUSCH</b> , Micro Scissors for Rhinology	555
<b>FARABEUF</b> , Retractors	290
- Bone cutting forceps	478
- Raspatories	402
<b>FARABEUF-LAMBOTTE</b> , Bone cutting forceps	478
<b>FARREL</b> , Cotton applicators	277
<b>FAULKNER</b> , Eye instruments	596
<b>FAURE</b> , Towel clamps	146
- Biopsy forceps	648
<b>FEICHENFELD</b> , Tissue forceps	134
<b>FEIN</b> , Cotton applicators	278
<b>FENO</b> , Vaginal specula	656
<b>FERGUSSON</b> , Suction tubes	669
- Angiotribe forceps	166
<b>FERRIS-SMITH-KERRISON</b> , Laminectomy	454, 455, 456, 457
<b>FERRIS-SMITH-CUSHING</b> , Laminectomy	458
<b>FIBULA</b> , Bone cutting forceps	479
<b>FINOCCHIETTO</b> , Retractors	365
- Needle holders	257
<b>FINSEN</b> , Retractors	327
<b>FINSTERER</b> , Suction tubes	664
<b>FOERSTER-BALLENGER</b> , Sponge and dressing forceps	141
<b>FOMON</b> , Retractors	284
- Angolate scissors	59, 70, 71
- Bone files	410, 412, 572
- Rhinology	567
<b>FRANKFELDT</b> , Cotton applicators	279
<b>FRAZIER</b> , Suction tubes	669, 674, 680
- Retractors	350
<b>FREER</b> , Elevators	395
- Gouges	434
- Mucous knife	572
<b>FRENZEL</b> , Tongue forceps	4
<b>FRIEDMANN</b> , Bone rongeurs	467

## G

<b>GABON</b> , Bone cutters	586
<b>GALLAHER</b> , Bone files	408
<b>GARRETT</b> , Vascular dilator	227
<b>GELLHORN</b> , Biopsy forceps	647
<b>GELPI</b> , Retractors	328

<b>GELPI-LOKTITE</b> , Retractors	329
<b>GELPI-SEILETZ</b> , Retractors	329
<b>GEMINI</b> , Artery forceps and ligature	162
<b>GENTOFT</b> , Vaginal specula	656
<b>GERALD</b> , Tissue forceps	123
<b>GERALD-BROWN</b> , Tissue forceps	123
<b>GERSTER</b> , Bone surgery	487
<b>GERSTER-LOWMAN</b> , Bone surgery	487
<b>GIDEF</b> , Hemostatic forceps	150
<b>GIERTZ-STILLE</b> , Costotome	477
<b>GIGLI</b> , Amputation	414
<b>GIL-VERNET</b> , Retractors	293
<b>GILLIES</b> , Retractors	283
- Needle holders	247, 253
<b>GLASSMAN</b> , Operating scissors	52
<b>GLOVER</b> , Bulldog clamps	179, 180
- Vascular forceps	207
<b>GOLDMAN-FOX</b> , Operating scissors	49, 50, 80, 84
<b>GOELET</b> , Retractors	291
<b>GORNEY</b> , Operating scissors	68
- Suction tubes	667
<b>GOSSET</b> , Abdominal Retractors	357
<b>GOURDET</b> , Uterine curettes	651
<b>GRAEFE</b> , Delicate scissors	46
- Tissue forceps	114, 129
- Micro Retractors	589, 590
- Micro Knife	27, 590
<b>GRAY</b> , Ligature forceps	164
<b>GRAVE</b> , Vaginal specula	634
<b>GREGORY</b> , Vascular forceps	207
<b>GREENE</b> , Retractors	311
<b>GROSS</b> , Hemostatic forceps	139, 141
<b>GRUENWALD</b> , Tissue forceps	133
<b>GUILLIEN</b> , Suction tubes	667
<b>GUSBERG</b> , Endocervical Biopsy curettes	646
<b>GUTHRIE</b> , Retractors	283
<b>GUYON</b> , Gall duct dilator	628
- Catheters	624
- Kidney pedicle clamps forceps	175
- Uterine forceps	629

## H

<b>HABERER</b> , Spatulas malleable	326
<b>HAGLUND</b> , Plaster cast breakers	533
<b>HALLE</b> , Sharp curettes	422
<b>HALSEY</b> , Needle holders	243, 250
<b>HALSTED</b> , Hemostatic forceps	150, 152
<b>HALSTED-MOSQUITO</b> , Hemostatic forceps	149, 152
<b>HANK</b> , Uterine dilators	641
<b>HARRINGTON</b> , Retractors	317
<b>HARTMANN</b> , Tongue forceps	544
- Suction tubes	676, 677
- Tuning Forks	5
- Cotton applicators	278
- Bone cutting forceps	469
- Ear forceps	552, 553
- Nasal specula	18, 560, 561
<b>HARTMANN-BABY-MOSQUITO</b> , Hemostatic forceps	149
<b>HAYES</b> , Atraumatic vessel clamps	218
<b>HEANEY</b> , Needle holders	257
<b>HEANEY-HEGAR</b> , Needle holders	244
<b>HEAT</b> , Surgical mallets	431
<b>HEGAR</b> , Uterine dilators	639, 641
- Needle holders	244, 251
<b>HEGAR-MAYO-SEELEY</b> , Needle holders	245, 252
<b>HEGENBARTH</b> , Tissue forceps	271
<b>HEILDELBERG</b> , Cotton applicators	278
<b>HEISS</b> , Hemostatic forceps	158
<b>HEISTER</b> , Mouth gags	6, 537
<b>HEMINGWAY</b> , Sharp curettes	415
<b>HENAHAN</b> , Periostotomes	401
<b>HENLEY</b> , Retractors	344
<b>HENNIG</b> , Plaster cast breakers	533
<b>HEPARIN</b> , Needle malleable	682
<b>HEYMANN</b> , Angolate scissors	71
<b>HEYMANN-KNIGHT</b> , Angolate scissor	71
<b>HIBBS</b> , Retractors	297
- Osteotomes	439

<b>HOHMANN</b> , Elevators	391, 394
<b>HOLZBACH</b> , Retractors	349
<b>HÖPFNER</b> , Intestinal forceps	174
<b>HOPT</b> , Vascular forceps	219
<b>HOUSE</b> , Suction tubes	672
<b>HOWARD</b> , Bone files	408, 570
<b>HOWARTH</b> , Periostotomes	397
<b>HUNTER</b> , Splinter forceps	134
<b>HURD</b> , Periostotomes	397

## I

<b>INGE</b> , Lamina spreaders	356
<b>IRIS</b> , Delicate scissors	44, 81, 83, 84, 99
<b>ISRAEL</b> , Retractors	298
<b>ITARD</b> , Suction tubes	677

## J

<b>JACKSON-TESSIER</b> , Bone cutting scissors	476
<b>JACOBSON</b> , Sharp curettes	416
- Micro scissors	40
- Drilling Chucks	501, 502, 503, 527
- Needle holders	235, 241
<b>JACOBSON-UNIVERSAL</b> , Drilling Chucks	527
<b>JAMESON</b> , Delicate scissors	47
<b>JAMESON-WERBER</b> , Delicate scissors	47
<b>JANSEN</b> , Sharp curettes	416
- Retractors	327
- Bone cutting forceps	469
- Forceps	133
- Raspatories	402
<b>JANSEN-LEUER</b> , Bone cutting forceps	468
<b>JAVID</b> , Vascular forceps	222
<b>JONES</b> , Towel clamps	146
- Hemostatic forceps	139
<b>JOSEPH</b> , Retractors	284
- Scissors	58
- Bone files	408
- Rhinology	573, 574
- Periostotomes	401
<b>JUDD-MASSON</b> , Bladder Retractors	369

## K

<b>KALLMORGEN</b> , Vaginal specula	635
<b>KELLY</b> , Retractors	310
- Operating scissors	53, 85
- Hemostatic forceps	155
<b>KERN</b> , Bone cutting forceps	486
<b>KERPEL</b> , Sharp curettes	418
<b>KERSHNER</b> , Eye instruments	598
<b>KERRISON</b> , Laminectomy	453
<b>KERRISON-JACOBY</b> , Laminectomy	455
<b>KEVORKIAN</b> , Biopsy forceps	650
<b>KEY-HORSLEY</b> , Bone cutting forceps	475
<b>KEYES</b> , Dermal punches	28, 491
<b>KILLIAN</b> , Suction tubes	678
- Nasal scissors	72
- Rhinology	564
- Rhinology	565
- Nasal specula	560, 561
<b>KILLIAN-KLAUS</b> , Osteotomes	565
<b>KILNER</b> , Scissors	47, 52, 85
- Needle holders	256
<b>KILNER-DOUGHTY</b> , Mouth gags	540
<b>KIMURA</b> , Micro spatulas	592
<b>KIRSCH</b> , Retractors	304
<b>KIRSCHNER</b> , Retractors	361
<b>KLIMA-ROSEGGER</b> , Biopsy needle	377
<b>KOCHER</b> , Ligature needle	267
- Retractors	292, 294, 296, 301, 305, 307
- Hemostatic forceps	153, 155, 157
- Intestinal forceps	172, 173
- Conductor probes	269
<b>KOCHER-LANGENBECK</b> , Retractors	300
<b>KOCHER-OCHSNER</b> , Tissue forceps	154

<b>KOENIG</b> , Conductor probe	269
<b>KOERTE</b> , Retractor	323
<b>KÖNIG</b> , Elevator	381
<b>KRAUSE</b> , Ear polypus snares	562
- Trocars	375
<b>KRESSNER</b> , Nasal forceps	563
<b>KRISTELLER</b> , Vaginal specula	636
<b>KROENIG</b> , Tongue forceps	4
<b>KRONECKER</b> , Ligature needle	262
<b>KÜHNE</b> , Forceps	135
<b>KÜNTSCHER</b> , Wires	496
- Bone surgery	500

## L

<b>LA FORCE</b> , Micro knives	589
<b>LA GRANGE</b> , Operating scissors	50, 80
<b>LAHEY</b> , Retractors	288
<b>LAMBERT-KAY</b> , Vascular forceps	210
<b>LAMBOTTE</b> , Osteotomes	437
- Bone cutting forceps	478
- Raspatories	404
<b>LANDAU</b> , Vaginal specula	637
<b>LANDOLT</b> , Scalpel handles	34
- Biopsy forceps	465
<b>LANE</b> , Screw drivers	528
- Bone cutting forceps	486
<b>LANGE</b> , Retractors	289
<b>LANGENBECK</b> , Needle holders	259
- Retractors	299
- Elevator	395
- Raspatories	402
- Amputations	414
<b>LANGENBECK-RYDER</b> , Needle holders	259
<b>LAWRENCE</b> , Artery forceps and ligature	165
<b>LEES</b> , Vascular forceps	209
<b>LEKSELL</b> , Bone cutting forceps	470
<b>LELAND-JONES</b> , Vascular forceps	215
<b>LEMPERT</b> , Bone cutting forceps	468
<b>LERICHE</b> , Hemostatic forceps	151
<b>LEWIN</b> , Bone surgery	479
<b>LEWIS</b> , Bone files	409
- Rhinology	573
<b>LEXER</b> , Operating scissors	66, 95
- Osteotomes	446, 448
- Gouges	445, 446
<b>LEVIS</b> , Stethoscopes	10
<b>LICHTENBERG</b> , Needle holders	261
<b>LICHTWITZ</b> , Trocars	375
<b>LIEBERMANN-TENNANT</b> , Eye instruments	598
<b>LINDEMANN</b> , Amputations	414
<b>LISTER</b> , Bandage scissors	101
- Hemostatic forceps	139
<b>LISTER-BURCH</b> , Eye specula	599
<b>LISTON</b> , Bone cutting forceps	473
<b>LISTON-STILLE</b> , Bone cutting forceps	475
<b>LITTAUER</b> , Ear forceps	552
- Cilia forceps	135
<b>LITTLER</b> , Delicate scissors	59
<b>LITTLEWOOD</b> , Uterine forceps	644
<b>LOCHART</b> , Probes	275
<b>LOCKLIN</b> , Delicate scissors	48, 53
<b>LÖFFEL</b> , Rhinology	558
<b>LOGAN</b> , Retractors	327
<b>LORENZ</b> , Bandage scissors	101
<b>LORNA</b> , Towel clamps	147
<b>LOUTE</b> , Bone wire tighteners	499
<b>LOVE</b> , Retractors	289
<b>LOVE-GRUENWALD</b> , Biopsy forceps	460, 461
<b>LUCAE</b> , Tuning forks	5
- Surgical mallets	429
- Tissue forceps	133
- Otology instruments	551
<b>LUER</b> , Bone cutting forceps	467
<b>LUER-KÖRTE</b> , Uterine curettes	651
<b>LUER-LOCK</b> , Suction tubes handle	681
<b>LUER-STILLE</b> , Bone cutting forceps	469, 471, 472

## M

<b>MAGILL</b> , Suction tubes	678
- Catheter introducing forceps	7
<b>MAIER</b> , Sponge and dressing forceps	142, 633
<b>MALTZ</b> , Rhinology	574
<b>MARKHAM-MEYERDING</b> , Retractors	336
<b>MARTIN</b> , Retractor	314
- Bone cutting forceps	485
- Cotton applicators	277
- Uterine sounds	642
<b>MARTINI</b> , Sharp curettes	416
<b>MASING</b> , Elevators	396
<b>MASSON</b> , Needle holders	245, 257
<b>MATHIEU</b> , Retractors	290
- Anal Retractors	369
- Needle holders	248, 249, 260
- Vaginal specula	635
<b>MAYO</b> , Operating scissors	64, 65, 82, 96
- Uterine sounds malleable	642
- Spatulas	4
- Sterilizing forceps	697
<b>MAYO-HARRINGTON</b> , Scissors	75
<b>MAYO-HEGAR</b> , Needle holders	244, 251, 252
<b>MAYO-HEGAR-HEANEY</b> , Needle holders	256
<b>MAYO-LEXER</b> , Operating scissors	96
<b>MAYO-NOBLE</b> , Operating scissors	64
<b>MAYO-RUSSIAN</b> , Forceps	125
<b>MAYO-STILLE</b> , Scissors	67, 94
<b>MC DONALD</b> , Elevator	397
<b>MC INTOSH</b> , Laryngoscopes	11, 14, 16
<b>MC IVOR</b> , Mouth gags	541
<b>MC KENTY</b> , Elevator	397
<b>MC KESSON</b> , Suction tubes	660
<b>MC PHERSON</b> , Micro forceps	595, 596
<b>MEAD</b> , Elevator	395
- Surgical mallets	429
- Bone cutting forceps	467
<b>MEEKER</b> , H emostatic forceps and ligature	165
<b>MELLINGER</b> , Eye specula	599
<b>METZENBAUM</b> , Scissors	59, 60, 61, 81, 84, 89, 90, 91, 92, 99
<b>MEYERDING</b> , Retractors	312, 335
<b>MICHEL</b> , Clip applying forceps	271
<b>MICRO-HALSTEAD</b> , Hemostatic forceps	149
<b>MICRO-HARTMANN</b> , Otology forceps	552
<b>MICRO-IRIS</b> , Delicate scissors	44
<b>MICRO-RYDER</b> , Needle holders	258
<b>MICRO-VASCULAR</b> , Needle holders	255
<b>MIDDLELDORPF</b> , Retractors	306
<b>MIKULICZ</b> , Retractors	322, 323
- Hemostatic forceps	158
<b>MILLER</b> , Laryngoscopes	12, 15, 16
- Bone files	408, 570
<b>MILLIGAN</b> , Elevator	382
<b>MILLIN</b> , Bladder Retractors	369
<b>MINI-FRIEDMANN</b> , Bone cutting forceps	466, 467
<b>MINI-GILLIES</b> , Needle holders scissors	247, 253
<b>MINI-HOHMANN</b> , Elevators	389
<b>MINI-LAMBOTTE</b> , Osteotomes	437, 438
<b>MINI-LEXER</b> , Osteotomes	440, 445
<b>MINI-OLSEN-HEGAR</b> , Needle holders scissors	246
<b>MINI-ROUX</b> , Retractor	291
<b>MINNESOTA</b> , Retractor	539
<b>MISKIMON</b> , Retractors	340
<b>MIXTER</b> , Hemostatic forceps	164
<b>MOLLISON</b> , Retractors	335
<b>MOLT</b> , Mouth gags for children	537
- Periostotomes	401
<b>MORRIS-DE BAKEY</b> , Vascular forceps	195
<b>MORSE</b> , Rib spreaders	367
<b>MÜNCHEN</b> , Biopsy curettes	646
<b>MUSEUX</b> , Uterine forceps	644

## N

<b>NEGUS</b> , Hemostatic forceps and ligature	165
<b>NEGUS-GUEDEL</b> , Laryngoscopes	13, 16
<b>NELATON</b> , Probe	275



<b>NELSON</b> , Trocars	374
<b>NELSON-METZENBAUM</b> , Operating scissors	62, 93
<b>NEUBÜSER</b> , Tubal operation forceps	645
<b>NEUMANN</b> , Angolate scissors	50
<b>NICOLA</b> , Rhinology	555
<b>NOVAK</b> , Suction curettes	646
<b>NOYES</b> , Micro scissors	39, 601
<b>NUBOER</b> , Suction tubes	666

## O

<b>OBWEGESER</b> , Ligature needle	489
- Retractors	302, 303, 545
- Osteotomes	437, 449, 450, 568
- Periostotomes	398, 399, 400
<b>OCHSNER</b> , Vascular forceps	205
- Trocars	374
<b>OLDBERG</b> , Biopsy forceps	465
<b>OLIVECRONA</b> , Dissectors	383
- Bone cutting forceps	469
- Spatulas malleable	326
<b>OLLIER</b> , Retractors	297
<b>OLSEN-HEGAR</b> , Needle holders with scissor	246, 253
<b>OMBREDANNE</b> , Surgical mallets	431
<b>ORINGER</b> , Mouth gags	538
<b>OSHIKA-FAULKNER</b> , Eye instruments	596
<b>OVERHOLT</b> , Ligature forceps	161
<b>OVERHOLT-GEISSENDORFER</b> , Ligature forceps	161

## P

<b>PAPAVERO-CASPAR</b> , Nasal specula	559
<b>PAPAVERO-HARTMANN</b> , Nasal specula	559
<b>PARAMETRIUM</b> , Operating scissors	97
<b>PARKER-LANGENBECK</b> , Retractors	290
<b>PARTSCH</b> , Osteotomes	435, 436
<b>PATELLA</b> , Bone surgery	481
<b>PAYR</b> , Intestinal forceps	174
- Conductor probes	269
<b>PEAN</b> , Hemostatic forceps	150, 153, 156
<b>PEAN-MURPHY</b> , Hemostatic forceps	140
<b>PECK-JOSEPH</b> , Operating scissors	84
<b>PEDERSON</b> , Vaginal specula	634
<b>PELTON-CRANE</b> , Suction tubes	679
<b>PENFIELD</b> , Dissectors	385
<b>PERRY</b> , Tissue forceps	115
<b>PERTHES</b> , Awis reamer	490
<b>PHILIPS</b> , Screw driver	528
<b>PIERCE</b> , Trocars	375
<b>PIERSE</b> , Micro forceps	594
<b>PLESTER</b> , Suction tubes	669
- Retractors	333, 334
<b>POOLE</b> , Suction tubes	675
<b>POTTS</b> , Vascular forceps	206, 208
<b>POTTS-SMITH</b> , Vascular scissors	73
- Tissue forceps	120, 131
<b>POTTS-YASARGIL</b> , Micro scissors	40
<b>POZZI</b> , Uterine forceps	643
<b>PRATT</b> , Uterine dilator	640
<b>PRICE-THOMAS</b> , Vascular forceps	224
<b>PROST</b> , Eye apecula	599
<b>PUTTI</b> , Bone files	413

## Q

<b>QUINBY</b> , Scissors	46
<b>QUINKE</b> , Biopsy needle	378, 684

## R

<b>RADOLF</b> , Nail nipper	488
<b>RAGNEL-DAVIS</b> , Retractor	288
<b>RAMPLEY</b> , Sponge and dressing forceps	142, 633
<b>RAMUS</b> , Bone cutting forceps	548
<b>RANDALL</b> , Suction tubes	646
- Kidney stone forceps	623

<b>RANKIN</b> , Hemostatic forceps	155
<b>RECAMIER</b> , Uterine curettes	653
<b>REDON</b> , Guide needles	270
<b>REILL</b> , Micro Needle holders	610
- Bone surgery	480
<b>REVERDIN</b> , Spatulas	326
<b>REYNOLDS</b> , Operating scissors	51
<b>RICARD</b> , Retractors	349
<b>RICHARDSON</b> , Retractors	309
<b>RICHARDSON-EASTMAN</b> , Retractors	309
<b>ROBB</b> , Elevator	384
<b>ROBIN</b> , Towel clamps	147
<b>ROCHARD</b> , Retractors	363
<b>ROCHESTER-CARMALT</b> , Hemostatic forceps	171
<b>ROCHESTER-PEAN</b> , Hemostatic forceps	154, 162
<b>RODHOIL</b> , Soluble lubricant for surgical instruments	687
<b>ROGGE</b> , Sterilizing forceps	696
<b>ROSEN</b> , Needles-Suction tubes	681
<b>ROSER-KÖNIG</b> , Mouth gags	6, 537
<b>ROSS</b> , Retractors	319
<b>ROTAN</b> , Suction tubes	671
<b>RÖTTGEN-RUSKIN</b> , Bone cutting forceps	471
<b>ROUX</b> , Retractors	291
<b>ROUX-MAGNUS</b> , Retractors	291
<b>ROWE</b> , Bone surgery	550
<b>RUBIN</b> , Nasal forceps	563
<b>RUMEL</b> , Hemostatic forceps	163
<b>RUSKIN-STILLE</b> , Bone cutting forceps	470
<b>RUSKIN-LISTON</b> , Bone cutting forceps	474
<b>RUSSIAN</b> , Tissue forceps	125
<b>RYDER</b> , Needle holders	258
<b>RYDEL-SEIFER</b> , Tuning fork	5

## S

<b>SACHS</b> , Elevators	382
<b>SALZBURG</b> , Elevators	396
<b>SANDERS-BROWN</b> , Ligature needle	489
<b>SANTULLI</b> , Bulldog clamps	180
<b>SAROT</b> , Needle holders	254
<b>SATINSKY</b> , Scissors	69
- Vascular forceps	225
<b>SAUERBRUCH</b> , Costotomes	477
- Retractors	301, 315
- Bone cutting forceps	472
- Sterilizing forceps	697
<b>SAUERBRUCH-FREY</b> , Costotomes	477
<b>SAUG-RASPATORIUM</b> , Suction tubes	667
<b>SCHAEDEL</b> , Towel clamps	146
<b>SCHEDÉ</b> , Sharp curettes	419
<b>SCHLESINGER</b> , Cervical laminectomy	456
<b>SCHMID</b> , Vascular needles malleable	228, 681
<b>SCHMIEDEN</b> , Ligature needles	267
<b>SCHMIEDEN-DICK</b> , Ligature needles	267
<b>SCHMIEDEN-TAYLOR</b> , Operating scissors	70
<b>SCHNEIDER</b> , Raspatories	402
<b>SCHRÖDER</b> , Sharp curettes	424
- Uterine forceps	643
<b>SCHUBERT</b> , Biopsy forceps	649
<b>SCHUMACHER</b> , Elevator	392
- Costotomes	477
- Biopsy forceps	650
<b>SCOVILLE</b> , Retractor	292, 350, 351
<b>SCOVILLE-HAVERFIELD</b> , Retractor	350
<b>SEDILLOT</b> , Periostotomes	397
- Raspatories	402
<b>SELDIN</b> , Elevator	395
<b>SELMAN</b> , Hemostatic forceps	125
<b>SEMB</b> , Raspatories	403
<b>SEMKEN</b> , Tissue forceps	115, 120, 130
<b>SENN-GREEN</b> , Retractors	287
<b>SENN-MILLER</b> , Retractors	288
<b>SEPTUN-NADEL</b> , Needles-Suction tubes	680
<b>SHAPLEIGH</b> , Otology curettes	551
<b>SIEBENMANN</b> , Suction tubes	677
<b>SIEBOLD</b> , Operating scissors	78
<b>SIGMOID-NOTCH</b> , Periostotomes-Retractors	388, 547
<b>SILVER</b> , Rhinology	566
<b>SIMON</b> , Sharp curettes	424

- Retractors	314
<b>SIMPSON</b> , Uterine sounds	642
<b>SIMPSON-BRAUN</b> , Uterine forceps	656
<b>SIMS</b> , Operating scissors	75, 76, 98
- Uterine sounds	642
<b>SINGLEY-TUTTLE</b> , Dressing forceps	125
<b>SMITH</b> , Wire and plate cutting scissors	102
<b>SMITH-BUIE</b> , Retractors	370
<b>SMITH-PETERSEN</b> , Osteotomes	442
<b>SNELLEN</b> , Eye instruments	591
<b>SPENCER</b> , Ligature scissors	100
<b>SPLIT</b> , Osteotomes	578
<b>SPURLING</b> , Biopsy forceps	461
<b>STACKE</b> , Probes	276
<b>STAMMBERGER</b> , Rhinology forceps	556
<b>STEINHÄUSER</b> , Periostotomes	400
<b>STEINMANN</b> , Wires extension	496, 497
<b>STELLBRINK</b> , Bone rongeurs	466
<b>STERNBERG</b> , Retractors	290, 539
<b>STEVENS</b> , Delicate scissors	51
- Needle holders	242
<b>STIEGLITZ</b> , Splinter forceps	134
<b>STILLE</b> , Operating scissors	67
- Osteotomes	441
- Bone rongeurs	471
- Tissue forceps	118
- Plaster cast breakers	533
- Kidney pedicle clamps forceps	175
- Needle holders	249
- Uterine forceps	629
- Gouges	441
<b>STILLE-BARRAYA</b> , Tissue forceps	124
<b>STRULLY</b> , Operating scissors	69
<b>STRUYCKEN</b> , Rhinology forceps	556
<b>SUBRAMANIAN</b> , Vascular forceps	221
<b>SUBRAMANIAN-MINIATURE</b> , Vascular forceps	221
<b>SWEDESH mod.</b> , Needle holder	254
<b>SYPERT</b> , Osteotomes	433
- Biopsy forceps	464

## T

<b>TAKAHASHI</b> , Biopsy forceps	460
<b>TAYLOR</b> , Retractors	351
- Elevators	394
- Percussion hammers	3
- Tissue forceps	131
<b>TERRIER</b> , Hemostatic forceps	139
<b>TESSIER</b> , Sharp curettes	425, 583
- Retractors	313, 545
- Osteotomes	443, 583
- Bone cutting forceps	585
- Bone holding forceps	549
<b>THOMS-GAYLOR</b> , Biopsy forceps	647
<b>TISCHLER-MORGAN</b> , Biopsy forceps	650
<b>TOBOLD</b> , Tongue forceps	544
<b>TÖNNIS</b> , Operating scissors	63
- Needle holders	247, 259
<b>TÖNNIS-ADSON</b> , Operating scissors	63, 97
<b>TÖNNIS-RYDER</b> , Needle holders	259
<b>TROELTSCH</b> , Operating scissors	133
<b>TROEMNER</b> , Percussion hammers	3
<b>TROUTMAN</b> , Micro Eye forceps	596
- Micro Eye scissors	603
<b>TUBBS</b> , Retractors	229
<b>TUFFIER</b> , Rib spreader	367
- Spatulas malleable	326
<b>TUOHY</b> , Biopsy needle	378, 684

## U

<b>UFFENORDE</b> , Sharp curettes	418
<b>ULRICH</b> , Bone cutting forceps	484
<b>UNIVERSAL</b> , Cotton applicators	277
- Trocars	376
<b>URO-TANGENTIAL</b> , Vascular forceps	220

## V

<b>VALLEIX</b> , Uterine sounds	642
<b>VAN DOREN</b> , Biopsy forceps	648
<b>VANNAS</b> , Micro scissors	39, 43, 600
<b>VARADAY</b> , Vein instruments	228
<b>VERBRUGGE</b> , Bone surgery	482
<b>VERRES</b> , Biopsy needle	684
<b>WISE</b> , Micro forceps	107
<b>VOLKMANN</b> , Sharp curettes	417, 420
- Retractors	294, 295
<b>VOLLMAR</b> , Stripper	228

## W

<b>WAGNER</b> , Bone surgery	500
- Biopsy forceps	464
<b>WALDMANN</b> , Episiotomy scissors	79
<b>WALLICH</b> , Uterine curettes	652
<b>WALTON</b> , Retractors	336
<b>WALTON-POOLE</b> , Suction tube	675
<b>WANGENSTEIN</b> , Tissue forceps	131
- needle holders	245, 252
<b>WASSMUND</b> , Retractors	299
<b>WEBER</b> , Eye instrumente	591
- Vascular forceps	204
<b>WEBSTER</b> , Needle holders	250
<b>WECKER</b> , Micro spatula	590
- Micro scissors	600
<b>WEIL-BLAKESLEY</b> , Biopsy forceps	459
<b>WEITLANER</b> , Retractors	330, 331, 332, 338
<b>WELLER</b> , Operating scissors	78
<b>WERTHEIM</b> , Operating scissors	58, 98
- Kidney pedicle clamps forceps	176, 630, 631
- Needle holders	256
<b>WEST</b> , Elevator	395
<b>WESTCOTT</b> , Micro scissors	39, 601
<b>WHERTEIMER</b> , Suction tube	674
<b>WHITEHEAD-JENNINGS</b> , Mouth gags	6, 540
<b>WIEDER</b> , Tongue forceps	544
<b>WIKSTROEM</b> , Ligature forceps	164
<b>WILDE</b> , Ear polypus snares	562
<b>WILDER</b> , Lacrymal dilators	592
<b>WILLIAMS</b> , Eye specula	599
<b>WILLIGER</b> , Sharp curettes	416, 422
- Elevators	381
- Surgical mallets	429
<b>WINTER</b> , Placenta and ovum forceps	632
<b>WOLFF</b> , Plaster cast breakers	532
<b>WULLSTEIN</b> , Suction tube	665, 681
- Retractors	330
- Ear instruments	554

## Y

<b>YANKAUER</b> , Suction tube	662
<b>YASARGIL</b> , Suction tube	668
- Micro scissors	40, 43
- Biopsy scissors	465
- Micro forceps	110
- Needle holders	236, 237
<b>YASARGIL-NICOLA</b> , Rhinology Micro forceps	555
<b>YOUNG</b> , Tongue forceps	8, 143

## Z

<b>ZAUFAL-JANSEN</b> , Bone surgery	470
<b>ZIEGLER</b> , Micro knife	27, 589
<b>ZIELINSKY</b> , Measuring instruments	22
<b>ZIELKE</b> , Osteotomes	448

## A

<b>ADLERKREUTZ</b> , Chirurgische Pinzetten	124
<b>ADSON</b> , Absaugkanülen	674
- Wundspreizer	338, 339, 341, 343
- Raspatorien	401
- Anatomische Pinzetten	116, 130
<b>ADSON-BROWN</b> , Chirurgische Pinzetten	116
<b>ALAN-PARKS</b> , Wundspreizer	370
<b>ALDERDYCE</b> , Elevatorien	395
<b>ALEXANDER</b> , Knochensplitterzangen	468
- Probeexzisionzangen	649
<b>ALLIS</b> , Gewebe Fasszangen	145, 223
<b>ALLISON</b> , Wundspreizer	318
<b>ALM</b> , Wundspreizer	327
<b>ANDERSON-ADSON</b> , Wundspreizer	335
<b>ANDREWS-PYNCHON</b> , Absaugkanülen	662
<b>ANEL</b> , Augeninstrumente	593
<b>ANGLE</b> , Drahtschneidezangen	510
<b>ARKANSAS</b> , Schleifesteine	688
<b>ARRUGA</b> , Nadelhalter	261
- Augeninstrumente	592
<b>ASH</b> , Rhinologie	563
<b>AUFRIECHT</b> , Rhinologie	565
- Knochenfeilen	409
<b>AUSTIN</b> , Chirurgische Pinzetten	115

## B

<b>BABBUSH</b> , Elevatorien	395
<b>BABCOCK</b> , Darmklemmen	144, 223
- Krampfader sonden, Biegsam	680
<b>BABINSKY</b> , Percussion Hämmer	3
<b>BABY-ADSON</b> , Arterienklemmen und Ligaturklemmen	160
<b>BABY-ALLIS</b> , Gewebe Fasszangen	145
<b>BABY-CRILE</b> , Arterienklemmen	152
<b>BABY-CRILE-WOOD</b> , Nadelhalter	250
<b>BABY-COLLIN</b> , Wundspreizer	346
<b>BABY-FINOCCHIETTO</b> , Wundspreizer	365
<b>BABY-METZENBAUM</b> , Feine Scheren	59
<b>BABY-MIXTER</b> , Arterienklemmen	160
<b>BABY-MORSE</b> , Ribbensperrerr	367
<b>BABY-WEITLANER</b> , Wundspreizer	330
<b>BABY-YANKAUER</b> , Absaugkanülen	662
<b>BACKHAUS</b> , Tuchklemmen	146
<b>BAILEY</b> , Ribbensperrerr	368
<b>BAINBRIDGE</b> , Darmklemmen	166
<b>BAKES</b> , Gallengang dilatatorien	625
<b>BALFOUR</b> , Bauchdeckenhalter	358, 359, 360
<b>BALFOUR-BABY</b> , Bauchdeckenhalter	358
<b>BALLENGER</b> , Rhinologie	569
- Scalpell	565
<b>BARON</b> , Absaugkanülen	670
<b>BARR</b> , Analspreizer	370
<b>BARRAQUER</b> , Sperrelevatorien	598
- Micro Pinzetten	595
- Micro Nadelhalter	609, 610, 611
- Pinzetten	135
- Nadelhalter	234
<b>BARTH</b> , Sharfe Löffel	416
<b>BAUMGARTNER</b> , Ligature Nadelhalter	511
<b>BEACHAM</b> , Amniotom für die Amnionblase	643
<b>BECK</b> , Atraumatische Gefäßklemmen	207
<b>BECKMANN</b> , Adenoidectomy	576
- Wundspreizer	342
<b>BECKMANN-EATON</b> , Wundspreizer	343
<b>BEEBE</b> , Draht und Blechsceren	103
<b>BEER</b> , Cilienpinzetten	135
<b>BELLUCCI</b> , Absaugkanülen	670
- Micro Scheren	554
<b>BENGOLEA</b> , Arterienklemmen	159
<b>BENIQUE</b> , Katheterspanner	624
<b>BENNET</b> , Elevatorien	393
<b>BERGH</b> , Cilienpinzetten	135
<b>BERGMANN</b> , Chirurgische Hämmer	430
<b>BERNHARD</b> , Tuchklemmen	148
<b>BEYER</b> , Hohlmeißelzangen	470
<b>BILLEAU</b> , Ohrschlingen	551

<b>BIRKETT</b> , Arterienklemmen	158
<b>BLAKE</b> , Uterusküretten	652
<b>BLOHMKE</b> , Darmklemmen	174
<b>BLOUNT</b> , Elevatorien	389, 393
<b>BLUMENTHAL</b> , Hohlmeißelzangen	467
<b>BÖHLER</b> , Hohlmeißelzangen	474
<b>BONNEY</b> , Chirurgische Pinzetten	131
<b>BOWLED-HENRY</b> , Wundspreizer	311
<b>BOWMAN</b> , Sonden	276
<b>BOYNTON</b> , Nadelhalter	249, 261
<b>BRAUN</b> , Chirurgische Scheren	
- Nierenstielklemmen	629
<b>BRAUN-STADLER</b> , Chirurgische Scheren	77
<b>BREISKY</b> , Scheidenspekula	638
<b>BROCK</b> , Scheren	41
- Pinzetten	109
- Nadelhalter	233
<b>BROWN</b> , Chirurgische Pinzetten	125
<b>BRUENINGS</b> , Zungenspatel	4
<b>BRUNNER</b> , Drahtumführungsnadel	268, 505
- Costotome	477
<b>BRUNS</b> , Sharfe Löffel	419
- Verband Scheren	101
<b>BUCHWALD</b> , Zungenspatel	4
<b>BÜCHS</b> , Wundspreizer	311
<b>BUCK</b> , Percussion Hämmer	3
<b>BUCK-GRAMCKO</b> , Elevatorien	389
<b>BUCKLEY</b> , Osteotome	434
<b>BUELAU</b> , Trokare	377
<b>BUMM</b> , Uterusküretten	654, 655
<b>BUNT</b> , Sterilisierzangen	697
<b>BUSHE</b> , Sharfe Löffel	423

## C

<b>CAPLAN</b> , Rhinologie	564
<b>CASPAR</b> , Sharfe Löffel	425
- Wundspreizer	304, 352, 353
- Wundspreizer	354, 355
- Meßinstrumente	22
- Osteotome	433
- Probeexzisionzangen	462, 463
<b>CASTANEDA</b> , Atraumatische Gefäßklemmen	182
<b>CASTROVIEJO</b> , Sperrelevatorien	599
- Micro Wundspreizer	591
- Micro Scheren	603
- Micro Pinzetten	596
- Micro Spatel	592
- Nadelhalter	238, 239, 240, 241, 242
- Meßinstrumente	19, 20, 21
<b>CHADWICK</b> , Feine Scheren	46
<b>CHARNELY</b> , Wundspreizer	364
<b>CHEATTLE</b> , Sterilisierzangen	697
<b>CHILD</b> , Schwammzangen	8, 143
<b>CINELLI</b> , Rhinologie	567
<b>CITELLI</b> , Hohlmeißelzangen	453
<b>CLEANLACT</b> , Wasserlösliche von Chirurgische Instrumente	687
<b>CLOWARD</b> , Wundspreizer	345
- Wirbelkörperspreizer	356
<b>CLOWARD-CONTOUR</b> , Wundspreizer	329
<b>COAKLEY</b> , Sharfe Küretten	575
<b>COBB</b> , Raspatorien	407
<b>COLIBRI</b> , Micro Pinzetten	594
<b>COLLIN</b> , Costotome	475
- Wundspreizer	346, 347, 348
- Arterienklemmen	139, 143, 633
- Zungenzangen	7
- Klammernanlegepinzetten	271
- Sterilisierzangen	697
- Amputations	414
<b>COLLIN-Standard</b> , Scheidenspekula	634
<b>CONVERSE</b> , Wundhaken	288
- Nadelhalter	250
- Tenotome	28
<b>COOLEY</b> , Dilatator für Mitralstenosen	229
- Ribbensperrerr	324, 366
- Atraumatische Gefäßklemmen	212, 213, 214, 215, 216
<b>COOPER</b> , Ligature Nadel	267
<b>COOK</b> , Sperrelevatorien	599

<b>CORYLLOS</b> , Wundhaken	315
<b>COTTLE</b> , Wundhaken	284
- Elevatorien	396
- Feine Scheren	71
- Knochenfeilen	409
- Chirurgische Hämmer	430
- Osteotome	438, 579
- Anatomische Pinzetten	129
- Raspatorien-Elevatorien	565
- Nasal Spekula	559
- Knorpelquetsche	564
<b>COTTLE-MASING</b> , Feine Scheren	46
<b>COTTLE-NEIVERT</b> , Wundhaken	565
<b>COTTLE-WALSHAM</b> , Rhinologie	563
<b>COUPLAND</b> , Absaugkanülen	664, 665
<b>CRAFOORD</b> , Ligature Pinzetten	163
<b>CRILE</b> , Arterienklemmen	151, 152
<b>CRILE-WOOD</b> , Nadelhalter	243, 250, 252
<b>CRILE-MURRAY</b> , Nadelhalter	243
<b>CUSCO</b> , Scheidenspekula	634
<b>CUSHING</b> , Wundhaken	288, 289, 292
- Periostotome	401
- Probeexzisionzangen	461
- Hohlmeißelzangen	469
- Pinzetten	121, 131
- Biegsame Spatel	326
<b>CUSHING-KOCHER</b> , Wundhaken	292

## D

<b>DALE</b> , Atraumatische Gefäßklemmen	217
<b>DANDY</b> , Feine Scheren	70
- Chirurgische Pinzetten	151
- Arterienklemmen	151
<b>DAUBENSPECK</b> , Sharfe Löffel	423
<b>DAUTREY-MUNRO</b> , Osteotome	581
<b>DAVIDSON</b> , Wundhaken	316
<b>DAVIS</b> , Elevatorien	382
- Sterilisierzangen	696
<b>DAVIS-BOYLE</b> , Mundsperrer	541
<b>DAY</b> , Instrumente für otologie	551
<b>DE BAKEY</b> , Absaugkanülen	664
- Gefäßdilatoren	226
- Scheren	73
- Nadelhalter	255
<b>DE BAKEY-BAHNSON</b> , Atraumatische Gefäßklemmen	193
<b>DE BAKEY-BAINBRIDGE</b> , Atraumatische Gefäßklemmen	187
<b>DE BAKEY-CAROTIS</b> , Atraumatische Gefäßklemmen	180
<b>DE BAKEY-MOSQUITO</b> , Atraumatische Gefäßklemmen	185
<b>DE BAKEY-HARKEN</b> , Atraumatische Gefäßklemmen	200
<b>DE BAKEY-PEAN</b> , Atraumatische Gefäßklemmen	186
<b>DE BAKEY (POTTS-SMITH)</b> , Scheren	73
- Pinzetten	126, 127, 128, 132
- Atraumatische Gefäßklemmen	183, 203
<b>DE BAKEY-RANKIN</b> , Atraumatische Gefäßklemmen	185
<b>DE BAKEY-SATINSKY</b> , Atraumatische Gefäßklemmen	180, 198
<b>DEAN</b> , Gezahnt Scheren	70
<b>DEAVER</b> , Chirurgische Scheren	57
- Wundhaken	320, 321
<b>DEJERINE</b> , Percussion Hämmer	3
<b>DEMEL</b> , Drahtumführungsnadel	504
<b>DENIS-BROWN</b> , Wundhaken	362
<b>DERF</b> , Nadelhalter	243, 250
<b>DERRA</b> , Atraumatische Gefäßklemmen	189
<b>DESCHAMPS</b> , Ligature Nadel	262, 263, 264, 265, 266
<b>DESJARDINS</b> , Nierensteinzangen	623
- Gallengangdilatoren	628
<b>DESMARRES</b> , Skalpelle	28
- Wundhaken	287
- Pinzetten	129
<b>DIETER</b> , Micro Hohlmeißelscheren	554
<b>DIETRICH</b> , Scheren	74
- Atraumatische Gefäßklemmen	205
- Micro Nadelhalter	240
<b>DIFFENBACH</b> , Bulldogklemmen	177
<b>DIXON-LOVELACE</b> , Arterienklemmen	158
<b>DINGMANN</b> , Mundsperrer	542
- Hohlmeißelzangen	485
<b>DITTEL</b> , Gallengangdilatoren	626

<b>DOCKHORN</b> , Wundspreizer	305
<b>DOLWICK-REICH</b> , Wundspreizer	337
<b>DOYEN</b> , Tuchklemmen	146
- Wundhaken	308, 363
- Atraumatische Gefäßklemmen	171
- Raspatorien	404
- Sonden	275
- Myom Instrumente	645
- Scheidenspekula	637
<b>DOYEN-COLLIN</b> , Mundsperrer	6, 537
<b>DOYEN-JANSEN</b> , Mundsperrer	6, 537
<b>DOYEN-STILLE</b> , Wundhaken	308
<b>DUBOIS</b> , Chirurgische Scheren	77
<b>DUKE</b> , Trokare	377
<b>DUNN-DAUTREY</b> , Wundhaken	546
<b>DUPLAY</b> , Spekula	18
<b>DUPUY-WEISSE</b> , Ligature Nadel	262
<b>DURANTE</b> , Pinzetten	125
<b>DUVAL</b> , Chirurgischen Pinzetten	129
- Atraumatische Gefäßklemmen	223
- Arterienklemmen	145, 629
<b>DUVAL-COLLIN</b> , Darmklemmen	629

## E

<b>ECHLIN</b> , Hohlmeißelzangen	470
<b>EDER</b> , Watterträger	279
<b>EISELBERG-MATHIEU</b> , Nadelhalter	249
<b>ELLIS</b> , Micro Scalpelle	589
<b>EPKER</b> , Osteotome	578
<b>ESMARCH</b> , Verband Scheren	101

## F

<b>FAGER</b> , Elevatorien	382
<b>FAHLBUSCH</b> , Micro Scheren für Rhinologie	555
<b>FARABEUF</b> , Wundspreizer	290
- Hohlmeißelzangen	478
- Raspatorien	402
<b>FARABEUF-LAMBOTTE</b> , Hohlmeißelzangen	478
<b>FARREL</b> , Watterträger	277
<b>FAULKNER</b> , Micro Pinzetten	596
<b>FAURE</b> , Tuchklemmen	146
- Probeexzisionzangen	648
<b>FEICHENFELD</b> , Chirurgische Pinzetten	134
<b>FEIN</b> , Watterträger	278
<b>FENO</b> , Scheidenspekula	656
<b>FERGUSSON</b> , Absaugkanülen	669
- Druckklemmen	166
<b>FERRIS-SMITH-KERRISON</b> , Laminektomie	454, 455, 456, 457
<b>FERRIS-SMITH-CUSHING</b> , Laminektomie	458
<b>FIBULA</b> , Hohlmeißelzangen	479
<b>FINOCCHIETTO</b> , Wundhaken	365
- Nadelhalter	257
<b>FINSEN</b> , Wundhaken	327
<b>FINSTERER</b> , Absaugkanülen	664
<b>FOERSTER-BALLENGER</b> , Tamponzangen	141
<b>FOMON</b> , Wundhaken	284
- Chirurgische Scheren	59, 70, 71
- Knochenfeilen	410, 412, 572
- Rhinologie	567
<b>FRANKFELDT</b> , Watterträger	279
<b>FRAZIER</b> , Absaugkanülen	669, 674, 680
- Wundhaken	350
<b>FREER</b> , Elevatorien	395
- Hohlmeißel	434
- Mucosameißer	572
<b>FRENZEL</b> , Zungenspatel	4
<b>FRIEDMANN</b> , Hohlmeißelzangen	467

## G

<b>GABON</b> , Knochenmühle	586
<b>GALLAHER</b> , Knochenfeilen	408
<b>GARRETT</b> , Gefäßdilatoren	227
<b>GELLHORN</b> , Probeexzisionzangen	647
<b>GELPI</b> , Wundhaken	328

<b>GELPI-LOKTITE</b> , Wundhaken	329
<b>GELPI-SEILETZ</b> , Wundhaken	329
<b>GEMINI</b> , Arterienklemmen und Ligaturklemmen	162
<b>GENTOFT</b> , Scheiden Spekula	656
<b>GERALD</b> , Chirurgische Pinzetten	123
<b>GERALD-BROWN</b> , Chirurgische Pinzetten	123
<b>GERSTER</b> , Knochenchirurgie	487
<b>GERSTER-LOWMAN</b> , Knochenchirurgie	487
<b>GIDEF</b> , Arterienklemmen	150
<b>GIERTZ-STILLE</b> , Costotome	477
<b>GIGLI</b> , Amputations	414
<b>GIL-VERNET</b> , Wundhaken	293
<b>GILLIES</b> , Wundhaken	283
- Nadelhalter	247, 253
<b>GLASSMAN</b> , Chirurgische Scheren	52
<b>GLOVER</b> , Bulldogklemmen	179, 180
- Atraumatische Gefäßklemmen	207
<b>GOLDMAN-FOX</b> , Chirurgische Scheren	49, 50, 80, 84
<b>GOELET</b> , Wundhaken	291
<b>GORNEY</b> , Chirurgische Scheren	68
- Absaugkanülen	667
<b>GOSSET</b> , Bauchdeckenhalter	357
<b>GOURDET</b> , Uterusküretten	651
<b>GRAEFE</b> , Feine Scheren	46
- Micro Pinzetten	114, 129
- Micro Wundhaken	589, 590
- Micro Skalpelle	27, 590
<b>GRAY</b> , Ligaturklemmen	164
<b>GRAVE</b> , Scheiden Spekula	634
<b>GREGORY</b> , Atraumatische Gefäßklemmen	207
<b>GREENE</b> , Wundhaken	311
<b>GROSS</b> , Arterienklemmen	139, 141
<b>GRUENWALD</b> , Chirurgische Pinzetten	133
<b>GUILLIEN</b> , Absaugkanülen	667
<b>GUSBERG</b> , Endocervix-Biopsieküretten	646
<b>GUTHRIE</b> , Wundhaken	283
<b>GUYON</b> , Gallengangdilatoren	628
- Katheterspanner	624
- Nierenklemmen	175
- Uterusklemmen	629

## H

<b>HABERER</b> , Biegsame Spatel	326
<b>HAGLUND</b> , Gipsschere	533
<b>HALLE</b> , Sharfe Löffel	422
<b>HALSEY</b> , Nadelhalter	243, 250
<b>HALSTED</b> , Arterienklemmen	150, 152
<b>HALSTED-MOSQUITO</b> , Arterienklemmen	149, 152
<b>HANK</b> , Uterusdilatoren	641
<b>HARRINGTON</b> , Wundhaken	317
<b>HARTMANN</b> , Zungendrucker	544
- Absaugkanülen	676, 677
- Stimmgabeln	5
- Watterträger	278
- Hohlmeißelzangen	469
- Ohr-Polypenzangen	552, 553
- Nasen Spekula	18, 560, 561
<b>HARTMANN-BABY-MOSQUITO</b> , Arterienklemmen	149
<b>HAYES</b> , Atraumatische Pinzetten	218
<b>HEANEY</b> , Nadelhalter	257
<b>HEANEY-HEGAR</b> , Nadelhalter	244
<b>HEAT</b> , Chirurgische Hämmer	431
<b>HEGAR</b> , Uterus Dilatoren	639, 641
- Nadelhalter	244, 251
<b>HEGAR-MAYO-SEELEY</b> , Nadelhalter	245, 252
<b>HEGENBARTH</b> , Chirurgische Pinzetten	271
<b>HEILDELBERG</b> , Watterträger	278
<b>HEISS</b> , Arterienklemmen	158
<b>HEISTER</b> , Mundsperrer	6, 537
<b>HEMINGWAY</b> , Sharfe Löffel	415
<b>HENAHAN</b> , Periostotome	401
<b>HENLEY</b> , Wundhaken	344
<b>HENNIG</b> , Gipsschere	533
<b>HEPARIN</b> , Biegsam Absaugkanülen	682
<b>HEYMANN</b> , Chirurgische Scheren	71
<b>HEYMANN-KNIGHT</b> , Chirurgische Scheren	71
<b>HIBBS</b> , Wundhaken	297
- Osteotome	439

<b>HOHMANN</b> , Elevatorien	391, 394
<b>HOLZBACH</b> , Wundhaken	349
<b>HÖPFNER</b> , Darmklemmen	174
<b>HOPT</b> , Atraumatische Gefäßklemmen	219
<b>HOUSE</b> , Absaugkanülen	672
<b>HOWARD</b> , Knochenfeilen	408, 570
<b>HOWARTH</b> , Periostotome	397
<b>HUNTER</b> , Splitterpinzetten	134
<b>HURD</b> , Periostotome	397

## I

<b>INGE</b> , Wirbelkörperspreizer	356
<b>IRIS</b> , Feine Scheren	44, 81, 83, 84, 99
<b>ISRAEL</b> , Wundhaken	298
<b>ITARD</b> , Absaugkanülen	677

## J

<b>JACKSON-TESSIER</b> , Knochensplitterschere	476
<b>JACOBSON</b> , Sharfe Löffel	416
- Micro Scheren	40
- Handbohrfutter	501, 502, 503, 527
- Nadelhalter	235, 241
<b>JACOBSON-UNIVERSAL</b> , Handbohrfutter	527
<b>JAMESON</b> , Feine Scheren	47
<b>JAMESON-WERBER</b> , Feine Scheren	47
<b>JANSEN</b> , Sharfe Löffel	416
- Wundhaken	327
- Hohlmeißelzangen	469
- Pinzetten	133
- Raspatorien	402
<b>JANSEN-LEUER</b> , Hohlmeißelzangen	468
<b>JAVID</b> , Atraumatische Gefäßklemmen	222
<b>JONES</b> , Tuchklemmen	146
- Arterienklemmen	139
<b>JOSEPH</b> , Wundhaken	284
- Chirurgische Scheren	58
- Knochenfeilen	408
- Rhinologie	573, 574
- Periostotome	401
<b>JUDD-MASSON</b> , Blasenwundspreizer	369

## K

<b>KALLMORGEN</b> , Scheidenspekula	635
<b>KELLY</b> , Wundhaken	310
- Chirurgische Scheren	53, 85
- Arterienklemmen	155
<b>KERN</b> , Hohlmeißelzangen	486
<b>KERPEL</b> , Sharfe Löffel	418
<b>KERSHNER</b> , Augeninstrumente	598
<b>KERRISON</b> , Laminectomie	453
<b>KERRISON-JACOBY</b> , Laminectomie	455
<b>KEVORKIAN</b> , Probeexzisionzangen	650
<b>KEY-HORSLEY</b> , Knochensplitterschere	475
<b>KEYES</b> , Hautstanzen	28, 491
<b>KILLIAN</b> , Absaugkanülen	678
- Nasen Scheren	72
- Rhinologie	564
- Hohlmeißel	565
- Nasen Spekula	560, 561
<b>KILLIAN-KLAUS</b> , Osteotome	565
<b>KILNER</b> , Scheren	47, 52, 85
- Nadelhalter	256
<b>KILNER-DOUGHTY</b> , Mundsperrer	540
<b>KIMURA</b> , Micro Spatula	592
<b>KIRSCH</b> , Wundhaken	304
<b>KIRSCHNER</b> , Wundhaken	361
<b>KLIMA-ROSEGGER</b> , Punktionskanülen	377
<b>KOCHER</b> , Unterbindungsnadel	267
- Wundhaken	292, 294, 296, 301, 305, 307
- Arterienklemmen	153, 155, 157
- Darmklemmen	172, 173
- Sonden	269
<b>KOCHER-LAGENBECK</b> , Wundhaken	300
<b>KOCHER-OCHSNER</b> , Chirurgische Pinzetten	154

<b>KOENIG</b> , Sonden	269
<b>KOERTE</b> , Wundhaken	323
<b>KÖNIG</b> , Elevatorien	381
<b>KRAUSE</b> , Polypenschnürer	562
- Trokare	375
<b>KRESSNER</b> , Nasen Pinzetten	563
<b>KRISTELLER</b> , Scheidenspekula und halter	636
<b>KROENIG</b> , Zungenspatel	4
<b>KRONECKER</b> , Ligaturnadel	262
<b>KÜHNE</b> , Cilienpinzetten	135
<b>KÜNTSCHER</b> , Bohrdrähte	496
- Knochenchirurgie	500

## L

<b>LA FORCE</b> , Micro Skalpelle	589
<b>LA GRANGE</b> , Chirurgische Scheren	50, 80
<b>LAHEY</b> , Wundhaken	288
<b>LAMBERT-KAY</b> , Atraumatische Gefäßklemmen	210
<b>LAMBOTTE</b> , Osteotome	437
- Hohlmeißelzangen	478
- Raspatorien	404
<b>LANDAU</b> , Scheidenspekula	637
<b>LANDOLT</b> , Skalpellgriffe	34
- Probeexzisionzangen	465
<b>LANE</b> , Schraubendreher	528
- Hohlmeißelzangen	486
<b>LANGE</b> , Wundhaken	289
<b>LANGENBECK</b> , Nadelhalter	259
- Wundhaken	299
- Elevatorien	395
- Raspatorien	402
- Amputations	414
<b>LANGENBECK-RYDER</b> , Nadelhalter	259
<b>LAWRENCE</b> , Arterienklemmen und Ligaturklemmen	165
<b>LEES</b> , Atraumatische Gefäßklemmen	209
<b>LEKSELL</b> , Hohlmeißelzangen	470
<b>LELAND-JONES</b> , Atraumatische Gefäßklemmen	215
<b>LEMPERT</b> , Hohlmeißelzangen	468
<b>LERICHE</b> , Arterienklemmen	151
<b>LEWIN</b> , Knochenhaltanzangen	479
<b>LEWIS</b> , Knochenfeilen	409
- Rhinologie	573
<b>LEXER</b> , Chirurgische Scheren	66, 95
- Osteotome	446, 448
- Hohlmeißel	445, 446
<b>LEVIS</b> , Sthetoskop	10
<b>LICHTENBERG</b> , Nadelhalter	261
<b>LICHTWITZ</b> , Trokare	375
<b>LIEBERMANN-TENNANT</b> , Augeninstrumente	598
<b>LINDEMANN</b> , Amputations	414
<b>LISTER</b> , Verband Scheren	101
- Arterienklemmen	139
<b>LISTER-BURCH</b> , Sperreleatoren	599
<b>LISTON</b> , Hohlmeißelzangen	473
<b>LISTON-STILLE</b> , Hohlmeißelzangen	475
<b>LITTAUER</b> , Ohr Instrumente	552
- Cilienpinzetten	135
<b>LITTLER</b> , Feine Scheren	59
<b>LITTLEWOOD</b> , Uterus Pinzetten	644
<b>LOCHART</b> , Sonden	275
<b>LOCKLIN</b> , Feine Scheren	48, 53
<b>LÖFFEL</b> , Rhinologie	558
<b>LOGAN</b> , Wundhaken	327
<b>LORENZ</b> , Verband Scheren	101
<b>LORNA</b> , Tuchklemmen	147
<b>LOUTE</b> , Drahtspanninstrumente	499
<b>LOVE</b> , Wundhaken	289
<b>LOVE-GRUENWALD</b> , Probeexzisionzangen	460, 461
<b>LUCAE</b> , Stimmgabeln	5
- Chirurgische Hämmer	429
- Chirurgische Pinzetten	133
- Instrumente für otologie	551
<b>LUER</b> , Hohlmeißelzangen	
<b>LUER-KÖRTE</b> , Uterus Cüretten	651
<b>LUER-LOCK</b> , Abasaugkanülen	681
<b>LUER-STILLE</b> , Hohlmeißelzangen	469, 471, 472

## M

<b>MAGILL</b> , Absaugkanülen	678
- Kathetereinführungszangen	7
<b>MAIER</b> , Tamponzangen	142, 633
<b>MALTZ</b> , Rhinologie	574
<b>MARKHAM-MEYERDING</b> , Wundhaken	336
<b>MARTIN</b> , Wundhaken	314
- Hohlmeißelzangen	485
- Watterträger	277
- Uterussonden	642
<b>MARTINI</b> , Sharfe Löffel	416
<b>MASING</b> , Elevatorien	396
<b>MASSON</b> , Nadelhalter	245, 257
<b>MATHIEU</b> , Wundhaken	290
- Blasewundspreizer	369
- Nadelhalter	248, 249, 260
- Scheidenspekula	635
<b>MAYO</b> , Chirurgische Scheren	64, 65, 82, 96
- Uterussonden Biagsam	642
- Spatel	4
- Sterilisierzangen	697
<b>MAYO-HARRINGTON</b> , Scheren	75
<b>MAYO-HEGAR</b> , Nadelhalter	244, 251, 252
<b>MAYO-HEGAR-HEANEY</b> , Nadelhalter	256
<b>MAYO-LEXER</b> , Chirurgische Scheren	96
<b>MAYO-NOBLE</b> , Chirurgische Scheren	64
<b>MAYO-RUSSIAN</b> , Pinzetten	125
<b>MAYO-STILLE</b> , Scheren	67, 94
<b>MC DONALD</b> , Elevatorien	397
<b>MC INTOSH</b> , Laringoskope	11, 14, 16
<b>MC IVOR</b> , Mundsperr	541
<b>MC KENTY</b> , Elevatorien	397
<b>MC KESSON</b> , Absaugkanülen	660
<b>MC PHERSON</b> , Micro Pinzetten	595, 596
<b>MEAD</b> , Elevatorien	395
- Chirurgische Hämmer	429
- Hohlmeißelzangen	467
<b>MEEKER</b> , Arterienklemmen und Ligaturklemmen	165
<b>MELLINGER</b> , Sperreleatoren	599
<b>METZENBAUM</b> , Scheren	59, 60, 61, 81, 84, 89, 90, 91, 92, 99
<b>MEYERDING</b> , Wundhaken	312, 335
<b>MICHEL</b> , Klammernanlegepinzetten	271
<b>MICRO-HALSTEAD</b> , Arterienklemmen	149
<b>MICRO-HARTMANN</b> , Ohr Instrumente	552
<b>MICRO-IRIS</b> , Feine Scheren	44
<b>MICRO-RYDER</b> , Nadelhalter	258
<b>MICRO-VASCULAR</b> , Nadelhalter	255
<b>MIDDLELDORPF</b> , Wundhaken	306
<b>MIKULICZ</b> , Wundhaken	322, 323
- Arterienklemmen	158
<b>MILLER</b> , Laringoskope	12, 15, 16
- Knochenfeilen	408, 570
<b>MILLIGAN</b> , Elevatorien	382
<b>MILLIN</b> , Blasenwundspreizer	369
<b>MINI-FRIEDMANN</b> , Hohlmeißelzangen	466, 467
<b>MINI-GILLIES</b> , Nadelhalter Scheren	247, 253
<b>MINI-HOHMANN</b> , Elevatorien	389
<b>MINI-LAMBOTTE</b> , Osteotome	437, 438
<b>MINI-LEXER</b> , Osteotome	440, 445
<b>MINI-OLSEN-HEGAR</b> , Nadelhalter Scheren	246
<b>MINI-ROUX</b> , Wundhaken	291
<b>MINNESOTA</b> , Wundhaken	539
<b>MISKIMON</b> , Wundhaken	340
<b>MIXTER</b> , Arterienklemmen	164
<b>MOLLISON</b> , Wundhaken	335
<b>MOLT</b> , Mundsperr für kinder	537
- Periostotome	401
<b>MORRIS-DE BAKEY</b> , Atraumatische Gefäßklemmen	195
<b>MORSE</b> , Rippensperr	367
<b>MÜNCHEN</b> , Uterus Biopsie Saugküretten	646
<b>MUSEUX</b> , Uterus Pinzetten	644

## N

<b>NEGUS</b> , Arterienklemmen und Ligaturklemmen	165
<b>NEGUS-GUEDEL</b> , Laringoskope	13, 16
<b>NELATON</b> , Sonden	275

<b>NELSON</b> , Trokare	374
<b>NELSON-METZENBAUM</b> , Chirurgische Pinzetten	62, 93
<b>NEUBÜSER</b> , Instrumente für Tubenoperationen	645
<b>NEUMANN</b> , Chirurgische Scheren	50
<b>NICOLA</b> , Micro Pinzetten für Rhinologie	555
<b>NOVAK</b> , Uterus Biopsie Saugküretten	646
<b>NOYES</b> , Micro Scheren	39, 601
<b>NUBOER</b> , Absaugkanülen	666

## O

<b>OBWEGESER</b> , Ligaturnadel	489
- Wundhaken	302, 303, 545
- Osteotome	437, 449, 450, 568
- Periostotome	398, 399, 400
<b>OCHSNER</b> , Atraumatische Gefäßklemmen	205
- Trokare	374
<b>OLDBERG</b> , Laminectomyzangen	465
<b>OLIVECRONA</b> , Dissektoren	383
- Hohlmeißelzangen	469
- Biegsame Spatel	326
<b>OLLIER</b> , Wundhaken	297
<b>OLSEN-HEGAR</b> , Nadelhalter mit Scheren	246, 253
<b>OMBREDANNE</b> , Chirurgische Hämmer	431
<b>ORINGER</b> , Mundsperrer	538
<b>OSHIKA-FAULKNER</b> , Augeninstrumente	596
<b>OVERHOLT</b> , Ligaturklemmen	161
<b>OVERHOLT-GEISSENDORFER</b> , Ligaturklemmen	161

## P

<b>PAPAVERO-CASPAR</b> , Nasen Spekula	559
<b>PAPAVERO-HARTMANN</b> , Nasen Spekula	559
<b>PARAMETRIUM</b> , Chirurgischen Scheren	97
<b>PARKER-LANGENBECK</b> , Wundhaken	290
<b>PARTSCH</b> , Osteotome	435, 436
<b>PATELLA</b> , Knochenchirurgie	481
<b>PAYR</b> , Darmklemmen	174
- Sonden	269
<b>PEAN</b> , Arterienklemmen	150, 153, 156
<b>PEAN-MURPHY</b> , Arterienklemmen	140
<b>PECK-JOSEPH</b> , Chirurgische Scheren	84
<b>PEDERSON</b> , Scheiden Spekula	634
<b>PELTON-CRANE</b> , Absaugkanülen	679
<b>PENFIELD</b> , Dissektoren	385
<b>PERRY</b> , Chirurgische Pinzetten	115
<b>PERTHES</b> , Bohrinstrumente pfrieme	490
<b>PHILIPS</b> , Schraubendreher	528
<b>PIERCE</b> , Trokare	375
<b>PIERSE</b> , Micro Pinzetten	594
<b>PLESTER</b> , Absaugkanülen	669
- Wundhaken	333, 334
<b>POOLE</b> , Absaugkanülen	675
<b>POTTS</b> , Atraumatische Gefäßklemmen	206, 208
<b>POTTS-SMITH</b> , Gefäßscheren	73
- Chirurgischen Pinzetten	120, 131
<b>POTTS-YASARGIL</b> , Micro Scheren	40
<b>POZZI</b> , Uterus Pinzetten	643
<b>PRATT</b> , Uterusdilatoren	640
<b>PRICE-THOMAS</b> , Atraumatische Gefäßklemmen	224
<b>PROST</b> , Perrelevatoren	599
<b>PUTTI</b> , Knochenfeilen	413

## Q

<b>QUINBY</b> , Scheren	46
<b>QUINKE</b> , Nadel für Biopsie	378, 684

## R

<b>RADOLF</b> , Nagel aus Reißzange	488
<b>RAGNEL-DAVIS</b> , Wundhaken	288
<b>RAMPLEY</b> , Tamponzangen	142, 633
<b>RAMUS</b> , Hohlmeißelzangen	548
<b>RANDALL</b> , Absaugkanülen	646
- Nierensteinzangen	623

<b>RANKIN</b> , Arterienklemmen	155
<b>RECAMIER</b> , Uterusküretten	653
<b>REDON</b> , Führungsnadel	270
<b>REILL</b> , Micro Nadelhalter	610
- Knochenchirurgie	480
<b>REVERDIN</b> , Spatel	326
<b>REYNOLDS</b> , Chirurgische Scheren	51
<b>RICARD</b> , Wundhaken	349
<b>RICHARDSON</b> , Wundhaken	309
<b>RICHARDSON-EASTMAN</b> , Wundhaken	309
<b>ROBB</b> , Elevatoren	384
<b>ROBIN</b> , Tuchklemmen	147
<b>ROCHARD</b> , Wundhaken	363
<b>ROCHESTER-CARMALT</b> , Arterienklemmen	171
<b>ROCHESTER-PEAN</b> , Arterienklemmen	154, 162
<b>RODHOIL</b> , Schmeiermittel für Chirurgische Instrumente	687
<b>ROGGE</b> , Sterilisierzangen	696
<b>ROSEN</b> , Absaugkanülen	681
<b>ROSER-KÖNIG</b> , Mundsperrer	6, 537
<b>ROSS</b> , Wunhaken	319
<b>ROTAN</b> , Absaugkanülen	671
<b>RÖTTGEN-RUSKIN</b> , Hohlmeißelzangen	471
<b>ROUX</b> , Wunhaken	291
<b>ROUX-MAGNUS</b> , Wunhaken	291
<b>ROWE</b> , Knochen chirurgie	550
<b>RUBIN</b> , Nasenzangen	563
<b>RUMEL</b> , Arterienklemmen und Ligaturklemmen	163
<b>RUSKIN-STILLE</b> , Hohlmeißelzangen	470
<b>RUSKIN-LISTON</b> , Hohlmeißelzangen	474
<b>RUSSIAN</b> , Chirurgische Pinzetten	125
<b>RYDER</b> , Nadelhalter	258
<b>RYDEL-SEIFER</b> , Stimmgabeln	5

## S

<b>SACHS</b> , Elevatoren	382
<b>SALZBURG</b> , Elevatoren	396
<b>SANDERS-BROWN</b> , Ligaturnadel	489
<b>SANTULLI</b> , Bulldogklemmen	180
<b>SAROT</b> , Nadelhalter	254
<b>SATINSKY</b> , Scheren	69
- Atraumatische Gefäßklemmen	225
<b>SAUERBRUCH</b> , Rippenscheren	477
- Wunhaken	301, 315
- Hohlmeißelzangen	472
- Sterilisierzangen	697
<b>SAUERBRUCH-FREY</b> , Rippenscheren	477
<b>SAUG-RASPATORIUM</b> , Absaugkanülen	667
<b>SCHAEDEL</b> , Tuchklemmen	146
<b>SCHEDÉ</b> , Sharfe Löffel	419
<b>SCHLESINGER</b> , Laminektomie	456
<b>SCHMID</b> , Gefäßspülkanülen Biegsam	228, 681
<b>SCHMIEDEN</b> , Ligaturnadel	267
<b>SCHMIEDEN-DICK</b> , Ligaturnadel	267
<b>SCHMIEDEN-TAYLOR</b> , Chirurgische Scheren	70
<b>SCHNEIDER</b> , Raspatorien	402
<b>SCHRÖDER</b> , Sharfe Löffel	424
- Uteruszangen	643
<b>SCHUBERT</b> , Probeexsizionzangen	649
<b>SCHUMACHER</b> , Elevatoren	392
- Rippenscheren	477
- Probeexsizionzangen	650
<b>SCOVILLE</b> , Wundhaken	292, 350, 351
<b>SCOVILLE-HAVERFIELD</b> , Wundhaken	350
<b>SEDILLOT</b> , Periostotome	397
- Raspatorien	402
<b>SELDIN</b> , Elevatoren	395
<b>SELMAN</b> , Anatomische Pinzetten	125
<b>SEMB</b> , Raspatorien	403
<b>SEMKEN</b> , Chirurgische Pinzetten	115, 120, 130
<b>SENN-GREEN</b> , Wundhaken	287
<b>SENN-MILLER</b> , Wundhaken	288
<b>SEPTUN-NADEL</b> , Absaugkanülen	680
<b>SHAPLEIGH</b> , Instrumente für otologie	551
<b>SIEBENMANN</b> , Absaugkanülen	677
<b>SIEBOLD</b> , Chirurgische Scheren	78
<b>SIGMOID-NOTCH</b> , Raspatorien-Wundhaken	388, 547
<b>SILVER</b> , Nasen Skalpelle	566
<b>SIMON</b> , Sharfe Löffel	424

- Wundhaken	314
<b>SIMPSON</b> , Uterussonden	642
<b>SIMPSON-BRAUN</b> , Geburtszange	656
<b>SIMS</b> , Chirurgische Scheren	75, 76, 98
- Uterussonden	642
<b>SINGLEY-TUTTLE</b> , Anatomische Pinzetten	125
<b>SMITH</b> , Dracht und Blechscheren	102
<b>SMITH-BUIE</b> , Wundhaken	370
<b>SMITH-PETERSEN</b> , Osteotome	442
<b>SNELLEN</b> , Augeninstrumente	591
<b>SPENCER</b> , Ligaturscheren	100
<b>SPLIT</b> , Rhinologie	578
<b>SPURLING</b> , Proobexsizionzangen	461
<b>STACKE</b> , Sonden	276
<b>STAMMBERGER</b> , Rhinologie	556
<b>STEINHÄUSER</b> , Raspatorien	400
<b>STEINMANN</b> , Bohrdrähte	496, 497
<b>STELLBRINK</b> , Knochenzangen	466
<b>STERNBERG</b> , Wundhaken	290, 539
<b>STEVENS</b> , Feine Scheren	51
- Nadelhalter	242
<b>STIEGLITZ</b> , Splitterpinzetten	134
<b>STILLE</b> , Chirurgische Pinzetten	67
- Osteotome	441
- Knochenzangen	471
- Chirurgische Pinzetten	118
- Gipsscheren	533
- Nierenklemmen	175
- nadelhalter	249
- Uteruszangen	629
- Hohlmeißel	441
<b>STILLE-BARRAYA</b> , Chirurgische Pinzetten	124
<b>STRULLY</b> , Chirurgische Scheren	69
<b>STRUYCKEN</b> , Rhinologie	556
<b>SUBRAMANIAN</b> , Atraumatische Gefäßklemmen	221
<b>SUBRAMANIAN-MINIATURE</b> , Atraumatische Gefäßklemmen	221
<b>SWEDESH mod.</b> , Nadelhalter	254
<b>SYPERT</b> , Osteotome	433
- Probeexsizionzange	464

## T

<b>TAKAHASHI</b> , Probeexsizionzange	460
<b>TAYLOR</b> , Wundhaken	351
- Elevatoren	394
- Percussion Hämmer	3
- Chirurgische Pinzetten	131
<b>TERRIER</b> , Arterienklemmen	139
<b>TESSIER</b> , Sharfe Löffel	425
- Wundhaken	313, 545
- Osteotome	443, 583
- Knochenchirurgie	585
- Knochenchirurgie	549
<b>THOMS-GAYLOR</b> , Probeexsizionzange	647
<b>TISCHLER-MORGAN</b> , Probeexsizionzange	650
<b>TOBOLD</b> , Zungendrucker	544
<b>TÖNNIS</b> , Chirurgische Scheren	63
- Nadelhalter	247, 259
<b>TÖNNIS-ADSON</b> , Chirurgische Scheren	63, 97
<b>TÖNNIS-RYDER</b> , Nadelhalter	259
<b>TROELTSCH</b> , Anatomische Pinzetten	133
<b>TROEMNER</b> , Percussion Hämmer	3
<b>TROUTMAN</b> , Micro Pinzetten	596
- Micro Scheren	603
<b>TUBBS</b> , Dilatatoren	229
<b>TUFFIER</b> , Rippensperrer	367
- Biegsame Spatel	326
<b>TUOHY</b> , Biopsie kanülen	378, 684

## U

<b>UFFENORDE</b> , Sharfe Löffel	418
<b>ULRICH</b> , Knochenhaltenzangen	484
<b>UNIVERSAL</b> , Watterträger	277
- Trokare	376
<b>URO-TANGENTIAL</b> , Atraumatische Gefäßklemmen	220

## V

<b>VALLEIX</b> , Uterussonden	642
<b>VAN DOREN</b> , Probeexsizionzangen	648
<b>VANNAS</b> , Micro Scheren	39, 43, 600
<b>VARADAY</b> , Ringstripper	228
<b>VERBRUGGE</b> , Knochenhaltenzangen	482
<b>VERES</b> , Biopsie Kanülen	684
<b>WISE</b> , Micro Pinzetten	107
<b>VOLKMANN</b> , Swharfe Löffel	417, 420
- Wundhaken	294, 295
<b>VOLLMAR</b> , Stripper	228

## W

<b>WAGNER</b> , Knochenchirurgie	500
- Probeexsizionzange	464
<b>WALDMANN</b> , Episiotomie-Scheren	79
<b>WALLICH</b> , Uterusküretten	652
<b>WALTON</b> , Wundhaken	336
<b>WALTON-POOLE</b> , Absaugkanülen	675
<b>WANGENSTEEN</b> , Chirurgische Pinzetten	131
- Nadelhalter	245, 252
<b>WASSMUND</b> , Wundhaken	299
<b>WEBER</b> , Augeninstrumente	591
- Atraumatische Gefäßklemmen	204
<b>WEBSTER</b> , Nadelhalter	250
<b>WECKER</b> , Micro Spatel	590
- Micro Scheren	600
<b>WEIL-BLAKESLEY</b> , Probeexsizionzange	459
<b>WEITLANER</b> , Wundhaken	330, 331, 332, 338
<b>WELLER</b> , Chirurgische Scheren	78
<b>WERTHEIM</b> , Chirurgische Scheren	58, 98
- Nierenklemmen	176, 630, 631
- Nadelhalter	256
<b>WEST</b> , Elevatoren	395
<b>WESTCOTT</b> , Micro Scheren	39, 601
<b>WHERTEIMER</b> , Absaugkanülen	674
<b>WHITEHEAD-JENNINGS</b> , Mundsperrer	6, 540
<b>WIEDER</b> , Zungendrucker	544
<b>WIKSTROEM</b> , Ligaturklemmen	164
<b>WILDE</b> , Polypenschnürer	562
<b>WILDER</b> , Tränenkanal Dilatatoren	592
<b>WILLIAMS</b> , Sperrelevatoren	599
<b>WILLIGER</b> , Sharfe Löffel	416, 422
- Elevatoren	381
- Chirurgische Hämmer	429
<b>WINTER</b> , Placentar und Abortuszangen	632
<b>WOLFF</b> , Gipszangen	532
<b>WULLSTEIN</b> , Absaugkanülen	665, 681
- Wundhaken	330
- Ohr Instrumente	554

## Y

<b>YANKAUER</b> , Absaugkanülen	662
<b>YASARGIL</b> , Absaugkanülen	668
- Micro Scheren	40, 43
- Probeexsizionzangen	465
- Micro Pinzetten	110
- Nadelhalter	236, 237
<b>YASARGIL-NICOLA</b> , Micro Pinzetten für Rhinologie	555
<b>YOUNG</b> , Zungenzangen	8, 143

## Z

<b>ZAUFAL-JANSEN</b> , Hohlmeißelzangen	470
<b>ZIEGLER</b> , Micro Skalpelle	27, 589
<b>ZIELINSKY</b> , Meißinstrumente	22
<b>ZIELKE</b> , Osteotome	448



## A

<b>ADLERKREUTZ</b> , Pincés chirurgiques	124
<b>ADSON</b> , Canules aspiratrices	674
- Ecarteurs	338, 339, 341, 343
- Rugines	401
- Pincés anatomiques	116, 130
<b>ADSON-BROWN</b> , Pincés chirurgiques	116
<b>ALAN-PARKS</b> , Ecarteurs	370
<b>ALDERDYCE</b> , Elevateurs	395
<b>ALEXANDER</b> , Pincés à os	468
- Pincés à biopsie	649
<b>ALLIS</b> , Pincés pour saisir les tissue	145, 223
<b>ALLISON</b> , Ecarteurs	318
<b>ALM</b> , Ecarteurs	327
<b>ANDERSON-ADSON</b> , Ecarteurs	335
<b>ANDREWS-PYNCHON</b> , Canules aspiratrices	662
<b>ANEL</b> , Instrumentes pour l'oftalmologie	593
<b>ANGLE</b> , Pincés à couper les fil	510
<b>ARKANSAS</b> , Pierres d'affutage	688
<b>ARRUGA</b> , Porte aiguilles	261
- Instrumentes pour l'oftalmologie	592
<b>ASH</b> , Rhinologie	563
<b>AUFRIEHT</b> , Rhinologie	565
- Limes à os	409
<b>AUSTIN</b> , Pincés chirurgiques	115

## B

<b>BABBUSH</b> , Elevateurs	395
<b>BABCOCK</b> , Pincés intestinales	144, 223
- Sondes pour varices malléable	680
<b>BABINSKY</b> , Marteaux percuteurs	3
<b>BABY-ADSON</b> , Pincés hémostatiques et à ligatures	160
<b>BABY-ALLIS</b> , Pincés pour saisir les tissue	145
<b>BABY-CRILE</b> , Pincés hémostatiques	152
<b>BABY-CRILE-WOOD</b> , Porte aiguilles	250
<b>BABY-COLLIN</b> , Ecarteurs	346
<b>BABY-FINOCCHIETTO</b> , Ecarteurs	365
<b>BABY-METZENBAUM</b> , Ciseaux chirurgicaux	59
<b>BABY-MIXTER</b> , Pincés hémostatiques	160
<b>BABY-MORSE</b> , Ecarteurs des cotes	367
<b>BABY-WEITLANER</b> , Ecarteurs	330
<b>BABY-YANKAUER</b> , Canules aspiratrices	662
<b>BACKHAUS</b> , Pincés pour fixer les compresses	146
<b>BAILEY</b> , Ecarteurs des cotes	368
<b>BAINBRIDGE</b> , Pincés intestinales	166
<b>BAKES</b> , Dilateurs pour les voies biliaires	625
<b>BALFOUR</b> , Divaricatori addominali	358, 359, 360
<b>BALFOUR-BABY</b> , Ecarteurs abdominaux	358
<b>BALLENGER</b> , Rhinologie	569
- Gouges	565
<b>BARON</b> , Canules aspiratrices	670
<b>BARR</b> , Ecarteurs rectaux	370
<b>BARRAQUER</b> , Blépharostats	598
- Micro pincés	595
- Micro porte aiguilles	609, 610, 611
- Pincés	135
- Porte aiguilles	234
<b>BARTH</b> , Curettes tranchantes	416
<b>BAUMGARTNER</b> , Porte aiguilles à ligatures	511
<b>BEACHAM</b> , Amniotome pour la vésicule amniotique	643
<b>BECK</b> , Pincés vasculaires	207
<b>BECKMANN</b> , Adénoïdes	576
- Ecarteurs	342
<b>BECKMANN-EATON</b> , Ecarteurs	343
<b>BEEBE</b> , Ciseaux coupe-fils métalliques	103
<b>BEER</b> , Pincés à épiler les ciles	135
<b>BELLUCCI</b> , Canules aspiratrices	670
- Micro Ciseaux	554
<b>BENGOLEA</b> , Pincés hémostatiques	159
<b>BENIQUE</b> , Sondes	624
<b>BENNET</b> , Elevateurs	393
<b>BERGH</b> , Pincés à épiler les ciles	135
<b>BERGMANN</b> , Maillets chirurgicaux	430
<b>BERNHARD</b> , Pincés pour fixer les compresses	148
<b>BEYER</b> , Pincés-gouges	470
<b>BILLEAU</b> , Anses auriculaires	551

<b>BIRKETT</b> , Pincés hémostatiques	158
<b>BLAKE</b> , Utérines curettes	652
<b>BLOHMKE</b> , Pincés intestinales	174
<b>BLOUNT</b> , Elevateur	389, 393
<b>BLUMENTHAL</b> , Pincés-gouges	467
<b>BÖHLER</b> , Pincés-gouges	474
<b>BONNEY</b> , Pincés chirurgiques	131
<b>BOWLED-HENRY</b> , Ecarteurs	311
<b>BOWMAN</b> , Sondes	276
<b>BOYNTON</b> , Porte aiguilles	249, 261
<b>BRAUN</b> , Ciseaux chirurgicaux	
- Utérines pincés	629
<b>BRAUN-STADLER</b> , Ciseaux chirurgicaux	77
<b>BREISKY</b> , Valve vaginaux	638
<b>BROCK</b> , Ciseaux	41
- Pincés	109
- Porte aiguilles	233
<b>BROWN</b> , Pincés chirurgiques	125
<b>BRUENINGS</b> , Abaisse langues	4
<b>BRUNNER</b> , Aiguilles passe-fils	268, 505
- Costotomes	477
<b>BRUNS</b> , Curettes tranchantes	419
- Ciseaux à bandages	101
<b>BUCHWALD</b> , Abaisse langues	4
<b>BÜCHS</b> , Ecarteurs	311
<b>BUCK</b> , Marteaux percuteurs	3
<b>BUCK-GRAMCKO</b> , Elevateur	389
<b>BUCKLEY</b> , Ostéotomes	434
<b>BUELAU</b> , Trocarts	377
<b>BUMM</b> , Utérines curettes	654, 655
<b>BUNT</b> , Pincés à stérilisation	697
<b>BUSHE</b> , Curettes tranchantes	423

## C

<b>CAPLAN</b> , Rhinologie	564
<b>CASPAR</b> , Curettes tranchantes	425
- Ecarteurs	304, 352, 353
- Ecarteurs	354, 355
- Instruments à mesurer	22
- Ostéotomes	433
- Pincés à biopsie	462, 463
<b>CASTANEDA</b> , Pincés vasculaires	182
<b>CASTROVIEJO</b> , Blépharostats	599
- Micro ecarteurs	591
- Micro ciseaux	603
- Micro pincés	596
- Micro spatules	592
- Porte aiguilles	238, 239, 240, 241, 242
- Instruments à mesurer	19, 20, 21
<b>CHADWICK</b> , Ciseaux délicate	46
<b>CHARNELY</b> , Ecarteurs	364
<b>CHEATTLE</b> , Pincés à stérilisation	697
<b>CHILD</b> , Pincés à tampons	8, 143
<b>CINELLI</b> , Rhinologie	567
<b>CITELLI</b> , Pincés-gouges	453
<b>CLEANLACT</b> , Lubrifiant pour instruments chirurgicaux	687
<b>CLOWARD</b> , Ecarteurs	345
- Ecarteurs vertébrale	356
<b>CLOWARD-CONTOUR</b> , Ecarteurs	329
<b>COAKLEY</b> , Curettes tranchantes	575
<b>COBB</b> , Rugines à périostomie	407
<b>COLIBRI</b> , Micro pincés	594
<b>COLLIN</b> , Costotomes	475
- Ecarteurs	346, 347, 348
- Pince hémostatiques	139, 143, 633
- Pincés tire langue	7
- Pincés pour agrafes	271
- Pincés à stérilisation	697
- Scies à amputation	414
<b>COLLIN-Standard</b> , Spéculum vaginaux	634
<b>CONVERSE</b> , Ecarteurs	288
- Porte aiguilles	250
- Tenotomes	28
<b>COOLEY</b> , Dilateurs	229
- Ecarteurs des cotes	324, 366
- Pincés vasculaires	212, 213, 214, 215, 216
<b>COOPER</b> , Aiguilles à ligatures	267
<b>COOK</b> , Blépharostats	599

<b>CORYLLOS</b> , Ecarteurs	315
<b>COTTLE</b> , Ecarteurs	284
- Elevateurs	396
- Ciseaux délicate	71
- Limes à os	409
- Marteaux chirurgicaux	430
- Osteotomes	438, 579
- Pincés anatomiques	129
- Rhinologie	565
- Rhinologie	559
- Instruments à écraser le cartilage	564
<b>COTTLE-MASING</b> , Ciseaux délicate	46
<b>COTTLE-NEIVERT</b> , Ecarteurs	565
<b>COTTLE-WALSHAM</b> , Rhinologie	563
<b>COUPLAND</b> , Canules aspiratrices	664, 665
<b>CRAFOORD</b> , Pincés à ligatures	163
<b>CRILE</b> , Pincés hémostatiques	151, 152
<b>CRILE-WOOD</b> , Porte aiguilles	243, 250, 252
<b>CRILE-MURRAY</b> , Porte aiguilles	243
<b>CUSCO</b> , Spéculum vaginaux	634
<b>CUSHING</b> , Ecarteurs	288, 289, 292
- Rugines	401
- Pincés à biopsie	461
- Pincés-gouges	469
- Pincés	121, 131
- Spatules flexible	326
<b>CUSHING-KOCHER</b> , Ecarteurs	292

## D

<b>DALE</b> , Pincés vasculaires	217
<b>DANDY</b> , Ciseaux délicate	70
- Pincés chirurgicaux	151
- Pincés hémostatiques	151
<b>DAUBENSPECK</b> , Curettes tranchantes	423
<b>DAUTREY-MUNRO</b> , Osteotomes	581
<b>DAVIDSON</b> , Ecarteurs	316
<b>DAVIS</b> , Elevateur	382
- Pincés à stérilisation	696
<b>DAVIS-BOYLE</b> , Ecarteur buccal	541
<b>DAY</b> , Instrumentes pour l'otologie	551
<b>DE BAKEY</b> , Canules aspiratrices	664
- Dilatateurs vasculaires	226
- Ciseaux	73
- Porte aiguilles	255
<b>DE BAKEY-BAHNSON</b> , Pincés vasculaires	193
<b>DE BAKEY-BAINBRIDGE</b> , Pincés vasculaires	187
<b>DE BAKEY-CAROTIS</b> , Pincés vasculaires	180
<b>DE BAKEY-MOSQUITO</b> , Pincés vasculaires	185
<b>DE BAKEY-HARKEN</b> , Pincés vasculaires	200
<b>DE BAKEY-PEAN</b> , Pincés vasculaires	186
<b>DE BAKEY (POTTS-SMITH)</b> , Ciseaux	73
- Pincés	126, 127, 128, 132
- Pincés vasculaires	183, 203
<b>DE BAKEY-RANKIN</b> , Pincés vasculaires	185
<b>DE BAKEY-SATINSKY</b> , Pincés vasculaires	180, 198
<b>DEAN</b> , Ciseaux dentée	70
<b>DEAVER</b> , Ciseaux chirurgicaux	57
- Ecarteurs	320, 321
<b>DEJERINE</b> , Marteaux percuteurs	3
<b>DEMEL</b> , Aiguilles passe-fils	504
<b>DENIS-BROWN</b> , Ecarteurs	362
<b>DERF</b> , Porte aiguilles	243, 250
<b>DERRA</b> , Pincés vasculaires	189
<b>DESCHAMPS</b> , Aiguilles pour ligatures	262, 263, 264, 265, 266
<b>DESJARDINS</b> , Pincés pour les calculs renaux	623
- Bougies dilatatrices	628
<b>DESMARRES</b> , Bistouris	28
- Ecarteurs	287
- Pincés	129
<b>DIETER</b> , Pincés auriculaires	554
<b>DIETRICH</b> , Ciseaux	74
- Pincés vasculaires	205
- Micro Porte aiguilles	240
<b>DIFFENBACH</b> , Pincés Bulldog	177
<b>DIXON-LOVELACE</b> , Pincés Hémostatiques	158
<b>DINGMANN</b> , Ecarteur buccal	542
- Pincés pour chirurgie osseuse	485
<b>DITTEL</b> , Bougies dilatatrices	626

<b>DOCKHORN</b> , Ecarteurs	305
<b>DOLWICK-REICH</b> , Ecarteurs	337
<b>DOYEN</b> , Pincés pour fixer les compresses	146
- Ecarteurs	308, 363
- Pincés Hémostatiques	171
- Rugines à périostomie	404
- Sondes	275
- Instruments pour fibromes	645
- Valves vaginaux	637
<b>DOYEN-COLLIN</b> , Ecarteur buccal	6, 537
<b>DOYEN-JANSEN</b> , Ecarteur buccal	6, 537
<b>DOYEN-STILLE</b> , Ecarteurs	308
<b>DUBOIS</b> , Ciseaux chirurgicaux	77
<b>DUKE</b> , Trocarts	377
<b>DUNN-DAUTREY</b> , Ecarteurs	546
<b>DUPLAY</b> , Spéculum pour l'otologie	18
<b>DUPUY-WEISSE</b> , Aiguilles pour ligatures	262
<b>DURANTE</b> , Pincés	125
<b>DUVAL</b> , Pincés chirurgicaux	129
- Pincés a-traumatiques	223
- Pince Hémostatiques	145, 629
<b>DUVAL-COLLIN</b> , Pincés intestinales	629

## E

<b>ECHLIN</b> , Pincés-gouges	470
<b>EDER</b> , Porte-coton	279
<b>EISELBERG-MATHIEU</b> , Porte aiguilles	249
<b>ELLIS</b> , Micro bistouris	589
<b>EPKER</b> , Osteotomes	578
<b>ESMARCH</b> , Ciseaux à bandages	101

## F

<b>FAGER</b> , Elevateur	382
<b>FAHLBUSCH</b> , Micro ciseaux pour Rhinologie	555
<b>FARABEUF</b> , Ecarteurs	290
- Pincés-gouges	478
- Rugines à périostomie	402
<b>FARABEUF-LAMBOTTE</b> , Pincés-gouges	478
<b>FARREL</b> , Porte-coton	277
<b>FAULKNER</b> , Micro pincés pour l'otologie	596
<b>FAURE</b> , Pincés pour fixer les compresses	146
- Pincés à biopsie	648
<b>FEICHENFELD</b> , Pincés chirurgicaux	134
<b>FEIN</b> , Porte-coton	278
<b>FENO</b> , Spéculum vaginaux	656
<b>FERGUSSON</b> , Canules aspiratrices	669
- Pincés pour angiotribes	166
<b>FERRIS-SMITH-KERRISON</b> , Laminectomie	454, 455, 456, 457
<b>FERRIS-SMITH-CUSHING</b> , Laminectomie	458
<b>FIBULA</b> , Pincés pour chirurgie osseuse	479
<b>FINOCCHIETTO</b> , Ecarteurs	365
- Porte aiguilles	257
<b>FINSEN</b> , Ecarteurs	327
<b>FINSTERER</b> , Canules aspiratrices	664
<b>FOERSTER-BALLENGER</b> , Pincés à tampons	141
<b>FOMON</b> , Ecarteurs	284
- Ciseaux chirurgicaux	59, 70, 71
- Limes à os	410, 412, 572
- Rhinologie	567
<b>FRANKFELDT</b> , Porte-coton	279
<b>FRAZIER</b> , Canules aspiratrices	669, 674, 680
- Ecarteurs	350
<b>FREER</b> , Elevateur	395
- Scalpel	434
- Bistouris	572
<b>FRENZEL</b> , Abaisse langues	4
<b>FRIEDMANN</b> , Pincés-gouges	467

## G

<b>GABON</b> , Chirurgie osseuse	586
<b>GALLAHER</b> , Limes à os	408
<b>GARRETT</b> , Dilatateurs v asculaires	227
<b>GELLHORN</b> , Pincés à biopsie	647
<b>GELPI</b> , Ecarteurs	328

<b>GELPI-LOKTITE</b> , Ecarteurs	329
<b>GELPI-SEILETZ</b> , Ecarteurs	329
<b>GEMINI</b> , Pincés hemostáticas à ligatures	162
<b>GENTOFT</b> , Spéculum vaginal	656
<b>GERALD</b> , Pincés chirurgicaux	123
<b>GERALD-BROWN</b> , Pince chirurgicaux	123
<b>GERSTER</b> , Chirurgie osseuse	487
<b>GERSTER-LOWMAN</b> , Chirurgie osseuse	487
<b>GIDEF</b> , Pincés hemostáticas	150
<b>GIERTZ-STILLE</b> , Costôtomes	477
<b>GIGLI</b> , Scies à amputation	414
<b>GIL-VERNET</b> , Ecarteurs	293
<b>GILLIES</b> , Ecarteurs	283
- Porte aiguilles	247, 253
<b>GLASSMAN</b> , Ciseaux chirurgicaux	52
<b>GLOVER</b> , Pincés Bulldog	179, 180
- Pincés vasculaires	207
<b>GOLDMAN-FOX</b> , Ciseaux chirurgicaux	49, 50, 80, 84
<b>GOELET</b> , Ecarteur	291
<b>GORNEY</b> , Ciseaux chirurgicaux	68
- Canules aspiratrices	667
<b>GOSSET</b> , Ecarteurs abdominaux	357
<b>GOURDET</b> , Uterines curettes	651
<b>GRAEFE</b> , Ciseaux délicate	46
- Pincés pour Micro chirurgie	114, 129
- Micro ecarteurs	589, 590
- Micro bistouris	27, 590
<b>GRAY</b> , Pincés à ligatures	164
<b>GRAVE</b> , Spéculum vaginal	634
<b>GREGORY</b> , Pincés vasculaires	207
<b>GREENE</b> , Ecarteurs	311
<b>GROSS</b> , Pincés hemostáticas	139, 141
<b>GRUENWALD</b> , Pincés chirurgicaux	133
<b>GUILLIEN</b> , Canules aspiratrices	667
<b>GUSBERG</b> , Curette pour biopsie endocervicales	646
<b>GUTHRIE</b> , Ecarteurs	283
<b>GUYON</b> , Bougies dilatatrices	628
- Sondes	624
- Pincés pour pédicules rénaux	175
- Pincés utérines	629

## H

<b>HABERER</b> , Spatules malléable	326
<b>HAGLUND</b> , Appareils plâtrés	533
<b>HALLE</b> , Curettes tranchantes	422
<b>HALSEY</b> , Porte aiguilles	243, 250
<b>HALSTED</b> , Pincés hemostáticas	150, 152
<b>HALSTED-MOSQUITO</b> , Pincés hemostáticas	149, 152
<b>HANK</b> , Uterines Dilatateurs	641
<b>HARRINGTON</b> , Ecarteurs	317
<b>HARTMANN</b> , Abaisse langue	544
- Canules aspiratrices	676, 677
- Diapasons	5
- Porte coton	278
- Pincés-gouges	469
- Pincés pour polypes auriculaires	552, 553
- Spéculum nasaux	18, 560, 561
<b>HARTMANN-BABY-MOSQUITO</b> , Pincés hemostáticas	149
<b>HAYES</b> , Pincés atraumatiques	218
<b>HEANEY</b> , Porte aiguilles	257
<b>HEANEY-HEGAR</b> , Porte aiguilles	244
<b>HEAT</b> , Marteaux chirurgicaux	431
<b>HEGAR</b> , Uterines dilateur	639, 641
- Porte aiguilles	244, 251
<b>HEGAR-MAYO-SEELEY</b> , Porte aiguilles	245, 252
<b>HEGENBARTH</b> , Pincés chirurgiques	271
<b>HEILDELBERG</b> , Porte coton	278
<b>HEISS</b> , Pincés hemostáticas	158
<b>HEISTER</b> , Ecarteur buccal	6, 537
<b>HEMINGWAY</b> , Curettes tranchantes	415
<b>HENAHAN</b> , Rugines	401
<b>HENLEY</b> , Ecarteurs	344
<b>HENNIG</b> , Appareils plâtrés	533
<b>HEPARIN</b> , Canules aspiratrices	682
<b>HEYMANN</b> , Ciseaux chirurgicaux	71
<b>HEYMANN-KNIGHT</b> , Ciseaux chirurgicaux	71
<b>HIBBS</b> , Ecarteurs	297
- Osteotome	439

<b>HOHMANN</b> , Elevateur	391, 394
<b>HOLZBACH</b> , Ecarteur	349
<b>HÖPFNER</b> , Pincés intestinales	174
<b>HOPT</b> , Pincés vasculaires	219
<b>HOUSE</b> , Canules aspiratrices	672
<b>HOWARD</b> , Limes à os	408, 570
<b>HOWARTH</b> , Rugines	397
<b>HUNTER</b> , Pincés à échardes	134
<b>HURD</b> , Rugines	397

## I

<b>INGE</b> , Ecarteurs vertébrale	356
<b>IRIS</b> , Ciseaux délicate	44, 81, 83, 84, 99
<b>ISRAEL</b> , Ecarteurs	298
<b>ITARD</b> , Canules aspiratrices	677

## J

<b>JACKSON-TESSIER</b> , Ciseaux à os	476
<b>JACOBSON</b> , Curettes tranchantes	416
- Micro Ciseaux	40
- Perforateurs à os	501, 502, 503, 527
- Porte aiguilles	235, 241
<b>JACOBSON-UNIVERSAL</b> , Perforateurs à os	527
<b>JAMESON</b> , Ciseaux délicate	47
<b>JAMESON-WERBER</b> , Ciseaux délicate	47
<b>JANSEN</b> , Curettes tranchantes	416
- Ecarteurs	327
- Pincés à os	469
- Pincés	133
- Rugines	402
<b>JANSEN-LEUER</b> , Pincés à os	468
<b>JAVID</b> , Pincés vasculaires	222
<b>JONES</b> , Pincés pour fixer les compresses	146
- Pincés hemostáticas	139
<b>JOSEPH</b> , Ecarteurs	284
- Ciseaux	58
- Limes à os	408
- Limes nasaux	573, 574
- Rugines	401
<b>JUDD-MASSON</b> , Ecarteurs vésicaux	369

## K

<b>KALLMORGEN</b> , Valves vaginaux	635
<b>KELLY</b> , Ecarteurs	310
- Ciseaux chirurgiques	53, 85
- Pincés hemostáticas	155
<b>KERN</b> , Pincés à os	486
<b>KERPEL</b> , Curettes tranchantes	418
<b>KERSHNER</b> , Ecarteur pour l'oftalmologie	598
<b>KERRISON</b> , Laminectomie	453
<b>KERRISON-JACOBY</b> , Laminectomie	455
<b>KEVORKIAN</b> , Pincés à biopsie	650
<b>KEY-HORSLEY</b> , Pincés à os	475
<b>KEYES</b> , Tréphines cutanées	28, 491
<b>KILLIAN</b> , Canules aspiratrices	678
- Ciseaux nasaux	72
- Ciseaux pour rhinologie	564
- Rhinologie	565
- Spéculum nasaux	560, 561
<b>KILLIAN-KLAUS</b> , Osteotomes	565
<b>KILNER</b> , Ciseaux	47, 52, 85
- Porte aiguilles	256
<b>KILNER-DOUGHTY</b> , Ecarteur buccal	540
<b>KIMURA</b> , Micro spatules	592
<b>KIRSCH</b> , Ecarteurs	304
<b>KIRSCHNER</b> , Ecarteurs	361, 304
<b>KLIMA-ROSEGGER</b> , Aiguilles pour biopsie	377
<b>KOCHER</b> , Aiguilles à ligatures	267
- Ecarteurs	292, 294, 296, 301, 305, 307
- Pincés hemostáticas	153, 155, 157
- Pincés intestinales	172, 173
- Sondes	269
<b>KOCHER-LAGENBECK</b> , Ecarteurs	300
<b>KOCHER-OCHSNER</b> , Ciseaux chirurgicaux	154

<b>KOENIG</b> , Sondes	269
<b>KOERTE</b> , Ecarteurs	323
<b>KÖNIG</b> , Elevateur	381
<b>KRAUSE</b> , Rhinologie	562
- Trocarts	375
<b>KRESSNER</b> , Pincés nasaux	563
<b>KRISTELLER</b> , Spéculum et valves vaginaux	636
<b>KROENIG</b> , Abaisse langue	4
<b>KRONECKER</b> , Aiguilles à ligatures	262
<b>KÜHNE</b> , Pincés à épiler les cils	135
<b>KÜNTSCHER</b> , Broches	496
- Chirurgie osseuse	500

## L

<b>LA FORCE</b> , Micro bistouris	589
<b>LA GRANGE</b> , Ciseaux chirurgicaux	50, 80
<b>LAHEY</b> , Ecarteurs	288
<b>LAMBERT-KAY</b> , Pincés vasculaires	210
<b>LAMBOTTE</b> , Ostéotomes	437
- Pincés à os	478
- Rugines	404
<b>LANDAU</b> , Valves vaginaux	637
<b>LANDOLT</b> , Manches de bistouris	34
- Pincés à biopsie	465
<b>LANE</b> , Tournevis	528
- Pincés pour chirurgie osseuse	486
<b>LANGE</b> , Ecarteurs	289
<b>LANGENBECK</b> , Porte aiguilles	259
- Ecarteurs	299
- Elevateurs	395
- Rugines	402
- Scies à amputation	414
<b>LANGENBECK-RYDER</b> , Porte aiguilles	259
<b>LAWRENCE</b> , Pincés hemostatiques et à ligatures	165
<b>LEES</b> , Pincés vasculaires	209
<b>LEKSELL</b> , Pincés-gouges	470
<b>LELAND-JONES</b> , Pincés vasculaires	215
<b>LEMPERT</b> , Pincés-gouges	468
<b>LERICHE</b> , Pincés hemostatiques	151
<b>LEWIN</b> , Pincés à os	479
<b>LEWIS</b> , Limes à os	409
- Limes nasaux	573
<b>LEXER</b> , Ciseaux chirurgicaux	66, 95
- Ostéotomes	446, 448
- Ostéotomes	445, 446
<b>LEVIS</b> , Fonendoscopes	10
<b>LICHTENBERG</b> , Porte aiguilles	261
<b>LICHTWITZ</b> , Trocarts	375
<b>LIEBERMANN-TENNANT</b> , Ecarteurs pour l'oftalmologie	598
<b>LINDEMANN</b> , Scies à amputation	414
<b>LISTER</b> , Ciseaux à bendages	101
- Pincés hemostatiques	139
<b>LISTER-BURCH</b> , Blépharostats	599
<b>LISTON</b> , Pincés à os	473
<b>LISTON-STILLE</b> , Pincés à os	475
<b>LITTAUER</b> , Pincés auriculaires	552
- Pincés à épiler les cils	135
<b>LITTLER</b> , Ciseaux délicate	59
<b>LITTLEWOOD</b> , Pincés uterines	644
<b>LOCHART</b> , Sondes	275
<b>LOCKLIN</b> , Ciseaux délicate	48, 53
<b>LÖFFEL</b> , Rhinologie	558
<b>LOGAN</b> , Ecarteurs	327
<b>LORENZ</b> , Ciseaux à bendages	101
<b>LORNA</b> , Pincés pour fixer les compresses	147
<b>LOUTE</b> , Tendeur serre fils	499
<b>LOVE</b> , Ecarteurs	289
<b>LOVE-GRUENWALD</b> , Pincés à biopsie	460, 461
<b>LUCAE</b> , Diapasons	5
- Marteaux chirurgicaux	429
- Pincés chirurgicaux	133
- Instrumentes pour l'otologie	551
<b>LUER</b> , Pincés à os	467
<b>LUER-KÖRTE</b> , Curettes uterines	651
<b>LUER-LOCK</b> , Manches porte canules	681
<b>LUER-STILLE</b> , Pincés à os	469, 471, 472

## M

<b>MAGILL</b> , Canules aspiratrices	678
- Pincés à intubation	7
<b>MAIER</b> , Pincés à tampons	142, 633
<b>MALTZ</b> , Limes nasaux	574
<b>MARKHAM-MEYERDING</b> , Ecarteurs	336
<b>MARTIN</b> , Ecarteurs	314
- Pincés pour chirurgie osseuse	485
- Porte coton	277
- Histéromètres	642
<b>MARTINI</b> , Curettes tranchantes	416
<b>MASING</b> , Elevateur	396
<b>MASSON</b> , Porte aiguilles	245, 257
<b>MATHIEU</b> , Ecarteurs	290
- Spéculum pour rectum	369
- Porte aiguilles	248, 249, 260
- Valves vaginaux	635
<b>MAYO</b> , Ciseaux chirurgicaux	64, 65, 82, 96
- Histéromètres malléables	642
- Spatules	4
- Pincés à stérilisation	697
<b>MAYO-HARRINGTON</b> , Ciseaux	75
<b>MAYO-HEGAR</b> , Porte aiguilles	244, 251, 252
<b>MAYO-HEGAR-HEANEY</b> , Porte aiguilles	256
<b>MAYO-LEXER</b> , Ciseaux chirurgicaux	96
<b>MAYO-NOBLE</b> , Ciseaux chirurgicaux	64
<b>MAYO-RUSSIAN</b> , Pincés	125
<b>MAYO-STILLE</b> , Ciseaux	67, 94
<b>MC DONALD</b> , Elevateur	397
<b>MC INTOSH</b> , Laringoscopes	11, 14, 16
<b>MC IVOR</b> , Ecarteurs buccal	541
<b>MC KENTY</b> , Elevateur	397
<b>MC KESSON</b> , Canules aspiratrices	660
<b>MC PHERSON</b> , Micro pincés	595, 596
<b>MEAD</b> , Elevateur	395
- Marteaux chirurgicaux	429
- Pincés à os	467
<b>MEEKER</b> , Pincés hemostatiques et ligatures	165
<b>MELLINGER</b> , Blépharostats	599
<b>METZENBAUM</b> , Ciseaux	59, 60, 61, 81, 84, 89, 90, 91, 92, 99
<b>MEYERDING</b> , Ecarteurs	312, 335
<b>MICHEL</b> , Pincés pour agrafes	271
<b>MICRO-HALSTEAD</b> , Pincés hemostatiques	149
<b>MICRO-HARTMANN</b> , Pincés pour l'otologie	552
<b>MICRO-IRIS</b> , Ciseaux délicate	44
<b>MICRO-RYDER</b> , Porte aiguilles	258
<b>MICRO-VASCULAR</b> , Porte aiguilles	255
<b>MIDDLELDORPF</b> , Ecarteurs	306
<b>MIKULICZ</b> , Ecarteurs	322, 323
- Pincés hemostatiques	158
<b>MILLER</b> , Laringoscopes	12, 15, 16
- Limes à os	408, 570
<b>MILLIGAN</b> , Elevateur	382
<b>MILLIN</b> , Ecarteurs vésicaux	369
<b>MINI-FRIEDMANN</b> , Pincés à os	466, 467
<b>MINI-GILLIES</b> , Porte aiguilles et ciseaux	247, 253
<b>MINI-HOHMANN</b> , Elevateur	389
<b>MINI-LAMBOTTE</b> , Ostéotomes	437, 438
<b>MINI-LEXER</b> , Ostéotomes	440, 445
<b>MINI-OLSEN-HEGAR</b> , Porte aiguilles et ciseaux	246
<b>MINI-ROUX</b> , Ecarteurs	291
<b>MINNESOTA</b> , Ecarteurs	539
<b>MISKIMON</b> , Ecarteurs	340
<b>MIXTER</b> , Pincés hemostatiques	164
<b>MOLLISON</b> , Ecarteurs	335
<b>MOLT</b> , Ecarteur buccal pour enfants	537
- Rugines	401
<b>MORRIS-DE BAKEY</b> , Pincés vasculaires	195
<b>MORSE</b> , Ecarteurs del cotes	367
<b>MÜNCHEN</b> , Curettes pour biopsie	646
<b>MUSEUX</b> , Pincés uterines	644

## N

<b>NEGUS</b> , Pincés hemostatiques et ligatures	165
<b>NEGUS-GUEDEL</b> , Laringoscopes	13, 16
<b>NELATON</b> , Sondes	275

<b>NELSON</b> , Trocarts	374
<b>NELSON-METZENBAUM</b> , Ciseaux chirurgicaux	62, 93
<b>NEUBÜSER</b> , Pincés pour tubes	645
<b>NEUMANN</b> , Ciseaux délicate	50
<b>NICOLA</b> , Micro pincés pour rhinologie	555
<b>NOVAK</b> , Curettes aspiratrices	646
<b>NOYES</b> , Micro ciseaux	39, 601
<b>NUBOER</b> , Canules aspiratrices	666

## O

<b>OBWEGESER</b> , Aiguilles pour ligatures	489
- Ecarteurs	302, 303, 545
- Ostéotomes	437, 449, 450, 568
- Rugines	398, 399, 400
<b>OCHSNER</b> , Pincés vasculaires	205
- Trocarts	374
<b>OLDBERG</b> , Pincés à biopsie	465
<b>OLIVECRONA</b> , Dissecteurs	383
- Pincés à os	469
- Spatules flexible	326
<b>OLLIER</b> , Ecarteurs	297
<b>OLSEN-HEGAR</b> , Porte aiguilles avec ciseaux	246, 253
<b>OMBREDANNE</b> , Marteaux chirurgicaux	431
<b>ORINGER</b> , Ecarteur buccal	538
<b>OSHIKA-FAULKNER</b> , Micro pincés pour l'oftalmologie	596
<b>OVERHOLT</b> , Pincés à ligatures	161
<b>OVERHOLT-GEISSENDORFER</b> , Pincés à ligatures	161

## P

<b>PAPAVERO-CASPAR</b> , Spéculum nasaux	559
<b>PAPAVERO-HARTMANN</b> , Spéculum nasaux	559
<b>PARAMETRIUM</b> , Ciseaux chirurgicaux	97
<b>PARKER-LANGENBECK</b> , Ecarteurs	290
<b>PARTSCH</b> , Ostéotomes	435, 436
<b>PATELLA</b> , Pincés à os	481
<b>PAYR</b> , Pincés intestinales	174
- Sondes	269
<b>PEAN</b> , Pincés hemostatiques	150, 153, 156
<b>PEAN-MURPHY</b> , Pincés hemostatiques	140
<b>PECK-JOSEPH</b> , Ciseaux chirurgicaux	84
<b>PEDERSON</b> , Spéculum vaginaux	634
<b>PELTON-CRANE</b> , Canules aspiratrices	679
<b>PENFIELD</b> , Dissecteurs	385
<b>PERRY</b> , Pincés chirurgicaux	115
<b>PERTHES</b> , Instruments à perforer alènes	490
<b>PHILIPS</b> , Tournevis	528
<b>PIERCE</b> , Trocarts	375
<b>PIERSE</b> , Micro pincés	594
<b>PLESTER</b> , Canules aspiratrices	669
- Ecarteurs	333, 334
<b>POOLE</b> , Canules aspiratrices	675
<b>POTTS</b> , Pincés vasculaires	206, 208
<b>POTTS-SMITH</b> , Ciseaux vasculaires	73
- Pincés chirurgicaux	120, 131
<b>POTTS-YASARGIL</b> , Micro ciseaux	40
<b>POZZI</b> , Pincés uterines	643
<b>PRATT</b> , Uterines dilatateur	640
<b>PRICE-THOMAS</b> , Pincés vasculaires	224
<b>PROST</b> , Blépharostats	599
<b>PUTTI</b> , Limes à os	413

## Q

<b>QUINBY</b> , Ciseaux	46
<b>QUINKE</b> , Aiguilles à biopsie	378, 684

## R

<b>RADOLF</b> , Pincés pour extraire les ongles	488
<b>RAGNEL-DAVIS</b> , Ecarteurs	288
<b>RAMPLEY</b> , Pincés a tampons	142, 633
<b>RAMUS</b> , Pincés à os	548
<b>RANDALL</b> , Curettes aspiratrices	646
- Pincés pour les calculs renaux	623

<b>RANKIN</b> , Pincés hemostatiques	155
<b>RECAMIER</b> , Curettes uterines	653
<b>REDON</b> , Aiguille d'introduction	270
<b>REILL</b> , Micro porte aiguilles	610
- Pincés à os	480
<b>REVERDIN</b> , Spatules	326
<b>REYNOLDS</b> , Ciseaux chirurgicaux	51
<b>RICARD</b> , Ecarteurs	349
<b>RICHARDSON</b> , Ecarteurs	309
<b>RICHARDSON-EASTMAN</b> , Ecarteurs	309
<b>ROBB</b> , Elevateurs	384
<b>ROBIN</b> , Pincés pour fixer les compresses	147
<b>ROCHARD</b> , Ecarteurs	363
<b>ROCHESTER-CARMALT</b> , Pincés hemostatiques	171
<b>ROCHESTER-PEAN</b> , Pincés hemostatiques	154, 162
<b>RODHOIL</b> , Lubrifiant pour instruments chirurgicaux	687
<b>ROGGE</b> , Pincés à stérilisation	696
<b>ROSEN</b> , Canules aspiratrices	681
<b>ROSER-KÖNIG</b> , Acarteur buccal	6, 537
<b>ROSS</b> , Ecarteurs	319
<b>ROTAN</b> , Canules aspiratrices	671
<b>RÖTTGEN-RUSKIN</b> , Pincés à os	471
<b>ROUX</b> , Ecarteurs	291
<b>ROUX-MAGNUS</b> , Ecarteurs	291
<b>ROWE</b> , Pincés à os	550
<b>RUBIN</b> , Pincés nasaux	563
<b>RUMEL</b> , Pincés hemostatiques et ligatures	163
<b>RUSKIN-STILLE</b> , Pincés à os	470
<b>RUSKIN-LISTON</b> , Pincés à os	474
<b>RUSSIAN</b> , Pincés chirurgicaux	125
<b>RYDER</b> , Porte aiguilles	258
<b>RYDEL-SEIFER</b> , Diapasons	5

## S

<b>SACHS</b> , Elevateur	382
<b>SALZBURG</b> , Elevateur	396
<b>SANDERS-BROWN</b> , Aiguilles à ligatures	489
<b>SANTULLI</b> , Pince Bulldog	180
<b>SAROT</b> , Porte aiguilles	254
<b>SATINSKY</b> , Ciseaux	69
- Pincés vasculaires	225
<b>SAUERBRUCH</b> , Costôtomes	477
- Ecarteurs	301, 315
- Pincés à os	472
- Pincés à stérilisation	697
<b>SAUERBRUCH-FREY</b> , Costôtomes	477
<b>SAUG-RASPATORIUM</b> , Canules aspiratrices	667
<b>SCHAEDEL</b> , Pincés pour fixer les compresses	146
<b>SCHEDÉ</b> , Curettes tranchantes	419
<b>SCHLESINGER</b> , Laminectomie	456
<b>SCHMID</b> , Aiguilles vasculaires malléables	228, 681
<b>SCHMIEDEN</b> , Aiguilles à ligatures	267
<b>SCHMIEDEN-DICK</b> , Aiguilles à ligatures	267
<b>SCHMIEDEN-TAYLOR</b> , Ciseaux chirurgicaux	70
<b>SCHNEIDER</b> , Rugines	402
<b>SCHRÖDER</b> , Curettes tranchantes	424
- Pincés uterines	643
<b>SCHUBERT</b> , Pincés à biopsie	649
<b>SCHUMACHER</b> , Elevateur	392
- Costôtomes	477
- Pincés à biopsie	650
<b>SCOVILLE</b> , Ecarteurs	292, 350, 351
<b>SCOVILLE-HAVERFIELD</b> , Ecarteurs	350
<b>SEDILLOT</b> , Rugines	397
- Rugines	402
<b>SELDIN</b> , Elevateur	395
<b>SELMAN</b> , Pincés hemostatiques	125
<b>SEMB</b> , Rugines	403
<b>SEMKEN</b> , Pincés chirurgicaux	115, 120, 130
<b>SENN-GREEN</b> , Ecarteurs	287
<b>SENN-MILLER</b> , Ecarteurs	288
<b>SEPTUN-NADEL</b> , Aiguilles-Canules	680
<b>SHAPLEIGH</b> , Curettes pour l'otologie	551
<b>SIEBENMANN</b> , Canules aspiratrices	677
<b>SIEBOLD</b> , Ciseaux chirurgicaux	78
<b>SIGMOID-NOTCH</b> , Rugines-Ecarteurs	388, 547
<b>SILVER</b> , Rhinologie	566
<b>SIMON</b> , Curettes tranchantes	424

- Ecarteurs	314
<b>SIMPSON</b> , Hystéromètres	642
<b>SIMPSON-BRAUN</b> , Forceps uterines	656
<b>SIMS</b> , Ciseaux chirurgicaux	75, 76, 98
- Hystéromètres	642
<b>SINGLEY-TUTTLE</b> , Pincés anatomiques	125
<b>SMITH</b> , Ciseaux coupe-fils métalliques	102
<b>SMITH-BUIE</b> , Ecarteurs	370
<b>SMITH-PETERSEN</b> , Ostéotomes	442
<b>SNELLEN</b> , Anses pour oftalmologie	591
<b>SPENCER</b> , Ciseaux à ligatures	100
<b>SPLIT</b> , Ostéotomes curves	578
<b>SPURLING</b> , Pincés à biopsie	461
<b>STACKE</b> , Sondes	276
<b>STAMMBERGER</b> , Pincés pour rhinologie	556
<b>STEINHÄUSER</b> , Ruginés	400
<b>STEINMANN</b> , Broches filiformes	496, 497
<b>STELLBRINK</b> , Pincés à os	466
<b>STERNBERG</b> , Ecarteurs	290, 539
<b>STEVENS</b> , Ciseaux délicate	51
- Porte aiguilles	242
<b>STIEGLITZ</b> , Pincés à écharde	134
<b>STILLE</b> , Ciseaux chirurgicaux	67
- Ostéotomes	441
- Pincés à os	471
- Pincés chirurgicaux	118
- Appareils plâtrés	533
- Pincés rénaux	175
- Porte aiguilles	249
- Pincés uterines	629
- Gouges	441
<b>STILLE-BARRAYA</b> , Pincés chirurgicaux	124
<b>STRULLY</b> , Ciseaux chirurgicaux	69
<b>STRUYCKEN</b> , Pincés pour rhinologie	556
<b>SUBRAMANIAN</b> , Pincés vasculaires	221
<b>SUBRAMANIAN-MINIATURE</b> , Pincés vasculaires	221
<b>SWEDESH mod.</b> , Porte aiguilles	254
<b>SYPERT</b> , Ostéotomes	433
- Pincés à biopsie	464
<b>T</b>	
<b>TAKAHASHI</b> , Pincés à biopsie	460
<b>TAYLOR</b> , Ecarteurs	351
- Elevateur	394
- Marteaux percuteurs	3
- Pincés chirurgicaux	131
<b>TERRIER</b> , Pincés hemostatiques	139
<b>TESSIER</b> , Curettes tranchantes	425
- Ecarteurs	313, 545
- Ostéotomes	443, 583
- Pincés à os	585
- Chirurgie osseuse	549
<b>THOMS-GAYLOR</b> , Pincés à biopsie	647
<b>TISCHLER-MORGAN</b> , Pincés à biopsie	650
<b>TOBOLD</b> , Abaisse langue	544
<b>TÖNNIS</b> , Ciseaux chirurgicaux	63
- Porte aiguilles	247, 259
<b>TÖNNIS-ADSON</b> , Ciseaux chirurgicaux	63, 97
<b>TÖNNIS-RYDER</b> , Porte aiguilles	259
<b>TROELTSCH</b> , Pincés anatomiques	133
<b>TROEMNER</b> , Marteaux percuteurs	3
<b>TROUTMAN</b> , Micro pincés pour oftalmologie	596
- Micro ciseaux pour oftalmologie	603
<b>TUBBS</b> , Ecarteurs	229
<b>TUFFIER</b> , Ecarteur des cotes	367
- Spatules malléable	326
<b>TUOHY</b> , Aiguilles à biopsie	378, 684
<b>U</b>	
<b>UFFENORDE</b> , Curettes tranchantes	418
<b>ULRICH</b> , Chirurgie osseuse	484
<b>UNIVERSAL</b> , Porte coton	277
- Trocarts	376
<b>URO-TANGENTIAL</b> , Pincés vasculaires	220

## V

<b>VALLEIX</b> , Hystéromètres	642
<b>VAN DOREN</b> , Pincés à biopsie	648
<b>VANNAS</b> , Micro ciseaux	39, 43, 600
<b>VARADAY</b> , Stripper à anneau	228
<b>VERBRUGGE</b> , Pincés à os	482
<b>VERES</b> , Aiguilles pour biopsie	684
<b>WISE</b> , Micro pincés	107
<b>VOLKMANN</b> , Curettes tranchantes	417, 420
- Ecarteurs	294, 295
<b>VOLLMAR</b> , Stripper	228

## W

<b>WAGNER</b> , Chirurgie osseuse	500
- Pincés à biopsie	464
<b>WALDMANN</b> , Ciseaux à épisiotomie	79
<b>WALLICH</b> , Curettes uterines	652
<b>WALTON</b> , Ecarteurs	336
<b>WALTON-POOLE</b> , Canules aspiratrices	675
<b>WANGENSTEIN</b> , Pincés chirurgicaux	131
- Porte aiguilles	245, 252
<b>WASSMUND</b> , Ecarteur	299
<b>WEBER</b> , Anses pour oftalmologie	591
- Pincés vasculaires	204
<b>WEBSTER</b> , Porte aiguilles	250
<b>WECKER</b> , Micro spatules	590
- Micro ciseaux	600
<b>WEIL-BLAKESLEY</b> , Pincés à biopsie	459
<b>WEITLANER</b> , Ecarteur	330, 331, 332, 338
<b>WELLER</b> , Ciseaux chirurgicaux	78
<b>WERTHEIM</b> , Ciseaux chirurgicaux	58, 98
- Pincés rénaux	176, 630, 631
- Porte aiguilles	256
<b>WEST</b> , Elevateur	395
<b>WESTCOTT</b> , Micro ciseaux	39, 601
<b>WHERTEIMER</b> , Canules aspiratrices	674
<b>WHITEHEAD-JENNINGS</b> , Ecarteur buccal	6, 540
<b>WIEDER</b> , Abaisse langue	544
<b>WIKSTROEM</b> , Pincés à ligatures	164
<b>WILDE</b> , Rhinologie	562
<b>WILDER</b> , Dilatateur pour oftalmologie	592
<b>WILLIAMS</b> , Blépharostats	599
<b>WILLIGER</b> , Curettes tranchantes	416, 422
- Elevateur	381
- Marteaux chirurgicaux	429
<b>WINTER</b> , Pincés à faux germes	632
<b>WOLFF</b> , Appareils plâtrés	532
<b>WULLSTEIN</b> , Canules aspiratrices	665, 681
- Ecarteurs	330
- Micro curettes	554

## Y

<b>YANKAUER</b> , Canules aspiratrices	662
<b>YASARGIL</b> , Canules aspiratrices	668
- Micro ciseaux	40, 43
- Pincés à biopsie	465
- Micro pincés	110
- Porte aiguilles	236, 237
<b>YASARGIL-NICOLA</b> , Micro pincés pour rhinologie	555
<b>YOUNG</b> , Pincés tire-langue	8, 143

## Z

<b>ZAUFAL-JANSEN</b> , Pincés à os	470
<b>ZIEGLER</b> , Micro bistouris	27, 589
<b>ZIELINSKY</b> , Instruments à mesurer	22
<b>ZIELKE</b> , Ostéotomes	448

## A

<b>ADLERKREUTZ</b> , Pinzas quirúrgicas	124
<b>ADSON</b> , Cánulas aspiradoras	674
- Separadores	338, 339, 341, 343
- Periostotomos	401
- Pinzas de disección	116, 130
<b>ADSON-BROWN</b> , Pinzas quirúrgicas	116
<b>ALAN-PARKS</b> , Separadores	370
<b>ALDERDYCE</b> , Elevadores	395
<b>ALEXANDER</b> , Pinzas para huesos	468
- Pinzas para biopsia	649
<b>ALLIS</b> , Pinzas para coger las encias	145, 223
<b>ALLISON</b> , Separadores	318
<b>ALM</b> , Separadores	327
<b>ANDERSON-ADSON</b> , Separadores	335
<b>ANDREWS-PYNCHON</b> , Cánulas aspiradoras	662
<b>ANEL</b> , Instrumentos oculares	593
<b>ANGLE</b> , Alicates para cortar alambre	510
<b>ARKANSAS</b> , Accesorios para el reafilado	688
<b>ARRUGA</b> , Portaagujas	261
- Instrumentos oculares	592
<b>ASH</b> , Rinología	563
<b>AUFRIEHT</b> , Rinología	565
- Limas para huesos	409
<b>AUSTIN</b> , Pinzas quirúrgicas	115

## B

<b>BABBUSH</b> , Elevadores	395
<b>BABCOCK</b> , Pinzas intestinales	144, 223
- Sondas para várices maleables	680
<b>BABINSKY</b> , Martillos de percusión	3
<b>BABY-ADSON</b> , Pinzas hemostáticas y para ligaduras	160
<b>BABY-ALLIS</b> , Pinzas para coger las encias	145
<b>BABY-CRILE</b> , Pinzas hemostáticas	152
<b>BABY-CRILE-WOOD</b> , Portaagujas	250
<b>BABY-COLLIN</b> , Separadores	346
<b>BABY-FINOCCHIETTO</b> , Separadores	365
<b>BABY-METZENBAUM</b> , Tijeras para cirugía general	59
<b>BABY-MIXTER</b> , Pinzas hemostáticas	160
<b>BABY-MORSE</b> , Separadores costales	367
<b>BABY-WEITLANER</b> , Separadores	330
<b>BABY-YANKAUER</b> , Cánulas aspiradoras	662
<b>BACKHAUS</b> , Pinzas de campo	146
<b>BAILEY</b> , Separadores costales	368
<b>BAINBRIDGE</b> , Pinzas intestinales	166
<b>BAKES</b> , Dilatadores para conducto biliar	625
<b>BALFOUR</b> , Separadores abdominales	358, 359, 360
<b>BALFOUR-BABY</b> , Separadores abdominales	358
<b>BALLENGER</b> , Rinología	569
- Rinología	565
<b>BARON</b> , Cánulas aspiradoras	670
<b>BARR</b> , Separadores rectales	370
<b>BARRAQUER</b> , Bléfarostatos	598
- Pinzas finos	595
- Micro portaagujas	609, 610, 611
- Pinzas depilatorie	135
- Portaagujas	234
<b>BARTH</b> , Cucharillas cortantes	416
<b>BAUMGARTNER</b> , Portaagujas para ligaduras	511
<b>BEACHAM</b> , Amniótomo para la vesícula amniótica	643
<b>BECK</b> , Pinzas vasculares	207
<b>BECKMANN</b> , Adenotomes	576
- Separadores	342
<b>BECKMANN-EATON</b> , Separadores	343
<b>BEEBE</b> , Tijeras para cortar alambre	103
<b>BEER</b> , Pinzas depilatorie	135
<b>BELLUCCI</b> , Cánulas aspiradoras	670
- Micro tijeras	554
<b>BENGOLEA</b> , Pinzas hemostáticas	159
<b>BENIQUE</b> , Catéteres	624
<b>BENNET</b> , Elevadores	393
<b>BERGH</b> , Pinzas depilatorie	135
<b>BERGMANN</b> , Martillos quirúrgicos	430
<b>BERNHARD</b> , Pinzas de campo	148
<b>BEYER</b> , Pinsa para huesos	470
<b>BILLEAU</b> , Ansa auriculares	551

<b>BIRKETT</b> , Pinzas hemostáticas	158
<b>BLAKE</b> , Curetas uterinas	652
<b>BLOHMKE</b> , Pinzas intestinales	174
<b>BLOUNT</b> , Elevadores	389, 393
<b>BLUMENTHAL</b> , Pinzas para huesos	467
<b>BÖHLER</b> , Pinzas para huesos	474
<b>BONNEY</b> , Pinzas quirúrgicas	131
<b>BOWLED-HENRY</b> , Separadores	311
<b>BOWMAN</b> , Estiletes	276
<b>BOYNTON</b> , Portaagujas	249, 261
<b>BRAUN</b> , Tijeras quirúrgicas	
- Pinzas uterinas	629
<b>BRAUN-STADLER</b> , Tijeras quirúrgicas	77
<b>BREISKY</b> , Valvas vaginales	638
<b>BROCK</b> , Tijeras	41
- Pinzas finos	109
- Portaagujas	233
<b>BROWN</b> , Pinzas quirúrgicas	125
<b>BRUENINGS</b> , Bejalenguas	4
<b>BRUNNER</b> , Agujas para ligaduras	268, 505
- Costótomos	477
<b>BRUNS</b> , Curetas cortante	419
- Tijeras para vendajes	101
<b>BUCHWALD</b> , Bejalenguas	4
<b>BÜCHS</b> , Separadores	311
<b>BUCK</b> , Martillos à percusión	3
<b>BUCK-GRAMCKO</b> , Elevadores	389
<b>BUCKLEY</b> , Ostéotomos	434
<b>BUELAU</b> , Trócares	377
<b>BUMM</b> , Curetas uterinas	654, 655
<b>BUNT</b> , Pinzas para esterilización	697
<b>BUSHE</b> , Curetas cortante	423

## C

<b>CAPLAN</b> , Tijeras para rinología	564
<b>CASPAR</b> , Curetas cortante	425
- Separadores	304, 352, 353
- Separadores	354, 355
- Instrumentos para medir	22
- Ostéotomos	433
- Pinzas para biopsia	462, 463
<b>CASTANEDA</b> , Pinzas vasculares	182
<b>CASTROVIEJO</b> , Bléfarostatos	599
- Micro separadores	591
- Micro tijeras oculares	603
- Pinzas finas oculares	596
- Instrumentos oculares	592
- Portaagujas	238, 239, 240, 241, 242
- Instrumentos para medir	19, 20, 21
<b>CHADWICK</b> , Tijeras finas	46
<b>CHARNELY</b> , Separadores	364
<b>CHEATTLE</b> , Pinzas para esterilización	697
<b>CHILD</b> , Pinzas para tampones	8, 143
<b>CINELLI</b> , Rinología	567
<b>CITELLI</b> , Pinzas para huesos	453
<b>CLEANLACT</b> , Lubrificante para instrumentos quirúrgicos	687
<b>CLOWARD</b> , Separadores	345
- Separadores vertebrales	356
<b>CLOWARD-CONTOUR</b> , Separadores	329
<b>COAKLEY</b> , Curetas cortante	575
<b>COBB</b> , Legras	407
<b>COLIBRI</b> , Pinzas finas	594
<b>COLLIN</b> , Costótomos	475
- Separadores	346, 347, 348
- Pinzas hemostáticas	139, 143, 633
- Pinzas tira-lengua	7
- Pinzas para agrafes	271
- Pinzas para esterilización	697
- Seguetas de amputación	414
<b>COLLIN-Standard</b> , Espéculos vaginales	634
<b>CONVERSE</b> , Separadores	288
- Portaagujas	250
- Tenótomos	28
<b>COOLEY</b> , Dilatadores para valvula mitral	229
- Separadores costales	324, 366
- Pinzas vasculares	212, 213, 214, 215, 216
<b>COOPER</b> , Agujas para ligaduras	267
<b>COOK</b> , Bléfarostatos	599

<b>CORYLLOS</b> , Separadores	315
<b>COTTLE</b> , Separadores	284
- Elevadores	396
- Tijeras finas	71
- Limas para huesos	409
- Martillos quirúrgicos	430
- Osteótomos	438, 579
- Pinzas de disección	129
- Rinología	565
- Espéculos nasales	559
- Instrumentos para magullar cartilagos	564
<b>COTTLE-MASING</b> , Tijeras finas	46
<b>COTTLE-NEIVERT</b> , Separadores	565
<b>COTTLE-WALSHAM</b> , Pinzas nasales	563
<b>COUPLAND</b> , Cánulas aspiradoras	664, 665
<b>CRAFOORD</b> , Pinzas para ligaduras	163
<b>CRILE</b> , Pinzas hemostáticas	151, 152
<b>CRILE-WOOD</b> , Portaagujas	243, 250, 252
<b>CRILE-MURRAY</b> , Portaagujas	243
<b>CUSCO</b> , Espéculos vaginales	634
<b>CUSHING</b> , Separadores	288, 289, 292
- Periostotomos	401
- Pinzas para biopsia	461
- Pinzas para huesos	469
- Pinzas finas	121, 131
- Espatules maleable	326
<b>CUSHING-KOCHER</b> , Separadores	292

## D

<b>DALE</b> , Pinzas vasculares	217
<b>DANDY</b> , Tijeras finas	70
- Pinzas quirúrgicas	151
- Pinzas hemostáticas	151
<b>DAUBENSPECK</b> , Curetas cortante	423
<b>DAUTREY-MUNRO</b> , Osteótomos	581
<b>DAVIDSON</b> , Separadores	316
<b>DAVIS</b> , Elevadores	382
- Pinzas para esterilización	696
<b>DAVIS-BOYLE</b> , Abre bocas	541
<b>DAY</b> , Instrumentos auriculares	551
<b>DE BAKEY</b> , Cánulas aspiradoras	664
- Dilatadores vasculares	226
- Tijeras	73
- Portaagujas	255
<b>DE BAKEY-BAHNSON</b> , Pinzas vasculares	193
<b>DE BAKEY-BAINBRIDGE</b> , Pinzas vasculares	187
<b>DE BAKEY-CAROTIS</b> , Pinzas vasculares	180
<b>DE BAKEY-MOSQUITO</b> , Pinzas vasculares	185
<b>DE BAKEY-HARKEN</b> , Pinzas vasculares	200
<b>DE BAKEY-PEAN</b> , Pinzas vasculares	186
<b>DE BAKEY (POTTS-SMITH)</b> , Tijeras	73
- Pinzas finas	126, 127, 128, 132
- Pinzas vasculares	183, 203
<b>DE BAKEY-RANKIN</b> , Pinzas vasculares	185
<b>DE BAKEY-SATINSKY</b> , Pinzas vasculares	180, 198
<b>DEAN</b> , Tijeras dentadas	70
<b>DEAVER</b> , Tijeras quirúrgicas	57
- Separadores	320, 321
<b>DEJERINE</b> , Martillos de percusión	3
<b>DEMEL</b> , Agujas para hilos	504
<b>DENIS-BROWN</b> , Separadores	362
<b>DERF</b> , Portaagujas	243, 250
<b>DERRA</b> , Pinzas vasculares	189
<b>DESCHAMPS</b> , Agujas para ligaduras	262, 263, 264, 265, 266
<b>DESJARDINS</b> , Pinzas para cálculos renales	623
- Bujías dilatadores	628
<b>DESMARRES</b> , Bisturios	28
- Separadores	287
- Pinzas finas	129
<b>DIETER</b> , Pinzas finas para huesos	554
<b>DIETRICH</b> , Tijeras	74
- Pinzas vasculares	205
- Portaagujas finos	240
<b>DIFFENBACH</b> , Pinzas Bulldog	177
<b>DIXON-LOVELACE</b> , Pinzas hemostáticas	158
<b>DINGMANN</b> , Abre bocas	542
- Pinzas para cirugía ósea	485
<b>DITTEL</b> , Bujías dilatadores	626

<b>DOCKHORN</b> , Separadores	305
<b>DOLWICK-REICH</b> , Separadores	337
<b>DOYEN</b> , Pinzas de campo	146
- Separadores	308, 363
- Pinzas traumáticas	171
- Legras	404
- Estiletes	275
- Instrumentos para fibroma	645
- Valvas vaginales	637
<b>DOYEN-COLLIN</b> , Abre bocas	6, 537
<b>DOYEN-JANSEN</b> , Abre bocas	6, 537
<b>DOYEN-STILLE</b> , Separadores	308
<b>DUBOIS</b> , Tijeras quirúrgicas	77
<b>DUKE</b> , Trócares	377
<b>DUNN-DAUTREY</b> , Separadores	546
<b>DUPLAY</b> , Espéculos	18
<b>DUPUY-WEISSE</b> , Agujas para ligaduras	262
<b>DURANTE</b> , Pinzas finas	125
<b>DUVAL</b> , Pinzas quirúrgicas	129
- Pinzas traumáticas	223
- Pinzas hemostáticas	145, 629
<b>DUVAL-COLLIN</b> , Pinzas intestinales	629

## E

<b>ECHLIN</b> , Pinzas para huesos	470
<b>EDER</b> , Porta-algodón	279
<b>EISELBERG-MATHIEU</b> , Portaagujas	249
<b>ELLIS</b> , Instrumentos oculares	589
<b>EPKER</b> , Osteótomos	578
<b>ESMARCH</b> , Tijeras para vendajes	101

## F

<b>FAGER</b> , Elevadores	382
<b>FAHLBUSCH</b> , Rinología	555
<b>FARABEUF</b> , Separadores	290
- Pinzas para huesos	478
- Legras	402
<b>FARABEUF-LAMBOTTE</b> , Pinzas para huesos	478
<b>FARREL</b> , Porta-algodón	277
<b>FAULKNER</b> , Pinzas finas para oftalmología	596
<b>FAURE</b> , Pinzas de campo	146
- Pinzas para biopsia	648
<b>FEICHENFELD</b> , Pinzas para espinas	134
<b>FEIN</b> , Porta-algodón	278
<b>FENO</b> , Espéculos vaginales	656
<b>FERGUSSON</b> , Cánulas aspiradoras	669
- Pinzas para presión progresiva	166
<b>FERRIS-SMITH-KERRISON</b> , Laminectomia	454, 455, 456, 457
<b>FERRIS-SMITH-CUSHING</b> , Laminectomia	458
<b>FIBULA</b> , Pinza para huesos	479
<b>FINOCCHIETTO</b> , Separadores	365
- Portaagujas	257
<b>FINSEN</b> , Separadores	327
<b>FINSTERER</b> , Cánulas aspiradoras	664
<b>FOERSTER-BALLENGER</b> , Pinzas para tampones	141
<b>FOMON</b> , Separadores	284
- Tijeras	59, 70, 71
- Limas para huesos	410, 412, 572
- Rinología	567
<b>FRANKFELDT</b> , Porta-algodón	279
<b>FRAZIER</b> , Cánulas aspiradoras	669, 674, 680
- Separadores	350
<b>FREER</b> , Elevadores	395
- Cinceles	434
- Bisturios	572
<b>FRENZEL</b> , Bejalenguas	4
<b>FRIEDMANN</b> , Pinzas para huesos	467

## G

<b>GABON</b> , Instrumentos para huesos	586
<b>GALLAHER</b> , Limas para huesos	408
<b>GARRETT</b> , Dilatadores vasculares	227
<b>GELLHORN</b> , Pinzas para biopsia	647
<b>GELPI</b> , Separadores	328



<b>GELPI-LOKTITE</b> , Separadores	329
<b>GELPI-SEILETZ</b> , Separadores	329
<b>GEMINI</b> , Pinzas hemostáticas y ligaduras	162
<b>GENTOFT</b> , Espéculos vaginales	656
<b>GERALD</b> , Pinzas quirúrgicas	123
<b>GERALD-BROWN</b> , Pinzas quirúrgicas	123
<b>GERSTER</b> , Cirugía ósea	487
<b>GERSTER-LOWMAN</b> , Cirugía ósea	487
<b>GIDEF</b> , Pinzas hemostáticas	150
<b>GIERTZ-STILLE</b> , Costótomos	477
<b>GIGLI</b> , Seguetas de amputación	414
<b>GIL-VERNET</b> , Separadores	293
<b>GILLIES</b> , Separadores	283
- Portaagujas	247, 253
<b>GLASSMAN</b> , Tijeras quirúrgicas	52
<b>GLOVER</b> , Pinzas Bulldog	179, 180
- Pinzas vasculares	207
<b>GOLDMAN-FOX</b> , Tijeras quirúrgicas	49, 50, 80, 84
<b>GOELET</b> , Separadores	291
<b>GORNEY</b> , Tijeras quirúrgicas	68
- Cánulas aspiradoras	667
<b>GOSSET</b> , Separadores abdominales	357
<b>GOURDET</b> , Curetas uterinas	651
<b>GRAEFE</b> , Bisturios	46
- Pinzas finas	114, 129
- Instrumentos oculares	589, 590
- Micro bisturios	27, 590
<b>GRAY</b> , Pinzas para ligaduras	164
<b>GRAVE</b> , Espéculos vaginales	634
<b>GREGORY</b> , Pinzas vasculares	207
<b>GREENE</b> , Separadores	311
<b>GROSS</b> , Pinzas hemostáticas	139, 141
<b>GRUENWALD</b> , Pinzas quirúrgicas	133
<b>GUILLIEN</b> , Cánula aspiradora	667
<b>GUSBERG</b> , Curetas para biopsia endocervical	646
<b>GUTHRIE</b> , Separadores	283
<b>GUYON</b> , Bujías dilatadoras	628
- Catéteres	624
- Pinzas para pedúnculos renales	175
- Pinzas uterinas	629

## H

<b>HABERER</b> , Espátulas maleable	326
<b>HAGLUND</b> , Pinzas para arrancar vendajes	533
<b>HALLE</b> , Curetas cortante	422
<b>HALSEY</b> , Portaagujas	243, 250
<b>HALSTED</b> , Pinzas hemostáticas	150, 152
<b>HALSTED-MOSQUITO</b> , Pinzas hemostáticas	149, 152
<b>HANK</b> , Dilatadores uterinos	641
<b>HARRINGTON</b> , Separadores	317
<b>HARTMANN</b> , Bejalenguas	544
- Cánulas aspiradoras	676, 677
- Diapasones	5
- Porta-algodón	278
- Pinza para huesos	469
- Pinzas auriculares	552, 553
- Espéculos nasales	18, 560, 561
<b>HARTMANN-BABY-MOSQUITO</b> , Pinzas hemostáticas	149
<b>HAYES</b> , Pinzas traumáticas	218
<b>HEANEY</b> , Portaagujas	257
<b>HEANEY-HEGAR</b> , Portaagujas	244
<b>HEAT</b> , Martillos quirúrgicos	431
<b>HEGAR</b> , Dilatadores uterinos	639, 641
- Portaagujas	244, 251
<b>HEGAR-MAYO-SEELEY</b> , Portaagujas	245, 252
<b>HEGENBARTH</b> , Pinzas quirúrgicas	271
<b>HEILDELBERG</b> , Porta-algodón	278
<b>HEISS</b> , Pinzas hemostáticas	158
<b>HEISTER</b> , Abre bocas	6, 537
<b>HEMINGWAY</b> , Curetas cortante	415
<b>HENAHAN</b> , Periostotomos	401
<b>HENLEY</b> , Separadores	344
<b>HENNIG</b> , Pinza para arrancar vendajes	533
<b>HEPARIN</b> , Cánulas aspiradoras maleable	682
<b>HEYMANN</b> , Tijeras	71
<b>HEYMANN-KNIGHT</b> , Tijeras	71
<b>HIBBS</b> , Separadores	297
- Osteótomos	439

<b>HOHMANN</b> , Elevadores	391, 394
<b>HOLZBACH</b> , Separadores	349
<b>HÖPFNER</b> , Pinzas intestinales	174
<b>HOPT</b> , Pinzas vasculares	219
<b>HOUSE</b> , Cánulas aspiradoras	672
<b>HOWARD</b> , Limas para huesos	408, 570
<b>HOWARTH</b> , Periostotomos	397
<b>HUNTER</b> , Pinzas para espinas	134
<b>HURD</b> , Periostotomos	397

## I

<b>INGE</b> , Separadores vertebrales	356
<b>IRIS</b> , Tijeras finas	44, 81, 83, 84, 99
<b>ISRAEL</b> , Separadores	298
<b>ITARD</b> , Cánulas aspiradoras	677

## J

<b>JACKSON-TESSIER</b> , Tijeras para huesos	476
<b>JACOBSON</b> , Curetas cortante	416
- Micro tijeras	40
- Perforadores para huesos	501, 502, 503, 527
- Portaagujas	235, 241
<b>JACOBSON-UNIVERSAL</b> , Perforadores para huesos	527
<b>JAMESON</b> , Tijeras finas	47
<b>JAMESON-WERBER</b> , Tijeras finas	47
<b>JANSEN</b> , Curetas cortante	416
- Separadores	327
- Pinzas para huesos	469
- Pinzas finas	133
- Legras	402
<b>JANSEN-LEUER</b> , Pinzas para huesos	468
<b>JAVID</b> , Pinzas vasculares	222
<b>JONES</b> , Pinzas de campo	146
- Pinzas hemostáticas	139
<b>JOSEPH</b> , Separadores	284
- Limas para huesos	408
- Limas nasales	573, 574
- Periostotomos	401
- Tijeras	58
<b>JUDD-MASSON</b> , Separadores vesicales	369

## K

<b>KALLMORGEN</b> , Valvas vaginales	635
<b>KELLY</b> , Separadores	310
- Tijeras quirúrgicas	53, 85
- Pinzas hemostáticas	155
<b>KERN</b> , Pinzas para Cirugía ósea	486
<b>KERPEL</b> , Curetas cortante	418
<b>KERSHNER</b> , Separadores para oftalmología	598
<b>KERRISON</b> , Laminectomia	453
<b>KERRISON-JACOBY</b> , Laminectomia	455
<b>KEVORKIAN</b> , Pinzas para biopsia	650
<b>KEY-HORSLEY</b> , Pinzas para huesos	475
<b>KEYES</b> , Trépanos cutáneos	28, 491
<b>KILLIAN</b> , Cánulas aspiradoras	678
- Tijeras nasales	72
- Tijeras para rinología	564
- Cinceles	565
- Espéculos nasales	560, 561
<b>KILLIAN-KLAUS</b> , Osteotomos	565
<b>KILNER</b> , Tijeras	47, 52, 85
- Portaagujas	256
<b>KILNER-DOUGHTY</b> , Abre bocas	540
<b>KIMURA</b> , Micro espátulas	592
<b>KIRSCH</b> , Separadores	304
<b>KIRSCHNER</b> , Separadores	361
<b>KLIMA-ROSEGGER</b> , Agujas para biopsia	377
<b>KOCHER</b> , Agujas para ligaduras	267
- Separadores	292, 294, 296, 301, 305, 307
- Pinzas hemostáticas	153, 155, 157
- Pinzas intestinales	172, 173
- Estiletes conductores	269
<b>KOCHER-LAGENBECK</b> , Separadores	300
<b>KOCHER-OCHSNER</b> , Pinzas quirúrgicas	154

<b>KOENIG</b> , Estiletes conductores	269
<b>KOERTE</b> , Separadores	323
<b>KÖNIG</b> , Elevadores	381
<b>KRAUSE</b> , Rinología	562
- Tròcartes	375
<b>KRESSNER</b> , Pinzas nasales	563
<b>KRISTELLER</b> , Espèculos vaginales	636
<b>KROENIG</b> , Bejalengua	4
<b>KRONECKER</b> , Agujas para ligaduras	262
<b>KÜHNE</b> , Pinzas depilatorie	135
<b>KÜNTSCHER</b> , Agujas	496
- Cirugia òsea	500

## L

<b>LA FORCE</b> , Micro bisturies	589
<b>LA GRANGE</b> , Tijeras quirùrgicas	50, 80
<b>LAHEY</b> , Separadores	288
<b>LAMBERT-KAY</b> , Pinzas vasculares	210
<b>LAMBOTTE</b> , Osteotomos	437
- Pinza para huesos	478
- Legras	404
<b>LANDAU</b> , Valvas vaginales	637
<b>LANDOLT</b> , Mango de bisturies	34
- Pinzas para biopsia	465
<b>LANE</b> , Destornilladores	528
- Pinzas para huesos	486
<b>LANGE</b> , Separadores	289
<b>LANGENBECK</b> , Portaagujas	259
- Separadores	299
- Elevadores	395
- Legras	402
- Seguetas de amputaciòn	414
<b>LANGENBECK-RYDER</b> , Portaagujas	259
<b>LAWRENCE</b> , Pinzas hemostàticas y para ligaduras	165
<b>LEES</b> , Pinzas vasculares	209
<b>LEKSELL</b> , Pinzas para huesos	470
<b>LELAND-JONES</b> , Pinzas vasculares	215
<b>LEMPERT</b> , Pinzas para huesos	468
<b>LERICHE</b> , Pinzas hemostàticas	151
<b>LEWIN</b> , Pinzas para huesos	479
<b>LEWIS</b> , Limas para huesos	409
- Limas nasales	573
<b>LEXER</b> , Tijeras quirùrgicas	66, 95
- Osteotomos	446, 448
- Cinceles	445, 446
<b>LEVIS</b> , Fonendoscopio	10
<b>LICHTENBERG</b> , Portaagujas	261
<b>LICHTWITZ</b> , Tròcartes	375
<b>LIEBERMANN-TENNANT</b> , Separador pàrpados	598
<b>LINDEMANN</b> , Seguetas para aamputaciòn	414
<b>LISTER</b> , Tijeras para vendajes	101
- Pinzas hemostàticas	139
<b>LISTER-BURCH</b> , Blèfarostatos	599
<b>LISTON</b> , Pinzas para huesos	473
<b>LISTON-STILLE</b> , Pinzas para huesos	475
<b>LITTAUER</b> , Pinzas auriculares	552
- Pinzas depilatorie	135
<b>LITTLER</b> , Tijeras finas	59
<b>LITTLEWOOD</b> , Pinzas uterinas	644
<b>LOCHART</b> , Estiletes	275
<b>LOCKLIN</b> , Tijeras finas	48, 53
<b>LÖFFEL</b> , Pinzas para rinología	558
<b>LOGAN</b> , Separadores	327
<b>LORENZ</b> , Tijeras para vendajes	101
<b>LORNA</b> , Pinzas de campo	147
<b>LOUTE</b> , Cirugia òsea	499
<b>LOVE</b> , Separadores	289
<b>LOVE-GRUENWALD</b> , Pinzas para biopsia	460, 461
<b>LUCAE</b> , Diapasones	5
- Martillos quirùrgicos	429
- Pinzas quirùrgicas	133
- Instrumentos auriculares	551
<b>LUER</b> , Pinzas para huesos	
<b>LUER-KÖRTE</b> , Curetas uterinas	651
<b>LUER-LOCK</b> , Mangos porta-cànules	681
<b>LUER-STILLE</b> , Pinza para huesos	469, 471, 472

## M

<b>MAGILL</b> , Cànules aspiradoras	678
- Pinzas para introducir catèteres	7
<b>MAIER</b> , Pinzas para tampones	142, 633
<b>MALTZ</b> , Limas nasales	574
<b>MARKHAM-MEYERDING</b> , Separadores	336
<b>MARTIN</b> , Separadores	314
- Pinza para huesos	485
- Porta-algodòn	277
- Histeròmetros	642
<b>MARTINI</b> , Curetas cortante	416
<b>MASING</b> , Elevadores	396
<b>MASSON</b> , Portaagujas	245, 257
<b>MATHIEU</b> , Separadores	290
- Separador rectale	369
- Portaagujas	248, 249, 260
- Valvas vaginales	635
<b>MAYO</b> , Tijeras quirùrgicas	64, 65, 82, 96
- Histeròmetros maleable	642
- Espatulas	4
- Pinzas para esterilizaciòn	697
<b>MAYO-HARRINGTON</b> , Tijeras	75
<b>MAYO-HEGAR</b> , Portaagujas	244, 251, 252
<b>MAYO-HEGAR-HEANEY</b> , Portaagujas	256
<b>MAYO-LEXER</b> , Tijeras quirùrgicas	96
<b>MAYO-NOBLE</b> , Tijeras quirùrgicas	64
<b>MAYO-RUSSIAN</b> , Pinzas finas	125
<b>MAYO-STILLE</b> , Tijeras	67, 94
<b>MC DONALD</b> , Elevadores	397
<b>MC INTOSH</b> , Laringoscopios	11, 14, 16
<b>MC IVOR</b> , Abrebocas	541
<b>MC KENTY</b> , Elevadores	397
<b>MC KESSON</b> , Cànules aspiradoras	660
<b>MC PHERSON</b> , Pinzas finas	595, 596
<b>MEAD</b> , Elevadores	395
- Martillos quirùrgicos	429
- Pinzas para huesos	467
<b>MEEKER</b> , Pinzas hemostàticas y ligaduras	165
<b>MELLINGER</b> , Blèfarostatos	599
<b>METZENBAUM</b> , Tijeras	59, 60, 61, 81, 84, 89, 90, 91, 92, 99
<b>MEYERDING</b> , Separadores	312, 335
<b>MICHEL</b> , Pinzas para agrafes	271
<b>MICRO-HALSTEAD</b> , Pinzas hemostàticas	149
<b>MICRO-HARTMANN</b> , Pinzas auriculares	552
<b>MICRO-IRIS</b> , Tijeras finas	44
<b>MICRO-RYDER</b> , Portaagujas	258
<b>MICRO-VASCULAR</b> , Portaagujas	255
<b>MIDDLELDORPF</b> , Separadores	306
<b>MIKULICZ</b> , Separadores	322, 323
- Pinzas hemostàticas	158
<b>MILLER</b> , Laringoscopios	12, 15, 16
- Limas para huesos	408, 570
<b>MILLIGAN</b> , Elevadores	382
<b>MILLIN</b> , Separadores vesicales	369
<b>MINI-FRIEDMANN</b> , Pinzas para huesos	466, 467
<b>MINI-GILLIES</b> , Portaagujas con tijeras	247, 253
<b>MINI-HOHMANN</b> , Elevadores	389
<b>MINI-LAMBOTTE</b> , Osteotomos	437, 438
<b>MINI-LEXER</b> , Osteotomos	440, 445
<b>MINI-OLSEN-HEGAR</b> , Portaagujas con tijeras	246
<b>MINI-ROUX</b> , Separadores	291
<b>MINNESOTA</b> , Separadores	539
<b>MISKIMON</b> , Separadores	340
<b>MIXTER</b> , Pinzas hemostàticas	162, 164
<b>MOLLISON</b> , Separadores	335
<b>MOLT</b> , Abrebocas para niños	537
- Periostotomos	401
<b>MORRIS-DE BAKEY</b> , Pinzas vasculares	195
<b>MORSE</b> , Separadores costales	367
<b>MÜNCHEN</b> , Curetas para biopsia	646
<b>MUSEUX</b> , Pinzas uterinas	644

## N

<b>NEGUS</b> , Pinza hemostàticas y ligaduras	165
<b>NEGUS-GUEDEL</b> , Laringoscopios	13, 16
<b>NELATON</b> , Estiletes	275

<b>NELSON</b> , Tròcartes	374
<b>NELSON-METZENBAUM</b> , Tijeras quirúrgicas	62, 93
<b>NEUBÜSER</b> , Pinzas para tube	645
<b>NEUMANN</b> , Tijeras	50
<b>NICOLA</b> , Rinologia	555
<b>NOVAK</b> , Curetas aspiradoras	646
<b>NOYES</b> , Micro tijeras	39, 601
<b>NUBOER</b> , Cànules aspiradores	666

## O

<b>OBWEGESER</b> , Agujas para ligaduras	489
- Separadores	302, 303, 545
- Osteòtomos	437, 449, 450, 568
- Periostòtomos	398, 399, 400
<b>OCHSNER</b> , Pinzas vasculares	205
- Tròcartes	374
<b>OLDBERG</b> , Pinzas para biopsia	465
<b>OLIVECRONA</b> , Disecadores	383
- Pinzas para huesos	469
- Espatulas maleable	326
<b>OLLIER</b> , Separadores	297
<b>OLSEN-HEGAR</b> , Portaagujas con tijeras	246, 253
<b>OMBREDANNE</b> , Martillos quirúrgicos	431
<b>ORINGER</b> , Abre bocas	538
<b>OSHIKA-FAULKNER</b> , Pinzas finas	596
<b>OVERHOLT</b> , Pinzas para ligaduras	161
<b>OVERHOLT-GEISSENDORFER</b> , Pinzas para ligaduras	161

## P

<b>PAPAVERO-CASPAR</b> , Especulum nasales	559
<b>PAPAVERO-HARTMANN</b> , Especulum nasales	559
<b>PARAMETRIUM</b> , Tijeras quirúrgicas	97
<b>PARKER-LANGENBECK</b> , Separadores	290
<b>PARTSCH</b> , Osteotomos	435, 436
<b>PATELLA</b> , Pinzas para huesos	481
<b>PAYR</b> , Pinzas intestinales	174
- Estiletos conductores	269
<b>PEAN</b> , Pinzas hemostáticas	150, 153, 156
<b>PEAN-MURPHY</b> , Pinzas hemostáticas	140
<b>PECK-JOSEPH</b> , Tijeras quirúrgicas	84
<b>PEDERSON</b> , Espéculos vaginales	634
<b>PELTON-CRANE</b> , Cànules aspiradoras	679
<b>PENFIELD</b> , Disecadores	385
<b>PERRY</b> , Pinzas quirúrgicas	115
<b>PERTHES</b> , Perforadores para huesos	490
<b>PHILIPS</b> , Destornilladores	528
<b>PIERCE</b> , Tròcartes	375
<b>PIERSE</b> , Pinzas finas	594
<b>PLESTER</b> , Cànules aspiradoras	669
- Separadores	333, 334
<b>POOLE</b> , Cànules aspiradoras	675
<b>POTTS</b> , Pinzas vasculares	206, 208
<b>POTTS-SMITH</b> , Tijeras vasculares	73
- Pinzas quirúrgicas	120, 131
<b>POTTS-YASARGIL</b> , Micro Tijeras	40
<b>POZZI</b> , Pinzas uterinas	643
<b>PRATT</b> , Dilatadores uterinos	640
<b>PRICE-THOMAS</b> , Pinzas vasculares	224
<b>PROST</b> , Bléfarostatos	599
<b>PUTTI</b> , Limas para huesos	413

## Q

<b>QUINBY</b> , Tijeras	46
<b>QUINKE</b> , Agujas para biopsia	378, 684

## R

<b>RADOLF</b> , Pinza para arrancar uñas	488
<b>RAGNEL-DAVIS</b> , Separadores	288
<b>RAMPLEY</b> , Pinzas para tampones	142, 633
<b>RAMUS</b> , Pinzas para huesos	548
<b>RANDALL</b> , Curetas aspiradoras	646
- Pinzas para cálculos renales	623

<b>RANKIN</b> , Pinzas hemostáticas	155
<b>RECAMIER</b> , Curetas uterinas	653
<b>REDON</b> , Agujas	270
<b>REILL</b> , Micro portaagujas	610
- Pinzas para huesos	480
<b>REVERDIN</b> , Espatulas	326
<b>REYNOLDS</b> , Tijeras quirúrgicas	51
<b>RICARD</b> , Separadores	349
<b>RICHARDSON</b> , Separadores	309
<b>RICHARDSON-EASTMAN</b> , Separadores	309
<b>ROBB</b> , Elevadores	384
<b>ROBIN</b> , Pinzas de campo	147
<b>ROCHARD</b> , Separadores	363
<b>ROCHESTER-CARMALT</b> , Pinzas hemostáticas	171
<b>ROCHESTER-PEAN</b> , Pinzas hemostáticas	154, 162
<b>RODHOIL</b> , Lubrificante para instrumentos	687
<b>ROGGE</b> , Pinzas para esterilización	696
<b>ROSEN</b> , Agujas-Cànules aspiradoras	681
<b>ROSER-KÖNIG</b> , Abre bocas	6, 537
<b>ROSS</b> , Separadores	319
<b>ROTAN</b> , Cànules aspiradores	671
<b>RÖTTGEN-RUSKIN</b> , Pinza para huesos	471
<b>ROUX</b> , Separadores	291
<b>ROUX-MAGNUS</b> , Separadores	291
<b>ROWE</b> , Pinzas para huesos	550
<b>RUBIN</b> , Pinzas nasales	563
<b>RUMEL</b> , Pinzas hemostáticas y ligaduras	163
<b>RUSKIN-STILLE</b> , Pinzas para huesos	470
<b>RUSKIN-LISTON</b> , Pinzas para huesos	474
<b>RUSSIAN</b> , Pinzas quirúrgicas	125
<b>RYDER</b> , Portaagujas	258
<b>RYDEL-SEIFER</b> , Diapasones	5

## S

<b>SACHS</b> , Elevadores	382
<b>SALZBURG</b> , Elevadores	396
<b>SANDERS-BROWN</b> , Agujas para ligaduras	489
<b>SANTULLI</b> , Pinzas Bulldog	180
<b>SAROT</b> , Portaagujas	254
<b>SATINSKY</b> , Tijeras	69
- Pinzas vasculares	225
<b>SAUERBRUCH</b> , Costotomos	477
- Separadores	301, 315
- Pinzas para huesos	472
- Pinzas para esterilización	697
<b>SAUERBRUCH-FREY</b> , Costotomos	477
<b>SAUG-RASPATORIUM</b> , Cànules aspiradoras	667
<b>SCHAEDEL</b> , Pinzas de campo	146
<b>SCHEDÉ</b> , Curetas cortante	419
<b>SCHLESINGER</b> , Laminectomía	456
<b>SCHMID</b> , Agujas vasculares maleable	228, 681
<b>SCHMIEDEN</b> , Agujas para ligaduras	267
<b>SCHMIEDEN-DICK</b> , Agujas para ligaduras	267
<b>SCHMIEDEN-TAYLOR</b> , Tijeras quirúrgicas	70
<b>SCHNEIDER</b> , Legras	402
<b>SCHRÖDER</b> , Curetas cortante	424
- Pinzas uterinas	643
<b>SCHUBERT</b> , Pinzas para biopsia	649
<b>SCHUMACHER</b> , Elevadores	392
- Costotomos	477
- Pinzas para biopsia	650
<b>SCOVILLE</b> , Separadores	292, 350, 351
<b>SCOVILLE-HAVERFIELD</b> , Separadores	350
<b>SEDILLOT</b> , Periostotomos	397
- Legras	402
<b>SELDIN</b> , Elevadores	395
<b>SELMAN</b> , Pinzas hemostáticas	125
<b>SEMB</b> , Separadores	403
<b>SEMKEN</b> , Pinzas quirúrgicas	115, 120, 130
<b>SENN-GREEN</b> , Separadores	287
<b>SENN-MILLER</b> , Separadores	288
<b>SEPTUN-NADEL</b> , Agujas-Cànules	680
<b>SHAPLEIGH</b> , Curetas auriculares	551
<b>SIEBENMANN</b> , Cànules aspiradoras	677
<b>SIEBOLD</b> , Tijeras quirúrgicas	78
<b>SIGMOID-NOTCH</b> , Periostotomos-Separadores	388, 547
<b>SILVER</b> , Cinceles	566
<b>SIMON</b> , Curetes cortante	424

- Separadores	314
<b>SIMPSON</b> , Histerómetros	642
<b>SIMPSON-BRAUN</b> , Pinzas para el útero y obstétricos	656
<b>SIMS</b> , Tijeras quirúrgicas	75, 76, 98
- Histerómetros	642
<b>SINGLEY-TUTTLE</b> , Pinzas de disección	125
<b>SMITH</b> , Tijeras para cortar alambre	102
<b>SMITH-BUIE</b> , Separadores	370
<b>SMITH-PETERSEN</b> , Osteotomos	442
<b>SNELLEN</b> , Instrumentos oculares	591
<b>SPENCER</b> , Tijeras para ligaduras	100
<b>SPLIT</b> , Osteotomos curvos	578
<b>SPURLING</b> , Pinzas para biopsia	461
<b>STACKE</b> , Estiletes	276
<b>STAMMBERGER</b> , Pinzas para rinología	556
<b>STEINHÄUSER</b> , Periotótomos	400
<b>STEINMANN</b> , Agujas	496, 497
<b>STELLBRINK</b> , Pinzas para huesos	466
<b>STERNBERG</b> , Separadores	290, 539
<b>STEVENS</b> , Tijeras finas	51
- Portaagujas	242
<b>STIEGLITZ</b> , Pinzas para espinas	134
<b>STILLE</b> , Tijeras quirúrgicas	67
- Osteotomos	441
- Pinza para huesos	471
- Pinzas quirúrgicas	118
- Pinza para arrancar vendajes	533
- Pinzas renales	175
- Portaagujas	249
- Pinzas uterinas	629
- Cinceles	441
<b>STILLE-BARRAYA</b> , Pinzas quirúrgicas	124
<b>STRULLY</b> , Tijeras quirúrgicas	69
<b>STRUYCKEN</b> , Pinzas para rinología	556
<b>SUBRAMANIAN</b> , Pinzas vasculares	221
<b>SUBRAMANIAN-MINIATURE</b> , Pinzas vasculares	221
<b>SWEDESH mod.</b> , Portaagujas	254
<b>SYPERT</b> , Osteotomos	433
- Pinzas para biopsia	464

## T

<b>TAKAHASHI</b> , Pinzas para biopsia	460
<b>TAYLOR</b> , Separadores	351
- Elevadores	394
- Martillos de percusión	3
- Pinzas quirúrgicas	131
<b>TERRIER</b> , Pinzas hemostáticas	139
<b>TESSIER</b> , Curetas cortante	425
- Separadores	313, 545
- Osteotomos	443, 583
- Pinzas para huesos	585
- Pinzas para huesos	549
<b>THOMS-GAYLOR</b> , Pinzas para biopsia	647
<b>TISCHLER-MORGAN</b> , Pinzas para biopsia	650
<b>TOBOLD</b> , Bejalenguas	544
<b>TÖNNIS</b> , Tijeras quirúrgicas	63
- Portaagujas	247, 259
<b>TÖNNIS-ADSON</b> , Tijeras quirúrgicas	63, 97
<b>TÖNNIS-RYDER</b> , Portaagujas	259
<b>TROELTSCH</b> , Pinzas de disección	133
<b>TROEMNER</b> , Martillos de percusión	3
<b>TROUTMAN</b> , Pinzas finas para oftalmología	596
- Micro tijeras para oftalmología	603
<b>TUBBS</b> , Dilatadores	229
<b>TUFFIER</b> , Separadores costales	367
- Espátulas maleable	326
<b>TUOHY</b> , Agujas para biopsia	378, 684

## U

<b>UFFENORDE</b> , Curetas cortante	418
<b>ULRICH</b> , Pinzas para huesos	484
<b>UNIVERSAL</b> , Porta-algodón	277
- Trócares	376
<b>URO-TANGENTIAL</b> , Pinzas vasculares	220

## V

<b>VALLEIX</b> , Histerómetros	642
<b>VAN DOREN</b> , Pinzas para biopsia	648
<b>VANNAS</b> , Micro Tijeras	39, 43, 600
<b>VARADAY</b> , Instrumentos para vârices	228
<b>VERBRUGGE</b> , Pinzas para huesos	482
<b>VERRES</b> , Agujas para biopsia	684
<b>WISE</b> , Pinzas finas	107
<b>VOLKMANN</b> , Curetas cortante	417, 420
- Separadores	294, 295
<b>VOLLMAR</b> , Sonda para vârices	228

## W

<b>WAGNER</b> , Cirugia ósea	500
- Pinzas para biopsia	464
<b>WALDMANN</b> , Tijeras para episiotomia	79
<b>WALLICH</b> , Curetas uterinas	652
<b>WALTON</b> , Separadores	336
<b>WALTON-POOLE</b> , Cánulas aspiradoras	675
<b>WANGENSTEIN</b> , Pinzas quirúrgicas	131
- Portaagujas	245, 252
<b>WASSMUND</b> , Separadores	299
<b>WEBER</b> , Anses oculares	591
- Pinzas vasculares	204
<b>WEBSTER</b> , Portaagujas	250
<b>WECKER</b> , Micro estaulas	590
- Micro tijeras	600
<b>WEIL-BLAKESLEY</b> , Pinzas para biopsia	459
<b>WEITLANER</b> , Separadores	330, 331, 332, 338
<b>WELLER</b> , Tijeras quirúrgicas	78
<b>WERTHEIM</b> , Tijeras quirúrgicas	58, 98
- Pinzas renales	176, 630, 631
- Portaagujas	256
<b>WEST</b> , Elevadores	395
<b>WESTCOTT</b> , Micro Tijeras	39, 601
<b>WHERTEIMER</b> , Cánulas aspiradoras	674
<b>WHITEHEAD-JENNINGS</b> , Abrebocas	6, 540
<b>WIEDER</b> , Bejalenguas	544
<b>WIKSTROEM</b> , Pinzas para ligaduras	164
<b>WILDE</b> , Polipótomos	562
<b>WILDER</b> , Dilatador ocular	592
<b>WILLIAMS</b> , Bléfarostatos	599
<b>WILLIGER</b> , Curetas cortante	416, 422
- Elevadores	381
- Martillos quirúrgicos	429
<b>WINTER</b> , Pinzas para aborte	632
<b>WOLFF</b> , Pinzas para arrancar vendajes	532
<b>WULLSTEIN</b> , Cánulas aspiradoras	665
- Separadores	330
- Micro Curetas	554

## Y

<b>YANKAUER</b> , Cánulas aspiradoras	662
<b>YASARGIL</b> , Cánulas aspiradoras	668
- Micro tijeras	40, 43
- Pinzas para biopsia	465
- Pinzas finas	110
- Portaagujas	236, 237
<b>YASARGIL-NICOLA</b> , Pinzas finas para rinología	555
<b>YOUNG</b> , Pinzas tira-lengua	8, 143

## Z

<b>ZAUFAL-JANSEN</b> , Pinzas para huesos	470
<b>ZIEGLER</b> , Micro bisturios	27, 589
<b>ZIELINSKY</b> , Instrumentos para medir	22
<b>ZIELKE</b> , Osteotomos	448

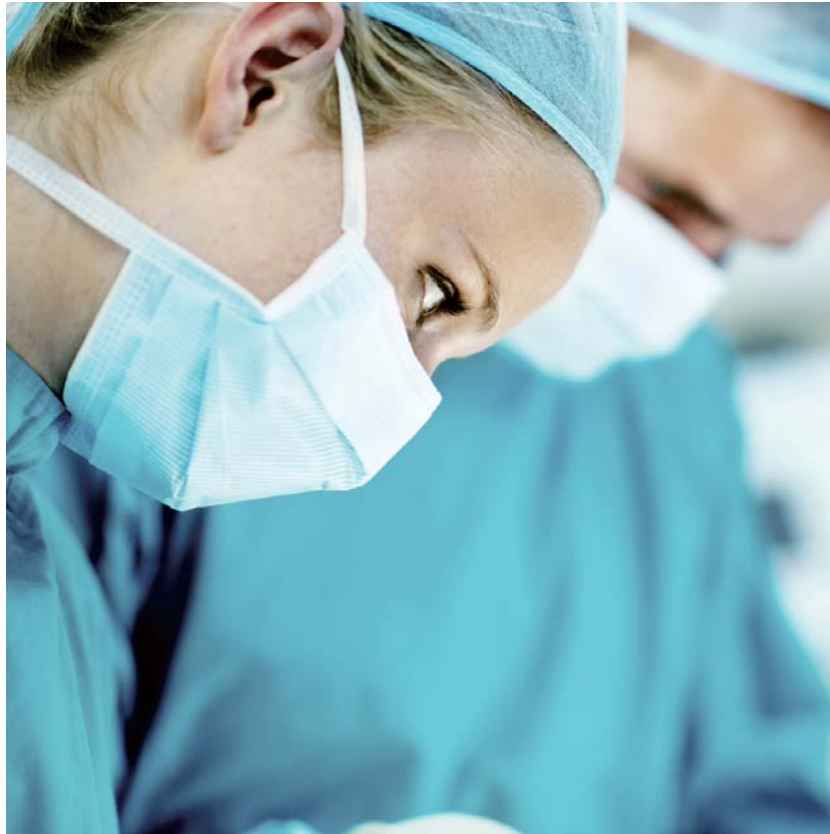

## 21

Indice alfanumerico  
Alphanumerical index  
Nummernverzeichnis  
Index alphanumérique  
Indice alfanumerico



Indice alfanumerico	Alfanumerical Index	Nummernverzeichnis	Index alphanumérique	Indice alfanumerico			
0101-HA	17	0102-FF	10	0204-GH	118	0204-BEE	119
0101-IA	17			0204-GI	112	0204-BEF	115
0101-LA08	17	0103-BB	5	0204-HA	116	0204-BEG	133
0101-BAA	11	0103-BC	5	0204-HB	116	0204-BEH	133
0101-BAB	11	0103-BD	5	0204-HC	116	0204-BEI	118
0101-BAC	11	0103-BE	5	0204-HD	116	0204-BEL	122
0101-BAD	11	0103-BF	5	0204-HE	117	0204-BFB	125
0101-BAE	11	0103-BG	5	0204-HF	117	0204-BFC	125
0101-BDA	17	0103-CA	5	0204-HG	117	0204-BFD	124
0101-BFB	17	0103-DA	5	0204-HI	117	0204-BFE	124
0101-BFD	17	0103-EA	5	0204-HL	117	0204-BFF	124
0101-CAA	12			0204-IA	127	0204-BFG	124
0101-CAB	12	0202-DI	34	0204-IB	127	0204-BFH	125
0101-CAC	12	0202-EA	34	0204-IC	127	0204-BGA	127
0101-CAD	12	0202-EG	34	0204-ID	127	0204-BGB	127
0101-CAE	12	0202-EI	34	0204-IE	127	0204-BGC	127
0101-CFA	15	0202-FA	34	0204-IF	127	0204-BGD	127
0101-CFB	15	0202-FC	34	0204-IG	127	0204-BGE	127
0101-CFC	15			0204-IH	127	0204-BGF	128
0101-CFD	15	0204-AE	114	0204-II	127	0204-BGG	128
0101-CFE	15	0204-AF	115	0204-IL	127	0204-BGH	128
0101-EAB	13	0204-AG	115	0204-LA	116	0204-BGI	128
0101-EAC	13	0204-AH	114	0204-LB	120	0204-BGL	128
0101-EAD	13	0204-AL	121	0204-LC	116	0204-BHA	128
0101-EAE	13	0204-BA	117	0204-LD	116	0204-BHB	128
0101-FAA	14	0204-BE	120	0204-LE	125	0204-BHC	128
0101-FAB	14	0204-BF	120	0204-LF	120	0204-BHD	128
0101-FAC	14	0204-BG	118	0204-LG	114	0204-BHE	134
0101-FAD	14	0204-BH	124	0204-LH	117	0204-BHF	125
0101-FAE	14	0204-BI	121	0204-LI	117	0204-BHG	125
0101-02BAA	11, 17	0204-BL	121	0204-LL	117	0204-BHL	133
0101-02BAB	11, 17	0204-CA	121	0204-BAA	117	0204-BIA	121
0101-18BAD	16	0204-CB	120	0204-BAB	133	0204-BIB	121
0101-18BAE	16	0204-CC	133	0204-BAC	133	0204-BIC	121
0101-18BAF	16	0204-CD	117	0204-BAE	121	0204-BID	121
0101-18CAD	16	0204-CE	117	0204-BAF	117	0204-BIE	124
0101-18CAE	16	0204-CF	117	0204-BAG	122	0204-BIF	124
0101-18CAF	16	0204-CG	117	0204-BAH	122	0204-BIG	126
0101-18CFD	16	0204-CH	125	0204-BAI	122	0204-BLA	126
0101-18CFE	16	0204-CI	124	0204-BAL	119	0204-BLB	126
0101-18CFF	16	0204-CL	125	0204-BBA	119	0204-BLC	126
0101-18EAD	16	0204-DA	116	0204-BBB	119	0204-BLD	133
0101-18EAE	16	0204-DB	116	0204-BBC	119	0204-BLE	114
0101-18FAD	16	0204-DC	113	0204-BBD	119	0204-BLF	114
0101-18FAE	16	0204-DD	113	0204-BBE	119	0204-BLG	114
0101-18FAF	16	0204-DE	113	0204-BBF	122	0204-BLI	129
0101-19GA	17	0204-DF	113	0204-BBG	122	0204-BLL	129
		0204-DG	113	0204-BBH	122	0204-CAA	112
0102-AE	18	0204-DH	125	0204-BBI	122	0204-CAB	112
0102-AF	18	0204-DI	121	0204-BBL	122	0204-CAC	112
0102-AG	18	0204-DL	121	0204-BCA	134	0204-CAD	112
0102-AH	18	0204-EA	113	0204-BCB	134	0204-CAE	618
0102-AL	18	0204-EB	113	0204-BCC	134	0204-CAF	112
0102-BA	3	0204-EC	113	0204-BCD	134	0204-CAG	112
0102-BB	3	0204-ED	113	0204-BCE	117	0204-CBA	130
0102-BC	3	0204-EE	115	0204-BCG	117	0204-CBB	130
0102-BE	3	0204-EF	115	0204-BCH	119	0204-CBC	130
0102-BG	3	0204-EG	115	0204-BCI	121	0204-CBD	130
0102-BI	3	0204-EH	115	0204-BCL	121	0204-CBE	130
0102-DC	18	0204-FA	134	0204-BDA	129	0204-CBF	130
0102-DC17	18	0204-FC	271	0204-BDB	129	0204-CBG	130
0102-DE	18	0204-FD	120	0204-BDC	129	0204-CBH	130
0102-DI	18	0204-FE	120	0204-BDD	121	0204-CBI	131
0102-EA	18	0204-GA	112	0204-BDE	121	0204-CBL	131
0102-EB	18	0204-GB	118	0204-BDF	129	0204-CCA	131
0102-EB17	18	0204-GC	112	0204-BDG	129	0204-CCB	132
0102-FA	10	0204-GD	118	0204-BDI	122	0204-CCC	132
0102-FB	10	0204-GE	112	0204-BDL	122	0204-CCD	132
0102-FC	10	0204-GF	118	0204-BEA	129	0204-CCE	132
0102-FE	10	0204-GG	112	0204-BEB	116	0204-CCF	132

Indice alfanumerico	Alfanumerical Index	Nummernverzeichnis	Index alphanumérique	Indice alfanumerico	
0204-CCG	131	0206-CG	140	0212-BH	267
0204-CCH	131	0206-CH	140	0212-BI	267
0204-CCI	131	0206-CI	140	0212-BL	262
0204-CCL	132	0206-CL	140	0212-CA	262
0204-CDA	130	0206-DA	142, 633	0212-CB	263
0204-CDB	130	0206-DB	142, 633	0212-CC	263
0204-CDC	131	0206-DC	632	0212-CD	263
0204-CDD	131	0206-DD	632	0212-CE	263
0204-CDE	131	0206-DE	632	0212-CF	269
0204-CDF	107, 618	0206-DF	632	0212-CG	269
0204-CDG	107	0206-DG	146	0212-CH	177
0204-CDH	107	0206-DI	146	0212-CI	268
0204-CDI	115	0206-EA	146	0212-CL	267
0204-CDL	115	0206-EB	146	0212-DA	177
0204-CEA	118	0206-EC	146, 620	0212-DB	177
0204-CEB	118	0206-ED	146	0212-DC	177
0204-CEC	118	0206-EE	146	0212-DD	177
0204-CED	118	0206-EF	146	0212-DE	177
0204-CEE	118	0206-EG	146	0212-DF	177
0204-CEF	118	0206-EI	146	0212-DG	177
0204-CEG	118	0206-EL	643	0212-DH	177
0204-CEH	118	0206-FA	147	0212-DI	177
0204-CEI	118	0206-FB	644	0212-DL	177
0204-CEL	118	0206-FC	147	0212-EA	269
0204-CFA	130	0206-FD	644	0212-EB	269
0204-CFB	130	0206-FE	644	0212-EE	265
0204-CFC	131	0206-FF	643	0212-EF	265
0204-CHB	119	0206-FL	643	0212-EG	266
0204-CHC	119	0206-GA	643	0212-EH	266
0204-CHD	119	0206-GB	644	0212-EI	265
0204-CHE	119	0206-GC	644	0212-EL	265
0204-CHF	119	0206-GD	644	0212-FA	505
0204-CHG	119	0206-GF	271	0212-FB	505
0204-CHH	119	0206-GI	271	0212-FC	266
0204-CHI	119	0206-GL	271	0212-FD	266
0204-CIB	120	0206-HC	147	0212-GA	269
0204-CIC	120	0206-HD	147	0212-GB	246
0204-CIH	120	0206-HE	147	0212-GC	246
0204-CII	120	0206-HF	147	0212-GD	246
0204-CIL	120	0206-HI	141	0212-GE	246
0204-CLA	120	0206-HL	141	0212-GF	264
0204-CLB	120	0206-IC	148	0212-GG	264
0204-CLC	120	0206-IF	148	0212-GI	268, 505
0204-DAD	110	0206-IG	148	0212-GL	268, 505
0204-DAG	110	0206-IH	148	0212-HA	267
0204-DBE	110	0206-II	148	0212-HB	267
0204-DBF	110	0206-LA	148	0212-HC	267
		0206-LB	148	0212-HD	267
0206-AB	142, 633	0206-LC	148	0212-HE	268, 505
0206-AC	142, 633	0206-LD	148	0212-HF	264
0206-AD	139, 633	0206-LE	141	0212-HG	264
0206-AE	139, 633	0206-LF	141	0212-HH	264
0206-AF	142	0206-LG	630	0212-HI	264
0206-AG	142	0206-LH	630	0212-HL	262
0206-AH	142	0206-BAA	631	0212-IA	262
0206-AI	142			0212-ID	263
0206-BA	139	0210-DA	533	0212-IE	263
0206-BB	141			0212-LD	177, 617
0206-BC	139	0212-AB	253	0212-LF	177, 617
0206-BD	141	0212-AC	253	0212-BAC	270
0206-BE	141	0212-AD	253	0212-BAD	270
0206-BF	141	0212-AE	253	0212-BAE	270
0206-BG	8, 144	0212-AL	504	0212-BAF	270
0206-BI	632	0212-BA	504	0212-BAG	270
0206-BL	632	0212-BB	504	0212-BAH	270
0206-CA	139	0212-BC	504	0212-BBC	270
0206-CC	140	0212-BD	504	0212-BBD	270
0206-CD	140	0212-BE	504	0212-BBE	270
0206-CE	140	0212-BF	262	0212-BBF	270
0206-CF	140	0212-BG	262	0212-BBG	270
				0212-BBH	270
				0212-BCC	270
				0212-BCD	270
				0212-BCE	270
				0212-BCF	270
				0212-BCG	270
				0212-BCH	270
				0212-BDC	270
				0212-BDD	270
				0212-BDE	270
				0212-BDF	270
				0212-BDG	270
				0212-BDH	270
				021518-BA	693
				021518-BC	693
				021518-BE	693
				021518-BF	693
				021518-BH	693
				0217-CA	693
				0217-CF	693
				0217-CI	693
				0218-B	691
				0218-CD	692
				0218-CH	692
				0218-CI	692
				0218-DA	692
				0218-EA	692
				0218-EB	692
				0218-EC	692
				0219-B	397
				0219-C	397
				0219-AD	322
				0219-AE	322
				0219-AF	401
				0219-AG	401
				0219-AH	401
				0219-BA	589
				0219-BC	589
				0219-BE	589
				0219-BF	283
				0219-BG	283, 617
				0219-BH	322
				0219-BI	288
				0219-BL	288
				0219-CA	290
				0219-CC	288
				0219-CD	297
				0219-CE	297
				0219-CF	290
				0219-CG	288
				0219-CH	288
				0219-CI	287
				0219-CL	288
				0219-DB	323
				0219-DD	299
				0219-DE	299
				0219-DF	299
				0219-DG	299
				0219-DH	397
				0219-DI	285
				0219-DL	285
				0219-EA	285
				0219-EB	285
				0219-EC	285
				0219-ED	299
				0219-EE	285



Indice alfanumerico	Alfanumerical Index	Nummernverzeichnis	Index alphanumérique	Indice alfanumerico			
0219-EF	285	0219-BCE	297	0219-CFA	301	0221-AC	599
0219-EG	285	0219-BCF	297	0219-CFB	301	0221-AE	599
0219-EI	287	0219-BCG	294	0219-CFC	301	0221-AF	599
0219-EL	287	0219-BCH	294	0219-CFD	301	0221-AG	599
0219-FA	286	0219-BCI	294	0219-CFE	301	0221-AH	330
0219-FB	286	0219-BDA	303	0219-CFF	363	0221-AI	327
0219-FC	286	0219-BDB	311	0219-CFG	363	0221-AL	330
0219-FE	286	0219-BDD	311	0219-CFH	363	0221-BA	327
0219-FF	286	0219-BDE	305	0219-CFI	363	0221-BB	329
0219-FG	286	0219-BDF	305	0219-CFL	363	0221-BC	327
0219-FH	565	0219-BDG	304	0219-CGA	300	0221-BD	329
0219-GA	300	0219-BDH	305	0219-CGB	300	0221-BE	328
0219-GC	300	0219-BDL	294	0219-CGC	300	0221-BF	328
0219-GE	300	0219-BEA	294	0219-CGD	300	0221-BG	328
0219-GF	300	0219-BEB	296	0219-CHE	323	0221-BH	328
0219-GG	300	0219-BEC	296	0219-CHF	293	0221-BI	331
0219-GH	303	0219-BED	296	0219-CHG	293	0221-BL	332
0219-GI	303	0219-BEE	296	0219-CHH	293	0221-CA	331
0219-GL	299	0219-BEF	296	0219-CHI	293	0221-CB	332
0219-HA	287, 618	0219-BEG	296	0219-CHL	293	0221-CC	331
0219-HB	287	0219-BEH	296	0219-CIA	309	0221-CD	332
0219-HC	287	0219-BEI	296	0219-CIB	309	0221-CE	332
0219-HD	287	0219-BFC	302	0219-CIC	291	0221-CF	332
0219-HE	287	0219-BFD	302	0219-CID	291	0221-CG	330
0219-HF	287	0219-BFE	302	0219-CIE	291	0221-CH	338
0219-HH	287	0219-BFF	302	0219-CIF	291	0221-CI	338
0219-HL	287	0219-BFG	302	0219-CIG	291	0221-DA	357
0219-IA	306	0219-BFH	302	0219-CIH	291	0221-DB	357
0219-IB	306	0219-BGA	320	0219-CII	291	0221-DC	357
0219-IC	306	0219-BGB	320	0219-CIL	291	0221-DD	357
0219-ID	291	0219-BGC	320	0219-CLA	309	0221-DF	350
0219-IE	576	0219-BGD	320	0219-CLB	290	0221-DG	327
0219-IF	576	0219-BGE	320	0219-CLE	290	0221-DH	327
0219-IG	576	0219-BGF	320	0219-CLG	289	0221-DI	327
0219-IH	576	0219-BGG	321	0219-CLH	289	0221-DL	327
0219-II	576	0219-BGH	321	0219-CLI	289	0221-EA	358
0219-IL	576	0219-BGI	321	0219-CLL	289	0221-EB	358
0219-LA	304	0219-BIA	306	0219-DBC	292	0221-EC	358
0219-LB	304	0219-BIB	306	0219-DBF	309	0221-ED	358
0219-LC	302	0219-BIC	306	0219-DBG	309	0221-EF	327
0219-LD	302	0219-BLA	285	0219-DBH	309	0221-EG	360
0219-LE	302	0219-BLB	285	0219-DBI	309	0221-EH	327
0219-LF	302	0219-BLC	285	0219-DBL	310	0221-EI	327
0219-LG	302	0219-BLD	285	0219-DCA	310	0221-EL	327
0219-LH	312	0219-BLE	285	0219-DCB	310	0221-FB	327
0219-LI	312	0219-BLF	285	0219-DCC	310	0221-FC	327
0219-LL	312	0219-CAD	283	0219-DCH	308	0221-FF	331
0219-BAA	302	0219-CAE	283	0219-DCI	308	0221-FG	331
0219-BAB	295	0219-CAH	283	0219-DCL	308	0221-FH	367
0219-BAC	295	0219-CAI	283	0219-DDA	308	0221-FI	366
0219-BAD	295	0219-CBA	284	0219-DCB	319	0221-FL	366
0219-BAE	295	0219-CBB	284	0219-DDC	319	0221-GA	365
0219-BAF	295	0219-CBC	284	0219-DDD	319	0221-GC	365
0219-BAG	295	0219-CBD	284	0219-DDE	319	0221-GE	365
0219-BAH	295	0219-CBE	284	0219-DDF	319	0221-GG	365
0219-BAI	295	0219-CBF	284	0219-DDG	319	0221-GI	341
0219-BAL	288	0219-CBG	284	0219-DEB	317	0221-GL	341
0219-BBA	301	0219-CBH	284	0219-DEC	317	0221-HA	341
0219-BBB	301	0219-CBI	284	0219-DEE	318	0221-HB	341
0219-BBC	301	0219-CCA	313	0219-DEF	318	0221-HC	341
0219-BBD	292	0219-CCB	313	0219-DEH	315	0221-HD	341
0219-BBE	292	0219-CCC	313	0219-DEI	315	0221-HE	341
0219-BBF	292	0219-CCD	313	0219-DEL	315	0221-HF	341
0219-BBG	292	0219-CCH	314	0219-DFA	315	0221-HG	335
0219-BBH	292	0219-CCI	314	0219-DFH	324	0221-HH	335
0219-BBI	292	0219-CCL	314	0219-DFI	324	0221-HI	335
0219-BCA	298	0219-CEG	307	0219-DFL	324	0221-HL	335
0219-BCB	298	0219-CEH	307	0219-DGA	316	0221-IA	356
0219-BCC	298	0219-CEI	307	0219-DGB	316	0221-IC	356
0219-BCD	298	0219-CEL	307			0221-IE	356

Indice alfanumerico	Alfanumerical Index	Nummernverzeichnis	Index alphanumérique	Indice alfanumerico			
0221-IF	356	0221-BHG	351	0221-CHF	352	0221-DFD	369
0221-IG	356	0221-BHH	351	0221-CHG	352	0221-DFH	369
0221-II	336	0221-BHI	351	0221-CHH	352	0221-DFI	369
0221-IL	336	0221-BHL	351	0221-CHL	352	0221-DFL	369
0221-LA	333	0221-BIA	351	0221-CIA	352	0221-DGA	369
0221-LB	333	0221-BIB	351	0221-CIB19	353	0221-DGG	348
0221-LC	333	0221-BIC	351	0221-CIC19	353	0221-DGH	348
0221-LD	333	0221-BID	349	0221-CID19	353	0221-DGI	348
0221-LE	334	0221-BIE	359	0221-CIE19	353	0221-DGL	348
0221-LF	334	0221-BIF	359	0221-CIF19	353	0221-DHA	348
0221-LG	334	0221-BIG	359	0221-CIG19	353	0221-DHB	348
0221-LH	334	0221-BIH	359	0221-CIH19	353	0221-DHC	346, 347
0221-LI	336	0221-BII	359	0221-CII19	353	0221-DHD	347
0221-LL	336	0221-BIL	359	0221-CIL19	353	0221-DHE	347
0221-BAB	337	0221-BLA	339	0221-CLA19	353	0221-DHF	347
0221-BAC	337	0221-BLB	339	0221-CLB19	353	0221-DHG	347
0221-BAI	329	0221-BLC	339	0221-CLC19	353	0221-DHH	347
0221-BAL	329	0221-BLD	339	0221-CLD19	353	0221-DHI	347
0221-BBA	335	0221-BLE	349	0221-CLE19	353	0221-DHL	347
0221-BBB	330	0221-BLF	349	0221-CLF19	353	0221-DIA	347
0221-BBC	330	0221-BLG	349	0221-CLG19	353	0221-DIB	347
0221-BBH	335	0221-BLH	349	0221-CLH19	353	0221-DIC	347
0221-BBI	335	0221-BLI	349	0221-CLI19	353	0221-DID	363
0221-BBL	338	0221-BLL	349	0221-CLL19	353	0221-DIE	363
0221-BCA	338	0221-CAA	349	0221-DAA19	353	0221-DIF	363
0221-BCB	342	0221-CAB	354	0221-DAB19	353	0221-DIG	363
0221-BCC	342	0221-CAC	354	0221-DAC19	353	0221-DIH	363
0221-BCD	343	0221-CAD	354	0221-DAD19	353	0221-DII	363
0221-BCE	343	0221-CAE	354	0221-DAE19	353	0221-DIL	363
0221-BCF	367	0221-CAF	354	0221-DAF19	353	0221-DLA	363
0221-BCG	367	0221-CAG	354	0221-DAG19	353		
0221-BCI	367	0221-CAH	354	0221-DAH19	353	03-B	415
0221-BDA	340	0221-CAI	354	0221-DAI19	353	03-C	415
0221-BDB	340	0221-CAL	355	0221-DAL19	353	03-D	415
0221-BDF	344	0221-CBA	355	0221-DBA19	353	03-E	415
0221-BDG	344	0221-CBB	355	0221-DBH	345		
0221-BDH	344	0221-CBC	355	0221-DBI	345	0318-AB	691
0221-BDI	344	0221-CBD	355	0221-DBL	345	0318-AC	691
0221-BDL	344	0221-CBE	355	0221-DCA	345	0318-AD	691
0221-BEB	346	0221-CBF	355	0221-DCB	345	0318-AE	691
0221-BEC	346	0221-CBG	355	0221-DCC	345	0318-AF	691
0221-BED	346	0221-CCL	353	0221-DCD	345	0318-AG	691
0221-BEE	349	0221-CEB	370	0221-DCE	345	0318-AH	693
0221-BEF	346	0221-CEC	370	0221-DCF	345	0318-AI	693
0221-BEG	346	0221-CEF	370	0221-DCG	345	0318-AL	693
0221-BEI	346	0221-CEG	370	0221-DCH	345	0318-BC	694
0221-BFA	360	0221-CEH	370	0221-DCI	345	0318-BF	694
0221-BFB	360	0221-CEI	370	0221-DCL	345	0318-BL	694
0221-BFC	360	0221-CEL	352	0221-DDA	345	0318-CA	694
0221-BFD	359	0221-CFA	352	0221-DCB	361	0318-CB	694
0221-BFG	359	0221-CFB	352	0221-DDC	361	0318-CC	694
0221-BFH	359	0221-CFC	352	0221-DDD	361	0318-CF	694
0221-BFI	349	0221-CFD	352	0221-DDE	361	0318-DA	694
0221-BFL	349	0221-CFE	352	0221-DDF	361	0318-DC	694
0221-BGA	350	0221-CFF	352	0221-DDG	361	0318-DD	694
0221-BGB	350	0221-CFG	352	0221-DDH	361	0318-DE	694
0221-BGC	349	0221-CFH	352	0221-DDI	361	0318-EA	694
0221-BGD	351	0221-CFI	352	0221-DDL	361	0318-EB	694
0221-BGE	351	0221-CFL	352	0221-DEA	362	0318-EC	694
0221-BGF	351	0221-CGA	352	0221-DEB	362	0318-ED	694
0221-BGG	351	0221-CGC	364	0221-DEC	362	0318-EE	694
0221-BGH	351	0221-CGD	364	0221-DED	362	0318-EF	694
0221-BGI	351	0221-CGE	364	0221-DEE	362	0318-FB	691
0221-BGL	351	0221-CGF	364	0221-DEF	362	0318-FC	691
0221-BHA	351	0221-CGL	352	0221-DEG	361	0318-FF	691
0221-BHB	351	0221-CHA	352	0221-DEH	361	0318-GB	693
0221-BHC	351	0221-CHB	352	0221-DEI	361	0318-GD	693
0221-BHD	351	0221-CHC	352	0221-DEL	362	0318-GF	693
0221-BHE	351	0221-CHD	352	0221-DFA	362	0318-GG	693
0221-BHF	351	0221-CHE	352	0221-DFE	369	0318-GH	693

Indice alfanumerico	Alfanumerical Index	Nummernverzeichnis	Index alphanumérique	Indice alfanumerico			
0318-IA	691	0414-BG	562	0414-LG	546	0414-BIH	578
0318-IB	691	0414-BH	562	0414-LH	546	0414-BII	578
0318-IC	691	0414-BI	437	0414-LI	387	0414-BLA	440
0318-ID	691	0414-BL	549	0414-LL	387	0414-BLB	440
		0414-CA	567	0414-BAB	400	0414-BLC	440
0402-B11	687	0414-CB	567	0414-BAC	400	0414-BLD	440
0402-E	688	0414-CC	567	0414-BAD	400	0414-BLE	440
0402-F11	687	0414-CD	567	0414-BAE	387	0414-BLF	440
0402-G-01	688	0414-CE	567	0414-BAF	387	0414-BLG	440
0402-CA	551	0414-CF	567	0414-BAG	400	0414-BLH	440
0402-CB	551, 617	0414-CG	567	0414-BAH	400	0414-BLI	546
0402-CC-01	688	0414-CH	567	0414-BAI	388	0414-BLL	546
0402-CD	551	0414-CL	549	0414-BAL	573	0414-CAD	581
0402-CE	551	0414-DA	489	0414-BBA	568	0414-CAF	581
0402-CF	551	0414-DB	489	0414-BBB	396	0414-CAG	581
0402-DA	551	0414-DC	489	0414-BBC	568	0414-CBD	289
0402-DB	551	0414-DE	566	0414-BBH	399	0414-CBE	289
0402-DC	551	0414-DF	566	0414-BBI	577	0414-CBF	289
0402-DG	551	0414-DG	566	0414-BBL	577	0414-CCA	386
0402-DH	551	0414-EA	545	0414-BCA	568	0414-CCB	386
0402-DI	551	0414-EB	545	0414-BCB	568	0414-CCC	386
0402-DL	551	0414-EC	545	0414-BCC	568	0414-CCD	386
0402-LG	688	0414-ED	545	0414-BCF	547	0414-CCE	386
0402-LH	552	0414-EE	489	0414-BCG	547	0414-CEA	396
0402-LI	552	0414-EF	388, 547	0414-BDA	438	0414-CEB	396
0402-LL	552	0414-EG	388, 547	0414-BDB	438	0414-CEC	381
0402-BAA	554	0414-EH	396	0414-BDC	438	0414-CED	381
0402-BAB	459	0414-EI	565	0414-BDD	438	0414-CEE	396
0402-BAC	459	0414-EL	489	0414-BDI	400	0414-CEH	548
0402-BAD	459	0414-FA	569	0414-BDL	400	0414-CEI	548
0402-BAE	459	0414-FB	569	0414-BEA	438	0414-CFA	582
0402-BAF	459	0414-FC	569	0414-BEB	438	0414-CFB	582
0402-BAG	554	0414-FD	569	0414-BEC	545	0414-CFC	582
0402-BAH	554	0414-FE	569	0414-BED	438	0414-CFH	581
0402-BAI	554	0414-FF	569	0414-BEE	565	0414-CFI	581
0402-BAL	554	0414-FG	289	0414-BEF	565	0414-CGA	582
0402-BBB	552	0414-FH	289	0414-BEG	565	0414-CGB	582
0402-BBD	552	0414-FI	289	0414-BEH	563	0414-CGC	582
0402-BBE	552	0414-FL	398	0414-BEI	563	0414-CGE	564
0402-BCA	553	0414-GA	396	0414-BEL	563	0414-CHE	575
0402-BCB	553	0414-GD	398	0414-BFA	579	0414-CIF	575
0402-BCC	553	0414-GF	398	0414-BFB	579	0414-CIG	575
0402-BCD	553	0414-GH	398	0414-BFC	579	0414-CIH	575
0402-BCE	553	0414-GI	399	0414-BFD	579	0414-CLA	575
0402-BCF	553	0414-GL	399	0414-BFE	579		
0402-BCL	553	0414-HA	409	0414-BFF	579	0415-AI	506
0402-BEB	459	0414-HB	409	0414-BFG	579	0415-AL	488
0402-BED	459	0414-HC	573	0414-BFH	563	0415-BI	506
0402-BEF	459	0414-HD	574	0414-BFI	579	0415-HB	506
0402-BFA	648	0414-HE	574	0414-BGB	580	0415-HF	506
0402-BIA	453	0414-HF	409	0414-BGC	580	0415-LA	102, 512
0402-BIB	453	0414-HG	409	0414-BGD	580	0415-LB	103
0402-BIC	453	0414-HH	573	0414-BGE	580	0415-LC	103
0402-CLL	688	0414-HI	573	0414-BGF	580	0415-LG	508
0402-1411	688	0414-HL	410	0414-BGG	580	0415-BAB	103
0402-141117	687	0414-IA	410	0414-BGH	580	0415-BAC	103
		0414-IB	410	0414-BGI	412, 572	0415-BAD	103
04050113	70	0414-IC	410	0414-BGL	412, 572	0415-BAE	103
		0414-ID	410	0414-BHA	577	0415-BAF	103
0414-B	408, 570	0414-IE	577	0414-BHB	577	0415-BCA	102, 512
0414-C	408, 570	0414-IF	577	0414-BHC	577	0415-HCF	22
0414-D	408, 570	0414-IG	388	0414-BHE	289		
0414-AI	544	0414-IH	573	0414-BHF	311	0417-FA	134
0414-AL	544	0414-II	575	0414-BHI	409	0417-GA	134
0414-BA	550	0414-IL	575	0414-BHL	574		
0414-BB	550	0414-LA	399	0414-BIA	578	0418-AB	543
0414-BC	550	0414-LB	565	0414-BIB	578	0418-AC	543
0414-BD	550	0414-LC	565	0414-BIC	578		
0414-BE	550	0414-LE	546	0414-BIF	578	0501-BA	172
0414-BF	550	0414-LF	546	0414-BIG	578	0501-BB	172

Indice alfanumerico	Alfanumerical Index	Nummernverzeichnis	Index alphanumérique	Indice alfanumerico			
0501-BC	172	0502-FF	641	0502-BEE	636	0502-CFD	626
0501-BD	172	0502-FG	641	0502-BFA	637	0502-CFE	626
0501-BE	172	0502-FH	641	0502-BFB	637	0502-CFF	626
0501-BF	172	0502-FI	641	0502-BFC	637	0502-CFG	626
0501-CA	174	0502-FL	641	0502-BFG	637	0502-CFH	626
0501-CB	174	0502-GA	641	0502-BFH	637	0502-CFI	626
0501-DA	171	0502-GB	641	0502-BFI	637	0502-CFL	626
0501-DB	171	0502-GC	641	0502-BGA	637	0502-CGA	626
0501-DC	171	0502-GD	641	0502-BGC	637	0502-CGB	626
0501-DD	171	0502-GE	641	0502-BGD	637	0502-CGC	626
0501-DG	171	0502-GF	641	0502-BGE	637	0502-CGD	626
0501-DH	171	0502-GG	641	0502-BGG	637	0502-CGE	626
0501-EA	369	0502-GH	641	0502-BHA	638	0502-CGF	626
0501-FA	173	0502-GI	641	0502-BHB	638	0502-CGG	626
0501-FB	173	0502-GL	641	0502-BHC	638	0502-CGH	626
0501-FC	173	0502-HA	641	0502-BHD	638		
0501-FD	173	0502-HB	641	0502-BHE	638	0517-BB	653
0501-FE	173	0502-HC	641	0502-BHF	638	0517-BC	653
0501-FF	173	0502-HD	641	0502-BHG	638	0517-BD	653
0501-GA	624	0502-HE	641	0502-BHH	638	0517-BE	653
0501-GC	624	0502-HF	641	0502-BHI	638	0517-BF	653
0501-GD	624	0502-HG	641	0502-BHL	638	0517-BG	653
0501-GE	624	0502-HH	641	0502-BIE	638	0517-BH	653
0501-GF	624	0502-HI	641	0502-BIL	638	0517-BI	653
0501-GG	624	0502-HL	641	0502-BLA	637	0517-CB	653
0501-GH	624	0502-IA	641	0502-BLB	637	0517-CC	653
0501-HA	624	0502-IB	641	0502-CAB	626	0517-CD	653
0501-HC	624	0502-IC	641	0502-CAC	626	0517-CE	653
0501-HE	624	0502-ID	641	0502-CAD	626	0517-CF	653
0501-HG	624	0502-IE	641	0502-CAE	626	0517-CG	653
0501-HH	624	0502-IF	641	0502-CAF	626	0517-CH	653
0501-HI	624	0502-IG	641	0502-CAG	626	0517-CI	653
0501-HL	624	0502-IH	641	0502-CAH	626	0517-DB	654
0501-LA	624	0502-II	641	0502-CAI	626	0517-DC	654
0501-LB	624	0502-IL	641	0502-CAL	626	0517-EB	654
0501-LC	624	0502-LA	641	0502-CBA	626	0517-EC	654
0501-LD	624	0502-LB	641	0502-CBB	626	0517-EG	634
		0502-LC	641	0502-CBC	626	0517-EH	634
		0502-LD	641	0502-CBD	626	0517-EI	634
0502-BB	623	0502-BAA	635	0502-CBE	626	0517-EL	634
0502-BC	623	0502-BAB	635	0502-CBF	626	0517-FA	656
0502-BD	623	0502-BAC	635	0502-CBG	626	0517-FB	656
0502-BE	623	0502-BAD	635	0502-CBH	626	0517-FC	656
0502-BF	645	0502-BAE	635	0502-CBI	626	0517-FD	656
0502-BG	645	0502-BAF	635	0502-CBL	626	0517-GB	634
0502-BI	628	0502-BAG	635	0502-CCA	626	0517-GC	634
0502-BL	628	0502-BAH	635	0502-CCB	626	0517-GD	634
0502-CA	628	0502-BCA	636	0502-CCC	626	0517-HC	634
0502-CB	651	0502-BCB	636	0502-CCD	626	0517-HD	634
0502-CC	651	0502-BCC	636	0502-CDB	628	0517-HE	634
0502-CD	651	0502-BCD	636	0502-CDC	628	0517-HH	646
0502-CF	644	0502-BCE	636	0502-CDD	628	0517-HI	646
0502-DA	629	0502-BCF	636	0502-CDE	628	0517-HL	646
0502-DB	175, 629	0502-BCG	636	0502-CDF	628	0517-IA	651
0502-DC	175, 629	0502-BCH	636	0502-CDG	628	0517-IB	651
0502-DG	623	0502-BCI	636	0502-CDH	628	0517-IC	651
0502-DH	623	0502-BDA	636	0502-CDI	628	0517-ID	651
0502-DI	623	0502-BDB	636	0502-CDL	628	0517-IE	651
0502-DL	623	0502-BDC	636	0502-CEA	628	0517-II	652
0502-EC	627	0502-BDD	636	0502-CEB	628	0517-LA	652
0502-ED	627	0502-BDE	636	0502-CEC	628	0517-LB	634
0502-EE	627	0502-BDF	636	0502-CED	628	0517-LC	634
0502-EF	627	0502-BDG	636	0502-CEE	628	0517-LD	634
0502-EG	627	0502-BDH	636	0502-CEF	628	0517-LG	634
0502-EH	627	0502-BDI	636	0502-CEG	628	0517-LH	634
0502-EI	627	0502-BDL	636	0502-CEH	628	0517-BAA	642
0502-EL	627	0502-BEA	636	0502-CEI	628	0517-BAB	642
0502-FB	641	0502-BEB	636	0502-CEL	628	0517-BAC	642
0502-FC	641	0502-BEC	636	0502-CFB	626	0517-BAD	642
0502-FD	641	0502-BED	636	0502-CFC	626	0517-BAE	642
0502-FE	641						

Indice alfanumerico	Alfanumerical Index	Nummernverzeichnis	Index alphanumérique	Indice alfanumerico			
0517-BAF	642	0602-CA	188	0602-LB	185	0602-BIA	197
0517-BAG	642	0602-CB	189	0602-LC	185	0602-BIB	197
0517-BAH	642	0602-CC	187	0602-LD	185	0602-BIC	197
0517-BAI	642	0602-CD	187	0602-LE	205	0602-BID	197
0517-BBA	640	0602-CE	187	0602-LF	205	0602-BIE	207
0517-BBB	640	0602-CF	197	0602-LG	217	0602-BIF	207
0517-BBC	640	0602-CG	197	0602-LH	217	0602-BIG	207
0517-BBD	640	0602-CH	197	0602-LI	217	0602-BIH	216
0517-BBE	640	0602-CI	197	0602-LL	217	0602-BII	215
0517-BBF	640	0602-CL	191	0602-BAB	229	0602-BIL	216
0517-BBG	640	0602-DA	191	0602-BAD	229	0602-BLA	213
0517-BBH	640	0602-DB	191	0602-BAH	228	0602-BLB	189
0517-BBI	640	0602-DC	191	0602-BAI	228	0602-BLC	216
0517-BCA	639	0602-DD	191	0602-BAL	228	0602-BLD	216
0517-BCB	639	0602-DE	191	0602-BBA	207	0602-BLE	216
0517-BCC	639	0602-DF	190	0602-BBB	207	0602-BLF	214
0517-BCD	639	0602-DG	190	0602-BBC	207	0602-BLG	214
0517-BCE	639	0602-DH	190	0602-BBD	222	0602-BLH	214
0517-BCF	639	0602-DI	194	0602-BBE	222	0602-BLI	214
0517-BCG	639	0602-DL	194	0602-BCF	208	0602-BLL	214
0517-BCH	639	0602-EA	194	0602-BCG	208	0602-CAB	184
0517-BCI	639	0602-EB	176, 630	0602-BCH	208	0602-CAC	184
0517-BCL	639	0602-EC	176	0602-BCI	208	0602-CAD	184
0517-BDA	639	0602-ED	176, 631	0602-BCL	208	0602-CAE	184
0517-BDB	639	0602-EE	194	0602-BDA	208	0602-CAF	184
0517-BDC	639	0602-EF	186	0602-BDB	206	0602-CAG	213
0517-BEA	655	0602-EG	225	0602-BDC	206	0602-CAH	213
0517-BEB	655	0602-EH	186	0602-BDD	188	0602-CAL	213
0517-BEC	655	0602-EI	186	0602-BDI	202	0602-CBA	213
0517-BED	655	0602-EL	186	0602-BDL	202	0602-CBB	183
0517-BEE	655	0602-FA	211	0602-BEA	196	0602-CBC	183
0517-BEF	655	0602-FB	211	0602-BEB	196	0602-CBD	183
0517-BEG	655	0602-FC	224	0602-BEC	196	0602-CBE	183
0517-BFA	645	0602-FD	224	0602-BED	203	0602-CBF	183
0517-BFB	645	0602-FE	224	0602-BEE	203	0602-CBG	185
0517-BFC	645	0602-FF	186	0602-BEF	204	0602-CBH	185
0517-BGB	641	0602-FH	186	0602-BEG	204	0602-CDG	182
0517-BGC	641	0602-FI	186	0602-BEH	199	0602-CDH	182
0517-BGD	641	0602-FL	186	0602-BEI	199	0602-CDI	182
0517-BGE	641	0602-GA	180	0602-BEL	199	0602-CDL	182
0517-BGF	641	0602-GB	180	0602-BFA	199	0602-CEB	181
0517-BGG	641	0602-GC	180	0602-BFB	199	0602-CEC	181
		0602-GD	180	0602-BFC	200	0602-CED	181
0518-EE	135	0602-GE	180	0602-BFD	200	0602-CEE	181
0518-EF	135	0602-GF	180	0602-BFE	200	0602-CEF	181
0518-EG	135	0602-GG	180	0602-BFF	200	0602-CEG	181
0518-EH	135	0602-GH	178	0602-BFG	209	0602-CEH	181
0518-EI	135	0602-GI	178	0602-BFH	209	0602-CEI	181
0518-GE	135	0602-GL	178	0602-BFI	209	0602-CEL	181
0518-GF	135	0602-HA	178	0602-BFL	210	0602-CFB	182
		0602-HB	178	0602-BGA	210	0602-CFC	182
0602-AB	187	0602-HC	178	0602-BGB	195	0602-CFD	182
0602-AC	187	0602-HD	178	0602-BGC	195	0602-CFE	182
0602-AD	189	0602-HE	178	0602-BGD	195	0602-CFF	182
0602-AE	189	0602-HF	178	0602-BGE	195	0602-CFG	182
0602-AF	189	0602-HG	179	0602-BGF	193	0602-CFH	182
0602-AG	215	0602-HH	179	0602-BGG	193	0602-CGF	198
0602-AH	215	0602-HI	179	0602-BGH	193	0602-CGG	198
0602-AI	192	0602-HL	179	0602-BGI	201	0602-CGH	198
0602-AL	192	0602-IA	179	0602-BGL	201	0602-CGI	219
0602-BA	192	0602-IB	179	0602-BHA	201	0602-CGL	219
0602-BB	212	0602-IC	179	0602-BHB	201	0602-CHA	219
0602-BC	212	0602-ID	179	0602-BHC	201	0602-CHB	220
0602-BD	212	0602-IE	177	0602-BHD	201	0602-CHC	220
0602-BE	187	0602-IF	177	0602-BHE	201	0602-CHD	218
0602-BF	187	0602-IG	177	0602-BHF	201	0602-CHE	218
0602-BG	214	0602-IH	177	0602-BHG	221	0602-CIA	212
0602-BH	192	0602-II	225	0602-BHH	221	0602-CIB	212
0602-BI	190	0602-IL	225	0602-BHI	221	0602-CID	212
0602-BL	188	0602-LA	185	0602-BHL	211	0602-CLG	368

Indice alfanumerico	Alfanumerical Index	Nummernverzeichnis	Index alphanumérique	Indice alfanumerico			
0602-CLH	368	0604-AB	605	0604-HL	39, 600, 619	0604-BLB	40
0602-CLI	368	0604-AC	605	0604-IA	39, 600, 619	0604-CAB	109
0602-DAA	226	0604-AD	602	0604-IB	39, 600, 619	0604-CAC	109
0602-DAB	226	0604-AE	602	0604-IC	607	0604-CAD	109, 233
0602-DAC	226	0604-AF	602, 617	0604-ID	607	0604-CAE	109, 233
0602-DAD	226	0604-AG	39	0604-IE	607, 617	0604-CBB	233
0602-DAE	226	0604-AH	605	0604-IF	607, 617	0604-CBD	233
0602-DAF	226	0604-AI	39	0604-IG	607	0604-CBE	610
0602-DAG	226	0604-AL	605	0604-IH	607	0604-CBF	610
0602-DAH	226	0604-BA	39, 601	0604-II	607	0604-CBG	610
0602-DAI	226	0604-BB	604	0604-IL	607	0604-CBI	241
0602-DAL	226	0604-BC	39, 601	0604-LA	608	0604-CBL	241
0602-DBA	226	0604-BD	39, 601	0604-LB	608	0604-CCB	41
0602-DBB	226	0604-BE	238	0604-LC	608	0604-CCD	41
0602-DBC	226	0604-BF	601	0604-LD	608	0604-CDB	600
0602-DCA	625	0604-BG	238	0604-LE	608	0604-CDC	600
0602-DCB	625	0604-BH	238	0604-LF	608	0604-CDD	600
0602-DCC	625	0604-BI	238	0604-BAF	234, 609, 620	0604-CDE	600
0602-DCD	625	0604-BL	238	0604-BAG	234, 609	0604-CDF	604
0602-DCE	625	0604-CA	238	0604-BAH	234, 609	0604-CEA	607
0602-DCF	625	0604-CB	239	0604-BAI	234, 609	0604-CEB	607
0602-DCG	625	0604-CC	239	0604-BAL	609	0604-CEC	608
0602-DCH	625	0604-CD	239	0604-BBA	609	0604-CED	608
0602-DCI	625	0604-CE	234	0604-BBB	609	0604-CEE	608, 620
0602-DCL	625	0604-CF	239	0604-BBC	609	0604-CEF	608
0602-DDA	625	0604-CH	240	0604-BBD	234	0604-CEG	235
0602-DCB	625	0604-CI	239	0604-BBE	234	0604-CEH	235
0602-DDC	625	0604-CL	239	0604-BBF	234	0604-CEI	235
0602-DCD	625	0604-DA	241	0604-BBG	234	0604-CEL	235
0602-DDE	625	0604-DB	242	0604-BBI	595, 618, 619	0604-DAG	42
0602-DDF	625	0604-DC	241	0604-BBL	595	0604-DAH	42
0602-DDG	625	0604-DD	240	0604-BCA	595	0604-DBA	42
0602-DDH	625	0604-DE	242	0604-BCB	611	0604-DBB	42
0602-DDI	625	0604-DF	240	0604-BCC	611	0604-DBI	237
0602-DDL	625	0604-DG	242	0604-BCD	595, 618, 619	0604-DBL	237
0602-DEA	625	0604-DH	242	0604-BCE	597, 617	0604-DCA	237
0602-DEB	625	0604-DI	242	0604-BCF	597	0604-DCB	237
0602-DEC	625	0604-DL	240	0604-BCG	597	0604-DCG	237
0602-DED	625	0604-EA	606	0604-BCH	597	0604-DCH	237
0602-DFA	227	0604-EB	602	0604-BCI	240	0604-DCI	237
0602-DFB	227	0604-EC	602, 617	0604-BCL	620	0604-DCL	237
0602-DFC	227	0604-ED	605	0604-BDA	597	0604-EAI	43
0602-DFD	227	0604-EE	605	0604-BDC	597, 618, 619	0604-EAL	43
0602-DFE	227	0604-EF	39	0604-BDE	597	0604-EBA	43
0602-DFG	227	0604-EG	39	0604-BDF	617	0604-EBB	43
0602-DFH	227	0604-EL	602	0604-BDG	597, 619	0604-EBC	43
0602-DFI	227	0604-FA	602	0604-BDH	41, 606	0604-ECA	236
0602-DFL	227	0604-FB	605	0604-BDI	41, 606	0604-ECB	236
0602-DGA	227	0604-FC	605	0604-BEG	604	0604-ECD	236
0602-DGB	227	0604-FE	617	0604-BEH	604		
0602-DGC	227	0604-FF	602	0604-BEI	241	0606-BA	557
0602-DGD	227	0604-FG	602	0604-BEL	241	0606-BB	557
0602-DGE	227	0604-FH	605	0604-BFA	609	0606-BC	557
0602-DGF	227	0604-FI	605	0604-BFB	609	0606-BD	557
0602-DGG	227	0604-FL	606	0604-BFC	610	0606-BE	556
0602-DGH	227	0604-GA	606	0604-BFD	610	0606-BF	556
0602-DGI	227	0604-GB	604	0604-BFE	610	0606-BG	556
0602-DGL	227	0604-GC	604	0604-BFF	610	0606-BH	556
0602-DIA	228	0604-GD	235	0604-BFG	610	0606-CA	465
0602-DIB	228	0604-GE	601	0604-BFH	610	0606-CB	465
0602-DIC	228	0604-GF	601	0604-BFI	617	0606-CC	465
0602-DID	228	0604-GG	603	0604-BFL	617	0606-CD	465
0602-DIE	228	0604-GH	603	0604-BGA	608	0606-DA	647
0602-DIF	228	0604-GI	603	0604-BGB	608	0606-DB	648
0602-DIG	228	0604-GL	603, 619	0604-BGC	609	0606-DC	647
0602-DIH	228	0604-HA	603, 619	0604-BGF	611	0606-DD	647
0602-DII	228	0604-HB	603	0604-BGG	611	0606-DE	647
0602-DIL	228	0604-HC	603	0604-BGL	611	0606-DF	649
		0604-HD	603	0604-BIG	40	0606-DG	649
		0604-HE	603	0604-BIH	40	0606-DH	649

Indice alfanumerico	Alfanumerical Index	Nummernverzeichnis	Index alphanumérique	Indice alfanumerico			
0606-DI	648	0606-CBE	559	0607-FG	51	0607-BFH	49
0606-DL	648	0606-CBF	559	0607-FH	51	0607-BFI	49
0606-FL	650	0606-CBG	559	0607-FI	47	0607-BFL	49
0606-GA	650	0606-EAB	555	0607-GA	63	0607-BGA	102
0606-GB	650	0606-EAC	555	0607-GB	63	0607-BGB	102
0606-GC	650	0606-EAD	555	0607-GD	97	0607-BGH	84
0606-GE	649	0606-EAE	555	0607-GE	97	0607-BGI	84
0606-HA	460	0606-EBB	555	0607-GG	52	0607-BIA	79
0606-HB	460	0606-EBC	555	0607-GH	52	0607-BIB	101
0606-HC	460	0606-EBD	555	0607-GI	52		
0606-HD	460	0606-EBE	555	0607-GL	52	0610-AB	420
0606-HE	460			0607-HA	73	0610-B	53
0606-IA	461	0607-B	44, 619	0607-HB	73	0610-B1903	85
0606-IB	461	0607-B1803	81	0607-HC	73	0610-AC	420
0606-IC	461	0607-B1903	84	0607-HD	63	0610-C	53
0606-ID	461	0607-C	44, 619	0607-HE	63	0610-C1903	85
0606-IE	461	0607-C1803	81	0607-HF	63	0610-AD	420
0606-IF	461	0607-C1903	84	0607-HI	73	0610-AE	420
0606-IG	461	0607-D	46	0607-HL	73	0610-AF	420
0606-LA	464	0607-E	44	0607-IA	74	0610-AG	420
0606-LB	464	0607-F	44	0607-IB	74	0610-AH	420
0606-LC	464	0607-G03	52	0607-IC	74	0610-AI	420
0606-BAC	462	0607-G17	52	0607-ID	74	0610-AL	500
0606-BAD	462	0607-H	71	0607-IE	74	0610-BA	53
0606-BAE	462	0607-I	71	0607-IF	74	0610-BB	414
0606-BAF	462	0607-L	71	0607-IG	73	0610-BC	395
0606-BAG	462	0607-BA	68	0607-IH	73	0610-BD	414
0606-BAH	462	0607-BB11	83	0607-II	69	0610-BE	414
0606-BAI	462	0607-BC11	83	0607-IL	73	0610-BF	404
0606-BAL	462	0607-BD	44	0607-LC	84	0610-BG	404
0606-BBA	462	0607-BE	61	0607-LG	77	0610-BH	404
0606-BBB	462	0607-BF	44	0607-LH	77	0610-BI	404
0606-BCA	463	0607-BG	57	0607-LL	71	0610-BL	404
0606-BCB	463	0607-BH	57	0607-BAA	59	0610-CA	389
0606-BCC	463	0607-BI	57	0607-BAB	45	0610-CB	421
0606-BCD	463	0607-BL03	52	0607-BAC	45	0610-CC	421
0606-BCE	463	0607-BL17	52	0607-BAD	45	0610-CD	421
0606-BCF	463	0607-CA	50	0607-BAE	44	0610-CE	421
0606-BCG	463	0607-CB	47	0607-BAF	45	0610-CF	421
0606-BCH	463	0607-CC	47	0607-BAG	69	0610-CG	421
0606-BCI	463	0607-CD	45	0607-BAH	69	0610-CH	389
0606-BCL	463	0607-CE	45	0607-BAI	46	0610-CI	389
0606-BDA	463	0607-CF	48	0607-BAL	46	0610-DA	389
0606-BDB	463	0607-CG	48	0607-BBA	72, 476	0610-DB	421
0606-BDC	463	0607-CH	48	0607-BBB	476	0610-DC	421
0606-BDD	463	0607-CI	61	0607-BBG	58	0610-DD	421
0606-BDE	463	0607-DA	46	0607-BBH	57	0610-DE	421
0606-BDF	463	0607-DB	101	0607-BBL	46	0610-DF	421
0606-BDG	463	0607-DC	101	0607-BCD	47	0610-DG	421
0606-BDH	463	0607-DD	101	0607-BCE	47	0610-DH	421
0606-BDI	463	0607-DE	77	0607-BCF	68	0610-DI	421
0606-BDL	463	0607-DF	77	0607-BCG	68	0610-DL	421
0606-BEA	463	0607-DG	47	0607-BCH	68	0610-EA	403
0606-BEB	463	0607-DH	47	0607-BCI	68	0610-EB	403
0606-BEC	463	0607-DI	46	0607-BCL	78	0610-EC	403
0606-BED	463	0607-DL	46	0607-BDB	48	0610-ED	403
0606-BEE	463	0607-EA	72, 476	0607-BDC	69	0610-EE	403
0606-BEF	463	0607-EB	70	0607-BDD	69	0610-EF	389
0606-BEG	463	0607-EC	70	0607-BDI	76	0610-EG	389
0606-BEH	433	0607-ED	59	0607-BDL	76	0610-EH	394
0606-BEI	433	0607-EE	59	0607-BEA	58	0610-EI	389
0606-BEL	433	0607-EH	57	0607-BEB	58	0610-EL	389
0606-BIA	558	0607-EI	57	0607-BEC	58	0610-FB	390
0606-BIB	558	0607-EL	57	0607-BEE	78	0610-FC	390
0606-BIC	558	0607-FA	51	0607-BEH	58	0610-FD	390
0606-BID	558	0607-FB	51	0607-BEI	58	0610-FE	391
0606-BIE	558	0607-FC	51	0607-BEL	79	0610-FF	391
0606-BIF	558	0607-FD	51	0607-BFA	101	0610-FG	393
0606-BIG	558	0607-FE	51	0607-BFC	70	0610-FH	394
0606-BIH	558	0607-FF	51	0607-BFG	49	0610-FI	392

Indice alfanumerico	Alfanumerical Index	Nummernverzeichnis	Index alphanumérique	Indice alfanumerico			
0610-FL	392	0610-BDI	418	0610-CDI	406	0611-IB	441
0610-GA	420	0610-BDL	418	0610-CEA	406	0611-IC	441
0610-GB	420	0610-BEA	424	0610-CED	414	0611-ID	441
0610-GC	420	0610-BEB	424	0610-CEE	414	0611-IE	444
0610-GD	420	0610-BEC	424	0610-CEI	402	0611-IF	444
0610-GE	420	0610-BED	424	0610-CEL	402	0611-IG	444
0610-GF	420	0610-BEE	424	0610-CFA	402	0611-IH	444
0610-GG	420	0610-BEF	424	0610-CFB	402	0611-II	444
0610-GH	420	0610-BEH	424	0610-CFC	401	0611-IL	444
0610-GI	420	0610-BEI	424	0610-CFE	402	0611-LA	444
0610-GL	420	0610-BEL	424	0610-CFF	402	0611-LB	441
0610-HA	416	0610-BFA	424	0610-CFG	402	0611-LC	441
0610-HB	416	0610-BFB	424	0610-CFH	402	0611-LD	441
0610-HC	417	0610-BFC	424	0610-CFI	402	0611-LE	437
0610-HD	417	0610-BFD	424	0610-CGA	401	0611-LF	437
0610-HE	417	0610-BFE	424	0610-CGB	401	0611-LG	437
0610-HF	416	0610-BFF	424	0610-CGC	401	0611-LH	437
0610-HG	416	0610-BFG	407	0610-CGD	401	0611-LI	437
0610-HH	416	0610-BFH	407			0611-LL	437
0610-HI	416	0610-BFI	407	0611-AB	429	0611-BAA	441
0610-HL	417	0610-BFL	407	0611-AC	429	0611-BAB	441
0610-IA	401	0610-BGA	423	0611-AD	435	0611-BAC	441
0610-IB	392	0610-BGB	423	0611-AE	435	0611-BAD	441
0610-IC	401	0610-BGC	423	0611-AF	435	0611-BAE	430
0610-ID	416	0610-BGD	423	0611-AG	432	0611-BAF	430
0610-IE	416	0610-BGE	394	0611-AL	429	0611-BAG	430
0610-IF	413	0610-BGI	394	0611-AL17	429	0611-BAH	431
0610-IG	413	0610-BGL	394	0611-BA12	429	0611-BAI	431
0610-IH	53	0610-BHA	423	0611-BB	429	0611-BAL	431
0610-II	53	0610-BHB	423	0611-BB17	429	0611-BBA	441
0610-LA	491	0610-BHC	423	0611-BC	429	0611-BBB	432
0610-LB	491	0610-BHD	423	0611-BC17	429	0611-BBC	431
0610-LC	491	0610-BHG	393	0611-BD	435	0611-BBD	432
0610-LD	393	0610-BHH	417	0611-BE	435	0611-BBE	435
0610-LE	413	0610-BHI	417	0611-BF	435	0611-BBF	435
0610-LF	413	0610-BHL	393	0611-BG	437	0611-BBG	435
0610-LG	411, 571	0610-BIA	423	0611-BH	437	0611-BBH	441
0610-LH	411, 571	0610-BIB	423	0611-BI	437	0611-BBI	435
0610-LI	411, 571	0610-BIC	423	0611-CA	434	0611-BBL	441
0610-LL	411, 571	0610-BID	423	0611-CB	434	0611-BCG	435
0610-BAA	492	0610-BII	418	0611-CC	434	0611-BCH	435
0610-BAB	492	0610-BIL	418	0611-CD	435	0611-BDC	435
0610-BAC	492	0610-BLA	423	0611-CE	435	0611-BDF	435
0610-BAD	492	0610-BLB	423	0611-CL	437	0611-BDG	435
0610-BAE	492	0610-BLC	423	0611-DA	434	0611-BDI	435
0610-BAF	493	0610-BLD	408	0611-DB	434	0611-BEH	449
0610-BAG	493	0610-BLE	408	0611-DC	437	0611-BEI	449
0610-BAH	493	0610-BLF	408	0611-DD	434	0611-BEL	449
0610-BAI	493	0610-BLG	408	0611-DE	437	0611-BFA	28, 491
0610-BAL	493	0610-BLH	422	0611-DF	434	0611-BFB	28, 491
0610-BBA	419	0610-BLI	422	0611-DG	437	0611-BFC	28, 491
0610-BBB	419	0610-CAA	426	0611-EA	435	0611-BFD	28, 491
0610-BBC	419	0610-CAB	425	0611-EB	437	0611-BGA	439
0610-BBD	419	0610-CAC	425	0611-EC	437	0611-BGC	439
0610-BBE	419	0610-CAD	425	0611-ED	437	0611-BGE	439
0610-BBF	419	0610-CAE	425	0611-EE	437	0611-BGG	439
0610-BBG	419	0610-CAF	426	0611-EF	437	0611-BGI	439
0610-BBL	412	0610-CAG	426	0611-EG	437	0611-BHA	439
0610-BCA	419	0610-CAH	426	0611-EH	437	0611-BHC	439
0610-BCB	419	0610-CAI	426	0611-EI	437	0611-BHE	439
0610-BCC	419	0610-CBB	425	0611-EL	437	0611-BHG	439
0610-BCD	419	0610-CBC	425	0611-FD	437	0611-BHH	436
0610-BCE	419	0610-CBD	425	0611-FE	437	0611-BHI	439
0610-BCF	419	0610-CCB	425	0611-FI	437	0611-BHL	436
0610-BCG	419	0610-CCC	425	0611-FL	440	0611-BIA	439
0610-BDA	422	0610-CCD	425	0611-GA	440	0611-BIB	436
0610-BDB	422	0610-CDA	405	0611-GB	440	0611-BIC	439
0610-BDC	422	0610-CDC	405	0611-GC	440	0611-BID	436
0610-BDG	418	0610-CDE	405	0611-GD	441	0611-BIE	436
0610-BDH	418	0610-CDG	406	0611-GE	441	0611-BIF	436



Indice alfanumerico		Alfanumerical Index		Nummernverzeichnis		Index alphanumérique		Indice alfanumerico	
0611-BIG	436	0611-DBF	443	0612-BG	75	0612-IB	65		
0611-BIH	436	0611-DBG	443	0612-BH	75	0612-IC	65		
0611-BII	436	0611-DCA	584	0612-BI	75	0612-ID	65		
0611-BIL	436	0611-DCC	584	0612-BL	75	0612-IE	65		
0611-BLA	445	0611-DCD	584	0612-CA	76	0612-IF	65		
0611-BLB	445	0611-DCE	584	0612-CB	76	0612-IG	66		
0611-BLC	445	0611-DDE	450	0612-CC	76	0612-IH	66		
0611-BLD	445	0611-DDF	450	0612-CD	76	0612-II	66		
0611-BLE	445	0611-DDG	450	0612-CE	64	0612-IL	66		
0611-BLI	425	0611-DDH	450	0612-CE1803	82	0612-LA	92		
0611-CBA	446	0611-DEA	442	0612-CF	64	0612-LB	92		
0611-CBB	446	0611-DEB	442	0612-CF1803	82	0612-LC	92		
0611-CBC	446	0611-DEC	442	0612-CG	77	0612-LE	92		
0611-CBD	446	0611-DED	442	0612-CH	55	0612-LG	84, 92		
0611-CBE	446	0611-DEE	442	0612-CI	55	0612-LH	92		
0611-CBF	446	0611-DEF	442	0612-CL	55	0612-LI	92		
0611-CBG	446	0611-DEG	442	0612-CL11	83	0612-LL	92		
0611-CCA	446	0611-DEH	442	0612-CL1803	82	0612-BAA	99		
0611-CCB	446	0611-DEI	442	0612-DA	55	0612-BAC	99		
0611-CCC	446	0611-DEL	442	0612-DA11	83	0612-BAE	99		
0611-CCD	446	0611-DFA	442	0612-DA1803	82	0612-BAL	59		
0611-CCE	446	0611-DFB	442	0612-DB	55	0612-BBA	67		
0611-CCF	446	0611-DFC	442	0612-DC	55	0612-BBB	67		
0611-CCG	446	0611-DFD	442	0612-DD	55	0612-BBC	62		
0611-CDA	445	0611-DFE	442	0612-DE	55	0612-BBD	62		
0611-CDB	445	0611-DFG	442	0612-DF	54	0612-BBE	62		
0611-CDC	445	0611-DFH	442	0612-DG	54	0612-BBF	62		
0611-CDD	445	0611-DFI	442	0612-DH	54	0612-BBG	62		
0611-CDE	445	0611-DFL	442	0612-DI	54	0612-BBH	62		
0611-CEA	445	0611-DGA	442	0612-DL	54	0612-BBI	85		
0611-CEB	445	0611-DGB	442	0612-EA	54	0612-BBL	85		
0611-CEC	445	0611-DGC	442	0612-EB	56	0612-BCA	61		
0611-CED	445	0611-EAB	583	0612-EC	56	0612-BCB	61		
0611-CEE	445	0611-EAC	583	0612-ED	56	0612-BCC	61		
0611-CFA	448	0611-EAD	583	0612-EE	56	0612-BDA	94		
0611-CFB	448	0611-EAE	583	0612-EF	56	0612-BDB	94		
0611-CFC	448	0611-EAF	583	0612-EG	56	0612-BDC	94		
0611-CFD	433	0611-EBA	583	0612-EH	59	0612-BDD	94		
0611-CFE	433	0611-EBB	583	0612-EI	59	0612-BDE	95		
0611-CFF	433	0611-EBC	583	0612-EL	55	0612-BDF	95		
0611-CFG	433			0612-FA	86	0612-BDG	95		
0611-CFH	433	0612-B	60	0612-FB	86	0612-BDH	95		
0611-CFI	433	0612-B06	60	0612-FC	86	0612-BDL	96		
0611-CFL	433	0612-B1803	81	0612-FD	86	0612-BEA	96		
0611-CGA	448	0612-C	60	0612-FE	87	0612-BEB	96		
0611-CGB	448	0612-C06	60	0612-FF	87	0612-BEC	96		
0611-CGC	448	0612-C1803	81	0612-FG	87	0612-BED	96		
0611-CGD	438	0612-D	60	0612-FH	87	0612-BEF	88		
0611-CGE	438	0612-D06	60	0612-FI	88	0612-BEG	88		
0611-CGF	438	0612-D1803	81	0612-FL	88	0612-BEH	88		
0611-CGG	438	0612-E	60	0612-GA	88	0612-BEI	86		
0611-CGH	438	0612-E06	60	0612-GB	88	0612-BEL	86		
0611-CGI	438	0612-E1803	81	0612-GC	55	0612-BFA	86		
0611-CGL	438	0612-F	64	0612-GD	55	0612-BFB	87		
0611-CHA	448	0612-F1803	82	0612-GF	55	0612-BFC	87		
0611-CHC	446	0612-G	64	0612-GG	89	0612-BFD	87		
0611-CIA	447	0612-G1803	82	0612-GH	89	0612-BFE	93		
0611-CIB	447	0612-H	56	0612-GI	89	0612-BFF	93		
0611-CIC	447	0612-H11	83	0612-GL	89	0612-BFG	93		
0611-CID	447	0612-I	56	0612-HA	61	0612-BFH	93		
0611-CIE	447	0612-I11	83	0612-HB	61	0612-BFL	93		
0611-CIF	447	0612-L	54	0612-HC	56	0612-BGA	89		
0611-DAH	443	0612-L11	83	0612-HD	56	0612-BGB	89		
0611-DAI	443	0612-BA	54	0612-HE	61	0612-BGC	89		
0611-DAL	443	0612-BA11	83	0612-HF	61	0612-BGD	89		
0611-DBA	443	0612-BB	62	0612-HG	67	0612-BHE	97		
0611-DBB	443	0612-BC	59	0612-HH	67	0612-BHF	77		
0611-DBC	443	0612-BD	62	0612-HI	67	0612-BIA	66		
0611-DBD	443	0612-BE	75	0612-HL	67	0612-BIB	66		
0611-DBE	443	0612-BF	75	0612-IA	65	0612-BII	64		

Indice alfanumerico	Alfanumerical Index	Nummernverzeichnis	Index alphanumérique	Indice alfanumerico			
0612-BIL	64	0614-GB	474	0614-BGB	472	0706-BA	662
0612-BLA	98	0614-GC	484	0614-BGC	453	0706-BB	665
0612-BLB	98	0614-GD	72, 476	0614-BGD	453	0706-BC	662
0612-BLC	98	0614-GE	480	0614-BGF	453	0706-BD	660
0612-BLD	97	0614-GF	483	0614-BHB	457	0706-BE	660
0612-BLE	98	0614-GG	480	0614-BHC	457	0706-BF	660
0612-CAB	90	0614-GH	479	0614-BHD	457	0706-BG	660
0612-CAC	91	0614-GI	480	0614-BHE	457	0706-BH	660
0612-CAD	90	0614-GL	479	0614-BHF	457	0706-BI	660
0612-CAE	91	0614-HB	483	0614-BIA	458	0706-BL	675
0612-CAF	90	0614-HC	483	0614-BIB	458	0706-CA	666
0612-CAG	91	0614-HD	483	0614-BIC	458	0706-CB	671
0612-CAH	90	0614-HE	483	0614-BID	458	0706-CC	675
0612-CAI	91	0614-HF	483	0614-BIE	458	0706-CD	675
0612-CAL	90	0614-HG	478	0614-BIF	458	0706-CE	671
0612-CBA	91	0614-HI	479	0614-BIG	458	0706-CF	671
0612-CBB	90	0614-HL	480	0614-BIH	458	0706-CG	671
0612-CBC	91	0614-IA	488	0614-BII	458	0706-CH	671
0612-DFA	85	0614-IB	480	0614-BIL	458	0706-CI	671
		0614-IC	484	0614-BLL	471	0706-CL	675
0614-BA	468	0614-IE	484	0614-CAA	472	0706-DA	659
0614-BB	469	0614-IF	466	0614-CAB	455	0706-DB	659
0614-BC	469	0614-IH	466	0614-CAC	455	0706-DC	659
0614-BD	469	0614-II	466	0614-CAD	455	0706-DD	659
0614-BE	469	0614-IL	466	0614-CAE	455	0706-DE	659
0614-BF	467	0614-LA	487	0614-CAF	455	0706-DF	659
0614-BG	467	0614-LB	487	0614-CBC	455	0706-DG	665
0614-BH	467	0614-LC	487	0614-CBD	455	0706-DH	665
0614-BI	467	0614-LD	479	0614-CBF	455	0706-DI	665
0614-BL	467	0614-LE	479	0614-CCC	456	0706-DL	665
0614-CA	470	0614-LG	487	0614-CCD	456	0706-EA	679
0614-CB	467	0614-BAA	454	0614-CCE	456	0706-EB	674
0614-CC	466	0614-BAB	454	0614-CCF	456	0706-EC	674
0614-CD	466	0614-BAC	454	0614-CLL	488	0706-ED	670
0614-CE	466	0614-BAD	454	0614-DAA	488	0706-EE	665
0614-CF	468	0614-BAE	454			0706-EF	670
0614-CH	468	0614-BAF	484	0617-BF	395	0706-EG	675
0614-CI	470	0614-BAI	474	0617-BI	572	0706-EH	670
0614-CL	470	0614-BBA	486	0617050517	395	0706-EI	667
0614-DA	470	0614-BBC	486			0706-EL	667
0614-DB	470	0614-BBE	486	07-I	9	0706-FA	667
0614-DC	470	0614-BBF	486	07-BA	9	0706-FB	668
0614-DD	468	0614-BBG	486	07-BC	9	0706-FC	668
0614-DE	470	0614-BBH	454	07-BE	9	0706-FD	672
0614-DF	470	0614-BBI	454	07-BG	9	0706-FE	662
0614-DG	471	0614-BBL	454	07-BI	9	0706-FF	672
0614-DH	469	0614-BCA	454	07-CA	9	0706-FG	672
0614-DI	471	0614-BCB	454	07-CC	9	0706-FH	672
0614-DL	469	0614-BCC	454	07-CE	9	0706-FI	672
0614-EA	475	0614-BCD	454	07-CG	9	0706-FL	672
0614-EB	473	0614-BCE	454	07-CI	9	0706-GA	674
0614-EC	473	0614-BCF	456	07-DA	9	0706-GB	674
0614-ED	468	0614-BCG	456			0706-GC	681
0614-EE	478	0614-BCH	456	0701-LF	586	0706-GD	670
0614-EF	469	0614-BCI	456	0701-LG	586	0706-GE	681
0614-EG	481	0614-BCL	456	0701-LH	586	0706-GF	670
0614-EH	481	0614-BDA	485	0701-LI	586	0706-GG	681
0614-EI	481	0614-BDB	485	0701-LL	586	0706-GH	670
0614-EL	481	0614-BDD	485	0701-BAA	586	0706-GL	674
0614-FA	478	0614-BDE	485			0706-HA	674
0614-FB	478	0614-BDG	585	0706-AB	665	0706-HB	667
0614-FC	478	0614-BDH	585	0706-AC	665	0706-HC	667
0614-FD	478	0614-BEB	563	0706-AD	665	0706-HF	661
0614-FE	478	0614-BEC	563	0706-AE	665	0706-HG	661
0614-FF	482	0614-BED	73, 564	0706-AF	665	0706-HH	661
0614-FG	482	0614-BEE	564	0706-AG	662	0706-HI	661
0614-FH	482	0614-BEG	474	0706-AH	662	0706-IA	673
0614-FI	474	0614-BFI	475	0706-AI	668	0706-IB	673
0614-FL	474	0614-BFL	488	0706-AL	666	0706-IC	673
0614-GA	474	0614-BGA	472	0706-AL02	666	0706-ID	673

Indice alfanumerico	Alfanumerical Index	Nummernverzeichnis	Index alphanumérique	Indice alfanumerico			
0706-IE	673	0706-BGF	677	0718-AL	697	1009-IC	495
0706-IF	678	0706-BGG	677	0718-BA	696	1009-IF	495
0706-IG	678	0706-BGH	677	0718-BB	696	1009-LA	495
0706-IH	678	0706-BGI	677	0718-BG	35	1009-LL	494
0706-II	678	0706-BGL	677	0718-BI	35	1009-BAA	494
0706-IL	684	0706-BHA	677	0718-CA	23	1009-BAC	494
0706-LA	684	0706-BHB	677	0718-CB	23	1009-BBE	494
0706-LC	676	0706-BHC	677	0718-CC	23	1009-BBF	494
0706-LD	676	0706-BHD	677	0718-CD	23, 104	1009-BBG	494
0706-LE	676	0706-BHE	677	0718-CE	23, 104	1009-BBH	494
0706-LG	676	0706-BHF	677	0718-CF	23, 104	1009-BBI	494
0706-LH	676	0706-BHG	677	0718-CG	23, 104	1009-BCA	494
0706-LI	666	0706-BHH	677	0718-CH	23, 104	1009-BCC	494
0706-LL	666	0706-BHI	677	0718-CI	23, 104	1009-BCF	494
0706-BAA	678	0706-BHL	677	0718-CL	23, 104	1009-BDA	494
0706-BAB	678	0706-BIA	679	0718-DA	697	1009-BGA	496
0706-BAC	678	0706-BIE	679	0718-DB	697	1009-BGB	496
0706-BAD	678	0706-BII	679	0718-EA	24	1009-BHF	497
0706-BAE	666	0706-BIL	679	0718-EC	24	1009-BHG	497
0706-BAG	377	0706-BLA	680	0718-EE	24	1009-BHH	497
0706-BAI	646	0706-BLB	680	0718-EG	24	1009-BHI	497
0706-BAL	646	0706-BLC	680	0718-EI	24	1009-BHL	497
0706-BBA	666	0706-BLD	663	0718-FA	24	1009-BIA	497
0706-BBB	676	0706-BLE	663			1009-BIB	497
0706-BBC	676	0706-BLF	663	1009-AA	494	1009-BIC	497
0706-BBD	676	0706-BLG	663	1009-AB	494	1009-BID	497
0706-BBE	664	0706-BLH	663	1009-AC	494	1009-BIE	497
0706-BBF	664	0706-CAA	679	1009-BA	516	1009-BIF	497
0706-BBG	664	0706-CBA	668	1009-BE	494	1009-BIG	497
0706-BBH	664	0706-CBB	668	1009-BF	494	1009-BIH	497
0706-BBI	675	0706-CBC	668	1009-BG	494	1009-BII	497
0706-BBL	675	0706-CBD	668	1009-BH	494	1009-BIL	497
0706-BCA	374	0706-CBE	668	1009-BI	494	1009-BLA	497
0706-BCB	374	0706-CBF	668	1009-CA	494	1009-BLB	497
0706-BCC	374	0706-CBG	668	1009-CC	494	1009-BLC	497
0706-BCD	374	0706-CBH	668	1009-CF	494	1009-BLD	497
0706-BCE	663	0706-CCC	668	1009-DA	494	1009-BLE	497
0706-BCF	663	0706-CCD	668	1009-EA	494	1009-BLF	497
0706-BCG	663	0706-CCE	668	1009-EB	494	1009-BLG	497
0706-BCH	663	0706-CCF	668	1009-EC	494	1009-BLH	497
0706-BCI	663	0706-CCG	668	1009-ED	494	1009-BLI	497
0706-BCL	663	0706-CCH	668	1009-EE	494	1009-BLL	497
0706-BDF	646	0706-CCI	668	1009-EF	494	1009-CAC	499
0706-BDG	646	0706-CCL	668	1009-EG	494	1009-CAD	499
0706-BDH	646	0706-CDA	668	1009-EH	494	1009-CAE	499
0706-BDI	646	0706-CDC	670	1009-EI	494	1009-CAF	499
0706-BDL	646	0706-CEA	669	1009-EL	494	1009-CAG	499
0706-BEA	669	0706-CEB	669	1009-FA	496	1009-CAH	499
0706-BEB	669	0706-CEC	669	1009-FB	496	1009-CAI	499
0706-BEC	669	0706-CED	669	1009-FC	496	1009-CAL	499
0706-BED	669	0706-CEE	669	1009-FD	496	1009-CBA	499
0706-BEE	669			1009-FE	496	1009-CBB	499
0706-BEF	664	070603	49	1009-FF	496	1009-CBC	499
0706-BEG	664	070603-18	45	1009-FG	496	1009-CCA	495
0706-BEH	664	070603-1803	80	1009-FH	496	1009-CCB	495
0706-BEI	664	070603-1903	84	1009-FI	496	1009-CCC	495
0706-BFA	669	070617	49	1009-GA	495	1009-CCD	495
0706-BFB	669	070617-18	45	1009-GB	495	1009-CDA	498
0706-BFC	669	070617-1803	80	1009-GC	495	1009-CDB	498
0706-BFD	669	070617-1903	84	1009-GD	495	1009-CDC	498
0706-BFE	669	070618	50	1009-GE	495	1009-CDI	498
0706-BFG	677	070618-1803	80	1009-GL	495	1009-CEA	498
0706-BFH	677			1009-HA	495	1009-CEC	498
0706-BFI	677	0718-AB	697	1009-HC	495	1009-CEE	498
0706-BFL	677	0718-AC	696	1009-HE	495	1009-CEG	498
0706-BGA	677	0718-AD	696	1009-HF	495	1009-CEI	498
0706-BGB	677	0718-AE	696	1009-HG	495	1009-CFC	496
0706-BGC	677	0718-AF	697	1009-HH	495	1009-CFE	496
0706-BGD	677	0718-AG	696	1009-HI	495	1009-CFG	496
0706-BGE	677	0718-AH	697	1009-IA	495	1009-CFI	496

Indice alfanumerico	Alfanumerical Index	Nummernverzeichnis	Index alphanumérique	Indice alfanumerico			
1009-CGA	496	1102-BC	33	1118-HI	530	1118-DBB	528
1009-CGC	496	1102-BC04	33	1118-IA	524	1118-DBC	528
1009-CGE	496	1102-BD	33	1118-IB	524	1118-DBD	528
1009-CIA	496	1102-BF	33	1118-IC	524	1118-DBE	528
1009-CIC	496	1102-BI	33	1118-ID	524	1118-DBF	528
1009-CIE	496	1102-CA	33	1118-IE	524	1118-DBG	529
1009-CIG	496	1102-CB	33	1118-IF	524	1118-DBH	529
1009-CII	496	1102-CC	33	1118-LA	525	1118-DBI	529
1009-CLA	496	1102-CD	33	1118-LB	525	1118-DCA	527
1009-CLD	498	1102-CE	33	1118-LC	525	1118-DCB	527
1009-CLE	498	1102-CF	33	1118-LD	525	1118-DCC	527
1009-CLF	498	1102-DG	33	1118-LE	518	1118-DCD	527
1009-CLG	498	1102-EA	35	1118-LF	518	1118-DCE	527
1009-CLH	498	1102-DGB	34	1118-LG	518	1118-DCF	527
1009-CLI	498	1102-DGC	34	1118-LH	518	1118-DCG	527
1009-DAA	497	1102-DGD	34	1118-LI	518	1118-DCL	527
1009-DAB	497	1102-DGE	34	1118-BAA	500	1118-DDA	527
1009-DAG	500	1102-DGF	34	1118-BAB	530	1118-EAA	531
1009-DAH	500	1102-DGG	34	1118-BAC	530	1118-EAF	531
1009-DAI	500	1102-DGH	34	1118-BAD	530	1118-EAG	531
1009-DCC	499	1102-DGI	34	1118-BAE	530	1118-EBA	531
1009-DDA	498	1102-DGL	34	1118-BAG	500		
1009-DDB	498			1118-BBA	499	1123-IA	507
1009-DDC	498	1107-B	50	1118-BBC	518	1123-IC	510
1009-DDD	498	1107-B1803	80	1118-BBD	518	1123-LC1903	510
1009-DDE	498	1107-C1803	80	1118-BBE	518	1123-LF1903	510
1009-DDF	498	1107-G	50	1118-BBF	518	1123-LG1903	510
1009-DDG	498			1118-BBG	526	1123-LL	510
		1110-B	48	1118-BBH	526	1123-BAC	513
1014-B	381	1110-C	53	1118-BBL	526	1123-BAD	513
1014-C	381	1110-D	48	1118-BCA	523	1123-BAE	514
1014-BB	565	1110-E	53	1118-BCB	526	1123-BAF	514
1014-BC	565			1118-BCC	530	1123-BAG	514
1014-BE	383	1118-AG	22, 516	1118-BCD	530	1123-BAH	515
1014-BF	383	1118-AH	22, 516	1118-BCE	526	1123-BAI	473
1014-BG	383	1118-AI	22, 516	1118-BCF	522	1123-BAL	473
1014-BH	383	1118-AL	22, 516	1118-BCG	522	1123-BBA	473
1014-BI	382	1118-BA	519	1118-BCH	529	1123-BBC	475
1014-BL	382	1118-BB	519	1118-BCI	529	1123-BBD	532
1014-CA	395	1118-BC	519	1118-BDF	522	1123-BBE	532
1014-CB	382	1118-BD	519	1118-BDG	522	1123-BBF	532
1014-CC	395	1118-BE	519	1118-BDH	522	1123-BCA	533
1014-CD	395	1118-BF	519	1118-BDI	522	1123-BCB	533
1014-CE	382	1118-BG	519	1118-BDL	522	1123-BCC	533
1014-CF	382	1118-BH	519	1118-BEA	522	1123-BCD	533
1014-CG	382	1118-CA	520	1118-CAA	517	1123-BCF	512
1014-CH	382	1118-CB	520	1118-CAB	517	1123-BDA	509
1014-CI	382	1118-CC	520	1118-CAC	517	1123-BDB	509
1014-CL	382	1118-CD	520	1118-CCH	501	1123-BDE	508
1014-DA	397	1118-CE	520	1118-CCI	501	1123-BDF	508
1014-DE	384	1118-CF	520	1118-CCL	501	1123-BDG	508
1014-DF	384	1118-CG	520	1118-CDA	503	1123-BDH	508
1014-DG	384	1118-CH	520	1118-CDB	503	1123-BDI	509
1014-DH	384	1118-CI	520	1118-CDC	503	1123-BDL	509
1014-DI	397	1118-CL	520	1118-CDD	501	1123-BEA	509
1014-DL	395	1118-DA	520	1118-CDE	503	1123-BEB	509
1014-EA	385	1118-DC	519	1118-CDF	527	1123-BGA	477
1014-EB	385	1118-DD	519	1118-CDG	501, 502	1123-BGB	477
1014-EC	385	1118-EA	521	1118-CDH	502	1123-BGC	477
1014-ED	385	1118-EB	521	1118-CDI	502	1123-BGD	477
1014-EE	385	1118-EC	521	1118-CDL	502	1123-BGE	477
1014-EG	397	1118-ED	521	1118-CEA	523	1123-BGF	477
1014-EH	383	1118-EE	521	1118-CEB	501, 502	1123-BGG	477
1014-EI	383	1118-EF	521	1118-CEC	523		
1014-EL	383	1118-EG	521	1118-CEE	523	1201-G	9
1014-FA	383	1118-EH	521	1118-DAA	414	1201-02B	30
1014-GA	289	1118-EI	521	1118-DAB	414	1201-02C	30
		1118-EL	521	1118-DAC	414	1201-02D	30
1102-BA	33	1118-FA	521	1118-DAD	414	1201-02D12	30
1102-BB	33	1118-HG	530	1118-DBA	528	1201-02D11	31

Indice alfanumerico	Alfanumerical Index	Nummernverzeichnis	Index alphanumérique	Indice alfanumerico			
1201-02E	32	1206-IF	615	1310-BI	27, 590, 617	1310-LC	599
1201-02E11	32	1206-IG	615	1310-BL	589	1310-LD	589, 618, 620
1201-02F	31	1206-IH	615	1310-CA	27, 590	1310-LE	592
1201-02G	32	1206-II	615	1310-CB	591	1310-LF	28
1201-02H	30	1206-LD	107, 617	1310-CC	591	1310-LG	28
1201-02H10	30	1206-LE	107, 617	1310-CD	591, 617	1310-LH	592, 618
1201-02I	30	1206-LH	618	1310-CE	591	1310-LI	592
1201-02L	30	1206-BAB	123	1310-CF	591	1310-LL	592
1201-02BA	32	1206-BAC	123	1310-CG	591	1310-BAA	28
1201-02BB	31	1206-BAD	123	1310-CH	590	1310-BAB	28
1201-02BC	31	1206-BAE	123	1310-CI	590, 617	1310-BAC	28
1201-02BF	31	1206-BAF	123	1310-CL	590	1310-BAF	592
		1206-BBA	108	1310-DA	27	1310-BAH	592
12050104	395	1206-BBB	108	1310-DB	29	1310-BAI	592
		1206-BBC	108	1310-DC	27	1310-BAL	592
1206-AE	107	1206-BBD	108	1310-DD	29	1310-BBA	592, 620
1206-BD	614	1206-BBE	108	1310-DE	27	1310-BBB	592, 620
1206-BE	614	1206-BBF	108	1310-DF	29	1310-BBC	592
1206-BF	614	1206-BCE	111	1310-DG	27	1310-BDB	599
1206-BG	614	1206-BCF	111	1310-DH	29	1310-DLI	618
1206-BH	614	1206-BCG	111	1310-DI	27	1310-EAB	595
1206-BL	614	1206-BCH	111	1310-DL	589	1310-EAD	595
1206-CA	614	1206-BCI	111	1310-EA	27	1310-ECA	598
1206-CB	614	1206-BCL	111	1310-EB	590	1310-ECB	598
1206-CC	614	1206-BEC19	111	1310-EC	590	1310-ECC	598
1206-CD	614	1206-BED19	111	1310-ED	590		
1206-CE	614	1206-BEE19	111	1310-EE	591	1411-AB	378, 680
1206-CF	614	1206-BEF19	111	1310-EF	591, 620	1411-AC	378, 680
1206-CG	614	1206-BEG19	111	1310-EG	591	1411-AD	378, 680
1206-CH	614	1206-BEH19	111	1310-EH	591	1411-AE	378, 680
1206-CI	614	1206-BEI	111	1310-EI	592, 618	1411-AF	378, 680
1206-CL	614	1206-BEL	111	1310-EL	589	1411-AG	682
1206-DA	614	1206-BFA	596	1310-FA	29	1411-AH	682
1206-DB	614	1206-BFB	596	1310-FB	29	1411-AI	682
1206-DC	614	1206-CDB	596	1310-FC	29	1411-AL	682
1206-DD	614	1206-CDC	596	1310-FD	29	1411-BA	682
1206-DE	612, 619	1206-CEF	596	1310-FE	29	1411-BB	682
1206-DF	612	1206-CEG	596	1310-FF	29	1411-BD	681
1206-DG	612	1206-CHI	596	1310-FG	29	1411-BE	681
1206-DH	612	1206-CHL	596	1310-FH	29	1411-BF	681
1206-DI	612	1206-DCA	132	1310-FL	592, 620	1411-BG	681
1206-EA	612, 619			1310-GA	594, 617	1411-BH	681
1206-EB	612	1214-BF	401	1310-GB	594	1411-BI	681
1206-EC	612			1310-GC	594	1411-BL	682
1206-ED	612	1215-CAB	617	1310-GD	594	1411-CA	593, 618
1206-EE	612	1215-CAD	618	1310-GE	594	1411-CC	681
1206-EG	613	1215-CAE	618	1310-GF	594	1411-CD	681
1206-EH	613	1215-CAG	618	1310-GG	594	1411-CE	681
1206-EI	613	1215-CAH	619	1310-GH	594	1411-CF	682
1206-EL	613	1215-CAI	619	1310-GL	594, 619	1411-CG	682
1206-FA	613	1215-CAL	620	1310-HA	594	1411-CH	682
1206-FC	613	1215-CBA	617	1310-HB	594	1411-CI	682
1206-FD	613			1310-HD	594	1411-CL	682
1206-FE	613	1310-B	34	1310-HE	589, 618	1411-DA	228, 681
1206-FF	613	1310-C	34	1310-HF	591, 618	1411-DB	228, 681
1206-FG	613	1310-AD	591	1310-HG	589	1411-DC	228, 681
1206-FI	617	1310-AE	591	1310-HH	594	1411-DD	228, 681
1206-GE	617	1310-AF	592	1310-HI	594	1411-DE	682
1206-HD	613	1310-AG	27, 589	1310-HL	598, 618	1411-DG	682
1206-HE	613	1310-AH	589	1310-IA	598, 617	1411-DH	682
1206-HF	613	1310-AI	27, 589	1310-IC	598	1411-DI	682
1206-HG	613	1310-AL	589, 618	1310-ID	598	1411-DL	682
1206-HH	616, 617	1310-BA	27, 589, 620	1310-IE	598, 620	1411-EA	377
1206-HI	616	1310-BB	590	1310-IF	35	1411-EB	378, 684
1206-HL	616, 617, 619	1310-BC	35, 617, 620	1310-IG	598	1411-EC	378, 684
1206-IA	616, 619	1310-BD	590	1310-IH	594	1411-ED	378, 684
1206-IB	107, 616	1310-BE	27, 590	1310-II	594	1411-EE	378, 684
1206-IC	107, 616	1310-BF	589	1310-IL	594	1411-EF	378, 684
1206-ID	616	1310-BG	27, 590	1310-LA	28	1411-EG	378, 684
1206-IE	616	1310-BH	589	1310-LB	28	1411-EH	378, 684

Indice alfanumerico	Alfanumerical Index	Nummernverzeichnis	Index alphanumérique	Indice alfanumerico	
1411-EI	378, 684	1412-FC	290, 539	1417-EA	22
1411-EL	378, 684	1412-FF	539	1417-EC	22
1411-FA	593, 620	1412-FI	539		
1411-FB	593, 620	1412-GA	6, 537	15-AA	9
1411-FC	593, 620	1412-GC	6, 537	15-A	9
1411-FD	593, 618, 620	1412-HE	538	15-AB	9
1411-FE	593	1412-HF	538	15-AC	9
1411-FF	593	1412-HG	538	15-AD	9
1411-FG	593	1412-HH	538	15-AE	9
1411-FH	593	1412-IA	325, 543	15-AF	9
1411-FI	593	1412-IB	325, 543	15-AG	9
1411-GD	682	1412-IC	325, 543	15-AH	174
1411-GE	682	1412-IF	325	15-AI	139
1411-GG	680	1412-IH	325, 543	15-AL	139
1411-GH	680	1412-II	325, 543	15-BA	168
1411-GI	680	1412-LA	538	15-BB	168
1411-GL	680	1412-LC	538	15-BC	166
1411-IG	683	1412-LI	543	15-BD	166
1411-IH	683	1412-LL	326	15-BE	166
1411-II	683	1412-BAA	543	15-BF	160
1411-IL	683	1412-BAB	326	15-BG	151
1411-LA	683	1412-BAC	326	15-BH	150
1411-LB	683	1412-BAD	326	15-BI	154
1411-LC	683	1412-BAE	326	15-BL	154
1411-LD	683	1412-BAF	326	15-CA	156
1411-LE	683	1412-BBA	542	15-CB	156
1411-LF	683	1412-BBB	542	15-CC	156
1411-LG	683	1412-BBC	542	15-CD	156
1411-LH	683	1412-BBD	542	15-CE	156
1411-LI	683	1412-BBE	542	15-CF	156
1411-LL	683	1412-BDG	6, 540	15-CG	156
		1412-BDH	6, 540	15-CH	156
1412-AE	4	1412-BDI	6, 540	15-CI	154
1412-AF	4	1412-BDL	6, 540	15-CL	154
1412-AG	544	1412-BEA	541	15-DA	156
1412-AH	4	1412-BEB	541	15-DB	156
1412-AI	544	1412-BEC	541	15-DC	156
1412-BA	7, 143	1412-BED	541	15-DD	156
1412-BB	7, 143	1412-BEE	541	15-DE	156
1412-BC	7	1412-BEF	541	15-DF	156
1412-BD	7	1412-BEG	541	15-DG	156
1412-BE	7	1412-BGA	540	15-DH	156
1412-BF	7	1412-BGB	540	15-DI	154
1412-BG	4	1412-BGC	540	15-DL	154
1412-BH	4	1412-BGD	540	15-EA	157
1412-BI	4	1412-BGE	540	15-EB	157
1412-BL	4	1412-BHA	541	15-EC	157
1412-CA	560	1412-BHB	541	15-ED	157
1412-CC	560	1412-BHC	541	15-EE	157
1412-CD	560	1412-BHD	541	15-EF	157
1412-CE	560	1412-BHE	541	15-EG	157
1412-CF	559	1412-CAB	326	15-EH	157
1412-CG	560	1412-CAC	326	15-EI	157
1412-CH	559	1412-CAD	326	15-EL	155
1412-CI	559	1412-CAE	326	15-FA	145
1412-CL	559	1412-CAI	326	15-FB	145
1412-DA	7, 143	1412-CAL	326	15-FC	223
1412-DC	561	1412-CBA	326	15-FD	145
1412-DE	561	1412-CBB	326	15-FE	155
1412-DG	561			15-FF	155
1412-DI	561	1417-BB	19	15-FG	154
1412-DL	559	1417-BC	20	15-FH	154
1412-EA	6, 537	1417-BD	19	15-FI	154
1412-EB	6, 537	1417-BE	20	15-FL	154
1412-EC	537	1417-BF	19	15-GA	139
1412-EE	8, 143	1417-BG	21	15-GB	151
1412-EF	8, 143	1417-BH	19	15-GC	151
1412-EG	8, 143	1417-BI	21	15-GD	151
1412-EH	8, 143	1417-BL	19	15-GE	151
1412-FA	290, 539	1417-BL	19	15-GF	158
		1417-CF	22		
				15-GG	158
				15-GH	158
				15-GI	150
				15-GL	150
				15-HA	157
				15-HB	157
				15-HC	157
				15-HD	157
				15-HE	157
				15-HF	157
				15-HG	157
				15-HH	157
				15-HI	157
				15-HL	155
				15-IB	151
				15-IC	151
				15-IE	155
				15-IF	155
				15-IG	151
				15-IH	151
				15-IL	155
				15-LB	150, 620
				15-LC	150
				15-LD	150
				15-LE	150
				15-LF	149
				15-LG	149
				15-LH	149
				15-LI	149
				15-LL	145, 629
				15-BAA	145
				15-BAB	149
				15-BAC	149
				15-BAD	144
				15-BAE	158
				15-BBB	620
				15-BBD	144
				15-BBE	144
				15-BBF	145
				15-BBI	145
				15-BBL	145
				15-BCA	149
				15-BCB	149
				15-BCC	151
				15-BCD	164
				15-BCF	164
				15-BCH	168
				15-BCI	168
				15-BDA	166
				15-BDB	166
				15-BDC	145
				15-BDD	145
				15-BDE	145
				15-BDF	149
				15-BDG	160
				15-BDH	160
				15-BDI	160
				15-BDL	160
				15-BEA	166
				15-BEB	166
				15-BEC	161
				15-BED	161
				15-BEE	161
				15-BEF	161
				15-BEG	161
				15-BEH	161
				15-BEI	161
				15-BEL	161
				15-BFA	161

Indice alfanumerico	Alfanumerical Index	Nummernverzeichnis	Index alphanumérique	Indice alfanumerico			
15-BFB	167	15-CCB	154	1506-DI	276	1508-HB	250
15-BFC	167	15-CCC	165	1506-DL	277	1508-HC	251
15-BFD	167	15-CCD	165	1506-EA	277	1508-HD	250
15-BFE	167	15-CCE	629	1506-EB	277	1508-HE	244
15-BFF	167	15-CCF	629	1506-EC	277	1508-HF	251
15-BFG	167	15-CCG	629	1506-ED	277	1508-HG	251
15-BFH	161	15-CCH	168	1506-EE	276	1508-HH	252
15-BFI	161	15-CCI	168	1506-EG	277	1508-HI	244
15-BFL	161	15-CCL	168	1506-EI	277	1508-HL	254
15-BGA	161	15-CDA	152	1506-EL	277	1508-IA	258
15-BGB	161	15-CDB	152	1506-FA	277	1508-IB	258
15-BGC	161	15-CDC	152	1506-FB	277	1508-IC	258
15-BGD	161	15-CDD	152	1506-FC	277	1508-ID	258
15-BGE	161	15-CDE	152	1506-FD	275	1508-IE	258
15-BGF	161	15-CDF	152	1506-FE	275	1508-IF	254
15-BGG	161	15-CDG	152	1506-FF	275	1508-IG	256
15-BGH	161	15-CDH	152	1506-FG	275	1508-IH	256
15-BGI	161	15-CDI	152	1506-FH	275	1508-II	256
15-BGL	161	15-CDL	152	1506-FI	275	1508-IL	256
15-BHA	160	15-CEA	152	1506-FL	275	1508-LB	257
15-BHB	160	15-CEB	152	1506-GA	278	1508-LD	257
15-BHC	160	15-CEC	152	1506-GB	278	1508-LE	257
15-BHD	160	15-CED	152	1506-GC	277	1508-LF	256
15-BHE	163	15-CEE	152	1506-GD	277	1508-LG	256
15-BHF	163	15-CEF	152	1506-GE	277	1508-LH	256
15-BHG	163	15-CEG	155	1506-GF	278	1508-LI	256
15-BHH	163	15-CEH	155	1506-GG	277	1508-BAB	255
15-BHI	163	15-CEI	158	1506-GH	277	1508-BAC	255
15-BHL	164	15-CEL	158	1506-GI	277	1508-BAD	255
15-BIA	164	15-CFA	153	1506-GL	277	1508-BAE	255
15-BIB	164	15-CFB	153	1506-HA	279	1508-BAG	254
15-BIC	223	15-CFC	153	1506-HB	279	1508-BAH	254
15-BID	223	15-CFD	153	1506-HC	279	1508-BAI	254
15-BIE	223	15-CFE	153	1506-HD	278	1508-BBA	255
15-BIF	223	15-CFF	153	1506-IA	275	1508-BBB	255
15-BIG	223	15-CFG	153	1506-IB	275	1508-BBC	255
15-BIH	223	15-CFH	153	1506-IC	275	1508-BBD	255
15-BII	223	15-CFI	153	1506-ID	275	1508-BBE	255
15-BIL	163	15-CFL	153	1506-IF	275	1508-BBH	251
15-BLA	163	15-CGA	153	1506-II	278	1508-BBI	251
15-BLB	162	15-CGB	153			1508-BBL	251
15-BLC	162	15-CGC	153	1508-DI	243	1508-BCA	251
15-BLD	162	15-CGD	153	1508-DL	243	1508-BCB	251
15-BLE	162			1508-EA	244	1508-BCC	251
15-BLF	162	1506-H	276	1508-EB	244	1508-BCD	251
15-BLG	162	1506-BA	277	1508-EC	244	1508-BCE	251
15-BLH	162	1506-BD	277	1508-ED	244	1508-BCF	251
15-BLI	165	1506-BE	276	1508-EE	244	1508-BCH	252
15-BLL	165	1506-BF	276	1508-EF	244	1508-BCI	252
15-CAA	158	1506-BH	275	1508-EG	245	1508-BCL	252
15-CAB	159	1506-BI	275	1508-EH	245	1508-BDA	252
15-CAC	159	1506-BL	275	1508-EI	243	1508-BDB	252
15-CAD	159	1506-CA	276	1508-EL	245	1508-BDC	254
15-CAE	159	1506-CB	276	1508-FC	244	1508-BDD	254
15-CAF	159	1506-CC	276	1508-FD	250	1508-BDE	254
15-CAG	159	1506-CD	276	1508-FE	250		
15-CAH	144	1506-CE	275	1508-FF	511	1514-DH	247
15-CAI	158	1506-CF	276	1508-FG	511	1514-DI	247
15-CAL	158	1506-CG	276	1508-FH	511	1514-EA	249
15-CBA	162	1506-CH	276	1508-FI	252, 511	1514-EG	249
15-CBB	159	1506-CI	276	1508-FL	251	1514-EH	249
15-CBC	159	1506-CL	276	1508-GB	243	1514-EI	249
15-CBD	159	1506-DA	276	1508-GC	243	1514-FA	260
15-CBE	159	1506-DB	276	1508-GD	243	1514-FB	260
15-CBF	162	1506-DC	276	1508-GE	243	1514-FC	260
15-CBG	162	1506-DD	276	1508-GF	250	1514-FF	261
15-CBH	162	1506-DE	276	1508-GG	250	1514-FG	261
15-CBI	171	1506-DF	276	1508-GI	250	1514-FL	247
15-CBL	171	1506-DG	276	1508-GL	250	1514-GA	248
15-CCA	174	1506-DH	276	1508-HA	244	1514-GF	248

Indice alfanumerico	Alfanumerical Index	Nummernverzeichnis	Index alphanumérique	Indice alfanumerico
1514-GG	260	1917-EE	373	
1514-GH	249	1917-EF	373	
1514-HB	248	1917-EG	373	
1514-HE	249	1917-EH	376	
1514-HF	249	1917-EI	376	
1514-HI	248	1917-EL	376	
1514-HL	248	1917-FA	376	
1514-IA	248	1917-FB	373	
1514-IB	248	1917-FC	373	
1514-IC	260	1917-FD	373	
1514-ID	260	1917-FE	373	
1514-IE	260	1917-FF	373	
1514-IF	261	1917-FG	373	
1514-IG	261	1917-FH	373	
1514-IH	261	1917-GB	374	
1514-II	249	1917-GC	374	
1514-IL	247	1917-GD	374	
1514-LA	248	1917-GE	374	
1514-LB	248	1917-GI	377	
1514-LC	260	1917-GL	377	
1514-LE	249	1917-HG	490	
1514-LH	253	1917-HH	490	
1514-LL	253	1917-HI	490	
1514-BBA	260			
1514-BCA	259	1918-FA	676	
1514-BCB	259	1918-BAB	695	
1514-BCC	259	1918-BAC	695	
1514-BCD	259	1918-BAD	695	
1514-BCE	259	1918-BAE	695	
1514-BCF	259			
1514-BCG	259	2106-LI	515	
1514-BCH	259	2106-LI12	515	
1514-BCI	259	2108-CA	507	
1514-BCL	259	2108-CB	507	
		2108-CD	507	
1803-B	100	2108-CF	507	
1803-C	100	2108-EA	512	
1803-F	100			
1803-BA	100	211503-G	691	
1803-BC	100	211503-I	691	
		211503-BA	691	
		211503-BC	691	
1811-B	415			
1811-C	415	2118-CA	693	
		2118-CG	693	
1907-BA	434	2118-DA	693	
1907-BB	434			
1907-BC	434			
1907-CA	434	22051819	395	
1907-CB	434	2207-BA	381	
1907-CC	434	2207-BC	381	
1907-CD	434	2207-BE	381	
1907-EA	434			
1907-EB	434			
1917-CA	373			
1917-CB	373			
1917-CC	373			
1917-CD	373			
1917-CE	373			
1917-CF	373			
1917-CG	373			
1917-DA	375			
1917-DC	375			
1917-DD	375			
1917-DE	375			
1917-DF	375			
1917-EA	373			
1917-EB	373			
1917-EC	373			
1917-ED	373			







ideal-tek  
manufacturer & supplier of precision instruments 

**Ideal-tek SA**  
via Motta 4  
6828 Balerna  
Switzerland

Phone: +41 91 683 32 29  
Fax: +41 91 683 03 71  
E-mail: [info@ideal-tek.com](mailto:info@ideal-tek.com)