



Mund-kiefer und Gesichts-chirurgie  
Oral Maxillo-Facial surgery  
Chirurgia Maxillofacciale  
Cirugia Oral y Maxilofacial  
Chirurgie Oralee et Maxilla-faciale









Messinstrumente  
 Measuring instruments  
 Strumenti per misura  
 Instrumentos para medir  
 Instruments à mesurer

Messzirkel  
 Calipers  
 Compassi  
 Compases  
 Compas

Meßbereich: 0 - 20 mm  
 Measuring range: 0 - 20 mm  
 Campo di misura: 0 - 20 mm  
 Alcance de medición: 0 - 20 mm  
 Etendue de mesure: 0 - 20 mm

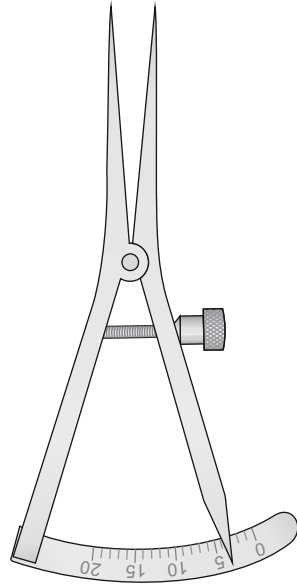

CASTROVIEJO  
 1417-BH  
 90 mm

Meßbereich: 0 - 20 mm  
 Measuring range: 0 - 20 mm  
 Campo di misura: 0 - 20 mm  
 Alcance de medición: 0 - 20 mm  
 Etendue de mesure: 0 - 20 mm

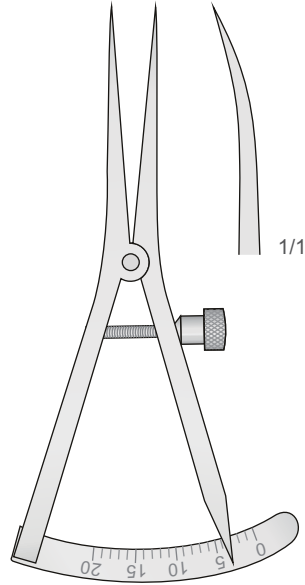

CASTROVIEJO  
 1417-BL  
 90 mm

Meßbereich: 0 - 80 mm  
 Measuring range: 0 - 80 mm  
 Campo di misura: 0 - 80 mm  
 Alcance de medición: 0 - 80 mm  
 Etendue de mesure: 0 - 80 mm



1417-EA  
 125 mm

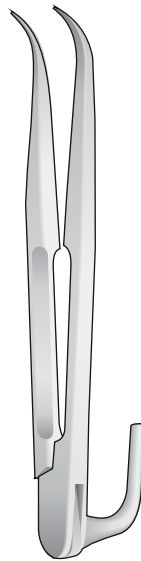

ZIELINSKY  
 0415-HCF  
 110 mm

0,5 mm



1118-AI  
 100 mm

0,5 mm



1118-AL  
 150 mm

Meßbereich: 0 - 40 mm  
 Measuring range: 0 - 40 mm  
 Campo di misura: 0 - 40 mm  
 Alcance de medición: 0 - 40 mm  
 Etendue de mesure: 0 - 40 mm

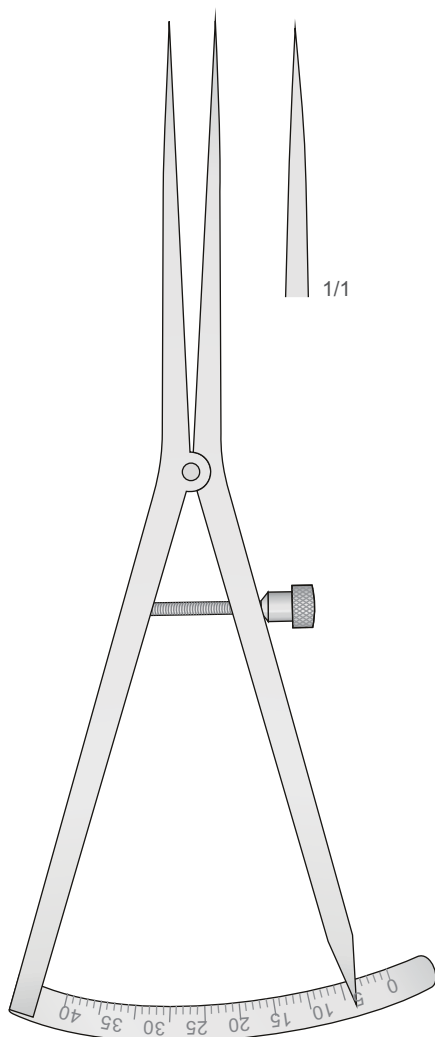

CASTROVIEJO  
**1417-BC**  
 170 mm

Meßbereich: 0 - 40 mm  
 Measuring range: 0 - 40 mm  
 Campo di misura: 0 - 40 mm  
 Alcance de medición: 0 - 40 mm  
 Etendue de mesure: 0 - 40 mm

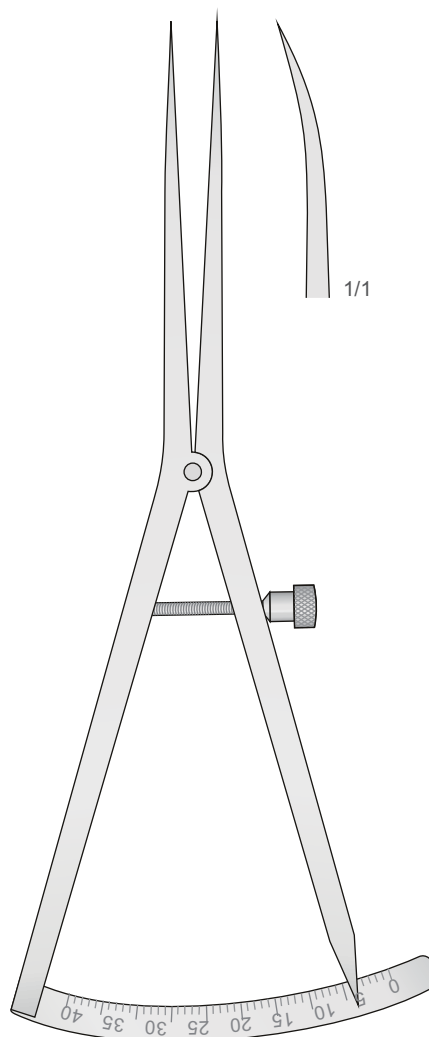

CASTROVIEJO  
**1417-BE**  
 170 mm

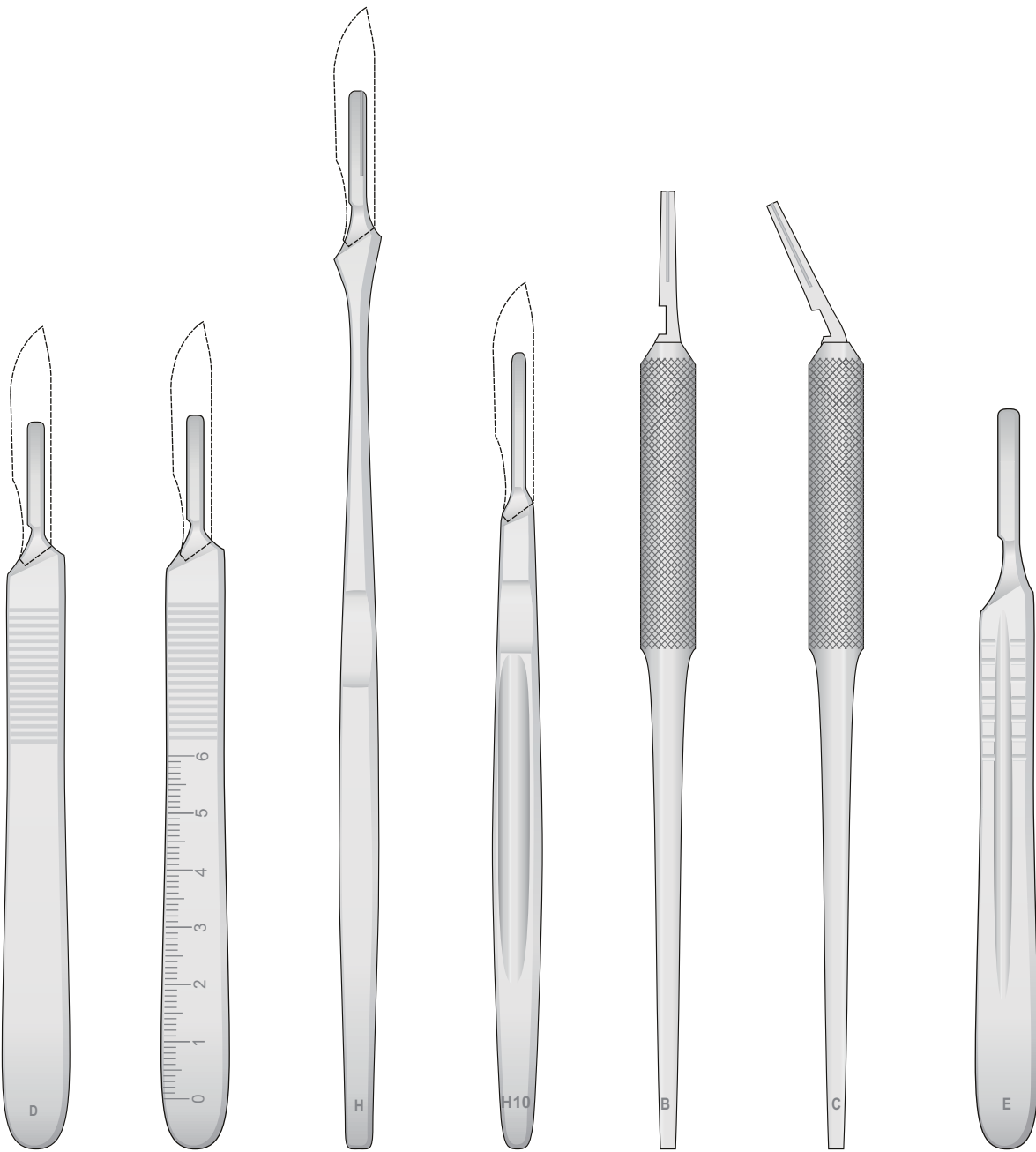

**1201-02D**  
Fig. D

**1201-02D12**  
Fig. D12

**1201-02H**  
Fig. H

**1201-02H10**  
Fig. H10

**1201-02B**  
Fig. B

**1201-02C**  
Fig. C

**1201-02E**  
Fig. E

Packungen à 100  
 Packages of 100 ea  
 Scatole da 100 pezzi  
 Cajas de 100 c/u  
 Boîtes de 100 pièces

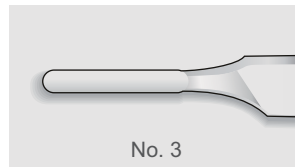

**1102-BA**  
Fig. BA



**1102-BB**  
Fig. BB

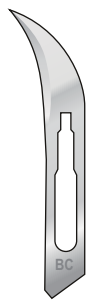

**1102-BC**  
Fig. BC

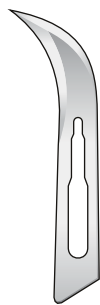

**1102-BC04**  
Fig. BC04



**1102-BD**  
Fig. BD



**1102-BF**  
Fig. BF



**1102-BF01**  
Fig. BF01



**1102-BF03**  
Fig. 15C

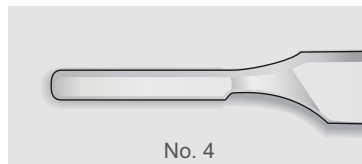

**1102-BI**  
Fig. BI



**1102-CA**  
Fig. CA



**1102-CB**  
Fig. CB



**1102-CC**  
Fig. CC



**1102-CD**  
Fig. CD



**1102-CE**  
Fig. CE



**1102-CF**  
Fig. CF



**1102-DG**  
Fig. DG



Skalpellgriffe, Mikro Scalpellklingen  
 Scalpel handles, Micro Scalpel blades  
 Manici per bisturi, Micro lame per bisturi  
 Mangos de bisturios, Micro hojas de bisturios  
 Manches de bistouris, Micro lames de bistouris

Skalpellgriffe für Mikro-Klingen  
 Scalpel handles for Micro blades  
 Manici per micro lame  
 Mangos de bisturí para micro hojas  
 Manches de bistouris pour micro lames

Micro-Klingen  
 Micro blades  
 Micro lame  
 Micro hojas  
 Micro lames

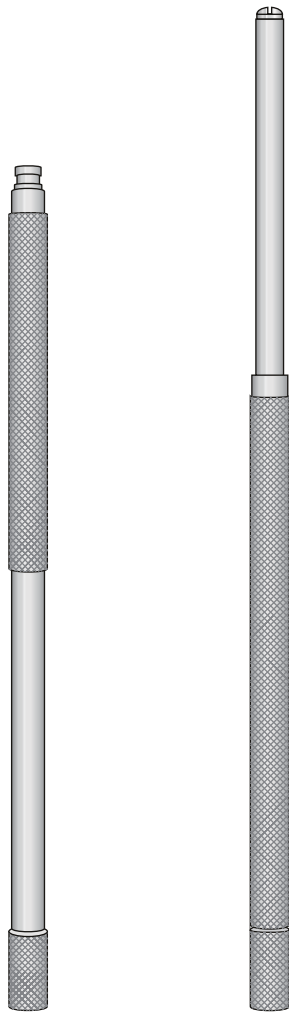

**0202-EG**  
135 mm

**0202-EI**  
155 mm



**1102-DGB**



**1102-DGC**



**1102-DGE**

Packung mit 10 Stück  
 Package with 10 units  
 Confezione 10 pezzi  
 Paquete con 10 unidades  
 Boîte avec 10 lames



**1102-DGF**



**1102-DGH**



**1102-DGI**

Packung mit 10 Stück  
 Package with 10 units  
 Confezione 10 pezzi  
 Paquete con 10 unidades  
 Boîte avec 10 lames



**1102-DGD**

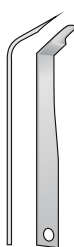

**1102-DGG**



**1102-DGL**

Packung mit 1 Stück  
 Package with 1 unit  
 Confezione 1 pezzo  
 Paquete con 1 unidade  
 Boîte avec 1 lame

Dermatome komplett mit 1 auswechselbarer Klinge und 2 Spannplatten  
Dermatome complete with 1 interchangeable blade and 2 skin plates  
Dermatomo con una lama intercambiabile, completo di 2 placche per stendere la pelle  
Dermatomo completo, con 1 hoja intercambiabile y 2 placas para extender la piel  
Dermatome avec 1 lame interchangeable et 2 plaques pour tendre la peau

Einstellbar von 0,1 bis 3,0 mm  
Adjustable from 0,1 to 3,0 mm  
Regolabile da 0,1 a 3,0 mm  
Regulable de 0,1 hasta 3,0 mm  
Réglable en épaisseur de 0,1 à 3,0 mm

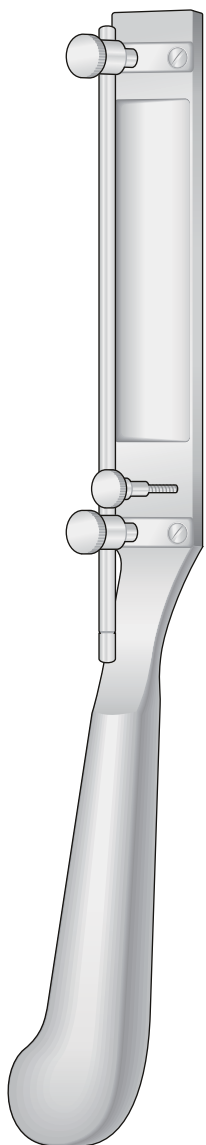

SCHINK  
0405-BD  
300 mm

Ersatzklinge, allein  
Spare Blade only  
Lama di ricambio sola  
Hoja de repuesto suelto  
Lame de rechange, seule



SCHINK  
0405-BE  
102 mm

Spannplatte  
Skin Fixing Plate  
Placca per stendere la pelle  
Placa para extender la piel  
Plaque pour tendre la peau



SCHINK  
0405-BA

Einstellbar von 0,1 bis 4,0 mm  
Adjustable from 0,1 to 4,0 mm  
Regolabile da 0,1 a 4,0 mm  
Regulable de 0,1 hasta 4,0 mm  
Réglable en épaisseur de 0,1 à 4,0 mm

Für handelsübliche Rasierklingen  
For usual razor blades  
Per lamette da barba standard  
Para hojas de afeitar usuales  
Pour lames de rasoir modèle standard



SILVER  
0405-BB  
190 mm

Ersatzklinge, allein  
Spare Blade only  
Lama di ricambio sola  
Hoja de repuesto suelto  
Lame de rechange, seule

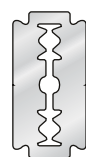

SILVER  
0405-BC  
43 mm

Hautstanzen  
 Tissue punches  
 Mucotomi Punches  
 Punches para cortar tejidos  
 Punches à couper le tissue

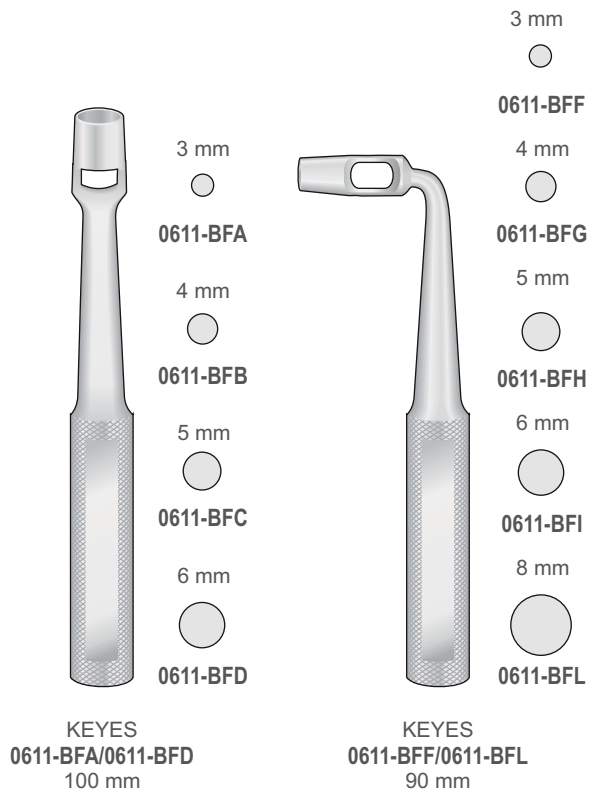

Zungen Spatel, Zungendrucker  
 Tongue Spatulas, Tongue depressors  
 Spatole per lingua, Abbassalingua  
 Espátulas bucales, Bajalengua  
 Spatules à langue, Abaisse-langues

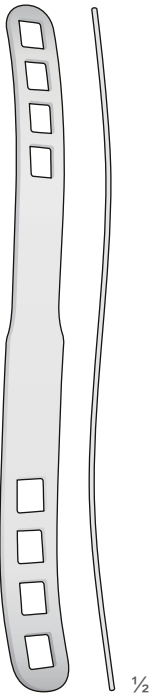

**BRUENINGS**  
**1412-AE**  
 190 mm

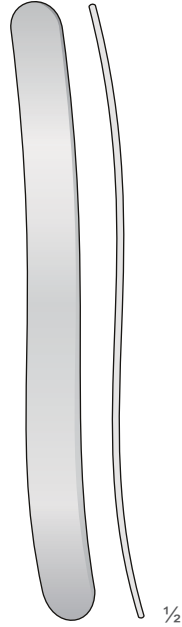

**1412-AF**  
 145 mm

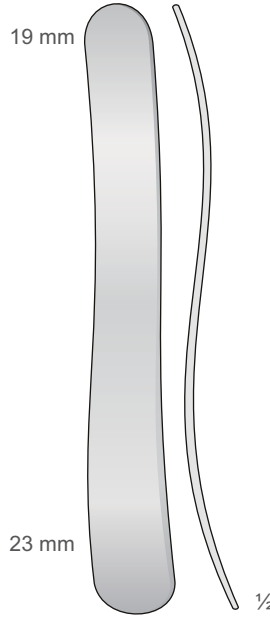

**KROENIG**  
**1412-BG**  
 150 mm

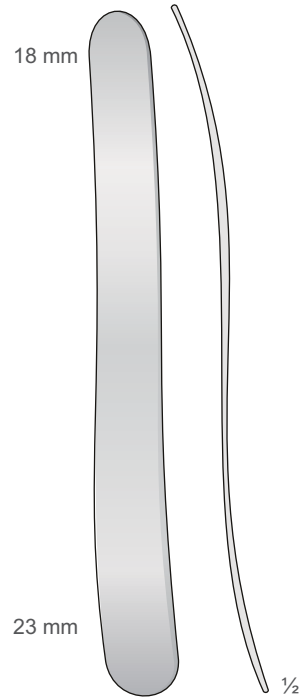

**BUCHWALD**  
**1412-BI**  
 180 mm

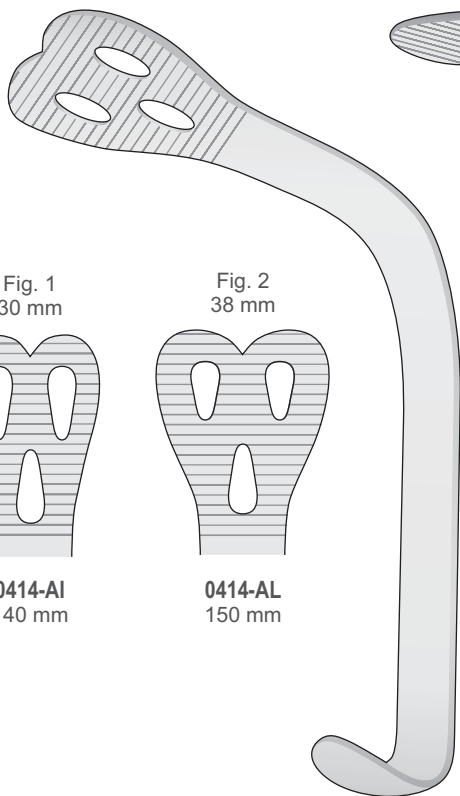

**WIEDER**  
**0414-AI/0414-AL**

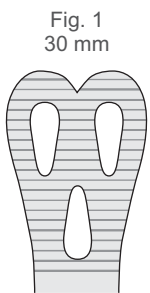

**0414-AI**  
 140 mm

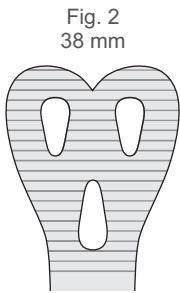

**0414-AL**  
 150 mm

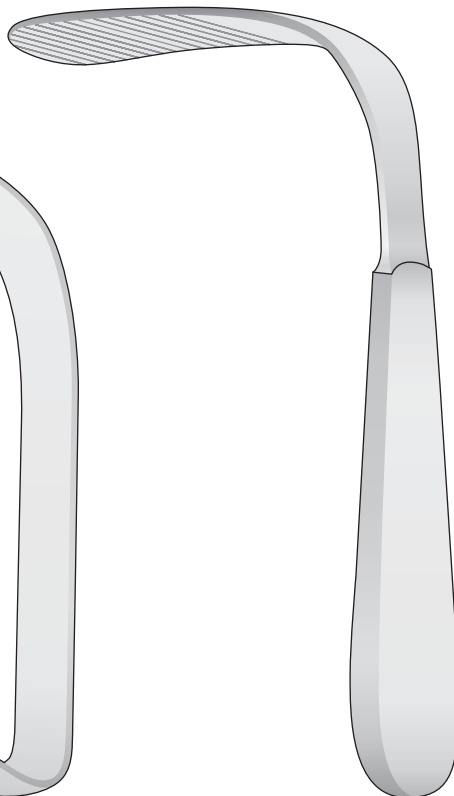

**TOBOLD**  
**1412-AI**  
 145 mm

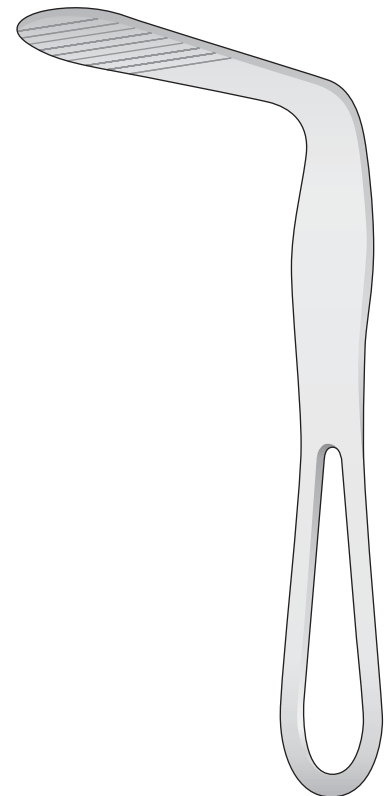

**HARTMANN**  
**1412-AG**  
 150 mm

Lippen- und Wangenhalter  
 Lip and Cheek Retractors  
 Divaricatori di labbra e guance  
 Separadores de labios y mejillas  
 Ecarteurs de lévres et de joues

22 mm

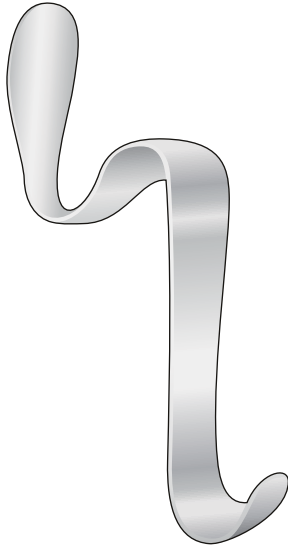

**BISHOP**  
**1412-GB**  
 130 mm



**MINNESOTA**  
**1412-FF**  
 140 mm

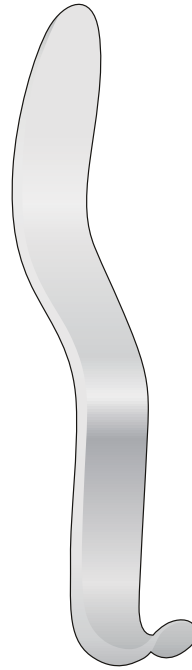

**CAWOOD-MINNESOTA**  
**1412-GG**  
 160 mm

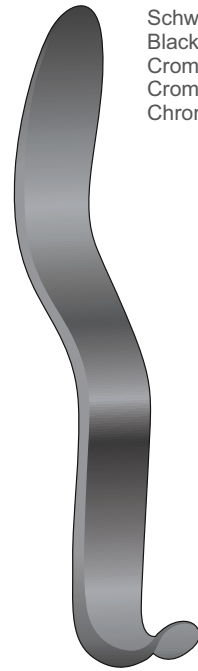

**CAWOOD-MINNESOTA**  
**1412-GG02**  
 160 mm

Schwarz Verchromt  
 Black anodized  
 Cromato nero  
 Cromado en negro  
 Chromé noir

Malleable Retractors, Protectors

Schwarz Verchromt  
 Black Chromium Plated  
 Cromate nere

18



22

**1412-IA**  
 200 mm

14



16

**1412-IB**  
 200 mm

18

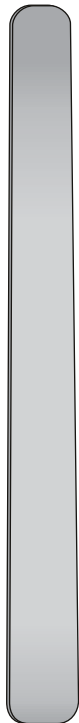

22

**1412-IH**  
 200 mm

14

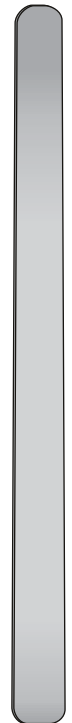

16

**1412-II**  
 200 mm

17



25

**TUFFIER**  
**1412-LL**  
 200 mm



**1412-LI**  
 195 mm

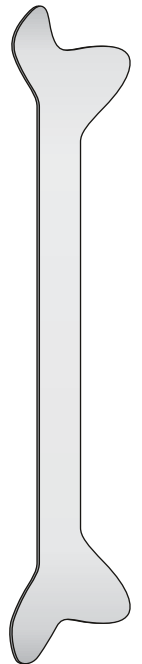

**1412-BAA**  
 180 mm

Lippen- und Wangenhalter  
 Lip and Cheek Retractors  
 Divaricatori di labbra e guance  
 Separadores de labios y mejillas  
 Ecarteurs de lévres et de joues

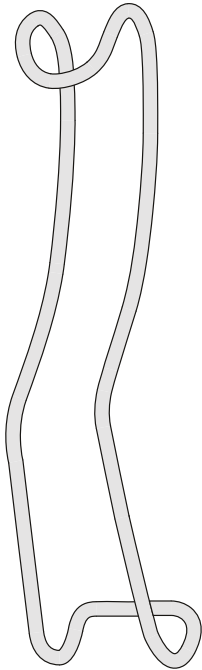

STERNBERG  
**1412-FA**  
 160 mm



STERNBERG  
**1412-FC**  
 160 mm

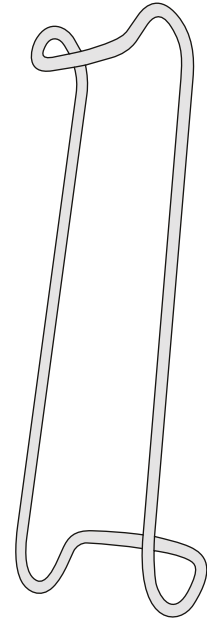

COLUMBIA  
**1412-GH**  
 140 mm

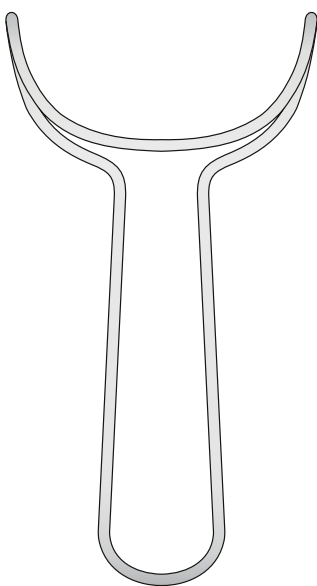

**1412-LA**  
 150 mm

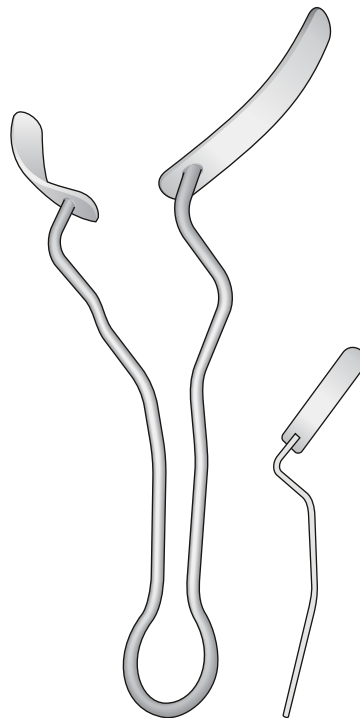

MATY  
**1412-LH**  
 170 mm

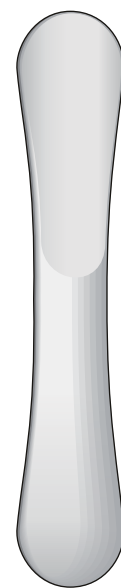

JAEGER  
**1412-AL**  
 110 mm

Mundsperrer  
 Mouth gags  
 Apribocca  
 Abrebocas  
 Ouvre-bouche

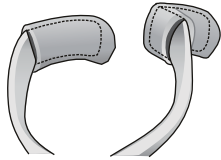

Paar Einsätze aus Silikon für:  
 Pair of silicone inserts for:  
 Coppia di inserti in silicone per:  
 Pareja de inserto de silicone para:  
 Paire de inserts en silicon pour:

**1412-EA - 1412-EB**

Ø 8 mm

Ø 11 mm



**1412-EA17**  
 30 mm

**1412-EB17**  
 30 mm

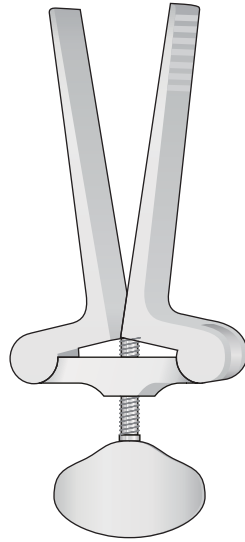

**HEISTER**  
**1412-GC**  
 135 mm

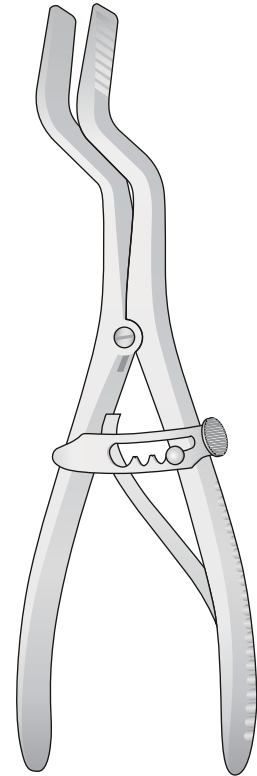

**ROSER KÖNIG**  
**1412-GA**  
 185 mm

Für Erwachsene  
 For adults  
 Per adulti  
 Para adultos  
 Pour adultes

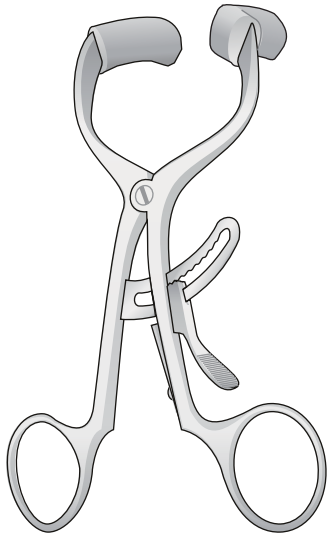

**MOLT**  
**DOYEN-JANSEN**  
**1412-EB**  
 140 mm

Für Erwachsene  
 For adults  
 Per adulti  
 Para adultos  
 Pour adultes

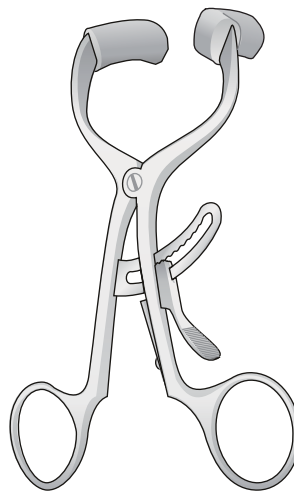

**MOLT**  
**DOYEN-COLLIN**  
**1412-EA**  
 120 mm

Für Kinder  
 For children  
 Per bambini  
 Para niños  
 Pour enfants

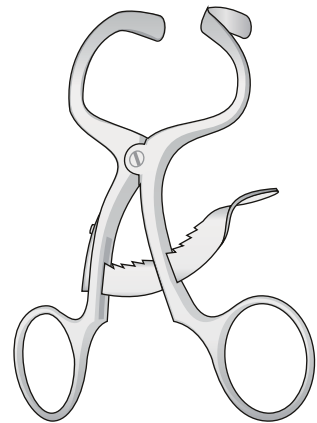

**MOLT**  
**1412-EC**  
 100 mm

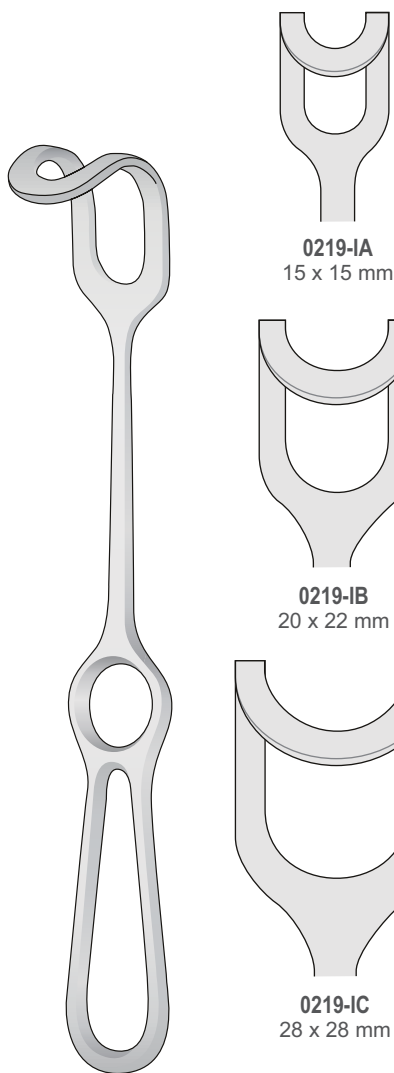

**0219-IA**  
 15 x 15 mm

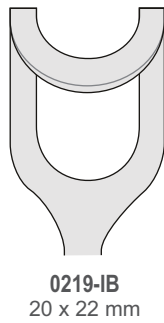

**0219-IB**  
 20 x 22 mm

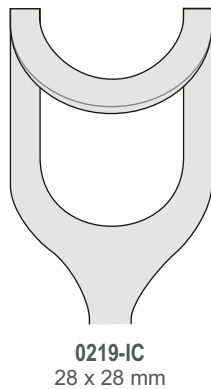

**0219-IC**  
 28 x 28 mm

MIDDELDORPF  
**0219-IA/0219-IC**  
 225 mm



**1412-HC**

Schwarzer Gummi  
 Black Rubber  
 Gomma nera  
 Caucho negro  
 Caoutchouc noir

LARGE  
 Groß, für Erwachsene  
 Large, for adults  
 Grande, per adulti  
 Grande, para adultos  
 Grand, pour adultes

Dampfsterilisation bis 134°C  
 Autoclavable to 134°C  
 Autoclavabile a 134°C  
 Autoclave hasta 134°C  
 Autoclavable jusqu'à 134°C

Packung mit 2 Stück  
 Package with 2 units  
 Confezione da 2 pezzi  
 Paquete con 2 unidades  
 Boîte avec 2 pièces



Mundsperrer  
 Mouth gags  
 Apribocca  
 Abrebocas  
 Ouvre-bouche

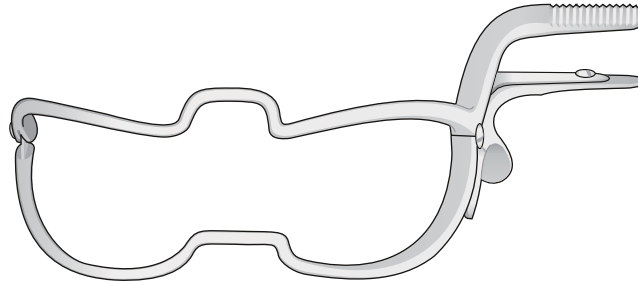

**WHITEHEAD-JENNINGS**

- 1412-BDG** 90 mm
- 1412-BDH** 110 mm
- 1412-BDI** 130 mm
- 1412-BDL** 150 mm

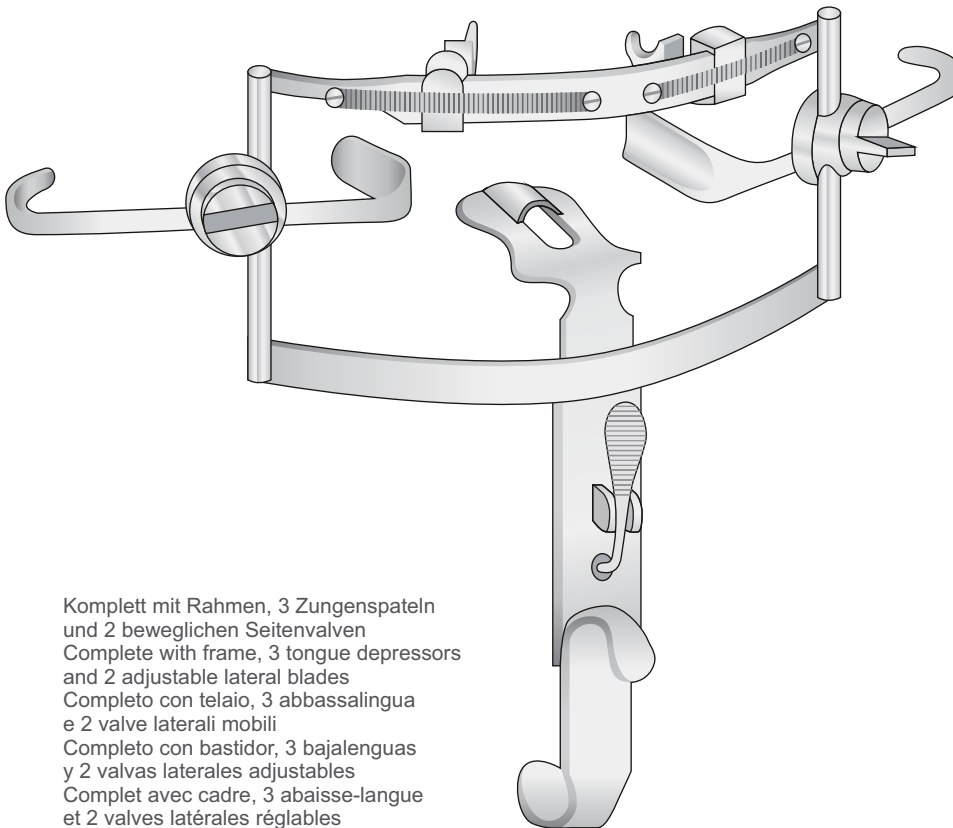

Komplett mit Rahmen, 3 Zungenspateln  
 und 2 beweglichen Seitenvallen  
 Complete with frame, 3 tongue depressors  
 and 2 adjustable lateral blades  
 Completo con telaio, 3 abbassalingua  
 e 2 valve laterali mobili  
 Completo con bastidor, 3 bajalenguas  
 y 2 valvas laterales ajustables  
 Complet avec cadre, 3 abaisse-langue  
 et 2 valves latérales réglables

**DINGMANN**  
**1412-BBA**  
 Set completo

**DINGMANN**  
 Zungenspatel  
 Tongue depressor  
 Abbassalingua  
 Bajalengua  
 Abaisse langue

Fig. 1

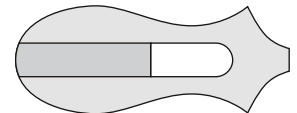

**1412-BBC**  
 65 x 25 mm

Fig. 2

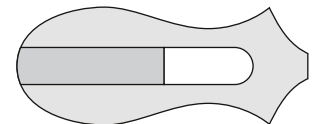

**1412-BBD**  
 70 x 29 mm

Fig. 3

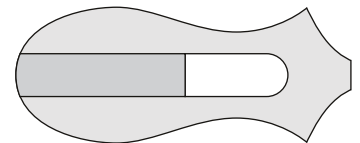

**1412-BBE**  
 80 x 32 mm

DAVIS-BOYLE

**1412-BFA**

Komplet mit 5 Zungenspatel  
Complete with 5 tongue depressors  
Completo con 5 abbassalingua  
Completo con 5 abaja lengua  
Complet avec 5 abaisse-langues

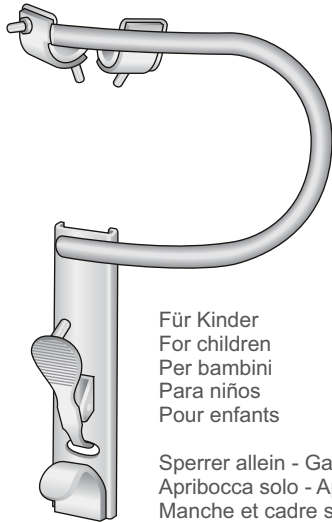

Für Kinder  
For children  
Per bambini  
Para niños  
Pour enfants

Sperrer allein - Gag only  
Apribocca solo - Apre-boca suelto  
Manche et cadre seuls

Zungenspatel  
Tongue depressors  
Abbassalingua  
Abaja lengua  
Abaisse-langues

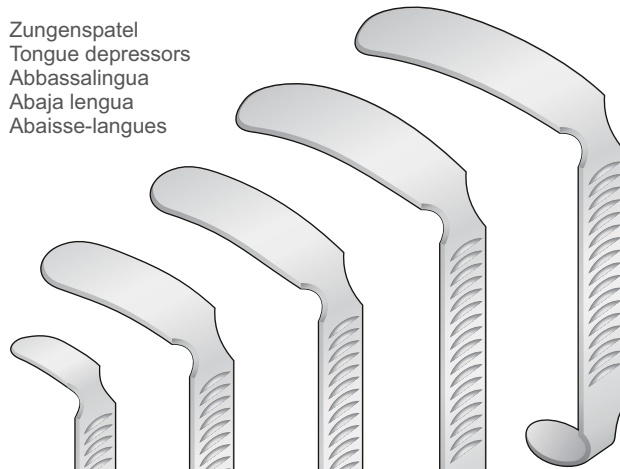

Fig. 1

Fig. 2

Fig. 3

Fig. 4

Fig. 5

**1412-BFC** Fig. 1 17x26 mm

**1412-BFD** Fig. 2 19x46 mm

**1412-BFE** Fig. 3 20x58 mm

**1412-BFF** Fig. 4 22x71 mm

**1412-BFG** Fig. 5 22x80 mm

DAVIS-BOYLE

**1412-BFB**

DAVIS-BOYLE

**1412-BEA**

Komplet mit 5 Zungenspatel  
Complete with 5 tongue depressors  
Completo con 5 abbassalingua  
Completo con 5 abaja lengua  
Complet avec 5 abaisse-langues



Sperrer allein  
Gag only  
Apribocca solo  
Apre-boca suelto  
Manche et cadre seuls

DAVIS-BOYLE

**1412-BEB**

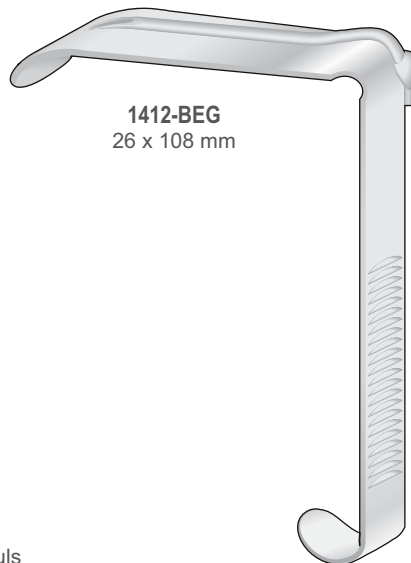

**1412-BEG**  
26 x 108 mm

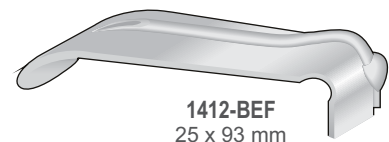

**1412-BEF**  
25 x 93 mm



**1412-BEE**  
24 x 80 mm



**1412-BED**  
23 x 65 mm

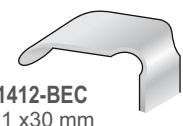

**1412-BEC**  
21 x 30 mm

**1412-BEC/1412-BEG**

Mundsperrer  
 Mouth gags  
 Apribocca  
 Abrebocas  
 Ouvre-bouche

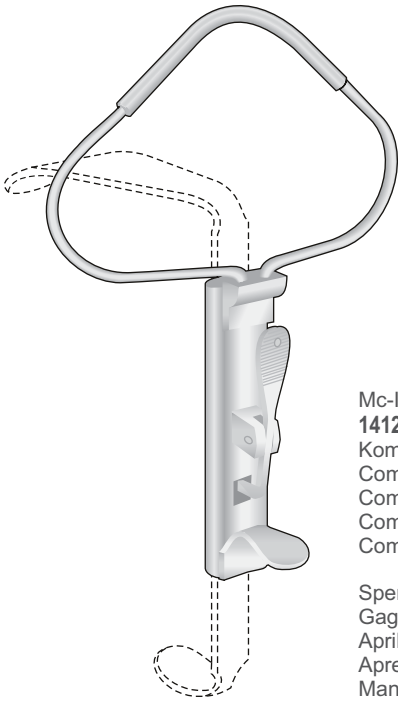

Mc-IVOR  
 1412-BHB

Mc-IVOR  
**1412-BHA**  
 Komplet mit 3 Zungenspatel  
 Complete with 3 tongue depressors  
 Completo di 3 abbassalingua  
 Completo con 3 abaja lengua  
 Complet avec 3 abaisse-langues

Sperrer allein  
 Gag only  
 Apribocca solo  
 Apre-boca suelto  
 Manche et cadre seuls

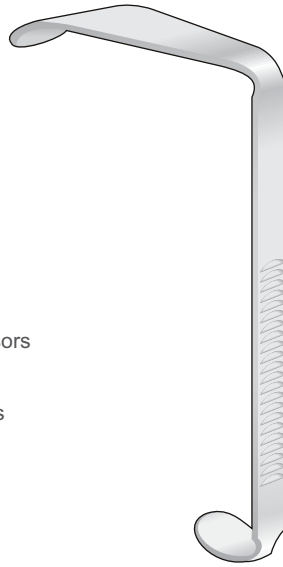

**1412-BHE**  
 26 x 100 mm

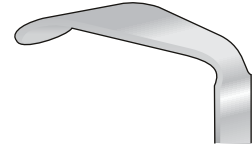

**1412-BHD**  
 25 x 86 mm

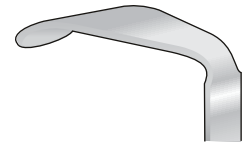

**1412-BHC**  
 23 x 70 mm

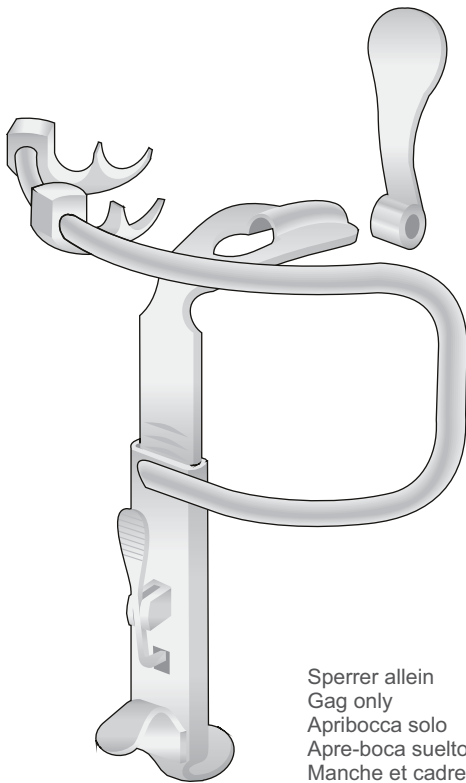

KILNER-DOUGHTY  
 1412-BGB

Sperrer allein  
 Gag only  
 Apribocca solo  
 Apre-boca suelto  
 Manche et cadre seuls

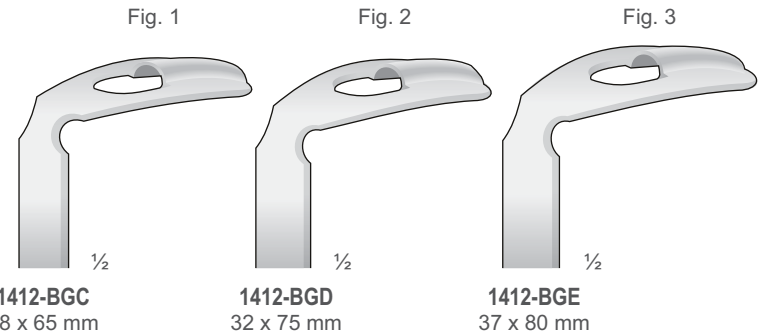

**1412-BGC**  
 28 x 65 mm

**1412-BGD**  
 32 x 75 mm

**1412-BGE**  
 37 x 80 mm

KILNER-DOUGHTY  
**1412-BGA**  
 Komplet mit 3 Zungenspatel  
 Complete with 3 tongue depressors  
 Completo con 3 abbassalingua  
 Completo con 3 abaja lengua  
 Complet avec 3 abaisse-langues

Nasen Spekula  
 Nasal specula  
 Speculum nasali  
 Espéculos nasales  
 Spéculums nasaux

Nasal spine  
 Retractors

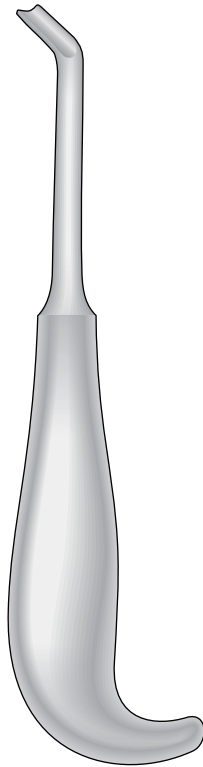

0414-BAI  
 190 mm

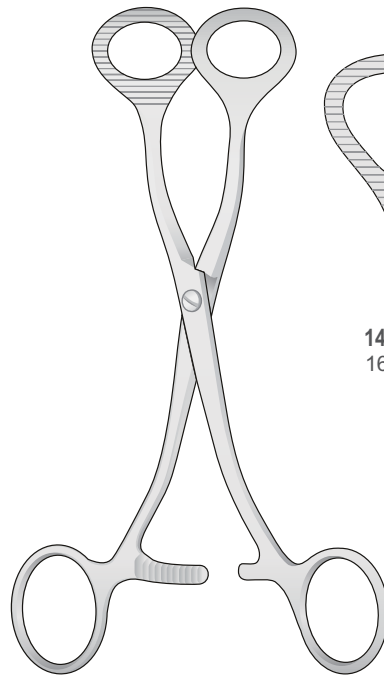

COLLIN  
 1412-BA/1412-DA

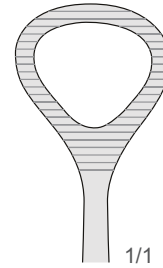

1412-DA  
 165 mm

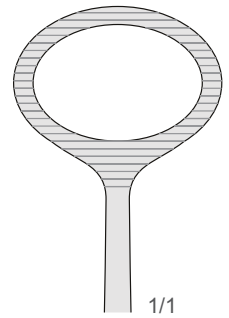

1412-BA  
 170 mm

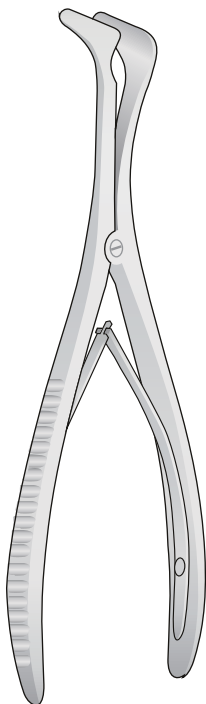

TIECK-HALLE  
 1412-EI/1412-EL  
 135 mm

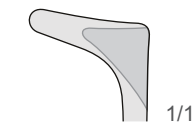

1412-EI  
 Fig. 1

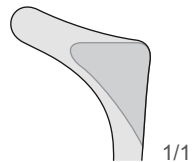

1412-EL  
 Fig. 2

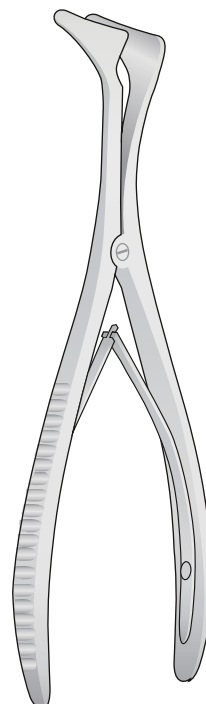

MODELL WIEN  
 1412-FG/1412-FL  
 140 mm

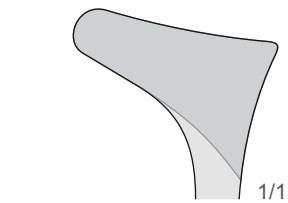

1412-FG  
 Fig. 1

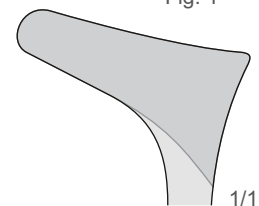

1412-FH  
 Fig. 2

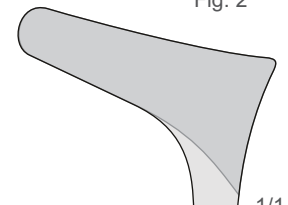

1412-FL  
 Fig. 3

Nasen Spekula  
 Nasal specula  
 Speculum nasali  
 Espéculos nasales  
 Spéculums nasaux

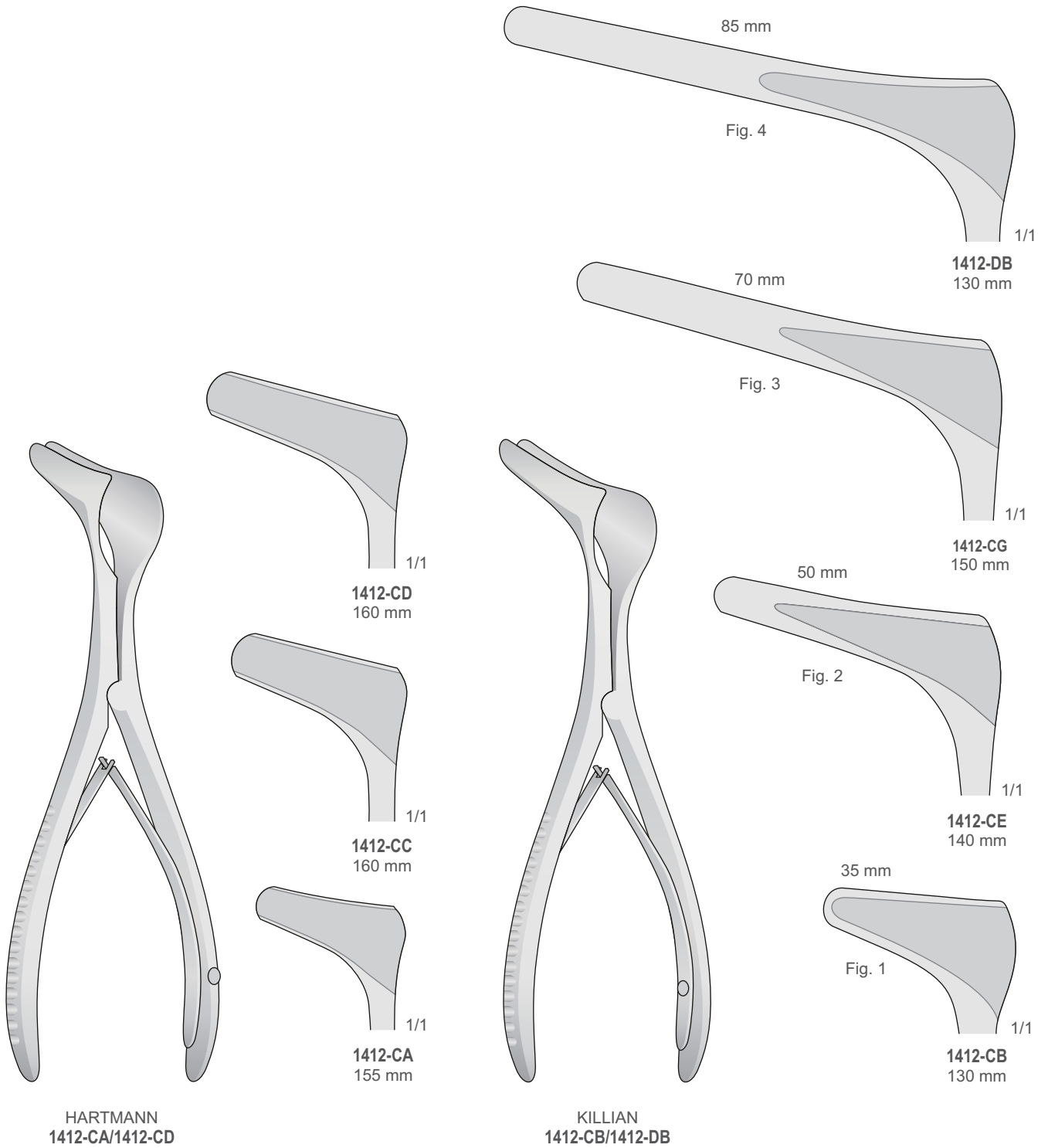

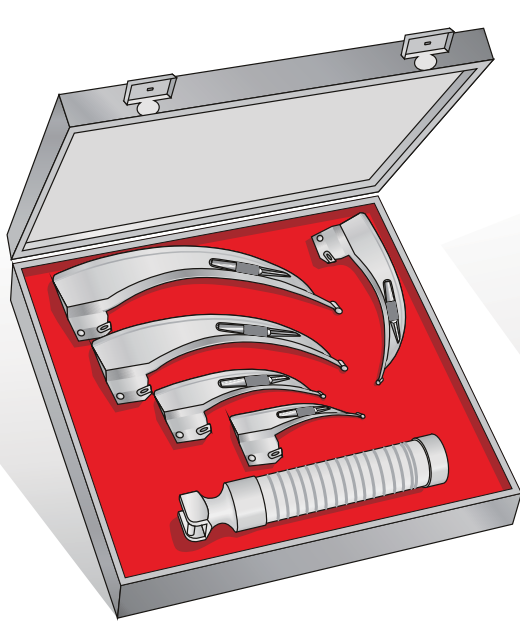

McINTOSH  
0101-18BAF

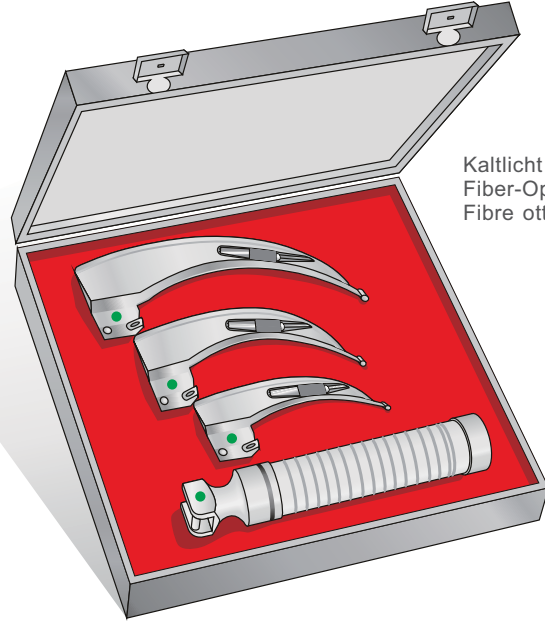

Kaltlicht  
Fiber-Optik  
Fibre ottiche

McINTOSH  
0101-18FAD

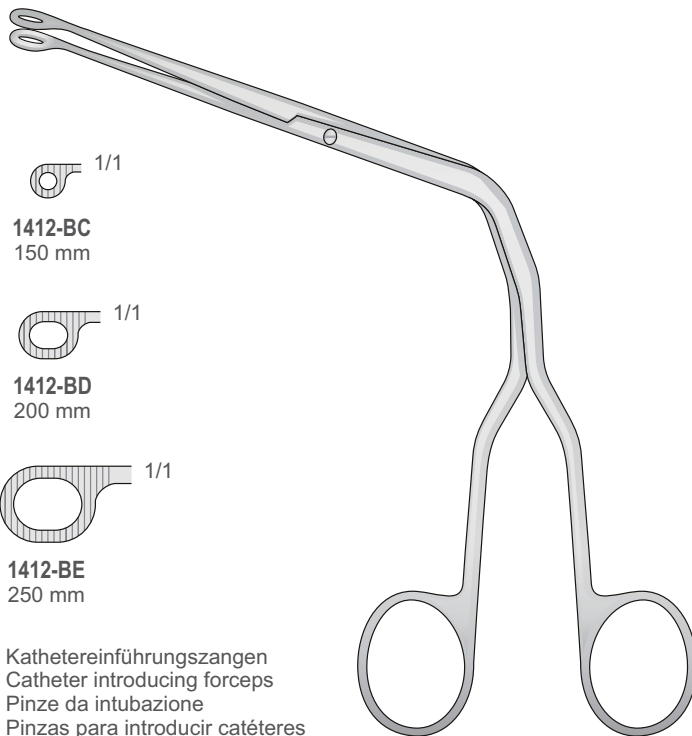

1/1

1412-BC  
150 mm



1/1

1412-BD  
200 mm

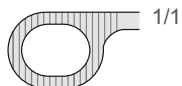

1/1

1412-BE  
250 mm

Kathetereinführungszangen  
Catheter introducing forceps  
Pinze da intubazione  
Pinzas para introducir catéteres

MAGILL  
1412-BC/1412-BE

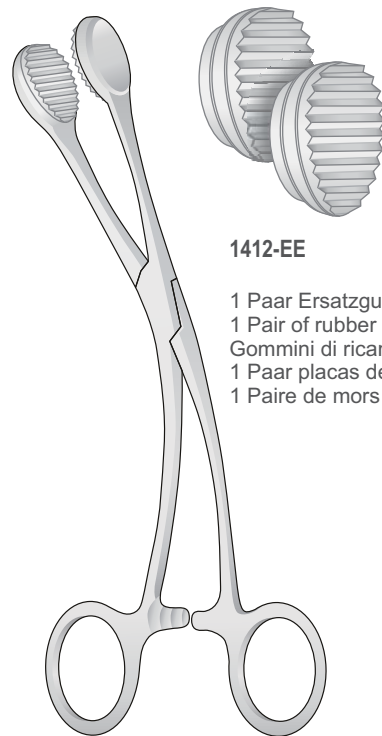

1412-EE

1 Paar Ersatzgummi  
1 Pair of rubber pads  
Gommini di ricambio 2 pezzi  
1 Paar placas de caucho  
1 Paire de mors caoutchouc

YOUNG  
1412-EF  
160 mm

6 x 13 mm

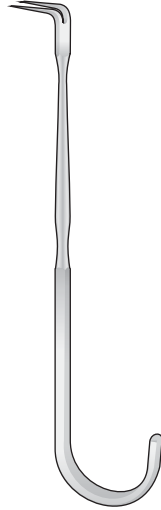

DUNN-DAUTREY  
**0414-BLI**  
130 mm

8 x 18 mm

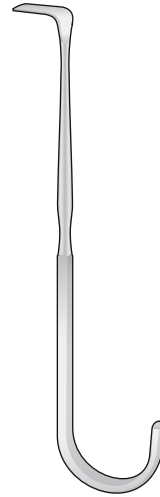

DUNN-DAUTREY  
**0414-BLL**  
125 mm

Posteriore  
Posterior

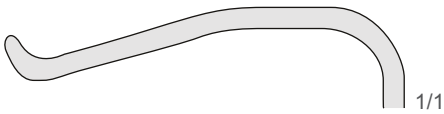

1/1

Anteriore  
Anterior

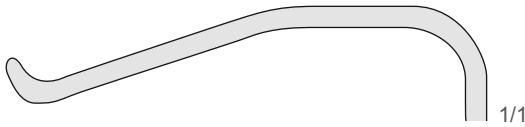

1/1

Superiore  
Superior

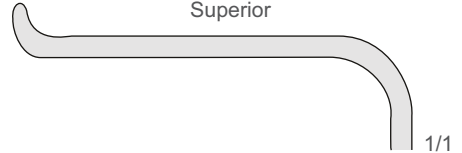

1/1

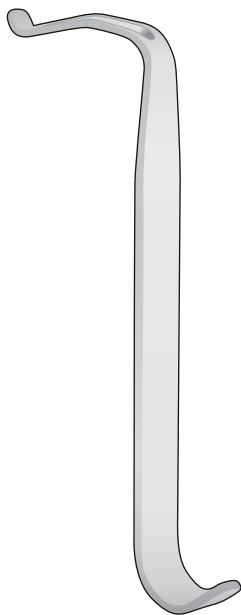

DUNN-DAUTREY  
**0414-LE** 6,5 x 50 mm  
140 mm

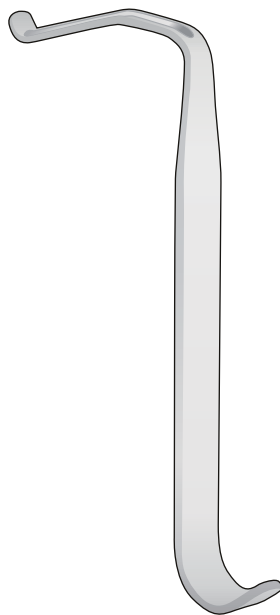

DUNN-DAUTREY  
**0414-LF** 6,5 x 60 mm  
140 mm

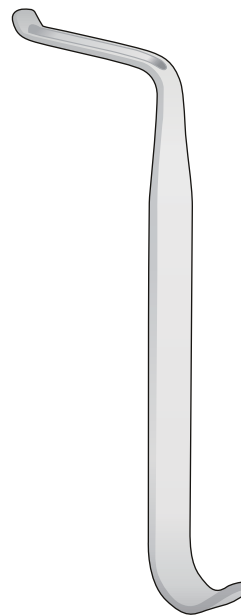

DUNN-DAUTREY  
**0414-LG** 8 x 50 mm  
140 mm

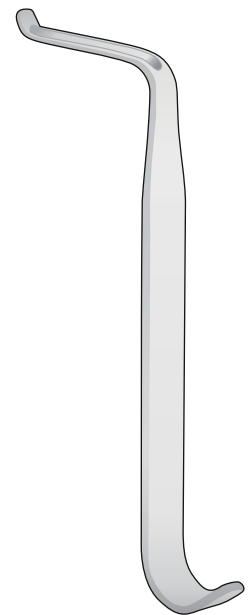

DUNN-DAUTREY  
**0414-LH** 6,5 x 50 mm  
140 mm

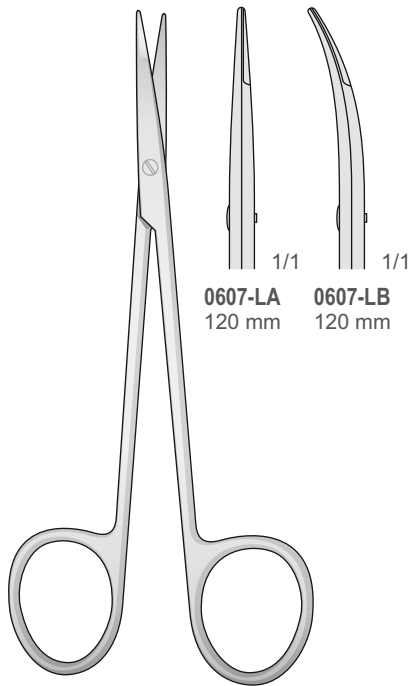

SHEA  
 0607-LA/0607-LB  
 120 mm

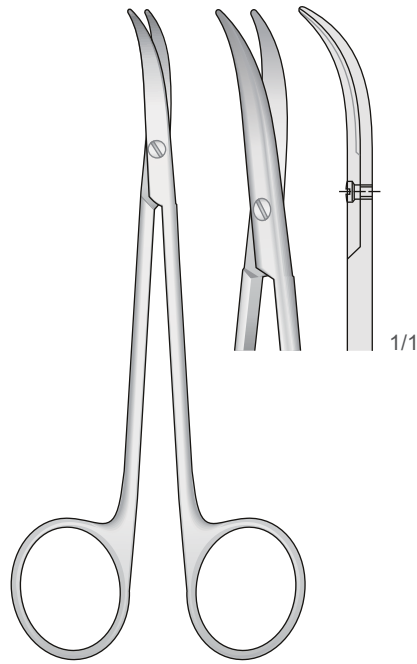

CINELLI  
 0607-LF  
 115 mm

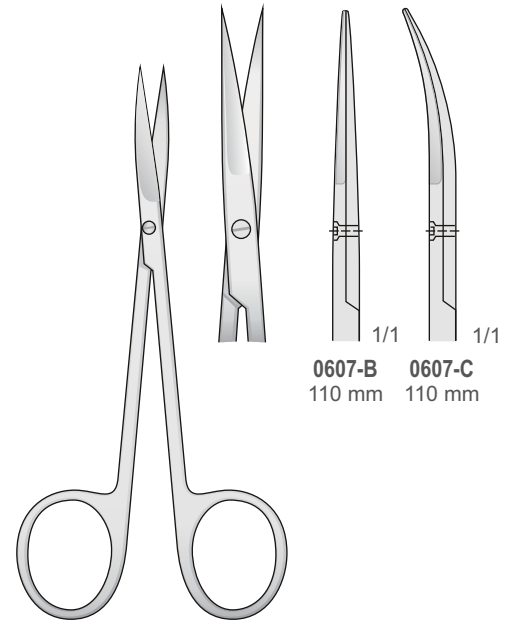

IRIS  
 0607-B/0607-C  
 110 mm

Gezahnt - Serrated  
 Dentellate - Dentadas  
 Dentelé

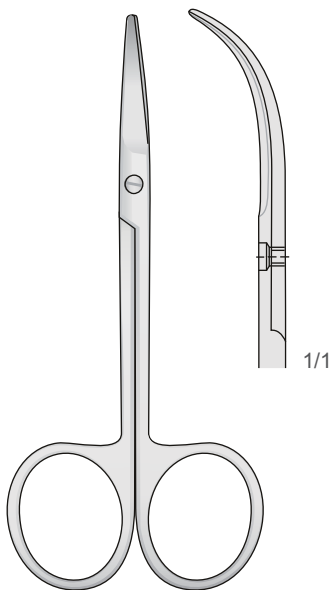

FOMON  
 0607-ED  
 110 mm

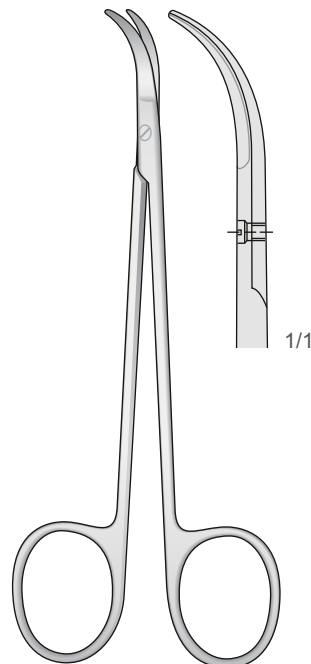

FOMON  
 0607-LD  
 135 mm

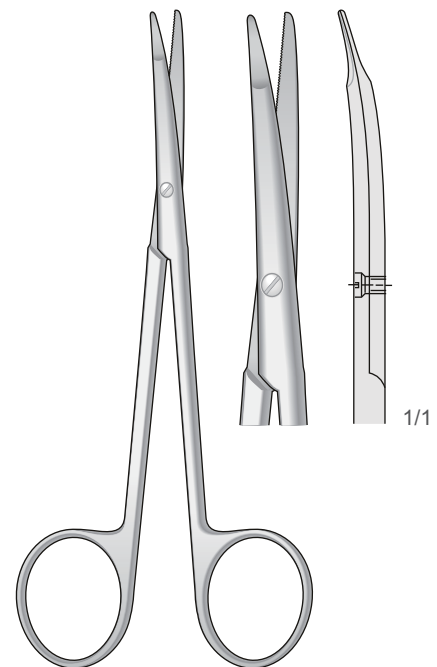

KILNER  
 0607-BCB  
 130 mm



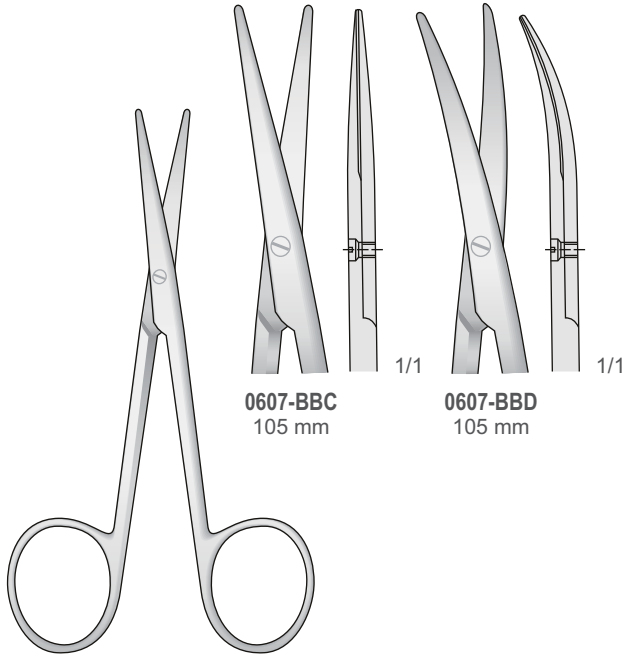

**0607-BBC**  
105 mm

**0607-BBD**  
105 mm

**COTTLE-KNAPP**  
**0607-BBC/0607-BBD**  
105 mm  
(LEXER-BABY)

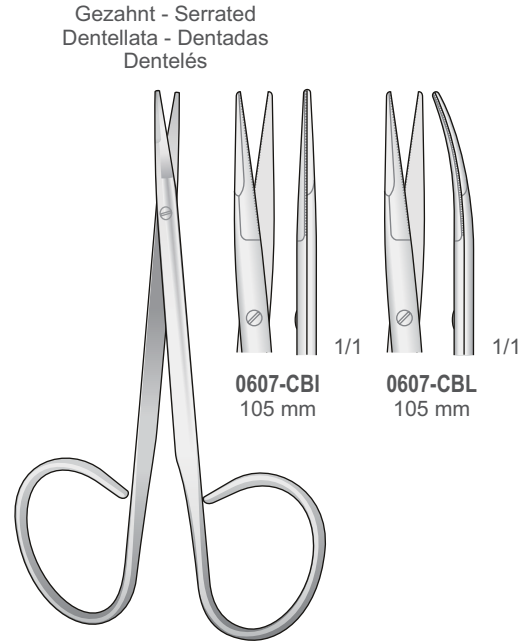

**0607-CBI**  
105 mm

**0607-CBL**  
105 mm

**KAYE**  
**0607-CBI/0607-CBL**  
105 mm

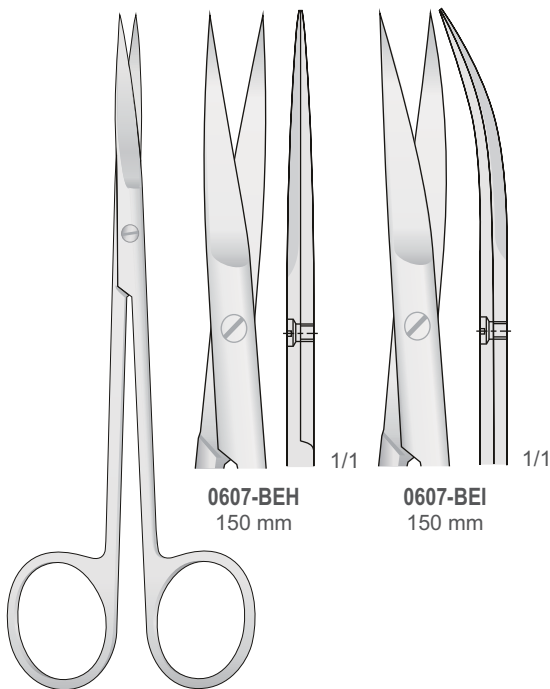

**0607-BEH**  
150 mm

**0607-BEI**  
150 mm

**JOSEPH**  
**0607-BEH/0607-BEI**  
150 mm

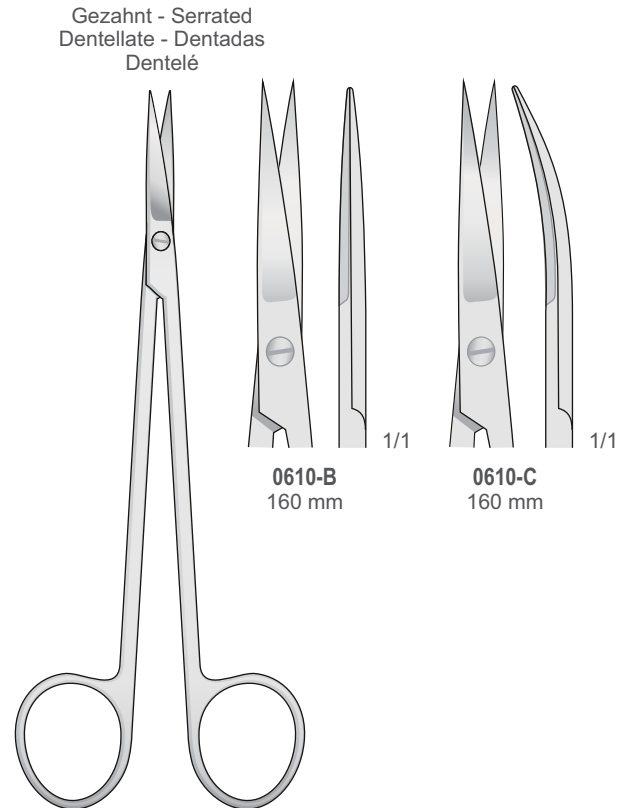

**0610-B**  
160 mm

**0610-C**  
160 mm

**KELLY**  
**0610-B/0610-C**  
160 mm

Chirurgische Scheren  
 Operating scissors  
 Forbici chirurgiche  
 Tijeras para cirugía general  
 Ciseaux chirurgicaux

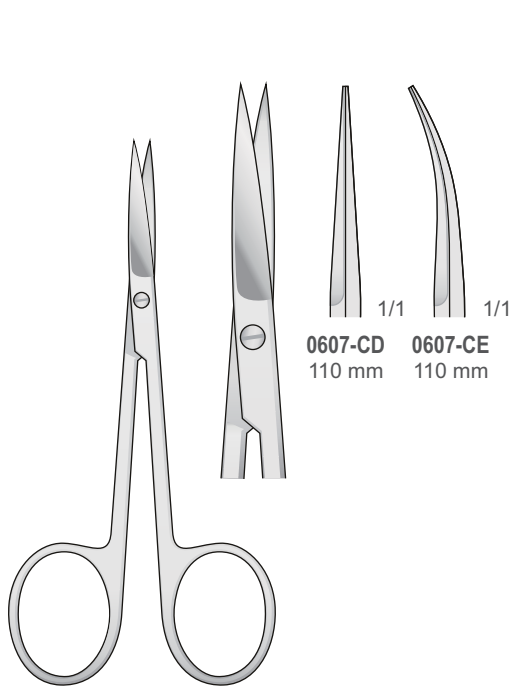

**0607-CD** 110 mm  
**0607-CE** 110 mm

**0607-CD/0607-CE**  
 110 mm

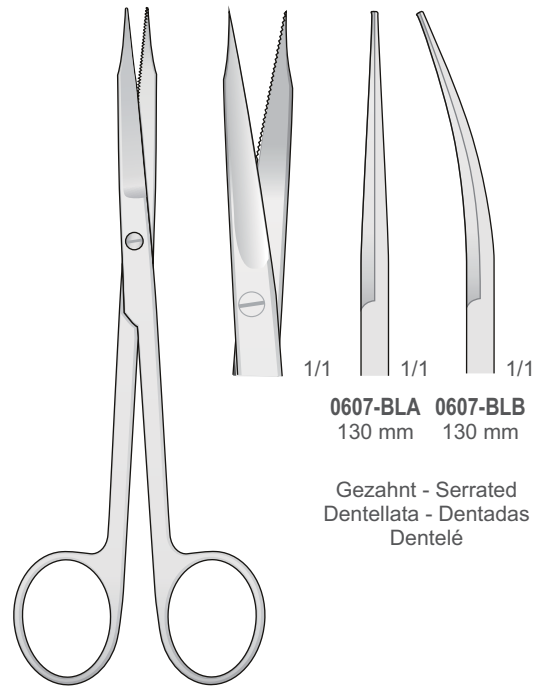

**0607-BLA** 130 mm  
**0607-BLB** 130 mm

Gezahnt - Serrated  
 Dentellata - Dentadas  
 Dentelé

**GOLDMAN-FOX**  
**0607-BLA/0607-BLB**  
 130 mm

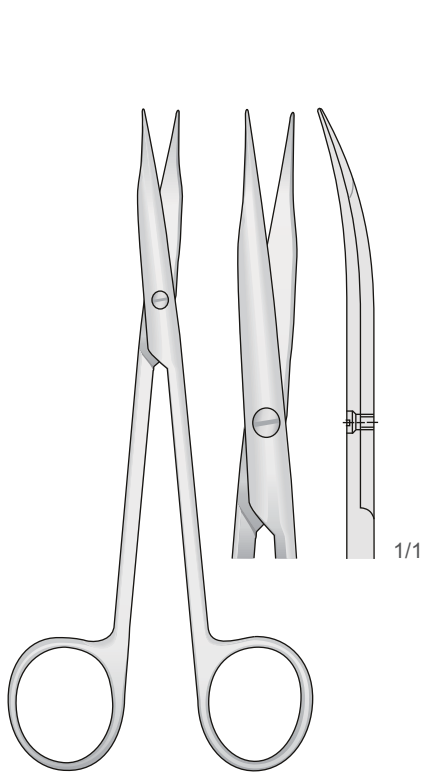

**JAMESON**  
**0607-BCE**  
 145 mm

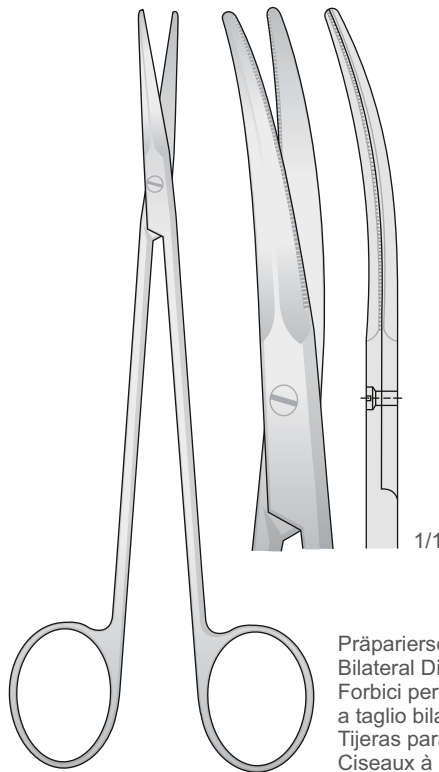

**GORNEY**  
**0607-BCH**  
 195 mm

Präparierscheren  
 Bilateral Dissecting scissors  
 Forbici per dissezione  
 a taglio bilaterale  
 Tijeras para preparacion  
 Ciseaux à dissection

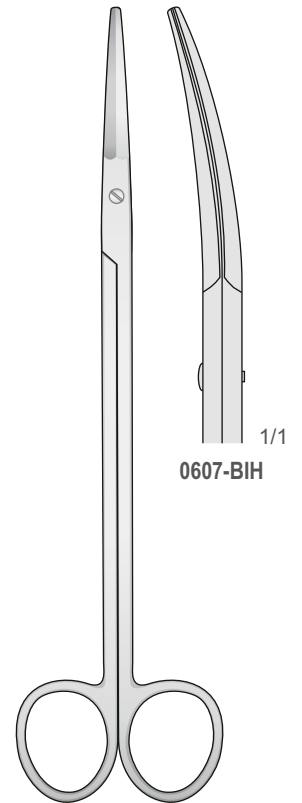

**KAHN**  
**0607-BIH**  
 205 mm

Chirurgische Scheren  
 Operating scissors  
 Forbici chirurgiche  
 Tijeras para cirugía general  
 Ciseaux chirurgicaux

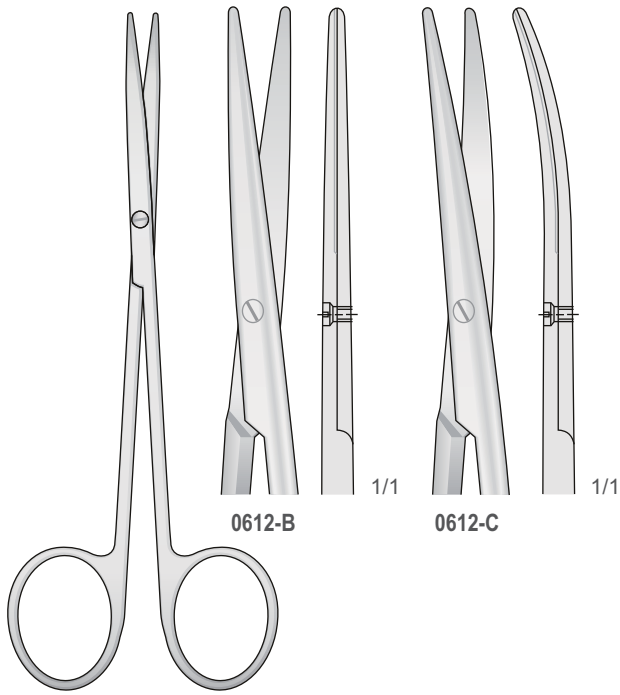

**METZENBAUM**  
**0612-B/0612-C**  
 145 mm

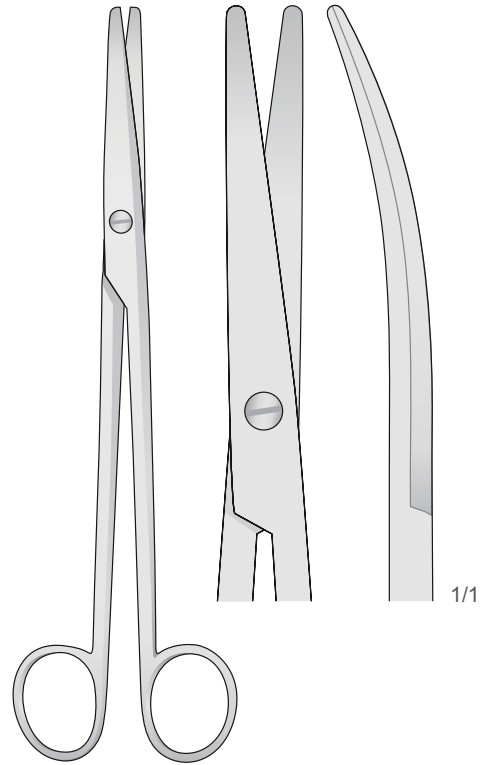

**MAYO-LEXER**  
**0612-HL**  
 165 mm

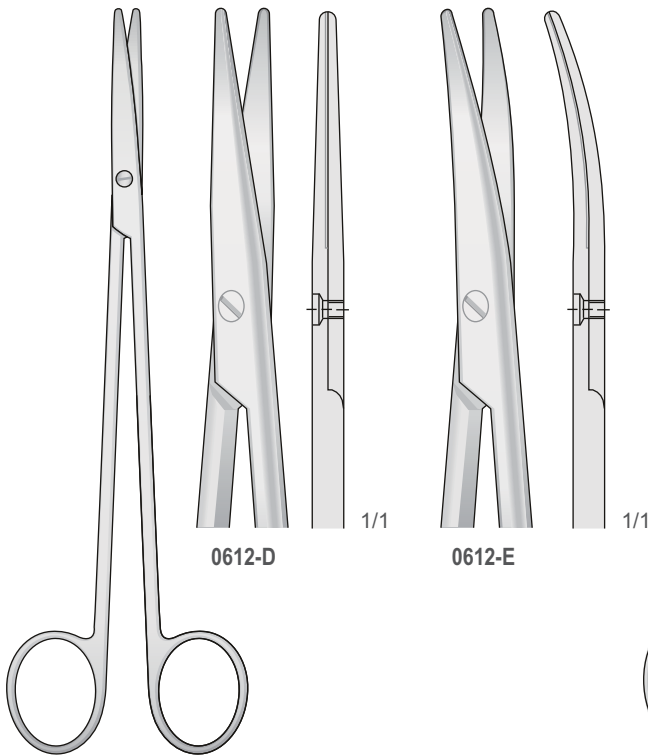

**METZENBAUM**  
**0612-D/0612-E**  
 185 mm

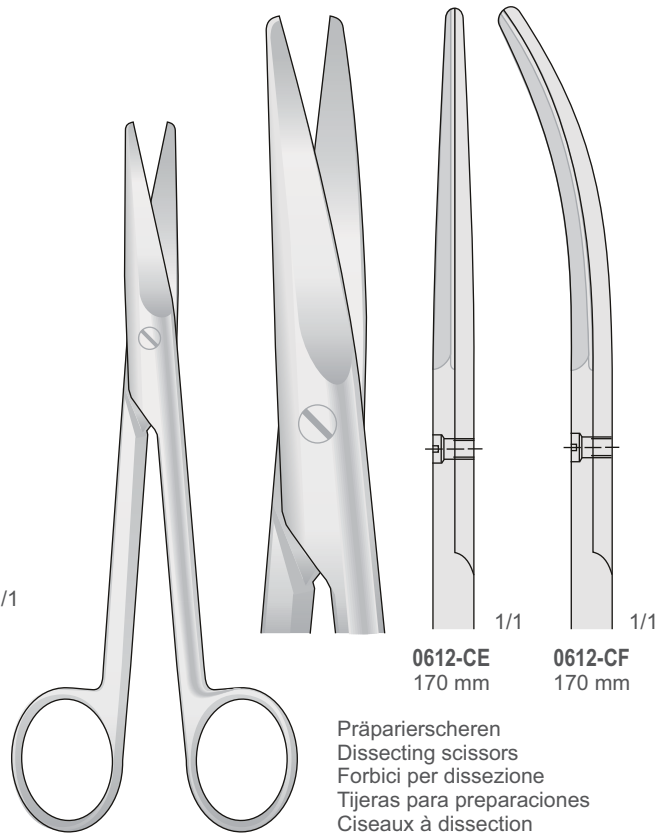

**MAYO**  
**0612-CE/0612-CF**  
 170 mm

Präparierscheren  
 Dissecting scissors  
 Forbici per dissezione  
 Tijeras para preparaciones  
 Ciseaux à dissection

Mit Hartmetalleinsätzen  
 Tungsten-carbide scissors  
 Con punta al carburo di tungsteno  
 Tijeras de tungsteno  
 Avec plaquettes en carbure de tungstène

Chirurgische Scheren  
 Operating scissors  
 Forbici chirurgiche  
 Tijeras para cirugía general  
 Ciseaux chirurgicaux

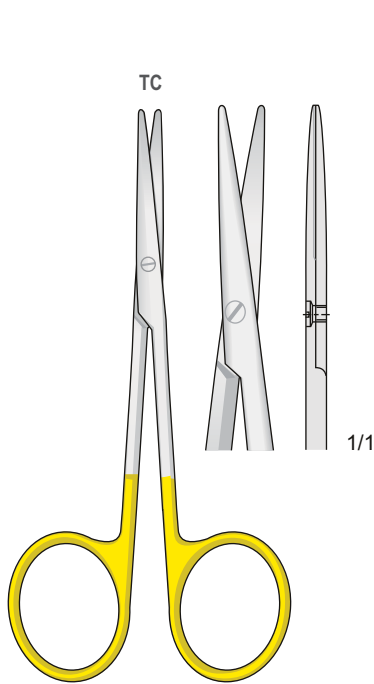

**0612-BBI**  
115 mm

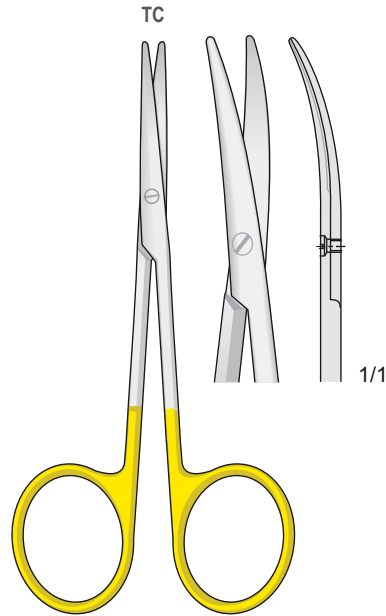

**0612-BBL**  
115 mm

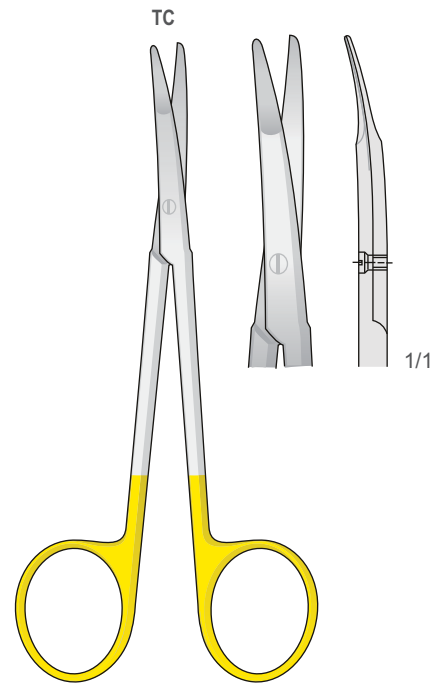

**KILNER (RAGNELL)**  
**0612-DFA**  
125 mm

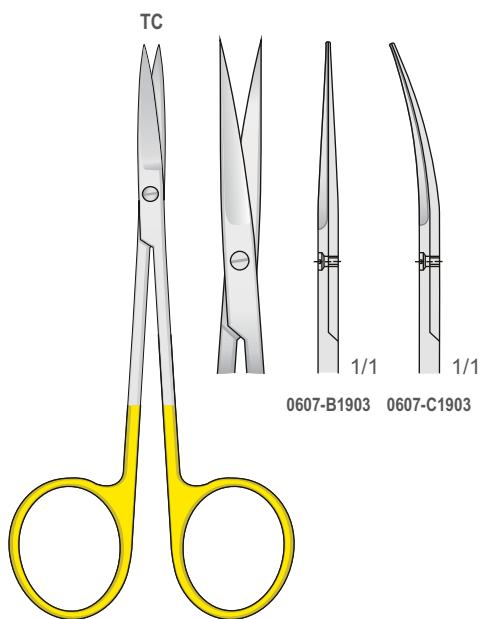

**IRIS**  
**0607-B1903/0607-C1903**  
115 mm

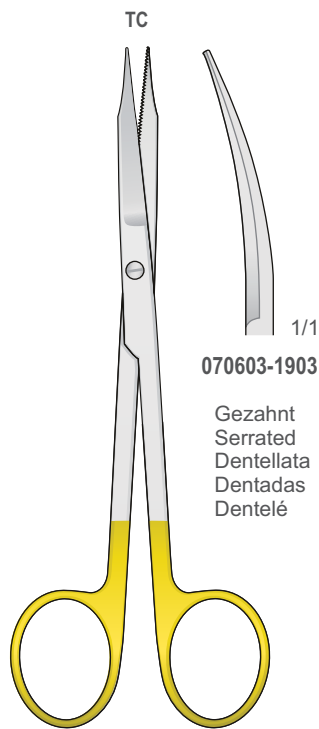

**GOLDMAN-FOX**  
**070603-1903**  
135 mm

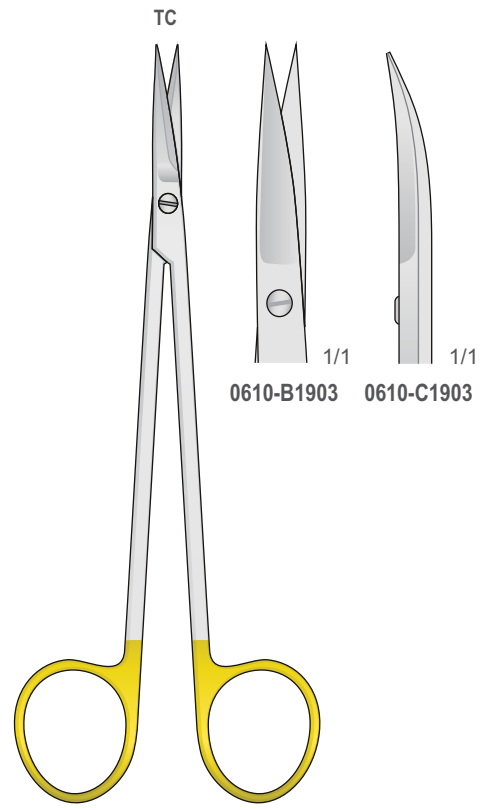

**KELLY**  
**0610-B1903/0610-C1903**  
160 mm

**070603-1903**  
 Gezahnt  
 Serrated  
 Dentellata  
 Dentadas  
 Dentelé

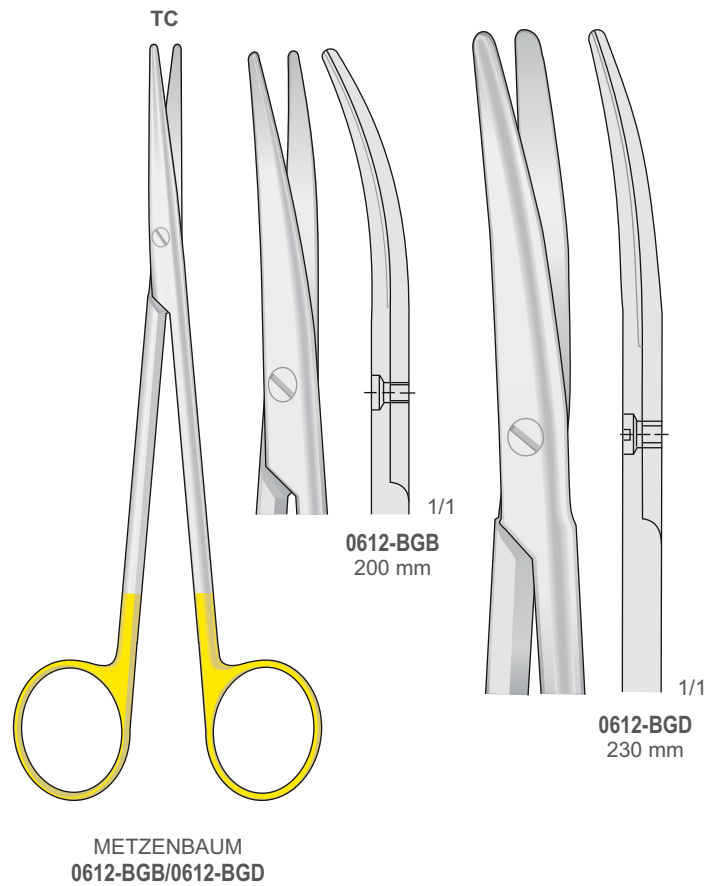
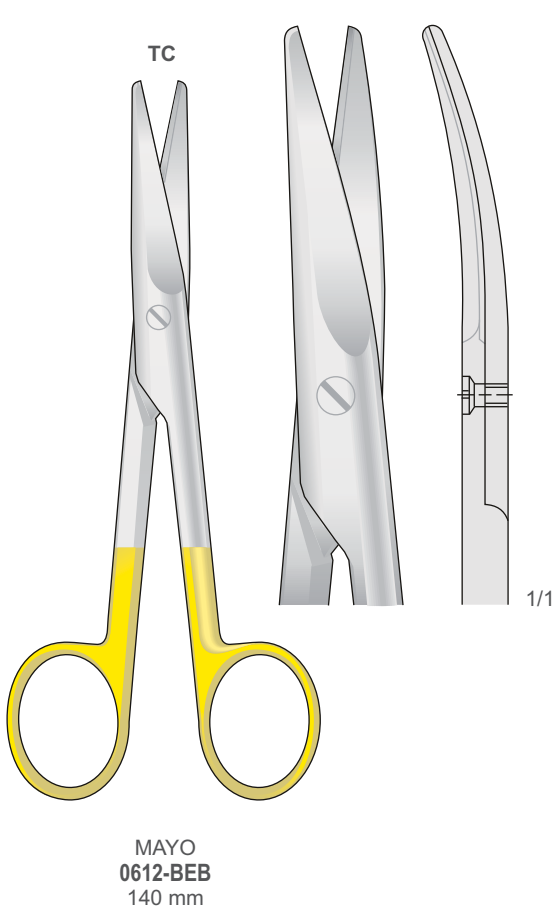
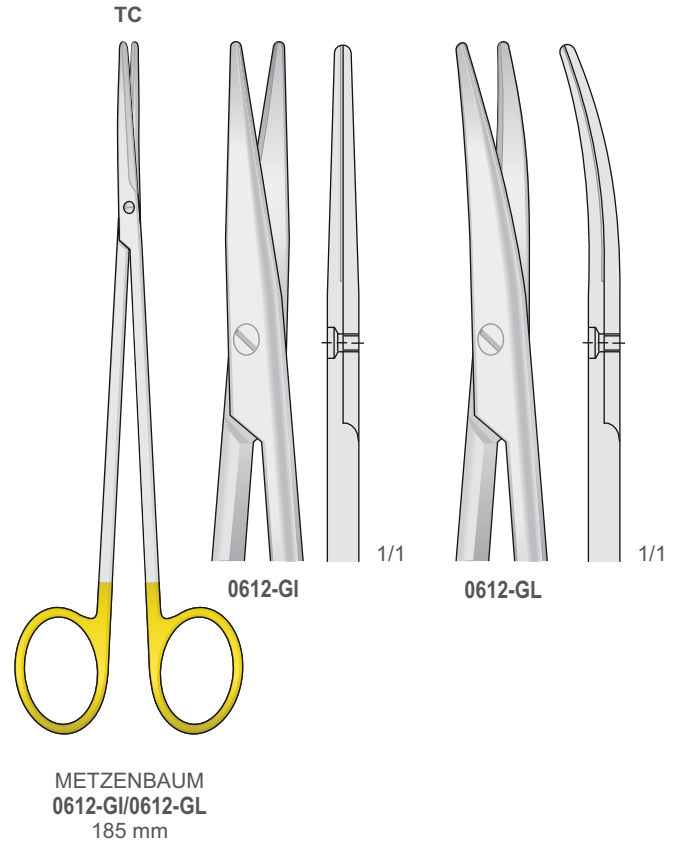
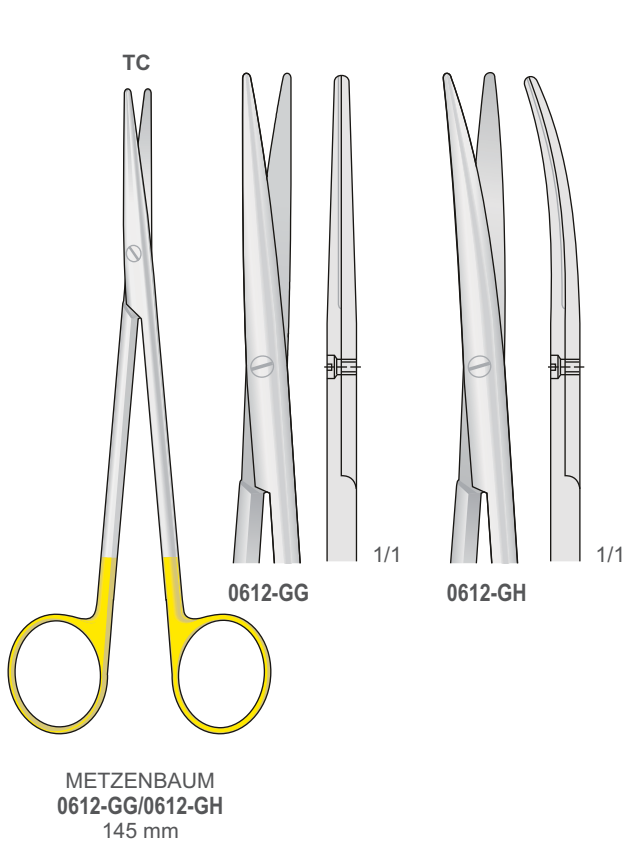

Mit Hartmetalleinsätzen  
 Tungsten-carbide scissors  
 Con punta al carburo di tungsteno  
 Tijeras de tungsteno  
 Avec plaquettes en carbure de tungstène

Chirurgische Scheren  
 Operating scissors  
 Forbici chirurgiche  
 Tijeras para cirugía general  
 Ciseaux chirurgicaux

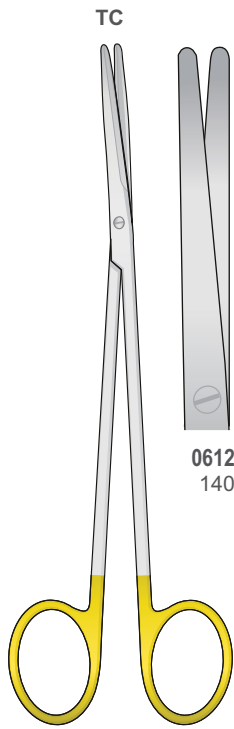

TC

**0612-CAC**  
140 mm

**0612-CAE**  
180 mm

**0612-CAG**  
200 mm

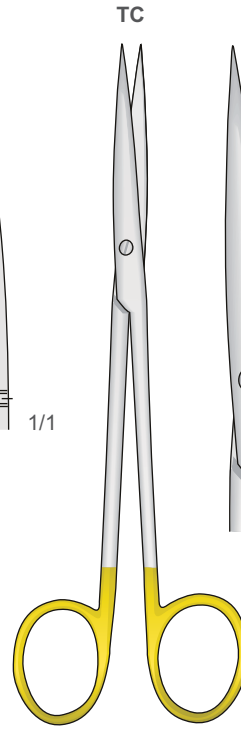

TC

**0612-LI**  
140 mm

**0612-LL**  
180 mm

METZENBAUM-FINO  
0612-CAC/0612-CAG

METZENBAUM-FINO  
0612-LI/0612-LL

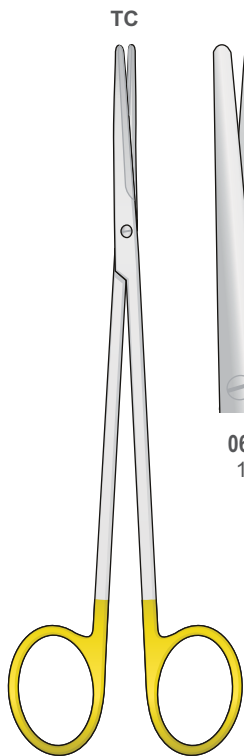

TC

**0612-CAB**  
140 mm

**0612-CAD**  
180 mm

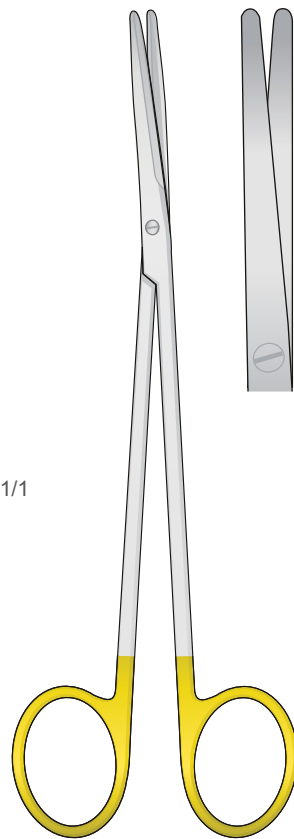

TC

METZENBAUM-FINO  
**0612-CAI**  
230 mm

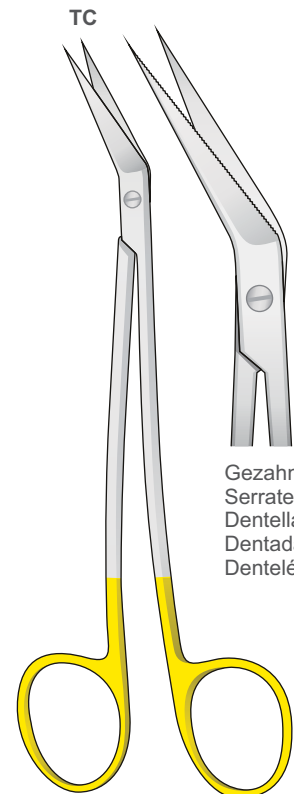

TC

Gezahnt  
Serrated  
Dentellate  
Dentadas  
Dentelé

**1110-BC**  
160 mm

Chirurgische Scheren  
 Operating scissors  
 Forbici chirurgiche  
 Tijeras para cirugía general  
 Ciseaux chirurgicaux

Mit Hartmetalleinsätzen  
 Tungsten-carbide scissors  
 Con punta al carburo di tungsteno  
 Tijeras de tungsteno  
 Avec plaquettes en carbure de tungstène

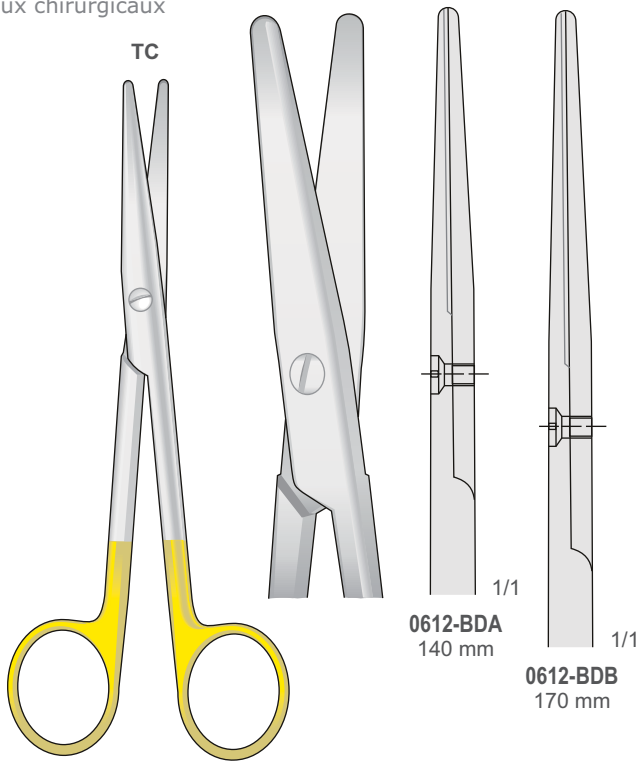

MAYO-STILLE  
 0612-BDA/0612-BDB

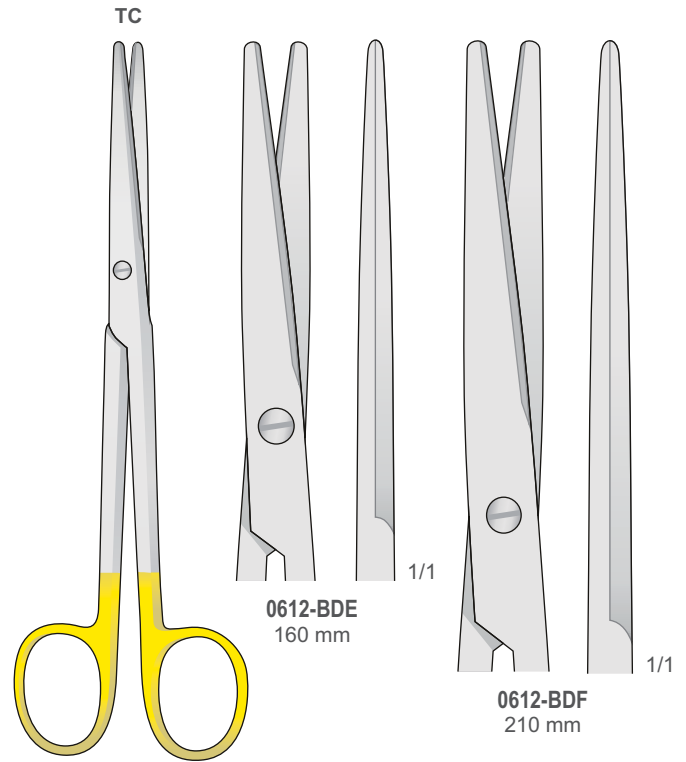

LEXER  
 0612-BDE/0612-BDF

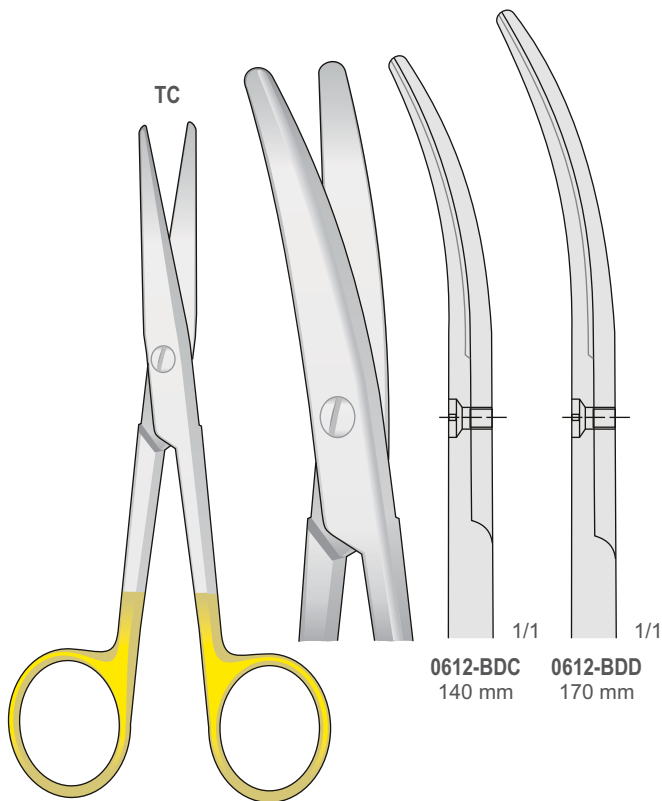

MAYO-STILLE  
 0612-BDC/0612-BDD

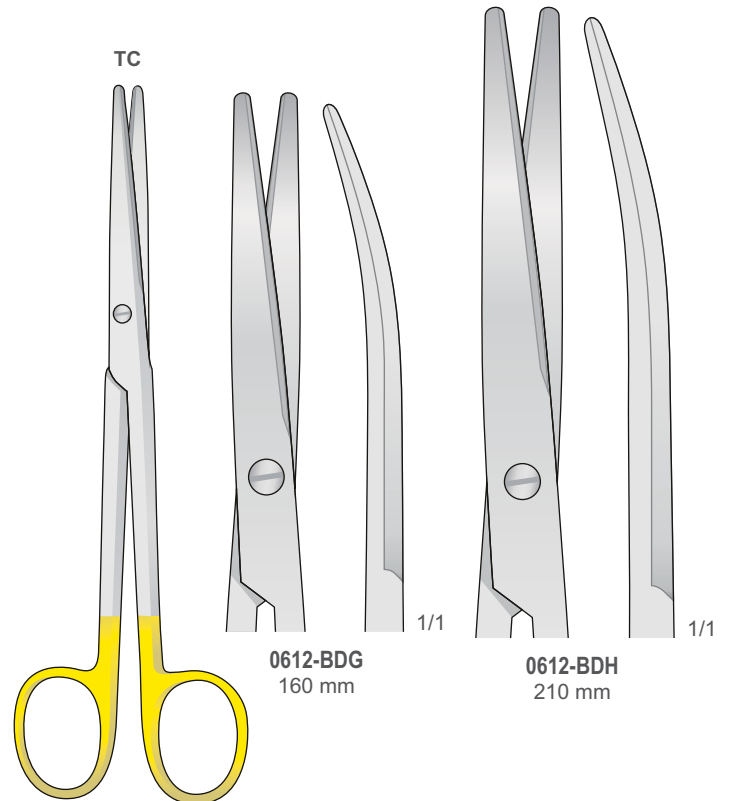

LEXER  
 0612-BDG/0612-BDH

Mit Hartmetalleinsätzen  
 Tungsten-carbide scissors  
 Con punta al carburo di tungsteno  
 Tijeras de tungsteno  
 Avec plaquettes en carbure de tungstène

Chirurgische Scheren  
 Operating scissors  
 Forbici chirurgiche  
 Tijeras para cirugía general  
 Ciseaux chirurgicaux

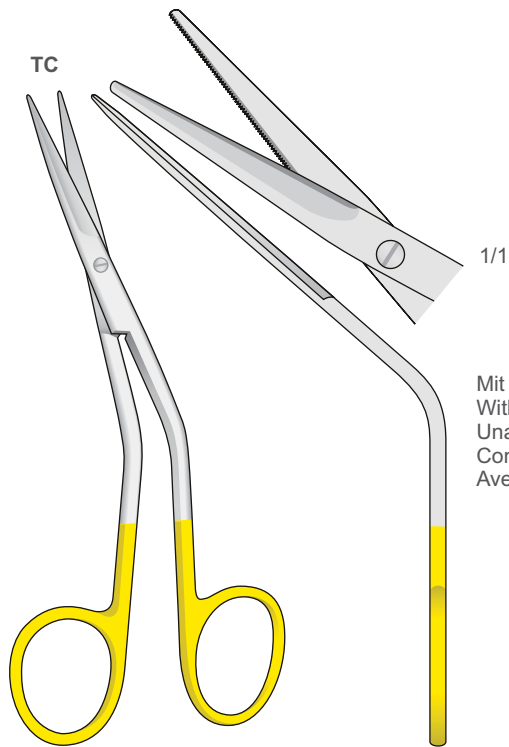

FOMON  
 0607-BGF  
 135 mm

Mit 1 Schneide Gezahnt  
 With 1 Blade Serrated  
 Una lama dentellata  
 Con 1 hoja dentadas  
 Avec 1 lame dentelé

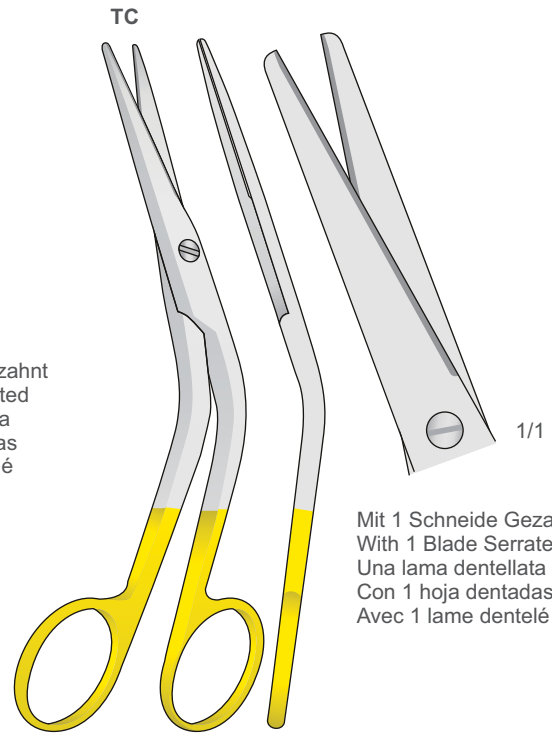

COTTLE  
 0607-BGG  
 160 mm

Mit 1 Schneide Gezahnt  
 With 1 Blade Serrated  
 Una lama dentellata  
 Con 1 hoja dentadas  
 Avec 1 lame dentelé

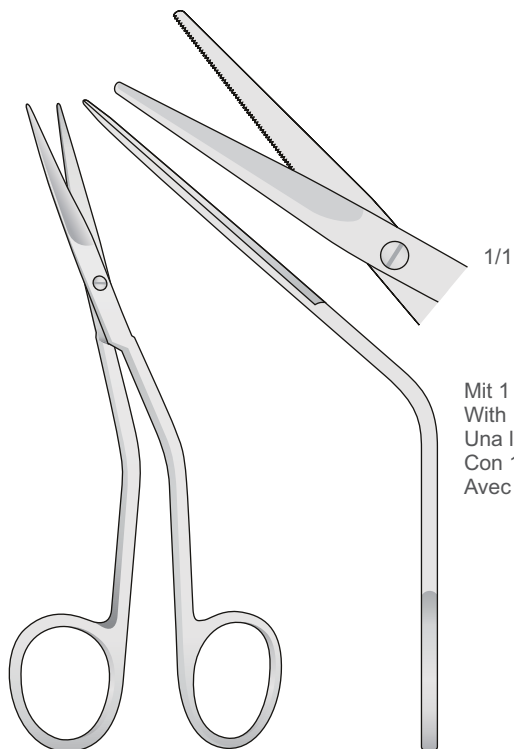

FOMON  
 0607-EB  
 135 mm

Mit 1 Schneide Gezahnt  
 With 1 Blade Serrated  
 Una lama dentellata  
 Con 1 hoja dentadas  
 Avec 1 lame dentelé

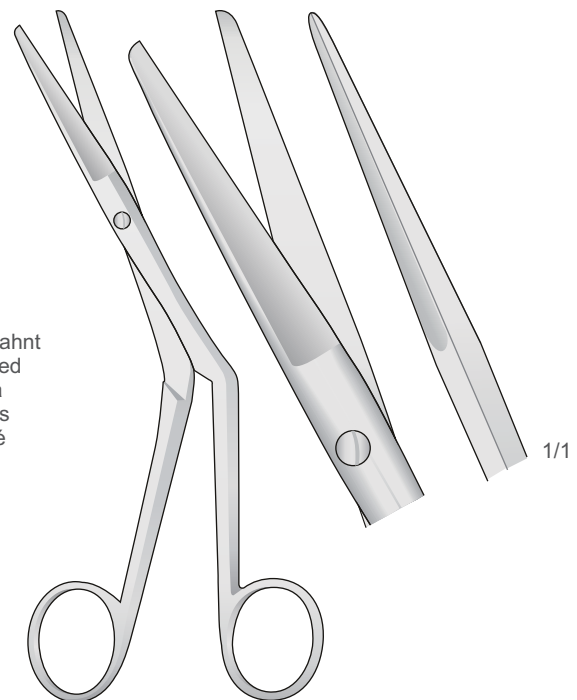

HEYMANN  
 0607-I  
 180 mm



Chirurgische pinzetten  
Tissue forceps  
Pinzette chirurgiche  
Pinzas chirùrgicas  
Pincas chirurgicales

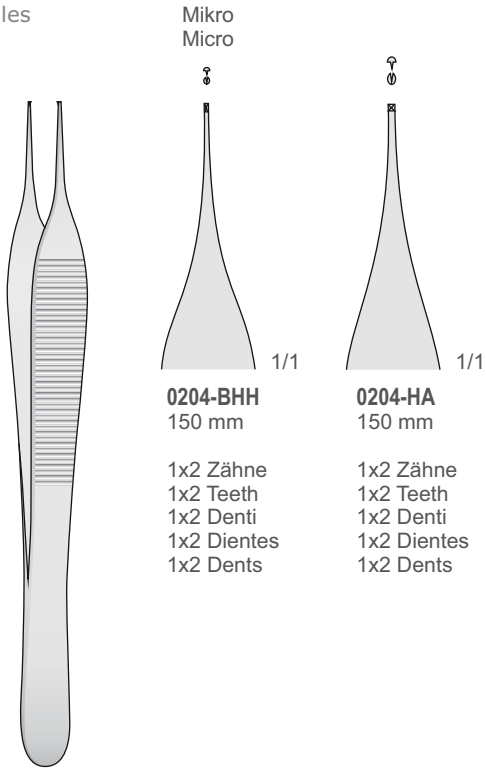

**0204-BHH**  
150 mm

1x2 Zähne  
1x2 Teeth  
1x2 Denti  
1x2 Dientes  
1x2 Dents

**0204-HA**  
150 mm

1x2 Zähne  
1x2 Teeth  
1x2 Denti  
1x2 Dientes  
1x2 Dents

ADSON  
**0204-HA/0204-BHH**  
150 mm

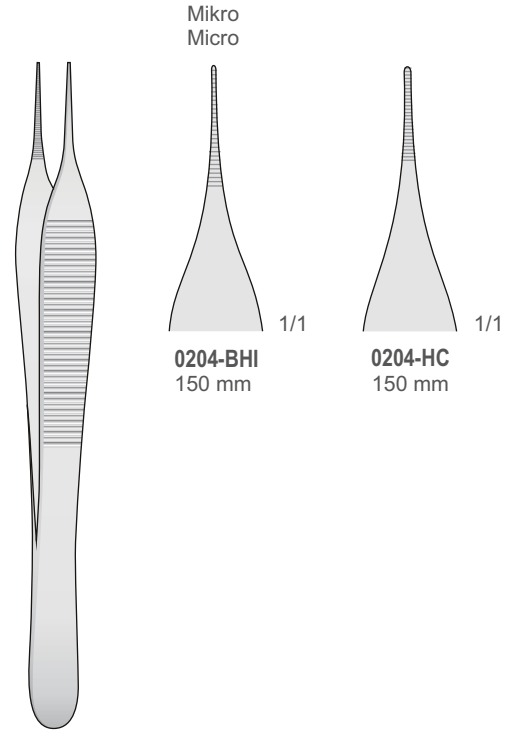

**0204-BHI**  
150 mm

1x2 Zähne  
1x2 Teeth  
1x2 Denti  
1x2 Dientes  
1x2 Dents

**0204-HC**  
150 mm

1x2 Zähne  
1x2 Teeth  
1x2 Denti  
1x2 Dientes  
1x2 Dents

ADSON  
**0204-HC/0204-BHI**  
150 mm

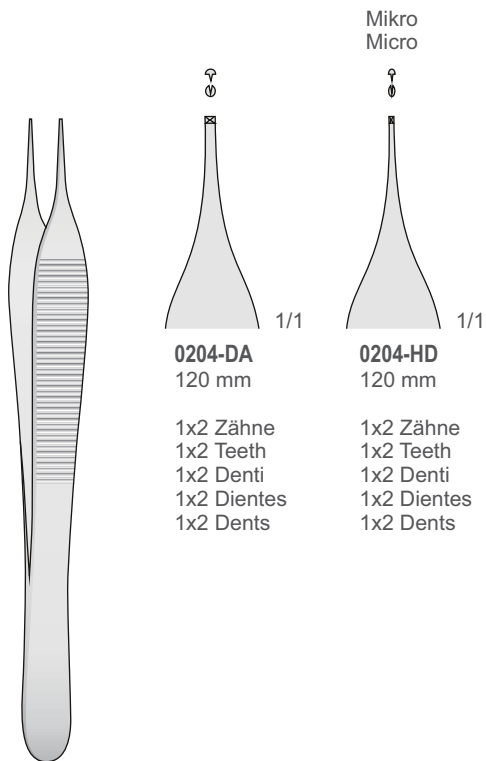

**0204-DA**  
120 mm

1x2 Zähne  
1x2 Teeth  
1x2 Denti  
1x2 Dientes  
1x2 Dents

**0204-HD**  
120 mm

1x2 Zähne  
1x2 Teeth  
1x2 Denti  
1x2 Dientes  
1x2 Dents

ADSON  
**0204-DA/0204-HD**  
120 mm

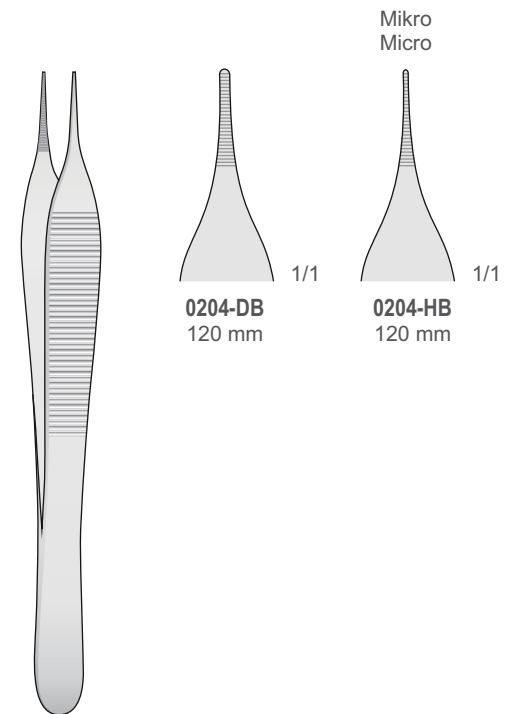

**0204-DB**  
120 mm

1x2 Zähne  
1x2 Teeth  
1x2 Denti  
1x2 Dientes  
1x2 Dents

**0204-HB**  
120 mm

1x2 Zähne  
1x2 Teeth  
1x2 Denti  
1x2 Dientes  
1x2 Dents

ADSON  
**0204-DB/0204-HB**  
120 mm

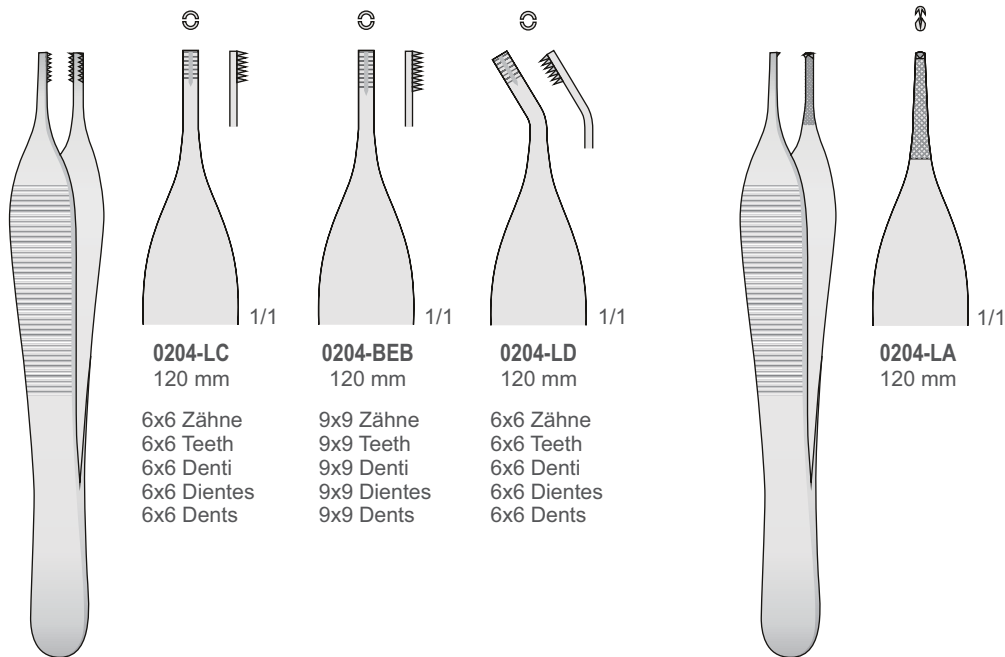

**0204-LC**  
120 mm

6x6 Zähne  
6x6 Teeth  
6x6 Denti  
6x6 Dientes  
6x6 Dents

**0204-BEB**  
120 mm

9x9 Zähne  
9x9 Teeth  
9x9 Denti  
9x9 Dientes  
9x9 Dents

**0204-LD**  
120 mm

6x6 Zähne  
6x6 Teeth  
6x6 Denti  
6x6 Dientes  
6x6 Dents

**0204-LA**  
120 mm

ADSON-BROWN  
**0204-LC/0204-BEB**  
120 mm

ADSON  
**0204-LA**  
120 mm

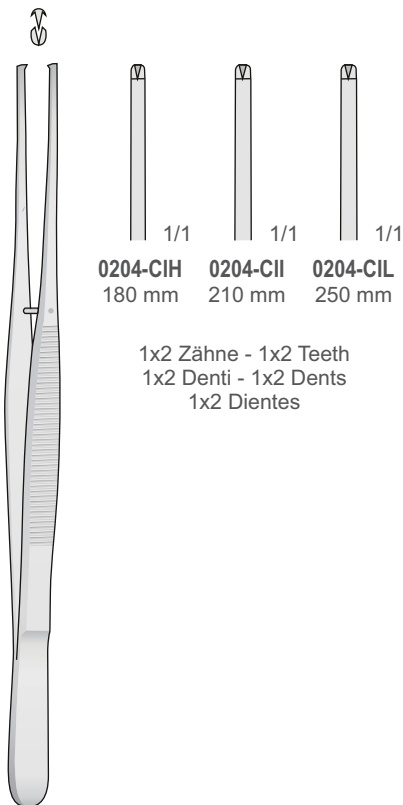

**0204-CIH** 180 mm  
**0204-CII** 210 mm  
**0204-CIL** 250 mm

1x2 Zähne - 1x2 Teeth  
1x2 Denti - 1x2 Dents  
1x2 Dientes

POTTS-SMITH  
**0204-CIH/0204-CIL**

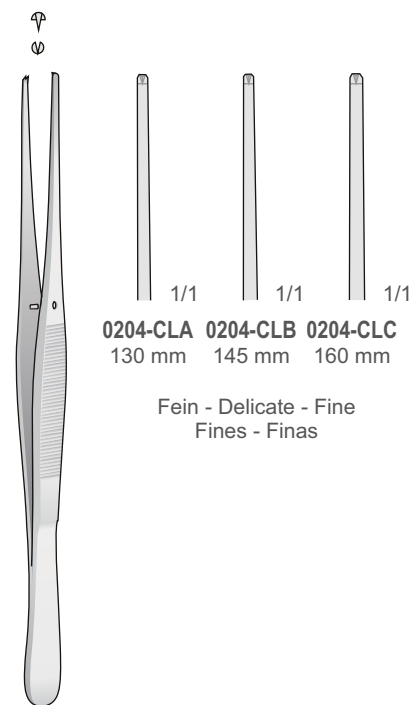

**0204-CLA** 130 mm  
**0204-CLB** 145 mm  
**0204-CLC** 160 mm

Fein - Delicate - Fine  
Fines - Finas

**0204-CLA/0204-CLC**

Chirurgische pinzetten  
Tissue forceps  
Pinzette chirurgiche  
Pinzas chirùrgicas  
Pincas chirurgicales

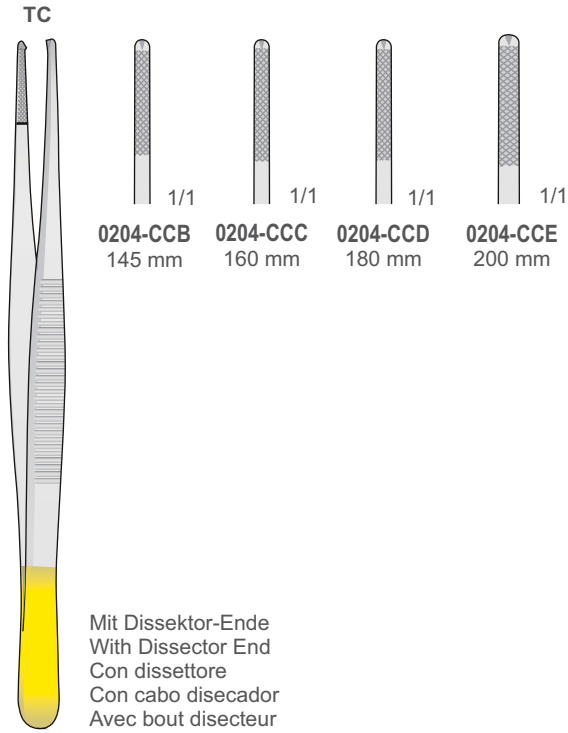

0204-CCB/0204-CCE

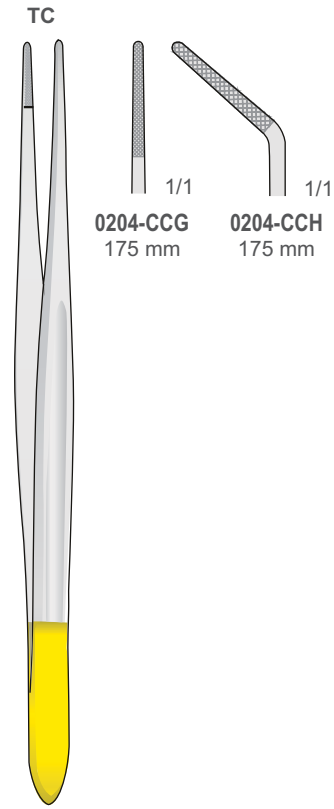

CUSHING  
0204-CCG/0204-CCH  
175 mm

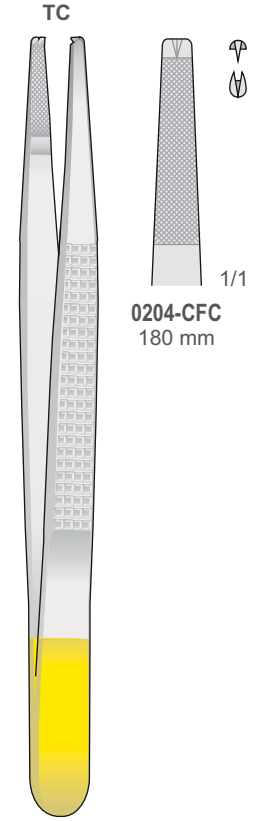

BONNEY  
0204-CFC  
180 mm

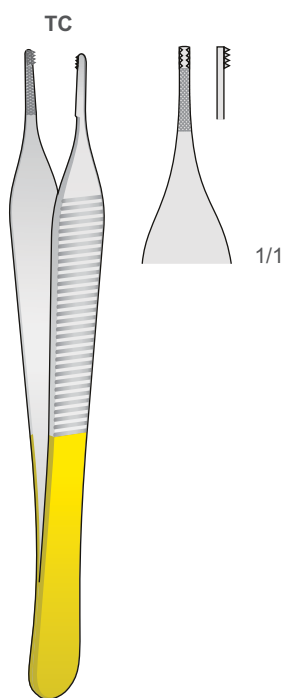

ADSON-BROWN  
0204-CFD  
120 mm

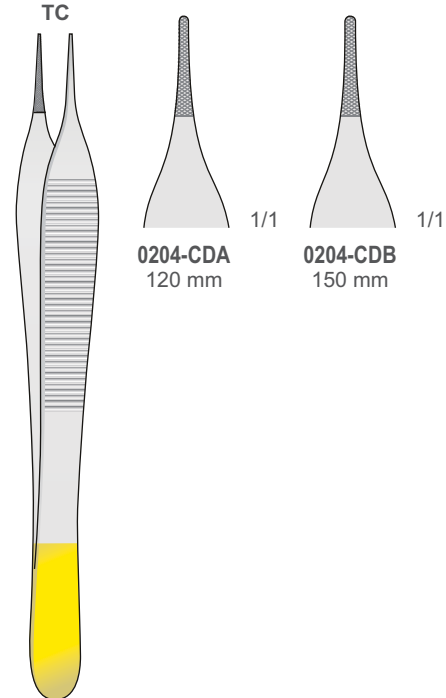

ADSON  
0204-CDA/0204-CDB

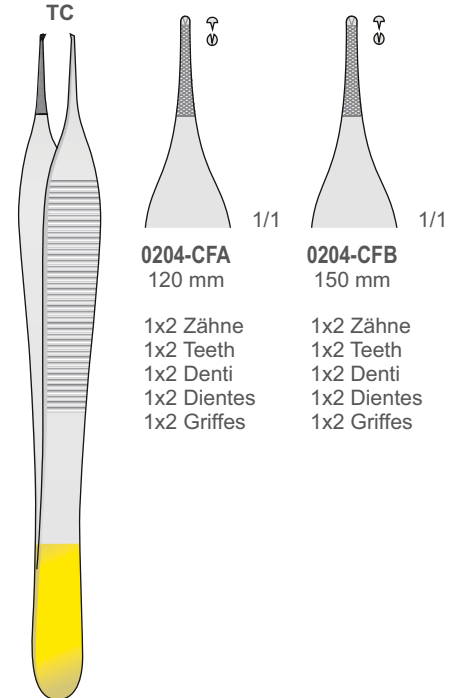

ADSON  
0204-CFA/0204-CFB

Mit Hartmetalleinsätzen  
 Tungsten-carbide scissors  
 Con punta al carburo di tungsteno  
 Tijeras de tungsteno  
 Avec plaquettes en carbure de tungstène

Nadelhalter  
 Needle Holders  
 Port'aghi  
 Portaagujas  
 Porte aiguilles

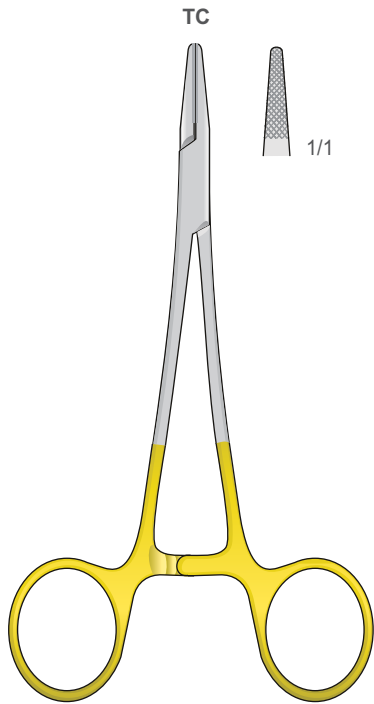

**BABY-CRILE-WOOD**  
**1508-FE**  
 150 mm

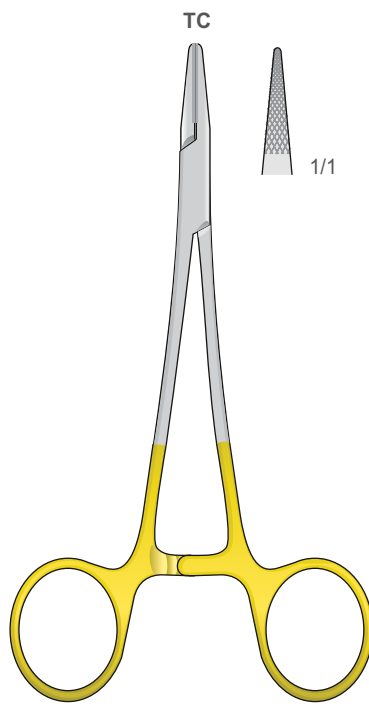

**CRILE-WOOD**  
**1508-HB**  
 150 mm

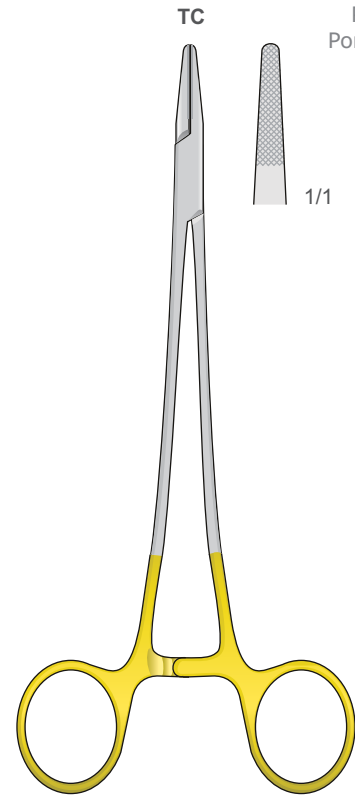

**CRILE-WOOD**  
**1508-HH**  
 180 mm

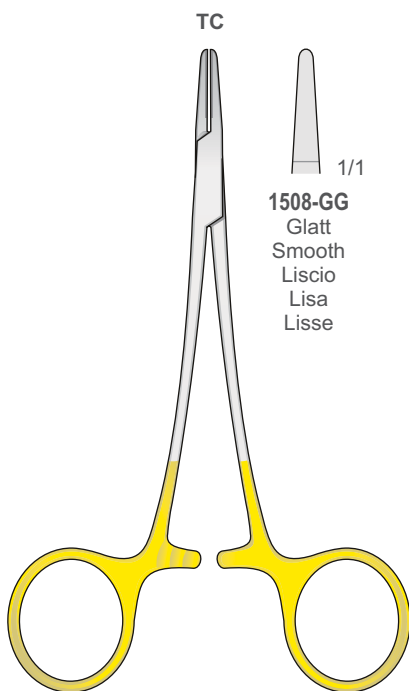

**WEBSTER**  
**1508-GG**  
 130 mm

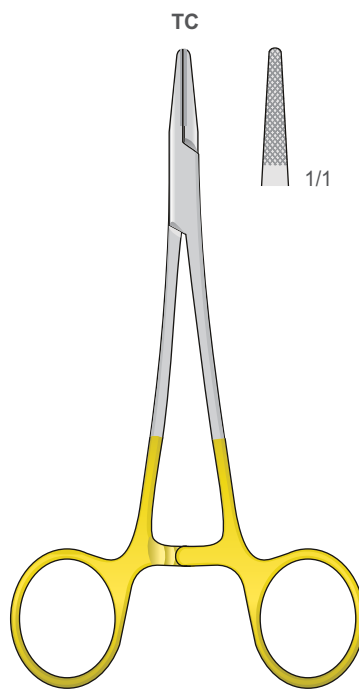

**CONVERSE**  
**1508-GI**  
 130 mm

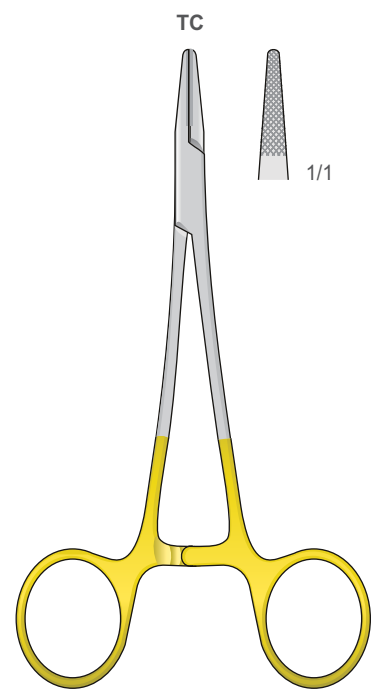

**HALSEY**  
**1508-HD**  
 130 mm

Nadelhalter  
Needle Holders  
Port'aghi  
Portaagujas  
Porte aiguilles

Mit Hartmetalleinsätzen  
Tungsten-carbide scissors  
Con punta al carburo di tungsteno  
Tijeras de tungsteno  
Avec plaquettes en carbure de tungstène

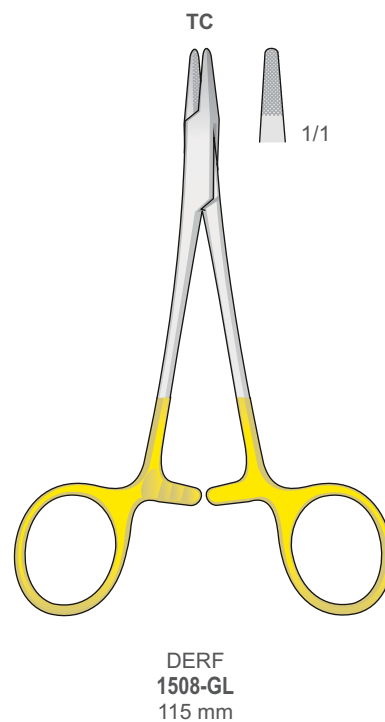
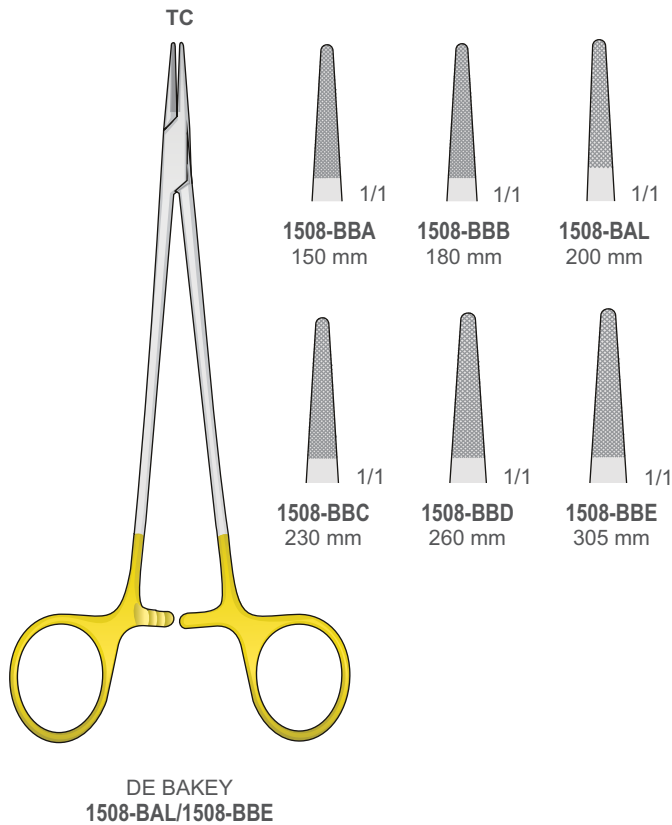
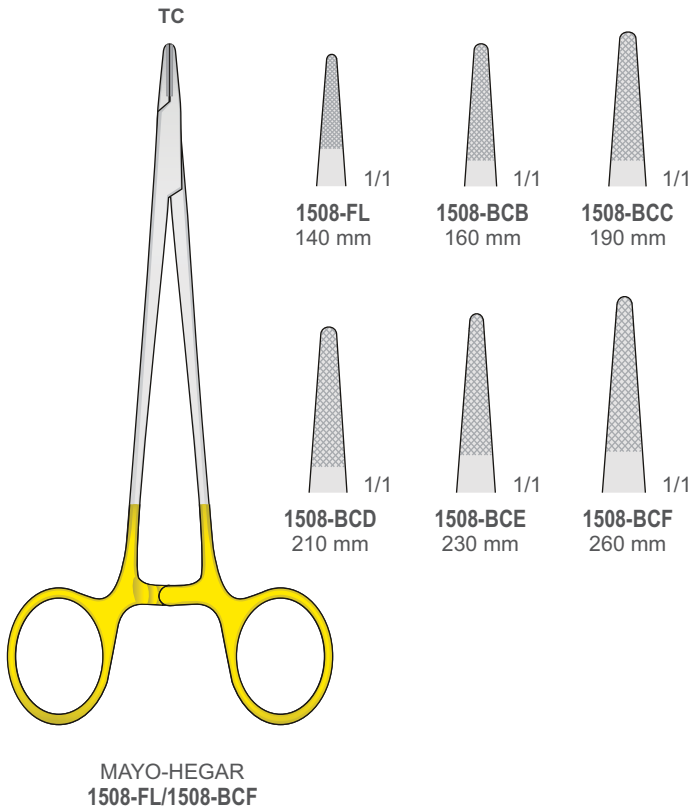

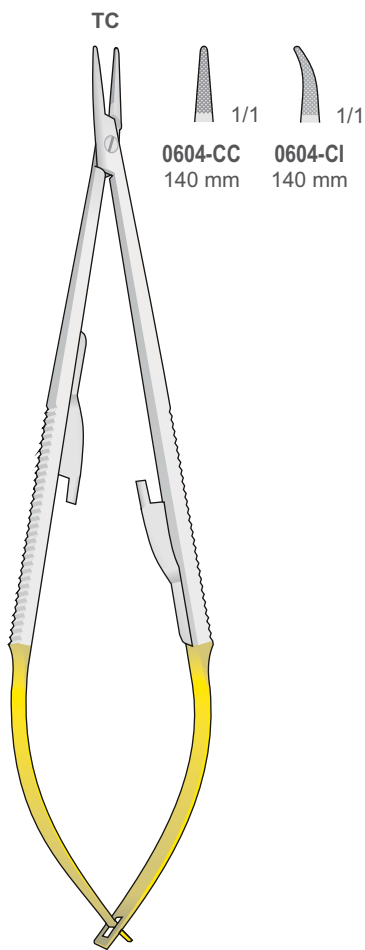

CASTROVIEJO  
0604-CC/0604-CI  
140 mm

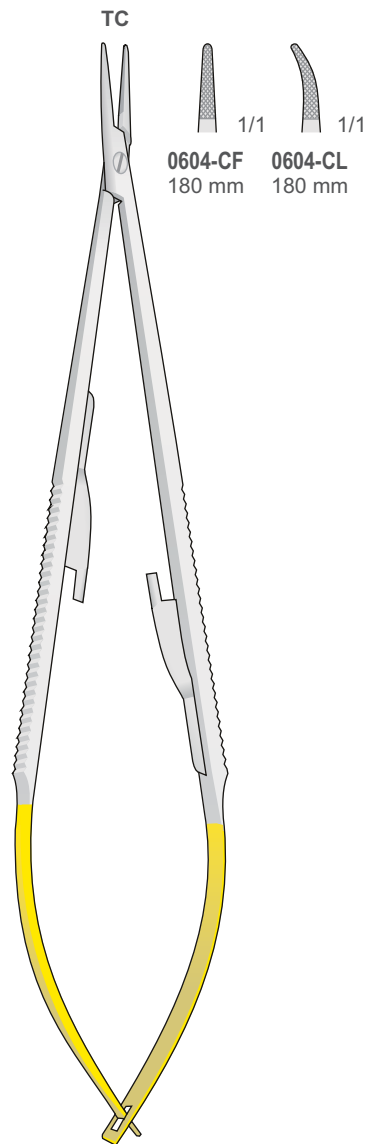

CASTROVIEJO  
0604-CF/0604-CL  
180 mm

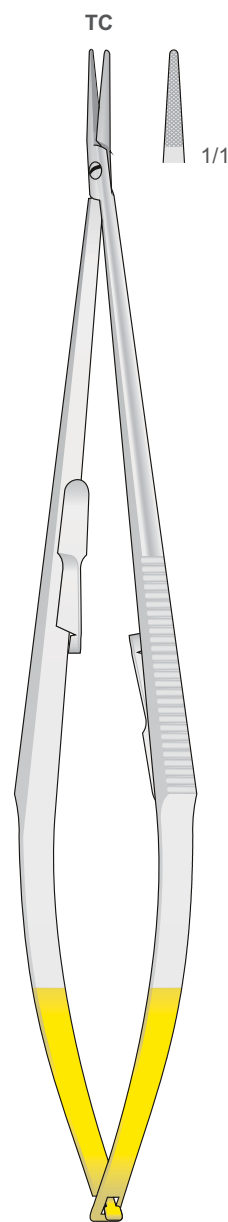

CASTROVIEJO  
0604-CH  
215 mm

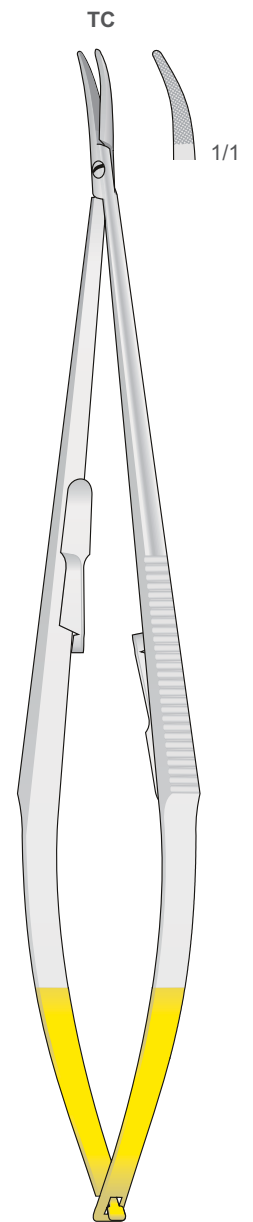

CASTROVIEJO  
0604-BCI  
215 mm

Arterienklemmen  
 Hemostatic forceps  
 Pinze emostatiche  
 Pinzas hemostáticas  
 Pincas hémostàtiques

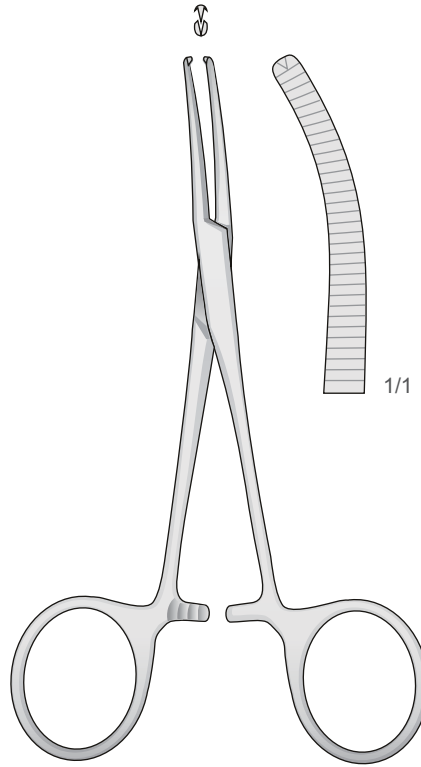

**15-HG**  
 180 mm

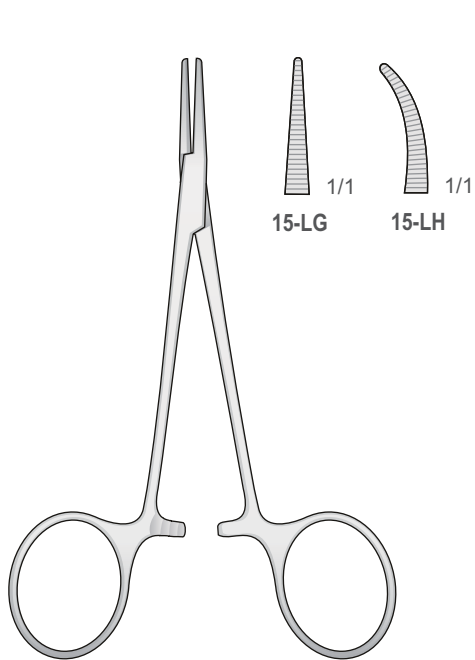

**HALSTED-MOSQUITO**  
**15-LG/15-LH**  
 120 mm

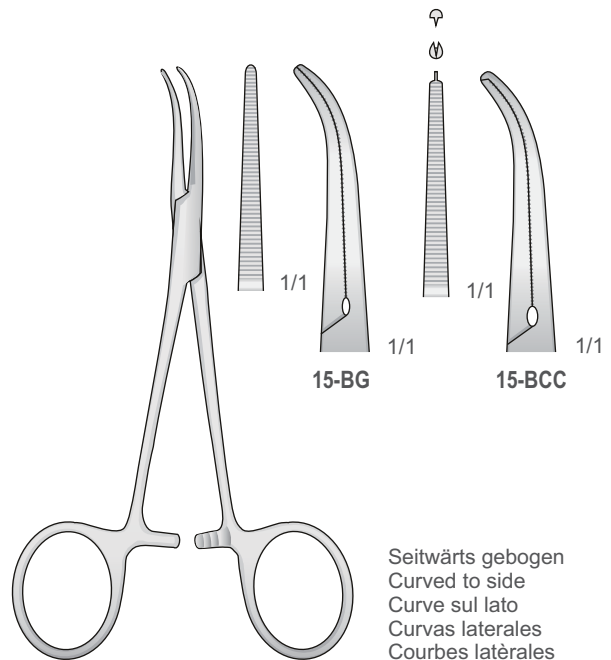

**DANDY**  
**15-BG/15-BCC**  
 140 mm

Seitwärts gebogen  
 Curved to side  
 Curve sul lato  
 Curvas laterales  
 Courbes latérales

Kopfschwartenzangen - Scalp Flap Forceps  
Pinze per il cuoio capelluto - Pinzas para el cuero cabelludo  
Pincés pour le cuir chevelu

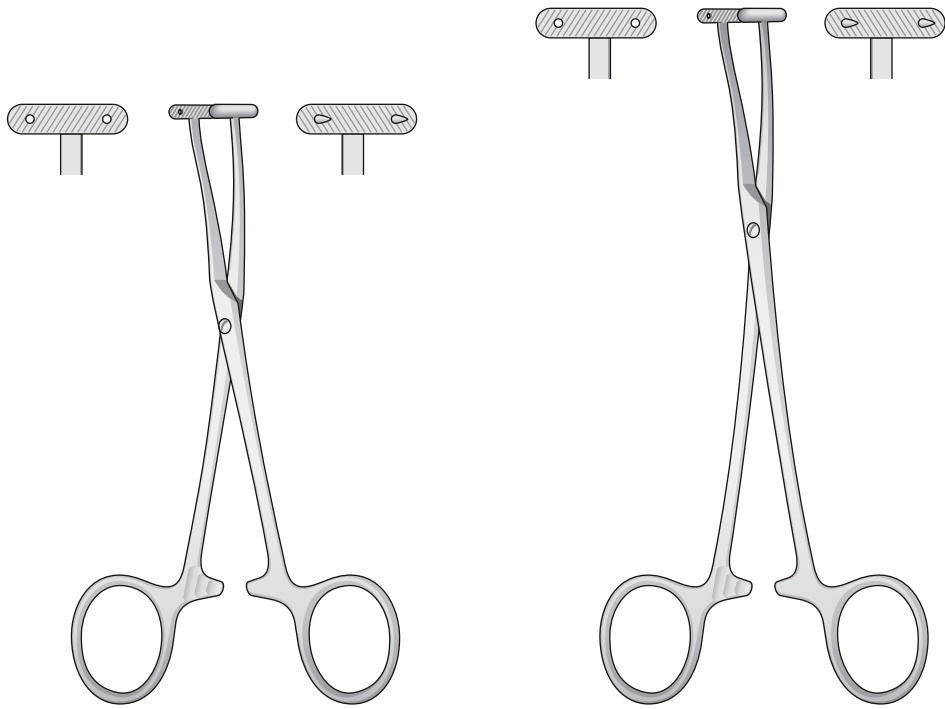

DE MARTEL  
0602-BBL  
140 mm

DE MARTEL  
0602-BCA  
180 mm

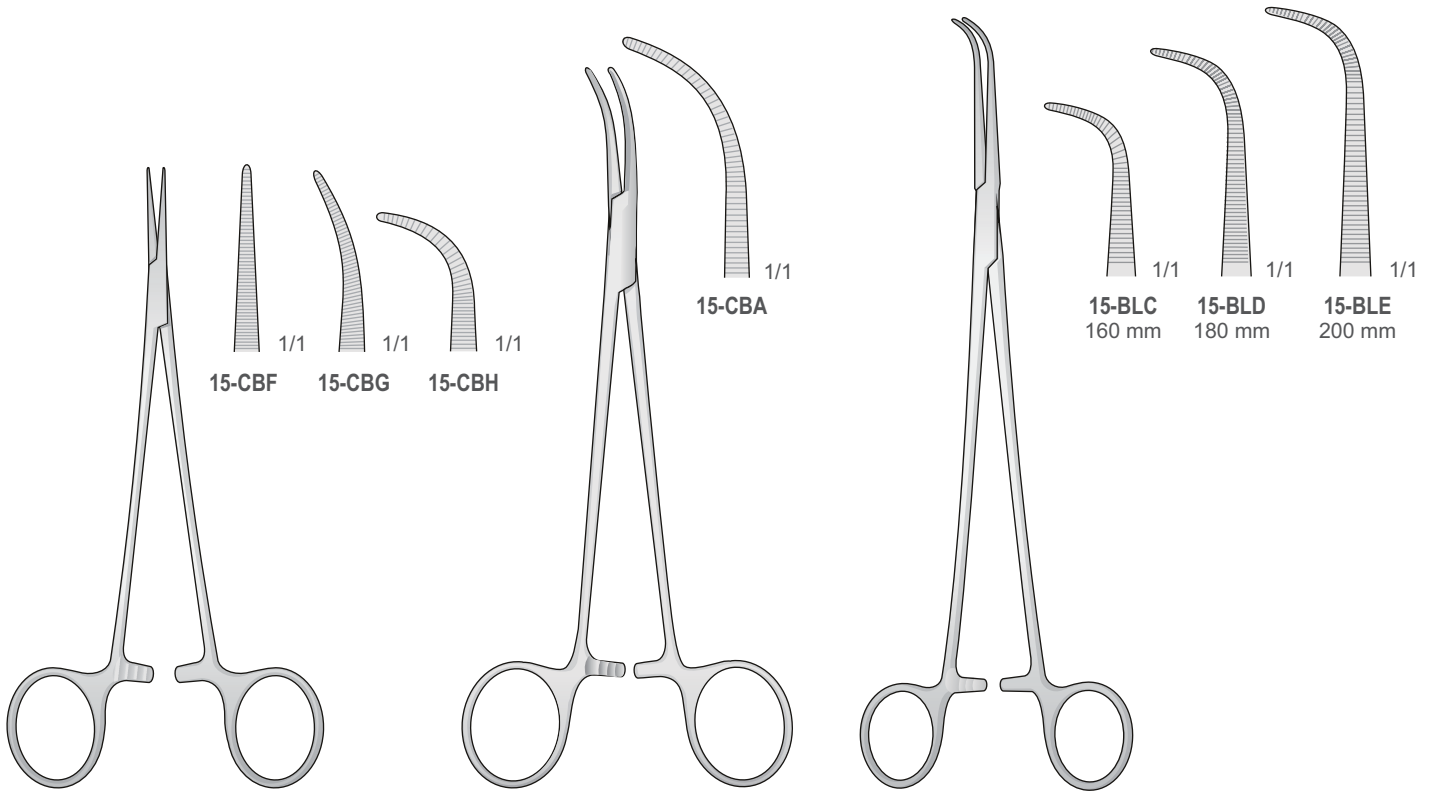

15-CBF/15-CBH  
160 mm

ROCHESTER-PEAN  
15-CBA  
180 mm

GEMINI  
15-BLC/15-BLE



Hauthäkchen - Cutaneous hook  
 Uncini cutanei - Ganchos cutâneos  
 Erignes cutanées

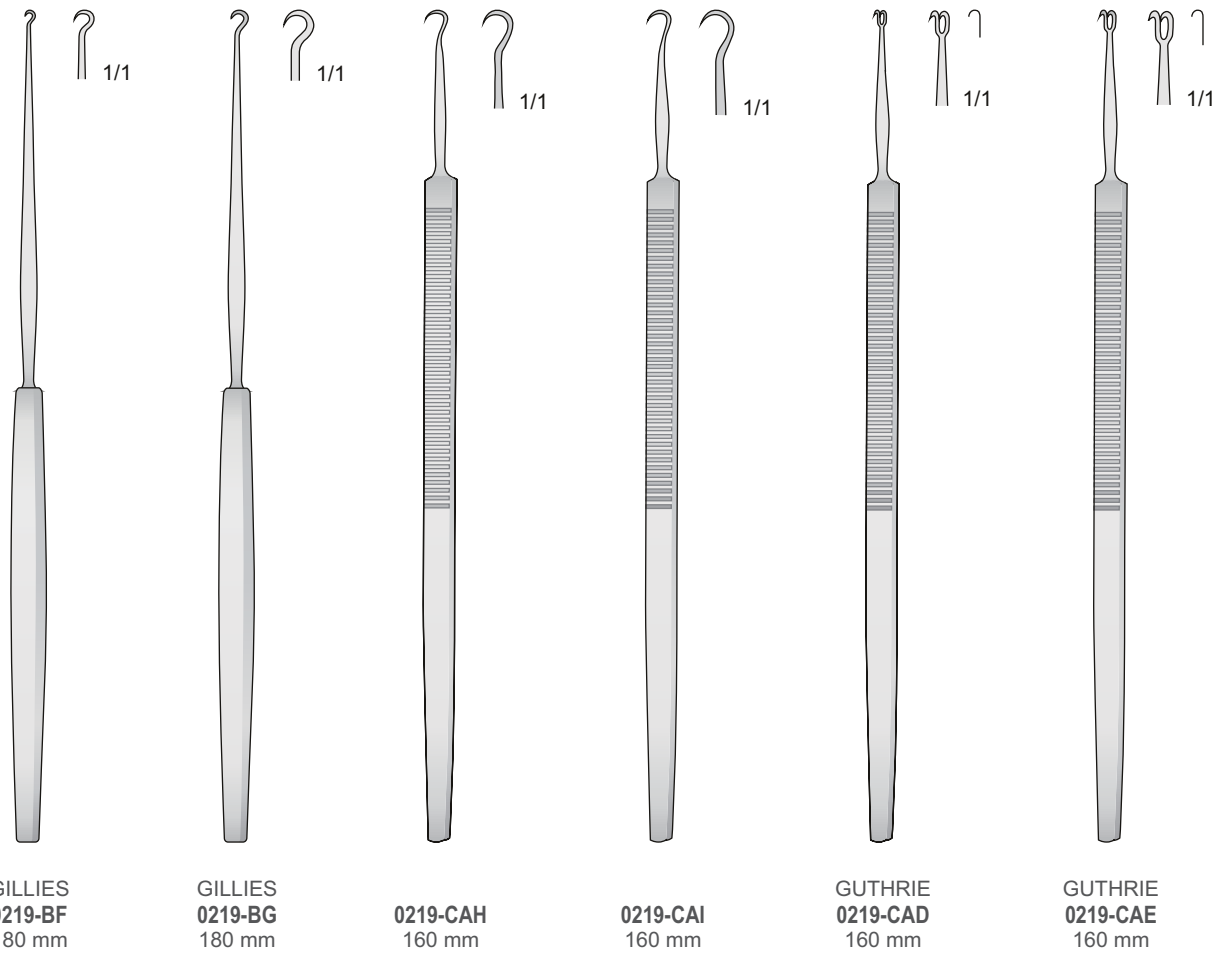

Feine Wundhaken  
 Delicate Retractors  
 Divaricatori delicati  
 Separadores finos  
 Ecarteurs fins

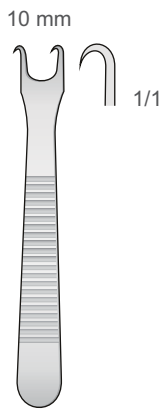
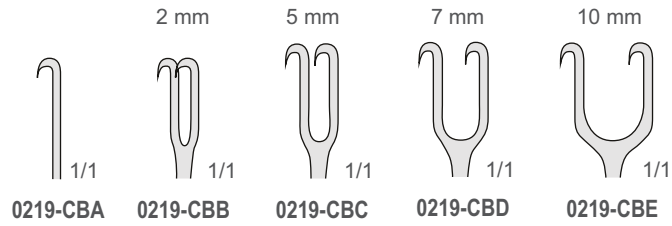

KILNER  
 0219-CHD  
 80 mm

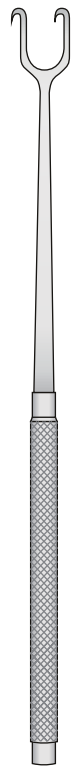

JOSEPH  
 0219-CBA/0219-CBE  
 160 mm

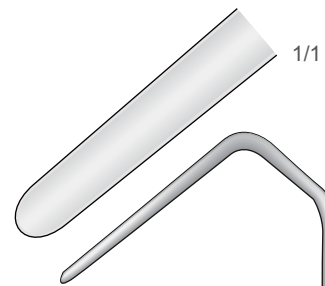

Nasenhaken  
 Nasal retractors  
 Divaricatori nasali  
 Separadores nasales  
 Ecarteurs nasaux

AUFRIEHT  
 0414-EI  
 175 mm

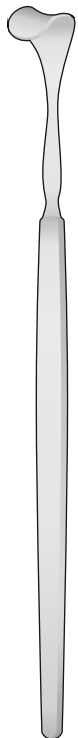

COTTLE  
 0219-CEF  
 150 mm

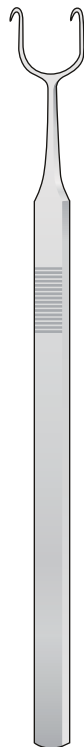

COTTLE  
 0219-CBF/0219-CBH  
 150 mm

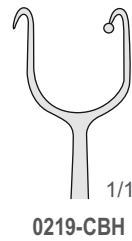
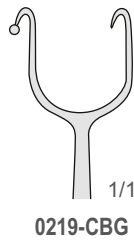
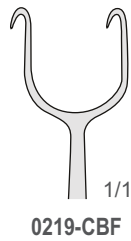

Weichteilhaken  
 Soft tissue retractors  
 Divaricatori per tessuti molli  
 Separadores para partes blandas  
 Ecarteurs pour parties molles

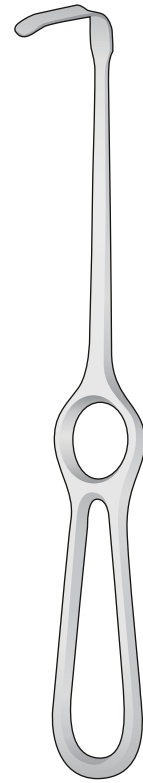
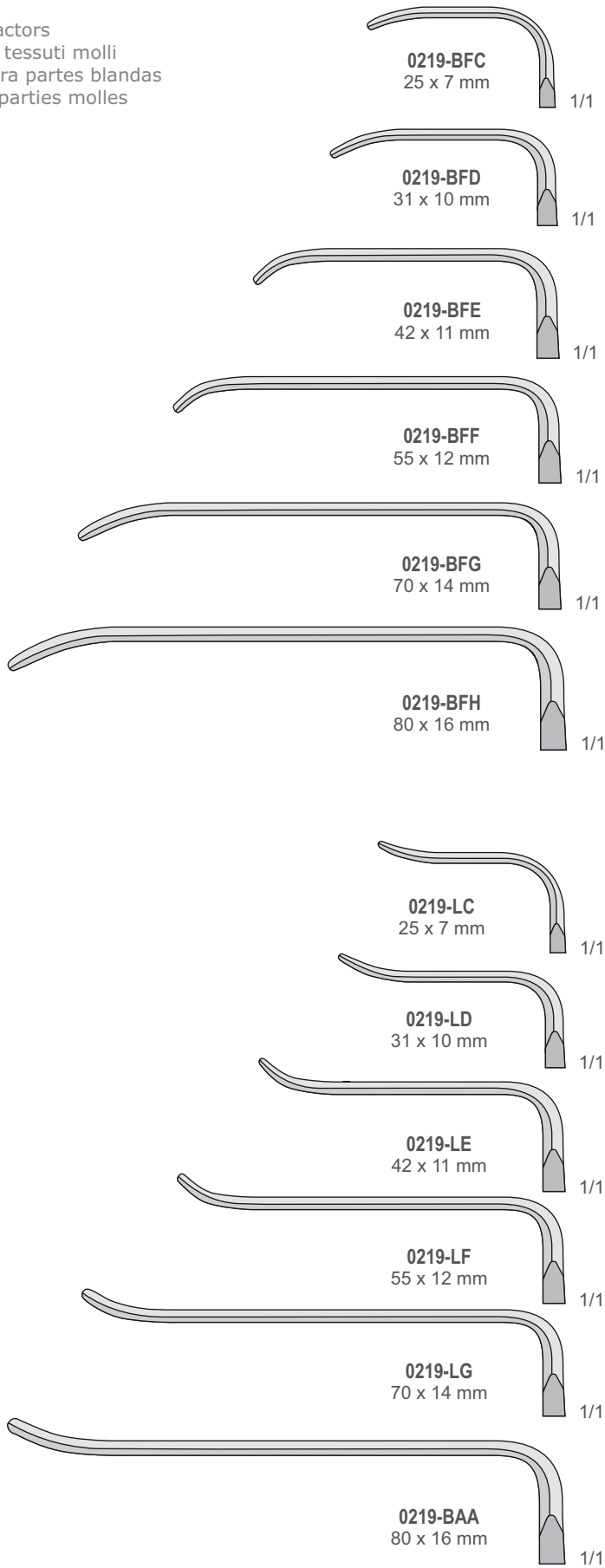

**OBWEGESER**  
**0219-BFC/0219-BFH**  
 220 mm

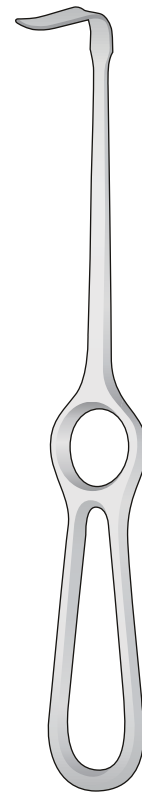

**OBWEGESER**  
**0219-LC/0219-BAA**  
 220 mm

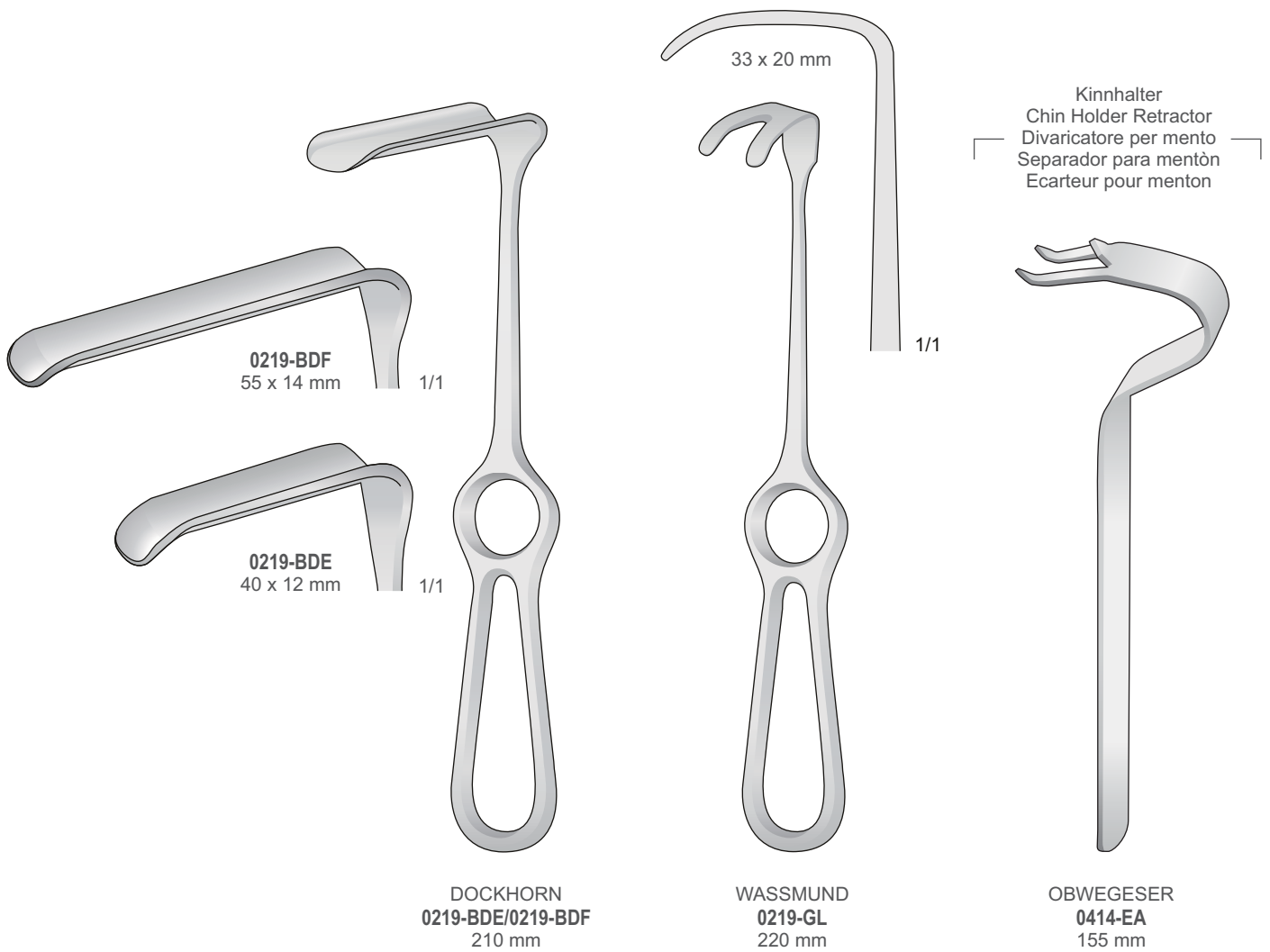

Spina Nasalis-haken  
 Nasal spine Retractor  
 Separatore per spina nasale  
 Separador para spina nasalis  
 Ecarteur pour spina nasalis

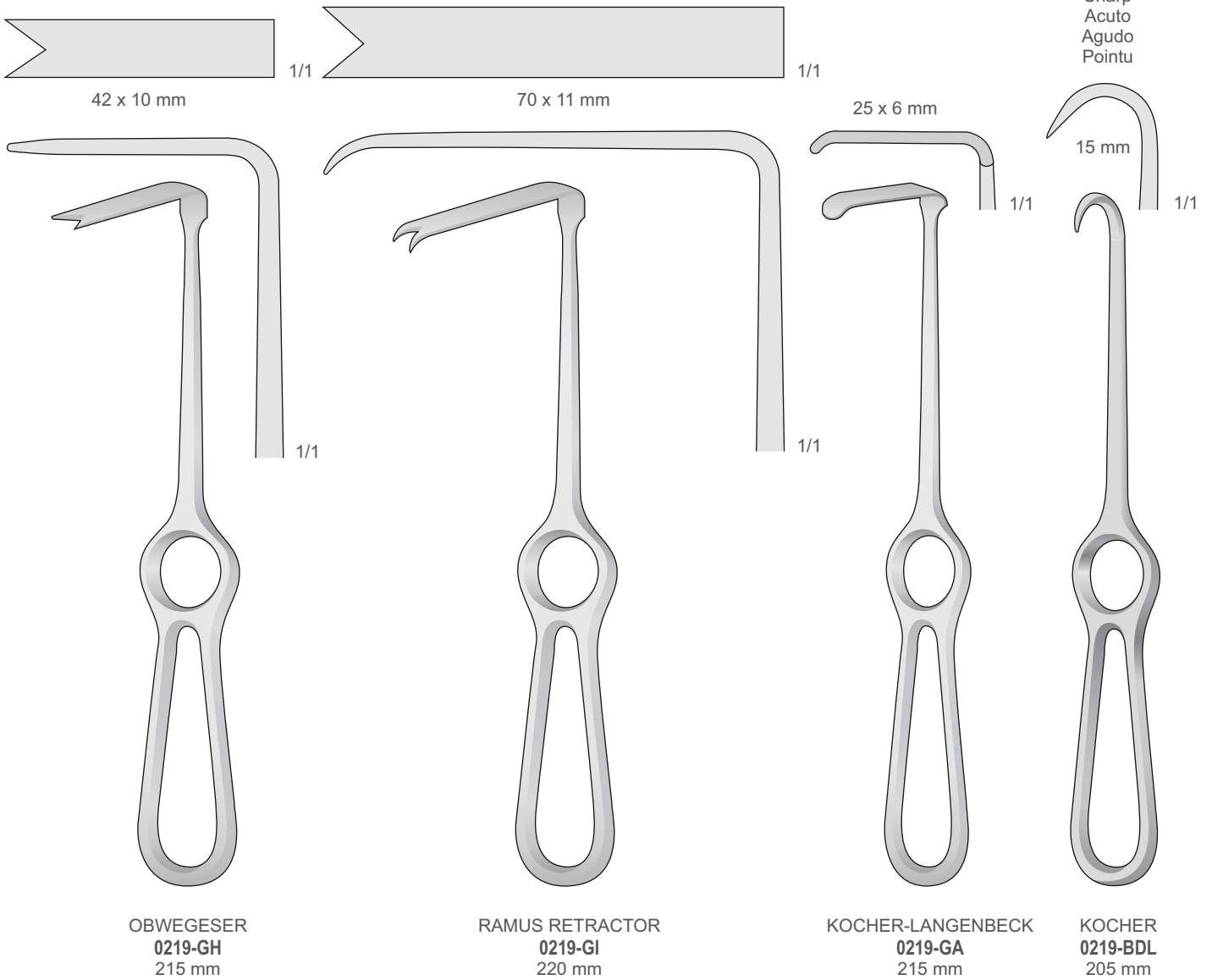

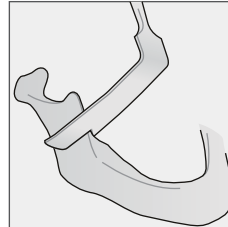

Ramus Retraktoren Rechts  
Ramus Retractor Right  
Retrattore Ramus destro  
Separadores Ramus derecho  
Ecarteur Ramus droites

Ramus Retraktoren Links  
Ramus Retractor Left  
Retrattore Ramus sinistro  
Separadores Ramus izquierdo  
Ecarteur Ramus gauches

Progenierinnen  
Mandibular Channel Retractors  
Separatori mandibolari  
Separadores mandibulares  
Ecarteurs mandibulaires

8 mm

10 mm

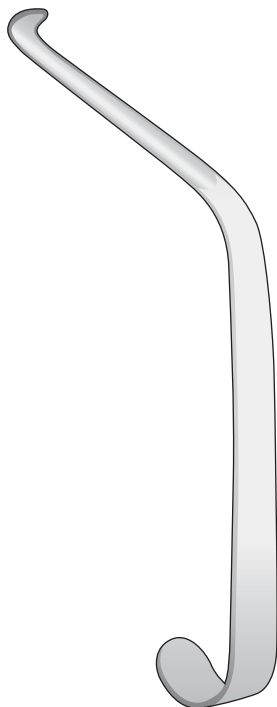

OBWEGESER  
**0414-EB**  
165 mm

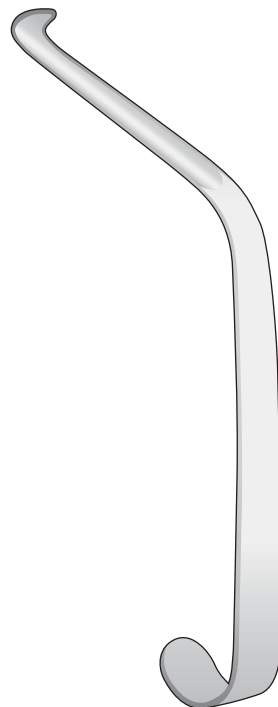

OBWEGESER  
**0414-BEC**  
165 mm



MISCH  
**0219-BFI**  
210 mm

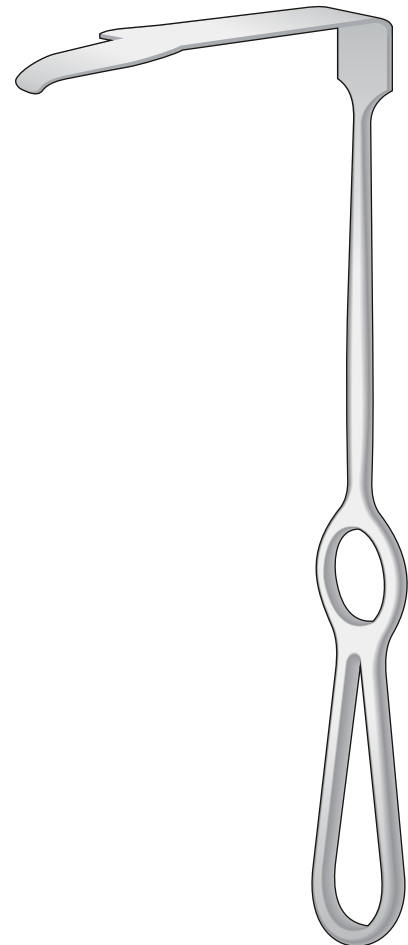

MISCH  
**0219-BFL**  
210 mm

Intraorale Retraktoren  
 Intraoral retractors  
 Separatori intraorali  
 Separadores intra orales  
 Rétracteurs intra-oraux

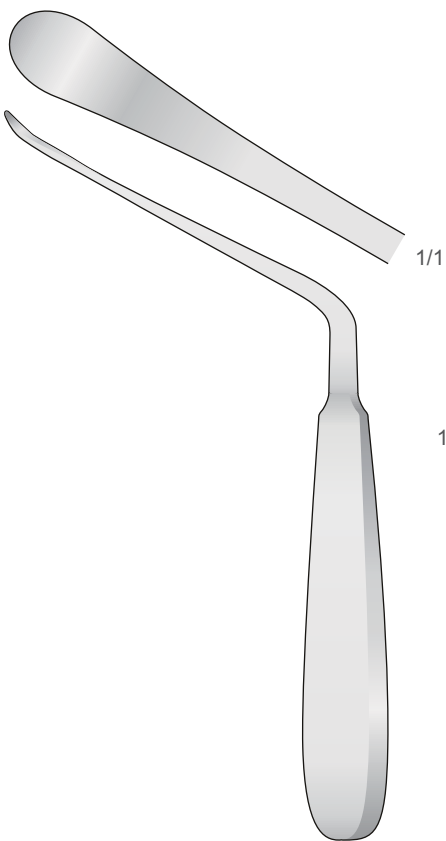

**0414-BCF**  
 210 mm

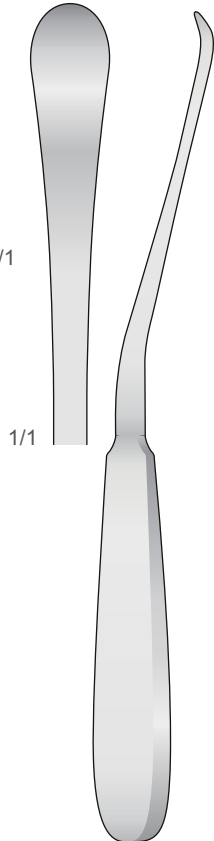

**0414-BCG**  
 235 mm

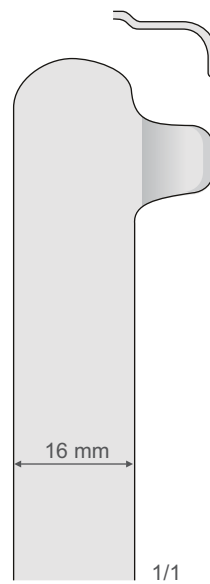

**0414-EF**

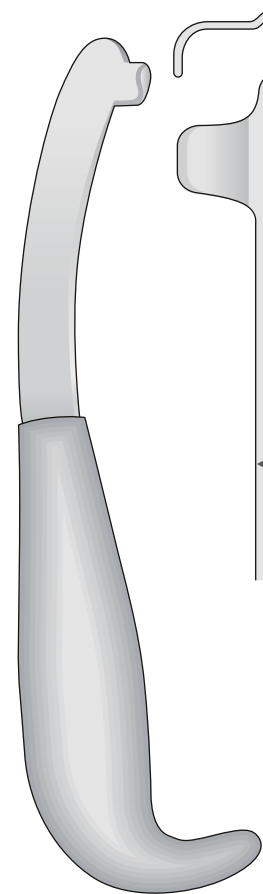

**0414-EG**

**SIGMOID NOTCH**  
**0414-EF/0414-EG**  
 240 mm

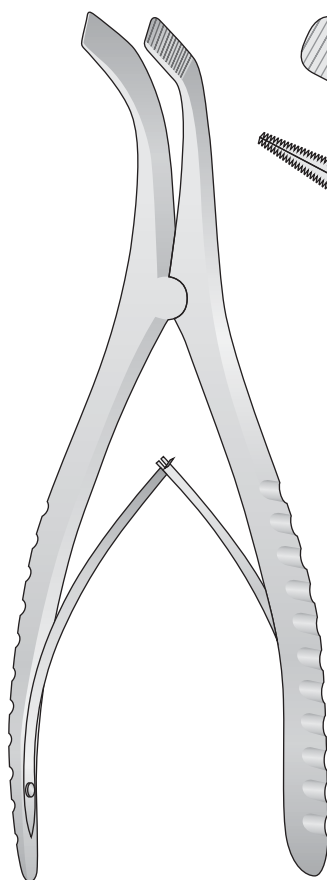
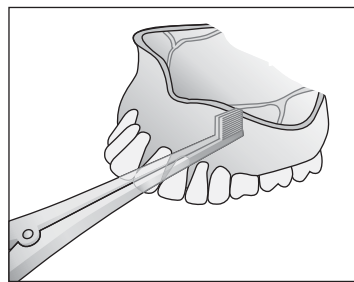

TESSIER  
**0414-BL**  
 180 mm

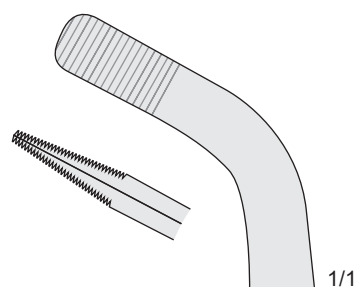

Spreizzange  
 Spreading forceps  
 Pinze per divaricare  
 Pinza de expansion  
 Pince à écarter

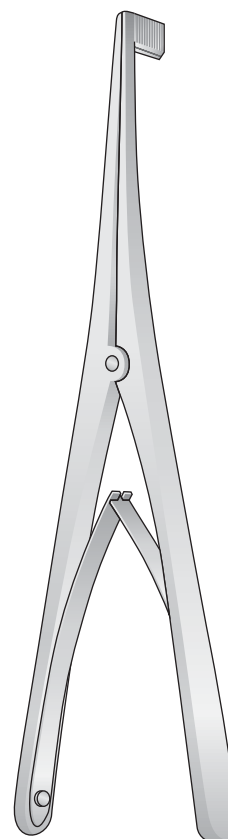

**0414-CL**  
 170 mm

Palatum Spreizer  
 Palatal expander  
 Separatore per palato  
 Separador paladial  
 Ecarteur pour  
 ostéotomie palatine



Knochen-Spreizer  
Bone Separators  
Separatore osseo  
Separadores de hueso  
Ecarteurs à os

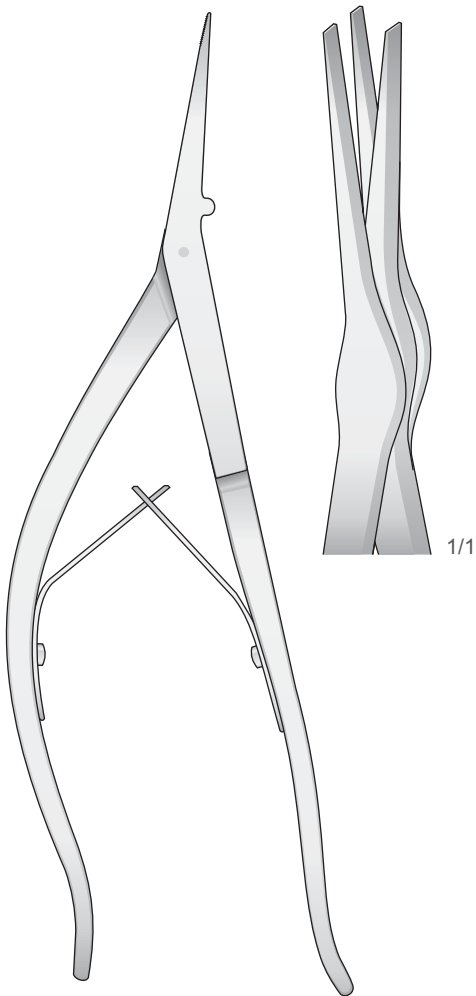
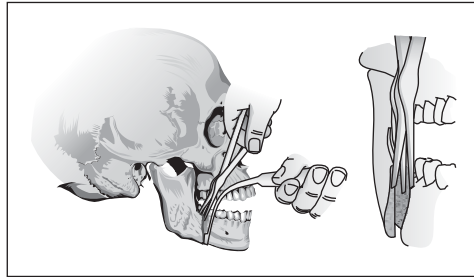

RAMUS  
0414-CEH  
230 mm

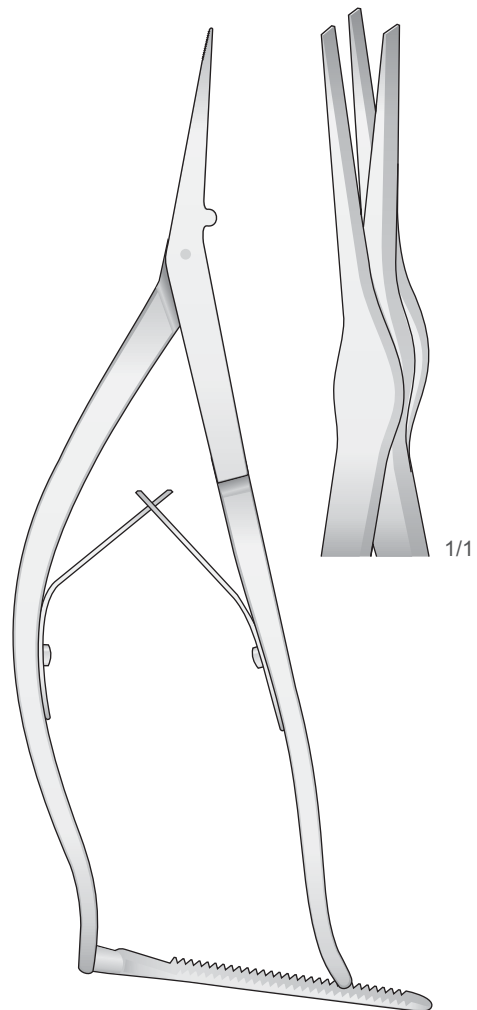

RAMUS  
0414-CEI  
230 mm

Beckenkamm Spatel  
Iliac Crest Retractors  
Divaricatori per cresta iliaca  
Separadores para cresta iliaca  
Rétracteur iliaque

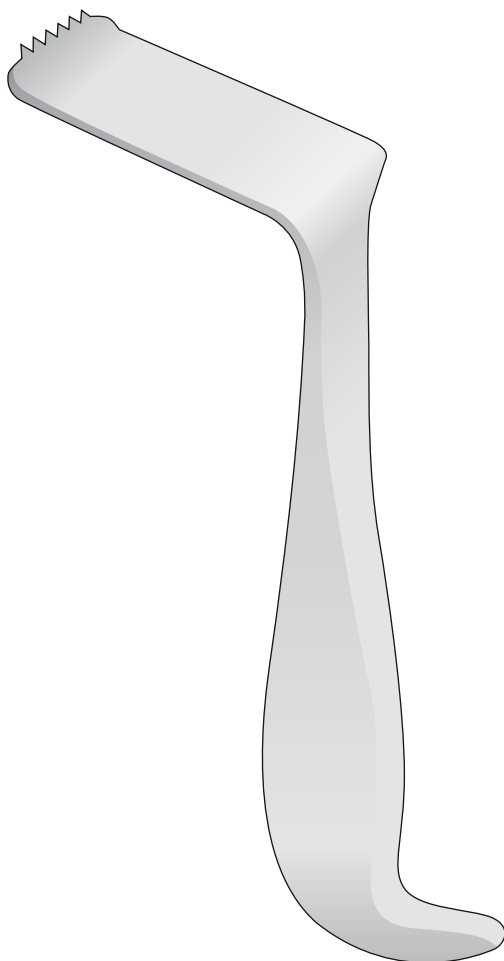

TESSIER  
0219-CCA/0219-CCD  
180 mm

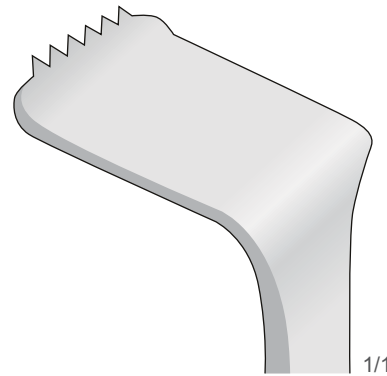

1/1  
0219-CCA  
36 X 50 mm

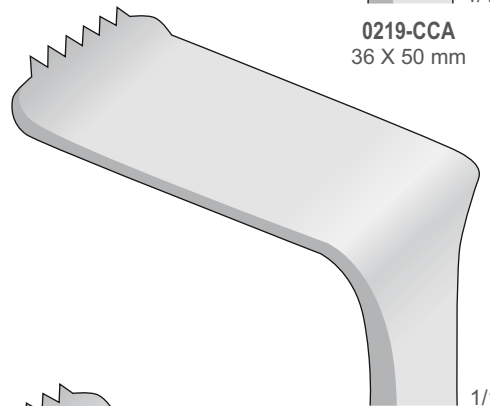

1/1  
0219-CCB  
52 X 50 mm

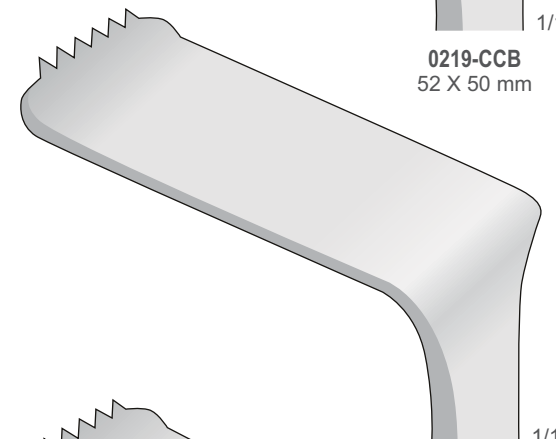

1/1  
0219-CCC  
59 X 50 mm

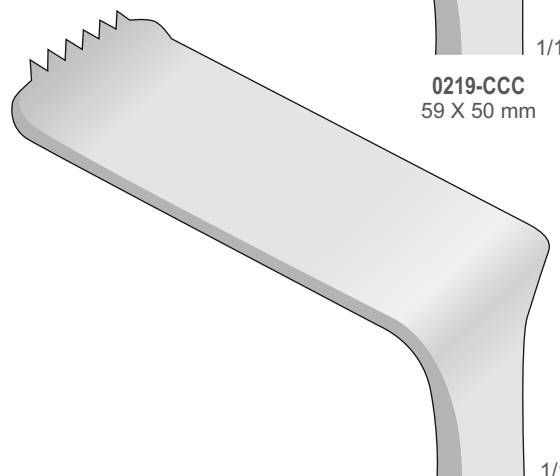

1/1  
0219-CCD  
66 X 50 mm

Elevatorium, Raspatorien  
 Elevator, Raspatories  
 Elevatori, Periostotomi  
 Elevador, Legras  
 Elévateur, Rugines

Septum Elevatorien  
 Periosteal Elevators  
 Elevatori per il setto nasale  
 Elevadores para el tabique nasal  
 Elévateurs pour cloison nasale

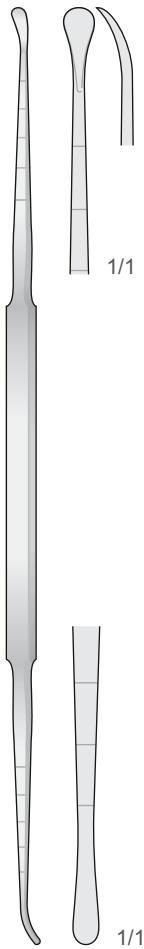

**COTTLE**  
**0414-GA**  
 220 mm

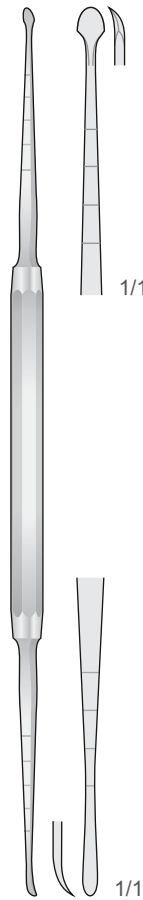

**MASING**  
**0414-EH**  
 210 mm

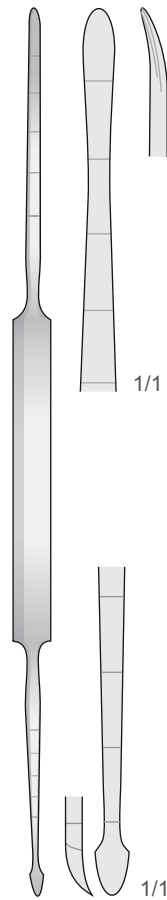

**COTTLE**  
**0414-BBB**  
 210 mm

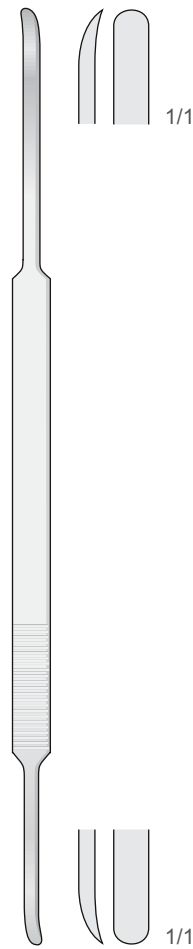

**MCKENTY**  
**1014-EG**  
 220 mm

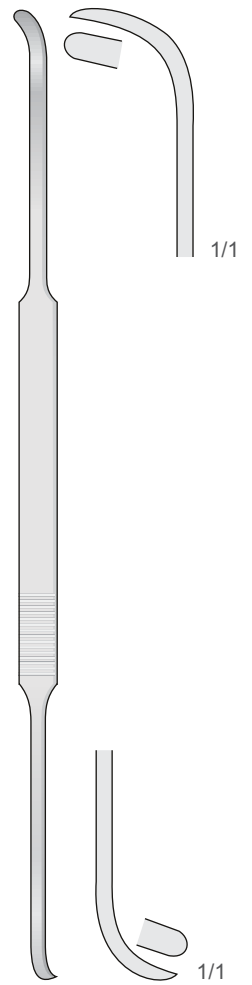

**COTTLE**  
**1014-BC**  
 230 mm

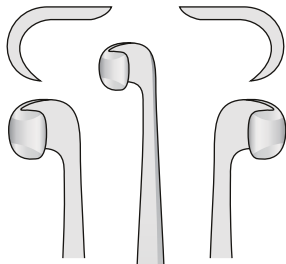

**0414-GI**

Links, Scharf  
Left, sharp  
Sinistra, tagliente  
A la izquierda, cortante  
À gauche, tranchant

**0414-GL**

Rechts, Scharf  
Right, sharp  
Destra, tagliente  
A la derecha, cortante  
À droite, tranchant

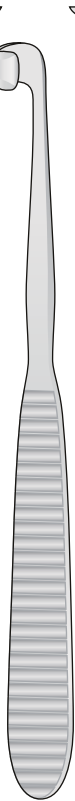

Unterkieferrand  
Raspatorien  
Mandibular inferior  
border Raspatories  
Staccaperiosteo per  
bordo mandibolare  
Legras para  
el borde mandibular  
Rugine - Raspatoires  
pour le bord mandibulaire

OBWEGESER  
**0414-GI/0414-GL**  
190 mm

Für Jochbögen  
For Zygomatic Archs  
Per arco zigomatico  
Para arcos cigomáticos  
Pour arcades cygomatiques

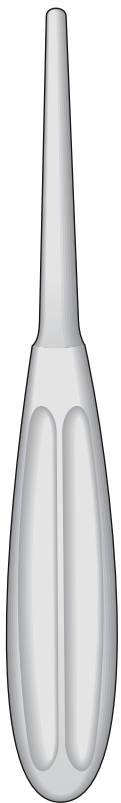

GOLDMANN  
**0414-CII**  
200 mm



DINGMANN  
**0414-CLB**  
210 mm

Dingmann  
Zygoma Elevator

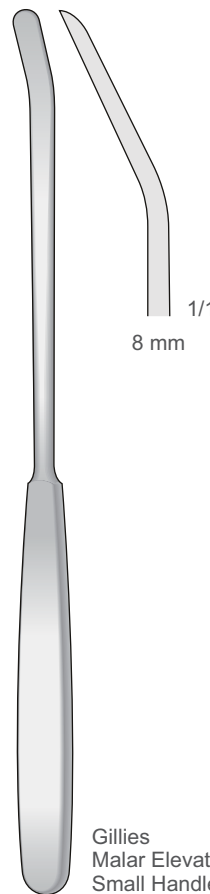

GILLIES  
**0414-CI**  
235 mm

Gillies  
Malar Elevator,  
Small Handle

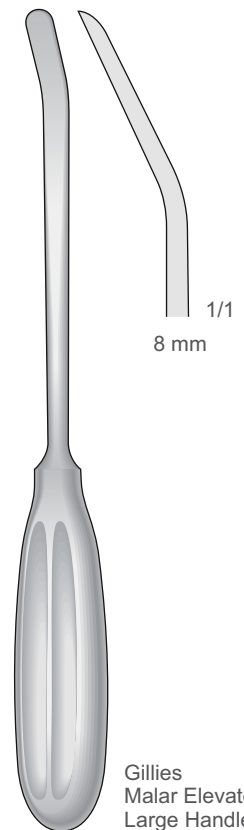

GILLIES  
**0414-BCI**  
210 mm

Gillies  
Malar Elevator,  
Large Handle

Wundhaken  
 Retractors  
 Divaricatori  
 Separadores  
 Ecarteurs

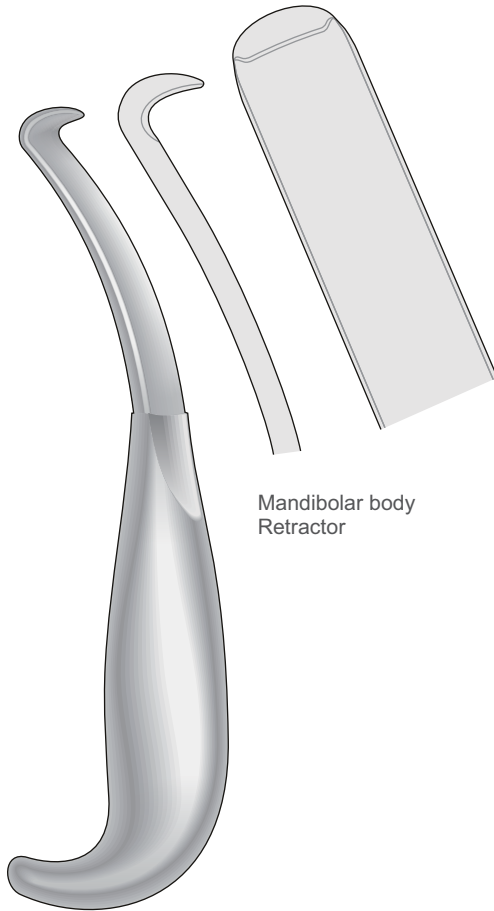

Mandibolar body  
 Retractor

HARGIS  
**0414-CID**  
 180 mm

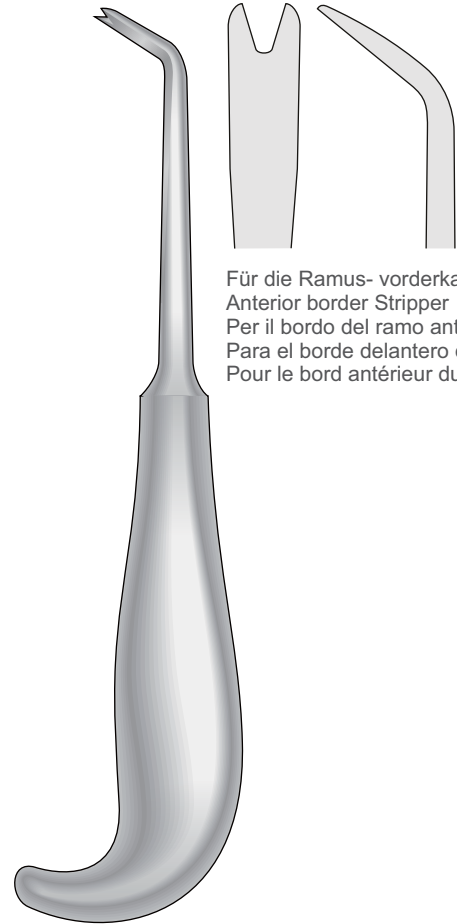

Für die Ramus- vorderkante  
 Anterior border Stripper  
 Per il bordo del ramo anteriore  
 Para el borde delantero del ramus  
 Pour le bord antérieur du rameau

HARGIS  
**0414-CIE**  
 190 mm

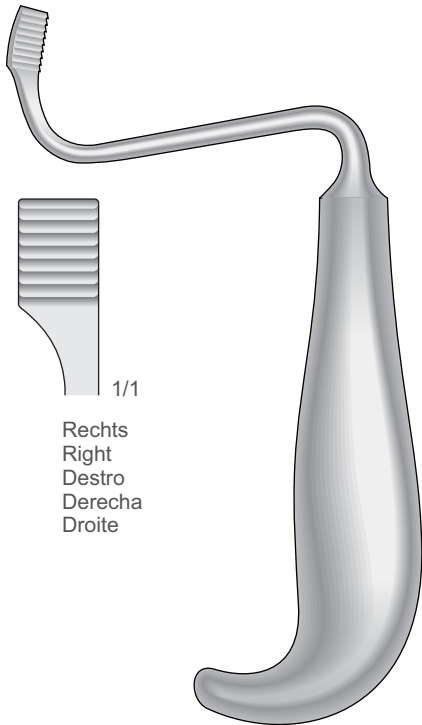

Rechts  
 Right  
 Destro  
 Derecha  
 Droite

Für Unterkiefer  
 Retro maxillary Levers  
 Per mandibole  
 Para mandibulas  
 Pour maxillaires

TESSIER  
**0414-EC**  
 150 mm

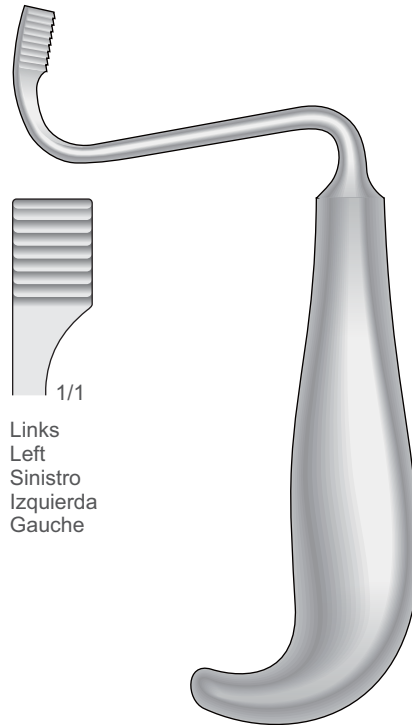

Links  
 Left  
 Sinistro  
 Izquierda  
 Gauche

Für Unterkiefer  
 Retro maxillary Levers  
 Per mandibole  
 Para mandibulas  
 Pour maxillaires

TESSIER  
**0414-ED**  
 150 mm

Raspatorien - Flach Angeschliffen  
Periosteal elevators - Flat cutting  
Elevatori periostali - Affilatura piana  
Legras - Biselado plano  
Rugines - Raspatoires - Tranchant plat

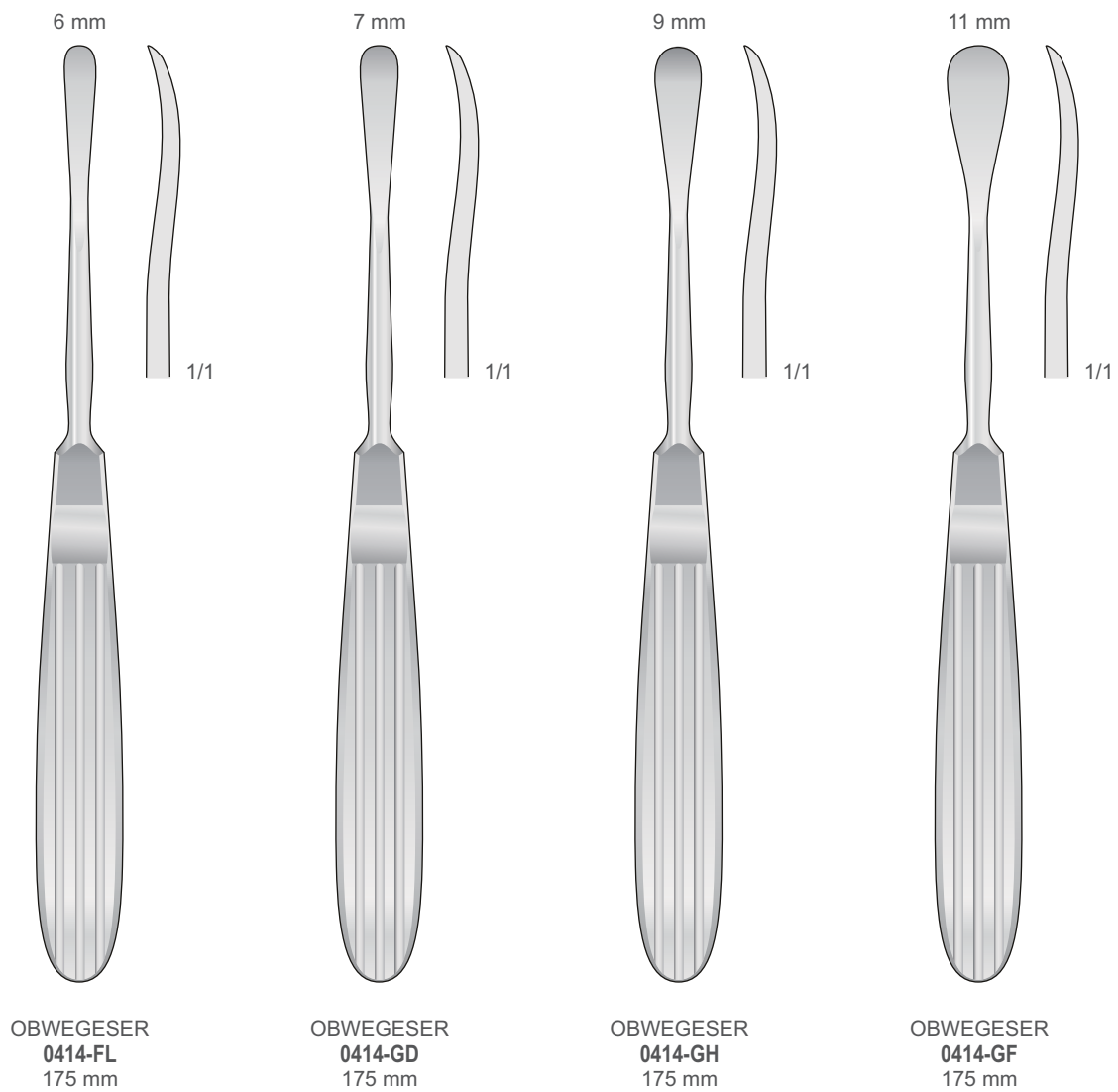

Ramus Raspatorien  
Ramus Periosteal elevators  
Periostotomi Ramus  
Legras para Ramus  
Rugines - Raspatoires pour Ramus

Taglienti - Sharp  
Scharf - Tranchant - Cortante

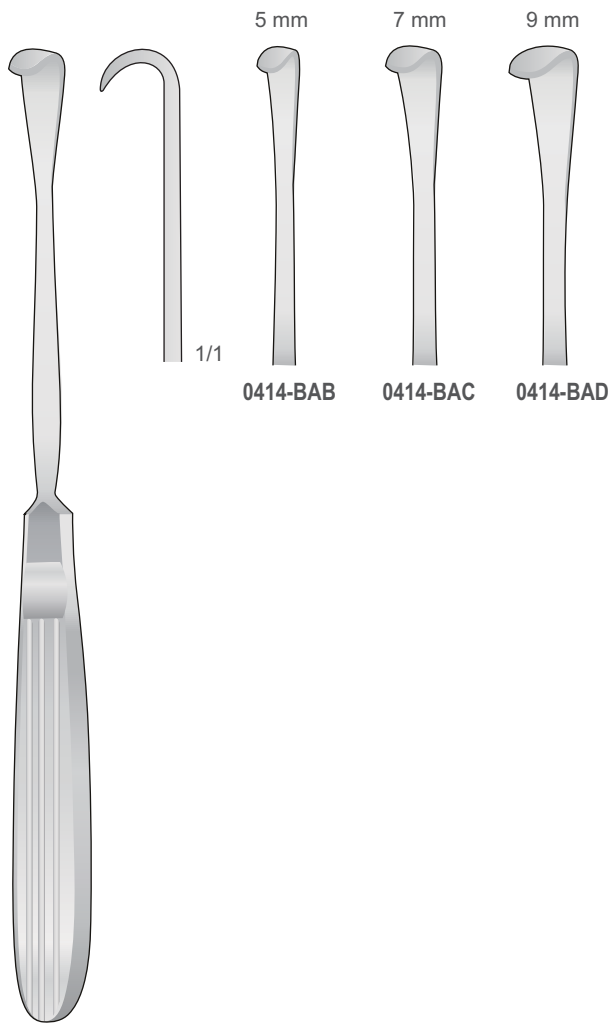

OBWEGESER  
0414-BAB/0414-BAD  
200 mm

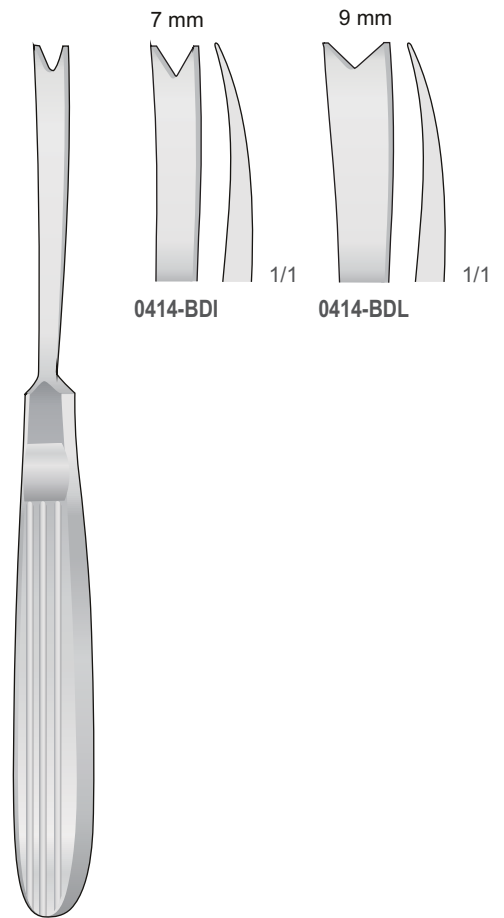

OBWEGESER  
0414-BDI/0414-BDL  
175 mm

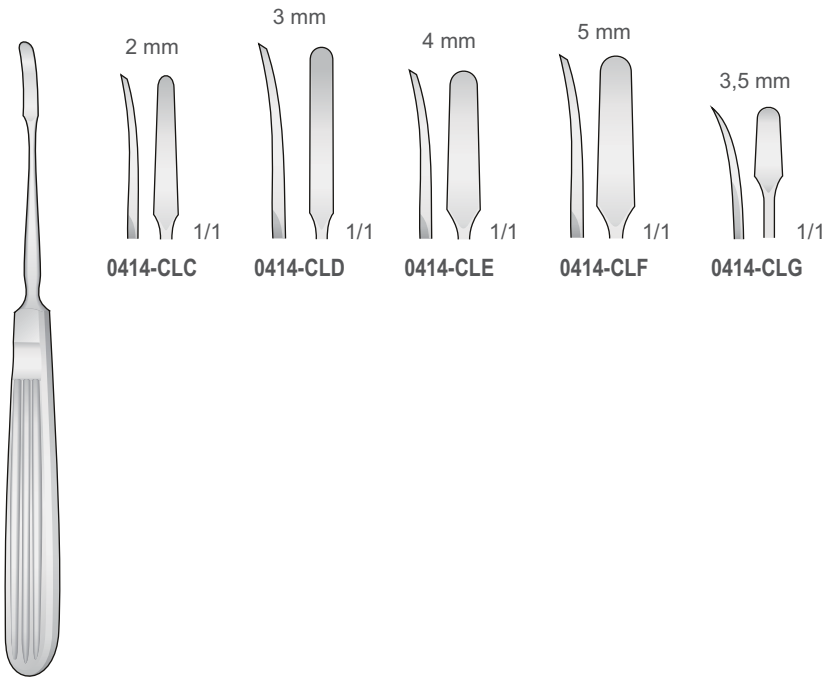

0414-CLC

0414-CLD

0414-CLE

0414-CLF

0414-CLG

WALTON  
0414-CLC/0414-CLG  
160 mm

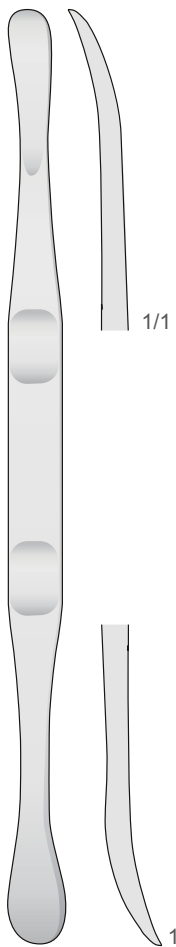

BABBUSH  
1014-CA  
180 mm

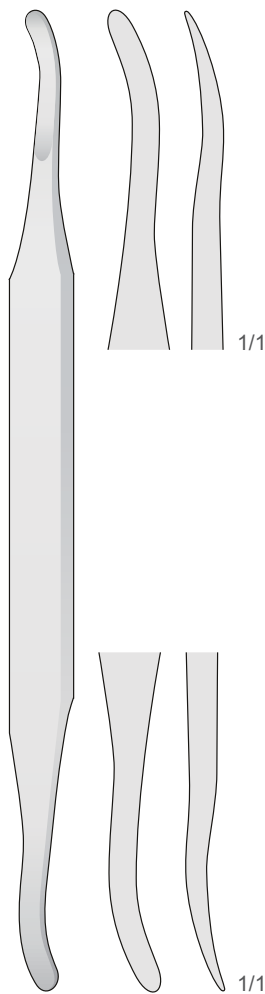

SELDIN  
1014-CC  
190 mm

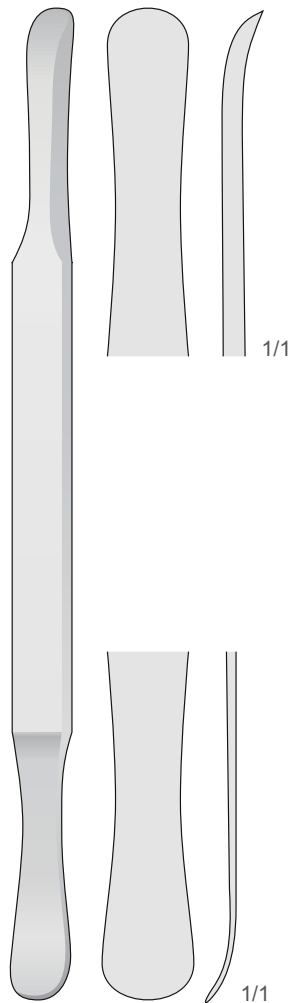

SELDIN  
1014-CD  
195 mm

Elevatorium Stumpf - Elevators Blunt  
Elevatori smussi - Elevadores romo  
Elévateurs mousse

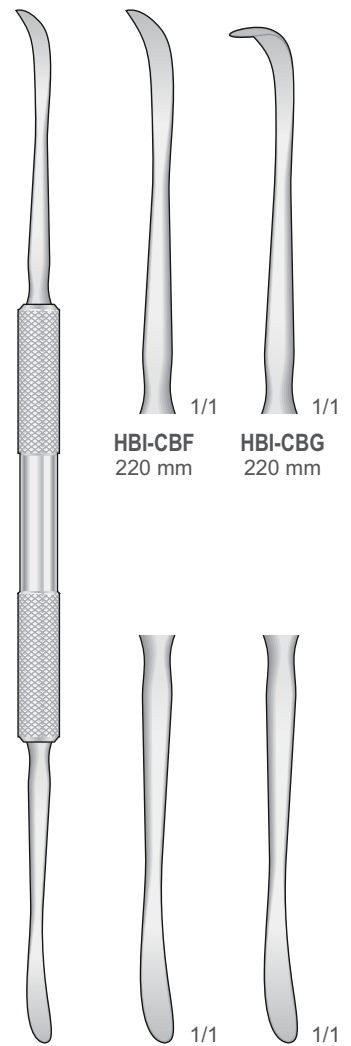

OBWEGESER-FREER  
HBI-CBF/HBI-CBG  
220 mm

HBI-CBF  
220 mm

HBI-CBG  
220 mm



Raspatorien  
Raspatories  
Periostotomi  
Legras  
Rugines

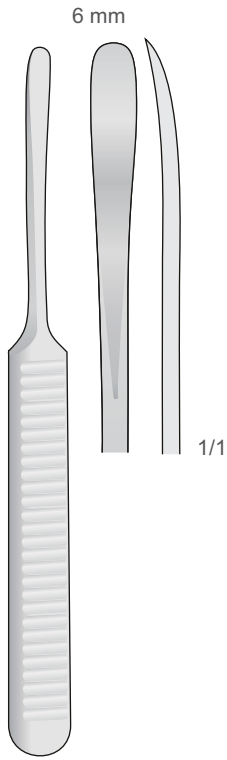

**WILLIGER**  
**2207-BC**  
160 mm

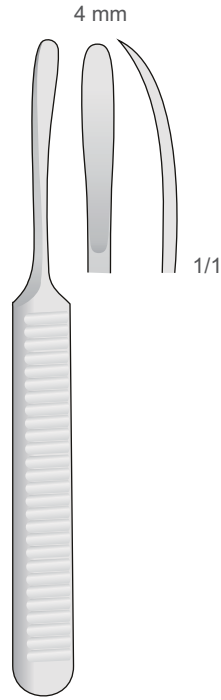

**WILLIGER**  
**2207-BE**  
140 mm

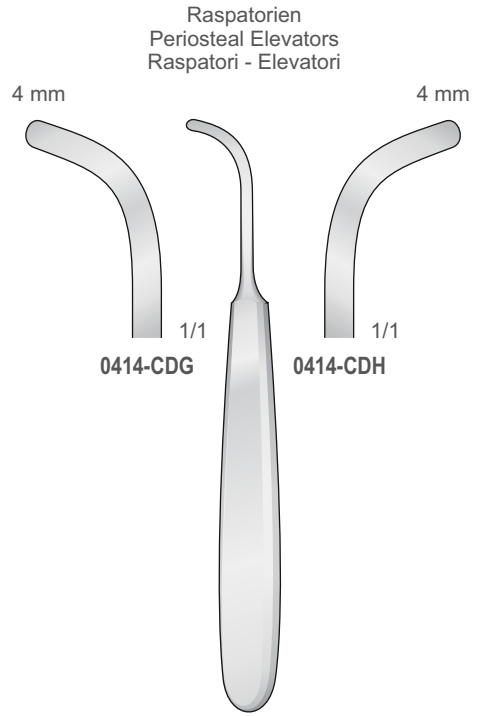

**0414-CDG/0414-CDH**  
140 mm



**CHOMPRET**  
**0308-B**  
165 mm

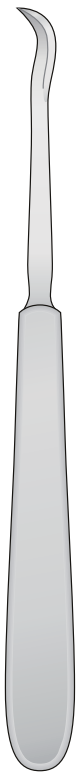

**CHOMPRET**  
**0308-C**  
165 mm

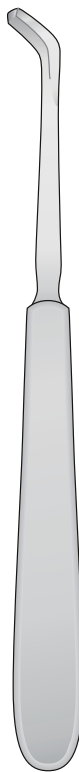

**CHOMPRET**  
**0308-D**  
165 mm

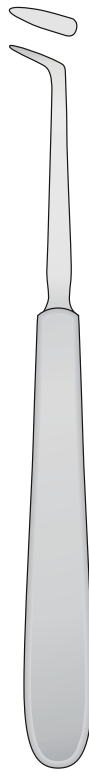

**CHOMPRET**  
**0308-E**  
160 mm

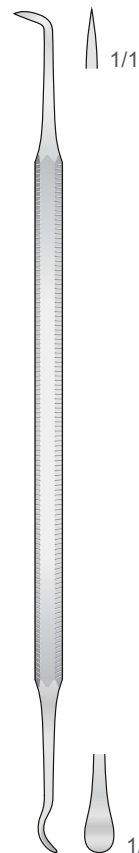

**MITCHEL**  
**0119-BC**  
170 mm

Fig. 12S

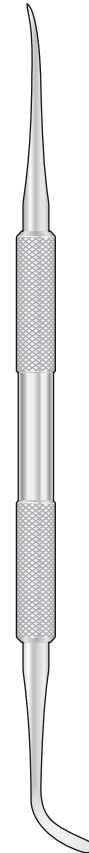

**BENNETT**  
**1014-FI**  
175 mm



**MOLT**  
**HBI-12L**  
170 mm

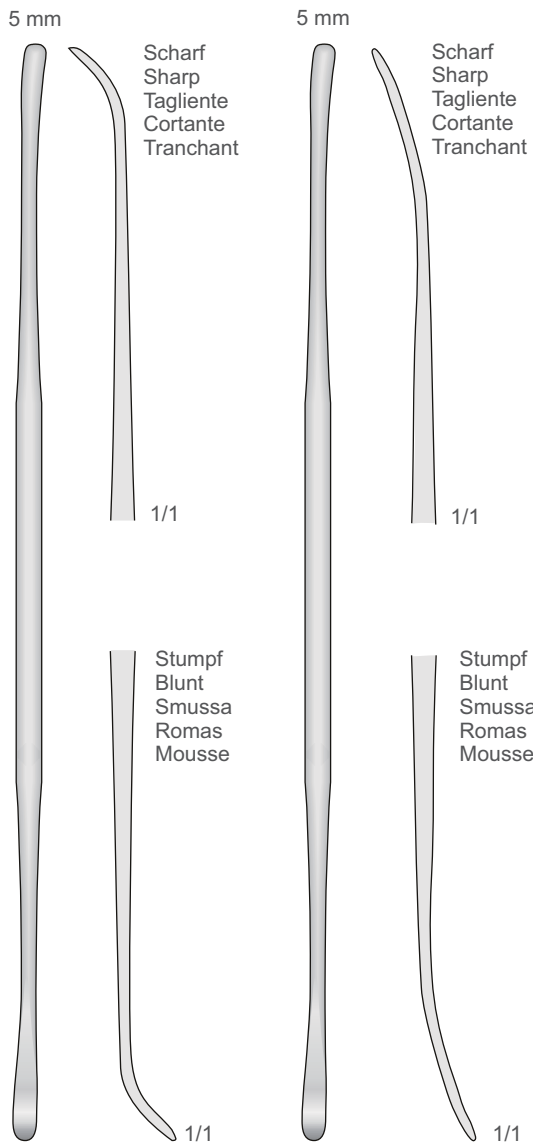

SALZBURG  
0414-CEA  
245 mm

SALZBURG  
0414-CEB  
245 mm

Sinus Lift Küretten - Sinus Lift Curettes  
Curette per sinus lift - Curetas para sinus lift  
Curettes pour sinus lift

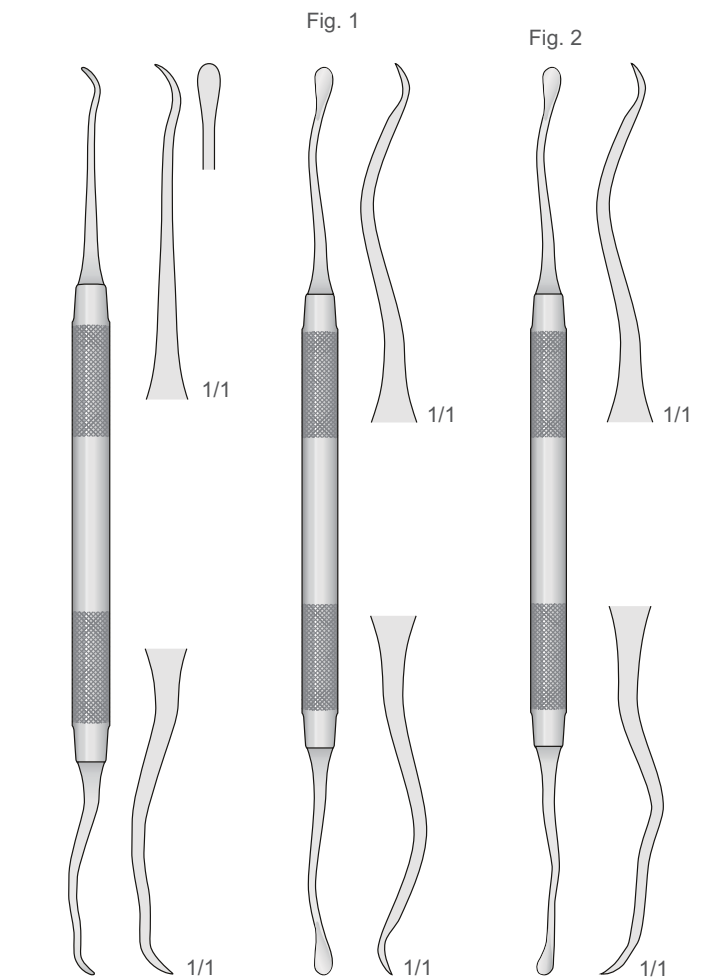

MILLER-COLBURN  
0320-1203B  
180 mm

SINUS  
1811-B  
180 mm

SINUS  
1811-C  
180 mm

Sinus Lift Instrumente - Sinus Lift Instruments  
 Strumenti per rialzo del seno - Instrumentos para elevación de senos  
 Instruments pour les soulevés de sinus

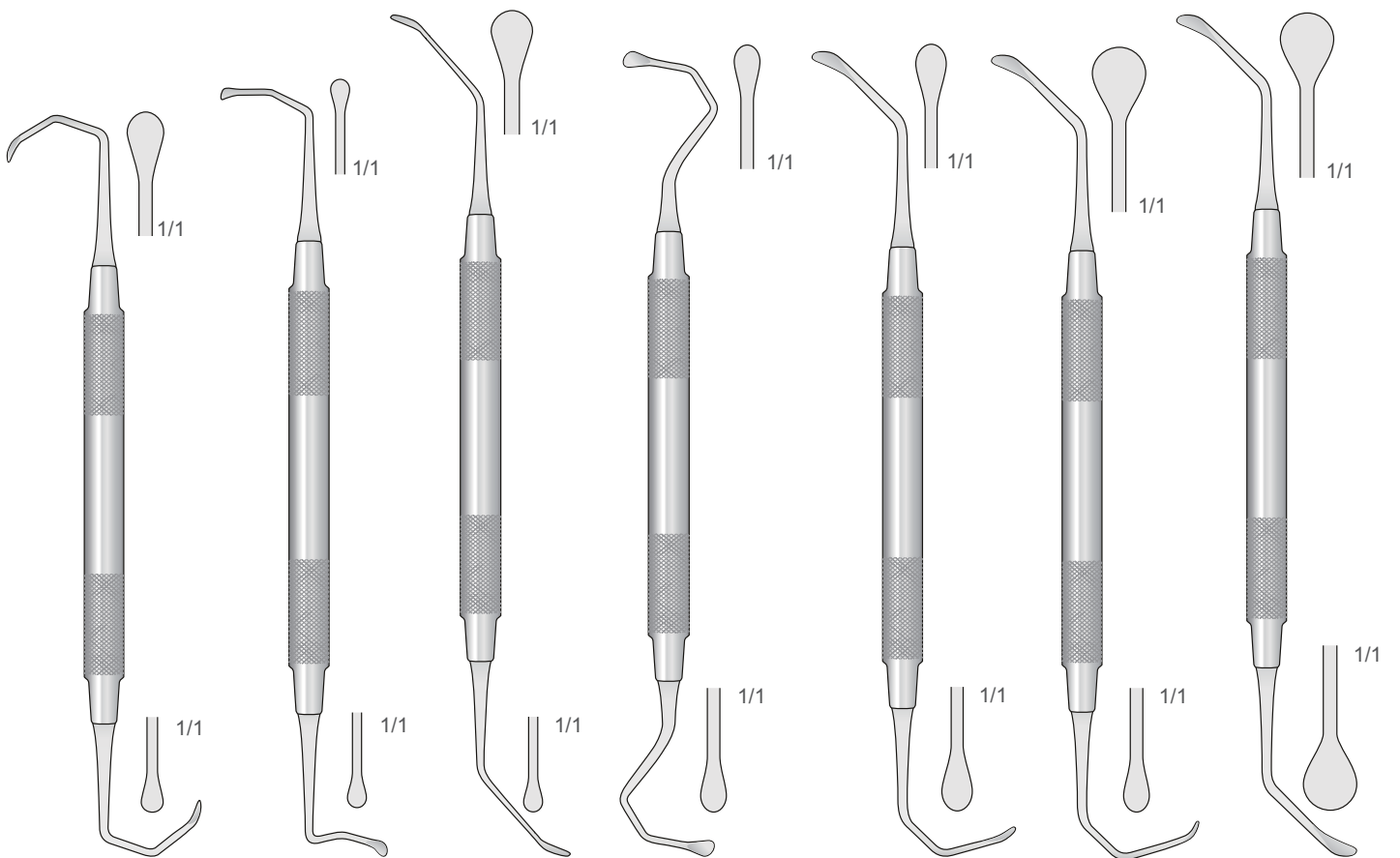

**0513-12B**  
160 mm

**0513-12C**  
160 mm

**0513-12D**  
180 mm

**0513-12E**  
170 mm

**0513-12F**  
175 mm

**0513-12G**  
175 mm

**0513-12H**  
180 mm

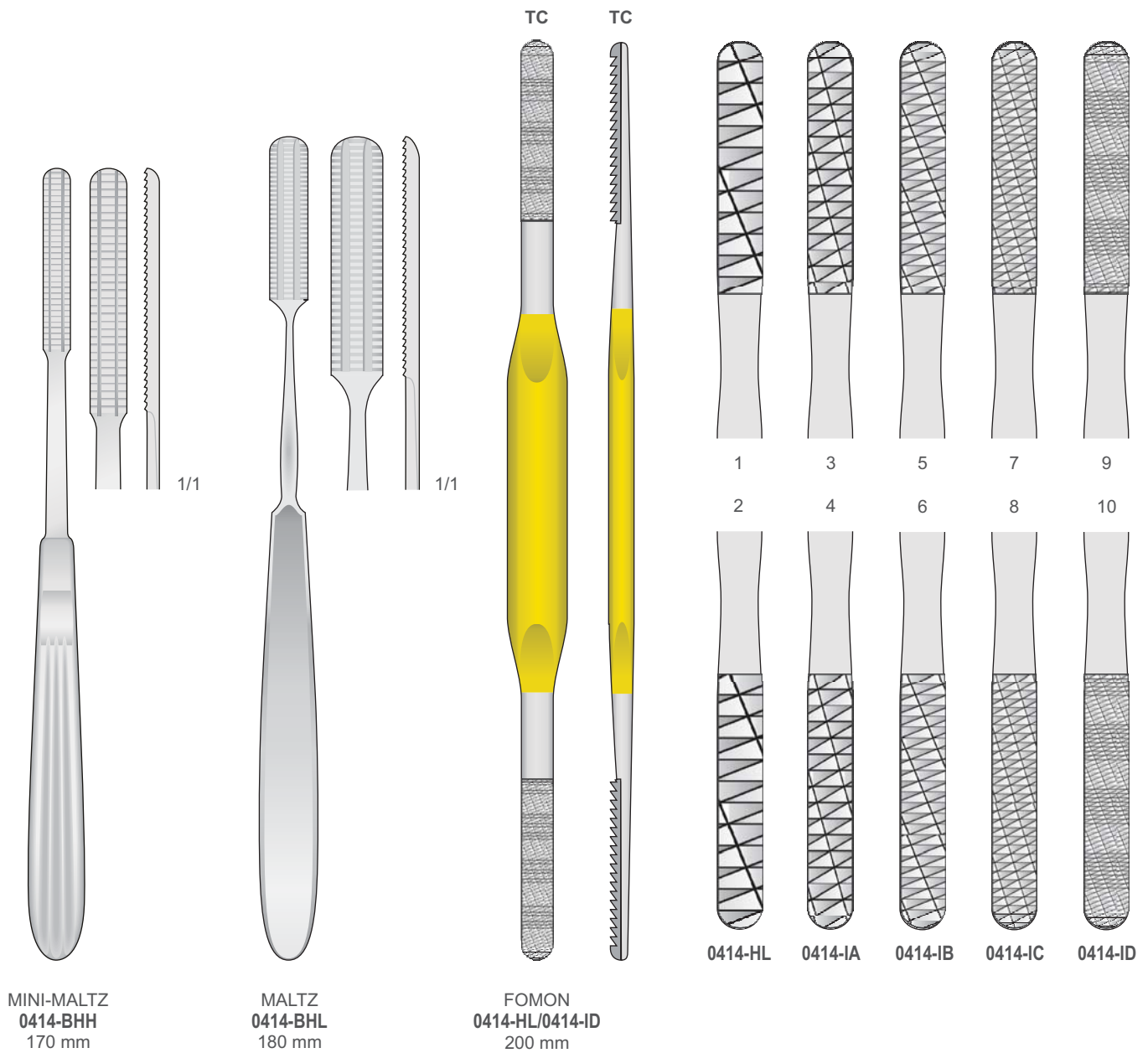

Nasenraspeln  
 Nasal Rasps  
 Raspe nasali  
 Raspadores nasales  
 Râpes nasales

Glabellaraspeln - Nasenraspeln  
 Glabella Rasps - Nasal Rasps  
 Raspe per glabella - Raspe nasali  
 Escofinas para glabella - Raspadores nasales  
 Râpes pour la glabelle - Râpes nasales

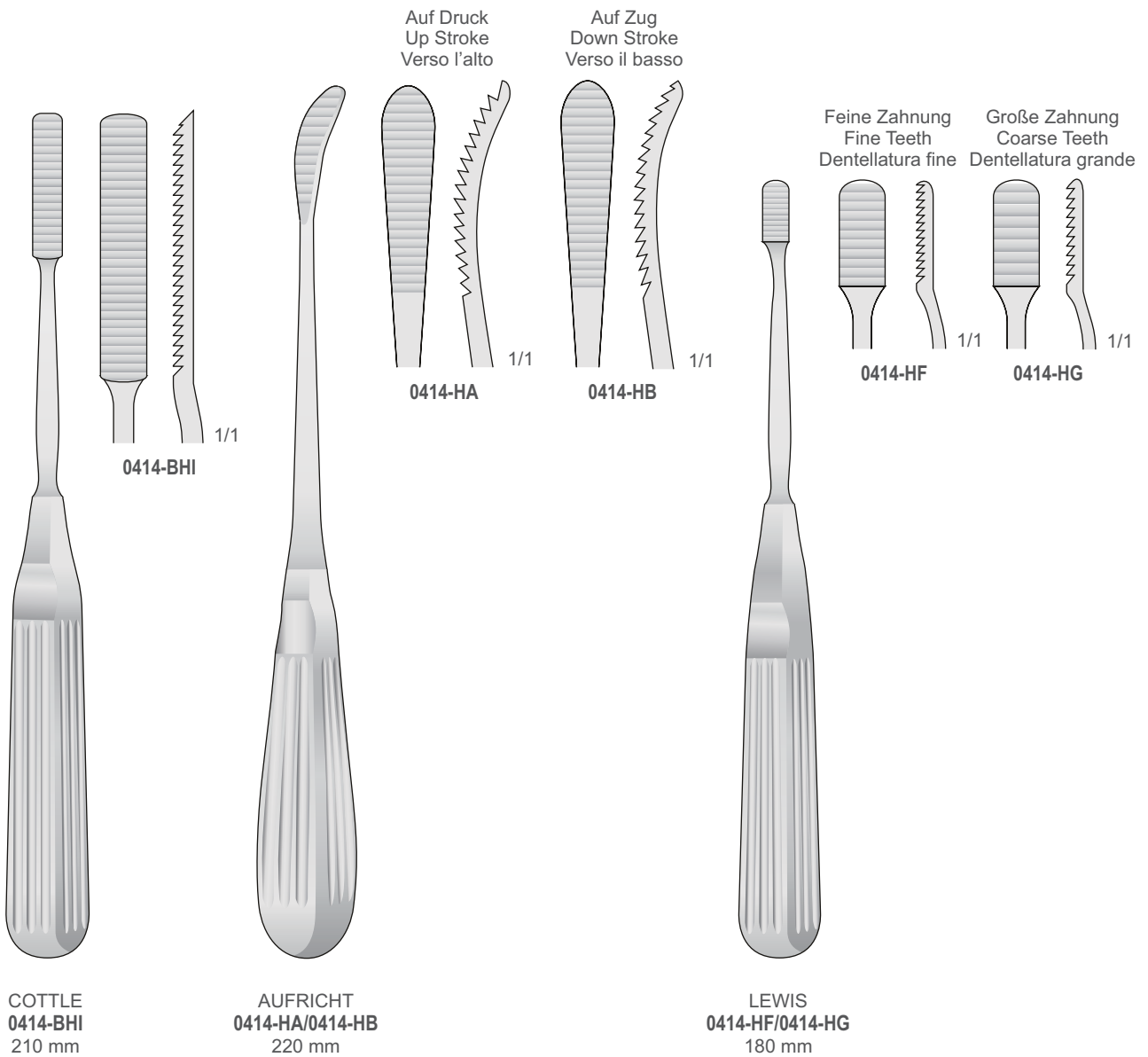

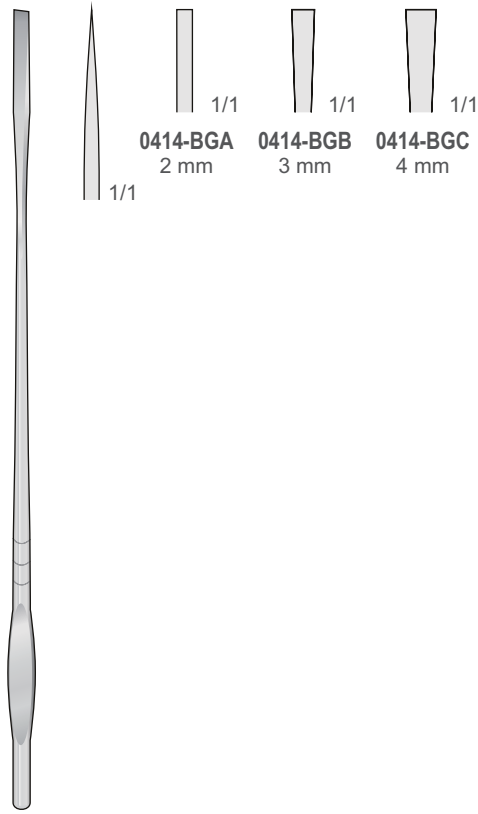

WALTER  
0414-BGA/0414-BGC  
190 mm

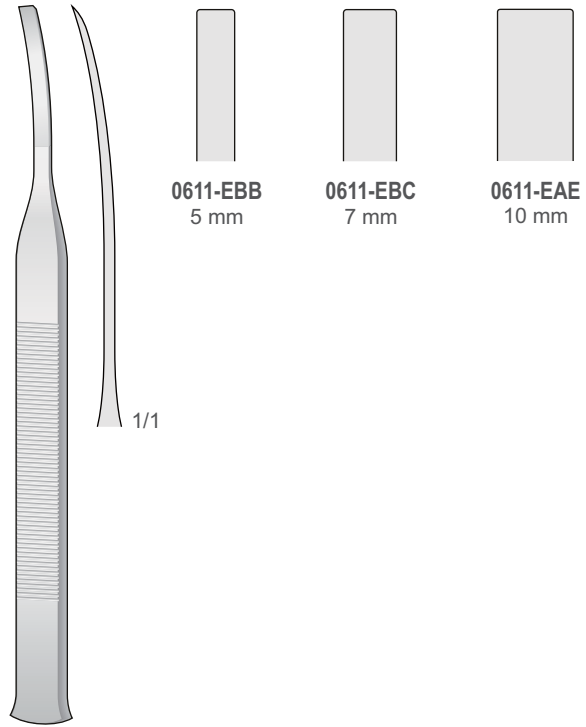

TESSIER  
0611-EAE/0611-EBC  
160 mm

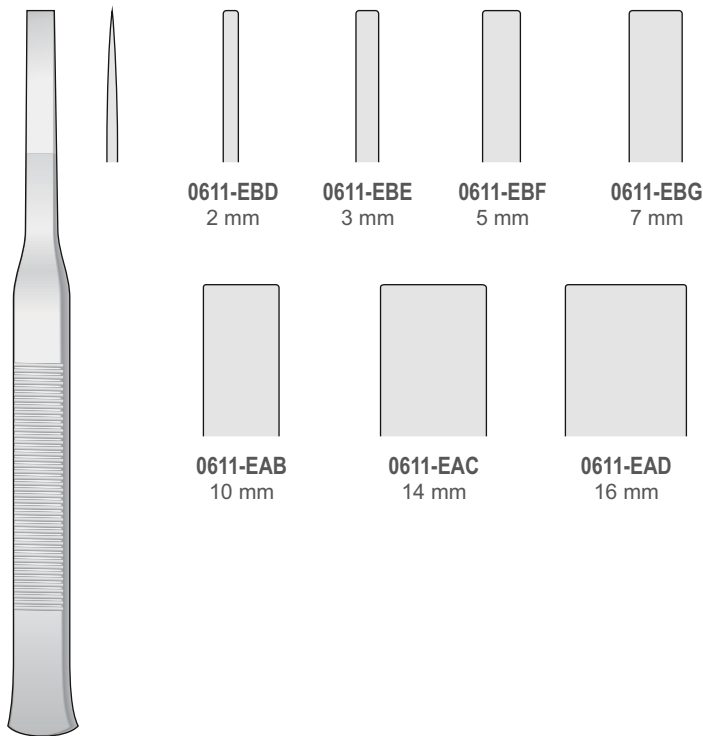

TESSIER  
0611-EAB/0611-EBG  
160 mm

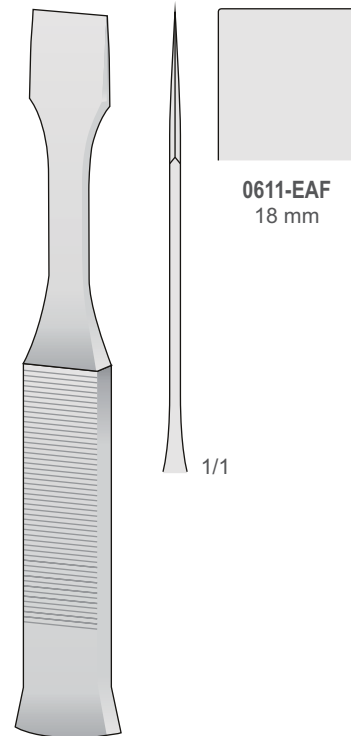

TESSIER  
0611-EAF  
160 mm

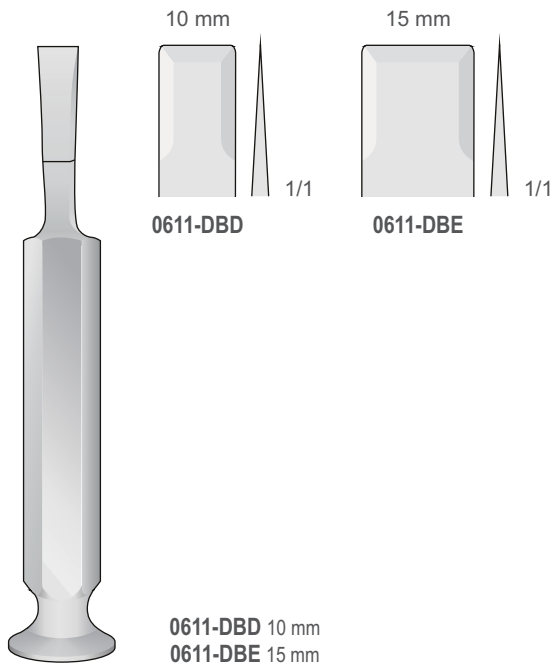

TESSIER  
0611-DBD/0611-DBE  
160 mm

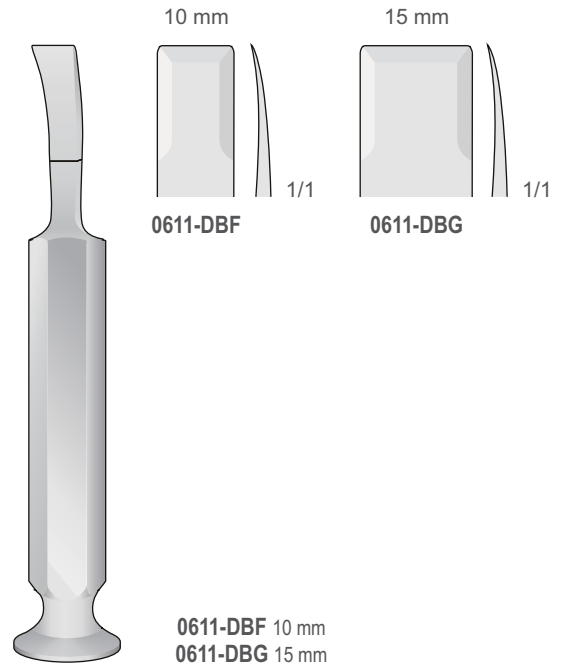

TESSIER  
0611-DBF/0611-DBG  
160 mm

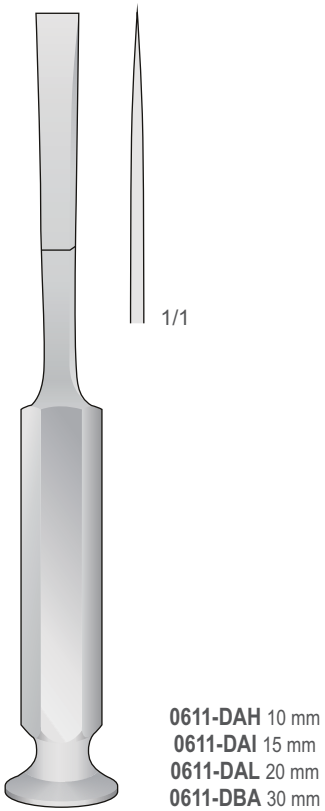

TESSIER  
0611-DAH/0611-DBA  
200 mm

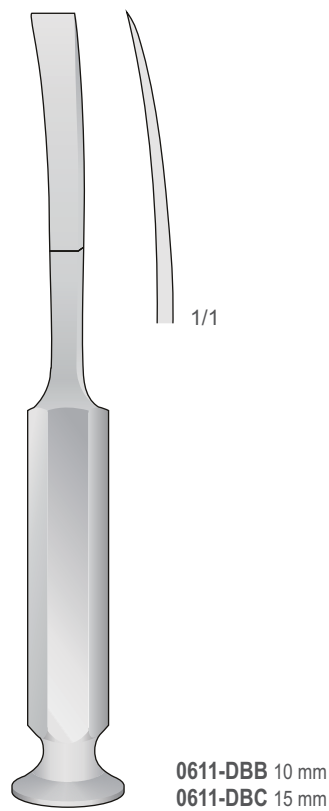

TESSIER  
0611-DBB/0611-DBC  
200 mm

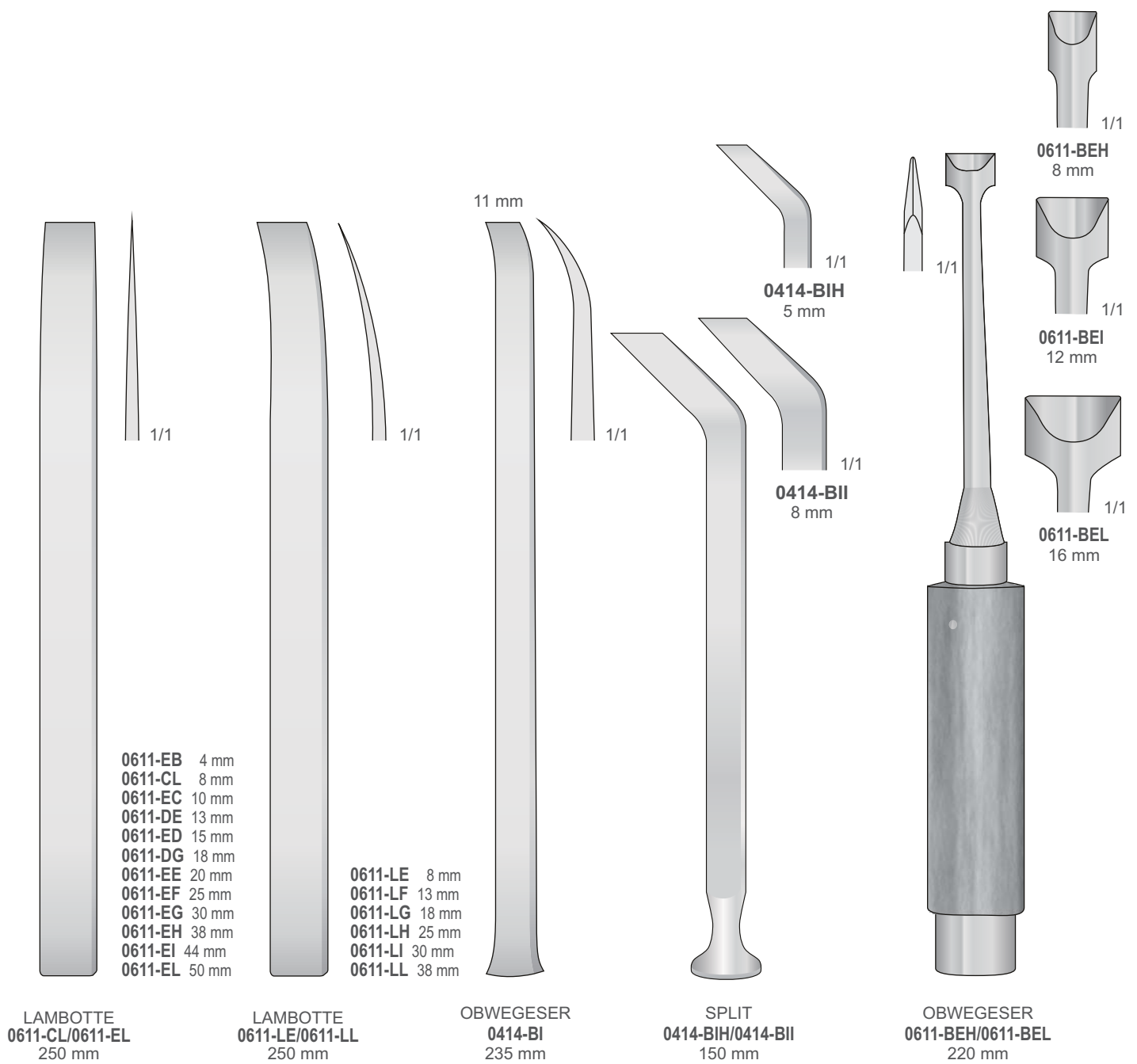



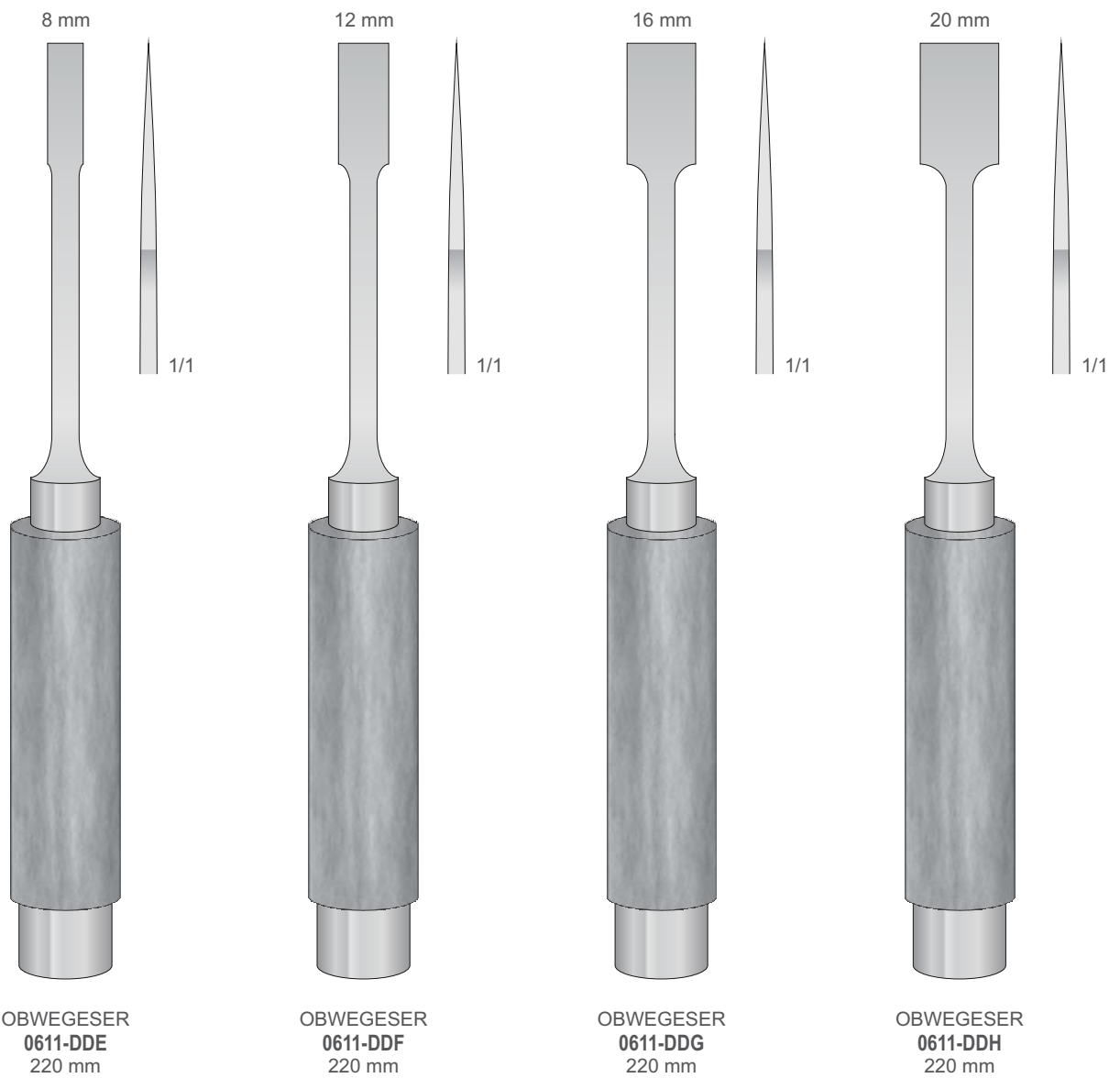

Nasenseptum Osteotome  
Nasal Septum Osteotomes  
Osteotomi per setto nasale  
Osteòtomos para el tabique nasal  
Ostéotomes pour cloison nasale

Graduiert - Graduated  
Graduato - Graduado  
Gradué

U form

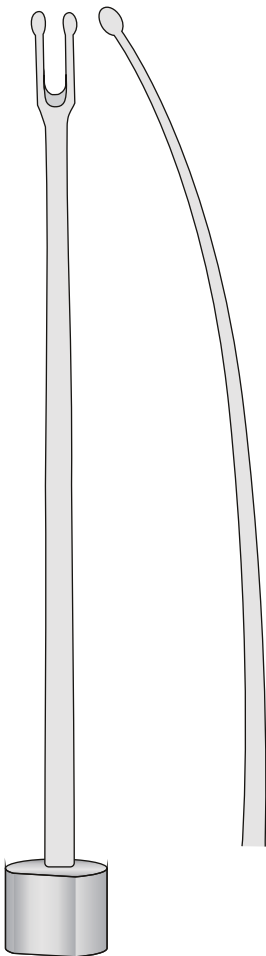

OBWEGESER  
**0414-BBA**  
185 mm

V form

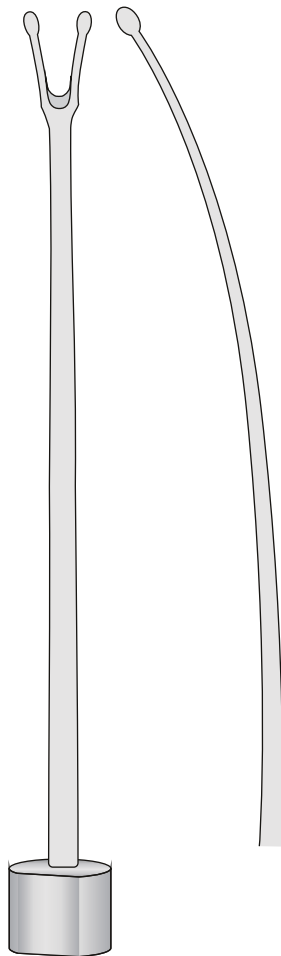

OBWEGESER  
**0414-BBC**  
185mm

4 mm

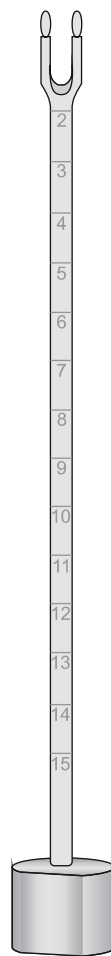

OBWEGESER  
**0414-BCA**  
185 mm

6 mm

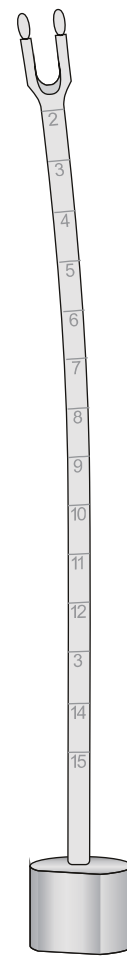

OBWEGESER  
**0414-BCB**  
185 mm

8 mm

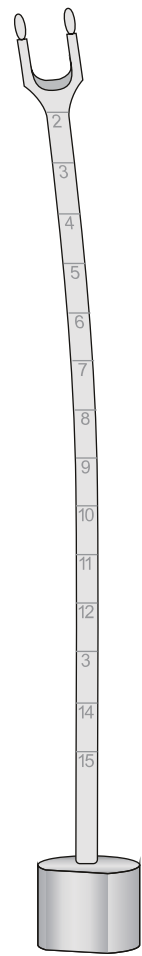

OBWEGESER  
**0414-BCC**  
185 mm

Osteotome  
 Osteotomes  
 Osteotomi  
 Osteòtomas  
 Ostéotomes

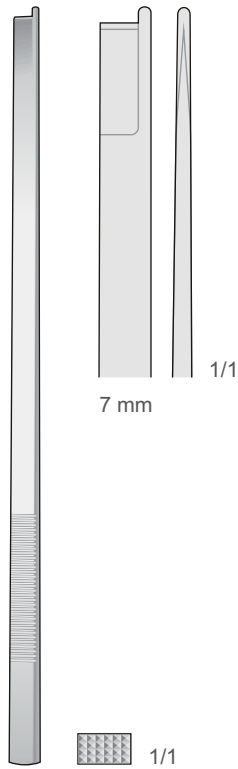

NEIVERT-ANDERSON  
**0414-CHG**  
 205 mm

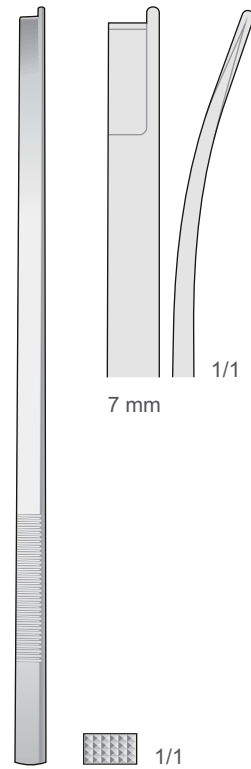

NEIVERT-ANDERSON  
**0414-CHH**  
 205 mm

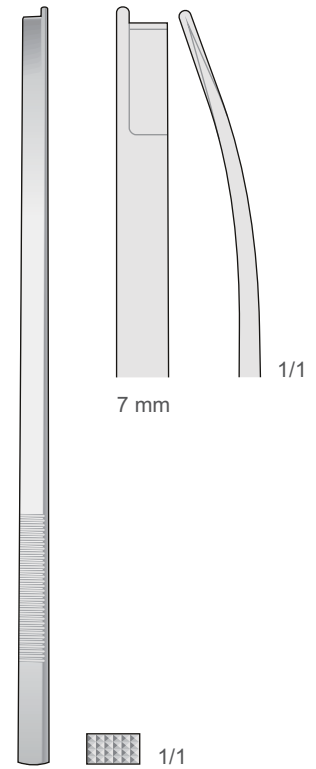

NEIVERT-ANDERSON  
**0414-CHI**  
 205 mm

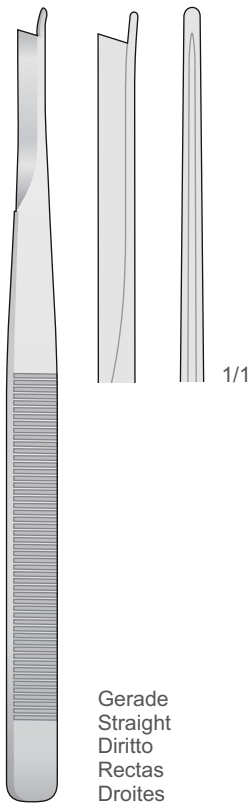

SILVER  
**0414-DE**  
 180 mm

Gerade  
 Straight  
 Diritto  
 Rectas  
 Droites

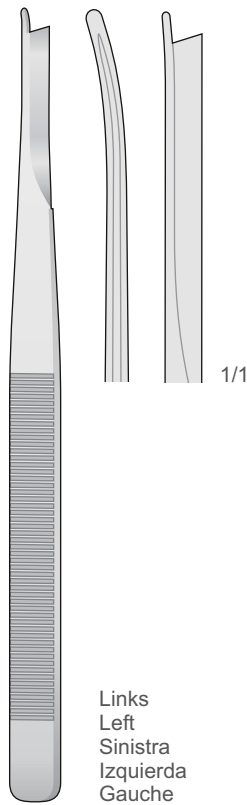

SILVER  
**0414-DF**  
 180 mm

Links  
 Left  
 Sinistra  
 Izquierda  
 Gauche

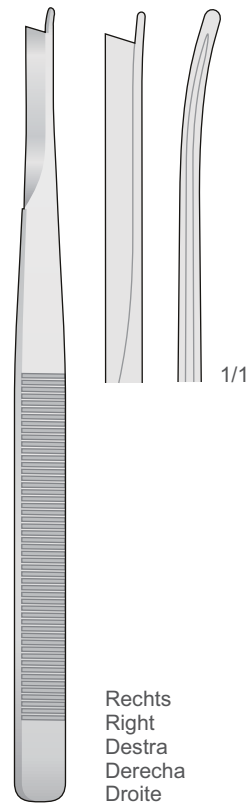

SILVER  
**0414-DG**  
 180 mm

Rechts  
 Right  
 Destra  
 Derecha  
 Droite

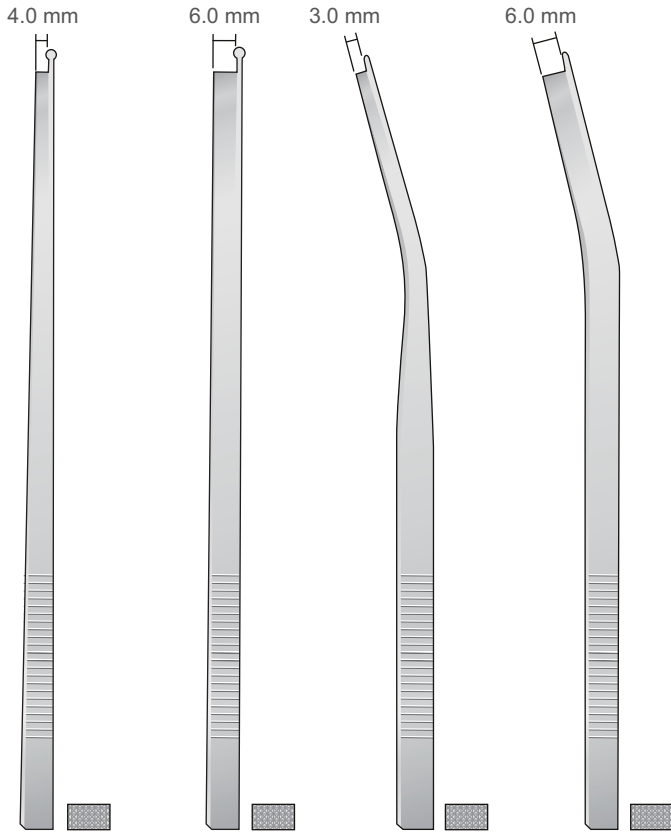

**0414-BBI**  
200 mm

**0414-BBL**  
200 mm

**0414-IE**  
200 mm

**0414-IF**  
200 mm

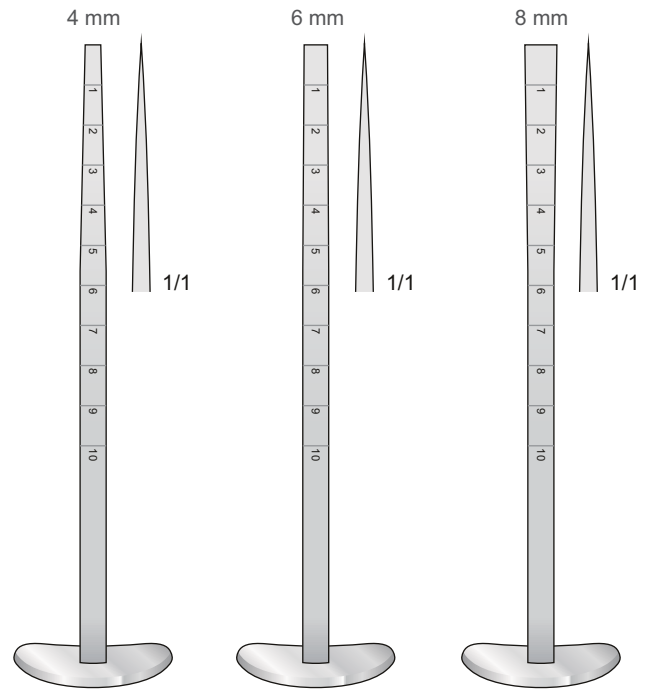

**0414-CGA**  
160 mm

**0414-CGB**  
160 mm

**0414-CGC**  
160 mm

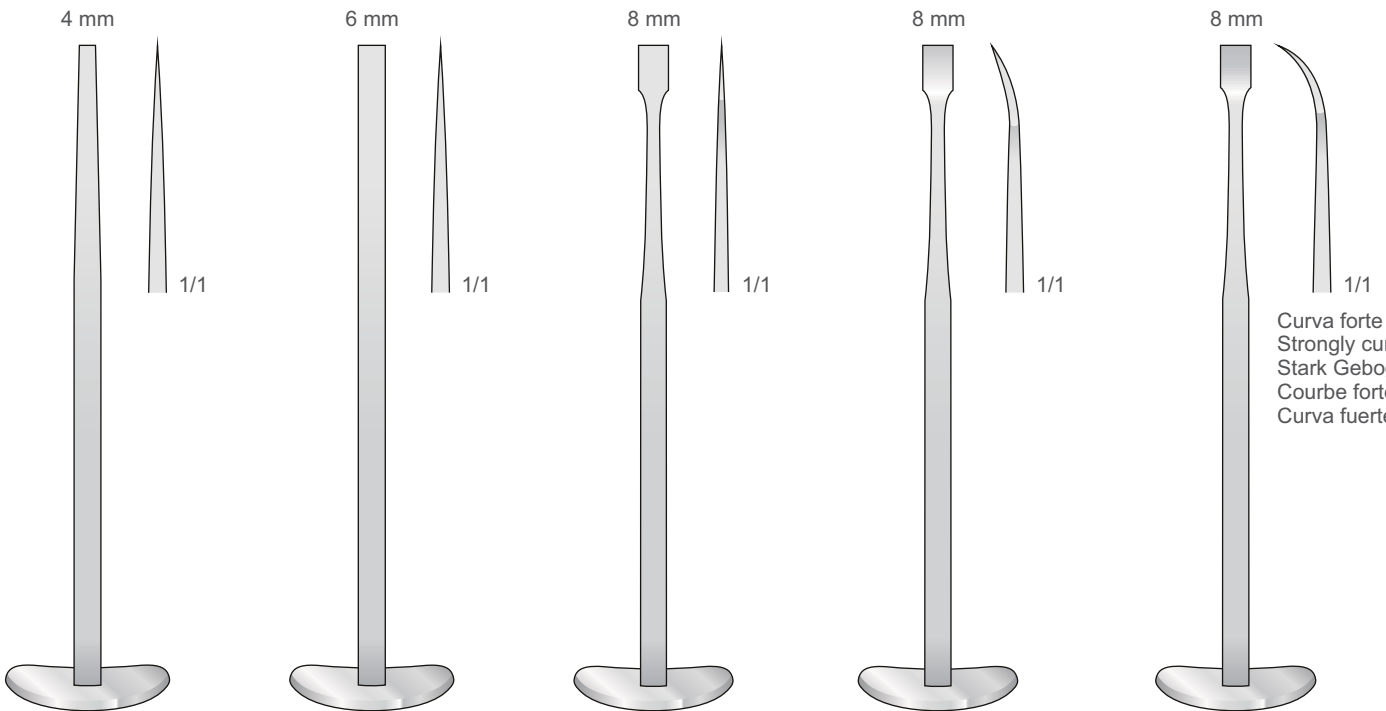

Curva forte  
Strongly curved  
Stark Gebogen  
Courbe forte  
Curva fuerte

**0414-CFH**  
165 mm

**0414-CFI**  
165 mm

**0414-CAD**  
165 mm

**0414-CAF**  
165 mm

**DAUTREY-MUNRO**  
**0414-CAG**  
165 mm

Hämmer - Osteotome  
 Mallets - Osteotomes  
 Martelli - Osteotomi  
 Martillos - Osteòtomos  
 Maillets - Ostéotomes

1 Seite flach - 1 Seite convex  
 1 Side flat - 1 Side convex  
 1 Lato piatto - 1 Lato convesso  
 1 Parte plana - 1 Parte convexe  
 1 Face plate - 1 Face convexe

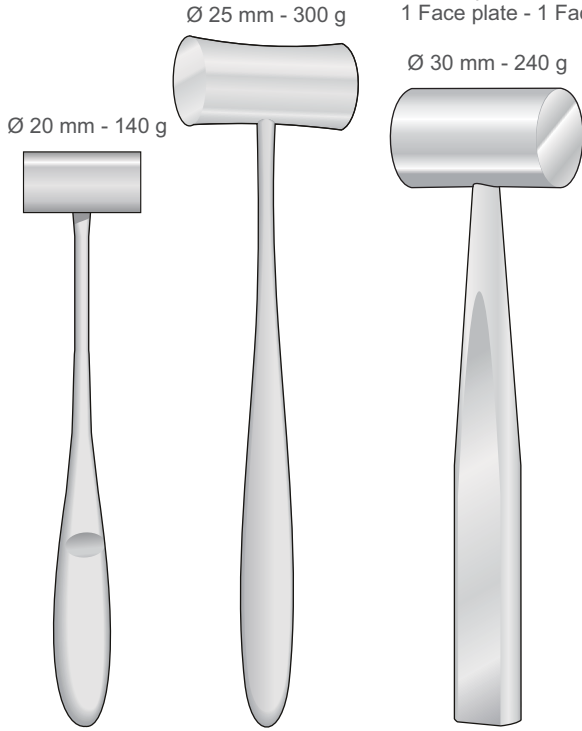

**0611-AB**  
165 mm

**LUCAE**  
**0611-BA12**  
190 mm

**COTTLE**  
**0611-BAE**  
185 mm

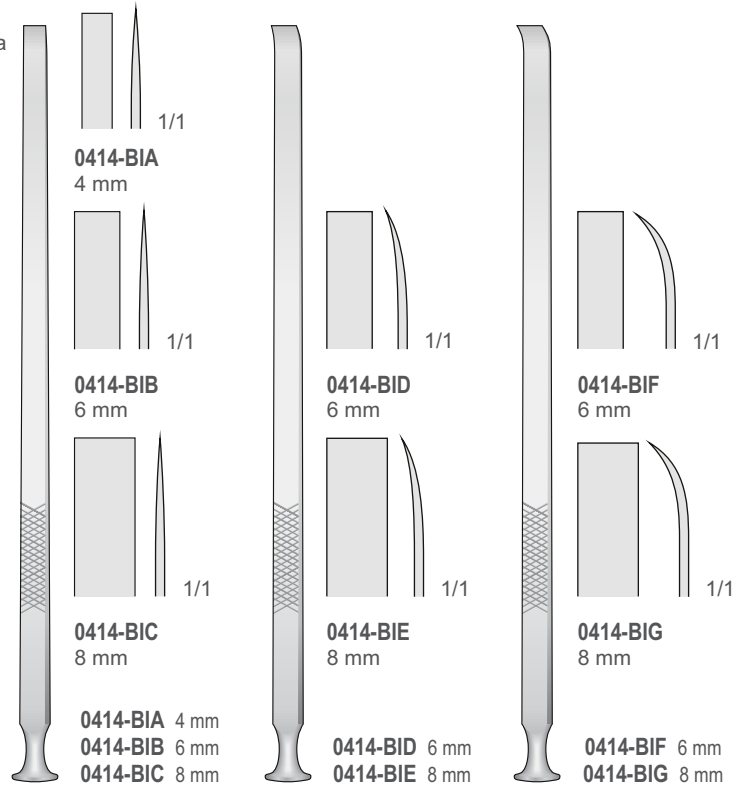

**EPKER**  
**0414-BIA/0414-BIC**  
180 mm

**EPKER**  
**0414-BID/0414-BIE**  
180 mm

**EPKER**  
**0414-BIF/0414-BIG**  
180 mm

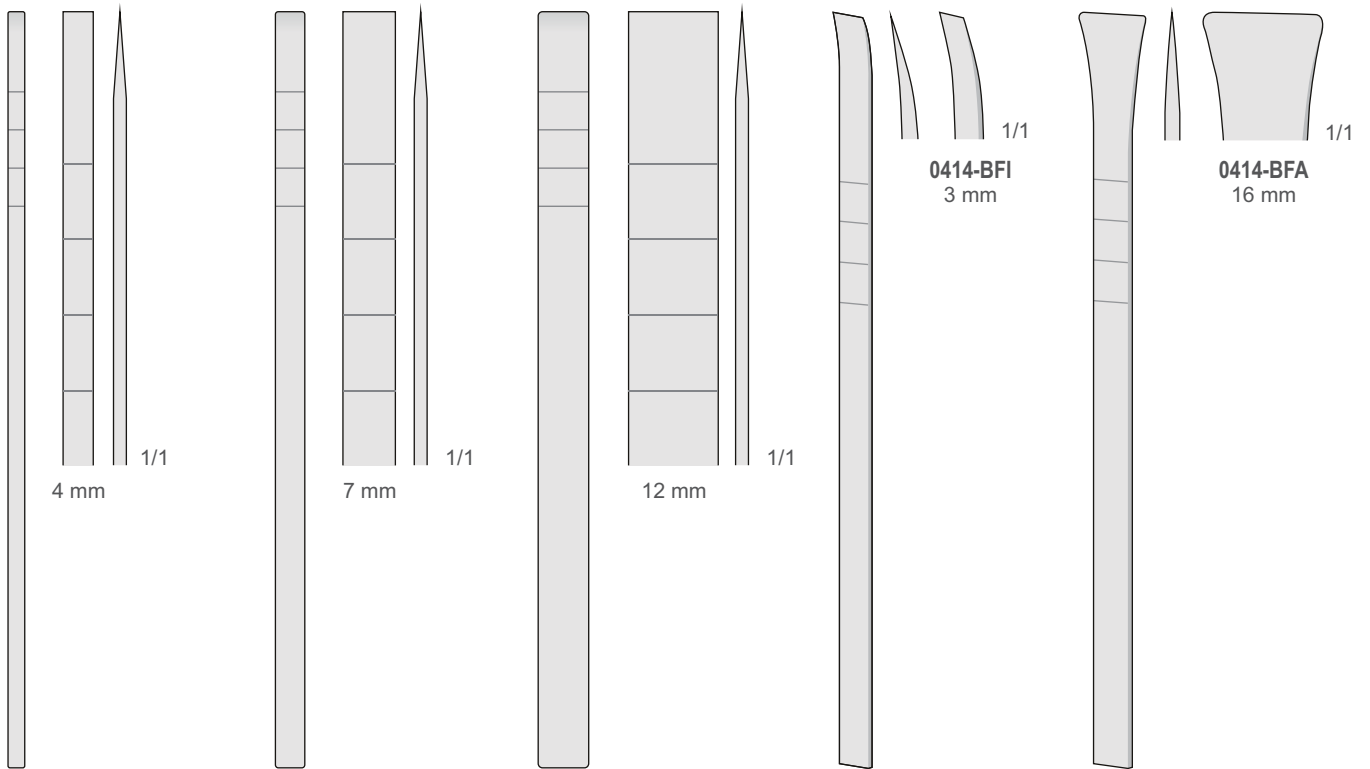

**COTTLE**  
**0414-BEA**  
180 mm

**COTTLE**  
**0414-BEB**  
180 mm

**COTTLE**  
**0414-BED**  
180 mm

**COTTLE**  
**0414-BFI**  
180 mm

**COTTLE**  
**0414-BFA**  
180 mm

Repositionszangen  
 Reposition forceps  
 Pinze per riposizione  
 Pinzas para reposicionar  
 Pincas à réposition

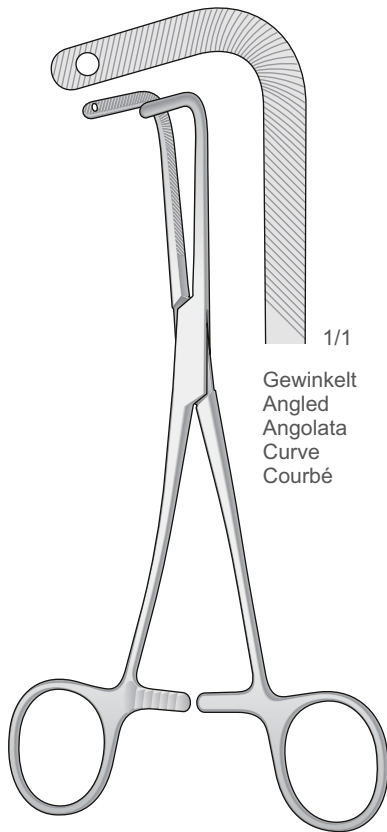

**15-DEB**  
 200 mm

Gewinkelt  
 Angled  
 Angolata  
 Curve  
 Courbé

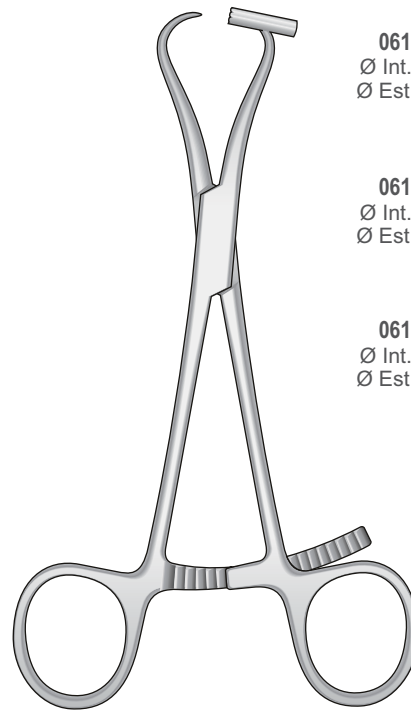

**0614-CEA/0614-CEC**  
 140 mm

- **0614-CEA**  
 Ø Int. 1,0 mm  
 Ø Est. 2,0 mm
- **0614-CEB**  
 Ø Int. 1,3 mm  
 Ø Est. 2,3 mm
- **0614-CEC**  
 Ø Int. 1,6 mm  
 Ø Est. 2,6 mm

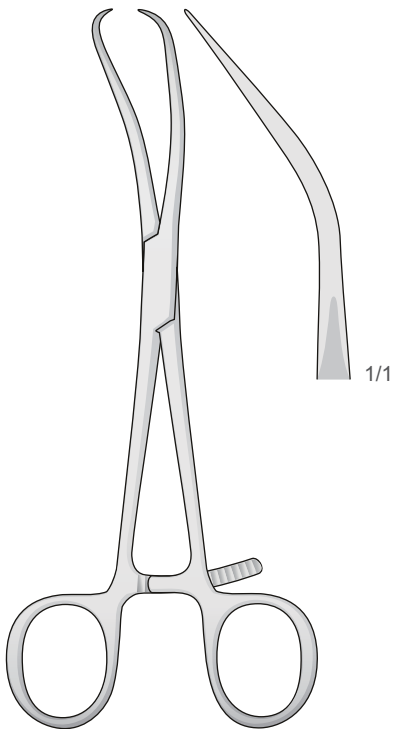

**REILL**  
**0614-GE**  
 170 mm

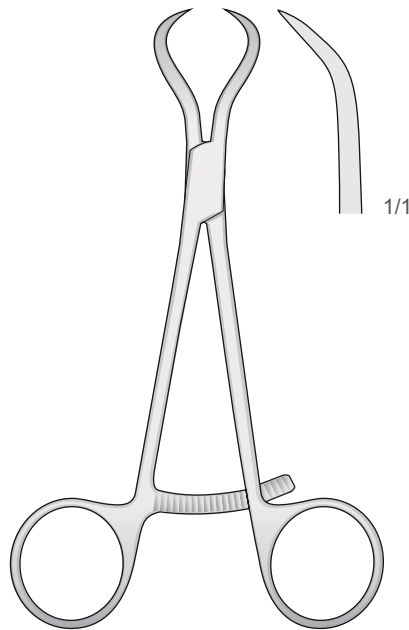

**0614-GG**  
 135 mm

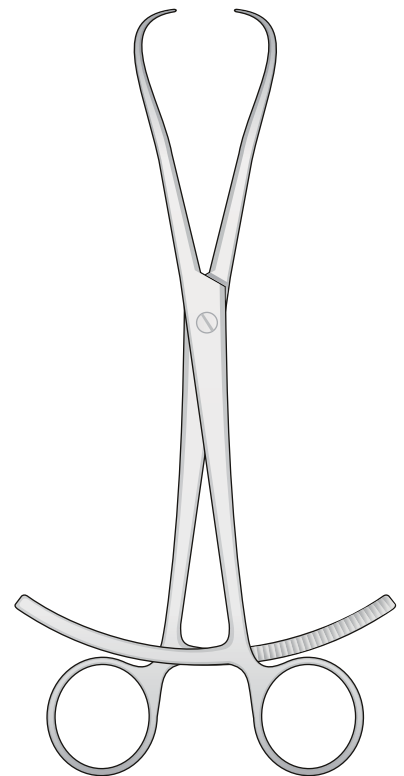

**0614-GI**  
 200 mm

Repositionszangen  
 Reposition forceps  
 Pinze per riposizione  
 Pinzas para reposicioner  
 Pincas à réposition

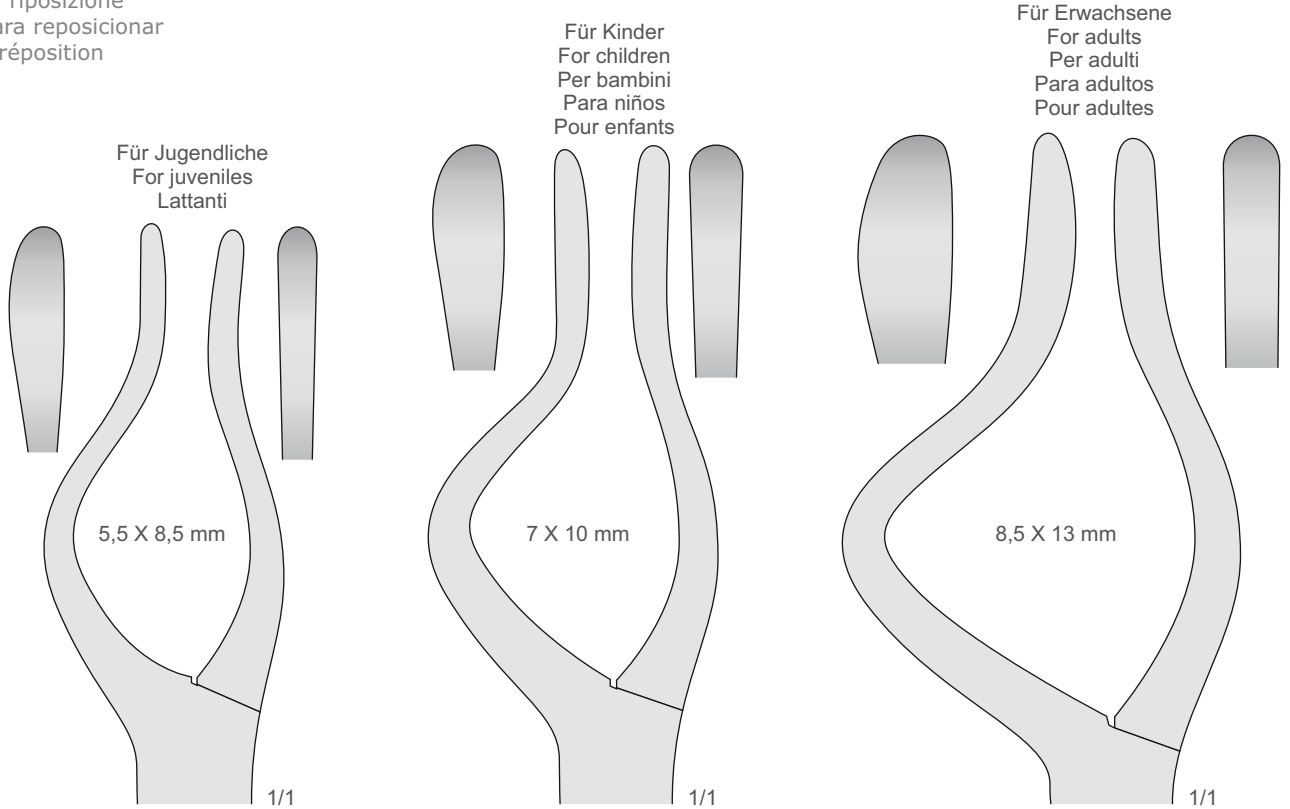

Für Jugendliche  
 For juveniles  
 Lattanti

5,5 X 8,5 mm

1/1

Für Kinder  
 For children  
 Per bambini  
 Para niños  
 Pour enfants

7 X 10 mm

1/1

Für Erwachsene  
 For adults  
 Per adulti  
 Para adultos  
 Pour adultes

8,5 X 13 mm

1/1

**0414-BA**  
**0414-BB**  
 225 mm

**0414-BC**  
**0414-BD**  
 235 mm

**0414-BE**  
**0414-BF**  
 240 mm

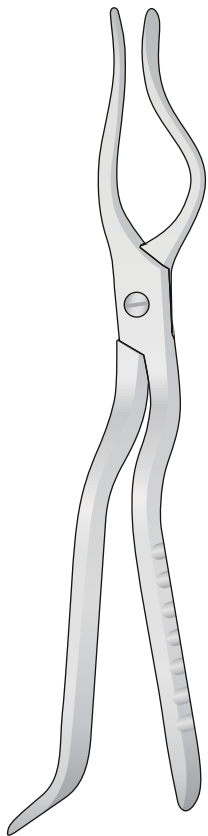

Links  
 Left  
 Sinistra  
 Izquierda  
 Gauche

ROWE

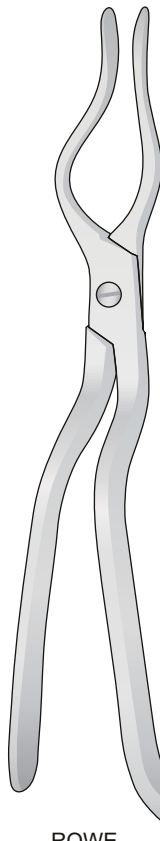

Rechts  
 Right  
 Destra  
 Derecha  
 Droite

ROWE

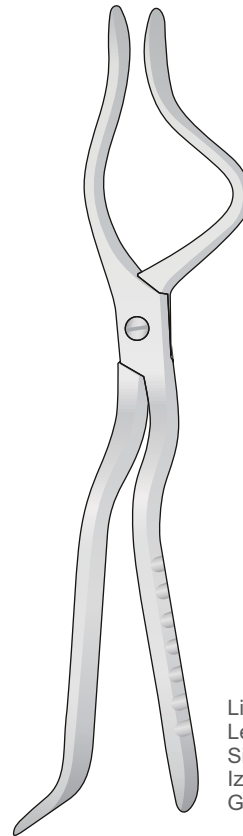

Links  
 Left  
 Sinistra  
 Izquierda  
 Gauche

ROWE

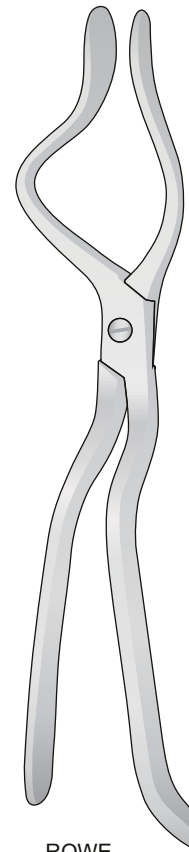

Rechts  
 Right  
 Destra  
 Derecha  
 Droite

ROWE

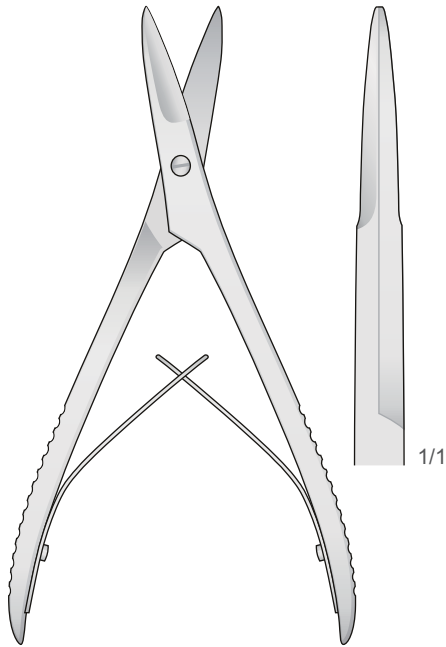

**0614-GD**  
160 mm

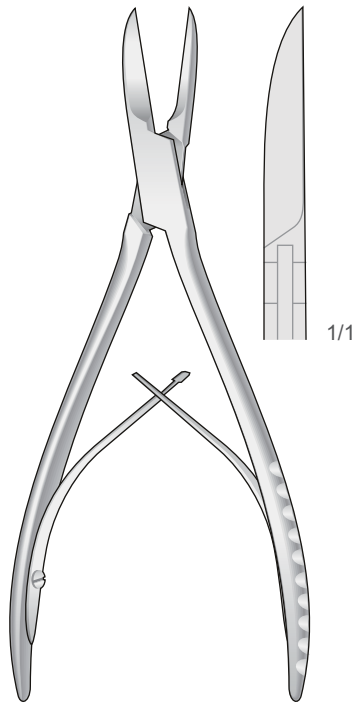

**COTTLE-KAZANJIAN**  
**0614-LF**  
190 mm

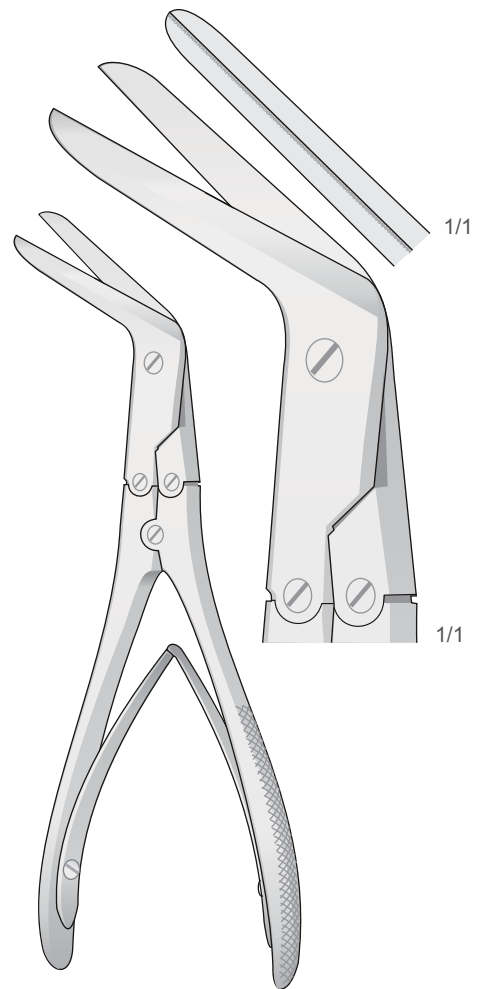

**KILLIAN**  
**0614-BED**  
210 mm

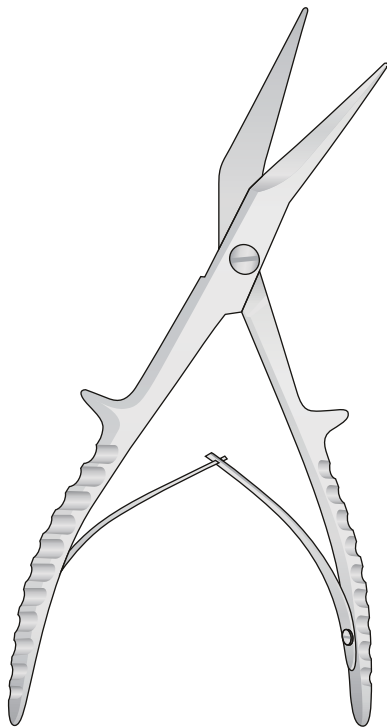

**0607-BBA**  
195 mm

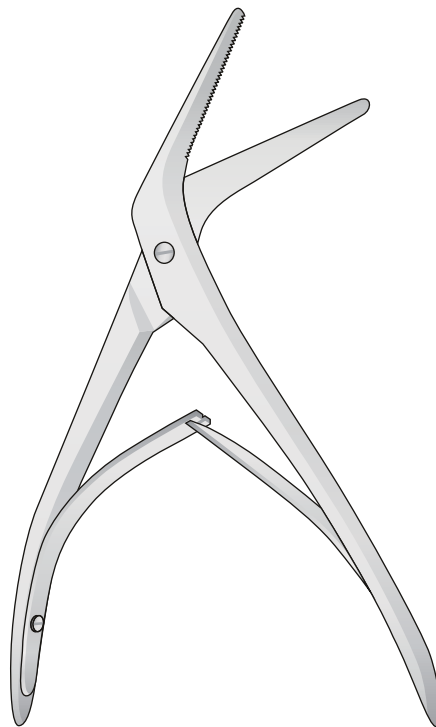

**JACKSON-TESSIER**  
**0607-BBB**  
190 mm



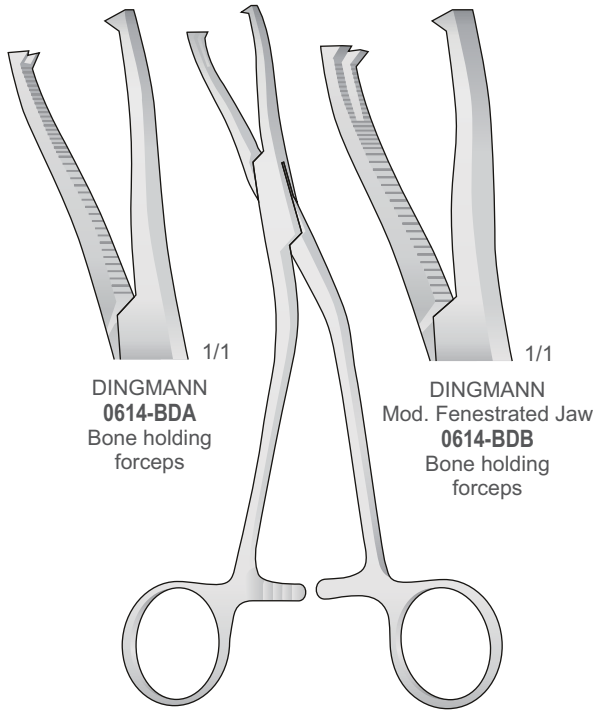

DINGMANN  
**0614-BDA**  
 Bone holding  
 forceps

DINGMANN  
 Mod. Fenestrated Jaw  
**0614-BDB**  
 Bone holding  
 forceps

DINGMANN  
**0614-BDA/0614-BDB**  
 190 mm

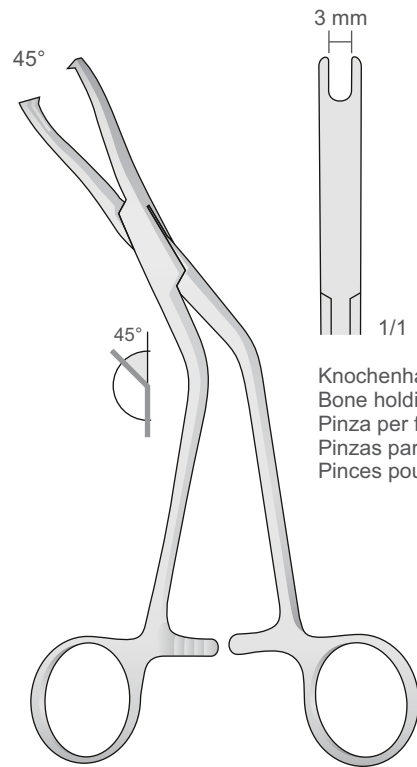

Knochenhaltezange  
 Bone holding forceps  
 Pinza per fissare l'osso  
 Pinzas para coger huesos  
 Pinces pour tenir l'os

DINGMANN - Mod. Fenestrated Jaw  
**0614-BDB18**  
 190 mm

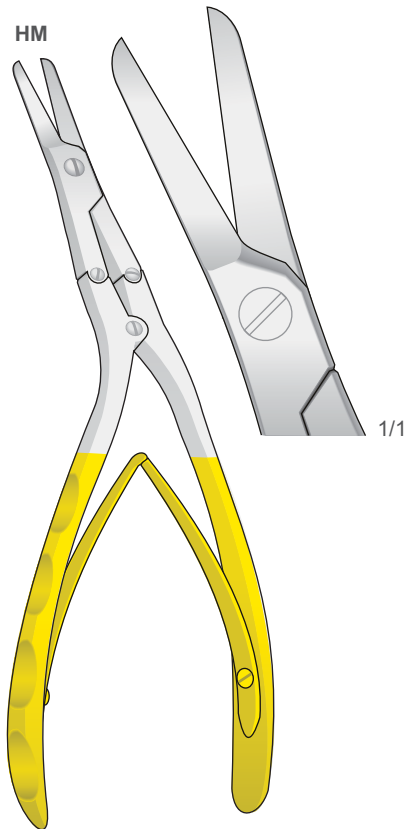

HM  
**CAPLAN**  
**0614-BEE**  
 200 mm

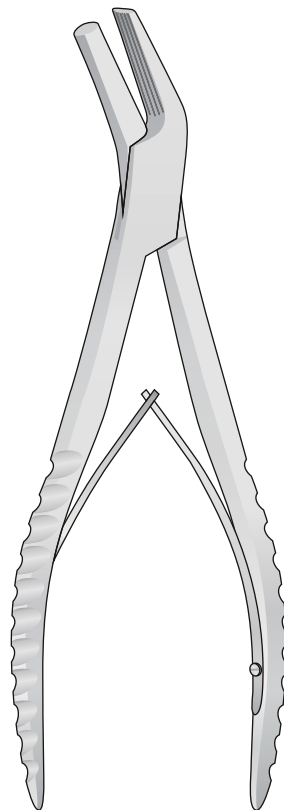

**TESSIER**  
**0614-BDH**  
 220 mm

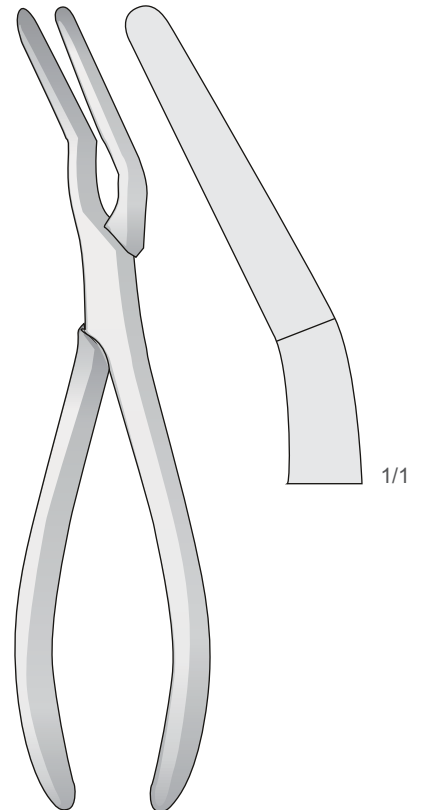

**ASCH**  
**0414-BFH**  
 230 mm

Für Jochbögen  
For zygomatic archs  
Per arco zigomatico  
Para arcos cigomáticos  
Pour arcades cygomatique

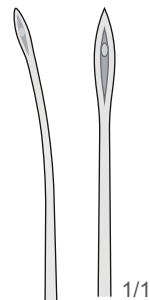

OBWEGESER  
**0414-DB**  
230 mm

Für Oberkiefer  
For maxillas  
Per mascelle  
Para maxilares superior  
Pour maxillaires supérieures

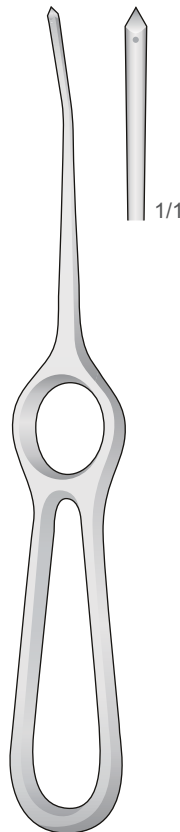

OBWEGESER  
**0414-DC**  
180 mm

Haken-Jochbogenahle  
Zigoma hook  
Uncini per arco zigomato  
Para arcos cigomáticos  
Pour arcades cygomatique

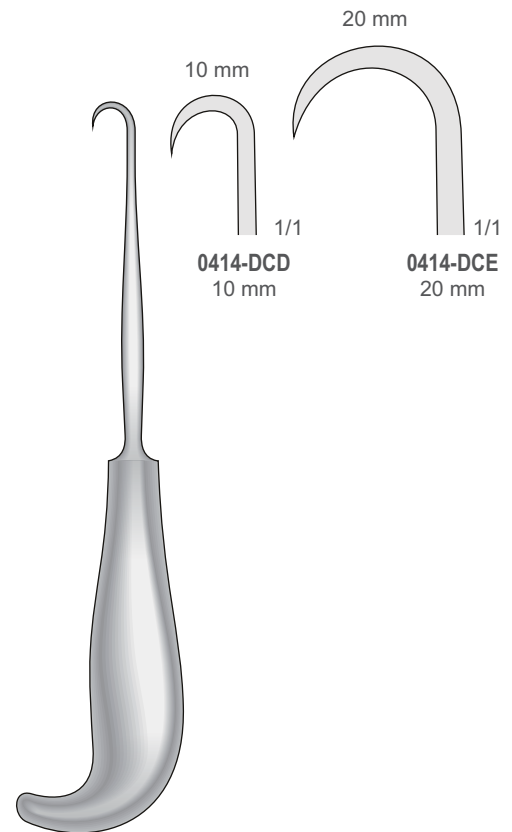

DINGMAN  
**0414-DCD** 10 mm  
**0414-DCE** 20 mm  
190 mm

Für Unterkiefer  
For mandibles  
Per mandibola  
Para mandibula  
Pour maxillaires inférieures

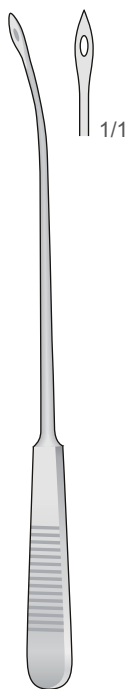

OBWEGESER  
**0414-DA**  
140 mm

Tamponstopfer  
Gauze Packer  
Porta tamponi  
Tamponador  
Porte-tampons

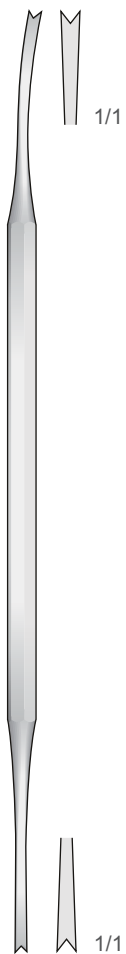

LUNIATSCHEK  
1506-G  
170 mm

Drahtpositionierer  
Wire pusher  
Posizionatore per filo  
Instrumento para  
posicionar alambre  
Positionneur à fil

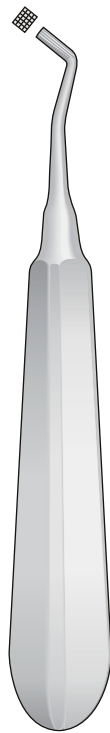

MERSHON  
0415-FA  
140 mm

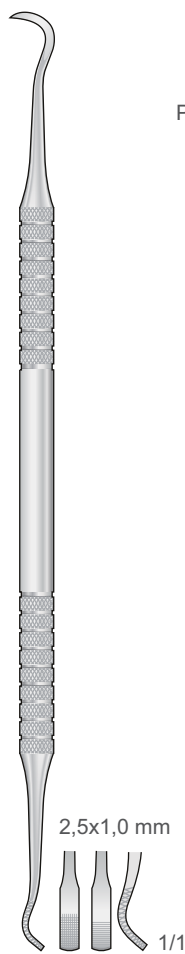

SHURE  
0415-BCE  
175 mm

Drahtdrehklemmen  
Wire twister  
Pinza per piegare fili  
Pinza para torcer alambre  
Pince à torsader le fil

Mit Hartmetalleinsätzen  
With Hard Metal Inserts  
Con punte in metallo duro  
Con puntas de metal duro  
Avec mors en métal dur

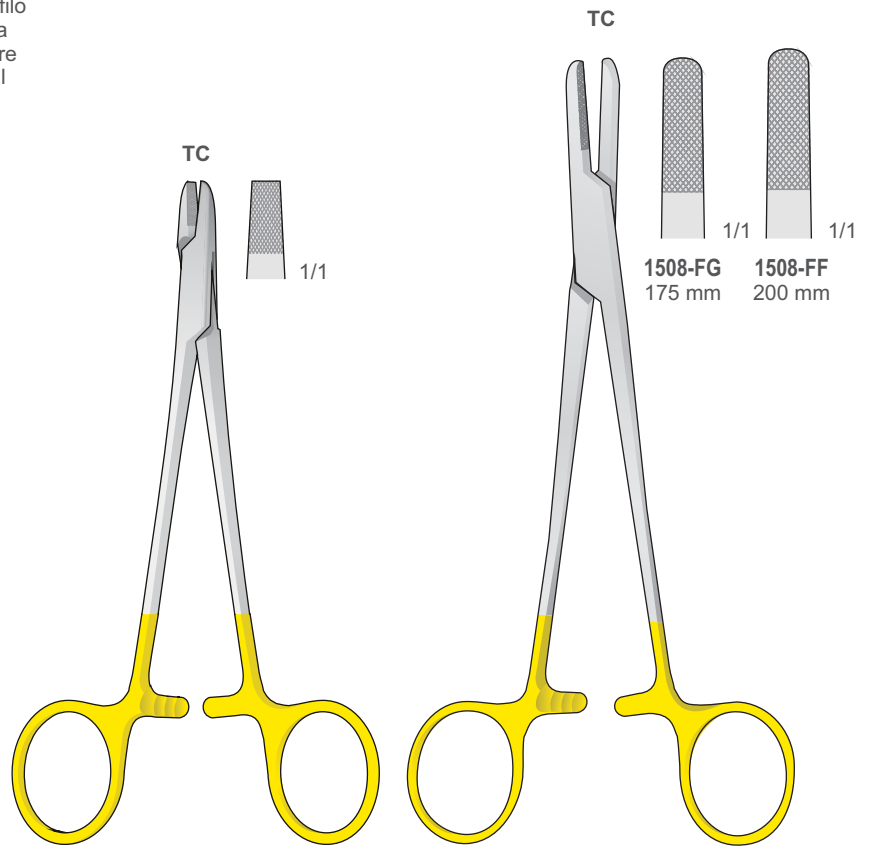

1508-FI  
150 mm

1508-FF/1508-FG

Drahtschneidezangen  
Wire cutting pliers  
Tronchesi per fili metallici  
Alicates para cortar alambre  
Pinces à couper le fil

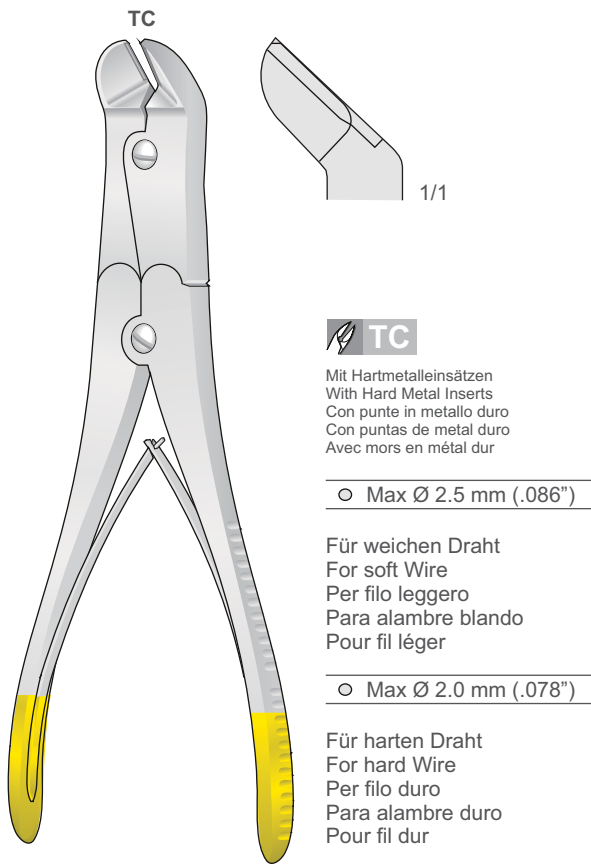

**1123-BAF**  
230 mm

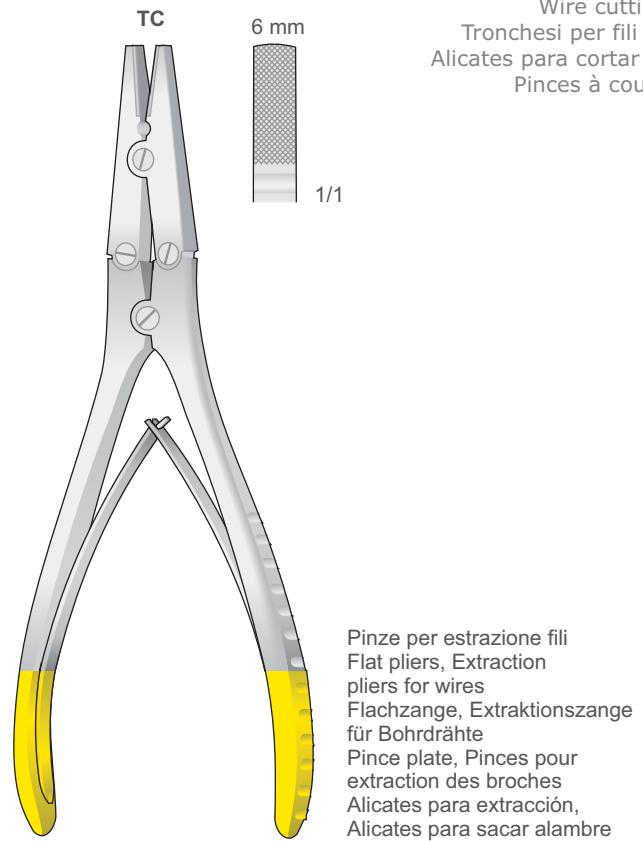

**1123-BEB**  
180 mm

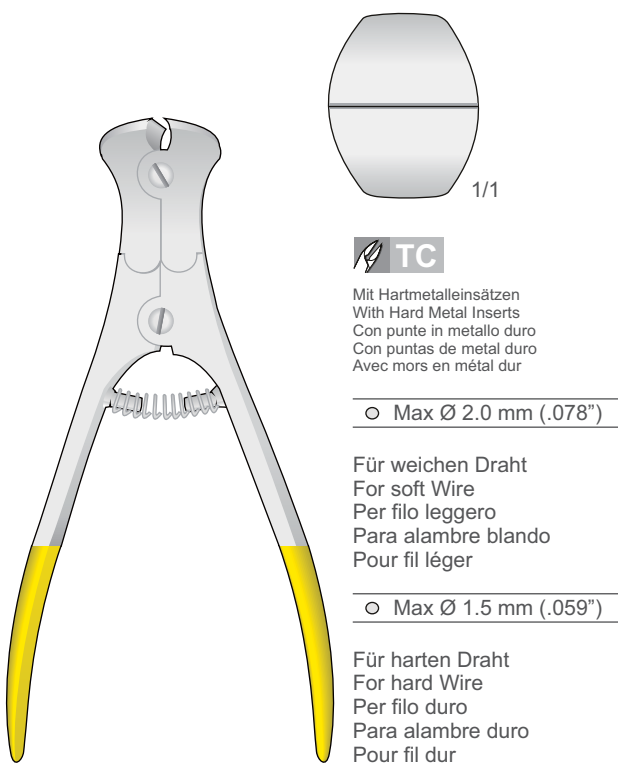

**1123-BAC**  
145 mm

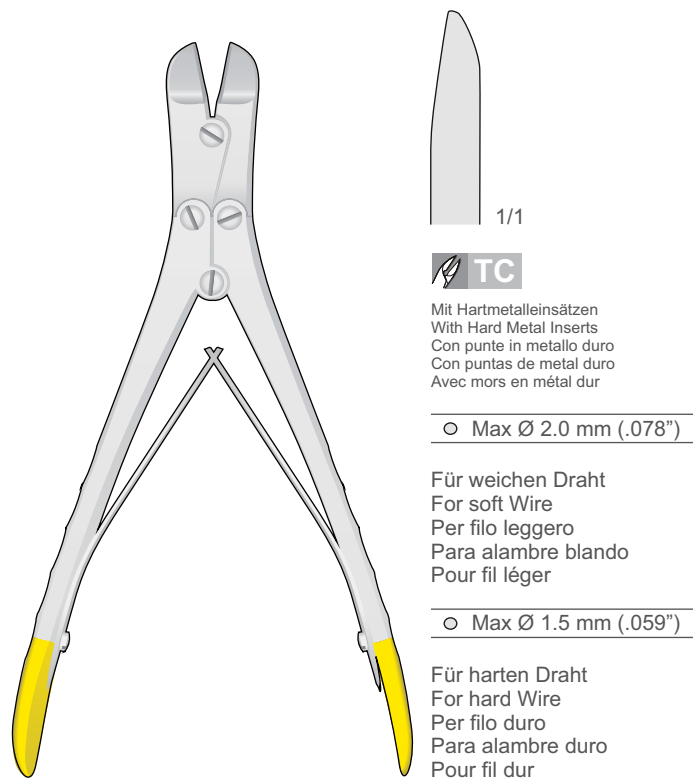

**1123-BAD**  
170 mm

Drahtschneidezangen  
Wire cutting pliers  
Tronchesi per fili metallici  
Alicates para cortar alambre  
Pinces à couper le fil

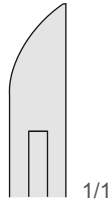
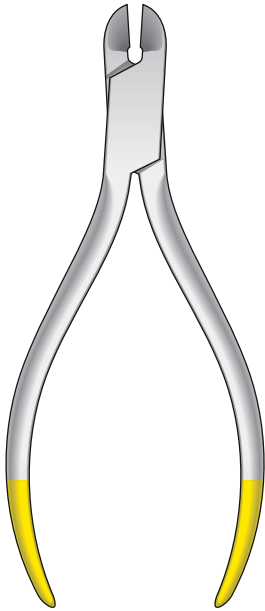

Mit Hartmetalleinsätzen  
With Hard Metal Inserts  
Con punte in metallo duro  
Con puntas de metal duro  
Avec mors en métal dur

- Max Ø 0.5 mm (.020")
- 0.41 x 0.56 mm (.016" x .022")

Für weichen und harten Draht  
For soft and hard Wire  
Per fili duri, sottili e medi  
Para alambre blando y duro  
Pour fil léger e dur

1123-LL  
120 mm

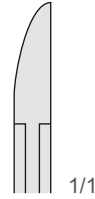
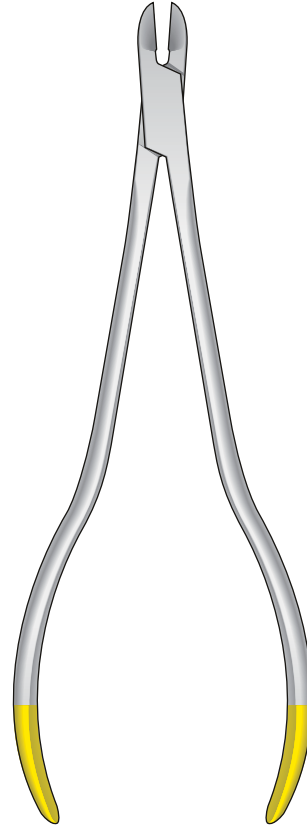

Mit Hartmetalleinsätzen  
With Hard Metal Inserts  
Con punte in metallo duro  
Con puntas de metal duro  
Avec mors en métal dur

- Max Ø 0.3 mm (.012")

Long Handle  
Con manici lunghi

Ligaturen Schneidezangen -Mini  
Mini Ligature Cutter  
Solo per rimuovere le legature  
Alicate de corte mini  
Pince coupante mini

Für weichen Draht  
For soft Wire  
Per fili sottili e morbidi  
Para alambre blando  
Pour fil léger

1123-LI  
175 mm

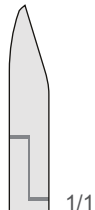
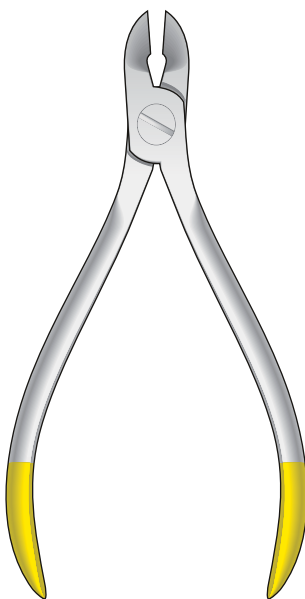

Mit Hartmetalleinsätzen  
With Hard Metal Inserts  
Con punte in metallo duro  
Con puntas de metal duro  
Avec mors en métal dur

- Max Ø 0.4 mm (.016")

Ligaturen-Cutter  
Ligature Cutter

Für weichen und harten Draht  
For soft and hard Wire  
Per filo leggero e duro  
Para alambre blando y duro  
Pour fil léger e dur

1123-II  
115 mm

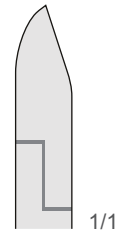
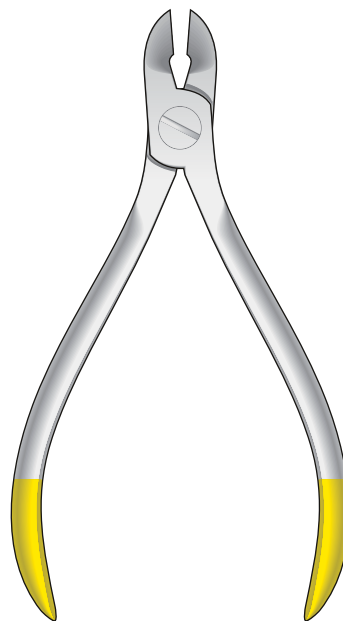

Mit Hartmetalleinsätzen  
With Hard Metal Inserts  
Con punte in metallo duro  
Con puntas de metal duro  
Avec mors en métal dur

- Max Ø 0.7 mm (.028")
- 0.56 x 0.71 mm (.022" x .028")
- ⊗ 0.53 x 0.64 mm (.021" x .025")

Bogen-Cutter  
Arch Cutter

Für weichen und harten Draht  
For soft and hard Wire  
Per fili duri, grossi e intrecciati  
Para alambre blando y duro  
Pour fil léger e dur

1123-IL  
120 mm

Flachzangen - Scheren  
 Nose Flat Pliers - Scissors  
 Pinze a punte piatte - Forbici  
 Alicates planos - Tijeras  
 Pincès à mors plats - Ciseaux

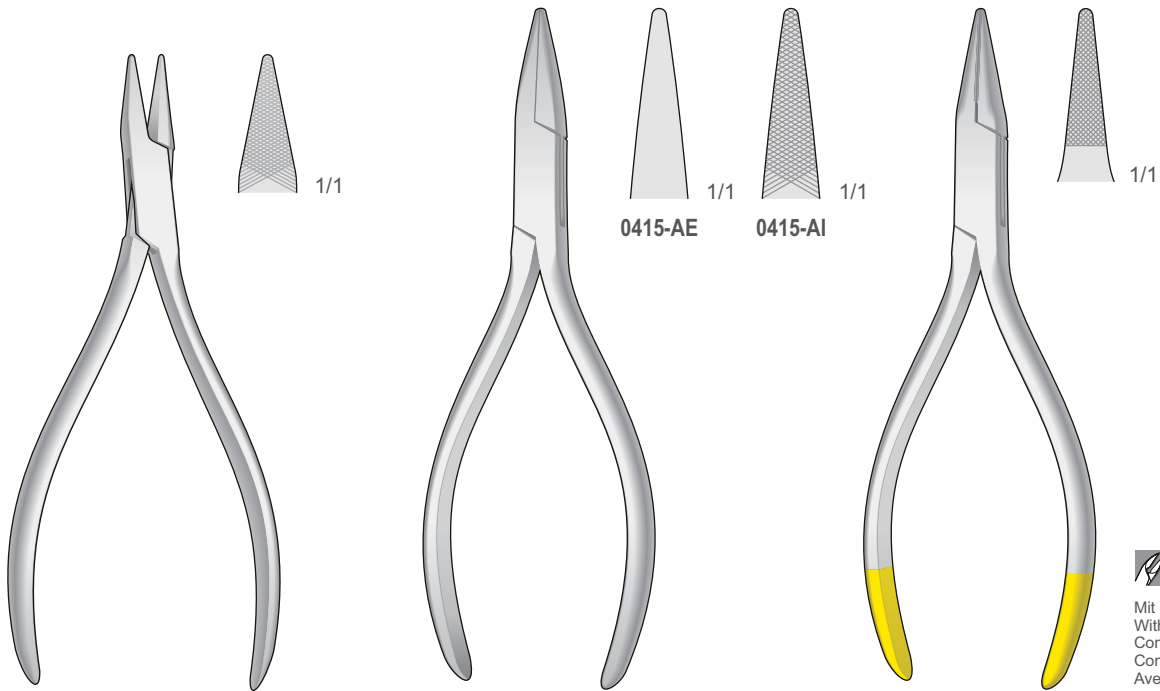

**0415-CH**  
125 mm

**0415-AE/0415-AI**  
140 mm

**0415-AI1903**  
140 mm



Mit Hartmetalleinsätzen  
 With Hard Metal Inserts  
 Con punte in metallo duro  
 Con puntas de metal duro  
 Avec mors en métal dur

Scheren für dünne Stahl-und Edelmetallbleche - Scissors for thin steel and precious metal sheets  
 Forbici per lamine sottili di acciaio e metalli preziosi - Tijeras para láminas delgadas de acero y metales preciosos  
 Ciseaux pour couper les feuilles de métaux

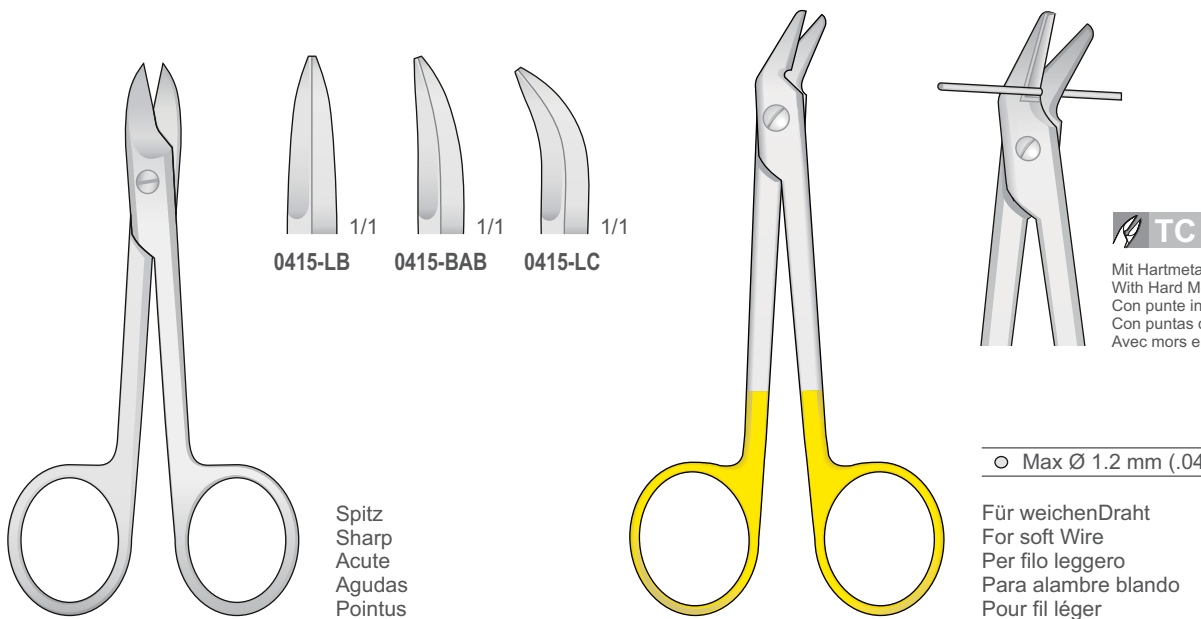

**BEEBE**  
**0415-LB/0415-BAB**  
110 mm

**0415-BCA**  
120 mm



Mit Hartmetalleinsätzen  
 With Hard Metal Inserts  
 Con punte in metallo duro  
 Con puntas de metal duro  
 Avec mors en métal dur

○ Max Ø 1.2 mm (.048")

Für weichen Draht  
 For soft Wire  
 Per filo leggero  
 Para alambre blando  
 Pour fil léger

Instrumente für Mikro-Implantate  
 Instruments for Micro Implants  
 Strumenti per micro impianti  
 Instrumentos para micro implantos  
 Instruments pour les micro implantés

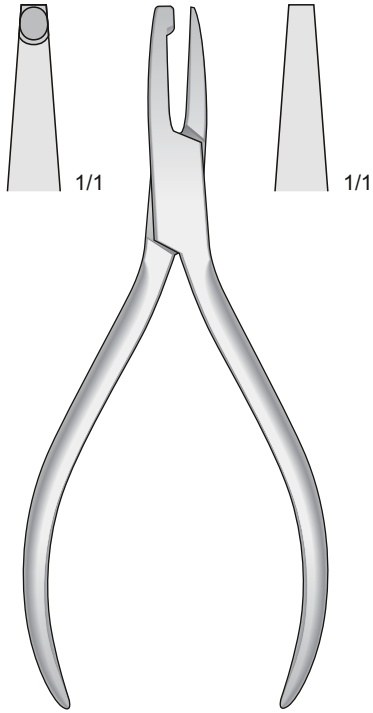

**0415-EL**  
140 mm

Plattenschneidezange  
 Plate cutting Pliers  
 Pinza taglia placche

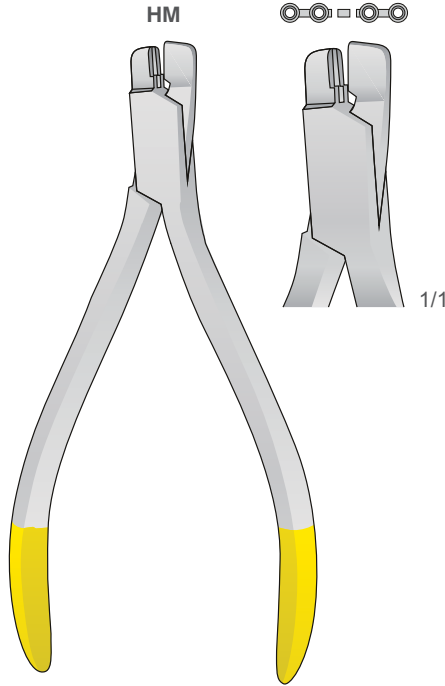

**1118-BFF**  
115 mm

Plattenschneidezange  
 Plate cutting Pliers  
 Pinza taglia placche

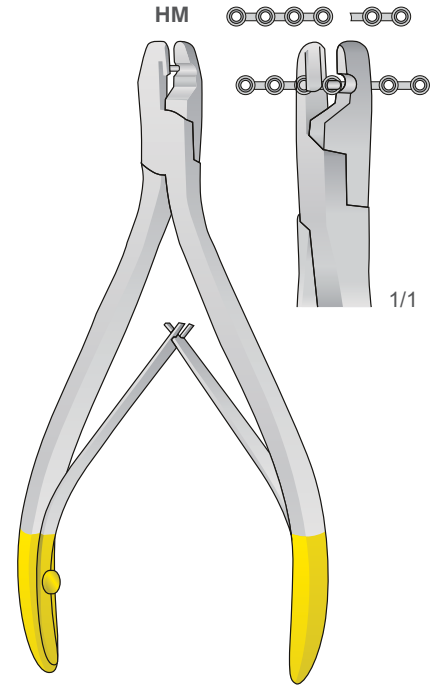

**1118-BFG**  
110 mm

Dreipunkt-Biegezange  
 Plate bending pliers  
 Pinze piega placche

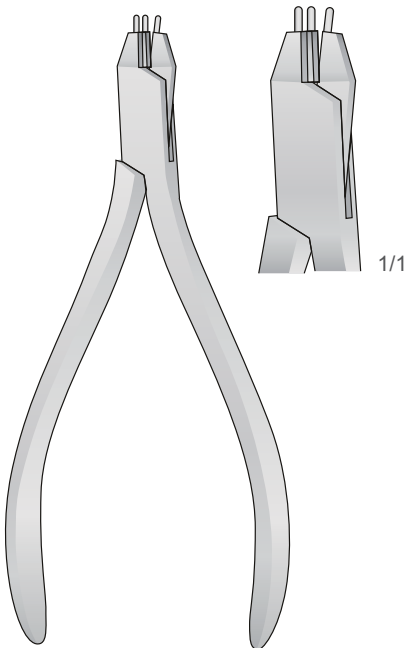

**1118-CBH**  
115 mm

Flachzange  
 Flat-nose pliers  
 Pinze piega placche piatta

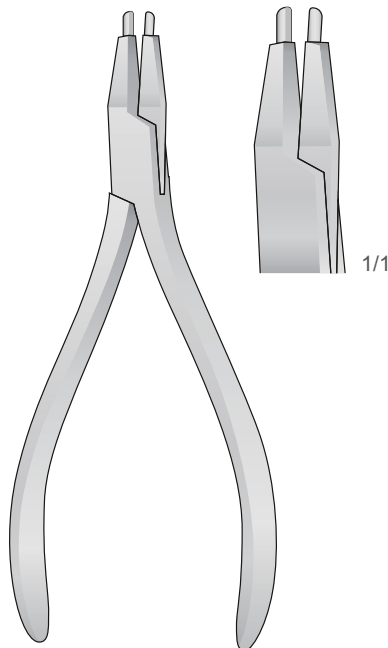

**1118-CBF**  
120 mm

Plattenschneidezange  
 Plate cutting Pliers  
 Pinza taglia placche

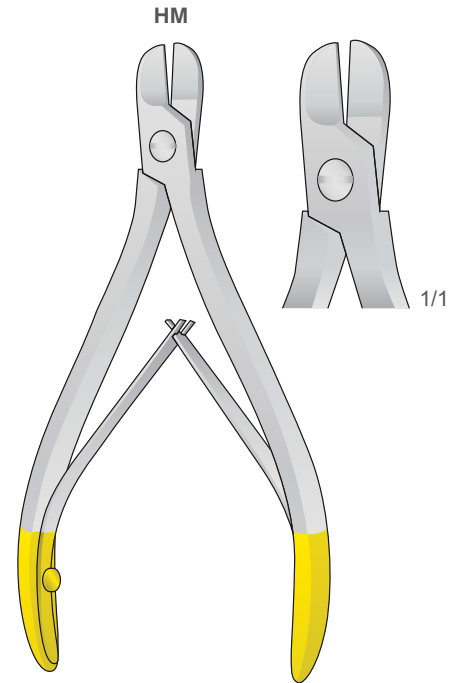

**1123-BFE**  
115 mm

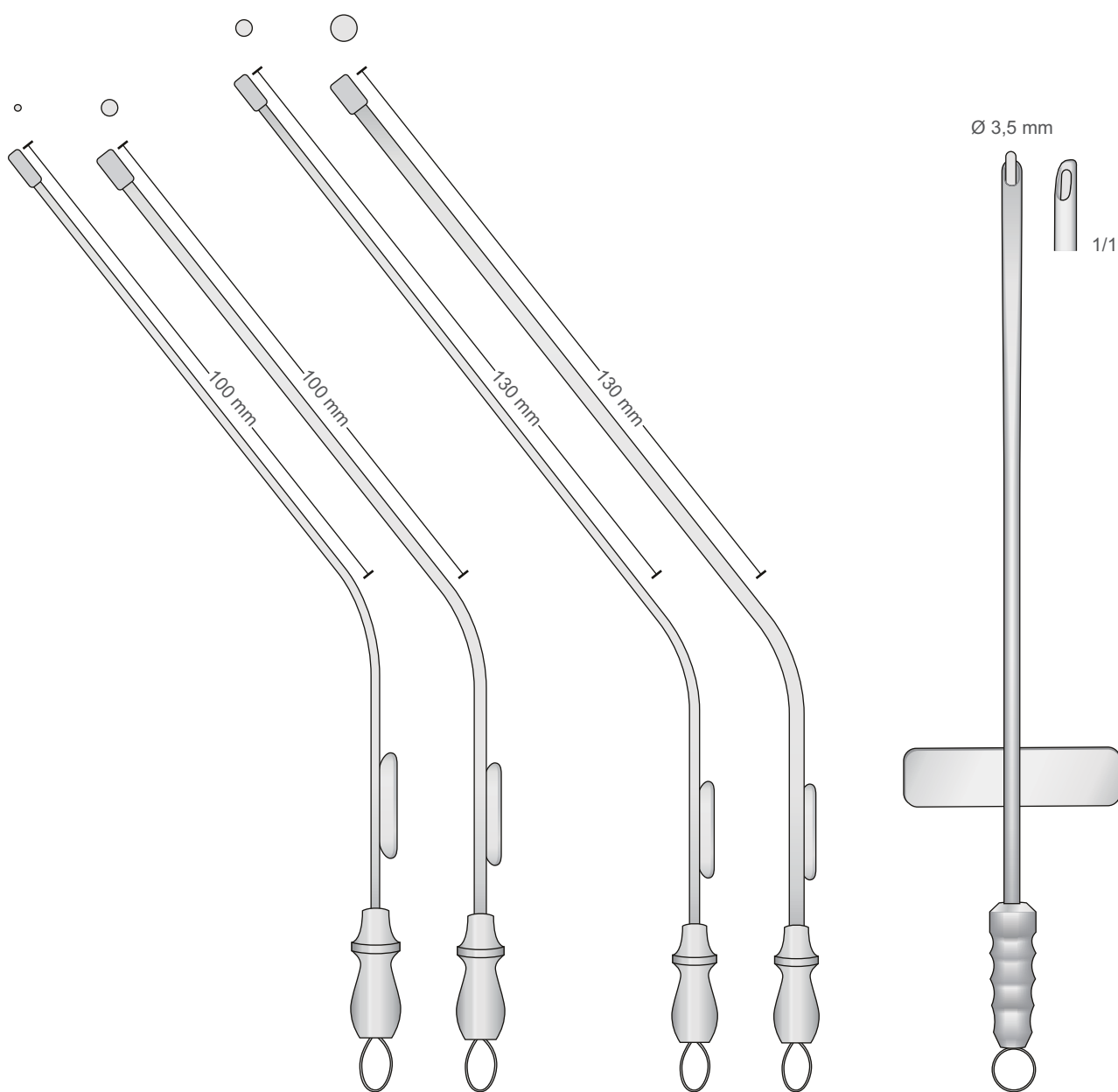

ROTAN  
**0706-CF**  
Charr. 3  
Ø 1 mm

ROTAN  
**0706-CH**  
Charr. 7  
Ø 2,5 mm

ROTAN  
**0706-CI**  
Charr. 7  
Ø 2,5 mm

ROTAN  
**0706-CE**  
Charr. 12  
Ø 4 mm

**0706-HE**  
180 mm



House Saug- und Spülrohr, Luer Konus

Saugrohr  
Suction tube  
Tubo per aspirazione  
Tube d'aspiration

Spülrohr  
Irrigation tube  
Tubo per irrigazione  
Tube d'irrigation

Char. 3	= 1 mm
Char 5	= 1,7 mm
Char 7	= 2,5 mm
Char 10	= 3,3 mm
Char 12	= 4 mm
Char 14	= 4,6 mm

Char. 2	= 0,6 mm
Char 4	= 1,21 mm
Char 5	= 1,7 mm
Char 7	= 2,5 mm
Char 8	= 2,4 mm
Char 12	= 4 mm

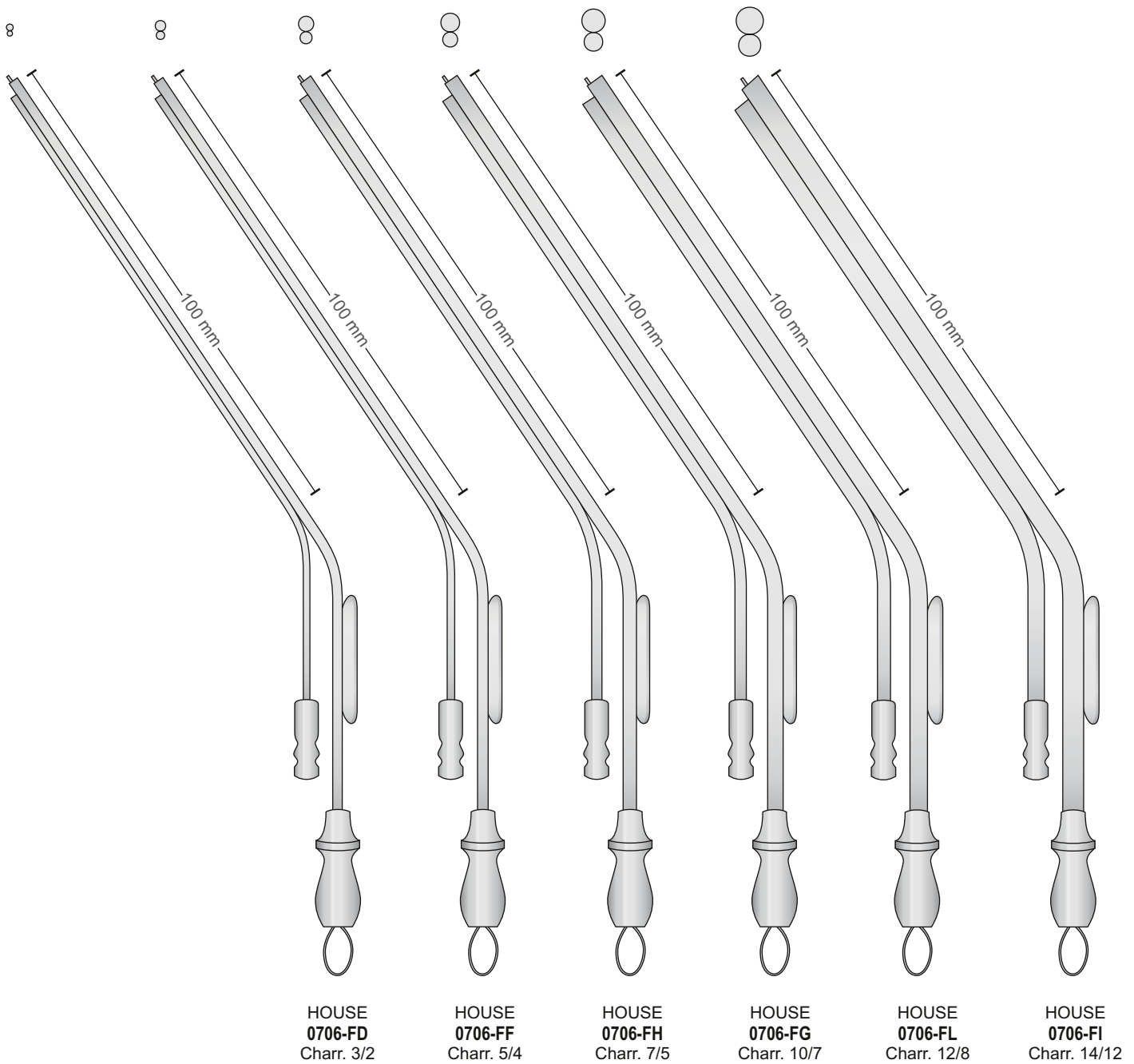





ideal-tek

manufacturer & supplier of precision instruments 



**A**

<b>ADSON</b> , Chirurgische Pinzetten	31, 33
<b>ADSON-BROWN</b> , Chirurgische Pinzetten	32, 33
<b>ASCH</b> , Knochenchirurgie	71
<b>AUFRICHT</b> , Nasenhaken	40
- Nasenraspeln	59

**B**

<b>BABBUSH</b> , Raspatorien	54
<b>BABY CRILE-WOOD</b> , Nadelhalter	34
<b>BEEBE</b> , Scheren für dünne Stahl-und Edelmetallbleche	76
<b>BENNETT</b> , Raspatorien	55
<b>BISHOP</b> , Lippen- und Wangenhalter	11
<b>BONNEY</b> , Chirurgische Pinzetten	33
<b>BRUENINGS</b> , Zungen Spatel	10
<b>BUCHWALD</b> , Zungen Spatel	10

**C**

<b>CAPLAN</b> , Knochenchirurgie	71
<b>CASTROVIEJO</b> , Nadelhalter	36
- Meßinstrumente	3, 4
<b>CAWOOD-MINNESOTA</b> , Lippen- und Wangenhalter	11
<b>CHOMPRET</b> , Raspatorien	55
<b>CINELLI</b> , Chirurgische Scheren	22
<b>COLLIN</b> , Nasen Spekula	18
<b>COLUMBIA</b> , Lippen- und Wangenhalter	12
<b>CONVERSE</b> , Nadelhalter	34
<b>COTTLE</b> , Feine Wundhaken	40
- Elevatorien	49
- Chirurgische Scheren	30
- Hämmer	67
- Osteotome	67
- Raspatorien	49
- Nasen Raspeln	59
<b>COTTLE-KAZANJIAN</b> , Knochensplitterzangen	70
<b>COTTLE-KNAPP</b> , Chirurgische Scheren	23
<b>CRILE-WOOD</b> , Nadelhalter	34
<b>CUSHING</b> , Chirurgische Pinzetten	33

**D**

<b>DANDY</b> , Arterienklemmen	37
<b>DAUTREY-MUNRO</b> , Osteotome	66
<b>DAVIS-BOYLE</b> , Mundsperrerr	16
<b>DE BAKEY</b> , Nadelhalter	35
<b>DE MARTEL</b> , Arterienklemmen	38
<b>DERF</b> , Nadelhalter	35
<b>DINGMAN</b> , Unterkieferahlen	72
- Elevatorien	50
<b>DINGMANN</b> , Mundsperrerr	15
- Knochenchirurgie	71
<b>DOCKHORN</b> , Lippen- und Wangenhalter	42
<b>DUNN-DAUTREY</b> , Wundhaken	21

**F**

<b>FOMON</b> , Chirurgische Scheren	22, 30
- Nasenraspeln	58

**G**

<b>GEMINI</b> , Arterienklemmen	38
<b>GILLIES</b> , Feine Wundhaken	39
- Elevatorien	50
<b>GOLDMAN-FOX</b> , Chirurgische Scheren	24, 26

<b>GOLDMANN</b> , Elevatorien	50
<b>GORNEY</b> , Chirurgische Scheren	24
<b>GUTHRIE</b> , Feine Wundhaken	39

**H**

<b>HALSEY</b> , Nadelhalter	34
<b>HALSTED-MOSQUITO</b> , Arterienklemmen	37
<b>HARGIS</b> , Wundhaken	51
<b>HARTMANN</b> , Zungendrucker	10
- Nasen Spekula	19
<b>HEGAR</b> , Nadelhalter	35
<b>HEISTER</b> , Mundsperrerr	13
<b>HEYMANN</b> , Chirurgische Scheren	30
<b>HOUSE</b> , Absaugkanülen	79
<b>HUMBY</b> , Dermatome	9

**I**

<b>IRIS</b> , Chirurgische Scheren	22, 26
------------------------------------	--------

**J**

<b>JACKSON-TESSIER</b> , Knochensplitterzangen	70
<b>JAMESON</b> , Chirurgische Scheren	24
<b>JOSEPH</b> , Feine Wundhaken	40
- Chirurgische Scheren	23

**K**

<b>KAHN</b> , Chirurgische Scheren	24
<b>KAYE</b> , Chirurgische Scheren	23
<b>KELLY</b> , Chirurgische Scheren	23, 26
<b>KEYES</b> , Dermatome	9
<b>KILLIAN</b> , Knochensplitterzangen	70
- Nasen Spekula	19
<b>KILNER</b> , Feine Wundhaken	40
- Chirurgische Scheren	22, 26
<b>KILNER-DOUGHTY</b> , Mundsperrerr	17
<b>KOCHER-LANGENBECK</b> , Wundhaken	43
<b>KROENIG</b> , Zungenspatel	10

**L**

<b>LAMBOTTE</b> , Osteotome	62
<b>LEWIS</b> , Nasen Raspeln	59
<b>LEXER</b> , Chirurgische Scheren	29
<b>LUCAE</b> , Hämmer	67
<b>LUNIATSCHEK</b> , Tamponstopfer	73

**M**

<b>MAGILL</b> , Diagnostik	20
<b>MALTZ</b> , Nasen Raspeln	58
<b>MASING</b> , Elevatorien	49
<b>MATY</b> , Lippen- und Wangrnhalter	12
<b>MAYO</b> , Chirurgische Scheren	27
- Präparierscheren	25
<b>MAYO-HEGAR</b> , Nadelhalter	35
<b>MAYO-LEXER</b> , Chirurgische Scheren	25
<b>MAYO-STILLE</b> , Chirurgische Scheren	29
<b>Mc INTOSH</b> , Diagnostik	20
<b>Mc IVOR</b> , Mundsperrerr	17
<b>Mc KENTY</b> , Raspatorien	49
<b>MERSHON</b> , Drahtpositionierer	73
<b>METZENBAUM</b> , Chirurgische Scheren	25, 27
<b>METZENBAUM-FINO</b> , Chirurgische Scheren	28
<b>MIDDELDORPF</b> , Lippen- und Wangenhalter	12

<b>MILLER-COLBURN</b> , Sinus Lift Küretten	56
<b>MINI-MALTZ</b> , Nasen Raspeln	58
<b>MINNESOTA</b> , Lippen- und Wangenhalter	11
<b>MISCH</b> , Ramus Retraktoren	44
<b>MITCHEL</b> , Raspatorien	55
<b>MOLT</b> , Mundsperrerr	13
- Raspatorien	55
<b>MOLT-DOYEN-COLLIN</b> , Mundsperrerr	13
<b>MOLT-DOYEN-JANSEN</b> , Mundsperrerr	13
<b>N</b>	
<b>NEIVERT-ANDERSON</b> , Osteotome	65
<b>O</b>	
<b>OBWEGESER</b> , Unterkieferahlen	72
- Wundhaken	43
- Wangenhalter	42
- Weichteilhaken	41
- Elevatorien	50
- Osteotome	62, 63, 64
- Raspatorien	52, 53
- Progenierinnen	44
<b>OBWEGESER-FREER</b> , Elevatorien	54
<b>P</b>	
<b>POTTS-SMITH</b> , Chirurgische Pinzetten	32
<b>R</b>	
<b>RAMUS RETRACTOR</b> , Wundhaken	43
<b>RAMUS</b> , Knochen-Spreizer	47
<b>REILL</b> , Repositionszangen	68
<b>ROCHESTER-PEAN</b> , Arterienklemmen	38
<b>ROSER KÖNIG</b> , Mundsperrerr	13
<b>ROTAN</b> , Absaugkanülen	78
<b>ROWE</b> , Repositionszangen	69
<b>S</b>	
<b>SALZBURG</b> , Raspatorien	56
<b>SCHINK</b> , Dermatome	8
<b>SELDIN</b> , Raspatorien	54
<b>SHEA</b> , Chirurgische Scheren	22
<b>SHURE</b> , Drahtinstrumente	73
<b>SIGMOID NOTCH</b> , Intraorale Retraktoren	45
<b>SILVER</b> , Dermatome	8
- Osteotome	65
<b>STERNBERG</b> , Lippen- und Wangenhalter	12
<b>T</b>	
<b>TESSIER</b> , Knochenchirurgie	71
- Wundhaken	51
- Beckenkamm Spatel	48
- Osteotome	60, 61
- Spreizzange	46
<b>TIECK-HALLE</b> , Nasen Spekula	18
<b>TOBOLD</b> , Zungendrücken	10
<b>W</b>	
<b>WALTER</b> , Osteotome	60
<b>WALTON</b> , Raspatorien	54
<b>WASSMUND</b> , Lippen- und Wangenhalter	42
<b>WEBSTER</b> , Nadelhalter	34

<b>WHITEHEAD-JENNINGS</b> , Mundsperrerr	15
<b>WIEDER</b> , Zungendrücken	10
<b>WIEN</b> , Nasen Spekula	18
<b>WILLIGER</b> , Raspatorien	55
<b>Y</b>	
<b>YOUNG</b> , Diagnostik	20
<b>Z</b>	
<b>ZIELINSKY</b> , Meßinstrumente	3



<b>A</b>			
<b>ADSON</b> , Tissue Forceps	31, 33		
<b>ADSON-BROWN</b> , Tissue Forceps	32, 33		
<b>ASCH</b> , Bone Surgery	71		
<b>AUFRICHT</b> , Nasal Retractor	40		
- Nasal Rasps	59		
<b>B</b>			
<b>BABBUSH</b> , Raspatories	54		
<b>BABY CRILE-WOOD</b> , Needle Holders	34		
<b>BEEBE</b> , Scissors for thin steel and precious metal sheets	76		
<b>BENNETT</b> , Raspatories	55		
<b>BISHOP</b> , Lip and Cheek Retractors	11		
<b>BONNEY</b> , Tissue Forceps	33		
<b>BRUENINGS</b> , Tongue Spatulas	10		
<b>BUCHWALD</b> , Tongue Spatulas	10		
<b>C</b>			
<b>CAPLAN</b> , Bone Surgery	71		
<b>CASTROVIEJO</b> , Needle Holders	36		
- Measuring Instruments	3, 4		
<b>CAWOOD-MINNESOTA</b> , Lip and Cheek Retractors	11		
<b>CHOMPRET</b> , Raspatories	55		
<b>CINELLI</b> , Operating scissors	22		
<b>COLLIN</b> , Nasal specula	18		
<b>COLUMBIA</b> , Lip and Cheek Retractors	12		
<b>CONVERSE</b> , Needle Holders	34		
<b>COTTLE</b> , Delicate Retractors	40		
- Elevators	49		
- Operating Scissors	30		
- Mallets	67		
- Osteotomes	67		
- Raspatories	49		
- Nasal Rasps	59		
<b>COTTLE-KAZANJIAN</b> , Bone cutting forceps	70		
<b>COTTLE-KNAPP</b> , Operating Scissors	23		
<b>CRILE-WOOD</b> , Needle Holders	34		
<b>CUSHING</b> , Tissue Forceps	33		
<b>D</b>			
<b>DANDY</b> , Hemostatic Forceps	37		
<b>DAUTREY-MUNRO</b> , Osteotomes	66		
<b>DAVIS-BOYLE</b> , Mouth Gags	16		
<b>DE BAKEY</b> , Needle Holders	35		
<b>DE MARTEL</b> , Hemostatic Forceps	38		
<b>DERF</b> , Needle Holders	35		
<b>DINGMAN</b> , Maxillary Awls	72		
- Elevators	50		
<b>DINGMANN</b> , Mouth Gags	15		
- Bone Surgery	71		
<b>DOCKHORN</b> , Cheek Retractors	42		
<b>DUNN-DAUTREY</b> , Retractors	21		
<b>F</b>			
<b>FOMON</b> , Operating Scissors	22, 30		
- Nasal Rasps	58		
<b>G</b>			
<b>GEMINI</b> , Hemostatic Forceps	38		
<b>GILLIES</b> , Delicate Retractors	39		
- Elevators	50		
<b>GOLDMAN-FOX</b> , Operating Scissors	24, 26		
<b>GOLDMANN</b> , Elevators	50		
<b>GORNEY</b> , Operating Scissors	24		
<b>GUTHRIE</b> , Delicate Retractors	39		
<b>H</b>			
<b>HALSEY</b> , Needle Holders	34		
<b>HALSTED-MOSQUITO</b> , Hemostatic Forceps	37		
<b>HARGIS</b> , Retractors	51		
<b>HARTMANN</b> , Tongue Depressors	10		
- Nasal Specula	19		
<b>HEGAR</b> , Needle Holders	35		
<b>HEISTER</b> , Mouth Gags	13		
<b>HEYMANN</b> , Operating Scissors	30		
<b>HOUSE</b> , Suction Tubes	79		
<b>HUMBY</b> , Dermatomes	9		
<b>I</b>			
<b>IRIS</b> , Operating Scissors	22, 26		
<b>J</b>			
<b>JACKSON-TESSIER</b> , Bone cutting Forceps	70		
<b>JAMESON</b> , Operating Scissors	24		
<b>JOSEPH</b> , Delicate Retractors	40		
- Operating Scissors	23		
<b>K</b>			
<b>KAHN</b> , Operating Scissors	24		
<b>KAYE</b> , Operating Scissors	23		
<b>KELLY</b> , Operating Scissors	23, 26		
<b>KEYES</b> , Dermatomes	9		
<b>KILLIAN</b> , Bone cutting Forceps	70		
- Nasal Specula	19		
<b>KILNER</b> , Delicate Retractors	40		
- Operating Scissors	22, 26		
<b>KILNER-DOUGHTY</b> , Mouth Gags	17		
<b>KOCHER-LANGENBECK</b> , Retractors	43		
<b>KROENIG</b> , Tongue Spatulas	10		
<b>L</b>			
<b>LAMBOTTE</b> , Osteotomes	62		
<b>LEWIS</b> , Nasal Rasps	59		
<b>LEXER</b> , Operating Scissors	29		
<b>LUCAE</b> , Mallets	67		
<b>LUNIATSCHEK</b> , Gauze Packer	73		
<b>M</b>			
<b>MAGILL</b> , Diagnostics	20		
<b>MALTZ</b> , Nasal Rasps	58		
<b>MASING</b> , Elevators	49		
<b>MATY</b> , Lip and Cheek Retractors	12		
<b>MAYO</b> , Operating Scissors	27		
- Dissecting Scissors	25		
<b>MAYO-HEGAR</b> , Needle Holders	35		
<b>MAYO-LEXER</b> , Operating Scissors	25		
<b>MAYO-STILLE</b> , Operating Scissors	29		
<b>Mc INTOSH</b> , Diagnostics	20		
<b>Mc IVOR</b> , Mouth Gags	17		
<b>Mc KENTY</b> , Raspatories	49		
<b>MERSHON</b> , Wire Pusher	73		
<b>METZENBAUM</b> , Operating Scissors	25, 27		
<b>METZENBAUM-FINO</b> , Operating Scissors	28		
<b>MIDDELDORPF</b> , Lip and Cheek Retractors	12		

<b>MILLER-COLBURN</b> , Sinus Lift Curettes	56
<b>MINI-MALTZ</b> , Nasal Rasps	58
<b>MINNESOTA</b> , Lip and Cheek Retractors	11
<b>MISCH</b> , Ramus Retractors	44
<b>MITCHEL</b> , Raspatories	55
<b>MOLT</b> , Mouth Gags	13
- Raspatories	55
<b>MOLT-DOYEN-COLLIN</b> , Mouth Gags	13
<b>MOLT-DOYEN-JANSEN</b> , Mouth Gags	13

## N

<b>NEIVERT-ANDERSON</b> , Osteotomes	65
--------------------------------------	----

## O

<b>OBWEGESER</b> , Maxillary Awls	72
- Retractors	43
- Cheek Retractors	42
- Soft Tissue Retractors	41
- Elevators	50
- Osteotomes	62, 63, 64
- Raspatories	52, 53
- Channel Retractors	44
<b>OBWEGESER-FREER</b> , Elevators	54

## P

<b>POTTS-SMITH</b> , Tissue Forceps	32
-------------------------------------	----

## R

<b>RAMUS RETRACTOR</b> , Retractors	43
<b>RAMUS</b> , Bone Separators	47
<b>REILL</b> , Reposition Forceps	68
<b>ROCHESTER-PEAN</b> , Hemostatic Forceps	38
<b>ROSER KÖNIG</b> , Mouth Gags	13
<b>ROTAN</b> , Suction Tubes	78
<b>ROWE</b> , Reposition Forceps	69

## S

<b>SALZBURG</b> , Raspatories	56
<b>SCHINK</b> , Dermatomes	8
<b>SELDIN</b> , Raspatories	54
<b>SHEA</b> , Operating Scissors	22
<b>SHURE</b> , Wire Instruments	73
<b>SIGMOID NOTCH</b> , Intraoral Retractors	45
<b>SILVER</b> , Dermatomes	8
- Osteotomes	65
<b>STERNBERG</b> , Lip and Cheek Retractors	12

## T

<b>TESSIER</b> , Bone Surgery	71
- Retractors	51
- Iliac Crest Retractors	48
- Osteotomes	60, 61
- Spreading Forceps	46
<b>TIECK-HALLE</b> , Nasal Specula	18
<b>TOBOLD</b> , Tongue Depressors	10

## W

<b>WALTER</b> , Osteotomes	60
<b>WALTON</b> , Raspatories	54
<b>WASSMUND</b> , Cheek Retractors	42
<b>WEBSTER</b> , Needle Holders	34

<b>WHITEHEAD-JENNINGS</b> , Mouth Gags	15
<b>WIEDER</b> , Tongue Depressors	10
<b>WIEN</b> , Nasal Specula	18
<b>WILLIGER</b> , Raspatories	55

## Y

<b>YOUNG</b> , Diagnostics	20
----------------------------	----

## Z

<b>ZIELINSKY</b> , Measuring Instruments	3
--	---



**A**

<b>ADSON</b> , Pinzette chirurgiche	31, 33
<b>ADSON-BROWN</b> , Pinzette chirurgiche	32, 33
<b>ASCH</b> , Chirurgia ossea	71
<b>AUFRICHT</b> , Divaricatore nasale	40
- Raspe nasali	59

**B**

<b>BABBUSH</b> , Periostotomi	54
<b>BABY CRILE-WOOD</b> , Port'aghi	34
<b>BEEBE</b> , Forbici per lamine e fili d'acciaio	76
<b>BENNETT</b> , Periostotomi	55
<b>BISHOP</b> , Divaricatore di labbra e guance	11
<b>BONNEY</b> , Pinzette chirurgiche	33
<b>BRUENINGS</b> , Spatole per lingua	10
<b>BUCHWALD</b> , Spatole per lingua	10

**C**

<b>CAPLAN</b> , Chirurgia ossea	71
<b>CASTROVIEJO</b> , Port'aghi	36
- Strumenti per misura	3, 4
<b>CAWOOD-MINNESOTA</b> , Divaricatore di labbra e guance	11
<b>CHOMPRET</b> , Periostotomi	55
<b>CINELLI</b> , Forbici chirurgiche	22
<b>COLLIN</b> , Speculum nasali	18
<b>COLUMBIA</b> , Divaricatore di labbra e guance	12
<b>CONVERSE</b> , Port'aghi	34
<b>COTTLE</b> , Divaricatori delicati	40
- Elevatori	49
- Forbici chirurgiche	30
- Martelli chirurgici	67
- Osteotomi	67
- Periostotomi	49
- Raspe nasali	59
<b>COTTLE-KAZANJIAN</b> , Pinze per ossa	70
<b>COTTLE-KNAPP</b> , Forbici chirurgiche	23
<b>CRILE-WOOD</b> , Port'aghi	34
<b>CUSHING</b> , Pinzette chirurgiche	33

**D**

<b>DANDY</b> , Pinze emostatiche	37
<b>DAUTREY-MUNRO</b> , Osteotomi	66
<b>DAVIS-BOYLE</b> , Apribocca	16
<b>DE BAKEY</b> , Port'aghi	35
<b>DE MARTEL</b> , Pinze emostatiche	38
<b>DERF</b> , Port'aghi	35
<b>DINGMAN</b> , Aghi mandibolari	72
- Elevatori	50
<b>DINGMANN</b> , Apribocca	15
- Chirurgia ossea	71
<b>DOCKHORN</b> , Divaricatore per guance	42
<b>DUNN-DAUTREY</b> , Divaricatori	21

**F**

<b>FOMON</b> , Forbici chirurgiche	22, 30
- Raspe nasali	58

**G**

<b>GEMINI</b> , Pinze emostatiche	38
<b>GILLIES</b> , Divaricatori delicati	39
- Elevatori	50
<b>GOLDMAN-FOX</b> , Forbici chirurgiche	24, 26

<b>GOLDMANN</b> , Elevatori	50
<b>GORNEY</b> , Forbici chirurgiche	24
<b>GUTHRIE</b> , Divaricatori delicati	39

**H**

<b>HALSEY</b> , Port'aghi	34
<b>HALSTED-MOSQUITO</b> , Pinze emostatiche	37
<b>HARGIS</b> , Divaricatori	51
<b>HARTMANN</b> , Abbassalingua	10
- Speculum nasali	19
<b>HEGAR</b> , Port'aghi	35
<b>HEISTER</b> , Apribocca	13
<b>HEYMANN</b> , Forbici chirurgiche	30
<b>HOUSE</b> , Cannule d'aspirazione	79
<b>HUMBY</b> , Dermatomi	9

**I**

<b>IRIS</b> , Forbici chirurgiche	22, 26
-----------------------------------	--------

**J**

<b>JACKSON-TESSIER</b> , Pinze per ossa	70
<b>JAMESON</b> , Forbici chirurgiche	24
<b>JOSEPH</b> , Divaricatori delicati	40
- Forbici chirurgiche	23

**K**

<b>KAHN</b> , Forbici chirurgiche	24
<b>KAYE</b> , Forbici chirurgiche	23
<b>KELLY</b> , Forbici chirurgiche	23, 26
<b>KEYES</b> , Dermatomi	9
<b>KILLIAN</b> , Pinze per ossa	70
- Speculum nasali	19
<b>KILNER</b> , Divaricatori delicati	40
- Forbici chirurgiche	22, 26
<b>KILNER-DOUGHTY</b> , Apribocca	17
<b>KOCHER-LANGENBECK</b> , Divaricatore	43
<b>KROENIG</b> , Spatole per lingua	10

**L**

<b>LAMBOTTE</b> , Osteotomi	62
<b>LEWIS</b> , Raspe nasali	59
<b>LEXER</b> , Forbici chirurgiche	29
<b>LUCAE</b> , Martelli chirurgici	67
<b>LUNIATSCHEK</b> , Porta tamponi	73

**M**

<b>MAGILL</b> , Diagnostica	20
<b>MALTZ</b> , Raspe nasali	58
<b>MASING</b> , Elevatori	49
<b>MATY</b> , Divaricatore di labbra e guance	12
<b>MAYO</b> , Forbici chirurgiche	27
- Forbici per dissezione	25
<b>MAYO-HEGAR</b> , Port'aghi	35
<b>MAYO-LEXER</b> , Forbici chirurgiche	25
<b>MAYO-STILLE</b> , Forbici chirurgiche	29
<b>Mc INTOSH</b> , Diagnostica	20
<b>Mc IVOR</b> , Apribocca	17
<b>Mc KENTY</b> , Periostotomi	49
<b>MERSHON</b> , Posizionatore per filo	73
<b>METZENBAUM</b> , Forbici chirurgiche	25, 27
<b>METZENBAUM-FINO</b> , Forbici chirurgiche	28
<b>MIDDELDORPF</b> , Divaricatore di labbra e guance	12

<b>MILLER-COLBURN</b> , Curette per Sinus Lift	56
<b>MINI-MALTZ</b> , Raspe nasali	58
<b>MINNESOTA</b> , Divaricatore di labbra e guance	11
<b>MISCH</b> , Retrattori Ramus	44
<b>MITCHEL</b> , Periostotomi	55
<b>MOLT</b> , Apribocca	13
- Periostotomi	55
<b>MOLT-DOYEN-COLLIN</b> , Apribocca	13
<b>MOLT-DOYEN-JANSEN</b> , Apribocca	13
<b>N</b>	
<b>NEIVERT-ANDERSON</b> , Osteotomi	65
<b>O</b>	
<b>OBWEGESER</b> , Aghi mandibolari	72
- Divaricatore	43
- Divaricatore per guance	42
- Divaricatore per tessuti molli	41
- Elevatori	50
- Osteotomi	62, 63, 64
- Periostotomi	52, 53
- Separatori mandibolari	44
<b>OBWEGESER-FREER</b> , Elevatori	54
<b>P</b>	
<b>POTTS-SMITH</b> , Pinzette chirurgiche	32
<b>R</b>	
<b>RAMUS RETRACTOR</b> , Divaricatore	43
<b>RAMUS</b> , Separatore osseo	47
<b>REILL</b> , Pinze per riposizione	68
<b>ROCHESTER-PEAN</b> , Pinze emostatiche	38
<b>ROSER KÖNIG</b> , Apribocca	13
<b>ROTAN</b> , Cannule d'aspirazione	78
<b>ROWE</b> , Pinze per riposizione	69
<b>S</b>	
<b>SALZBURG</b> , Periostotomi	56
<b>SCHINK</b> , Dermatomi	8
<b>SELDIN</b> , Periostotomi	54
<b>SHEA</b> , Forbici chirurgiche	22
<b>SHURE</b> , Strumenti per fili d'acciaio	73
<b>SIGMOID NOTCH</b> , Separatori intraorali	45
<b>SILVER</b> , Dermatomi	8
- Osteotomi	65
<b>STERNBERG</b> , Divaricatore di labbra e guance	12
<b>T</b>	
<b>TESSIER</b> , Chirurgia ossea	71
- Divaricatori	51
- Divaricatori per cresta iliaca	48
- Osteotomi	60, 61
- Pinze per divaricare	46
<b>TIECK-HALLE</b> , Speculum nasali	18
<b>TOBOLD</b> , Abbassalingua	10
<b>W</b>	
<b>WALTER</b> , Osteotomi	60
<b>WALTON</b> , Periostotomi	54
<b>WASSMUND</b> , Divaricatore per guance	42
<b>WEBSTER</b> , Port'aghi	34

<b>WHITEHEAD-JENNINGS</b> , Apribocca	15
<b>WIEDER</b> , Abbassalingua	10
<b>WIEN</b> , Speculum nasali	18
<b>WILLIGER</b> , Periostotomi	55
<b>Y</b>	
<b>YOUNG</b> , Diagnostica	20
<b>Z</b>	
<b>ZIELINSKY</b> , Strumenti per misura	3



<b>A</b>			
<b>ADSON</b> , Pinzas quirúrgicas	31, 33		
<b>ADSON-BROWN</b> , Pinzas quirúrgicas	32, 33		
<b>ASCH</b> , Pinzas para huesos	71		
<b>AUFRICHT</b> , Separadores nasales	40		
- Raspadores nasales	59		
<b>B</b>			
<b>BABBUSH</b> , Legras	54		
<b>BABY CRILE-WOOD</b> , Portaagujas	34		
<b>BEEBE</b> , Tijeras para láminas y alambre de acero	76		
<b>BENNETT</b> , Legras	55		
<b>BISHOP</b> , Separadores de labios y mejillas	11		
<b>BONNEY</b> , Pinzas quirúrgicas	33		
<b>BRUENINGS</b> , Espátulas bucales	10		
<b>BUCHWALD</b> , Espátulas bucales	10		
<b>C</b>			
<b>CAPLAN</b> , Pinzas para huesos	71		
<b>CASTROVIEJO</b> , Portaagujas	36		
- Instrumentos para medir	3, 4		
<b>CAWOOD-MINNESOTA</b> , Separadores de labios y mejillas	11		
<b>CHOMPRET</b> , Legras	55		
<b>CINELLI</b> , Tijeras para cirugía general	22		
<b>COLLIN</b> , Espéculos nasales	18		
<b>COLUMBIA</b> , Separadores de labios y mejillas	12		
<b>CONVERSE</b> , Portaagujas	34		
<b>COTTLE</b> , Separadores finos	40		
- Elevador	49		
- Tijeras para cirugía general	30		
- Martillos	67		
- Osteótomos	67		
- Legras	49		
- Raspadores nasales	59		
<b>COTTLE-KAZANJIAN</b> , Pinzas para huesos	70		
<b>COTTLE-KNAPP</b> , Tijeras para cirugía general	23		
<b>CRILE-WOOD</b> , Portaagujas	34		
<b>CUSHING</b> , Pinzas quirúrgicas	33		
<b>D</b>			
<b>DANDY</b> , Pinzas hemostáticas	37		
<b>DAUTREY-MUNRO</b> , Osteótomos	66		
<b>DAVIS-BOYLE</b> , Abre bocas	16		
<b>DE BAKEY</b> , Portaagujas	35		
<b>DE MARTEL</b> , Pinzas hemostáticas	38		
<b>DERF</b> , Portaagujas	35		
<b>DINGMAN</b> , Leznas maxilares	72		
- Elevador	50		
<b>DINGMANN</b> , Abre bocas	15		
- Pinzas para huesos	71		
<b>DOCKHORN</b> , Separadores de mejillas	42		
<b>DUNN-DAUTREY</b> , Separadores	21		
<b>F</b>			
<b>FOMON</b> , Tijeras para cirugía general	22, 30		
- Raspadores nasales	58		
<b>G</b>			
<b>GEMINI</b> , Pinzas hemostáticas	38		
<b>GILLIES</b> , Separadores finos	39		
- Elevador	50		
<b>GOLDMAN-FOX</b> , Tijeras para cirugía general	24, 26		
<b>GOLDMANN</b> , Elevador	50		
<b>GORNEY</b> , Tijeras para cirugía general	24		
<b>GUTHRIE</b> , Separadores finos	39		
<b>H</b>			
<b>HALSEY</b> , Portaagujas	34		
<b>HALSTED-MOSQUITO</b> , Pinzas hemostáticas	37		
<b>HARGIS</b> , Separadores	51		
<b>HARTMANN</b> , Bajalengua	10		
- Espéculos nasales	19		
<b>HEGAR</b> , Portaagujas	35		
<b>HEISTER</b> , Abre bocas	13		
<b>HEYMANN</b> , Tijeras para cirugía general	30		
<b>HOUSE</b> , Cánulas aspiradoras	79		
<b>HUMBY</b> , Dermátomos	9		
<b>I</b>			
<b>IRIS</b> , Tijeras para cirugía general	22, 26		
<b>J</b>			
<b>JACKSON-TESSIER</b> , Pinzas para huesos	70		
<b>JAMESON</b> , Tijeras para cirugía general	24		
<b>JOSEPH</b> , Separadores finos	40		
- Tijeras para cirugía general	23		
<b>K</b>			
<b>KAHN</b> , Tijeras para cirugía general	24		
<b>KAYE</b> , Tijeras para cirugía general	23		
<b>KELLY</b> , Tijeras para cirugía general	23, 26		
<b>KEYES</b> , Dermátomos	9		
<b>KILLIAN</b> , Pinzas para huesos	70		
- Espéculos nasales	19		
<b>KILNER</b> , Separadores finos	40		
- Tijeras para cirugía general	22, 26		
<b>KILNER-DOUGHTY</b> , Abre bocas	17		
<b>KOCHER-LANGENBECK</b> , Separadores	43		
<b>KROENIG</b> , Espátulas bucales	10		
<b>L</b>			
<b>LAMBOTTE</b> , Osteótomos	62		
<b>LEWIS</b> , Raspadores nasales	59		
<b>LEXER</b> , Tijeras para cirugía general	29		
<b>LUCAE</b> , Martillos	67		
<b>LUNIATSCHEK</b> , Tamponador	73		
<b>M</b>			
<b>MAGILL</b> , Diagnóstico	20		
<b>MALTZ</b> , Raspadores nasales	58		
<b>MASING</b> , Elevador	49		
<b>MATY</b> , Separadores de labios y mejillas	12		
<b>MAYO</b> , Tijeras para cirugía general	27		
- Tijeras para preparaciones	25		
<b>MAYO-HEGAR</b> , Portaagujas	35		
<b>MAYO-LEXER</b> , Tijeras para cirugía general	25		
<b>MAYO-STILLE</b> , Tijeras para cirugía general	29		
<b>Mc INTOSH</b> , Diagnóstico	20		
<b>Mc IVOR</b> , Abre bocas	17		
<b>Mc KENTY</b> , Legras	49		
<b>MERSHON</b> , Instrumentos para posicionar alambre	73		
<b>METZENBAUM</b> , Tijeras para cirugía general	25, 27		
<b>METZENBAUM-FINO</b> , Tijeras para cirugía general	28		
<b>MIDDELDORPF</b> , Separadores de labios y mejillas	12		

<b>MILLER-COLBURN</b> , Curetas para Sinus Lift	56
<b>MINI-MALTZ</b> , Raspadores nasales	58
<b>MINNESOTA</b> , Separadores de labios y mejillas	11
<b>MISCH</b> , Separadores Ramus	44
<b>MITCHEL</b> , Legras	55
<b>MOLT</b> , Abrebocas	13
- Legras	55
<b>MOLT-DOYEN-COLLIN</b> , Abrebocas	13
<b>MOLT-DOYEN-JANSEN</b> , Abrebocas	13
<b>N</b>	
<b>NEIVERT-ANDERSON</b> , Osteòtomos	65
<b>O</b>	
<b>OBWEGESER</b> , Leznas maxilares	72
- Separadores	43
- Separadores de mejillas	42
- Separadores para partes blandas	41
- Elevador	50
- Osteòtomos	62, 63, 64
- Legras	52, 53
- Separadores mandibulares	44
<b>OBWEGESER-FREER</b> , Elevador	54
<b>P</b>	
<b>POTTS-SMITH</b> , Pinzas quirùrgicas	32
<b>R</b>	
<b>RAMUS RETRACTOR</b> , Separadores	43
<b>RAMUS</b> , Separadores de hueso	47
<b>REILL</b> , Pinzas para reposicionar	68
<b>ROCHESTER-PEAN</b> , Pinzas hemostàticas	38
<b>ROSER KÖNIG</b> , Abrebocas	13
<b>ROTAN</b> , Cànulas aspiradoras	78
<b>ROWE</b> , Pinzas para reposicionar	69
<b>S</b>	
<b>SALZBURG</b> , Legras	56
<b>SCHINK</b> , Dermàtomos	8
<b>SELDIN</b> , Legras	54
<b>SHEA</b> , Tijeras para cirugia general	22
<b>SHURE</b> , Instrumentos para alambre	73
<b>SIGMOID NOTCH</b> , Separadores intra orales	45
<b>SILVER</b> , Dermàtomos	8
- Osteòtomos	65
<b>STERNBERG</b> , Separadores de labios y mejillas	12
<b>T</b>	
<b>TESSIER</b> , Pinzas para huesos	71
- Separadores	51
- Separadores para cresta iliaca	48
- Osteòtomos	60, 61
- Separadores	46
<b>TIECK-HALLE</b> , Espèculos nasales	18
<b>TOBOLD</b> , Bajalengua	10
<b>W</b>	
<b>WALTER</b> , Osteòtomos	60
<b>WALTON</b> , Legras	54
<b>WASSMUND</b> , Separadores de mejillas	42
<b>WEBSTER</b> , Portaagujas	34

<b>WHITEHEAD-JENNINGS</b> , Abrebocas	15
<b>WIEDER</b> , Bajalengua	10
<b>WIEN</b> , Espèculos nasales	18
<b>WILLIGER</b> , Legras	55
<b>Y</b>	
<b>YOUNG</b> , Diagnòstico	20
<b>Z</b>	
<b>ZIELINSKY</b> , Instrumentos para medir	3



<b>A</b>			
<b>ADSON</b> , Pincés chirurgicales	31, 33		
<b>ADSON-BROWN</b> , Pincés chirurgicales	32, 33		
<b>ASCH</b> , Chirurgie osseuse	71		
<b>AUFRICHT</b> , Ecarteurs nasaux	40		
- Râpes nasales	59		
<b>B</b>			
<b>BABBUSH</b> , Rugines	54		
<b>BABY CRILE-WOOD</b> , Porte aiguilles	34		
<b>BEEBE</b> , Ciseaux pour couper les feuilles de métaux	76		
<b>BENNETT</b> , Rugines	55		
<b>BISHOP</b> , Ecarteurs de lèvres et de joues	11		
<b>BONNEY</b> , Pincés chirurgicales	33		
<b>BRUENINGS</b> , Spatules à langue	10		
<b>BUCHWALD</b> , Spatules à langue	10		
<b>C</b>			
<b>CAPLAN</b> , Chirurgie osseuse	71		
<b>CASTROVIEJO</b> , Porte aiguilles	36		
- Instruments à mesurer	3, 4		
<b>CAWOOD-MINNESOTA</b> , Ecarteurs de lèvres et de joues	11		
<b>CHOMPRET</b> , Rugines	55		
<b>CINELLI</b> , Ciseaux chirurgicaux	22		
<b>COLLIN</b> , Spéculums nasaux	18		
<b>COLUMBIA</b> , Ecarteurs de lèvres et de joues	12		
<b>CONVERSE</b> , Porte aiguilles	34		
<b>COTTLE</b> , Ecarteurs fins	40		
- Elévateur	49		
- Ciseaux chirurgicaux	30		
- Maillets	67		
- Ostéotomes	67		
- Rugines	49		
- Râpes nasales	59		
<b>COTTLE-KAZANJIAN</b> , Pincés coupantes à os	70		
<b>COTTLE-KNAPP</b> , Ciseaux chirurgicaux	23		
<b>CRILE-WOOD</b> , Porte aiguilles	34		
<b>CUSHING</b> , Pincés chirurgicales	33		
<b>D</b>			
<b>DANDY</b> , Pincés hémostatiques	37		
<b>DAUTREY-MUNRO</b> , Ostéotomes	66		
<b>DAVIS-BOYLE</b> , Ouvre-bouche	16		
<b>DE BAKEY</b> , Porte aiguilles	35		
<b>DE MARTEL</b> , Pincés hémostatiques	38		
<b>DERF</b> , Porte aiguilles	35		
<b>DINGMAN</b> , Alénes maxillaires	72		
- Elévateur	50		
<b>DINGMANN</b> , Ouvre-bouche	15		
- Chirurgie osseuse	71		
<b>DOCKHORN</b> , Ecarteurs de joues	42		
<b>DUNN-DAUTREY</b> , Ecarteurs	21		
<b>F</b>			
<b>FOMON</b> , Ciseaux chirurgicaux	22, 30		
- Râpes nasales	58		
<b>G</b>			
<b>GEMINI</b> , Pincés hémostatiques	38		
<b>GILLIES</b> , Ecarteurs fins	39		
- Elévateur	50		
<b>GOLDMAN-FOX</b> , Ciseaux chirurgicaux	24, 26		
<b>GOLDMANN</b> , Elévateur	50		
<b>GORNEY</b> , Ciseaux chirurgicaux	24		
<b>GUTHRIE</b> , Ecarteurs fins	39		
<b>H</b>			
<b>HALSEY</b> , Porte aiguilles	34		
<b>HALSTED-MOSQUITO</b> , Pincés hémostatiques	37		
<b>HARGIS</b> , Ecarteurs	51		
<b>HARTMANN</b> , Abaisse-langues	10		
- Spéculums nasaux	19		
<b>HEGAR</b> , Porte aiguilles	35		
<b>HEISTER</b> , Ouvre-bouche	13		
<b>HEYMANN</b> , Ciseaux chirurgicaux	30		
<b>HOUSE</b> , Canules aspiratrices	79		
<b>HUMBY</b> , Dermatomes	9		
<b>I</b>			
<b>IRIS</b> , Ciseaux chirurgicaux	22, 26		
<b>J</b>			
<b>JACKSON-TESSIER</b> , Pincés coupantes à os	70		
<b>JAMESON</b> , Ciseaux chirurgicaux	24		
<b>JOSEPH</b> , Ecarteurs fins	40		
- Ciseaux chirurgicaux	23		
<b>K</b>			
<b>KAHN</b> , Ciseaux chirurgicaux	24		
<b>KAYE</b> , Ciseaux chirurgicaux	23		
<b>KELLY</b> , Ciseaux chirurgicaux	23, 26		
<b>KEYES</b> , Dermatomes	9		
<b>KILLIAN</b> , Pincés coupantes à os	70		
- Spéculums nasaux	19		
<b>KILNER</b> , Ecarteurs fins	40		
- Ciseaux chirurgicaux	22, 26		
<b>KILNER-DOUGHTY</b> , Ouvre-bouche	17		
<b>KOCHER-LANGENBECK</b> , Ecarteurs	43		
<b>KROENIG</b> , Spatules à langue	10		
<b>L</b>			
<b>LAMBOTTE</b> , Ostéotomes	62		
<b>LEWIS</b> , Râpes nasales	59		
<b>LEXER</b> , Ciseaux chirurgicaux	29		
<b>LUCAE</b> , Maillets	67		
<b>LUNIATSCHEK</b> , Porte-tampons	73		
<b>M</b>			
<b>MAGILL</b> , Diagnostic	20		
<b>MALTZ</b> , Râpes nasales	58		
<b>MASING</b> , Elévateur	49		
<b>MATY</b> , Ecarteurs de lèvres et de joues	12		
<b>MAYO</b> , Ciseaux chirurgicaux	27		
- Ciseaux à dissection	25		
<b>MAYO-HEGAR</b> , Porte aiguilles	35		
<b>MAYO-LEXER</b> , Ciseaux chirurgicaux	25		
<b>MAYO-STILLE</b> , Ciseaux chirurgicaux	29		
<b>Mc INTOSH</b> , Diagnostic	20		
<b>Mc IVOR</b> , Ouvre-bouche	17		
<b>Mc KENTY</b> , Rugines	49		
<b>MERSHON</b> , Positionneur à fil	73		
<b>METZENBAUM</b> , Ciseaux chirurgicaux	25, 27		
<b>METZENBAUM-FINO</b> , Ciseaux chirurgicaux	28		
<b>MIDDELDORPF</b> , Ecarteurs de lèvres et de joues	12		

<b>MILLER-COLBURN</b> , Curettes pour Sinus Lift	56
<b>MINI-MALTZ</b> , Râpes nasales	58
<b>MINNESOTA</b> , Ecarteurs de lèvres et de joues	11
<b>MISCH</b> , Ecarteurs Ramus	44
<b>MITCHEL</b> , Rugines	55
<b>MOLT</b> , Ouvre-bouche	13
- Rugines	55
<b>MOLT-DOYEN-COLLIN</b> , Ouvre-bouche	13
<b>MOLT-DOYEN-JANSEN</b> , Ouvre-bouche	13
<b>N</b>	
<b>NEIVERT-ANDERSON</b> , Ostéotomes	65
<b>O</b>	
<b>OBWEGESER</b> , Alénes maxillaires	72
- Ecarteurs	43
- Ecarteurs de joues	42
- Ecarteurs pour parties molles	41
- Elévateur	50
- Ostéotomes	62, 63, 64
- Rugines	52, 53
- Ecarteurs mandibulaires	44
<b>OBWEGESER-FREER</b> , Elévateur	54
<b>P</b>	
<b>POTTS-SMITH</b> , Pinces chirurgicales	32
<b>R</b>	
<b>RAMUS RETRACTOR</b> , Ecarteurs	43
<b>RAMUS</b> , Ecarteurs à os	47
<b>REILL</b> , Pinces à réposition	68
<b>ROCHESTER-PEAN</b> , Pinces hémostatiques	38
<b>ROSER KÖNIG</b> , Ouvre-bouche	13
<b>ROTAN</b> , Canules aspiratrices	78
<b>ROWE</b> , Pinces à réposition	69
<b>S</b>	
<b>SALZBURG</b> , Rugines	56
<b>SCHINK</b> , Dermatomes	8
<b>SELDIN</b> , Rugines	54
<b>SHEA</b> , Ciseaux chirurgicaux	22
<b>SHURE</b> , Instruments pour les feuilles de métaux	73
<b>SIGMOID NOTCH</b> , Rétracteurs intra-oraux	45
<b>SILVER</b> , Dermatomes	8
- Ostéotomes	65
<b>STERNBERG</b> , Ecarteurs de lèvres et de joues	12
<b>T</b>	
<b>TESSIER</b> , Chirurgie osseuse	71
- Ecarteurs	51
- Rétracteur iliaque	48
- Ostéotomes	60, 61
- Pince à écarter	46
<b>TIECK-HALLE</b> , Spéculums nasaux	18
<b>TOBOLD</b> , Abaisse-langues	10
<b>W</b>	
<b>WALTER</b> , Ostéotomes	60
<b>WALTON</b> , Rugines	54
<b>WASSMUND</b> , Ecarteurs de joues	42
<b>WEBSTER</b> , Porte aiguilles	34

<b>WHITEHEAD-JENNINGS</b> , Ouvre-bouche	15
<b>WIEDER</b> , Abaisse-langues	10
<b>WIEN</b> , Spéculums nasaux	18
<b>WILLIGER</b> , Rugines	55
<b>Y</b>	
<b>YOUNG</b> , Diagnostic	20
<b>Z</b>	
<b>ZIELINSKY</b> , Instruments à mesurer	3









HBI-CBF	54	0219-CBD	40	0414-BAI	18	0415-BCA	76
HBI-CBG	54	0219-CBE	40	0414-BBA	64	0415-BCE	73
HBI-12L	56	0219-CBF	40	0414-BBB	49	0415-HCF	3
0101-18BAF	20	0219-CBG	40	0414-BBC	64	0513-12B	57
0101-18FAD	20	0219-CBH	40	0414-BBI	66	0513-12C	57
0119-BC	55	0219-CCA	48	0414-BBL	66	0513-12D	57
0202-EG	7	0219-CCB	48	0414-BCA	64	0513-12E	57
0202-EI	7	0219-CCC	48	0414-BCB	64	0513-12F	57
0204-DA	31	0219-CCD	48	0414-BCC	64	0513-12G	57
0204-DB	31	0219-CEF	40	0414-BCF	45	0513-12H	57
0204-HA	31	0219-CHD	40	0414-BCG	45	0602-BBL	38
0204-HB	31	0308-B	55	0414-BCI	50	0602-BCA	38
0204-HC	31	0308-C	55	0414-BDI	53	0604-CC	36
0204-HD	31	0308-D	55	0414-BDL	53	0604-CF	36
0204-LA	32	0308-E	55	0414-BEA	67	0604-CH	36
0204-LC	32	0320-1203B	56	0414-BEB	67	0604-CI	36
0204-LD	32	0405-BA	8	0414-BEC	44	0604-CL	36
0204-BEB	32	0405-BB	8	0414-BED	67	0604-BCI	36
0204-BHH	31	0405-BC	8	0414-BFA	67	0607-B	22
0204-BHI	31	0405-BD	8	0414-BFH	71	0607-B1903	26
0204-CCB	33	0405-BE	8	0414-BFI	67	0607-C	22
0204-CCC	33	0414-AI	10	0414-BGA	60	0607-C1903	26
0204-CCD	33	0414-AL	10	0414-BGB	60	0607-I	30
0204-CCE	33	0414-BA	69	0414-BGC	60	0607-CD	24
0204-CCG	33	0414-BB	69	0414-BGH	58	0607-CE	24
0204-CCH	33	0414-BC	69	0414-BHI	59	0607-EB	30
0204-CDA	33	0414-BD	69	0414-BHL	58	0607-ED	22
0204-CDB	33	0414-BE	69	0414-BIA	67	0607-LA	22
0204-CFA	33	0414-BF	69	0414-BIB	67	0607-LB	22
0204-CFB	33	0414-BI	62	0414-BIC	67	0607-LD	22
0204-CFC	33	0414-BL	48	0414-BID	67	0607-LF	22
0204-CFD	33	0414-BL	48	0414-BIE	67	0607-BBA	70
0204-CIH	32	0414-CI	50	0414-BIF	67	0607-BBB	70
0204-CII	32	0414-CL	48	0414-BIG	67	0607-BBC	23
0204-CIL	32	0414-CL	48	0414-BIH	62	0607-BBD	23
0204-CLA	32	0414-DA	72	0414-BII	62	0607-BCB	22
0204-CLB	32	0414-DB	72	0414-BLI	21	0607-BCE	24
0204-CLC	32	0414-DC	72	0414-BLL	21	0607-BCH	24
0219-BF	39	0414-DE	65	0414-CAD	66	0607-BEH	23
0219-BG	39	0414-DF	65	0414-CAF	66	0607-BEI	23
0219-GA	43	0414-DG	65	0414-CAG	66	0607-BGF	30
0219-GH	43	0414-EA	42	0414-CDG	55	0607-BGG	30
0219-GI	43	0414-EB	44	0414-CDH	55	0607-BIH	24
0219-GL	42	0414-EC	51	0414-CEA	56	0607-BLA	24
0219-IA	14	0414-ED	51	0414-CEB	56	0607-BLB	24
0219-IB	14	0414-EF	45	0414-CEH	47	0607-CBI	23
0219-IC	14	0414-EG	45	0414-CEI	47	0607-CBL	23
0219-LC	41	0414-EH	49	0414-CFH	66	0610-B	23
0219-LD	41	0414-EI	40	0414-CFI	66	0610-B1903	26
0219-LE	41	0414-FL	52	0414-CG	66	0610-C	23
0219-LF	41	0414-GA	49	0414-CGA	66	0610-C1903	26
0219-LG	41	0414-GD	52	0414-CGB	66	0611-AB	67
0219-BAA	41	0414-GF	52	0414-CGC	66	0611-BA12	67
0219-BDE	42	0414-GH	52	0414-CHG	65	0611-CL	62
0219-BDF	42	0414-GI	50	0414-CHH	65	0611-DE	62
0219-BDL	43	0414-GL	50	0414-CHI	65	0611-DG	62
0219-BFC	41	0414-HA	59	0414-CID	51	0611-EB	62
0219-BFD	41	0414-HB	59	0414-CIE	51	0611-EC	62
0219-BFE	41	0414-HC	58	0414-CII	50	0611-ED	62
0219-BFF	41	0414-HD	58	0414-CLB	50	0611-EE	62
0219-BFG	41	0414-HF	59	0414-CLC	54	0611-EF	62
0219-BFH	41	0414-HG	59	0414-CLD	54	0611-EG	62
0219-BFI	44	0414-HL	58	0414-CLE	54	0611-EH	62
0219-BFL	44	0414-IA	58	0414-CLF	54	0611-EI	62
0219-CAD	39	0414-IB	58	0414-CLG	54	0611-EL	62
0219-CAE	39	0414-IC	58	0414-DCD	72	0611-LE	62
0219-CAH	39	0414-ID	58	0414-DCE	72	0611-LF	62
0219-CAI	39	0414-IE	66	0415-AE	76	0611-LG	62
0219-CBA	40	0414-IF	66	0415-AI	76	0611-LH	62
0219-CBB	40	0414-LC	21	0415-AI1903	76	0611-LI	62
0219-CBC	40	0414-LF	21	0415-CH	76		
		0414-LG	21	0415-EL	77		
		0414-LH	21	0415-FA	73		
		0414-BAB	53	0415-LB	76		
		0414-BAC	53	0415-LC	76		
		0414-BAD	53	0415-BAB	76		

0611-LL	62	0614-GG	68	1123-BEB	74	1412-BFB	16
0611-BAE	67	0614-GI	68	1123-BFE	77	1412-BFC	16
0611-BEH	62	0614-LF	70	1201-02B	5	1412-BFD	
0611-BEI	62	0614-BDA	71	1201-02C	5	1412-BFE	
0611-BEL	62	0614-BDB	71	1201-02D	5	1412-BFF	
0611-BFA	9	0614-BDB18	71	1201-02D12	5	1412-BFG	
0611-BFB	9	0614-BDH	70	1201-02E	5	1412-BGA	
0611-BFC	9	0614-BED	71	1201-02H	5	1412-BGB	
0611-BFD	9	0614-BEE	71	1201-02H10	5	1412-BGC	
0611-BFF	9	0614-CEA	68			1412-BGD	
0611-BFG	9	0614-CEB	68	1412-AE	10	1412-BGE	
0611-BFH	9	0614-CEC	68	1412-AF	10	1412-BHA	
0611-BFI	9			1412-AG	10	1412-BHB	
0611-BFL	9	070603-1903	26	1412-AI	10	1412-BHC	
0611-DAH	61			1412-AL	12	1412-BHD	
0611-DAI	61	0706-CE	78	1412-BA	18	1412-BHE	
0611-DAL	61	0706-CF	78	1412-BC	20		
0611-DBA	61	0706-CH	78	1412-BD	20	1417-BC	
0611-DBB	61	0706-CI	78	1412-BE	20	1417-BE	
0611-DBC	61	0706-FD	79	1412-BG	10	1417-BH	
0611-DBD	61	0706-FF	79	1412-BI	10	1417-BL	
0611-DBE	61	0706-FG	79	1412-CA	19	1417-EA	
0611-DBF	61	0706-FH	79	1412-CB	19		
0611-DBG	61	0706-FI	79	1412-CC	19	15-BG	
0611-DDE	63	0706-FL	79	1412-CD	19	15-HG	
0611-DDF	63	0706-HE	78	1412-CE	19	15-LG	
0611-DDG	63			1412-CG	19	15-LH	
0611-DDH	63	1014-BC	49	1412-DA	18	15-BCC	
0611-EAB	60	1014-CA	54	1412-DB	19	15-BLC	
0611-EAC	60	1014-CC	54	1412-EA	13	15-BLD	
0611-EAD	60	1014-CD	54	1412-EA17	13	15-BLE	
0611-EAE	60	1014-EG	49	1412-EB	13	15-CBA	
0611-EAF	60	1014-FI	55	1412-EB17	13	15-CBF	
0611-EBB	60			1412-EC	13	15-CBG	
0611-EBC	60	1102-BA	6	1412-EE	20	15-CBH	
0611-EBD	60	1102-BB	6	1412-EF	20	15-DEB	
0611-EBE	60	1102-BC	6	1412-EI	18		
0611-EBF	60	1102-BC04	6	1412-EL	18	1506-G	
0611-EBG	60	1102-BD	6	1412-FA	12		
		1102-BF	6	1412-FC	12	1508-FE	
0612-B	25	1102-BF01	6	1412-FF	11	1508-FF	
0612-C	25	1102-BF03	6	1412-FG	18	1508-FG	
0612-D	25	1102-BI	6	1412-FH	18	1508-FI	
0612-E	25	1102-CA	6	1412-FL	18	1508-FL	
0612-CE	25	1102-CB	6	1412-GA	13	1508-GG	
0612-CF	25	1102-CC	6	1412-GB	11	1508-GI	
0612-GG	27	1102-CD	6	1412-GC	13	1508-GL	
0612-GH	27	1102-CE	6	1412-GG	11	1508-HB	
0612-GI	27	1102-CF	6	1412-GG02	11	1508-HD	
0612-GL	27	1102-DG	6	1412-GH	12	1508-HH	
0612-HL	25	1102-DGB	7	1412-HC	14	1508-BAL	
0612-LI	28	1102-DGC	7	1412-IA	11	1508-BBA	
0612-LL	28	1102-DGD	7	1412-IB	11	1508-BBB	
0612-BBI	26	1102-DGE	7	1412-IH	11	1508-BBC	
0612-BBL	26	1102-DGF	7	1412-II	11	1508-BBD	
0612-BDA	29	1102-DGG	7	1412-LA	12	1508-BBE	
0612-BDB	29	1102-DGH	7	1412-LH	12	1508-BCB	
0612-BDC	29	1102-DGI	7	1412-LI	11	1508-BCC	
0612-BDD	29	1102-DGL	7	1412-LL	11	1508-BCD	
0612-BDE	29			1412-BAA	11	1508-BCE	
0612-BDF	29	1110-BC	28	1412-BBA	15	1508-BCF	
0612-BDG	29			1412-BBC	15		
0612-BDH	29	1118-AI	3	1412-BBD	15	1811-B	
0612-BEB	27	1118-AL	3	1412-BBE	15	1811-C	
0612-BGB	27	1118-BFF	77	1412-BDG	15		
0612-BGD	27	1118-BFG	77	1412-BDH	15	2207-BC	
0612-CAB	28	1118-CBF	77	1412-BDI	15	2207-BE	
0612-CAC	28	1118-CBH	77	1412-BDL	15		
0612-CAD	28			1412-BEA	16		
0612-CAE	28	1123-II	75	1412-BEB	16		
0612-CAG	28	1123-IL	75	1412-BEC	16		
0612-CAI	28	1123-LI	75	1412-BED	16		
0612-DFA	26	1123-LL	75	1412-BEE	16		
		1123-BAC	74	1412-BEF	16		
0614-GD	70	1123-BAD	74	1412-BEG	16		
0614-GE	68	1123-BAF	74	1412-BFA	16		





Ideal-tek SA  
via Motta 4  
6828 Balerna  
Switzerland

Phone: +41 91 683 32 29  
Fax: +41 91 683 03 71  
E-mail: [info@ideal-tek.com](mailto:info@ideal-tek.com)