



Mikro Chirurgie

Micro Surgery

Mikro Chirurgie
Micro Chirurgie

Mikro Chirurgie
Micro Surgery
Micro Chirurgie

Micro Chirurgia



Mikro Chirurgie
Micro Surgery
Micro Chirurgia
Micro Cirugia
Micro Chirurgie

Mikro Scheren

Micro scissors

Micro forbici

Micro tijeras

Micro ciseaux

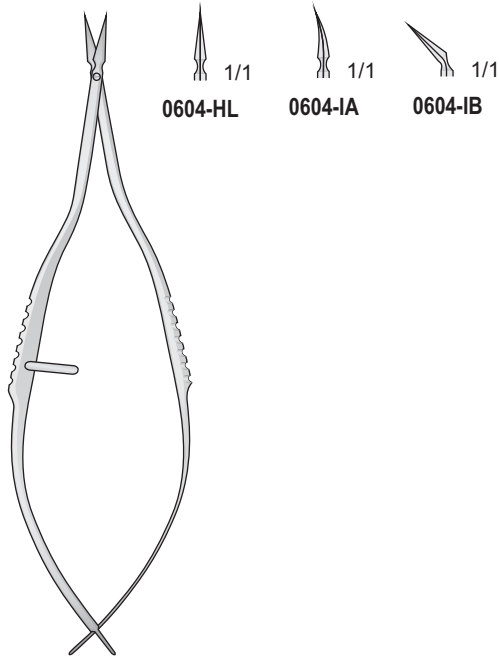

VANNAS
0604-HL/0604-IB
85 mm

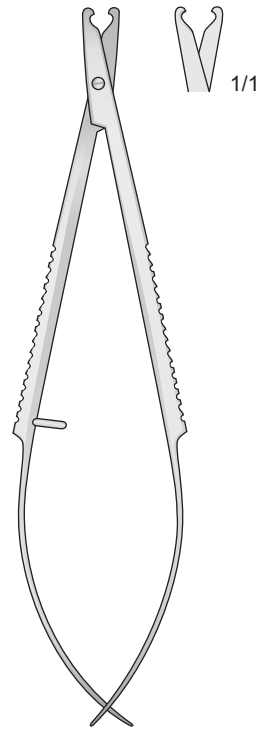

0604-GB
110 mm

Spitz - Sharp
Acuta - Agudas - Pointu

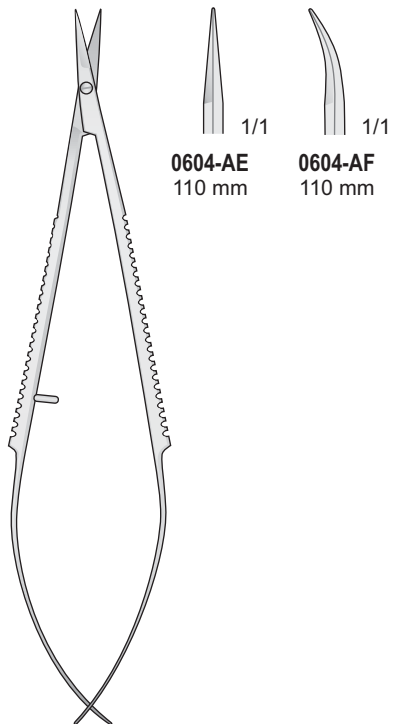

0604-AE/0604-AF
110 mm

Stumpf - Blunt
Smussa - Romas - Mousse

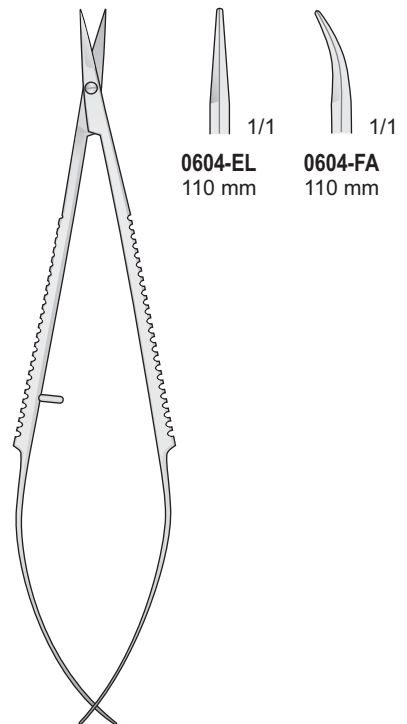

0604-FA
110 mm

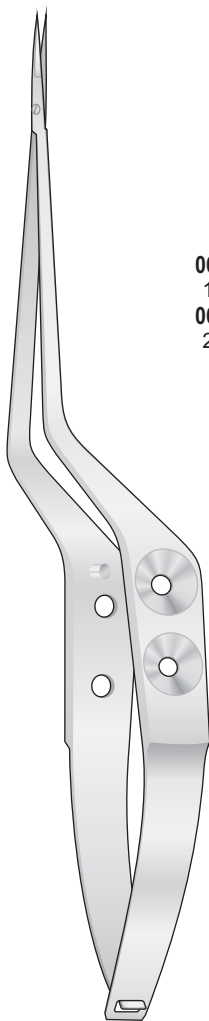

YASARGIL
0604-EAB/0604-EAH

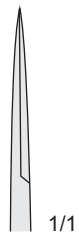

0604-EAB
165 mm
0604-EAD
200 mm

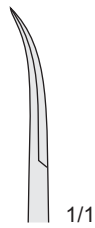

0604-EAC
165 mm
0604-EAE
200 mm

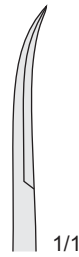

0604-EAF
200 mm

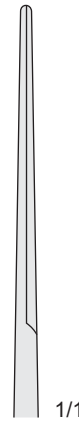

0604-EAG
200 mm

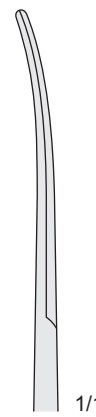

0604-EAH
200 mm

**Mikro-Federscheren
Bayonettförmig**

**Micro scissor
bayonet-shared**

**Micro forbici
a baionetta**

**Micro tijeras
Bajonet**

**Micro ciseaux
baionette**

Gezahnt
Serrated
Dentellata
Dentadas
Dentelés

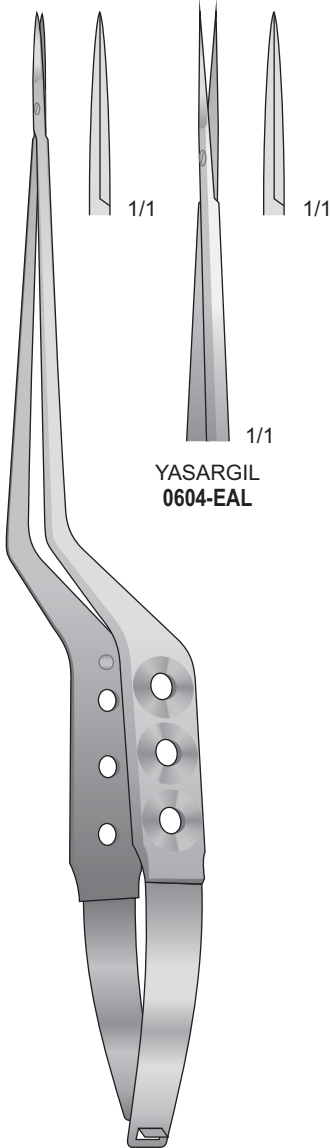

**YASARGIL
0604-EAL**

**YASARGIL
0604-EAI
225 mm**

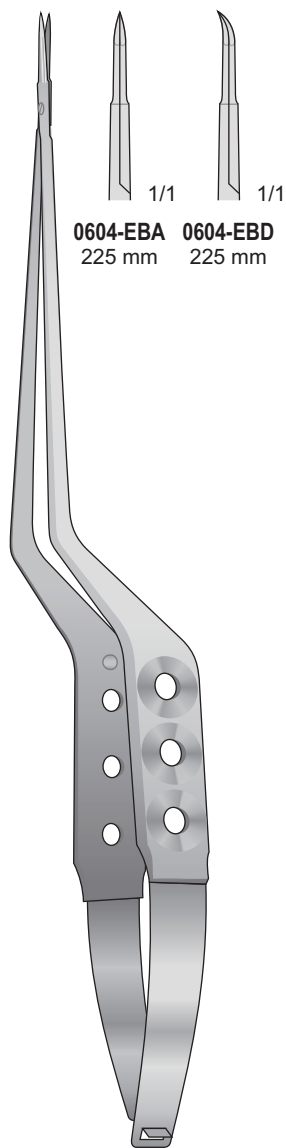

**VANNAS
0604-EBA/0604-EBD
225 mm**

**0604-EBA 0604-EBD
225 mm 225 mm**

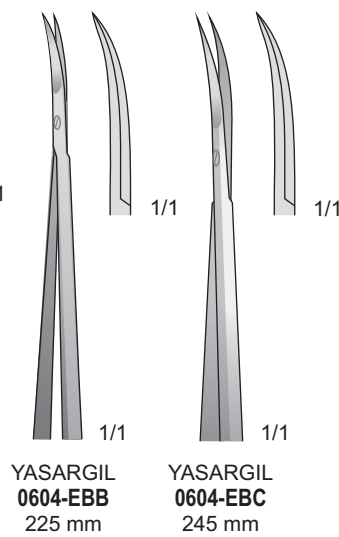

**YASARGIL
0604-EBB
225 mm**

**YASARGIL
0604-EBC
245 mm**

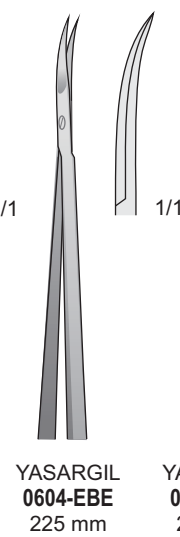

**YASARGIL
0604-EBE
225 mm**

**YASARGIL
0604-EBF
225 mm**

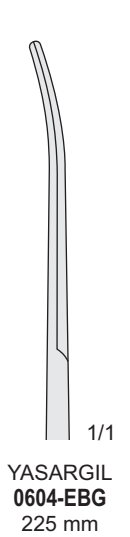

**YASARGIL
0604-EBG
225 mm**

Mikro Scheren

Micro scissors

Micro forbici

Micro tijeras

Micro ciseaux

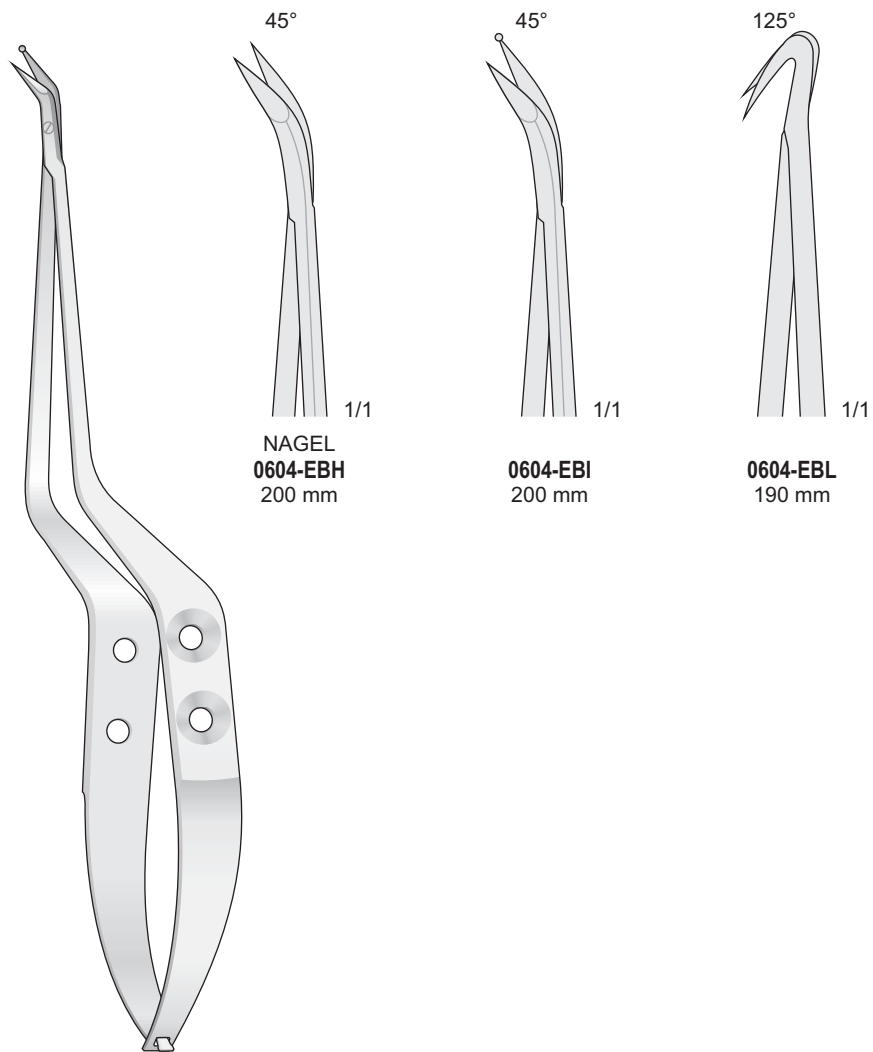

0604-EBH/0604-EBL

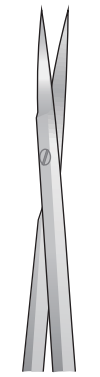
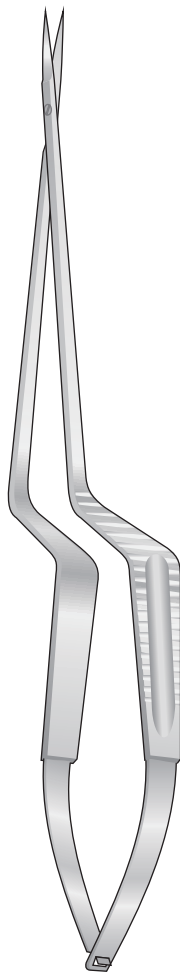

0604-DAG

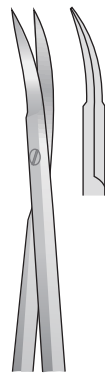

0604-DAH



0604-DBA

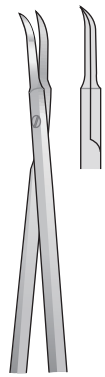

0604-DBB

0604-DAG/0604-DBB
190 mm

Mikro Scheren

Micro scissors

Micro forbici

Micro tijeras

Micro ciseaux

Spitz - Sharp
Acuta - Agudas - Pointu



0604-BDL 0604-BEA

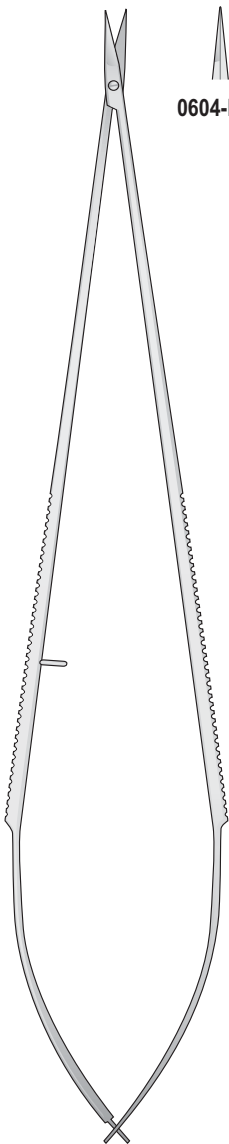

0604-BDL/0604-BEA
220 mm

Spitz - Sharp
Acuta - Agudas - Pointu



0604-BEB 0604-BEC

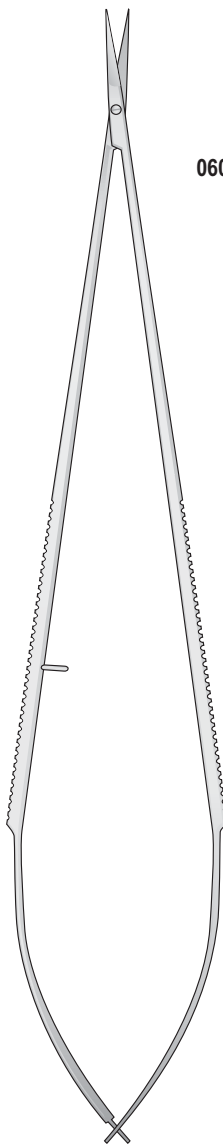

0604-BEB/0604-BEC
225 mm

Stumpf - Blunt
Smussa - Romas - Mousse



0604-BED 0604-BEE

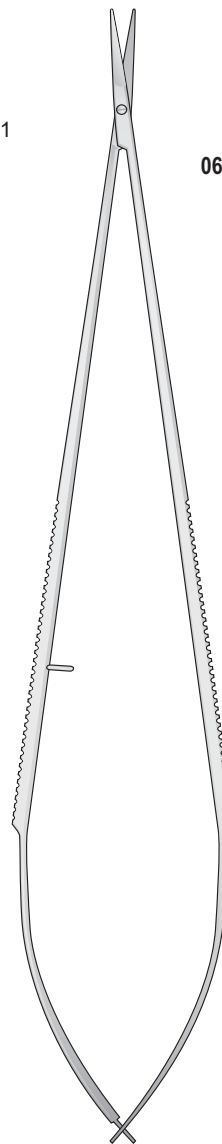

0604-BED/0604-BEE
225 mm

Stumpf - Blunt
Smussa - Romas - Mousse

Spitz - Sharp
Acuta - Agudas - Pointu

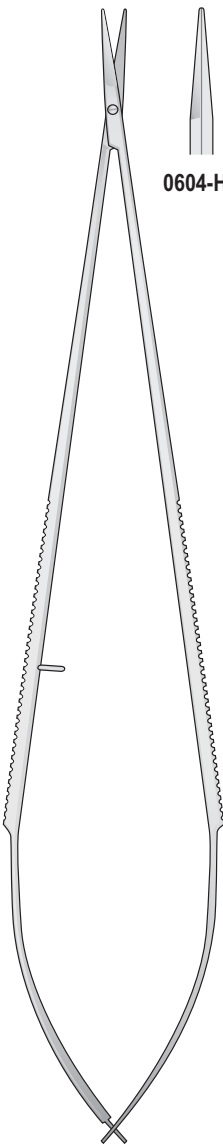

0604-HF/0604-HG
230 mm

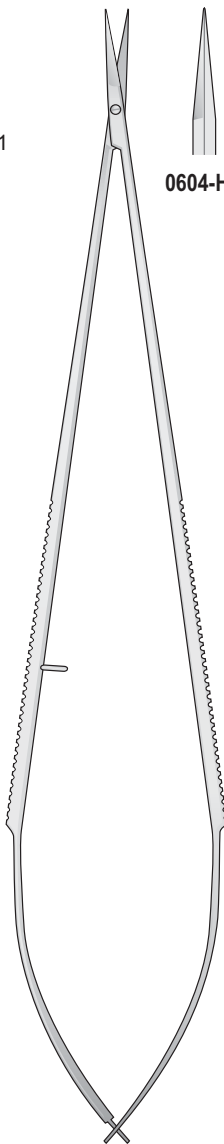
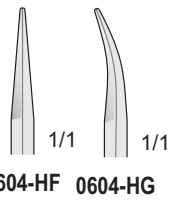

0604-HH/0604-HI
230 mm

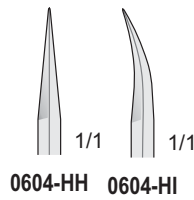

Stumpf
Blunt
Smussa

Schneiden gezahnt - Spitz
Serrated blades - Sharp
Lame zigrinate - Acuta

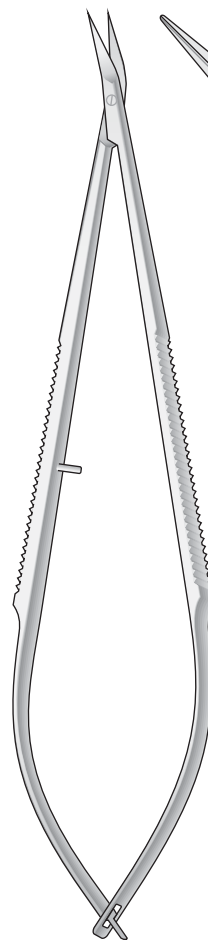

0604-BDD
160 mm

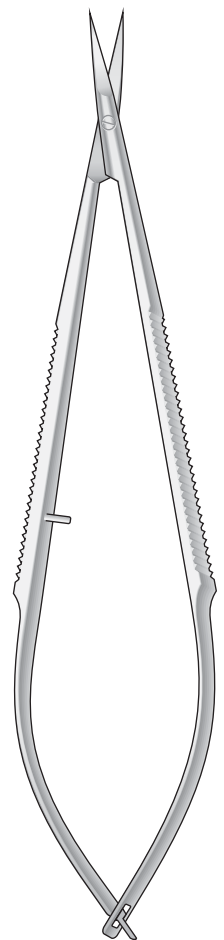
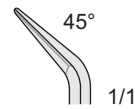

0604-BEF
160 mm

Mikro Scheren

Micro scissors

Micro forbici

Micro tijeras

Micro ciseaux

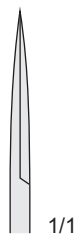
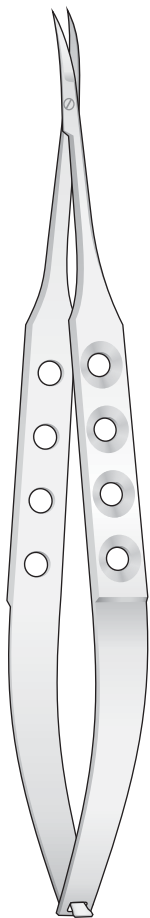

1/1

0604-EDA
120 mm
0604-EDC
160 mm
MILLES
0604-EDE
160 mm
YASARGIL
0604-EDG
185 mm

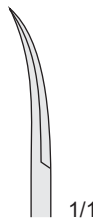

1/1

0604-EDB
120 mm
0604-EDD
160 mm
MILLES
0604-EDF
160 mm
JACOBSON
0604-EDH
185 mm

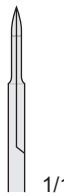

1/1

VANNAS
0604-EDI
120 mm
VANNAS
0604-EEB
160 mm

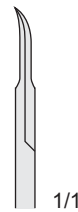

1/1

VANNAS
0604-EDL
120 mm
VANNAS
0604-EEC
160 mm

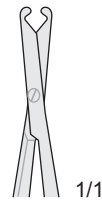

1/1

BIEMER
0604-EED
130 mm

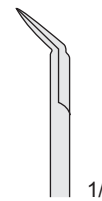

1/1

VANNAS
0604-EEA
120 mm

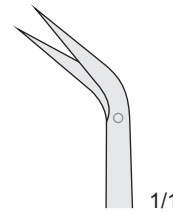

1/1

POTTS-YASARGIL
0604-EEE
185 mm

0604-EDA/0604-EEE

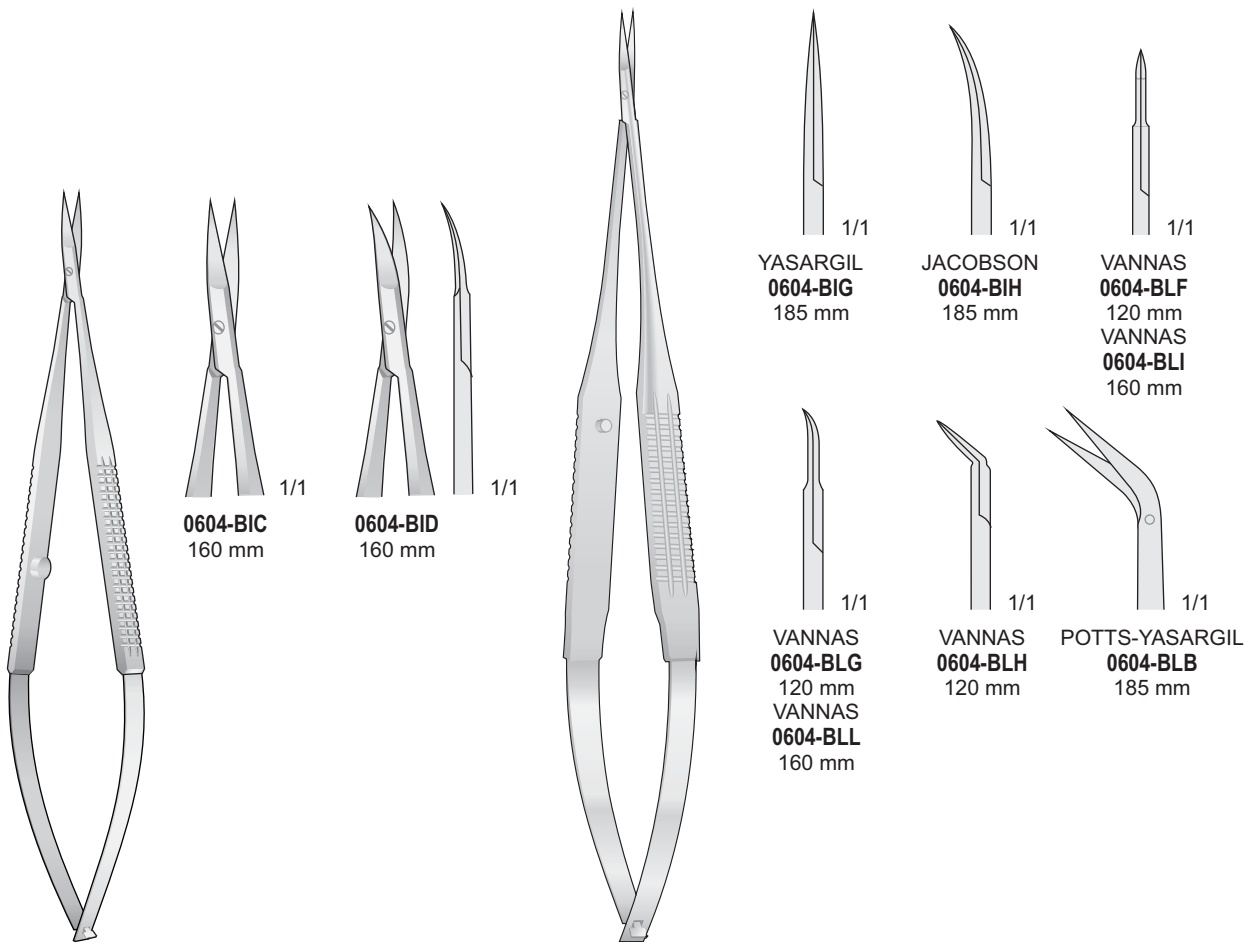

0604-BIC/0604-BID
160 mm

0604-BIG/0604-BLL

Mikro Scheren

Micro scissors

Micro forbici

Micro tijeras

Micro ciseaux

Stumpf - Blunt
Smussa - Romas
Mousse

Stumpf - Blunt
Smussa - Romas
Mousse

Spitz - Sharp
Acuta - Aguda
Pointu

Spitz - Sharp
Acuta - Aguda
Pointu

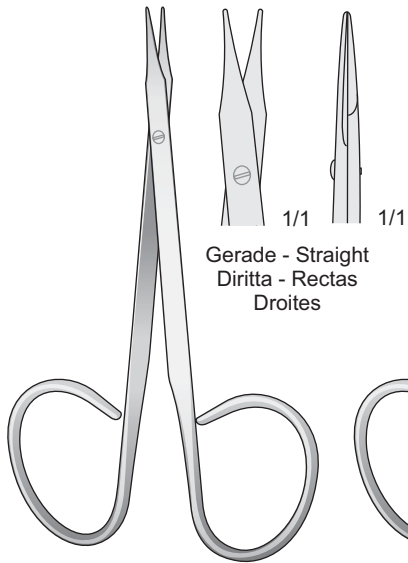

Gerade - Straight
Diritta - Rectas
Droites

Gebogen - Curved
Curva - Curvas
Courbes

Gerade - Straight
Diritta - Rectas
Droites

Gebogen - Curved
Curva - Curvas
Courbes

STEVENS
0607-CAL
100 mm

STEVENS
0607-CBA
100 mm

WALTON
0607-CBB
100 mm

WALTON
0607-CBC
100 mm

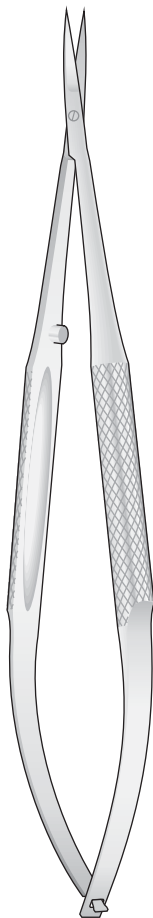

0604-CCE/0604-CDA

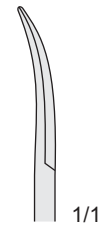
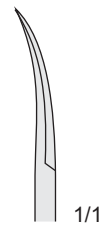
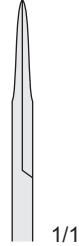
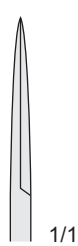

0604-CCE 145 mm
0604-CCH 180 mm



0604-CDA 230 mm

0604-CCF 145 mm
0604-CCI 180 mm

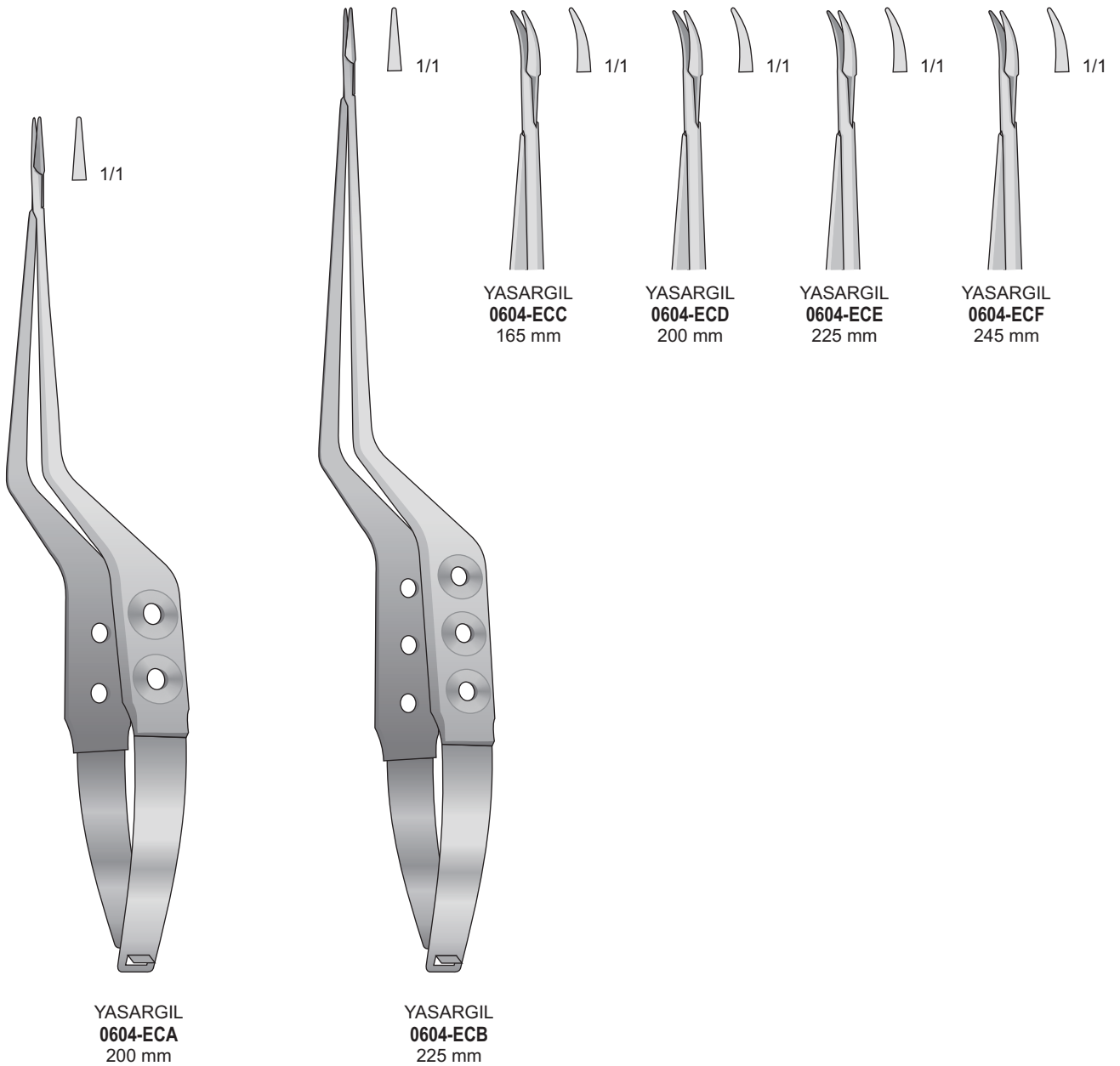
0604-CCG 145 mm
0604-CCL 180 mm

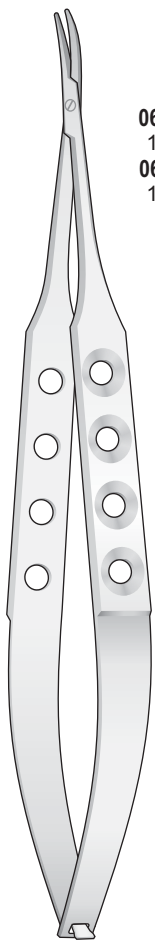





 1/1
0604-ECG
 160 mm
0604-ECH
 185 mm
 1/1
0604-ECI
 160 mm
0604-ECL
 185 mm

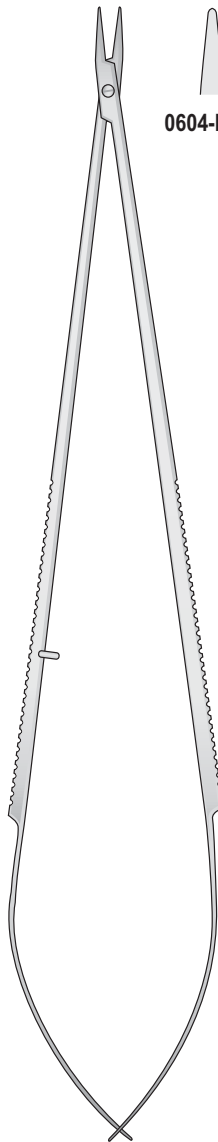

0604-ECG/0604-ECL

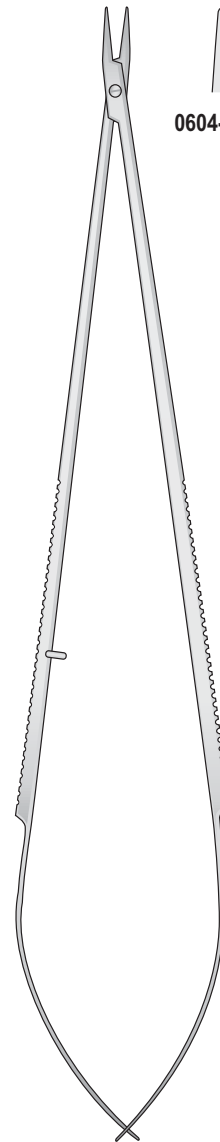

 1/1
0604-BAB
 1/1
0604-BAC

0604-BAB/0604-BAC
225 mm



 1/1
0604-BAD
 1/1
0604-BAE

0604-BAD/0604-BAE
225 mm

Glattes Maul - Smooth Jaw
 Morso liscio - Boca lisa
 Mors lisse

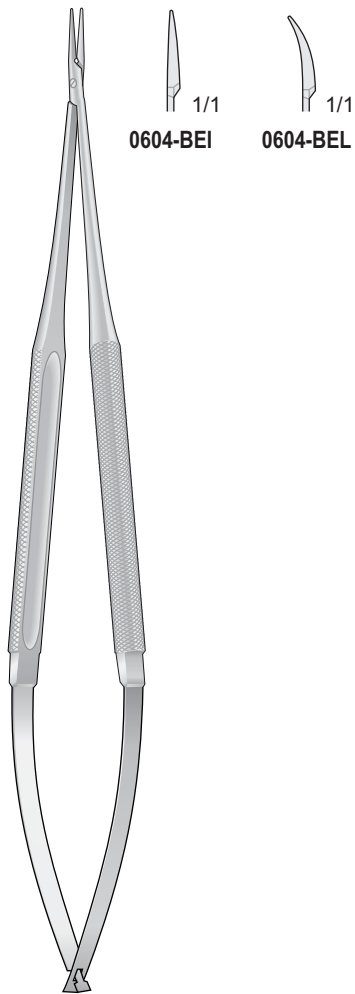

0604-BEI

0604-BEL

0604-BEI/0604-BEL
 185 mm

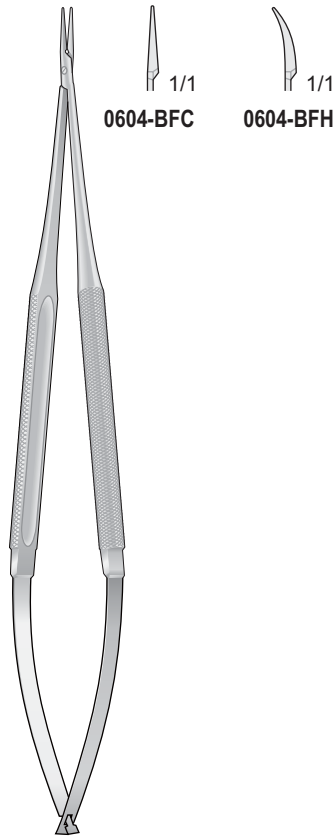

0604-BFC

0604-BFH

REILL
 0604-BFC/0604-BFH
 150 mm

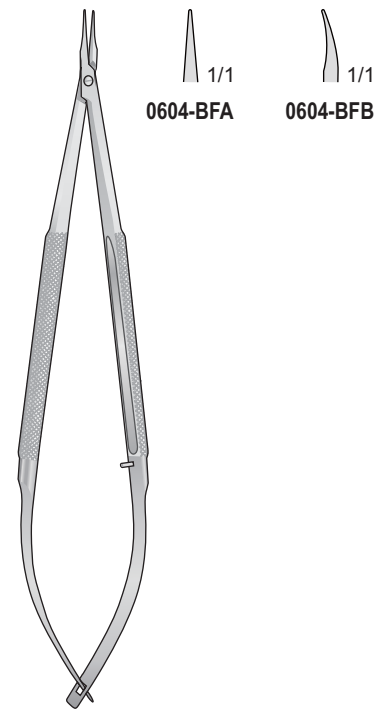

0604-BFA

0604-BFB

BARRAQUER
 0604-BFA/0604-BFB
 120 mm

Glattes Maul - Smooth Jaw
 Morso liscio - Boca lisa
 Mors lisse

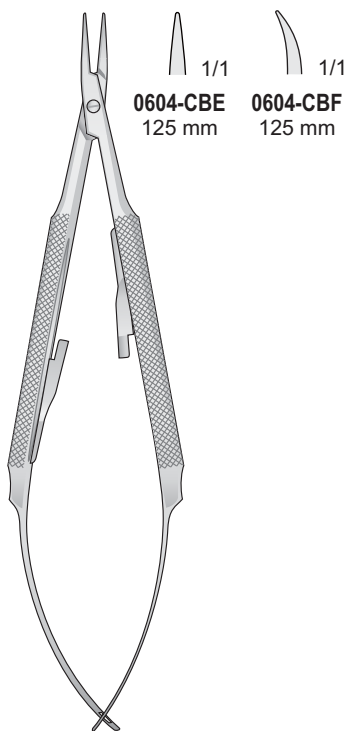

BARRAQUER
 0604-CBE/0604-CBF
 125 mm

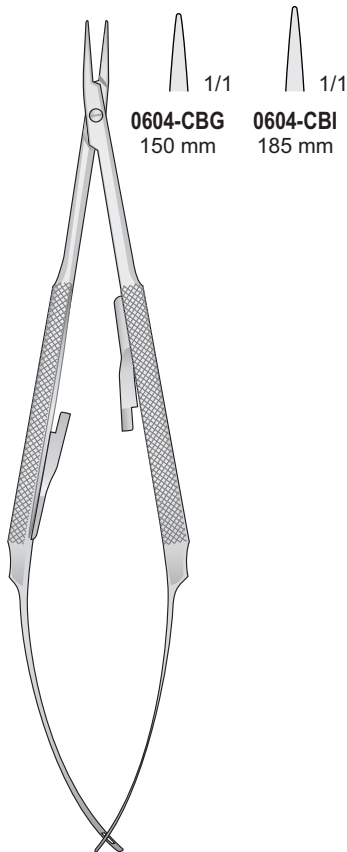

BARRAQUER
 0604-CBG/0604-CBI

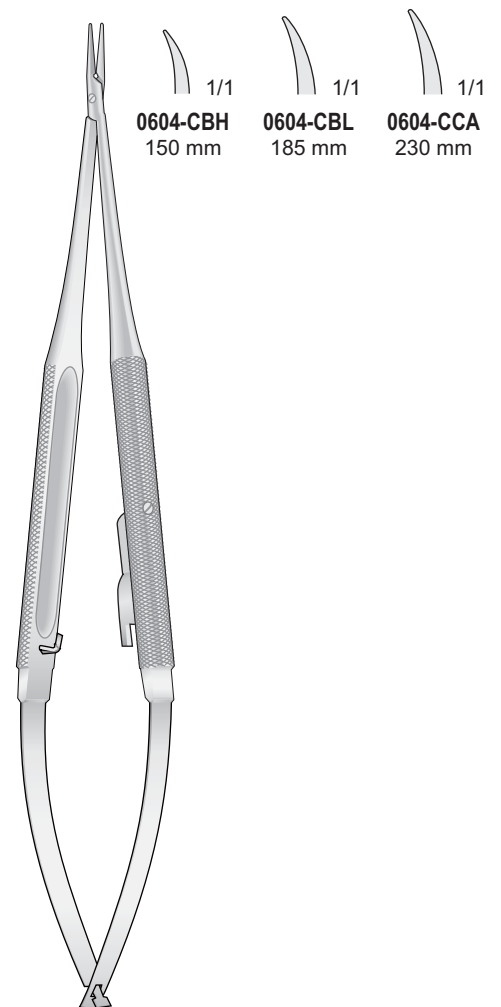

0604-CBH/0604-CCA

Glattes Maul
Smooth Jaw
Morso liscio
Boca lisa
Mors lisse

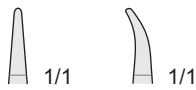

0604-BH 140 mm
0604-BL 140 mm

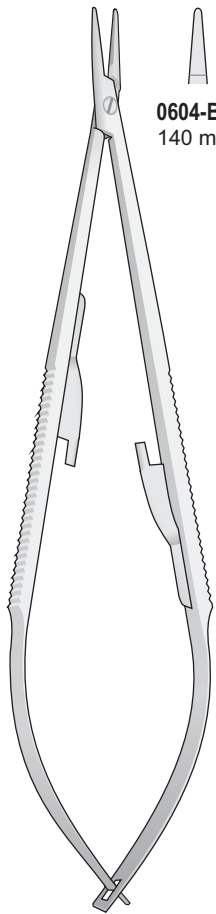

CASTROVIEJO
0604-BH/0604-BL
145 mm

Glattes Maul
Smooth Jaw
Morso liscio
Boca lisa
Mors lisse

TC

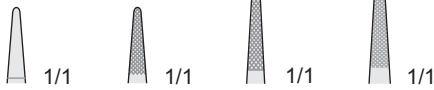

0604-CB 140 mm
0604-CC 140 mm
0604-CF 180 mm
0604-CH 215 mm

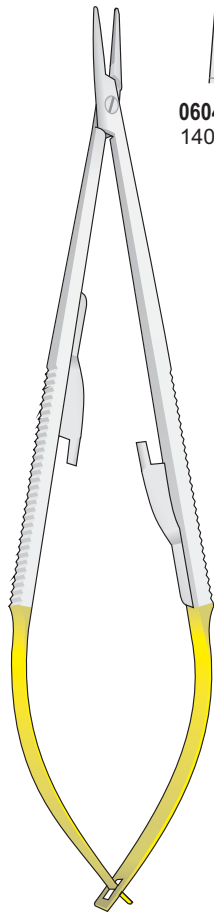

CASTROVIEJO
0604-CB/0604-CH

Glattes Maul
Smooth Jaw
Morso liscio
Boca lisa
Mors lisse

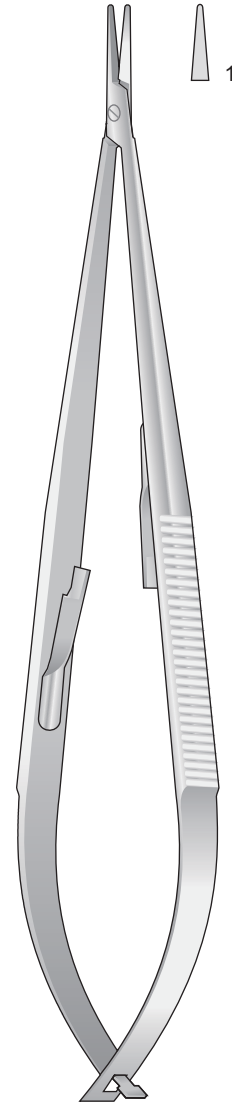

JACOBSON
0604-GD
180 mm

Mikro Nadelhalter
Mikro Pinzetten

Micro Needle Holders
Micro Forceps

Micro port'aghi
Micro pinzette

Micro portaagujas
Pinzas finos

Micro Porte aiguilles
Micro Pinces

Titan - Titanium - Titanio - Titane

Rund - Griffe Ø 8 mm

Mikro Nadelhalter
Micro Needle Holders
Micro port'aghi
Micro portaagujas
Micro porte aiguilles

Mikro Scheren
Micro Scissors
Micro forbici
Micro Tijeras
Micro ciseaux

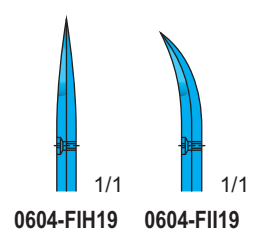
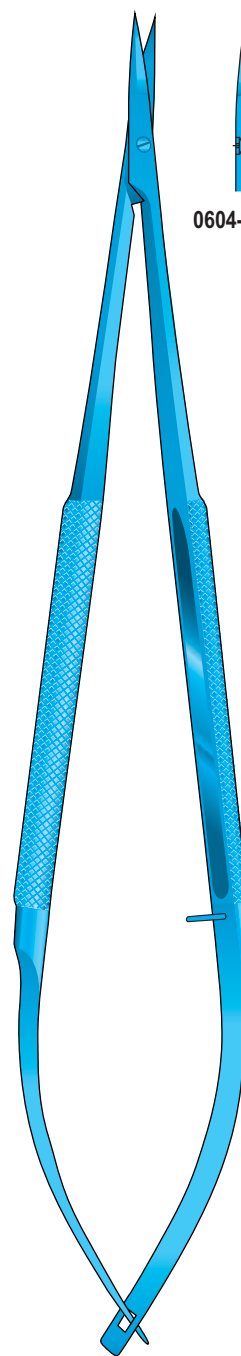
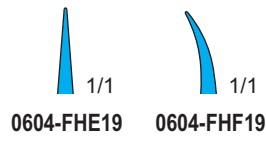
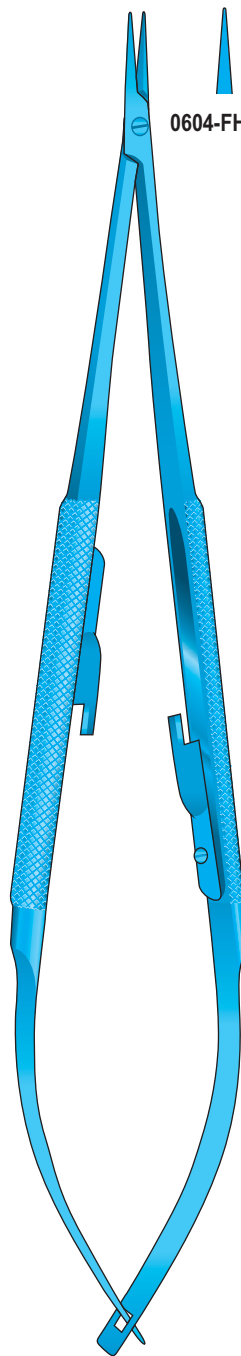
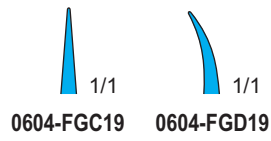
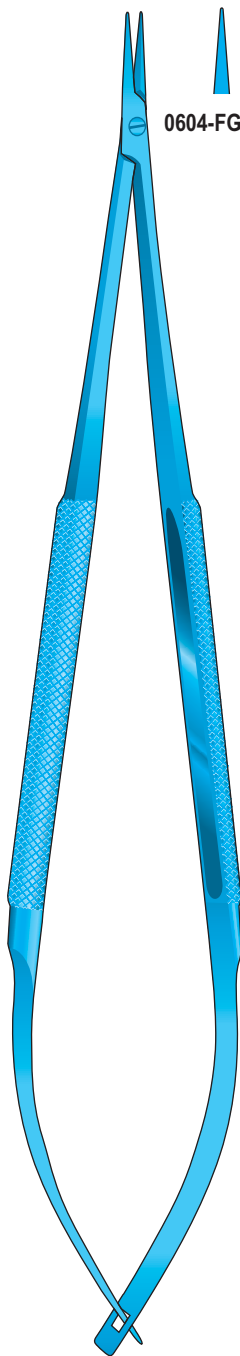

0604-FGC19/0604-FGD19
180 mm

0604-FHE19/0604-FHF19
180 mm

0604-FIH19/0604-FII19
180 mm

Titan - Titanium - Titanio - Titane

Mikro-Pinzette Ø 8 mm

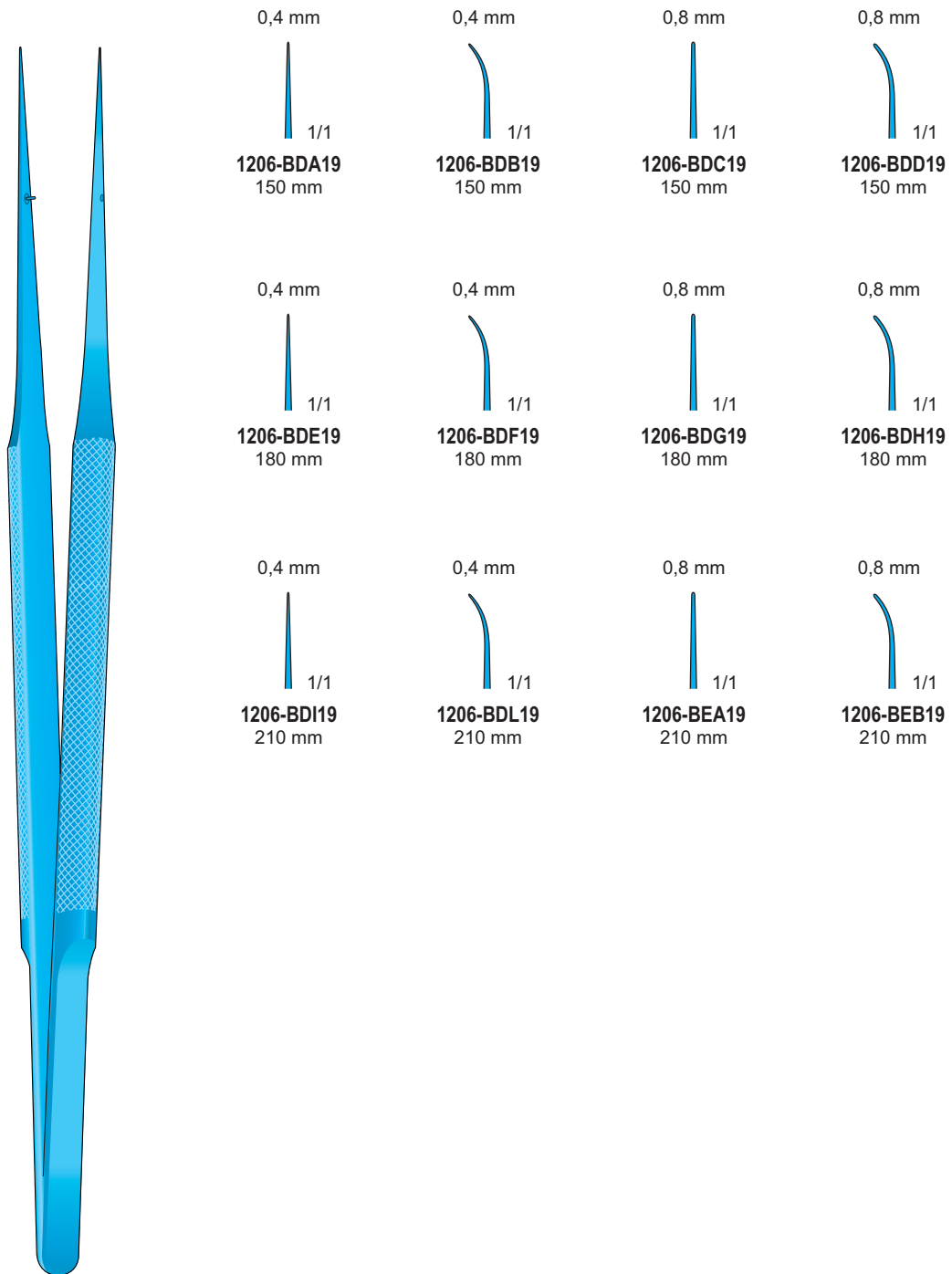

1206-BDA19/1206-BEB19

Titan - Titanium - Titanio - Titane

Mikro-Knüppfpinzette Ø 8 mm

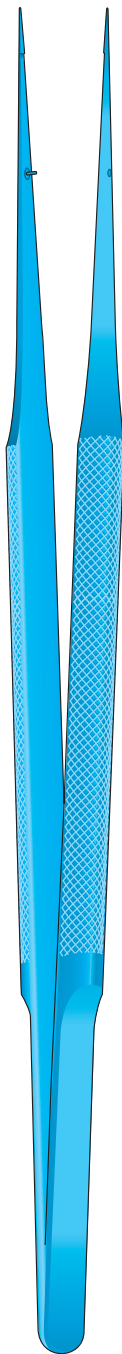

6 x 0,4 mm



1/1

1206-DGC19
150 mm

6 x 0,4 mm



1/1

1206-DGD19
150 mm

6 x 0,8 mm



1/1

1206-DGE19
180 mm

6 x 0,8 mm



1/1

1206-DGF19
180 mm

6 x 0,8 mm



1/1

1206-DGG19
210 mm

6 x 0,8 mm



1/1

1206-DGH19
210 mm

1206-DGC19/1206-DGH19

Titan - Titanium - Titanio - Titane

Mikro-Ringpinzette Ø 8 mm

Glatt - Smooth
Liscia - Lisa
Lisses

Gerieft - Serrated
Zigrinata - Estriadas
Stries

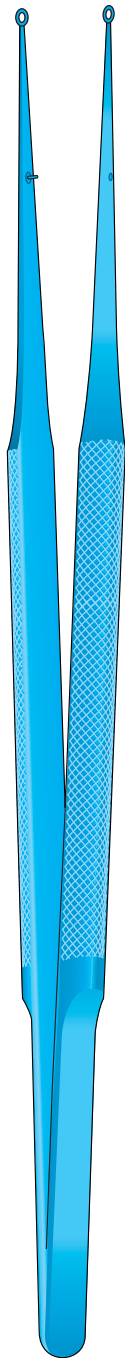

1 x 0,5 mm



1/1

1206-BEC19
150 mm

2 x 1 mm



1/1

1206-BEF19
150 mm

1 x 0,5 mm



1/1

1206-DEC19
150 mm

2 x 1 mm



1/1

1206-DEF19
150 mm

1 x 0,5 mm



1/1

1206-BED19
180 mm

2 x 1 mm



1/1

1206-BEG19
180 mm

1 x 0,5 mm



1/1

1206-DED19
180 mm

2 x 1 mm



1/1

1206-DEG19
180 mm

1 x 0,5 mm



1/1

1206-BEE19
210 mm

2 x 1 mm



1/1

1206-BEH19
210 mm

1 x 0,5 mm



1/1

1206-DEE19
210 mm

2 x 1 mm



1/1

1206-DEH19
210 mm

1206-BEC19/1206-DEH19

Titan - Titanium - Titanio - Titane

Mikro-Atrauma-Pinzette Ø 8 mm

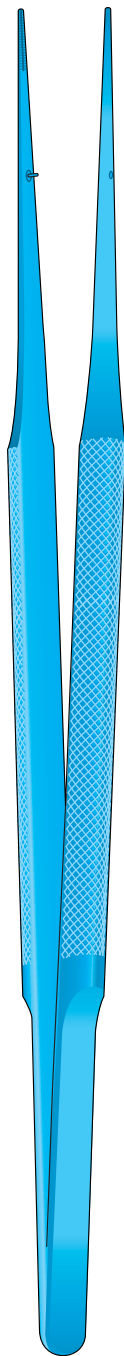

Atrauma-Fino
1,2 mm



1/1

1206-DEI19
150 mm

Atrauma-Fino
1,2 mm



1/1

1206-DEL19
150 mm

Atrauma-Standard
1,8 mm



1/1

1206-DFE19
150 mm

Atrauma-Standard
1,8 mm



1/1

1206-DFF19
150 mm

Atrauma-Fino
1,2 mm



1/1

1206-DFA19
180 mm

Atrauma-Fino
1,2 mm



1/1

1206-DFB19
180 mm

Atrauma-Standard
1,8 mm



1/1

1206-DFG19
180 mm

Atrauma-Standard
1,8 mm



1/1

1206-DFH19
180 mm

Atrauma-Fino
1,2 mm



1/1

1206-DFC19
210 mm

Atrauma-Fino
1,2 mm



1/1

1206-DFD19
210 mm

Atrauma-Standard
1,8 mm



1/1

1206-DFI19
210 mm

Atrauma-Standard
1,8 mm



1/1

1206-DFL19
210 mm

1206-DEI19/1206-DFL19

Titan - Titanium - Titanio - Titane

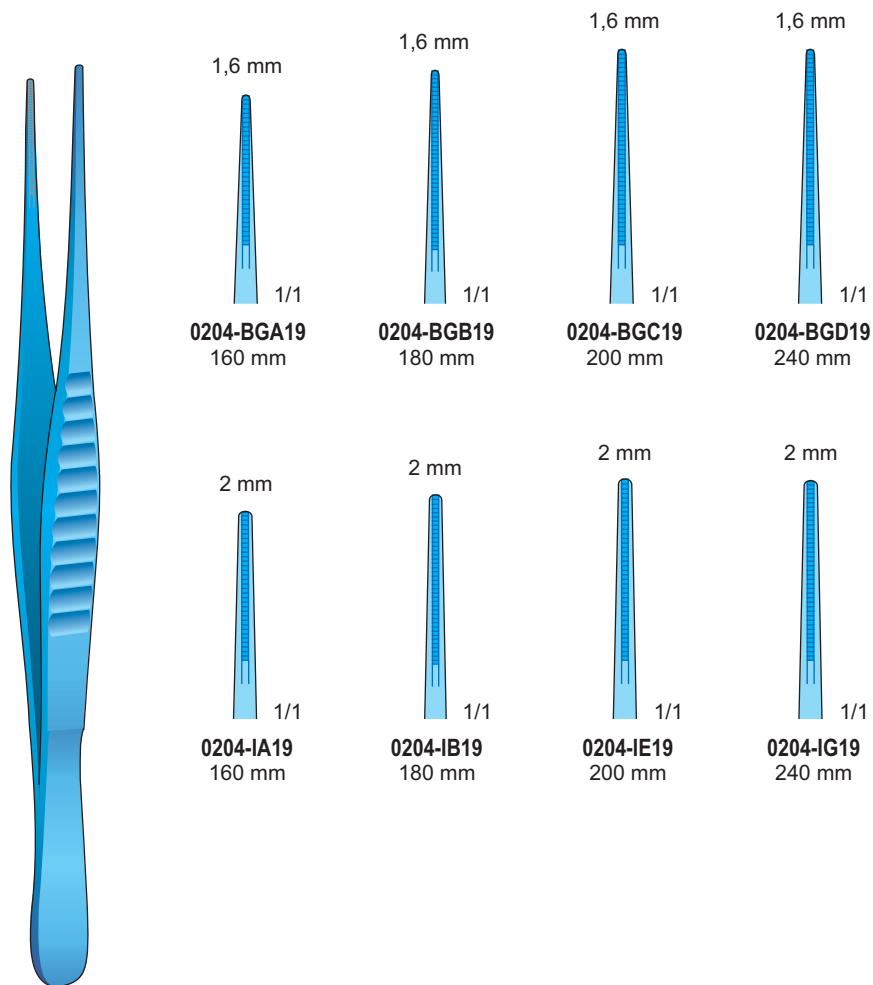

DE BAKEY
0204-IA19/0204-BGD19

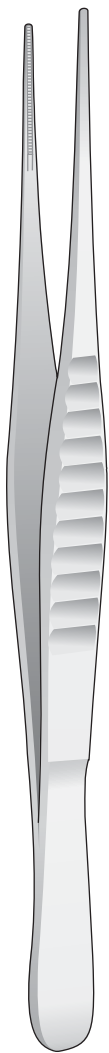

DE BAKEY
0204-BGF/0204-BHD

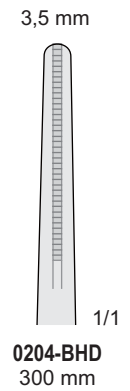
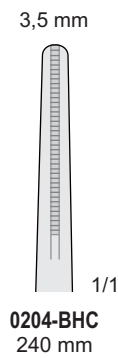
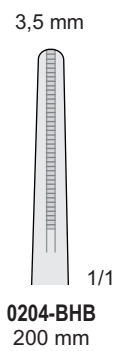
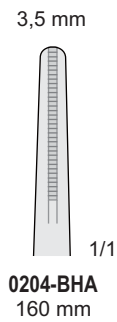
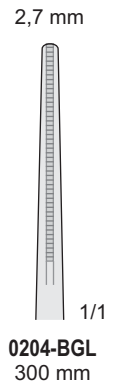
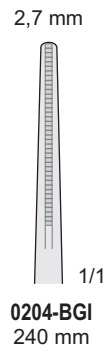
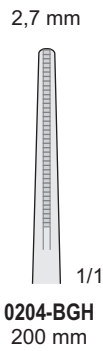
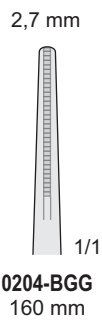
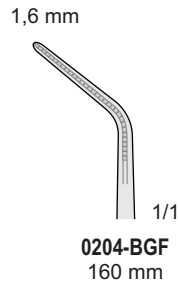

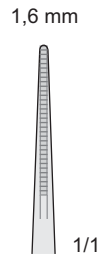

0204-BGA
160 mm

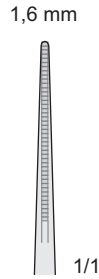

0204-BGB
180 mm

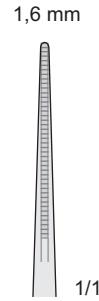

0204-BCG
200 mm

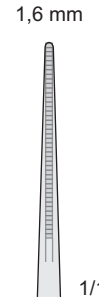

0204-BDG
240 mm

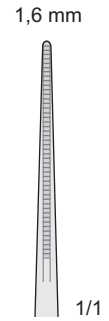

0204-BGE
300 mm

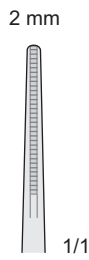

0204-IA
160 mm

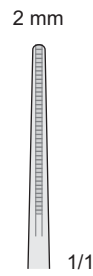

0204-IB
180 mm

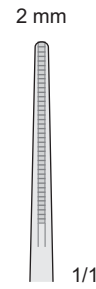

0204-IE
200 mm

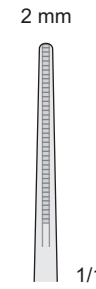

0204-IG
240 mm

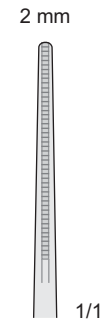

0204-II
300 mm

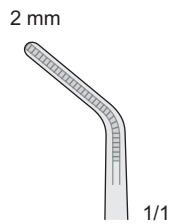

0204-IC
160 mm

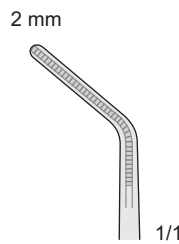

0204-ID
180 mm

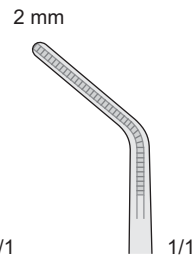

0204-IF
200 mm

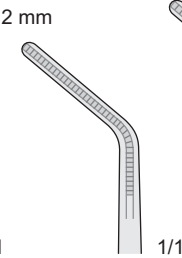

0204-IH
240 mm

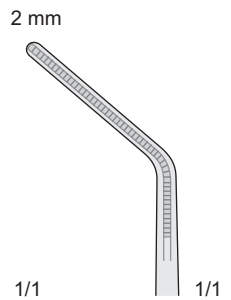

0204-IL
300 mm



DE BAKEY
0204-IA/0204-BGE

Mikro
Knüpfpinzetten

Micro Suture
Tying forceps

Micro pinzette
per legature

Micro Pinzas
de ligadura

Micro pinces
à ligature

Rundgriff Ø 8 mm - Round Handle Ø 8 mm
Manico rotondo Ø 8 mm - Mango redondo Ø 8 mm
Manche rond Ø 8 mm

Mikro-Knüpfpinzetten mit Plateau - Micro Suture Tying Forceps with platform
Micro pinze per legature con piattino - Micro-Pinzas de ligadura con plataforma
Micro-Pinces à ligature avec plate-forme

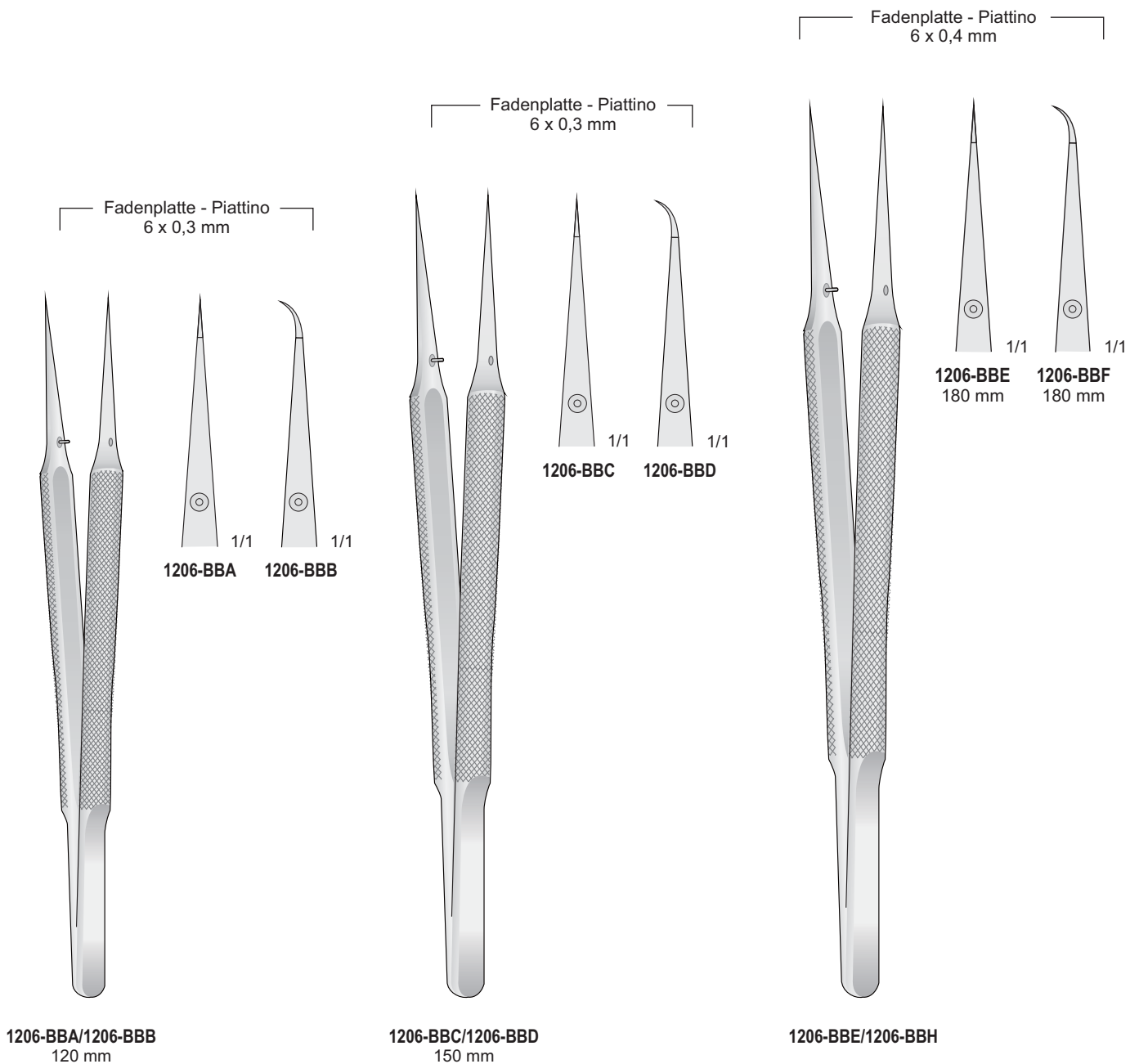

**Mikro
Knüpfpinzetten**

**Micro Suture
Tying forceps**

**Micro pinzette
per legature**

**Micro Pinzas
de ligadura**

**Micro pinces
à ligature**

Mikro-Knüpfpinzetten mit Plateau - Micro Suture Tying Forceps with platform
 Micro pinze per legature con piattino - Micro-Pinzas de ligadura con plataforma
 Micro-Pinces à ligature avec plate-forme

Rundgriff Ø 8 mm
 Round Handle Ø 8 mm
 Manico rotondo Ø 8 mm
 Mango redondo Ø 8 mm
 Manche rond Ø 8 mm

Fadenplatte - Piattino
 6 x 0,8 mm

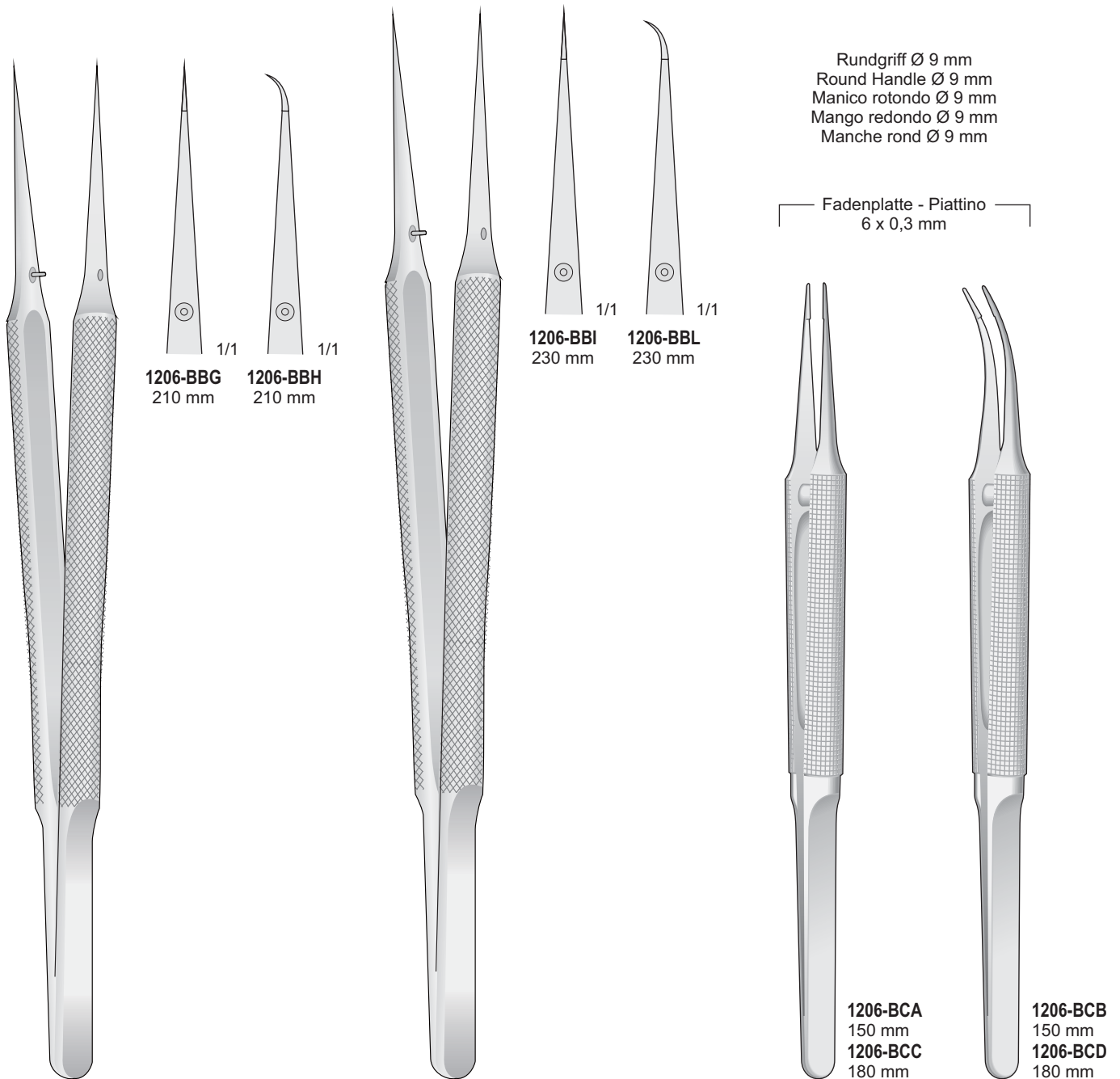

Rundgriff Ø 9 mm
 Round Handle Ø 9 mm
 Manico rotondo Ø 9 mm
 Mango redondo Ø 9 mm
 Manche rond Ø 9 mm

Fadenplatte - Piattino
 6 x 0,3 mm

1206-BBG/1206-BBH
210 mm

1206-BBI/1206-BBL
230 mm

1206-BCA/1206-BCC

1206-BCB/1206-BCD

Mikro Pinzetten

Delicate forceps

Micro pinzette

Pinzas finos

Micro pinces

Mikro Pinzette - Rundgriff Ø 8 mm
Mit Führungsstift diamantiert
Fadenplatte 6x0,7 mm

Diamantiert
Diamond Coated
Diamantate
Diamantadas
Diamanté

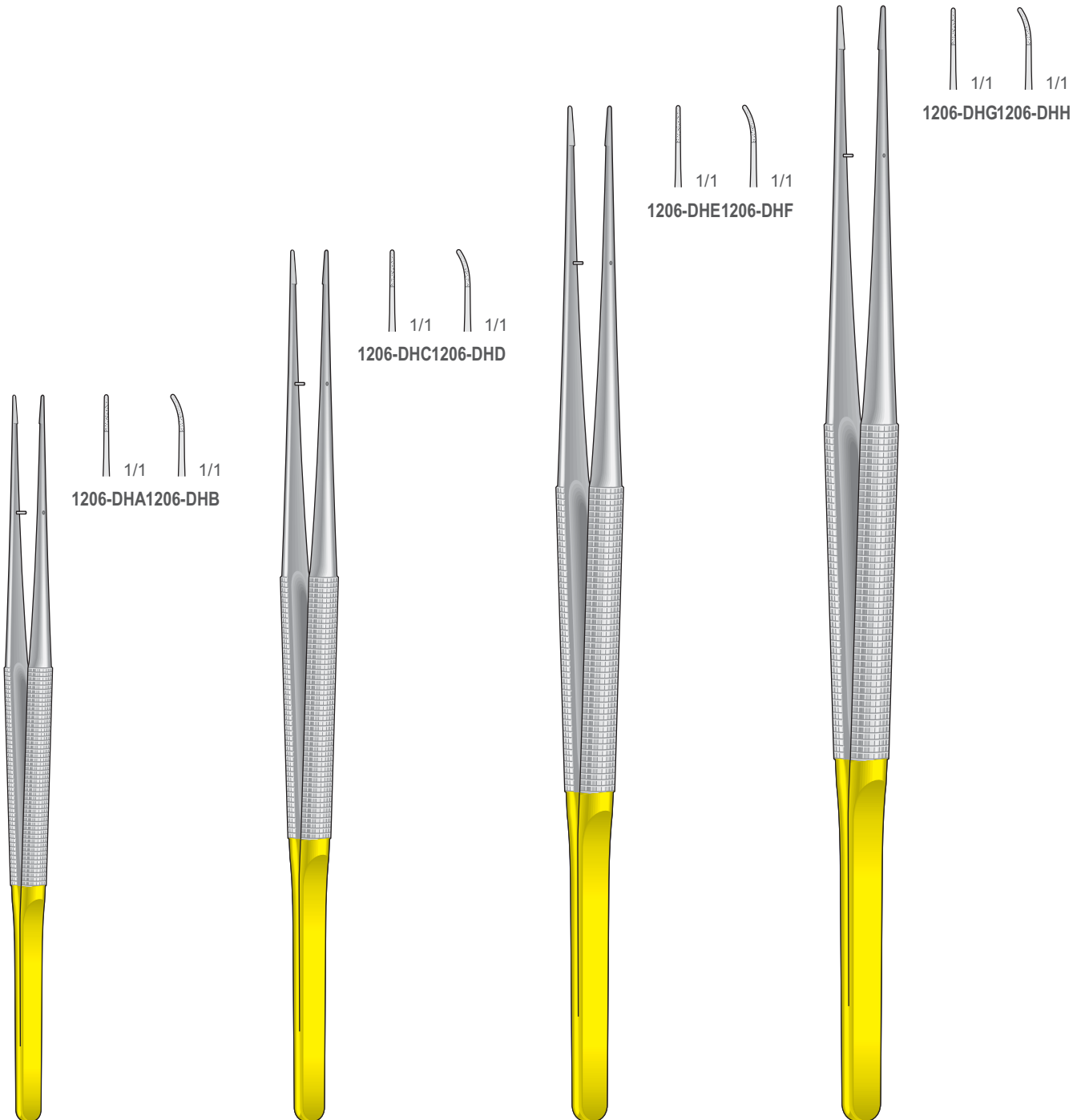

1206-DHA/1206-DHB
150 mm

1206-DHC/1206-DHD
180 mm

1206-DHE/1206-DHF
210 mm

1206-DHG/1206-DHH
230 mm

Mikro Pinzette - Rundgriff Ø 8 mm
Mit Führungsstift diamantiert
Fadenplatte 6x0,7 mm

Diamantiert
Diamond Coated
Diamantate
Diamantadas
Diamanté

1x2 Zähne
1x2 Teeths
1x2 Denti
1x2 Dientes
1x2 Dents

1x2 Zähne
1x2 Teeths
1x2 Denti
1x2 Dientes
1x2 Dents

1x2 Zähne
1x2 Teeths
1x2 Denti
1x2 Dientes
1x2 Dents

1x2 Zähne
1x2 Teeths
1x2 Denti
1x2 Dientes
1x2 Dents

1206-DIE 1206-DIF

1206-DIC 1206-DID

1206-DIA 1206-DIB

1206-DHI 1206-DHL

1206-DHI/1206-DHL
150 mm

1206-DIA/1206-DIB
180 mm

1206-DIC/1206-DID
210 mm

1206-DIE/1206-DIF
230 mm

Mikro Pinzetten

Delicate forceps

Micro pinzette

Pinzas finos

Micro pinces

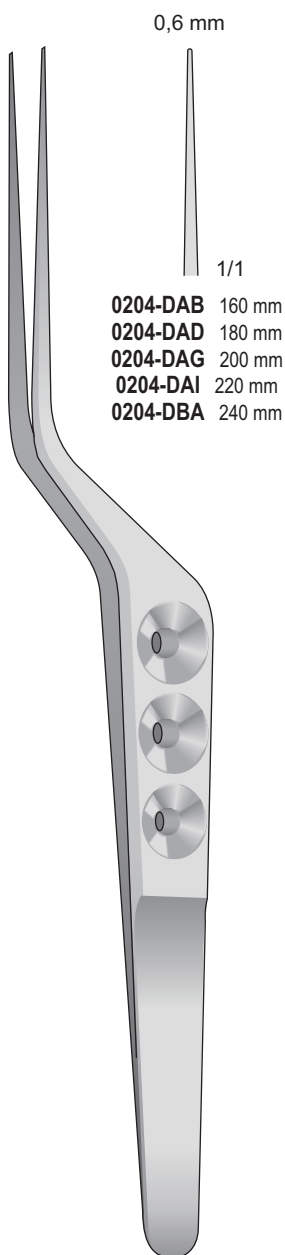

YASARGIL
0204-DAB/0204-DBA

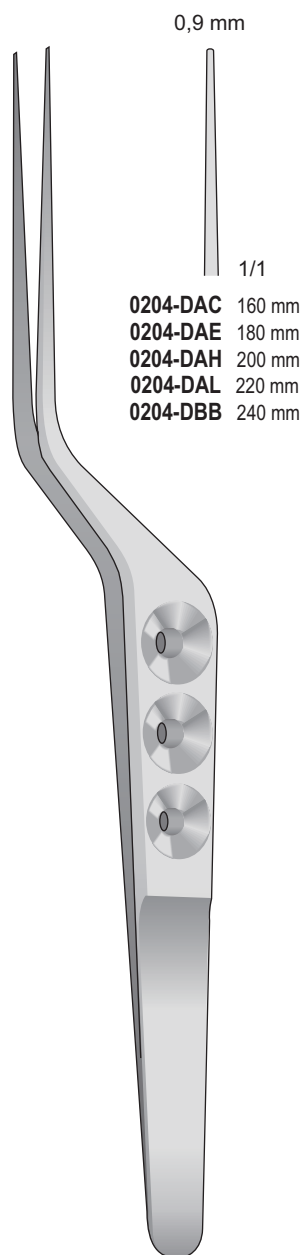

YASARGIL
0204-DAC/0204-DBB

1x2 Zähne
 1x2 Teeth
 1x2 Denti
 1x2 Dientes
 1x2 Dents

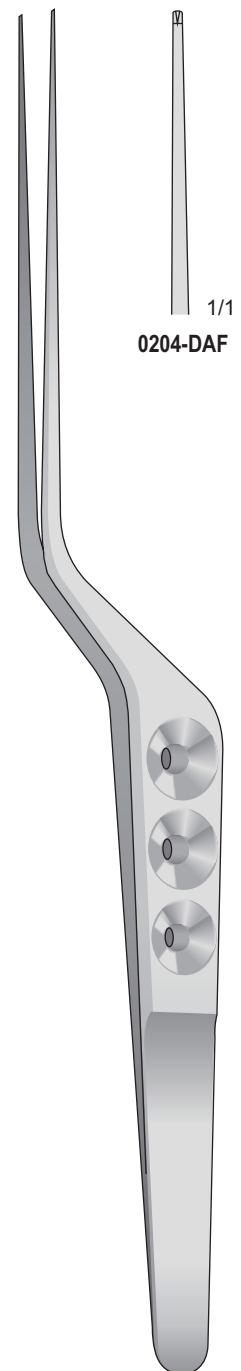

YASARGIL
0204-DAF
180 mm

Tumor Faßpinzetten
Tumor Grasping Forceps
Pinza per tumori
Pinzas para tumores
Pinces pour tumeurs

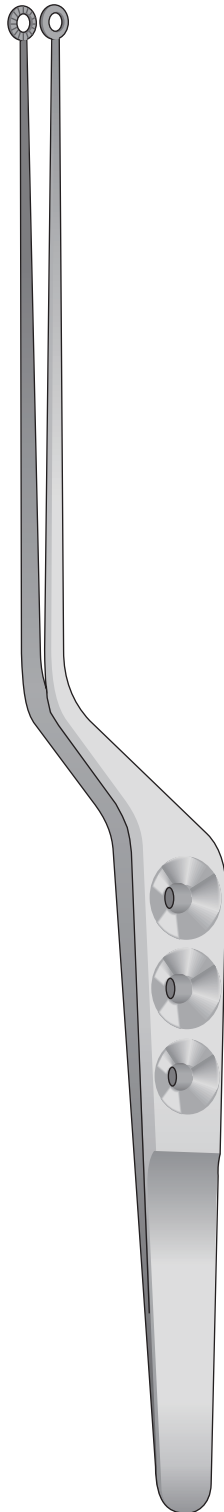

0204-DBC/0204-DCA
220 mm

Ø 3 mm



1/1
YASARGIL
0204-DBC
220 mm

Ø 5 mm



1/1
YASARGIL
0204-DBD
220 mm

Ø 5 mm



1/1
YASARGIL-SAMII
0204-DCA
240 mm

Ø 3 mm



1/1
YASARGIL
0204-DBE
220 mm

Ø 5 mm



1/1
YASARGIL
0204-DBF
220 mm

Ø 3 mm



1/1
HEIFETZ
0204-DBG
220 mm

Ø 5 mm



1/1
HEIFETZ
0204-DBH
220 mm

Ø 3 mm



1/1
YASARGIL-SAMII
0204-DBI
240 mm

Ø 5 mm



1/1
YASARGIL-SAMII
0204-DBL
240 mm

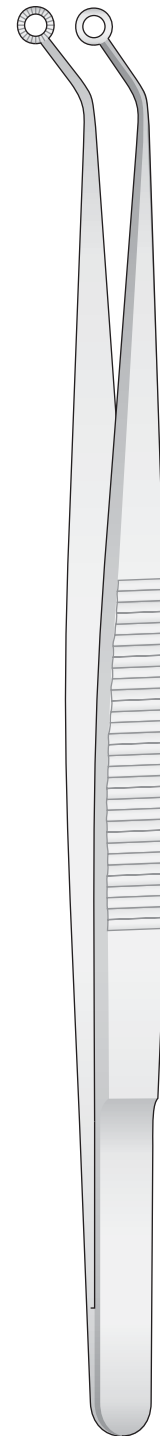

HUNT
0204-DDC
200 mm

Ø 5 mm



1/1

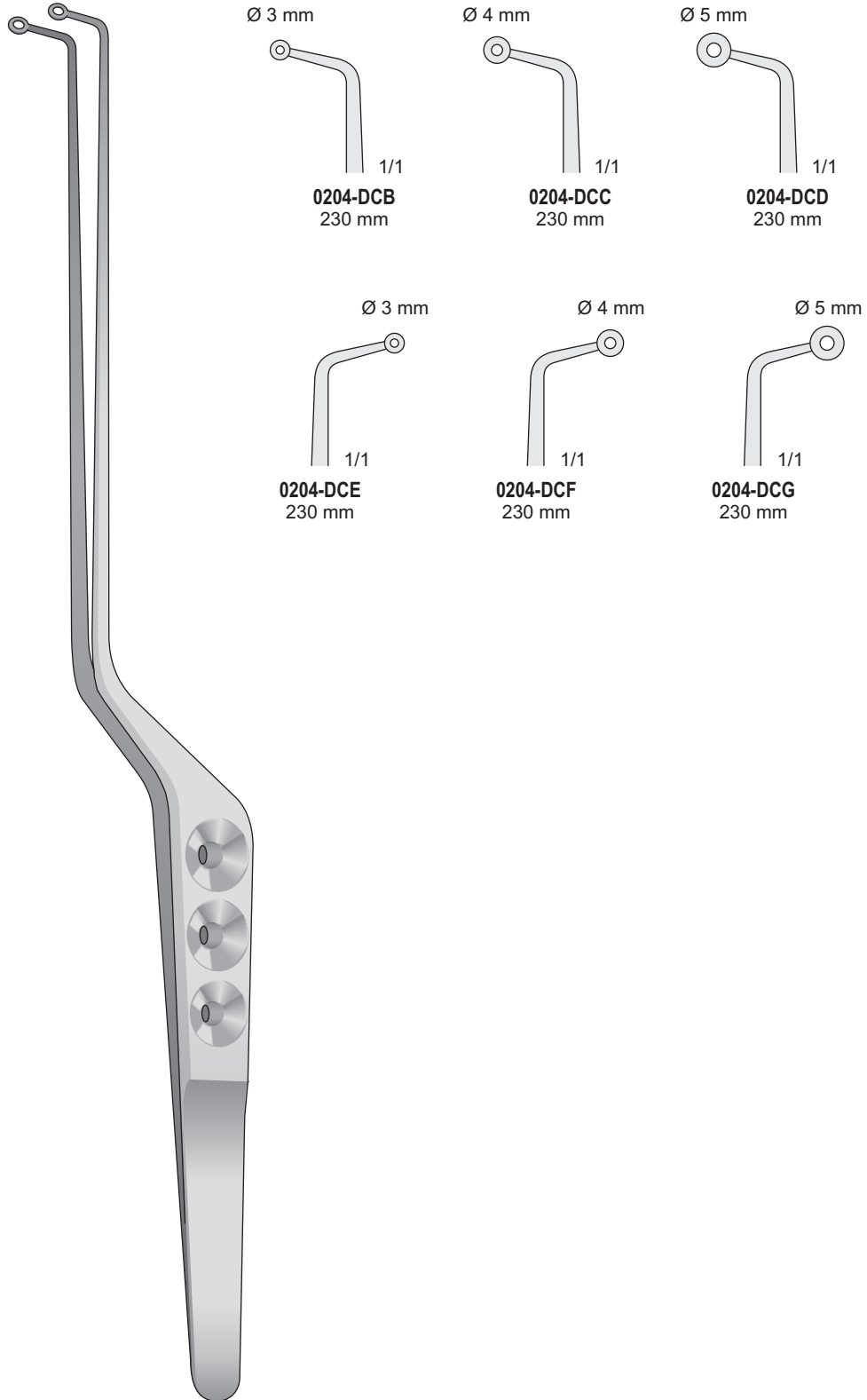

SAMII
0204-DCB/0204-DCG
230 mm

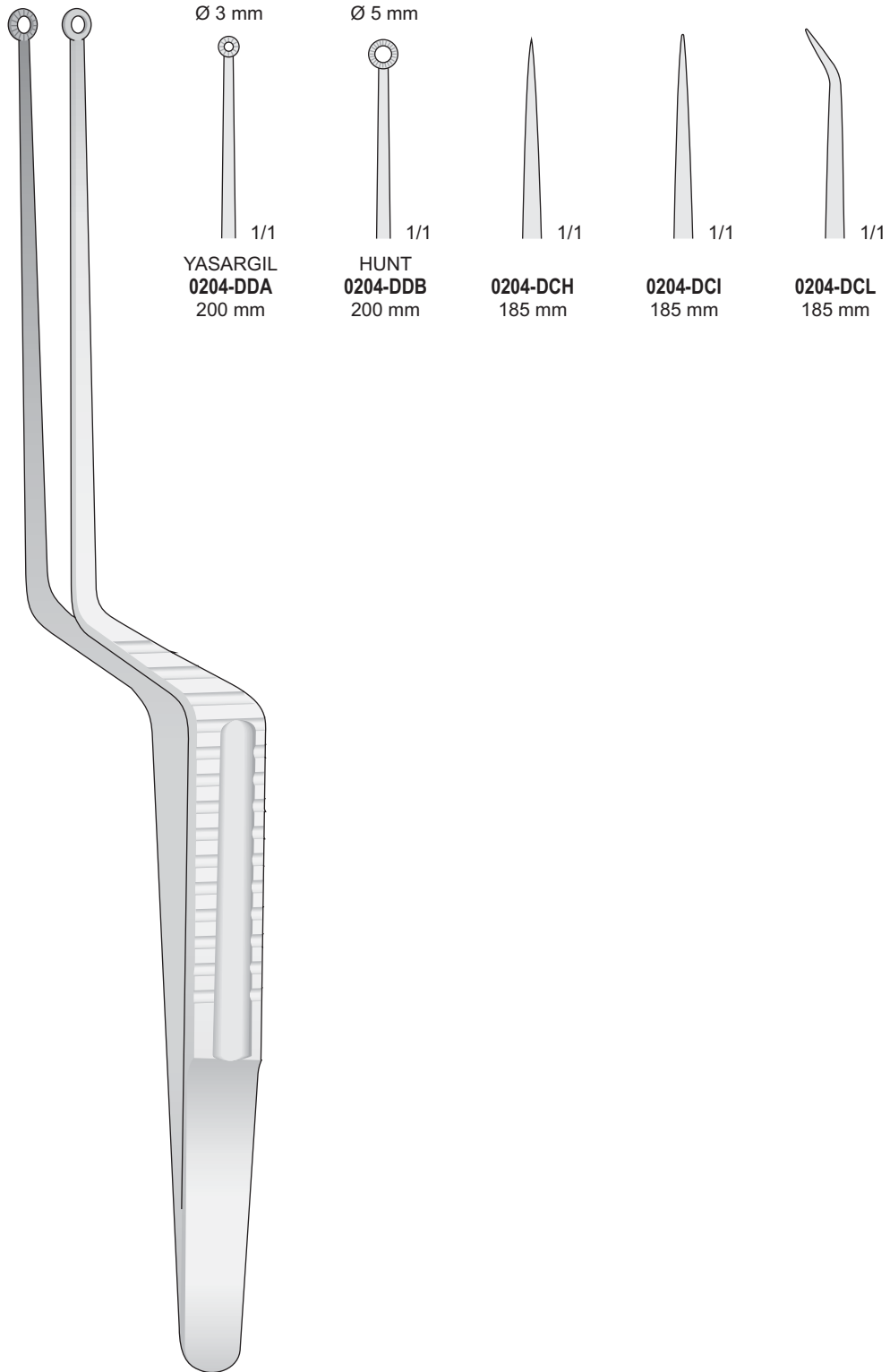

0204-DCH/0204-DDB

Mikro Pinzetten

Delicate forceps

Micro pinzette

Pinzas finos

Micro pinces

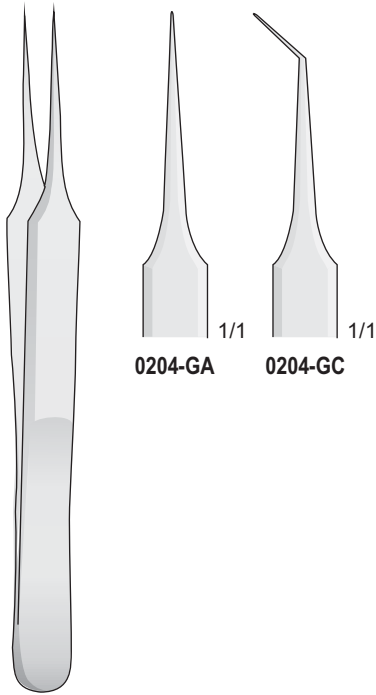

0204-GA

0204-GC

0204-GA/0204-GC
110 mm



0204-CAG
115 mm



0204-CDI
95 mm

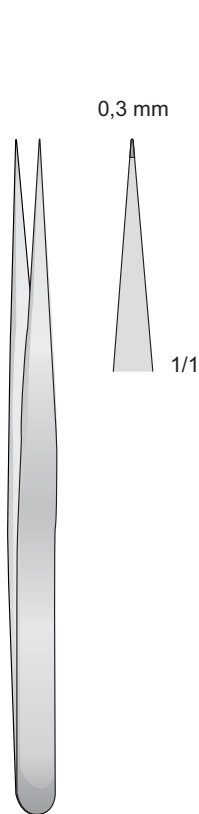

0204-CDF
120 mm

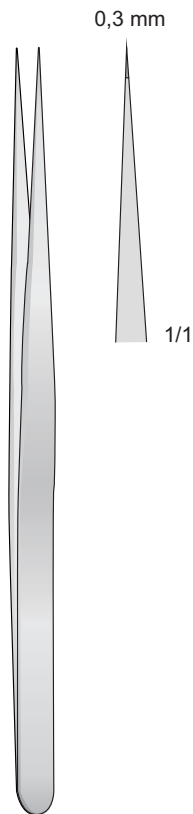

VISE
0204-CDG
135 mm

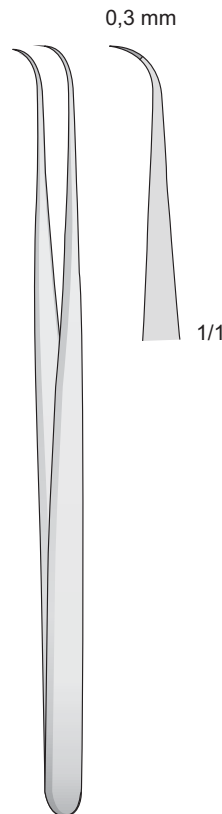

VISE
0204-CDH
135 mm

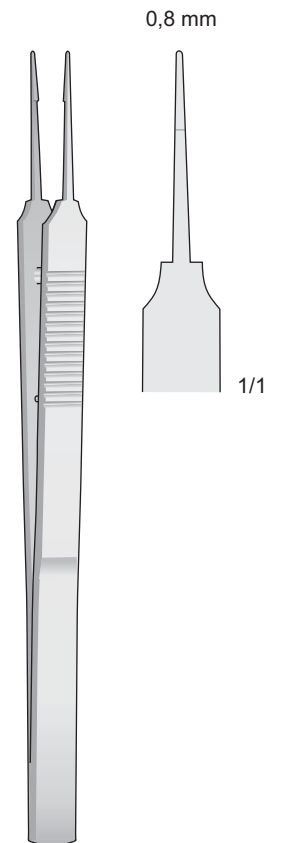

AUSTIN
0204-CDL
140 mm

Mikro Pinzetten

Delicate forceps

Micro Pinzette

Pinzas finos

Micro pincers

Mikro Precision Pinzetten

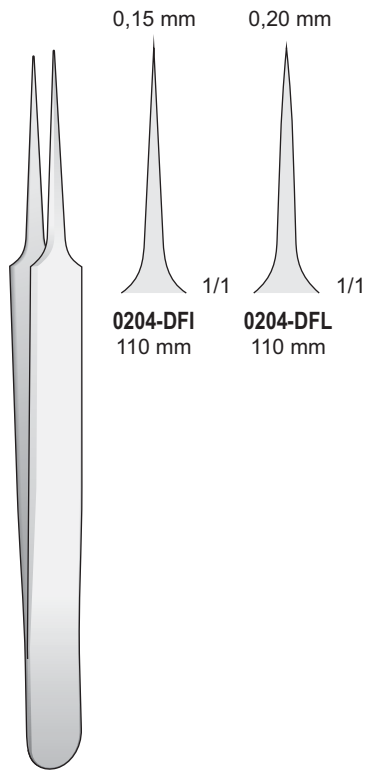

0204-DFI/0204-DFL
110 mm

Titan - Titanium - Titano - Titane

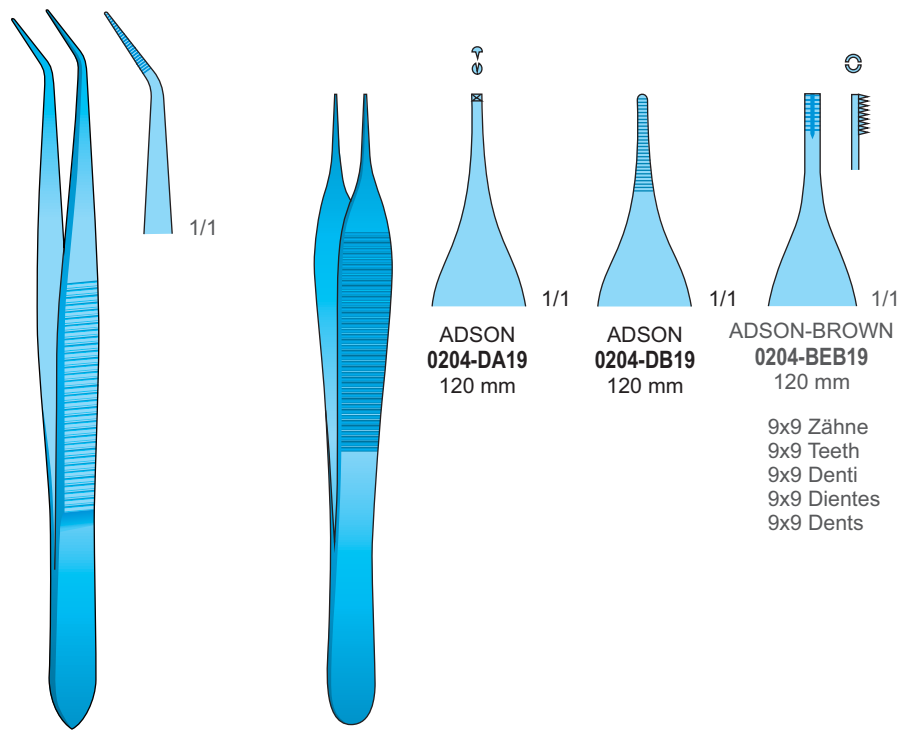

0204-DEB19
115 mm

0204-DA19/0204-BEB19
120 mm

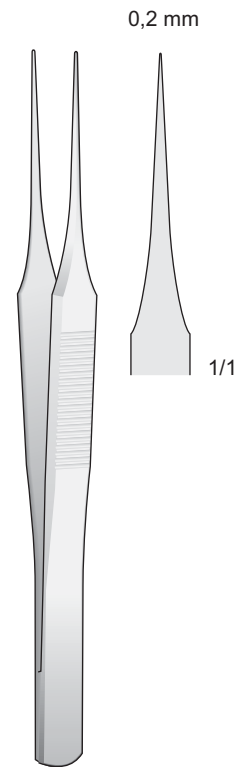

0204-DGA
110 mm

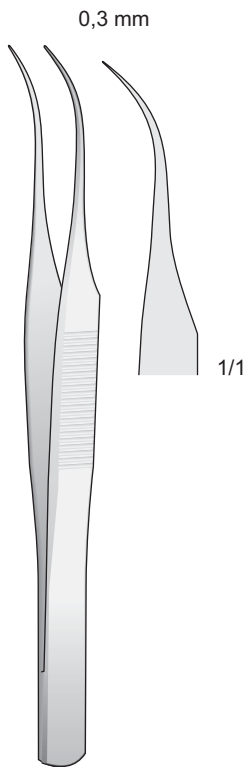

0204-DGB
110 mm

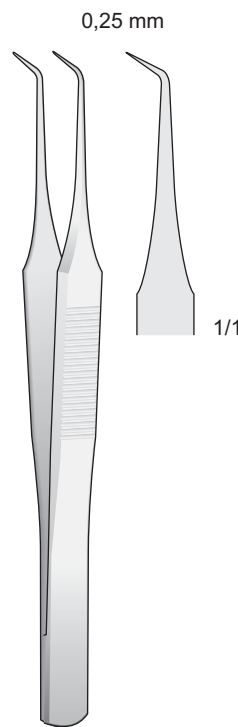

0204-DGC
100 mm

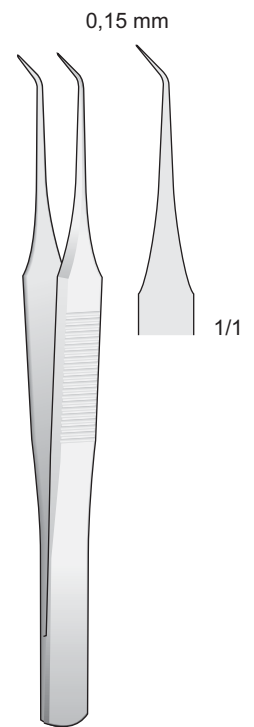

0204-DGD
100 mm

Mikro Pinzetten

Delicate forceps

Micro Pinzette

Pinzas finos

Micro pinces

Titan - Titanium - Titanio - Titane

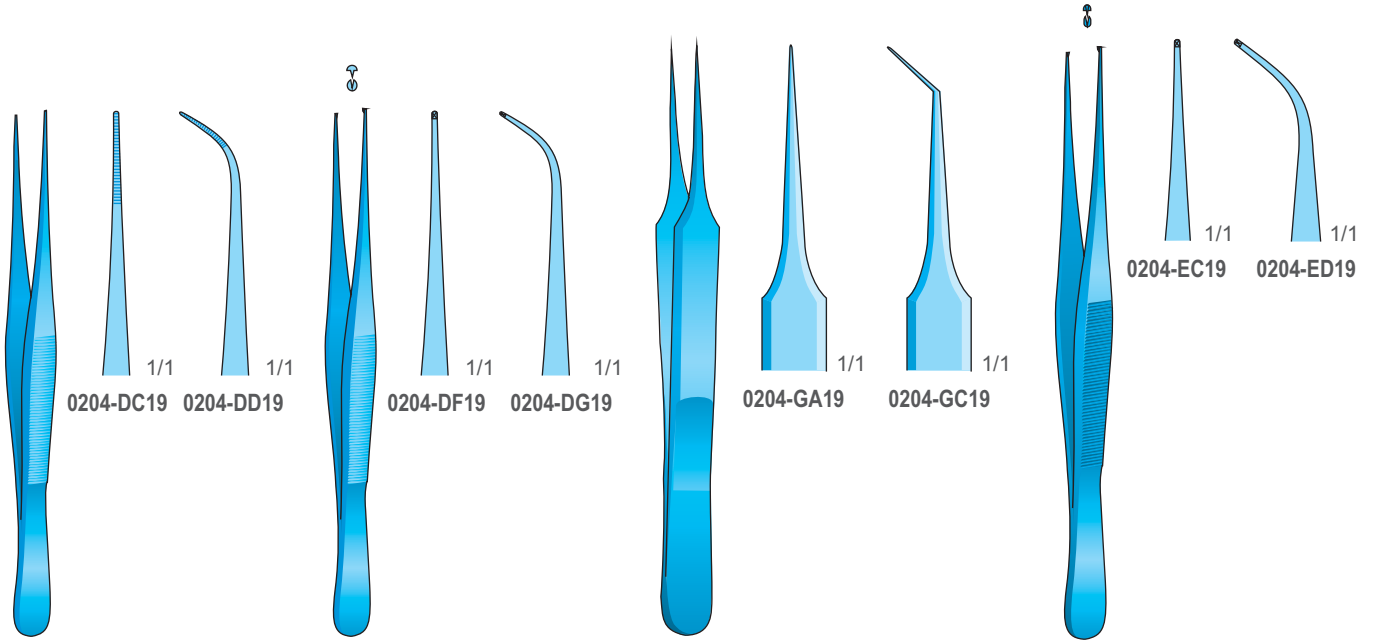

0204-DC19/0204-DD19
100 mm

0204-DF19/0204-DG19
100 mm

0204-GA19/0204-GC19
110 mm

0204-EC19/0204-ED19
110 mm

Mikro Precision Pinzetten

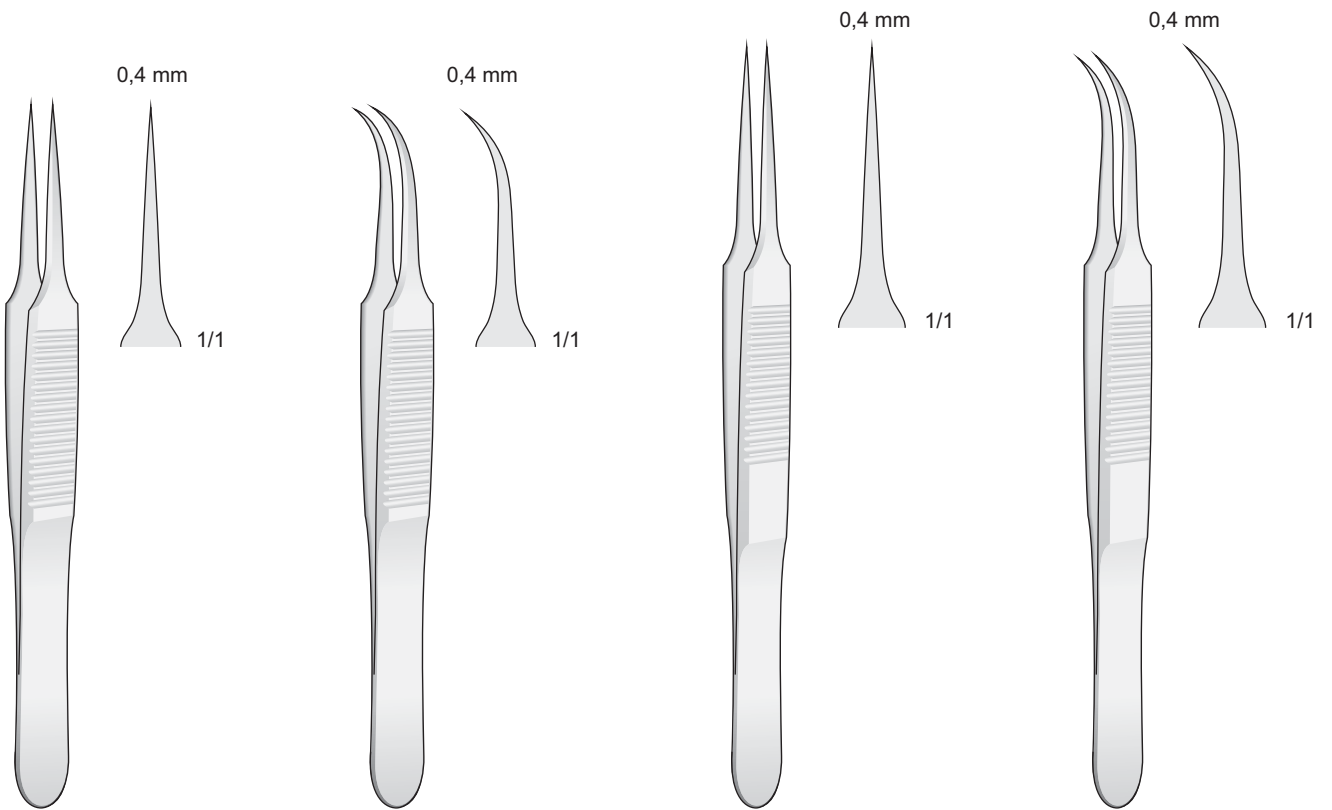

0204-DGE
110 mm

0204-DGF
110 mm

0204-DGG
130 mm

0204-DGH
130 mm

Skalpelligriffe

Scalpel Handles

Manici per bisturi

Mangos de bisturi

Manches pour bistouris

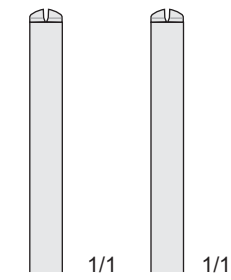

0202-EG
135 mm

0202-EI
155 mm

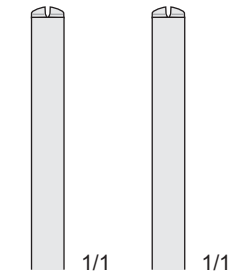

CASPAR
0202-FA
180 mm

0202-FC
200 mm

0202-EG/0202-FC

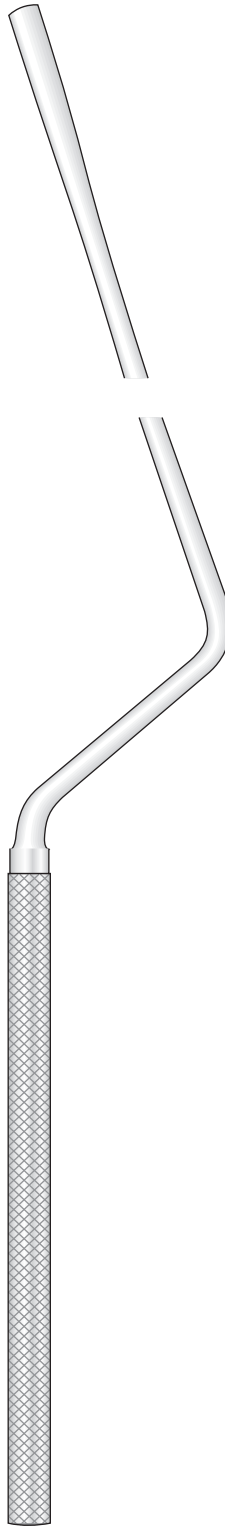

LANDOLT
0202-DI
250 mm

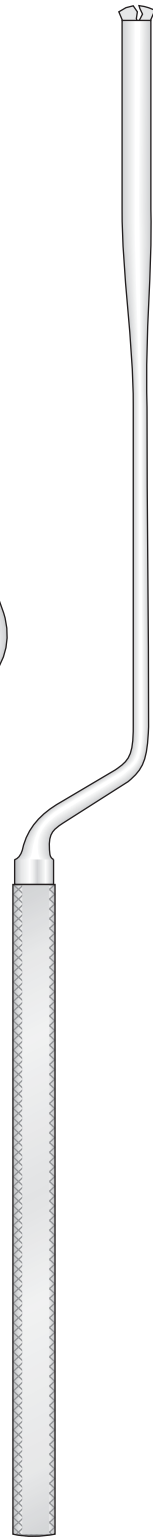

LANDOLT
0202-EA
210 mm

Packung mit 10 Stück - Package with 10 units
Confezione 10 pezzi - Paquete con 10 unidades
Boîte avec 10 lames

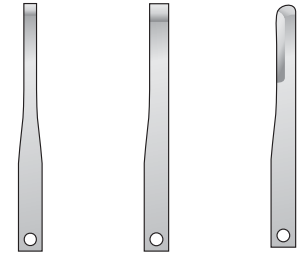

1102-DGB

1102-DGC

1102-DGE

Packung mit 10 Stück - Package with 10 units
Confezione 10 pezzi - Paquete con 10 unidades
Boîte avec 10 lames

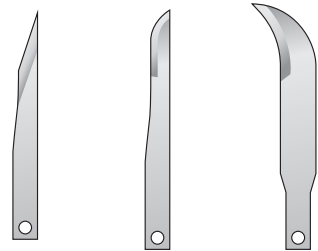

1102-DGF

1102-DGH

1102-DGI

Packung mit 1 Stück - Package with 1 unit
Confezione 1 pezzo - Paquete con 1 unidade
Boîte avec 1 lame

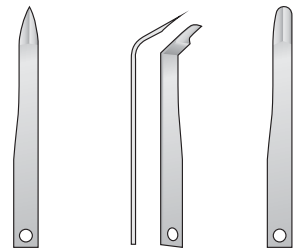

1102-DGD

1102-DGG

1102-DGL

Skalpellgriffe

Scapel Handles

Manici per bisturi

Mangos de bisturi

Manches pour bistouris

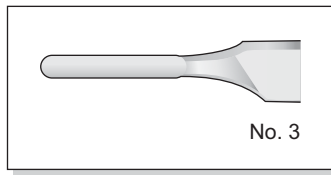

Packung mit 100 Stück - Package with 100 units
 Scatola da 100 pezzi - Paquete con 100 unidades
 Boîte avec 100 lames



1102-BA
Fig. 10



1102-BB
Fig. 11

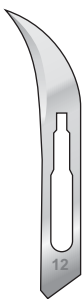

1102-BC
Fig. 12

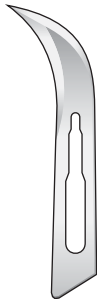

1102-BC04
Fig. 12D



1102-BD
Fig. 13



1102-BF
Fig. 15



1102-BF01
Fig. 15A



1102-BF03
Fig. 15C

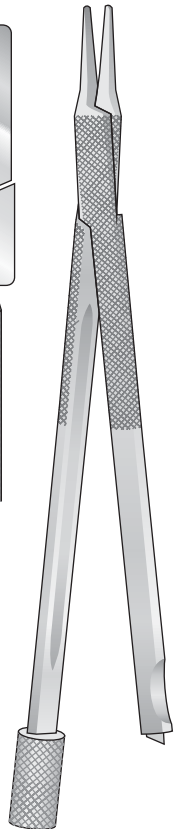
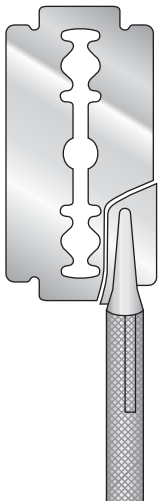

1310-BC
120 mm

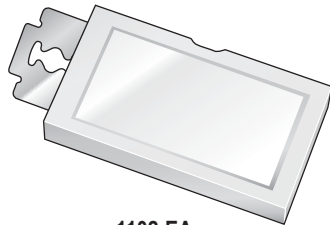

1102-EA
 Packung 10 Klengen
 Package 10 blades
 Scatola da 10 lame
 Cajita de 10 hojas
 Boîte de 10 lames



1201-02D
Fig. 3



1201-02H
Fig. 7

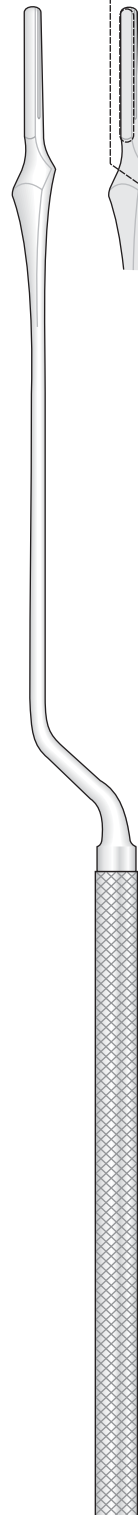
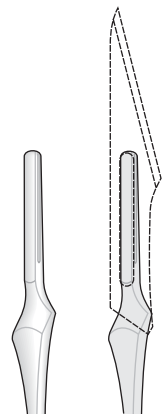

1201-02BF
210 mm

Dura Dissektoren
 Dura Dissectors
 Dissettori per Dura-Madre
 Disecadores para Dura-Madre
 Dissecteurs à Dure-Mère

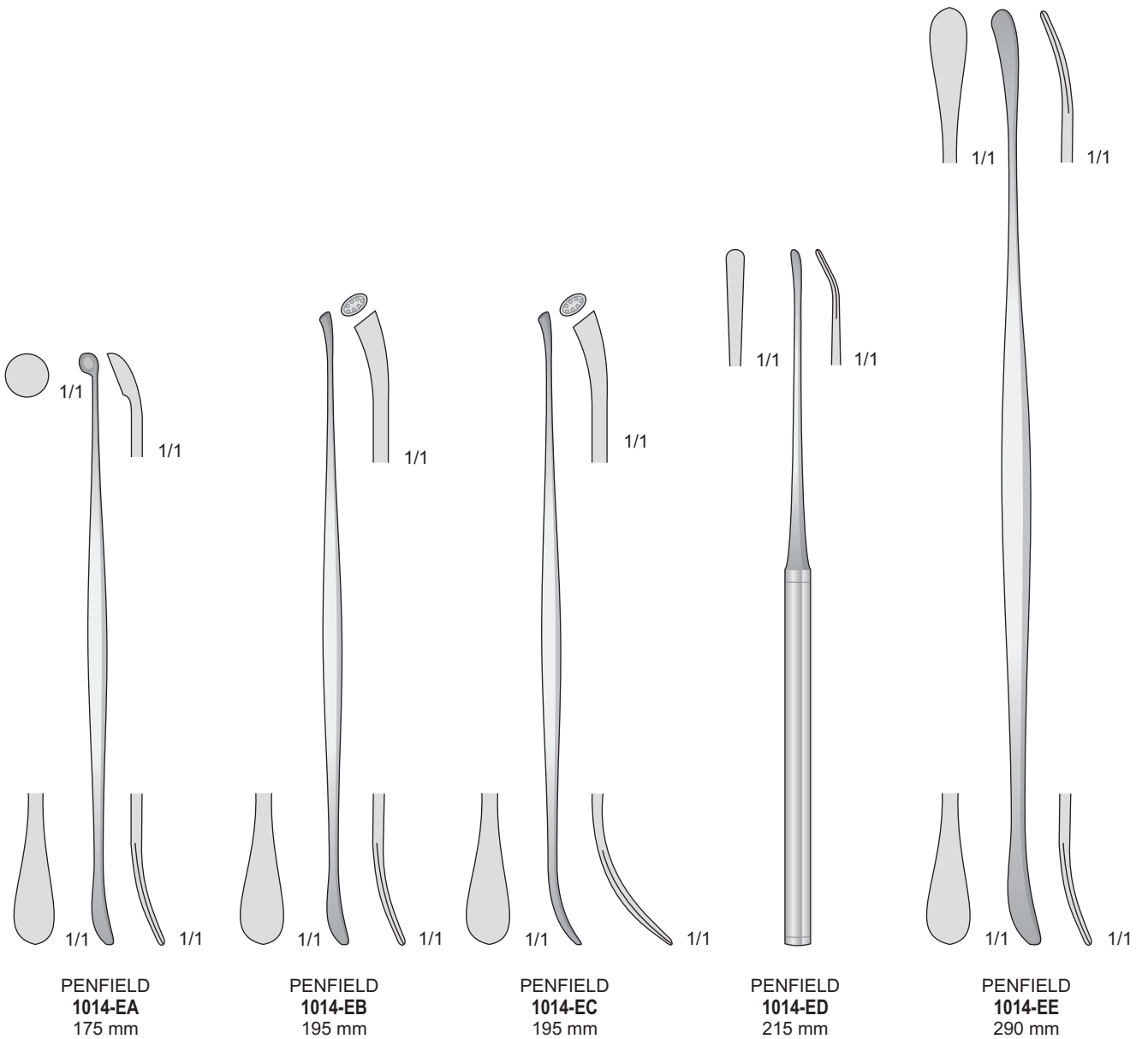

Raspatorien
Dissektoren

Raspatories
Dissectors

Raspatori
Dissettori

Legras
Disecadores

Rugines
Dissecteurs

Scharf/Stumpf - Sharp/Blunt
Tagliente/Smusso - Cortante/Romo
Tranchant/Mousse

Stumpf
Blunt
Smussa
3,3 mm

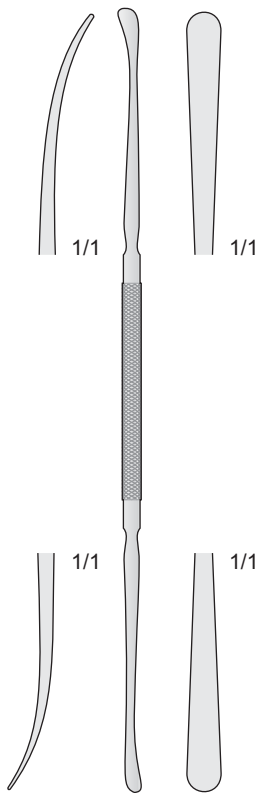

DAVIS
1014-CB
245 mm

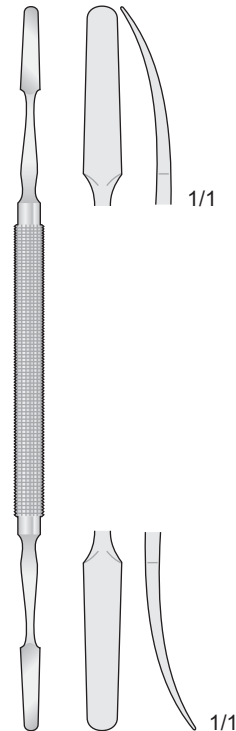

KILIAN
1014-BB
180 mm

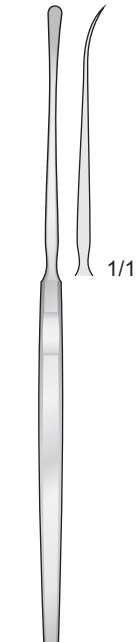

HALLE
1014-HC
180 mm

Scharf

Scharf

Scharf

Stumpf

4,5 mm

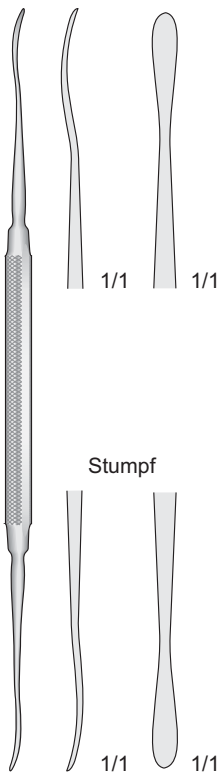

FREER
0617-BG
185 mm

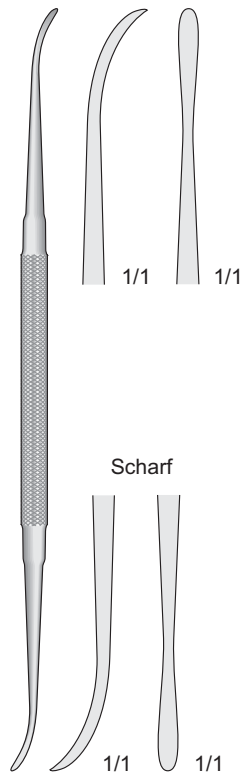

FREER-YASARGIL
0617-BH
185 mm

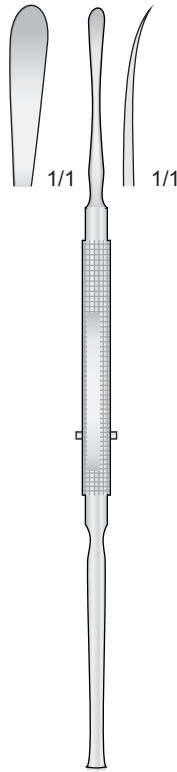

FREER
0617-GE
190 mm

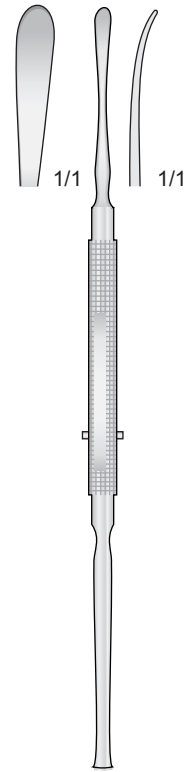

FREER
0617-GF
190 mm

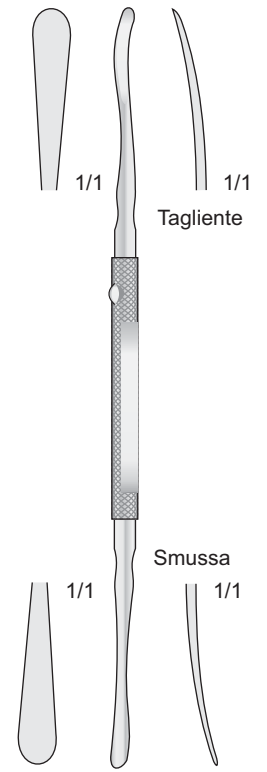

FREER
0617050517
180 mm

Raspatorien
Dissektoren

Raspatories
Dissectors

Raspatori
Dissettori

Legras
Disecadores

Rugines
Dissecteurs

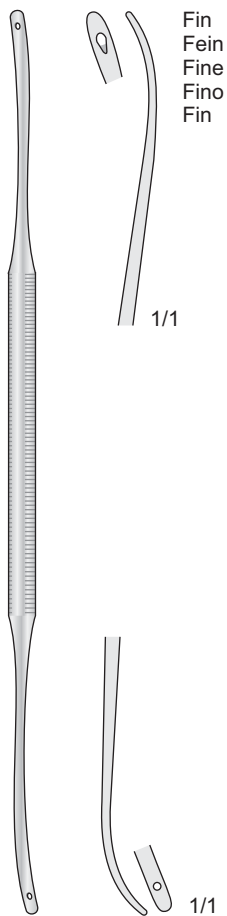

Fin
Fein
Fine
Fino
Fin

1014-BE - 180 mm
1014-BF - 240 mm

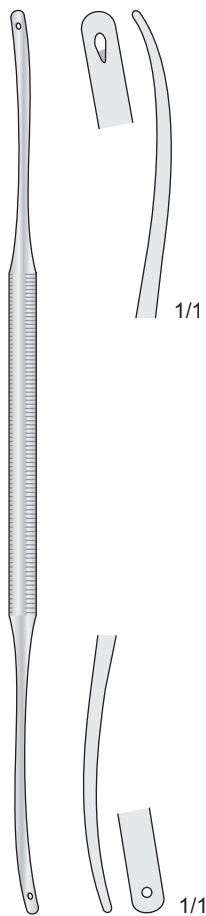

1014-BG - 180 mm
1014-BH - 240 mm

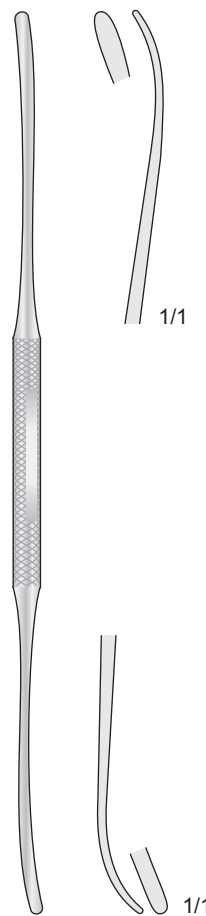

OLIVECRONA
1014-EH - 180mm
1014-EI - 240mm

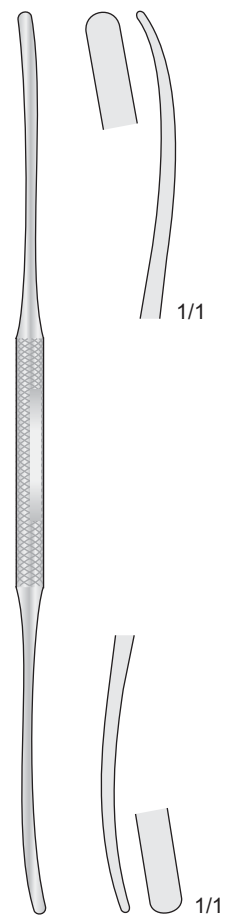

OLIVECRONA
1014-EL - 195mm
1014-FA - 240mm

Raspatorien
Dissektoren

Raspatories
Dissectors

Raspatori
Dissettori

Legras
Disecadores

Rugines
Dissecteurs

Hauthäkchen
Cutaneous hook
Uncini cutanei
Ganchos cutáneos
Erignes cutanées



COTTLE
0219-BLG
160 mm

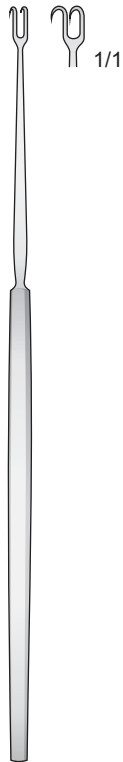

FREER
0219-CAA
150 mm

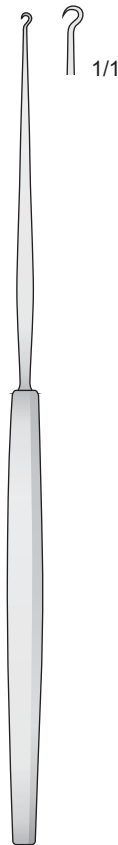

GILLIES
0219-BF
180 mm

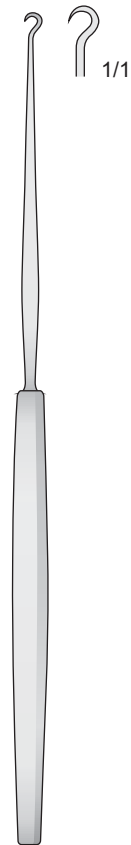

GILLIES
0219-BG
180 mm

Nervwulzer
-haken

Nerve root
Retractors

Uncini per le
radici dei nervi

Separadores de
raíz de nervios

Retracteurs pour
racines nerveuses

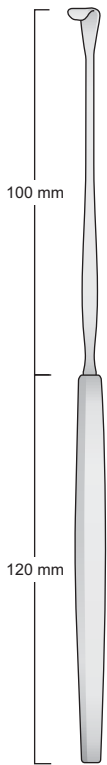

LOVE
0414-FG
220 mm

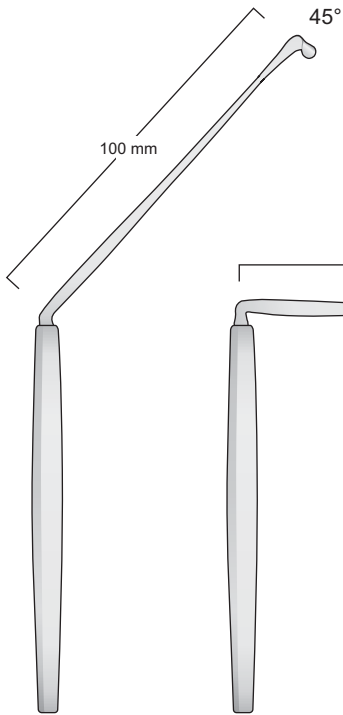

LOVE
0414-FH
205 mm

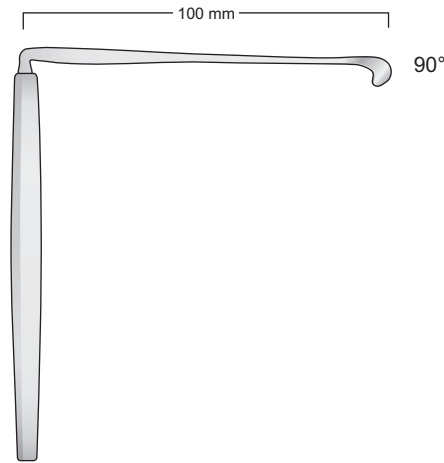

LOVE
0414-FI
120 mm

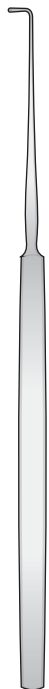

CUSHING
0219-CLG/0219-CLH
190 mm



0219-CLG 1/1



0219-CLH 1/1



CUSHING
0219-CLI/0219-CLL
280 mm



0219-CLI 1/1



0219-CLL 1/1



LOVE
0414-BHE
210 mm

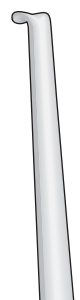

1/1

Nervhaken

Nerve Hooks

Uncini per nervi

Ganchos para nervios

Crochet à nerfs

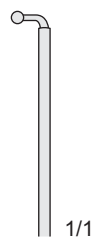

0219-DAA

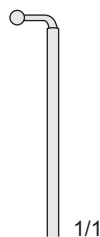

0219-DAB

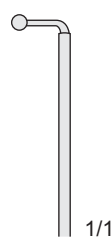

0219-DAC

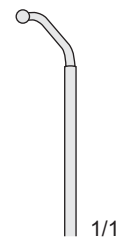

0219-DAD



CASPAR
0219-DAA/0219-DAD
245 mm

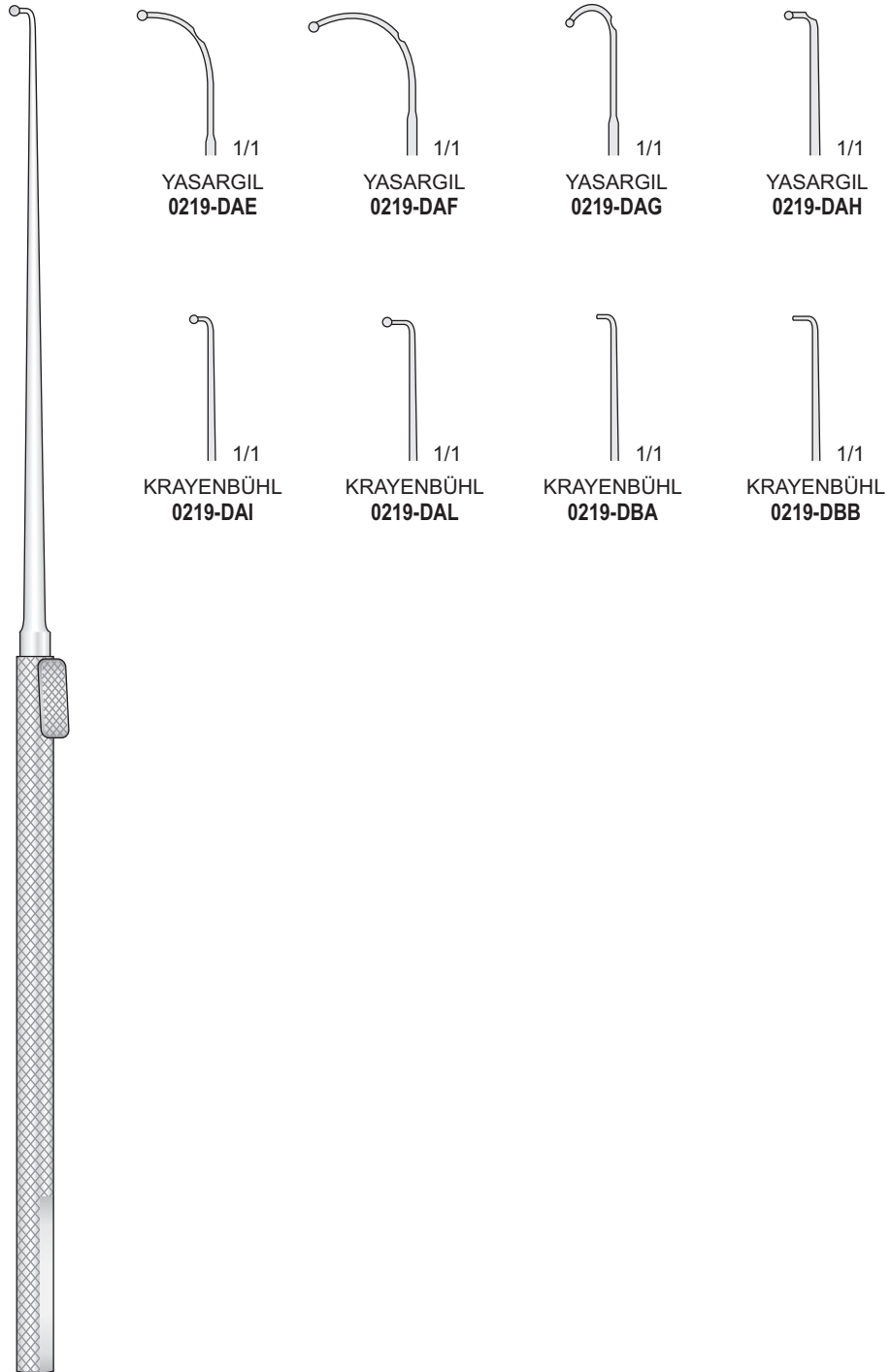

1/1
YASARGIL
0219-DAE

1/1
YASARGIL
0219-DAF

1/1
YASARGIL
0219-DAG

1/1
YASARGIL
0219-DAH

1/1
KRAYENBÜHL
0219-DAI

1/1
KRAYENBÜHL
0219-DAL

1/1
KRAYENBÜHL
0219-DBA

1/1
KRAYENBÜHL
0219-DBB

KRAYENBÜHL
0219-DAE/0219-DBB
185 mm

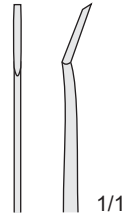

YASARGIL
0604-DDB
185 mm

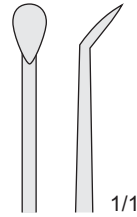

YASARGIL
0604-DDC
185 mm

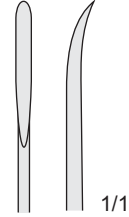

YASARGIL
0604-DDD
185 mm

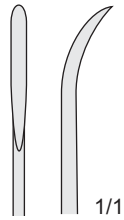

YASARGIL
0604-DDE
185 mm

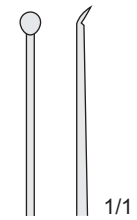

0604-DDF
230 mm

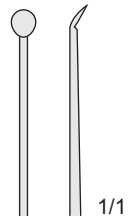

0604-DDG
230 mm

YASARGIL
0604-DDB/0604-DDG

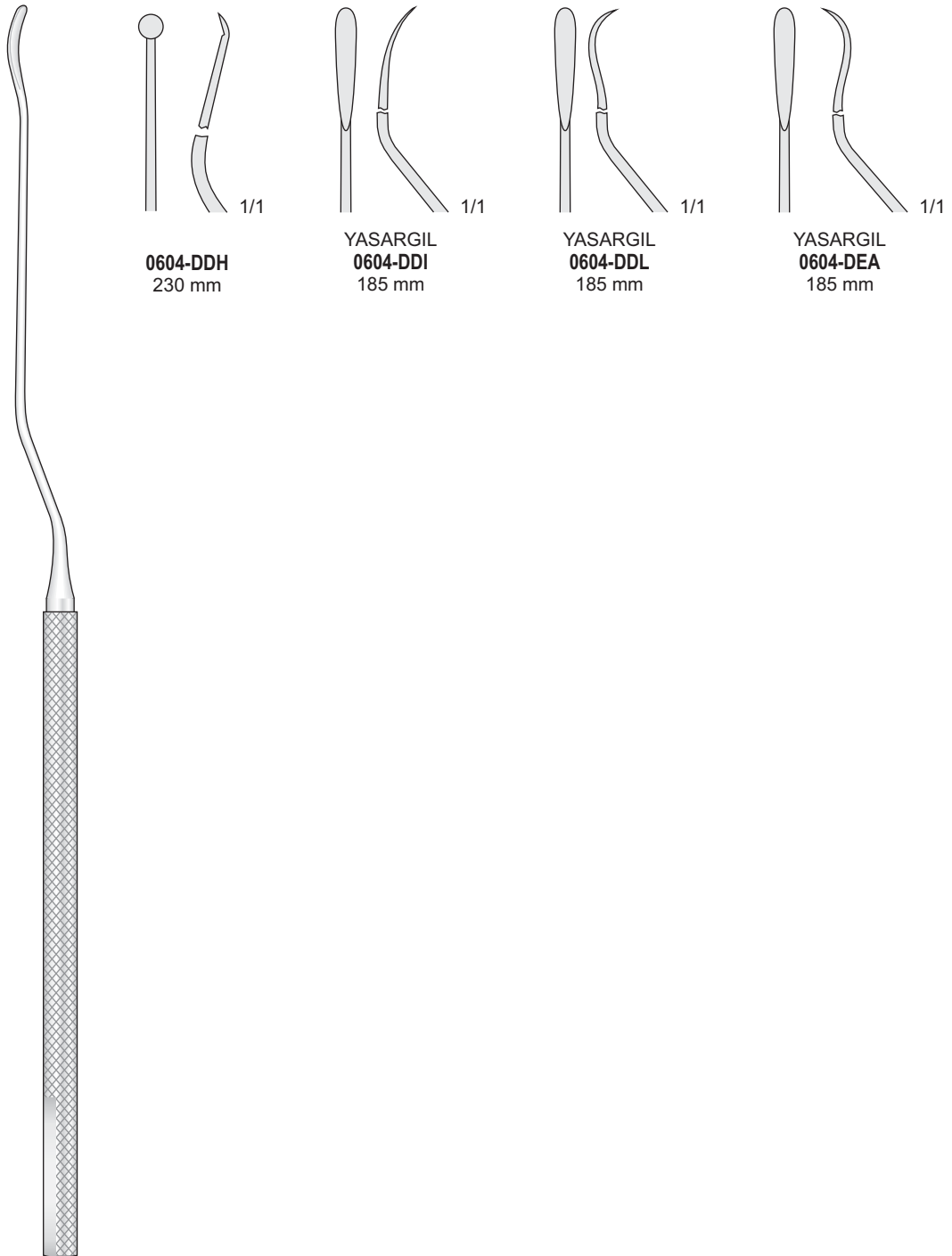

YASARGIL
0604-DDH/0604-DEA

Mikro-Löffel

Micro Scoops

Micro Curette

Micro Cucharillas

Micro Curettes

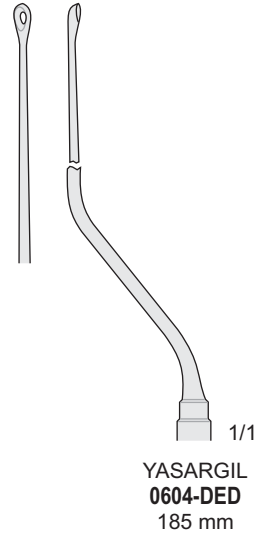
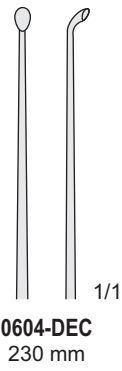
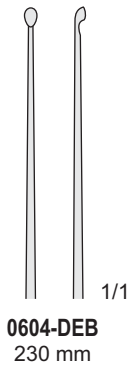

YASARGIL
0604-DEB/0604-DED



1/1

JACOBSON
0604-DEE
95 mm



1/1

0604-DEF
85 mm



Griff für auswechselbare
Gefäßmesser und Häkchen
Handle for interchangeable
Vessel Knives and Hooks
Manico intercambiabile
per uncini e coltelli

1201-I
125 mm

Mikro-Häkchen,
Micro-Gefäßmesser

Micro Hooks,
Micro Vessel Knives

Micro Uncini,
Micro Coltelli per vasi

Micro Ganchitos,
Micro Cuchillos para vasos

Micro Crochets,
Micro Couteaux pour vaisseaux



0604-DEH
230 mm

0604-DEI
230 mm

90°
0604-DEL
185 mm

Scharfen Häkchen
Sharp Hook
Uncino acuto

90°
FISCH
0604-DFA
185 mm

Scharfen Häkchen
Sharp Hook
Uncino acuto

1/1
JACOBSON
0604-DFB
185 mm

0604-DEH/0604-DFB

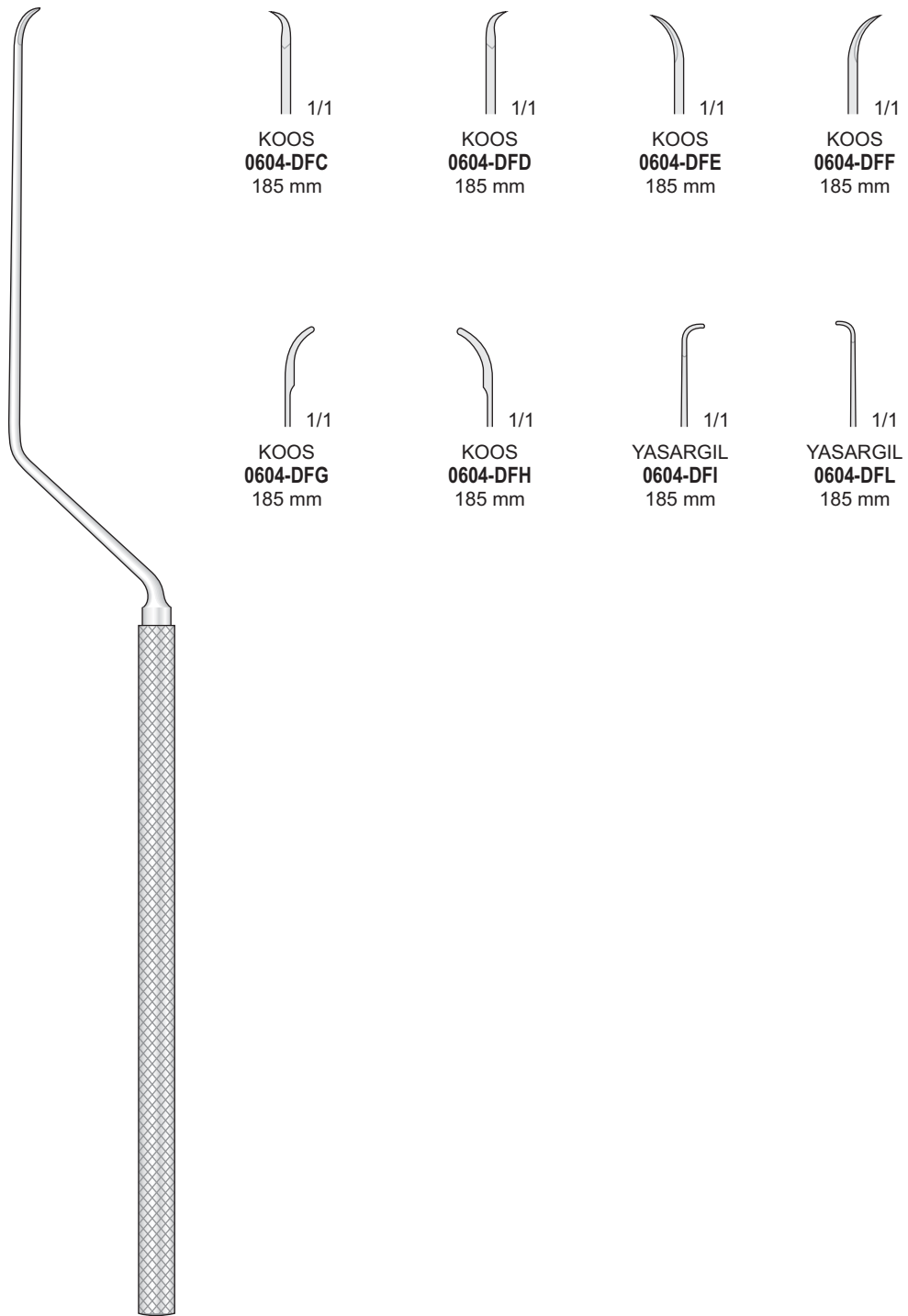

1/1
KOOS
0604-DFC
185 mm

1/1
KOOS
0604-DFD
185 mm

1/1
KOOS
0604-DFE
185 mm

1/1
KOOS
0604-DFE
185 mm

1/1
KOOS
0604-DFG
185 mm

1/1
KOOS
0604-DFH
185 mm

1/1
YASARGIL
0604-DFI
185 mm

1/1
YASARGIL
0604-DFL
185 mm

KOOS
0604-DFC/0604-DFL

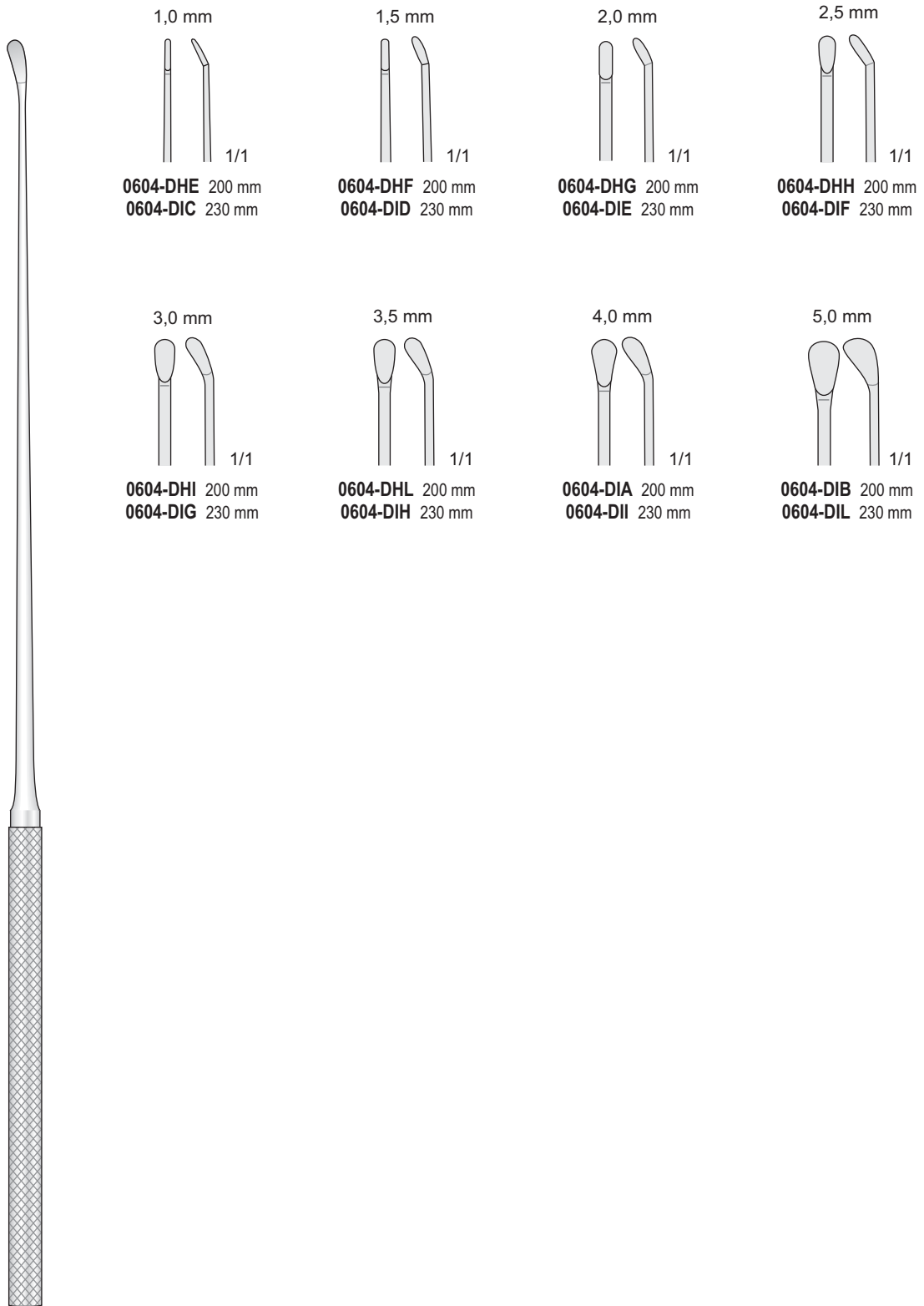

1,0 mm

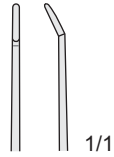

0604-DHE 200 mm
0604-DIC 230 mm

1,5 mm

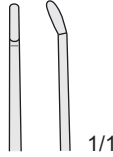

0604-DHF 200 mm
0604-DID 230 mm

2,0 mm

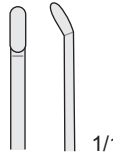

0604-DHG 200 mm
0604-DIE 230 mm

2,5 mm

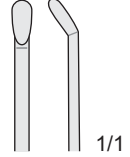

0604-DHH 200 mm
0604-DIF 230 mm

3,0 mm

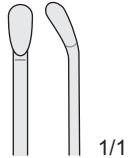

0604-DHI 200 mm
0604-DIG 230 mm

3,5 mm

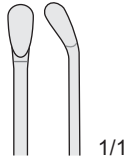

0604-DHL 200 mm
0604-DIH 230 mm

4,0 mm

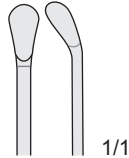

0604-DIA 200 mm
0604-DII 230 mm

5,0 mm

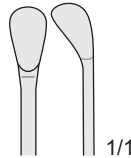

0604-DIB 200 mm
0604-DIL 230 mm

SAMII
0604-DHE/0604-DIL

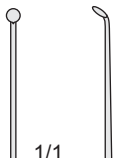

1,5 mm

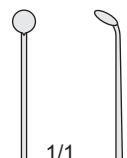
 1/1 1/1
0604-DLA 200 mm
0604-DLE 230 mm

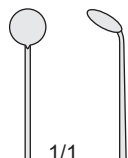
3,0 mm

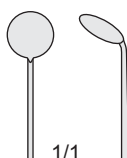
 1/1 1/1
0604-DLB 200 mm
0604-DLF 230 mm

4,5 mm

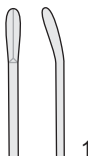
 1/1 1/1
0604-DLC 200 mm
0604-DLG 230 mm

6,0 mm

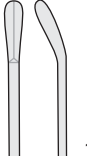
 1/1 1/1
0604-DLD 200 mm
0604-DLH 230 mm

Lanzettenmesser
 Lancet Knives

1,8 mm

 1/1
0604-DLI
 230 mm

2,5 mm

 1/1
0604-DLL
 230 mm

SAMII
 0604-DLA/0604-DLL

Mikro-Dissektoren

Micro Dissectors

Micro Dissettori

Micro Disecadores

Micro Dissecteurs

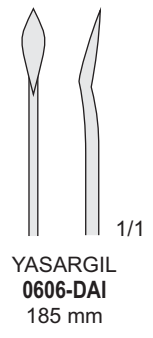
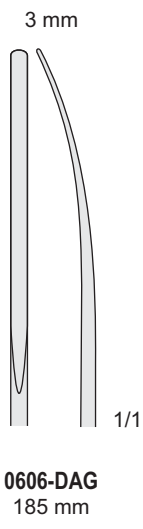
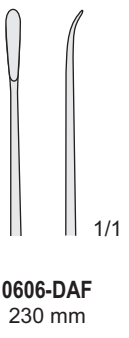
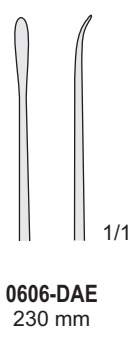
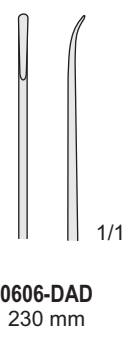
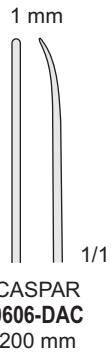
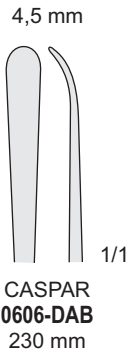

0606-DAB/0606-DAI

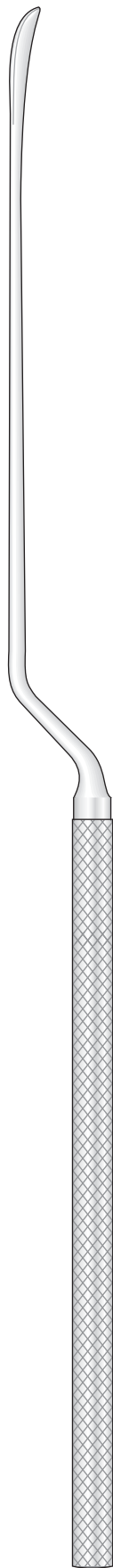

4,5 mm

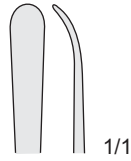

CASPAR
0606-DAL
230 mm

2 mm

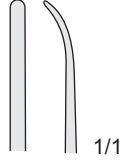

CASPAR
0606-DBA
230 mm

1 mm

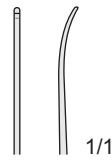

CASPAR
0606-DBB
210 mm

1 mm

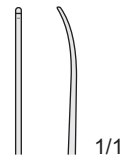

CASPAR
0606-DBC
210 mm

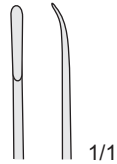

0606-DBD
230 mm

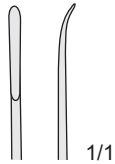

0606-DBE
230 mm

0606-DAL/0606-DBE

Fadengabel
Gewebekrallen

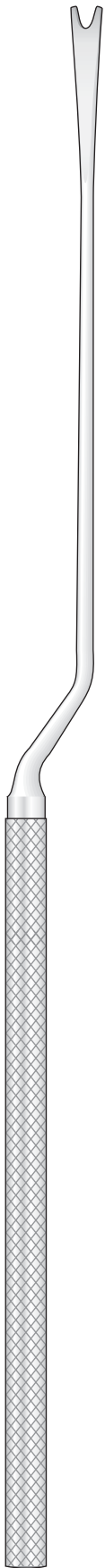

CASPAR
0606-DBF/0606-DBG

Suture Pusher
Tissue Picks

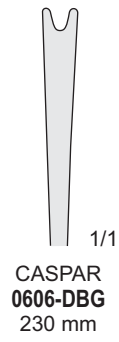

Strumenti da sutura
Elevatore per tessuti

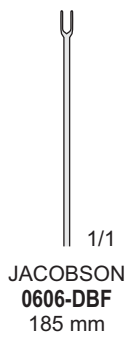

Horquilla de hilos
Elevador para tejidos



0604-DGG
185 mm

Ø 1,8 mm

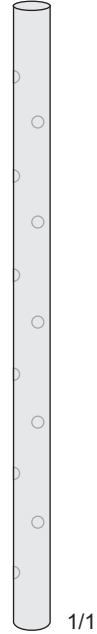
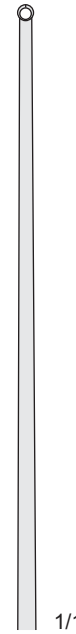

Schutzhülse zur Lagerung
und Sterilisation
Protector for Storing
and Sterilisation



3 mm

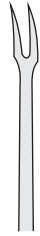

1/1

0606-DBH

4 mm



1/1

0606-DBI

5 mm



1/1

0606-DBL

8 mm



1/1

0606-DCA

OKONEK-YASARGIL
0606-DBH/0606-DCA
230 mm

Gefäßspreizer,
Gefäßdilatoren,
Knopfsonden

Vessel Spreader,
Vessel Dilators,
Vessel Probes

Dilatatori vascolari,
Sonda doppia

Dilatadores vasculares,
Sonda doble

Dilateurs vasculaires,
Sonde double

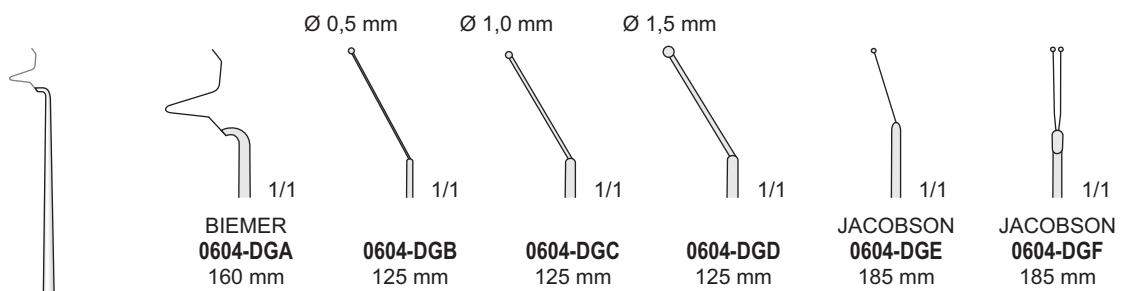

BIEMER
0604-DGA/0604-DGF

Anlegezange
für Clips

Appling Forceps
for Clips

Pinze per
applicare Clips

Pinza para
juntar clips

Pince pour
poser les clips

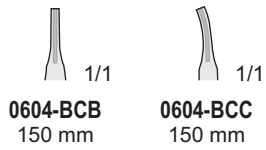
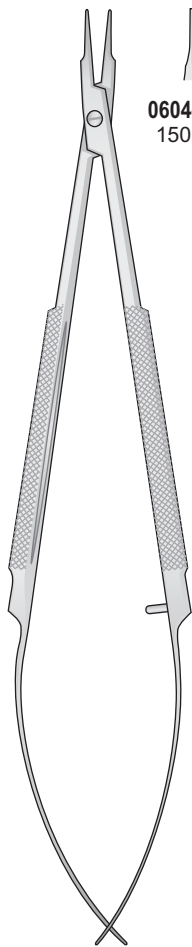

BARRAQUER
0604-BCB/0604-BCC
150 mm

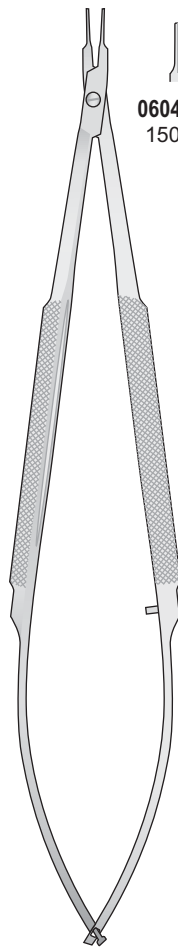

BARRAQUER
0604-BGF/0604-BGG
150 mm

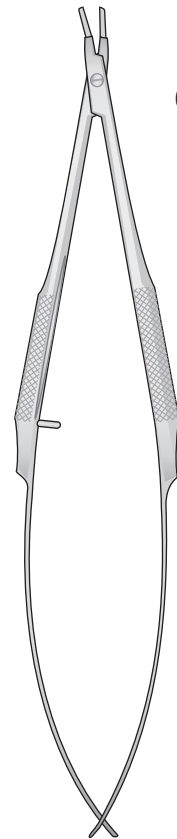

BARRAQUER
0604-BGL
135 mm

Mikro-Gefäßclips

Micro Vessel Clips

Micro Clips vascolari

Micro Clips Vasculares

Micro Clips vasculaires

8 mm



Ø Gefäß / Vessel
0,4 - 1,0 mm

Einzelklemmen
Single Clamp
Clip solo
Clip suelto
Clip simple



Vein - Vene
Artery - Arterie

0605-CB
0605-CC

Einzelklemmen
Single Clamp
Clip solo
Clip suelto
Clip simple



0605-CH
0605-CI

Approximator
Approximator
Approssimatore
Aproximador
Aproximateur



0605-DH
0605-DI

Approximator
Approximator
Approssimatore
Aproximador
Aproximateur



0605-ED
0605-EE

Doppelklemmen
Double Clamp
Clip doppio
Clip doble
Clip double



0605-EL
0605-FA

11 mm

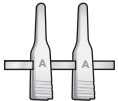

Ø Gefäß / Vessel
0,6 - 1,5 mm



Vein - Vene
Artery - Arterie

0605-CD
0605-CE



0605-CL
0605-DA



0605-DL
0605-EA



0605-EF
0605-EG

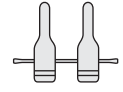

0605-FB
0605-FC

17 mm

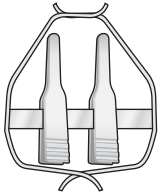

Ø Gefäß / Vessel
1,0 - 2,25 mm



Vein - Vene
Artery - Arterie

0605-CF
0605-CG



0605-DB
0605-DC

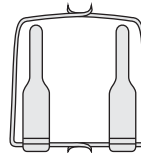

0605-EB
0605-EC

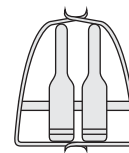

0605-EH
0605-EI

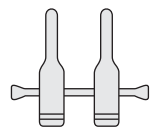

0605-FD
0605-FE

25 mm



Ø Gefäß / Vessel
1,5 - 3,5 mm



Vein - Vene
Artery - Arterie

0605-DD
0605-DE

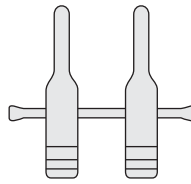

0605-FF
0605-FG

Klemmen-Anlegepinzette
Clamp Applying Forceps
Pinzetta per applicare clips
Pinzas para aplicar clips
Pinces pour poser les clips



36 mm



Ø Gefäß / Vessel
2,0 - 5,0 mm



Vein - Vene
Artery - Arterie

0605-DF
0605-DG

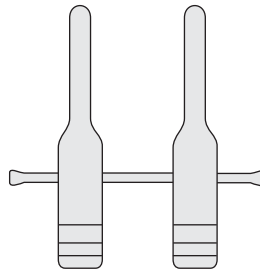

0605-FH
0605-FI

0605-FL mit Schloß, with lock
0605-GA ohne Schloß, without lock
140 mm

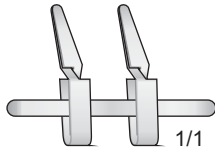

BIEMER-MÜLLER
0604-FAH/0604-FBB

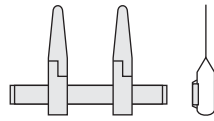

0604-FAH 5,0 mm 9,0 mm 25-30 gr.

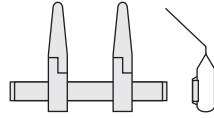

0604-FAI 5,0 mm 9,0 mm 25-30 gr.

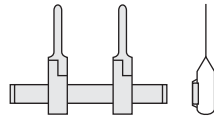

0604-FAL 5,0 mm 9,0 mm 25-30 gr.

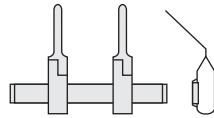

0604-FBA 5,0 mm 9,0 mm 25-30 gr.

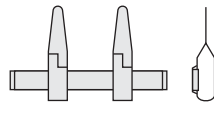

0604-FBB 3,5 mm 4,5 mm 25-30 gr.

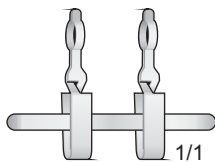

MÜLLER
0604-FBC/0604-FBF

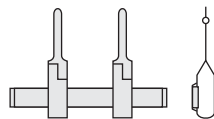

0604-FBC Ø 1,0 mm 25-30 gr.

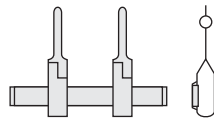

0604-FBD Ø 2,0 mm 25-30 gr.

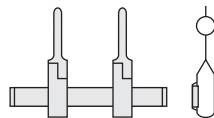

0604-FBE Ø 3,0 mm 25-30 gr.

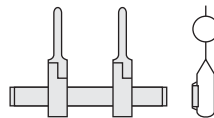

0604-FBF Ø 4,0 mm 25-30 gr.

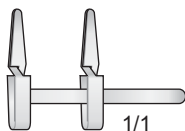

BIEMER
0604-FBH

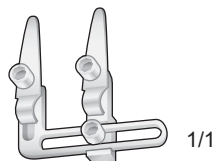

0604-FBI

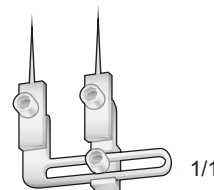

BIEMER
0604-FBL

0604-FBG

Approximator mit Anlegepinzette
Approximator with Applying forceps

0604-FBH

Approximator allein
Approximator only

0604-FBI

Approximator mit Schlüssel
Approximator with key

0604-FBL

Approximator mit Schlüssel
Approximator with key

0604-FCA

1 Paar Ersatznadeln
1 Pair of spare needles



BIEMER
0604-FAA/0604-FAC



0604-FAA 4,0 mm 6,0 mm 30-40 gr.



0604-FAB 5,0 mm 9,0 mm 30-40 gr.



0604-FAC 5,0 mm 9,0 mm 20-25 gr.



MEHDORN
0604-FAD/0604-FAG



0604-FAD 4 x 1,0 mm 10-15 gr.



0604-FAE 4 x 1,4 mm 15-20 gr.

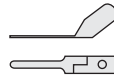

0604-FAF 6 x 1,0 mm 10-15 gr.

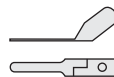

0604-FAG 6 x 1,4 mm 15-20 gr.

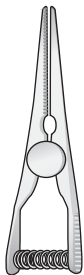

1/1

0602-IE
35 mm

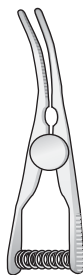

1/1

FB-85
35 mm

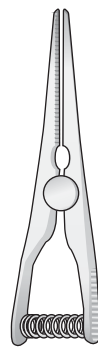

1/1

0602-IG
45 mm

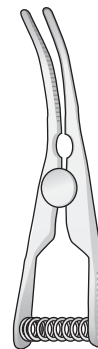

1/1

0602-IH
45 mm

Bulldogklemmen

Bulldog Clamps

Clamps Bulldog

Clamps Bulldog

Clamps Bulldog

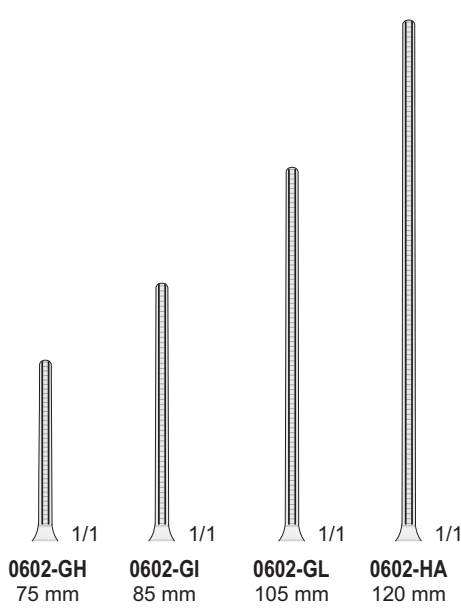

0602-GH/0602-HA

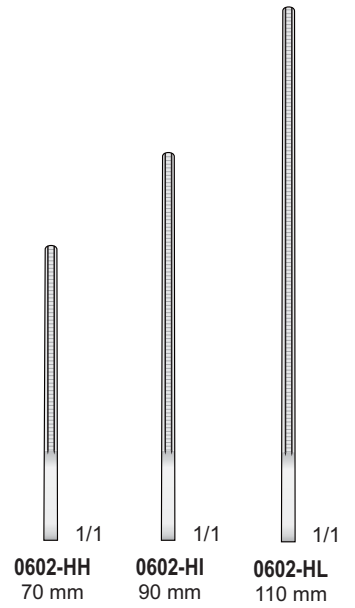
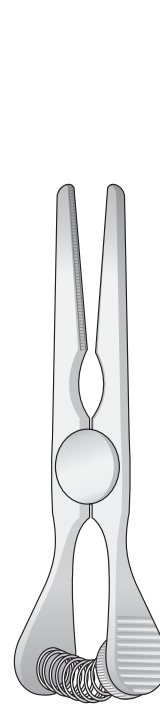

GLOVER
0602-HG/0602-HL

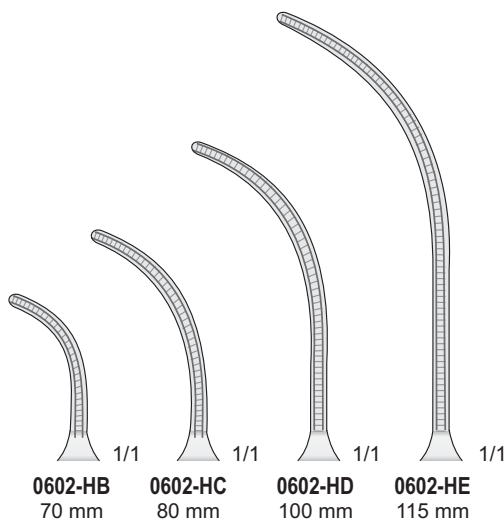
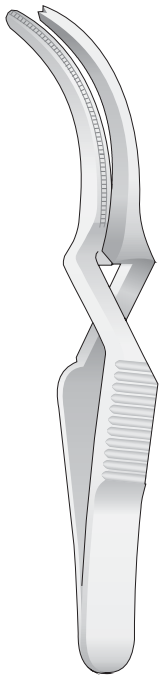

0602-HB/0602-HE

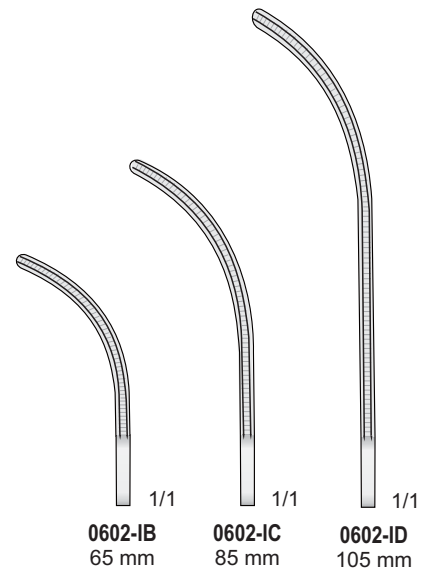
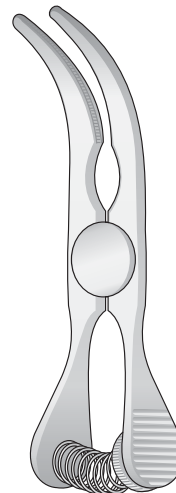

GLOVER
0602-IA/0602-ID

Fine-Arterienklemmen

Fine
Haemostatic Forceps

Pinze emostatiche
delicate

Pinzas hemostáticas
fino

Delicate
Pincés hémostatiques

Titan - Titanium - Titanio - Titane

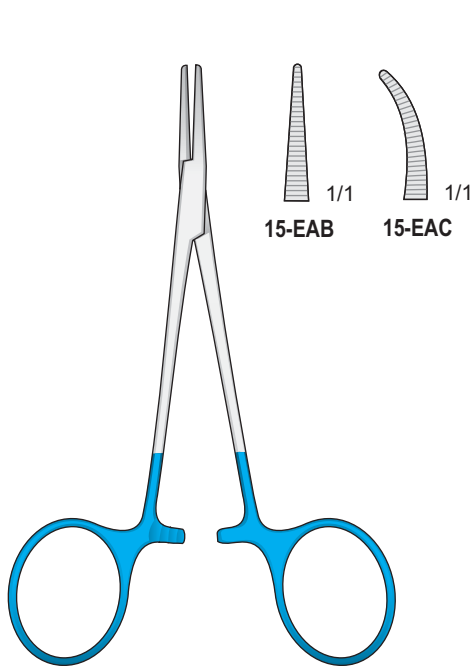

HALSTED-MOSQUITO
15-EAB/15-EAC
120 mm

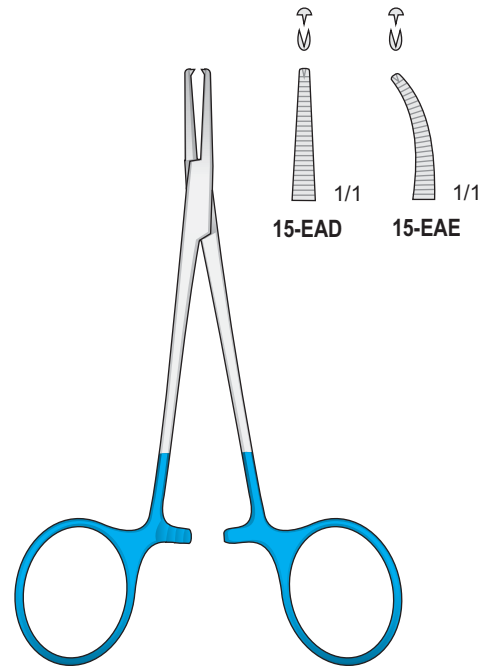

HALSTED-MOSQUITO
15-EAD/15-EAE
120 mm

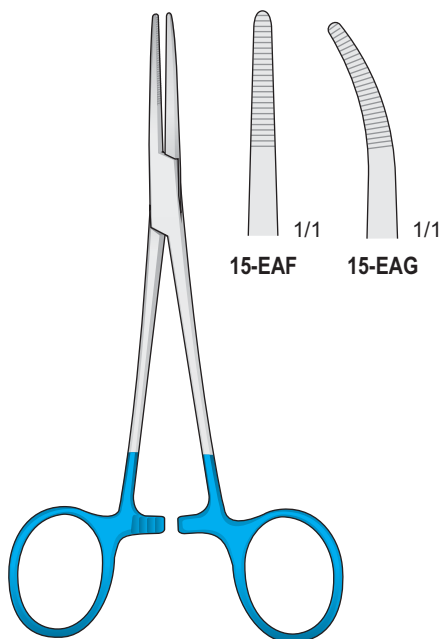

KELLY
15-EAF/15-EAG
140 mm

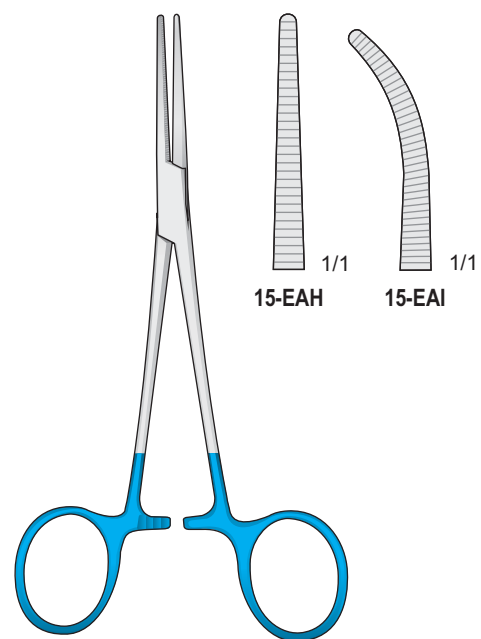

CRILE
15-EAH/15-EAI
140 mm

LEYLA Retractor System

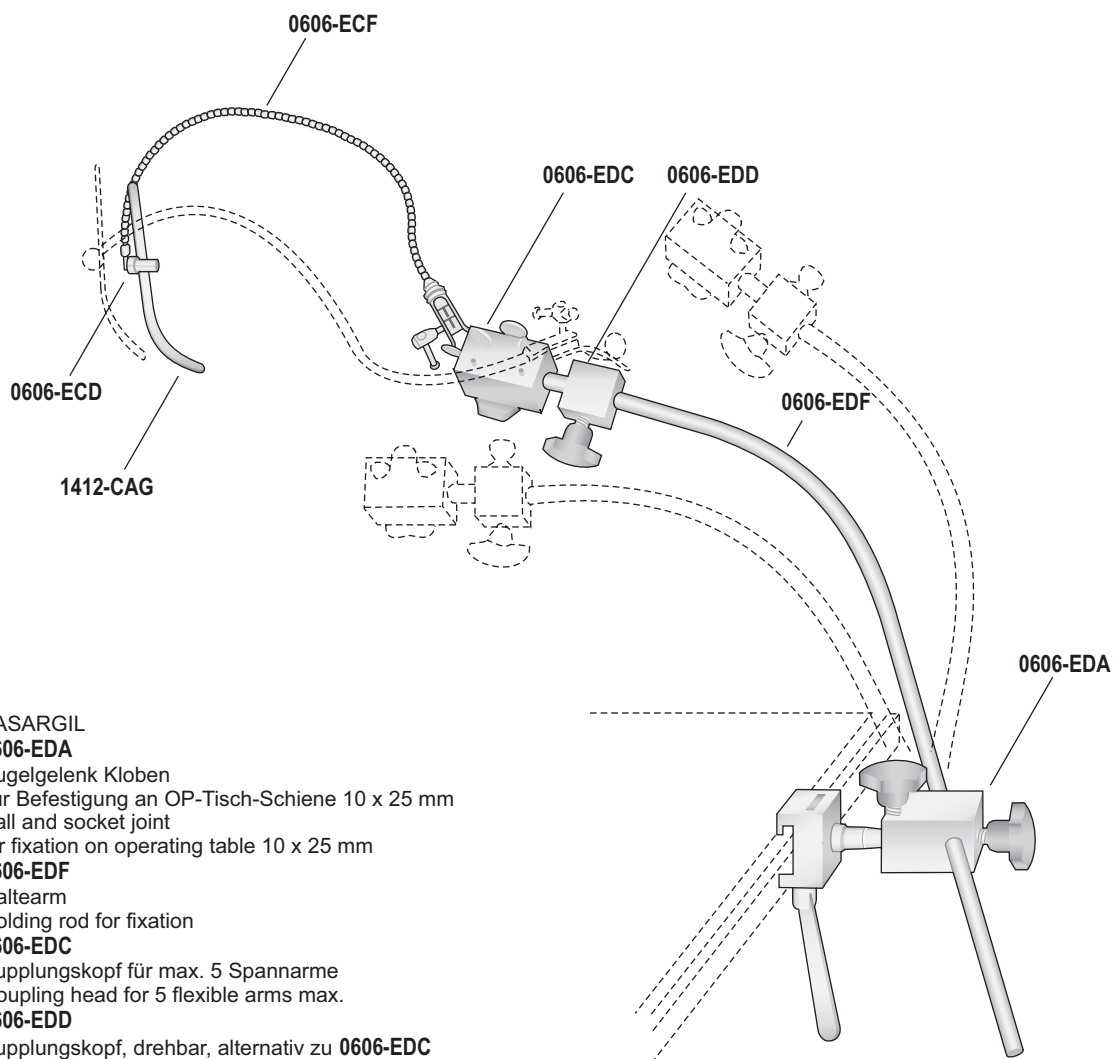

YASARGIL

0606-EDA

Kugelgelenk Kloben
zur Befestigung an OP-Tisch-Schiene 10 x 25 mm
Ball and socket joint
for fixation on operating table 10 x 25 mm

0606-EDF

Haltearm
Holding rod for fixation

0606-EDC

Kupplungskopf für max. 5 Spannarme
Coupling head for 5 flexible arms max.

0606-EDD

Kupplungskopf, drehbar, alternativ zu **0606-EDC**
Coupling head, turnable, alternative to **0606-EDC**

0606-EDE

Kupplungskopf, seitlich offen, alternativ zu **0606-EDC**
Coupling head, laterally open, alternative to **0606-EDC**

0606-ECF

Flexibler Spannarm
Flexible arm

0606-ECD

Halter für flache Hirnspatel
Holder for flat brain spatula

1412-CAG

Hirnspatel
Brain spatula

LEYLA Retractor System

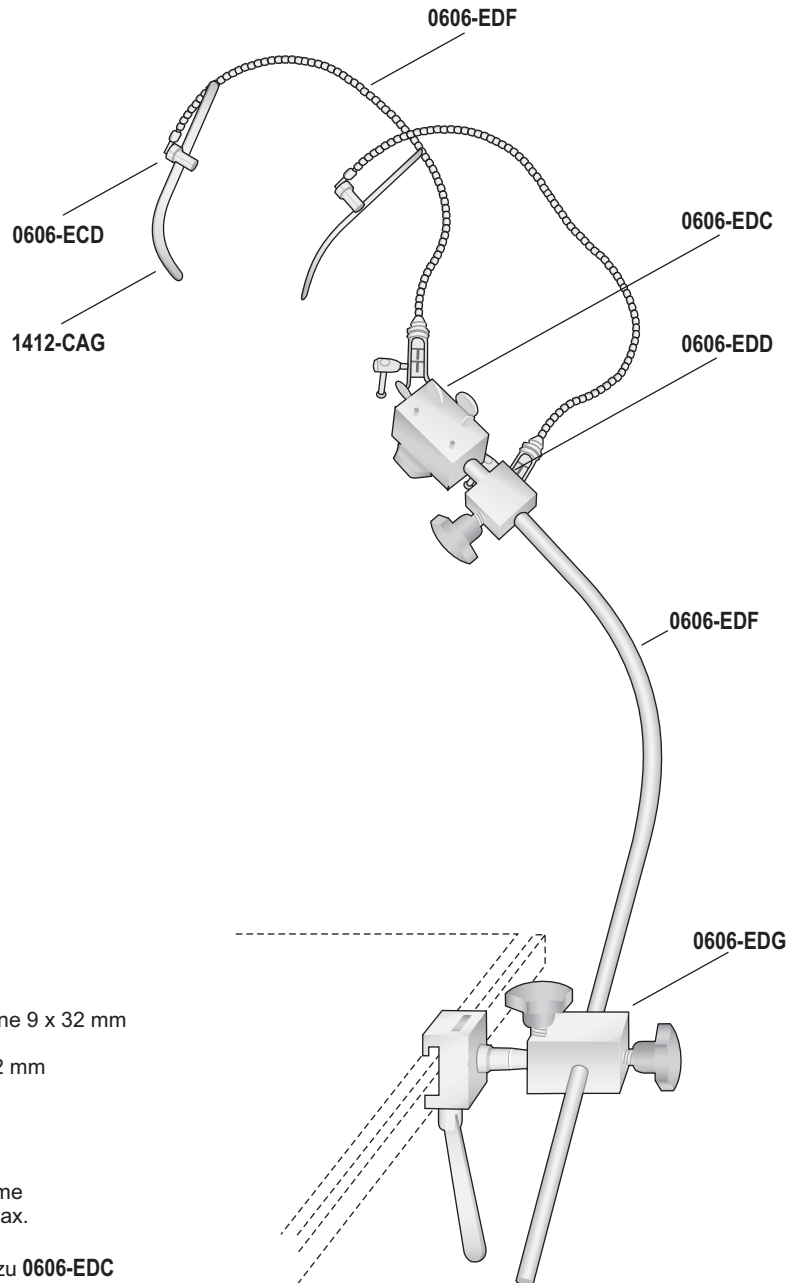

YASARGIL

0606-EDG

Kugelgelenk Kloben
zur Befestigung an OP-Tisch-Schiene 9 x 32 mm
Ball and socket joint
for fixation on operating table 9 x 32 mm

0606-EDF

Haltearm
Holding rod for fixation

0606-EDC

Kupplungskopf für max. 5 Spannarme
Coupling head for 5 flexible arms max.

0606-EDD

Kupplungskopf, drehbar, alternativ zu **0606-EDC**
Coupling head, turnable, alternative to **0606-EDC**

0606-EDE

Kupplungskopf, seitlich offen, alternativ zu **0606-EDC**
Coupling head, laterally open, alternative to **0606-EDC**

0606-ECF

Flexibler Spannarm
Flexible arm

0606-ECD

Halter für flache Hirnspatel
Holder for flat brain spatula

1412-CAG

Hirnspatel
Brain spatula

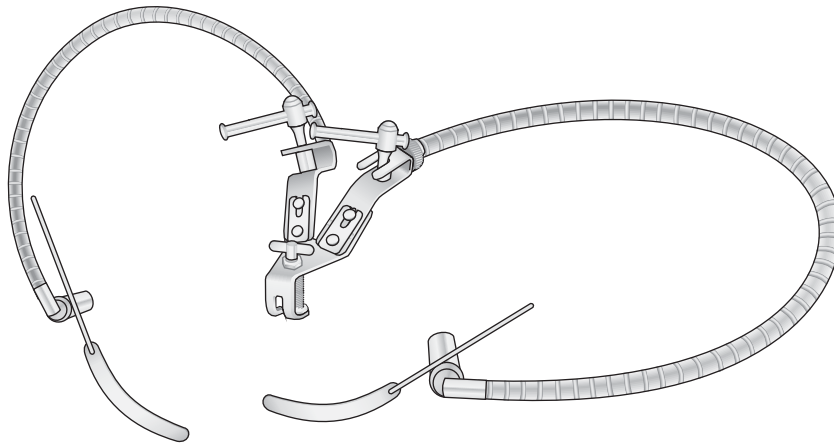

0606-ECA

Hirnspatelhalter, flexibel, für flache Spatel, mit 1 Spannarm, komplett, bestehend aus: Brain retractor, k flexible, for flat spatula, with 1 flexible arm, complete, consisting of:

0606-ECH

Fixiervorrichtung für 1 Spannarm
Fixation base for 1 flexible arm

0606-ECF

Spannarm
Flexible arm only

0606-ECD

Spatelhalter für flache Spatel
Support for flat brain spatulas

YASARGIL

0606-ECC

Hirnspatelhalter, flexibel, für flache Spatel, mit 2 Spannarm, komplett, bestehend aus: Brain retractor, k flexible, for flat spatula, with 2 flexible arm, complete, consisting of:

0606-ECI

Fixiervorrichtung für 2 Spannarm
Fixation base for 2 flexible arm

0606-ECF

Spannarm (2x)
Flexible arm only (2x)

0606-ECD

Spatelhalter für flache Spatel (2x)
Support for flat brain spatulas (2x)

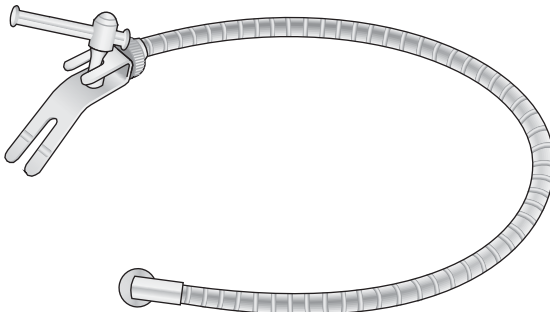

YASARGIL

0606-ECF

Flexibler Spannarm allein
Flexible arm only

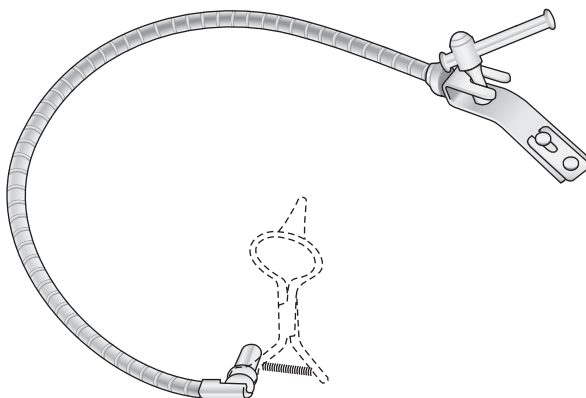

YASARGIL

0606-ECB

Ohrspekulahalter komplett, bestehend aus: Ear specula holder complete, consisting of:

0606-ECF

Spannarm allein
Flexible arm only

0606-ECG

Fixiervorrichtung zum befestigen an Rohrteilen bis Ø 16 mm
Clamp for fixation on bars up to 16 mm

0606-ECL

Ohrtrichterhalter allein
Ear specula holder only

LEYLA Zubehör
Spatel

LEYLA Accessories
Spatulas

LEYLA Accessori
Spatole

LEYLA Accesorios
Espatulas

LEYLA Accessoires
Spatules

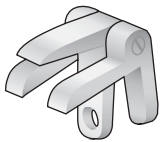

0606-ECD

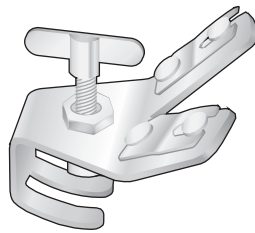

0606-ECI

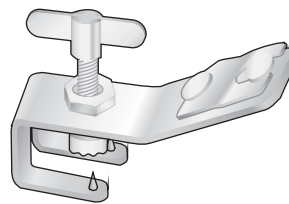

0606-ECH

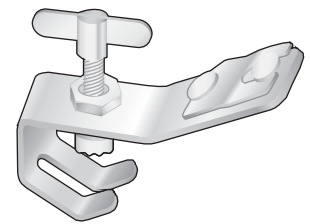

0606-ECG



1412-CAB 7 mm + 9 mm
1412-CAC 11 mm + 13 mm
1412-CAD 15 mm + 18 mm
1412-CAE 18 mm + 22 mm

CUSHING
1412-CAB/1412-CAE
180 mm

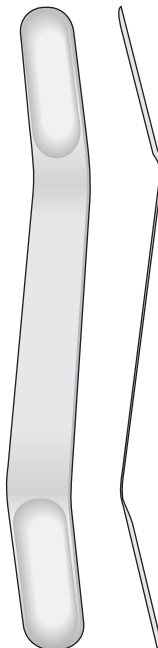

1412-CAI 7 mm + 9 mm
1412-CAL 11 mm + 13 mm
1412-CBA 15 mm + 18 mm
1412-CBB 18 mm + 22 mm

OLIVECRONA
1412-CAI/1412-CBB
180 mm

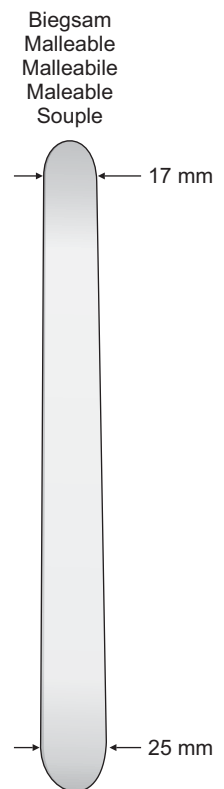

TUFFIER
1412-LL
200 mm

1412-IF
 Komplettsset mit 3 Spatel
 Set complete with 3 spatulas
 Set completo con 3 spatole
 Set completos con 3 espátulas
 Set complete avec 3 spatules
1412-IA + OM-81 + OM-82

Biegsam - Malleable - Malleabili
 Maleables - Souples

18 mm



22 mm

1412-IA
200 mm

14 mm



16 mm

1412-IB
200 mm

5 mm

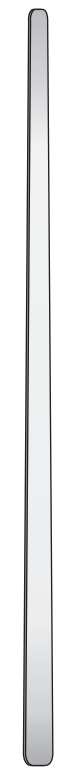

8 mm

1412-IC
240 mm

Rostfrei - Stainless Steel - Acciaio - Acero - Acer
 Biegsam - Malleable - Malleabili - Maleables - Souples

18 mm



22 mm

1412-IH
200 mm

14 mm

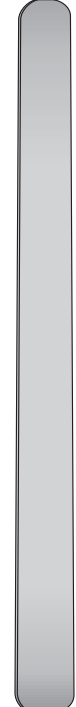

16 mm

1412-II
200 mm

Schwarz Verchromt
 Black anodized
 Cromato nero
 Cromado en negro
 Chromé noir

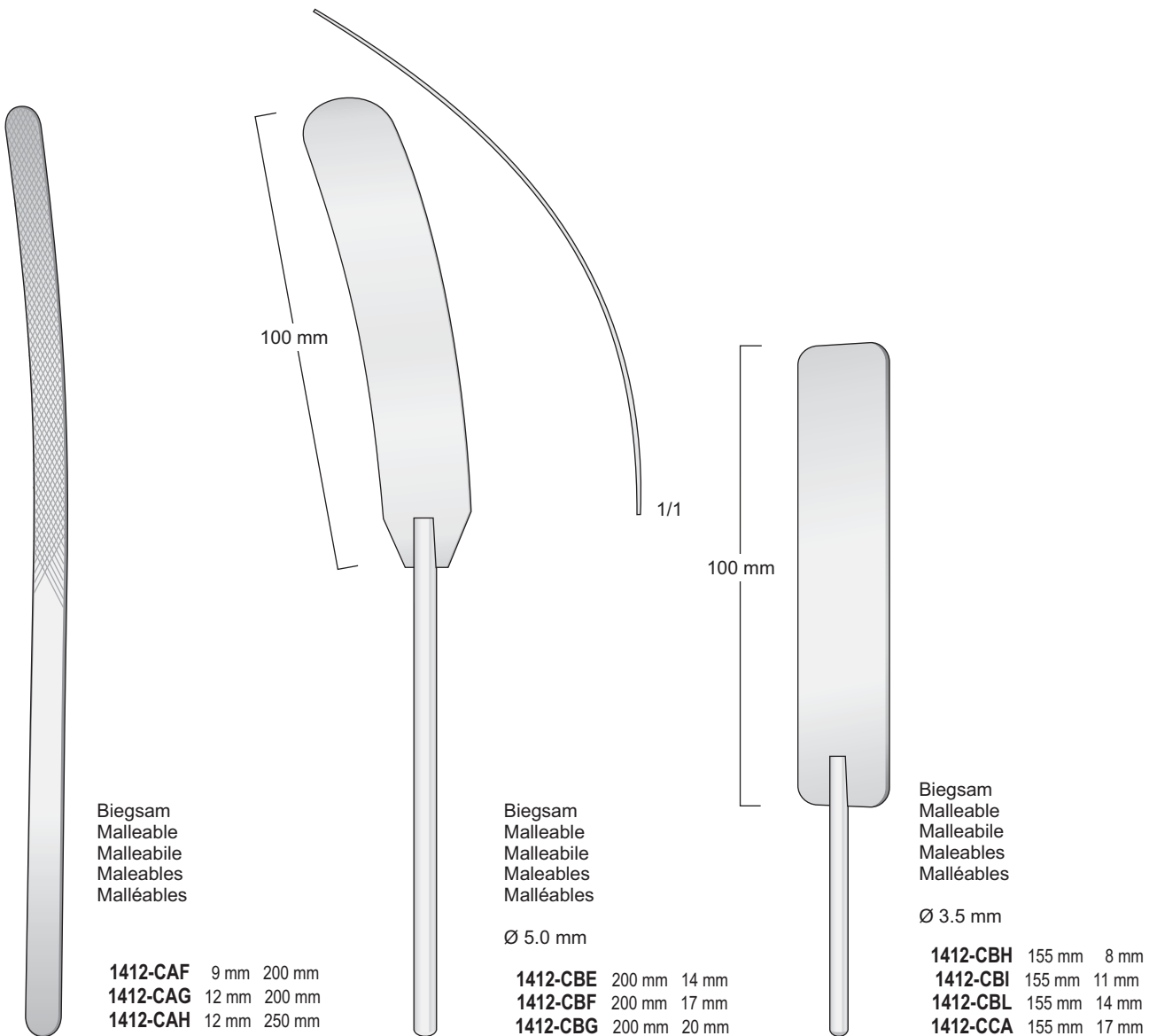

Biegsam
Malleable
Malleabile
Maleables
Malléables

1412-CAF 9 mm 200 mm
1412-CAG 12 mm 200 mm
1412-CAH 12 mm 250 mm

Biegsam
Malleable
Malleabile
Maleables
Malléables

Ø 5.0 mm

1412-CBE 200 mm 14 mm
1412-CBF 200 mm 17 mm
1412-CBG 200 mm 20 mm

Biegsam
Malleable
Malleabile
Maleables
Malléables

Ø 3.5 mm

1412-CBH 155 mm 8 mm
1412-CBI 155 mm 11 mm
1412-CBL 155 mm 14 mm
1412-CCA 155 mm 17 mm

1412-CAF/1412-CAH

HEIFETZ
1412-CBE/1412-CBG

HEIFETZ
1412-CBH/1412-CCA

Nervwurzelhaken

Nerve Root Retractors

Retrattori da radice

Separadores de raíz de nervios

Retracteurs pour racines nerveuses

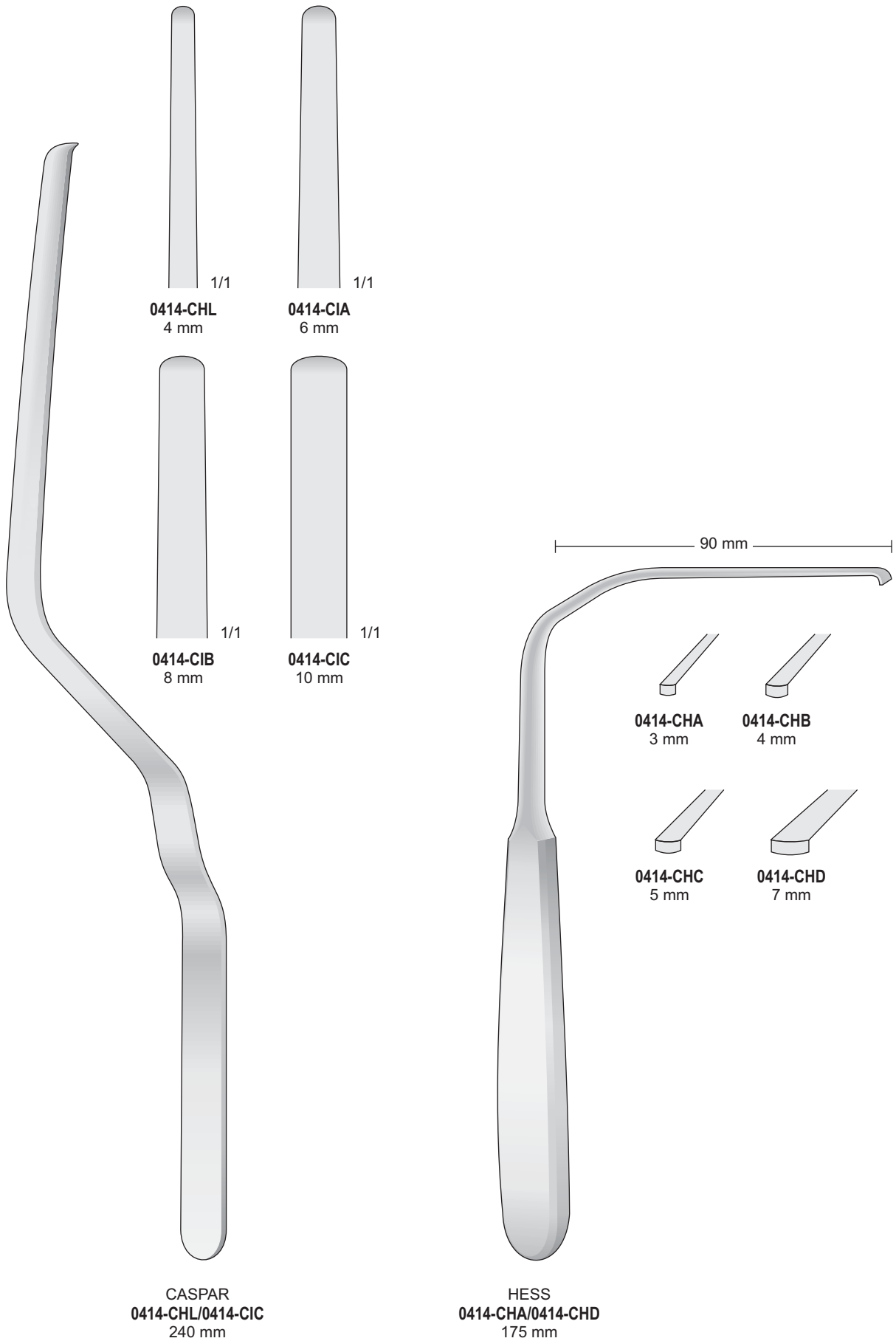

CASPAR
0414-CHL/0414-CIC
240 mm

HESS
0414-CHA/0414-CHD
175 mm

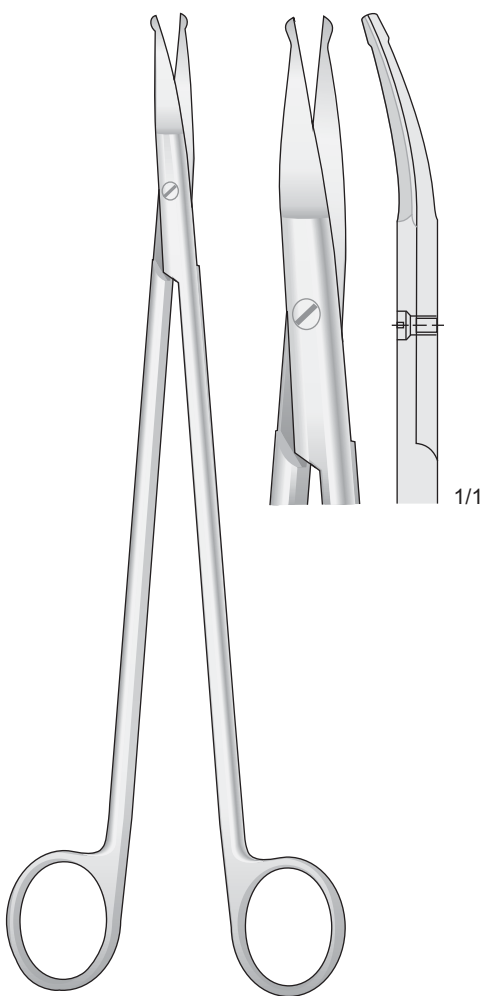

STRULLY
0607-BAH
220 mm

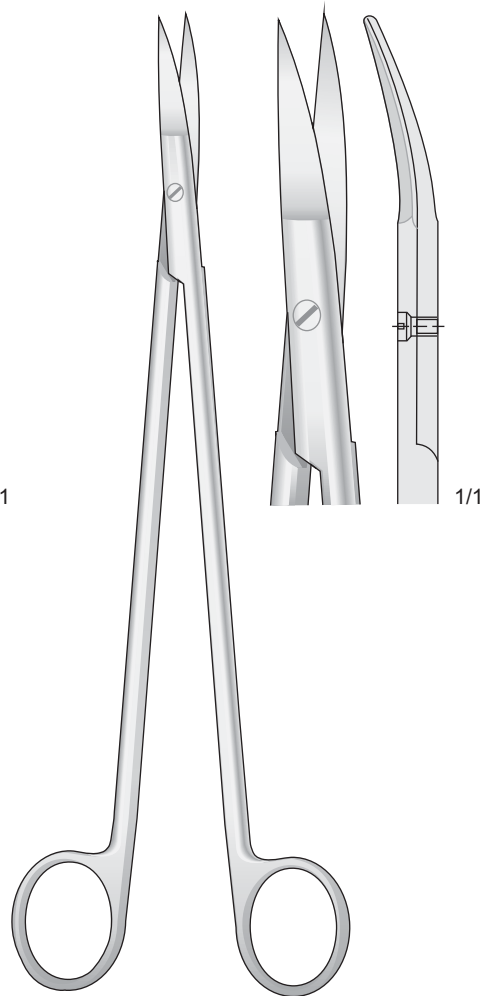

STRULLY
0607-BAG
220 mm

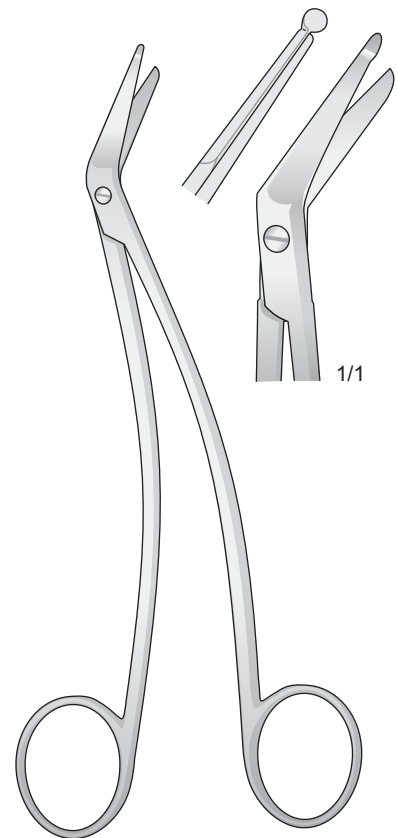

SCHMIEDEN-TAYLOR
0607-BFC
155 mm

Arterienklemmen

Hemostatic forceps

Pinze emostatiche

Pinzas hemostáticas

Pinces hémostatiques

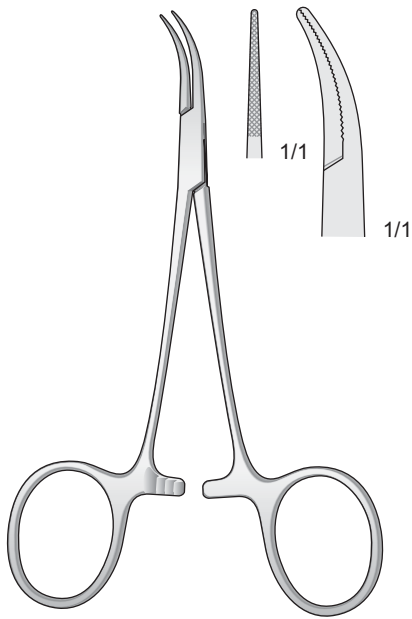

DANDY-MOSQUITO
15-DDC
120 mm

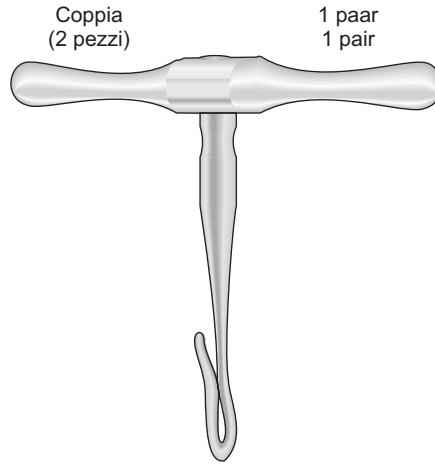

GIGLI
0610-BB

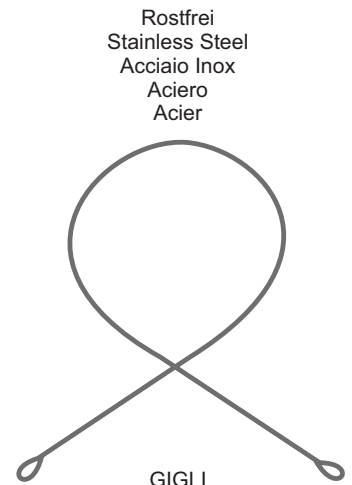

Rostfrei
Stainless Steel
Acciaio Inox
Aciero
Acier

GIGLI
0610-BD
300 mm
0610-BE
500 mm

Seitwärts gebogen
Curved to side
Curve sul lato
Curvas laterales
Courbes latérales

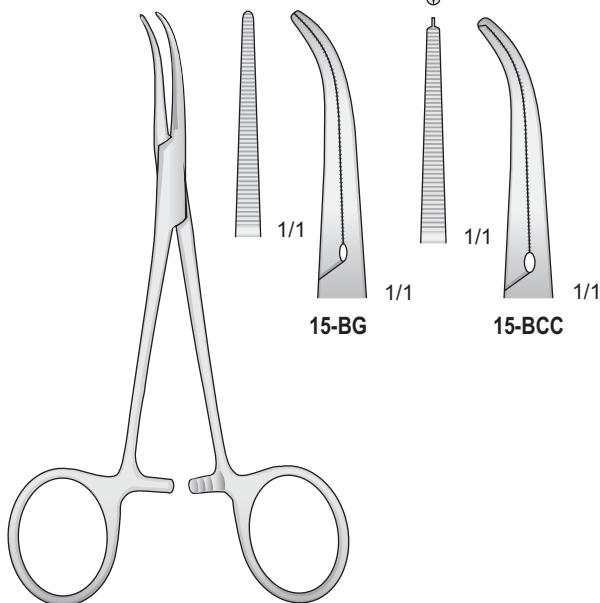

DANDY
15-BG/15-BCC
140 mm

Kopfhautklemme
Scalp Haemostatic forceps
Pinza emostatica per il cuoio capelluto
Pinza hemostáticas para pericraneo

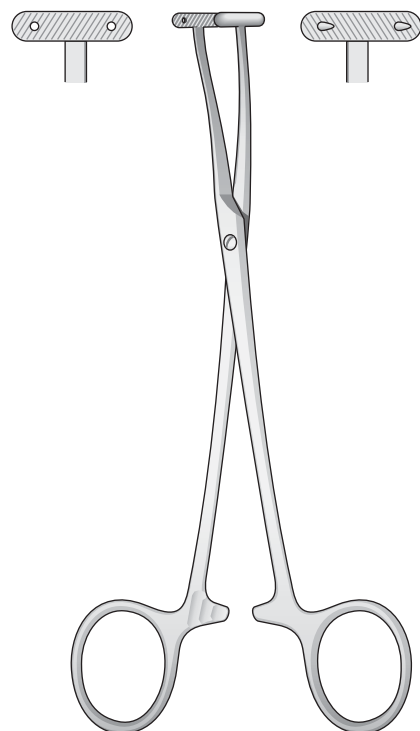

DE MARTEL
0602-BCA
180 mm

0617-CA

0617-CB 0617-CC + 0617-CD 0617-CE 0617-CF 0617-CG
 Komplet, mit Fräsern Fig. 1-4 und Verlängerungsstück
 Complete, with burrs no. 1-4 and extension piece
 Completo, con fresa Fig. 1-4 e giunto di prolungamento
 Completo, con fresas no. 1-4 y pieza de prolongación
 Complet, avec fraises no. 1-4 et pièce de rallonge



Verlängerungsstück
 Extension Piece
 Giunto di prolungamento
 Pieza de prolongación
 Pièce de rallonge

HUDSON
0617-CC

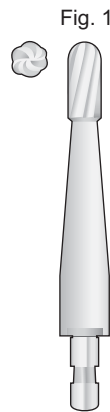

Fig. 1
 HUDSON
0617-CD
 Ø 9 mm

Kegelfräser
 Conical Burr
 Fresa cuneiforme
 Fresa cónica
 Fraise conique



Fig. 2
 HUDSON
0617-CE
 Ø 14 mm

Kegelfräser
 Conical Burr
 Fresa cuneiforme
 Fresa cónica
 Fraise conique

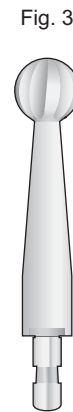

Fig. 3
 HUDSON
0617-CF
 Ø 16 mm

Kugelfräser
 Spherical Burr
 Fresa sferica
 Fresa esférica
 Fraise spherique

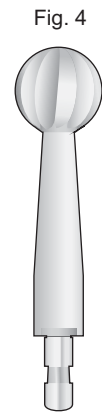
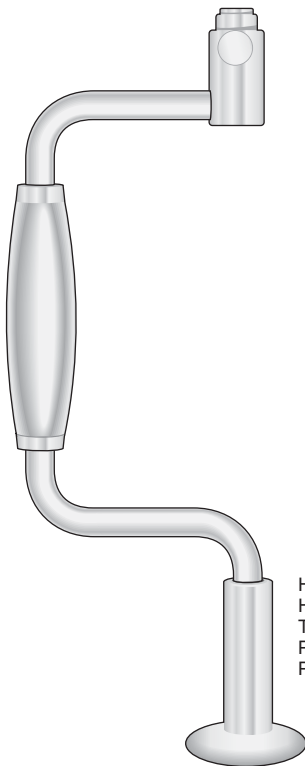

Fig. 4
 HUDSON
0617-CG
 Ø 22 mm

Kugelfräser
 Spherical Burr
 Fresa sferica
 Fresa esférica
 Fraise spherique



HUDSON
0617-CB
 280 mm

Handbohrer allein
 Hand drill only
 Trapano solo
 Perforador suelto
 Perforateur seul

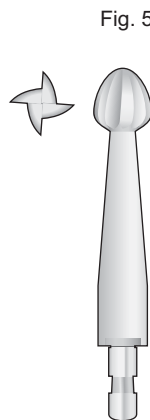

Fig. 5
 ADSON
0617-CH
 Ø 15 mm

Bohrer
 Burr
 Punta
 Fresa
 Fraise



Fig. 6
 Mc KENZIE
0617-CI
 Ø 13 mm

Bohrer
 Burr
 Punta
 Fresa
 Fraise



Fig. 7
 CUSHING
0617-CL
 Ø 14 mm

Flachbohrer
 Flat Trepine
 Trapano piatto
 Taladro plano
 Fraise plate

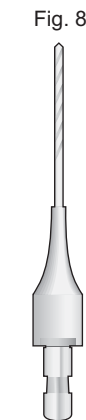

Fig. 8
0617-DA
 Ø 2 mm

Spiralbohrer
 Twist Drill
 Punta a spirale
 Broca espiral
 Mèche hélicoidale

Clips und
Anlegezangen

Clips and
Applying forceps

Agrafes e
pinza applicatrice

Grapas y
pinzas aplicadoras

Clips et pinces
pour appliquer

Kopfhautklammer
Scalp Clip
Agrafes per il cuoio capelluto
Grapa para cuero cabelludo
Agrafes pour cuir chevelu

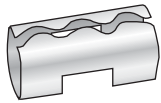

RANEY
0614-ID

Anlege- und Abnehmzange für die Kopfhautklammern
Applying and Removing forceps for Scalp haemostasis
Pinza per applicare e rimuovere le agrafe
emostatiche al cuoio capelluto
Pinza para aplicar y quitar agrafes
Pince pour appliquer et enlever les clips

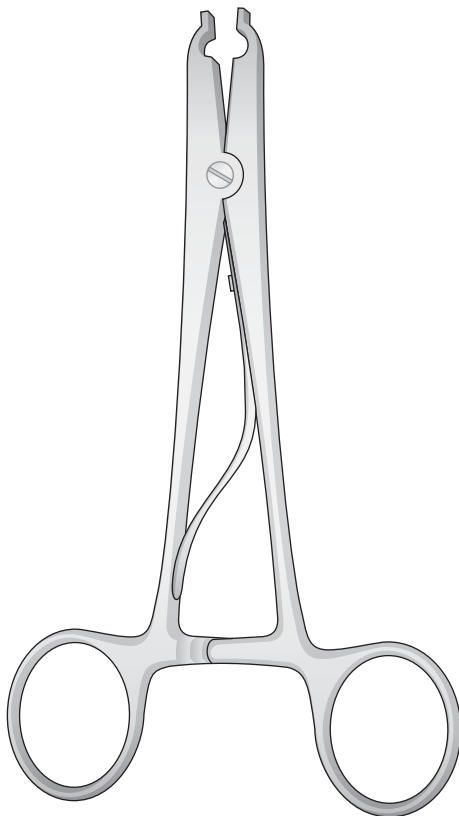

RANEY
0614-IG

Galeahaken - Galea Hooks
Uncini per Galea - Gancho para Galea
Crochets à Galea

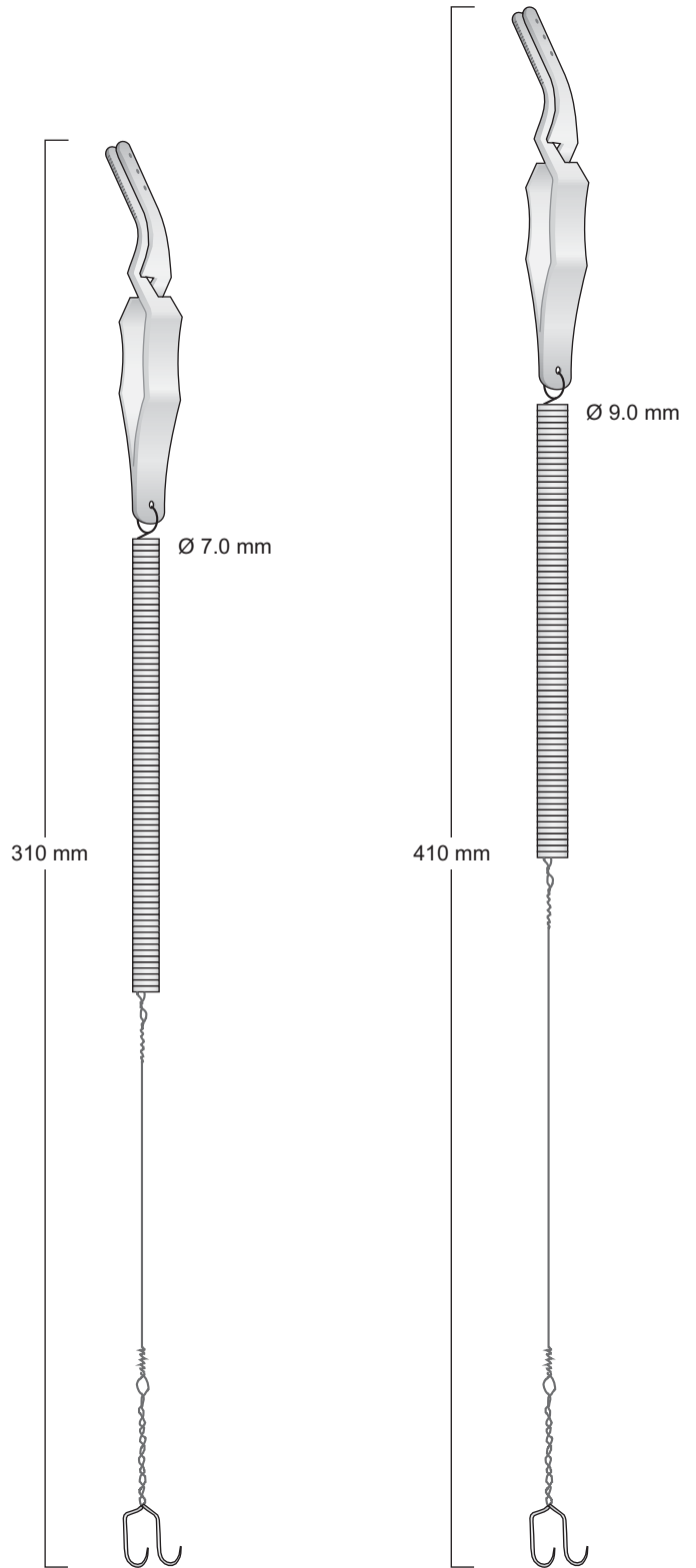

YASARGIL
0606-GI
310 mm

YASARGIL
0606-GL
410 mm

Laminektomie-
Zangen

Laminectomy
Rongeurs

Pinze per
Laminectomia

Pinzas para
Laminectomía

Pinces pour
Laminectomie

Gerade
Straight
Diritta
Rectas
Droites

180 mm

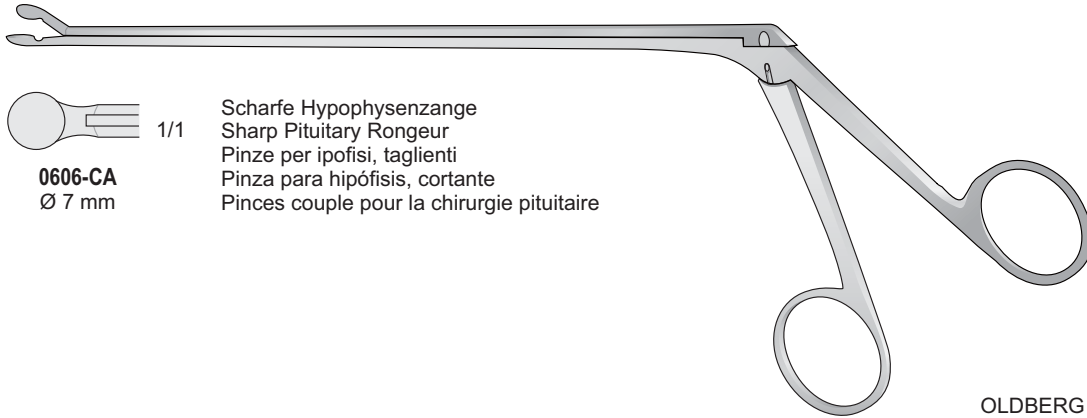

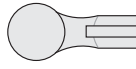
 1/1
0606-CA
Ø 7 mm

Scharfe Hypophysenzange
Sharp Pituitary Rongeur
Pinze per ipofisi, taglienti
Pinza para hipófisis, cortante
Pinces couple pour la chirurgie pituitaire

OLDBERG
0606-CA

Gerade
Straight
Diritta
Rectas
Droites

190 mm

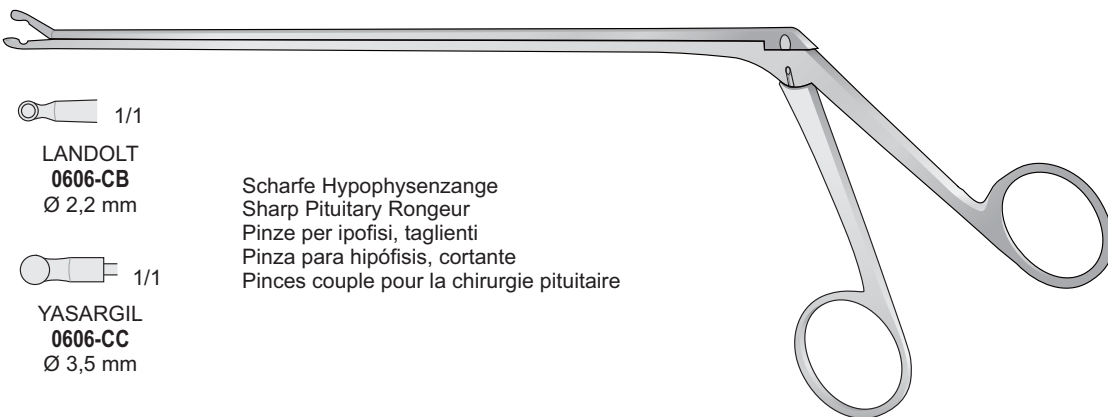

 1/1
LANDOLT
0606-CB
Ø 2,2 mm

 1/1
YASARGIL
0606-CC
Ø 3,5 mm

Scharfe Hypophysenzange
Sharp Pituitary Rongeur
Pinze per ipofisi, taglienti
Pinza para hipófisis, cortante
Pinces couple pour la chirurgie pituitaire

0606-CB/0606-CC

Gerade
Straight
Diritta
Rectas
Droites

200 mm

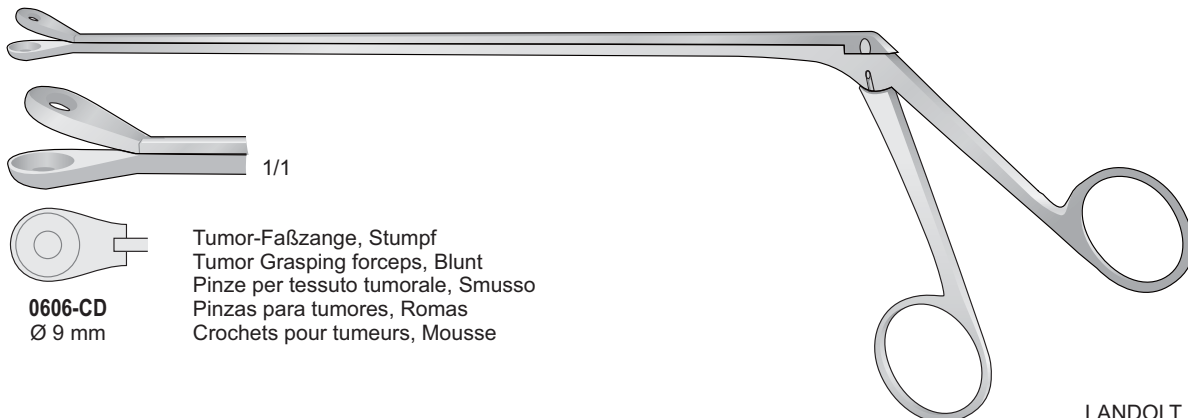

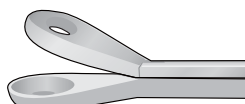
 1/1

 **0606-CD**
Ø 9 mm

Tumor-Faßzange, Stumpf
Tumor Grasping forceps, Blunt
Pinze per tessuto tumorale, Smusso
Pinzas para tumores, Romas
Crochets pour tumeurs, Mousse

LANDOLT
0606-CD

Laminektomie-
Zangen

Laminectomy
Rongeurs

Pinze per
Laminectomia

Pinzas para
Laminectomía

Pinces pour
Laminectomie

Gerade
Straight
Diritta
Rectas
Droites

← 180 mm →

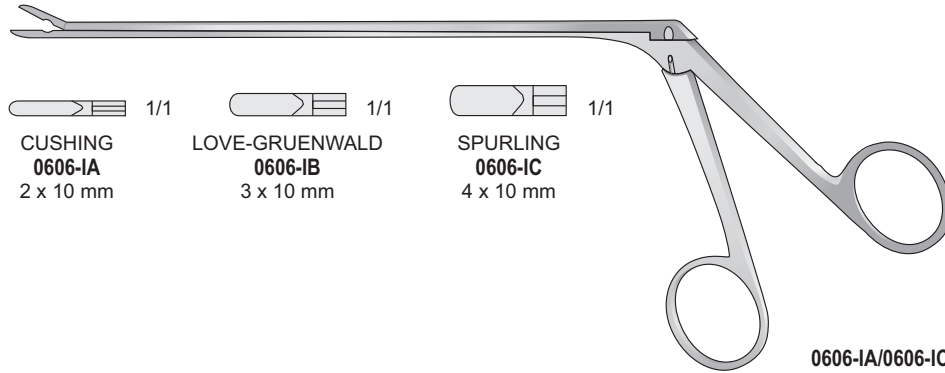

Aufwärtsgebogen
Top curved
Curva verso l'alto
Curvos
Courbe vers le haut

← 180 mm →

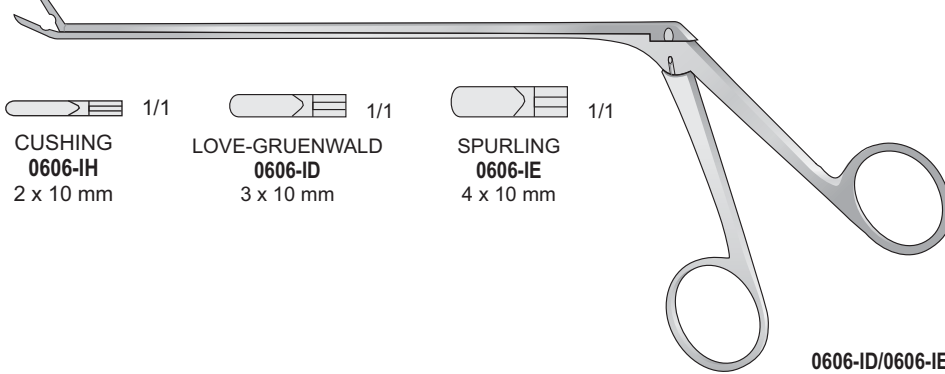

Abwärts gebogen
Bottom curved
Curva verso il basso
Curvos
Courbe vers le bas

← 180 mm →

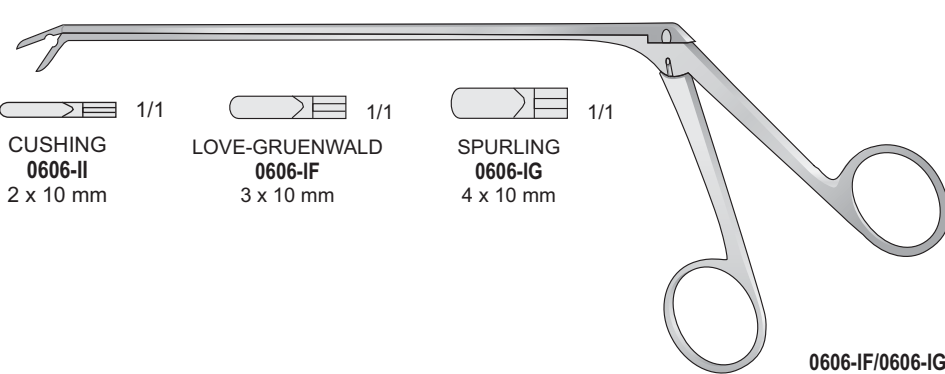

Laminektomie-
Zangen

Laminectomy
Rongeurs

Pinze per
Laminectomia

Pinzas para
Laminectomía

Pinces pour
Laminectomie

Gerade
Straight
Diritta
Rectas
Droites

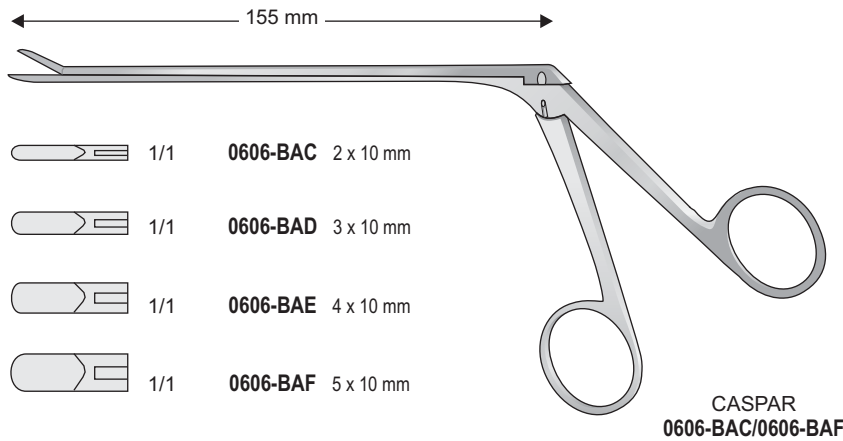

Aufwärtsgebogen
Top curved
Curva verso l'alto
Curvos
Courbe vers le haut

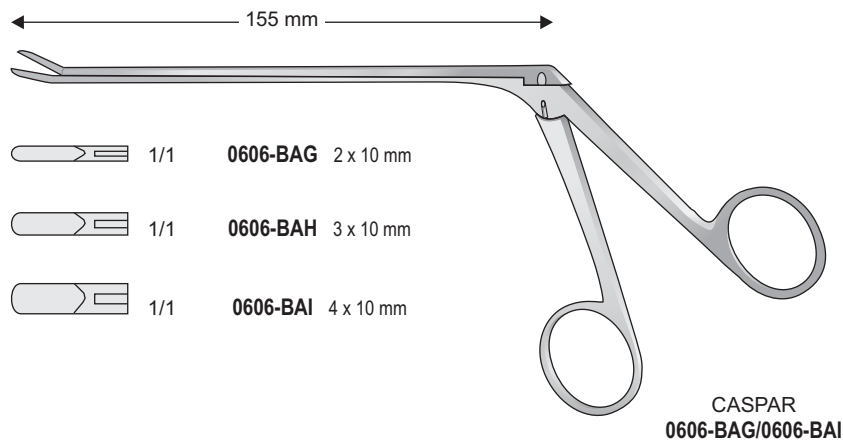

Abwärts gebogen
Bottom curved
Curva verso il basso
Curvos
Courbe vers le bas

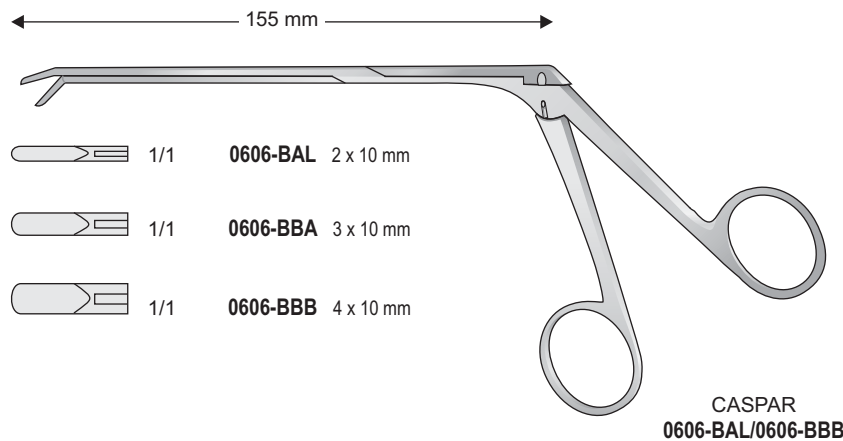

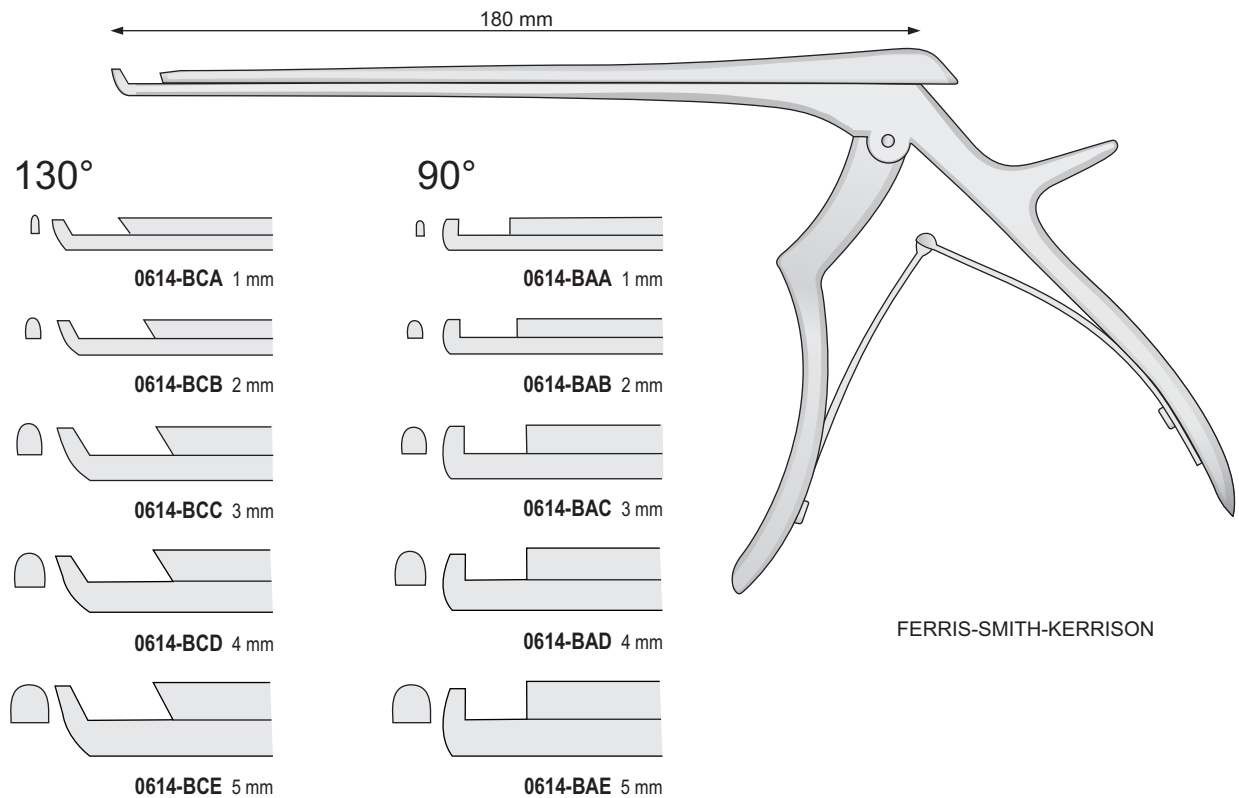
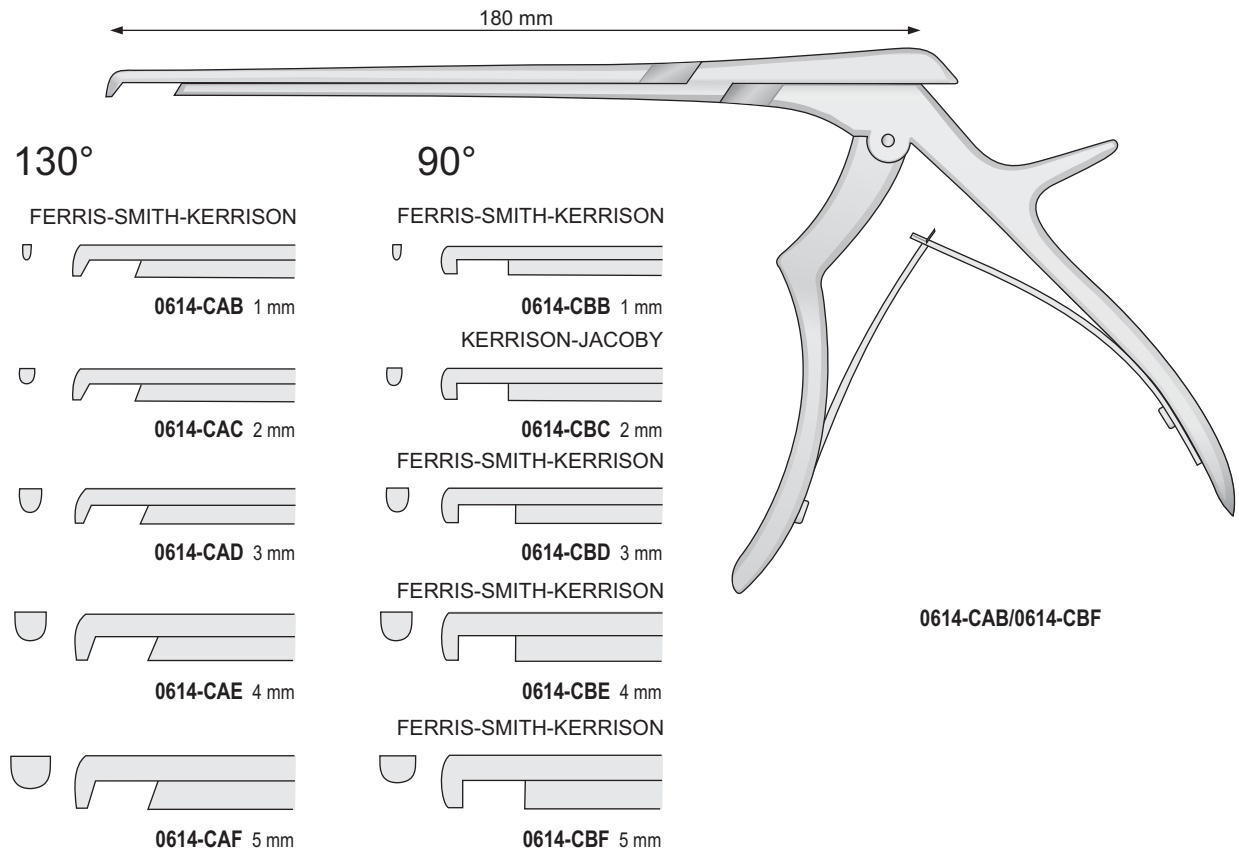

**Meißel
Hämmer**

8 mm



**COSCIA
0611-DGI**
180 mm

**Chisel
Mallet**

4 mm

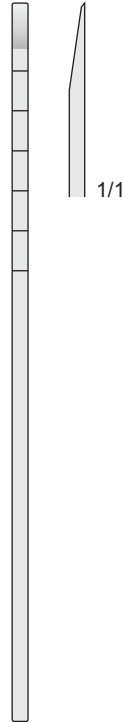

**COTTLE
0414-BDA**
180 mm

**Scalpelli
Martello**

Taglio singolo

7 mm

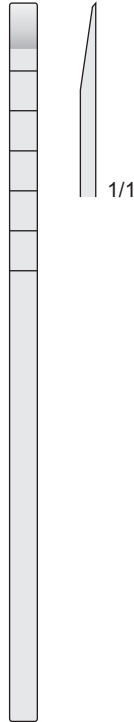

**COTTLE
0414-BDB**
180 mm

**Cinceles
Martillo**

9 mm

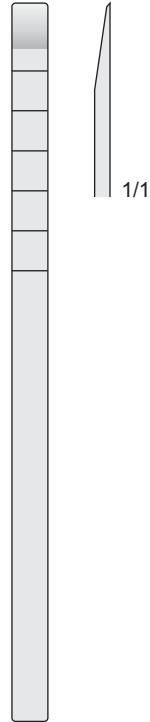

**COTTLE
0414-BDC**
180 mm

**Scapel
Maillet**

12 mm

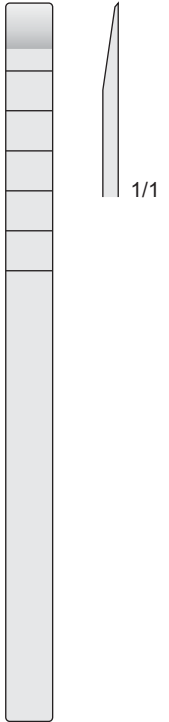

**COTTLE
0414-BDD**
180 mm

Ø 30 mm
240 g

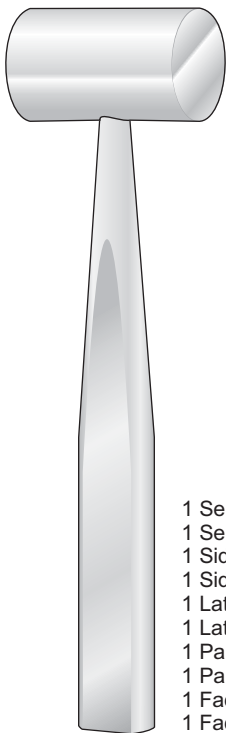

**COTTLE
0611-BAE**
185 mm

- 1 Seite flach
- 1 Seite convex
- 1 Side flat
- 1 Side convex
- 1 Lato piatto
- 1 Lato convesso
- 1 Parte plana
- 1 Parte convexa
- 1 Face plate
- 1 Face convexe

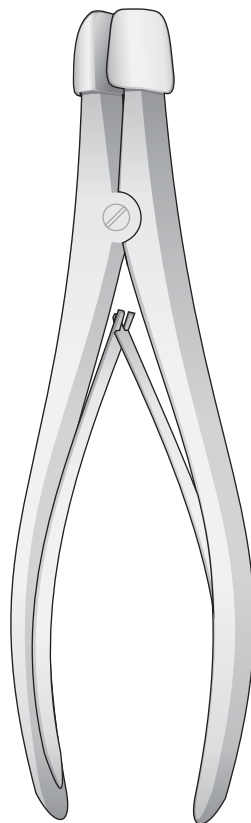

**LANDOLT
0606-CBD**
210 mm

Spekula für Trans-Sphenoidale Hypophysektomie
Specula for Trans-Sphenoidal Hypophysectomy
Specolo per ipofisi transfenoidale

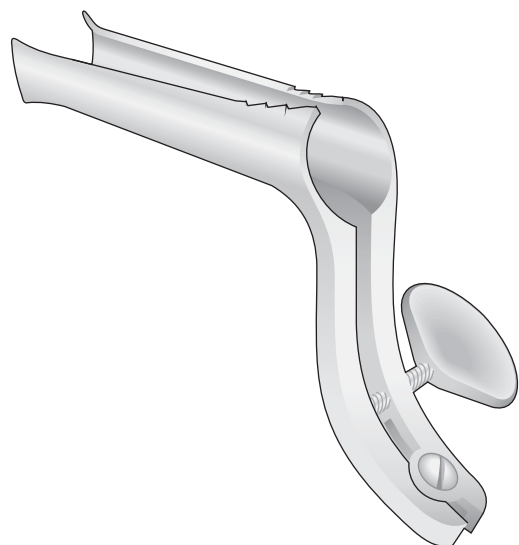

CUSHING-LANDOLT
0606-CBA 70 x 15 mm
0606-CBB 90 x 15 mm
0606-CBC 110 x 15 mm

Hypophysektomie
-Instrumente

Pituitary
Instruments

Strumenti per
ipofisi cerebrale

Instrumentos
para hipófisis

Instruments pour la
chirurgie pituitaire

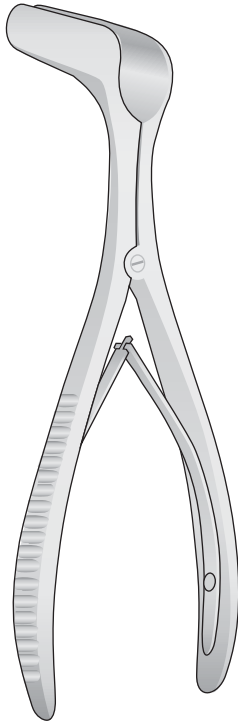

PAPAVERO-HARTMANN
1412-DL
140 mm

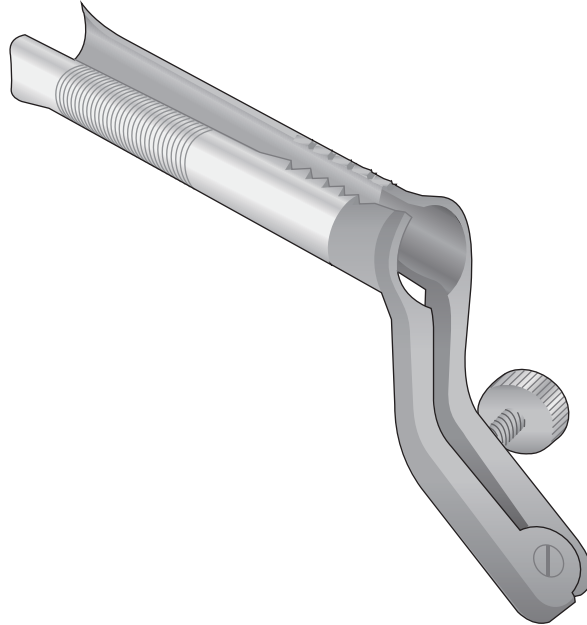

PAPAVERO-CASPAR
0606-CBE 80 x 11 mm
0606-CBF 90 x 13 mm
0606-CBG 100 x 15 mm

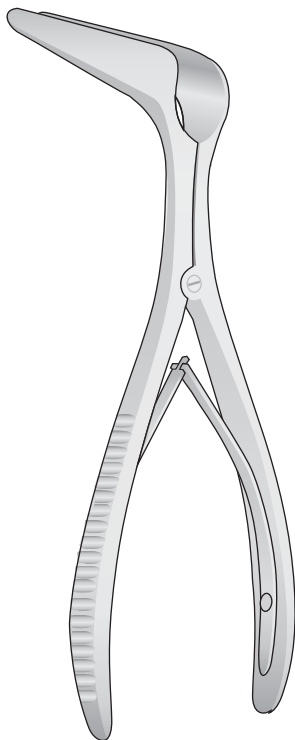

COTTLE
1412-CF/1412-CL
150 mm

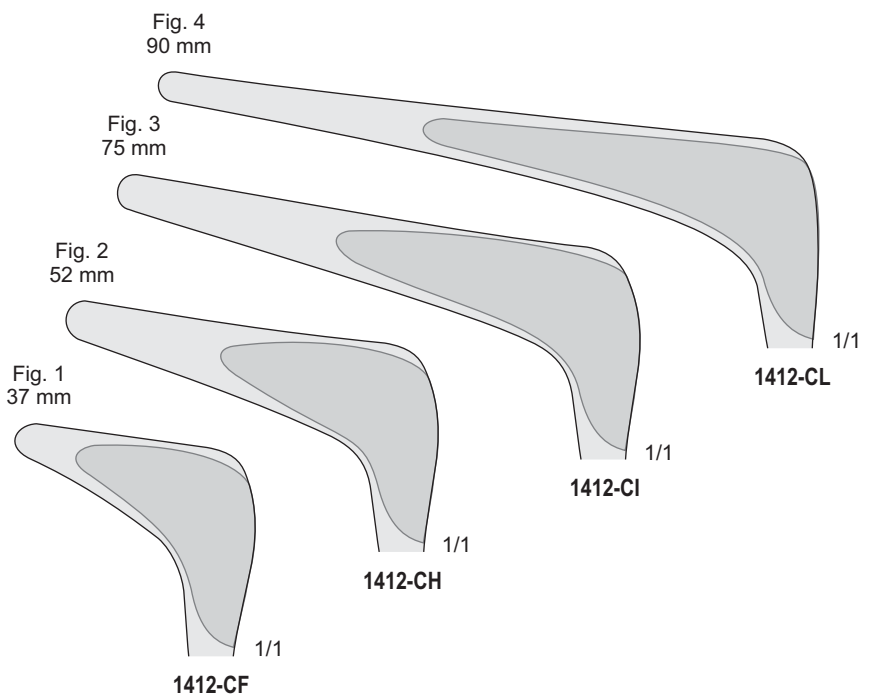

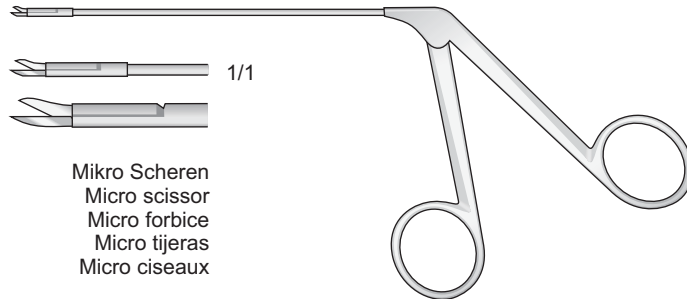

Mikro Scheren
Micro scissor
Micro forbice
Micro tijeras
Micro ciseaux

BELLUCCI
0402-BAG
80 mm

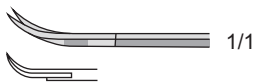

Mikro-Schere
Micro Scissor
FAHLBUSCH
0606-EAB
165 mm

Scharfe Zange
Forceps, Scoop-shaped

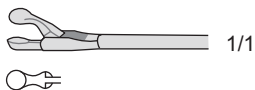

NICOLA
0606-EAC
165 mm

Mikro-Schere Gerade
Micro Scissor Straight

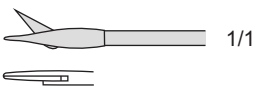

NICOLA
0606-EAD
165 mm

Faßzange
Forceps

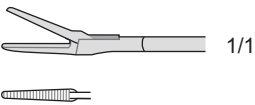

YASARGIL-NICOLA
0606-EAE
165 mm

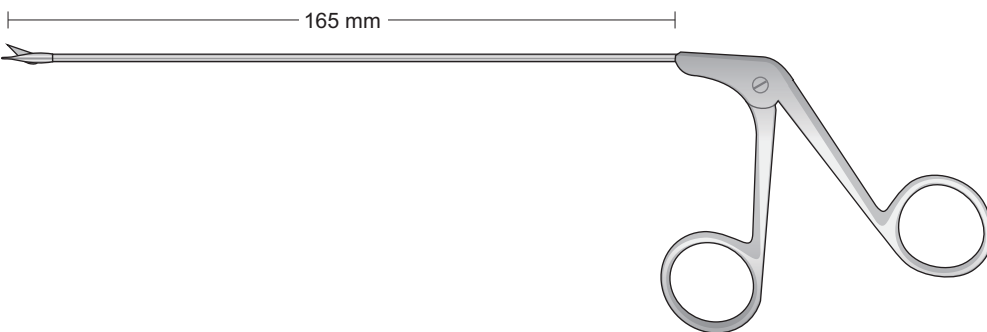

NICOLA
0606-EAD
165 mm

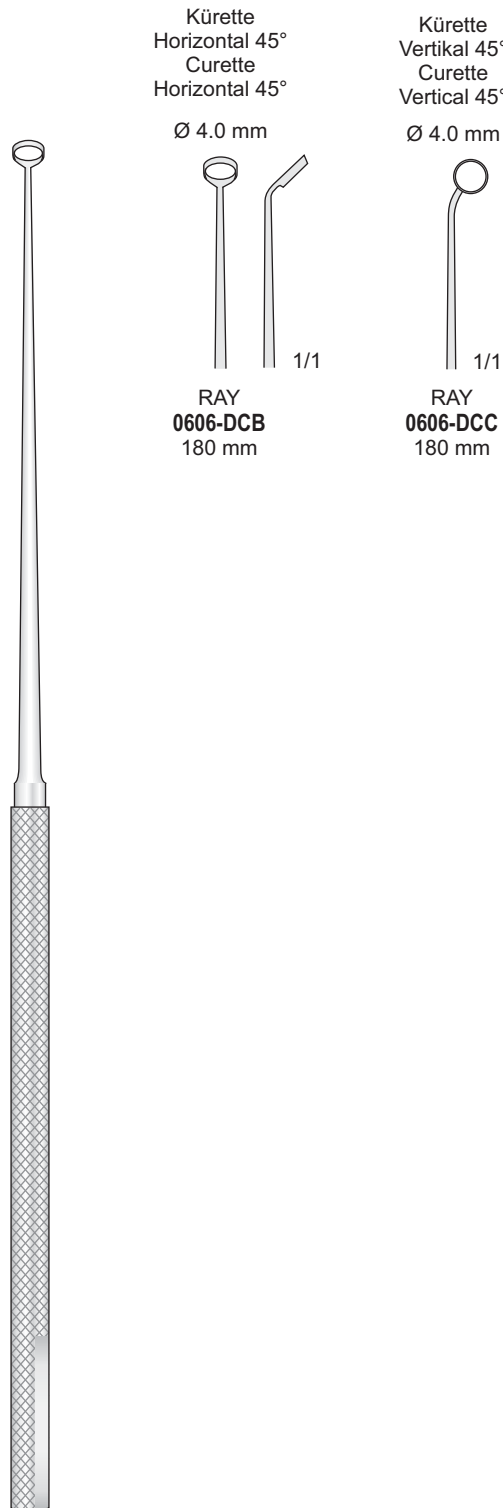

Kürette
Horizontal 45°
Curette
Horizontal 45°

Ø 4.0 mm

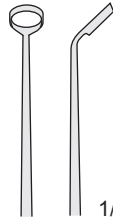

1/1

RAY
0606-DCB
180 mm

Kürette
Vertikal 45°
Curette
Vertical 45°

Ø 4.0 mm



1/1

RAY
0606-DCC
180 mm

RAY
0606-DCB/0606-DCC
180 mm

Hypophysektomie
-Instrumente

Pituitary
Instruments

Strumenti per
ipofisi cerebrale

Instrumentos
para hipófisis

Instruments pour la
chirurgie pituitaire

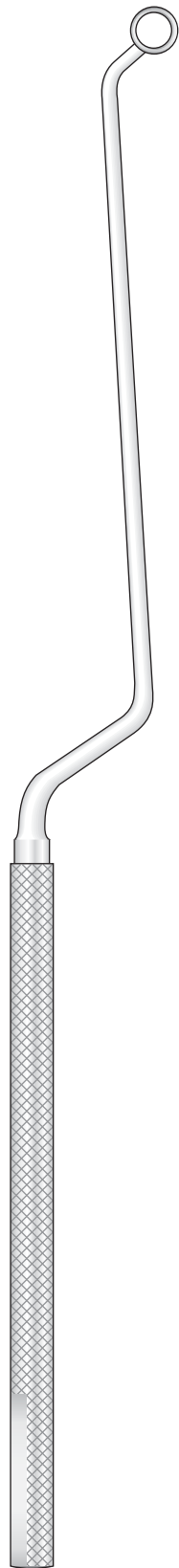

NICOLA
0606-DCD/0606-DCG
215 mm

Ø 6.5 mm

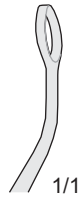

1/1

NICOLA
0606-DCD
215 mm

Nach Rechts Schneidend
Cutting to the right
Tagliente a destra
Cortante a la derecha
Couple à droite

Ø 6.5 mm

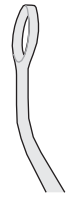

1/1

NICOLA
0606-DCE
215 mm

Nach Links Schneidend
Cutting to the left
Tagliente a sinistra
Cortante a la izquierda
Couple à gauche

6,5 mm



1/1

NICOLA
0606-DCF
215 mm

Kürette, Biegsam
Curette, Malleable
Curette, Malleabile
Cucharillo, Maleable
Curettes, Maleable

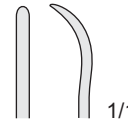

1/1

NICOLA
0606-DCG
215 mm

Raspatorium
Raspatory
Raspatore
Legras
Rugines

Hypophysectomie
-Instrumente

Pituitary
Instruments

Strumenti per
ipofisi cerebrale

Instrumentos
para hipófisis

Instruments pour la
chirurgie pituitaire

Enucleator - Eucleator
Eucleatori

Stumpf
Blunt
Smusso
Romas
Mousse

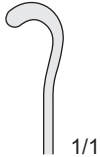

1/1

HARDY
0606-DDA Right/Rechts
0606-DEA Left/Links
245 mm

Stumpf
Blunt
Smusso
Romas
Mousse

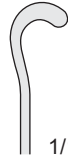

1/1

HARDY
0606-DOB Right/Rechts
0606-DEB Left/Links
245 mm

Spitz
Sharp
Acuto
Agudas
Pointu



1/1

HARDY
0606-DDC Right/Rechts
0606-DEC Left/Links
245 mm

Spitz
Sharp
Acuto
Agudas
Pointu

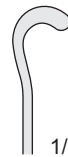

1/1

HARDY
0606-DDD Right/Rechts
0606-DED Left/Links
245 mm

Implantations-Gabel
Implant Fork

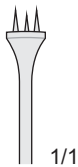

1/1

HARDY
0606-DDE
245 mm

Dissektor Innen Scharf
Dissector Sharpened inner edge



1/1

HARDY-FAHLBUSCH
0606-DDF
245 mm



1/1

HARDY-FAHLBUSCH
0606-DDG
245 mm

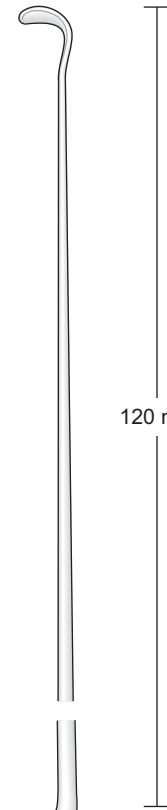

120 mm

HARDY
0606-DDA/0606-DED
245 mm

Hypophysektomie
-Instrumente

Pituitary
Instruments

Strumenti per
ipofisi cerebrale

Instrumentos
para hipófisis

Instruments pour la
chirurgie pituitaire

Enukleator, Stumpf, Biegsam
Enucleator, Blunt, Malleable

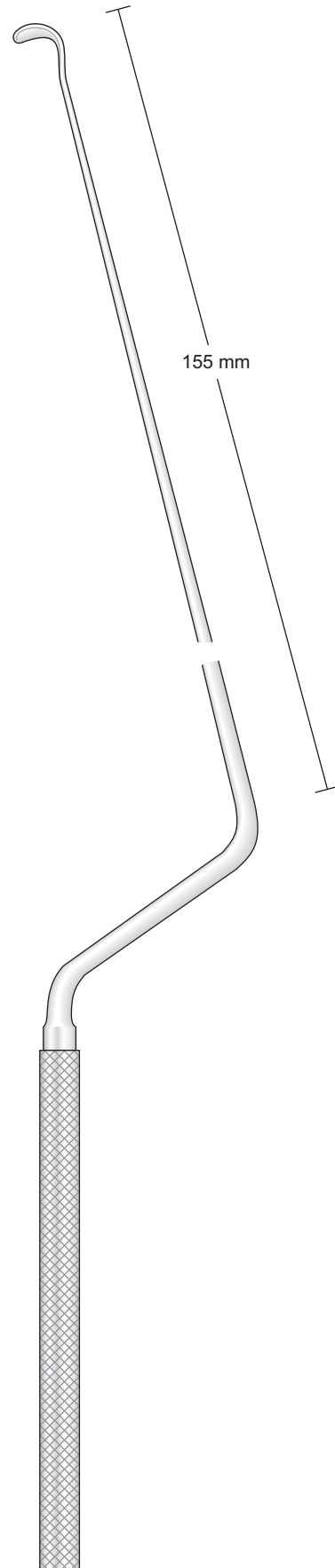
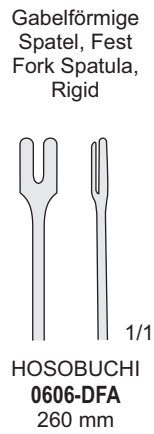
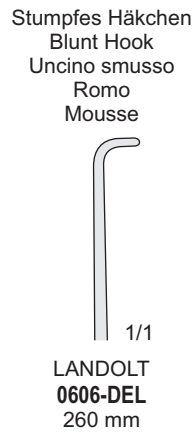
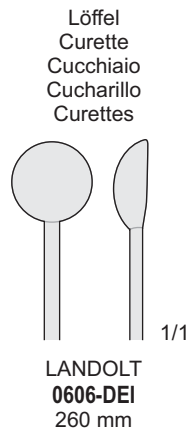
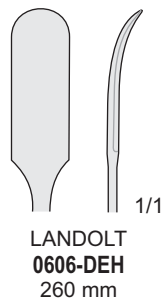
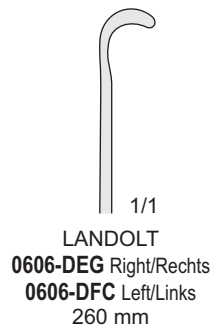
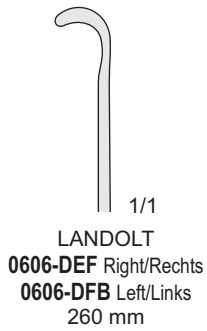

LANDOLT
0606-DEF/0606-DFC
260 mm

Hypophysektomie
-Instrumente

Pituitary
Instruments

Strumenti per
ipofisi cerebrale

Instrumentos
para hipófisis

Instruments pour la
chirurgie pituitaire

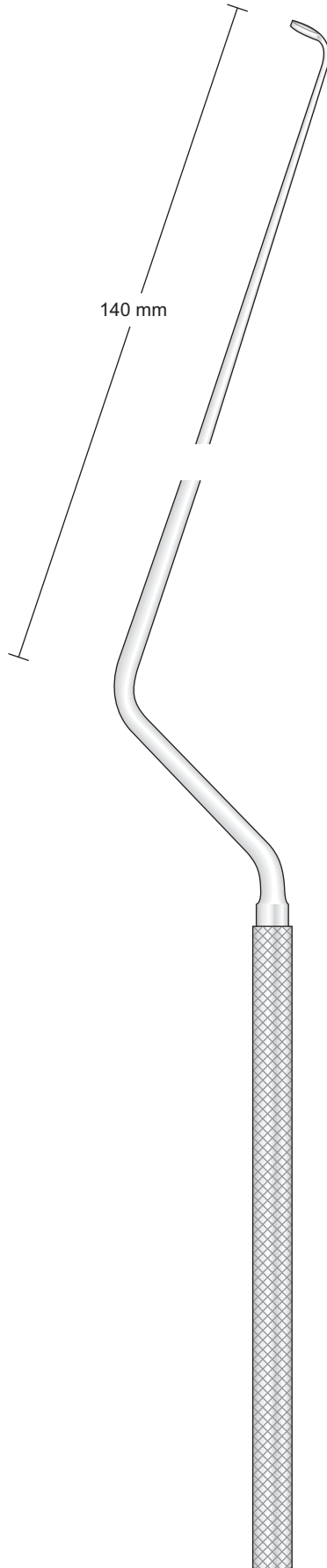

Kürette - Curette - Curette
Curetas - Curette

Ø 4.0 mm

Ø 6.0 mm



0606-DFD
260 mm

0606-DFE
260 mm

Biegsam - Malleable - Malleabili
Maleable - Maleable

HARDY
0606-DFD/0606-DFE
260 mm

Hypophysektomie
-Instrumente

Pituitary
Instruments

Strumenti per
ipofisi cerebrale

Instrumentos
para hipófisis

Instruments pour la
chirurgie pituitaire

Löffel, Biegsam
Scoop, Malleable
Cucchiaio, Malleabile
Cuchillo, Maleable
Curette, Maleable

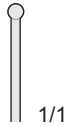

FAHLBUSCH
0606-DGA
260 mm

Kürette
Curette
Curette
Curetas
Curette

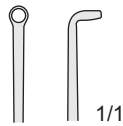

FAHLBUSCH
0606-DGB
260 mm

Ø 2.2 mm

Raspatorium, Fest
Raspatories, Rigid
Raspatore, Rigido
Legras
Rugines

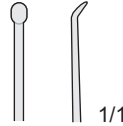

LANDOLT-REULEN
0606-DGC
260 mm

Ø 3.2 mm

Küretten, Fest
Curette, Rigid
Curette, Rigido
Curetas
Curettes

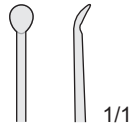

LANDOLT-REULEN
0606-DGD
260 mm

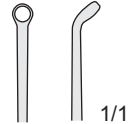

LANDOLT-REULEN
0606-DGE
260 mm

Stumpfes Häkchen, Fest
Blunt Hook, Rigid
Uncino smusso, Rigido



LANDOLT-REULEN
0606-DGF
260 mm

Dissektor, Fest
Dissector, Rigid
Dissettore, Rigido

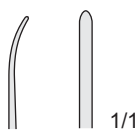

LANDOLT-REULEN
0606-DGG
260 mm

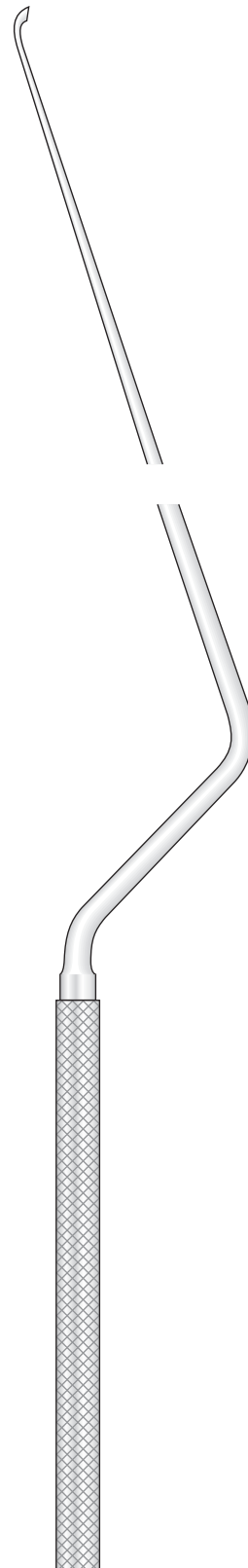

FAHLBUSCH
0606-DGA/0606-DGG
260 mm

Wundspreizer zur
Mikrodissektomie

Retractors for
Micro-Lumbar Dissectomy

Divaricatori per
microchirurgia lombare

Separadors para
micro chirurgia

Ecarteurs pour
Micro chirurgie

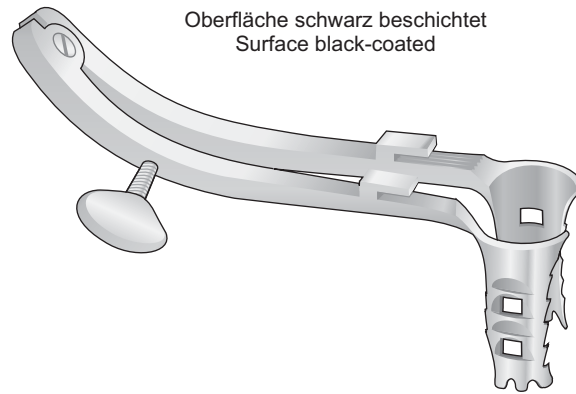

Oberfläche schwarz beschichtet
Surface black-coated

CASPAR
0221-CAB/0221-CAI

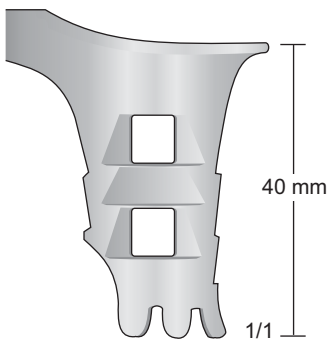

0221-CAB

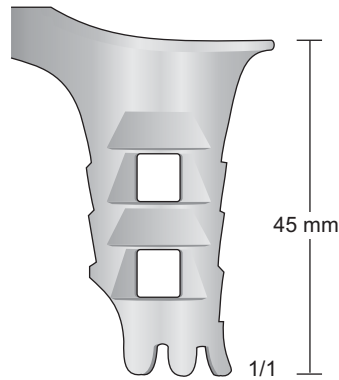

0221-CAC

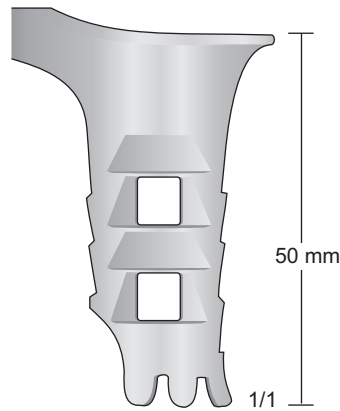

0221-CAD

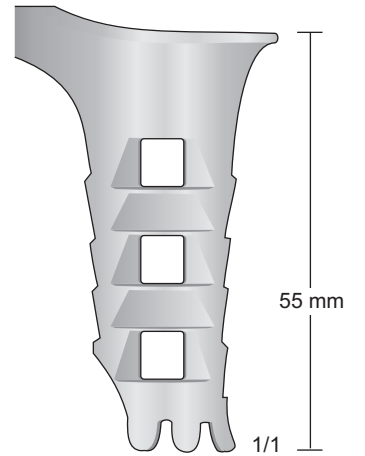

0221-CAE

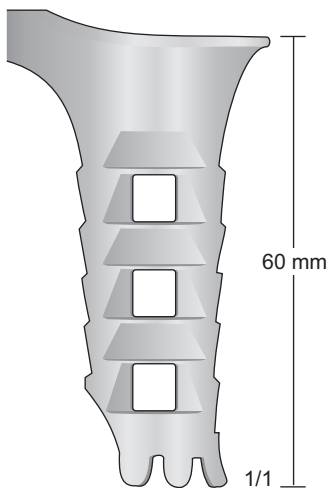

0221-CAF

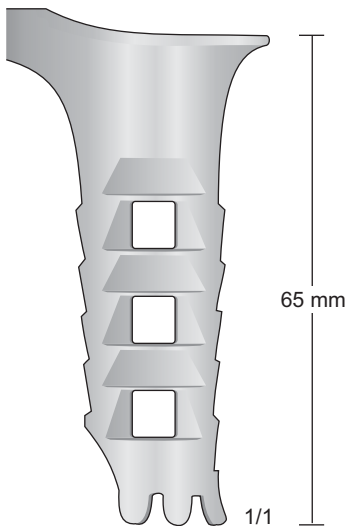

0221-CAG

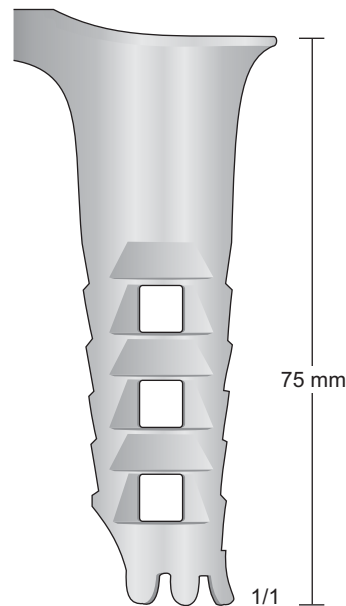

0221-CAH

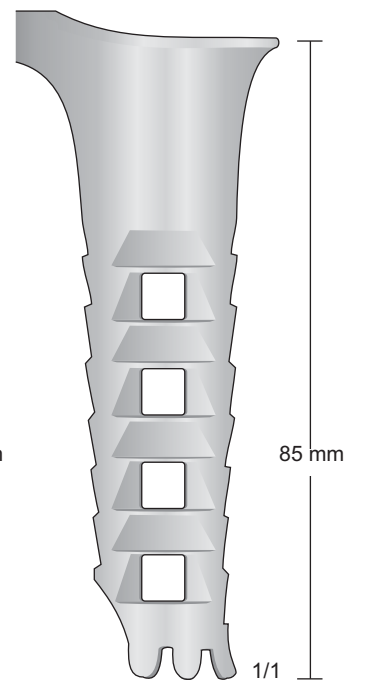

0221-CAI

Wundspreizer zur
Mikrodissektomie

Retractors for
Micro-Lumbar Discectomy

Divaricatori per
microchirurgia lombare

Separadors para
micro chirurgia

Ecarteurs pour
Micro chirurgie

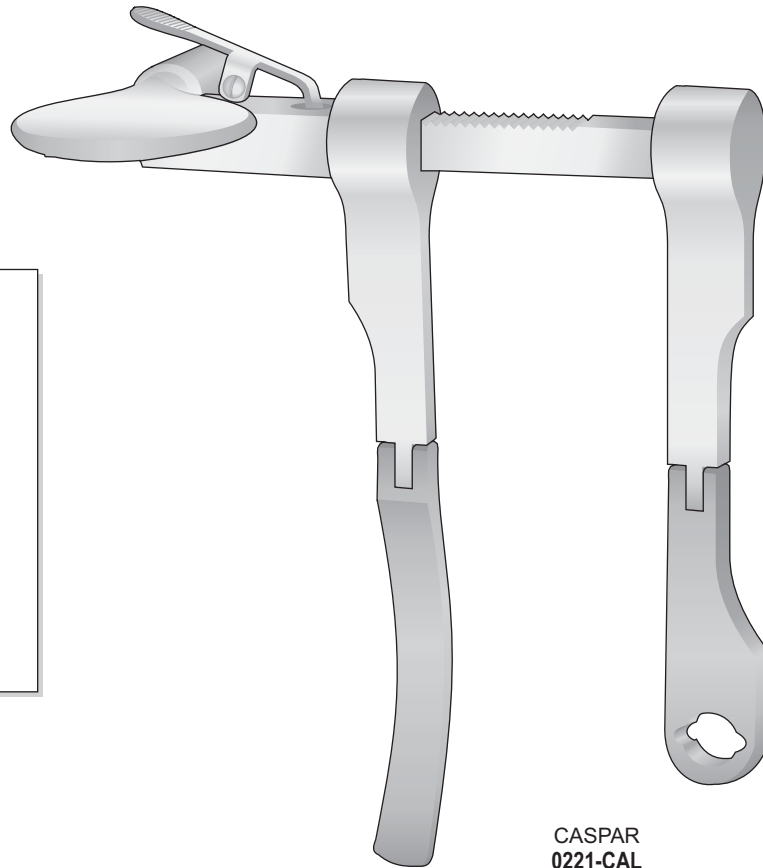

**CASPAR
0221-CBA**

Sperrer komplett mit
Retractor complete with
Divaricatore completo di
Separador completo con
Ecarteur complet avec

0221-CBB Valva anti-riflesso mm. 35
0221-CBC Valva anti-riflesso mm. 40
0221-CBD Valva anti-riflesso mm. 45
0221-CBE Valva anti-riflesso mm. 50
0221-CBF Valva anti-riflesso mm. 55
0221-CBG Valva anti-riflesso mm. 60

0221-CAL
Sperrer allein
Retractor only
Divaricatore solo
Separador suelto
Ecarteur seul

CASPAR
0221-CAL

Blätter Geschwärzt
Surface Black-finish
Valve anti-riflesso
Inoxidable en negro
Surface noircie

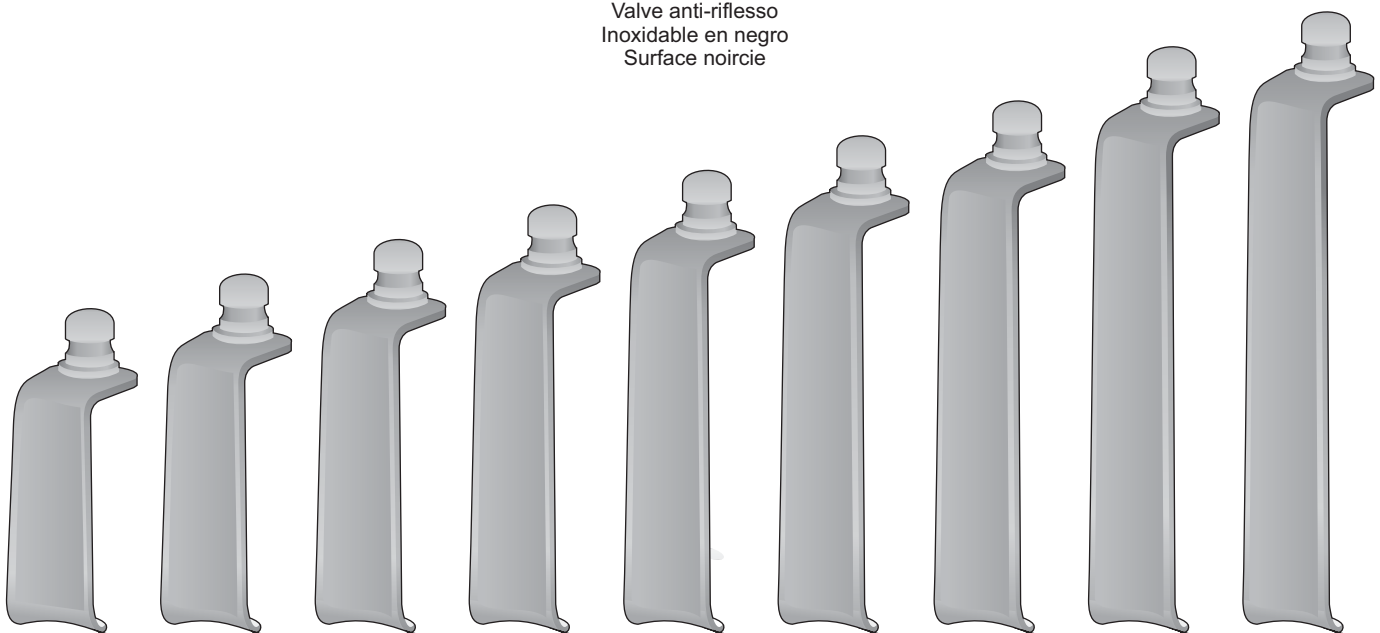

0221-CBB
35 mm

0221-CBC
40 mm

0221-CBD
45 mm

0221-CBE
50 mm

0221-CBF
55 mm

0221-CBG
60 mm

0221-CBH
65 mm

0221-CBI
75 mm

0221-CBL
85 mm

Wundspreizer zur
Mikrodissektomie

Retractors for
Micro-Lumbar Discectomy

Divaricatori per
microchirurgia lombare

Separadors para
micro chirurgia

Ecarteurs pour
Micro chirurgie

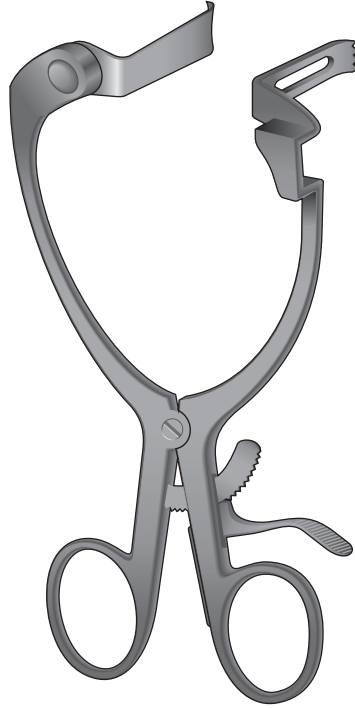

CASPAR
0221-CDA
Gegensperrerr komplett
mit 7 Blätter
Retractor complete
with 7 blades
Divaricatore completo
con 7 valve

CASPAR
0221-CDI
Gegensperrerr allein
mit 1 festem Blatt
Retractor only
with 1 fixed blade

CASPAR
0221-CDA
170 mm

Blätter Geschwärzt
Surface Black-finish
Valve anti-riflesso
Inoxidable en negro
Surface noircie

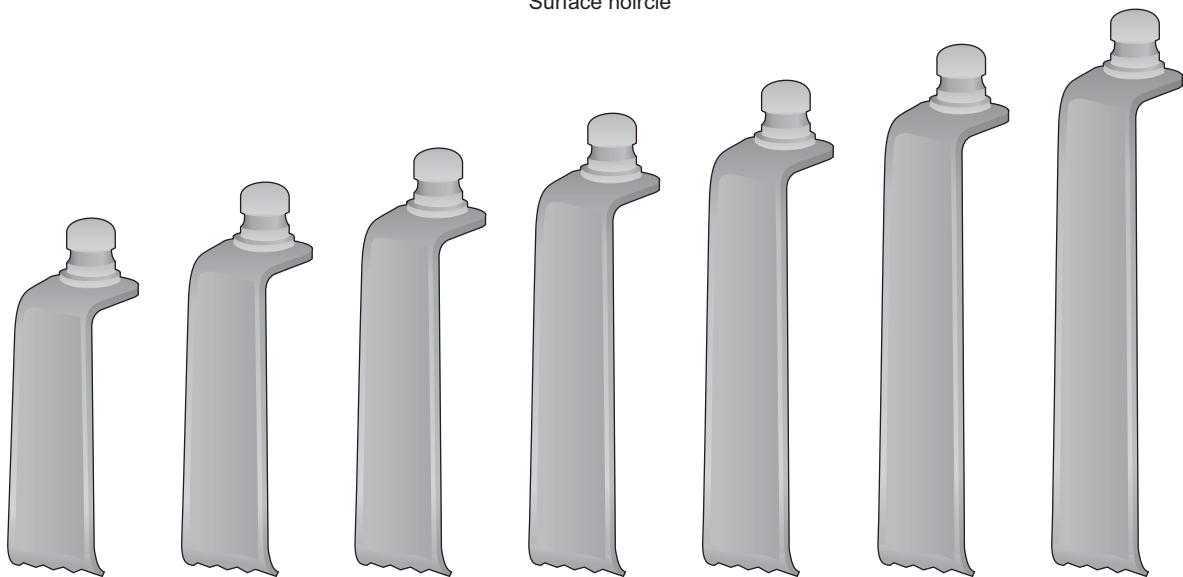

0221-CDB
40 mm

0221-CDC
45 mm

0221-CDD
50 mm

0221-CDE
55 mm

0221-CDF
60 mm

0221-CDG
65 mm

0221-CDH
70 mm

Char. 6	=	2 mm
Char 7	=	2,5 mm
Char 8	=	2,7 mm
Char 9	=	3 mm
Char 10	=	3,3 mm
Char 12	=	4 mm
Char 15	=	5 mm

Saugkanüle, isoliert
mit Saugunterbrecher und Mandrin
Suction cannula, insulated
with finger cut-off and stylet
Ø 4 mm
Ch.12

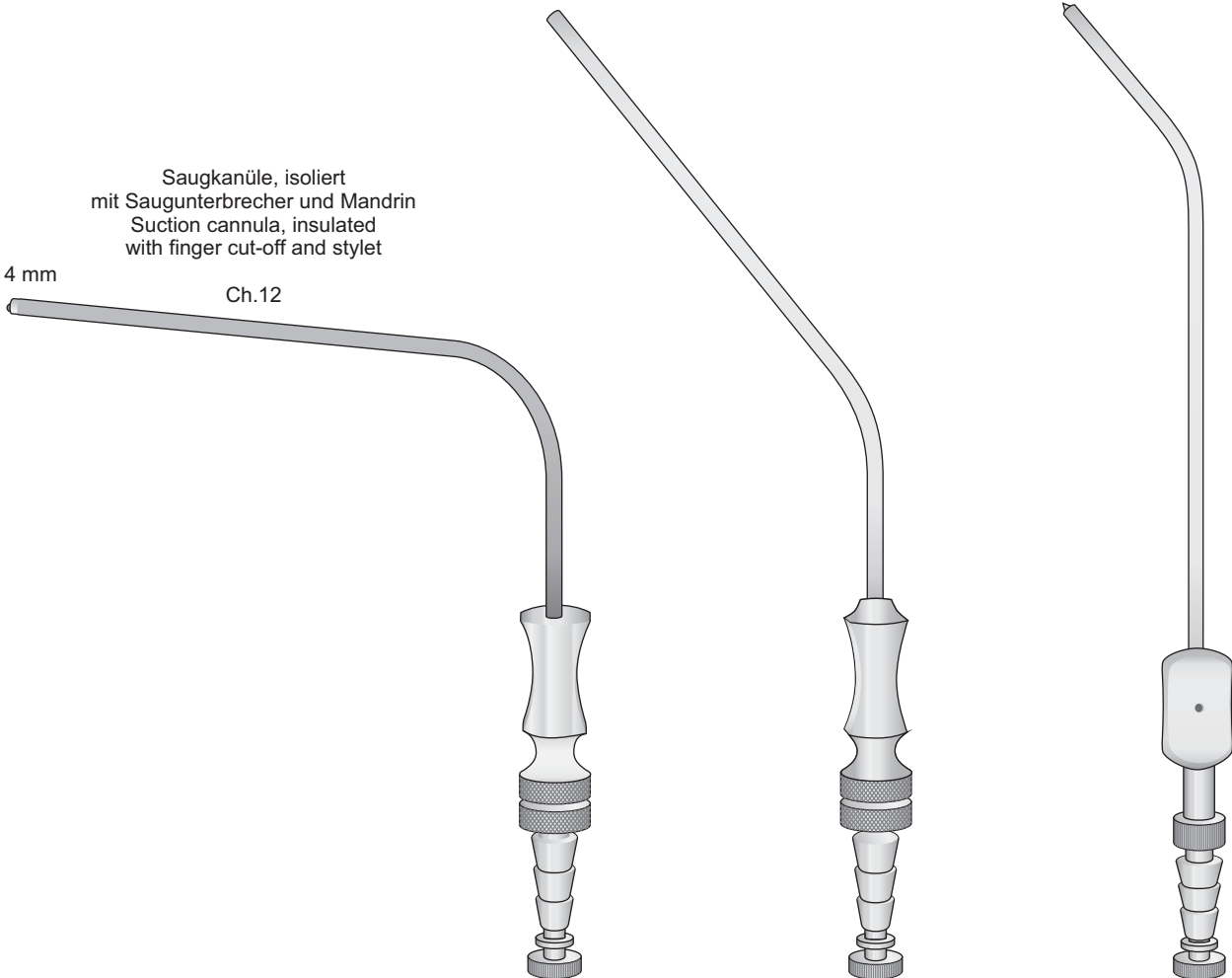

FERGUSON
0706-CFC
150 mm

FRAZIER
0706-CEA Ch. 6 2,0 mm
0706-CEB Ch. 7 2,5 mm
0706-CEB02 Ch. 8 2,7 mm
0706-CEC Ch. 9 3,0 mm
0706-CEC02 Ch. 10 3,3 mm
0706-CED Ch. 12 4,0 mm
0706-CEE Ch. 15 5,0 mm
180 mm

PLESTER
0706-BFA Ch. 6 2,0 mm
0706-BFB Ch. 7 2,5 mm
0706-BFB02 Ch. 8 2,7 mm
0706-BFC Ch. 9 3,0 mm
0706-BFC02 Ch. 10 3,3 mm
0706-BFD Ch. 12 4,0 mm
0706-BFE Ch. 15 5,0 mm
200 mm

YASARGIL	Usable length	Ø
0706-CBA	130 mm	1,5 mm
0706-CBB	150 mm	1,5 mm
0706-CBC	180 mm	1,5 mm
0706-CBD	220 mm	1,5 mm

YASARGIL	Usable length	Ø
0706-CBE	130 mm	2,0 mm
0706-CBF	150 mm	2,0 mm
0706-CBG	180 mm	2,0 mm
0706-CBH	220 mm	2,0 mm

YASARGIL	Usable length	Ø
0706-CCC	130 mm	2,5 mm
0706-CCD	150 mm	2,5 mm
0706-CCE	180 mm	2,5 mm
0706-CCF	220 mm	2,5 mm

YASARGIL	Usable length	Ø
0706-CCG	130 mm	3,5 mm
0706-CCH	150 mm	3,5 mm
0706-CCI	180 mm	3,5 mm
0706-CCL	220 mm <td 3,5 mm	

YASARGIL	Usable length	Ø
0706-CDA	180 mm	4,5 mm

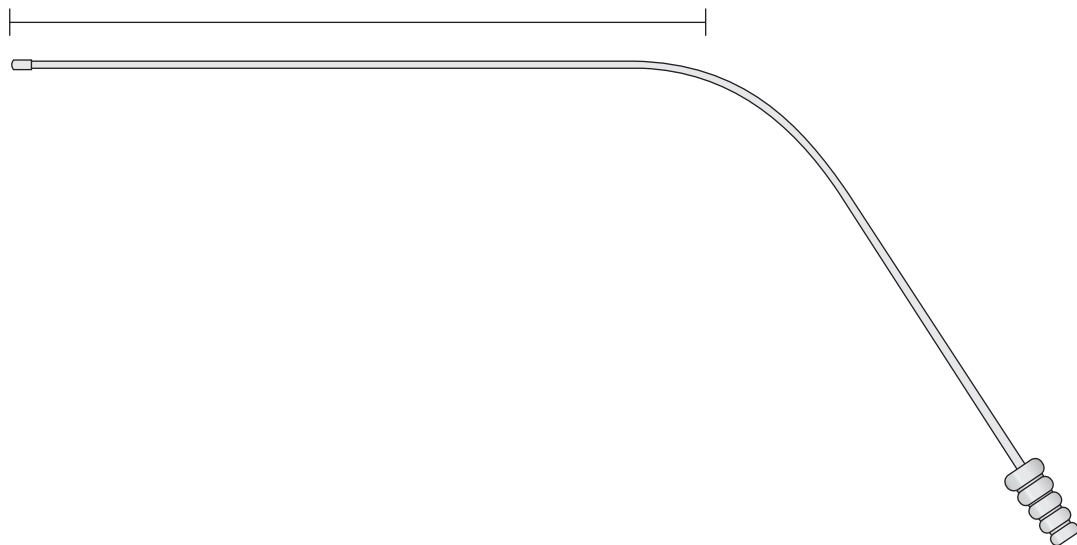

YASARGIL
0706-CBA/0706-CDA

Indice alfanumerico		Alfanumerical Index		Nummernverzeichnis		Index alfabétique		Indice alfanumerico	
Article	Page	Article	Page	Article	Page	Article	Page	Article	Page
0202-DI	37	0204-DBD	31	0221-CBI	90				
0202-EA	37	0204-DBE	31	0221-CBL	90				
0202-EG	37	0204-DBF	31	0221-CDA	91				
0202-EI	37	0204-DBG	31	0221-CDB	91				
0202-FA	37	0204-DBH	31	0221-CDC	91				
0202-FC	37	0204-DBI	31	0221-CDD	91				
		0204-DBL	31	0221-CDE	91				
0204-DA19	35	0204-DCA	31	0221-CDF	91				
0204-DB19	35	0204-DCB	32	0221-CDG	91				
0204-DC19	36	0204-DCC	32	0221-CDH	91				
0204-DD19	36	0204-DCD	32	0221-CDI	91				
0204-DF19	36	0204-DCE	32						
0204-DG19	36	0204-DCF	32	0402-BAG	82				
0204-EC19	36	0204-DCG	32						
0204-ED19	36	0204-DCH	33	0414-FG	43				
0204-GA	34	0204-DCI	33	0414-FH	43				
0204-GA19	36	0204-DCL	33	0414-FI	43				
0204-GC	34	0204-DDA	33	0414-BDA	80				
0204-GC19	36	0204-DCB	33	0414-BDB	80				
0204-IA	25	0204-DDC	31	0414-BDC	80				
0204-IA19	23	0204-DEB19	35	0414-BDD	80				
0204-IB	25	0204-DFI	35	0414-BHE	43				
0204-IB19	23	0204-DFL	35	0414-CHA	71				
0204-IC	25	0204-DGA	35	0414-CHB	71				
0204-ID	25	0204-DGB	35	0414-CHC	71				
0204-IE	25	0204-DGC	35	0414-CHD	71				
0204-IE19	23	0204-DGD	35	0414-CHL	71				
0204-IF	25	0204-DGE	36	0414-CIA	71				
0204-IG	25	0204-DGF	36	0414-CIB	71				
0204-IG19	23	0204-DGG	36	0414-CIC	71				
0204-IH	25	0204-DGH	36						
0204-II	25			0602-GH	63				
0204-IL	25	0219-BF	42	0602-GI	63				
0204-BEB19	35	0219-BG	42	0602-GL	63				
0204-BGA	25	0219-BLG	42	0602-HA	63				
0204-BGA19	23	0219-CAA	42	0602-HB	63				
0204-BGB	25	0219-CLG	43	0602-HC	63				
0204-BGB19	23	0219-CLH	43	0602-HD	63				
0204-BCG	25	0219-CLI	43	0602-HE	63				
0204-BGC19	23	0219-CLL	43	0602-HH	63				
0204-BDG	25	0219-DAA	44	0602-HI	63				
0204-BGD19	23	0219-DAB	44	0602-HL	63				
0204-BGE	25	0219-DAC	44	0602-IB	63				
0204-BGF	24	0219-DAD	44	0602-IC	63				
0204-BGG	24	0219-DAE	45	0602-ID	63				
0204-BGH	24	0219-DAF	45	0602-IE	62				
0204-BGI	24	0219-DAG	45	0602-IF	62				
0204-BGL	24	0219-DAH	45	0602-IG	62				
0204-BHA	24	0219-DAI	45	0602-IH	62				
0204-BHB	24	0219-DAL	45	0602-BCA	73				
0204-BHC	24	0219-DBA	45						
0204-BHD	24	0219-DBB	45	0604-AE	3				
0204-CAG	34			0604-AF	3				
0204-CDF	34	0221-CAB	89	0604-BH	17				
0204-CDG	34	0221-CAC	89	0604-BL	17				
0204-CDH	34	0221-CAD	89	0604-CB	17				
0204-CDI	34	0221-CAE	89	0604-CC	17				
0204-CDL	34	0221-CAF	89	0604-CF	17				
0204-DAB	30	0221-CAG	89	0604-CH	17				
0204-DAC	30	0221-CAH	89	0604-FA	3				
0204-DAD	30	0221-CAI	89	0604-GB	3				
0204-DAE	30	0221-CAL	90	0604-GD	17				
0204-DAF	30	0221-CBA	90	0604-HF	9				
0204-DAG	30	0221-CBB	90	0604-HG	9				
0204-DAH	30	0221-CBC	90	0604-HH	9				
0204-DAI	30	0221-CBD	90	0604-HI	9				
0204-DAL	30	0221-CBE	90	0604-HL	3				
0204-DBA	30	0221-CBF	90	0604-IA	3				
0204-DBB	30	0221-CBG	90	0604-IB	3				
0204-DBC	31	0221-CBH	90	0604-BAB	14				

Indice alfanumerico		Alfanumerical Index		Nummernverzeichnis		Index alfabétique		Indice alfanumerico	
Article	Page	Article	Page	Article	Page	Article	Page	Article	Page
0604-BAC	14	0604-DFC	51	0604-EDA	10				
0604-BAD	14	0604-DFD	51	0604-EDB	10				
0604-BAE	14	0604-DFE	51	0604-EDC	10				
0604-BCB	59	0604-DFG	51	0604-EDD	10				
0604-BCC	59	0604-DFH	51	0604-EDE	10				
0604-BDD	9	0604-DFI	51	0604-EDF	10				
0604-BDL	8	0604-DFL	51	0604-EDG	10				
0604-BEA	8	0604-DGA	58	0604-EDH	10				
0604-BEB	8	0604-DGB	58	0604-EDI	10				
0604-BEC	8	0604-DGC	58	0604-EDL	10				
0604-BED	8	0604-DGD	58	0604-EEA	10				
0604-BEE	8	0604-DGE	58	0604-EEB	10				
0604-BEF	9	0604-DGF	58	0604-EEC	10				
0604-BEI	15	0604-DGG	56	0604-EED	10				
0604-BEL	15	0604-DHE	52	0604-EEE	10				
0604-BFA	15	0604-DHF	52	0604-FAA	62				
0604-BFB	15	0604-DHG	52	0604-FAB	62				
0604-BFC	15	0604-DHH	52	0604-FAC	62				
0604-BFH	15	0604-DHI	52	0604-FAD	62				
0604-BGF	59	0604-DHL	52	0604-FAE	62				
0604-BGG	59	0604-DIA	52	0604-FAF	62				
0604-BGL	59	0604-DIB	52	0604-FAG	62				
0604-BIC	11	0604-DIC	52	0604-FAH	61				
0604-BID	11	0604-DID	52	0604-FAI	61				
0604-BIG	11	0604-DIE	52	0604-FAL	61				
0604-BIH	11	0604-DIF	52	0604-FBA	61				
0604-BLB	11	0604-DIG	52	0604-FBB	61				
0604-BLF	11	0604-DIH	52	0604-FBC	61				
0604-BLG	11	0604-DII	52	0604-FBD	61				
0604-BLH	11	0604-DIL	52	0604-FBE	61				
0604-BLI	11	0604-DLA	53	0604-FBF	61				
0604-BLL	11	0604-DLB	53	0604-FBG	61				
0604-CBE	16	0604-DLC	53	0604-FBH	61				
0604-CBF	16	0604-DLD	53	0604-FBI	61				
0604-CBG	16	0604-DLE	53	0604-FBL	61				
0604-CBH	16	0604-DLF	53	0604-FCA	61				
0604-CBI	16	0604-DLG	53	0604-FGC19	18				
0604-CBL	16	0604-DLH	53	0604-FGD19	18				
0604-CCA	16	0604-DLI	53	0604-FHE19	18				
0604-CCE	12	0604-DLL	53	0604-FHF19	18				
0604-CCF	12	0604-EAB	4	0604-FIH19	18				
0604-CCG	12	0604-EAC	4	0604-FII19	18				
0604-CCH	12	0604-EAD	4						
0604-CCI	12	0604-EAE	4	0605-CB	60				
0604-CCL	12	0604-EAF	4	0605-CC	60				
0604-CDA	12	0604-EAG	4	0605-CD	60				
0604-DAG	7	0604-EAH	4	0605-CE	60				
0604-DAH	7	0604-EAI	5	0605-CF	60				
0604-DBA	7	0604-EAL	5	0605-CG	60				
0604-DBB	7	0604-EBA	5	0605-CH	60				
0604-DBD	46	0604-EBB	5	0605-CI	60				
0604-DDC	46	0604-EBC	5	0605-CL	60				
0604-DDD	46	0604-EBD	5	0605-DA	60				
0604-DDE	46	0604-EBE	5	0605-DB	60				
0604-DDF	46	0604-EBF	5	0605-DC	60				
0604-DDG	46	0604-EBG	5	0605-DD	60				
0604-DDH	47	0604-EBH	6	0605-DE	60				
0604-DDI	47	0604-EBI	6	0605-DF	60				
0604-DDL	47	0604-EBL	6	0605-DG	60				
0604-DEA	47	0604-ECA	13	0605-DH	60				
0604-DEB	48	0604-ECC	13	0605-DI	60				
0604-DEC	48	0604-ECD	13	0605-DL	60				
0604-DED	48	0604-ECE	13	0605-EA	60				
0604-DEE	49	0604-ECF	13	0605-EB	60				
0604-DEF	49	0604-ECG	14	0605-EC	60				
0604-DEH	50	0604-ECH	14	0605-ED	60				
0604-DEI	50	0604-ECI	14	0605-EE	60				
0604-DEL	50	0604-ECL	14	0605-EF	60				
0604-DFA	50			0605-EG	60				
0604-DFB	50			0605-EH	60				

Indice alfanumerico		Alfanumerical Index		Nummernverzeichnis		Index alfabétique		Indice alfanumerico	
Article	Page	Article	Page	Article	Page	Article	Page	Article	Page
0605-EI	60	0606-DCF	84	0614-BAD	79				
0605-EL	60	0606-DCG	84	0614-BAE	79				
0605-FA	60	0606-DDA	85	0614-BCA	79				
0605-FB	60	0606-DEB	85	0614-BCB	79				
0605-FC	60	0606-DDC	85	0614-BCC	79				
0605-FD	60	0606-DDD	85	0614-BCD	79				
0605-FE	60	0606-DDE	85	0614-BCE	79				
0605-FF	60	0606-DDF	85	0614-CAB	79				
0605-FG	60	0606-DDG	85	0614-CAC	79				
0605-FH	60	0606-DEA	85	0614-CAD	79				
0605-FI	60	0606-DEB	85	0614-CAE	79				
0605-FL	60	0606-DEC	85	0614-CAF	79				
0605-GA	60	0606-DED	85	0614-CBB	79				
		0606-DEF	86	0614-CBC	79				
0606-CA	76	0606-DEG	86	0614-CBD	79				
0606-CB	76	0606-DEH	86	0614-CBE	79				
0606-CC	76	0606-DEI	86	0614-CBF	79				
0606-CD	76	0606-DEL	86						
0606-GI	75	0606-DFA	86	0617-BG	38				
0606-GL	75	0606-DFB	86	0617-BH	38				
0606-IA	77	0606-DFC	86	0617-CA	74				
0606-IB	77	0606-DFD	87	0617-CD	74				
0606-IC	77	0606-DFE	87	0617-CE	74				
0606-ID	77	0606-DGA	88	0617-CF	74				
0606-IE	77	0606-DGB	88	0617-CG	74				
0606-IF	77	0606-DGC	88	0617-CH	74				
0606-IG	77	0606-DGD	88	0617-CI	74				
0606-IH	77	0606-DGE	88	0617-CL	74				
0606-II	77	0606-DGF	88	0617-DA	74				
0606-BAC	78	0606-DGG	88	0617-GE	38				
0606-BAD	78	0606-EAB	82	0617-GF	38				
0606-BAE	78	0606-EAC	82						
0606-BAF	78	0606-EAD	82	0617050517	38				
0606-BAG	78	0606-EAE	82						
0606-BAH	78	0606-ECA	67	0706-BFA	92				
0606-BAI	78	0606-ECB	67	0706-BFB	92				
0606-BAL	78	0606-ECC	67	0706-BFB02	92				
0606-BBA	78	0606-ECD	65, 66, 67, 68	0706-BFC	92				
0606-BBB	78	0606-ECF	65, 66, 67	0706-BFC02	92				
0606-CBA	80	0606-ECG	67, 68	0706-BFD	92				
0606-CBB	80	0606-ECH	67, 68	0706-BFE	92				
0606-CBC	80	0606-ECI	67, 68	0706-CBA	93				
0606-CBD	80	0606-ECL	67	0706-CBB	93				
0606-CBE	81	0606-EDA	65	0706-CBC	93				
0606-CBF	81	0606-EDC	65, 66	0706-CBD	93				
0606-CBG	81	0606-EDD	65, 66	0706-CBE	93				
0606-DAB	54	0606-EDE	65, 66	0706-CBF	93				
0606-DAC	54	0606-EDF	65, 66	0706-CBG	93				
0606-DAD	54	0606-EDG	66	0706-CBH	93				
0606-DAE	54			0706-CCC	93				
0606-DAF	54	0607-BAG	72	0706-CCD	93				
0606-DAG	54	0607-BAH	72	0706-CCE	93				
0606-DAH	54	0607-BFC	72	0706-CCF	93				
0606-DAI	54	0607-CAL	12	0706-CCG	93				
0606-DAL	55	0607-CBA	12	0706-CCH	93				
0606-DBA	55	0607-CBB	12	0706-CCI	93				
0606-DBB	55	0607-CBC	12	0706-CCL	93				
0606-DBC	55			0706-CDA	93				
0606-DBD	55	0610-BB	73	0706-CEA	92				
0606-DBE	55	0610-BD	73	0706-CEB	92				
0606-DBF	56	0610-BE	73	0706-CEB02	92				
0606-DBG	56			0706-CEC	92				
0606-DBH	57	0611-BAE	80	0706-CEC02	92				
0606-DBI	57	0611-DGI	80	0706-CEJ	92				
0606-DBL	57			0706-CEE	92				
0606-DCA	57	0614-ID	75	0706-CFC	92				
0606-DCB	83	0614-IG	75						
0606-DCC	83	0614-BAA	79	1014-BB	40				
0606-DCD	84	0614-BAB	79	1014-BE	41				
0606-DCE	84	0614-BAC	79	1014-BF	41				

Indice alfanumerico		Alfanumerical Index		Nummernverzeichnis		Index alfabétique		Indice alfanumerico	
Article	Page	Article	Page	Article	Page	Article	Page	Article	Page
1014-BG	41	1206-DEC19	21	1412-CBI	70				
1014-BH	41	1206-DED19	21	1412-CBL	70				
1014-CB	40	1206-DEE19	21	1412-CCA	70				
1014-EA	39	1206-DEF19	21			15-BG	73		
1014-EB	39	1206-DEG19	21			15-BCC	73		
1014-EC	39	1206-DEH19	21			15-DDC	73		
1014-ED	39	1206-DEI19	22			15-EAB	64		
1014-EE	39	1206-DEL19	22			15-EAC	64		
1014-EH	41	1206-DFA19	22			15-EAD	64		
1014-EI	41	1206-DFB19	22			15-EAE	64		
1014-EL	41	1206-DFC19	22			15-EAF	64		
1014-FA	41	1206-DFD19	22			15-EAG	64		
1014-HC	40	1206-DFE19	22			15-EAH	64		
		1206-DFF19	22			15-EAI	64		
1102-BA	38	1206-DFG19	22						
1102-BB	38	1206-DFH19	22						
1102-BC	38	1206-DFI19	22						
1102-BC04	38	1206-DFL19	22						
1102-BD	38	1206-DGC19	20						
1102-BF	38	1206-DGD19	20						
1102-BF01	38	1206-DGE19	20						
1102-BF03	38	1206-DGF19	20						
1102-EA	38	1206-DGG19	20						
1102-DGB	37	1206-DGH19	20						
1102-DGC	37	1206-DHA	28						
1102-DGD	37	1206-DHB	28						
1102-DGE	37	1206-DHC	28						
1102-DGF	37	1206-DHD	28						
1102-DGG	37	1206-DHE	28						
1102-DGH	37	1206-DHF	28						
1102-DGI	37	1206-DHG	28						
1102-DGL	37	1206-DHH	28						
		1206-DHI	29						
1201-02D	38	1206-DHL	29						
1201-02H	38	1206-DIA	29						
1201-02BF	38	1206-DIB	29						
1201-BA	49	1206-DIC	29						
		1206-DID	29						
1206-BBA	26	1206-DIE	29						
1206-BBB	26	1206-DIF	29						
1206-BBC	26			1310-BC	38				
1206-BBD	26					1412-CF	81		
1206-BBE	26					1412-CH	81		
1206-BBF	26					1412-CI	81		
1206-BBG	27					1412-CL	81		
1206-BBH	27					1412-DL	81		
1206-BBI	27					1412-IA	69		
1206-BBL	27					1412-IB	69		
1206-BCA	27					1412-IC	69		
1206-BCB	27					1412-IF	69		
1206-BCC	27					1412-IH	69		
1206-BCD	27					1412-II	69		
1206-BDA19	19					1412-LL	66		
1206-BDB19	19					1412-CAB	68		
1206-BDC19	19					1412-CAC	68		
1206-BDD19	19					1412-CAD	68		
1206-BDE19	19					1412-CAE	68		
1206-BDF19	19					1412-CAF	70		
1206-BDG19	19					1412-CAG	65, 66, 70		
1206-BDH19	19					1412-CAH	70		
1206-BDI19	19					1412-CAI	68		
1206-BDL19	19					1412-CAL	68		
1206-BEA19	19					1412-CBA	68		
1206-BEB19	19					1412-CBB	68		
1206-BEC19	21					1412-CBE	70		
1206-BED19	21					1412-CBF	70		
1206-BEE19	21					1412-CBG	70		
1206-BEF19	21					1412-CBH	70		
1206-BEG19	21								
1206-BEH19	21								



ideal-tek
manufacturer & supplier of precision instruments 

Ideal-tek SA
via Motta 4
6828 Balerna
Switzerland

Phone: +41 91 683 32 29
Fax: +41 91 683 03 71
E-mail: info@ideal-tek.com