



ideal-tek
manufacturer & supplier of precision instruments 

estetica

Pediküre-Instrumente

Pedicure Instruments
Podologia - Estetica
Instruments de pédicure



ideal-tek

manufacturer & supplier of precision instruments 

Spatel

Spatulas

Spatole

Espatulas

Spatules

1,5 mm

2,5 mm

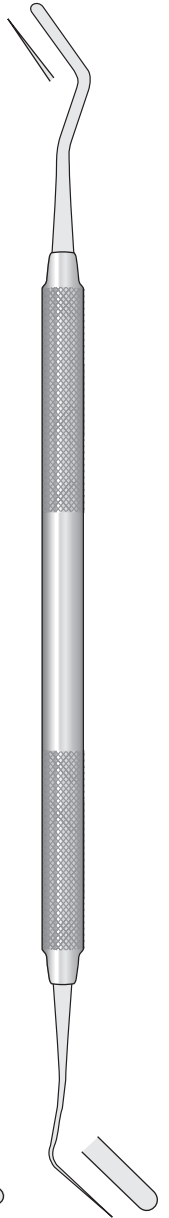
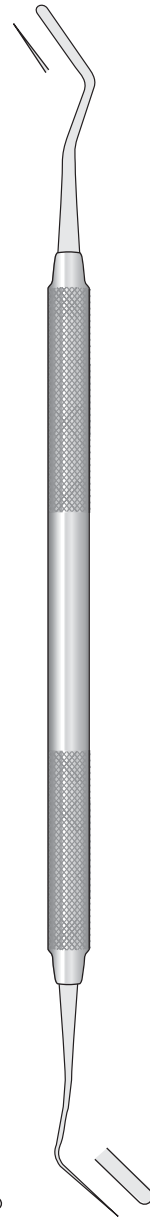
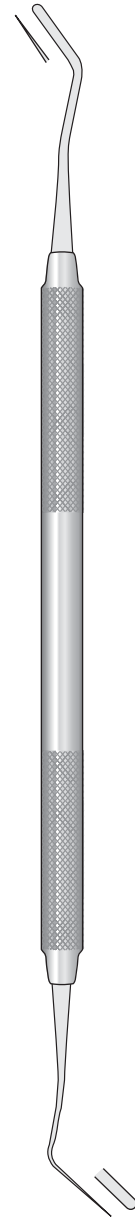
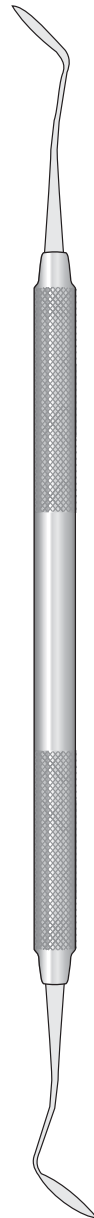
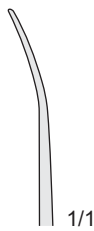
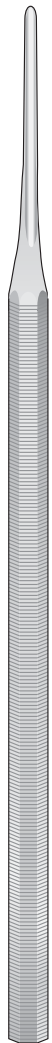

Flexibel Spatel - Spatulas flexible
Spatole Flessibili - Espatulas flexible
Spatules flexible

0518-BA
140 mm

0518-BB
140 mm

0518-CH
160 mm

0518-CB
140 mm

0518-CD
120 mm

0518-CE
155 mm

17-C
170 mm

08-B
170 mm

08-C
170 mm

08-D
170 mm

Fußpflege
Instrumente

Chiropody
Instruments

Strumenti
per pedicure

Instrumentos
para pedicuras

Instruments
de pédicure

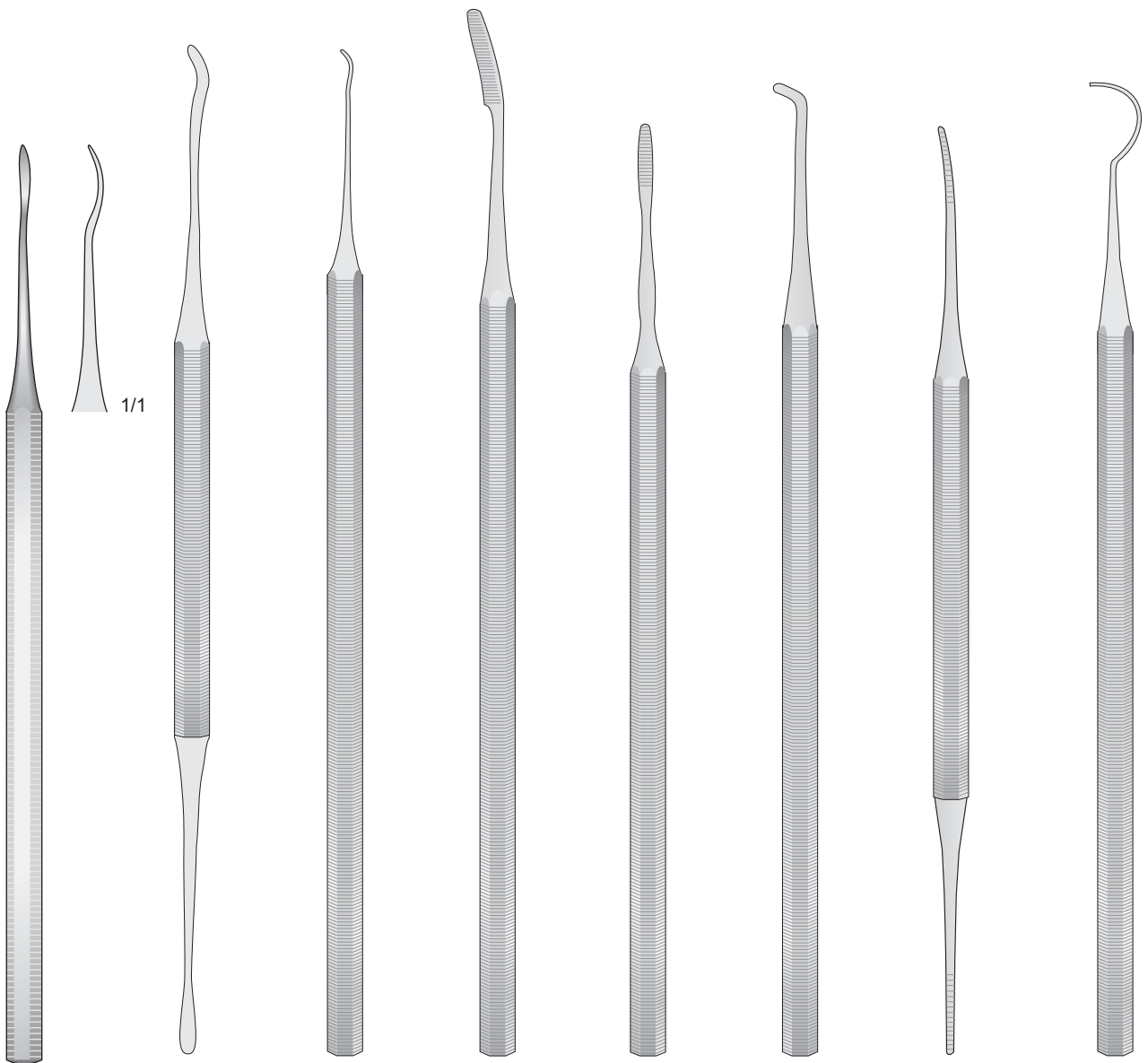

0518-BD
135 mm

0518-CF
150 mm

0518-CG
150 mm

0518-DA
155 mm

0518-DB
140 mm

0518-DC
145 mm

0518-DD
140 mm

0518-EA
145 mm

**Fußpflege
Instrumente**

**Chiropody
Instruments**

**Strumenti
per pedicure**

**Instrumentos
para pedicuras**

**Instruments
de pédicure**

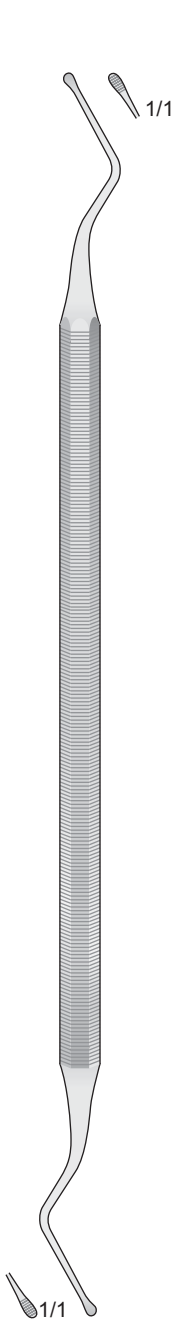

**HIRSCHFELD
0806-D/H
170 mm**



HBH-GG



HBH-GE

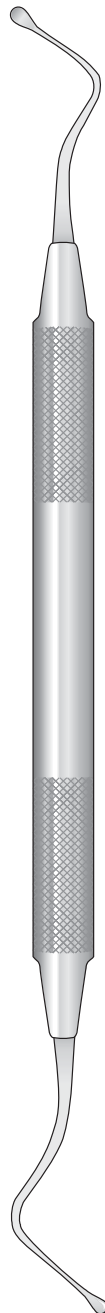

**LUCAS
HCA-IG**

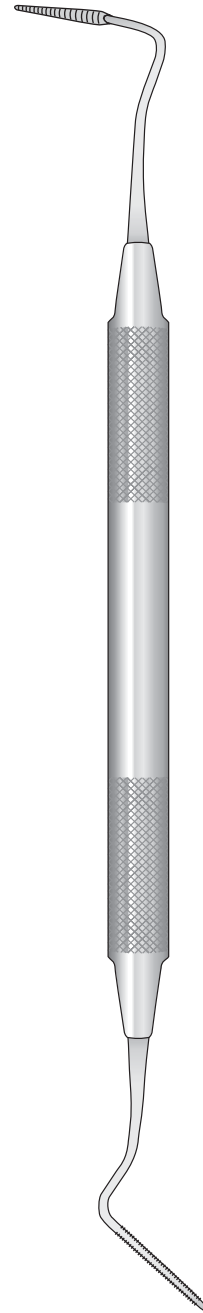

**SUGARMAN
HBI-CBC18**



**GOLDMAN-FOX
HBI-BEH**

Skalpellgriffe
Klingen

Scalpel handles
blades

Manici e lame
per bisturi

Mangos
de Bisturios hojas

Manche
pour Bistouris

Klingen für - Blades for
Lama per - Hojas para
Lames pour

BB-46/BB-48

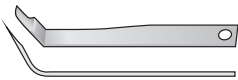

1102-DGG
Conf. 10 pz.

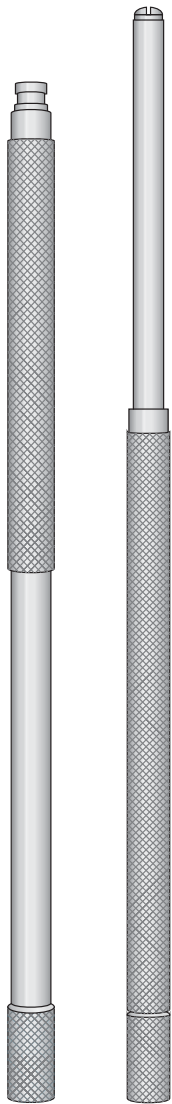

0202-EG
135 mm

0202-EI
155 mm



1201-02D
Fig. 3

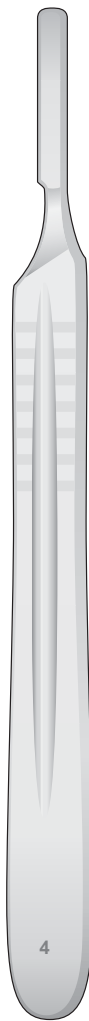

1201-02E
Fig. 4

Klingen für - Blades for
Lama per - Hojas para
Lames pour

MA-B3

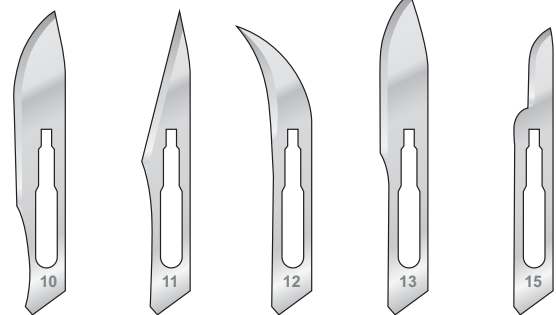

1102-BA
Fig. 10

1102-BB
Fig. 11

1102-BC
Fig. 12

1102-BD
Fig. 13

1102-BF
Fig. 15

Klingen für - Blades for
Lama per - Hojas para
Lames pour

MA-B4



1102-CA
Fig. 20

1102-CB
Fig. 21

1102-CC
Fig. 22

1102-CD
Fig. 23

1102-CE
Fig. 24

1102-CF
Fig. 25

Milienmesser
Lanzetten

Milium knives
Lancets

Micro-bisturi
lancette

Micro-bisturies
lancetas

Couteaux à millets
lancettes

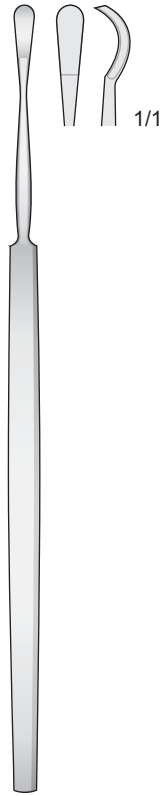

VIDAL
0418-CF
140 mm



1310-EL
125 mm



ZIEGLER
1310-AG/1310-AI
115 mm

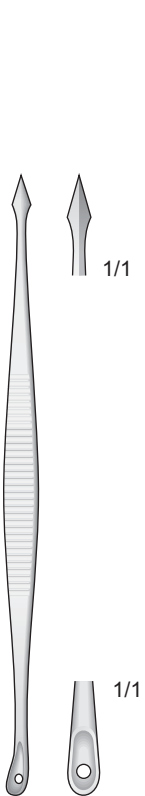
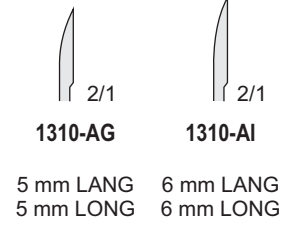

SAALFELD
0418-CG
100 mm

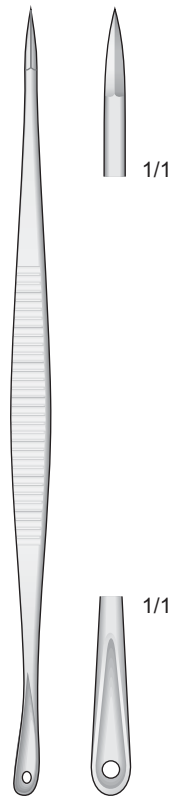

SAALFELD
0418-CH
140 mm

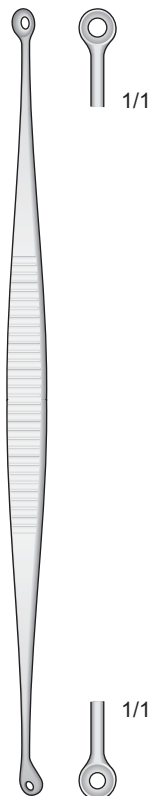

UNNA
0418-CI
140 mm

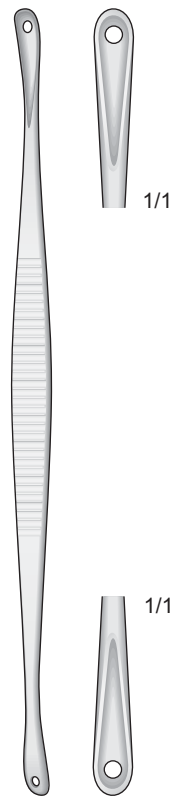

UNNA
0418-CL
140 mm

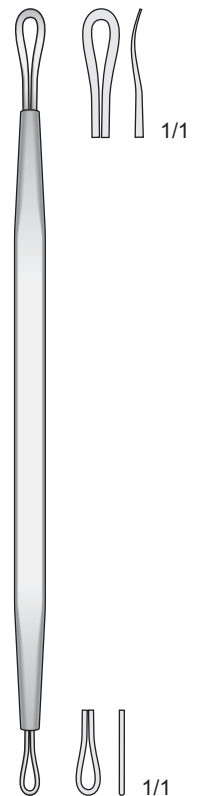

0518-CC
130 mm

Cilienpinzetten

Cilia forceps

Pinzette Depilatorie

Pinzas depilatorie

Pinces à épiler les cils

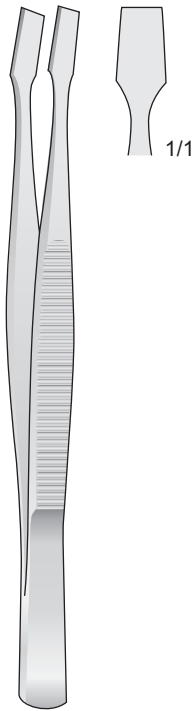

KÜHNE
0518-EE
105 mm

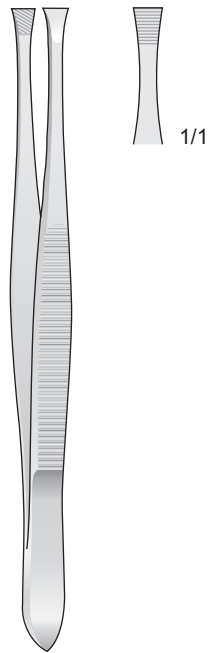

LITTAUER
0518-GE
85 mm

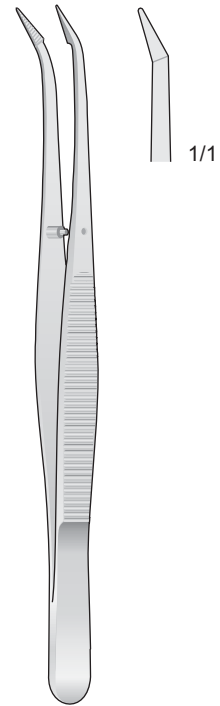

BARRAQUER
0518-GF
105 mm

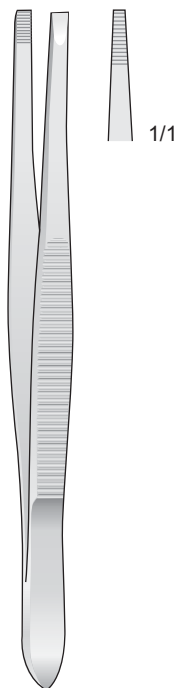

0518-EF
90 mm

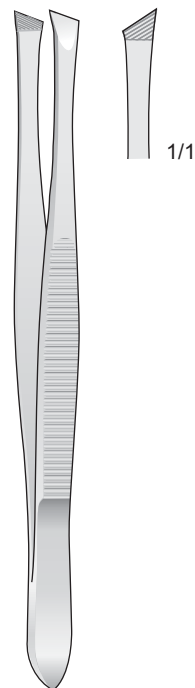

0518-EG
90 mm

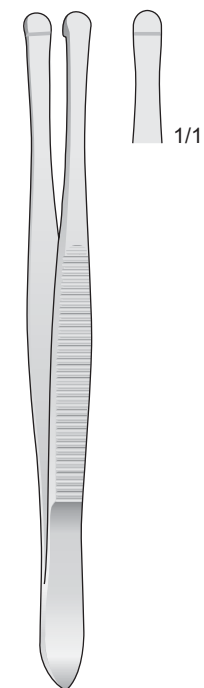

BEER
0518-EI
90 mm

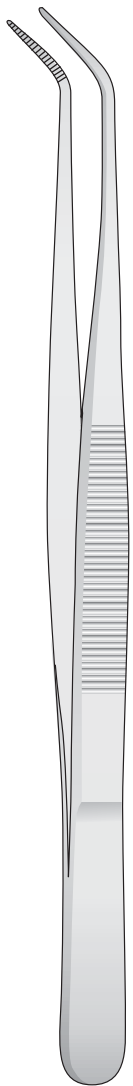

03141111050705
150 mm

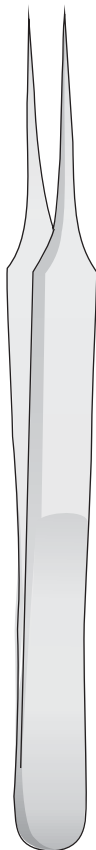

0204-GA
110 mm

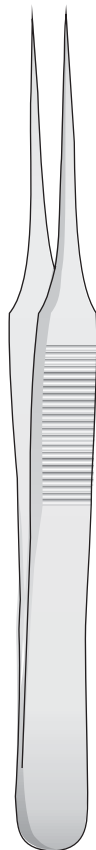

0204-GE
110 mm

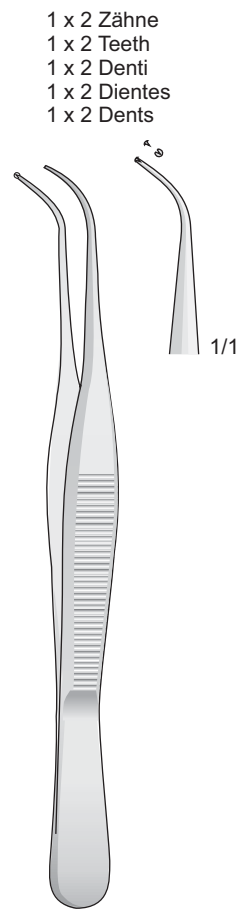
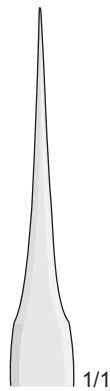

0204-DG
100 mm



FEICHENFELD
0204-BCC
100 mm



Nagelhautscheren

Cuticle Scissors

Forbici per unghie

Tijeras para uñas

Ciseaux à envies

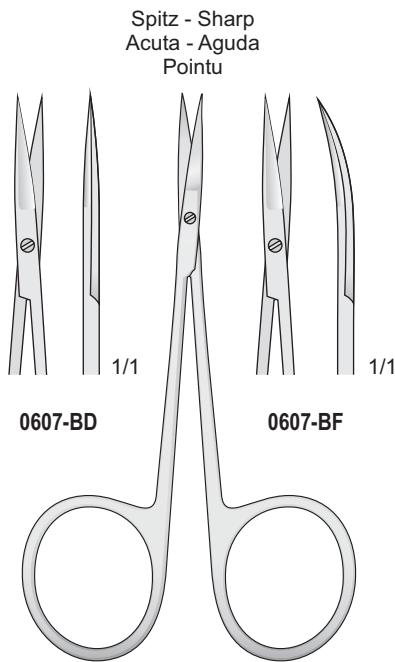

MICRO-IRIS
0607-BD/0607-BF
85 mm

Spitz - Sharp Stumpf - Blunt
Acuta - Aguda Smussa - Romas
Pointu Mousse

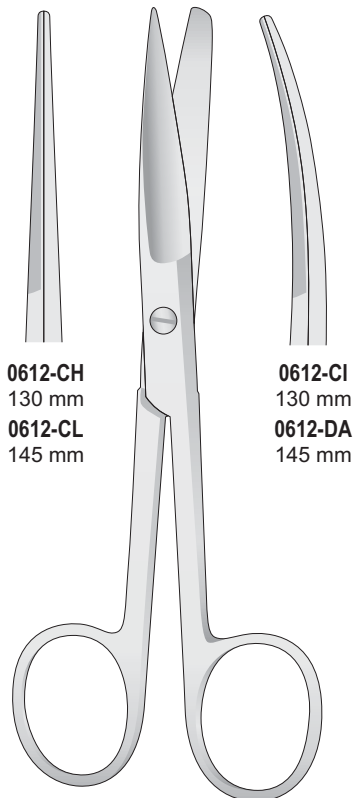

0612-CH/0612-DA

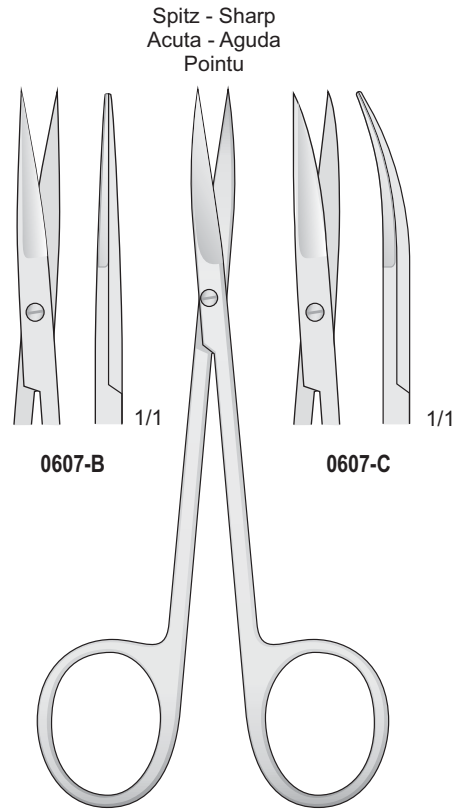

IRIS
0607-B/0607-C
110 mm

Stumpf - Blunt
Smussa - Romas
Mousse

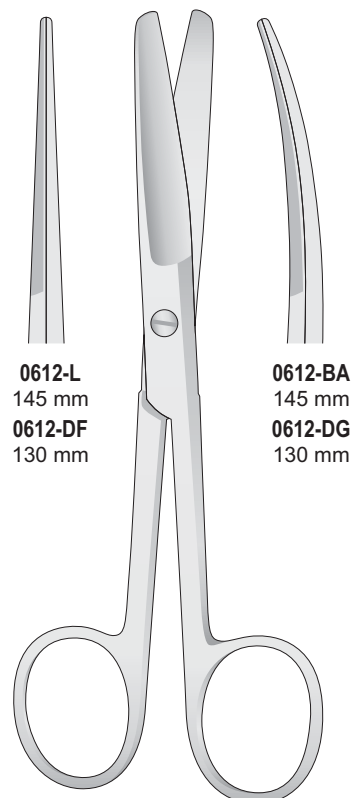

0612-L/0612-EA

**Vorbereitung
Nagel scheren**

**Preparation
Nail scissors**

**Preparazione
Forbici per unghie**

**Preparacion
Tijeras para uñas**

**Ciseaux et pinces
à ongles**

Rostfrei - Stainless Steel
Acciaio inossidabile - Acero inoxidable
Acier inoxydable

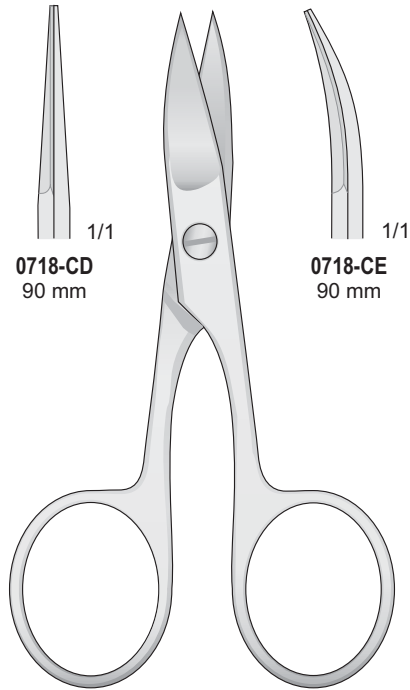

0718-CD/0718-CE

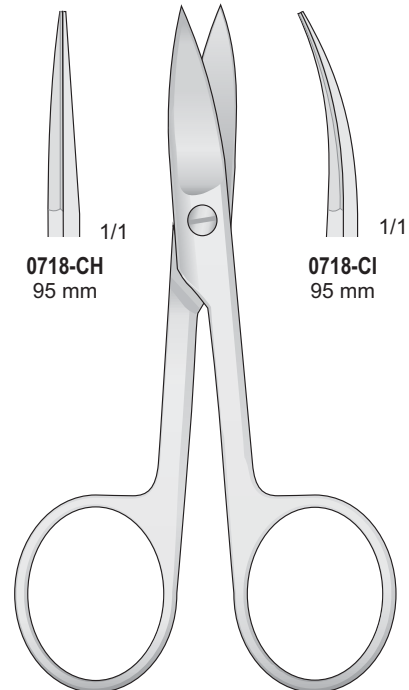

0718-CH/0718-CI

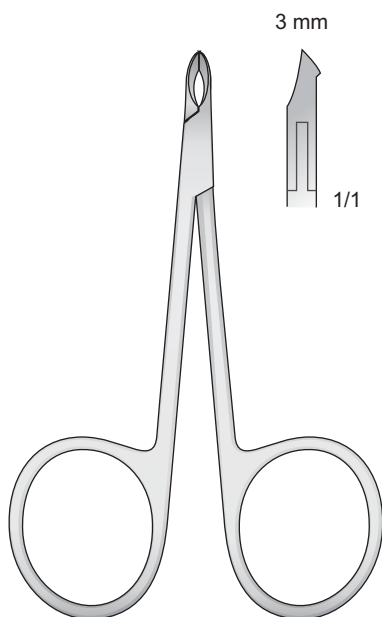

**0718-EA
85 mm**

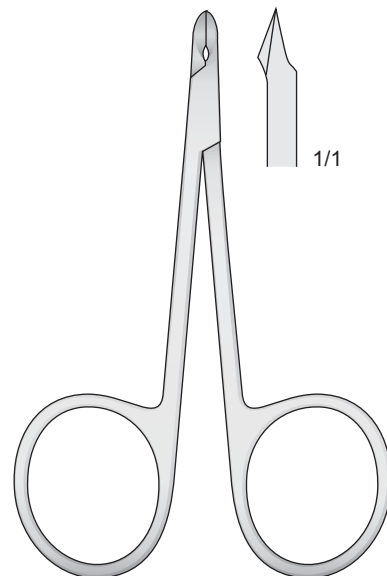

**0718-FB
85 mm**

Vorbereitung
Nagel scheren

Preparation
Nail scissors

Preparazione
Forbici per unghie

Preparacion
Tijeras para uñas

Ciseaux et pinces
à ongles

Rostfrei - Stainless Steel
Acciaio inossidabile - Acero inoxidable
Acier inoxydable

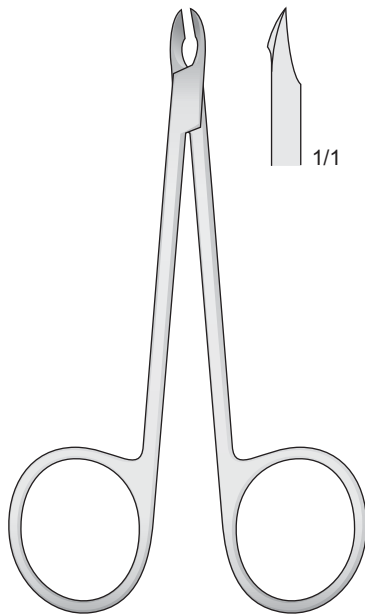

0718-FC
100 mm

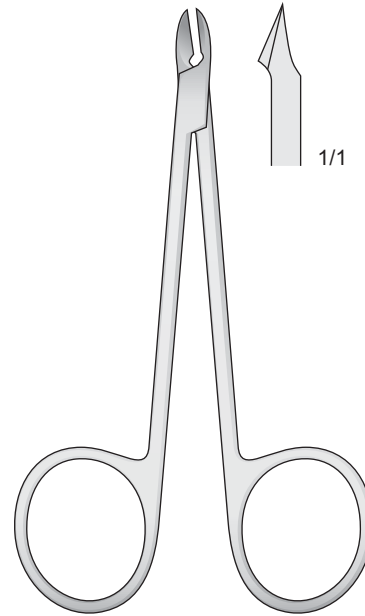

0718-FD
100 mm

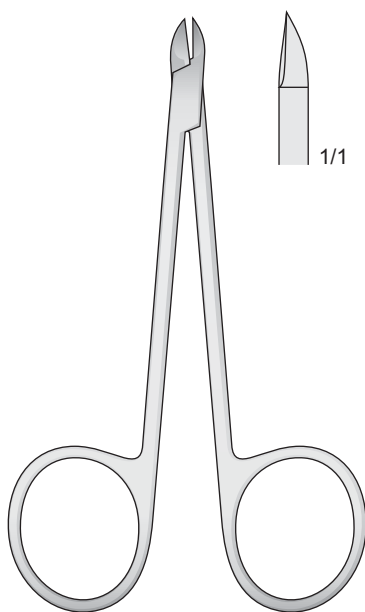

0718-FE
100 mm

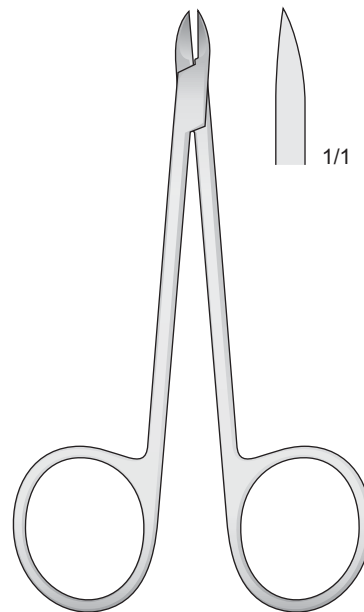

0718-FF
100 mm

Eckenzangen

Nail corner forceps

Tronchesi per unghie

Corta uñas

Pinces à angles

Rostfrei - Stainless Steel
 Acciaio inossidabile - Acero inoxidable
 Acier inoxydable

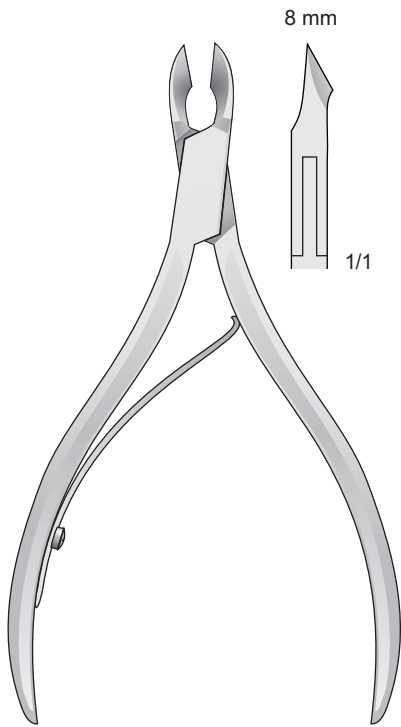

**COHEN
 1123-GA
 100 mm**

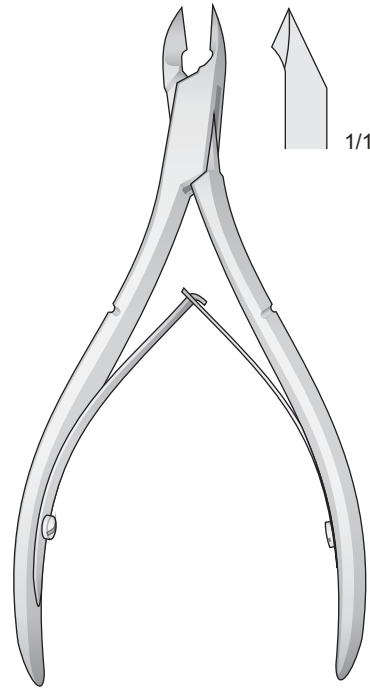

**0718-FG
 100 mm**

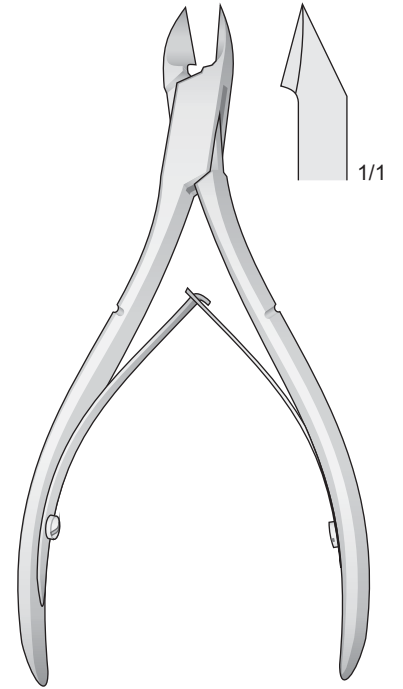

**0718-FI
 110 mm**

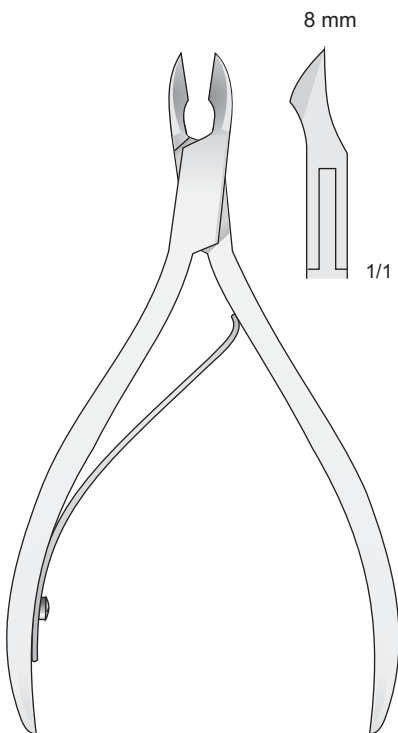

**0718-EB
 110 mm**

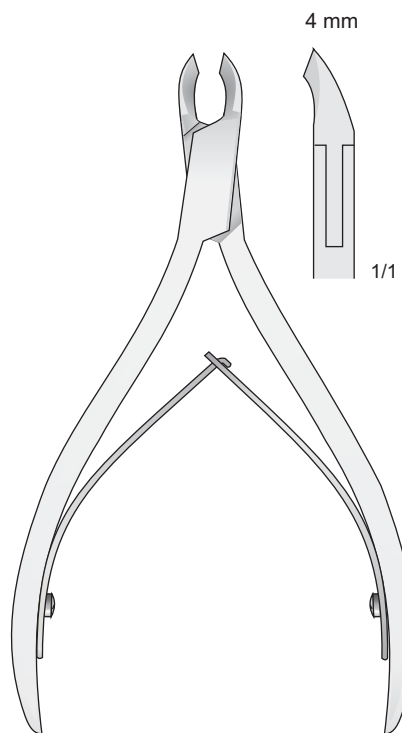

**0718-EF
 110 mm**

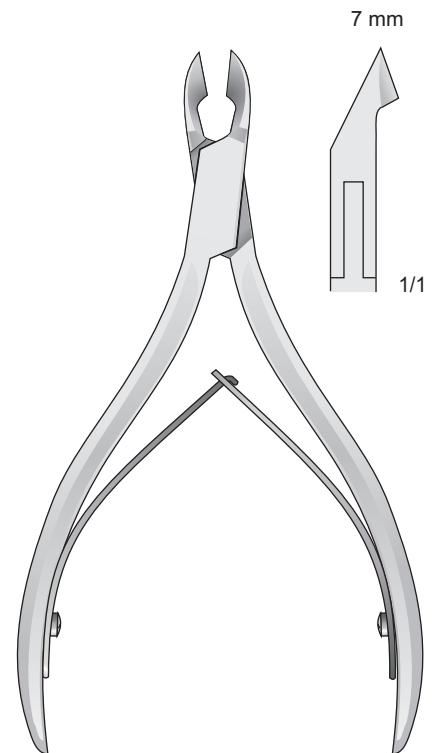

**ILIC
 1123-FA
 115 mm**

Eckenzangen

Nail corner forceps

Tronchesi per unghie

Corta uñas

Pinces à ongles

Rostfrei - Stainless Steel
 Acciaio inossidabile - Acero inoxidable
 Acier inoxydable

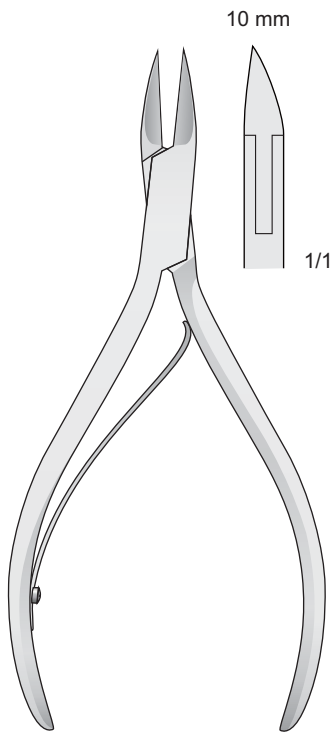

0718-EC
 100 mm

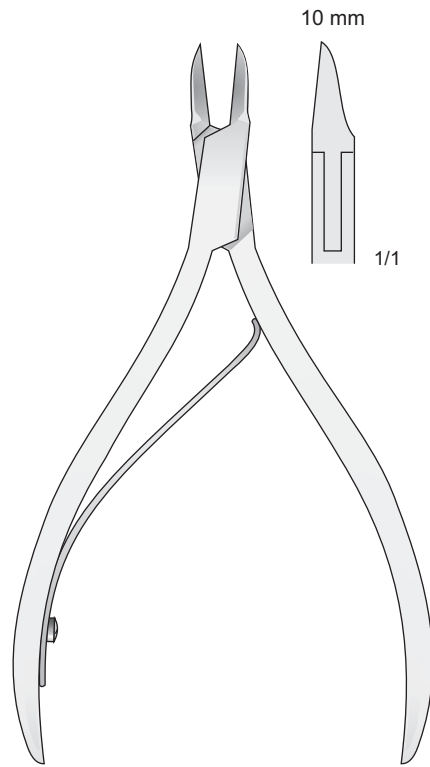

0718-ED
 110 mm

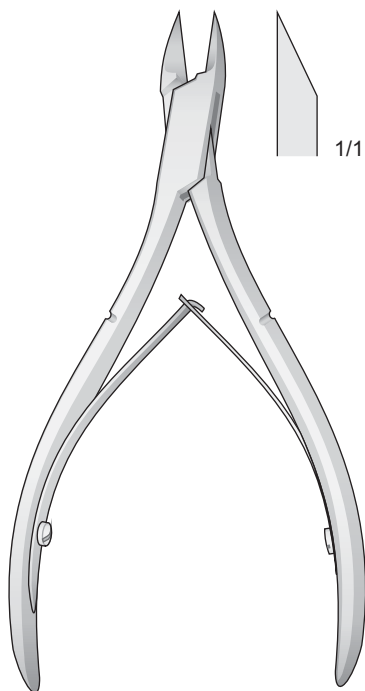

0718-FH
 100 mm

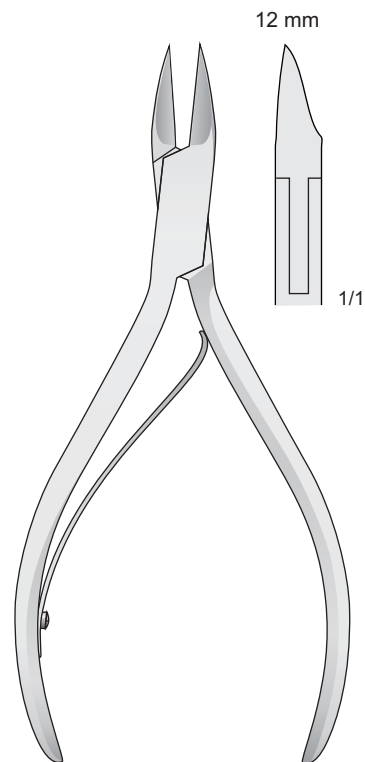

0718-EE
 110 mm

Eckenzangen

Nail corner forceps

Tronchesi per unghie

Corta uñas

Pinces à ongles

Rostfrei - Stainless Steel
 Acciaio inossidabile - Acero inoxidable
 Acier inoxydable

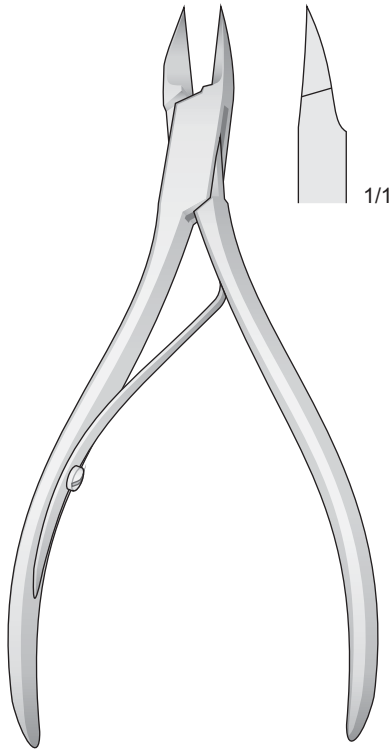

0718-HA
115 mm

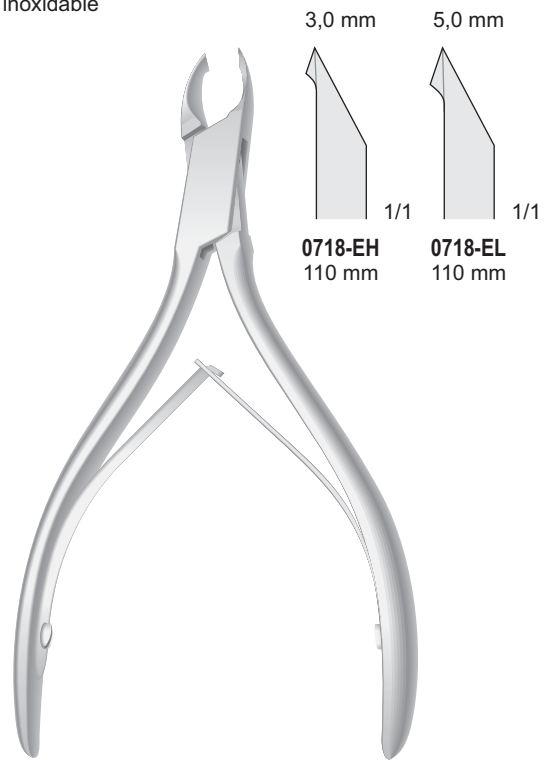

0718-EH/0718-EL
110 mm

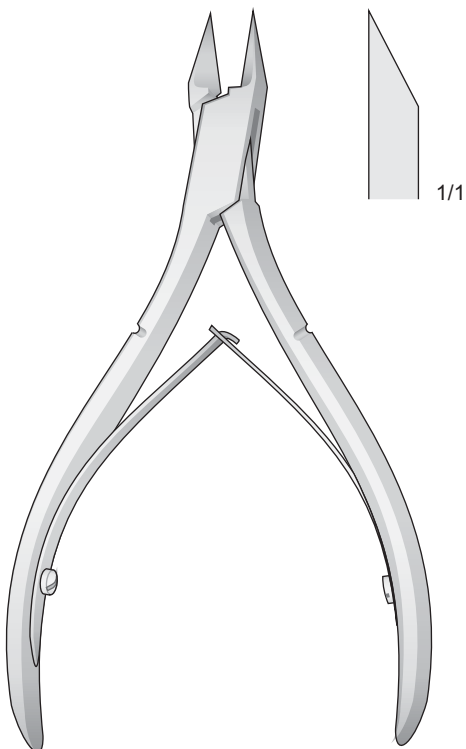

0718-FL
115 mm

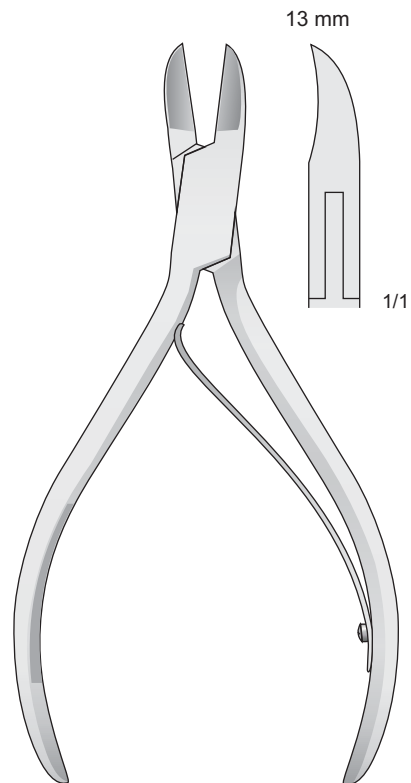

0718-CB
120 mm

Eckenzangen

Nail corner forceps

Tronchesi per unghie

Corta uñas

Pinces à ongles

Rostfrei - Stainless Steel
 Acciaio inossidabile - Acero inoxidable
 Acier inoxydable

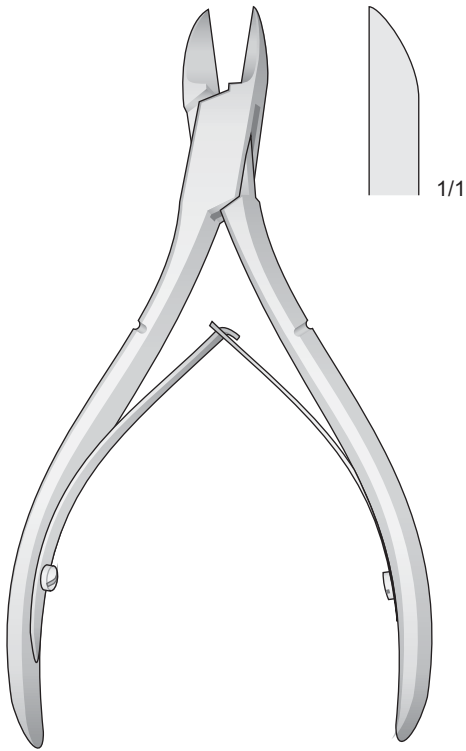

0718-GE
115 mm

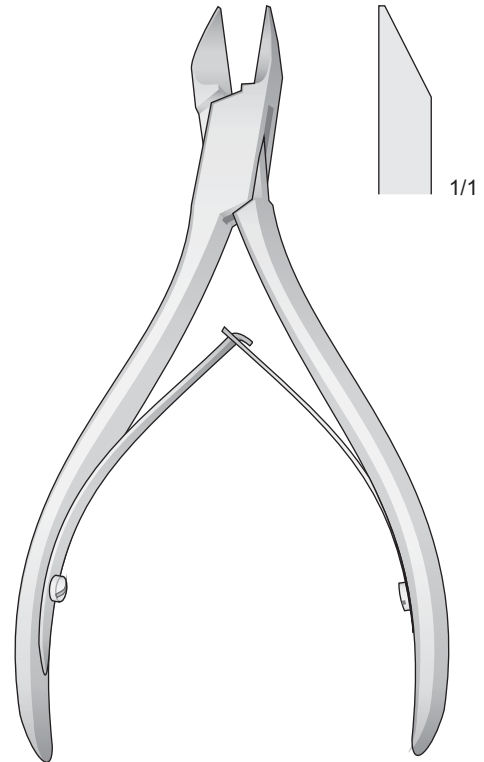

0718-GL
120 mm

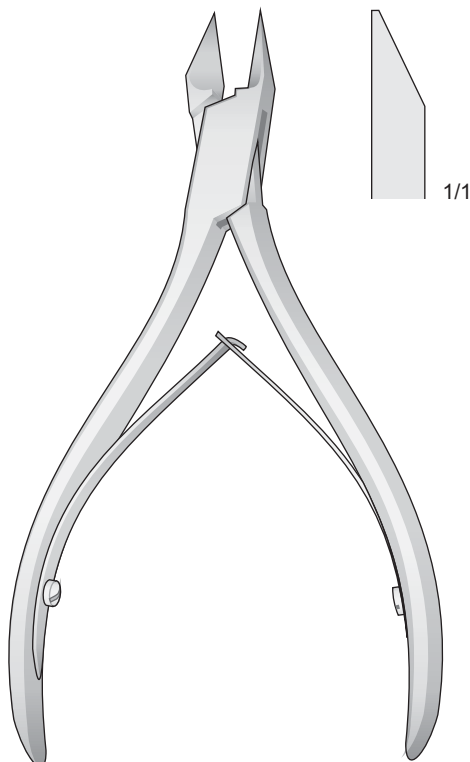

0718-GA
120 mm

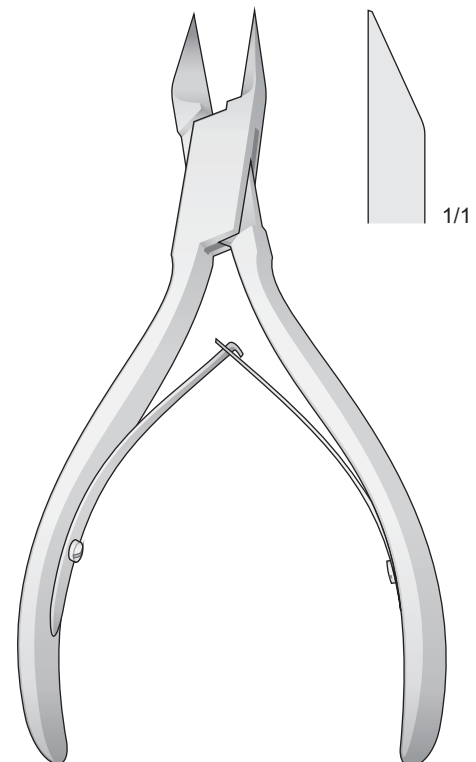

0718-GH
120 mm

Rostfrei - Stainless Steel
Acciaio inossidabile - Acero inoxidable
Acier inoxydable

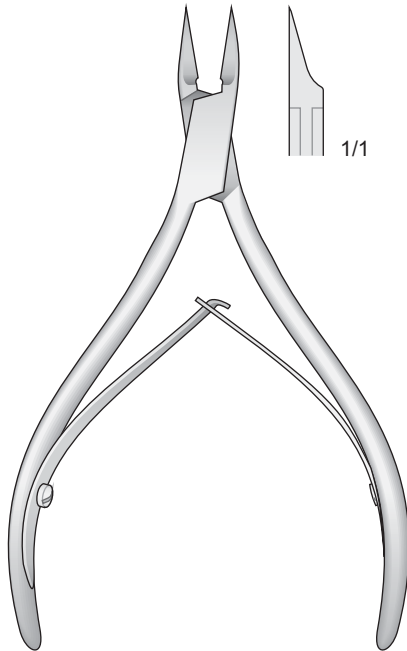

0718-HB
100 mm

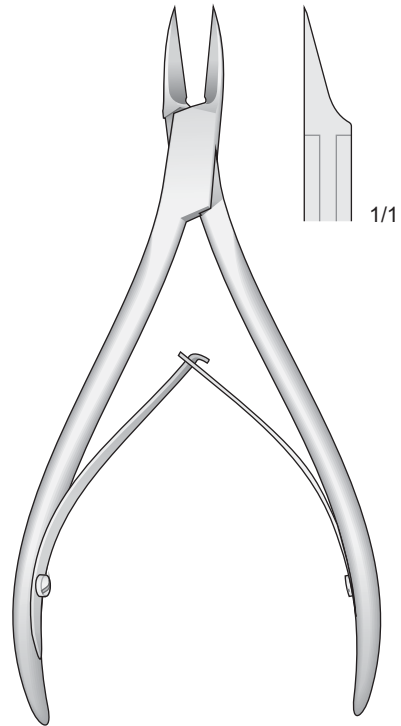

0718-HC
115 mm

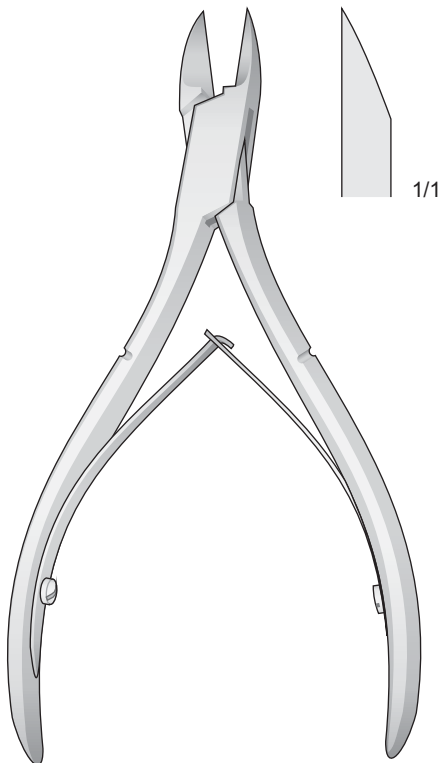

0718-GB
130 mm

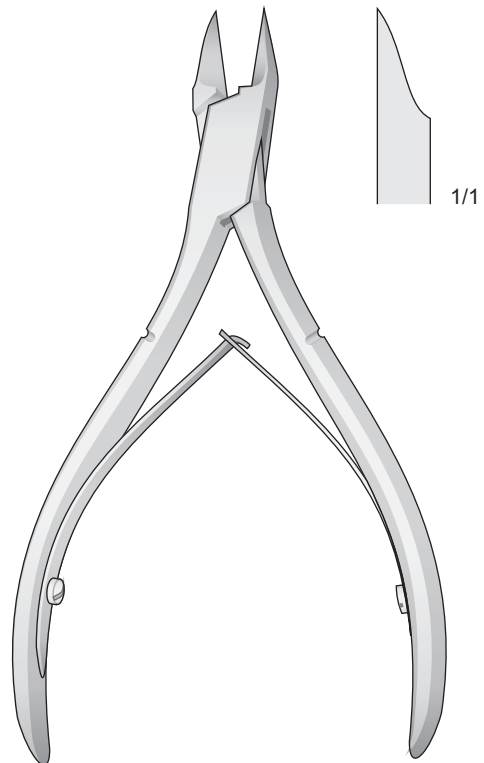

0718-GC
130 mm

Eckenzangen

Nail corner forceps

Tronchesi per unghie

Corta uñas

Pinces à ongles

Rostfrei - Stainless Steel
 Acciaio inossidabile - Acero inoxidable
 Acier inoxydable

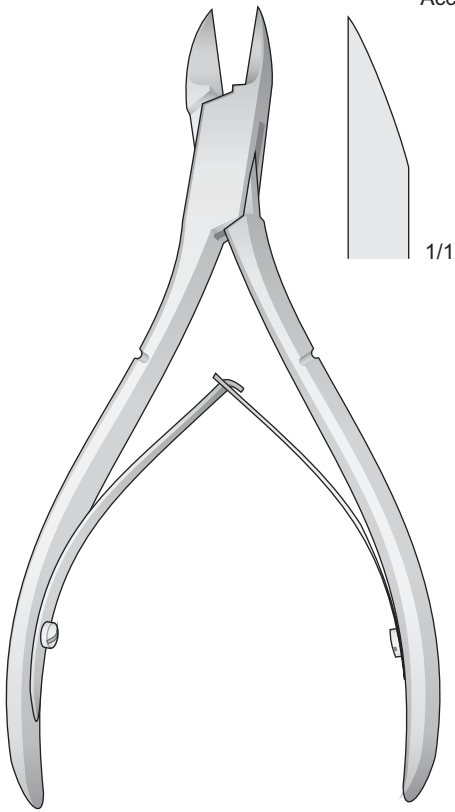

0718-GD
160 mm

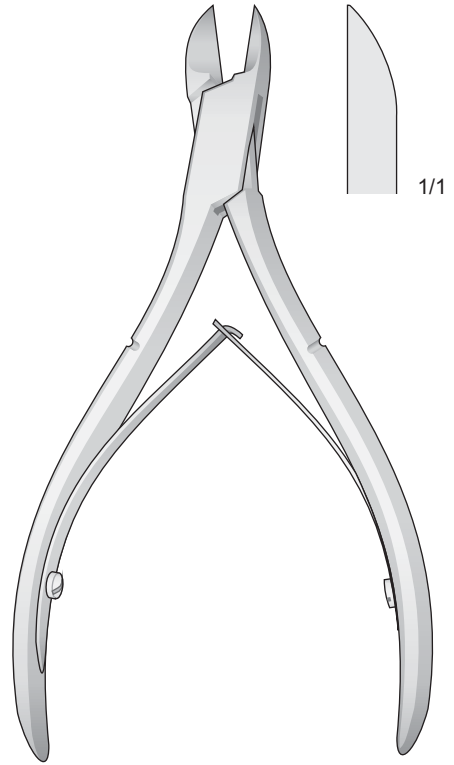

0718-GF
130 mm

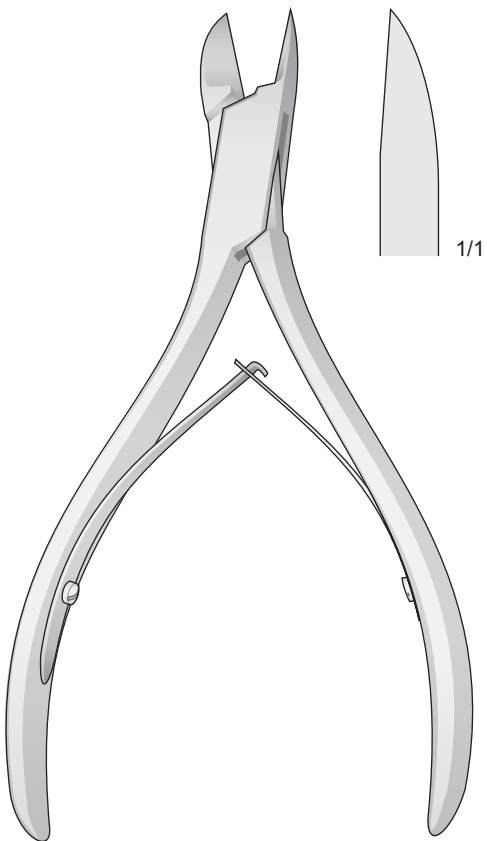

0718-GI
150 mm

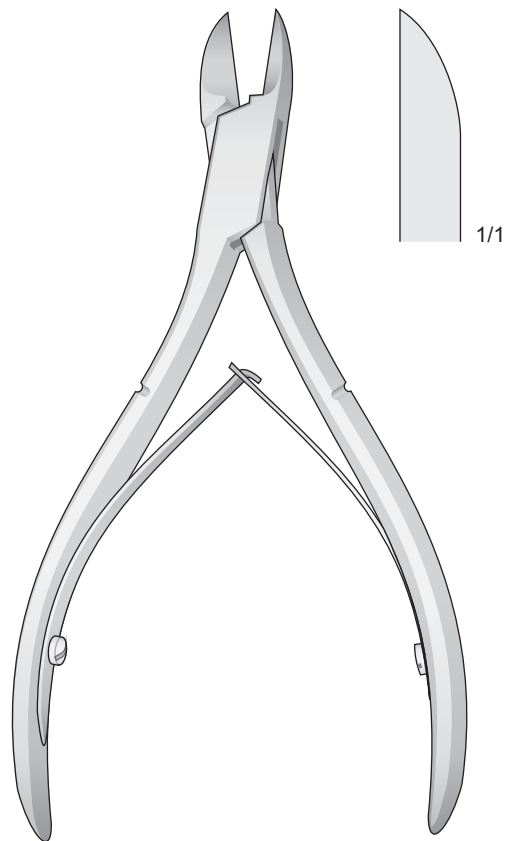

0718-GG
160 mm

Eckenzangen

Nail corner forceps

Tronchesi per unghie

Corta uñas

Pinces à ongles

Rostfrei - Stainless Steel
 Acciaio inossidabile - Acero inoxidable
 Acier inoxydable

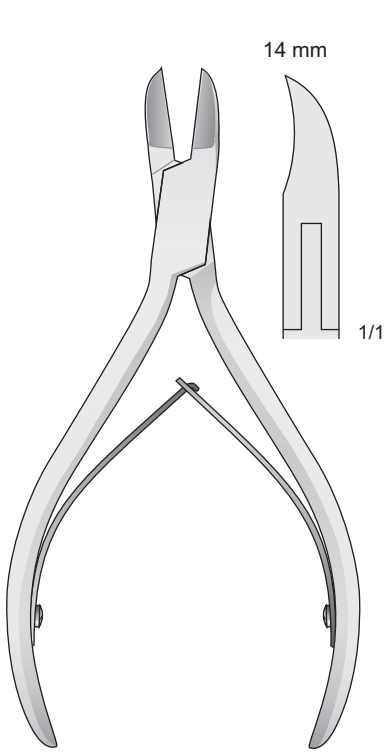

0718-DC
120 mm

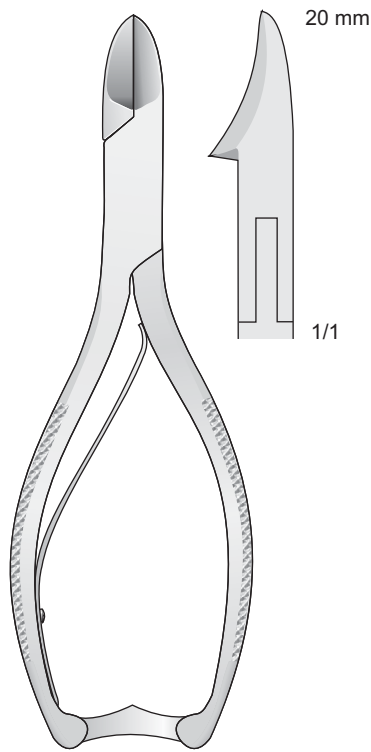

0718-CA
135 mm

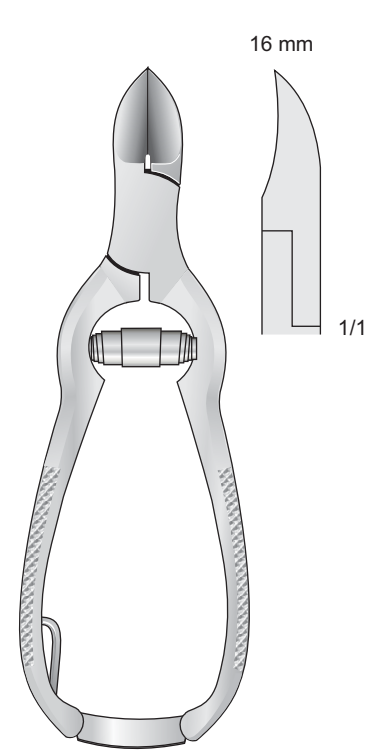

0718-EG
120 mm

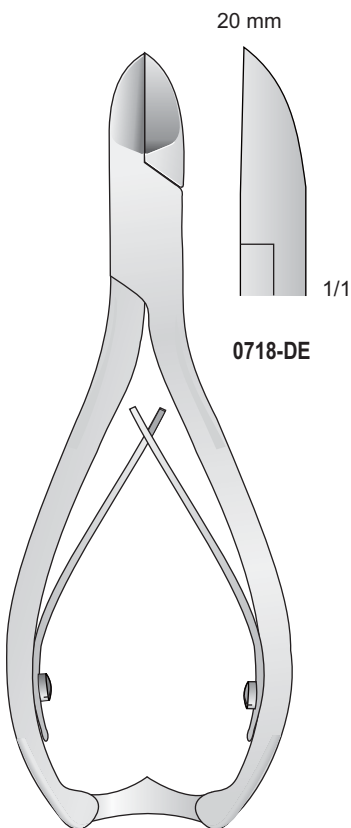

0718-DE

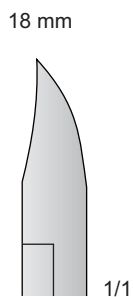

0718-DF

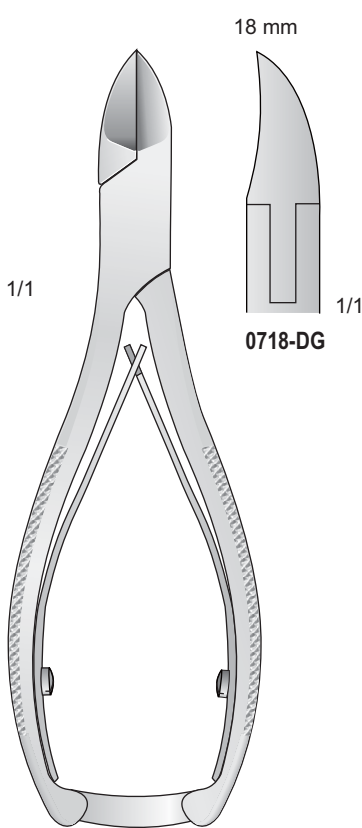

0718-DG

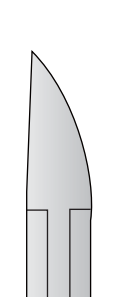

0718-DH

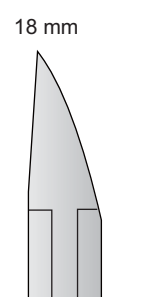

0718-DI

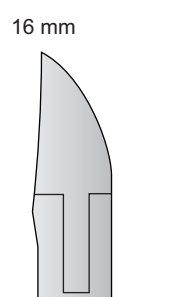

0718-EI

0718-DE/0718-DF
140 mm

0718-DG/0718-EI
140 mm

Eckenzangen
Fusspflege Instrumente

Nail corner forceps
Chiropody instruments

Tronchesi per unghie
Strumenti da pedicura

Pinces à ongles
Instrumentos pra pedicuras

Pinces à ongles
Instruments de pédicure

Rostfrei - Stainless Steel
Acciaio inossidabile - Acero inoxidable
Acier inoxydable

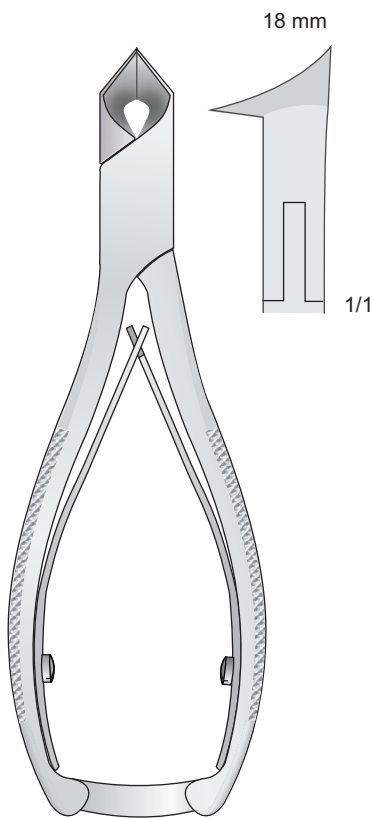

0718-FA
135 mm

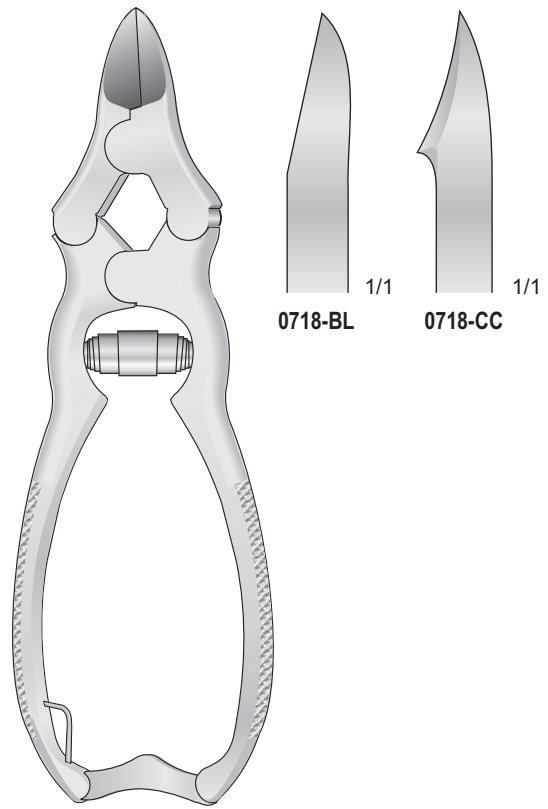

0718-BL/0718-CC
155 mm



WARWICK-JAMES
0411-CA

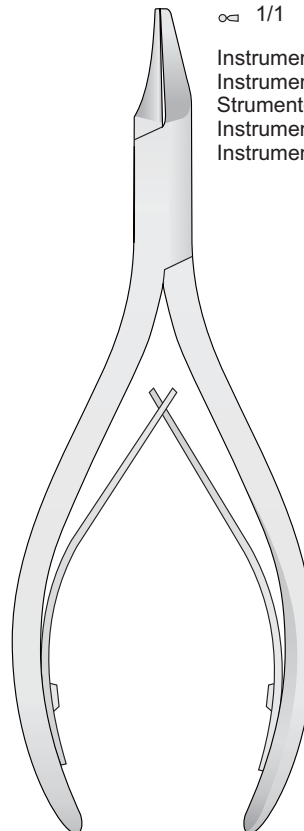

0415-AL
135 mm

∞ 1/1
Instrument für Nägel
Instrument for nails
Strumento per unghie incarnite
Instrumento para los clavos
Instrument pour des ongles

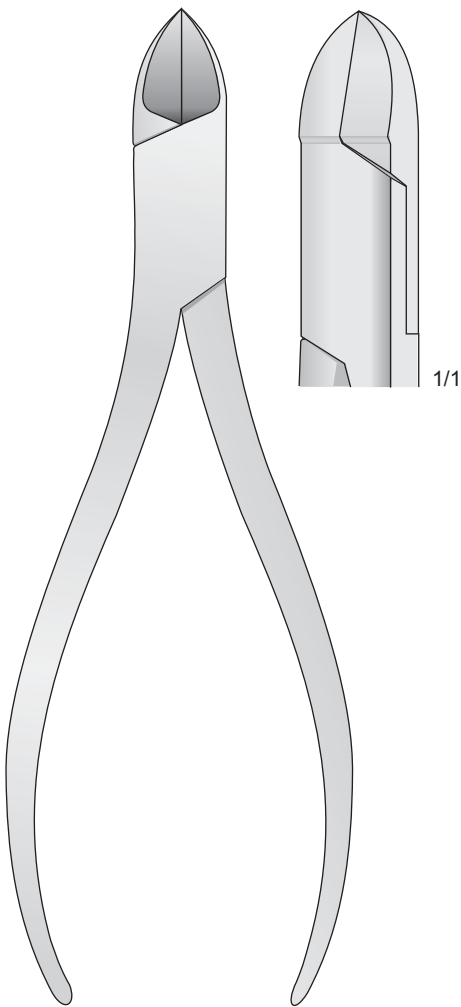

1123-LG
150 mm

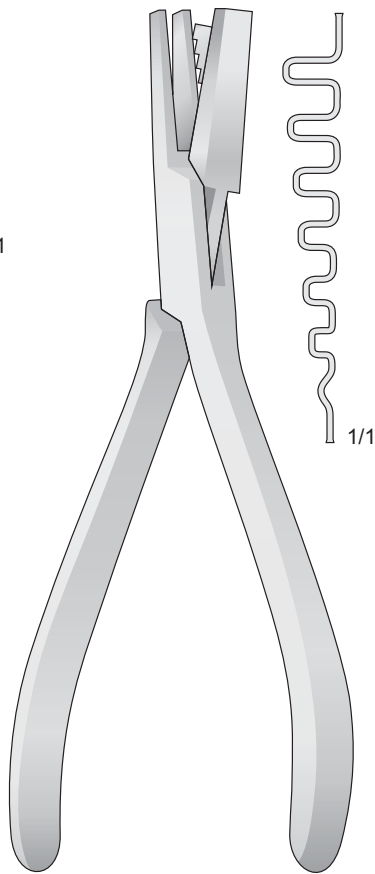

0415-II
140 mm

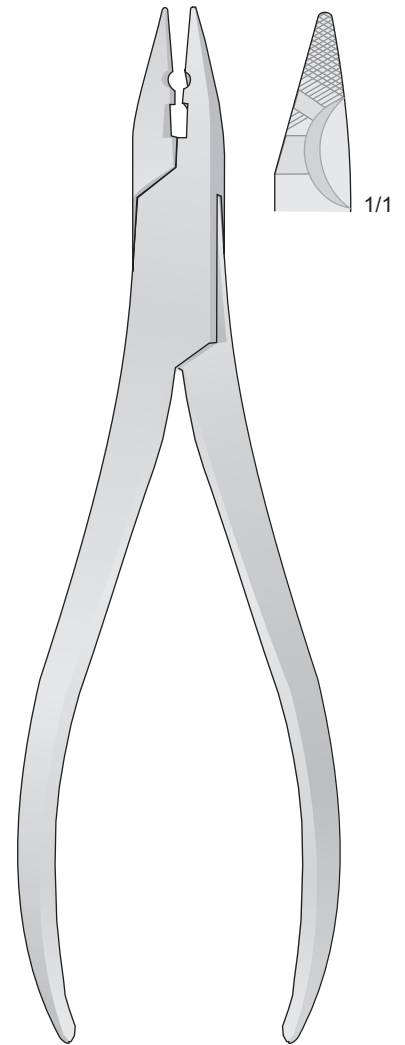

0415-HF
160 mm

Verbandscheren
Ligatureinstrumente

Dressing scissors
Ligating Instruments

Forbici per bende
Pinza per legature

Tijeras para bandas
Instrumentos para ligadura

Ciseaux à pansements
Instruments à ligature

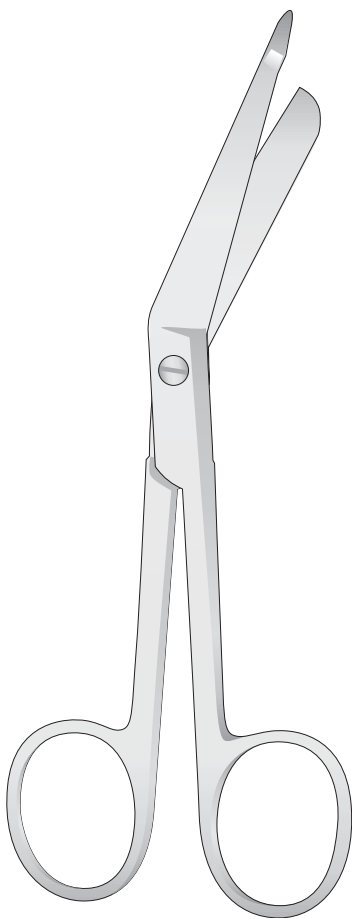

LISTER
0607-DB
145 mm

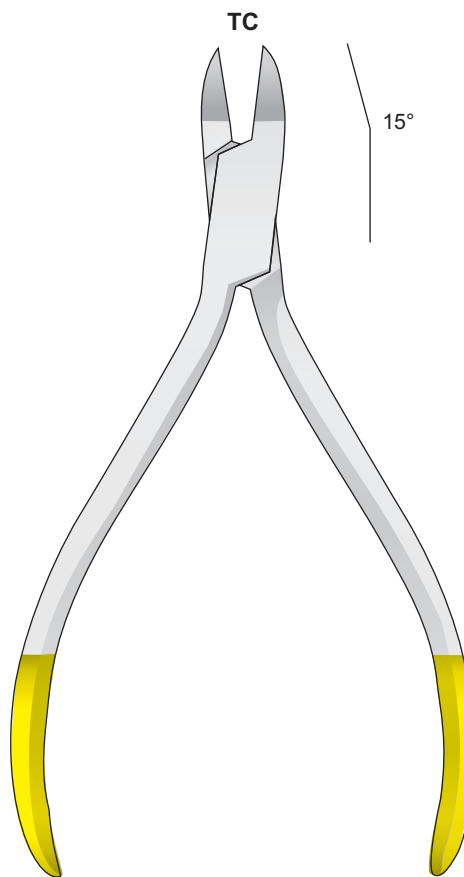

1123-LA
125 mm

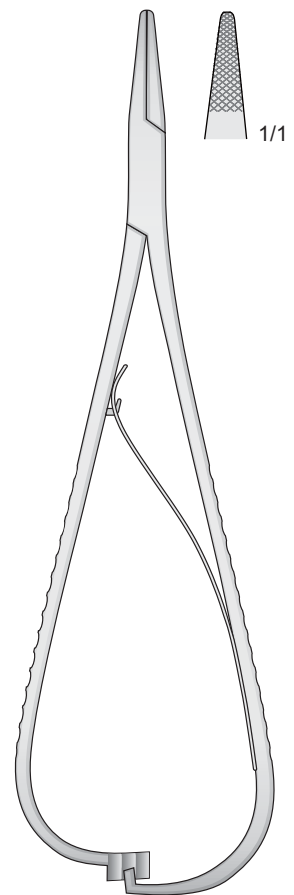

MATHIEU
1514-IA
140 mm

Sterilisierzangen zum Fassen
und Halten Steriler Instrumente
Sterilizing forceps for picking up
and holding of sterile instruments
Pinza per prelevare
strumenti sterilizzati

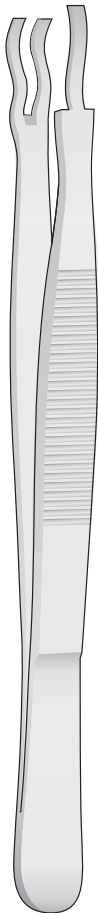

0718-AC
145 mm

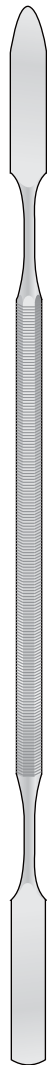

18-C
180 mm



1801-D
200 mm

Flexibel Spatel - Spatulas flexible
Spatole Flessibili - Espatulas flexible
Spatules flexible

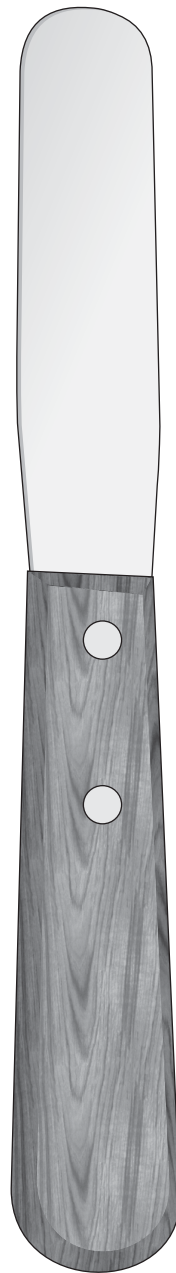

1801-C
210 mm

**Steril
Container**

**Sterilizing
containers**

**Contenitori
per sterilizzare**

**Contenedores
para esterilización**

**Containers
pour stérilizer**

Runder Sterilbehälter mit Ausguss
Lotion bowis capsules
Capsule inox con fondo piano e becco
Capsule en acier inox

Jarin glass with lid in stainless steel
Vaso in vetro con coperchio in acciaio inox
Pot en verre avec couvercle en acier inox

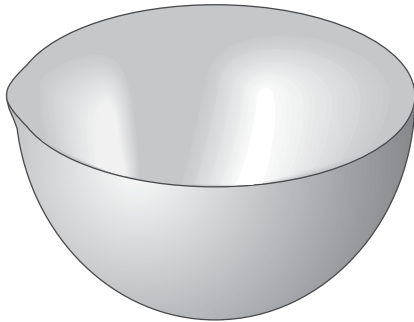

0318-AE Ø 100 mm 325 cc
0318-AF Ø 120 mm 500 cc



211503-G
Ø 100 x 100 mm



0217-CA 200 mm

Für 8 instrumente - For 8 instruments
Per 8 strumenti - Para 8 instrumentos
Pour 8 instruments

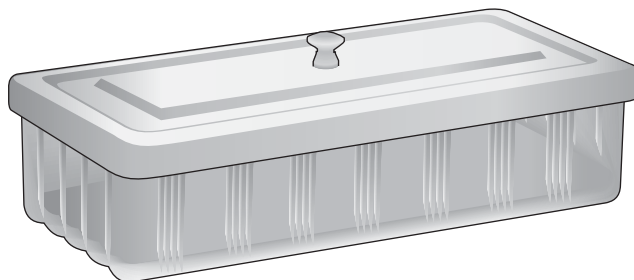

021518-BC 200x60x40 mm
021518-BE 220x100x50 mm

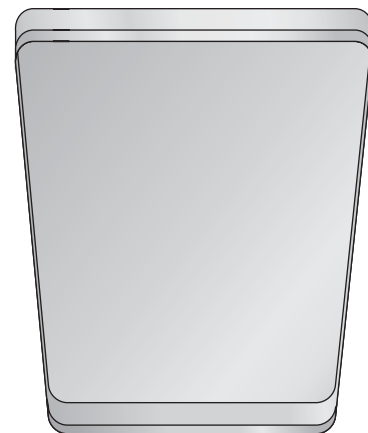

0318-BC 125x125 mm

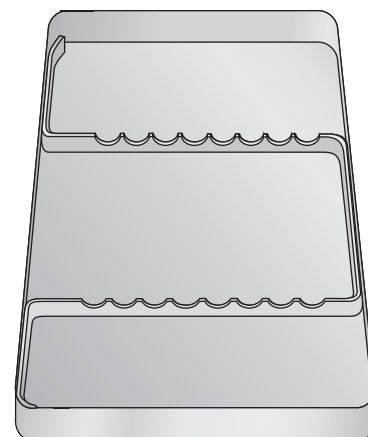

1815-I
183 x 140 x 17 mm

Instrumentenpflege

Maintenance of instruments

Mantenimento dello strumentario

Mantenimiento del instrumental

Nettoyage d'instruments

Silikon Matten
Matte en silicone
Tappeti in aghi di silicone
Tapete en agujas de silicona
Tapis en Silicone

Sterilisierbar
Autoclavable
Autoclavabile

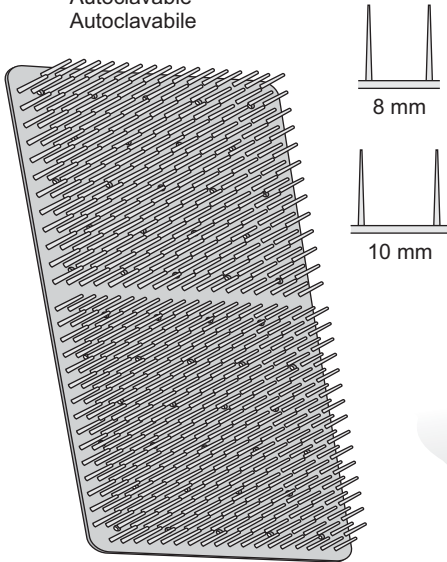

1918-BAE
270 x 180 mm

Schleifsteine - Sharpening stones
Pietre di Arkansas per affilatura strumenti
Materiales para afilar - Pierres d'affutage



0402-E
ARKANSAS
n° 4

Olio lubrificante per
strumenti chirurgici

RODHOIL

Schmiermittel mit hoher Dichte. Es sichert den perfekten Gebrauch und die Leichtgängigkeit aller chirurgischen Instrumente. Man gibt es auf die Verbindungen und Gelenke und in alle beweglichen Teile, die Reibungen unterworfen sind.

RODHOIL

Lubrifiant to high density. It assures the perfect utility and fluency of all the surgical instruments. For apply in to loosens, join and in all the parts in subject movement subject to attrition.

RODHOIL

Lubrificante ad alta densità. Assicura la perfetta funzionalità e scorrevolezza di tutti gli strumenti chirurgici. Da applicare negli snodi, giunture e in tutte le parti in movimento soggette ad attrito.



0402-1411
30 cc

Das wasserlösliche Schmiermittel verlängert die Lebensdauer von chirurgischen Instrumenten
Soluble lubricant extends useful life of surgical instruments
Lubrificante anticorrosivo e detergente per strumenti chirurgici
Lubrificante soluble en agua, so uso prolonga la duracion de los instrumentos quirurgicos
Lubrifiant soluble dans l'eau prolonge la vie des instruments chirurgicaux

CLEANLACT

Reinigungskonzentrat für chirurgische Instrumente. Es wirkt antibakteriell, nicht-ätzend und schmierig. Es garantiert die perfekte Erhaltung aller Instrumente aus Stahl, entfernt eventuelle Flecken, Ränder, und Bräunungen von Sterilisationen, Desinfektionen und Reinigungen mit hartem Wasser. Es sollte regelmäßig verwendet werden.

CLEANLACT

Product concentrated for surgical instruments. It explains an action anti-corrosive, antibacterium and lubricant. It guarantees the perfect maintenance of all the instruments in steel eliminating eventual stains and burnishes to sterilization, disinfection and to washings with hard waters. It used periodically.

CLEANLACT

Prodotto concentrato per strumenti chirurgici. Esplica un azione anticorrosiva batteriostatica e lubrificante. Garantisce il perfetto mantenimento di tutti gli strumenti in acciaio eliminando eventuali macchie, aloni e brunture dovute a sterilizzazioni, disinfezioni e a lavaggi con acque dure. Va usato periodicamente.



DB-10M
250 cc

**Steril
Container**

**Sterilizing
containers**

**Contenitori
per sterilizzare**

**Contenedores
para esterilizaci3n**

**Containers
pour st3rilizer**

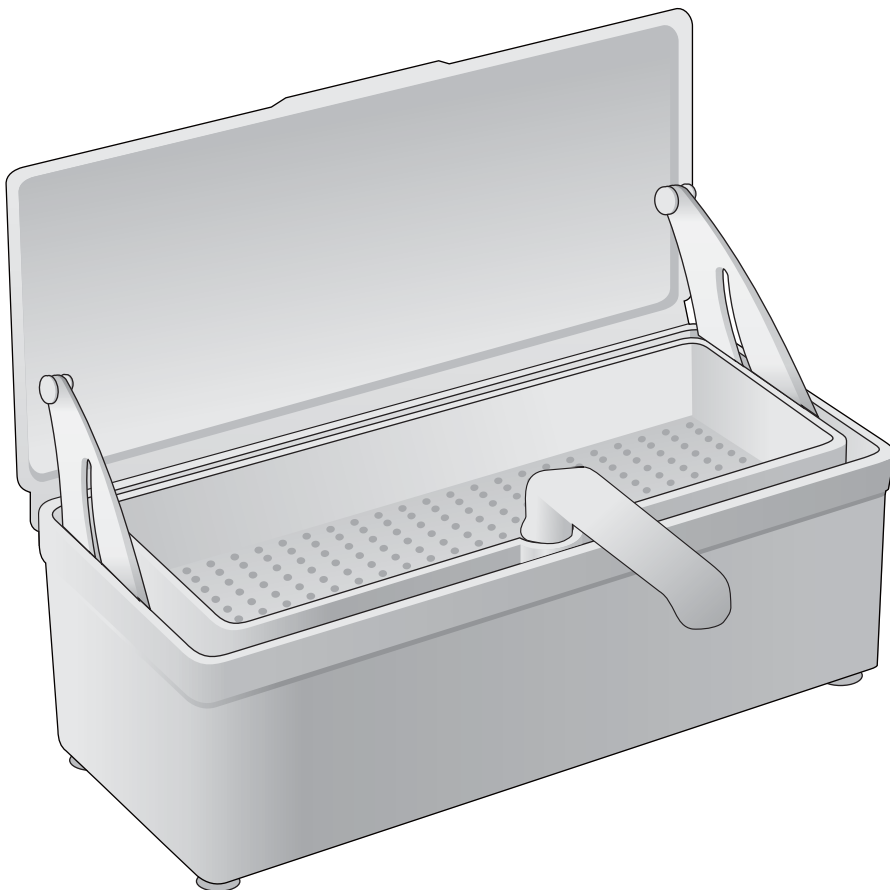

**STERILTRAY
0218-BAA**
25,5 X 10,5 X 8,5

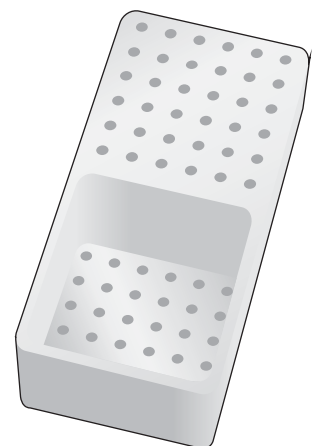

**BOXTRAY
0218-BAB**

Nummernverzeichnis		Alfanumerical Index		Indice alfanumerico		Indice alfanumerico		Index alfabétique	
Article	Page	Article	Page	Article	Page	Article	Page	Article	Page
HBH-GE	5	0612-BA	10	1102-CC	6				
HBH-GG	5	0612-CH	10	1102-CD	6				
HBI-BEH	5	0612-CI	10	1102-CE	6				
HBI-CBC18	5	0612-CL	10	1102-CF	6				
HCA-IG	5	0612-DA	10	1102-DGG	6				
		0612-DF	10						
0202-EG	6	0612-DG	10	1123-FA	13				
0202-EI	6			1123-GA	13				
		0718-AC	23	1123-LA	22				
0204-DG	9	0718-BL	20	1123-LG	21				
0204-GA	9	0718-CA	19						
0204-GE	9	0718-CB	15	1201-02D	6				
0204-BCC	9	0718-CC	20	1201-02E	6				
		0718-CD	11						
0217-CA	24	0718-CE	11	1310-AG	7				
		0718-CH	11	1310-AI	7				
0218-BAA	26	0718-CI	11	1310-EL	7				
0218-BAF	26	0718-DC	19						
		0718-DE	19	1514-IA	22				
03141111050705	9	0718-DF	19						
		0718-DG	19	17-C	3				
0318-AE	24	0718-DH	19						
0318-AF	24	0718-DI	19	18-C	23				
0318-BC	24	0718-EA	11						
		0718-EB	13	1801-C	23				
0402-1411	25	0718-EC	14	1801-D	23				
0402-E	25	0718-ED	14						
0402-FA12	25	0718-EE	14	1915-I01	24				
		0718-EF	13	1915-I03	24				
0411-CA	20	0718-EG	19	1915-I07	24				
		0718-EH	15						
0415-AL	20	0718-EI	19	1918-BAE	25				
0415-HF	21	0718-EL	15						
0415-II	21	0718-FA	20						
		0718-FB	11						
0418-CF	7	0718-FC	12						
0418-CG	7	0718-FD	12						
0418-CH	7	0718-FE	12						
0418-CI	7	0718-FF	12						
0418-CL	7	0718-FG	13						
		0718-FH	14						
0518-BA	3	0718-FI	13						
0518-BB	3	0718-FL	15						
0518-BD	4	0718-GA	16						
0518-CB	3	0718-GB	17						
0518-CC	7	0718-GC	17						
0518-CD	3	0718-GD	18						
0518-CE	3	0718-GE	16						
0518-CF	4	0718-GF	18						
0518-CG	4	0718-GG	18						
0518-CH	3	0718-GH	16						
0518-DA	4	0718-GI	18						
0518-DB	4	0718-GL	16						
0518-DC	4	0718-HA	15						
0518-DD	4	0718-HB	17						
0518-EA	4	0718-HC	17						
0518-EE	8			08-B	3				
0518-EF	8			08-C	3				
0518-EG	8			08-D	3				
0518-EI	8								
0518-GE	8			0806-D/H	5				
0518-GF	8								
		1102-BA	6						
0607-B	10	1102-BB	6						
0607-C	10	1102-BC	6						
0607-BD	10	1102-BD	6						
0607-BF	10	1102-BF	6						
0607-DB	22	1102-CA	6						
		1102-CB	6						
0612-L	10								



ideal-tek
manufacturer & supplier of precision instruments 

Ideal-tek SA
via Motta 4
6828 Balerna
Switzerland

Phone: +41 91 683 32 29
Fax: +41 91 683 03 71
E-mail: info@ideal-tek.com