

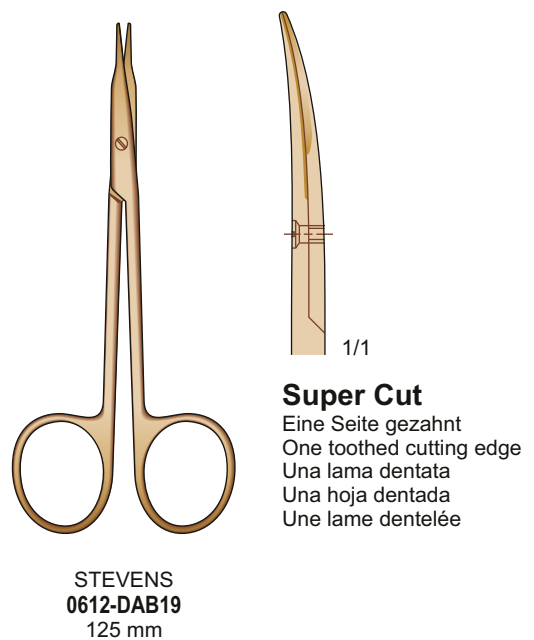

Plastische und Ästhetische Chirurgie
Plastic and Aesthetic Surgery
Chirurgia Plastica ed Estetica
Cirugía Plástica y Estética
Chirurgie plastique et esthétique

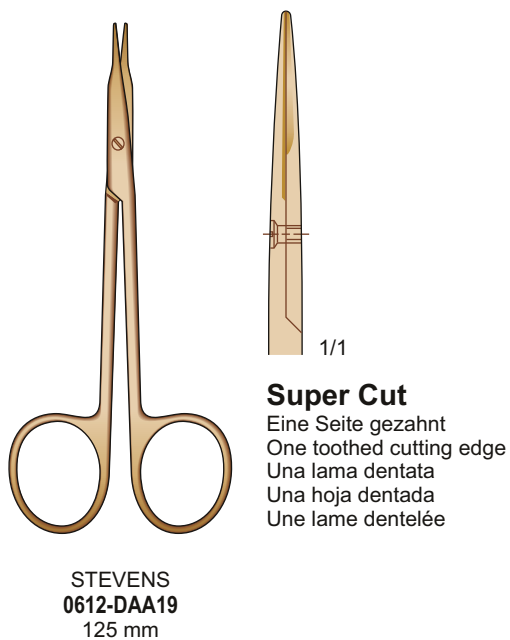

**Additions
and New Products**

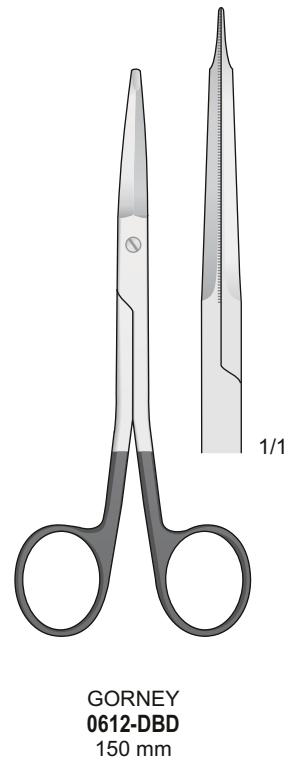
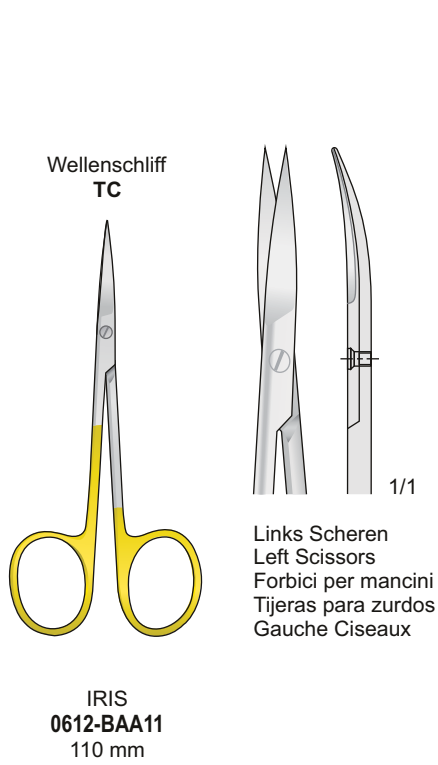

Super Cut

Mit einer Schneide gezahnt
 With one blade serrated
 Con una lama dentellata
 Con una hoja dentada
 Avec une lame dentèle

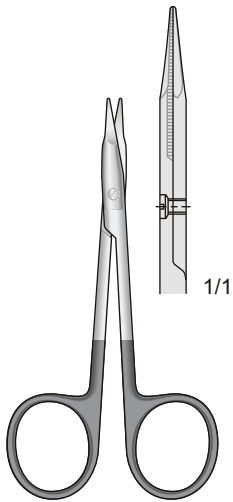

STEVENS
 0612-DAC
 105 mm

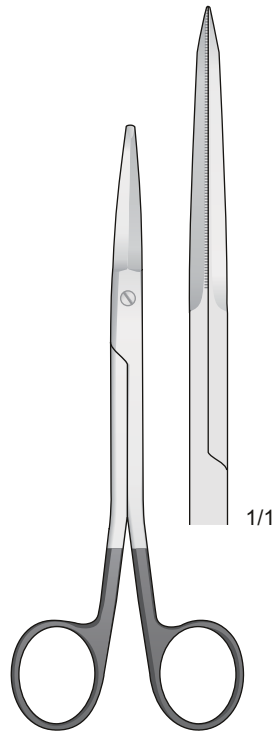

FACE-LIFT
 0612-DAI
 160 mm

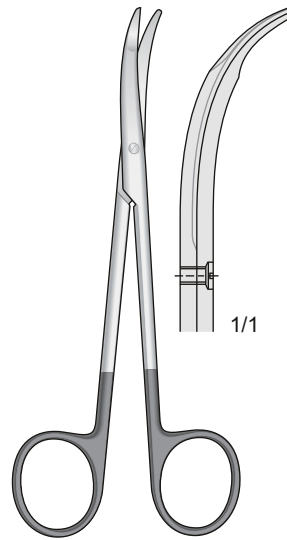

FOMON
 0607-BGD
 140 mm

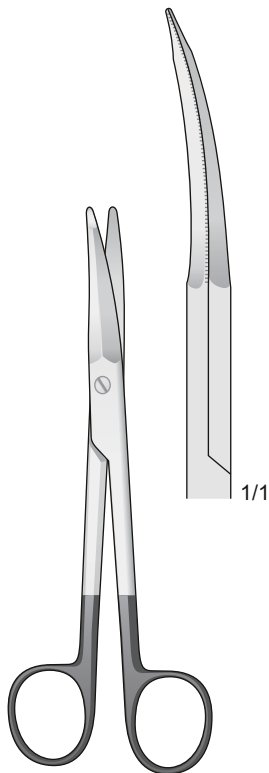

REES-FACE-LIFT
 0612-DAE
 150 mm

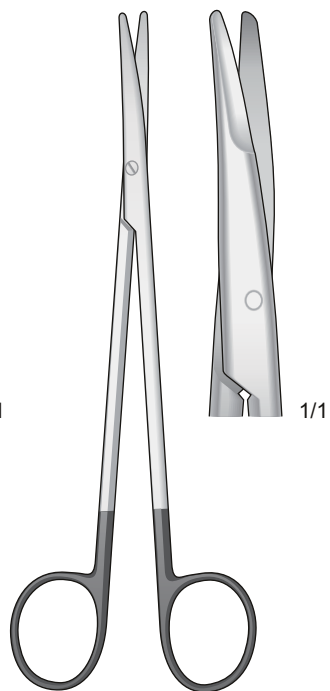

METZENBAUM
 0612-DBI/0612-DBL
 180 mm

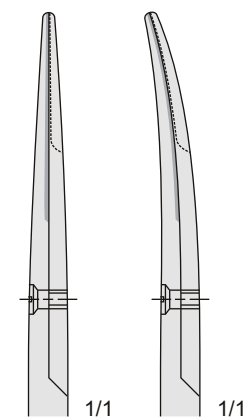

0612-DBI
 180 mm

0612-DBL
 180 mm

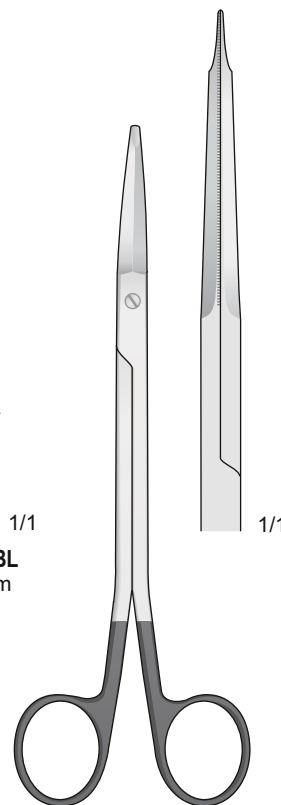

FREEMANN-KAYE
 0612-DDC
 180 mm

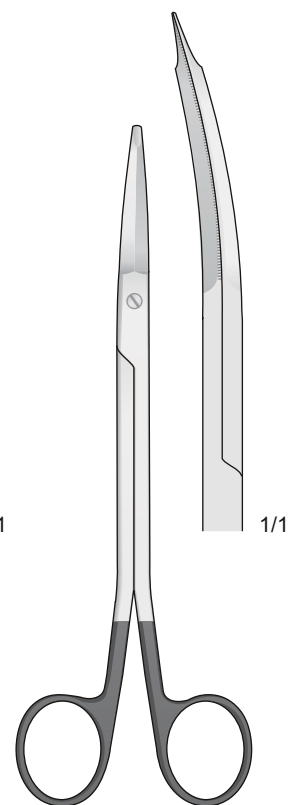

FREEMANN-KAYE
 0612-DDD
 180 mm

Vergoldet Super Cut

Mit einer Schneide gezahnt
With one blade serrated
Con una lama dentellata
Con una hoja dentada
Avec une lame dentèle

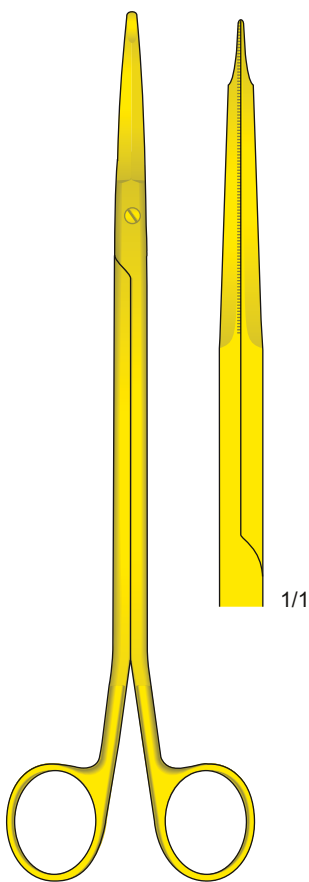

GORNEY
0612-DBD07
230 mm

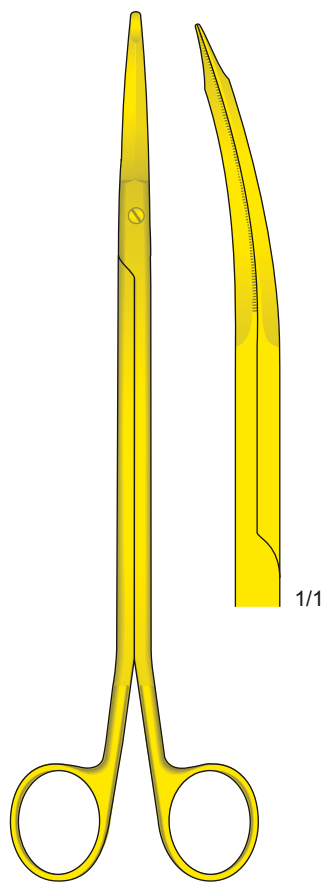

GORNEY
0612-DBE07
230 mm

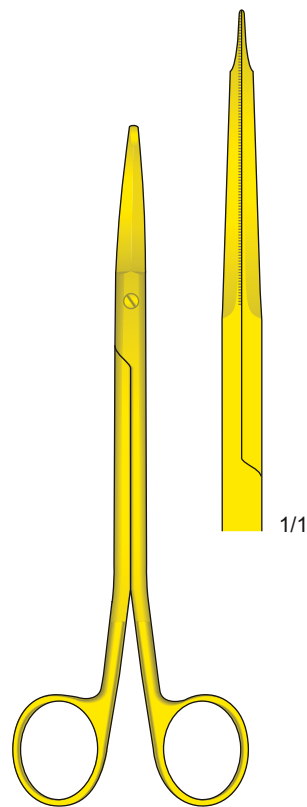

FREEMAN KAYE
0612-DDC07
180 mm

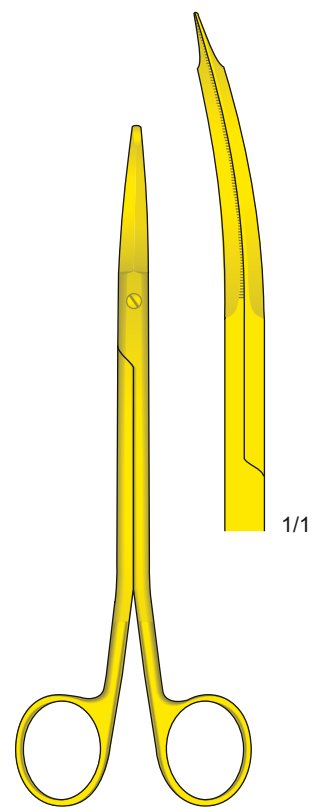

FREEMAN KAYE
0612-DDD07
180 mm

Scheren Gezahnt

Serrated scissors

Forbici dentellate

Tijeras dentadas

Ciseaux dentelé

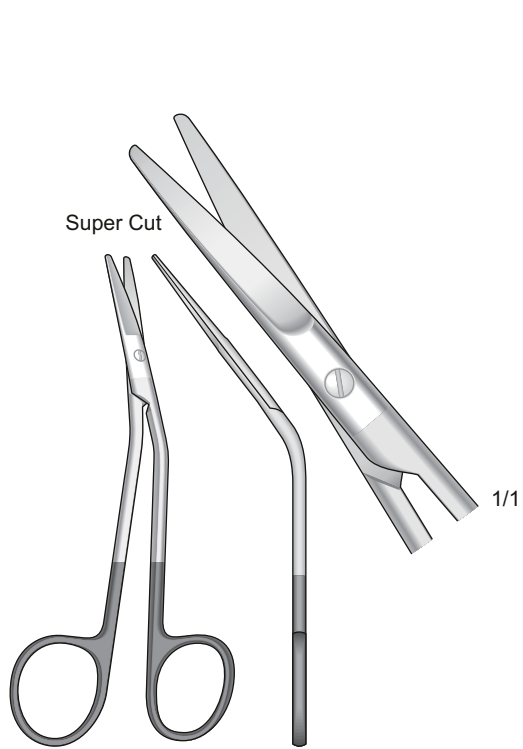

FOMON
0607-BLC
130 mm

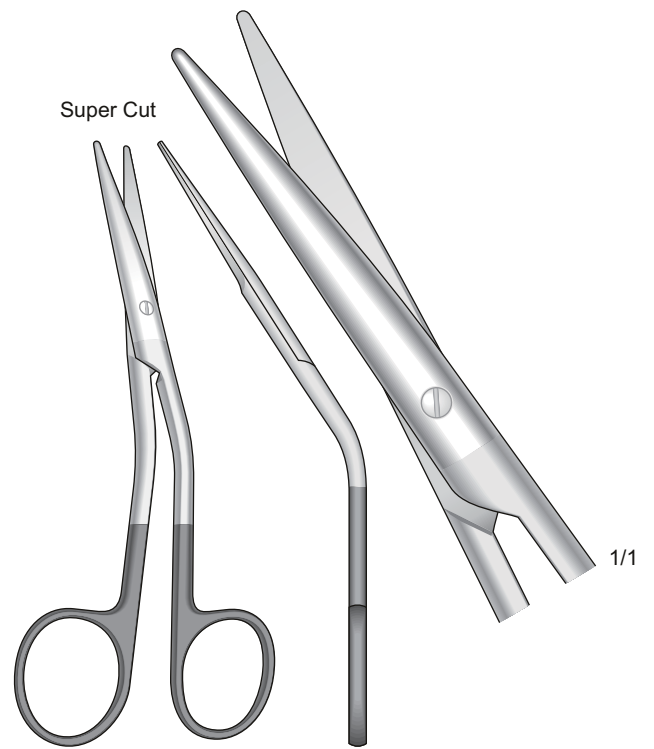

COTTLE
0607-BLD
160 mm

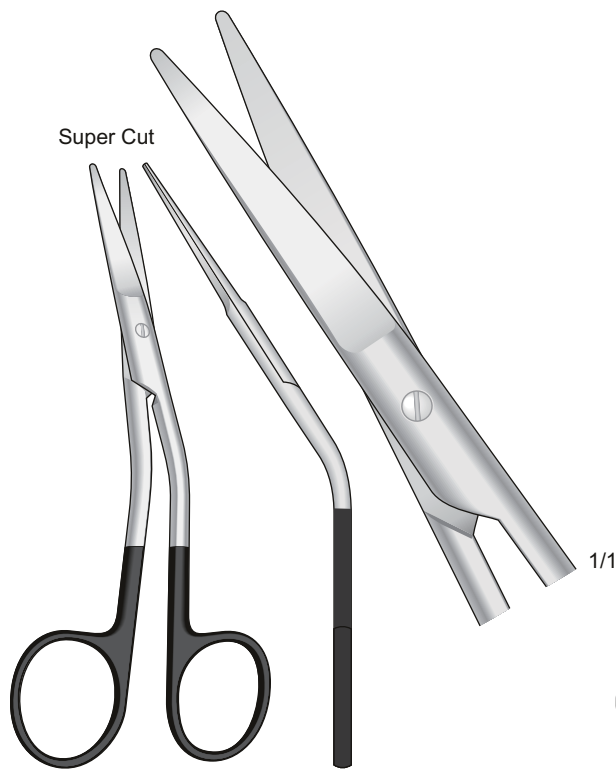

COTTLE
0607-BLE
160 mm

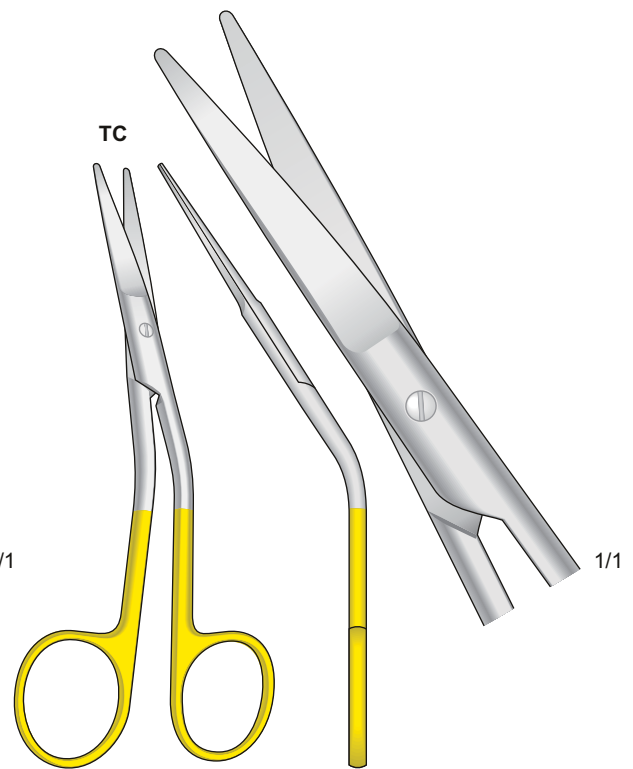

COTTLE
0607-BLF
160 mm

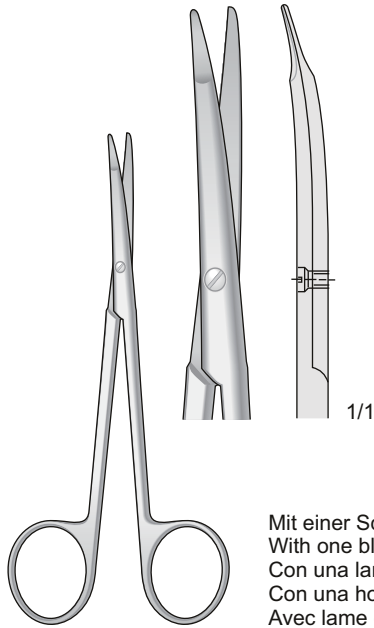

Mit einer Schneide gezahnt
With one blade serrated
Con una lama zigrinata
Con una hoja dentada
Avec lame dentée

KILNER
0607-BCB
130 mm

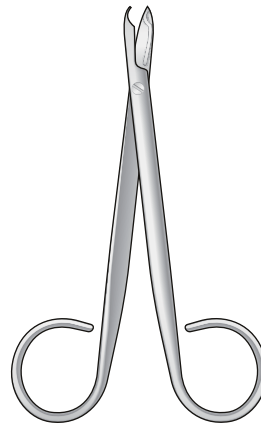

1803-D
110 mm

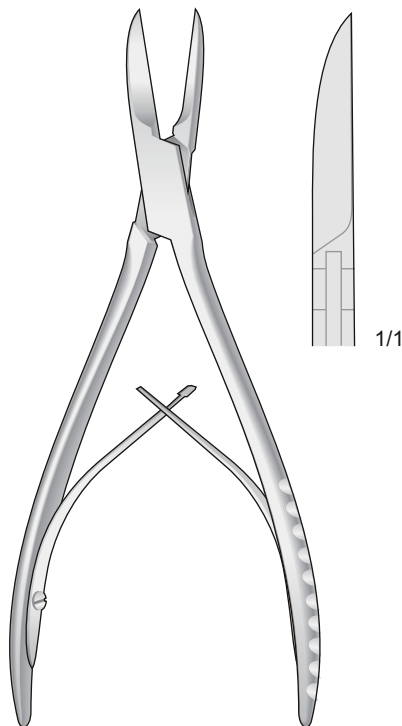

COTTLE-KAZANJIAN
0614-LF
190 mm

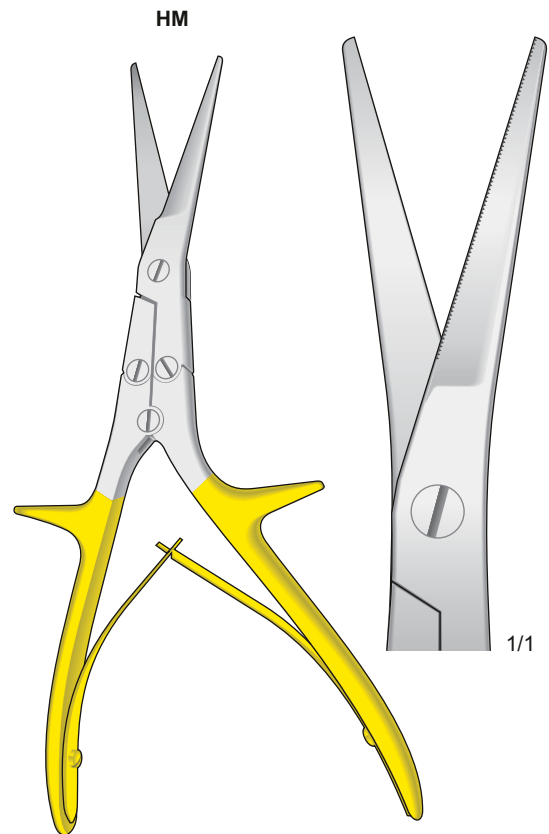

GORNEY
0614-BLA
205 mm

Wundhaken mit
Fiberoptikstab

Retractors with
Fiber optic

Divaricatore con
fibra ottica

Retractor con
iluminación de luz fría

Ecarteur avec illumination
à lumière froide

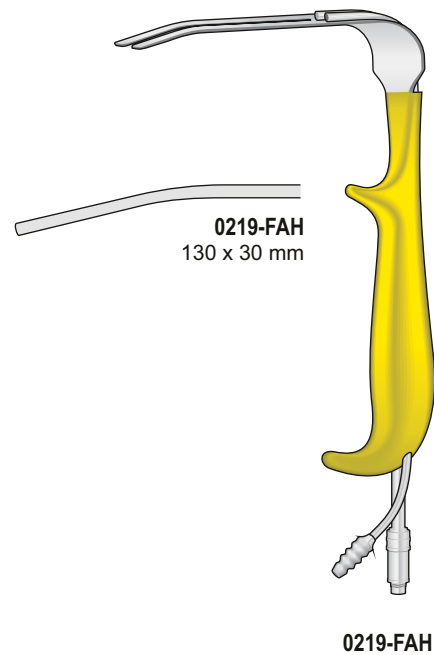
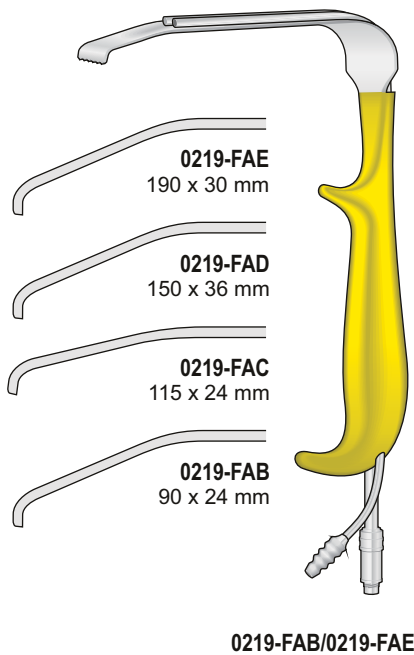
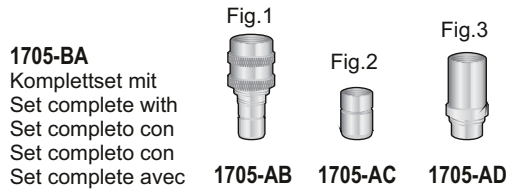

Fiber Optic Retractor - Divaricatore a fibra ottica

Advantages - Vantaggi

Sterilizable. Removable. Protected fiber-optic piece
Oval Shaped optic end for great light field
Retractor with concave blade for added operative space and visibility
Equiped with universal adapters WOLF, STORZ, OLYMPUS
German Stainless Steel, cool Fiber optic light sterilizable till 134°C

Asportabile e sterilizzabile. Fibra ottica protetta su tutto lo strumento per garantire una maggiore stabilità e sicurezza del movimento
Progettato e realizzato per garantire all'operatore massima maneggevolezza ed alta intensità di luce fredda in tutte quelle situazioni che comportano una visione operatoria a cielo chiuso
Grazie ai suoi tre attacchi universali WOLF, STORZ e OLYMPUS, facilita l'operatore nel potersi muovere da un ambito ambulatoriale ad uno ospedaliero senza dover rinunciare a un campo visivo indispensabile per la sua professione
Acciaio tedesco Fiber Optic luce fredda, Sterilizzabile fino a 134°C

Sizes - Misure dei divaricatori:

0219-FAB 90 x 24 mm	1705-AB Fig.1
0219-FAC 115 x 24 mm	1705-AC Fig.2
0219-FAD 150 x 36 mm	1705-AD Fig.3
0219-FAE 190 x 30 mm	1705-BA Set Fig.1 + Fig.2 + Fig.3

Wundhaken mit
Fiberoptikstab oval

Retractors with
Fiber optic oval

Divaricatori a
fibre ottiche ovale

Retractor con
iluminación de luz fría

Ecarteur avec
illumination à lumière froide

Spiral Breast Retractor
Retrattore della mammella a spirale

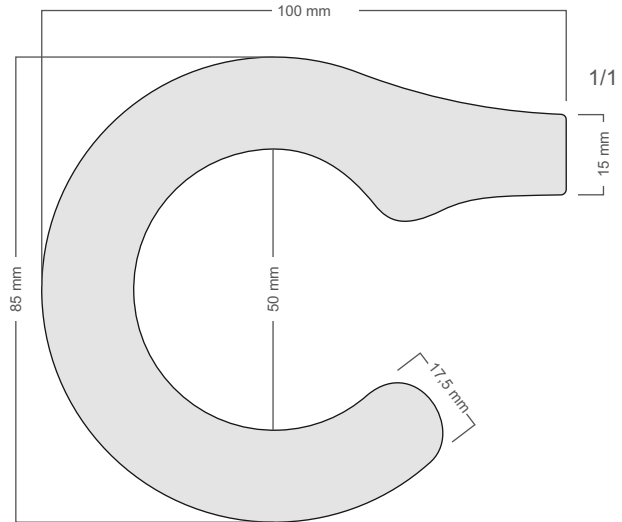
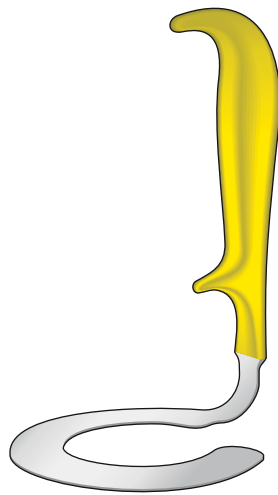

0219-FAG
150 mm

Wundhaken mit Fiberoptikstab
Retractors with Fiber optic illumination
Divaricatori con illuminazione a fibre ottiche
Retractor con iluminación de luz fría
Ecarteur avec illumination à lumière froide

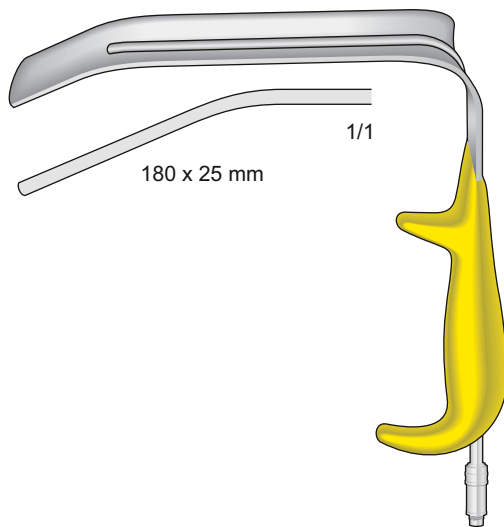

0219-FAF

Wundhaken
Retractor
Divaricatore
Separador
Ecarteur

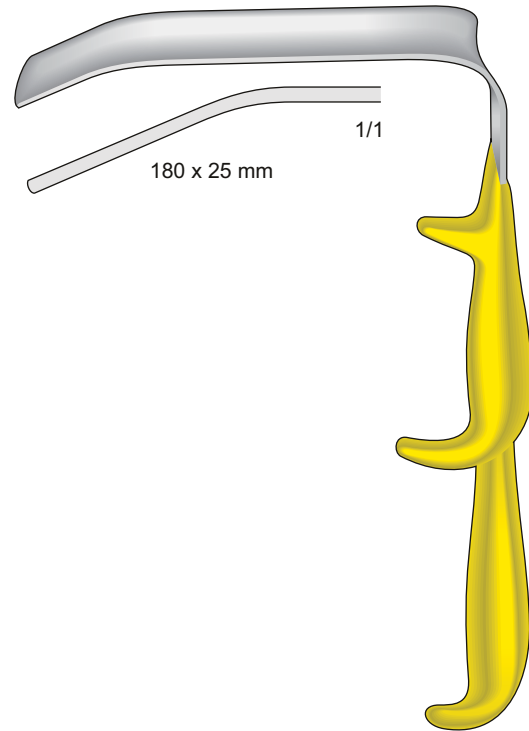

0219-FBA

**Glasfaser
-technik**

**Optical Fiber
Technology**

**Tecnologia
a fibre ottiche**

**Tecnología de
fibra óptica**

**Technologie de
la fibre optique**

0819-110504

LED Coldlight Technology for medical applications
Tecnologia LED a luce fredda per applicazioni mediche



Lamp: Lampada	LED-HTS
Lifespan: Durata	> 40.000 h
Light guide connection: Collegamento luce	System STORZ
Safety Standard: Standard di sicurezza	IEC 60601-1, 60601-1-2
Power Supply: Alimentazione	100-240VAC 50/60 Hz
Power consumption: Consumo di energia	30 W
Dimensions (WxHxD): Dimensioni (LxAxP)	360x80x310 mm
Weight: Peso	Approx. 5,8 Kg

0819-BIA23

ColdLight Source Technology for medical applications
Fonte di luce fredda per applicazioni mediche



Lamp: Lampada	Xenon 180 W
Light guide connection: Collegamento luce	System STORZ
Safety Standard: Standard di sicurezza	IEC 60601-1, 60601-1-2
Power Supply: Alimentazione	100-240VAC 50/60 Hz
Power consumption: Consumo di energia	230 W
Dimensions (WxHxD): Dimensioni (LxAxP)	360x150x310 mm
Weight: Peso	Approx. 11,0 Kg

0819-CFA18

ColdLight Source Technology for medical applications
Fonte di luce fredda per applicazioni mediche



Lamp: Lampada	2 x Halogen 250 W
Color Temperature: Temperatura di colore	Approx. 3200K
Light guide connection: Collegamento luce	System STORZ
Power Supply: Alimentazione	115-230VAC 50/60 Hz
Power consumption: Consumo di energia	265 W
Dimensions (WxHxD): Dimensioni (LxAxP)	360x150x310 mm
Weight: Peso	Approx. 11,0 Kg

0819-BDB10

Fiber Optic Cable
Cavo a fibra ottica



Cable Diameter: Diametro del cavo	3,5 mm
Length: Lunghezza	230 cm
Sterilization: Sterilizzazione	Autoclavable

0819-BDE10

Fiber Optic Cable
Cavo a fibra ottica



Cable Diameter: Diametro del cavo	4,8 mm
Length: Lunghezza	230 cm
Sterilization: Sterilizzazione	Autoclavable

Double ended
Breast Retractor

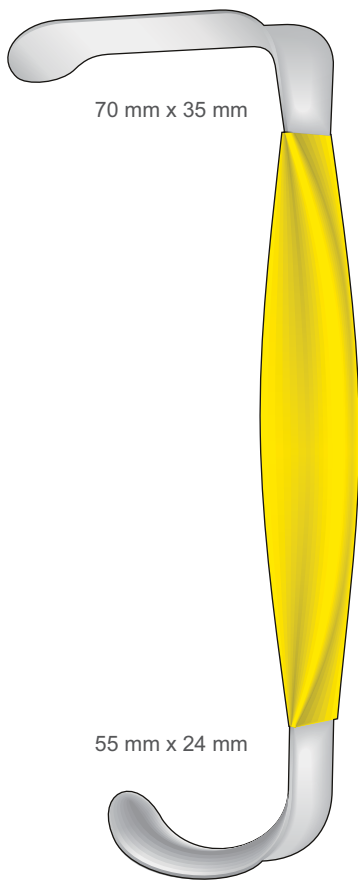

70 mm x 35 mm

55 mm x 24 mm

0518-BEF
230 mm

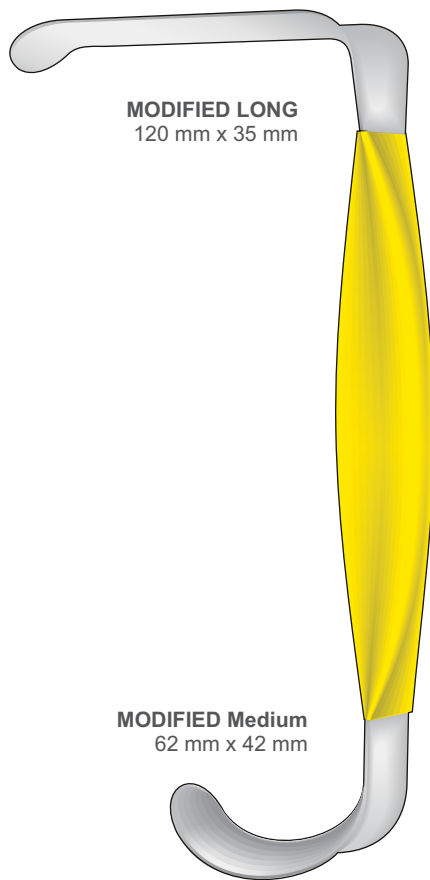

MODIFIED LONG
120 mm x 35 mm

MODIFIED Medium
62 mm x 42 mm

0518-BEF12
230 mm

Mit Fiberoptikstab
With Fiber optic
Con illuminazione a fibre ottiche
Con iluminación de luz fría
Avec illumination à lumière froide

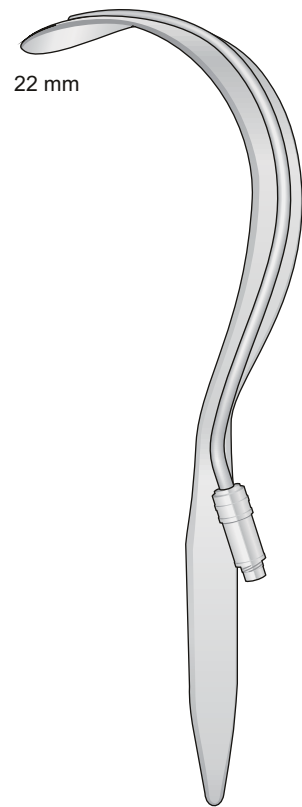

22 mm

DEAVER
0219-FBB
215 mm

Dissector

Dissector

Dissettori

Disecadores

Dissecteur

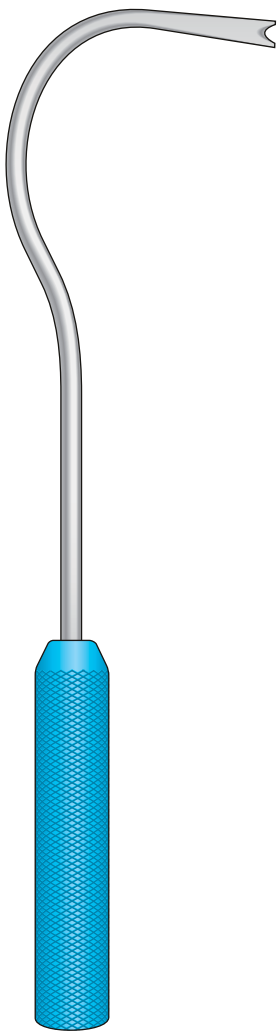

FOERSTER
0518-BEG
270 mm

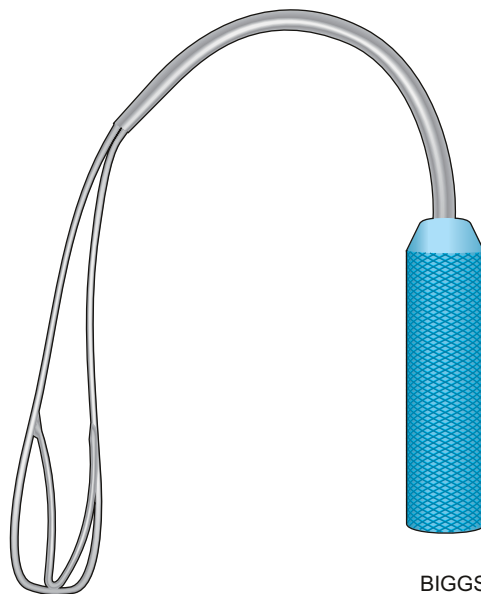

BIGGS
0518-BEI



Links - Left
Sinistra - Izquierda
Gauche

Rechts - Right
Dextra - Derecha
Droite

AGRIS-DINGMAN
0518-BEH
360 mm



Brustheber
Breast Elevator
Elevatore mammario
Elevador mamario
Élévateur mammaire

0518-EFA
280 mm

Scharf - Sharp
Taglienti - Cortante
Tranchant

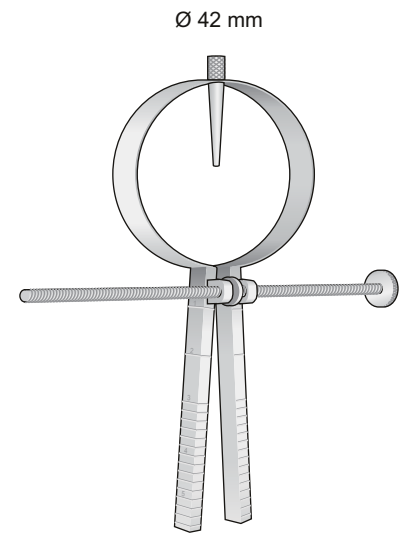
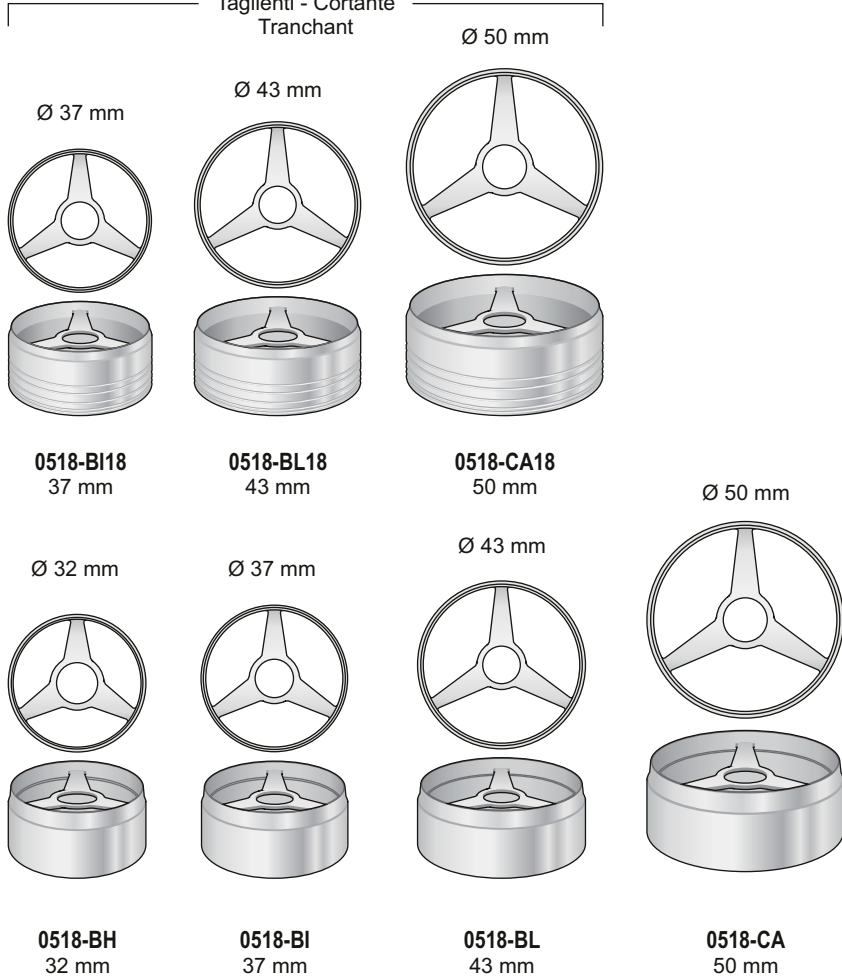

0518-BGF
110 mm

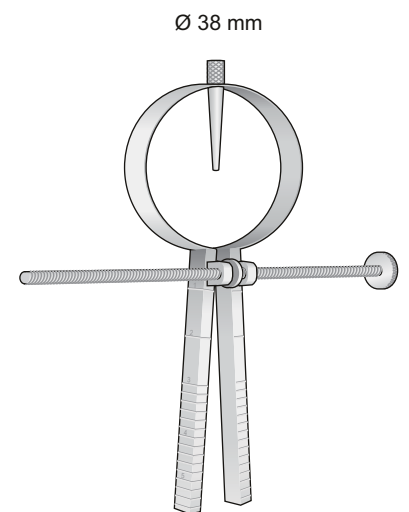

0518-BGE
105 mm

Dissektoren

Dissectors

Dissettori

Separadores

Dissecteurs

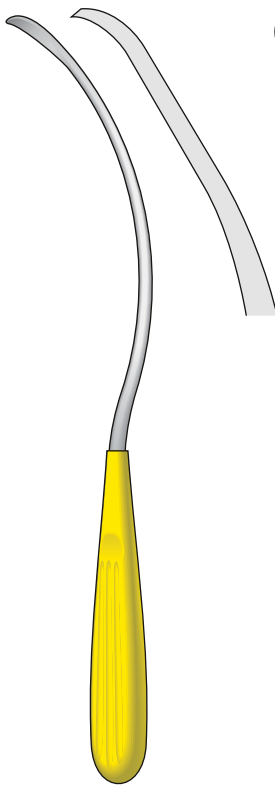

0518-BDG
255 mm

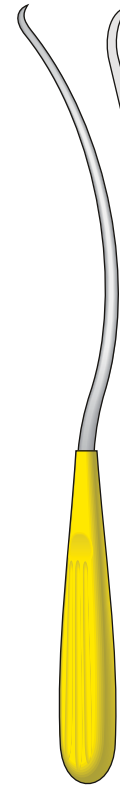

0518-BDH
260 mm

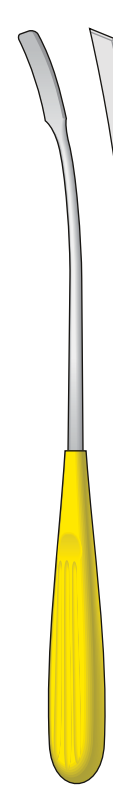

0518-BDI
250 mm

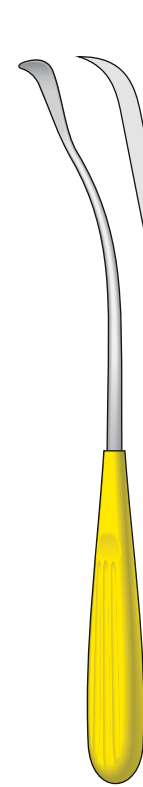
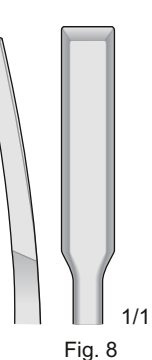

0518-BDL
230 mm

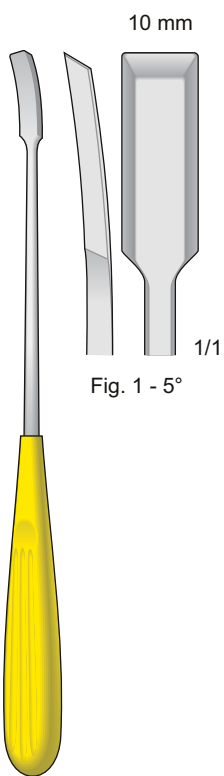
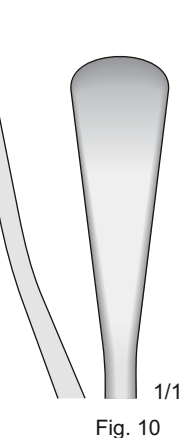

0518-BDB
240 mm

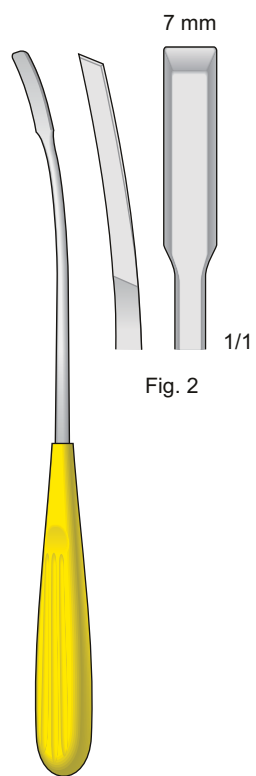
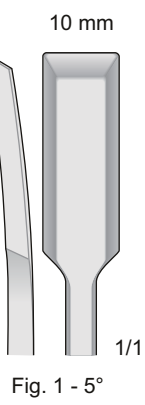

0518-BDC
240 mm

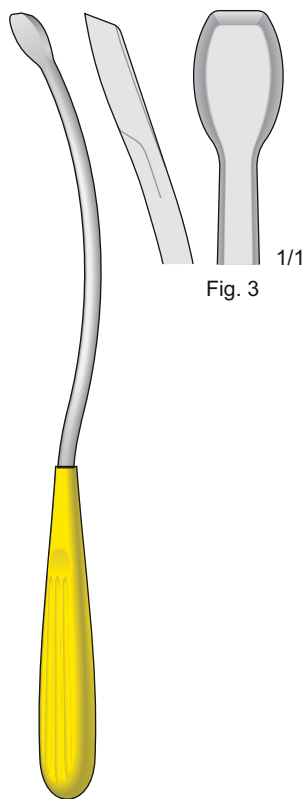
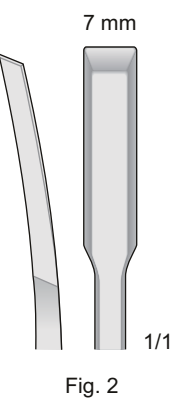

0518-BDD
265 mm

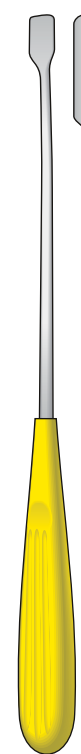
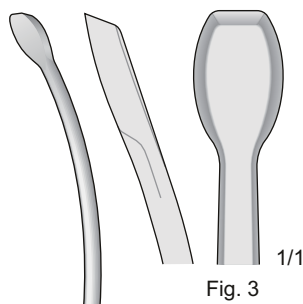

0518-BDE
250 mm

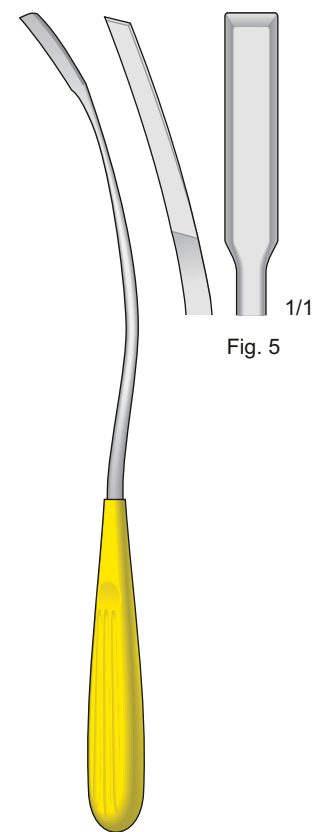
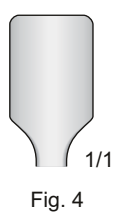

0518-BDF
280 mm

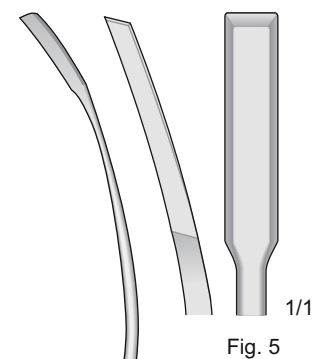

Dissektoren
Elevatoren

Dissectors
Elevators

Dissettori
Elevatori

Separadores
Elevadores

Dissecteurs
Elevateurs

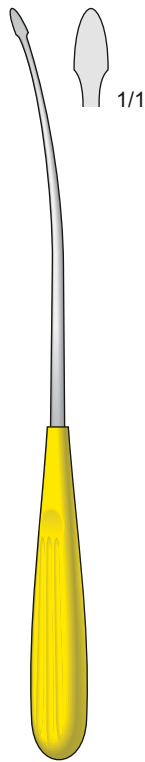

0518-CBG
235 mm

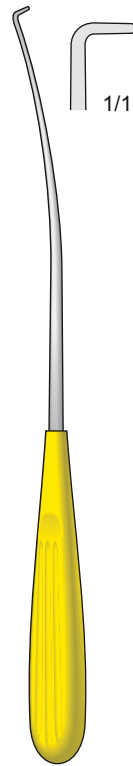

0518-CBH
235 mm

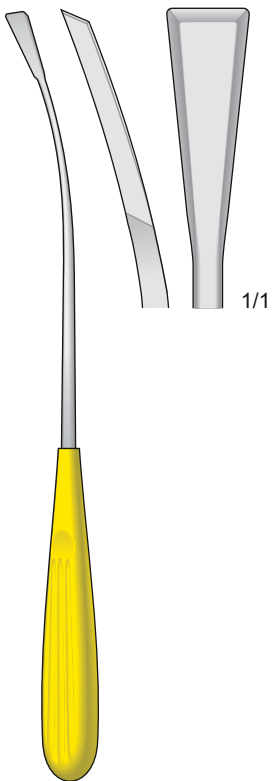

0518-CBB
240 mm

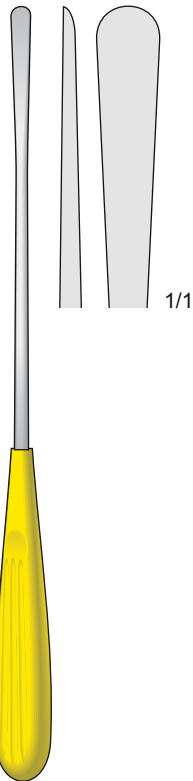

0518-CBC
240 mm

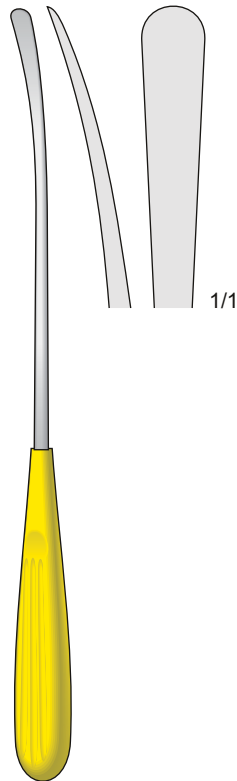

0518-CBD
240 mm

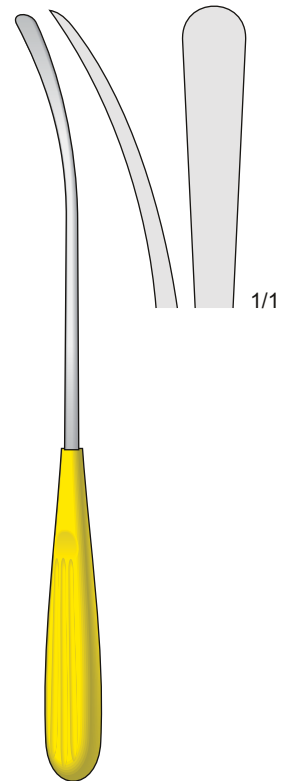

0518-CBF
240 mm

Dissector
Wundhaken

Dissector
Retractors

Dissettori
Divaricatori

Disecadores
Separadores

Dissecteur
Ecarteur

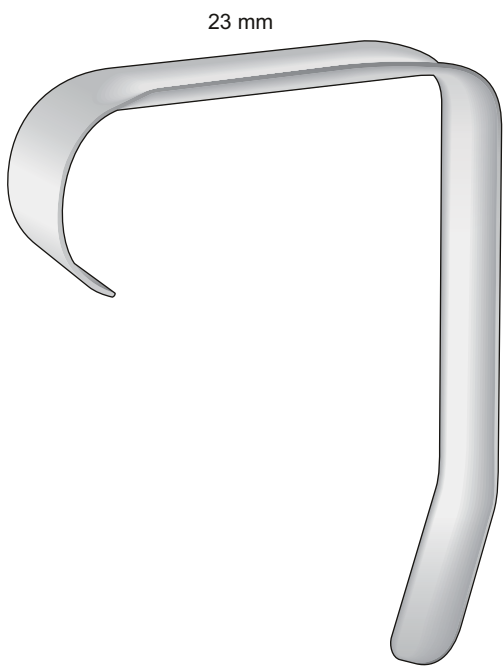

FACE-LIFT
0518-BGD
120 mm



CONVERSE
0414-CAH
50 mm

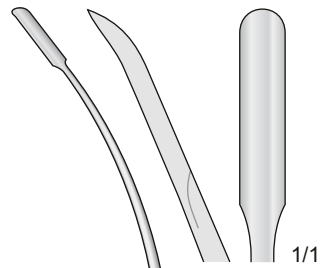

1/1
Halb-Biegsam
Semi-malleable
Semi malleabile
Semi maleable
Semi-souple

0518-CBL
270 mm

Spatulated
Breast

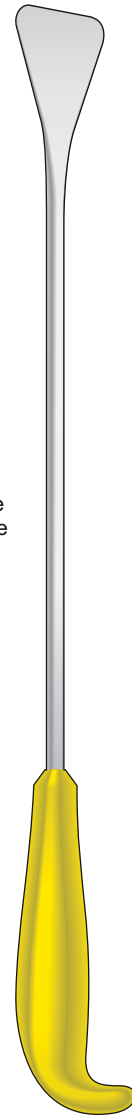

0518-BEE
330 mm

Spatulated Ovale
Breast

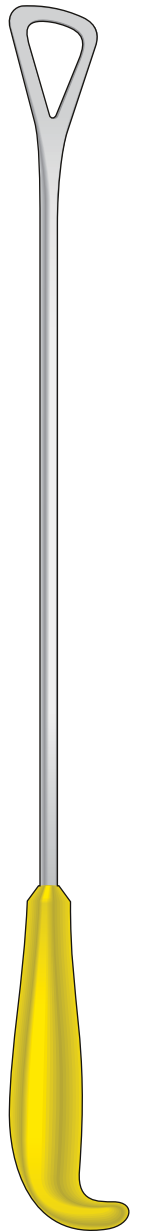

0518-BEL
390 mm

Rostfrei - Stainless Steel
Acciaio - Acero
Acer

Schwarz Verchromt
Black anodized
Cromato nero
Cromado en negro
Chromé noir

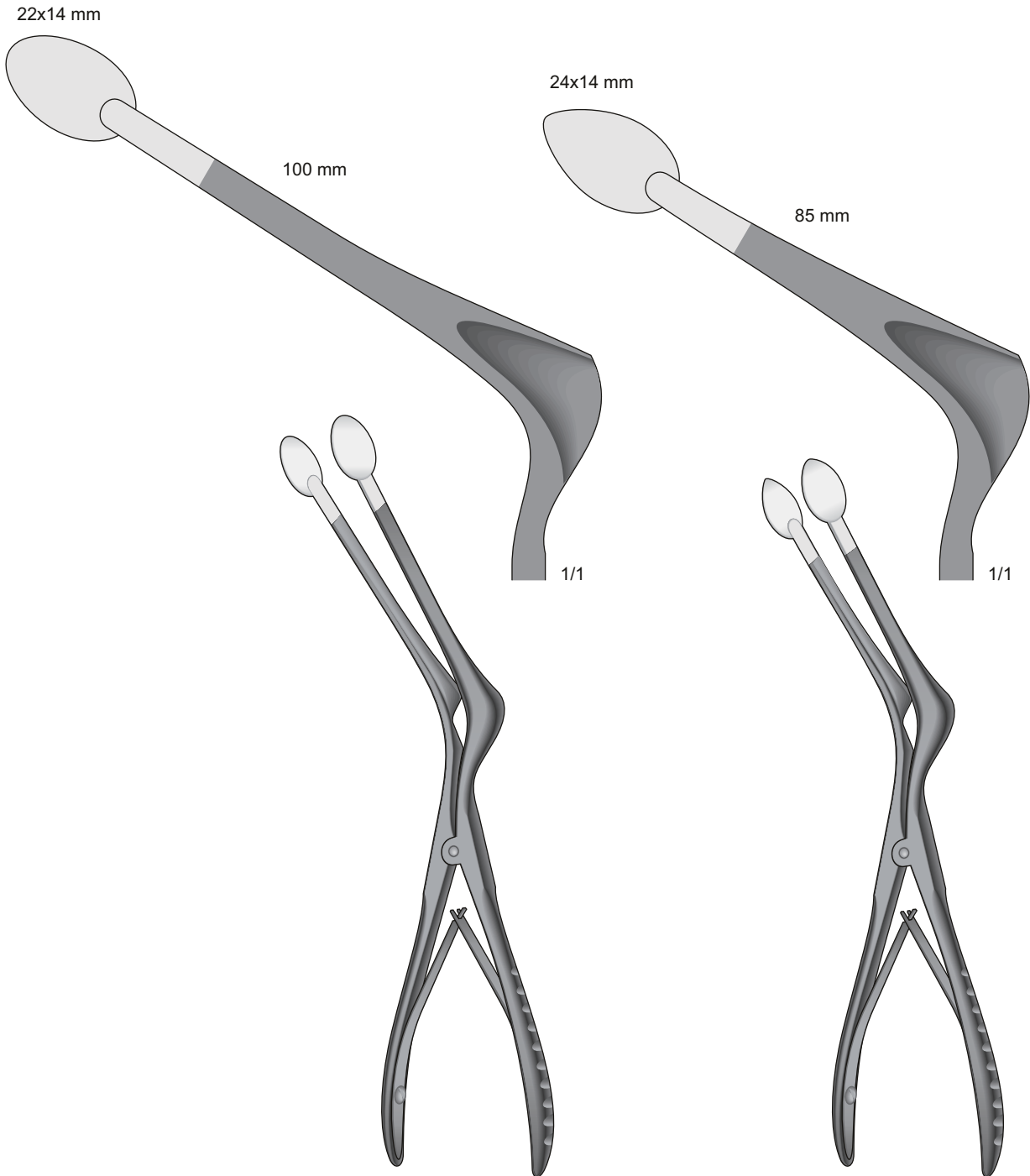

MENEGHINI
1412-CDA
200 mm

MENEGHINI
1412-CDB
180 mm

Protettore oculare
Conchiglia protettiva per Blefaroplastica

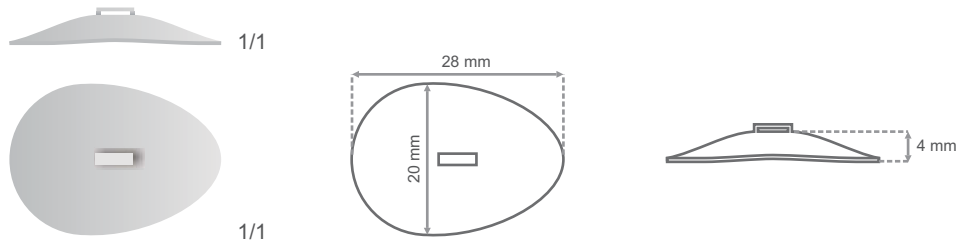

1310-EAA

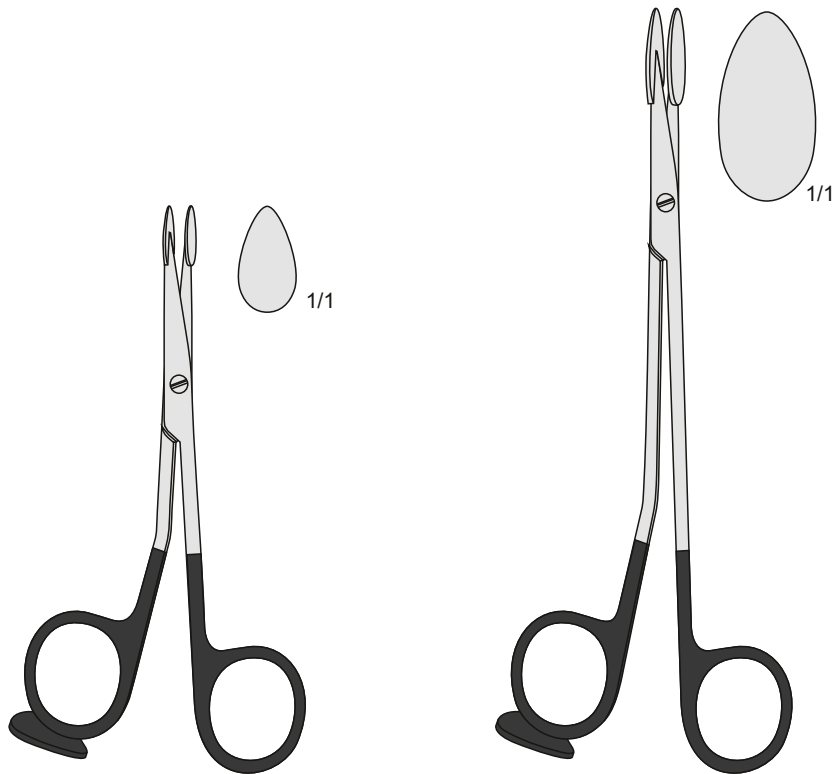

0612-EAA
130 mm

0612-EAB
180 mm

Wundhaken mit
Fiberoptikstab oval

Retractors with
Fiber optic oval

Divaricatore a
fibra ottica ovale

Retractor con
iluminación de luz fría

Ecarteur avec
illumination à lumière froide

Sterilizable. Removable. Protected fiber-optic piece
Oval Shaped optic end for great light field
Retractor with concave blade for added operative space and visibility
Equiped with universal adapters WOLF, STORZ, OLYMPUS

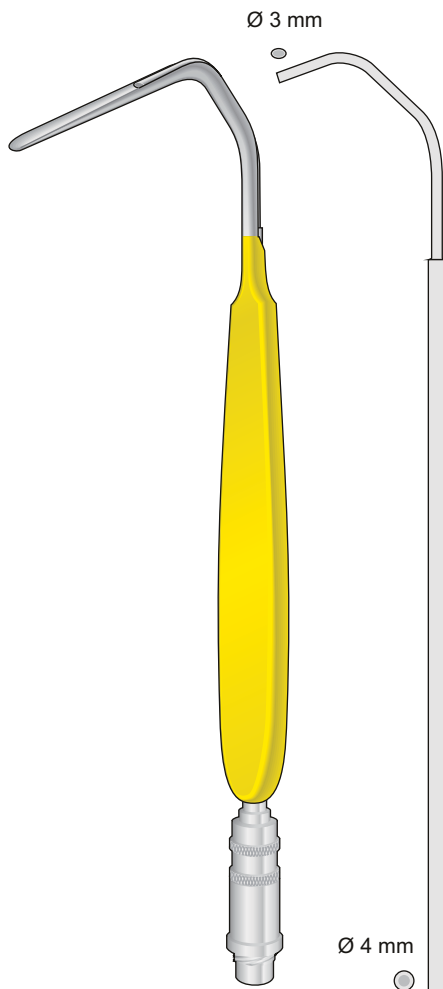
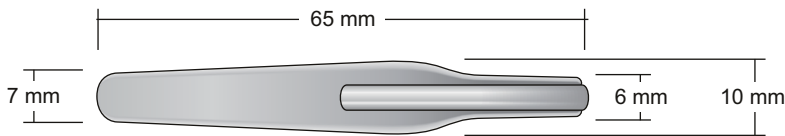

0414-EAB
185 mm

0414-EAB17
182 mm

1705-BA
Komplettset mit
Set complete with
Set completo con
Set completo con
Set complete avec

1705-AB RE-02 RE-03

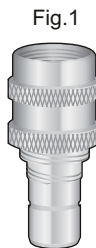

1705-AB



1705-AC



1705-AD

Mit Absaugkanülen
With Suction Tube
Con aspirazione
Con aspiración
Avec aspiration

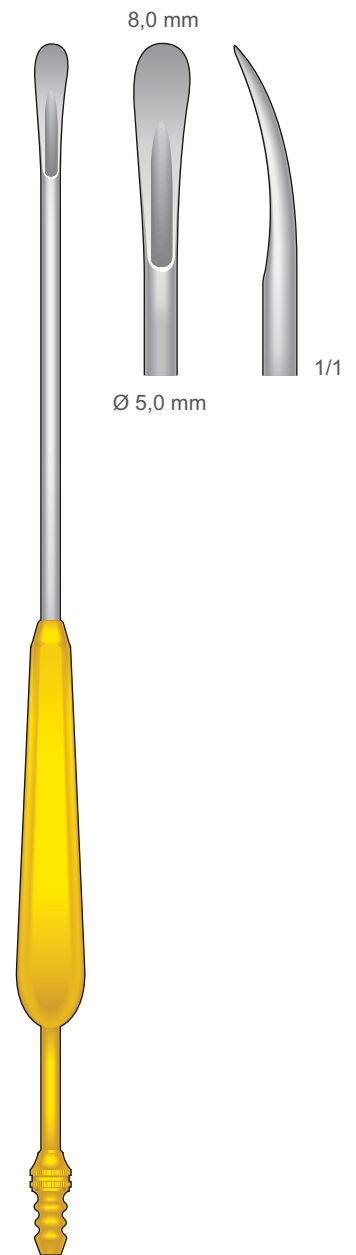

0518-BDA
270 mm

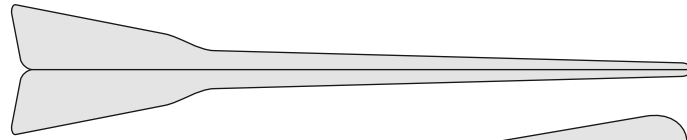

90 mm



1412-BLC11
150 mm

1/1

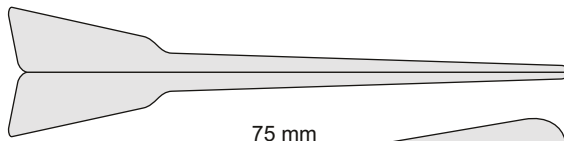

75 mm

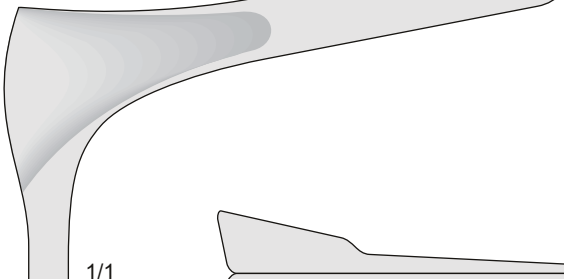

1412-BLC
150 mm

1/1

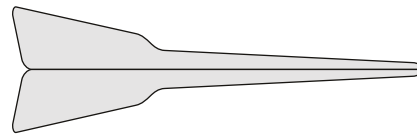

55 mm

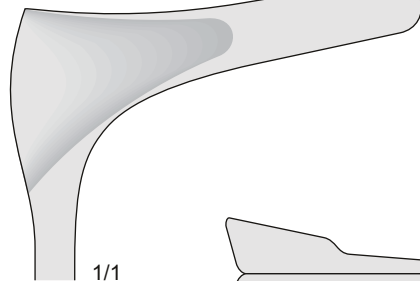

1412-BLB
140 mm

1/1

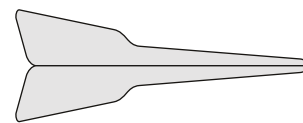

40 mm

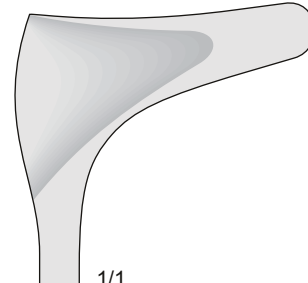

1412-BLA
130 mm

1/1

Dünnes Blatt
Thin valve
Valve platte

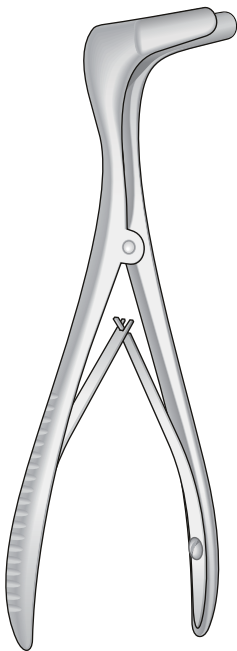

KILLIAN
1412-BLA/1412-BLC

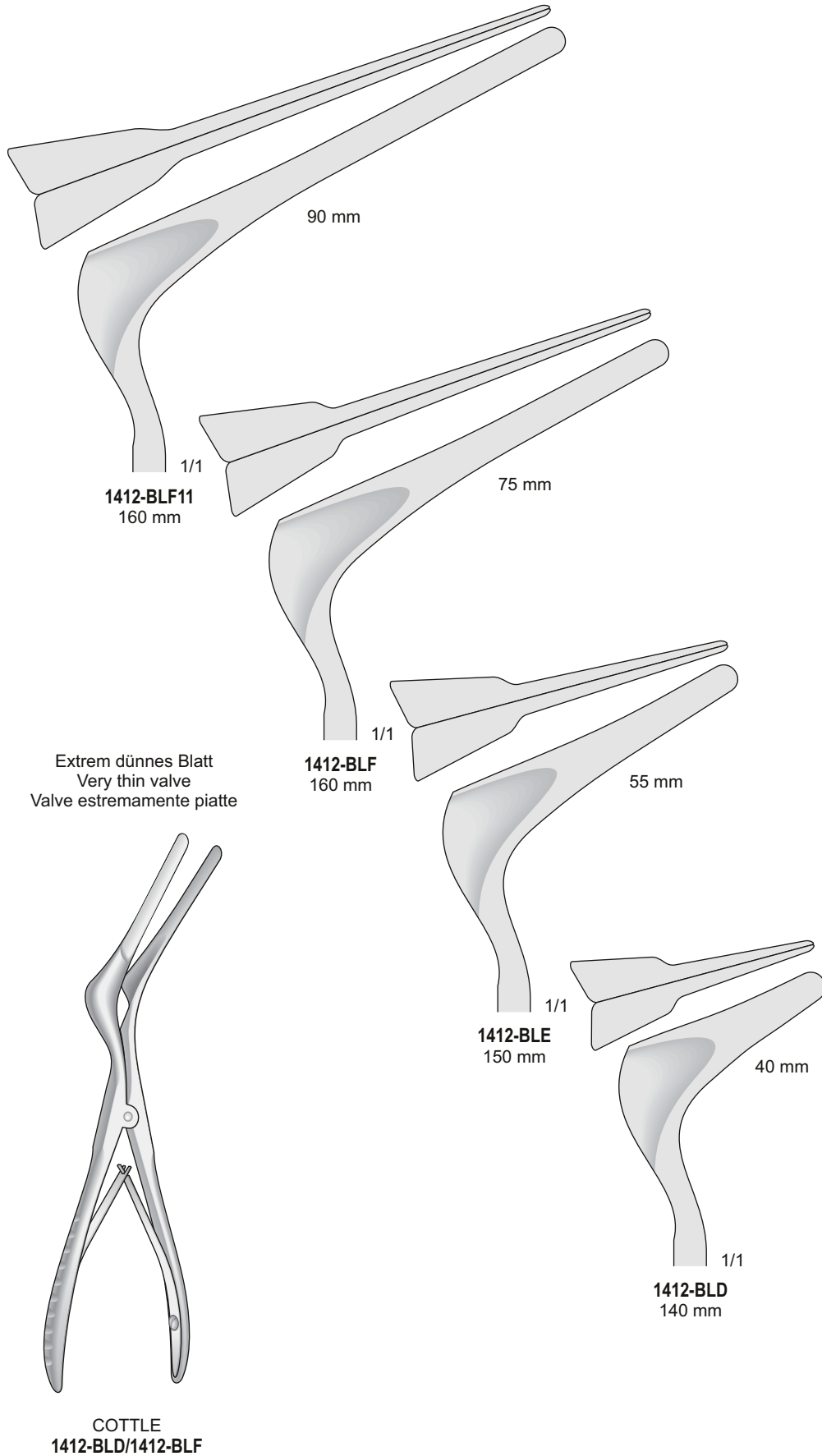

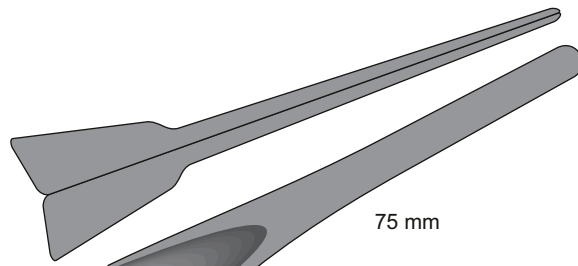

75 mm



1/1

1412-BLI
160 mm

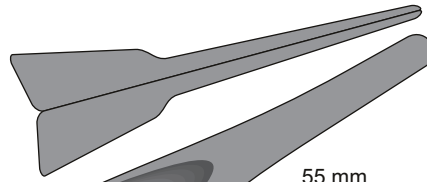

55 mm

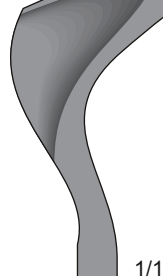

1/1

1412-BLH
150 mm

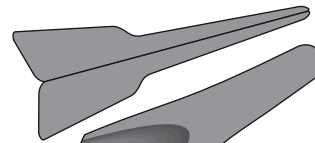

40 mm

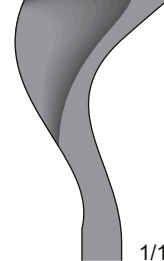

1/1

1412-BLG
140 mm

Schwarz Verchromt
Black Finish
Cromato nero

Extrem dünnes Blatt
Very thin valve
Valve estremamente piatte

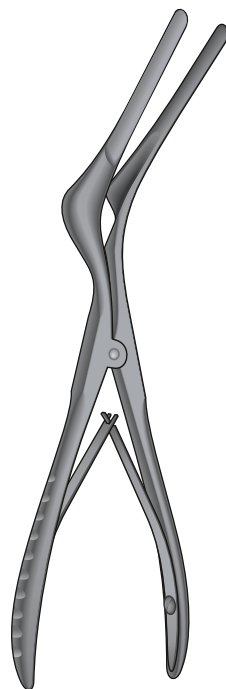

COTTLE
1412-BLG/1412-BLI

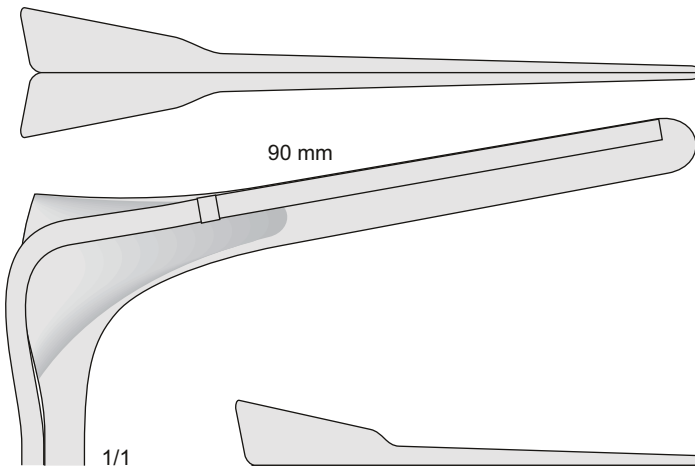

90 mm

1/1

1412-CED
150 mm

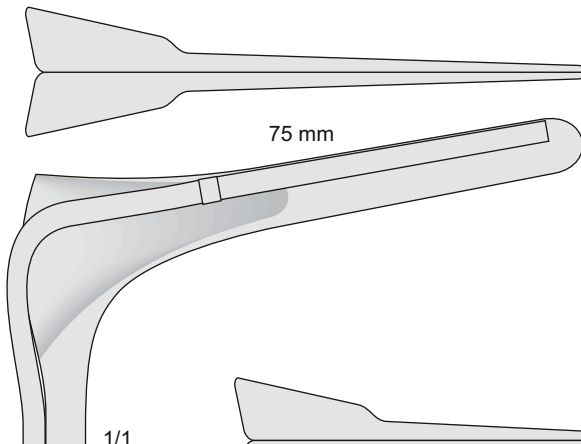

75 mm

1/1

1412-CEC
150 mm

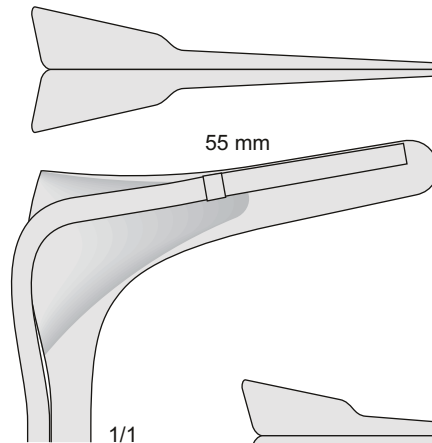

55 mm

1/1

1412-CEB
140 mm

Dünnes Blatt
Thin valve
Valve piatte

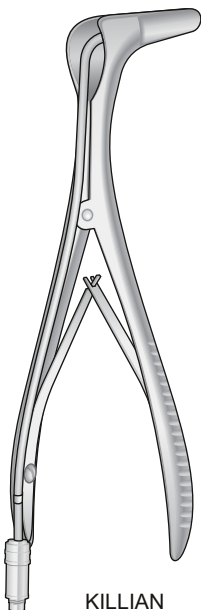

KILLIAN
1412-CEA/1412-CED

Mit Fiberoptikstab
With Fiber optic illumination
Con illuminazione a fibre ottiche
Con iluminación de luz fría
Avec illumination à lumière froide

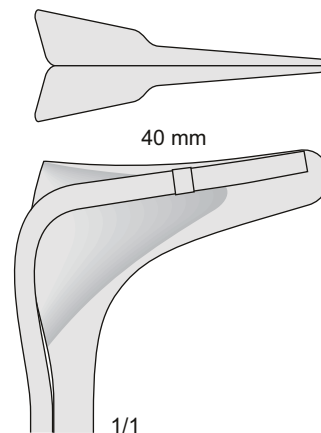

40 mm

1/1

1412-CEA
130 mm

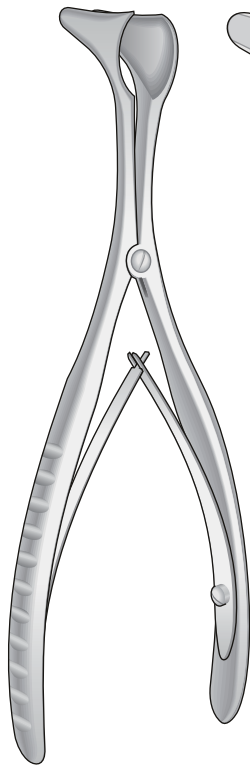

HARTMANN-HALLE
1412-BAI12
150 mm

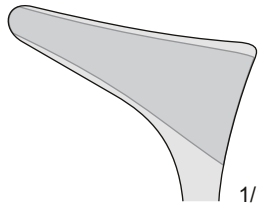

1412-BAI12
Fig. 2
1/1

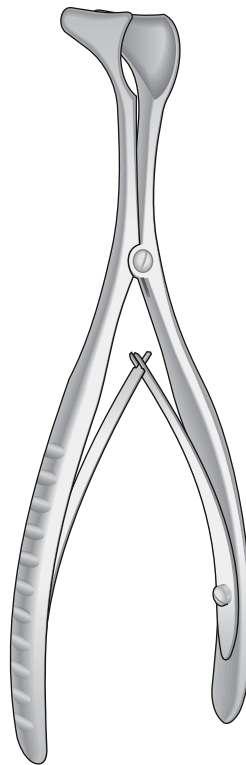

HARTMANN-HALLE
1412-BAG/1412-BAL
150 mm

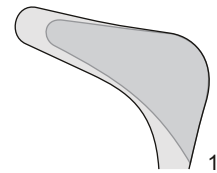

1412-BAG
Fig. 00

Kinder
Children
Bambini
Niños
Enfants

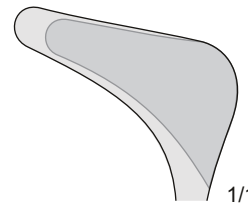

1412-BAH
27 mm
Fig. 1

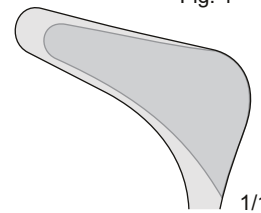

1412-BAI
31 mm
Fig. 2

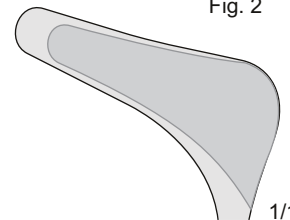

1412-BAL
35 mm
Fig. 3

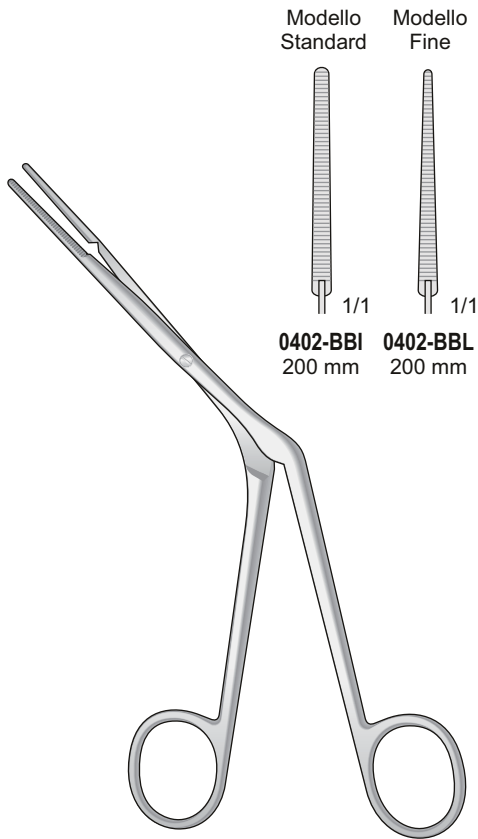

WESTMACOTT
0402-BBI/0402-BBL
200 mm

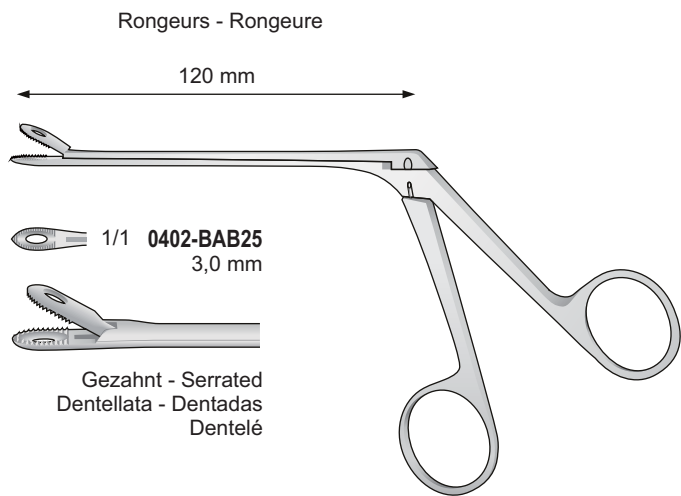

WEIL-BLAKESLEY
0402-BAB25
190 mm



Ohne Sperre
Without catch
Senza cremagliera
Sin cremallera
Sans crémaillère

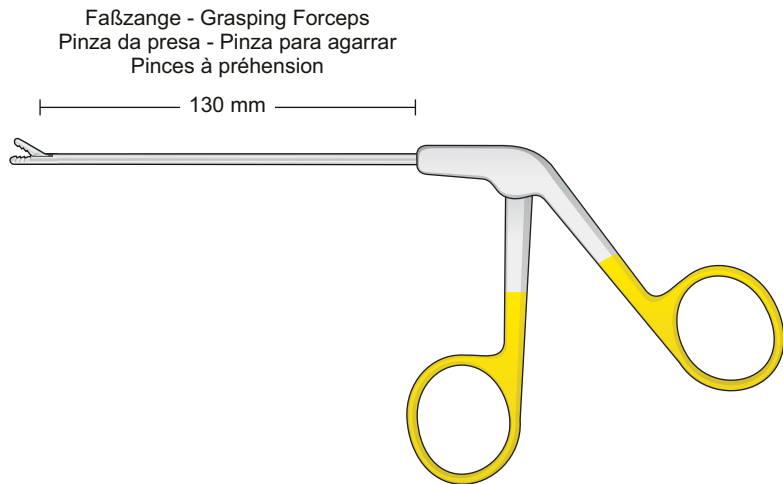

0614-DFA

Endoplastikinstrumente

Endoplastic Instruments

Strumenti per Endopastica

Instrumentos para Endoplastica

Instruments pour Endoplastique

Gerade - Straight
Diritta - Recto - Droit



0614-DHA
Ø 2,7 mm

30° rechts - right
destra - derecha - droite



0614-DHB
Ø 2,7 mm

30° links - left - sinistra
izquierda - gauche



0614-DHC
Ø 2,7 mm

Hakenstanzen mit Schaufel - Hook Punches with Scoop
Pinze per biopsia con pala - Pinzas para biopsia con pala
Pincas à biopsie à pelle

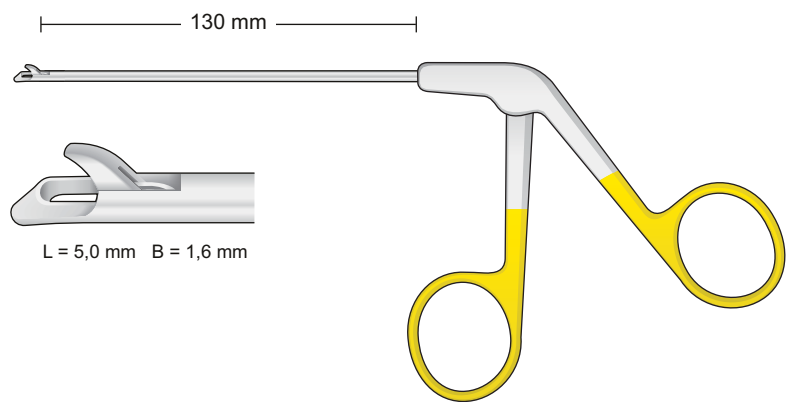

0614-DHA/0614-DHC

Gerade - Straight
Diritta - Recto - Droit



0614-DLA
Ø 2,7 mm

30° rechts - right
destra - derecha - droite



0614-DLB
Ø 2,7 mm

30° links - left - sinistra
izquierda - gauche



0614-DLC
Ø 2,7 mm

15° auf - up - sopra



0614-DLH
Ø 2,7 mm

Hakenschere - Hook Scissors
Pinze a gancio - Tijeras de gancho
Pincas - ciseaux

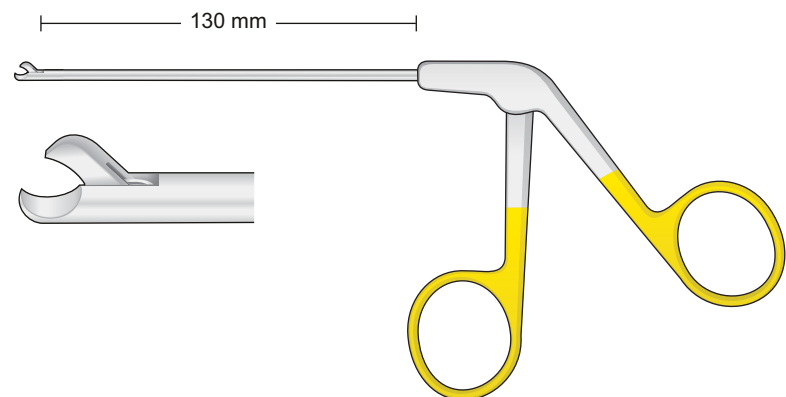

0614-DLA/0614-DLH

Feine Wundhäkchen

Fine Retractors

Divaricatori fini

Separadores finas

Ecarteurs très fins

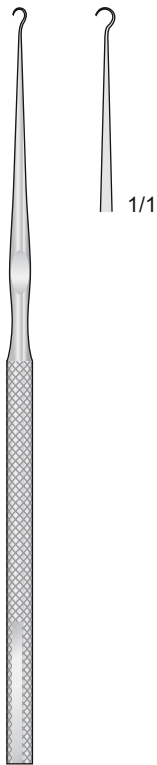

KILNER
0219-FD
150 mm

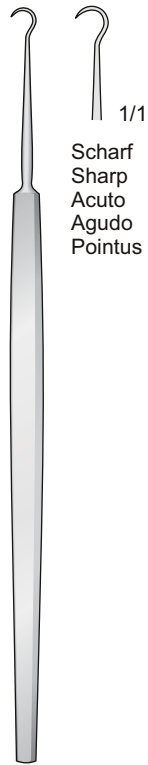

FRAZIER
0219-DGC 130 mm
0219-DGD 180 mm

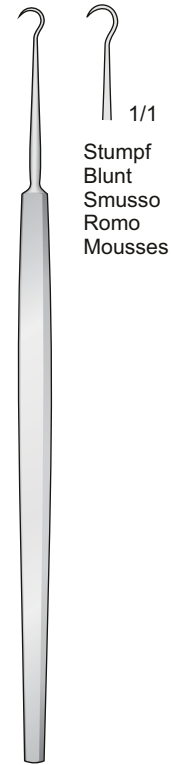

FRAZIER
0219-DGE 130 mm
0219-DGF 180 mm

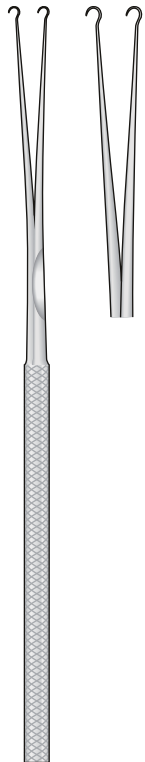

BARSKY
0219-DHA
150 mm

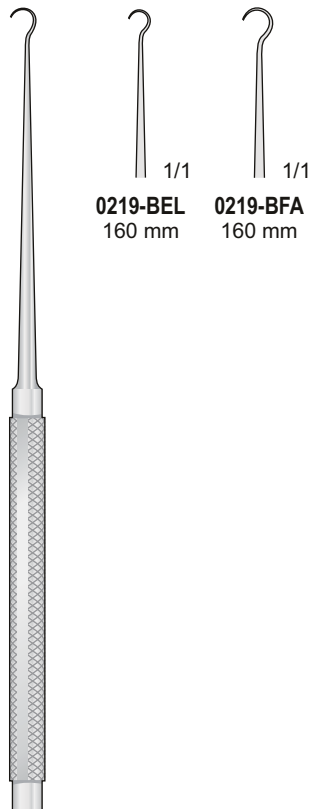

KLEINERT-KUTZ
0219-BEL/0219-BFA
160 mm

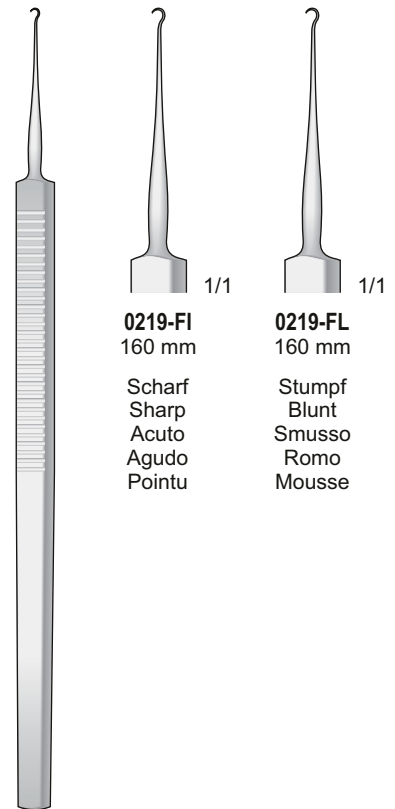

GRAEFE
0219-FI/0219-FL
160 mm

**Dissector
Wundhaken**



0518-BBA
125 mm

**Dissector
Retractors**



0219-CB
110 mm

**Dissettori
Divaricatori**

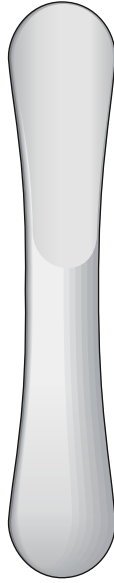

**JAEGER
1412-AL**
110 mm

**Disecadores
Separadores**

Nasenflügelhaken
Alar Retractor
Divaricatore per alette nasali
Separador para las alas nasales
Ecarteur pour les ailes du nez

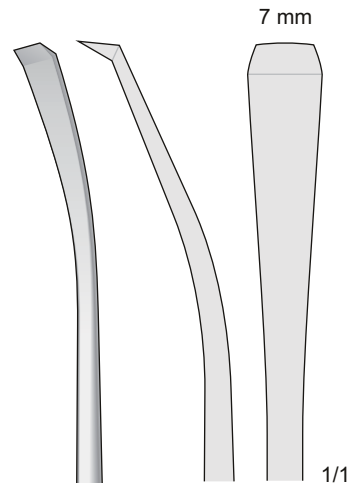

**MENEGHINI
0518-CCB**
215 mm

Measuring and Sculpturing
the lateral crus in open Rhinoplasty
Scoltura delle crus laterali
nella Rinoplastica aperta

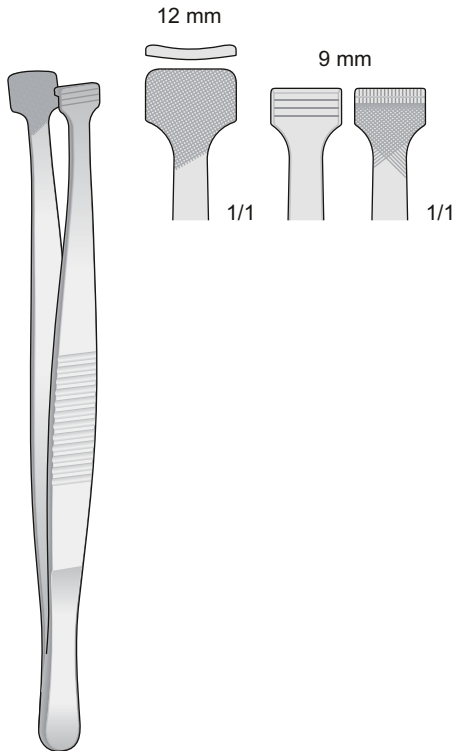

**MENEGHINI
0204-DFA**
125 mm

22 x 13 mm



**MICHELI-PELLEGRINI
0617-BLA**
150 mm

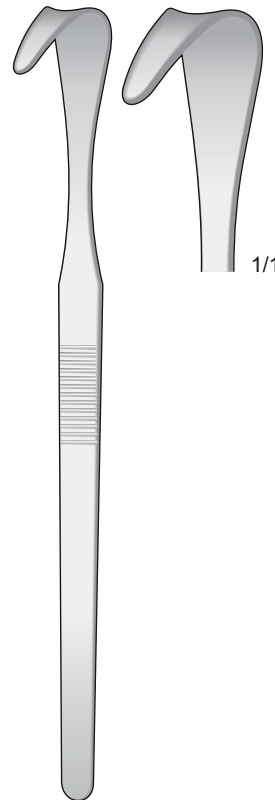

**COTTLE
0219-BDI**
150 mm

Osteotome

Osteotomes

Osteotomi

Osteòtoms

Ostéotomes



JOSEPH
0617-DE
150 mm

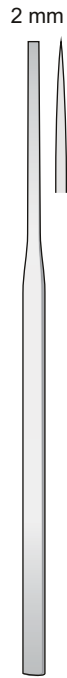

MINI-LAMBOTTE
0611-BL
125 mm



TESSIER
0611-EBD/0611-EBG
160 mm



0611-EBD
2 mm



0611-EBE
3 mm



0611-EBF
5 mm



0611-EBG
7 mm

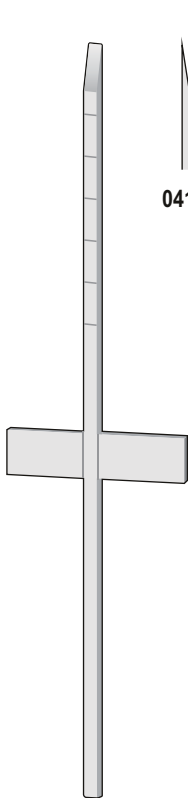

COTTLE
0414-CBL
180 mm

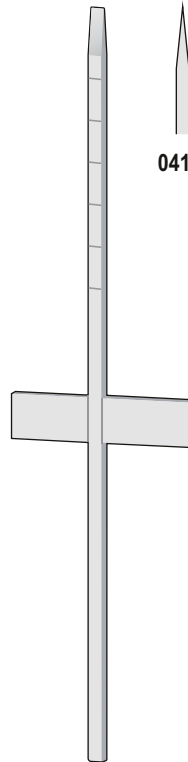
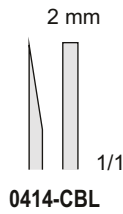

COTTLE
0414-CCI/0414-CDL
180 mm

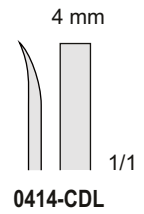
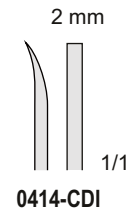
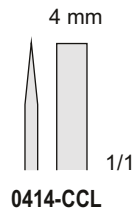
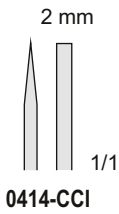

Osteotome

Osteotomes

Osteotomi

Osteótomos

Ostéotomes

2 mm

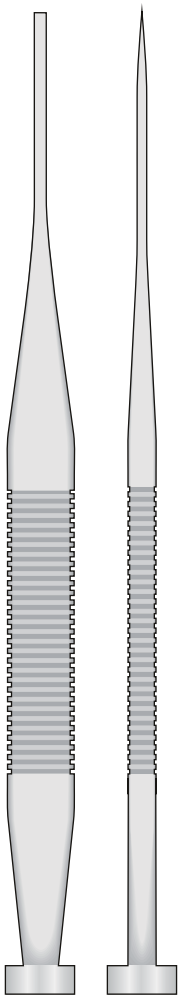

0414-BBD
170 mm

3 mm

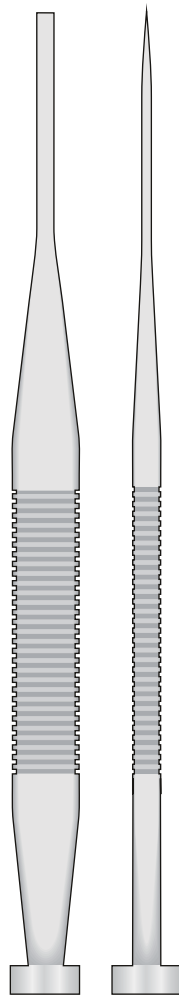

0414-BBE
170 mm

4 mm

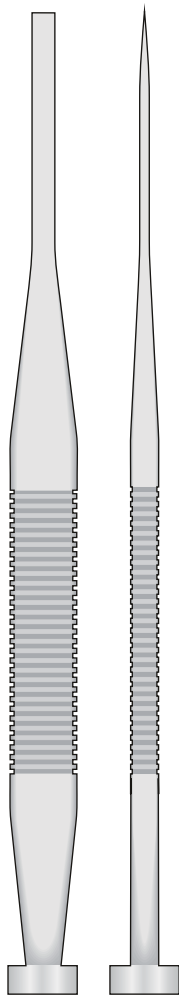

0414-BBF
170 mm

4 mm

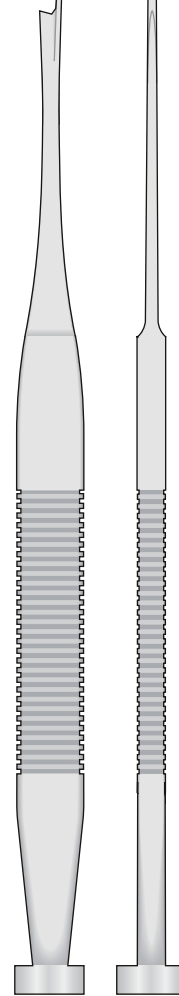

0414-BBG
170 mm



0414-BDF
185 mm

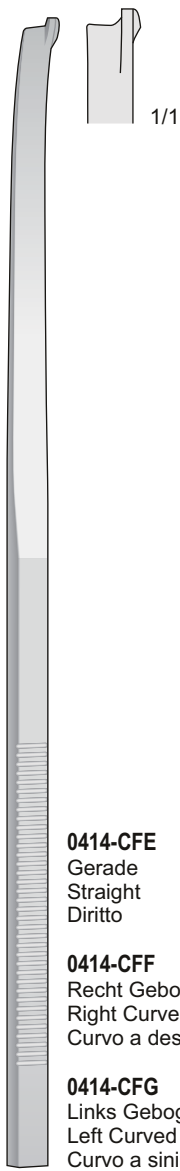

GUNTER
0414-CFE/0414-CFG
200 mm

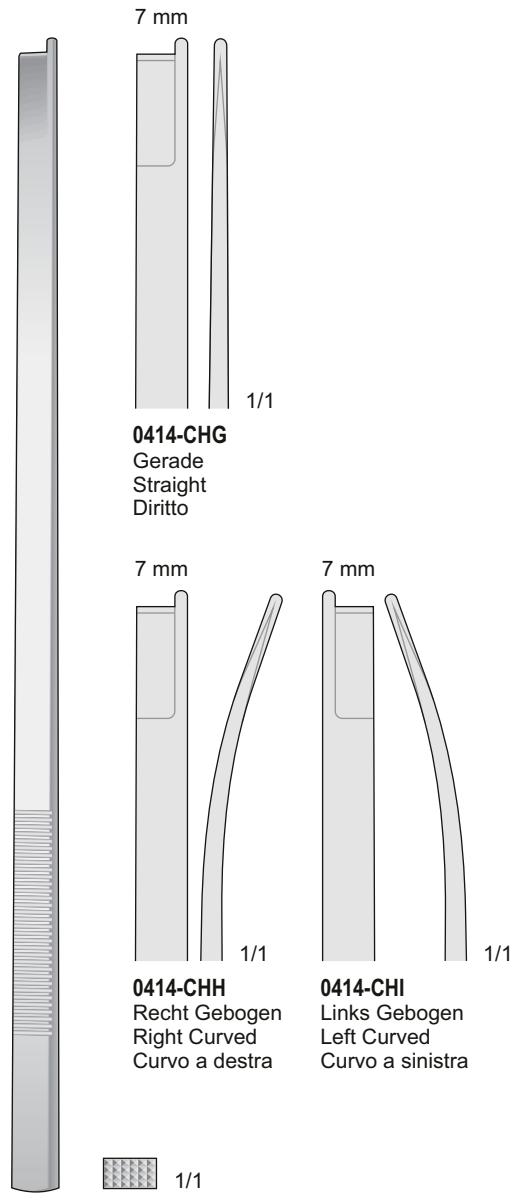

NEIVERT-ANDERSON
0414-CHG/0414-CHI
205 mm

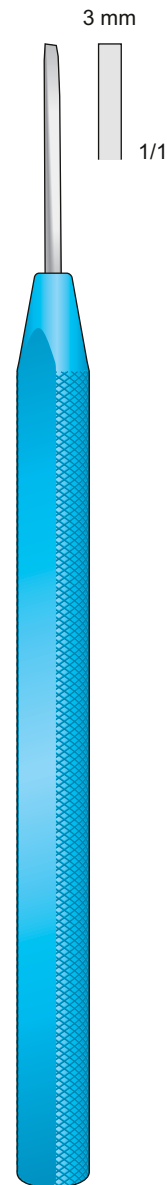

REES
0414-CHF
205 mm

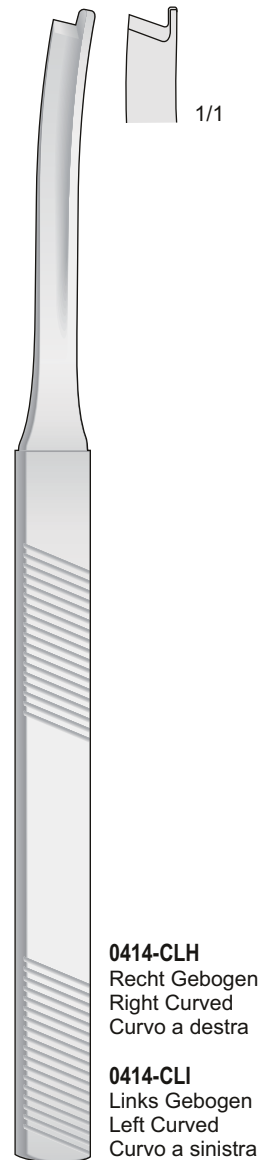

RISTOW
0414-CLH/0414-CLI
205 mm

Osteotome

Osteotomes

Osteotomi

Osteòtomos

Ostéotomes

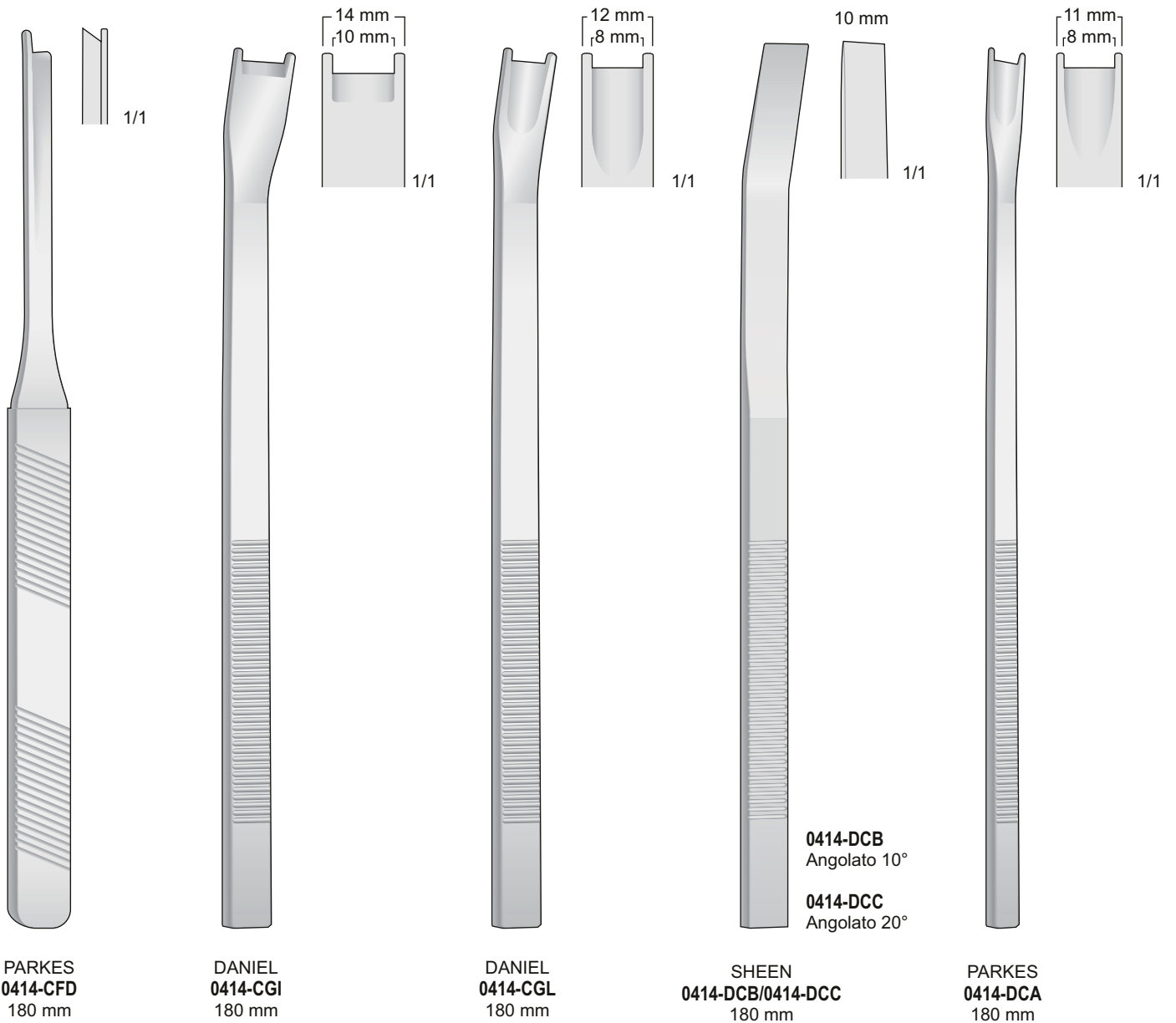

Osteotome mit
Doppelt Protezion

Osteotome with
Double Guarded

Osteotomi con
doppia protezione

Osteotom con
doble protezion

Osteotome avec
double protection

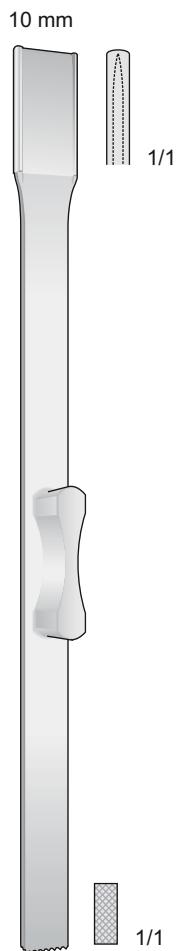

0414-CAI
160 mm

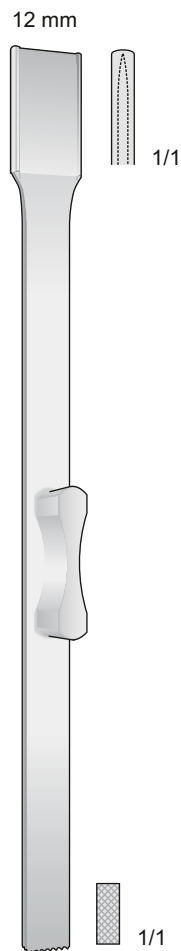

0414-CAL
160 mm

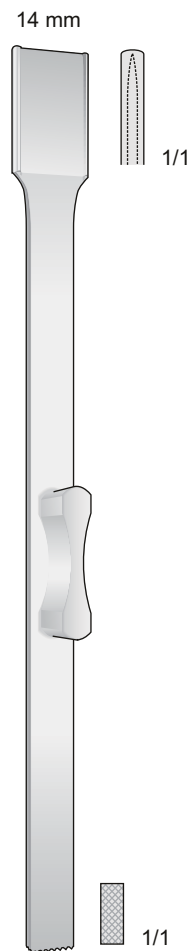

0414-CBA
160 mm

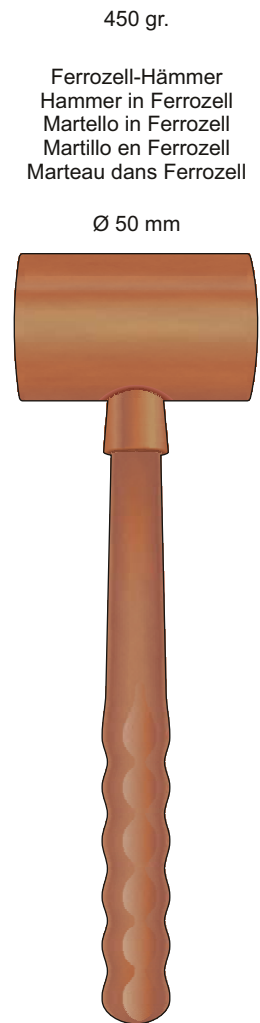

450 gr.

Ferozell-Hämmer
Hammer in Ferrozell
Martello in Ferrozell
Martillo en Ferrozell
Marteau dans Ferrozell

Ø 50 mm

0611-BCL
260 mm

Knochenfeilen

Bone files

Lime per osso

Limas para huesos

Limes à os



Kopfhautklemme
Scalp Haemostatic
forceps
Pinza emostatica per
il cuoio capelluto
Pinza hemostáticas
para pericraneo

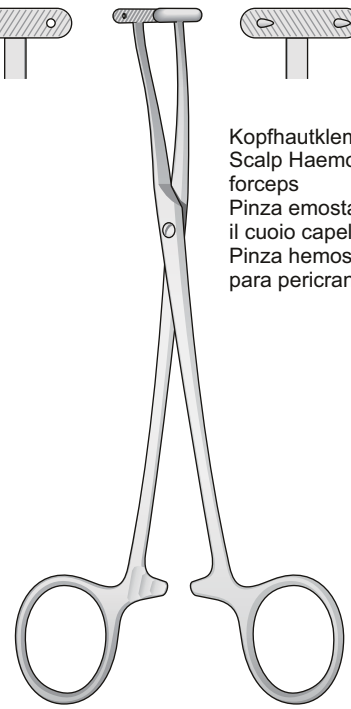

DE MARTEL
0602-BBL
145 mm

Intranasal Brecher
Intranasal Hammer
Martello intranasale



QUISLING
0611-BDH
175 mm

Diamantaufage
Diamond Jaw
Punte diamantate

7 mm

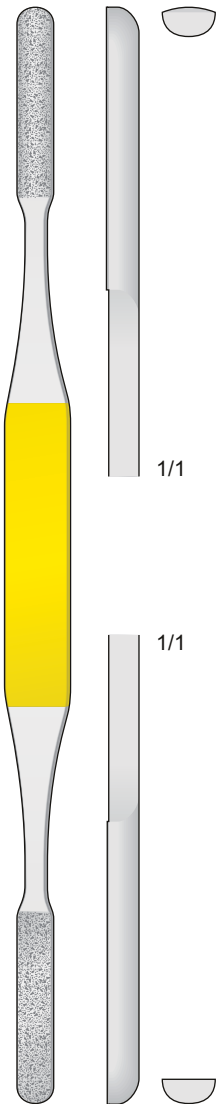

0414-DBG
215 mm

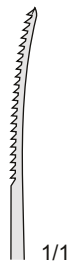

1/1

0414-DAA
190 mm



0414-CGH
190 mm

U form

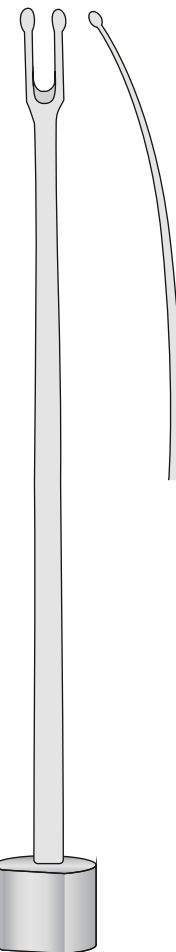

OBWEGESER
0414-BBA
185 mm

Mikro Pinzetten

Delicate forceps

Micro Pinzette

Pinzas finos

Micro pinces

Mikro Precision Pinzetten

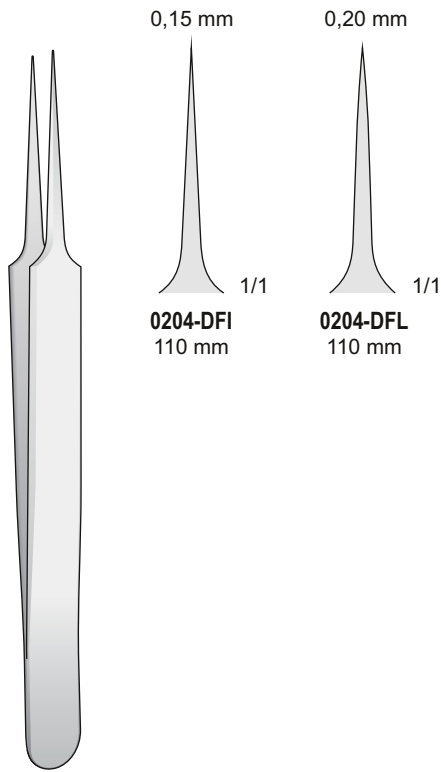

0,15 mm

0,20 mm

1/1

1/1

0204-DFI
110 mm

0204-DFL
110 mm

0204-DFI/0204-DFL
110 mm

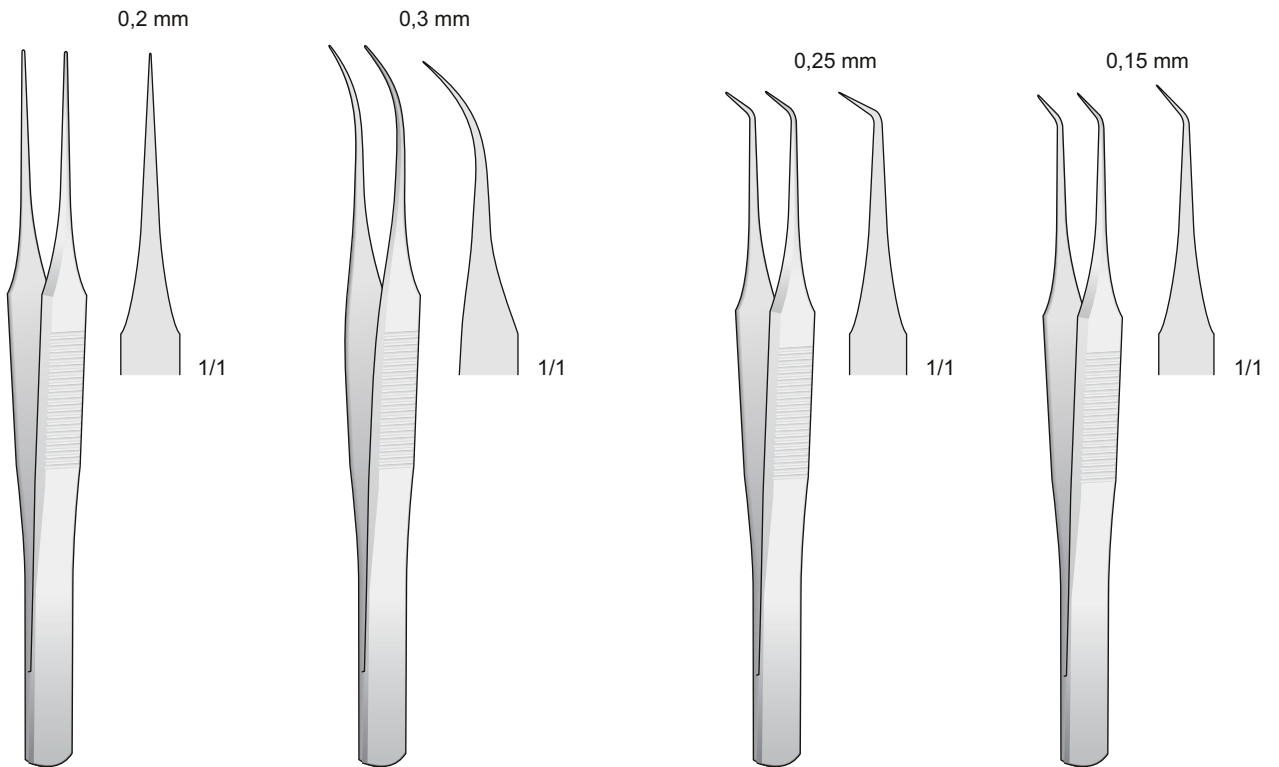

0,2 mm

0,3 mm

0,25 mm

0,15 mm

1/1

1/1

1/1

1/1

0204-DGA
110 mm

0204-DGB
110 mm

0204-DGC
100 mm

0204-DGD
100 mm

Mikro Pinzetten

Delicate forceps

Micro Pinzette

Pinzas finos

Micro pinces

Mikro Precision Pinzetten

Mikro diamantiertes Maul - Micro Diamond Jaw
 Micro punta diamantata - Micro boca diamantada
 Micro mors diamanté

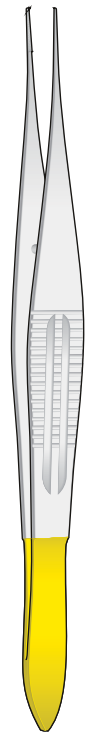

1/1
 1x2 Zähne
 1x2 Tooth
 1x2 Denti
 1x2 Dientes
 1x2 Dents



1/1
 9x9 Zähne
 9x9 Tooth
 9x9 Denti
 9x9 Dientes
 9x9 Dents

CASTROVIEJO
 0204-DEH 0.5 mm
 0204-DEI 0.9 mm
 120 mm

BROWN
 0204-DEL
 120 mm



0,4 mm
 1/1



0,4 mm
 1/1



0,4 mm
 1/1



0,4 mm
 1/1

0204-DGE
 110 mm

0204-DGF
 110 mm

0204-DGG
 130 mm

0204-DGH
 130 mm

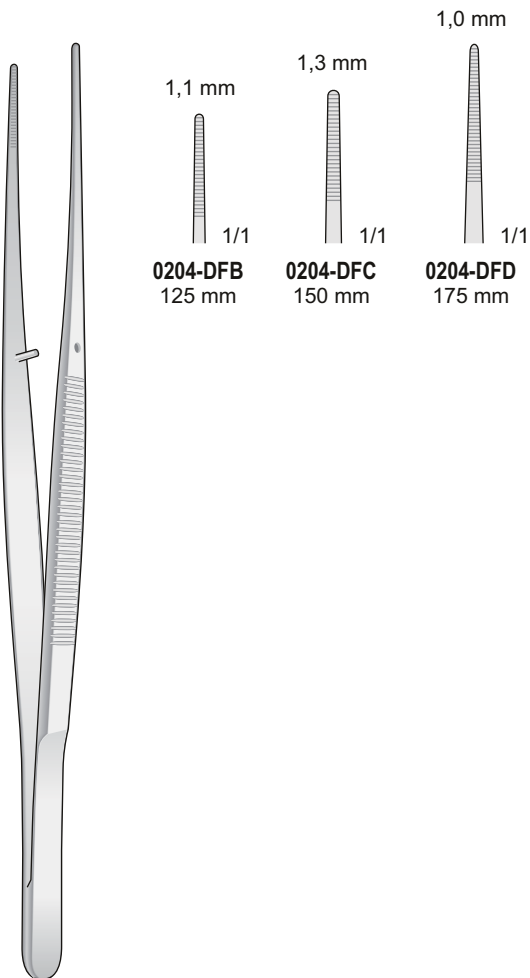

0204-DFB/0204-DFD

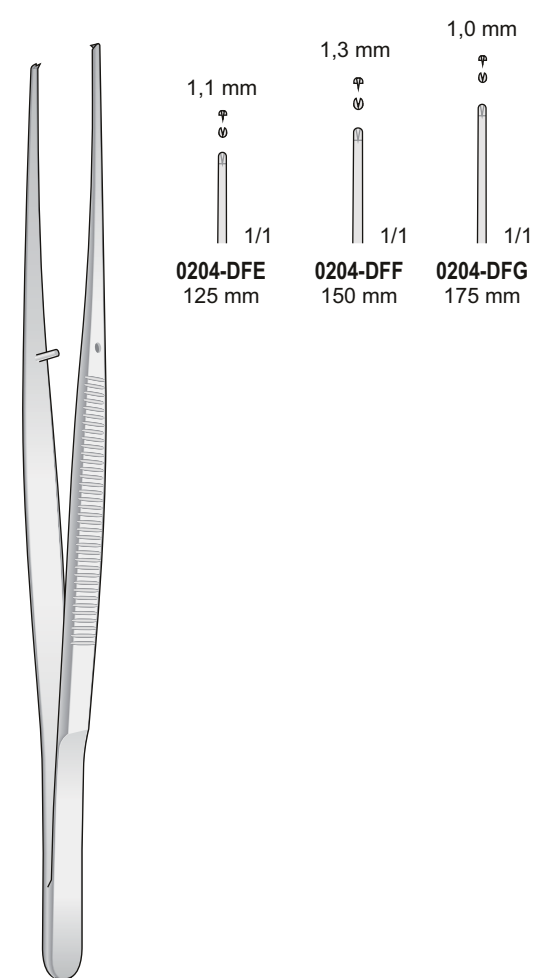

0204-DFE/0204-DFF

Chirurgische Pinzetten
Anatomische Pinzetten

Tissue forceps
Dressing forceps

Pinzette chirurgische
Pinzette anatomiche

Pinzas quirúrgicas
Pinzas de diseccion

Pinces chirurgicales
Pinces anatomiques

Mit Fadenplatte
With tying platform
Con piano prendifilo
Con plataforma
Avec plateaux pour monofil

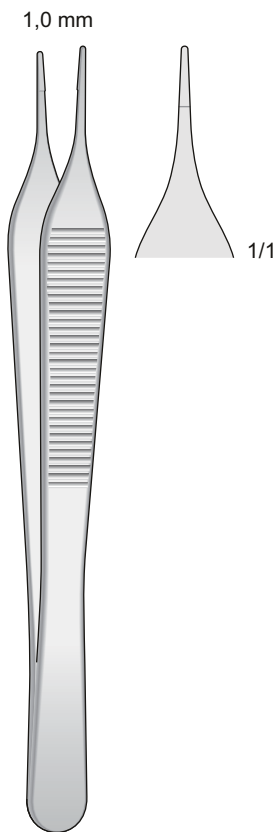

ADSON
0204-DHA
120 mm

Mit Fadenplatte
With tying platform
Con piano prendifilo
Con plataforma
Avec plateaux pour monofil

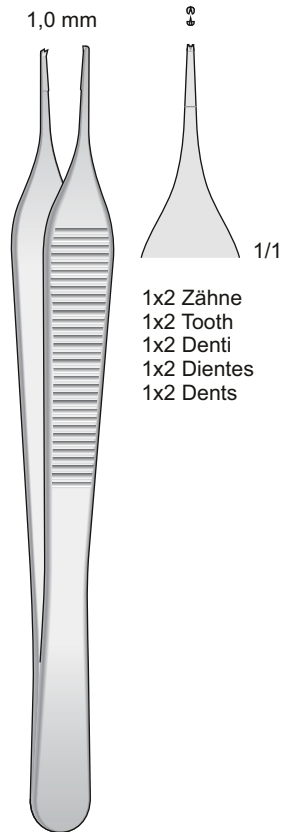

ADSON
0204-DHB
120 mm

Extra fein
Extra fine
Extra fine

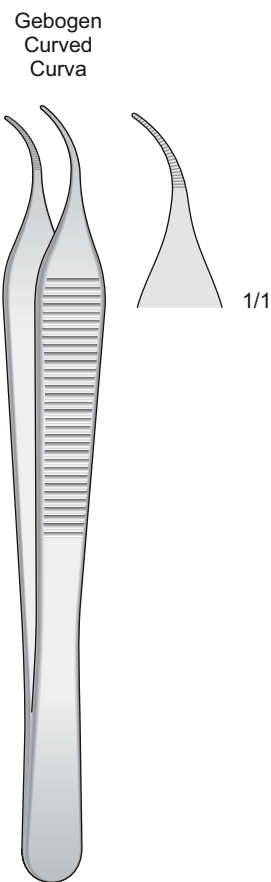

MICRO-ADSON
0204-DHC
120 mm

Extra fein
Extra fine
Extra fine

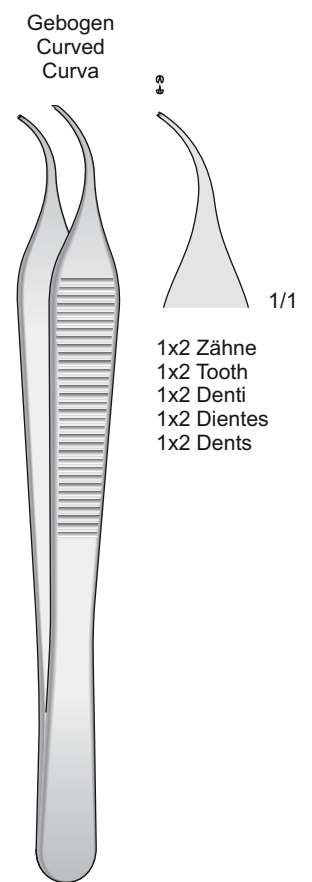

MICRO-ADSON
0204-DHD
120 mm

Chirurgische Pinzetten
Anatomische Pinzetten

Tissue forceps
Dressing forceps

Pinzette chirurgische
Pinzette anatomiche

Pinzas chirùrgicas
Pinzas de diseccion

Pincas chirùrgicas
Pincas anatomiques

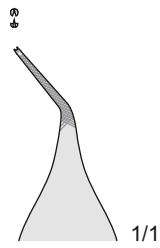

1x2 Zähne
1x2 Tooth
1x2 Denti
1x2 Dientes
1x2 Dents

Kreuzgerieft
Cross serrated
Zigrinata a croce
Estrjada a cruz
Striéé

Abgewinkelt
Angled
Angolata

MICRO-ADSON
0204-DHG
120 mm

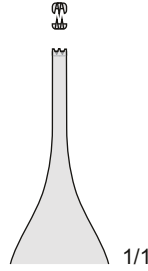

2x3 Zähne
2x3 Tooth
2x3 Denti
2x3 Dientes
2x3 Dents

ADSON
0204-DHH
120 mm

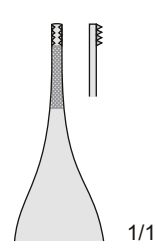

ADSON-BROWN
0204-CFD
120 mm

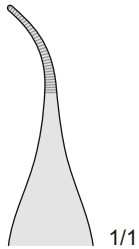

MICRO-ADSON
0204-DHE
150 mm

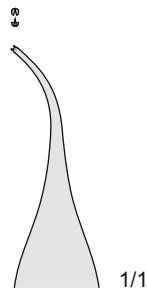

MICRO-ADSON
0204-DHF
150 mm

1x2 Zähne
1x2 Tooth
1x2 Denti
1x2 Dientes
1x2 Dents

Standard

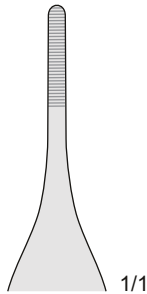

ADSON
0204-DIA
150 mm

Standard

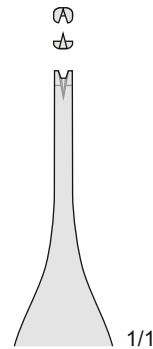

ADSON
0204-DIB
150 mm

1x2 Zähne
1x2 Tooth
1x2 Denti
1x2 Dientes
1x2 Dents

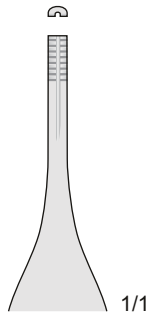

ADSON-BROWN
0204-DIC
150 mm

9x9 Zähne
9x9 Tooth
9x9 Denti
9x9 Dientes
9x9 Dents

Chirurgische Pinzetten
Anatomische Pinzetten

Tissue forceps
Dressing forceps

Pinzette chirurgiche
Pinzette anatomiche

Pinzas quirúrgicas
Pinzas de disección

Pinces quirúrgicas
Pinces anatómicas

Pinzette bipolari per coagulazione

Con rivestimento isolante in plastica sterilizzabile

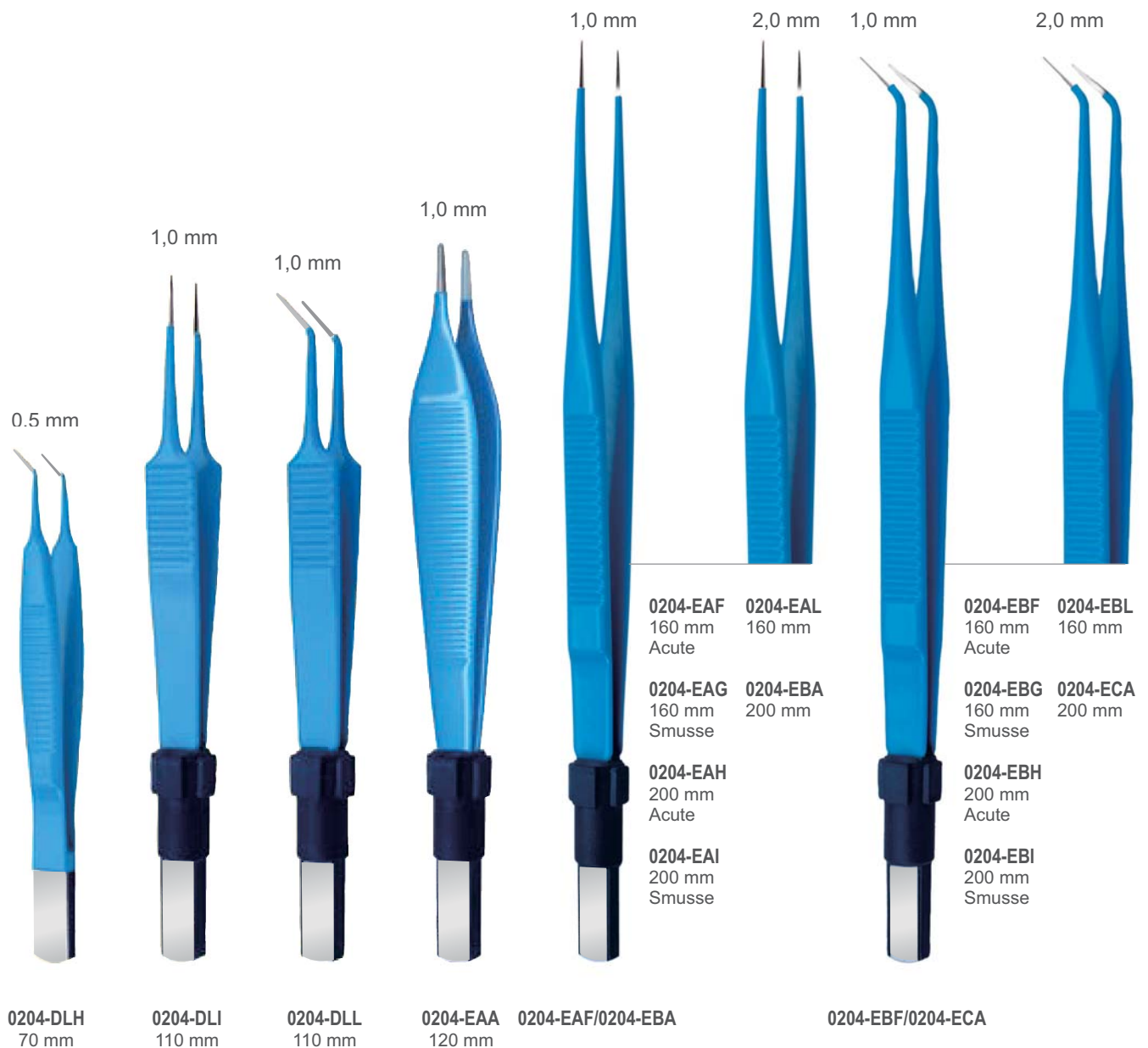

Pinzette bipolari per coagulazione

Con rivestimento isolante in plastica sterilizzabile

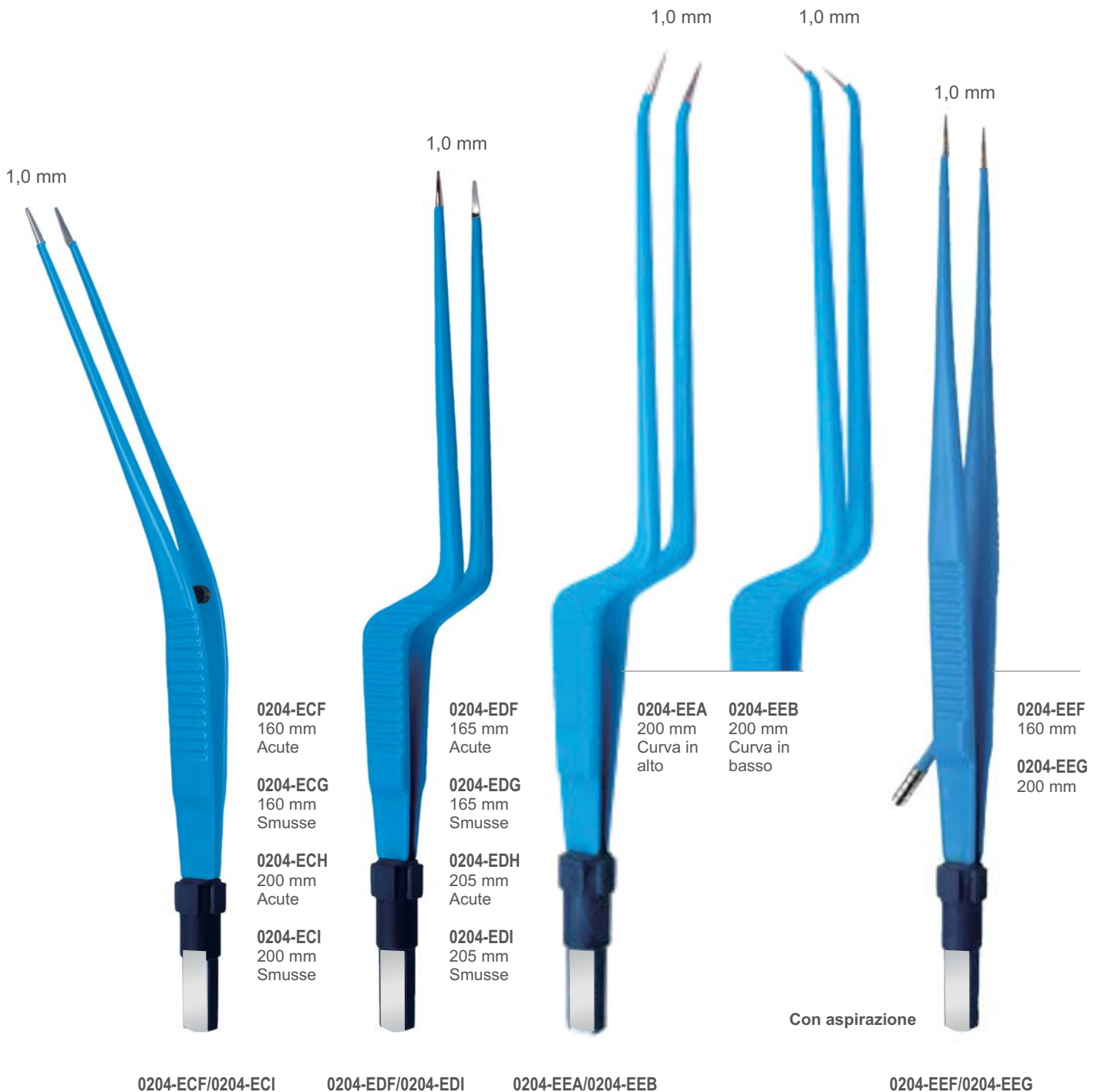

Kanüle
für Liposculture

Cannula
for Liposculture

Cannule da
Liposcultura

Cânulas de
Liposcultura

Canules pour
liposculture

Luer-Lock Cannule

Ø 3,0 mm

Ø 3,0 mm

Ø 2,0 mm

Ø 3,0 mm

Ø 3,0 mm

Ø 3,0 mm

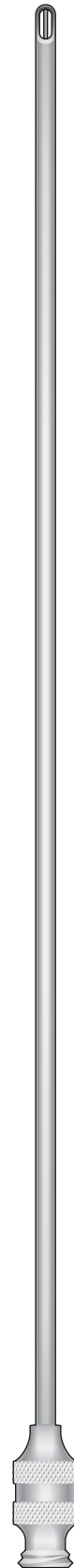
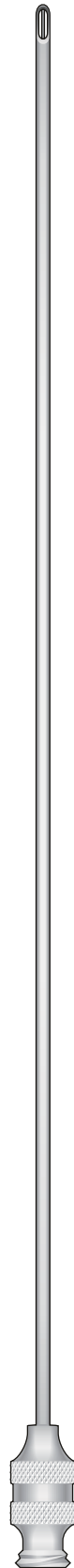
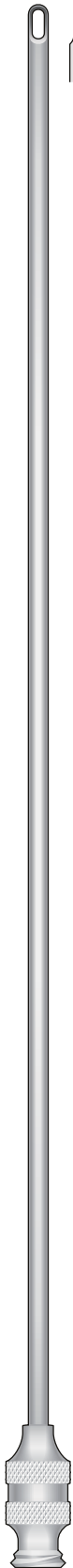
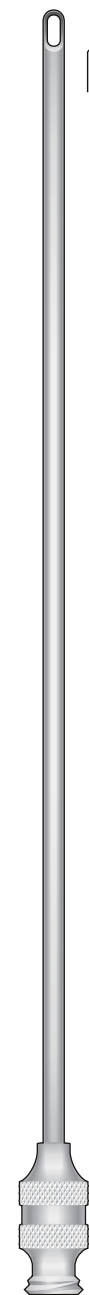

0518-DBB
150 mm

0518-DBC
200 mm

0518-DBD
200 mm

0518-DBE
200 mm

0518-DBF
200 mm

0518-DBG
200 mm

Kanüle
für Liposculture

Cannula
for Liposculture

Cannule da
Liposcultura

Cânulas de
Liposcultura

Canules pour
liposculture

Luer-Lock Cannule

Ø 2,0 mm

Ø 3,0 mm

Ø 3,0 mm

Ø 2,5 mm

Ø 3,0 mm

Ø 3,0 mm

Ø 3,0 mm

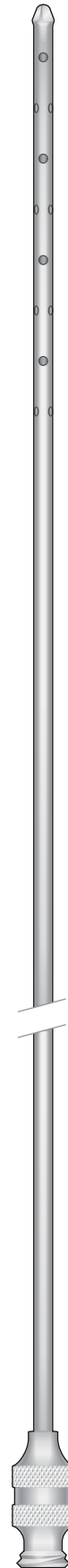
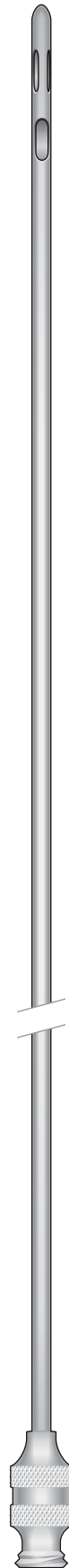
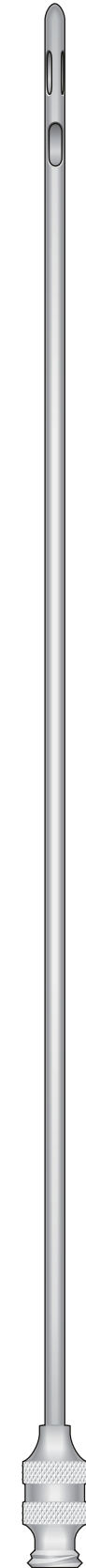
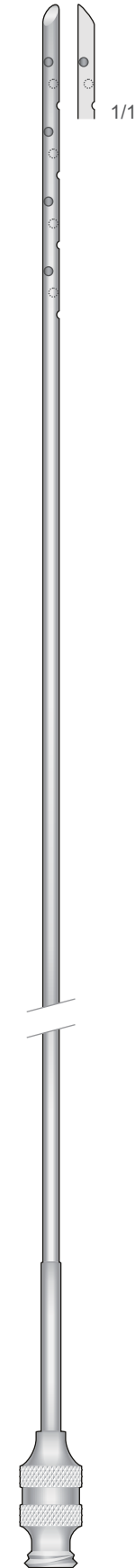
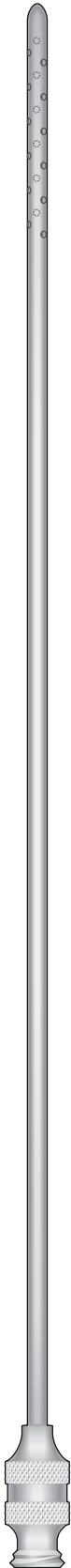
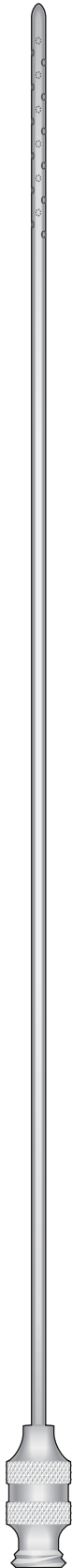

0518-DBH
200 mm

0518-DBI
200 mm

0518-DBL
300 mm

0518-DCA
250 mm

0518-DCB
200 mm

0518-DCC
300 mm

0518-DCD
250 mm

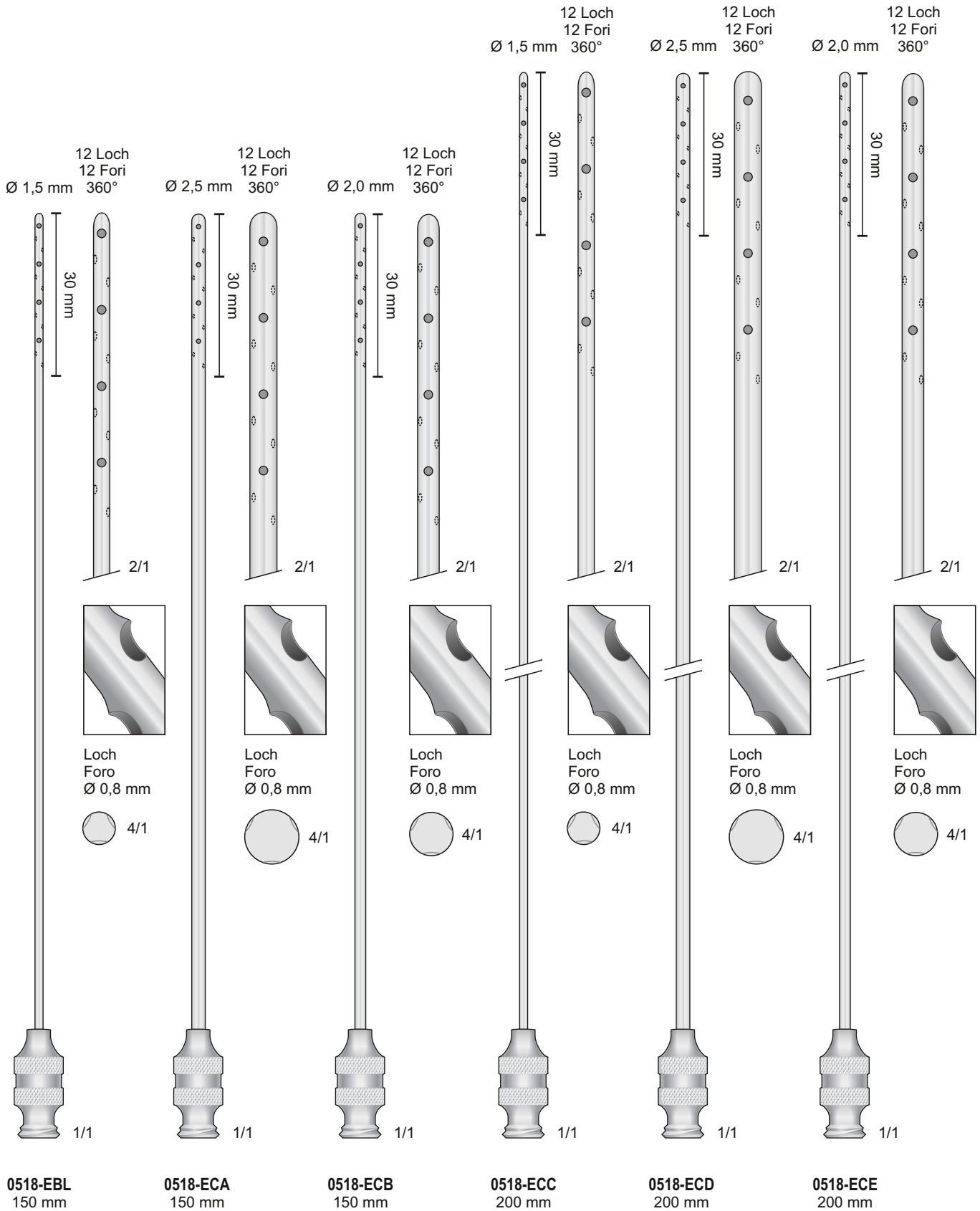

**Makro
Absaugkanülen**

**Macro
Suctions Tubes**

**Macro cannule
per aspirazione**

**Macro Cànulas
aspiradoras**

**Macro Canules
aspiratrices**

5 Loch - 5 Openings
5 Fori - 5 Bucos - 5 Troues

Ø 4.0 mm

3 Loch
3 Fori
Ø 2 mm

2,5 mm

4,0 mm

1/1

Ø 2,0 mm

1/1

Ø 3,0 mm

3 Loch
3 Fori

Ø 1,5 mm

Ø 2,5 mm

Ø 1,5 mm

Ø 2,0 mm

4,0 mm
4,0 mm

2,8 mm

2,0 mm

0518-AF18
70 mm

0518-AF12
70 mm

0518-AF1811
110 mm

0518-ED
110 mm

0518-BHA
300 mm

0518-BGL
300 mm

0518-EAB
200 mm

0518-EAC
200 mm

0518-EBB
100 mm

Rostfreies Verbindungsteil zum Kanüle-Nadel
 Connection piece for cannula-needles
 Raccordo inox per cannula-ago
 Juntura inox para jeringa-agujas
 Adapter en acier pour canule-aiguilles

Universal Adapter for Syringe

Aluminium Blau
 Aluminium Blue
 Alluminio Blu
 Aluminio Azul
 Aluminium Bleu



0518-AC

Griff Rostfrei
 Stainless Steel Handle
 Manico in acciaio Inox
 Mango de acero inoxidable
 Manche en acier inoxydable

Ø 15 mm



0518-CL
 195 mm

130 mm



1804-FA
 50 ml

Raccordo per
 due siringhe



Luer Lock

Luer Lock

1/1

0518-AD
 21 mm



0518-DAB
 160 mm

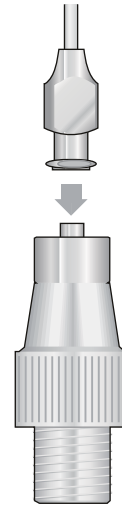

0518-AE



0518-DAC
 155 mm

Raccordo
 Luer Lock



1/1

0518-DAG
 34 mm



0518-DAD
 155 mm

Infiltration Kanüle

Infiltration Cannula

Canulle da infiltrazione

Cánulas de infiltración

Canules pour infiltration

Ø 2,0 mm

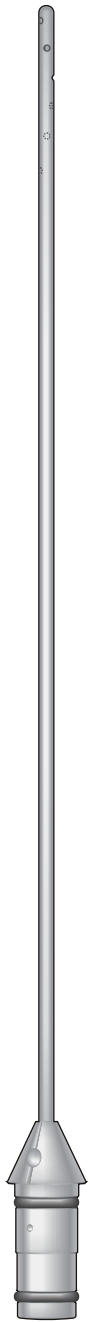

0518-DDB
150 mm

Ø 3,0 mm

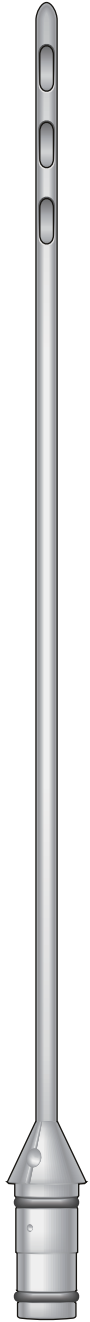

0518-DDL
150 mm

Ø 4,0 mm

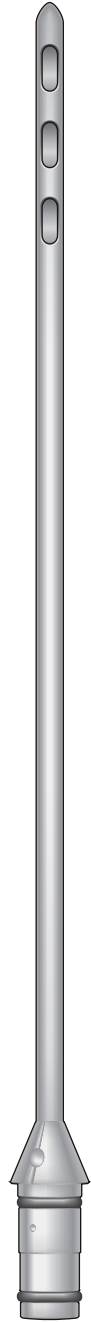

0518-DEA
150 mm

Ø 3,0 mm

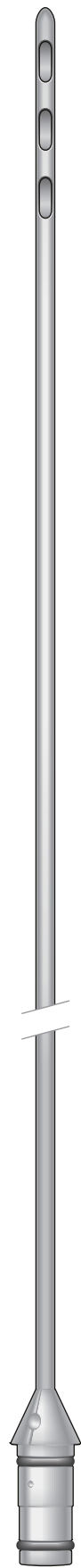

0518-DEB
250 mm

Ø 4,0 mm

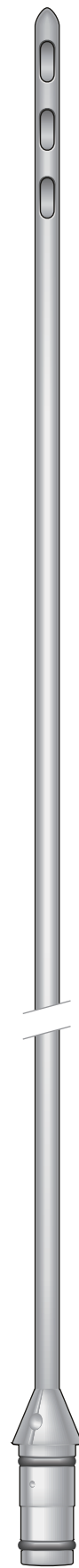

0518-DEC
250 mm

Ø 4,0 mm

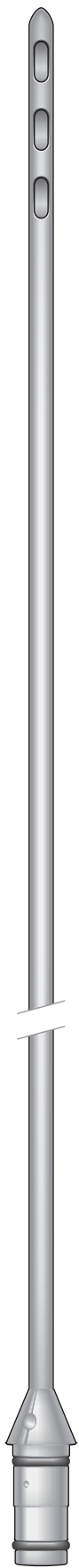

0518-DED
300 mm

Infiltration Kanüle

Infiltration Cannula

Cannule da infiltrazione

Cànullas de infiltración

Canules pour infiltration

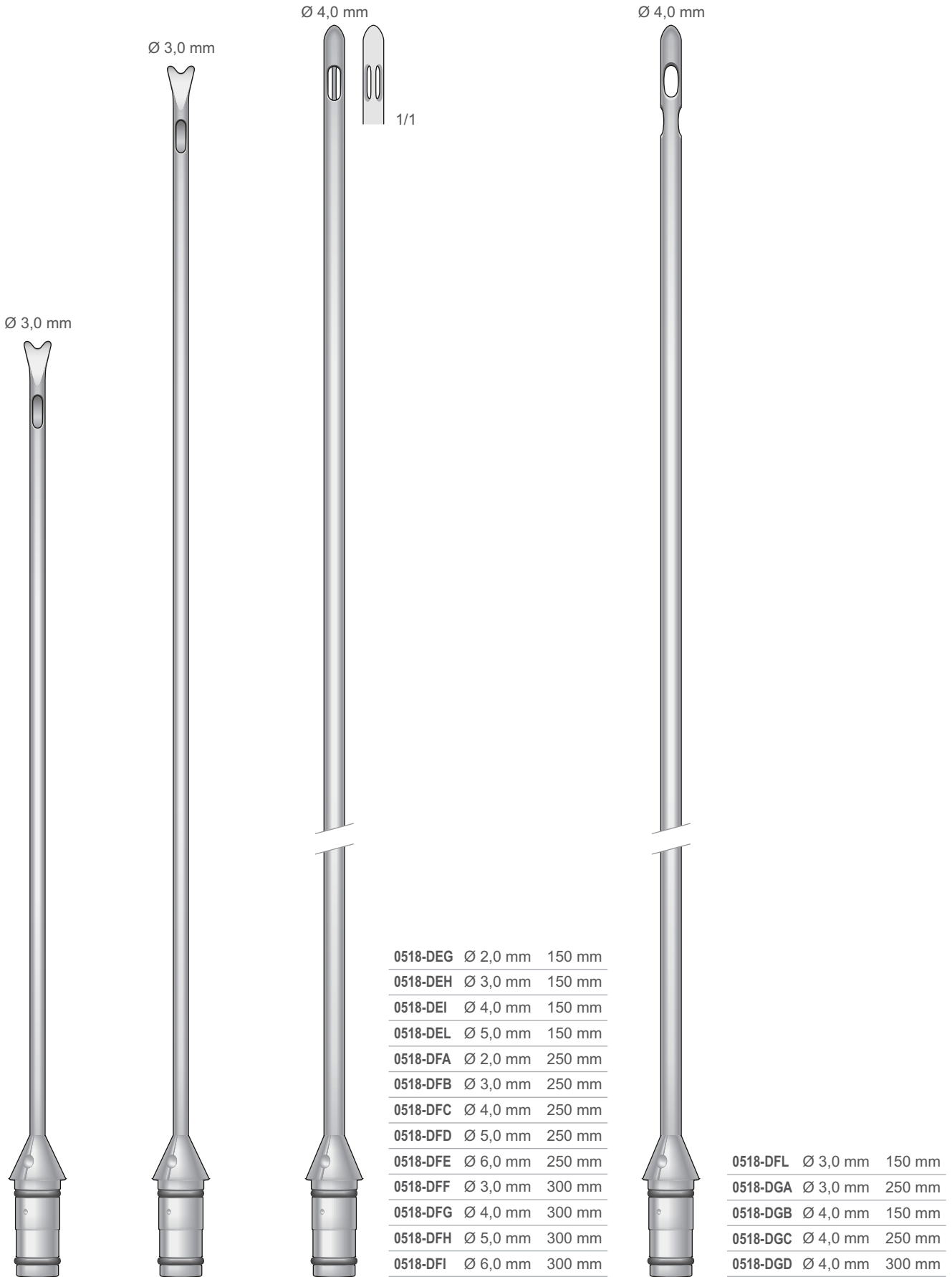

0518-DEG	Ø 2,0 mm	150 mm
0518-DEH	Ø 3,0 mm	150 mm
0518-DEI	Ø 4,0 mm	150 mm
0518-DEL	Ø 5,0 mm	150 mm
0518-DFA	Ø 2,0 mm	250 mm
0518-DFB	Ø 3,0 mm	250 mm
0518-DFC	Ø 4,0 mm	250 mm
0518-DFD	Ø 5,0 mm	250 mm
0518-DFE	Ø 6,0 mm	250 mm
0518-DFH	Ø 3,0 mm	300 mm
0518-DFG	Ø 4,0 mm	300 mm
0518-DFH	Ø 5,0 mm	300 mm
0518-DFI	Ø 6,0 mm	300 mm

0518-DFL	Ø 3,0 mm	150 mm
0518-DGA	Ø 3,0 mm	250 mm
0518-DGB	Ø 4,0 mm	150 mm
0518-DGC	Ø 4,0 mm	250 mm
0518-DGD	Ø 4,0 mm	300 mm

0518-DEE
150 mm

0518-DEF
200 mm

MERCEDES
0518-DEG/0518-DFI

LAS VEGAS
0518-DFL/0518-DGD

**Makro
Absaugkanülen**

Ø 2 mm

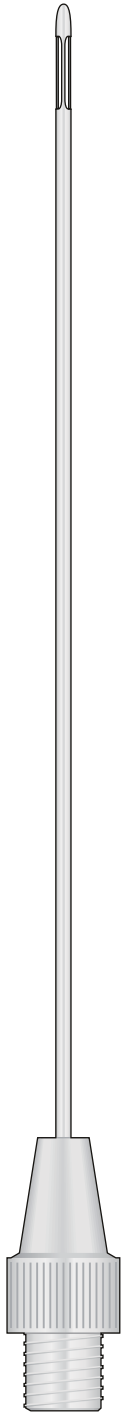

**MERCEDES
0518-BIA**
150 mm

**Macro
Suctions Tubes**

Ø 2 mm

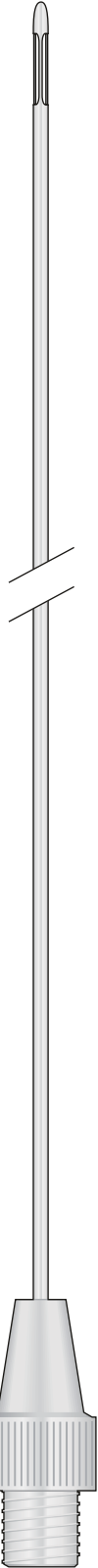

**MERCEDES
0518-BIB**
250 mm

**Macro cannule
per aspirazione**

Ø 3 mm

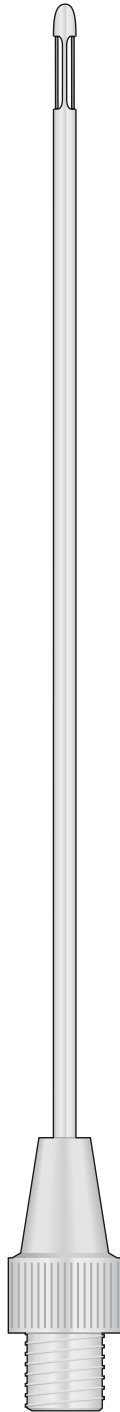

**MERCEDES
0518-BIC**
150 mm

**Macro Cànulas
aspiradoras**

Ø 3 mm

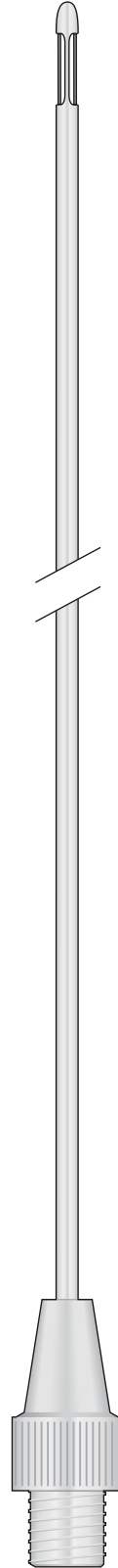

**MERCEDES
0518-BID**
250 mm

**Macro Canules
aspiratrices**

Ø 3 mm

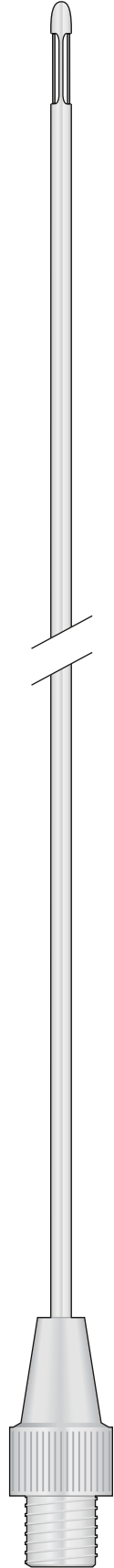

**MERCEDES
0518-BIE**
300 mm

Absaugkanülen

Suctions Tubes

Cannule per aspirazione

Cànulas aspiradoras

Canules aspiratrices

Makro
Macro

Ø 6 mm

Ø 6 mm

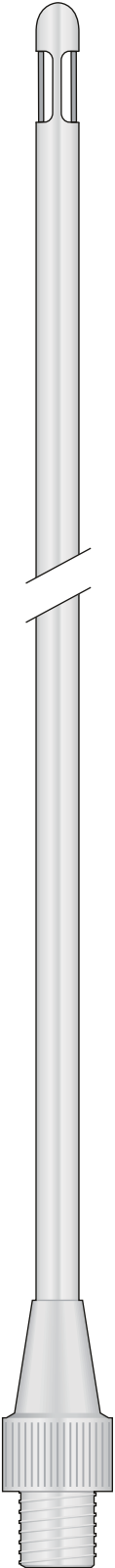

MERCEDES
0518-BLB
250 mm

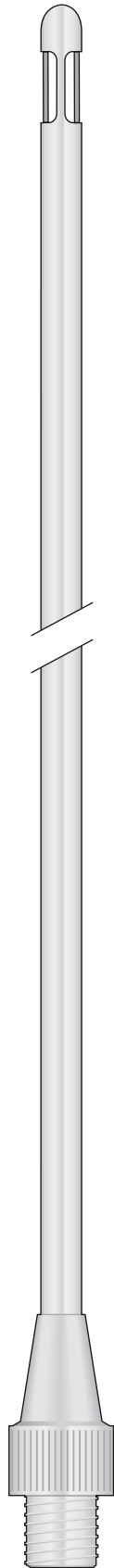

MERCEDES
0518-BLC
300 mm

3 Loch - 3 Openings
3 Fori - 3 Bucos - 3 Troues

Ø 3 mm

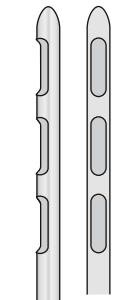

1/1

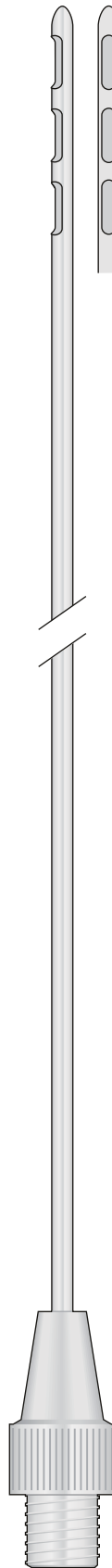

0518-IG
300 mm

Ø 3,0 mm

4,0 mm

6,0 mm

7,0 x 2,0 mm



0518-IH
300 mm

3 Loch - 3 Openings
3 Fori - 3 Bucos - 3 Troues

Ø 4,0 mm

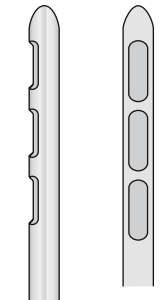

1/1

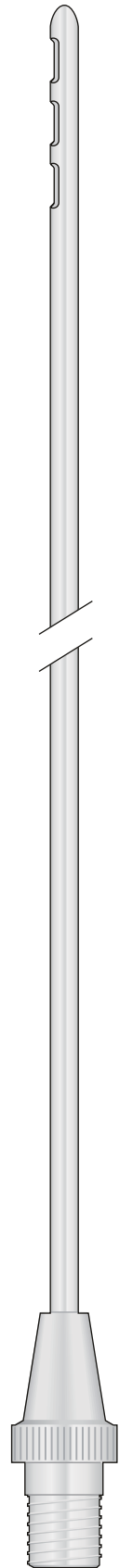

0518-BHL
300 mm

**Makro
Absaugkanülen**

**Macro
Suctions Tubes**

**Macro cannule
per aspirazione**

**Macro Cànulas
aspiradoras**

**Macro Canules
aspiratrices**

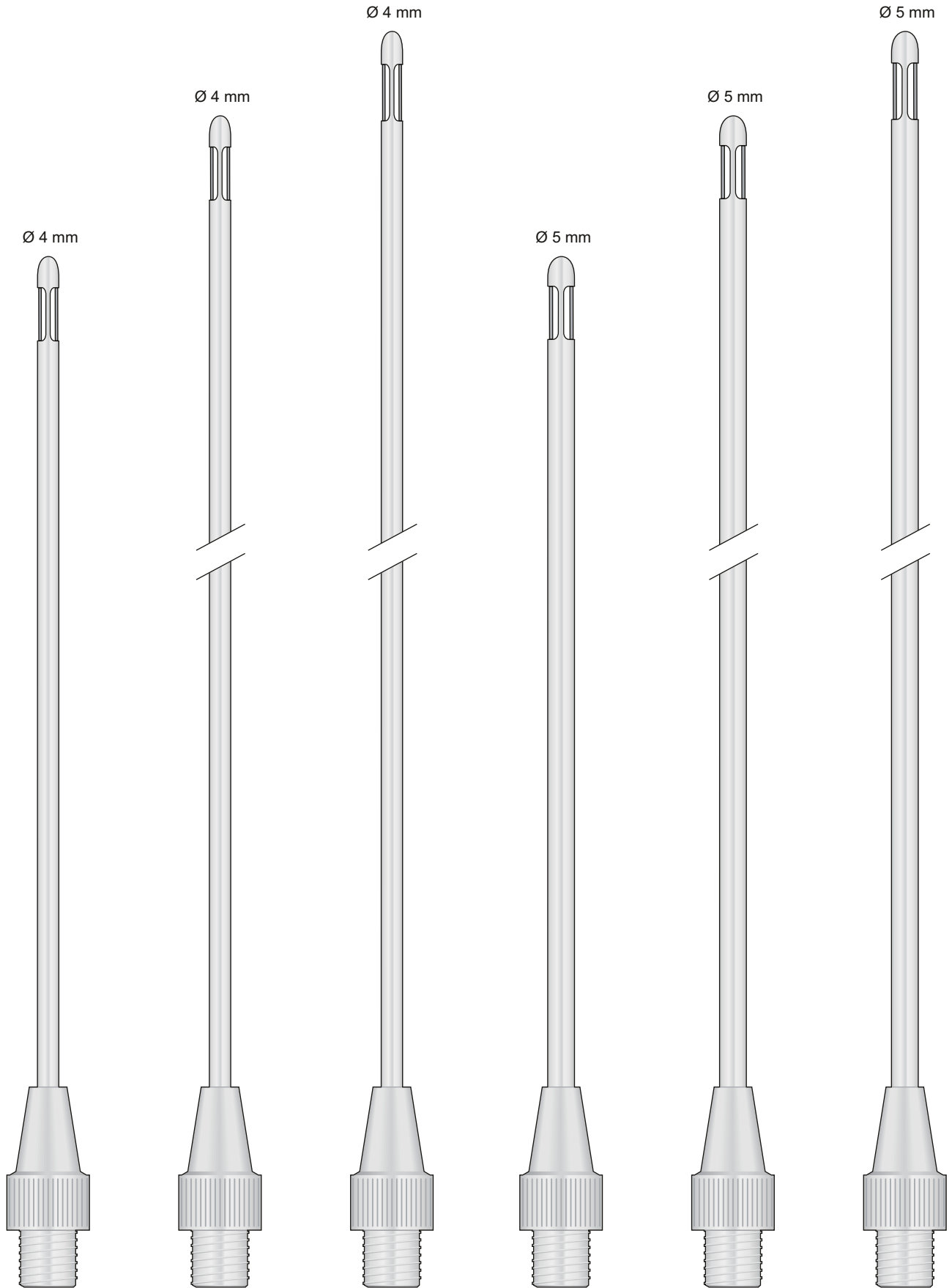

**MERCEDES
0518-BIF**
150 mm

**MERCEDES
0518-BIG**
250 mm

**MERCEDES
0518-BIH**
300 mm

**MERCEDES
0518-BII**
150 mm

**MERCEDES
0518-BIL**
250 mm

**MERCEDES
0518-BLA**
300 mm

**Makro
Absaugkanülen**

**Macro
Suctions Tubes**

**Macro cannule
per aspirazione**

**Macro Cánulas
aspiradoras**

**Macro Canules
aspiratrices**

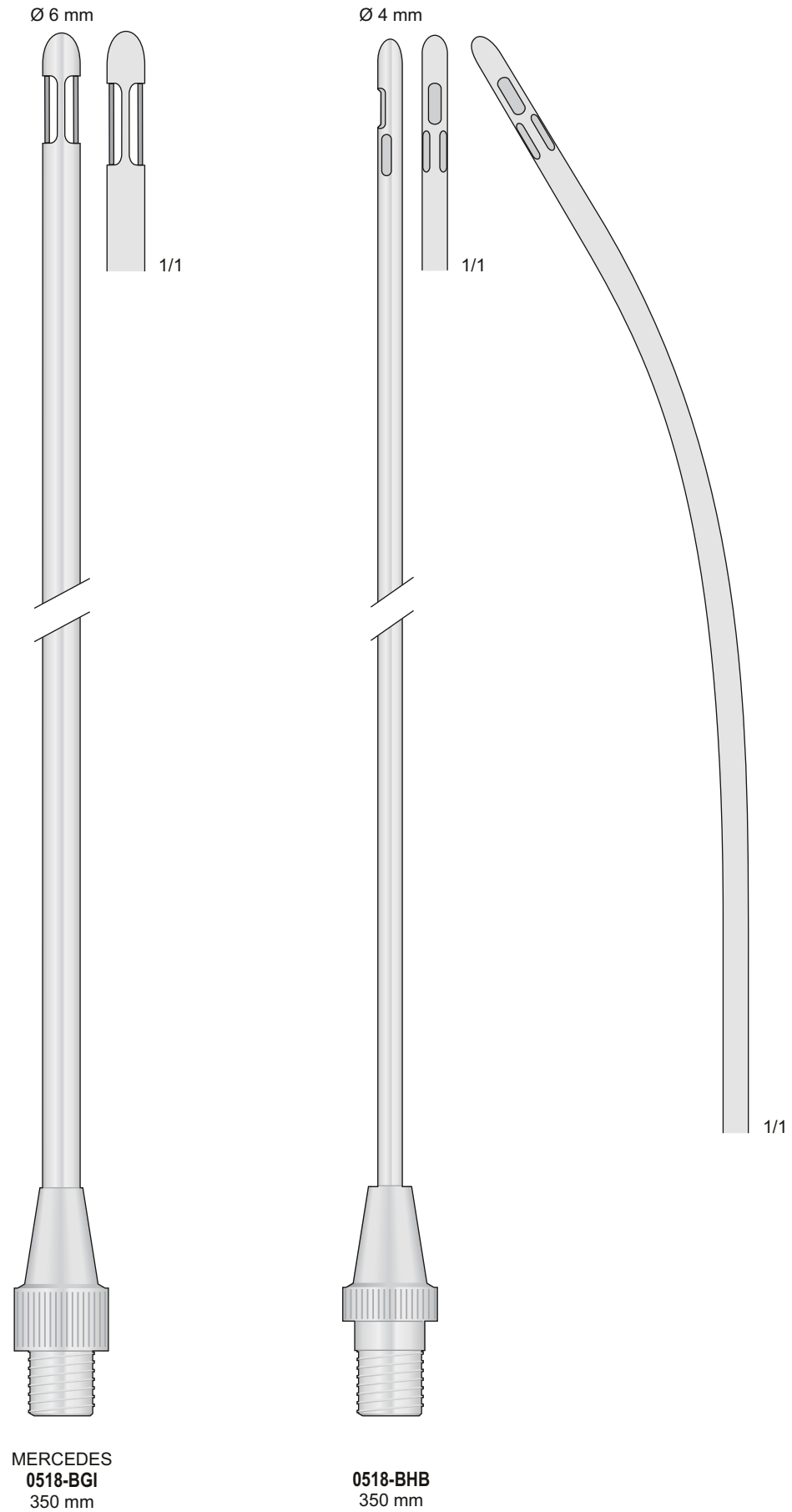

**Makro
Absaugkanülen**

**Macro
Suctions Tubes**

**Macro cannule
per aspirazione**

**Macro Cànulas
aspiradoras**

**Macro Canules
aspiratrices**

Absaugkanülen für Fettleibige - Needles and Tubes for obese patients
Aghi da infiltrazione per grandi obesi - Cànulas aspiradoras para obeso
Canules aspiratrices pour obèse

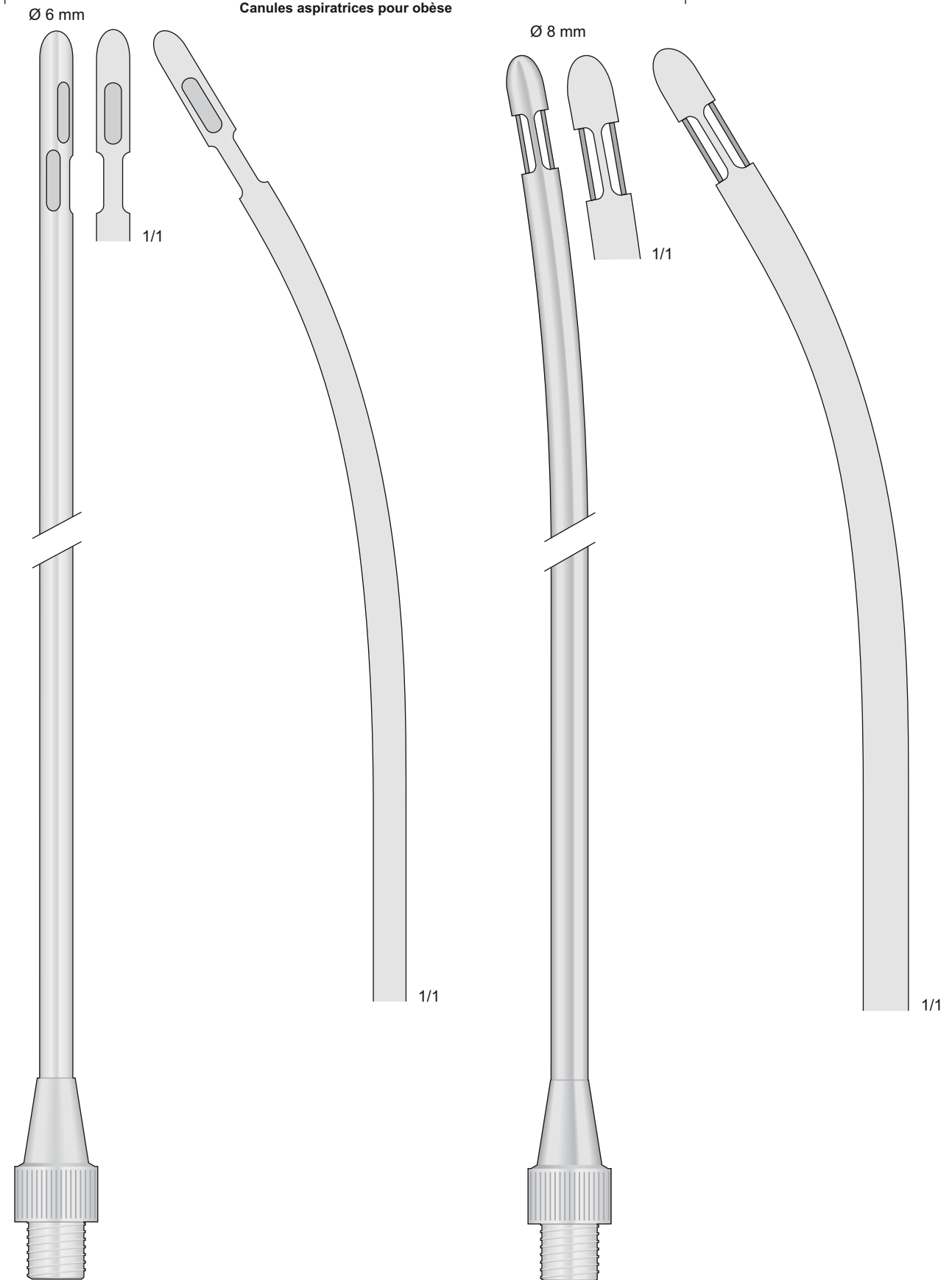

0518-BHC
350 mm

**MERCEDES
0518-BHD**
350 mm

Infiltration Kanüle

Infiltration Cannula

Cannule da infiltrazione

Cánulas de infiltración

Canules pour infiltration

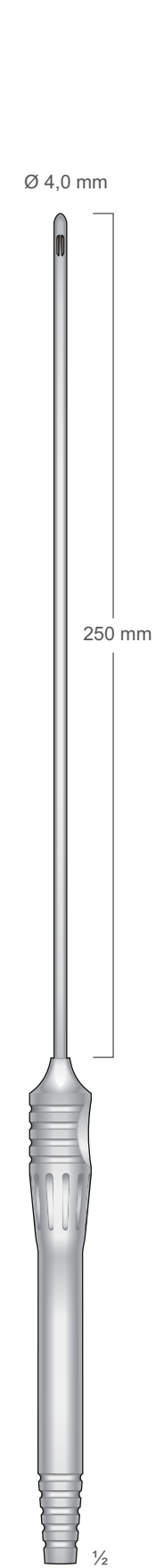

MERCEDES
0518-DHC
400 mm

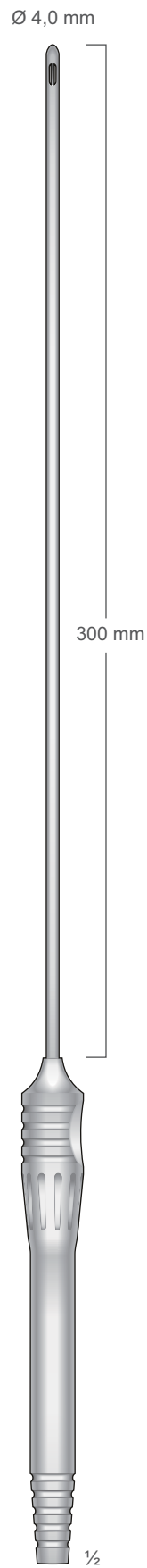

MERCEDES
0518-DHD
450 mm

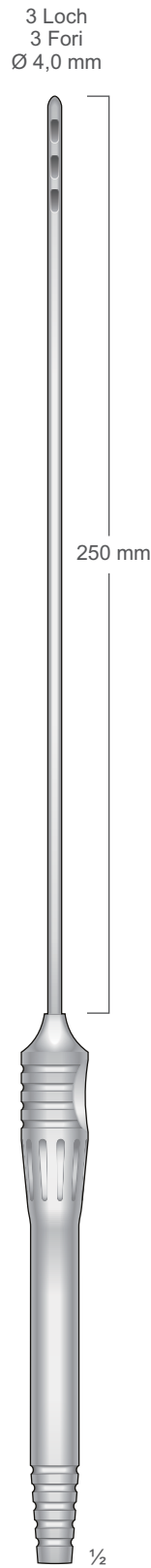

0518-DHE
400 mm

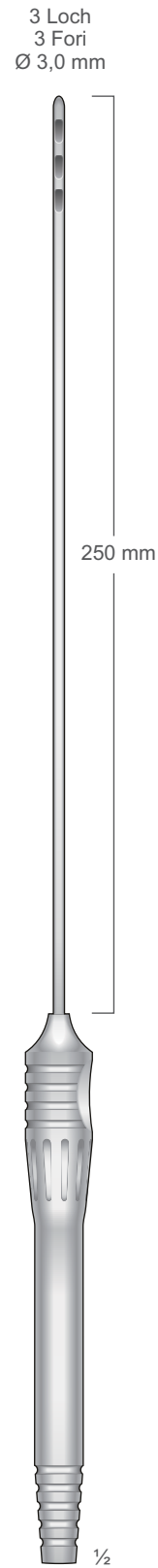

0518-DHE18
400 mm

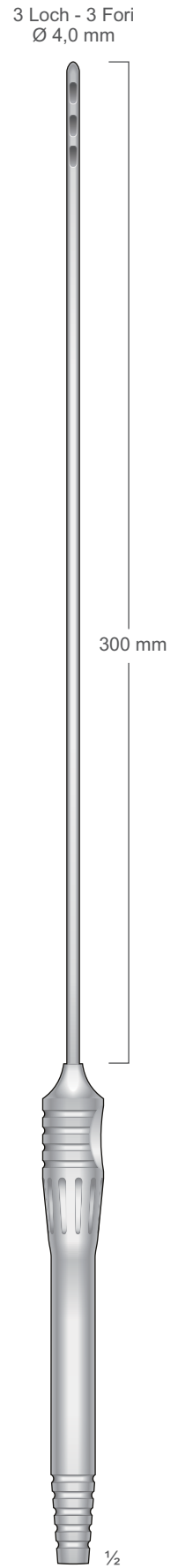

0518-DHF
450 mm

Kanülenreinigungs-
bürsten

Cleaning brush
for tubes

Scovolini per
pulizia cannule

Cepillo para
limpiar cánulas

Brosse de nettoyage
pour canules

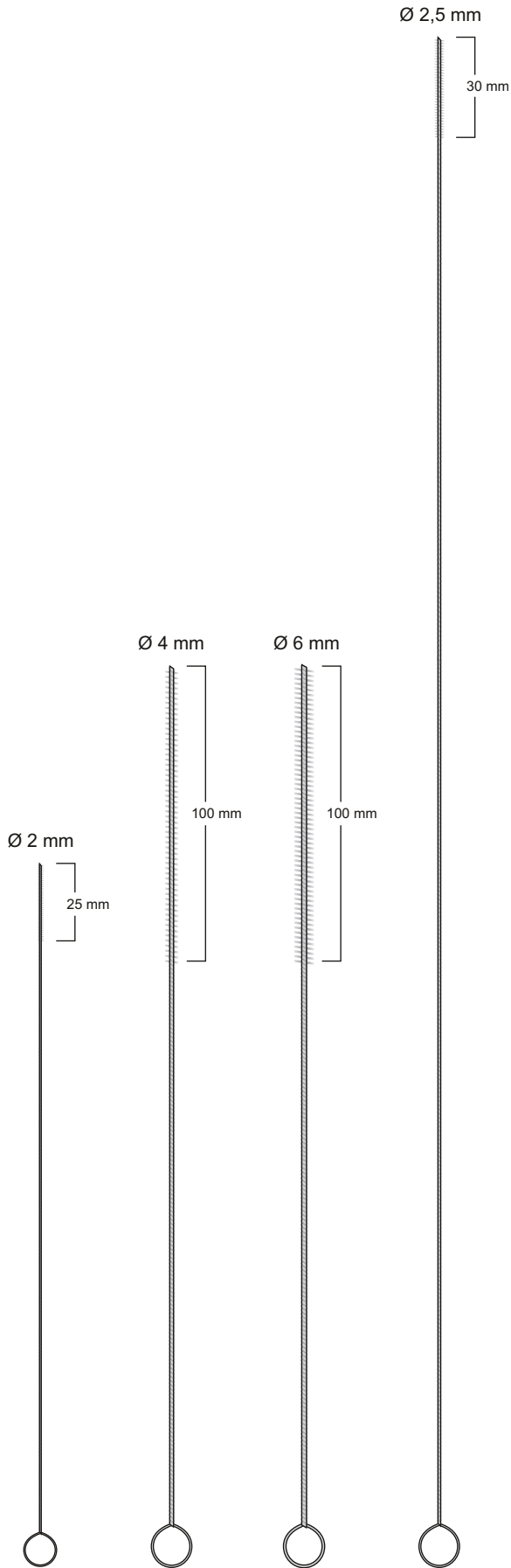

0706-BIC
215 mm

0706-BID
300 mm

0706-BIF
300 mm

0706-BIG
500 mm

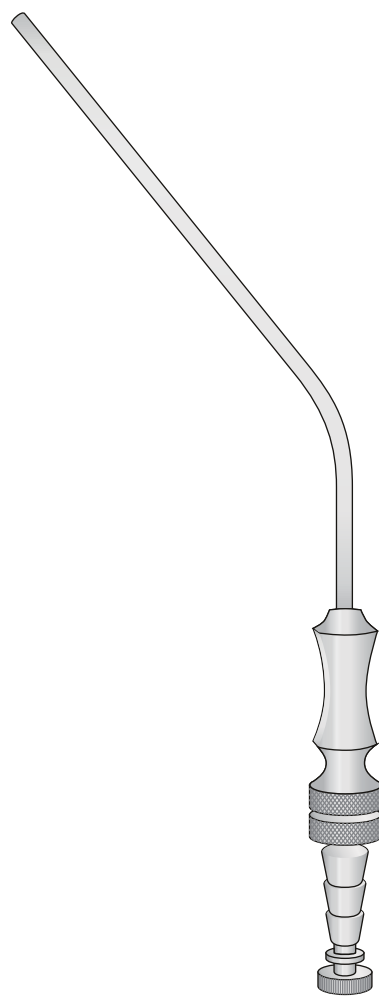

FRAZIER
0706-CEB02 Ch. 8 2,7 mm
0706-CEC02 Ch. 10 3,3 mm
180 mm

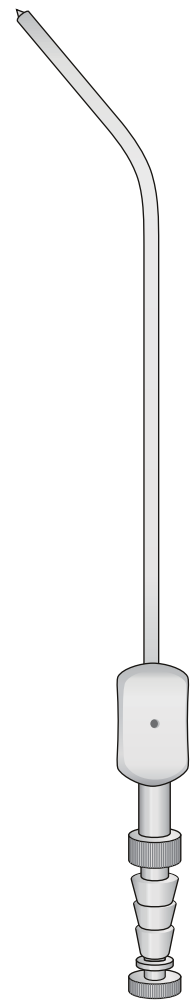

PLESTER
0706-BFB02 Ch. 8 2,7 mm
0706-BFC02 Ch. 10 3,3 mm
200 mm

new

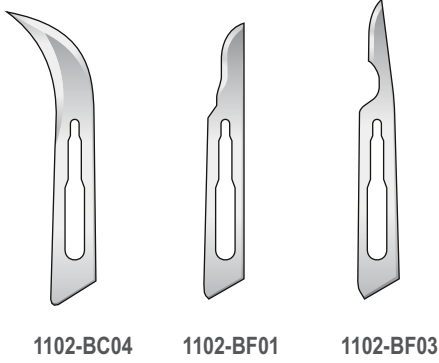

Pinza per unghie
Nail nipper
Nagelspaltzange
Pince à ongles
Pinzas corta uñas

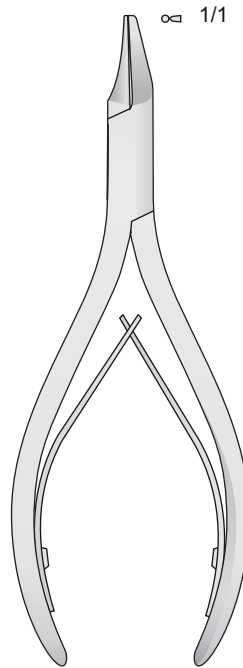

0415-AL
135 mm

2,5 x 1,4 mm 0,2 x 4,0 mm



0415-BAL
130 mm

Raspatorien, Dissektoren
Raspatories, Dissector
Raschiatori, Dissettori
Separadores
Rugines

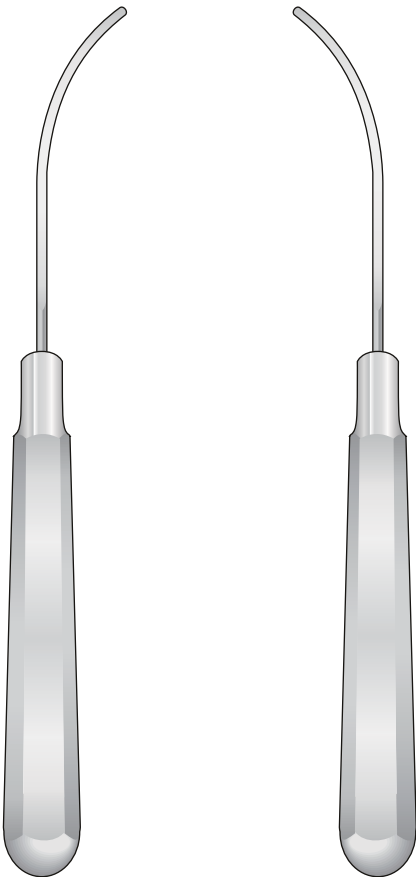

DINGMANN
0414-CGF
155 mm
1-L

DINGMANN
0414-CGG
155 mm
2-R

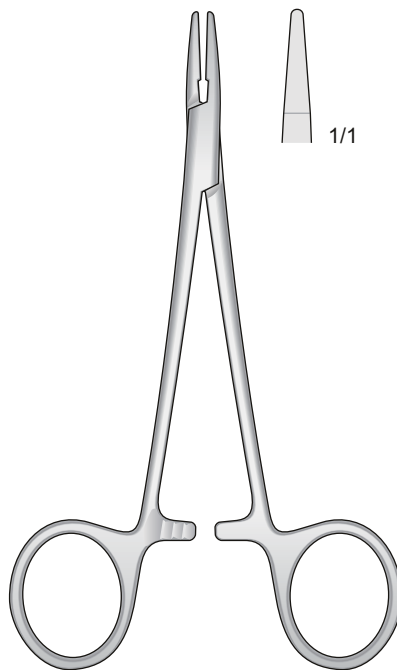

HALSEY
1508-DH
130 mm

Pinza per rimozione
punti metallici

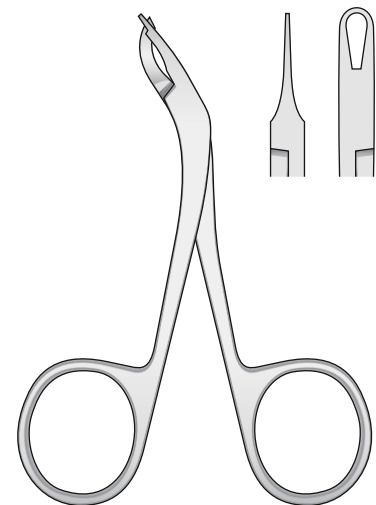
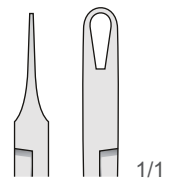

0206-GE
115 mm

Dermatome

Dermatomes

Dermatomi

Dermátomos

Dermatomes

Dermatome komplett mit 1 auswechselbarer Klinge und 2 Spannplatten
 Dermatome complete with 1 interchangeable blade and 2 skin plates
 Dermatomo a mano, con una lama intercambiabile, completo di 2 placche per stendere la pelle
 Dermatomo completo, con 1 hoja intercambiabile y 2 placas para extender la piel
 Dermatome avec 1 lame interchangeable et 2 plaques pour tendre la peau

Einstellbar von 0,1 bis 3,0 mm
 Adjustable from 0,1 to 3,0 mm
 Regolazione da 0,1 a 3,0 mm
 Regulable de 0,1 hasta 3,0 mm
 Réglable en épaisseur de 0,1 à 3,0 mm

Einstellbar von 0,1 bis 4,0 mm
 Adjustable from 0,1 to 4,0 mm
 Regolazione da 0,1 a 4,0 mm
 Regulable de 0,1 hasta 4,0 mm
 Réglable en épaisseur de 0,1 à 4,0 mm

Für handelsübliche Rasierklingen
 For usual razor blades
 Per lamette standard
 Para hojas de afeitar usuales
 Pour lames de rasoir modèle standard

Spanplatte
 Skin Fixing Plate
 Placca per stendere la pelle
 Placa para extender la piel
 Plaque pour tendre la peau



SCHINK
0405-BA

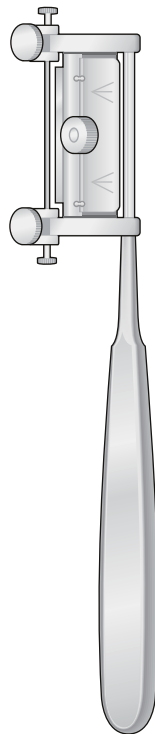

SILVER
0405-BB
190 mm

Ersatzklinge, allein
 Spare Blade only
 Lama di ricambio sola
 Hoja de repuesto
 Lame de rechange, seule



SILVER
0405-BC
43 mm

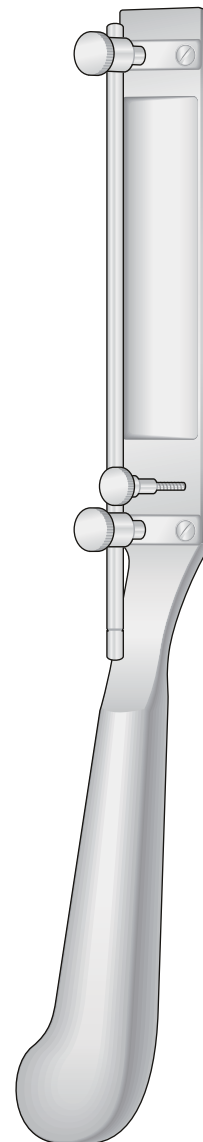

SCHINK
0405-BD
300 mm

Ersatzklinge, allein
 Spare Blade only
 Lama di ricambio sola
 Hoja de repuesto
 Lame de rechange, seule



SCHINK
0405-BE
102 mm

Dermatome

Dermatomes

Dermatomi

Dermátomos

Dermatomes

Dermatome komplett mit 1 auswechselbarer Klinge und 2 Spannplatten

Dermatome complete with 1 interchangeable blade and 2 skin plates

Dermatomo a mano, con una lama intercambiabile, completo di 2 placche per stendere la pelle

Dermatomo completo, con 1 hoja intercambiabile y 2 placas para extender la piel

Dermatome avec 1 lame interchangeable et 2 plaques pour tendre la peau

Einstellbar von 0,1 bis 1,5 mm
Adjustable from 0,1 to 1,5 mm
Regolazione da 0,1 a 1,5 mm
Regulable de 0,1 hasta 1,5 mm
Réglable en épaisseur de 0,1 à 1,5 mm

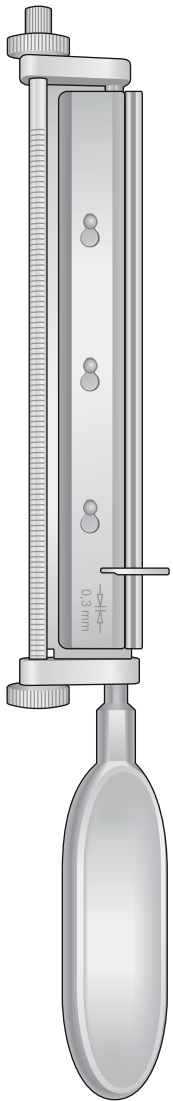

WATSON
0405-BF
300 mm

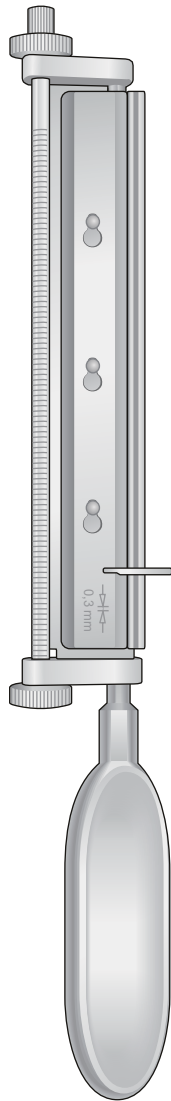

COBBETT
0405-BG
300 mm

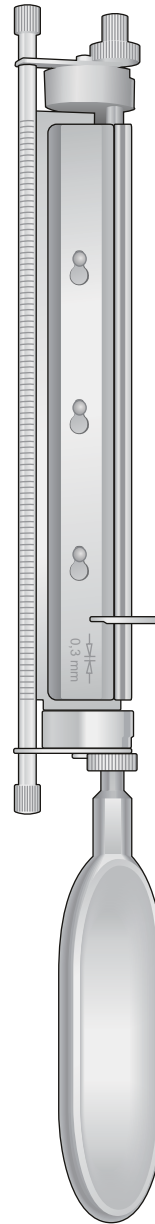

HUMBY
0405-BH
320 mm

Ersatzklinge, allein
Spare Blade only
Lama di ricambio sola
Hoja de repuesto
Lame de rechange, seule



HUMBY
0405-BI
157 mm

0518-BFA
 Komplettsset mit 3 Stück - Set complete with 3 pieces
 Set completo con 3 pezzi - Set completo con 3 piezas
 Set complete avec 3 pièces

0518-BFB + 0518-BFC + 0518-BFD

Ø 4.0 mm



Fig.1
1/1



0518-BFB
120 mm

Fig.2
1/1



0518-BFC
125 mm

Fig.3
1/1



0518-BFD
130 mm

Fig.4
1/1



0518-BFE
135 mm

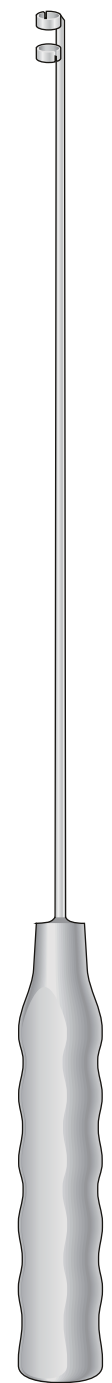

FISCHER 0614-CDF
310 mm

Original Arkansas



0402-LG
ARKANSAS n°8
100 x 50 x 13 mm

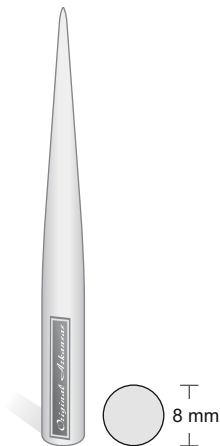

0402-CLL
ARKANSAS
conica n° 299
90 mm

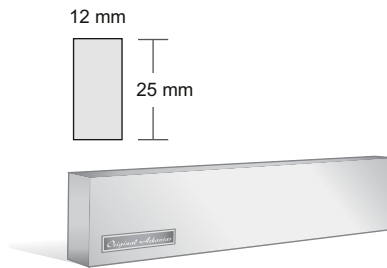

0402-E
ARKANSAS n°4
100 mm

Special Gummi für Metal
Special Rubber for Metal
Gomme speciali per metalli

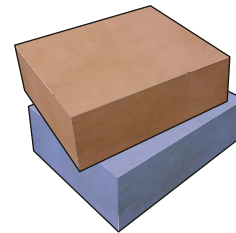

0402-AH **0402-AI**
50 x 40 x 20 mm 50 x 40 x 20 mm
Fein - Fine Größ - Large
Grana Fine Grana grossa
Finas - Fin Grande - Large

Instrumente-Reinigungsbürste
Brush for instruments
Spazzolino per pulizia strumenti
Cepillo para instrumentos
Brosse pour instruments



SCHARPENOIL
0402-1411
30 cc

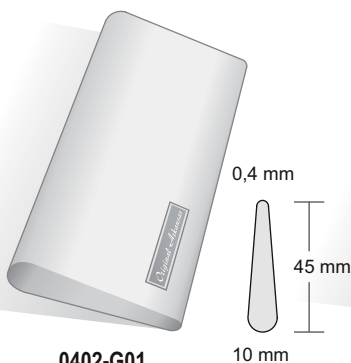

0402-G01
ARKANSAS n°6A
100 mm

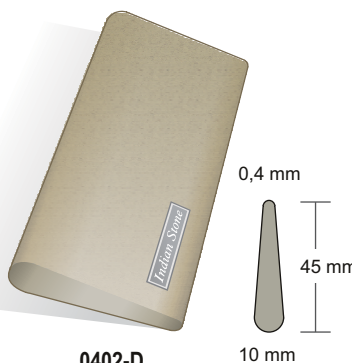

0402-D
INDIA n°6
100 mm

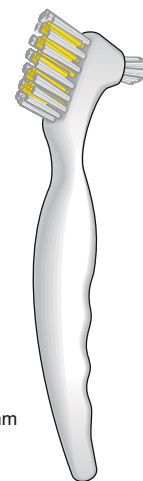

0402-BB
155 mm

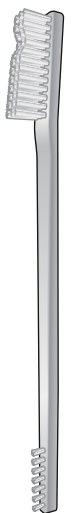

0402-BC
175 mm

**Steril
Container**

**Sterilizing
containers**

**Contenitori per
sterilizzare**

**Contenedores
para esterilización**

**Containers
pour stérilizer**



Kleinsetcontainer / Mini Container

Außen / outside / esterno
exterior / extérieur
300 x 140 x 40 mm

- 0319-FFF13
- 0319-FFG13
- 0319-FFH13
- 0319-FFI13
- 0319-FFL13

Innen / inside / interno
interior / intérieur
280 x 130 x 27 mm

Kleinsetcontainer / Mini Container

Außen / outside / esterno
exterior / extérieur
300 x 140 x 70 mm

- 0319-FGA13
- 0319-FGB13
- 0319-FGC13
- 0319-FGD13
- 0319-FGE13

Innen / inside / interno
interior / intérieur
280 x 130 x 55 mm

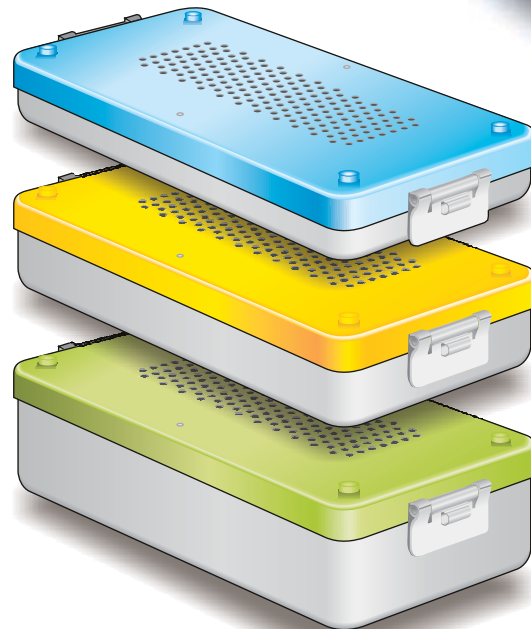

Kleinsetcontainer / Mini Container

Außen / outside / esterno
exterior / extérieur
300 x 140 x 100 mm

- 0319-FGF13
- 0319-FGG13
- 0319-FGH13
- 0319-FGI13
- 0319-FGL13

Innen / inside / interno
interior / intérieur
280 x 130 x 84 mm

1918-BAD

260 x 120 mm - 6 mm

Silikon Noppenmatten
Silicon Mats
Tappeti in aghi di silicone
Tapete en agujas de silicona
Tapis de silicone

Sterilisierbar
Autoclavable
Autoclavabili
Esterilizable
Stérilisable

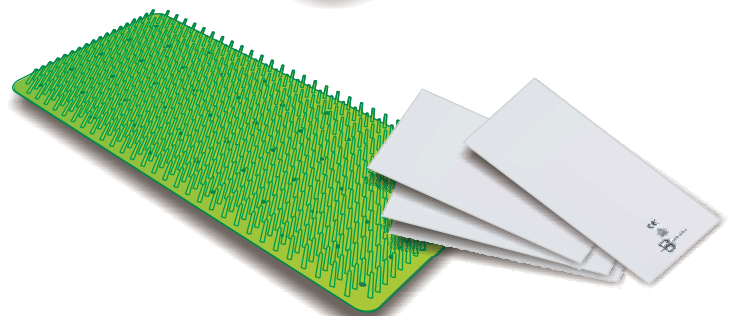

0319-GGA

94 x 215 mm - Box 1 pc.

Teflon Filter für 1200 Zyklen
Teflon Filter for 1200 cycles
Filtro in teflon per 1200 cicli
Filtro de teflón para 1200 ciclos
Filtre de téflon pour 1200 cycles

0319-GHA

Box 100 pc.

Kunststoff-Dichtungen
Plastic seals
Sigilli di plastica
Sellos de plástico
Scellés en plastique

0319-GHC

Box 100 pc.

Label Einweg
Disposable-Label
Etichetta monouso
Etiqueta desechables
Étiquettes jetables

0319-HAC

65 x 65 mm

Baumwolle Handtuch Verpackung
Cotton Towel Packaging
Telo in cotone per confezionamento
Embalaje de toallas de algodón
Emballage de serviettes de coton

Indice alfanumerico		Alfanumerical Index		Nummernverzeichnis		Index alfabétique		Indice alfanumerico	
Article	Page	Article	Page	Article	Page	Article	Page	Article	Page
0204-CFD	39	0219-DGC	27	0414-CCI	29				
0204-DEH	36	0219-DGD	27	0414-CCL	29				
0204-DEI	36	0219-DGE	27	0414-CDI	29				
0204-DEL	36	0219-DGF	27	0414-CDL	29				
0204-DFA	28	0219-DHA	27	0414-CFD	32				
0204-DFB	37	0219-FAB	8	0414-CFE	31				
0204-DFC	37	0219-FAC	8	0414-CFF	31				
0204-DFD	37	0219-FAD	8	0414-CFG	31				
0204-DFE	37	0219-FAE	8	0414-CGF	56				
0204-DFF	37	0219-FAF	9	0414-CGG	56				
0204-DFG	37	0219-FAG	9	0414-CGH	34				
0204-DFI	35	0219-FAH	8	0414-CGI	32				
0204-DFL	35	0219-FBA	9	0414-CGL	32				
0204-DGA	35	0219-FBB	11	0414-CHF	31				
0204-DGB	35			0414-CHG	31				
0204-DGC	35	0319-FFF	61	0414-CHH	31				
0204-DGD	35	0319-FFG	61	0414-CHI	31				
0204-DGE	36	0319-FFH	61	0414-CLH	31				
0204-DGF	36	0319-FFI	61	0414-CLI	31				
0204-DGG	36	0319-FFL	61	0414-DAA	34				
0204-DGH	36	0319-FGA	61	0414-DBG	34				
0204-DHA	38	0319-FGB	61	0414-DCA	32				
0204-DHB	38	0319-FGC	61	0414-DCB	32				
0204-DHC	38	0319-FGD	61	0414-DCC	32				
0204-DHD	38	0319-FGE	61	0414-EAB	19				
0204-DHE	39	0319-FGF	61	0414-EAB17	19				
0204-DHF	39	0319-FGG	61						
0204-DHG	39	0319-FGH	61	0415-AL	56				
0204-DHH	39	0319-FGI	61	0415-BAL	56				
0204-DIA	39	0319-FGL	61						
0204-DIB	39	0319-GGA	61	0518-AC	46				
0204-DIC	39	0319-GHA	61	0518-AD	46				
0204-DLH	40	0319-GHC	61	0518-AE	46				
0204-DLI	40	0319-HAC	61	0518-AF12	45				
0204-DLL	40			0518-AF18	45				
0204-EAA	40	0402-AH	60	0518-AF1811	45				
0204-EAF	40	0402-AI	60	0518-BH	13				
0204-EAG	40	0402-D	60	0518-BI	13				
0204-EAH	40	0402-E	60	0518-BL	13				
0204-EAI	40	0402-G01	60	0518-BI18	13				
0204-EAL	40	0402-BB	60	0518-BL18	13				
0204-EBA	40	0402-BC	60	0518-CA18	13				
0204-EBF	40	0402-LG	60	0518-CA	13				
0204-EBG	40	0402-BAB25	25	0518-CL	46				
0204-EBH	40	0402-BBI	25	0518-ED	45				
0204-EBI	40	0402-BBL	25	0518-IG	50				
0204-EBL	40	0402-CLL	60	0518-IH	50				
0204-ECA	40	0402-1411	60	0518-BBA	28				
0204-ECF	41			0518-BDA	19				
0204-ECG	41	0405-BA	57	0518-BDB	14				
0204-ECH	41	0405-BB	57	0518-BDC	14				
0204-ECI	41	0405-BC	57	0518-BDD	14				
0204-EDF	41	0405-BD	57	0518-BDE	14				
0204-EDG	41	0405-BE	57	0518-BDF	14				
0204-EDH	41	0405-BF	58	0518-BDG	14				
0204-EDI	41	0405-BG	58	0518-BDH	14				
0204-EEA	41	0405-BH	58	0518-BDI	14				
0204-EEB	41	0405-BI	58	0518-BDL	14				
0204-EEF	41			0518-BEE	16				
0204-EEG	41	0414-BBA	34	0518-BEF	11				
		0414-BBD	30	0518-BEF12	11				
0206-GE	56	0414-BBE	30	0518-BEG	12				
		0414-BBF	30	0518-BEH	12				
0219-CB	28	0414-BBG	30	0518-BEI	12				
0219-FD	27	0414-BDF	30	0518-BEL	16				
0219-FI	27	0414-CAH	16	0518-BFA	51				
0219-FL	27	0414-CAI	33	0518-BFB	59				
0219-BDI	28	0414-CAL	33	0518-BFC	59				
0219-BEL	27	0414-CBA	33	0518-BFD	59				
0219-BFA	27	0414-CBL	29	0518-BFE	59				

Indice alfanumerico		Alfanumerical Index		Nummernverzeichnis		Index alphabétique		Indice alfanumerico	
Article	Page	Article	Page	Article	Page	Article	Page	Article	Page
0518-BGD	16	0518-DGA	48	0706-BFB02	55				
0518-BGE	13	0518-DGB	48	0706-BFC02	55				
0518-BGF	13	0518-DGC	48	0706-BIC	55				
0518-BGI	52	0518-DGD	48	0706-BID	55				
0518-BGL	45	0518-DHC	54	0706-BIF	55				
0518-BHA	45	0518-DHD	54	0706-BIG	55				
0518-BHB	52	0518-DHE	54	0706-CEB02	55				
0518-BHC	53	0518-DHE18	54	0706-CEC02	55				
0518-BHD	53	0518-DHF	54						
0518-BHL	50	0518-EAB	45	0819-BDB10	10				
0518-BIA	49	0518-EAC	45	0819-BDE10	10				
0518-BIB	49	0518-EBB	45	0819-BIA23	10				
0518-BIC	49	0518-EBL	44	0819-CFA18	10				
0518-BID	49	0518-ECA	44	0819-110504	10				
0518-BIE	49	0518-ECB	44						
0518-BIF	51	0518-ECC	44	1102-BC04	56				
0518-BIG	51	0518-ECD	44	1102-BF01	56				
0518-BIH	51	0518-ECE	44	1102-BF03	56				
0518-BII	51	0518-EFA	44						
0518-BIL	51			1310-EAA	18				
0518-BLA	51	0602-BBL	44						
0518-BLB	50			1412-AL	28				
0518-BLC	50	0607-BCB	7	1412-BAG	24				
0518-CBB	15	0607-BGD	4	1412-BAH	24				
0518-CBC	15	0607-BLC	6	1412-BAI	24				
0518-CBD	15	0607-BLD	6	1412-BAI12	24				
0518-CBF	15	0607-BLE	6	1412-BAL	24				
0518-CBG	15	0607-BLF	6	1412-BLA	20				
0518-CBH	15			1412-BLB	20				
0518-CBL	16	0611-BL	29	1412-BLC	20				
0518-CCB	28	0611-BCL	33	1412-BLC11	20				
0518-DAB	46	0611-BDH	34	1412-BLD	21				
0518-DAC	46	0611-EBD	29	1412-BLE	21				
0518-DAD	46	0611-EBE	29	1412-BLF	21				
0518-DAG	46	0611-EBF	29	1412-BLF11	21				
0518-DBB	42	0611-EBG	29	1412-BLG	22				
0518-DBC	42			1412-BLH	22				
0518-DBD	42	0612-BAA11	3	1412-BLI	22				
0518-DBE	42	0612-DAA19	3	1412-CDA	17				
0518-DBF	42	0612-DAB19	3	1412-CDB	17				
0518-DBG	42	0612-DAC	4	1412-CEA	23				
0518-DBH	43	0612-DAE	4	1412-CEB	23				
0518-DBI	43	0612-DAI	4	1412-CEC	23				
0518-DBL	43	0612-DBD	3	1412-CED	23				
0518-DCA	43	0612-DBD07	5						
0518-DCB	43	0612-DBE07	5	1508-DH	56				
0518-DCC	43	0612-DBI	4						
0518-DCD	43	0612-DBL	4	1705-AB	8, 19				
0518-DDB	47	0612-DDC	4	1705-AC	8, 19				
0518-DDL	47	0612-DDC07	5	1705-AD	8, 19				
0518-DEA	47	0612-DDD	4	1705-BA	8, 19				
0518-DEB	47	0612-DDD07	5						
0518-DEC	47	0612-EAA	18	1803-D	7				
0518-DED	47	0612-EAB	18						
0518-DEE	48			1804-FA	46				
0518-DEF	48	0614-LF	7						
0518-DEG	48	0614-BLA	7						
0518-DEH	48	0614-CDF	44						
0518-DEI	48	0614-DFA	25						
0518-DEL	48	0614-DHA	26						
0518-DFA	48	0614-DHB	26						
0518-DFB	48	0614-DHC	26						
0518-DFC	48	0614-DLA	26						
0518-DFD	48	0614-DLB	26						
0518-DFE	48	0614-DLC	26						
0518-DFF	48	0614-DLH	26						
0518-DFG	48								
0518-DFH	48	0617-DE	29						
0518-DFI	48	0617-BLA	28						
0518-DFL	48								



ideal-tek
manufacturer & supplier of precision instruments 

Ideal-tek SA
via Motta 4
6828 Balerna
Switzerland

Phone: +41 91 683 32 29
Fax: +41 91 683 03 71
E-mail: info@ideal-tek.com