



ideal-tek
manufacturer & supplier of precision instruments +



traumatología, ortopedia

traumatologie, orthopädie

traumatologie, orthopädie
traumatology, orthopaedics



Orthopädie
Bone Surgery
Traumatologia
Traumatologia
Traumatologie

Wundhaken

Retractors

Divaricatori

Separadores

Ecarteurs

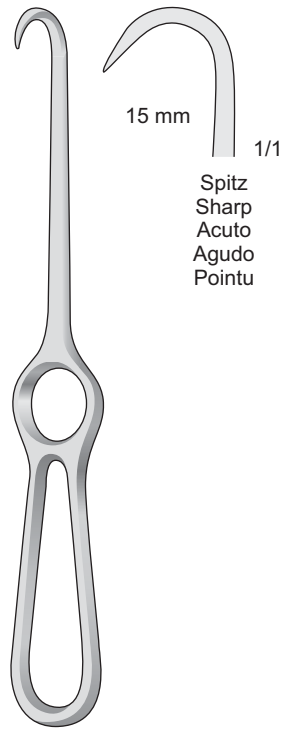

KOCHER
0219-BDL
205 mm

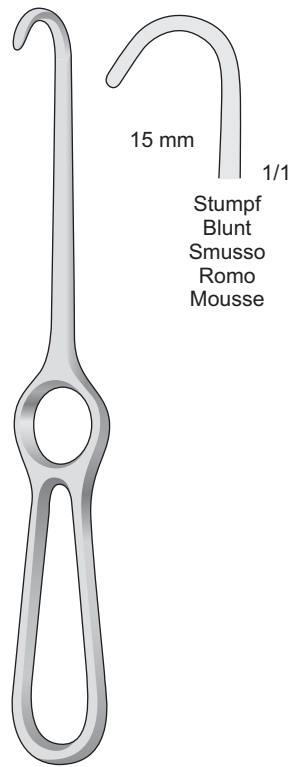

KOCHER
0219-BEA
220 mm

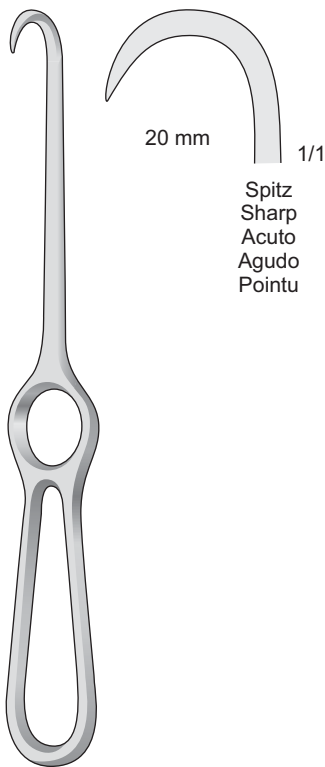

VOLKMANN
0219-BCG
220 mm

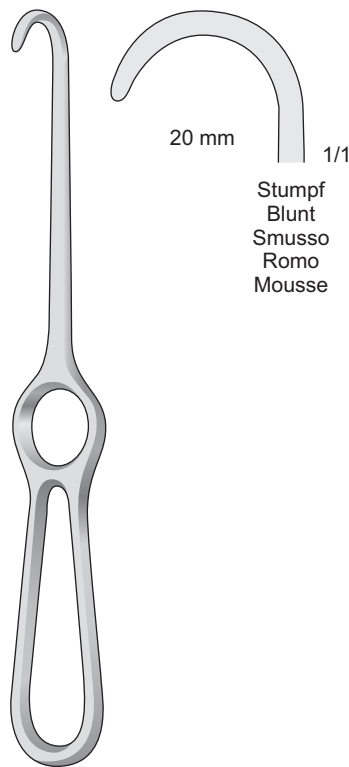

VOLKMANN
0219-BCH
220 mm

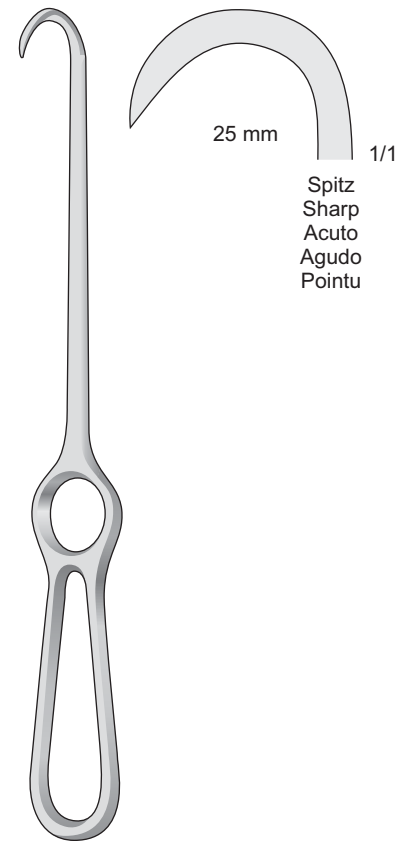

0219-BCI
245 mm

Wundhaken

Retractors

Divaricatori

Separadores

Ecarteurs

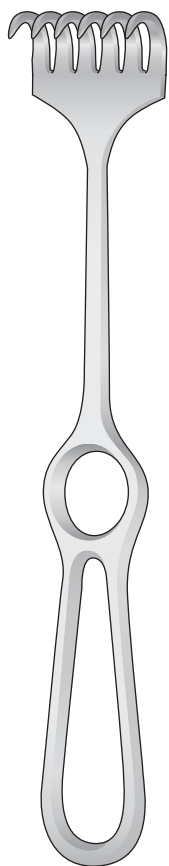

VOLKMANN
0219-BAB/0219-BAI
220 mm

Spitz
Sharp
Acuto
Agudo
Pointu

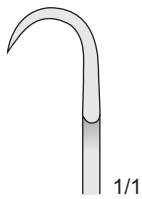

0219-BAB
9 x 8 mm



0219-BAD
9 x 13 mm



0219-BAF
9 x 19 mm

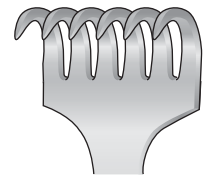

0219-BAH
9 x 29 mm

Stumpf
Blunt
Smusso
Romo
Mousse

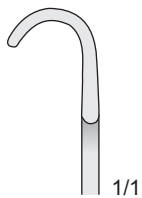

0219-BAC
9 x 8 mm



0219-BAE
9 x 13 mm



0219-BAG
9 x 19 mm

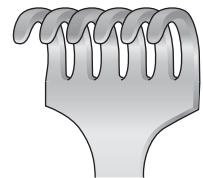

0219-BAI
9 x 29 mm

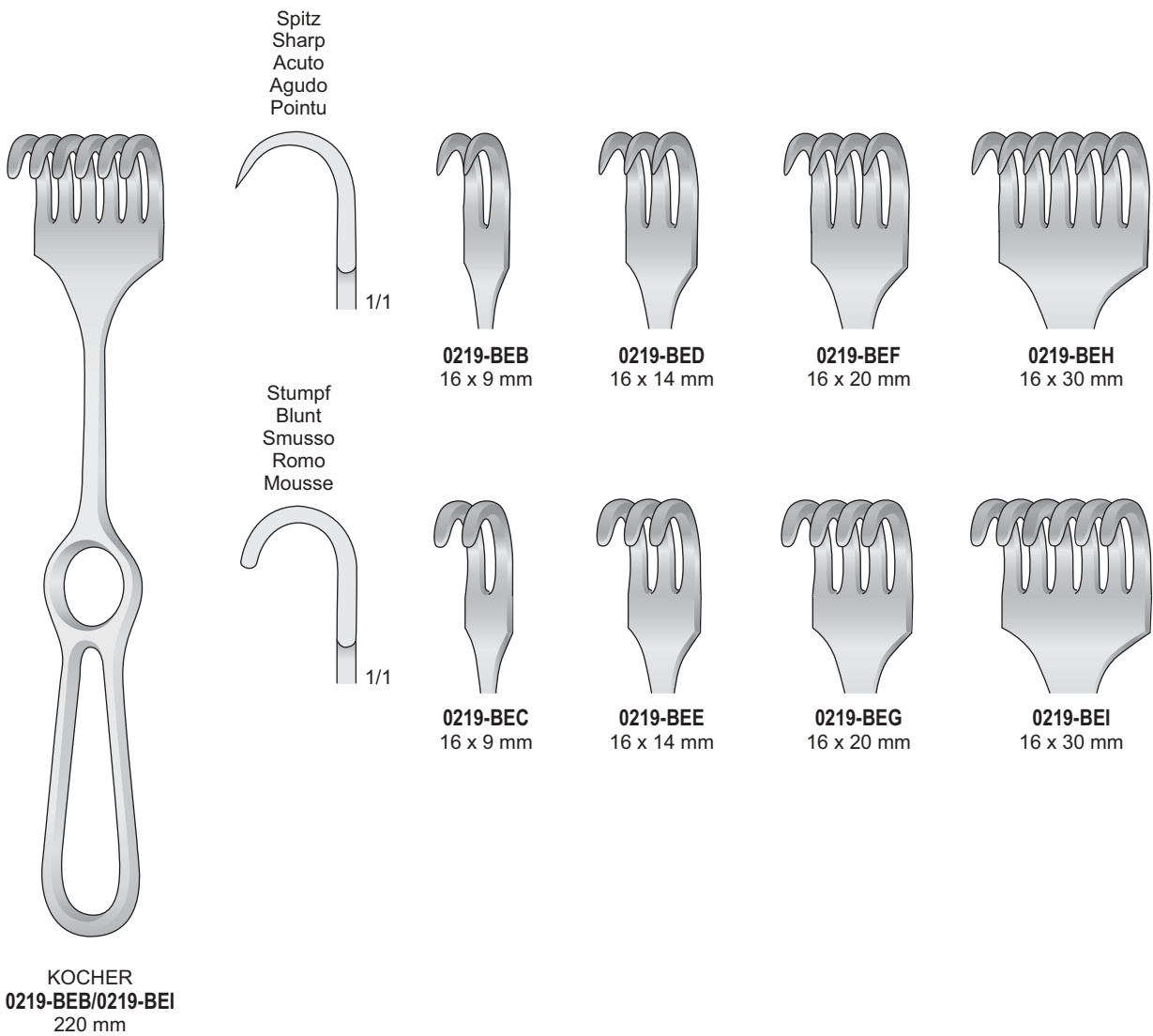

Wundhaken

Retractors

Divaricatori

Separadores

Ecarteurs

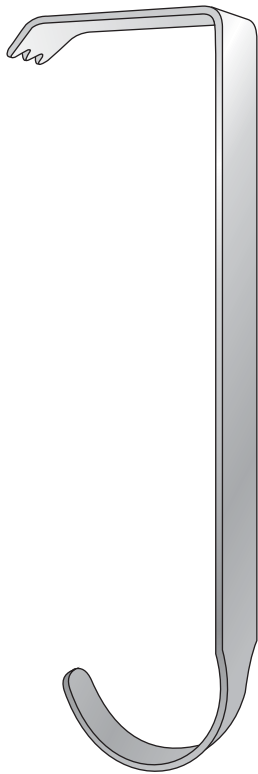

HIBBS
0219-CD/0219-CE
240 mm



1/1

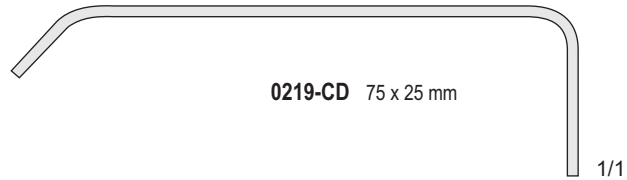

0219-CD 75 x 25 mm

1/1

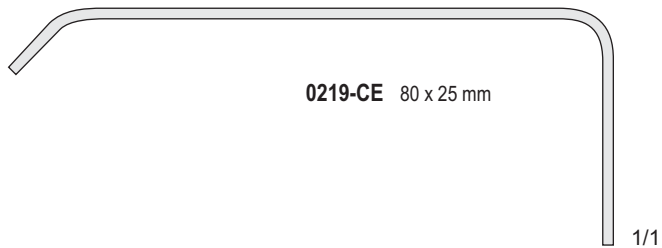

0219-CE 80 x 25 mm

1/1

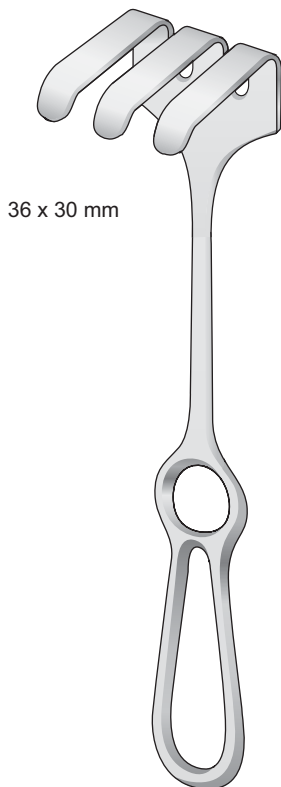

36 x 30 mm

OLLIER
0219-BCE
225 mm

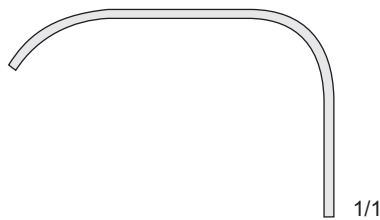

1/1

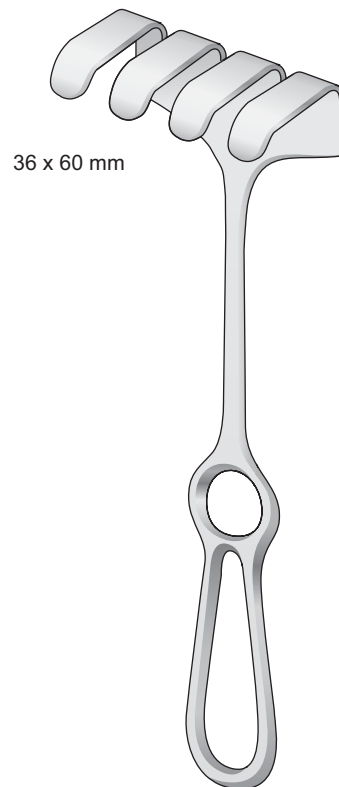

36 x 60 mm

OLLIER
0219-BCF
225 mm

40 x 40 mm

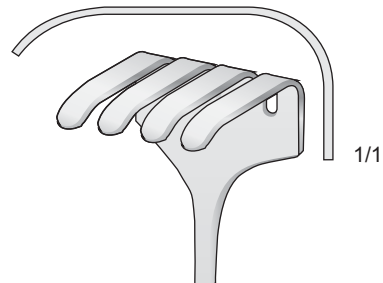

0219-BCA

45 x 50 mm

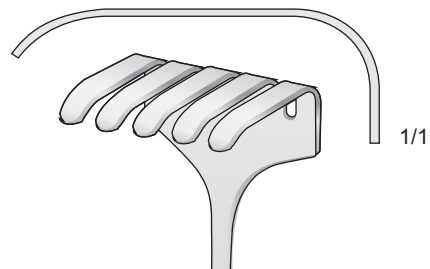

0219-BCB

50 x 60 mm

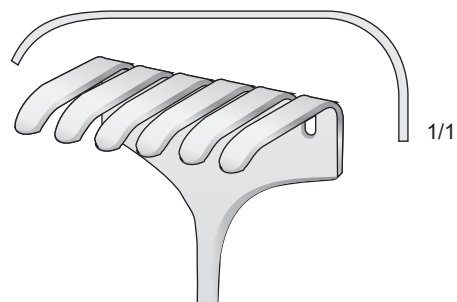

0219-BCC

70 x 70 mm

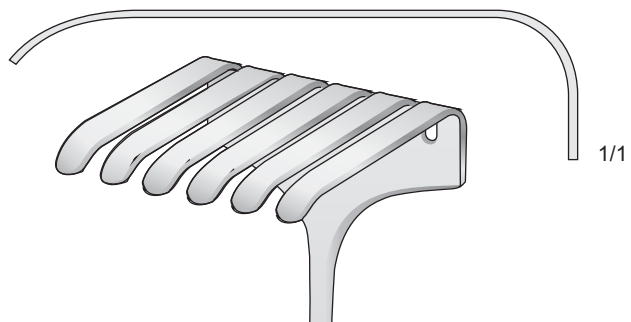

0219-BCD

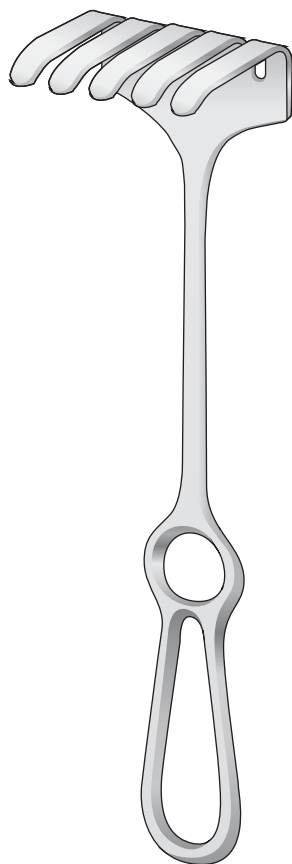

ISRAEL
0219-BCA/0219-BCD
250 mm

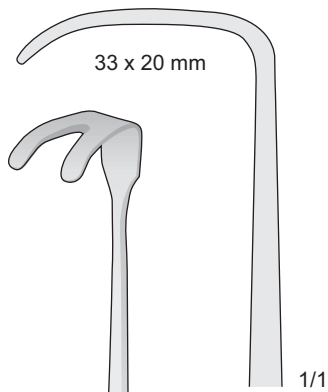

WASSMUND
0219-GL
220 mm

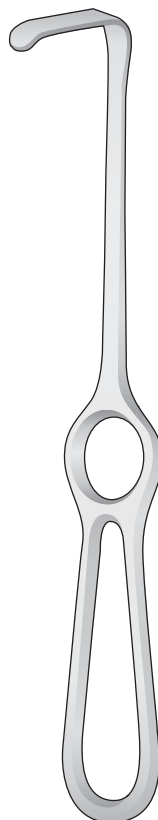

LANGENBECK
0219-DD/0219-ED
210 mm

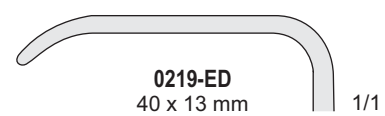
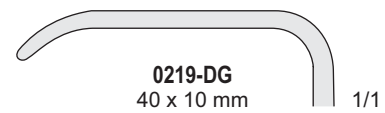
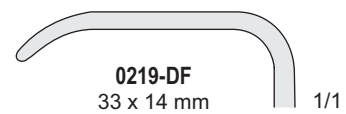
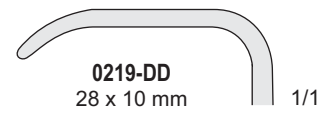

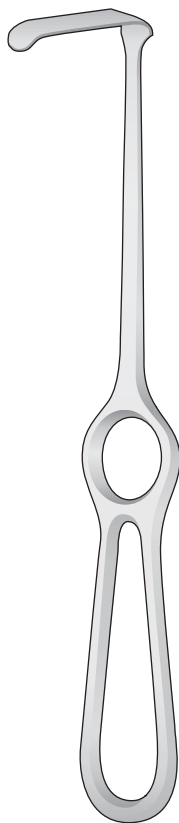

KOCHER-LANGENBECK
0219-GA/0219-CGD
215 mm

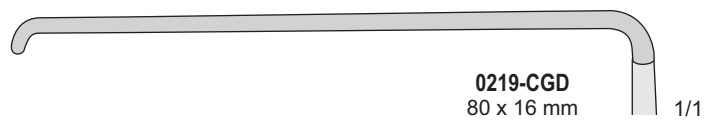
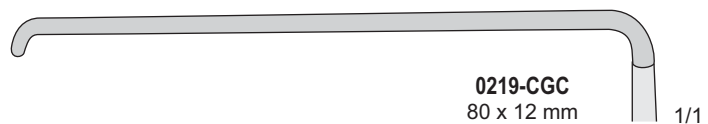
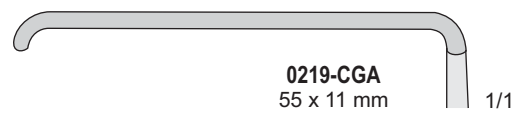
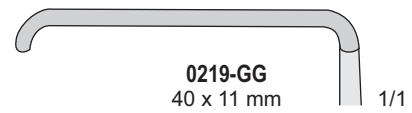
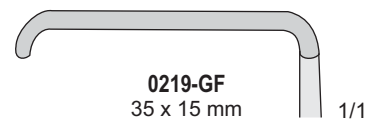
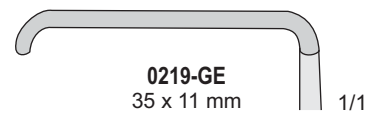
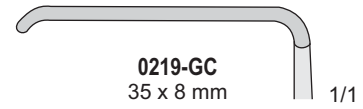
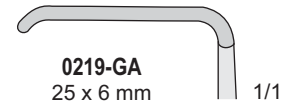

Wundhaken

Retractors

Divaricatori

Separadores

Ecarteurs

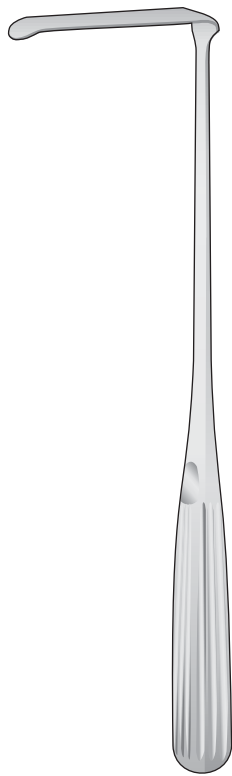

SAUERBRUCH
0219-BBA/0219-BBC
225 mm

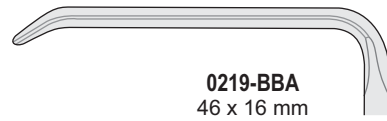

0219-BBA
46 x 16 mm 1/1

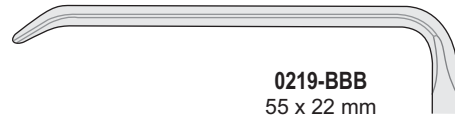

0219-BBB
55 x 22 mm 1/1

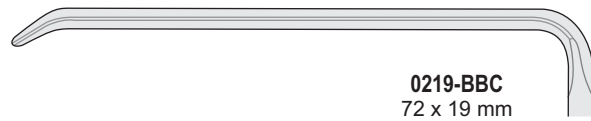

0219-BBC
72 x 19 mm 1/1

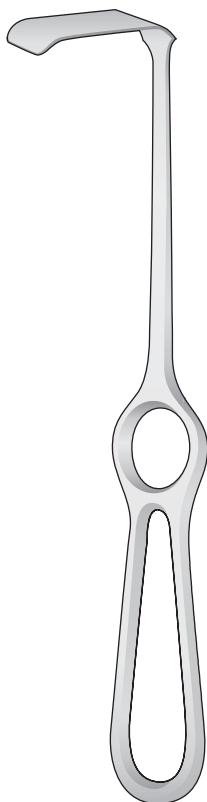

KOCHER
0219-CFA/0219-CFE
230 mm

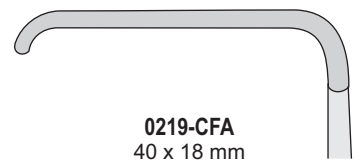

0219-CFA
40 x 18 mm 1/1

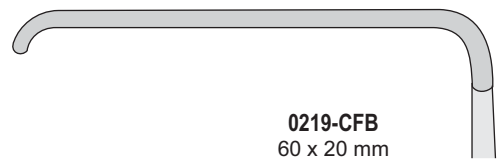

0219-CFB
60 x 20 mm 1/1

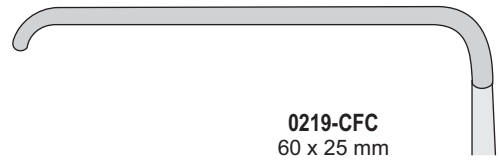

0219-CFC
60 x 25 mm 1/1

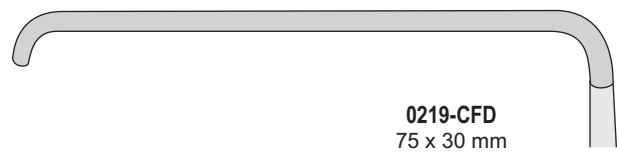

0219-CFD
75 x 30 mm 1/1

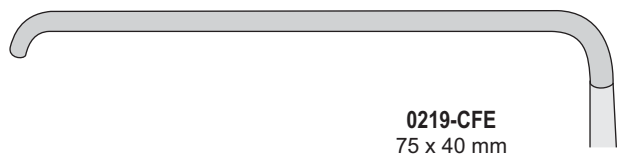

0219-CFE
75 x 40 mm 1/1

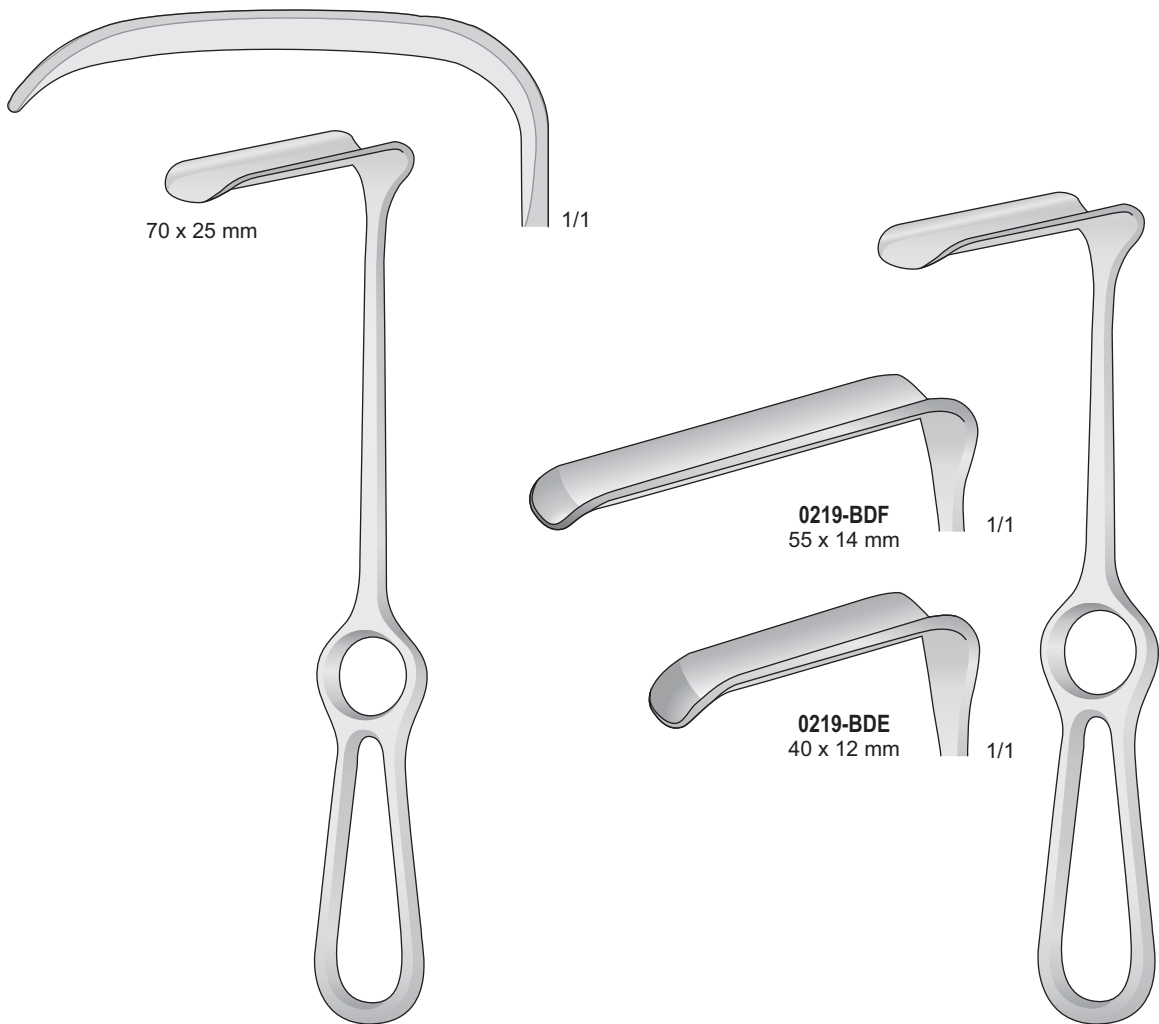

KOCHER
0219-BDH
240 mm

DOCKHORN
0219-BDE/0219-BDF
210 mm

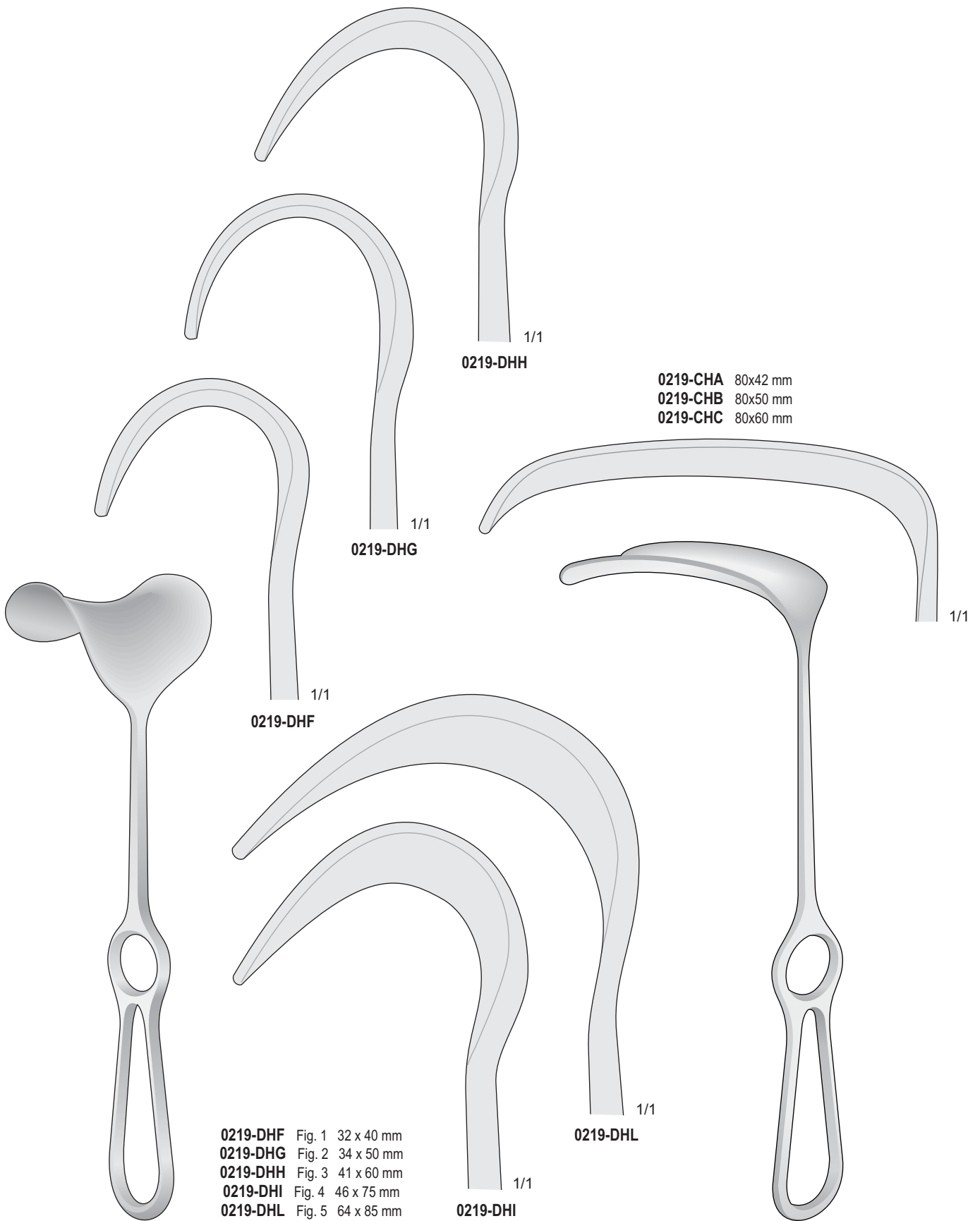

0219-CHA 80x42 mm
 0219-CHB 80x50 mm
 0219-CHC 80x60 mm

0219-DHF Fig. 1 32 x 40 mm
 0219-DHG Fig. 2 34 x 50 mm
 0219-DHH Fig. 3 41 x 60 mm
 0219-DHI Fig. 4 46 x 75 mm
 0219-DHL Fig. 5 64 x 85 mm

FRITSCH
 0219-DHF/0219-DHL
 240 mm

KOCHER
 0219-CHA/0219-CHC
 250 mm

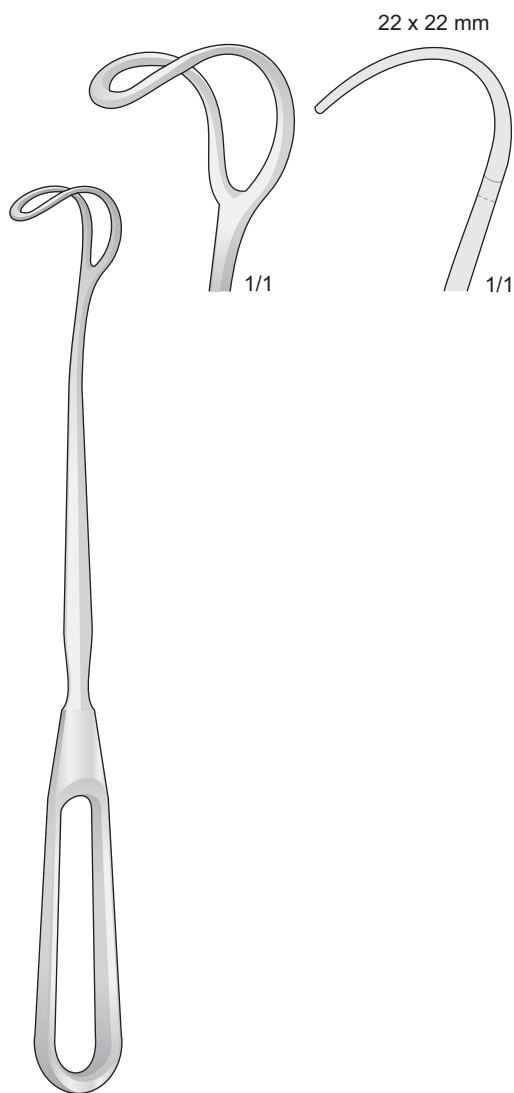

GREENE
0219-BDB
225 mm

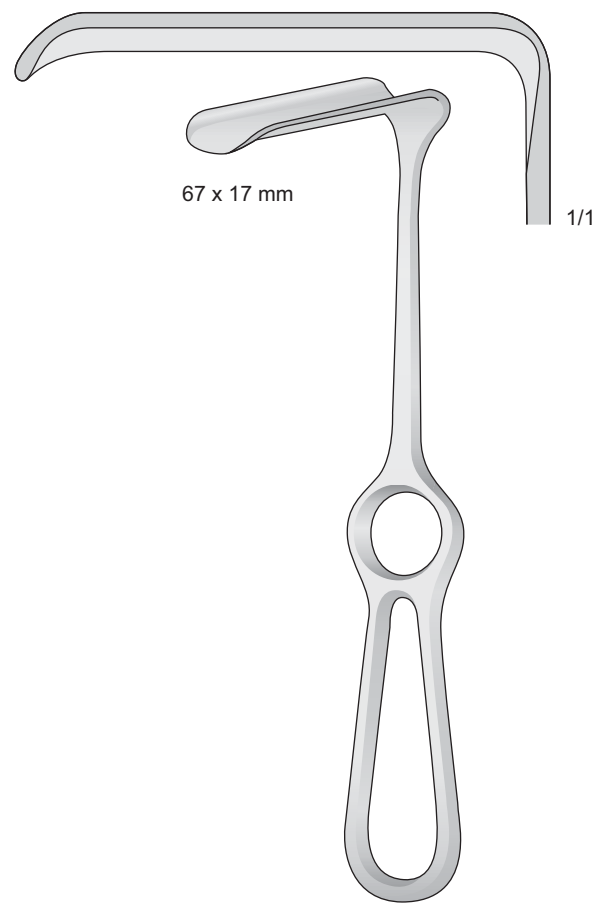

CASPAR
0219-BDG
210 mm

Wundhaken

Retractors

Divaricatori

Separadores

Ecarteurs

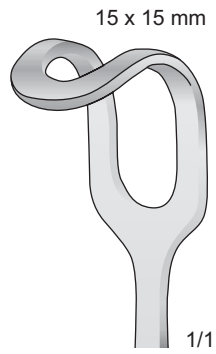

0219-IA
225 mm

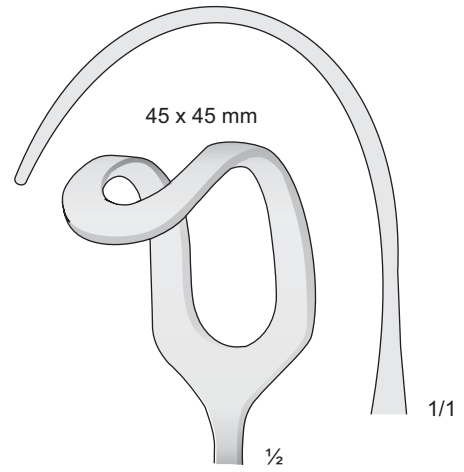

0219-BIA
255 mm

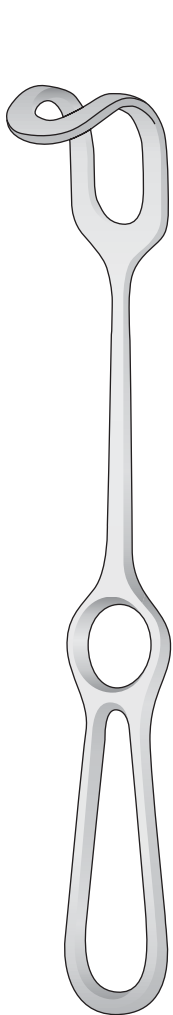

20 x 22 mm

0219-IB
225 mm

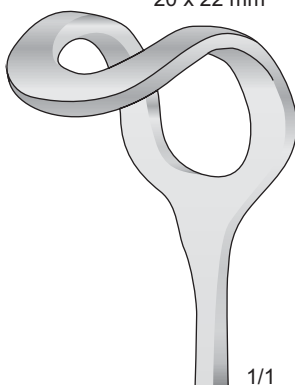

28 x 28 mm

0219-IC
225 mm

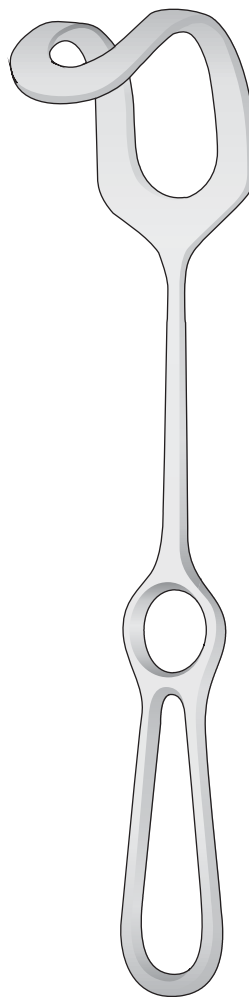

45 x 50 mm

0219-BIB
255 mm

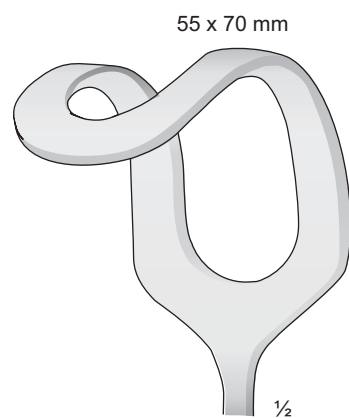

55 x 70 mm

0219-BIC
255 mm

MIDDELDORPF
0219-IA/0219-IC
225 mm

MIDDELDORPF
0219-BIA/0219-BIC
255 mm

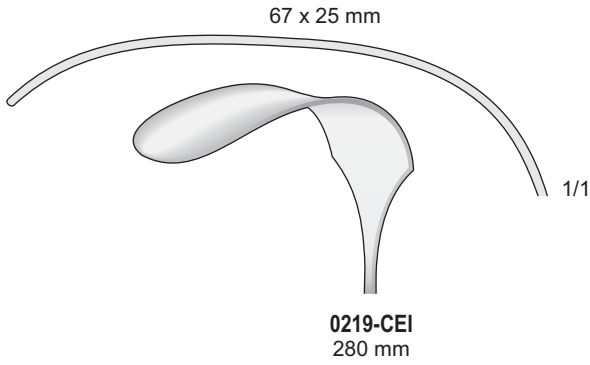
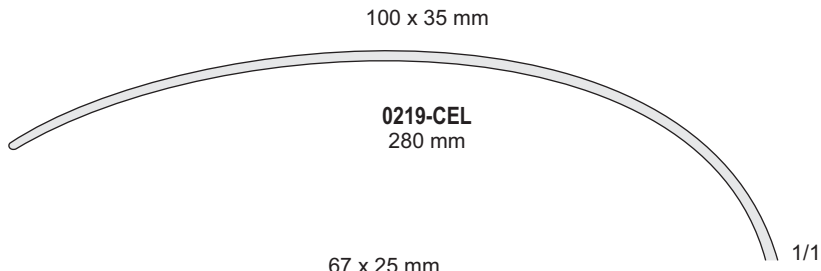

0219-CHA 80x42 mm
0219-CHB 80x50 mm
0219-CHC 80x60 mm

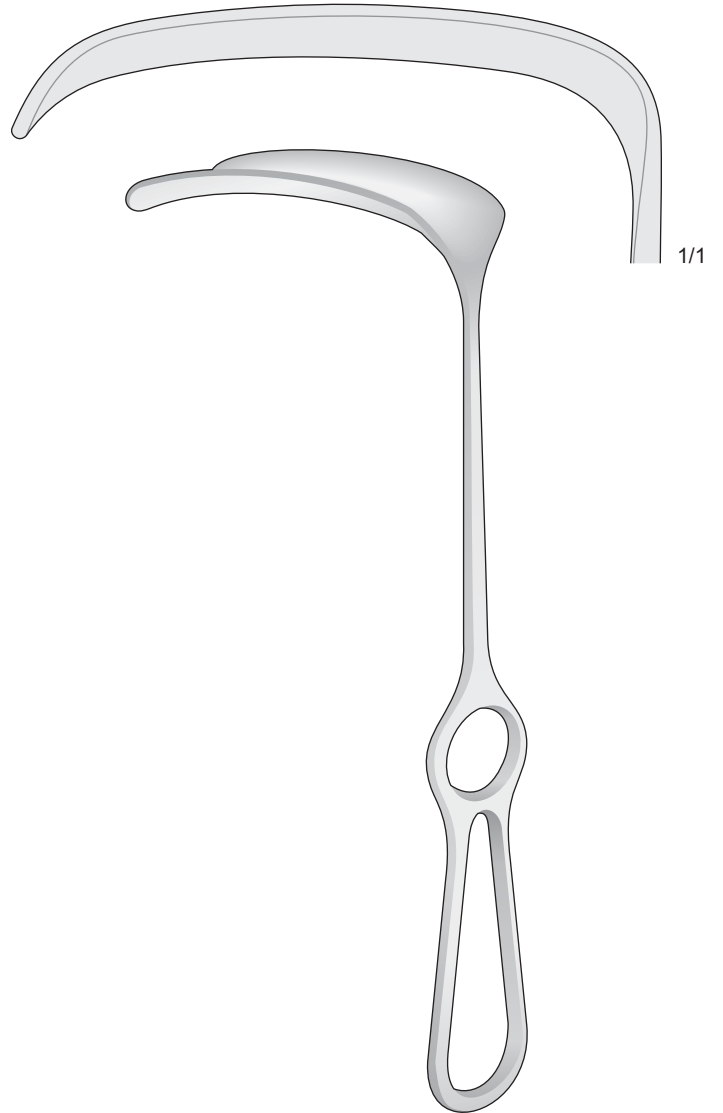
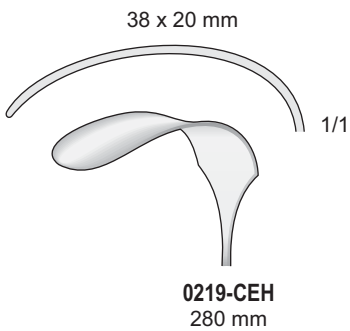
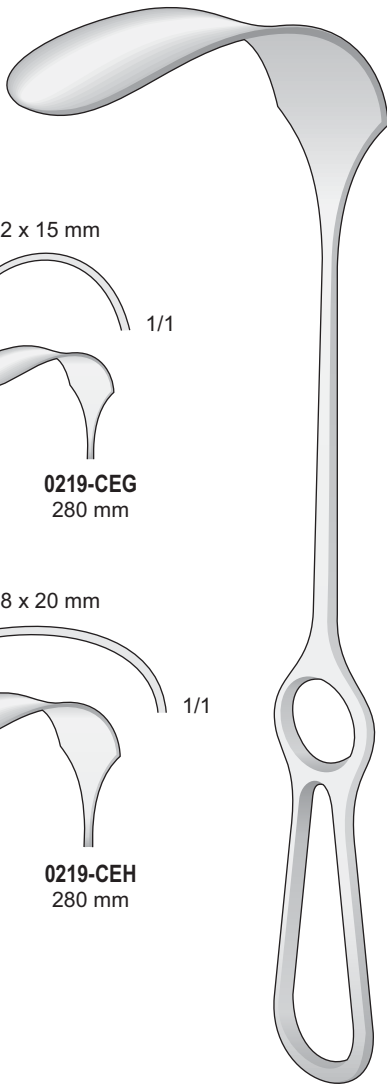

KOCHER
0219-CEG/0219-CEL
 280 mm

KOCHER
0219-CHA/0219-CHC
 250 mm

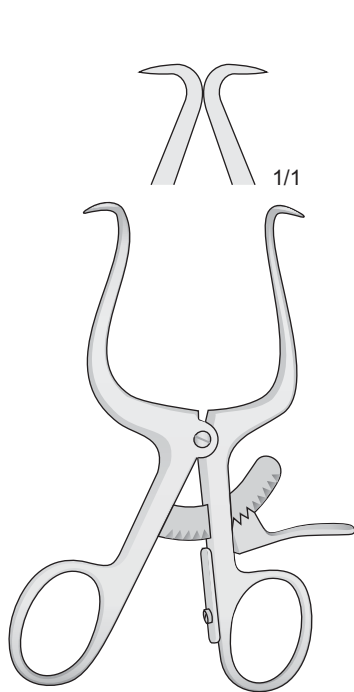

GELPI
0221-BE
90 mm

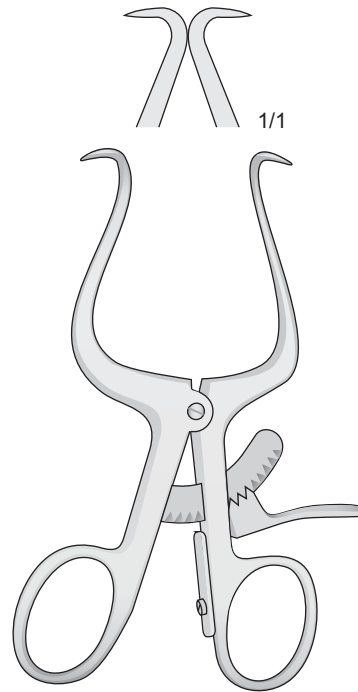

GELPI
0221-BF
110 mm

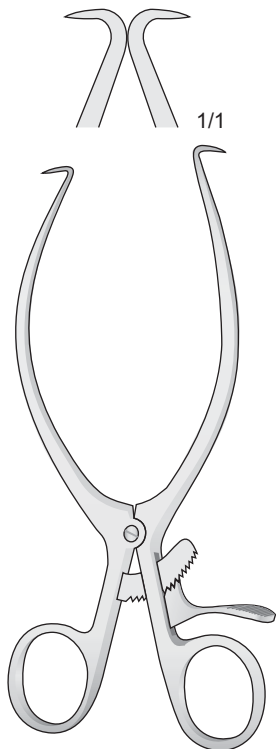

GELPI
0221-BG
140 mm

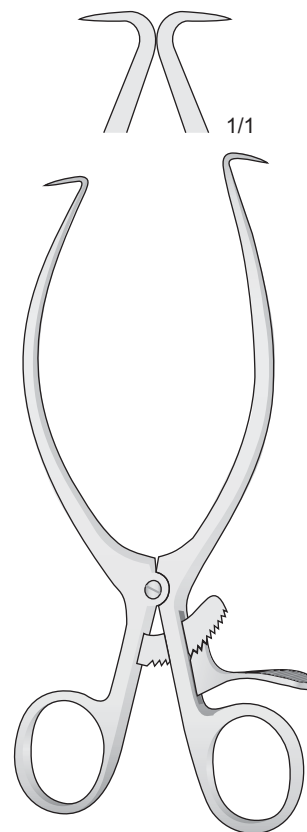

GELPI
0221-BH
180 mm

Wundspreizer

Self retaining retractors

Divaricatori

Separadores

Ecarteurs

Femur-Wundspreizer für kinder
Femur Retractor for children
Divaricatore femorale per bambini

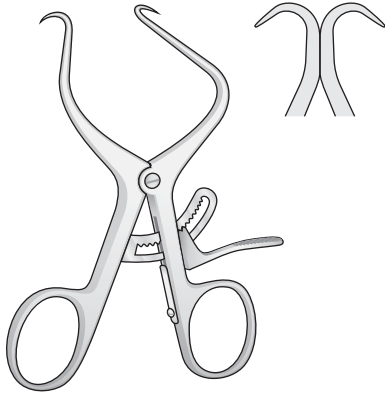

DE BAKEY
0221-DBF
100 mm

Femur-Wundspreizer
Femur Retractor
Divaricatore femorale

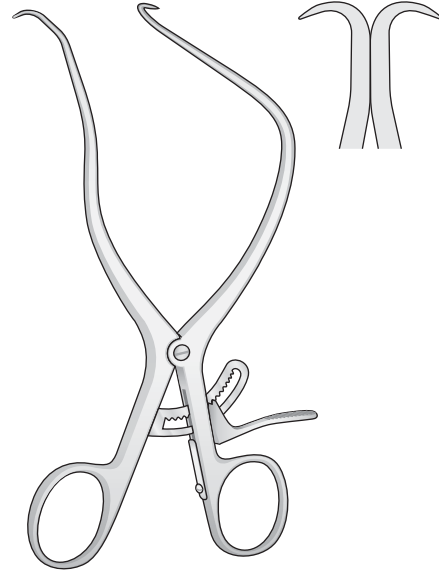

DE BAKEY
0221-DBG
170 mm

Wundspreizer
Retractors for shoulder
Divaricatori da spalla
Separadores
Ecarteurs

Stumpf - Blunt
Smusso - Romo
Mousse

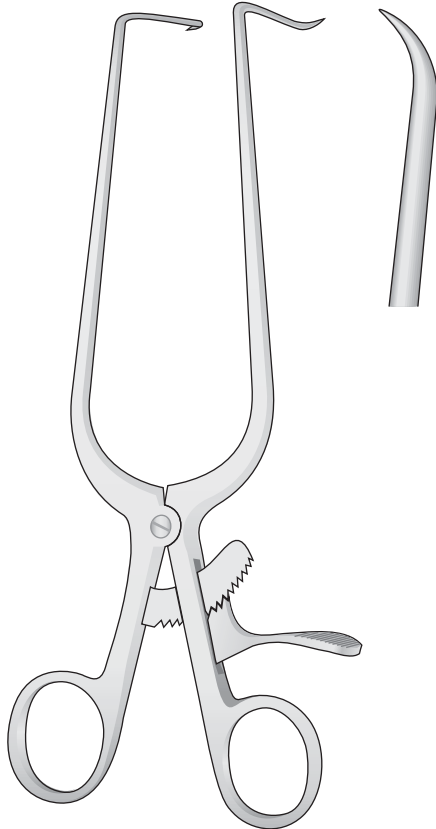

0221-BAA
215 mm

Stumpf - Blunt
Smusso - Romo
Mousse

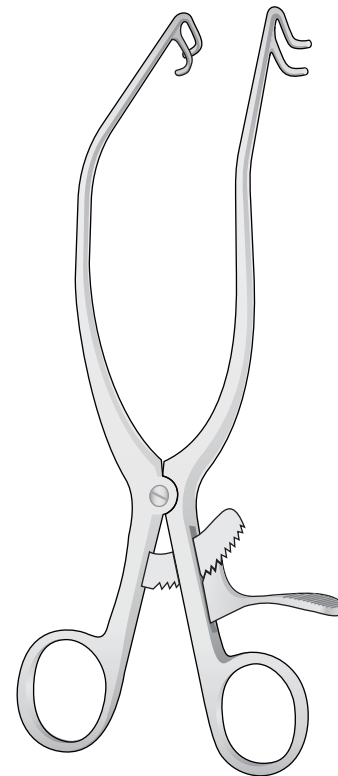
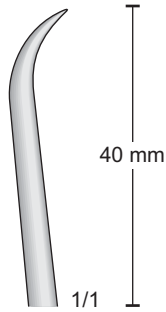

KÖLBEL
0221-BAD
180 mm

Wundspreizer

Self retaining retractors

Divaricatori

Separadores

Ecarteurs

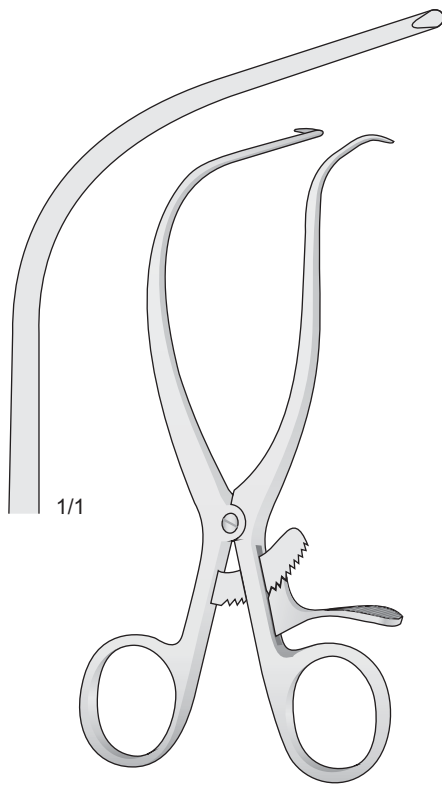

GELPI-SELETZ
0221-BB
165 mm

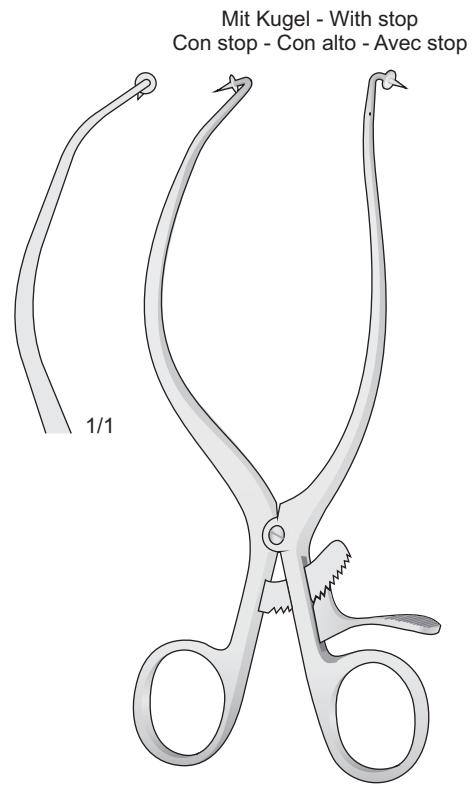

GELPI-LOKTITE
0221-BD
190 mm

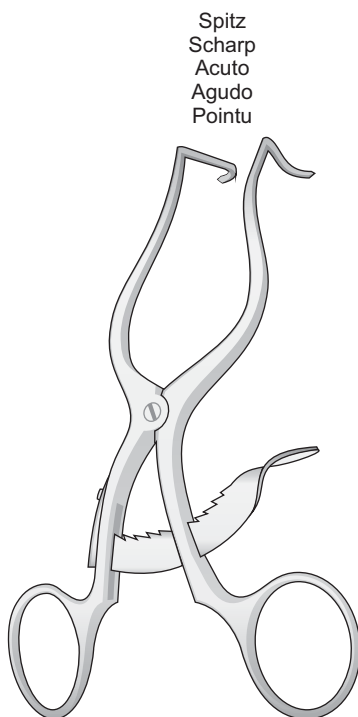

CLOWARD-CONTOUR
0221-BAI
140 mm

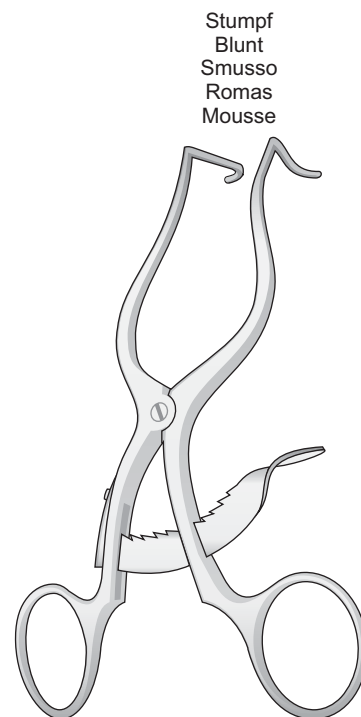

CLOWARD-CONTOUR
0221-BAL
140 mm

Wundspreizer

Self retaining retractors

Divaricatori

Separadores

Ecarteurs

Spitz
Scharp
Acuto
Agudo
Pointu

Stumpf
Blunt
Smusso
Romas
Mousse

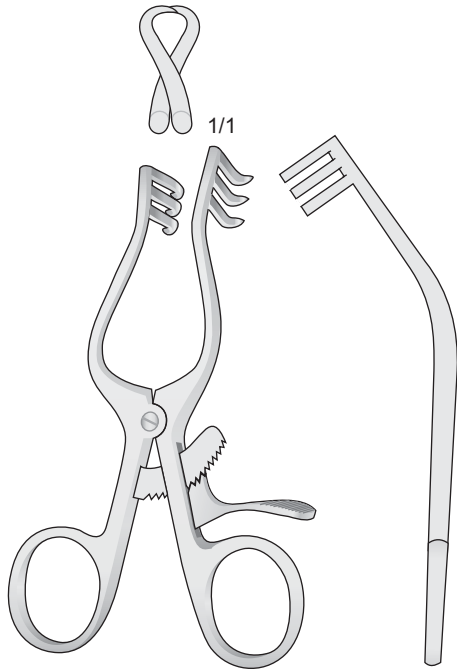

WULLSTEIN
0221-BBB
105 mm

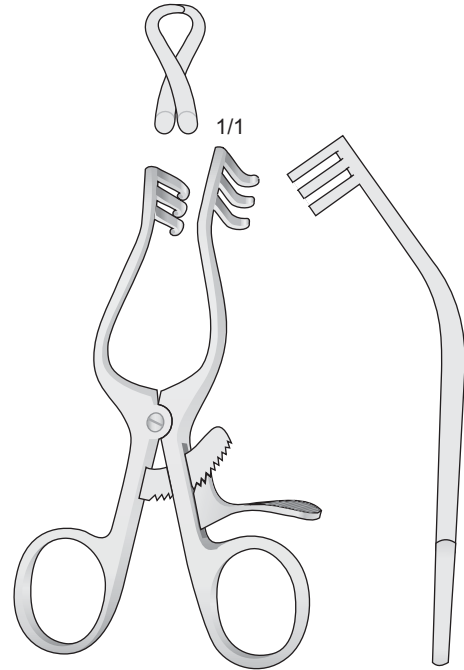

WULLSTEIN
0221-BBC
105 mm

Spitz
Scharp
Acuto
Agudo
Pointu

Stumpf
Blunt
Smusso
Romas
Mousse

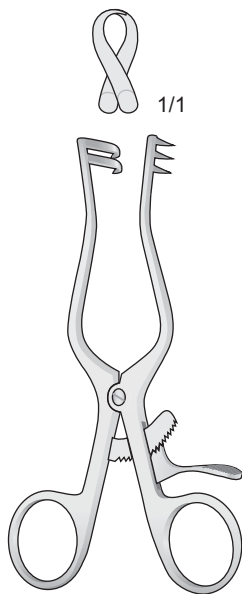

WEITLANER
0221-AH
110 mm

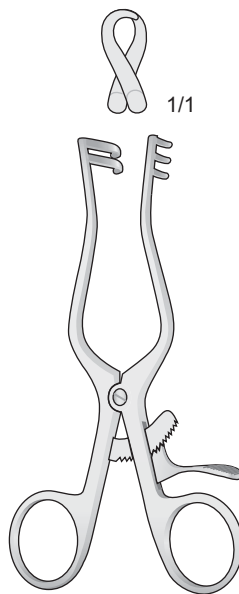

WEITLANER
0221-AL
110 mm

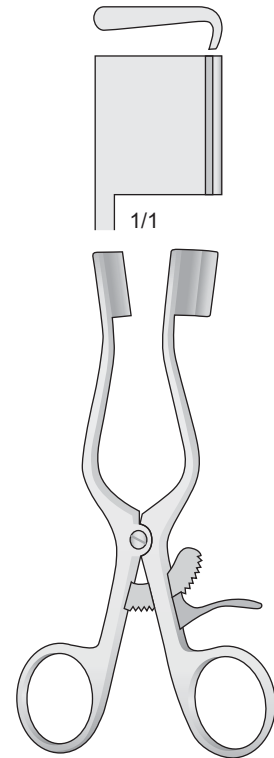

BABY-WEITLANER
0221-CG
140 mm

Wundspreizer

Self retaining retractors

Divaricatori

Separadores

Ecarteurs

Halbscharf - Semi Sharp - Semi acuto
Semi Agudas - Semi Pointu

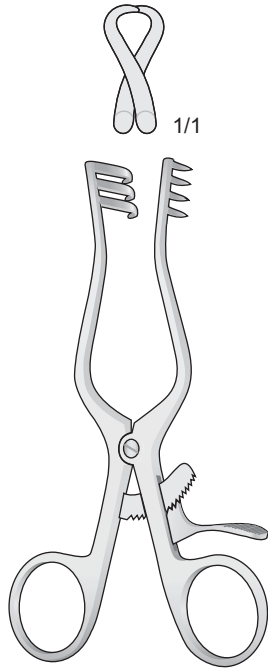

WEITLANER
0221-BI
135 mm

Spitz - Sharp - Acuto
Agudas - Pointu

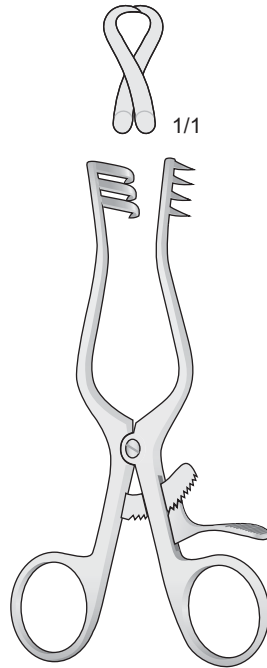

WEITLANER
0221-CA
135 mm

Stumpf - Blunt - Smusso
Romas - Mousse

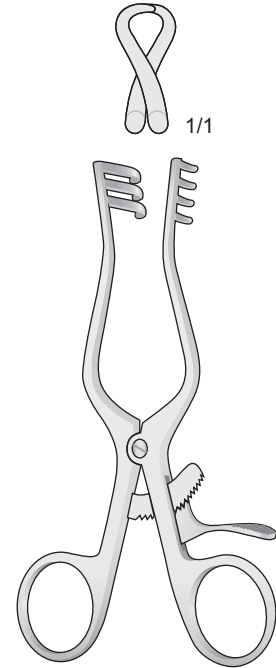

WEITLANER
0221-CC
135 mm

Spitz - Sharp - Acuto
Agudas - Pointu

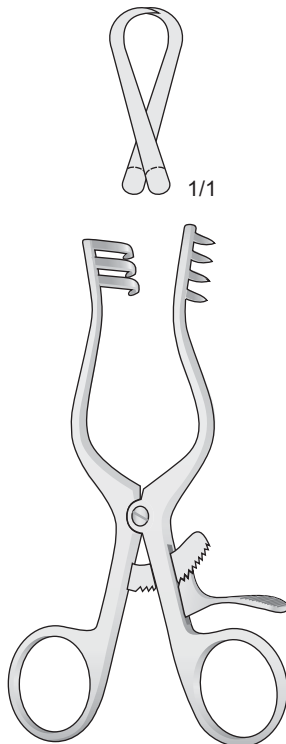

WEITLANER
0221-FF
135 mm

Stumpf - Blunt - Smusso
Romas - Mousse

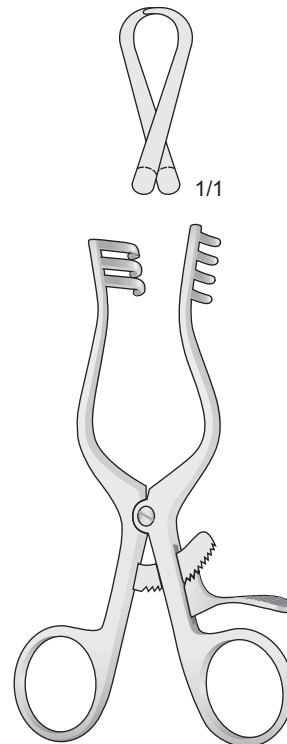

WEITLANER
0221-FG
135 mm

Wundspreizer

Self retaining retractors

Divaricatori

Separadores

Ecarteurs

Halbscharf - Semi Sharp - Semi acuto
Semi Agudas - Semi Pointu

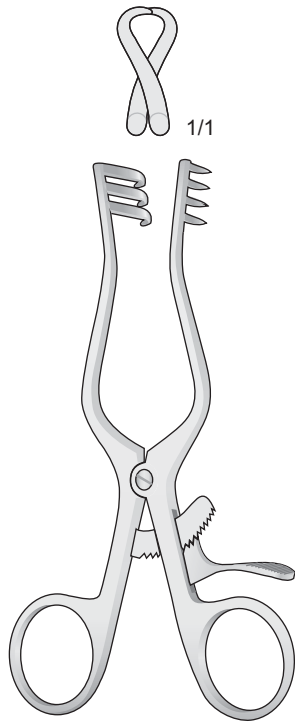

WEITLANER
0221-BL
165 mm

Spitz - Sharp - Acuto
Agudas - Pointu

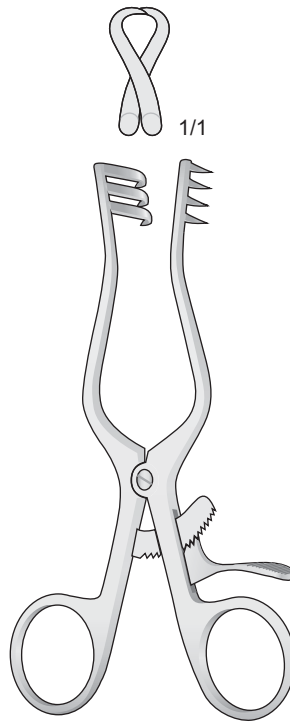

WEITLANER
0221-CB
165 mm

Stumpf - Blunt - Smusso
Romas - Mousse

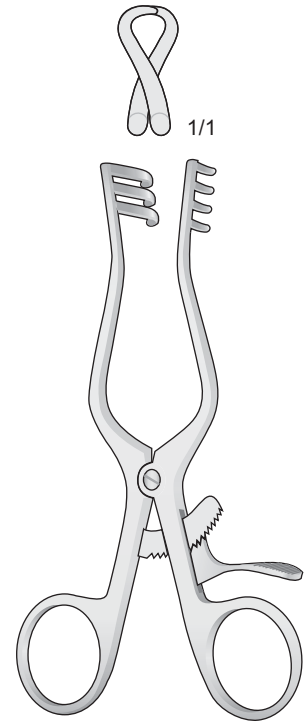

WEITLANER
0221-CD
165 mm

Spitz - Sharp - Acuto
Agudas - Pointu

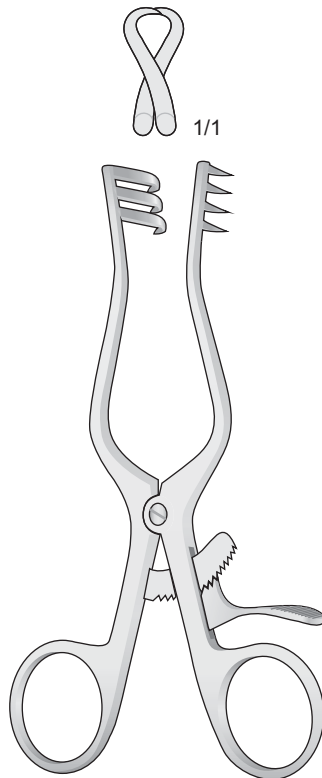

WEITLANER
0221-CE
200 mm

Stumpf - Blunt - Smusso
Romas - Mousse

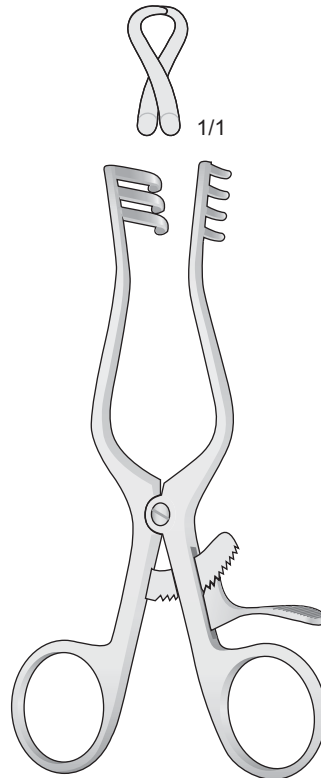

WEITLANER
0221-CF
200 mm

Wundspreizer

Self retaining retractors

Divaricatori

Separadores

Ecarteurs

Spitz - Sharp - Acuto
Agudas - Pointu

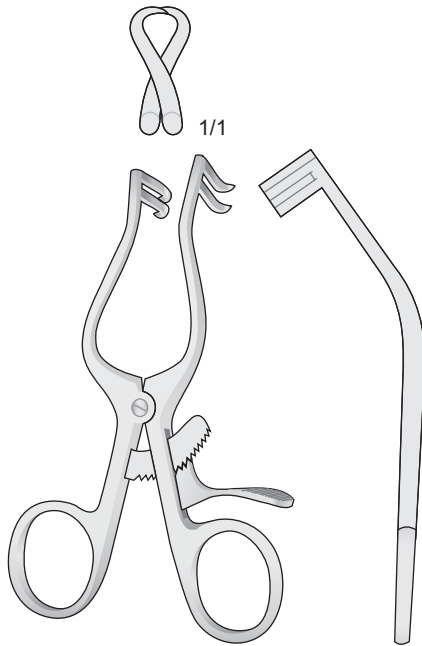

PLESTER
0221-LA
110 mm

Stumpf - Blunt - Smusso
Romas - Mousse

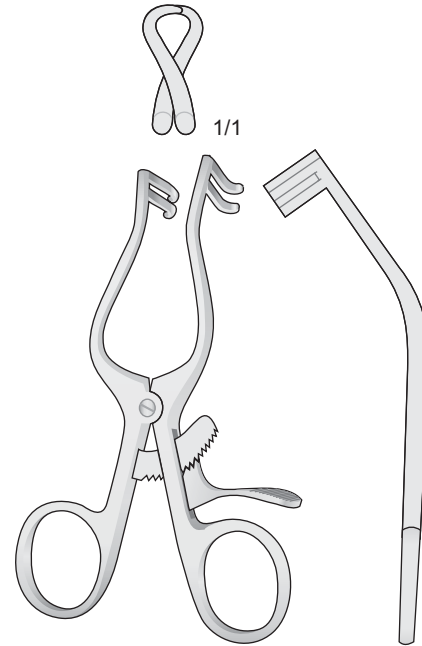

PLESTER
0221-LB
110 mm

Spitz - Sharp - Acuto
Agudas - Pointu

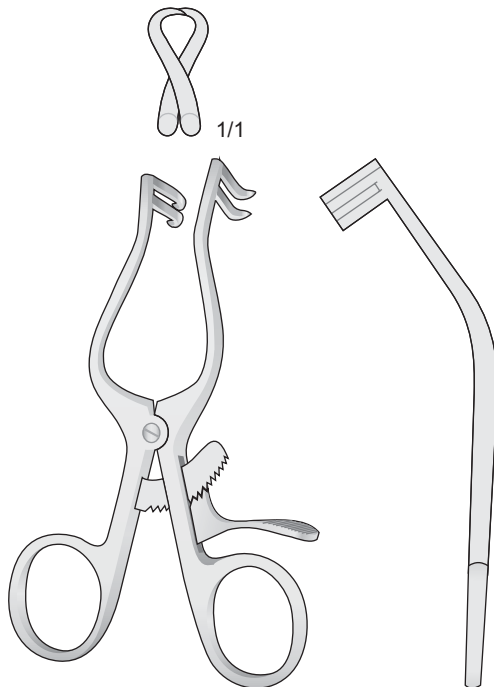

PLESTER
0221-LC
135 mm

Stumpf - Blunt - Smusso
Romas - Mousse

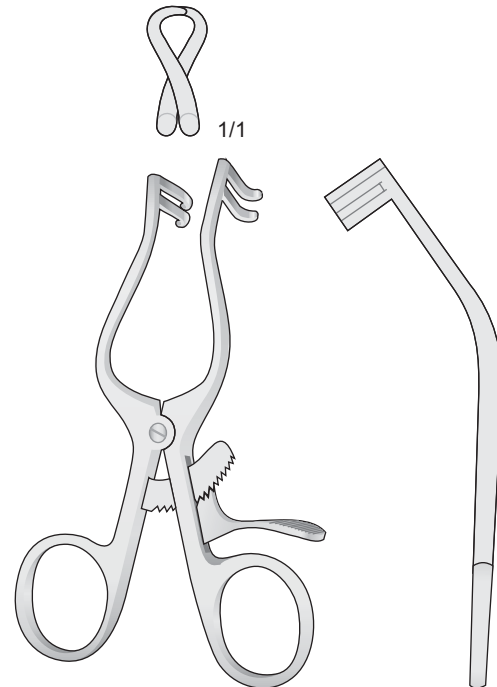

PLESTER
0221-LD
135 mm

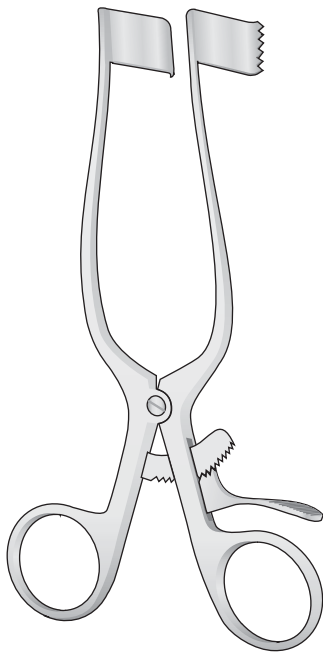

MEYERDING
0221-HG - 32 x 25 mm
0221-HH - 60 x 25 mm
0221-HI - 54 x 25 mm
0221-HL - 60 x 20 mm
 180 mm

Spitz - Sharp - Acuto
 Agudas - Pointu

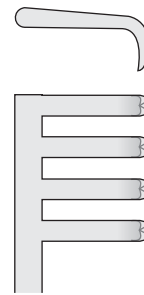

0221-BBH

Stumpf - Blunt - Smusso
 Romas - Mousse

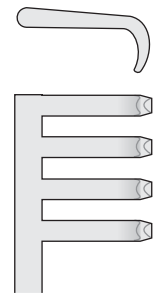

0221-BBI

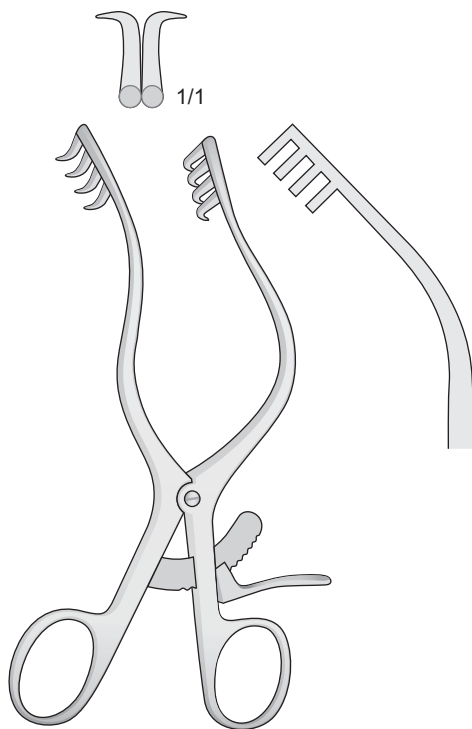

MOLLISON
0221-BBA
 160 mm

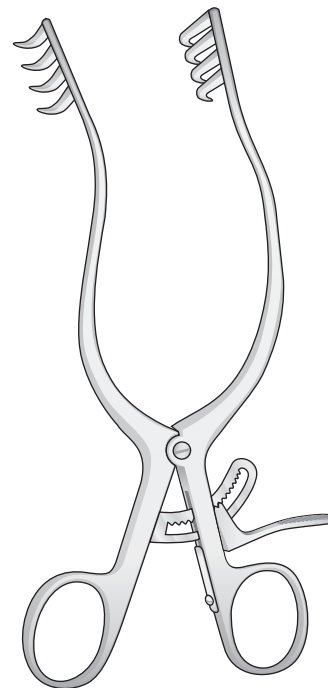

ANDERSON-ADSON
0221-BBH/0221-BBI
 200 mm

Wundspreizer

Self retaining retractors

Divaricatori

Separadores

Ecarteurs

Spitz - Sharp - Acuto
Agudas - Pointu

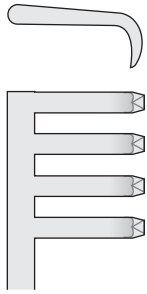

0221-BBL

Stumpf - Blunt - Smusso
Romas - Mousse

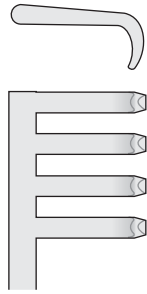

0221-BCA

4 x 4 Zähne
4 x 4 Teeth
4 x 4 Denti
4 x 4 Dientes
4 x 4 Dents

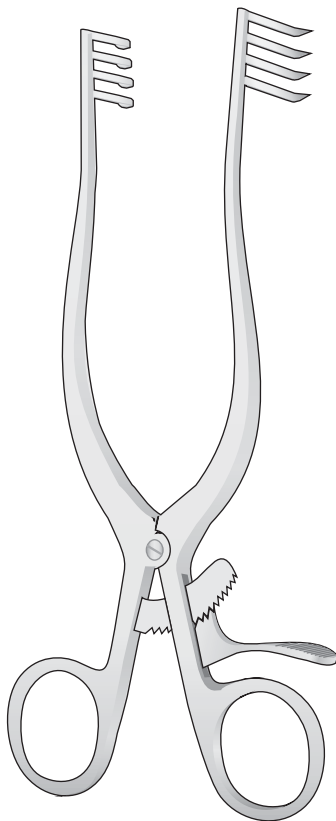

ADSON
0221-BBL/0221-BCA
200 mm

Spitz - Sharp - Acuto
Agudas - Pointu

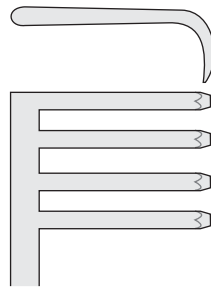

0221-CH

Stumpf - Blunt - Smusso
Romas - Mousse

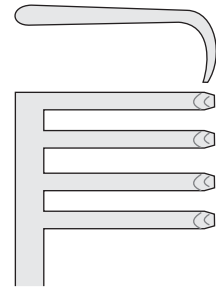

0221-CI

4 x 4 Zähne
4 x 4 Teeth
4 x 4 Denti
4 x 4 Dientes
4 x 4 Dents

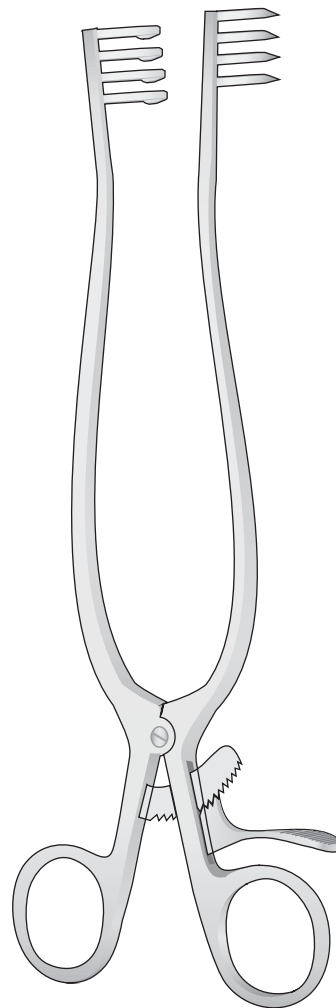

WEITLANER
0221-CH/0221-CI
250 mm

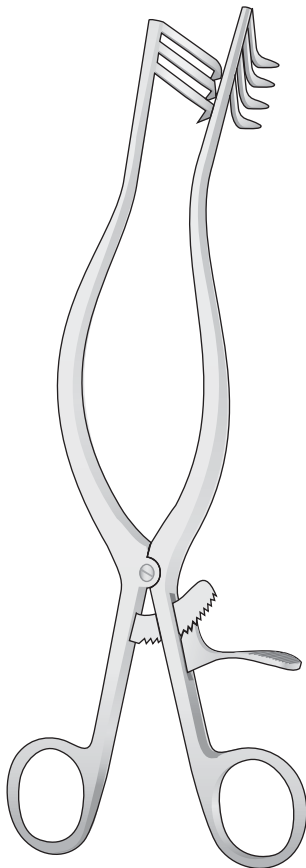

ADSON
0221-BLA/0221-BLD
265 mm

3 x 4 Zähne
3 x 4 Teeth
3 x 4 Denti
3 x 4 Dientes
3 x 4 Dents

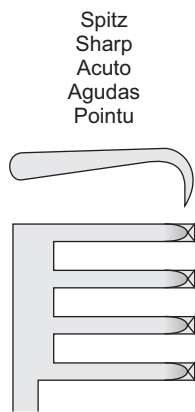

0221-BLA

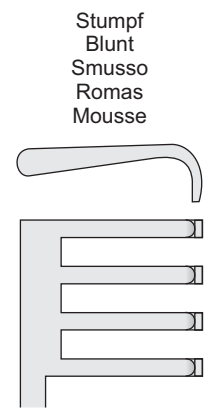

0221-BLB

6 x 6 Zähne
6 x 6 Teeth
6 x 6 Denti
6 x 6 Dientes
6 x 6 Dents

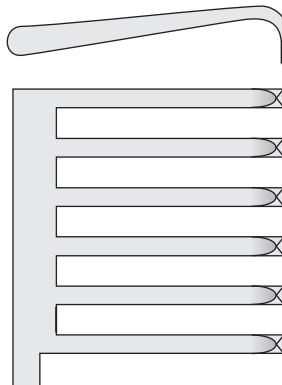

0221-BLC

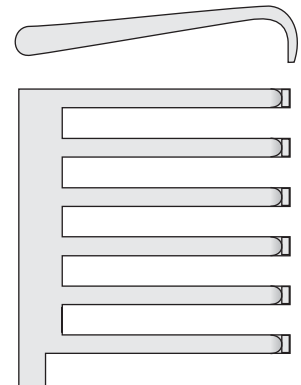

0221-BLD

Wundspreizer

Self retaining retractors

Divaricatori

Separadores

Ecarteurs

Spitz
Scharp
Acuto
Agudo
Pointu

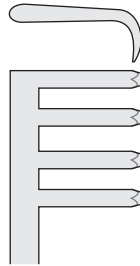

0221-GI
140 mm

Stumpf
Blunt
Smusso
Romas
Mousse

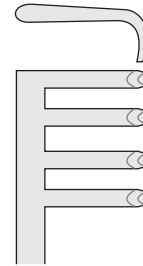

0221-HA
140 mm

3 x 4 Zähne
3 x 4 Teeth
3 x 4 Denti
3 x 4 Dientes
3 x 4 Dents

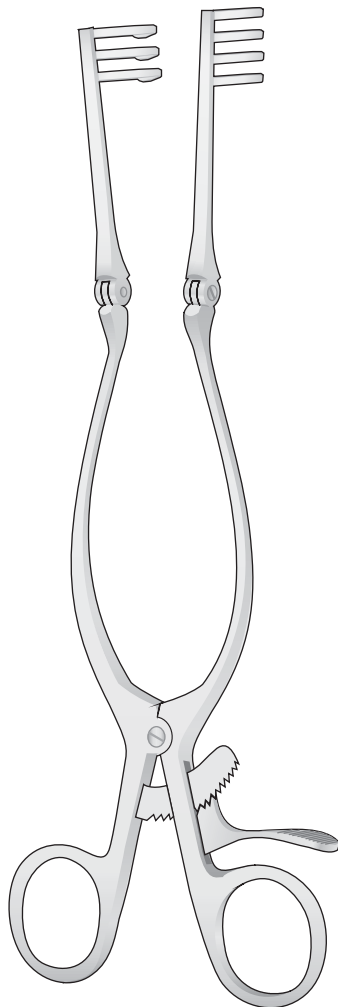

ADSON
0221-GI/0221-HF

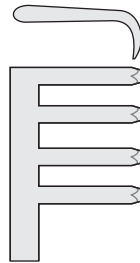

0221-GL
165 mm

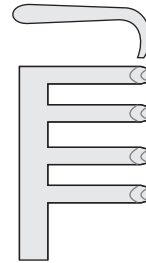

0221-HB
165 mm

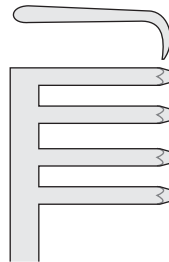

0221-HC
200 mm

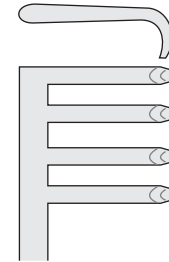

0221-HD
200 mm

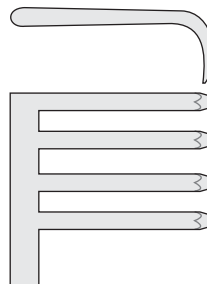

0221-HE
250 mm

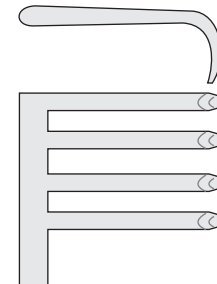

0221-HF
250 mm



Elevatorii

Elevators

Elevatori

Elevadores

Elevateurs

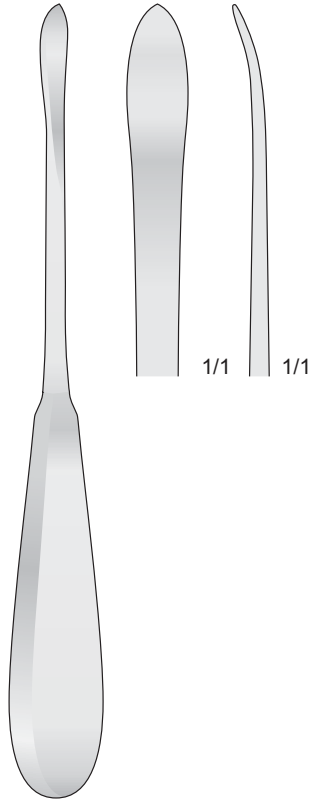

LANGENBECK
0610-BC
200 mm

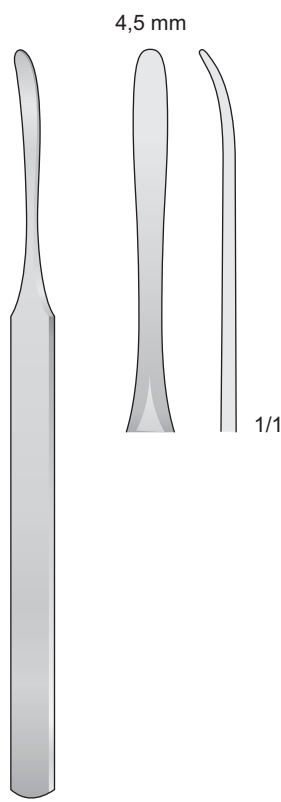

KÖNIG
1014-B
155 mm

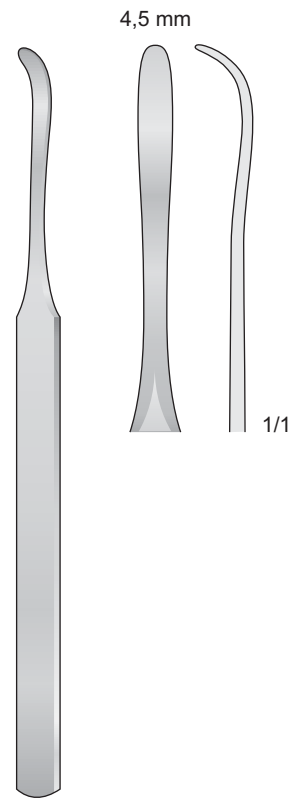

KÖNIG
1014-C
155 mm

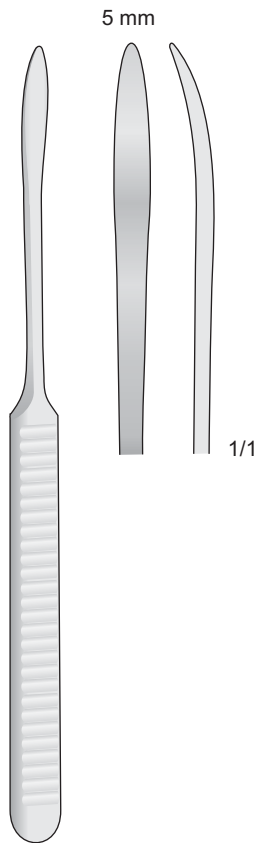

WILLIGER
2207-BA
165 mm

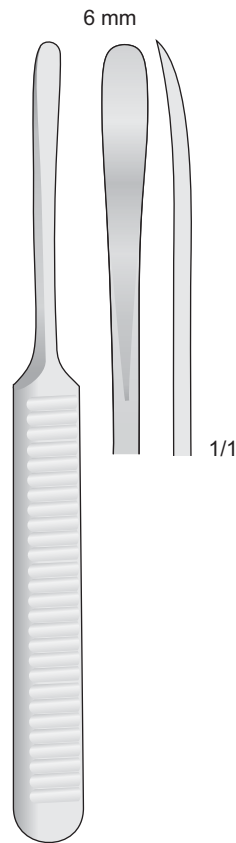

WILLIGER
2207-BC
160 mm

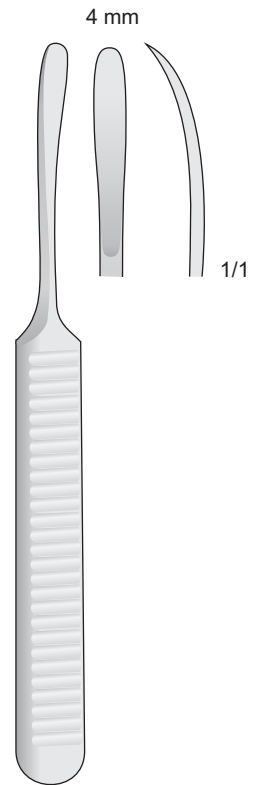

WILLIGER
2207-BE
140 mm

Raspatorien
Periosteal Raspatories
Periostotomi
Legras periostotomos
Rugines à périostomie

Elevatorien

Elevators

Elevatori

Elevadores

Elevateurs

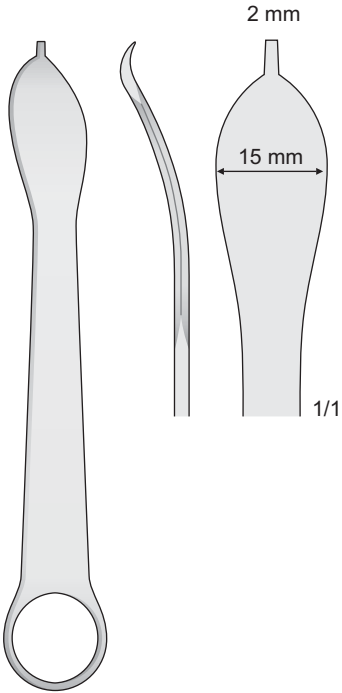

0610-EF
120 mm

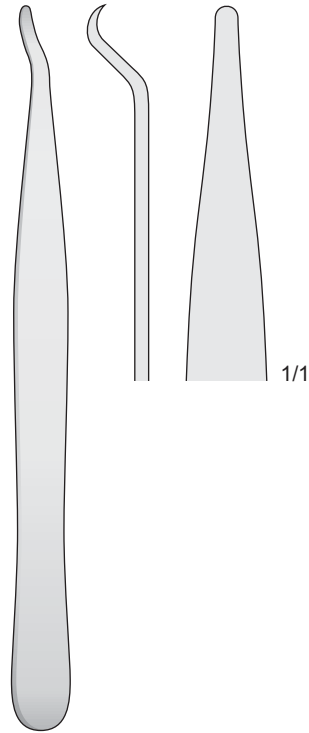

0610-EG
140 mm

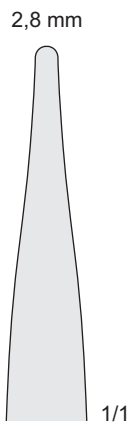

MINI-HOHMANN
0610-EI
160 mm

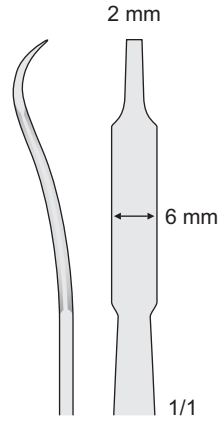

MINI-HOHMANN
0610-EL
160 mm

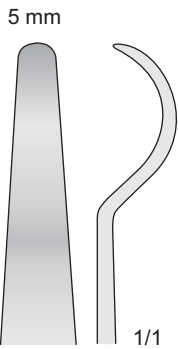
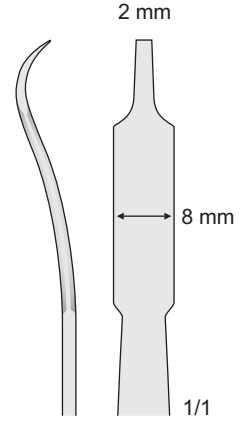

0610-DA
150 mm

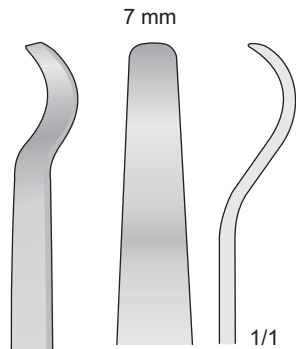

0610-CI
150 mm

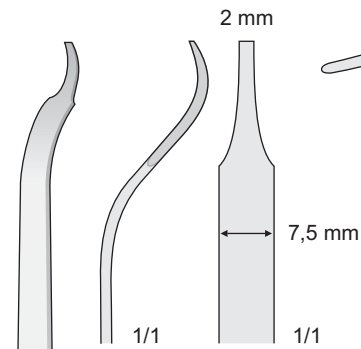

BUCK-GRAMCKO
0610-CA
150 mm

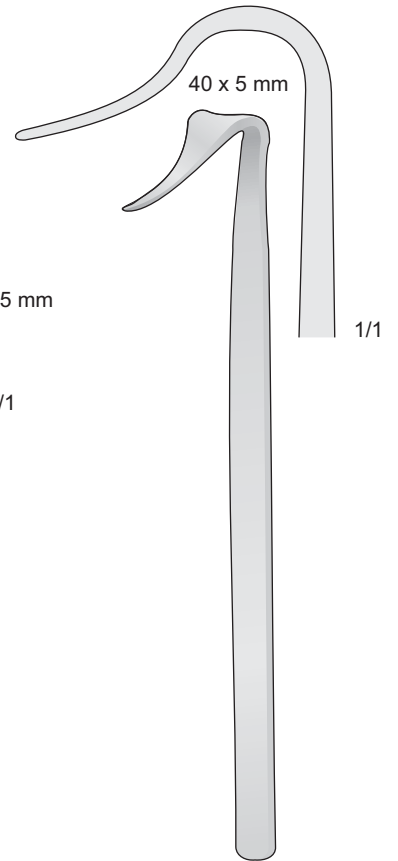

BLOUNT
0610-CH
175 mm

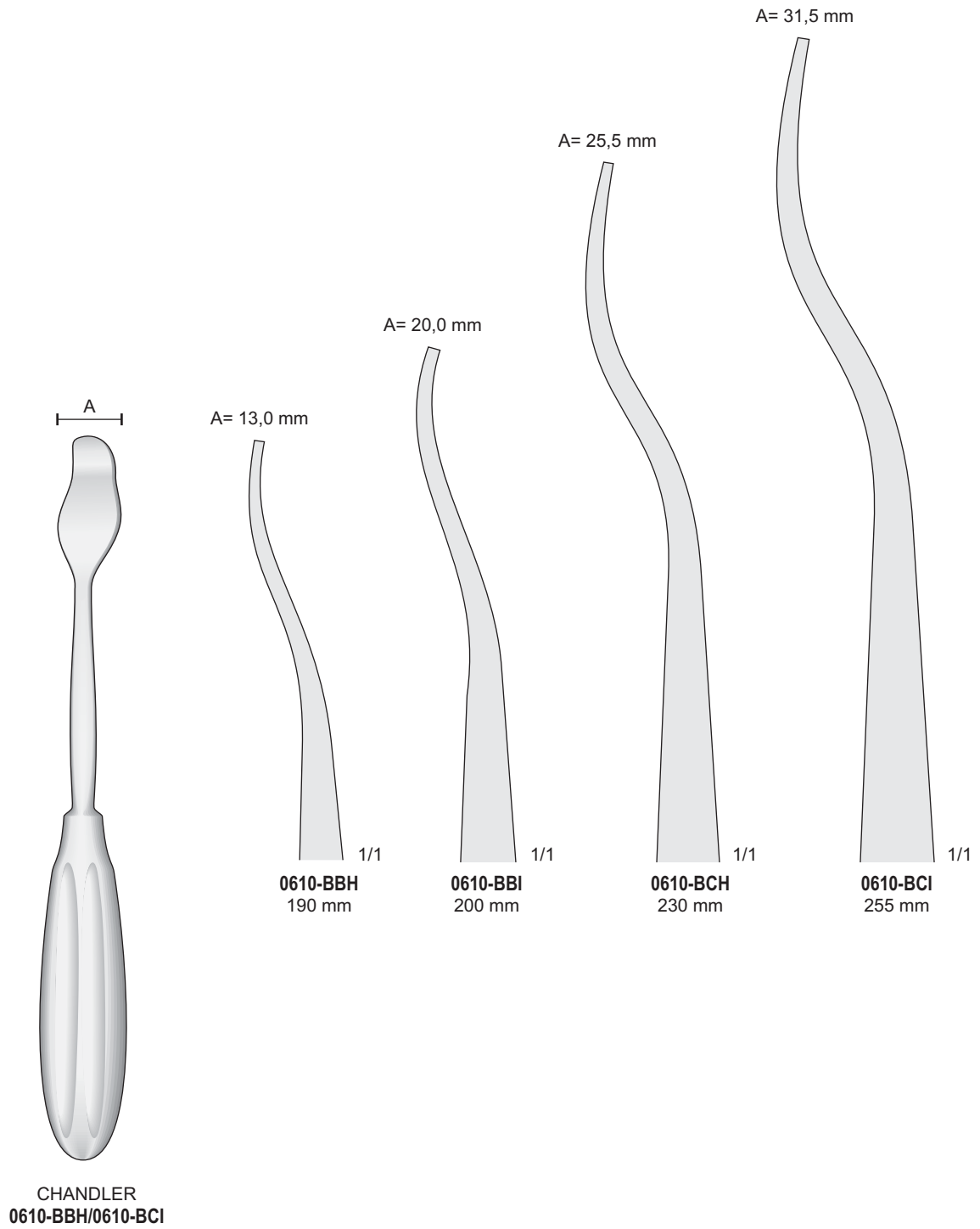

Elevatorii

Elevators

Elevatori

Elevadores

Elevateurs

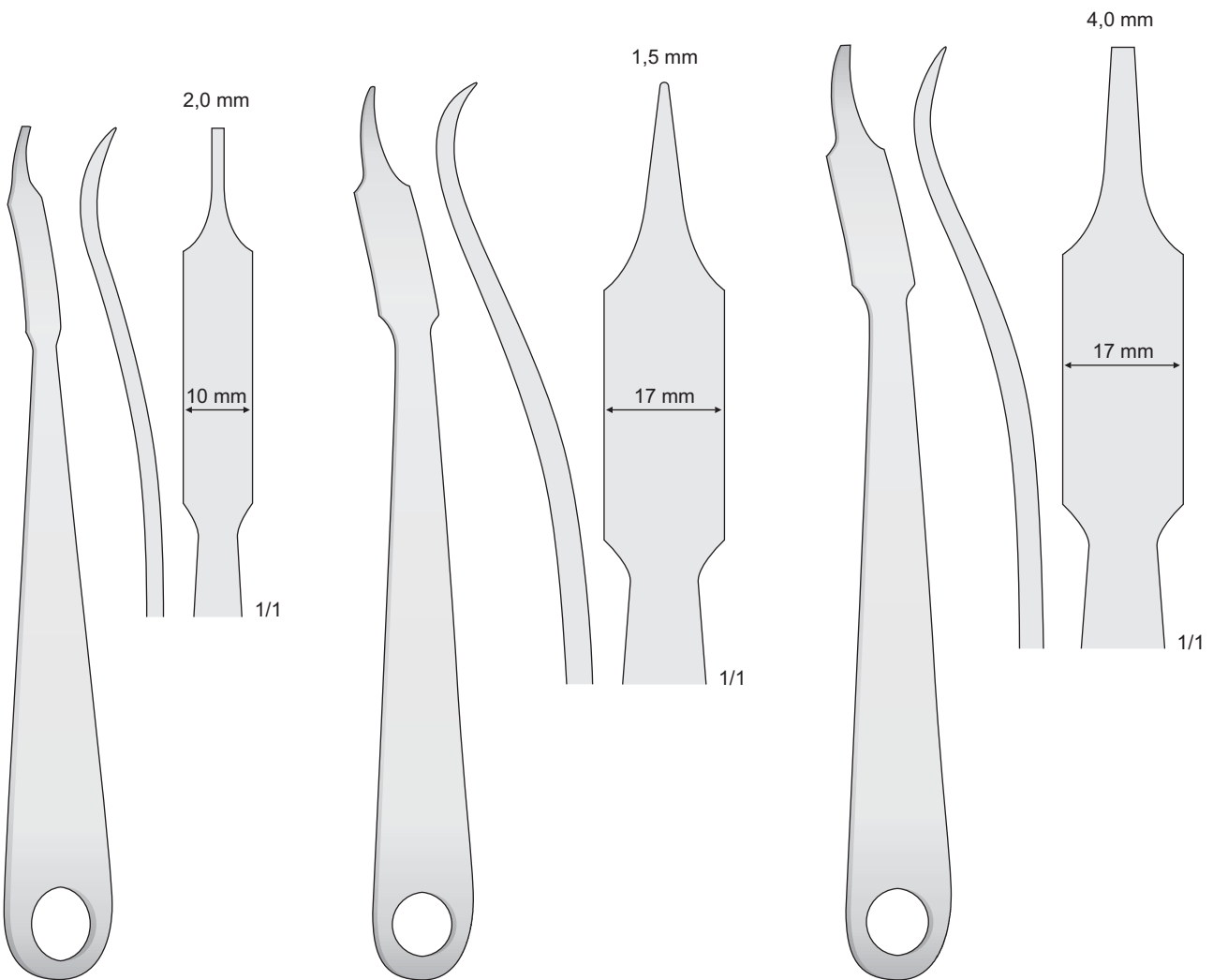

0610-FB
220 mm

0610-FC
240 mm

0610-FD
240 mm

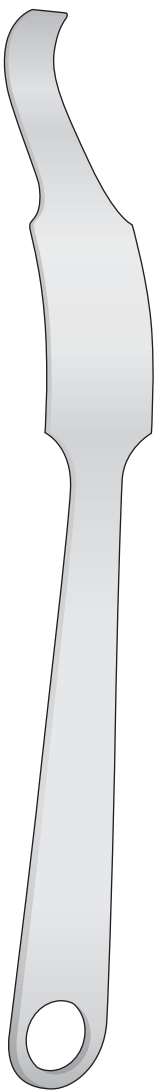

HOHMANN
0610-FE/0610-FF



0610-FE
260 mm

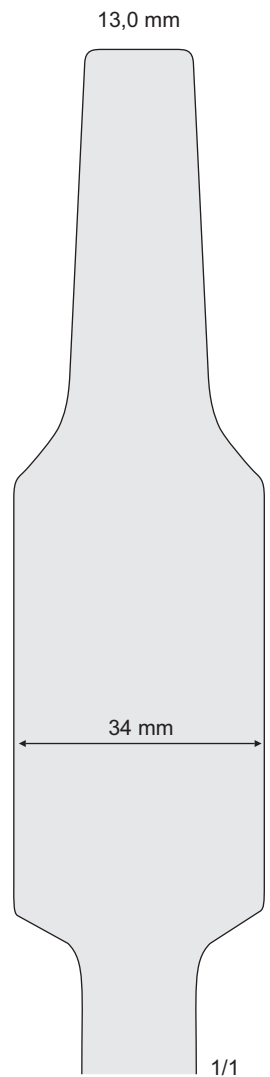

0610-FF
285 mm

Elevatorii

Elevators

Elevatori

Elevadores

Elevateurs

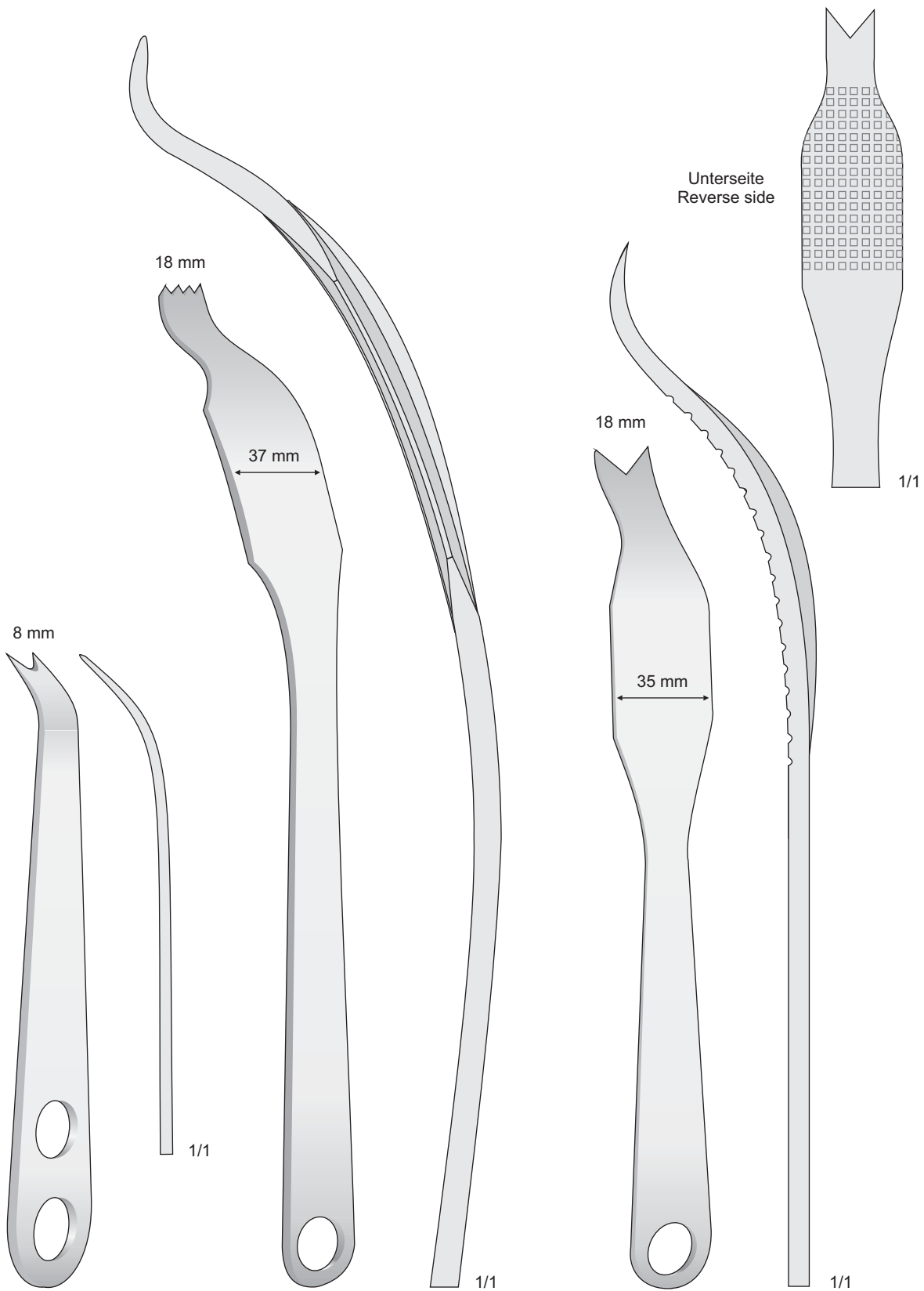

0610-IB
140 mm

SCHUMACHER mod. WAGNER
0610-FI
345 mm

SCHUMACHER
0610-FL
285 mm

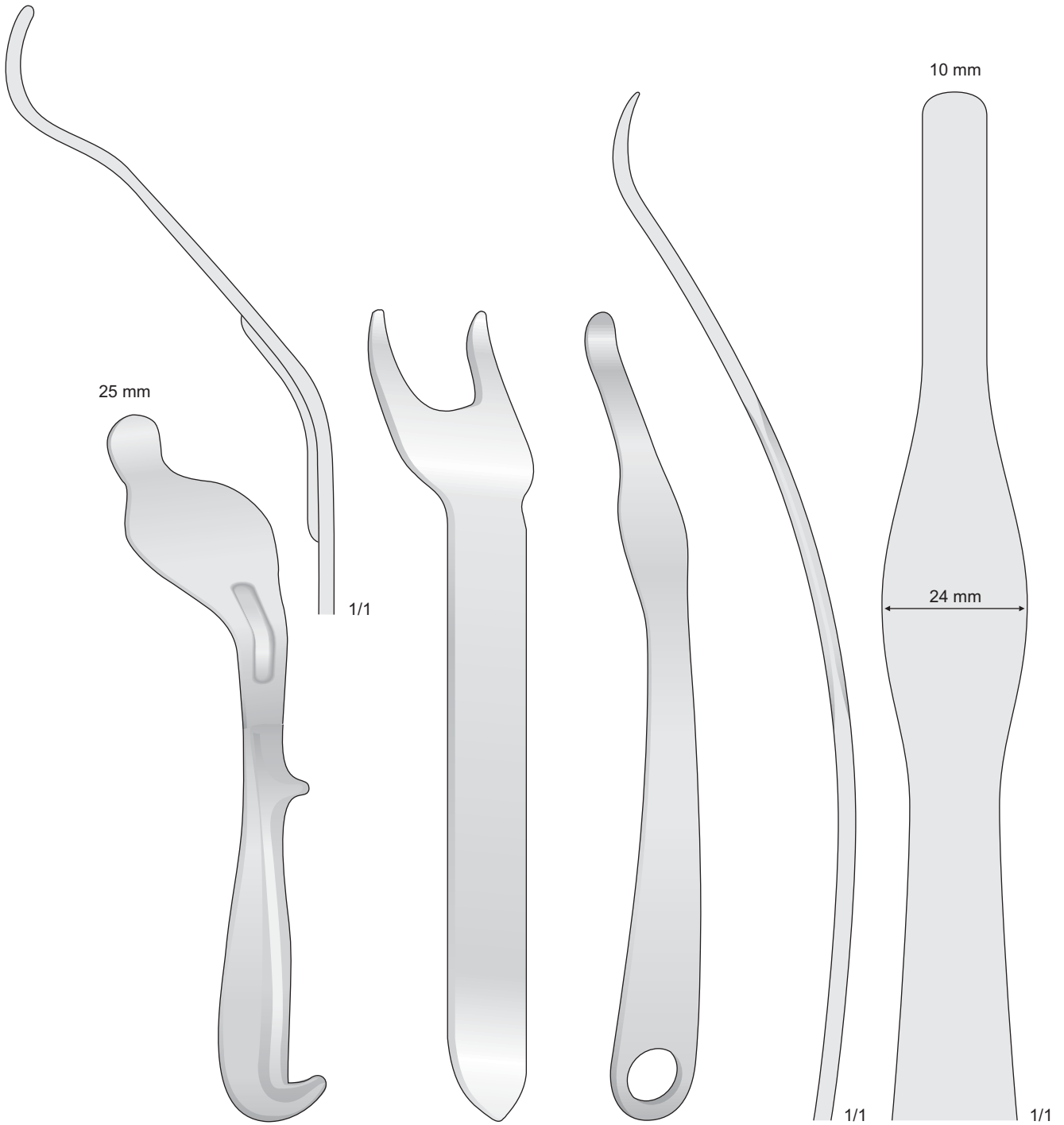

BENNETT
0610-BHG 43 mm
0610-BHL 60 mm
 240 mm

BLOUNT
0610-LD
 260 mm

0610-FG
 260 mm

Elevatorii

Elevators

Elevatori

Elevadores

Elevateurs

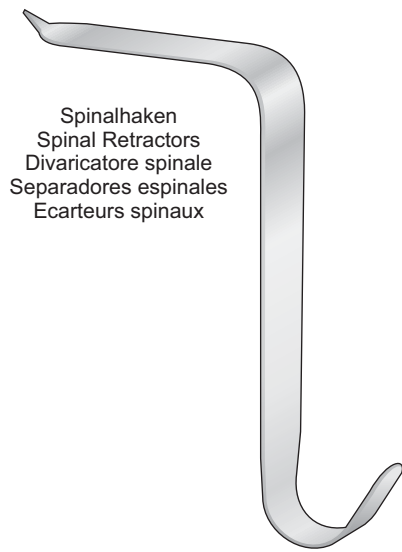

Spinalhaken
Spinal Retractors
Divaricatore spinale
Separadores espinales
Ecarteurs spinaux

TAYLOR
0610-BGI 75 x 30 mm
0610-BGL 100 x 30 mm
165 mm

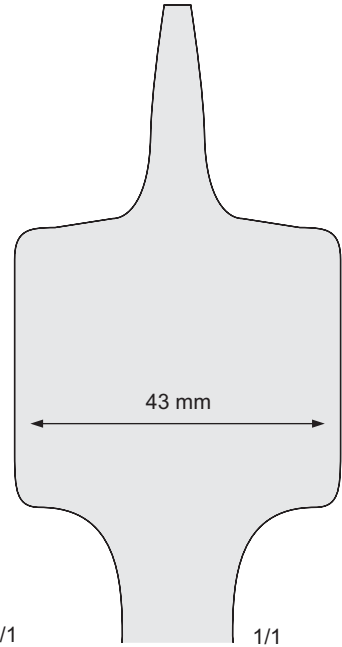
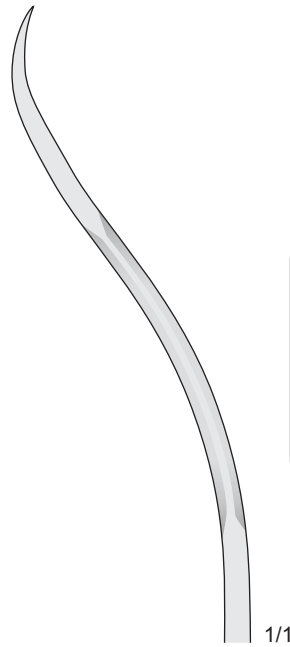

0610-FH
240 mm

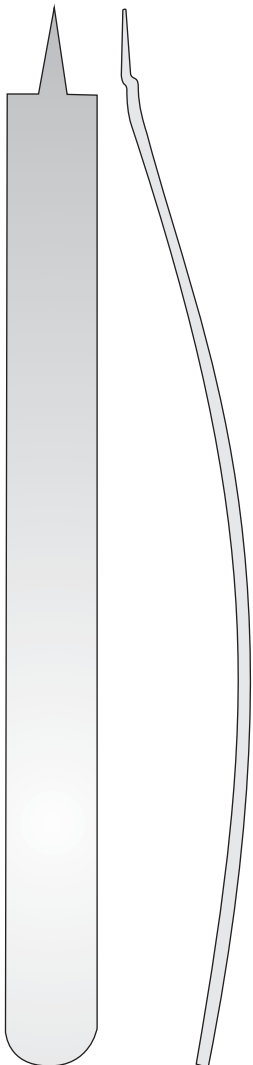

0610-BGE
250 mm

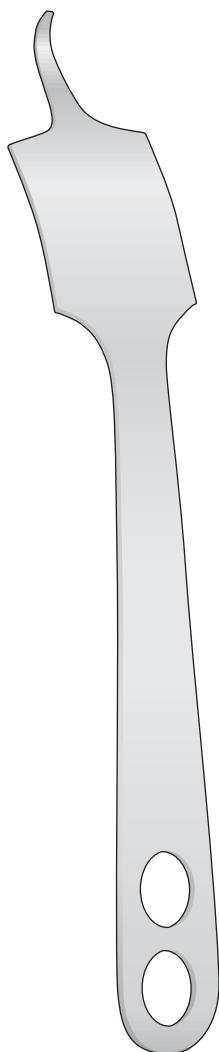

HOHMANN
0610-EH/0610-FH
240 mm

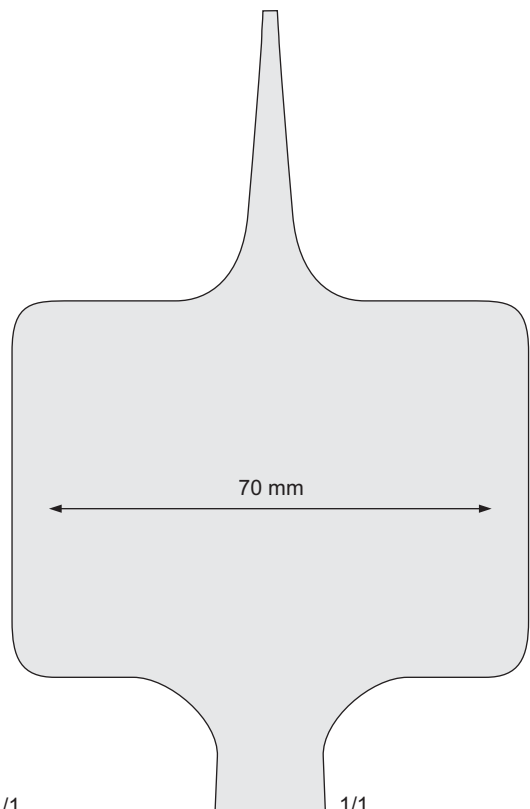
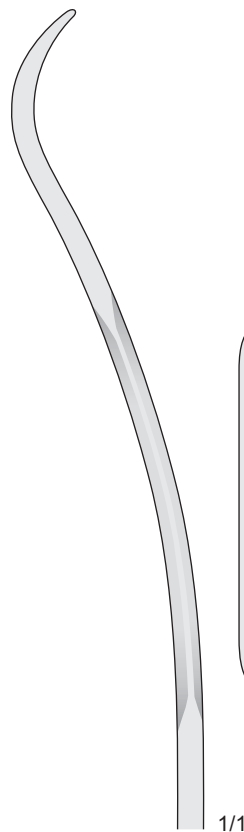

0610-EH
240 mm

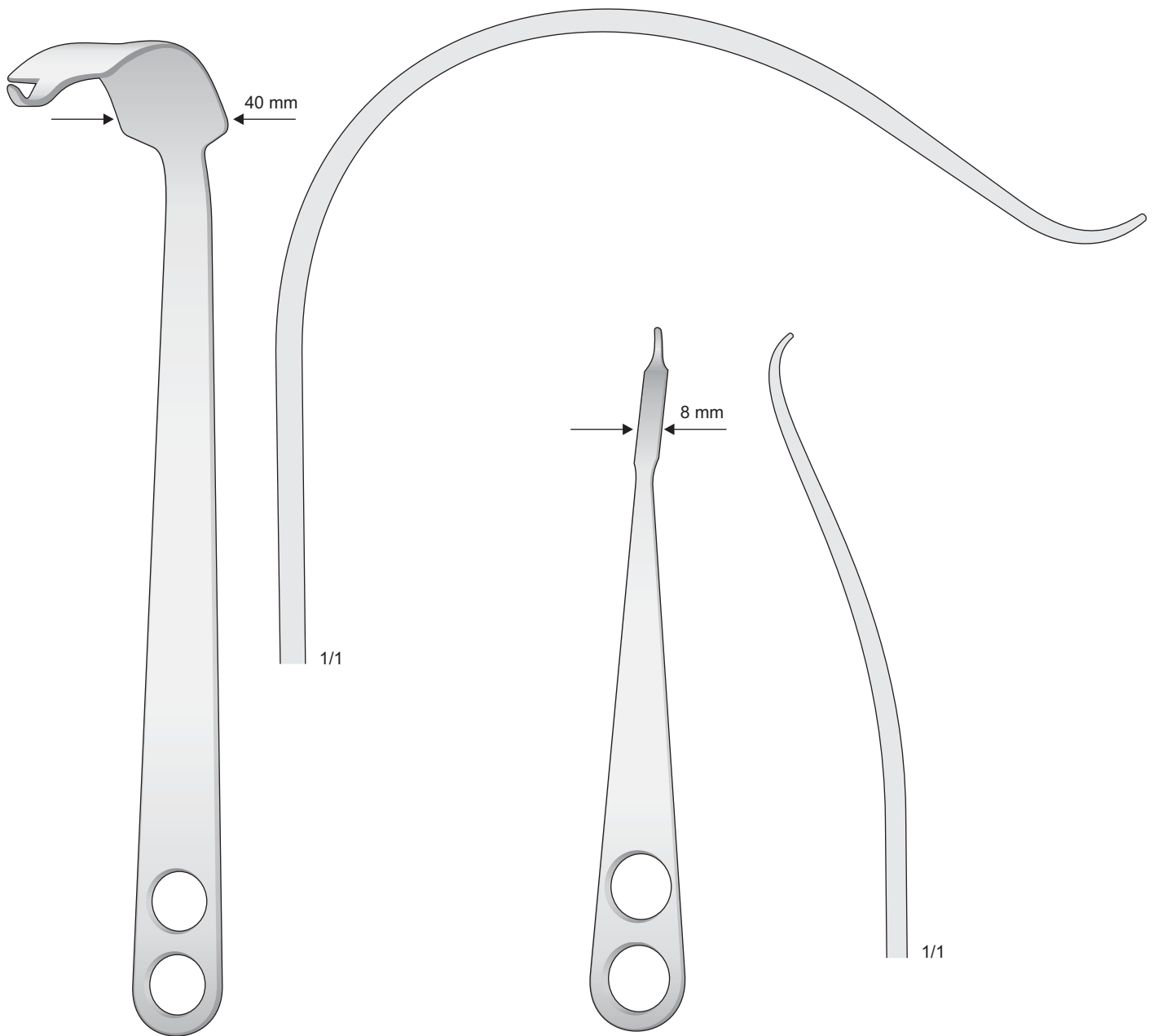

HOHMANN
0610-BDF
330 mm

HOHMANN
0610-BDD
225 mm

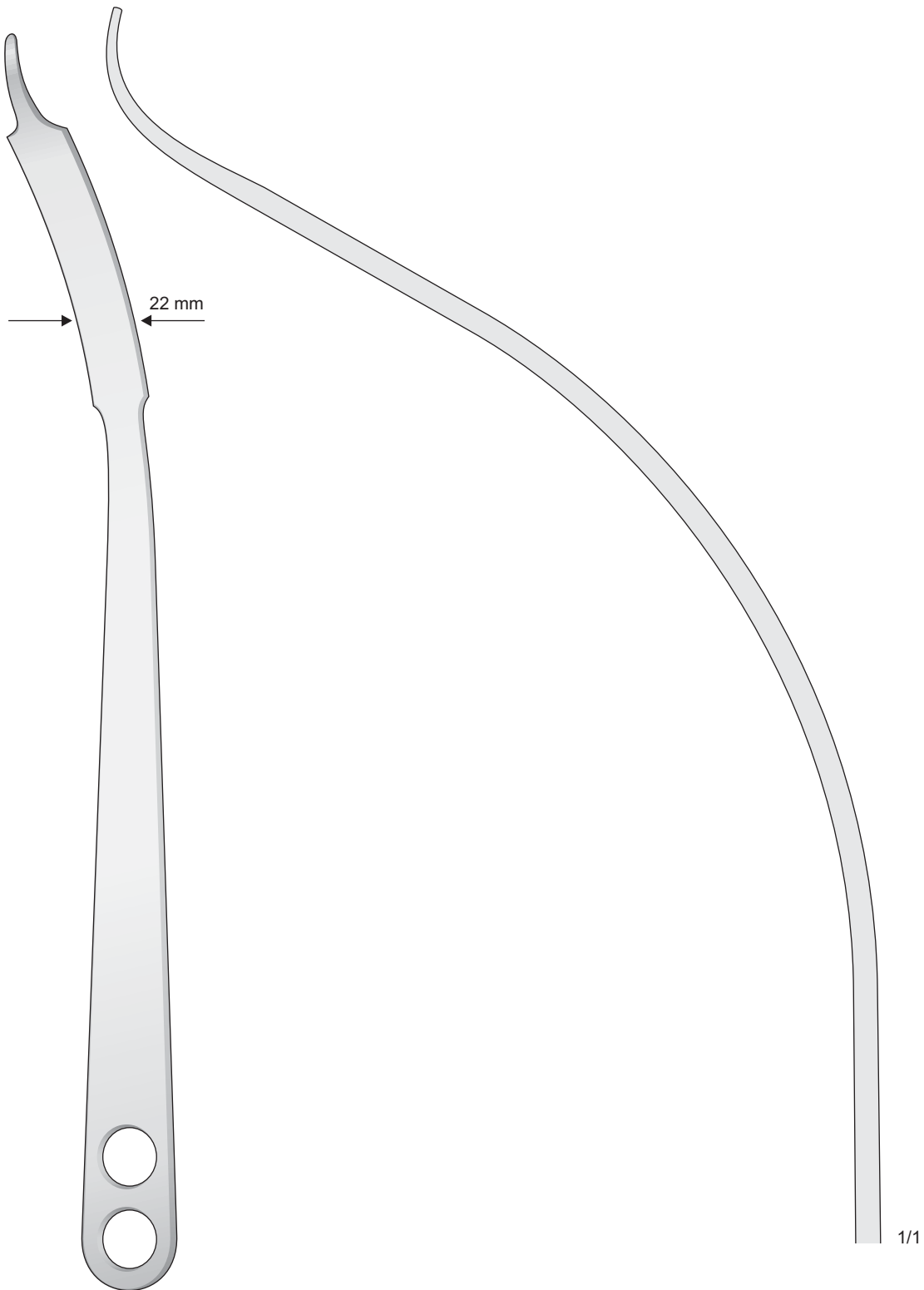

HOHMANN
0610-BDE
400 mm

Raspatorien

Periosteal Raspatories

Periostotomi - Raspatori

Periostotomos - Legras

Rugines à périostomie

15 mm

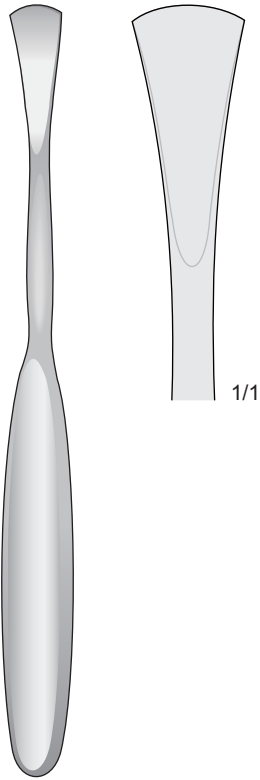

CUSHING
0610-CFC
190 mm

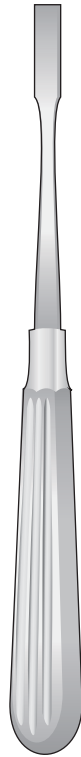

ADSON
0610-CGA/0610-CGD
170 mm

8 mm

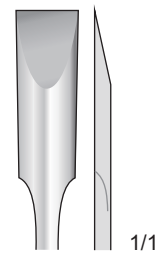

0610-CGA

7 mm



0610-CGB

7 mm



0610-CGC

7 mm



0610-CGD

2,5 mm

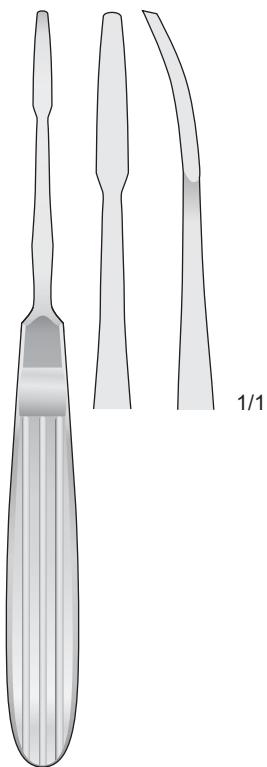

JOSEPH
0610-IA
170 mm

4 mm

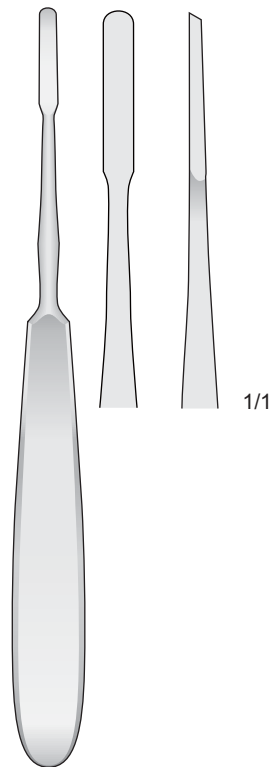

FOMON
0610-CGE
170 mm

4 mm

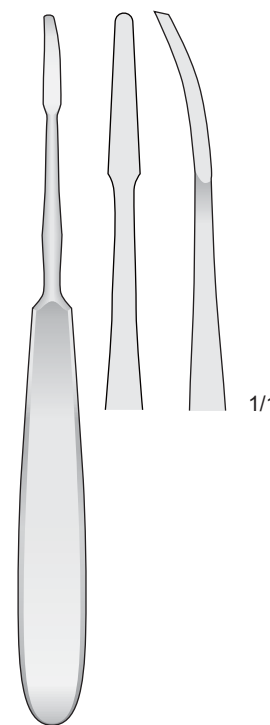

JOSEPH
0610-CGF
160 mm

7 mm

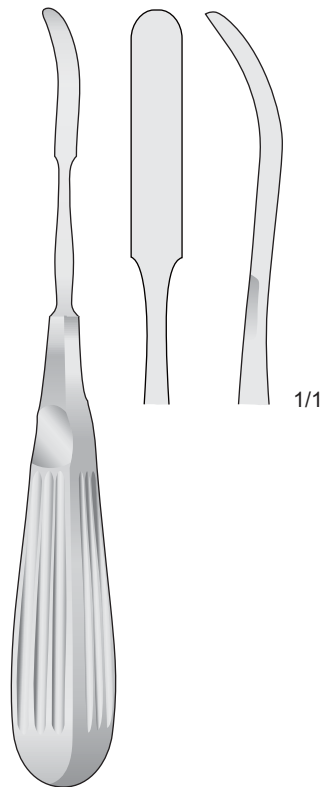

JOSEPH
0610-IC
180 mm

Raspatorien

Periosteal Raspatories

Periostotomi - Raspatori

Periostotomos - Legras

Rugines à périostomie

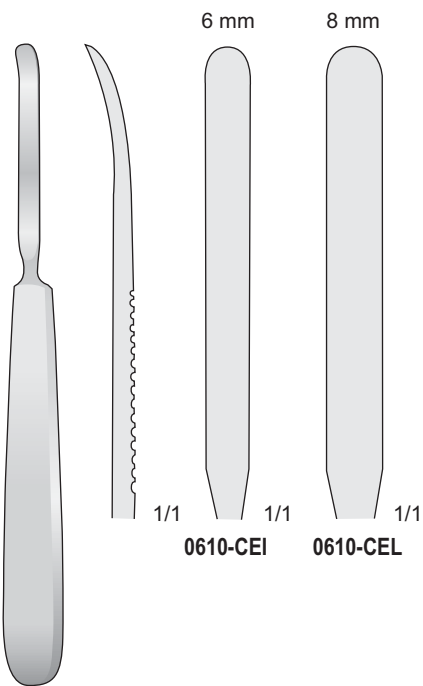

0610-CEI/0610-CEL
170 mm

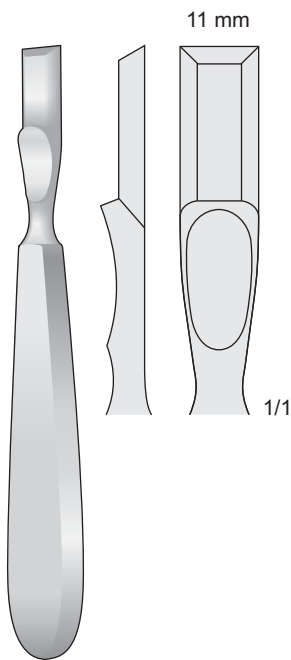

FARABEU-FOLLIN
0610-CEH
160 mm

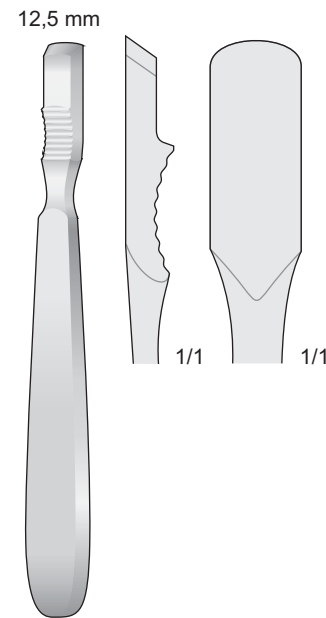

FARABEU
0610-CFA
150 mm

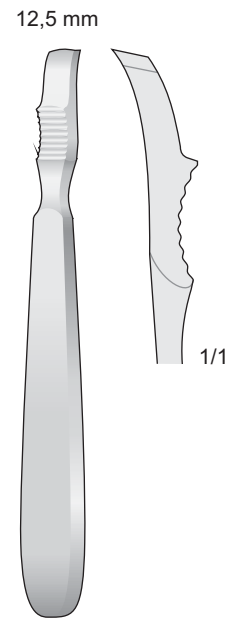

FARABEU
0610-CFB
150 mm

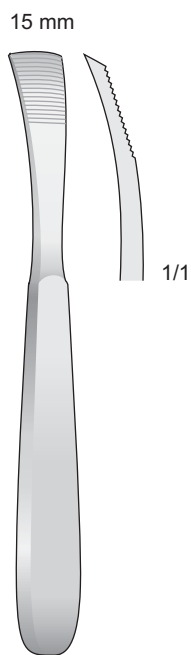

JANSEN
0610-CFF
165 mm

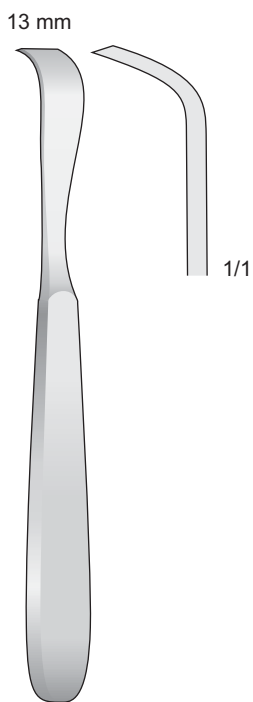

SCHNEIDER
0610-CFI
175 mm

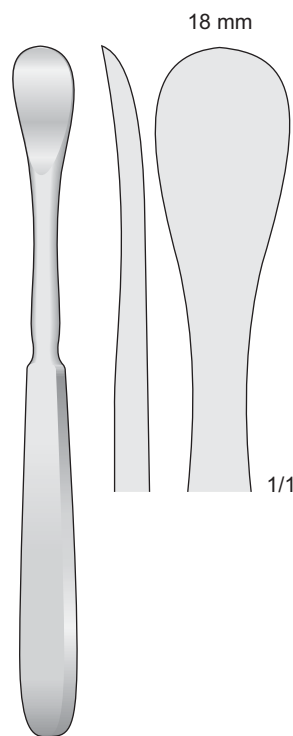

SEDILLOT
0610-CFE
185 mm

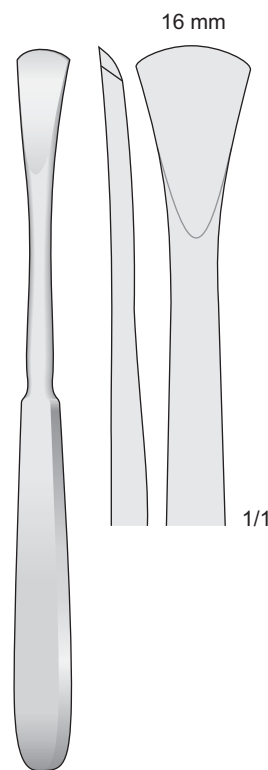

LANGENBECK
0610-CFG
190 mm

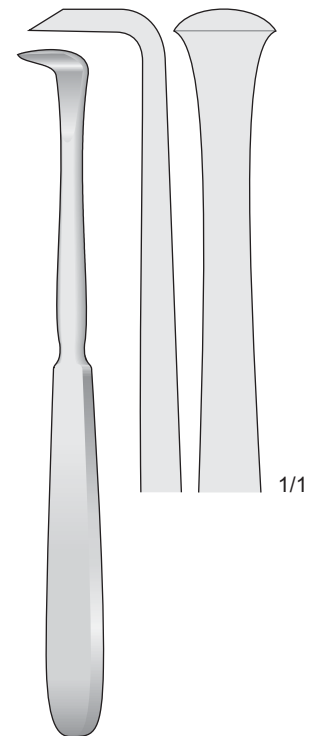

LANGENBECK
0610-CFH
180 mm

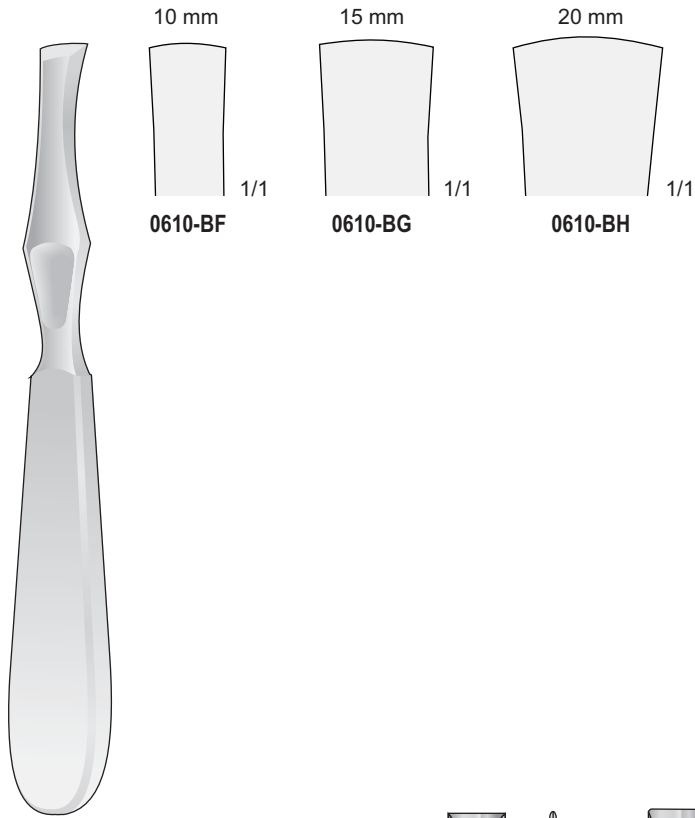

LAMBOTTE
0610-BF/0610-BH
205 mm

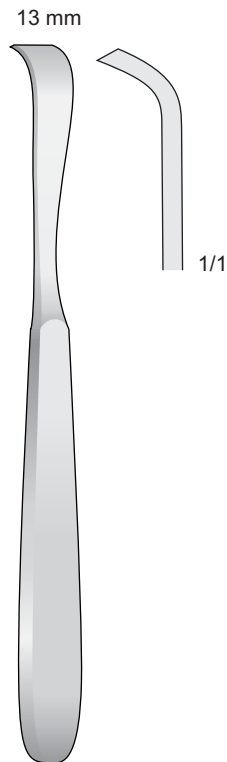

SCHNEIDER-SAUERBRUCH
0610-CFL
190 mm

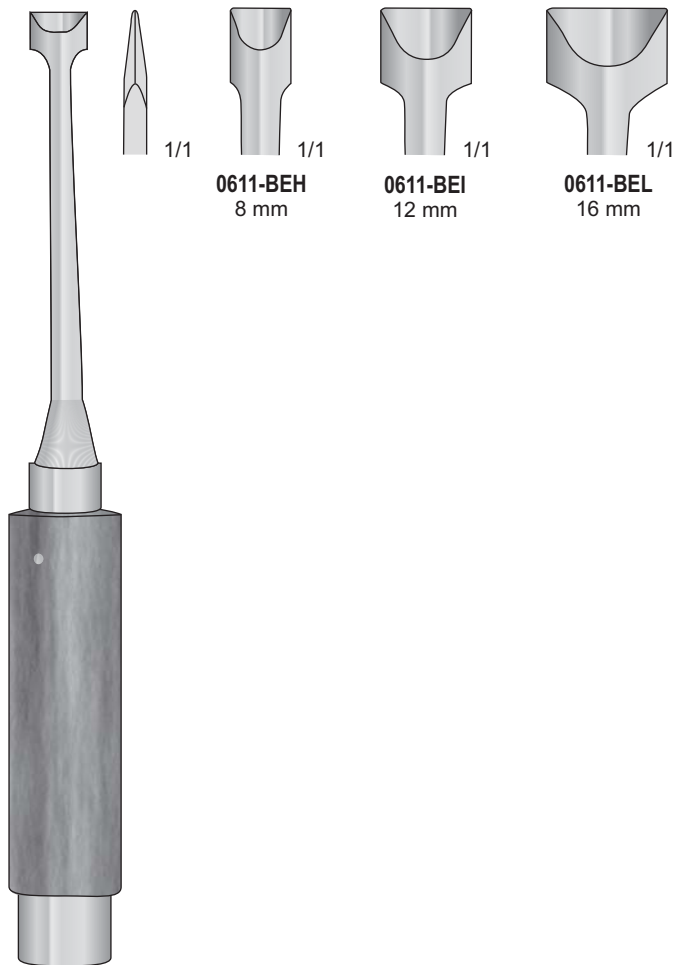

OBWEGESER
0611-BEH/0611-BEL
220 mm

Mit Ferrozellgriff
 With Ferrozell handle
 Con manico Ferrozell
 Con mango de Ferrozell
 Avec poignée en Ferrozell



0610-CDE
180 mm



0610-CDA
190 mm



0610-CDC
190 mm

Mit Ferrozellgriff
 With Ferrozell handle
 Con manico Ferrozell
 Con mango de Ferrozell
 Avec poignée en Ferrozell

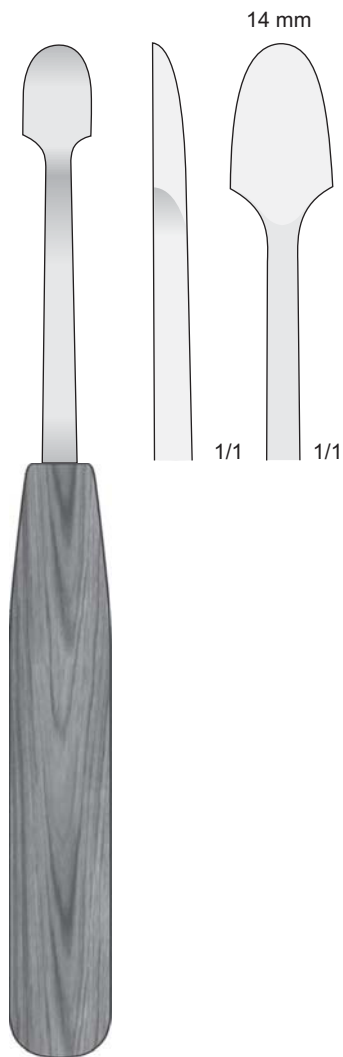

0610-CDG
200 mm

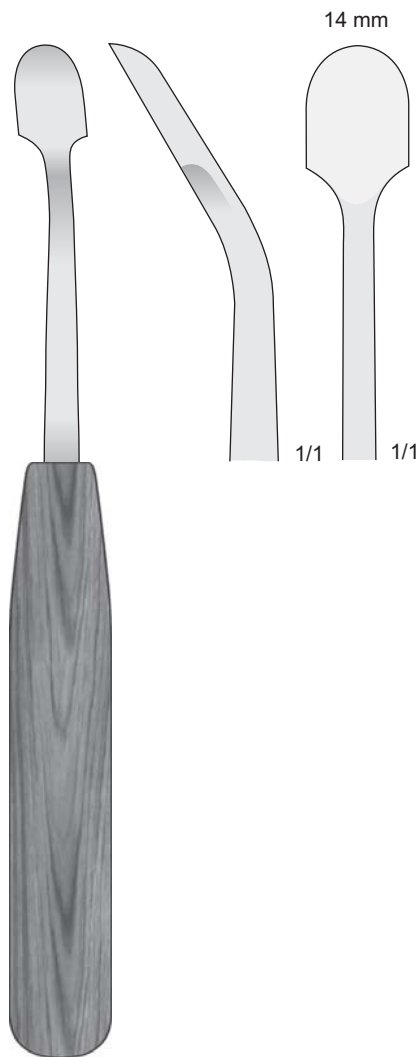

0610-CDI
200 mm

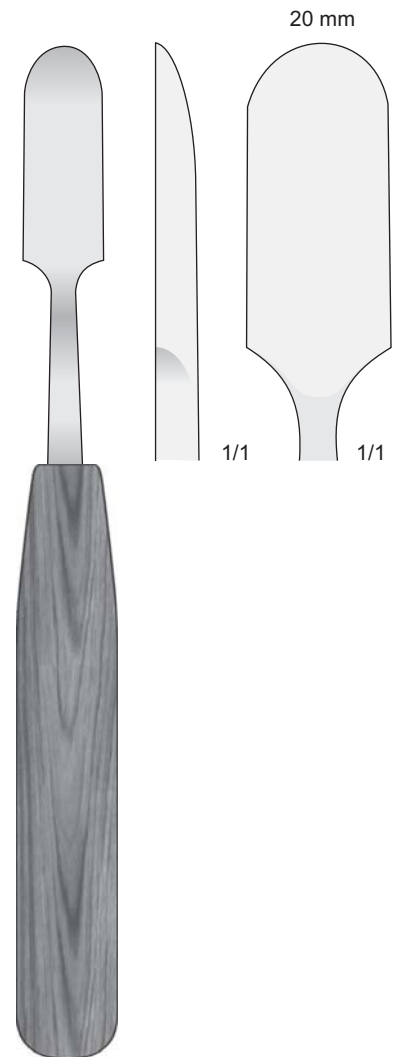

0610-CEA
200 mm

Mit Ferrozellgriff
 With Ferrozell handle
 Con manico Ferrozell
 Con mango de Ferrozell
 Avec poignée en Ferrozell

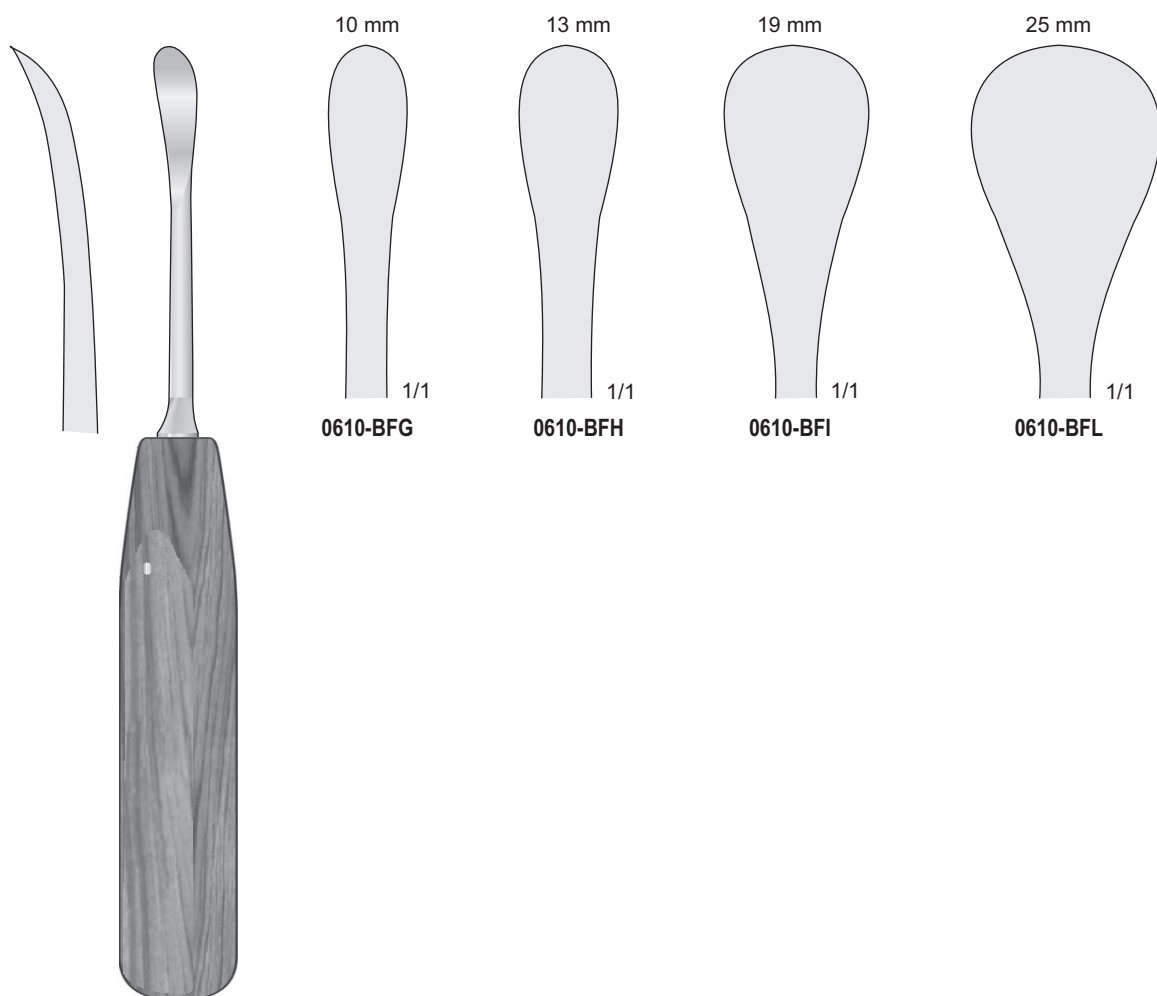

COBB
 0610-BFG/0610-BFL
 250 mm

Knochenfeilen

Bone files

Lime per osso

Limas para huesos

Limes à os

Fig. 67

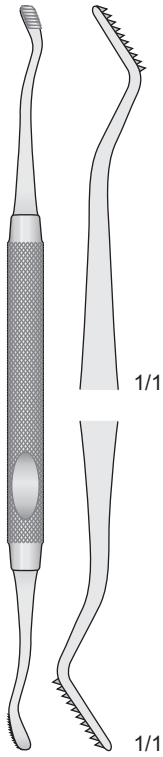

HOWARD
0414-B
180 mm

Fig. 45

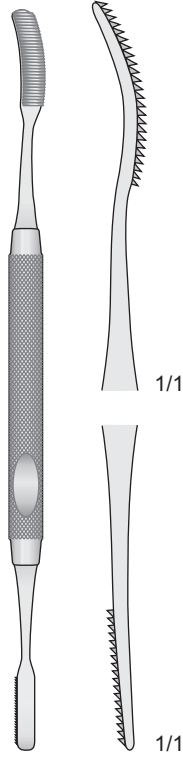

MILLER
0414-C
185 mm

Fig. 52

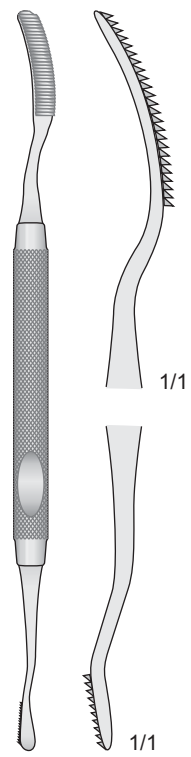

MILLER
0414-D
180 mm

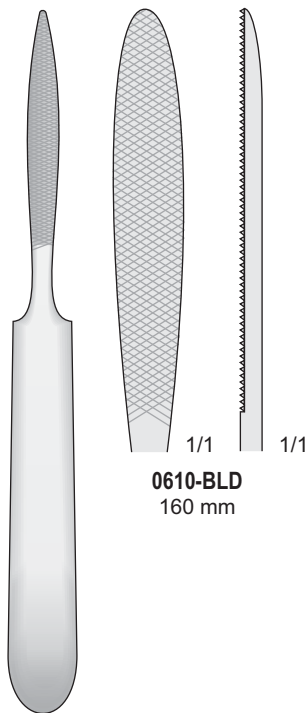

JOSEPH
0610-BLD
160 mm

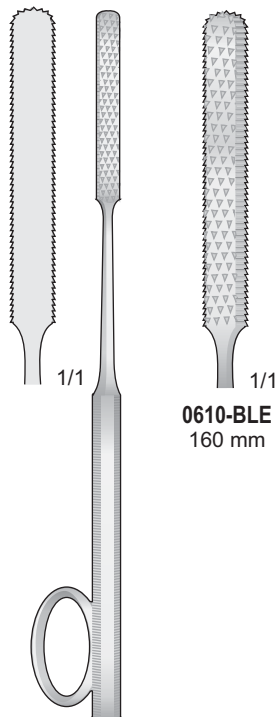

GALLAHER
0610-BLE/0610-BLG
160 mm

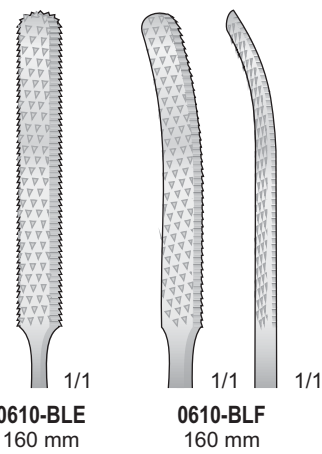

0610-BLE
160 mm

0610-BLF
160 mm

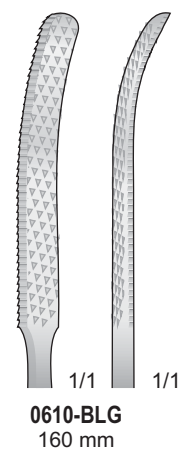

0610-BLG
160 mm

Knochenfeilen

Bone files

Lime per osso

Limas para huesos

Limes à os

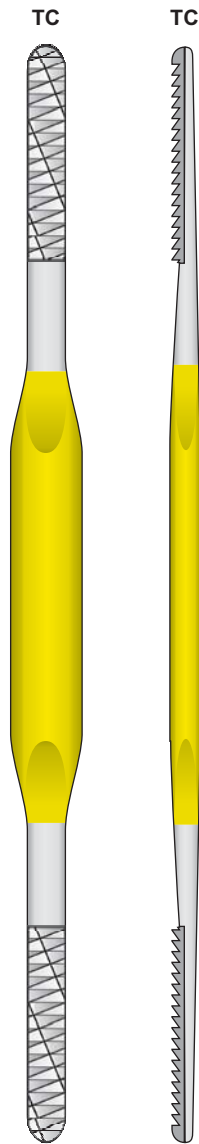

FOMON
0414-HL/0414-ID
200 mm

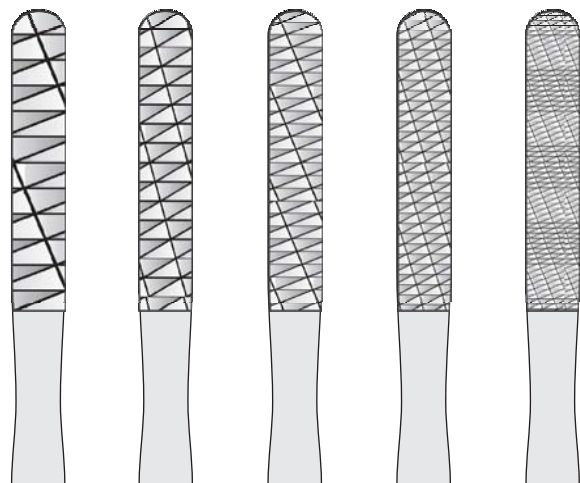

1

3

5

7

9

2

4

6

8

10

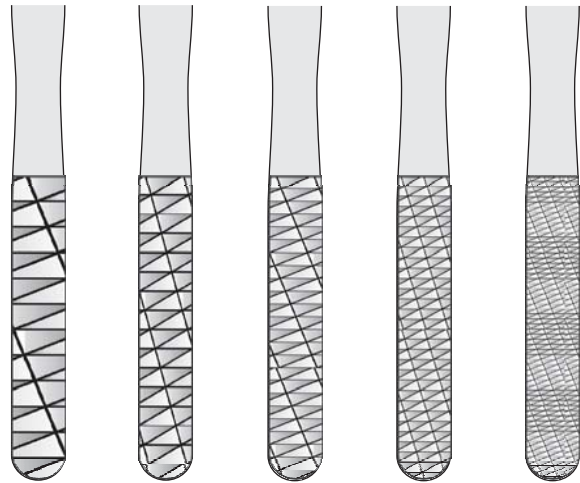

0414-HL

0414-IA

0414-IB

0414-IC

0414-ID

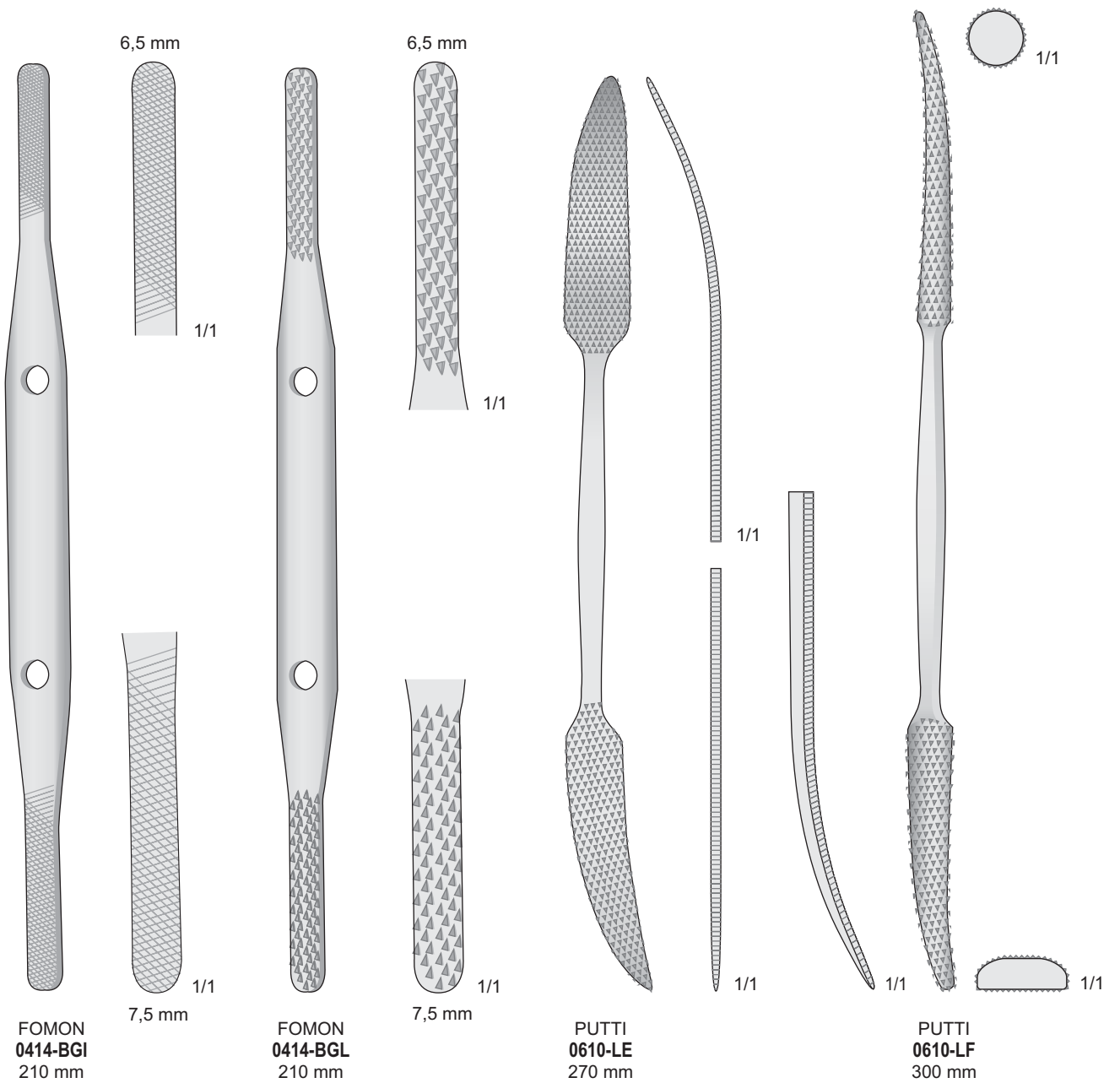

Knochenfeilen

Bone files

Lime per osso

Limas para huesos

Limes à os



0610-IF
295 mm

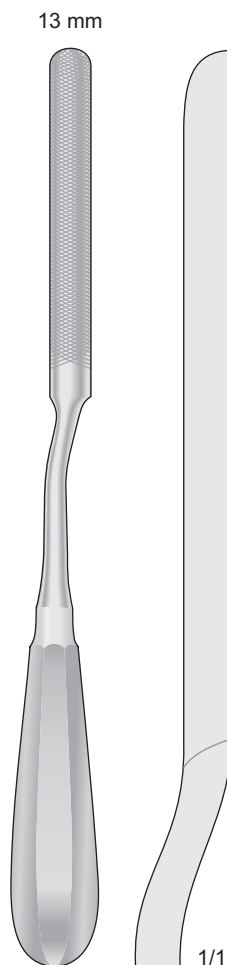

0610-IG
240 mm

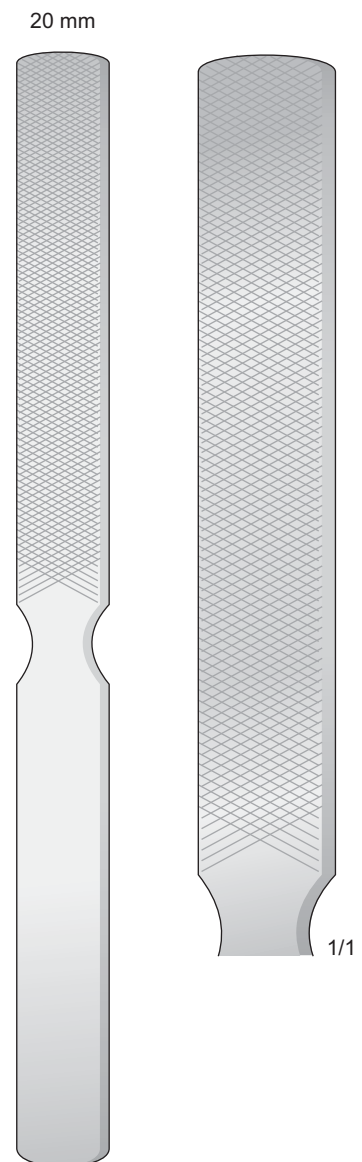

0610-BBL
220 mm

Scharfe Löffel

Sharp currettes

Curette, Cucchiai taglienti

Cucharillas cortantes

Currettes tranchantes

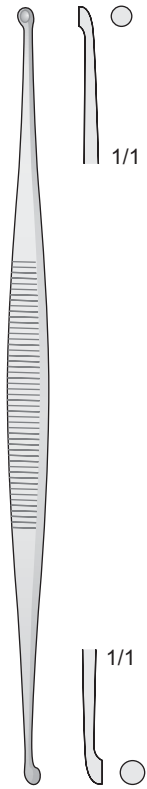

MARTINI
0610-HA
140 mm

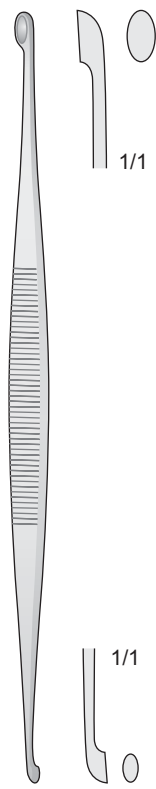

WILLIGER
0610-HB
145 mm

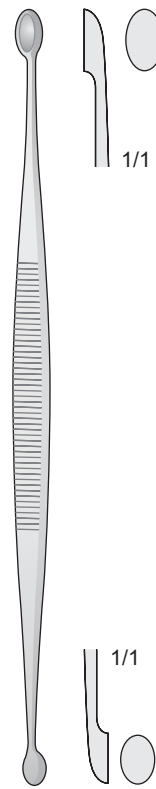

JACOBSON
0610-HF
140 mm

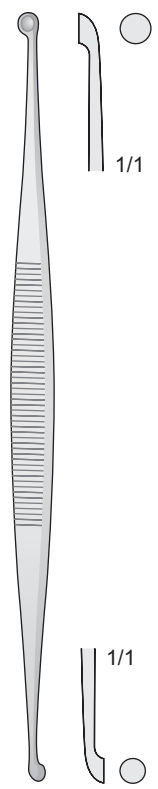

MARTINI
0610-HG
140 mm

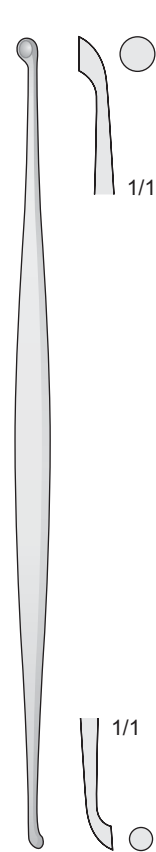

JANSEN
0610-HH
160 mm

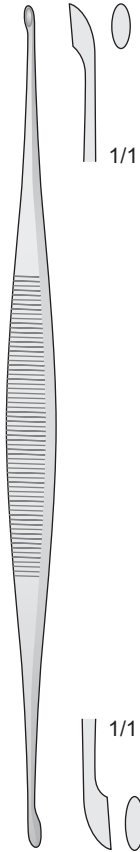

BARTH
0610-HI
180 mm

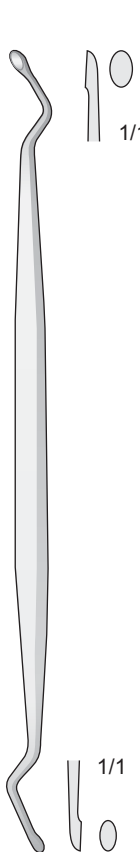

0610-ID
160 mm

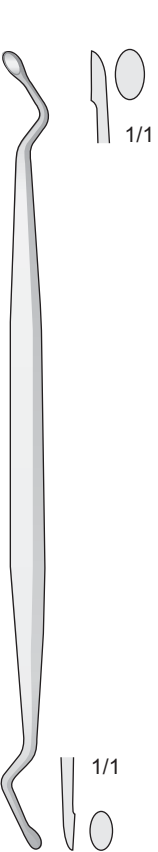

JANSEN
0610-IE
160 mm

Scharfe Löffel

Sharp curettes

Curette, Cucchiali taglienti

Cucharillas cortantes

Curettes tranchantes

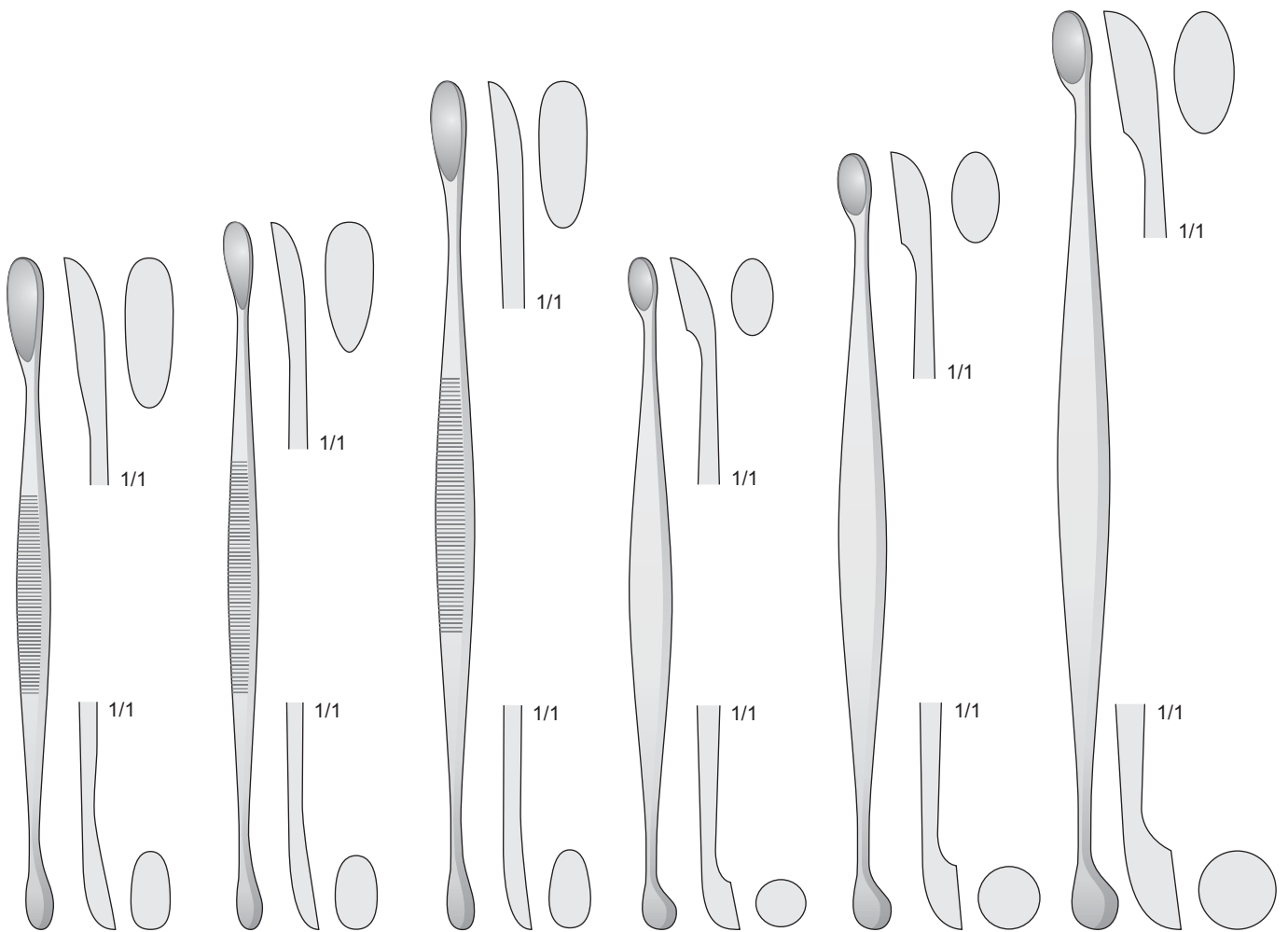

VOLKMANN
0610-HL
130 mm

VOLKMANN
0610-HC
145 mm

VOLKMANN
0610-HD
170 mm

0610-BHH
130 mm

0610-HE
160 mm

0610-BHI
200 mm

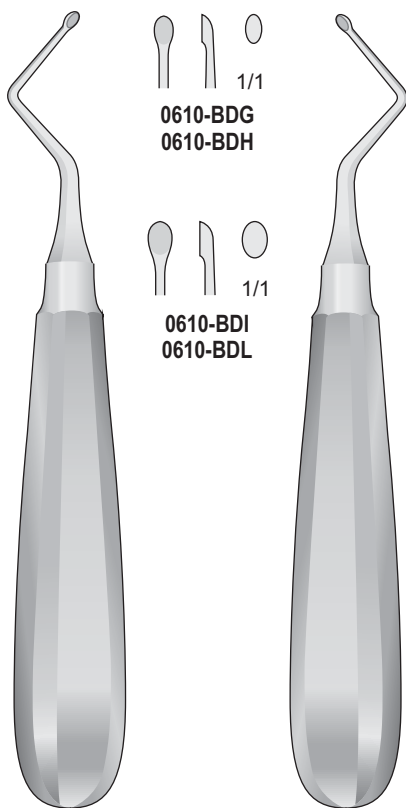

KERPEL
0610-BDG
0610-BDI
145 mm

KERPEL
0610-BDH
0610-BDL
145 mm

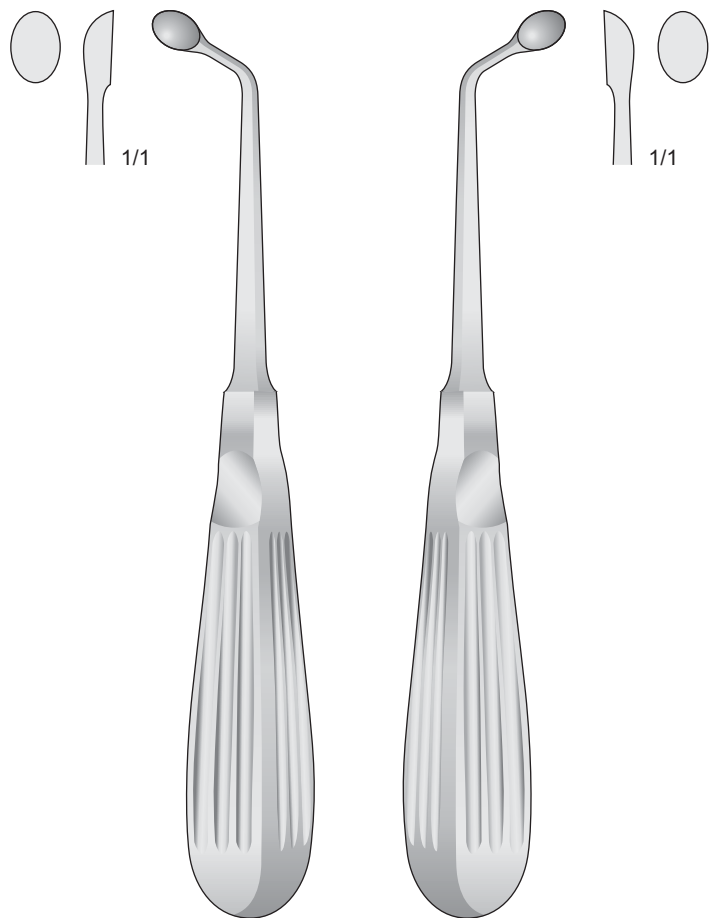

UFFENDORDE
0610-BII
170 mm

UFFENDORDE
0610-BIL
170 mm

Scharfe Löffel

Sharp cures

Curette, Cucchiari taglienti

Cucharillas cortantes

Curettes tranchantes

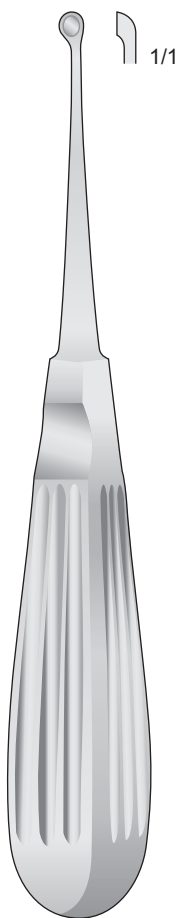

BRUNS
0610-BBA/0610-BBG
165 mm

Fig.000 3 mm	Fig.00 4 mm	Fig.0 5 mm
0610-BBA	0610-BBB	0610-BBC
Fig.1 6 mm	Fig.2 8 mm	
0610-BBD	0610-BBE	
Fig.3 10 mm	Fig.4 12 mm	
0610-BBF	0610-BBG	

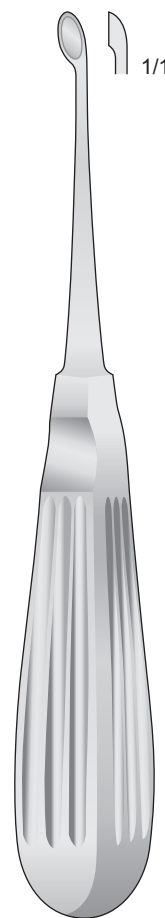

SCHEDE
0610-BCA/0610-BCG
170 mm

Fig.000 2,5 mm	Fig.00 3,4 mm	Fig.0 4,2 mm
0610-BCA	0610-BCB	0610-BCC
Fig.1 5,2 mm	Fig.2 6,3 mm	
0610-BCD	0610-BCE	
Fig.3 7,4 mm	Fig.4 8 mm	
0610-BCF	0610-BCG	

Scharfe Löffel

Sharp currettes

Curette, Cucchiari taglienti

Cucharillas cortantes

Currettes tranchantes

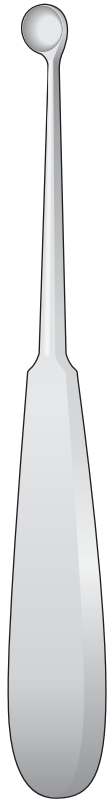

0610-AB/0610-AI
180 mm

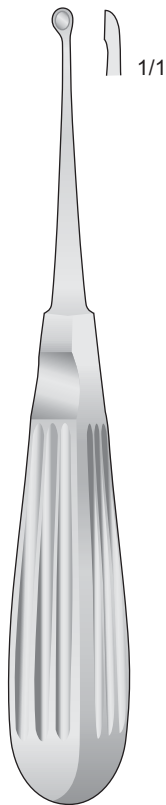
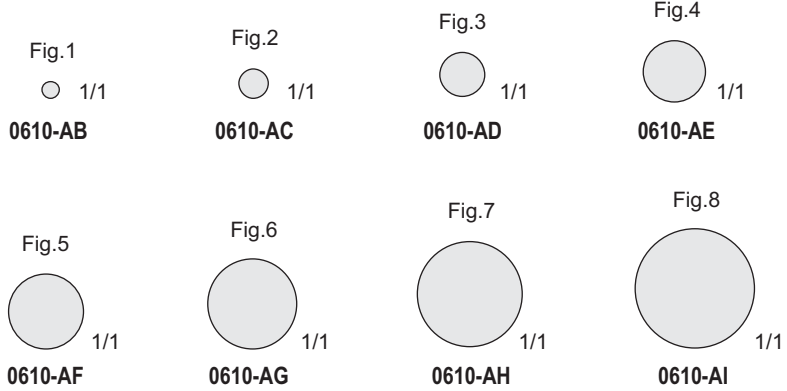

VOLKMANN
0610-GA/0610-GL
170 mm

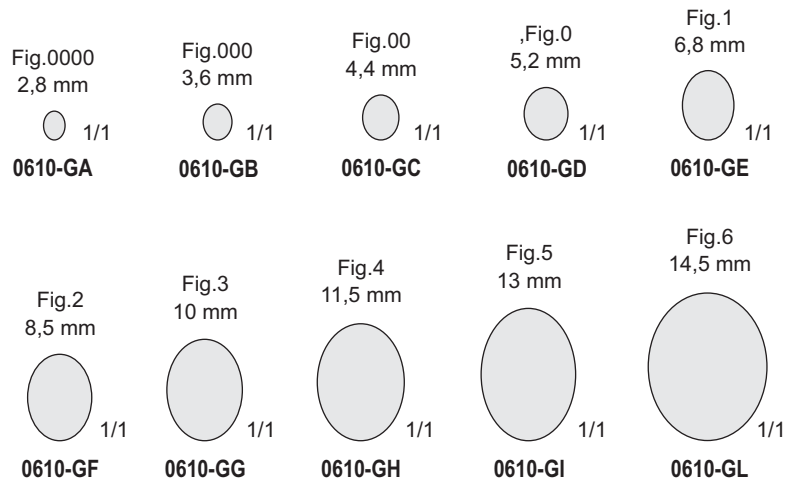

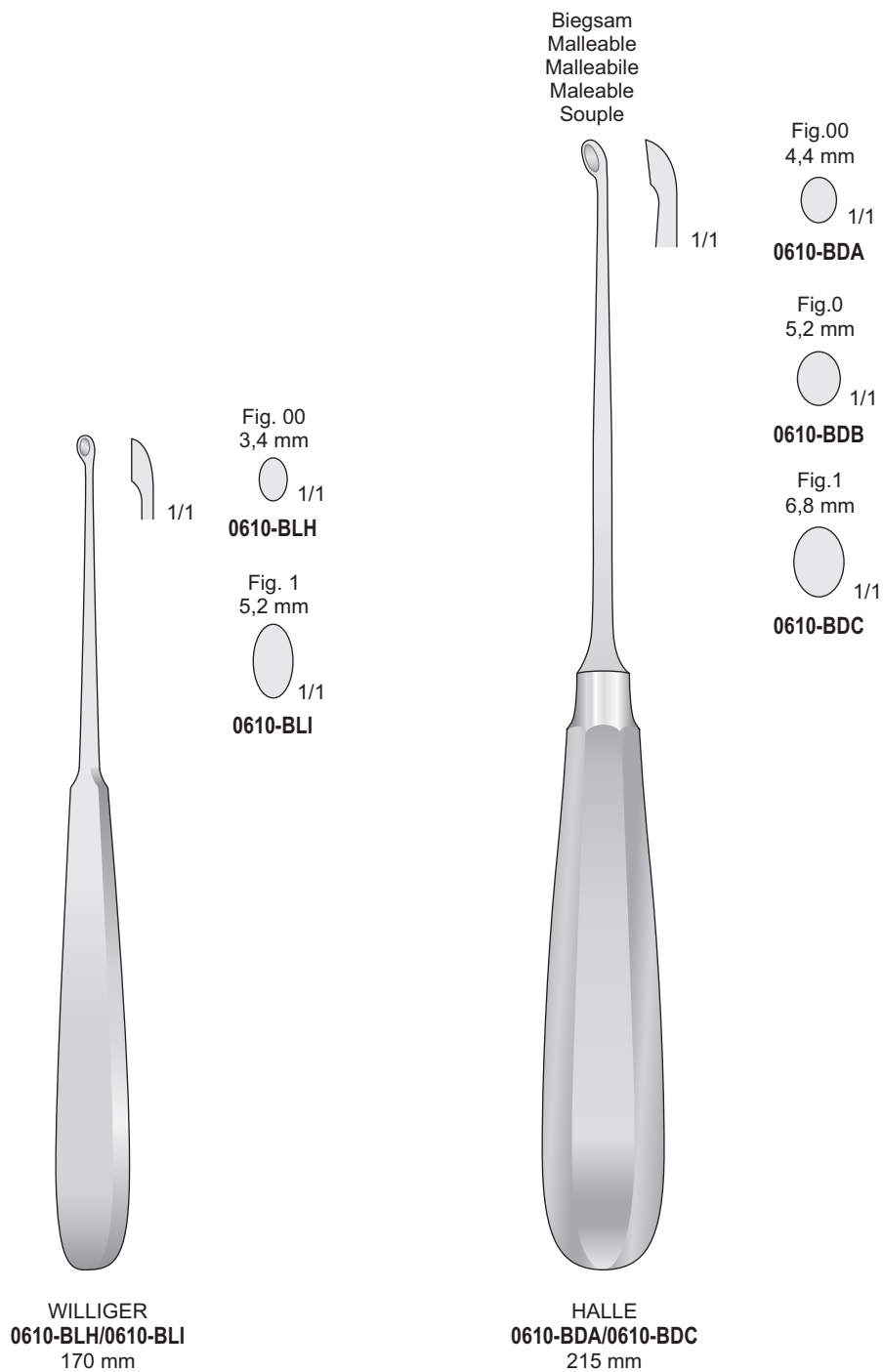

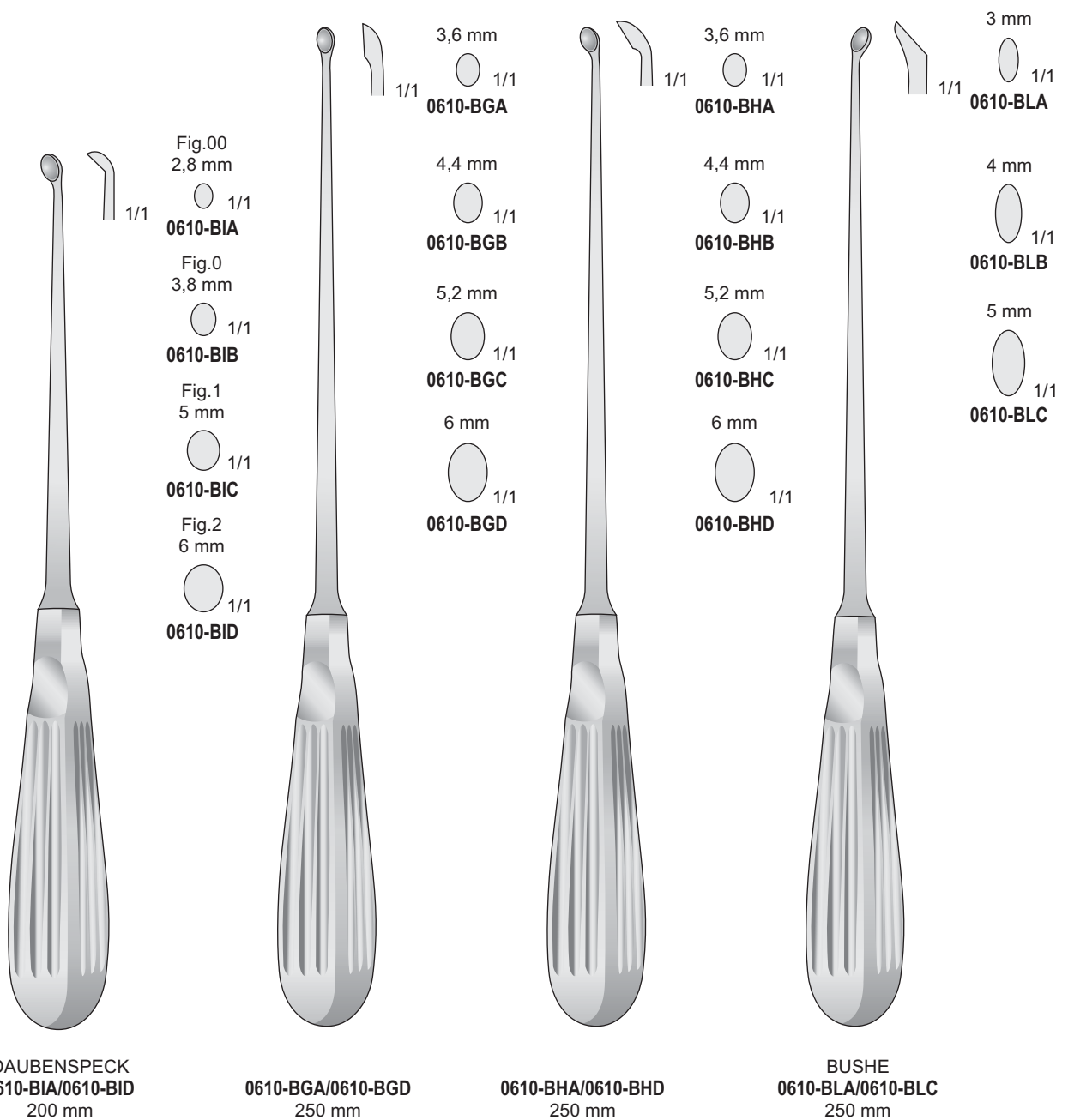

Scharfe Löffel

Sharp currettes

Curette, Cucchiari taglienti

Cucharillas cortantes

Currettes tranchantes

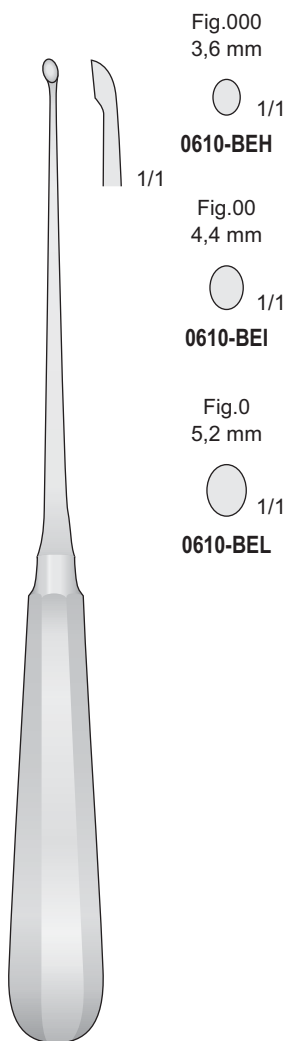

SIMON
0610-BEH/0610-BEL
235 mm

- Fig.000
3,6 mm
1/1
0610-BEH
- Fig.00
4,4 mm
1/1
0610-BEI
- Fig.0
5,2 mm
1/1
0610-BEL

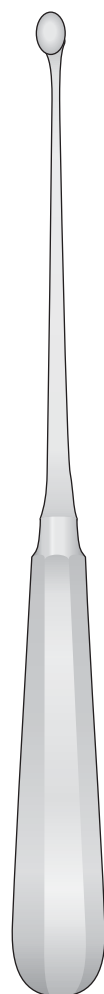

SIMON
0610-BEA/0610-BEF
240 mm

- Fig.1
6,8 mm
1/1
0610-BEA
- Fig.2
8,5 mm
1/1
0610-BEB
- Fig.3
10 mm
1/1
0610-BEC
- Fig.4
11,5 mm
1/1
0610-BED
- Fig.5
13 mm
1/1
0610-BEE
- Fig.6
14,5 mm
1/1
0610-BEF

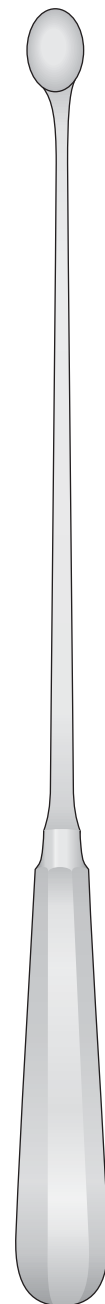

SCHRÖDER
0610-BFA/0610-BFF
310 mm

- Fig.1
6,8 mm
1/1
0610-BFA
- Fig.2
8,5 mm
1/1
0610-BFB
- Fig.3
10 mm
1/1
0610-BFC
- Fig.4
11,5 mm
1/1
0610-BFD
- Fig.5
13 mm
1/1
0610-BFE
- Fig.6
14,5 mm
1/1
0610-BFF

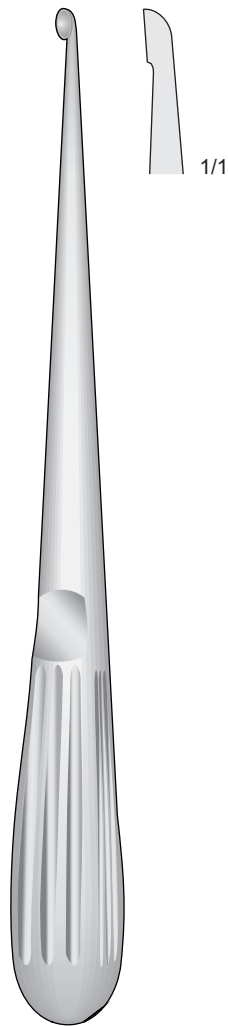

BRUNS
0610-CIA/0610-CLA
170 mm

Fig.5/0
2,2 mm



1/1

0610-CIA

Fig.4/0
2,5 mm



1/1

0610-CIB

Fig.3/0
2,8 mm



1/1

0610-CIC

Fig.2/0
3,3 mm



1/1

0610-CID

Fig.0
3,6 mm



1/1

0610-CIE

Fig.1
4,3 mm



1/1

0610-CIF

Fig.2
4,8 mm



1/1

0610-CIG

Fig.3
5,6 mm



1/1

0610-CIH

Fig.4
6,0 mm



1/1

0610-CII

Fig.5
6,7 mm



1/1

0610-CIL

Fig.6
8,8 mm



1/1



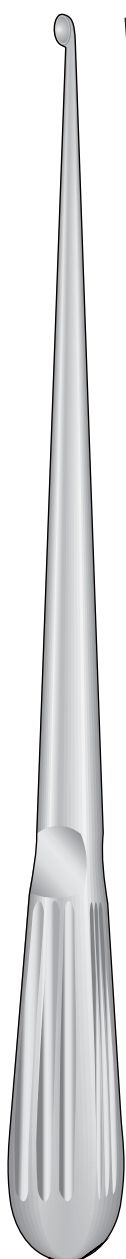





0610-CLA



BRUNS
0610-CLB/0610-CLL
225 mm



1/1



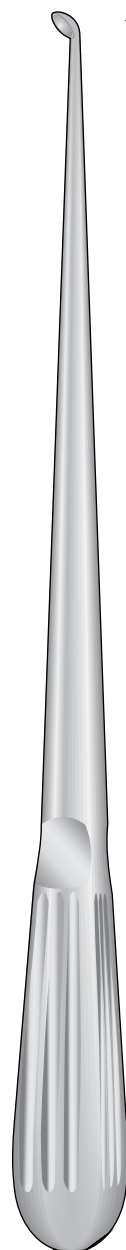





Fig.3/0 2,8 mm  1/1 0610-CLB	Fig.2/0 3,3 mm  1/1 0610-CLC	Fig.0 3,6 mm  1/1 0610-CLD
Fig.1 4,3 mm  1/1 0610-CLE	Fig.2 4,8 mm  1/1 0610-CLF	Fig.3 5,6 mm  1/1 0610-CLG
Fig.4 6,0 mm  1/1 0610-CLH	Fig.5 6,7 mm  1/1 0610-CLI	Fig.6 8,8 mm  1/1 0610-CLL



BRUNS
0610-DAA/0610-DAI
225 mm



1/1

Fig.3/0 2,8 mm  1/1 0610-DAA	Fig.2/0 3,3 mm  1/1 0610-DAB	Fig.0 3,6 mm  1/1 0610-DAC
Fig.1 4,3 mm  1/1 0610-DAD	Fig.2 4,8 mm  1/1 0610-DAE	Fig.3 5,6 mm  1/1 0610-DAF
Fig.4 6,0 mm  1/1 0610-DAG	Fig.5 6,7 mm  1/1 0610-DAH	Fig.6 8,8 mm  1/1 0610-DAI

Mit Ferrozellgriff - With Ferrozell handle
 Con manico Ferrozell - Con mango de Ferrozell
 Avec poignée en Ferrozell

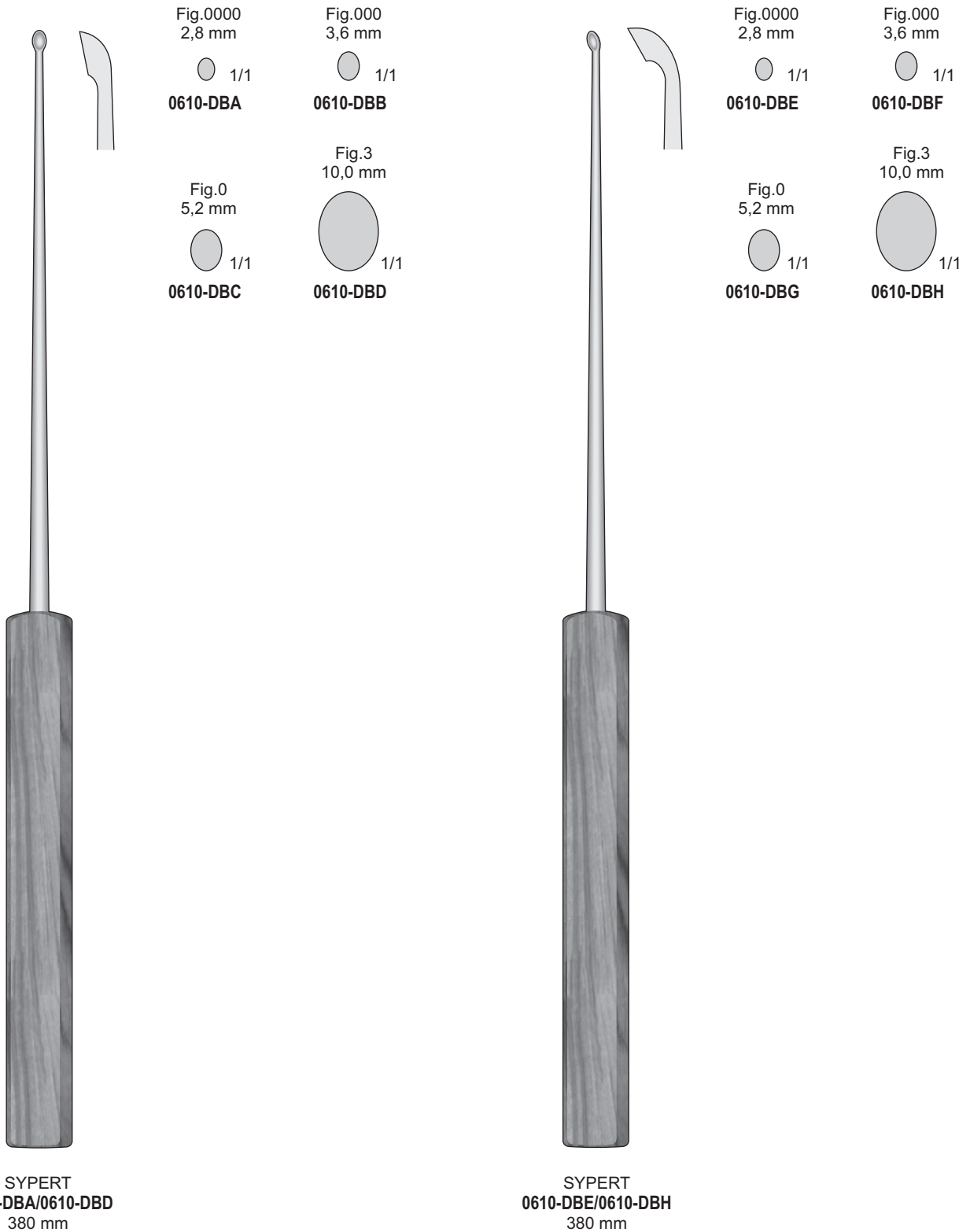

Scharfe Löffel

Sharp currettes

Curette, Cucchiari taglienti

Cucharillas cortantes

Currettes tranchantes

Mit Ferrozellgriff - With Ferrozell handle
 Con manico Ferrozell - Con mango de Ferrozell
 Avec poignée en Ferrozell

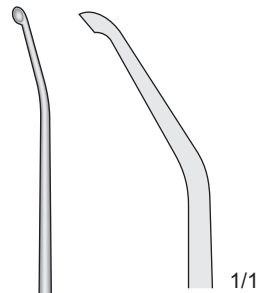

Fig.0000
2,8 mm

1/1
0610-DBI

Fig.000
3,6 mm

1/1
0610-DBL



SYPERT
0610-DBI/0610-DBL
420 mm

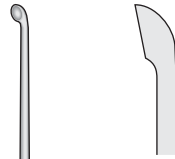

Fig.000
3,6 mm

1/1
0610-DCA

Fig.00
4,4 mm

1/1
0610-DCB

Fig.0
5,2 mm

1/1
0610-DCC

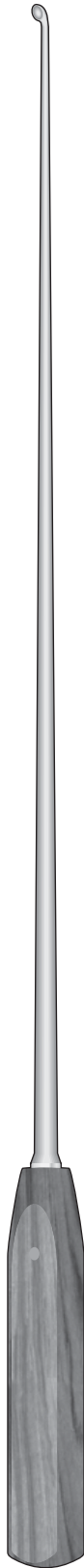

0610-DCA/0610-DCC
410 mm

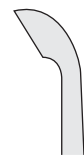

Fig.000
3,6 mm

1/1
0610-DCD

Fig.00
4,4 mm

1/1
0610-DCE

Fig.0
5,2 mm

1/1
0610-DCF

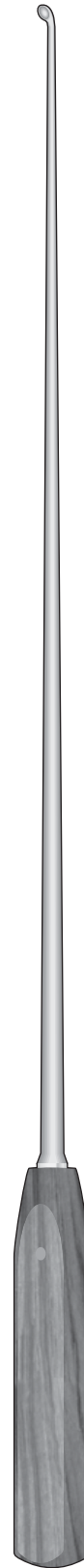

0610-DCD/0610-DCF
410 mm

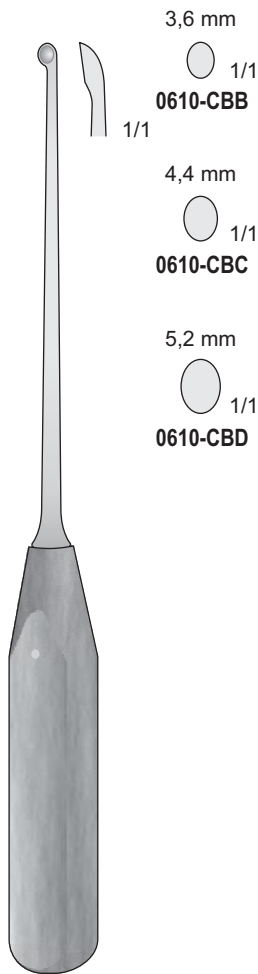

CASPAR
0610-CBB/0610-CBD
220 mm

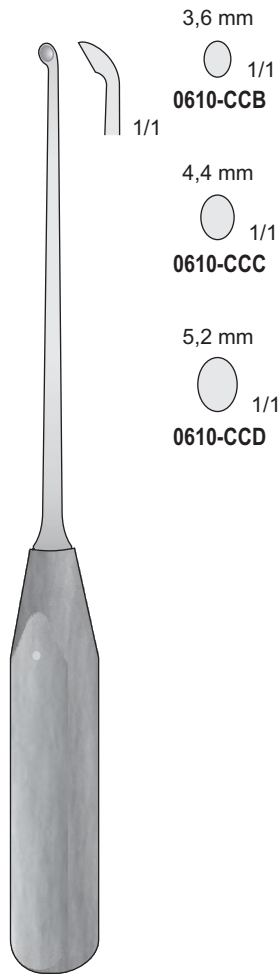

CASPAR
0610-CCB/0610-CCD
220 mm

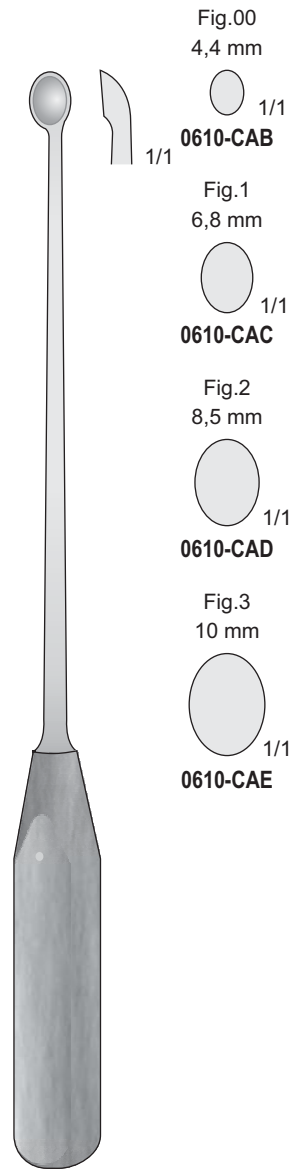

0610-CAB/0610-CAE
270 mm

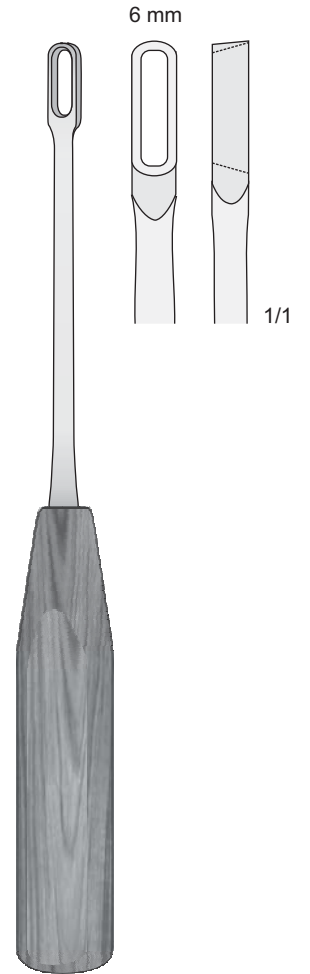

TESSIER
0611-BLI
220 mm

Femoral prosthesis instrumentation
 Strumentario per protesi femorale
 Instruments pour prothese femorale

Mit Ferrozellgriff
 With Ferrozell handle
 Con manico Ferrozell
 Con mango de Ferrozell
 Avec poignée en Ferrozell

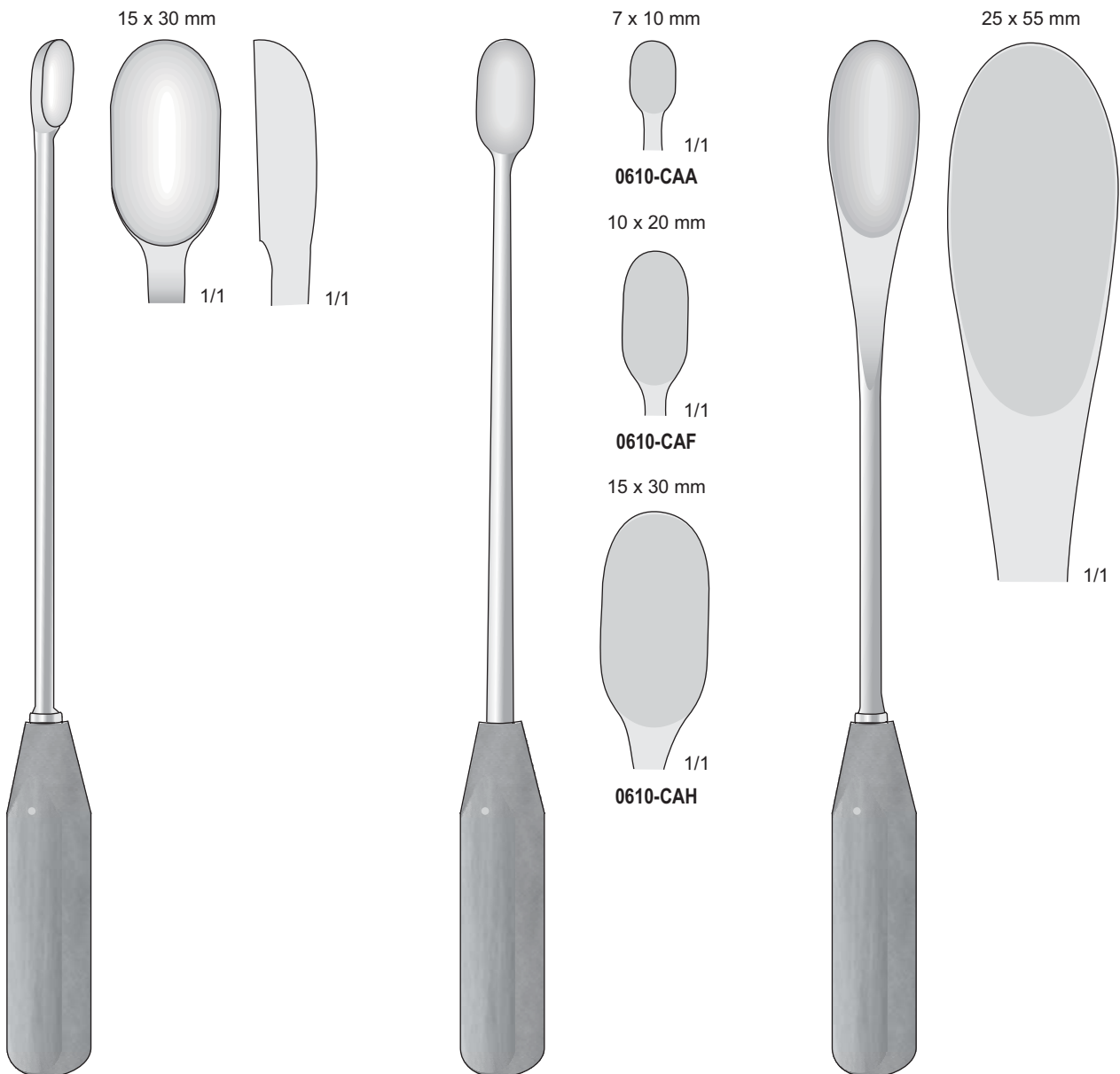

0610-CAG
300 mm

0610-CAA/0610-CAH
300 mm

0610-CAI
300 mm



ideal-tek

manufacturer & supplier of precision instruments 

Chirurgische Hämmer

Surgical mallets

Martelli chirurgici

Martillos quirurgicos

Maillets chirurgicaux

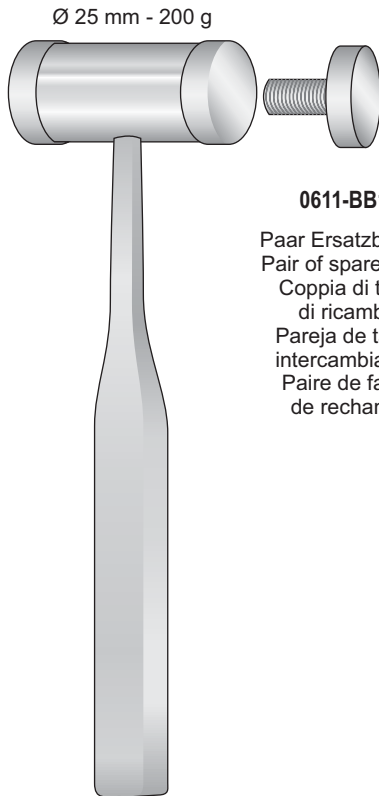

0611-BB17

Paar Ersatzbacken
Pair of spare faces
Coppia di teste
di ricambio
Pareja de tapas
intercambiables
Paire de faces
de rechange

MEAD
0611-BB
200 mm

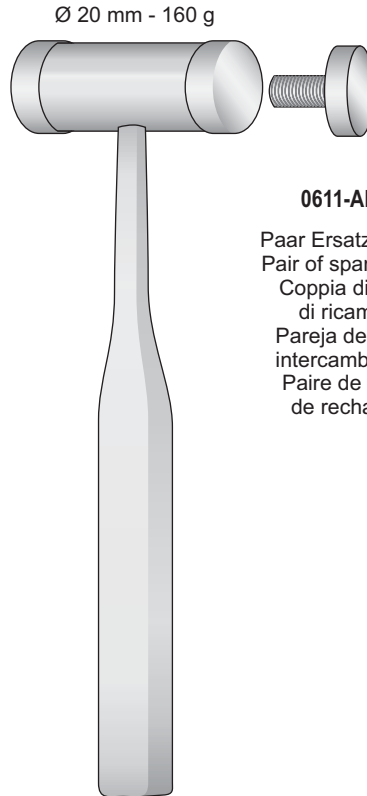

0611-AL17

Paar Ersatzbacken
Pair of spare faces
Coppia di teste
di ricambio
Pareja de tapas
intercambiables
Paire de faces
de rechange

MEAD
0611-AL
190 mm

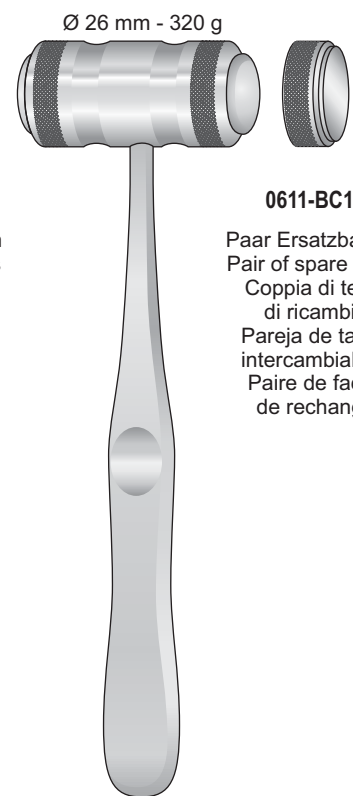

0611-BC17

Paar Ersatzbacken
Pair of spare faces
Coppia di teste
di ricambio
Pareja de tapas
intercambiables
Paire de faces
de rechange

MEAD
0611-BC
190 mm



0611-AB
165 mm

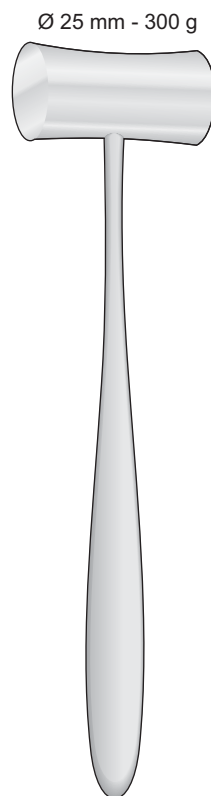

LUCAE
0611-BA12
190 mm

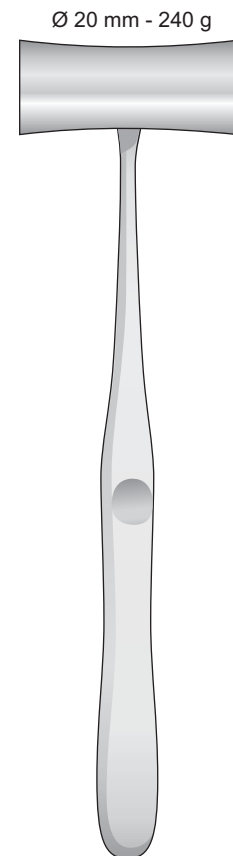

WILLIGER
0611-AC
240 mm

1 Seite flach - 1 Seite convex
 1 Side flat - 1 Side convex
 1 Lato piatto - 1 Lato convesso
 1 Parte plana - 1 Parte convexe
 1 Face plate - 1 Face convexe

Ø 30 mm - 240 g

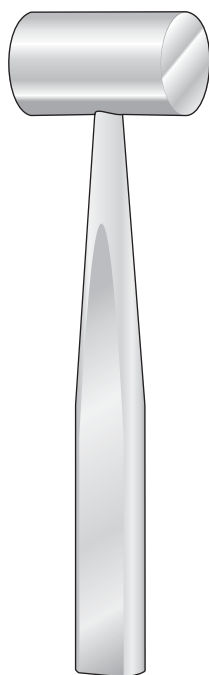

COTTLE
0611-BAE
 185 mm

Ø 30 mm - 300 g



BERGMANN
0611-BAF
 235 mm

Ø 45 mm - 300 g



BERGMANN
0611-BAG
 245 mm



0611-BAH
240 mm



OMBREDANNE
0611-BAI
240 mm



HEATH
0611-BAL
185 mm

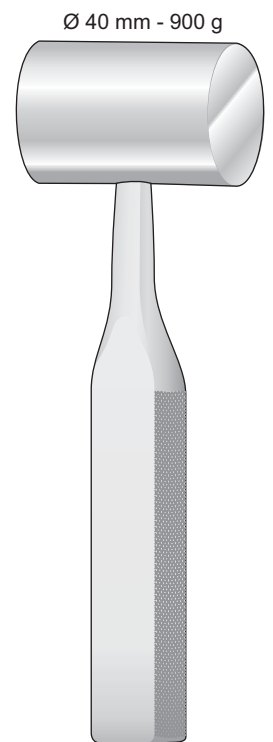

0611-BBC
190 mm

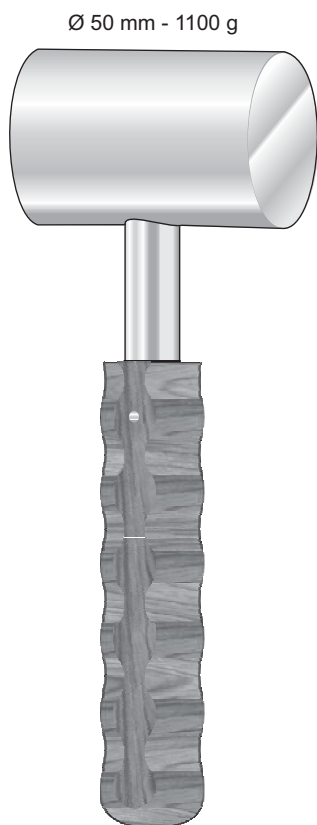

0611-BBB
200 mm

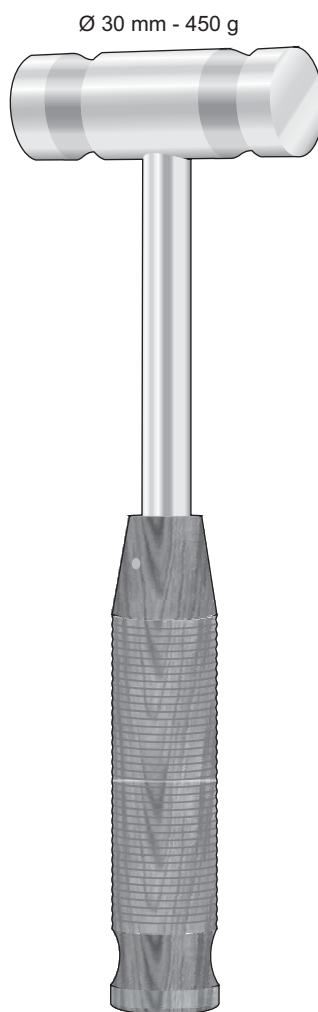

0611-AG
260 mm

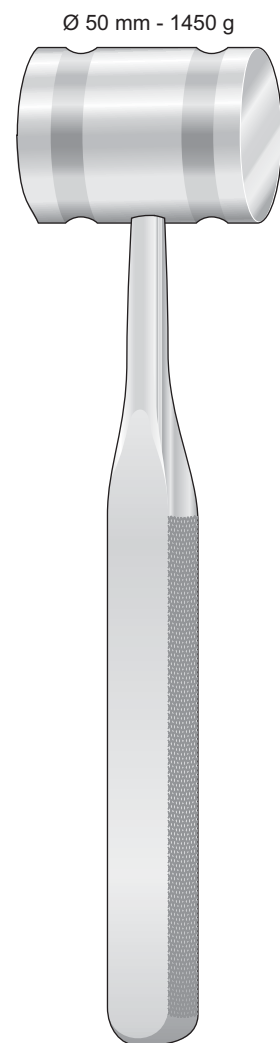

0611-BBD
270 mm

Stössel

Tampers

Battitori

Batidor

Pilons



-  **0606-BEH**
Ø3 mm
-  **0606-BEI**
Ø5 mm
-  **0606-BEL**
Ø8 mm

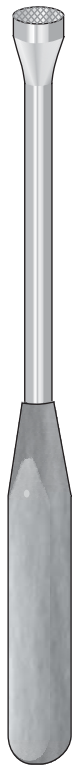

CASPAR
0606-BEH/0606-BEL
200 mm

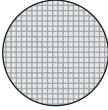
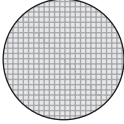

-  **0611-CFD**
Ø12 mm
-  **0611-CFE**
Ø14 mm
-  **0611-CFF**
Ø16 mm

0611-CFD/0611-CFF
200 mm

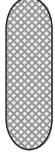

-  **0611-CFG**
3x8 mm
-  **0611-CFH**
4x10 mm
-  **0611-CFI**
5x15 mm
-  **0611-CFL**
6x20 mm

SYPERT
0611-CFG/0611-CFL
290 mm

Osteotome - Stosel

Osteotomi - Battitori

Osteotomes - Tampers

Ostèotomes - Pilons

Osteòtomos - Batidor

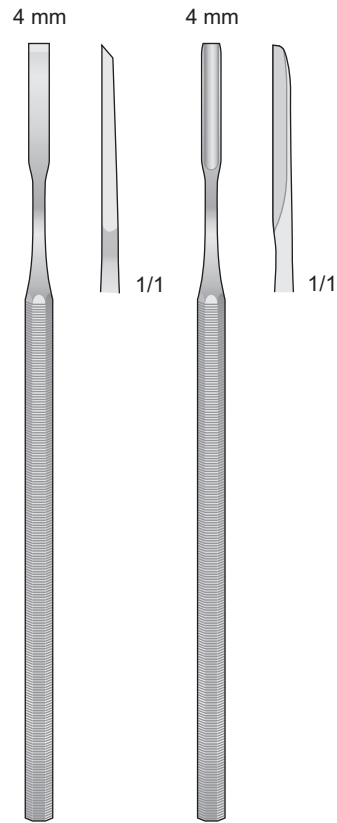

BUCKLEY
1907-EA
160 mm

BUCKLEY
1907-EB
160 mm

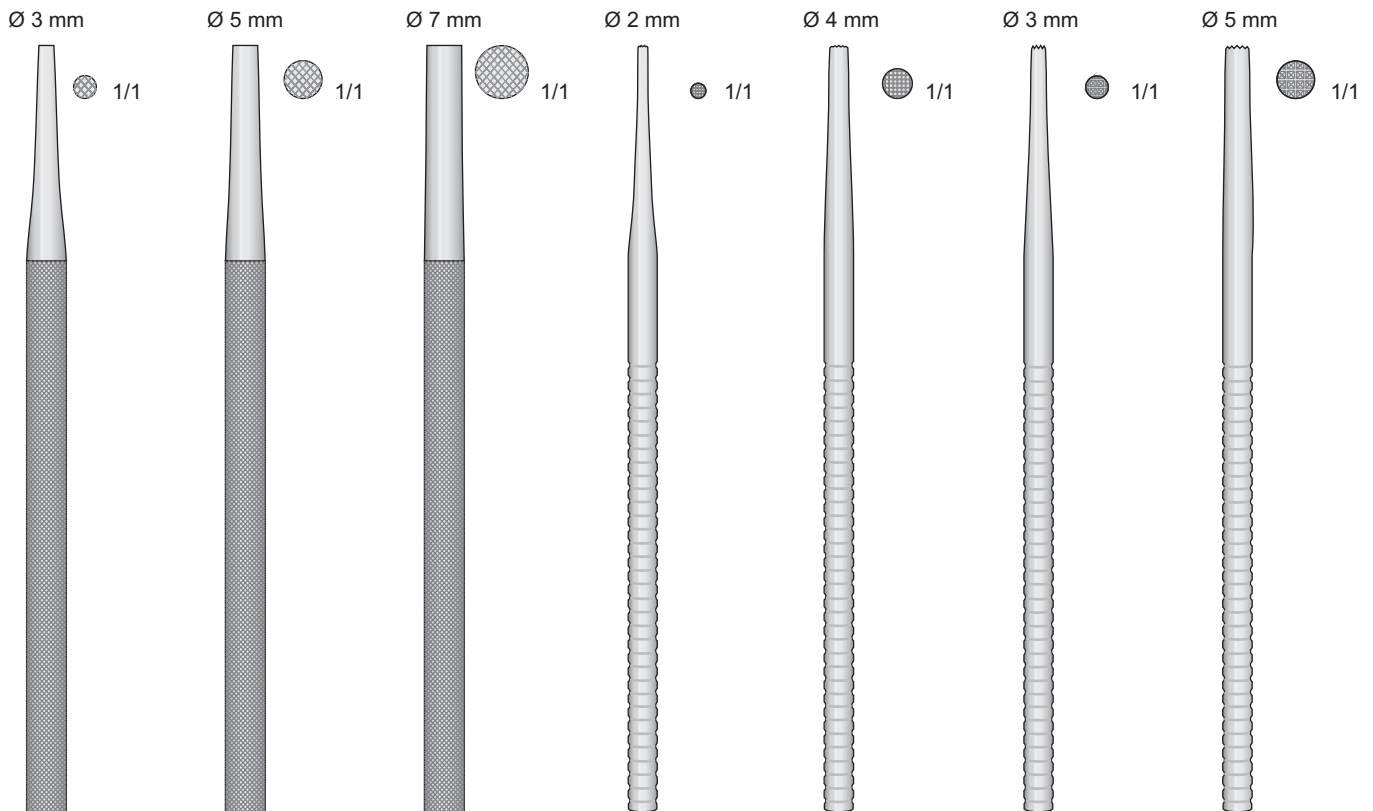

0611-CA
155 mm

0611-CB
155 mm

0611-CC
155 mm

0611-DA
155 mm

0611-DB
155 mm

0611-DD
155 mm

0611-DF
155 mm

Osteotome -Osteotomes
Osteotomi - Osteótomos - Ostéotomes

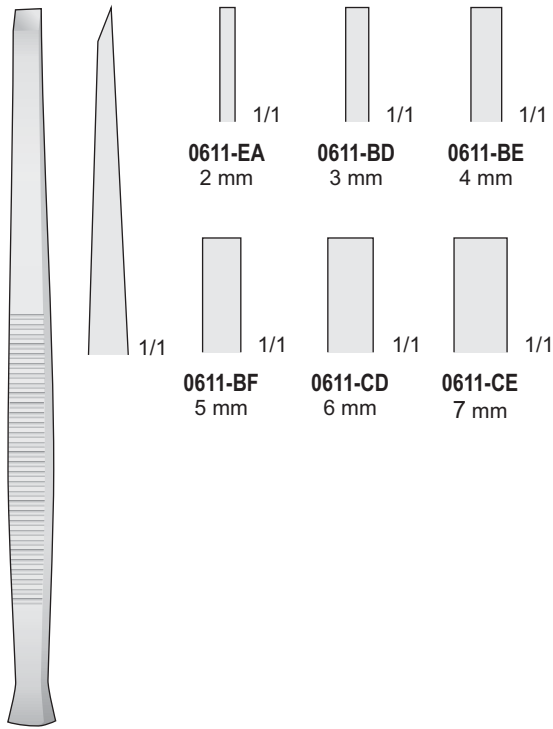

PARTSCH
0611-BD/0611-EA
140 mm

Hohlmeissel - Gouges
Sgorbie - Gubias - Gouges

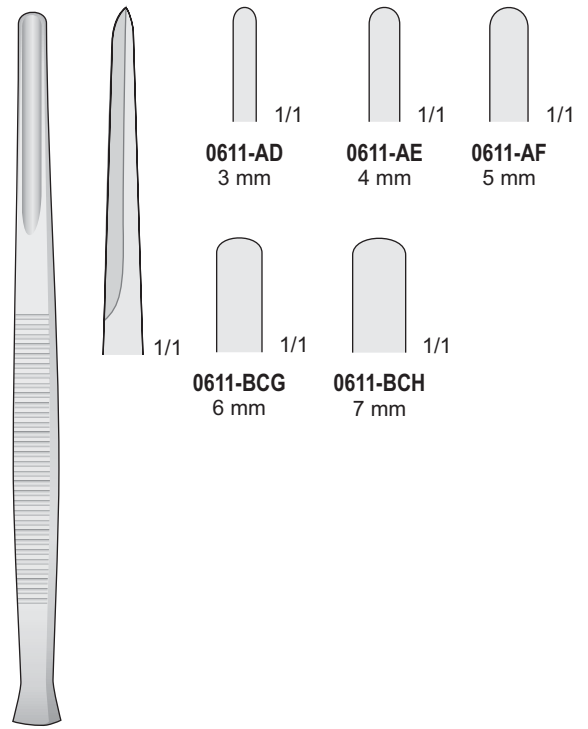

PARTSCH
0611-AD/0611-BCH
140 mm

Osteotome -Osteotomes
Osteotomi - Osteótomos - Ostéotomes

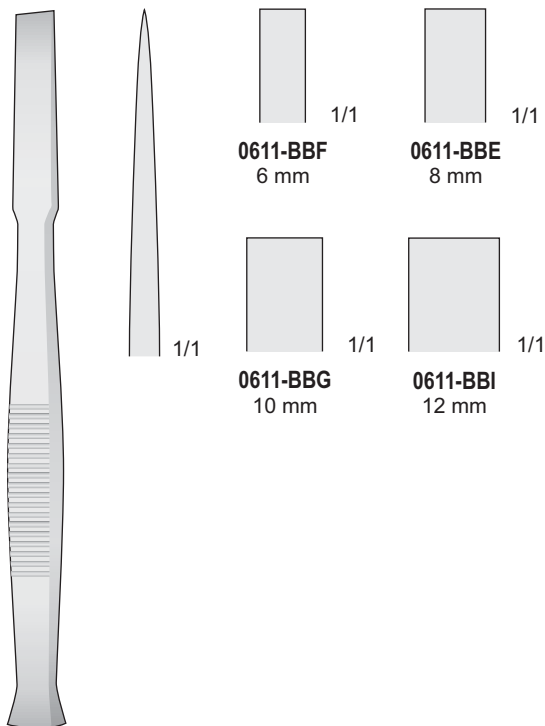

0611-BBE/FL-118
140 mm

Hohlmeissel - Gouges
Sgorbie - Gubias - Gouges

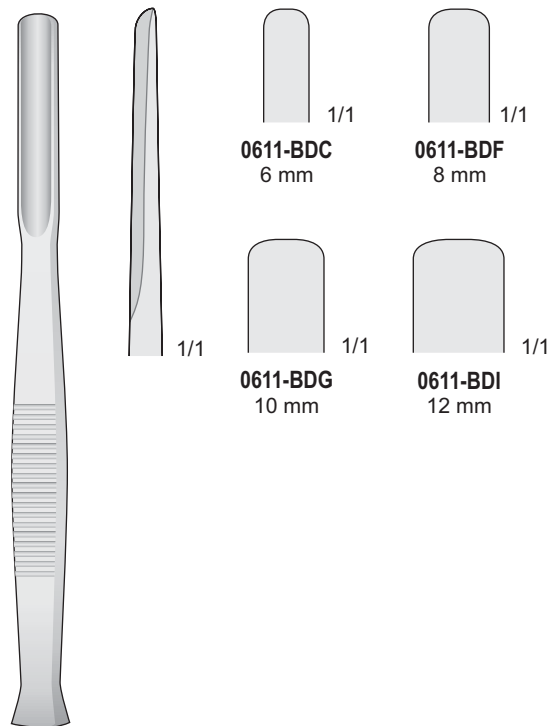

0611-BDC/0611-BDI
140 mm

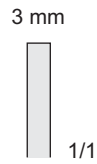

0611-BHH

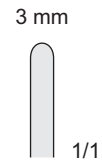

0611-BIF

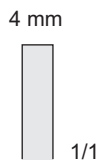

0611-BHL

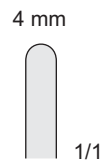

0611-BIG

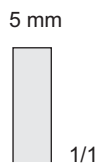

0611-BIB

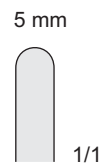

0611-BIH

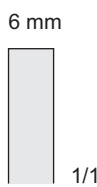

0611-BID

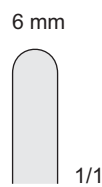

0611-BII

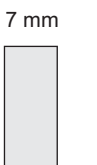

0611-BIE

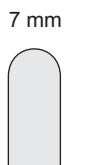

0611-BIL

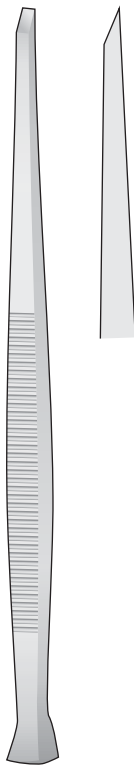

PARTSCH
0611-BHH/0611-BIE
170 mm

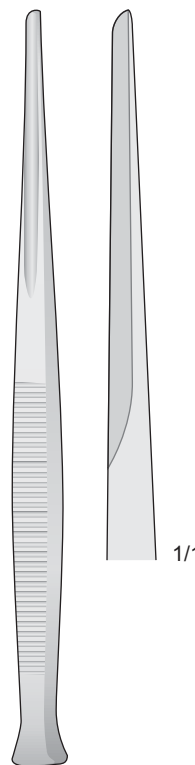

PARTSCH
0611-BIF/0611-BIL
170 mm

Hohlmeissel

Gouges

Sgorbie

Gubias

Gouges

8 mm

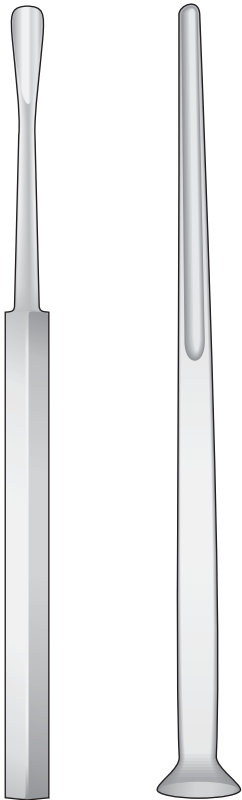

COSCIA
0611-DGI
180 mm

ALEXANDER
0611-CAG/0611-CAL
170 mm

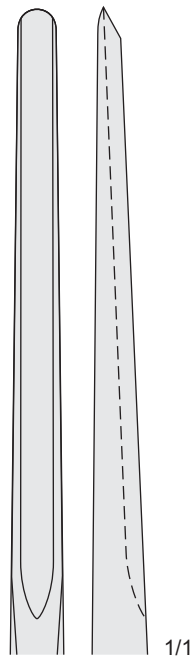

0611-CAG
5 mm

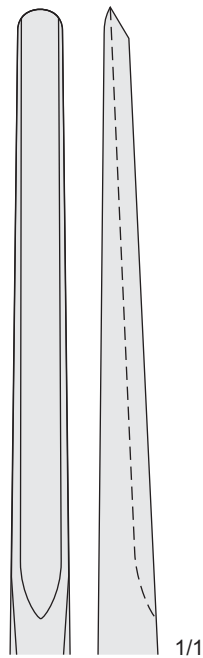

0611-CAH
7 mm

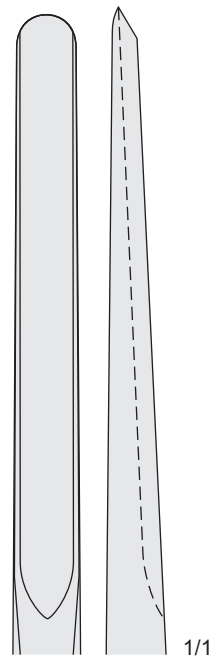

0611-CAI
9 mm

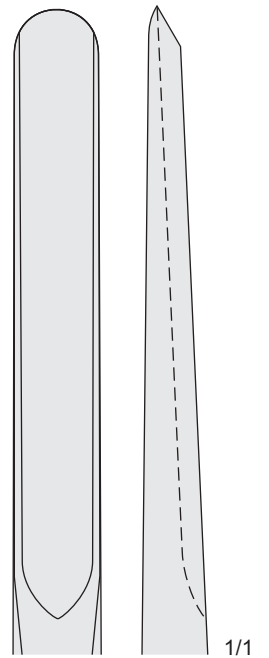

0611-CAL
11 mm

Osteotome

Osteotomes

Osteotomi

Osteotomos

Ostéotomes

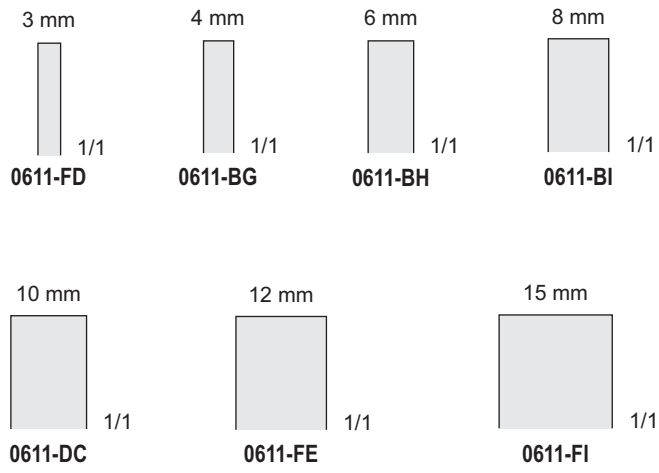
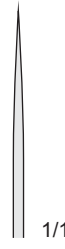

MINI-LAMBOTTE
0611-BG/0611-FI
125 mm

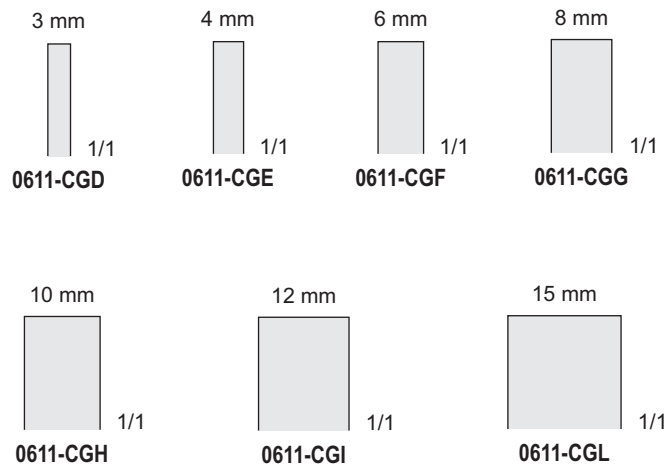
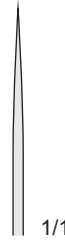

MINI-LAMBOTTE
0611-CGD/0611-CGL
170 mm

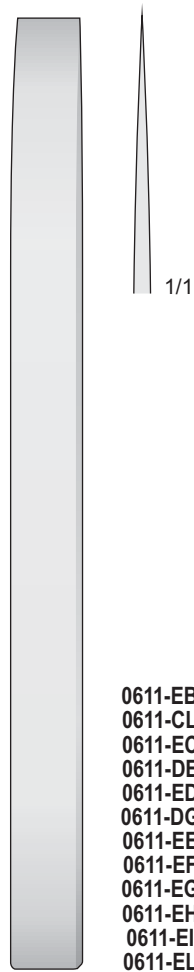

LAMBOTTE
0611-EB/0611-EL
250 mm

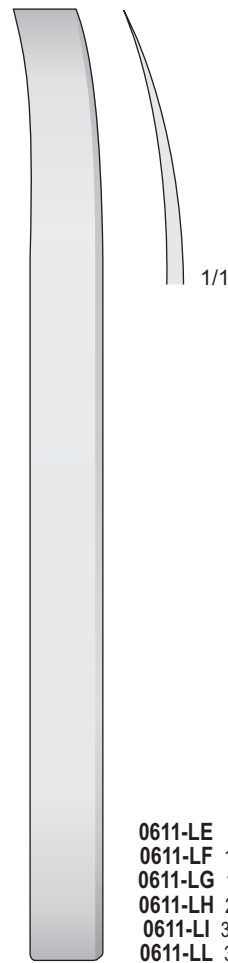

LAMBOTTE
0611-LE/0611-LL
250 mm

Osteotome

Osteotomes

Osteotomi

Osteótomos

Ostéotomes

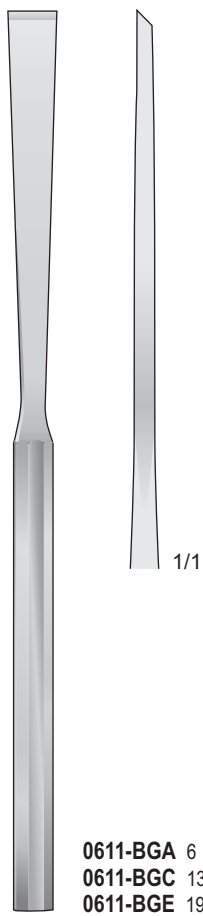

0611-BGA 6 mm
0611-BGC 13 mm
0611-BGE 19 mm

HIBBS
0611-BGA/0611-BGE
230 mm

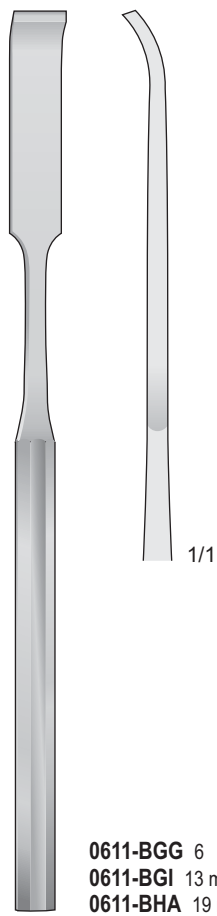

0611-BGG 6 mm
0611-BGI 13 mm
0611-BHA 19 mm

HIBBS
0611-BGG/0611-BHA
230 mm

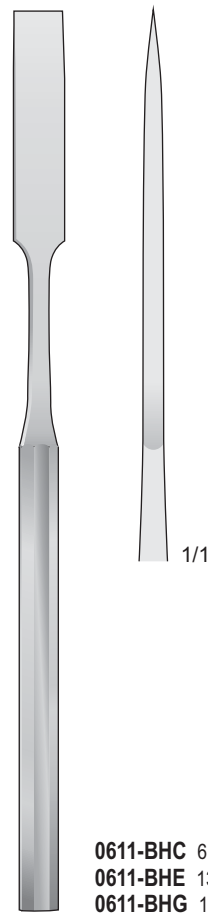

0611-BHC 6 mm
0611-BHE 13 mm
0611-BHG 19 mm

HIBBS
0611-BHC/0611-BHG
230 mm

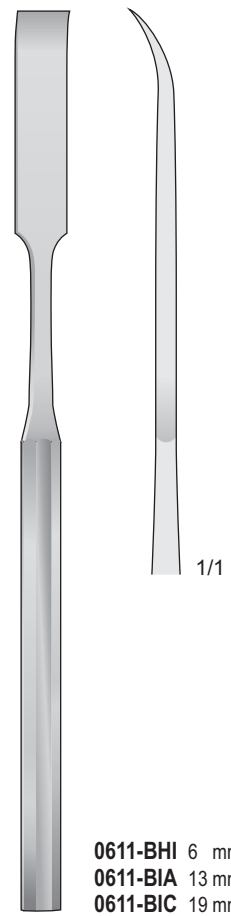

0611-BHI 6 mm
0611-BIA 13 mm
0611-BIC 19 mm

HIBBS
0611-BHI/0611-BIC
230 mm

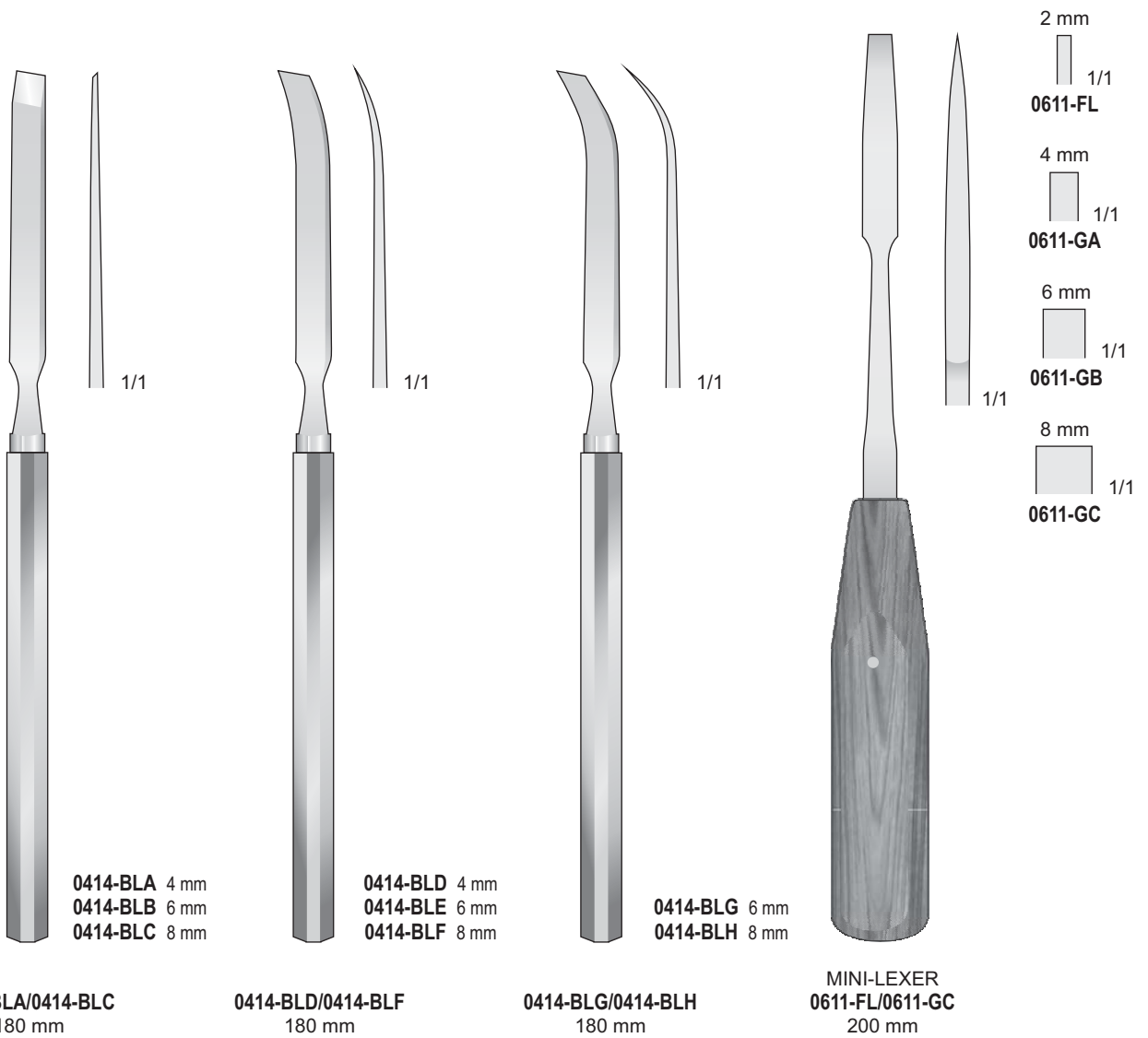

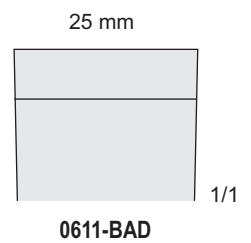
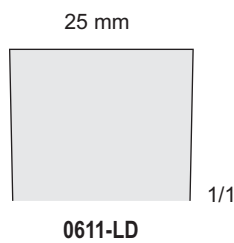
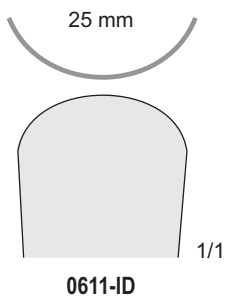
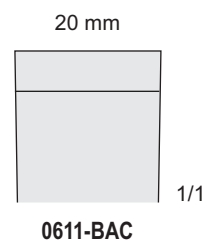
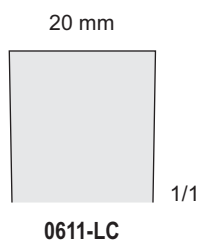
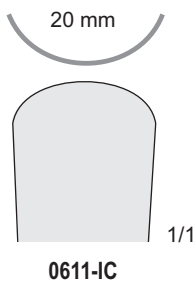
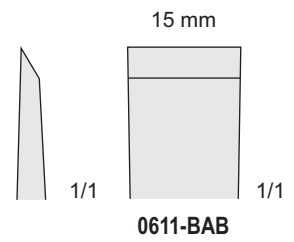
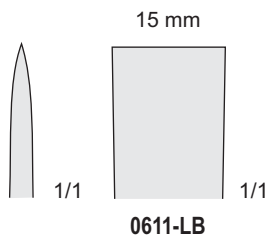
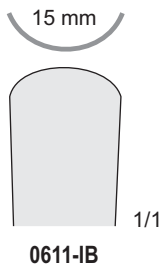
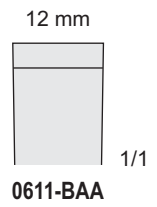
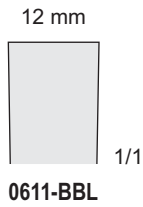
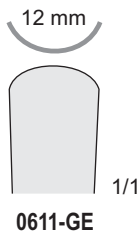
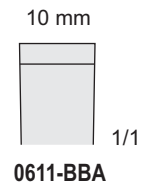
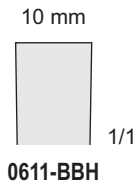
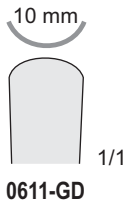

STILLE
0611-GD/0611-ID
200 mm

STILLE
0611-LB/0611-BBL
200 mm

STILLE
0611-BAA/0611-BBA
200 mm

Osteotome

Osteotomes

Osteotomi

Osteótomos

Ostéotomes

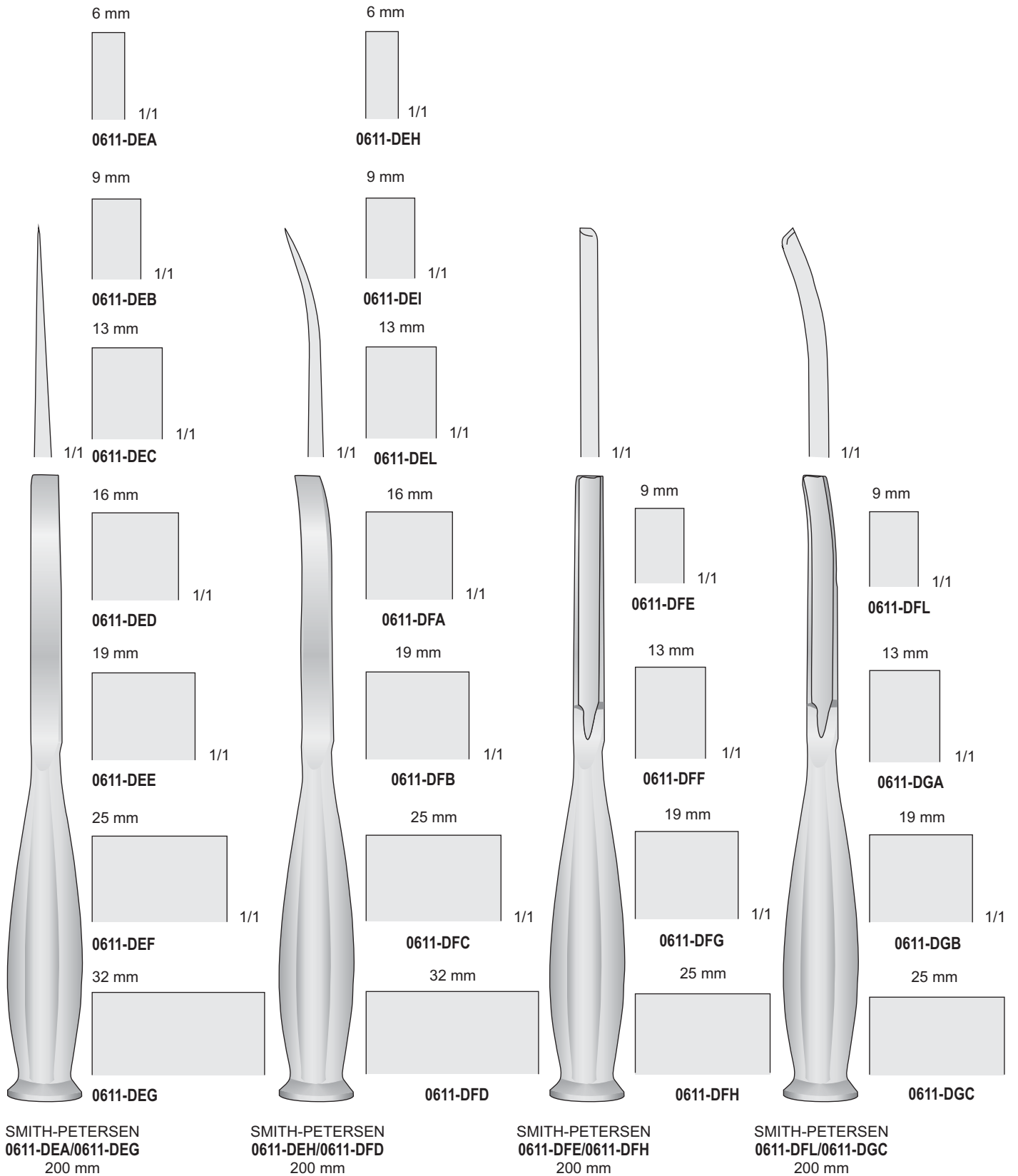

Osteotome

Osteotomes

Osteotomi

Osteotomos

Ostéotomes

3,0 mm



0610-CHD
175 mm

6,0 mm

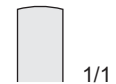

0610-CHE
175 mm

10,0 mm

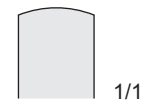

0610-CHF
190 mm

13,0 mm



0610-CHG
190 mm

16,0 mm



0610-CHH
200 mm

19,0 mm



0610-CHI
200 mm

25,0 mm

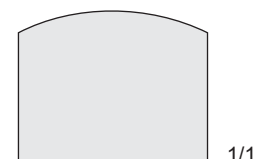

0610-CHL
210 mm

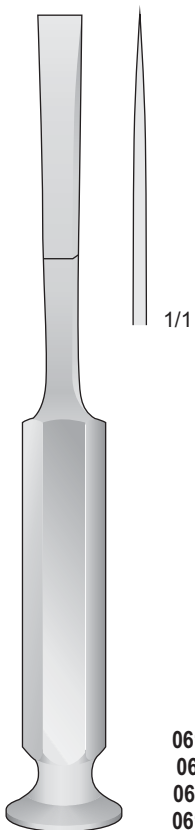

0611-DAH 10 mm
0611-DAI 15 mm
0611-DAL 20 mm
0611-DBA 30 mm

TESSIER
0611-DAH/0611-DBA
200 mm

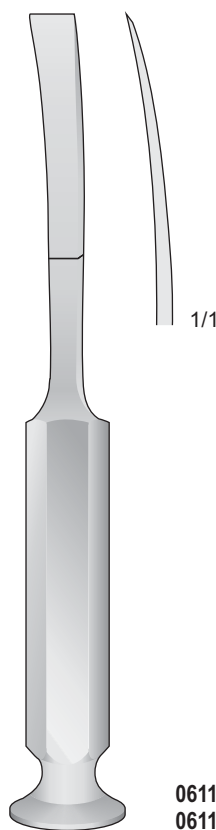

0611-DBB 10 mm
0611-DBC 15 mm

TESSIER
0611-DBB/0611-DBC
200 mm

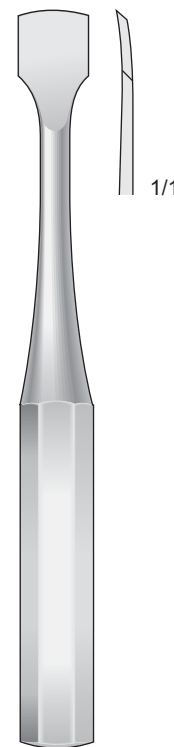

KEY
0610-CHD/0610-CHL
190 mm

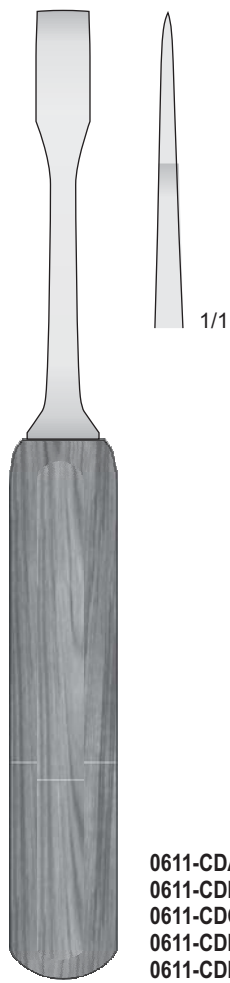

- 0611-CDA 4 mm
- 0611-CDB 6 mm
- 0611-CDC 8 mm
- 0611-CDD 10 mm
- 0611-CDE 12 mm

MINI-LEXER
0611-CDA/0611-CDE
180 mm

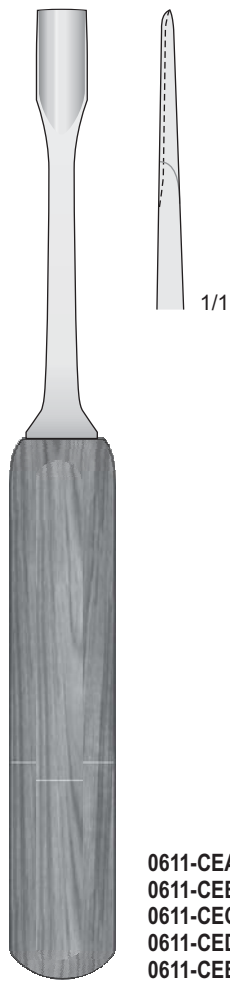

- 0611-CEA 4 mm
- 0611-CEB 6 mm
- 0611-CEC 8 mm
- 0611-CED 10 mm
- 0611-CEE 12 mm

MINI-LEXER
0611-CEA/0611-CEE
180 mm



- 0611-BLA 4 mm
- 0611-BLB 6 mm
- 0611-BLC 8 mm
- 0611-BLD 10 mm
- 0611-BLE 12 mm

LEXER
0611-BLA/0611-BLE
180 mm

Osteotome

Osteotomes

Osteotomi

Osteótomos

Ostéotomes

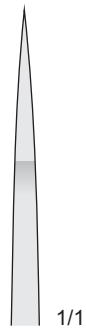

1/1

- 0611-CBA 5 mm
- 0611-CBB 7 mm
- 0611-CBC 10 mm
- 0611-CBD 15 mm
- 0611-CBE 20 mm
- 0611-CBF 25 mm
- 0611-CBG 30 mm

LEXER
0611-CBA/0611-CBG
220 mm

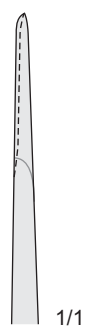

1/1

- 0611-CCA 5 mm
- 0611-CCB 7 mm
- 0611-CCC 10 mm
- 0611-CCD 15 mm
- 0611-CCE 20 mm
- 0611-CCF 25 mm
- 0611-CCG 30 mm

LEXER
0611-CCA/0611-CCG
220 mm

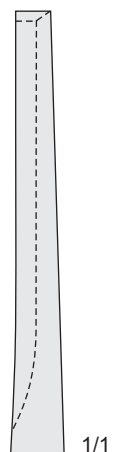
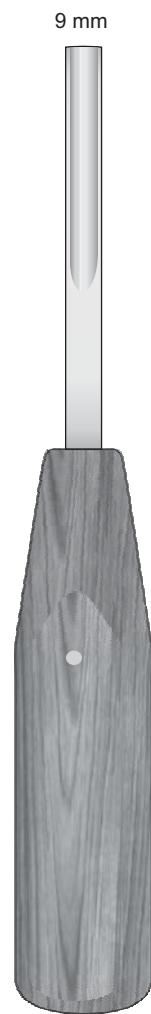

1/1

9 mm

0611-CHC
220 mm

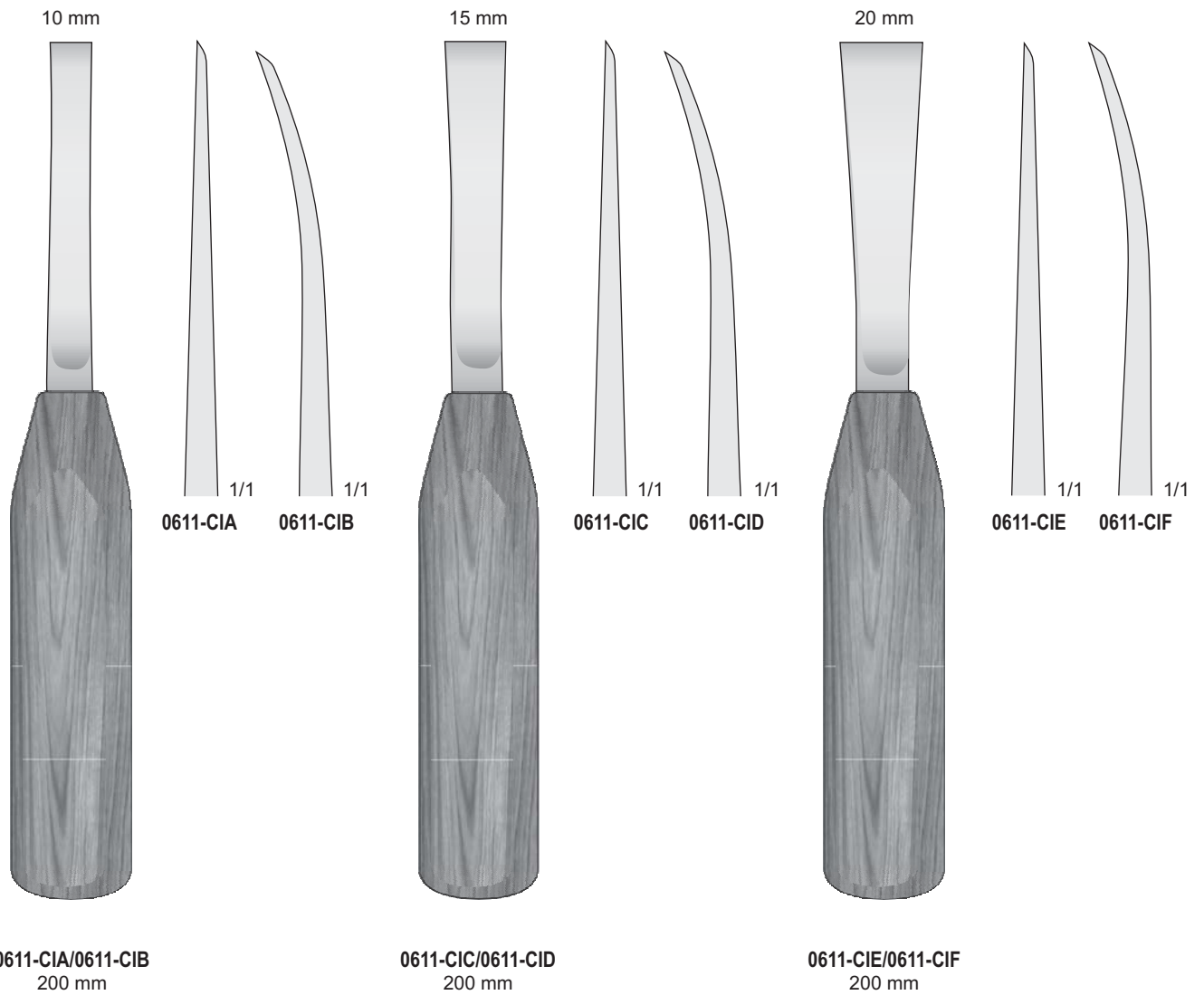

Hohlmeissel - Gouges
Sgorbie - Gubias - Gouges

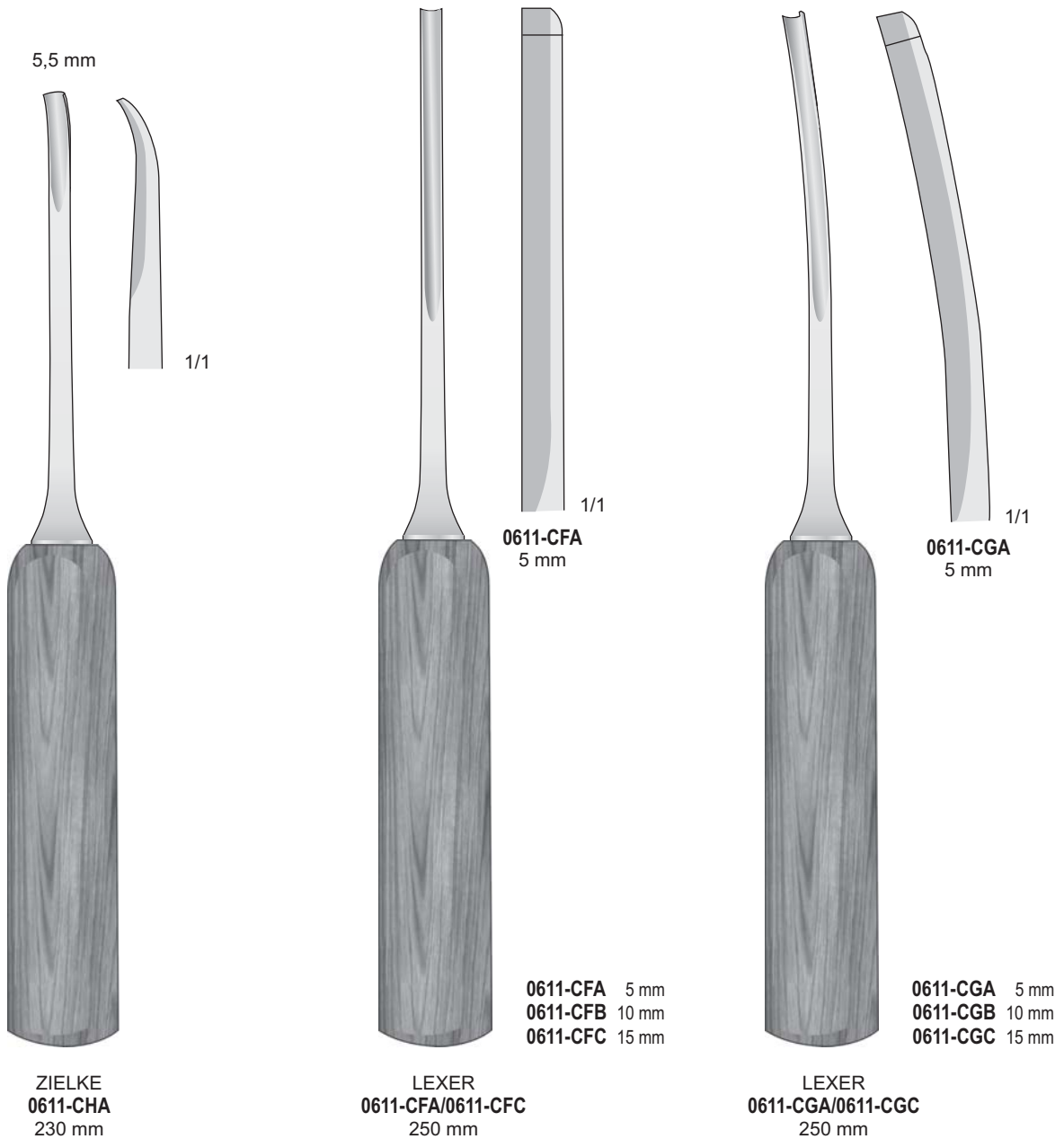

Osteotome

Osteotomes

Osteotomi

Osteotomos

Ostéotomes

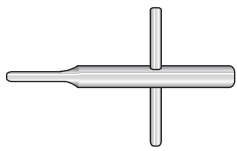

0611-IE
90 mm

Fig. 1
5 mm

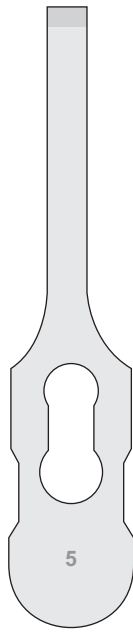

0611-IG
85 mm

1/1

Fig. 2
10 mm

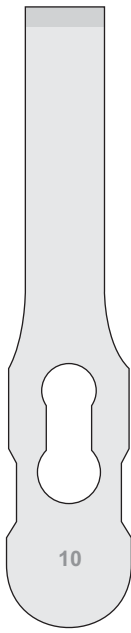

0611-IH
85 mm

1/1

Fig. 3
16 mm

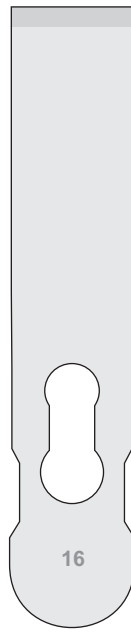

0611-II
85 mm

1/1

Fig. 4
25 mm

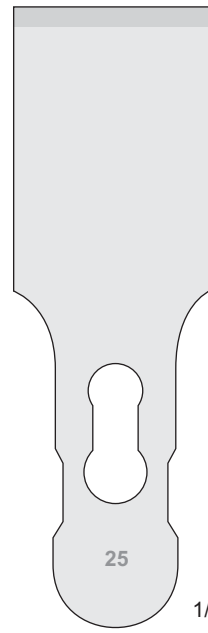

0611-IL
85 mm

1/1



Meißel
Chisel
Scalpelli
Cinceles
Ciseaux-burins



0611-IF
190 mm

Fig. 1
5 mm

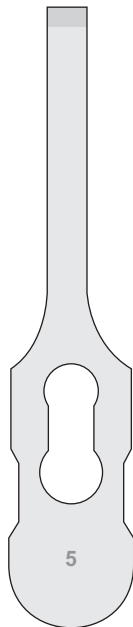

0611-CIG
85 mm

1/1

Fig. 2
10 mm

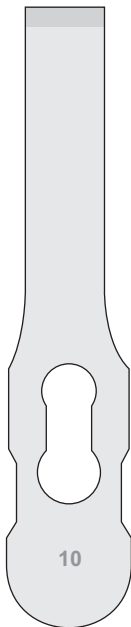

0611-CIH
85 mm

1/1

Fig. 3
16 mm

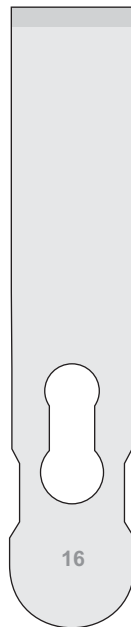

0611-CII
85 mm

1/1

Fig. 4
25 mm

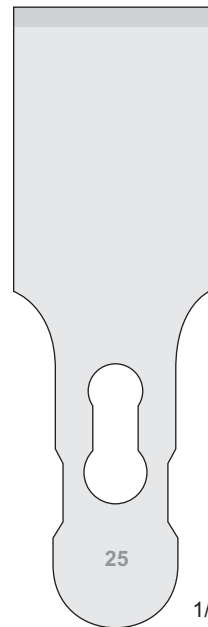

0611-CIL
85 mm

1/1



Osteotom
Gouge
Osteotomi
Cubias
Gouges



Meniskus und Knorpelfasszangen - Meniscus and cartilage clamp
 Pinze per menisco e cartilagine - Pince à saisir ménisque et cartilages

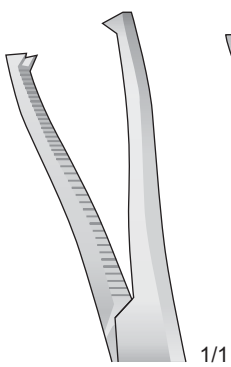

DINGMANN
0614-BDA

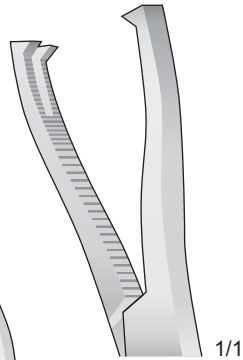

DINGMANN MODIF.
0614-BDB

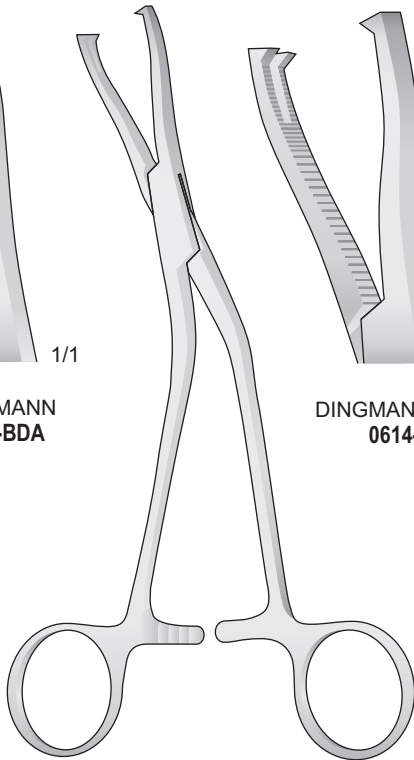

DINGMANN
0614-BDA/0614-BDB
190 mm

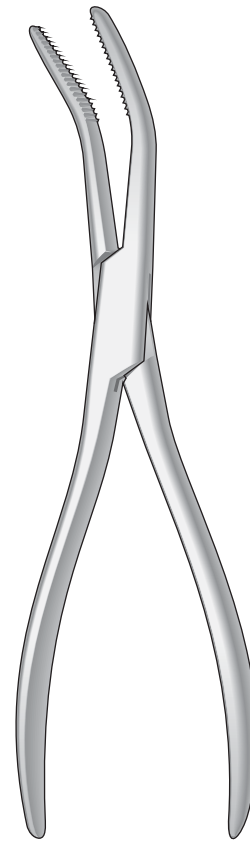

VAN BUREN
0614-CBH
225 mm

Seitwärts gebogen
Curved to side
Curva su un lato

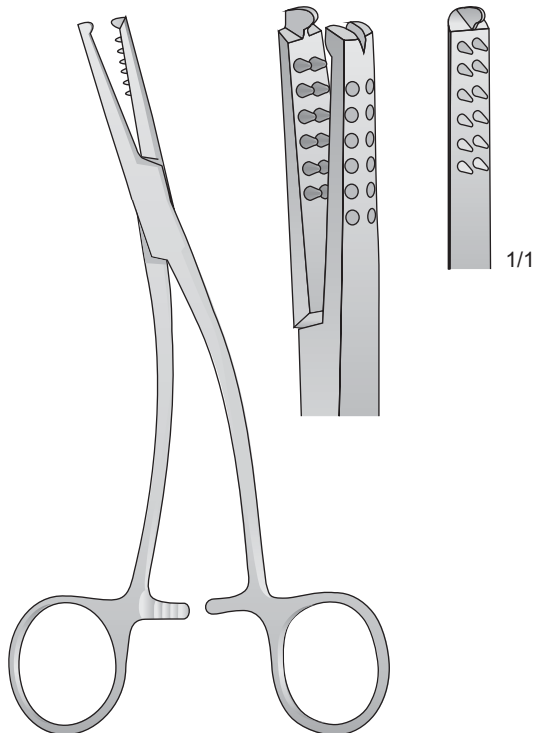

0614-BDE
185 mm

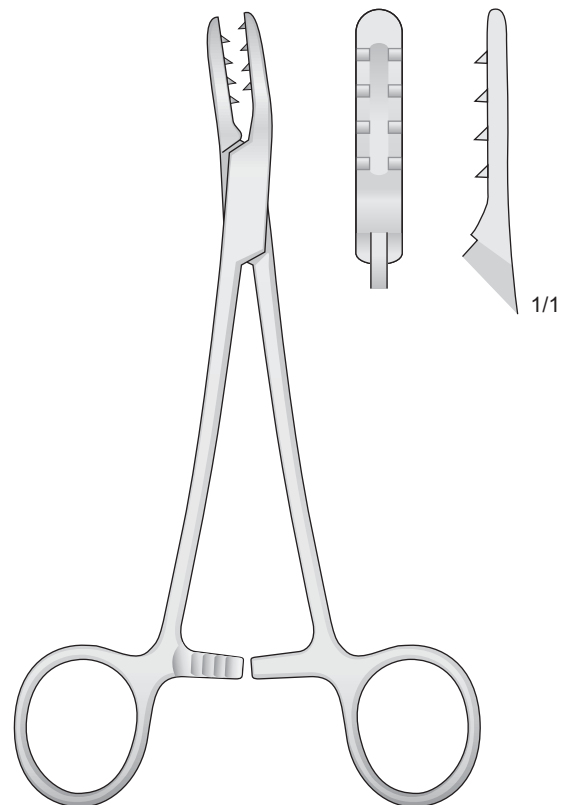

MARTIN
0614-BDD
200 mm

Repositionszangen - Reposition forceps
 Pinze riposizionatrici di osso - Pinzas para la reducci3n de huesos

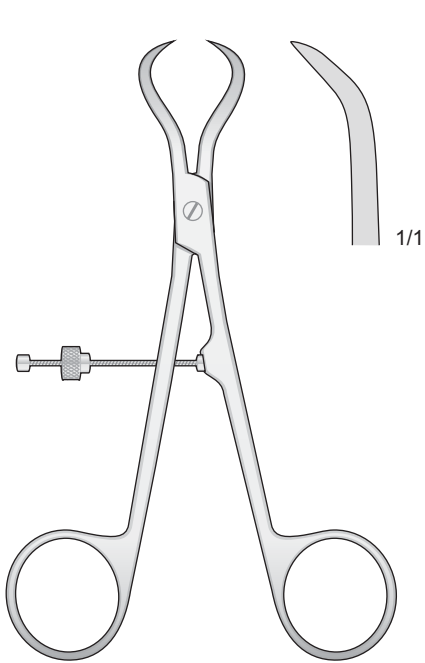

0614-HL
140 mm

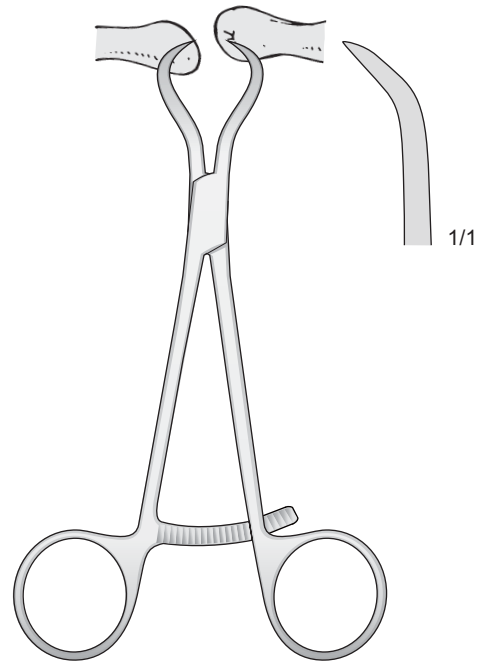

0614-GG
135 mm

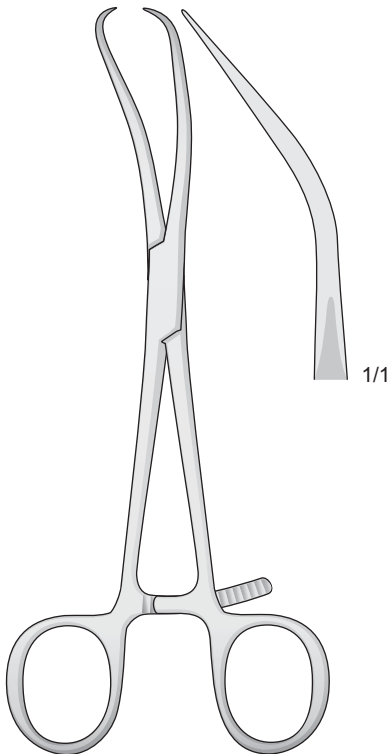

REILL
0614-GE
170 mm

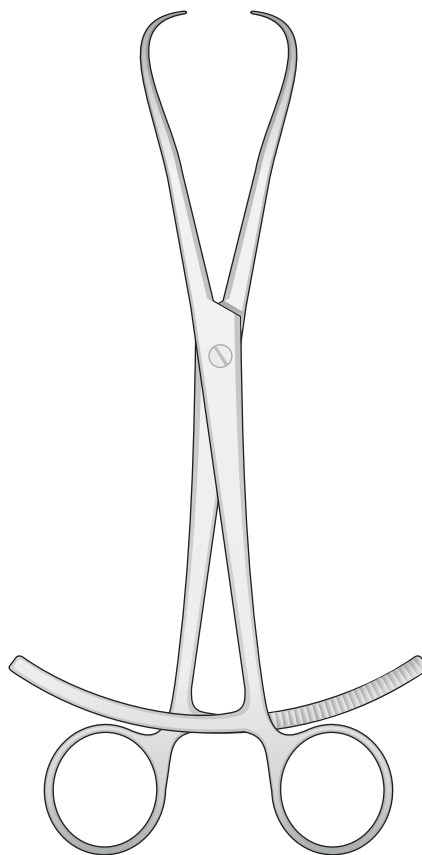

0614-GI
200 mm

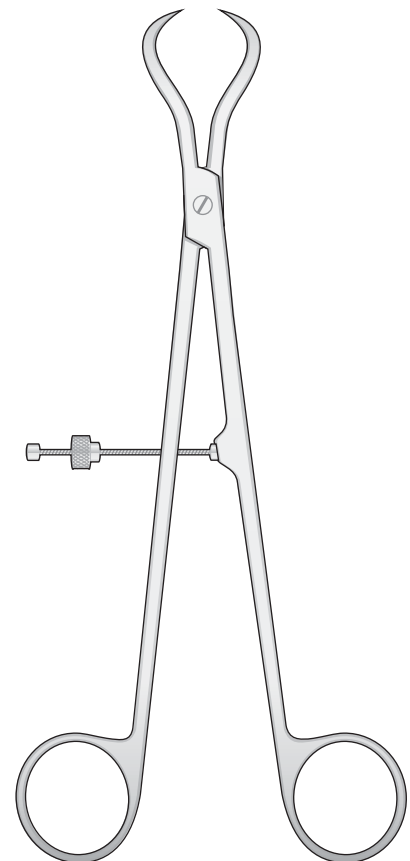

0614-IB
210 mm

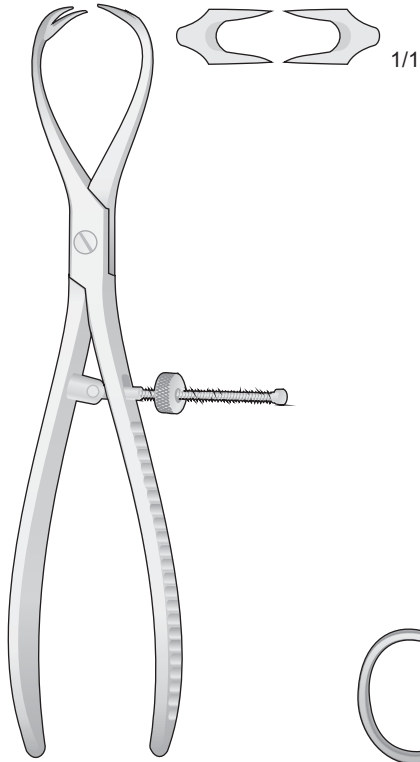

PATELLA
0614-EG
185 mm

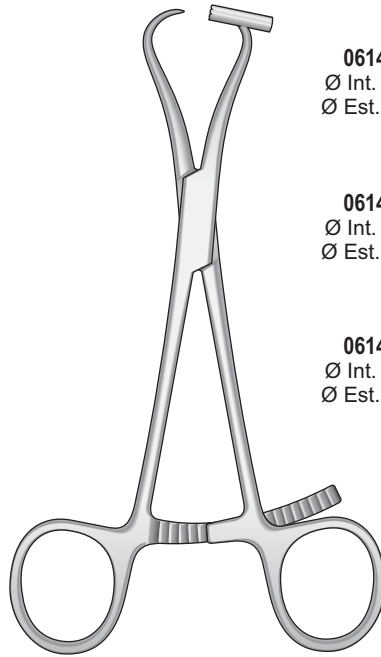

0614-CEA/0614-CEC
140 mm

- **0614-CEA**
Ø Int. 1,0 mm
Ø Est. 2,0 mm
- **0614-CEB**
Ø Int. 1,3 mm
Ø Est. 2,3 mm
- **0614-CEC**
Ø Int. 1,6 mm
Ø Est. 2,6 mm

Zange mit Gewindsperr
Forceps with thread fixation
Pinza con regolazione
Davier avec système d'arrêt fileté

Zange mit Zahnsperre
Forceps with ratchet fixation
Pinza con cremagliera
Davier à crémaillère

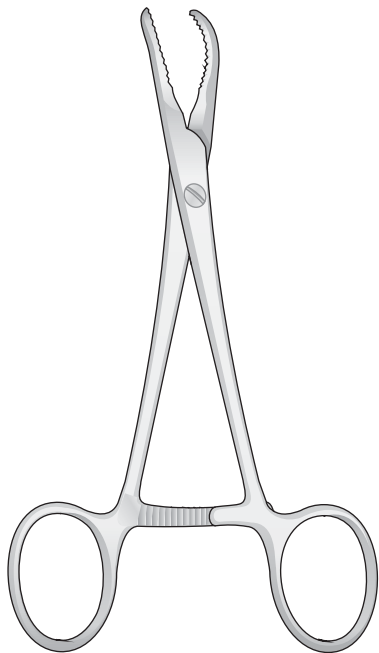

0614-EH
140 mm

Zange mit Gewindsperr
Forceps with thread fixation
Pinza con regolazione
Davier avec système d'arrêt fileté

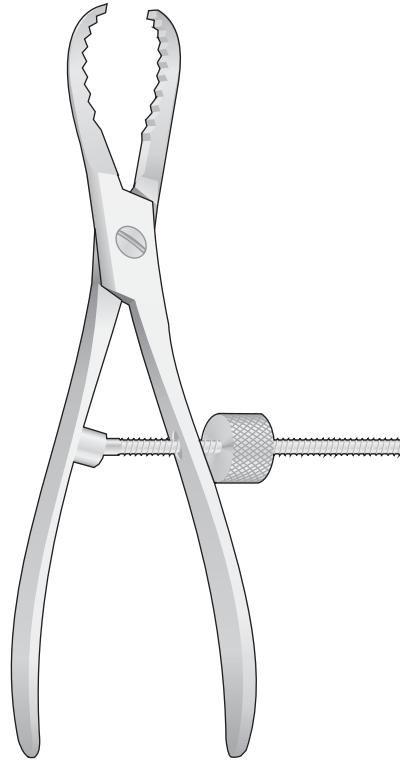

0614-EI
170 mm

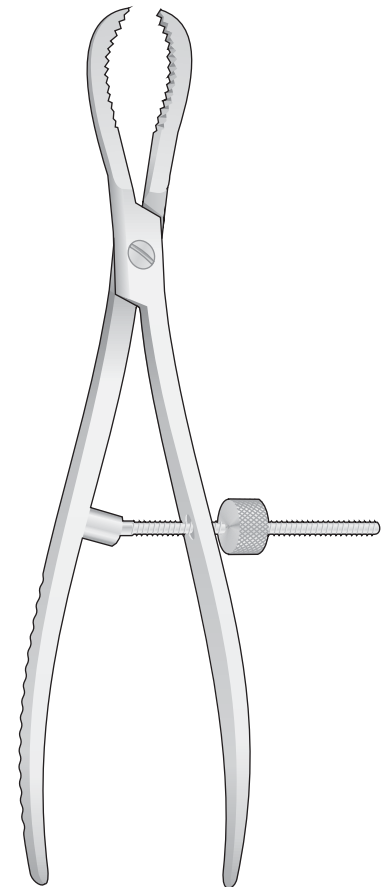

0614-EL
235 mm

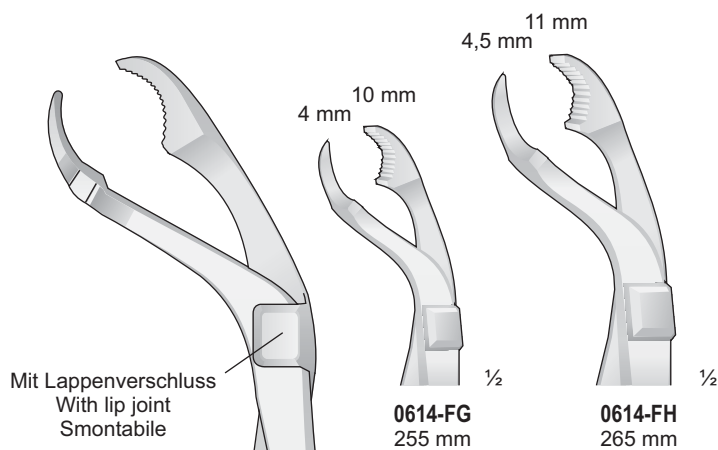

VERBRUGGE
0614-FG/0614-FH

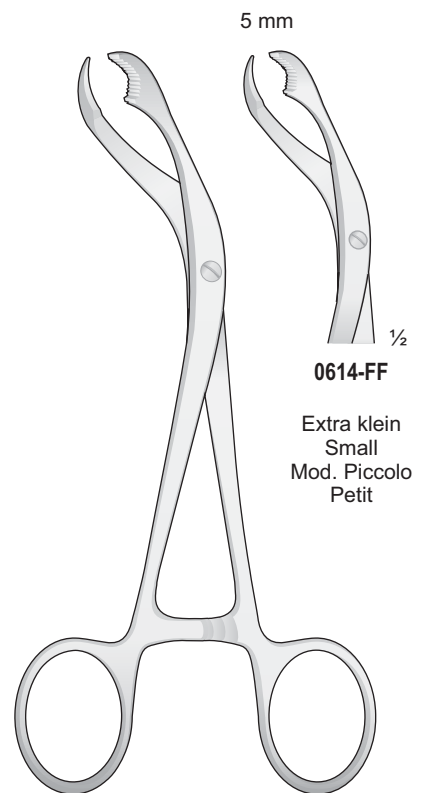

VERBRUGGE
0614-FF
175 mm

Selbstzentrierend mit Gewindesperre
 Self-centering bone holding forceps with thread lock
 Autocentrante con blocco
 À centrage automatique avec arrêt de filetage

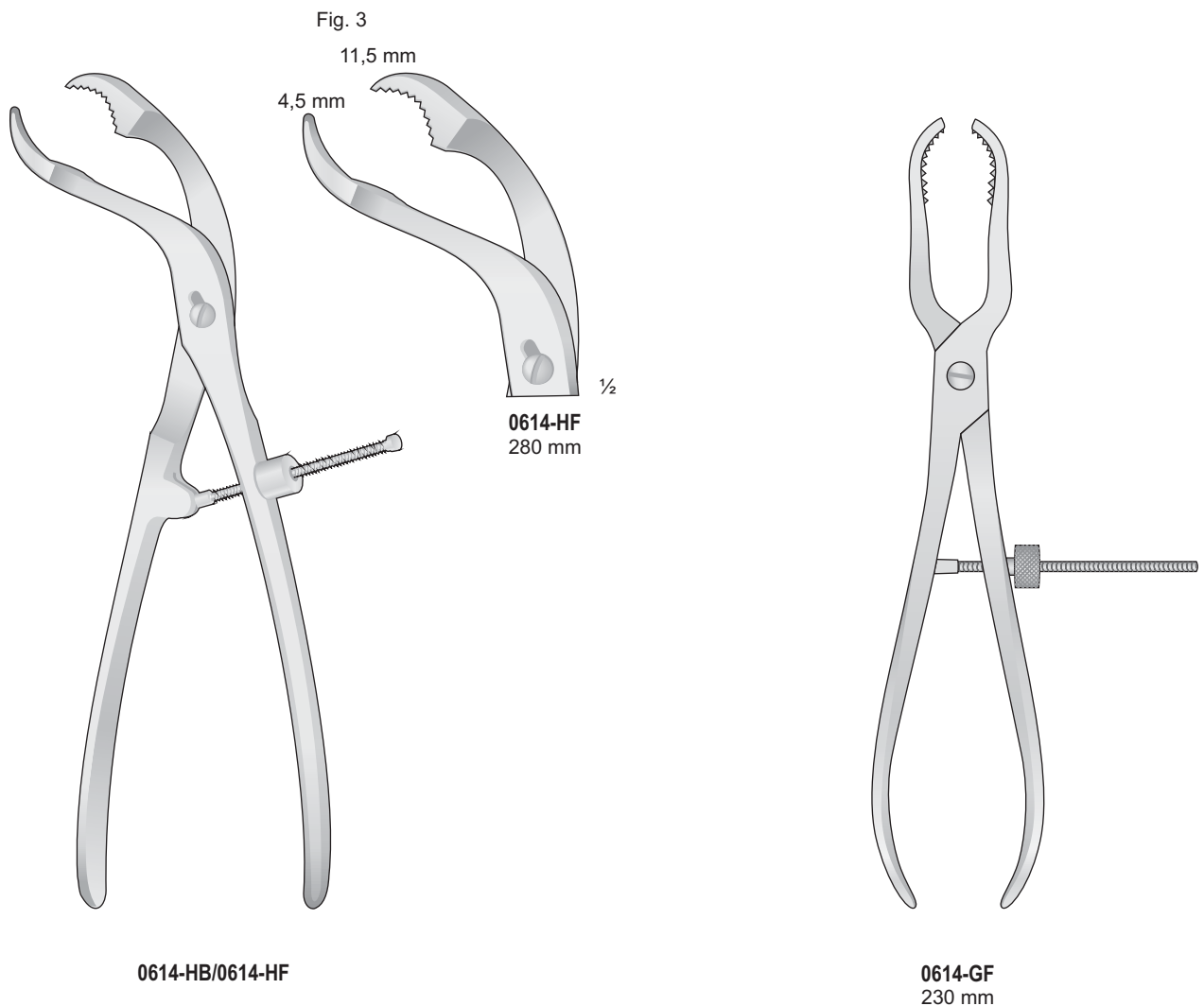
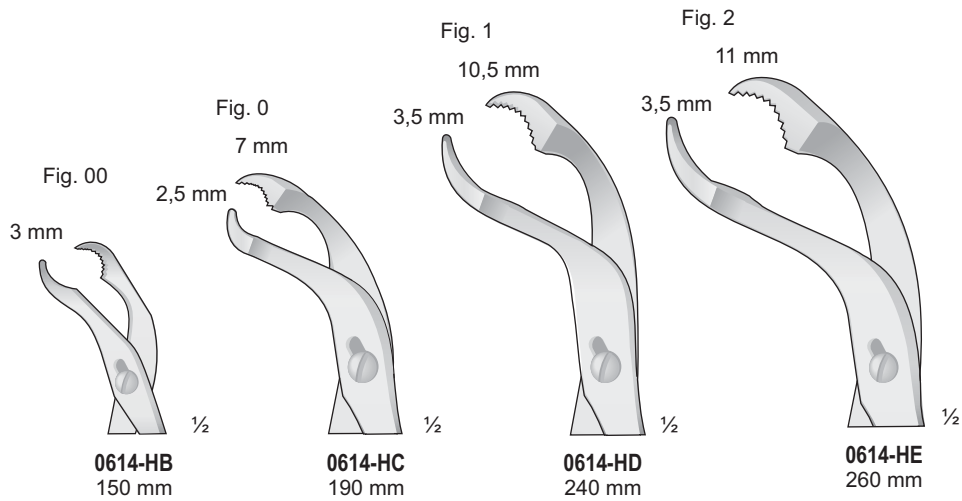

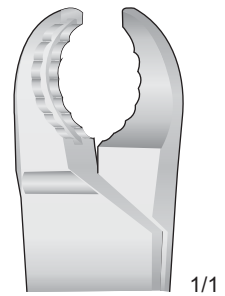

1/1

0614-GC
230 mm

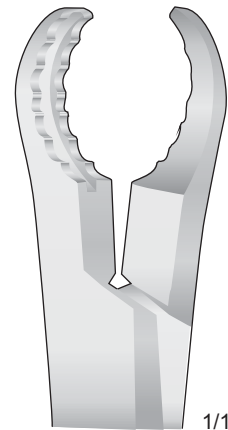

1/1

0614-IC
250 mm

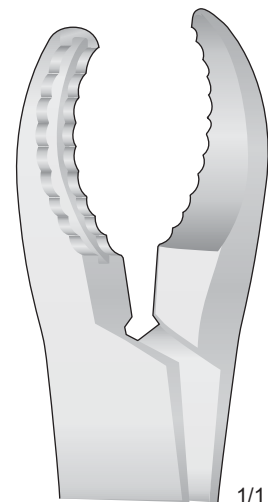

1/1

0614-BAF
280 mm

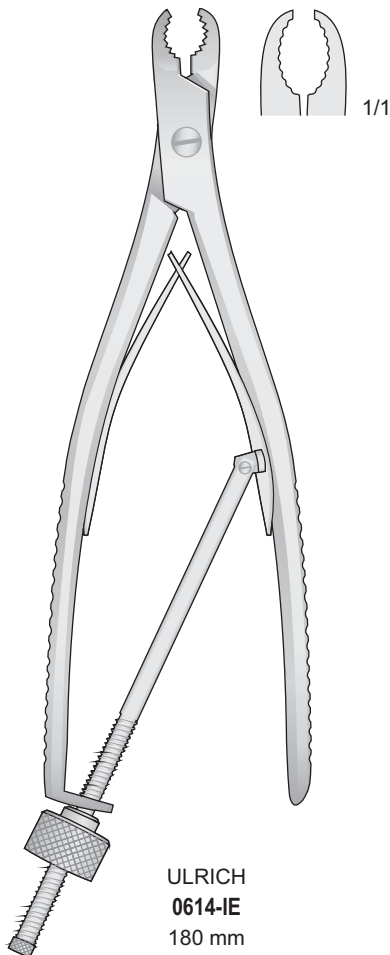

1/1

ULRICH
0614-IE
180 mm

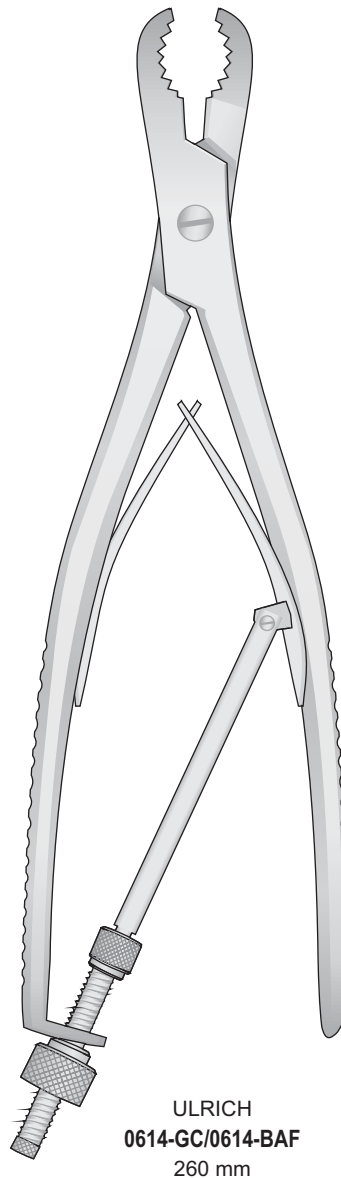

ULRICH
0614-GC/0614-BAF
260 mm

Knochenhaltezangen

Bone holding forceps

Pinze per ossa

Pinzas para huesos

Daviers porte os

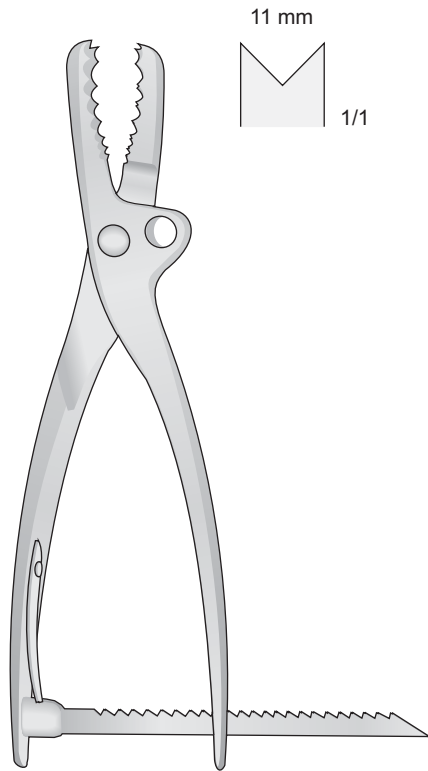

FARABEU-FC
0614-FC
250 mm

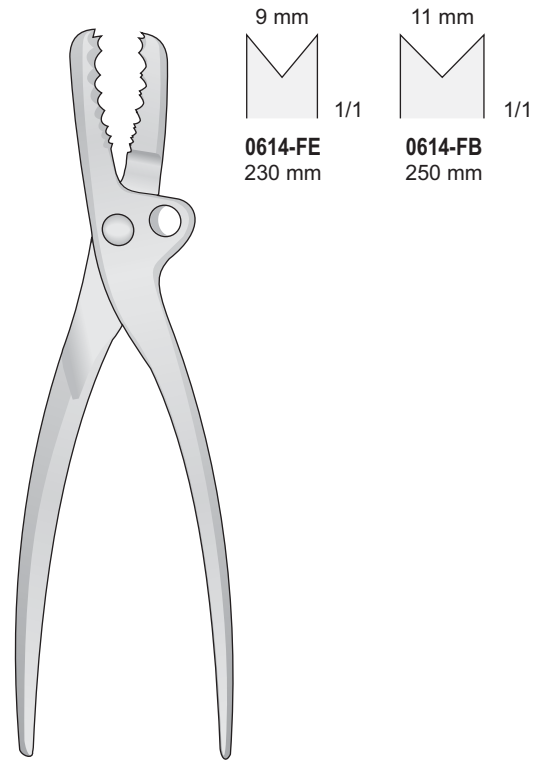

FARABEU
0614-FB/0614-FE

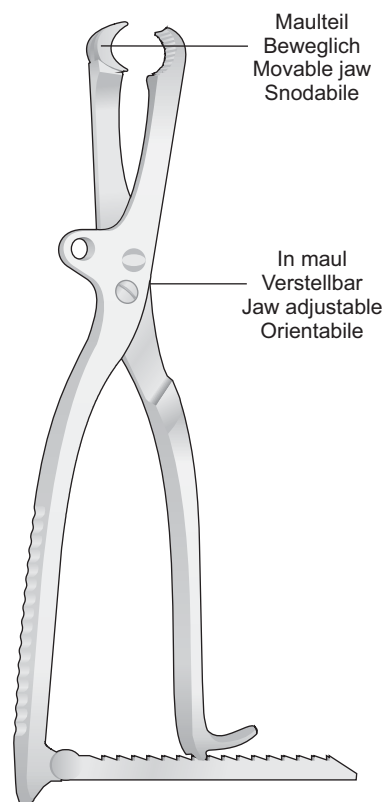

LAMBOTTE
0614-EE
265 mm

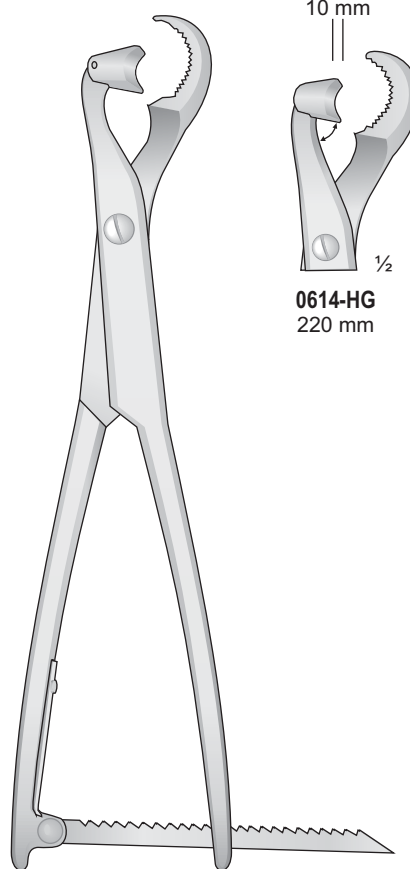

LAMBOTTE
0614-FA/0614-HG

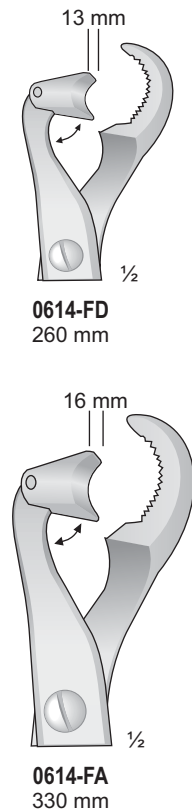

0614-FA
330 mm

Knochenchirurgie

Bone surgery

Chirurgia ossea

Cirurgia òsea

Chirurgie osseuse

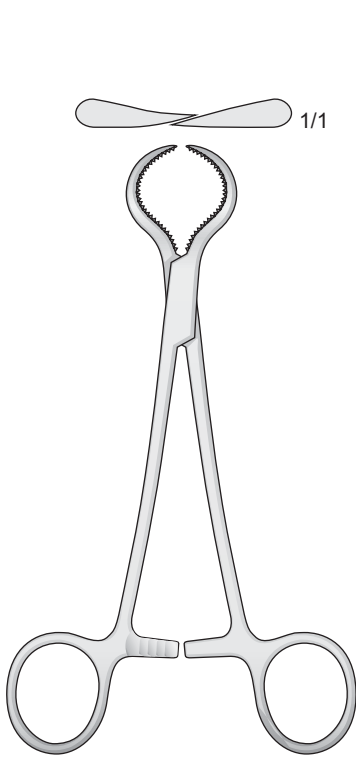

LEWIN
0614-GL
180 mm

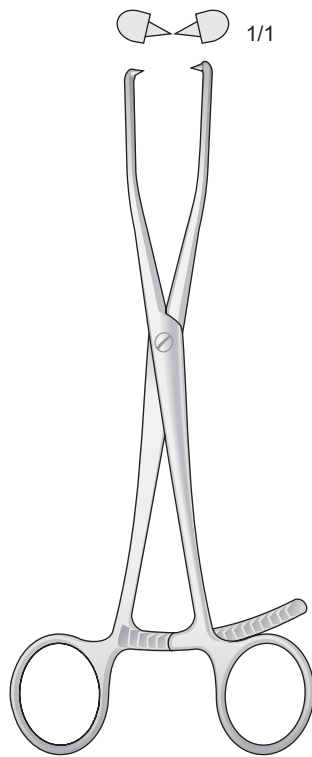

0614-GH
210 mm

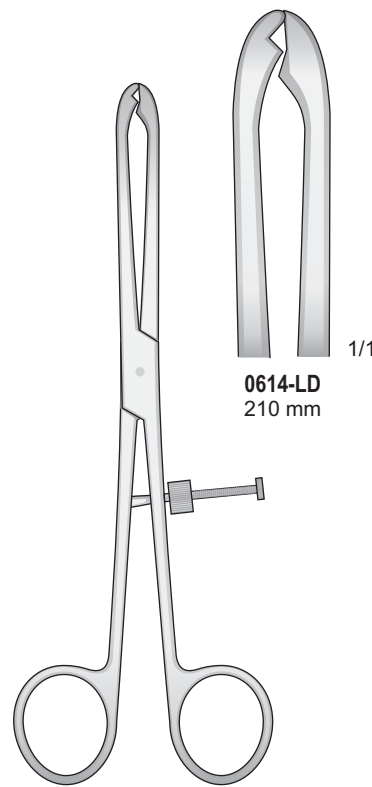

FIBULA
0614-LD/0614-LE
210 mm

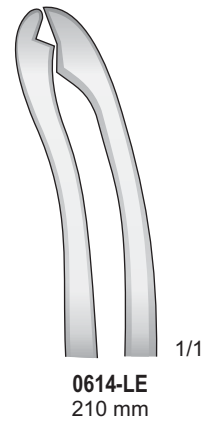

0614-LE
210 mm

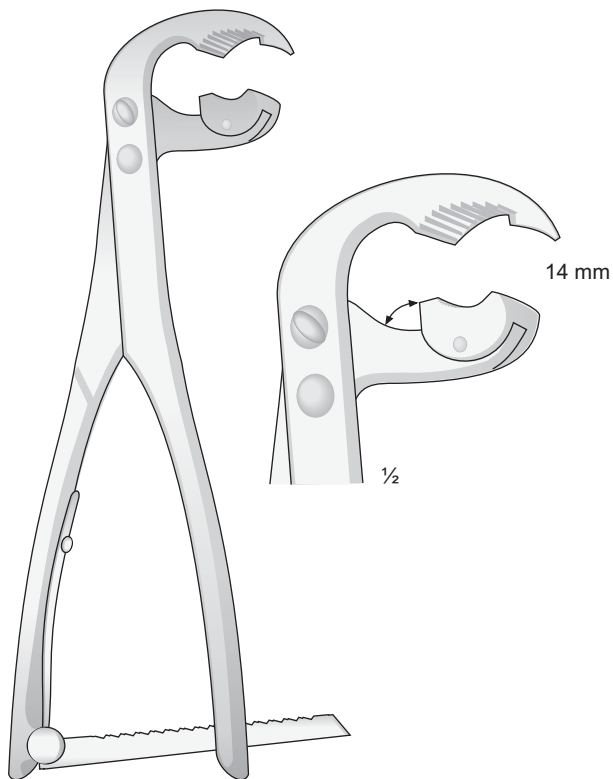

0614-HI
215 mm

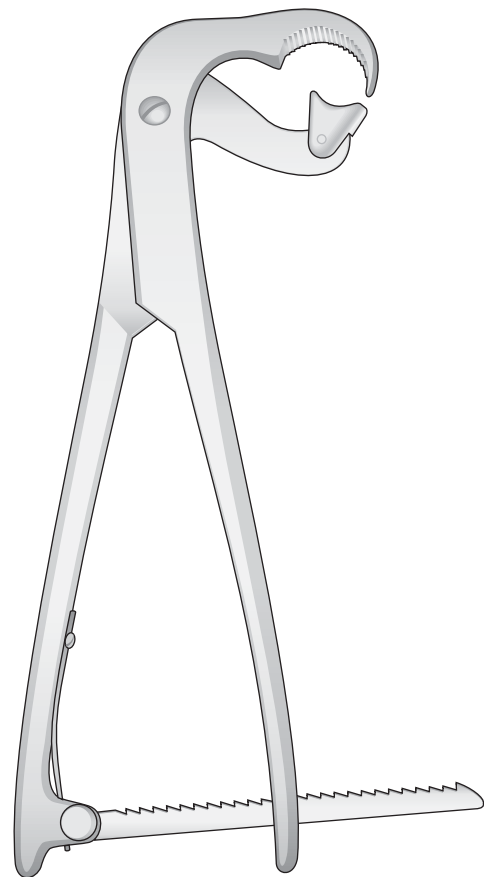

0614-BAG
275 mm

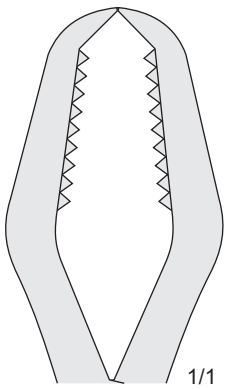

13 mm

1/1

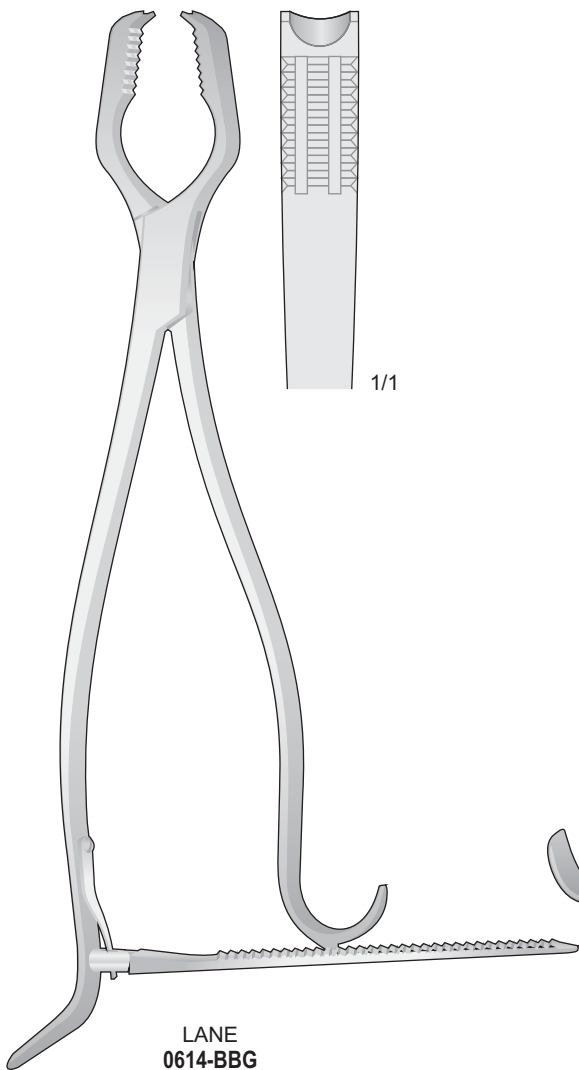

LANE
0614-BBG
320 mm

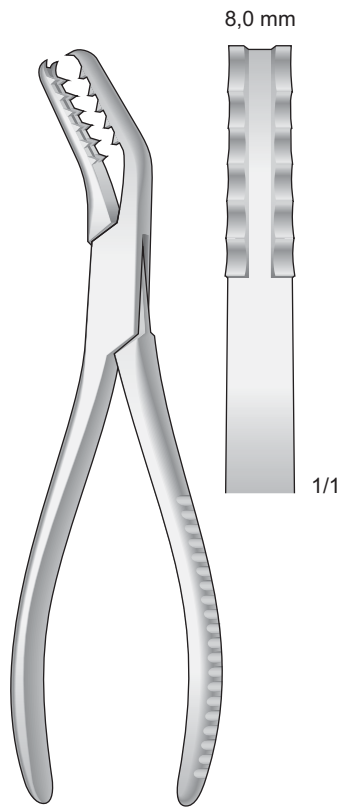

SEMB
0614-CDG
190 mm

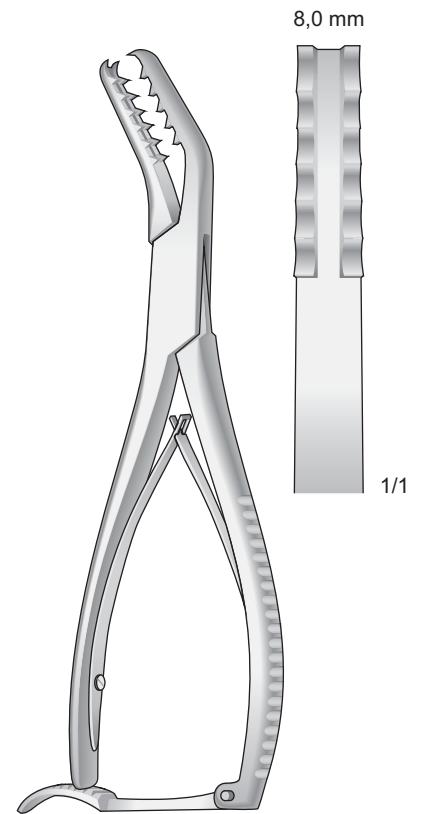

SEMB
0614-CDH
190 mm

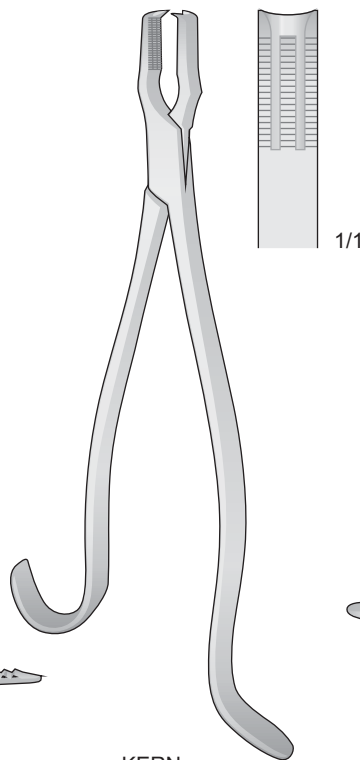

KERN
0614-BBE 170 mm
0614-BBF 220 mm

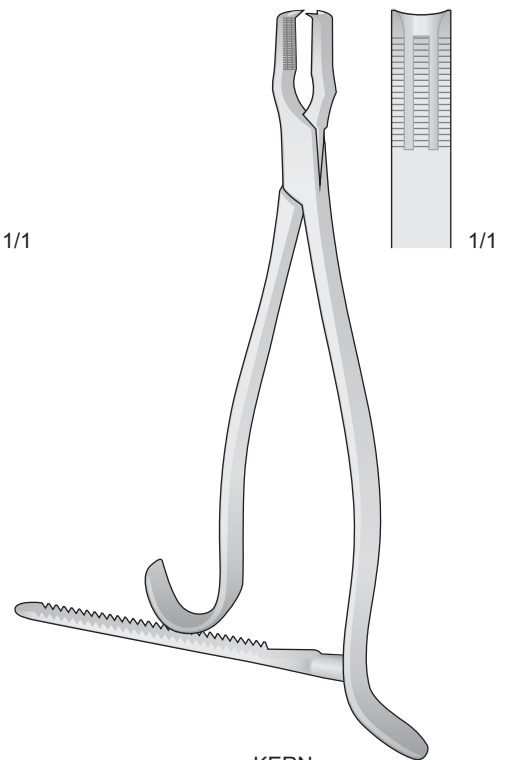

KERN
0614-BBA 170 mm
0614-BBC 220 mm

Knochenhalteklammern

Bone holding clamps

Pinze per osso

Pinces à os

Pinzas para huesos

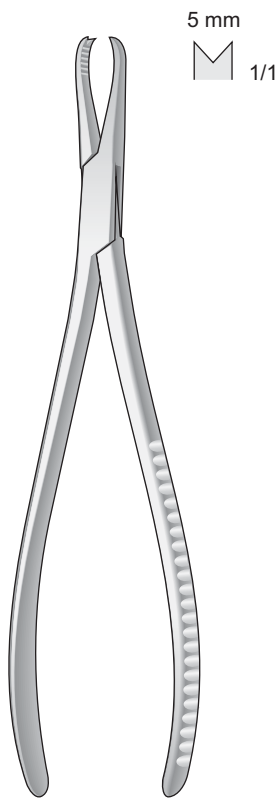

LANGENBECK
0614-LL
200 mm

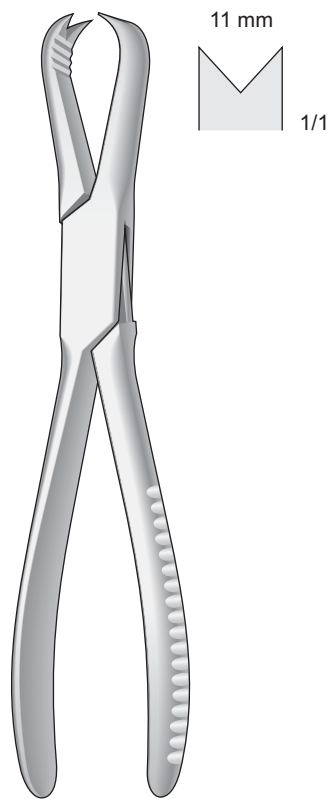

LANGENBECK
0614-BBB
205 mm

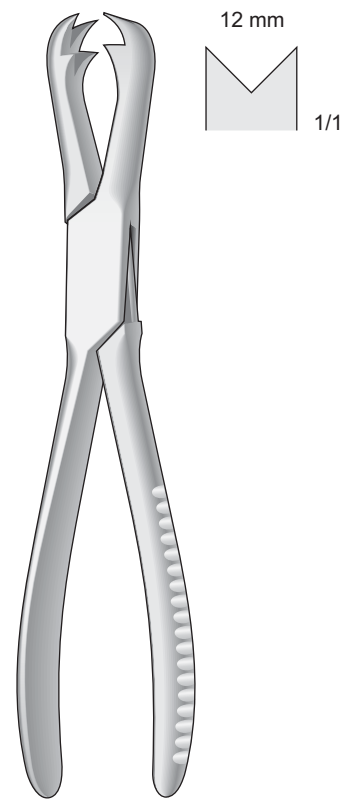

FERGUSSON
0614-BBD
205 mm

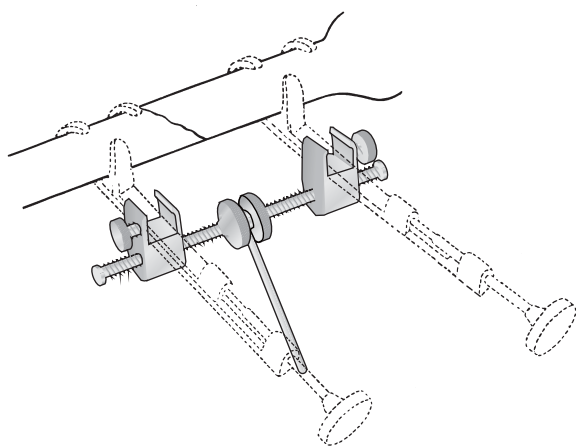

GERSTER
0614-LG

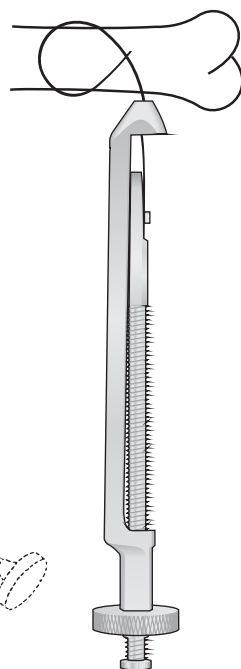

PARHAM
0614-LI
175 mm

Matrice di ricambio
per FO-98



0614-LH
190 mm

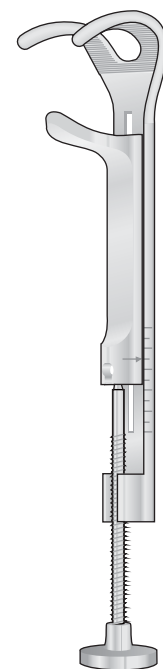

GERSTER-LOWMAN
0614-LA 120 mm
0614-LB 185 mm
0614-LC 200 mm

Für kinder
For children
Per bambini
Para niños
Pour enfants

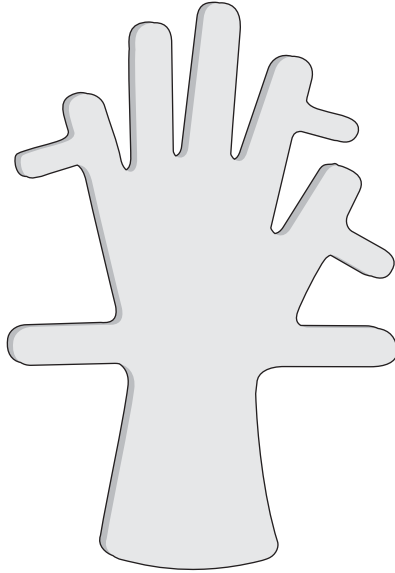

0614-CLL

Für Erwachsene - For adults - Per adulti
Para adultos - Pour adultes

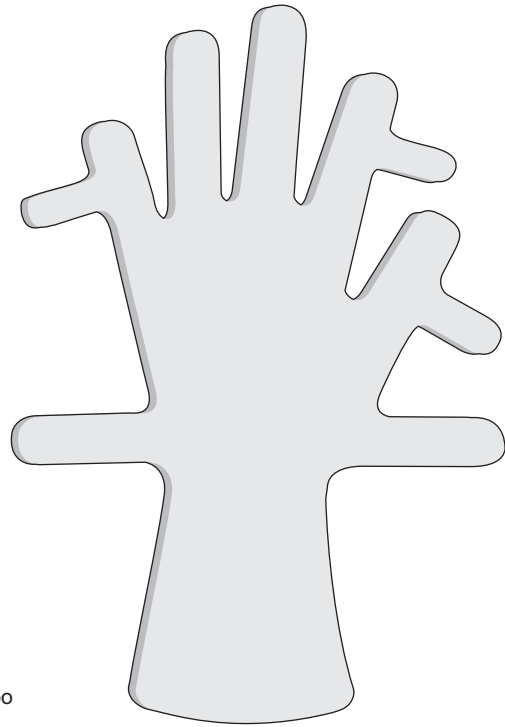

Bleihände
Lead hands
Mani di piombo
Manos de plombo
Main de plomb

0614-DAA

Fingerringsägen - Forceps for opening rings
Pinza taglia anelli - Sierra para anillos - Scies pour bagues

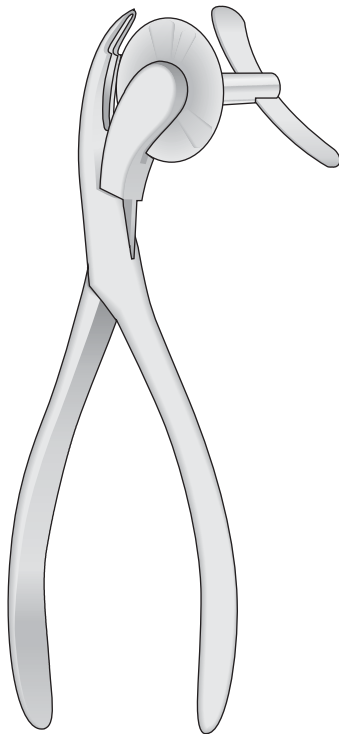

0614-IA
170 mm

Nagel -Ausreisszange
Nail extracting forceps
Pinza per estrazione delle unghie
Pinzas para arrancar uñas
Pince pour extraire les ongles

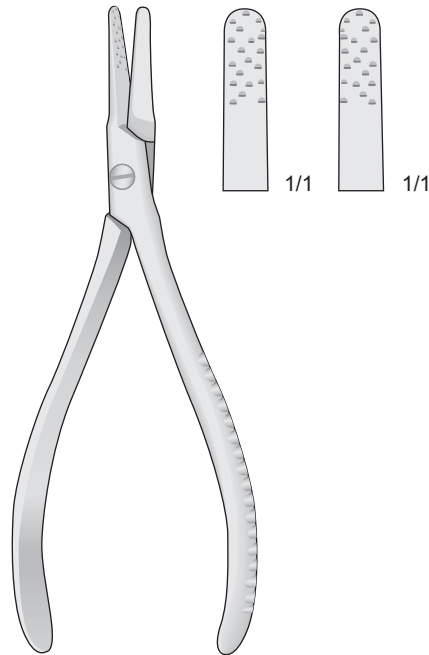

RADOLF
0614-BFL
135 mm

Nagelspaltzange
Nail nipper
Pinza per unghie
Pinzas corta uñas
Pince à ongles

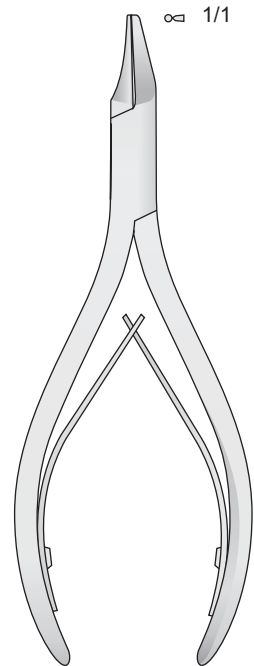

0415-AL
135 mm

Hohlmeißelzangen

Bone rongeurs

Pinze ossivore

Pinza-gubias

Pinces-gouges

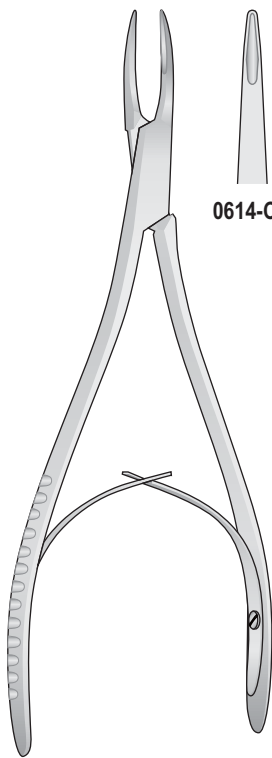

MINI-FRIEDMANN
0614-CC/0614-CC0
150 mm

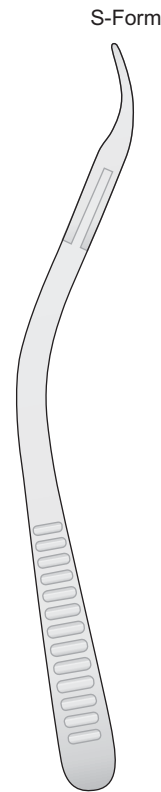
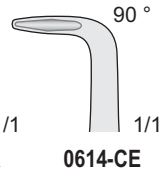
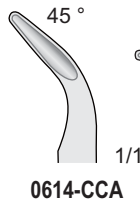
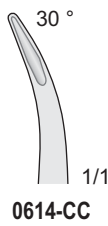
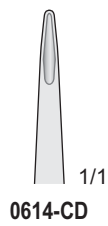

MINI-FRIEDMANN
0614-IF
145 mm

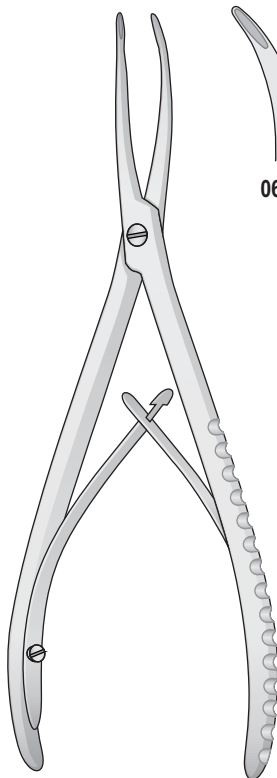
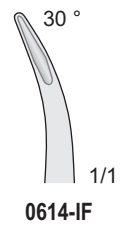

STELLBRINK
0614-II/0614-IL
170 mm

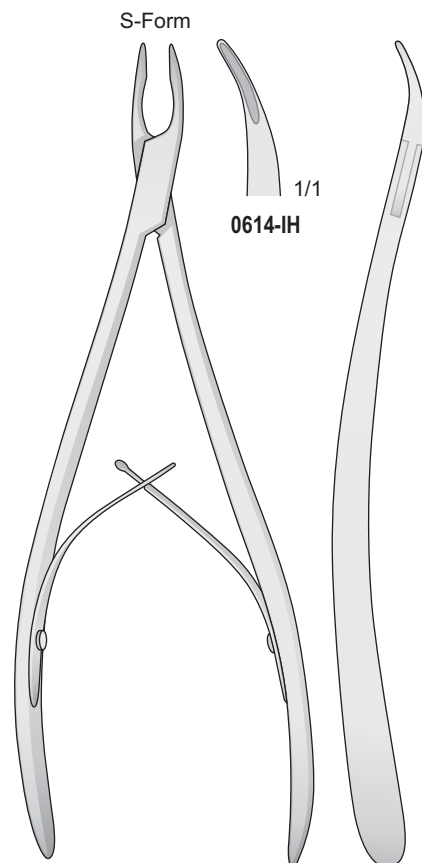
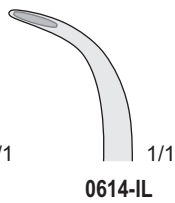
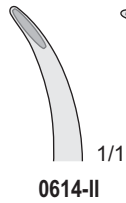

STELLBRINK
0614-IH
190 mm

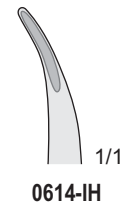

Hohlmeißelzangen

Bone rongeurs

Pinze ossivore

Pinza-gubias

Pinces-gouges

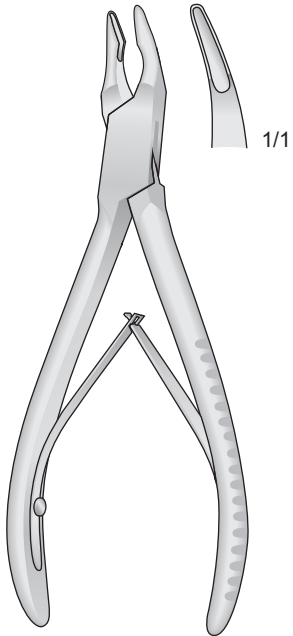

MINI FRIEDMANN
0614-BF
120 mm

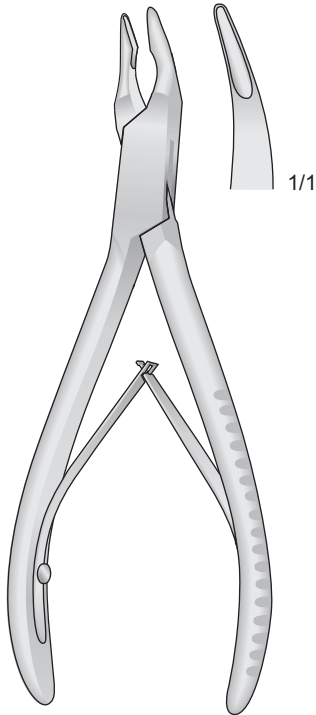

FRIEDMANN
0614-BH
140 mm

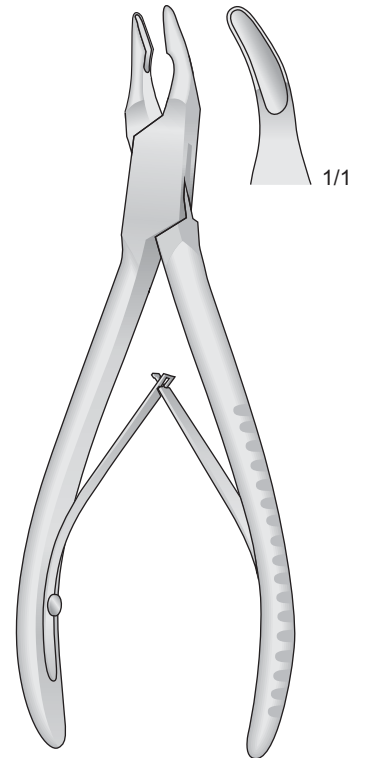

BLUMENTHAL
0614-BL
155 mm

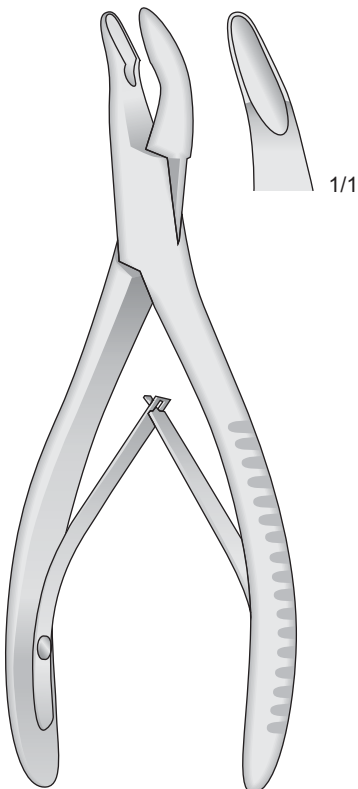

MEAD
0614-CB
165 mm

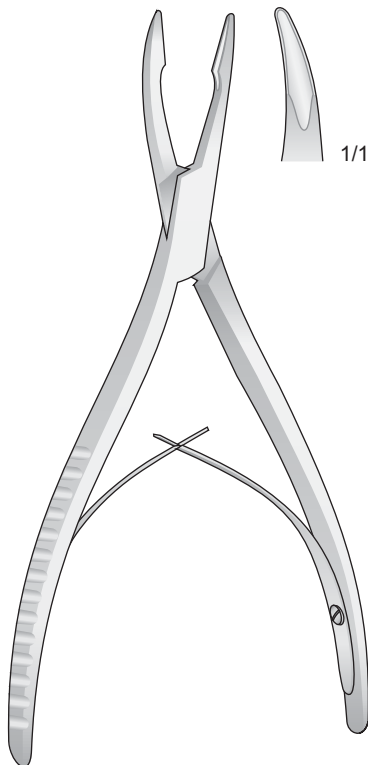

FRIEDMANN
0614-BG
160 mm

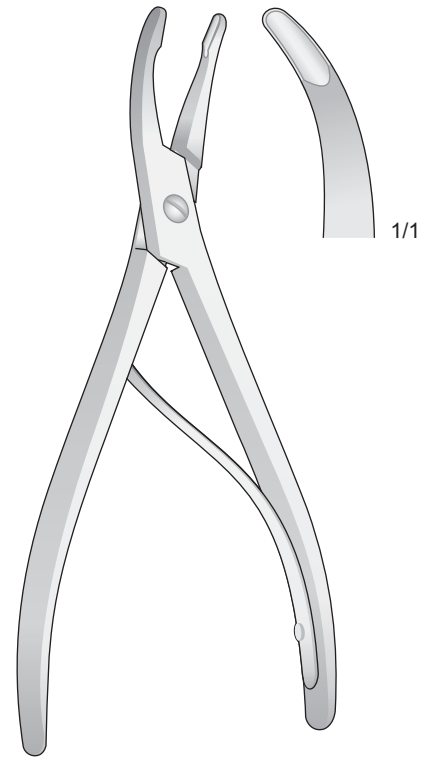

LUER
0614-BI
155 mm

Hohlmeißelzangen

Bone rongeurs

Pinze ossivore

Pinza-gubias

Pinces-gouges

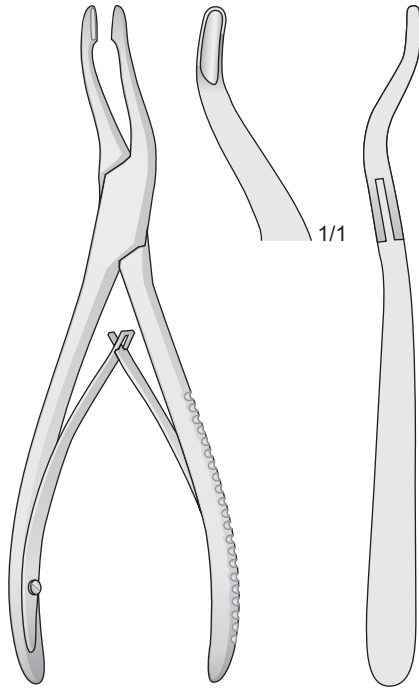

ALEXANDER
0614-CH
140 mm

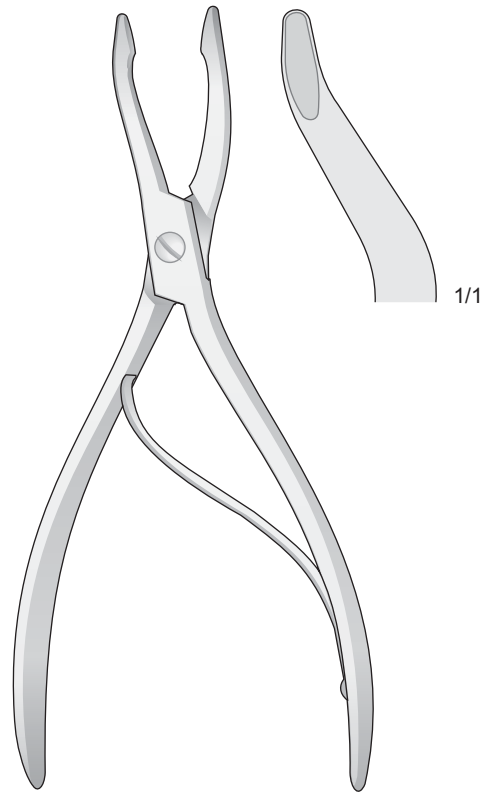

JANSEN-LEUER
0614-BA
180 mm

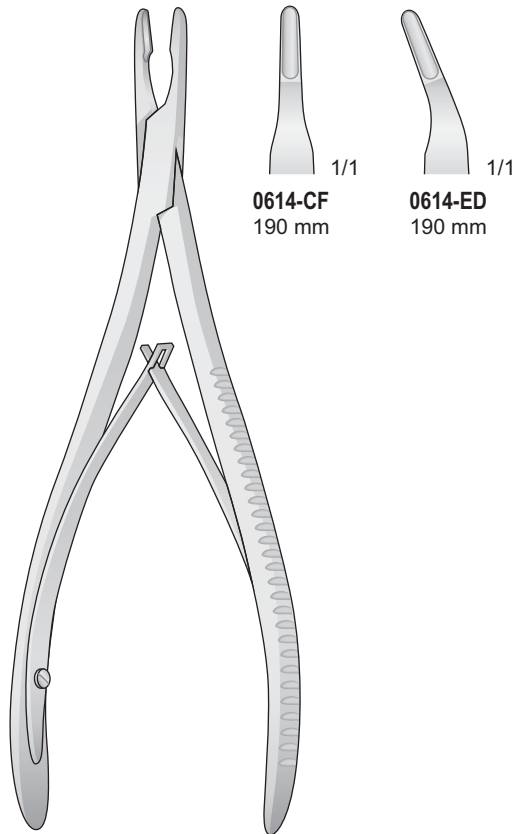

LEMPERT
0614-CF/0614-ED
190 mm

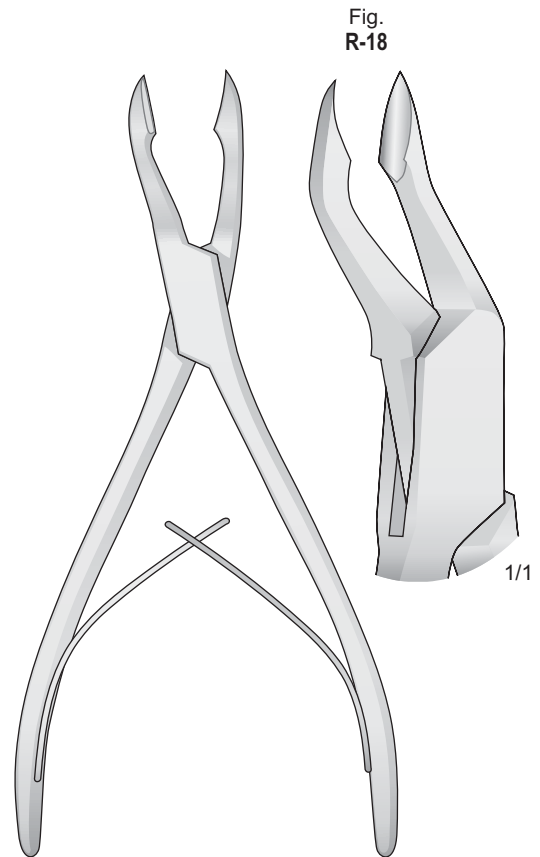

0614-DD
175 mm

Hohlmeißelzangen

Bone rongeurs

Pinze ossivore

Pinza-gubias

Pinces-gouges

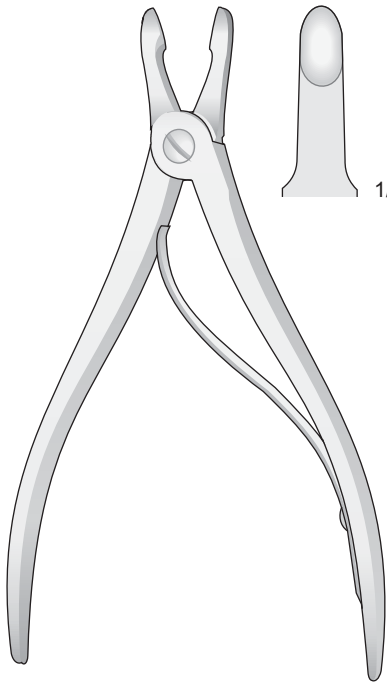

HARTMANN
0614-BE
155 mm

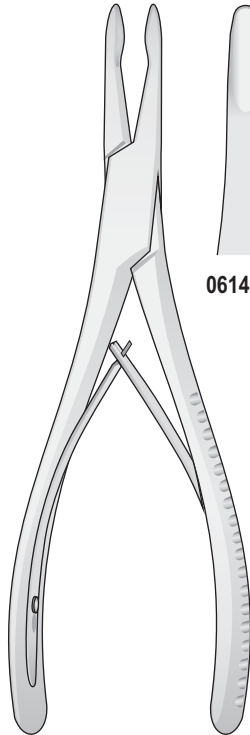

JANSEN
0614-DH/0614-DL
170 mm

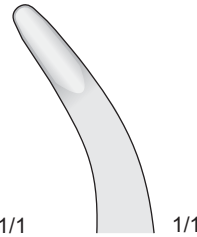

0614-DL

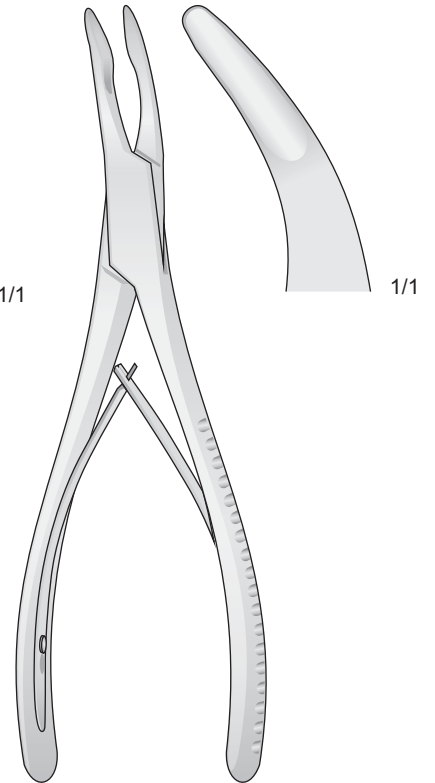

OLIVECRONA
0614-EF
190 mm

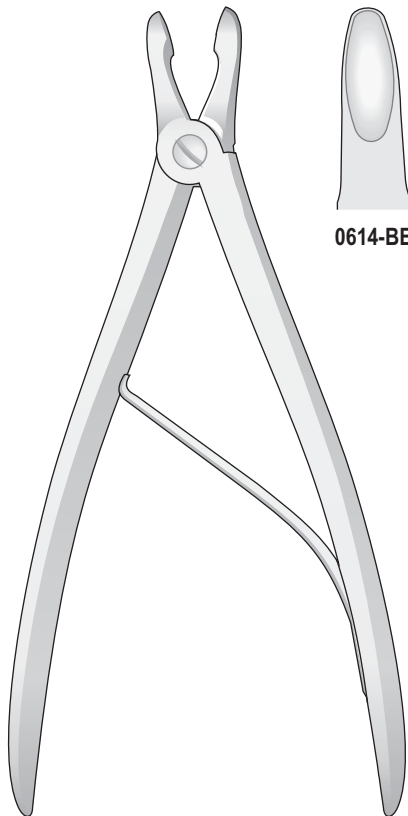

CUSHING
0614-BB/0614-BC
190 mm

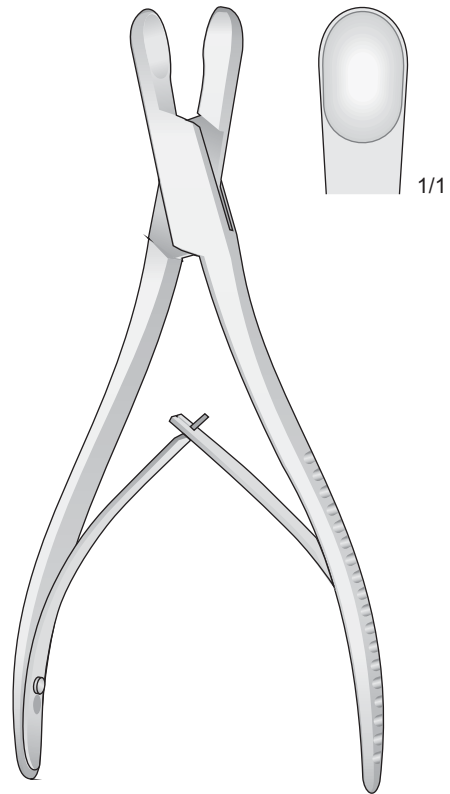
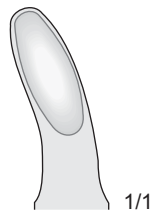
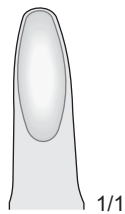

LUER-STILLE
0614-BD
185 mm

Hohlmeißelzangen

Bone rongeurs

Pinze ossivore

Pinza-gubias

Pinces-gouges

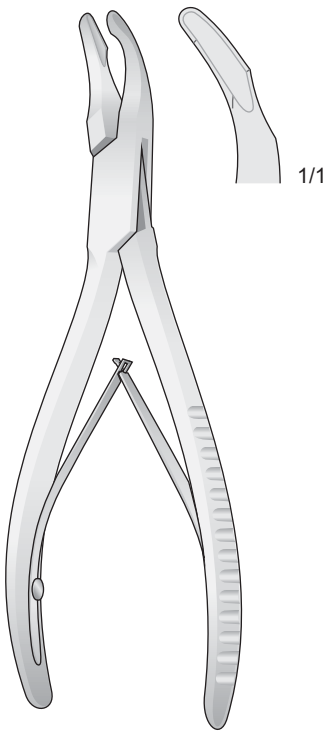

CLEVELAND
0614-CDB 140 mm
0614-CDC 170 mm

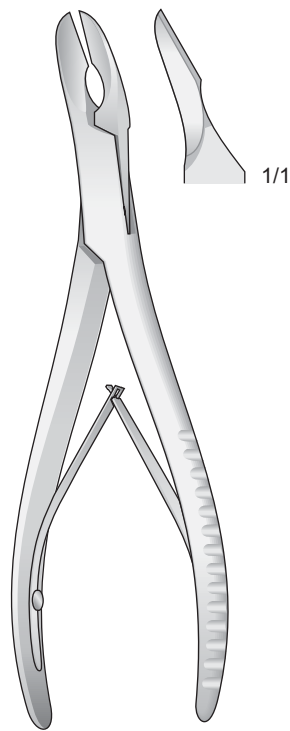

CLEVELAND
0614-CDD 150 mm
0614-CDE 170 mm

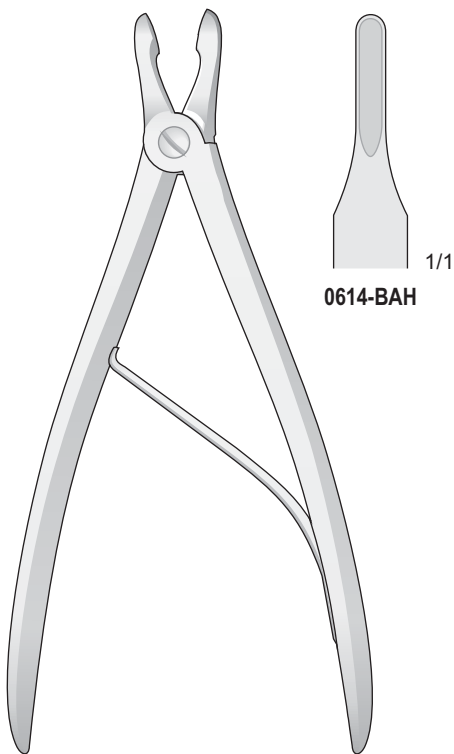

CUSHING
0614-BAH/0614-BAL
 190 mm

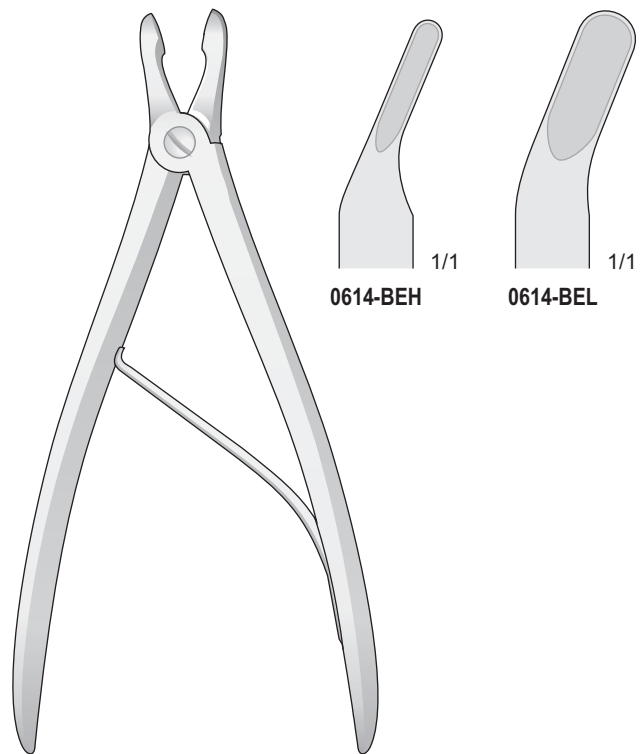

CUSHING
0614-BEH/0614-BEL
 190 mm

Hohlmeißelzangen

Bone rongeurs

Pinze ossivore

Pinza-gubias

Pinces-gouges

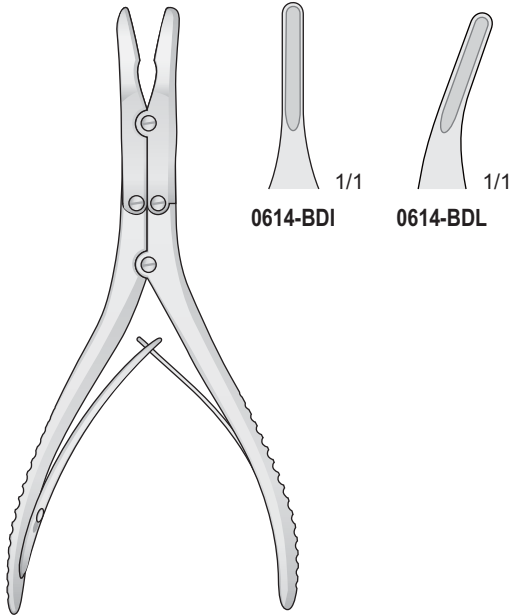

0614-BDI

0614-BDL

RUSKIN
0614-BDI/0614-BDL
150 mm

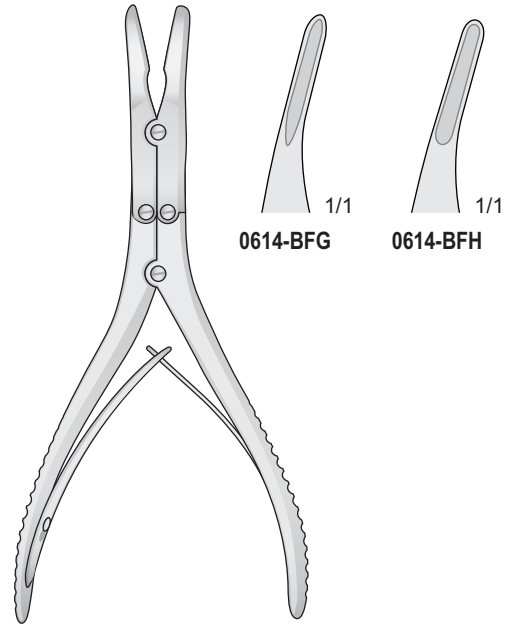

0614-BFG

0614-BFH

KLEINERT-KUTZ
0614-BFG/0614-BFH
155 mm

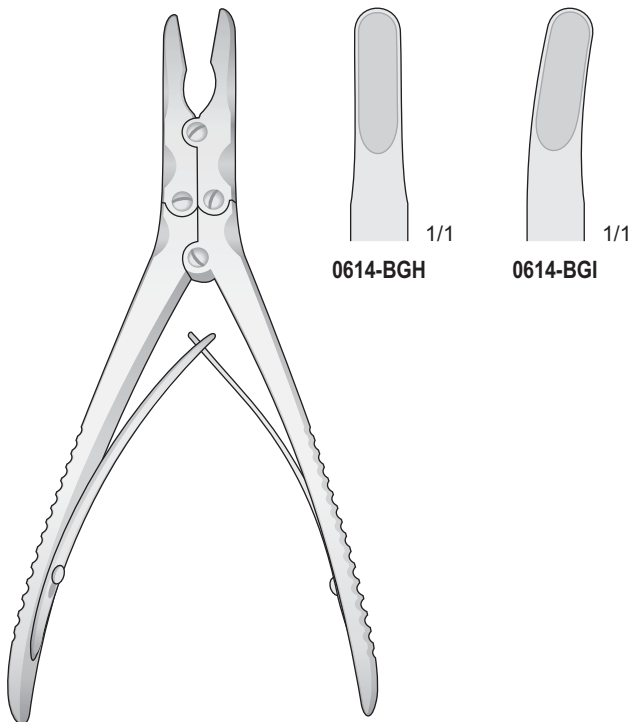

0614-BGH

0614-BGI

RUSKIN
0614-BGH/0614-BGI
185 mm

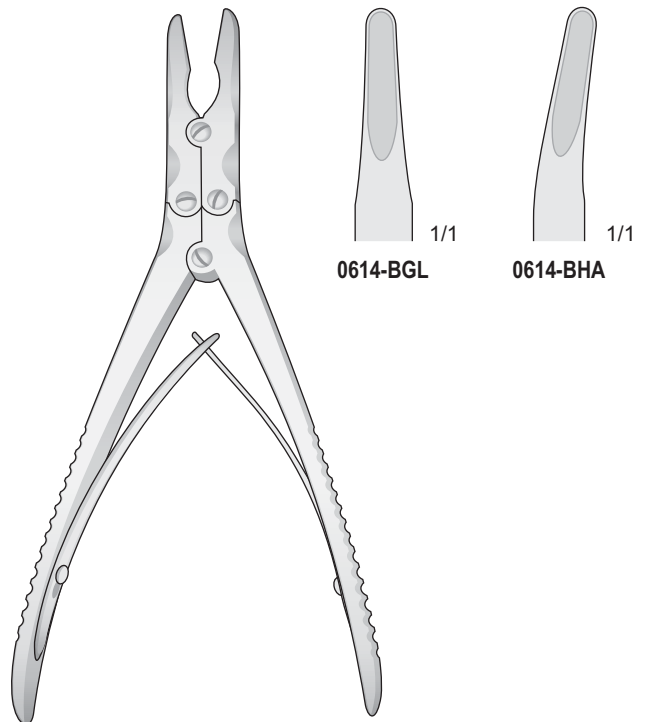

0614-BGL

0614-BHA

RUSKIN
0614-BGL/0614-BHA
185 mm

Hohlmeißelzangen

Bone rongeurs

Pinze ossivore

Pinza-gubias

Pinces-gouges

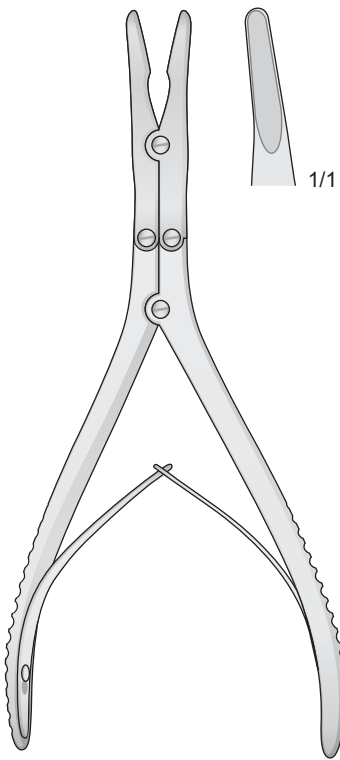

BEYER
0614-CA
180 mm

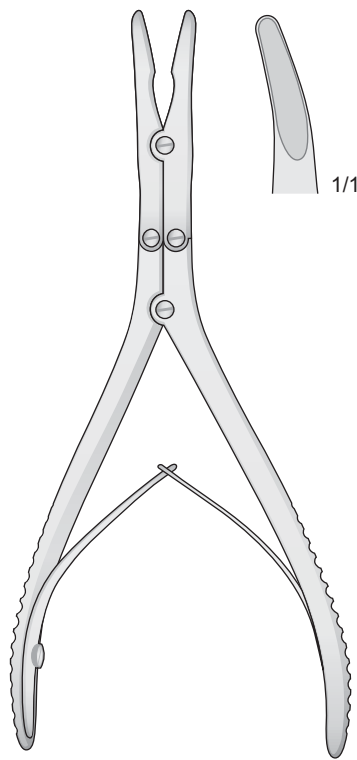

ZAUFAL-JANSEN
0614-DE
180 mm

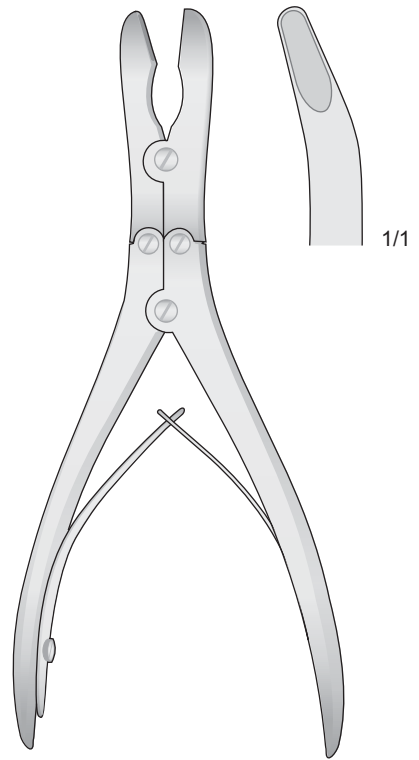

RUSKIN-STILLE
0614-DF
180 mm

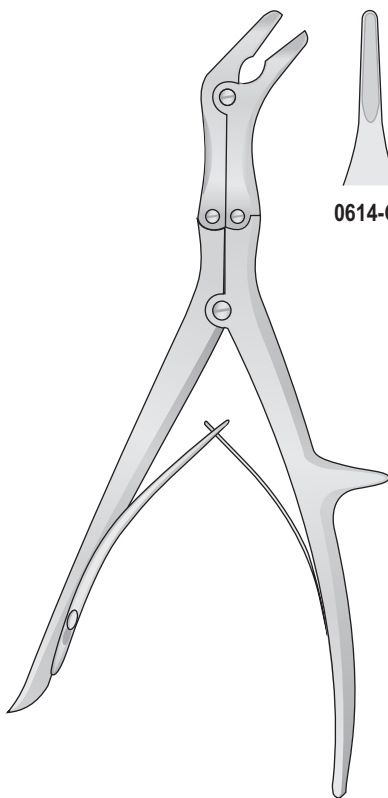

ECHLIN
0614-CI/0614-DA
230 mm

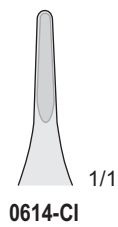

0614-CI

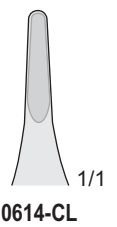

0614-CL

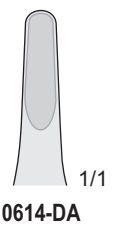

0614-DA

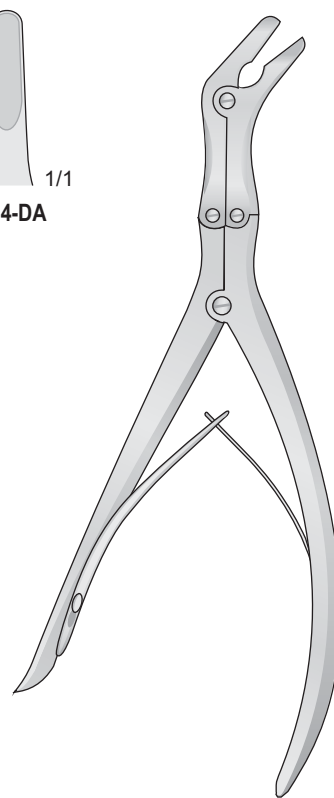

LEKSELL
0614-DB/0614-DC

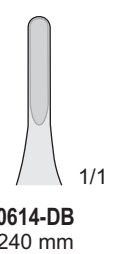

0614-DB
240 mm

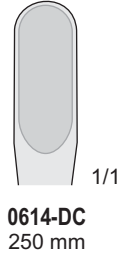

0614-DC
250 mm

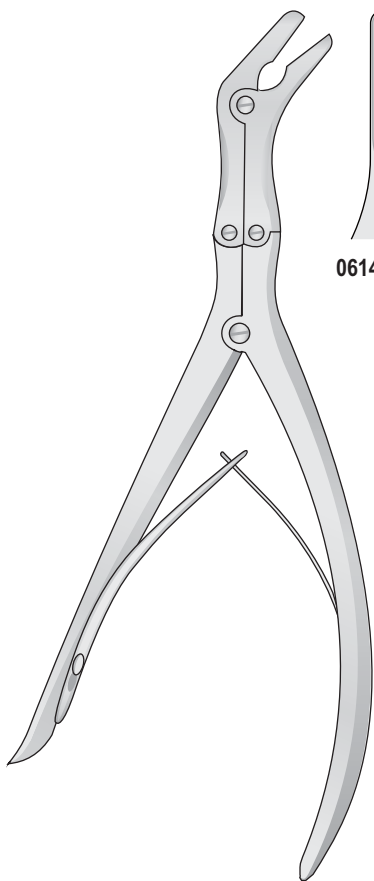

LEKSELL
0614-BDF/0614-BEF
250 mm

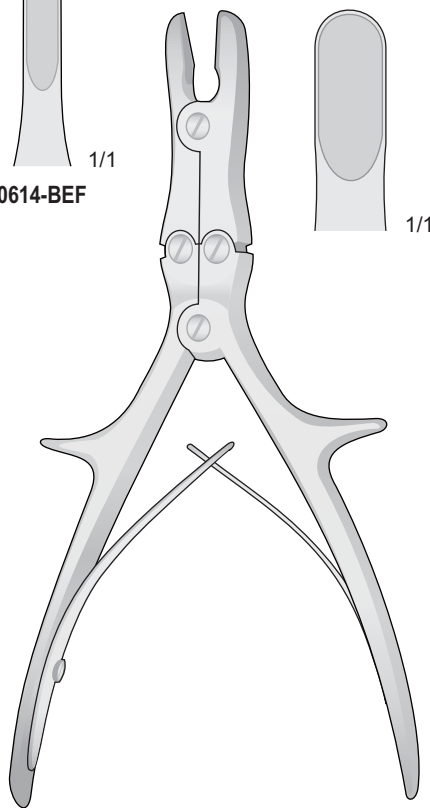

LUER-STILLE
0614-BEI
220 mm

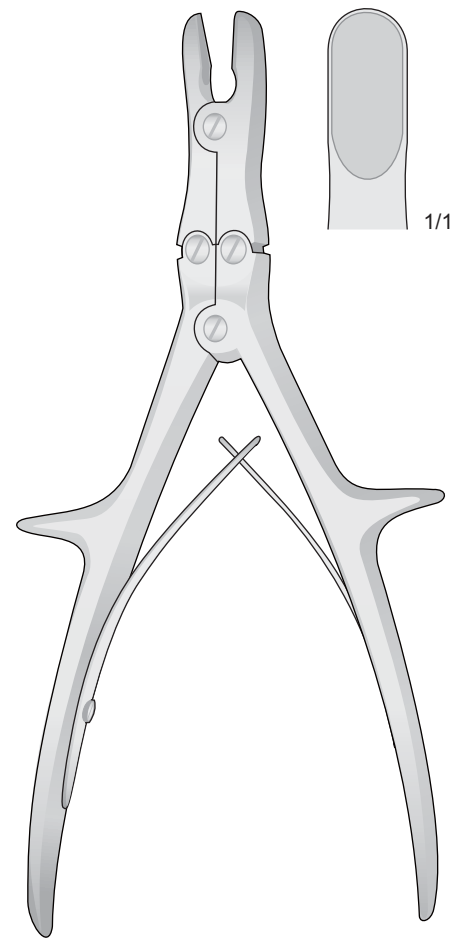

LUER-STILLE
0614-BHG
260 mm

Hohlmeißelzangen

Bone rongeurs

Pinze ossivore

Pinza-gubias

Pinces-gouges

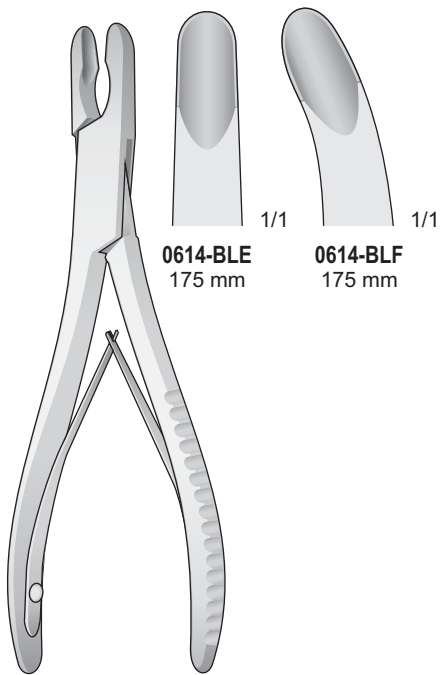

LUER
0614-BLE/0614-BLF
175 mm

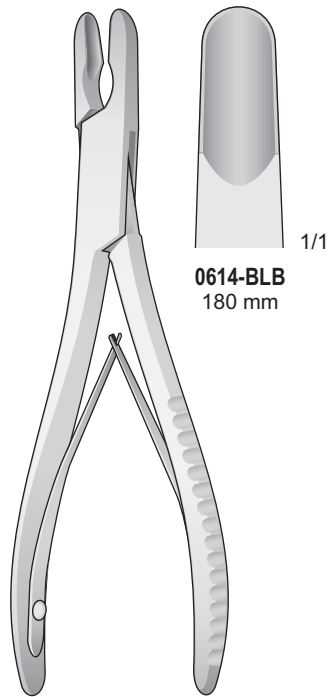

LUER
0614-BLB
180 mm

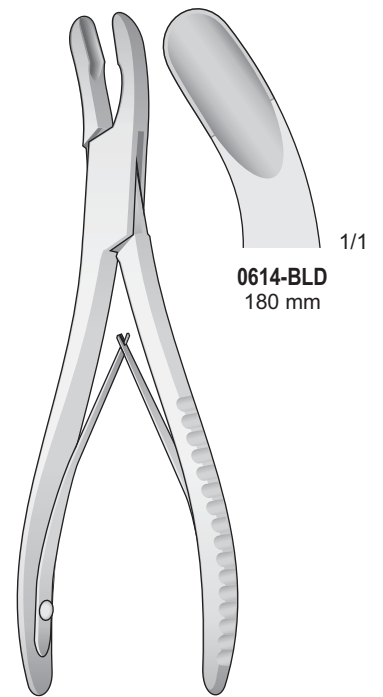

LUER
0614-BLD
180 mm

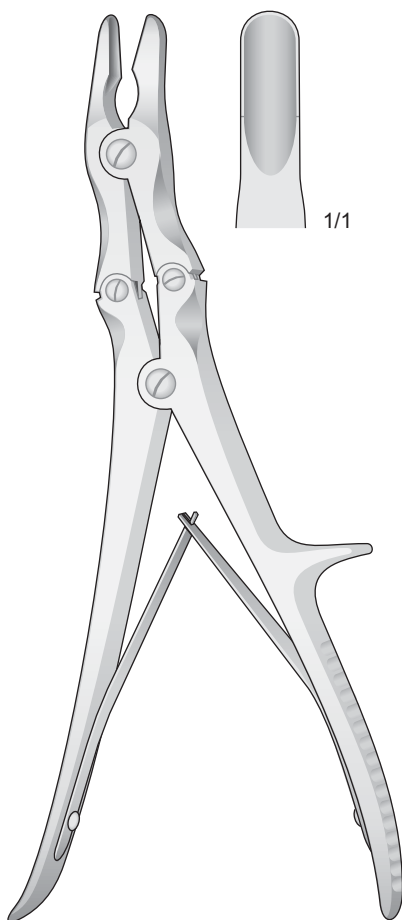

LEKSELL-STILLE
0614-BLG
240 mm

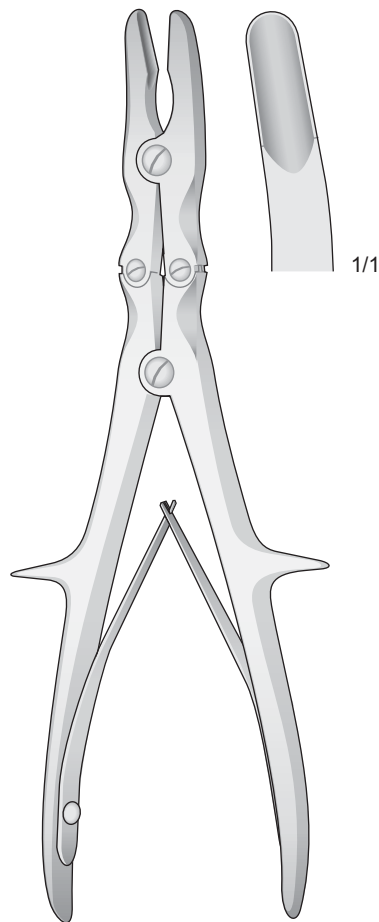

STILLE-RUSKIN
0614-BLH
240 mm

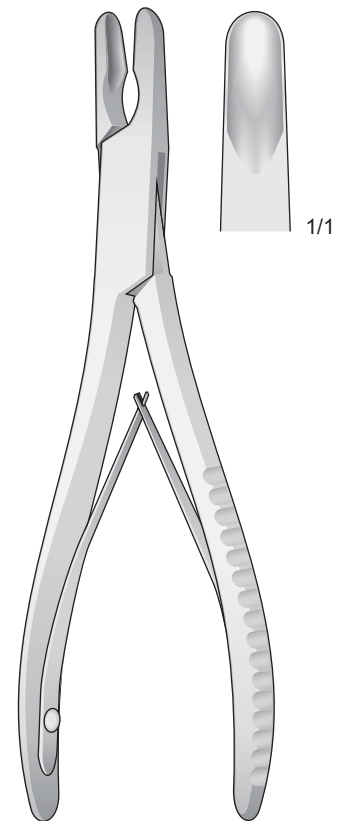

ADSON
0614-BLI
210 mm

Hohlmeißelzangen

Bone rongeurs

Pinze ossivore

Pinza-gubias

Pinces-gouges

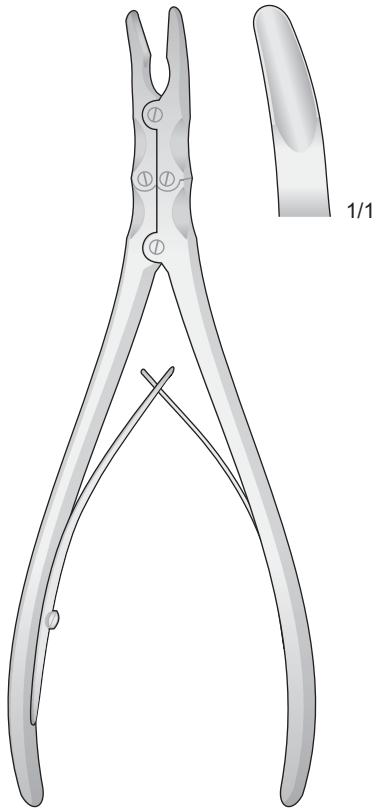

RÖTTGEN-RUSKIN
0614-BLL
240 mm

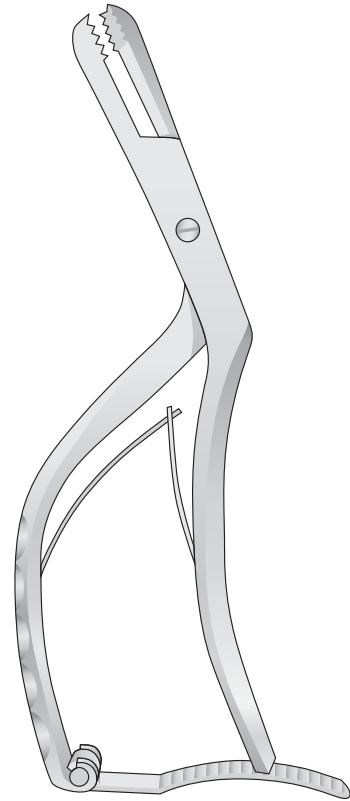

0614-BEA
200 mm

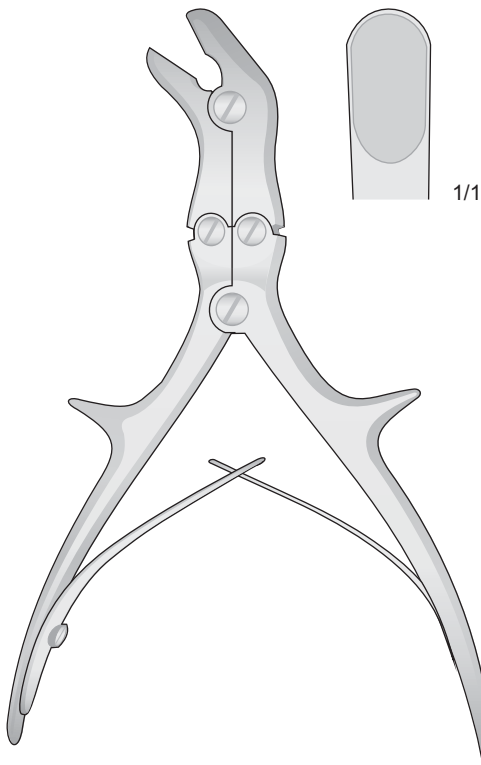

STILLE
0614-DG
210 mm

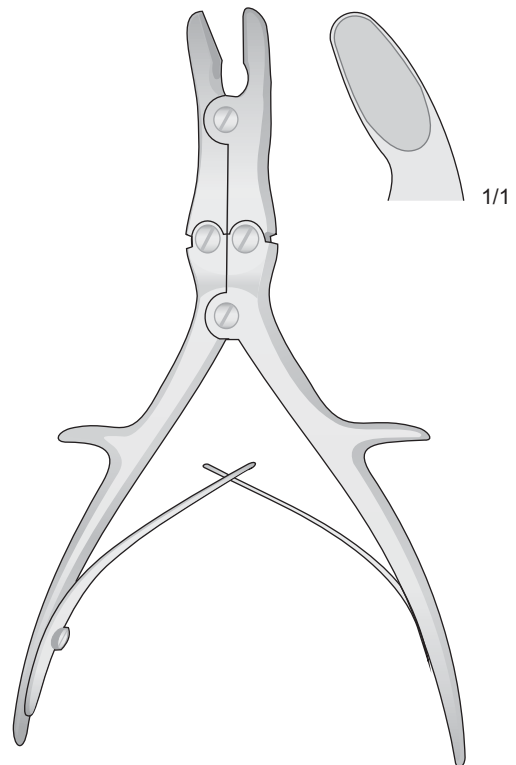

LUER-STILLE
0614-DI
210 mm

Hohlmeißelzangen

Bone rongeurs

Pinze ossivore

Pinza-gubias

Pinces-gouges

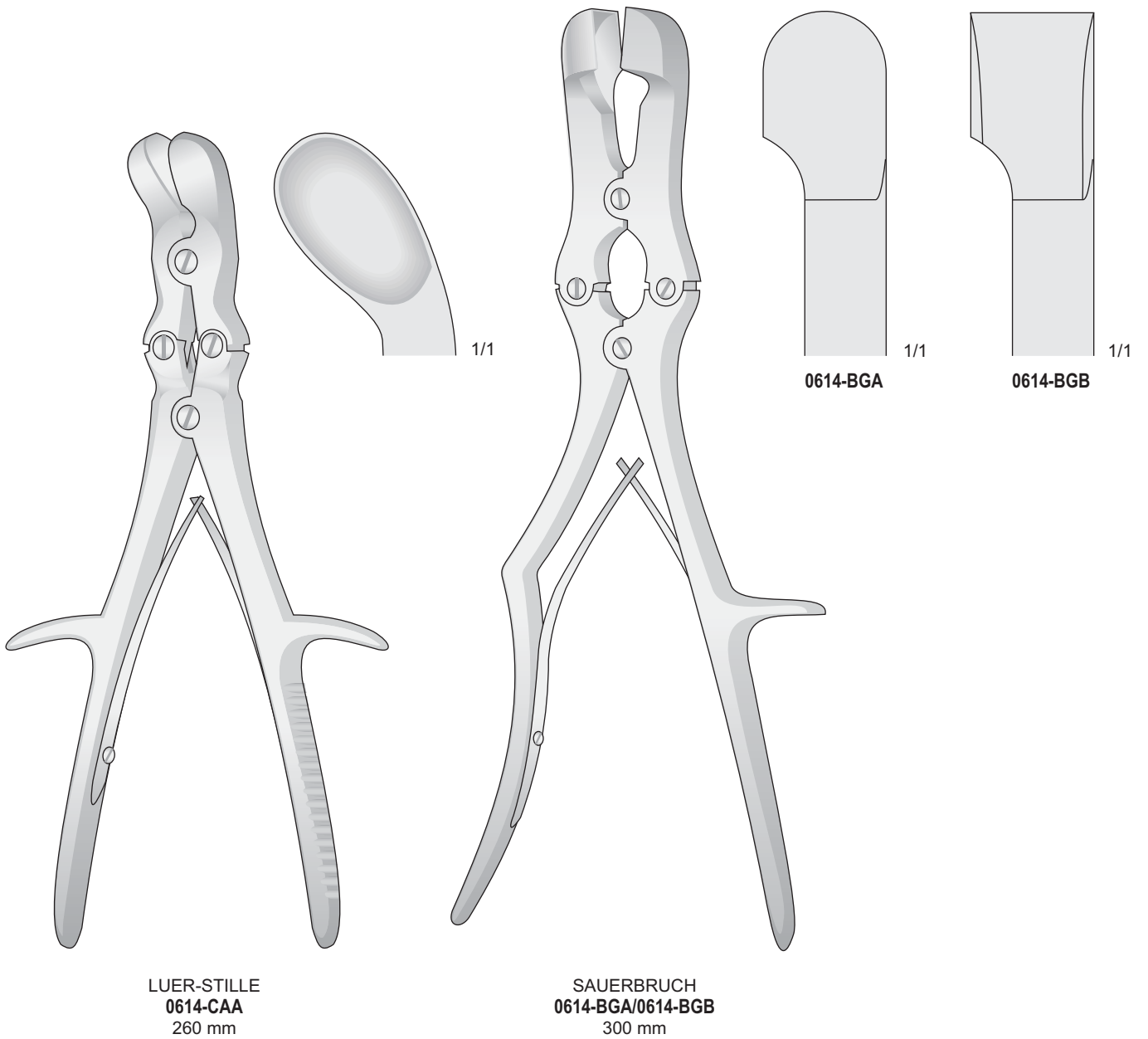

Hohlmeißelzangen

Bone rongeurs

Pinze ossivore

Pinza-gubias

Pinces-gouges

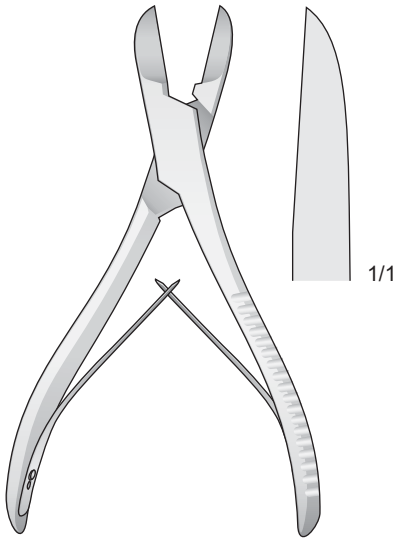

LISTON
1123-BBB
140 mm

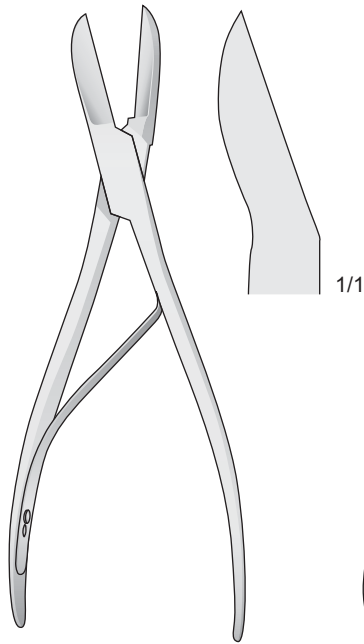

LISTON
1123-BAL
170 mm

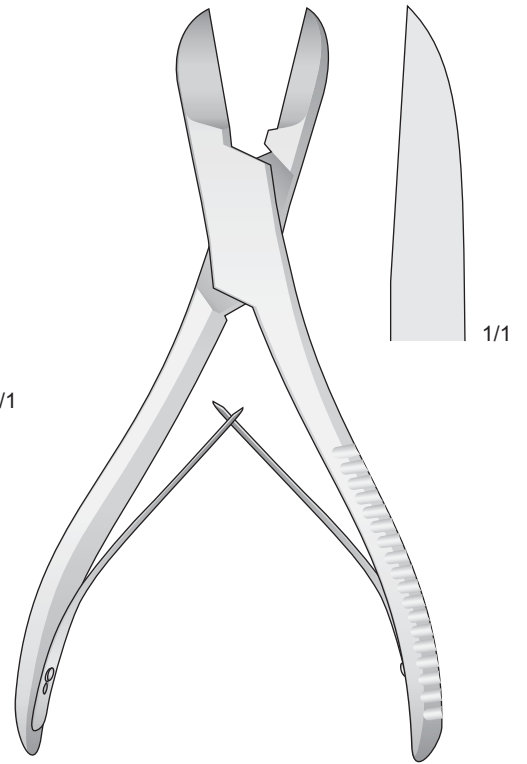

LISTON
1123-BBG
200 mm

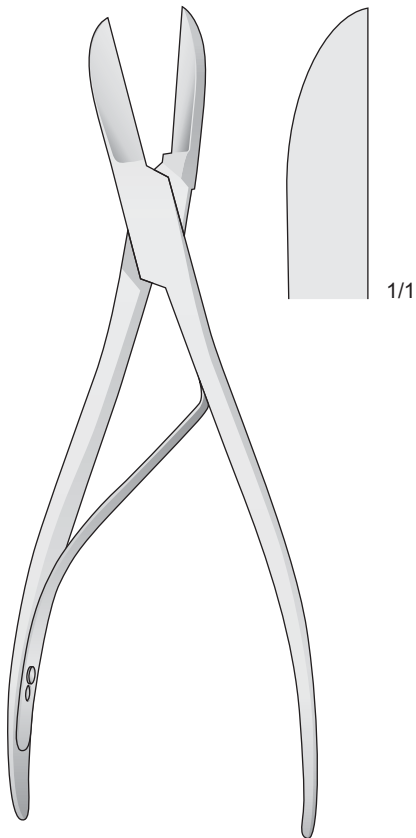

LISTON
1123-BAI
220 mm

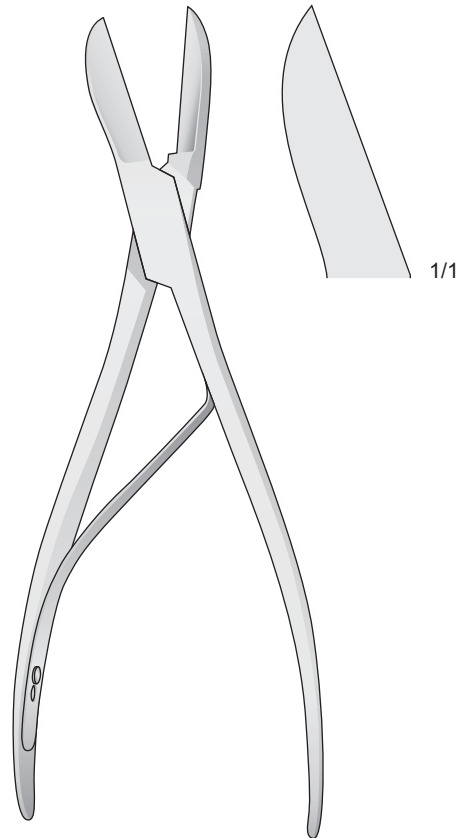

LISTON
1123-BBA
220 mm

Hohlmeißelzangen

Bone rongeurs

Pinze ossivore

Pinza-gubias

Pinces-gouges

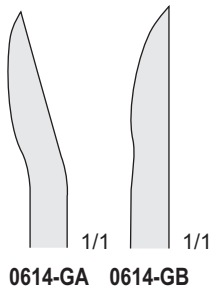
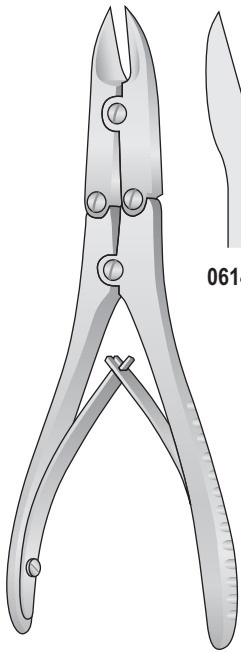

BÖHLER
0614-GA/0614-GB
150 mm

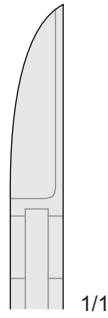
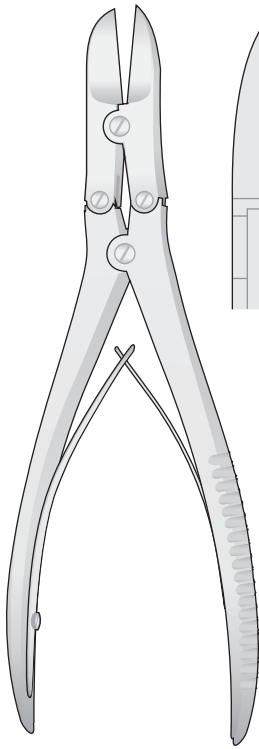

RUSKIN-LISTON
0614-BAI
190 mm

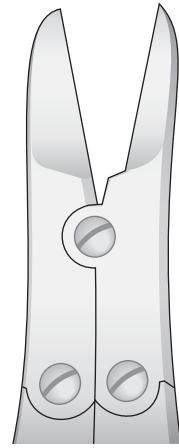

1/1

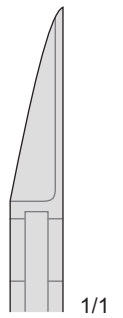
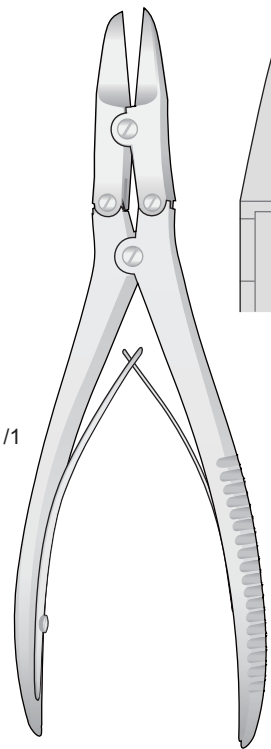

RUSKIN-LISTON
0614-BHI
190 mm

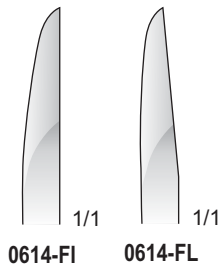
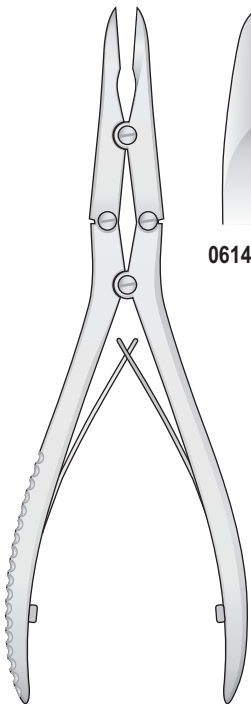

0614-FI/0614-FL
180 mm

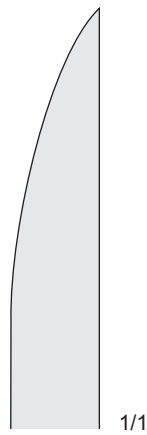
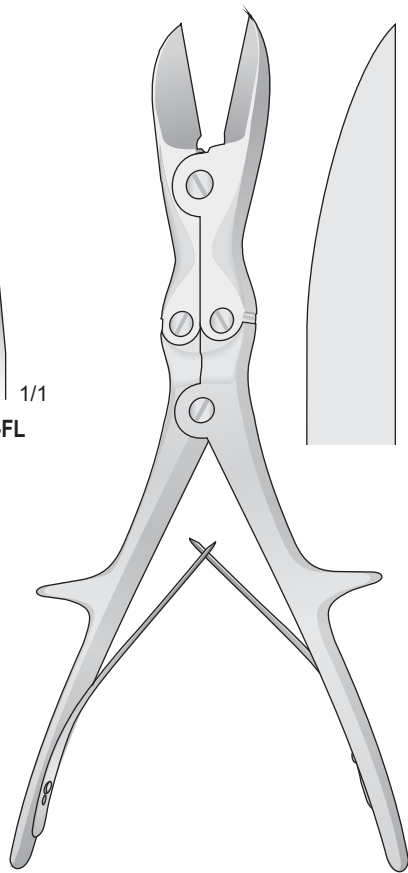

LISTON
0614-EB
270 mm

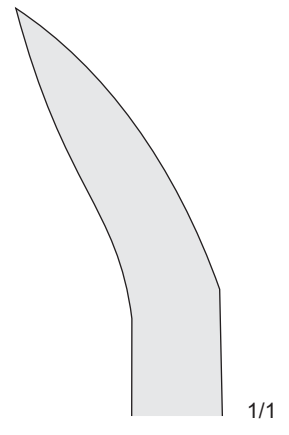
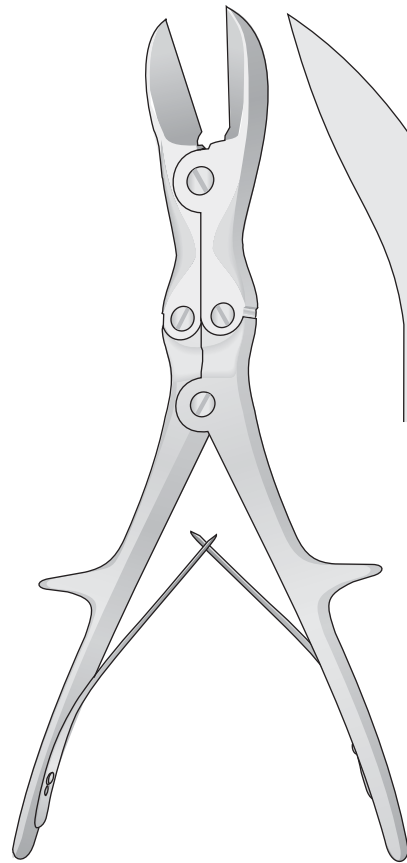

LISTON
0614-EC
270 mm

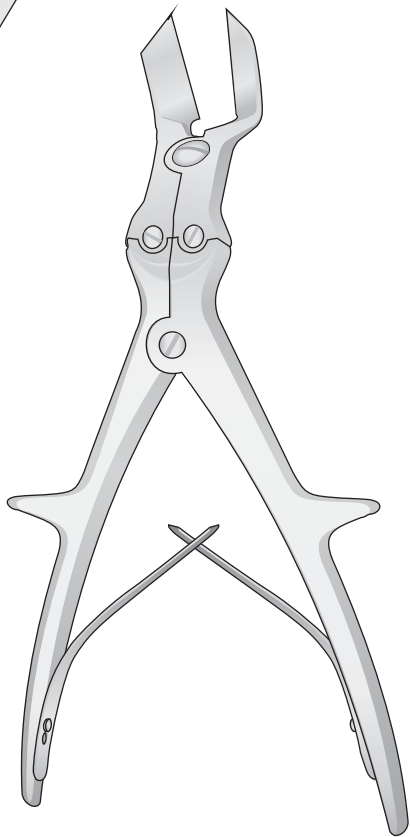
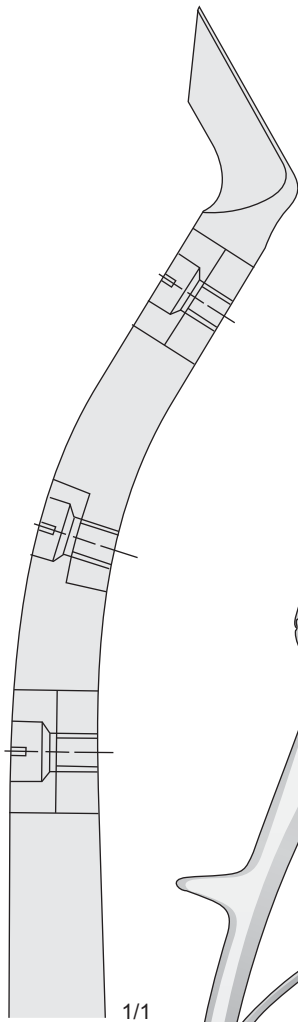

KEY-HORSLEY
0614-EA
235 mm

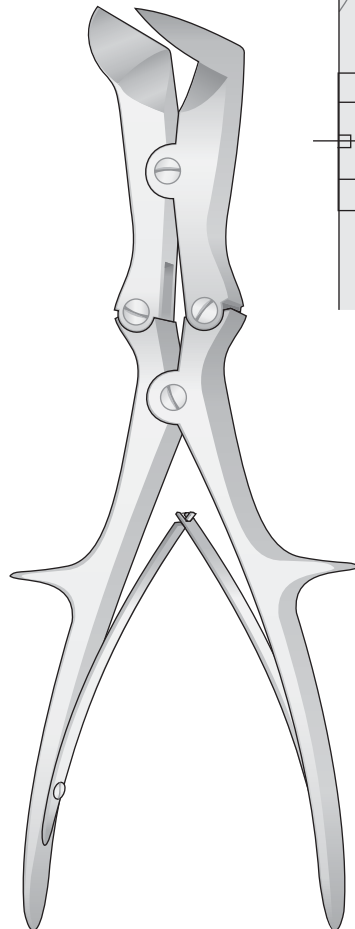
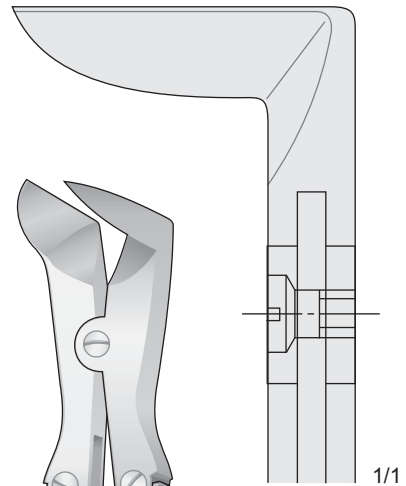

LISTON-STILLE
0614-BFI
265 mm

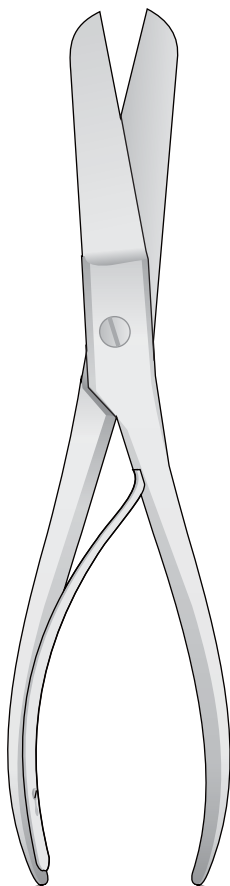

0607-EA
230 mm

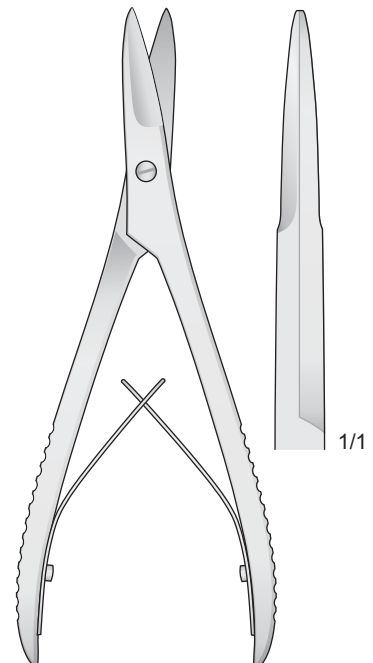
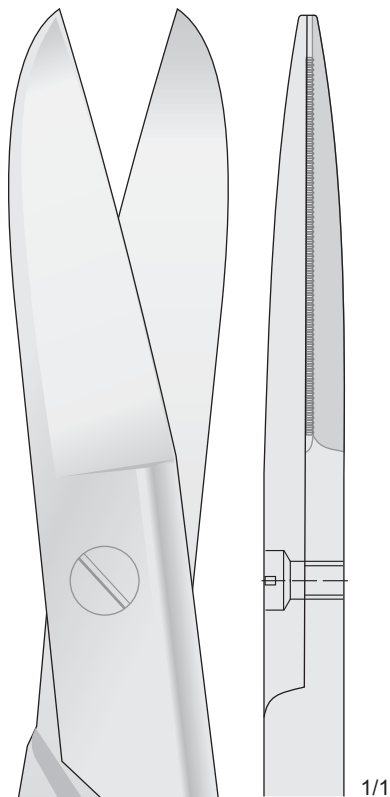

0614-GD
160 mm



Bohrdrahte
Wires extension
Chiodi Kirschner
Agujas
Broches filiformes



KIRSCHNER
 Trokarspitze
 Trocar point
 Punta trequarti
 Punta de trocar
 Pointe de Trocart



KIRSCHNER
 Trokarspitze
 Trocar point
 Punta trequarti
 Punta de trocar
 Pointe de Trocart

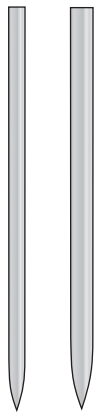

KIRSCHNER
 Lanzenspitze
 Lance point
 Punta lanceolate
 Punta lanceolar
 Pointe lancette



Trokarspitze
 Trocar point
 Punta trequarti
 Punta de trocar
 Pointe de Trocart

310 mm



Rundes ende
 Round shaft
 Punta rotonda
 Punta redonda
 Pointe ronde

310 mm

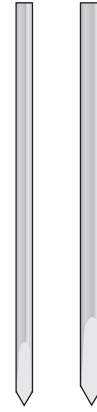

Lanzenspitze
 Lance point
 Punta lanceolate
 Punta lanceolar
 Pointe lancette

310 mm

Ø/Diam.	Pack. 10 pcs.
0,8 mm	1009-LL
1,0 mm	1009-BAA
1,2 mm	1009-BAC
1,4 mm	1009-BBE
1,5 mm	1009-BBF
1,6 mm	1009-BBG
1,7 mm	1009-BBH
1,8 mm	1009-BBI
2,0 mm	1009-BCA
2,2 mm	1009-BCC
2,5 mm	1009-BCF
3,0 mm	1009-BDA

Ø/Diam.	Pack. 10 pcs..
0,8 mm	1009-AA
1,0 mm	1009-AB
1,2 mm	1009-AC
1,4 mm	1009-BE
1,5 mm	1009-BF
1,6 mm	1009-BG
1,7 mm	1009-BH
1,8 mm	1009-BI
2,0 mm	1009-CA
2,2 mm	1009-CC
2,5 mm	1009-CF
3,0 mm	1009-DA

Ø/Diam.	Pack. 10 pcs.
0,8 mm	1009-EA
1,0 mm	1009-EB
1,2 mm	1009-EC
1,5 mm	1009-ED
1,6 mm	1009-EE
1,8 mm	1009-EF
2,0 mm	1009-EG
2,2 mm	1009-EH
2,5 mm	1009-EI
3,0 mm	1009-EL

Bohrdrahte
Wires extension
Chiodi Kirschner
Agujas
Broches filiformes



KIRSCHNER
 Trokarspitze
 Trocar point
 Punta trequarti
 Punta de trocar
 Pointe de Trocart



KIRSCHNER
 Trokarspitze
 Trocar point
 Punta trequarti
 Punta de trocar
 Pointe de Trocart

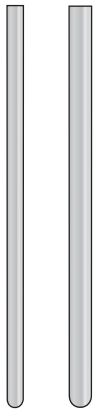

KIRSCHNER
 Lanzenspitze
 Lance point
 Punte lanceolate
 Punta lanceolar
 Pointe lancette



Rundes ende
 Round shaft
 Punta rotonda
 Punta redonda
 Pointe ronde

150 mm

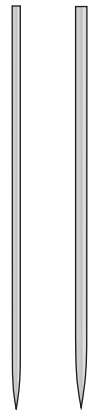

Trokarspitze
 Trocar point
 Punta trequarti
 Punta de trocar
 Pointe de Trocart

150 mm



Lanzenspitze
 Lance point
 Punte lanceolate
 Punta lanceolar
 Pointe lancette

150 mm

Ø/Diam.	Pack. 10 pcs
0,8 mm	1009-GL
1,0 mm	1009-HA
1,2 mm	1009-HC
1,4 mm	1009-HE
1,5 mm	1009-HF
1,6 mm	1009-HG
1,7 mm	1009-HH
1,8 mm	1009-HI
2,0 mm	1009-IA
2,2 mm	1009-IC
2,5 mm	1009-IF
3,0 mm	1009-LA

Ø/Diam.	Pack. 10 pcs.
0,8 mm	1009-GA
1,0 mm	1009-GB
1,2 mm	1009-GC
1,4 mm	1009-GD
1,6 mm	1009-GE
1,8 mm	1009-GF
2,0 mm	1009-GG
2,2 mm	1009-GH
2,5 mm	1009-GI
3,0 mm	1009-HB

Ø/Diam.	Pack. 10 pcs.
0,8 mm	1009-CL
1,0 mm	1009-DB
1,2 mm	1009-DC
1,5 mm	1009-DD
1,6 mm	1009-DE
1,8 mm	1009-DF
2,0 mm	1009-DG
2,2 mm	1009-DH
2,5 mm	1009-DI
3,0 mm	1009-DL

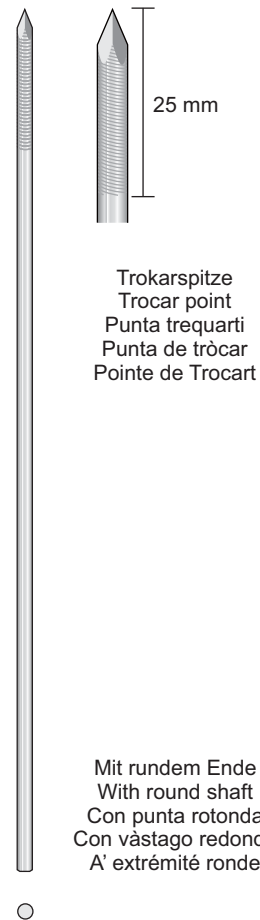
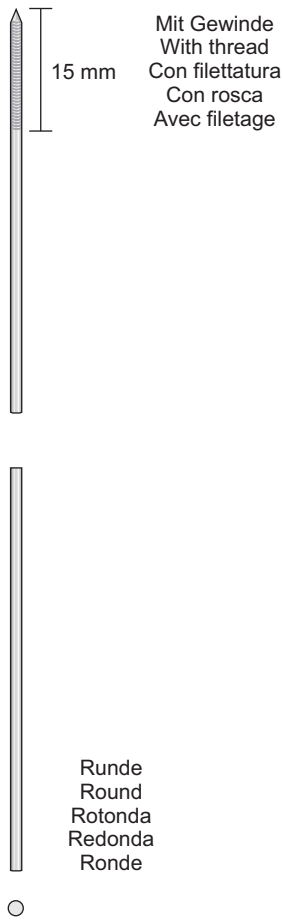

KIRSCHNER			
Code	Ø mm	Lenght	Wire Len.
1009-CCA	1,5	150	5
1009-CCB	1,6	150	15
1009-CCC	2	150	15
1009-CCD	2	200	15

KIRSCHNER			
Code	Ø mm	Lenght	Wire Len.
1009-CCE	2,5	200	25
1009-CCF	2,5	230	25
1009-CCG	2,5	300	25
1009-CCH	3,0	300	25
1009-CCI	3,5	300	25
1009-CCL	4,0	260	25
1009-CDD	4,5	300	25

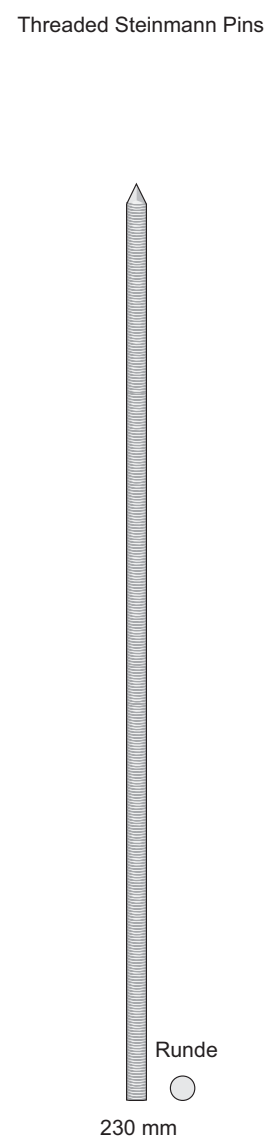
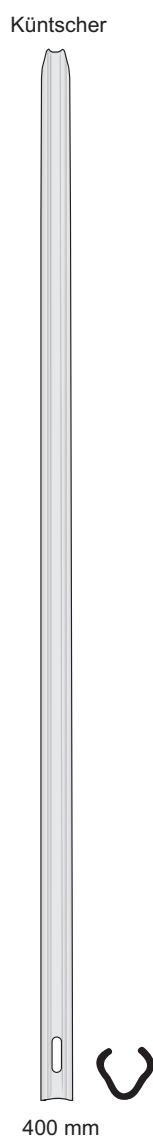
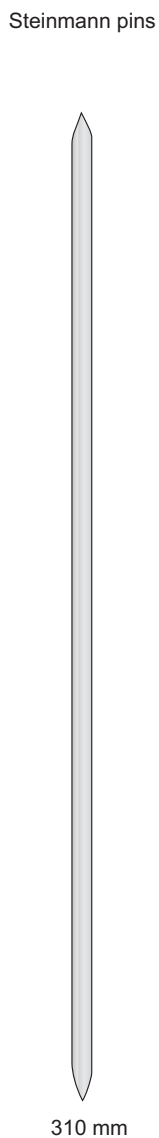
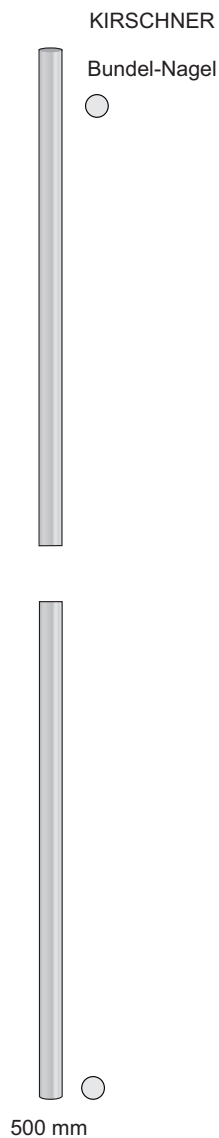
Bohrdrähte
Wires extension
Chiodi Kirschner
Agujas
Broches filiformes

Ø/Diam.	Pack. 10 pcs
2,0 mm	1009-FA
2,5 mm	1009-FB
3,0 mm	1009-FC
3,5 mm	1009-FD
4,0 mm	1009-FE
4,5 mm	1009-FF
5,0 mm	1009-FG
5,5 mm	1009-FH
6,0 mm	1009-FI

Ø/Diam.	Pack. 1 pc
3,5 mm	1009-CIA
4,0 mm	1009-CIC
4,5 mm	1009-CIE
5,0 mm	1009-CIG
6,0 mm	1009-CII
6,5 mm	1009-CLA

Ø/Diam.	Pack. 1 pc
6,0 mm	1009-CFC
7,0 mm	1009-CFE
8,0 mm	1009-CFG
9,0 mm	1009-CFI
10 mm	1009-CGA
11 mm	1009-CGC
12 mm	1009-CGE

Ø/Diam.	Pack. 1 pc
2,0 mm	1009-BGA
2,5 mm	1009-BGB

Bohrdrähte und
knochennägel mit Gewinde

Threaded Wires
and pines

Chiodi filettati
Schanz

Agujas y clavos
con rosca

Broches et clous
avec filetage

Negativo

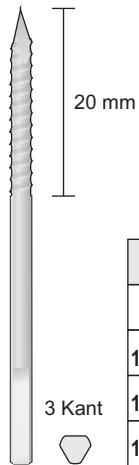

SCHANZ			
Code	Ø mm	Lenght	Wire Len.
1009-CDA	3	60	20
1009-CDB	3	80	20
1009-CDC	4	60	25

Negativo

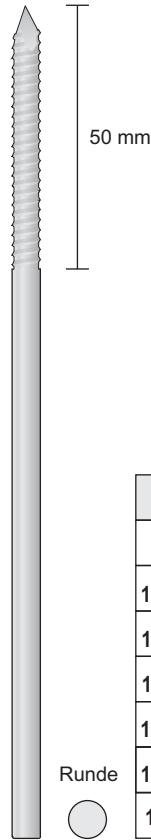

SCHANZ			
Code	Ø mm	Lenght	Wire Len.
1009-CLD	2	150	50
1009-CLE	3	150	50
1009-CLF	3,5	150	50
1009-CLG	4	150	50
1009-CLH	4,5	150	50
1009-CLI	5	150	50

Negativo

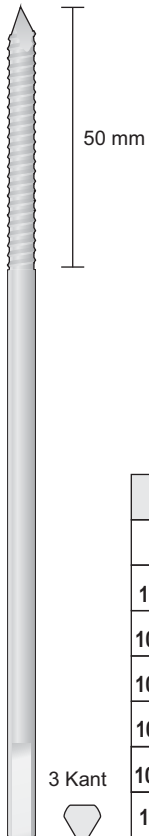

SCHANZ			
Code	Ø mm	Lenght	Wire Len.
1009-CDI	2	150	50
1009-CEA	3	150	50
1009-CEC	3,5	150	50
1009-CEE	4	150	50
1009-CEG	4,5	150	50
1009-CEI	5	150	50

Positivo

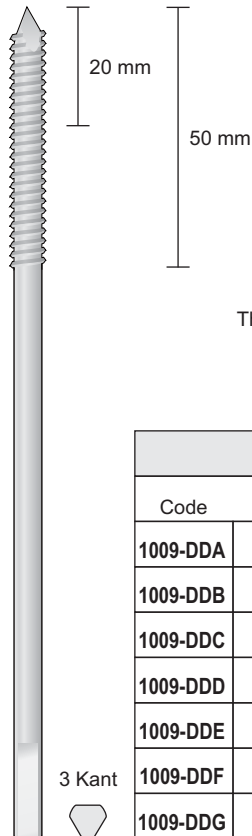

Thread - Ø is 0,5 mm
more than pin - Ø

SCHANZ			
Code	Ø mm	Lenght	Wire Len.
1009-DDA	2	150	20
1009-DBB	3	150	20
1009-DDC	3,5	150	50
1009-DDD	4	150	25
1009-DDE	4	150	50
1009-DDF	4,5	150	50
1009-DDG	5	150	50

Bohrdrähte und
knochennägel mit Gewinde

Threaded Wires
and pines

Chiodi filettati
Schanz

Agujas y clavos
con rosca

Broches et clous
avec filetage

Steinmann Pins with Central Thread with Trocar Point

Bohrdrahtspender
Contentitore per
sterilizzazione Kirschner

Positivo
Thread - Ø is 0,5 mm
more than pin - Ø

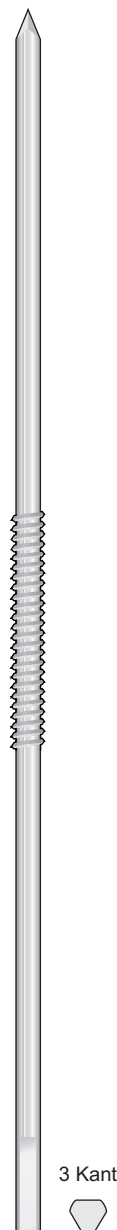

STEINMANN PINS		
Code	Ø mm	Lenght
1009-BHF	3	150
1009-BHG	3	180
1009-BHH	3	200
1009-BHI	3	230
1009-BHL	3,5	150
1009-BIA	3,5	180
1009-BIB	3,5	200
1009-BIC	3,5	230
1009-BID	4	150
1009-BIE	4	180
1009-BIF	4	200
1009-BIG	4	230
1009-BIH	4	250
1009-BII	4,5	150
1009-BIL	4,5	180
1009-BLA	4,5	200
1009-BLB	4,5	230
1009-BLC	4,5	250
1009-BLD	4,5	300
1009-BLE	5	150
1009-BLF	5	180
1009-BLG	5	200
1009-BLH	5	230
1009-BLI	5	250
1009-BLL	5	300

Ø 10 mm

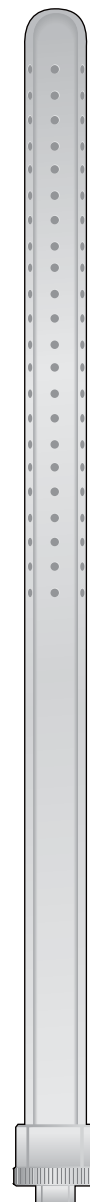

1009-DAA
320 mm
1009-DAB
190 mm

Bis Ø 3 mm
Up to Ø 3 mm
Fino a Ø 3 mm

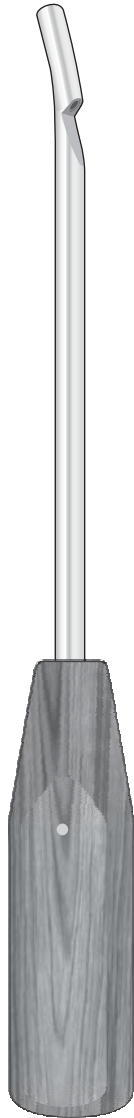

WAGNER
1118-BAG
300 mm

Extraktionshaken
Extraction hooks
Gancio d'estrazione
Ganchos extractores
Crochets d'extraction

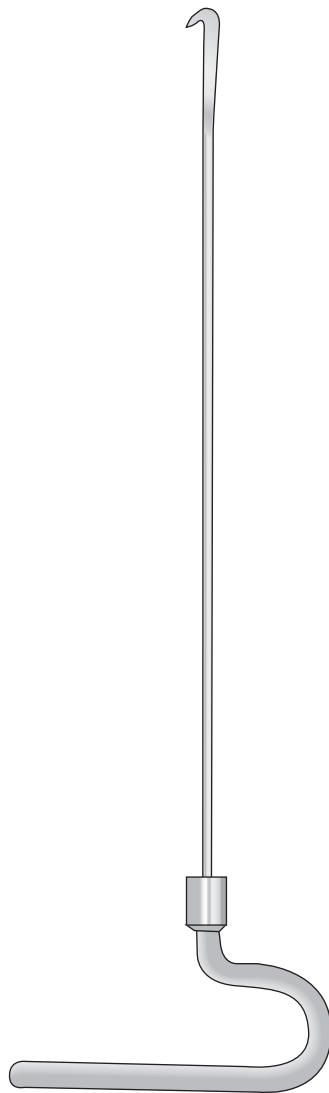

1009-DAG - 290 mm
1009-DAH - 370 mm
1009-DAI - 420 mm

Ø Int. 2,5 mm



Ø Int. 1,2 mm

1118-BAA
120 mm

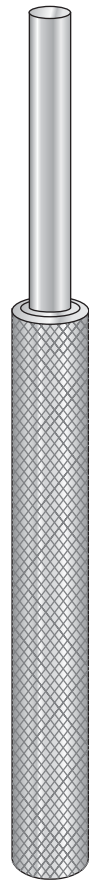

KÜNTSCHER
0610-AL
210 mm

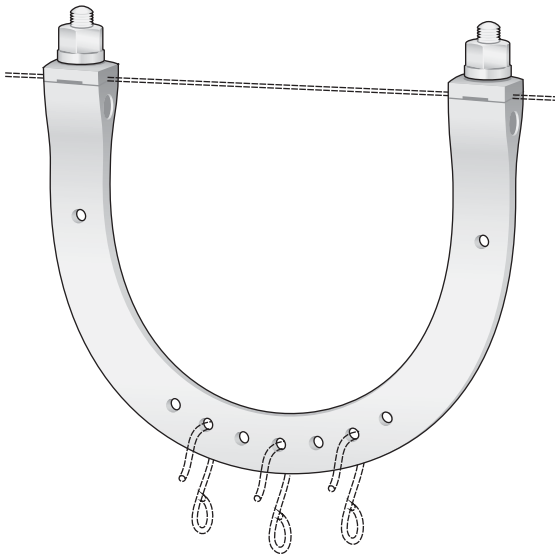

- 1118-DHA** 200 x 155 mm
- 1118-DHB** 155 x 155 mm
- 1118-DHC** 155 x 100 mm
- 1118-DHD** 135 x 130 mm
- 1118-DHE** 120 x 120 mm
- 1118-DHF** 105 x 100 mm
- 1118-DHG** 95 x 110 mm
- 1118-DHH** 105 x 80 mm
- 1118-DHI** 95 x 70 mm

KIRSCHNER
1118-DHA/1118-DHI

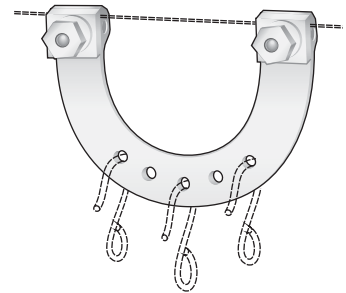

KIRSCHNER
1118-DHL
60 x 50 mm

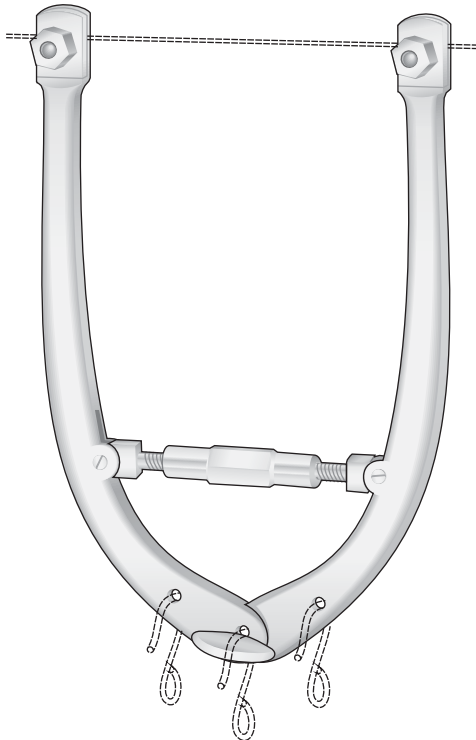

1118-DIA 180 x 100 mm
1118-DIB 270 x 160 mm

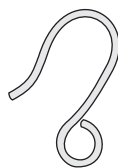

1118-DIC

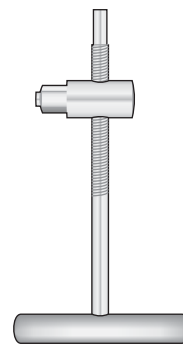

1118-DID

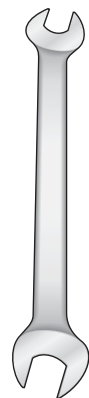

1118-DIE

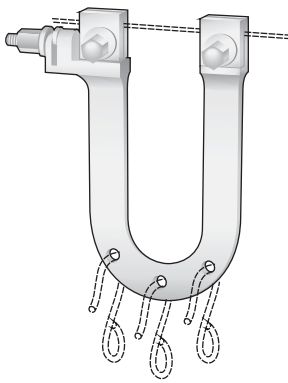

1118-DIF
30 x 80 mm

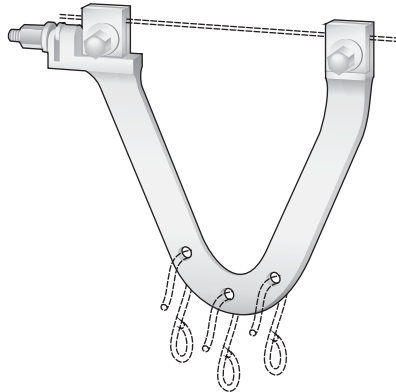

1118-DIG
60 x 70 mm

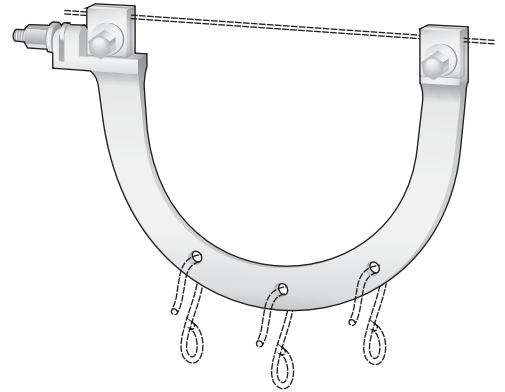

1118-DIH
105 x 80 mm

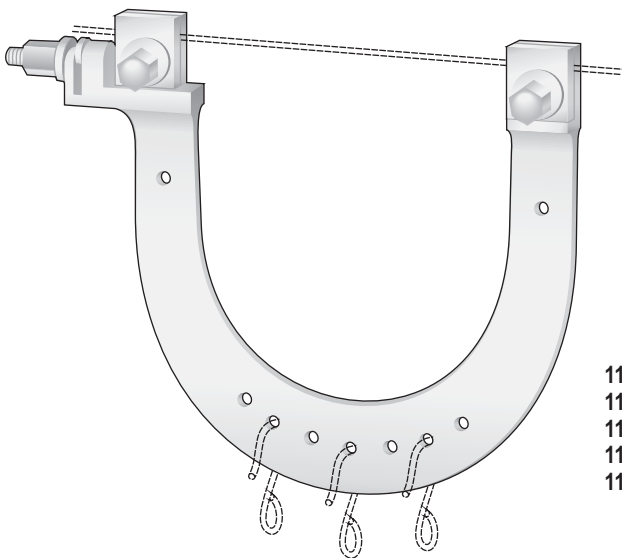

1118-DLA/1118-DLE

- 1118-DLA** 95 x 155 mm
- 1118-DLB** 120 x 115 mm
- 1118-DLC** 135 x 125 mm
- 1118-DLD** 155 x 140 mm
- 1118-DLE** 200 x 140 mm

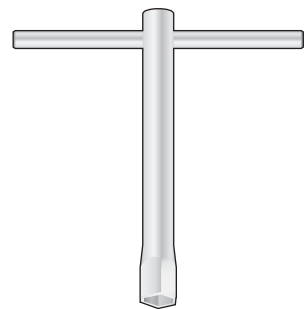

1118-DII/1118-DIL

Spiralbohrer

Twist drills

Maschiatori - Taps

Formadores de guia para tornillos

Taraud pour vis

Dental schaft
Attacco Dentale

Ø 1,5 mm



1118-DC
50 mm

Ø 2,0 mm



1118-DD
55 mm

Mit AO schaft
Attacco AO

Ø 1,5 mm



1118-BA
65 mm

Ø 2 mm



1118-BB
70 mm

Ø 2,7 mm



1118-BC
100 mm

Passo della vite
a 1,25 mm

Ø 3,5 mm



1118-BD
110 mm

Passo della vite
a 1,75 mm

Ø 3,5 mm



1118-BE
110 mm

Ø 4,5 mm



1118-BF
130 mm

Ø 4,5 mm



1118-BG
130 mm

Ø 6,5 mm



1118-BH
170 mm

Mit AO schaft
Drill bits
Attacco AO

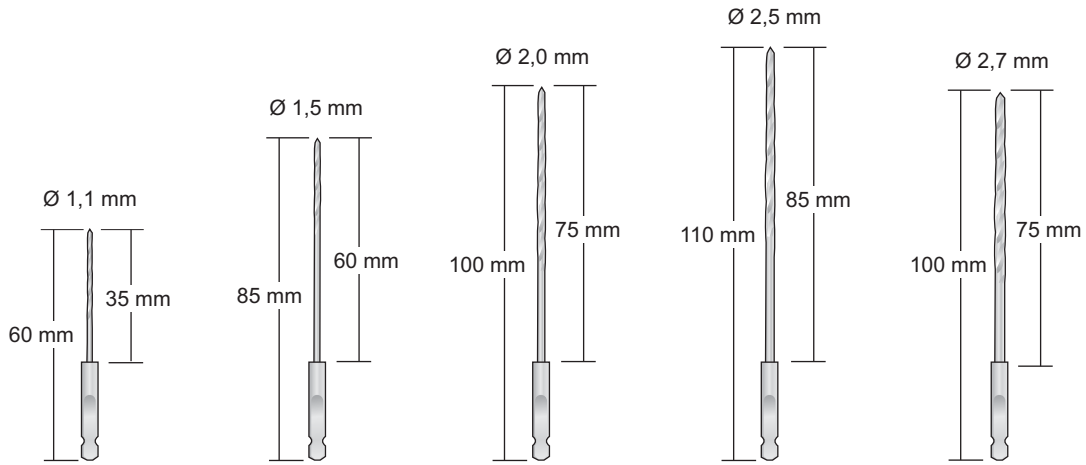

1118-CA

1118-CB

1118-CC

1118-CD

1118-CE

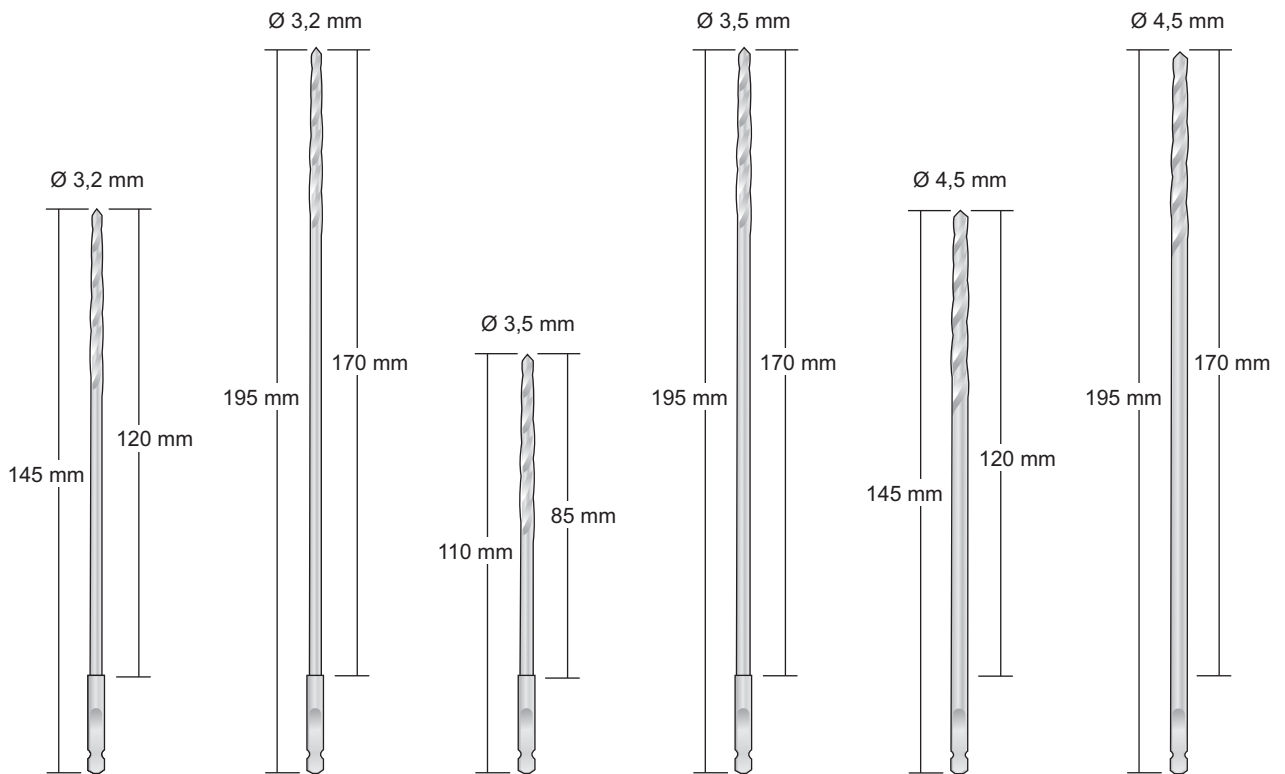

1118-CF

1118-CG

1118-CH

1118-CI

1118-CL

1118-DA

Mit rundschaft
Drill bits
Con attacco rotondo

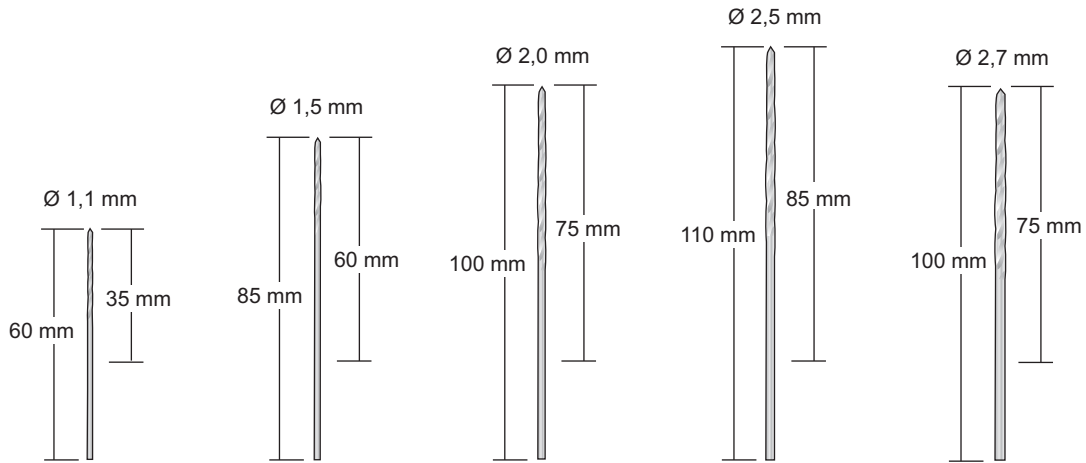

1118-EA

1118-EB

1118-EC

1118-ED

1118-EE

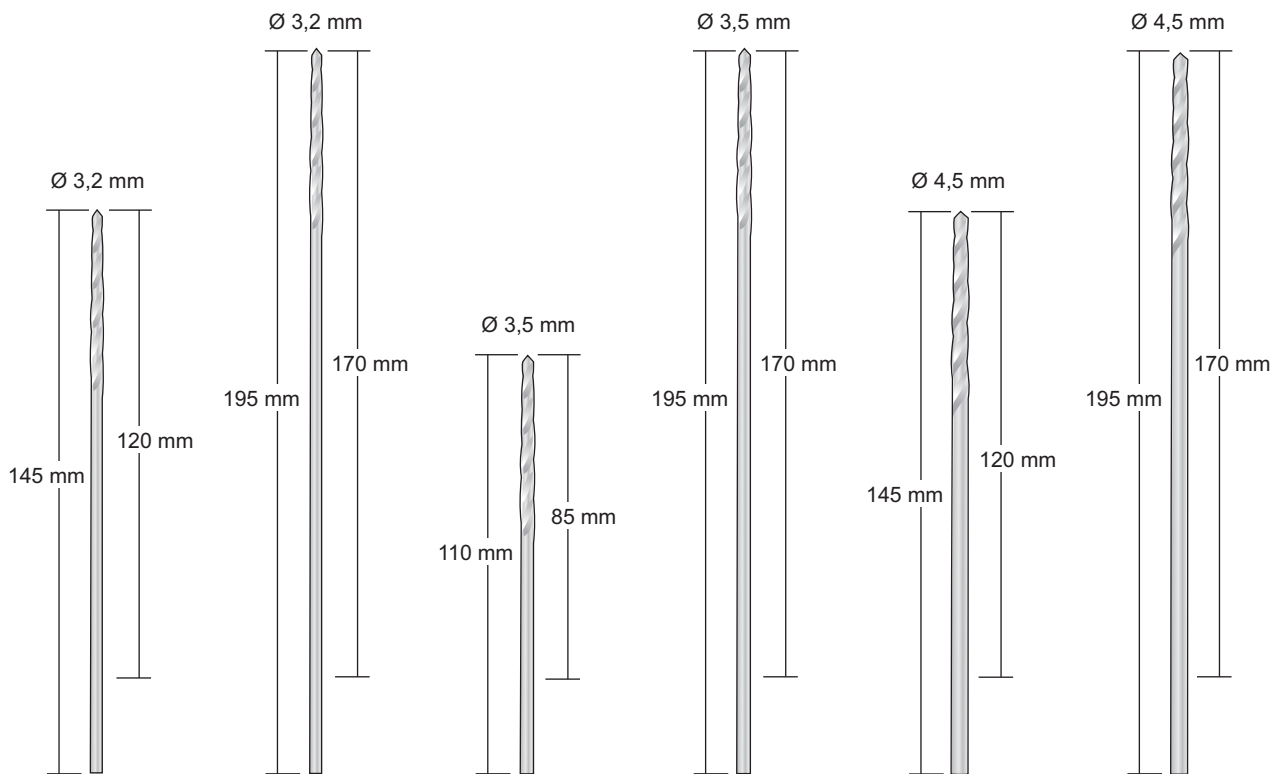

1118-EF

1118-EG

1118-EH

1118-EI

1118-EL

1118-FA

Mit rundschaft
Drill bits
Con attacco rotondo

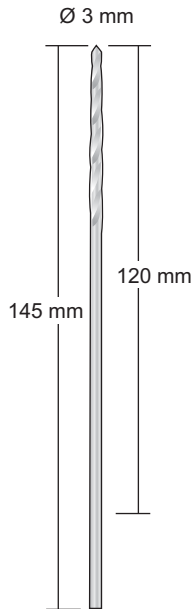

1118-FB

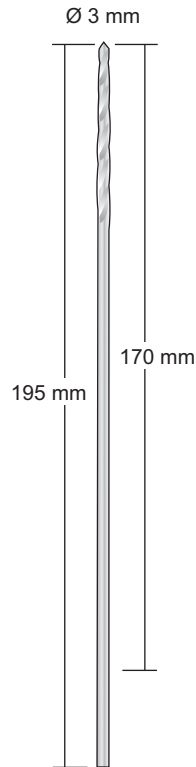

1118-FC

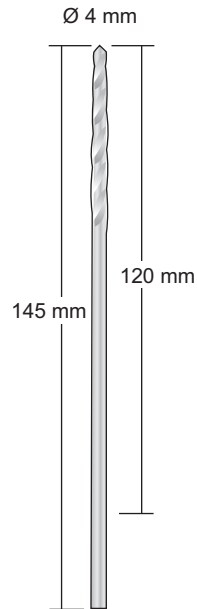

1118-FD

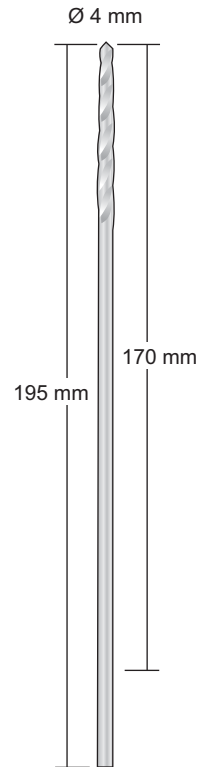

1118-FE

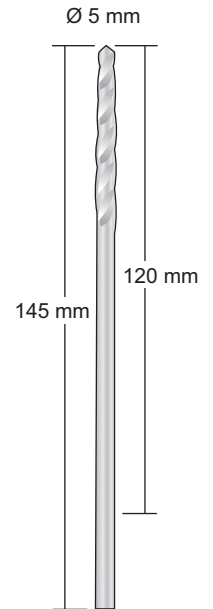

1118-FF

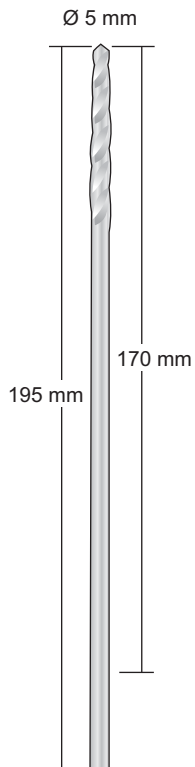

1118-FG

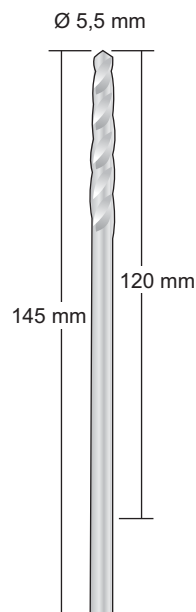

1118-FH

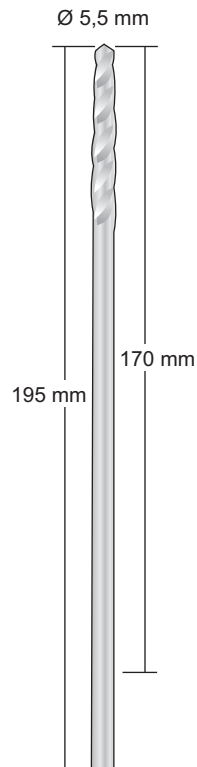

1118-FI

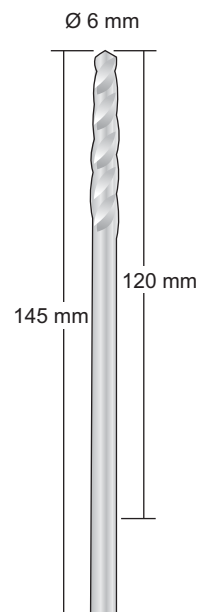

1118-FL

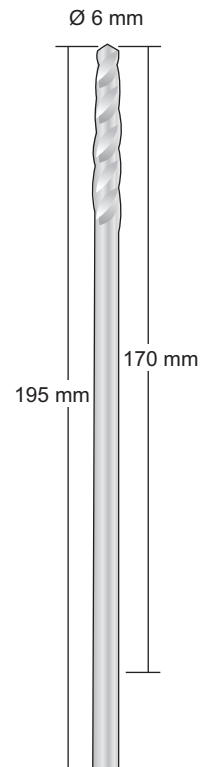

1118-GA

Orthopädie
Osteosintese

Bone Surgery
Osteosynthesis

Ortopedia
Osteosintesi

Cirurgia òsea
Osteosintesis

Orthopédie
Ostéosynthèse

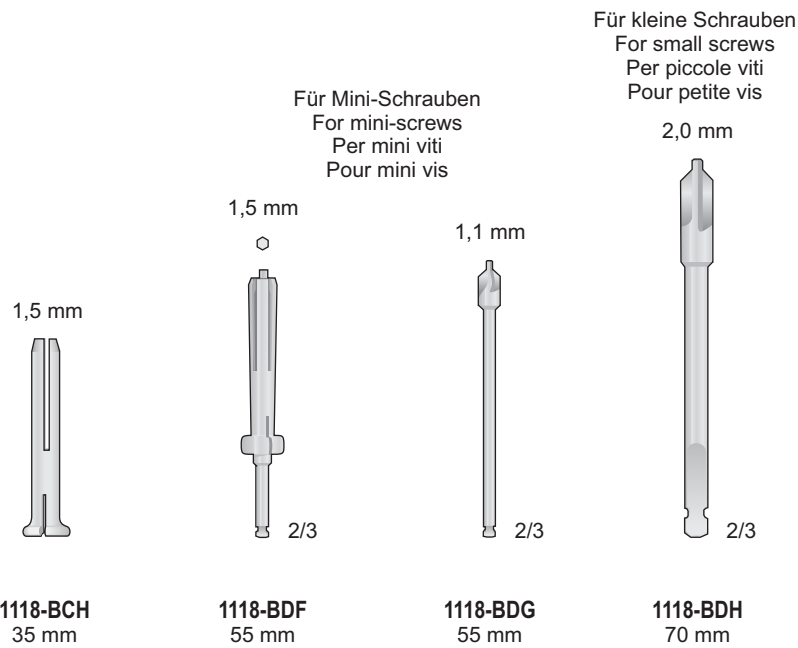

Für Malleolarschrauben
For malleolar screws
Per viti malleolari
Pour vis à malléole

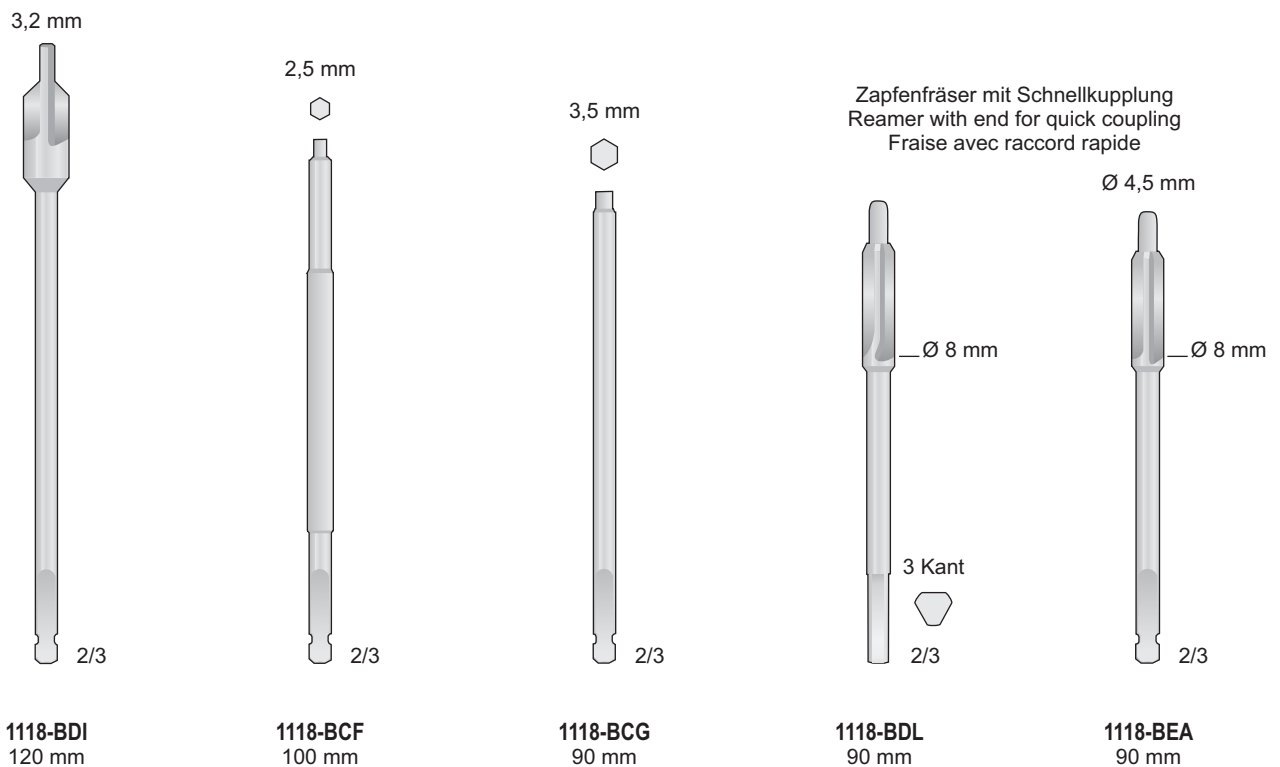

Handgriffe mit schnellspann futter
Handles with quick-action chuck
Manico con mandrino rapido
Poignées avec mandrins rapides

Ø 4 mm

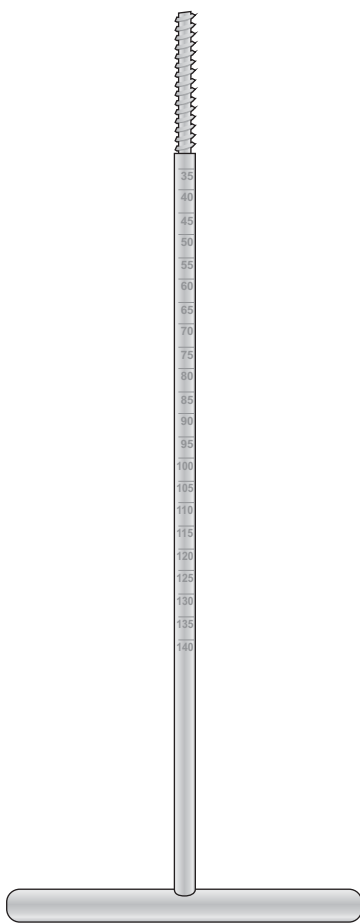

1118-BCA
260 mm

AO-Schaft



Dental-Schaft



4kant-Schaft



MANICO FERROZELL
1118-CEC
125 mm

1118-CEE
110 mm

1118-CEA
80 mm

1118-CDD
 Komplett mit - Complete with
 Completo con - Completos con
 Completes avec:
 1 **1118-CDG**
 1 **1118-CCL**
 1 **1118-CEB**

Attacco AO

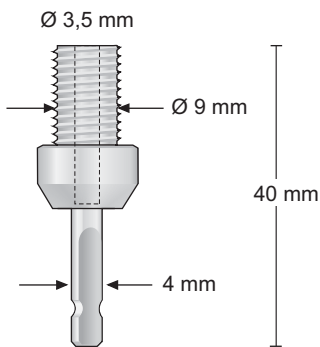

1118-CCH
40 mm

Inox
 ORIGINAL JACOBS

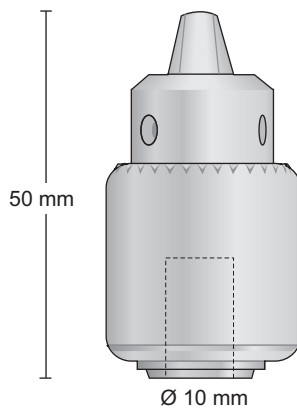

1118-CDG
50 mm

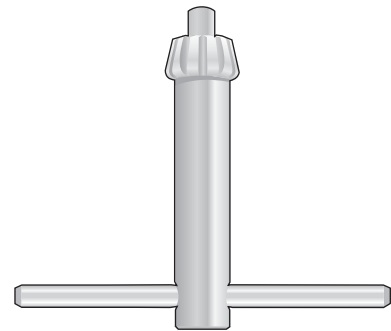

1118-CEB
52 mm

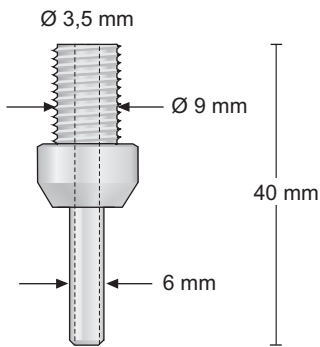

1118-CCI
40 mm

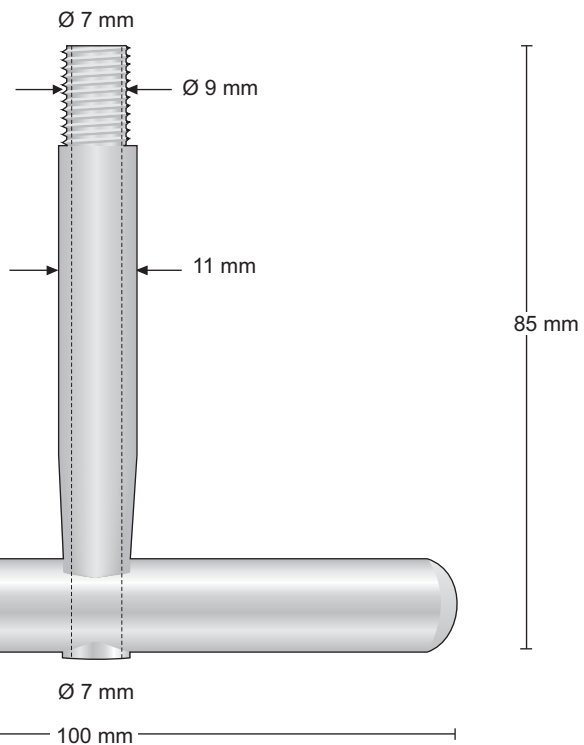

1118-CCL
85 mm

1118-CDL
 Komplet mit - Complete with
 Completo con - Completos con
 Completes avec:
 1 **1118-CDG**
 1 **1118-CDH**
 1 **1118-CDI**
 1 **1118-CEB**

Inox
 ORIGINAL JACOBS

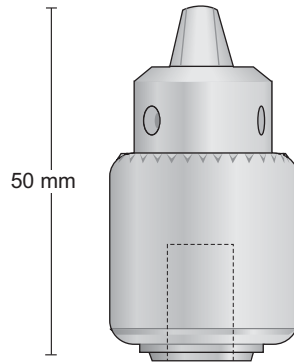

Ø 10 mm

1118-CDG
 50 mm

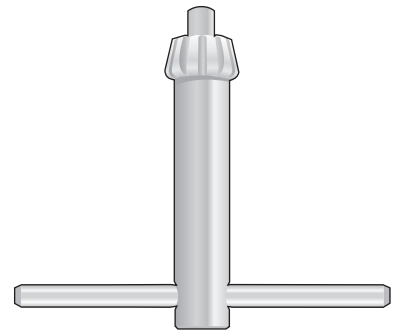

1118-CEB
 52 mm

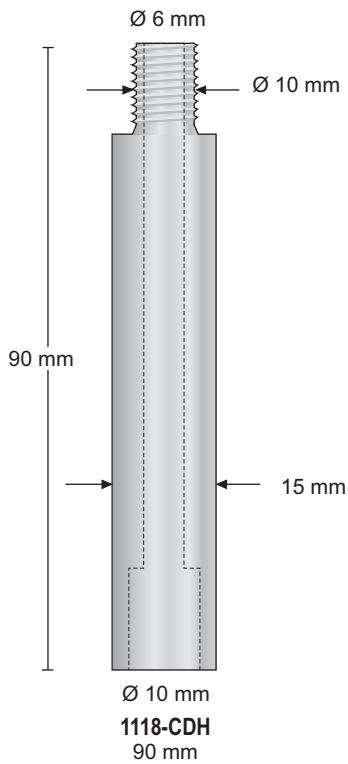

Ø 10 mm
1118-CDH
 90 mm

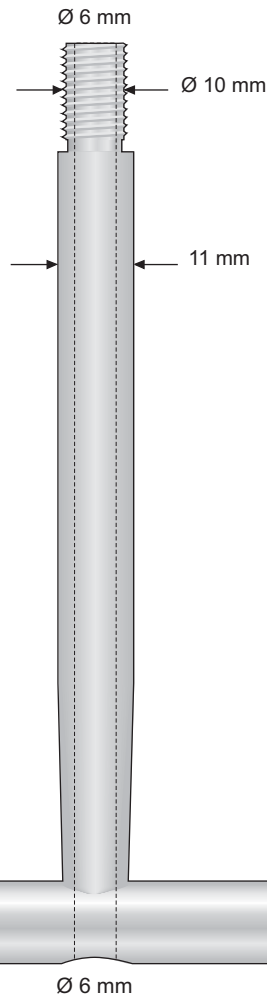

1118-CDI
 130 mm

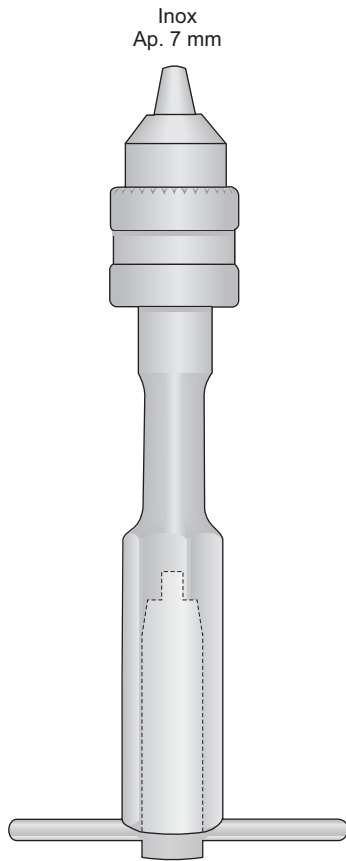

1118-CDC
130 mm

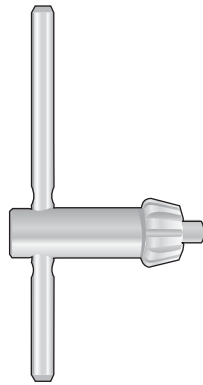

1118-CDB
32 mm

Von Hand zu spannen
Tightened by hand
Con chiusura a mano

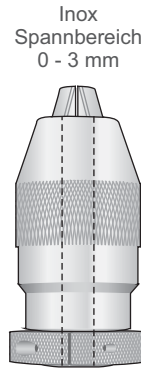

1118-CCC

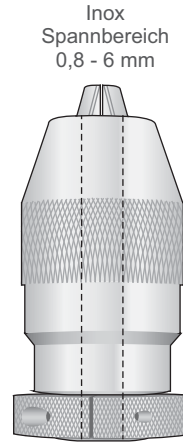

1118-CCE

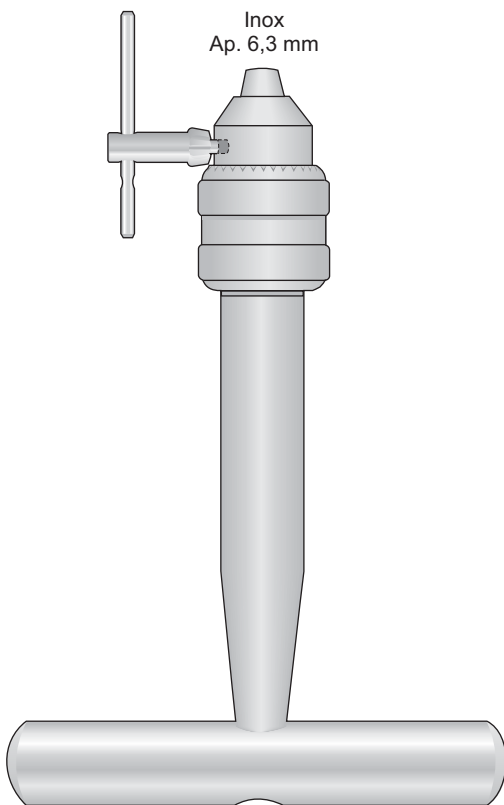

1118-CDA
130 mm

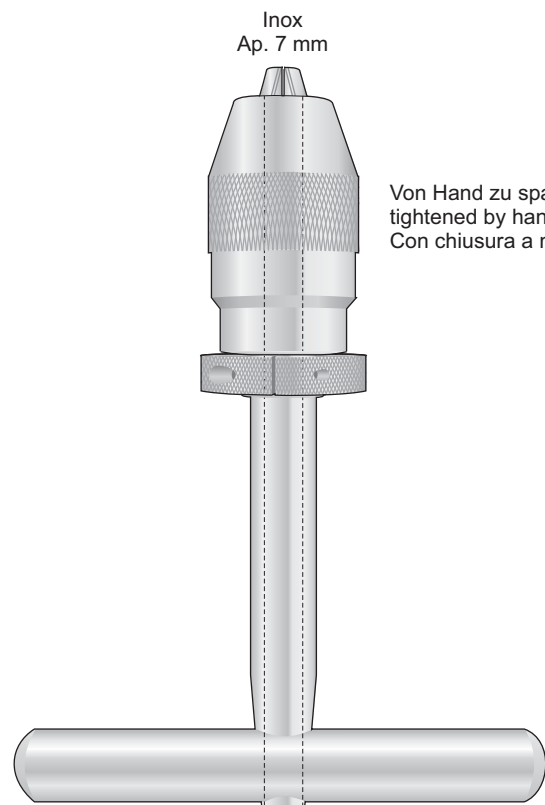

1118-CDE
135 mm

Von Hand zu spannen
tightened by hand
Con chiusura a mano

Orthopädie
Osteosintese

Bone Surgery
Osteosynthesis

Ortopedia
Osteosintesi

Cirurgia òsea
Osteosintesis

Orthopédie
Ostéosynthèse

Schraubenzieher, Set mit Etui - Box with screws driver - Scatola con set giraviti
Set destornilladores - Jeu de tournevis, en boîte

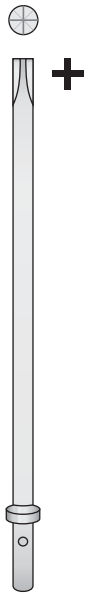

1118-DCB
140 mm

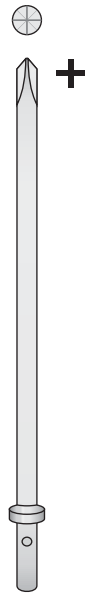

1118-DCC
140 mm



1118-DCD
140 mm

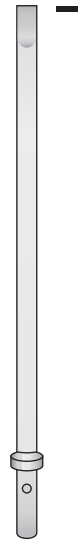

1118-DCE
140 mm

2,5 mm

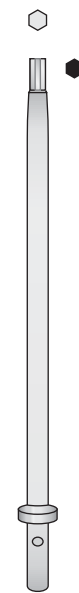

1118-DCF
140 mm

3,5 mm

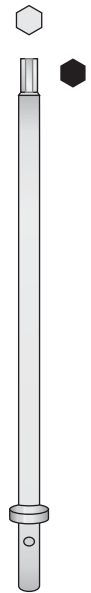

1118-DCG
140 mm

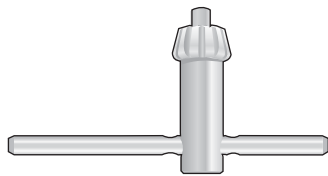

1118-CDB
32 mm

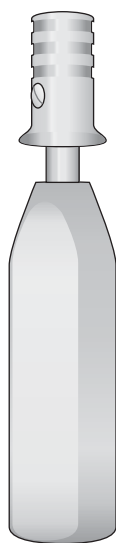

1118-DCA
145 mm

Max. Ø 6,3 mm

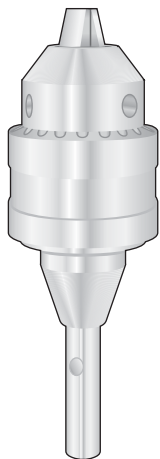

UNIVERSAL
1118-CDF
75 mm

1118-DDA

Schraubenzieher, Set mit Etui - Komplett
Box with screws driver - Complete
Scatola con set giraviti - Completo
Set destornilladores - Completos
Jeu de tournevis, en boîte - Complete

Etui allein
Box only
Solo scatola
Seul boîte

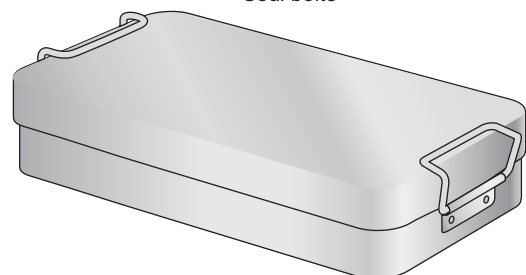

1118-DCL
200x100x40 mm

Schraubendreher

Screw drivers

Cacciaviti

Destornilladores

Tourne-vis

Schraubenzieher mit Ferrozellgriff
 Screws driver with Ferrozell handle
 Giraviti con manico di Ferrozell
 Destornilladores con mango de Ferrozell
 Jeu de tournevis avec poignée en Ferrozell

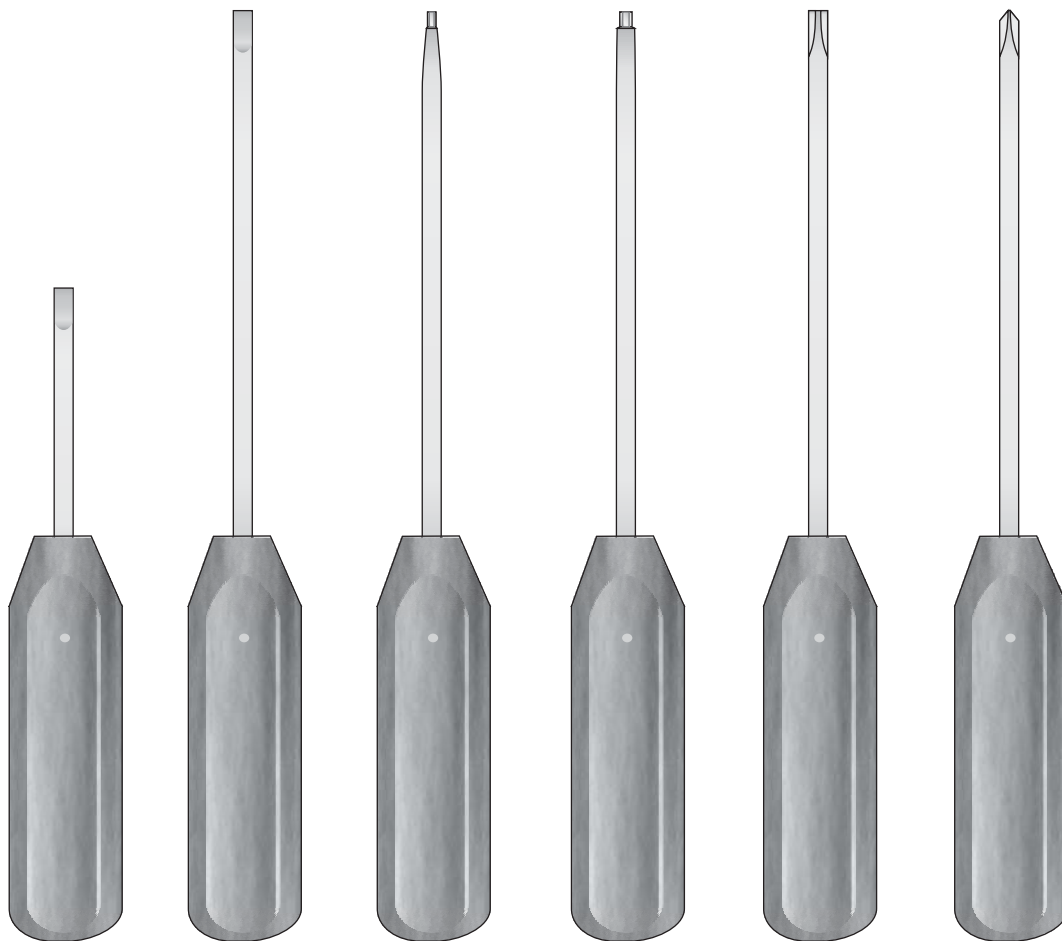
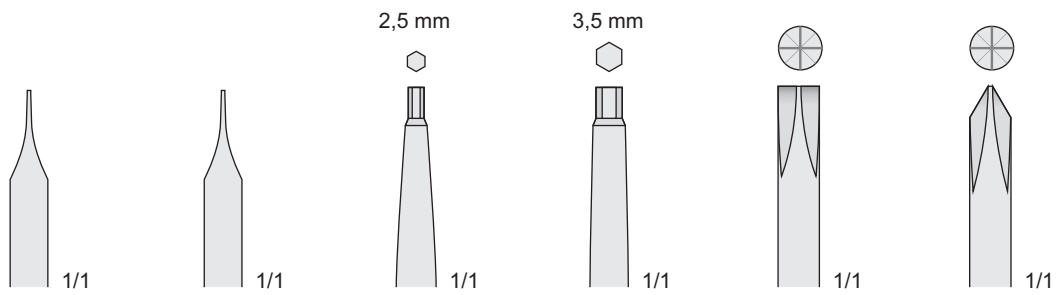

1118-DBA
170 mm

LANE
1118-DBB
250 mm

1118-DBC
250 mm

1118-DBD
250 mm

1118-DBE
250 mm

PHILIPS
1118-DBF
250 mm

Schraubenzieher mit Ferrozellgriff
Screws driver with Ferrozell handle
Giraviti con manico di Ferrozell
Destornilladores con mango de Ferrozell
Jeu de tournevis avec poignée en Ferrozell

2,5 mm

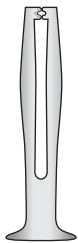

1118-BCI
50 mm

+ 1,5 -2,5 mm

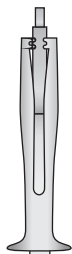

1118-DBG
195 mm

o 1,5 mm

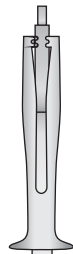

1118-DBH
195 mm

o 2,5 mm

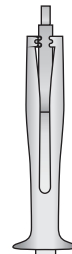

1118-DBI
195 mm

Drahtinstrumentarium
Wire instrument set
Strumenti per filo di cerchiaggio
Instrumental para cerclaje
Instruments à fil

Draht weich
Wire soft
Filo malleabile
per compattare l'osso
Alambre ligadura
Fil à os

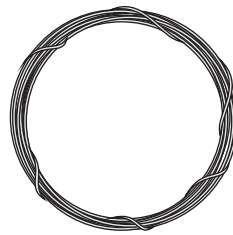

10 mt.

Ø/Diam.	Code
0,2 mm	1009-CAC
0,3 mm	1009-CAD
0,4 mm	1009-CAE
0,5 mm	1009-CAF
0,6 mm	1009-CAG
0,7 mm	1009-CAH
0,8 mm	1009-CAI
0,9 mm	1009-CAL
1,0 mm	1009-CBA
1,2 mm	1009-CBB
1,5 mm	1009-CBC

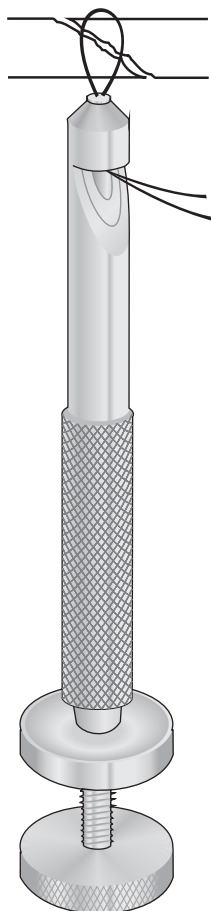

LOUTE
1009-DCC
220 mm

Drahtspanninstrument
Bone wire tighteners
Strumenti tendifili
Tensor cierra-hilos
Tendeur serre fils

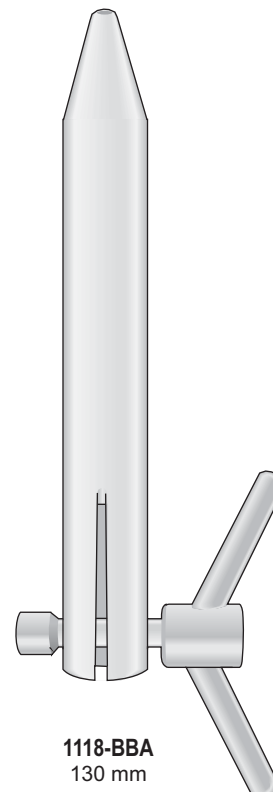

1118-BBA
130 mm

Bohrbüchsen zu Knochenplatten - Drill guides - Centratori guida punte - Guide méche

Color codification
green = centric
gold = eccentric

Drill Ø 2,0 mm
Cortical screws Ø 2,7 mm

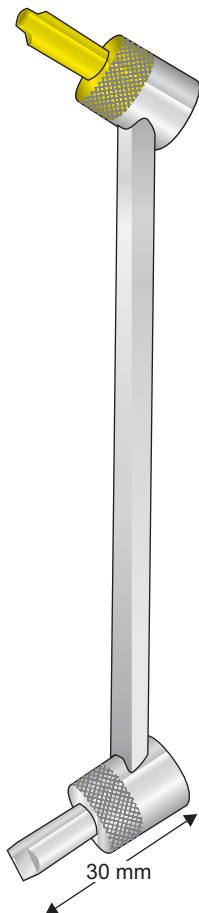

1118-LB
140 mm

Drill Ø 2,5 mm
Cortical screws Ø 3,5 mm

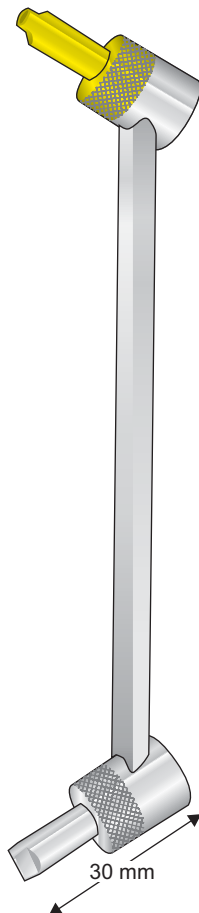

1118-LA
140 mm

Drill Ø 3,2 mm
Cortical screws Ø 4,5 mm

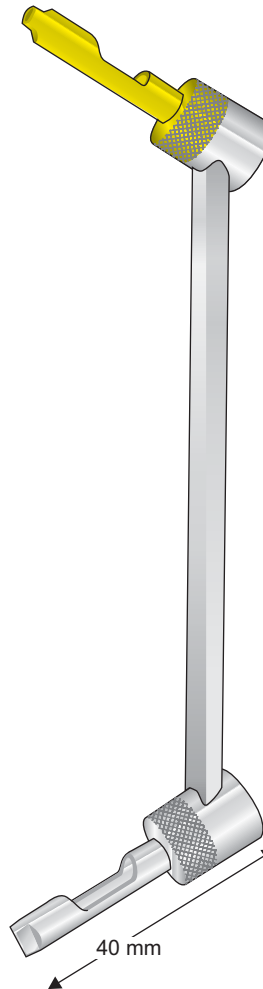

1118-LC
165 mm

Drill Ø 3,2 mm
Cortical screws Ø 4,5 mm

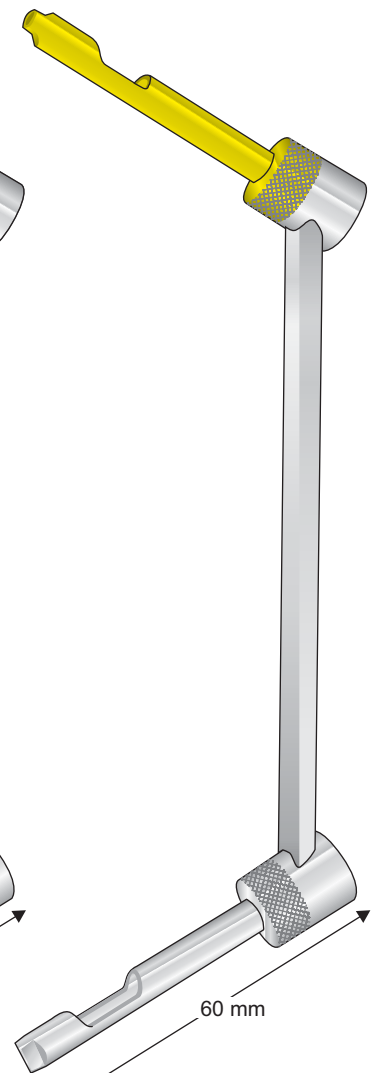

1118-LD
170 mm

Osteosynthese
Schränkeisen

Osteosynthesis
Instruments

Strumenti per
osteosintesi

Instrumentos para
Osteosintesis

Instruments pour
Ostéosynthèse

Bohrbüchsen zu Knochenplatten - Drill guides - Centrori guida punte - Guide méche

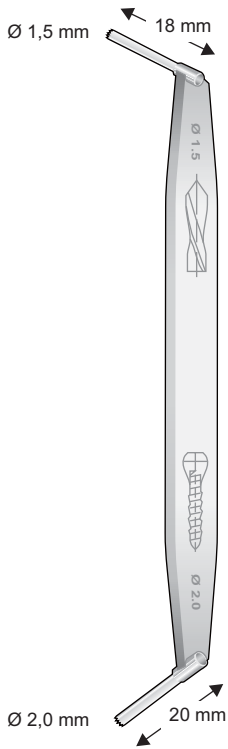

1118-HD
120 mm

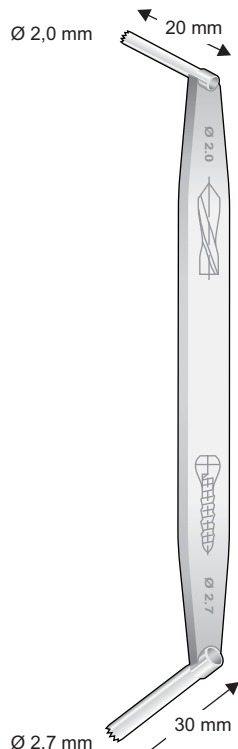

1118-HE
120 mm

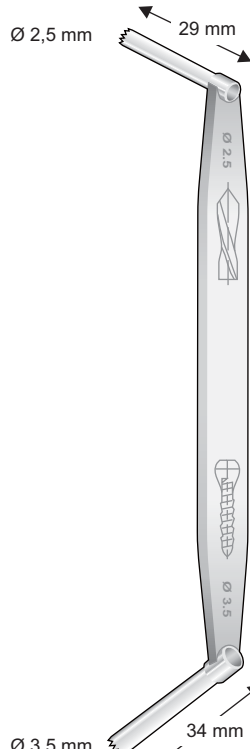

1118-HF
120 mm

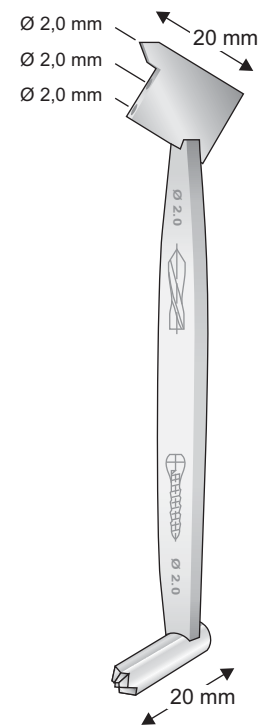

1118-IA
110 mm

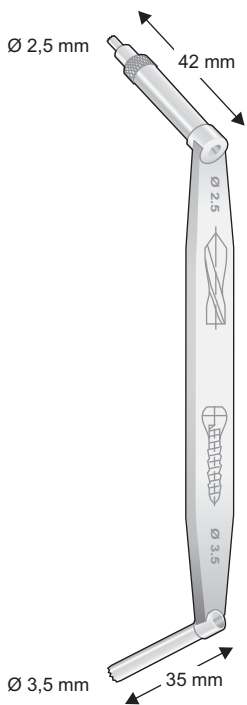

1118-IB

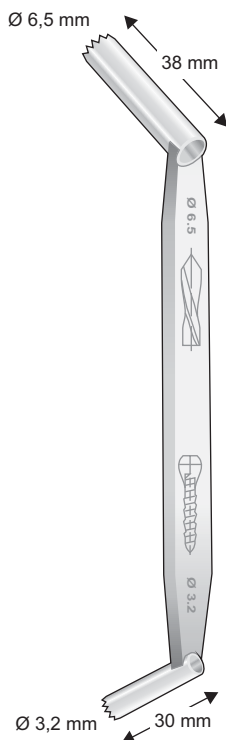

1118-IC



1118-ID
105 mm

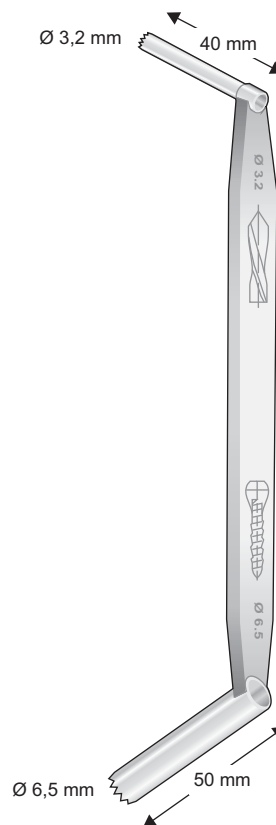

1118-IE
160 mm



1118-IF

Bohrbüchsen zu Knochenplatten - Drill guides - Centrori guida punte - Guide méche

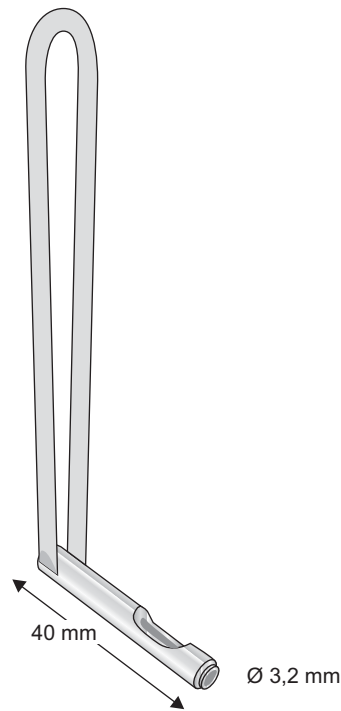

1118-BBH
125 mm

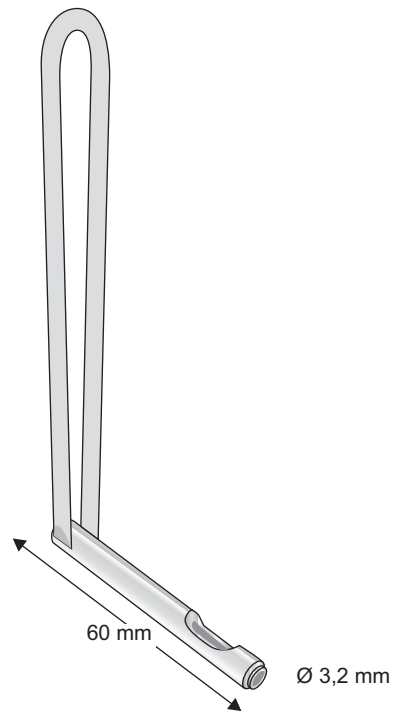

1118-BCE
125 mm

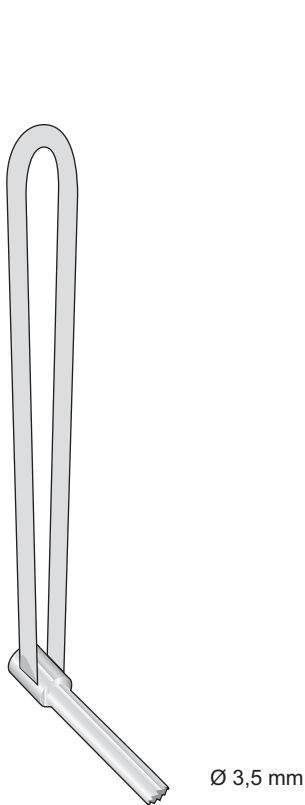

1118-BBG
125 mm

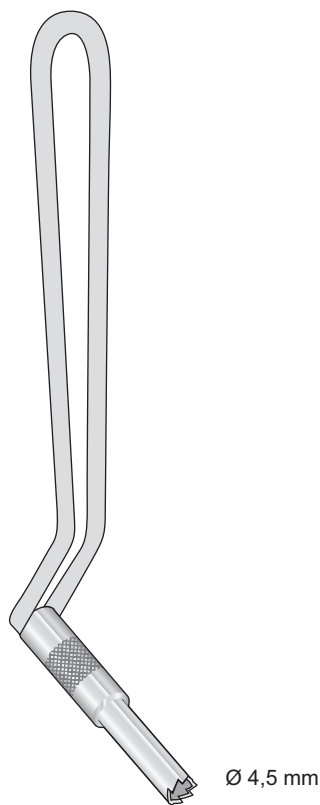

1118-BBL
150 mm

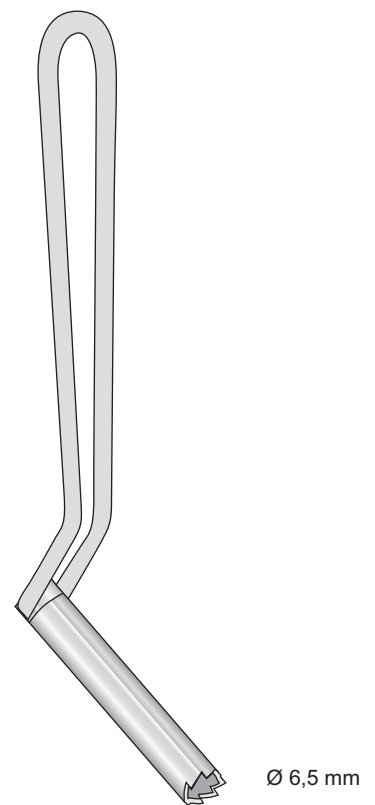

1118-BCB
150 mm

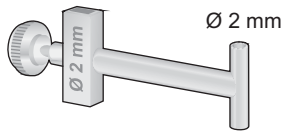

1118-LG

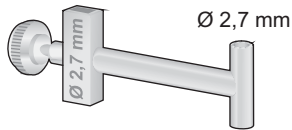

1118-LH

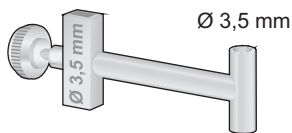

1118-LI

Steckbohrbüchsen
Manicotto dentato
Centrapunte
Insert-drill

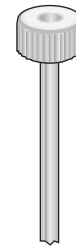

Ø Außen
Ø Outside
Ø Esterno
Ø Exterior
Ø Extérieur

Ø Für Bohrer
Ø For drills
Ø Per punte
Ø Para agujas
Ø Pour Mèches

Cod. Art.	Ø Außen	Ø Für Bohrer
1118-BBD	4,5 mm	3,2 mm
1118-BBE	3,5 mm	2 mm
1118-BBF	3,5 mm	2,7 mm

1118-LF
Complete with 3 guide
Completo di 3 guide
1118-LE+1118-LG+1118-LH+1118-LI

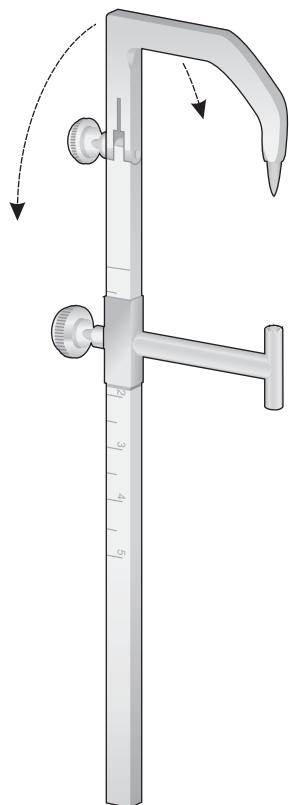

1118-LF
145 mm

1118-LE
Drill guide only
Centratore solo

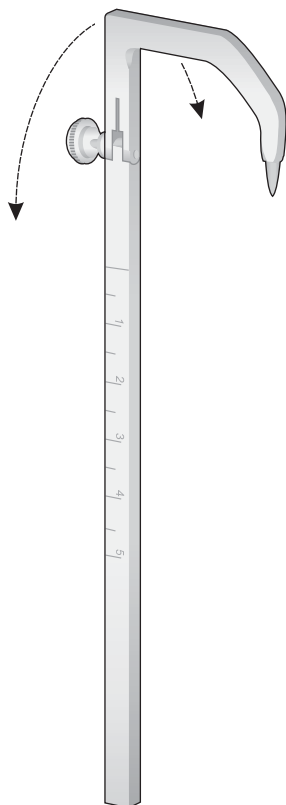

1118-LE
145 mm

Gewebeschtühlsen
Guida per punte elicoidali

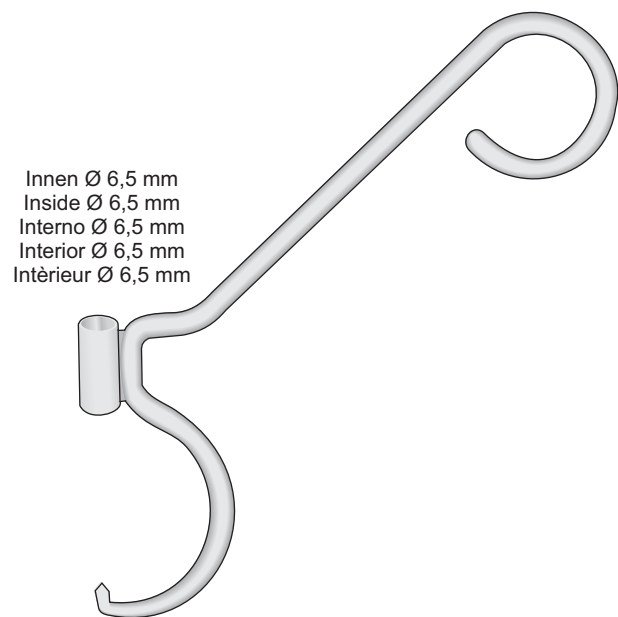
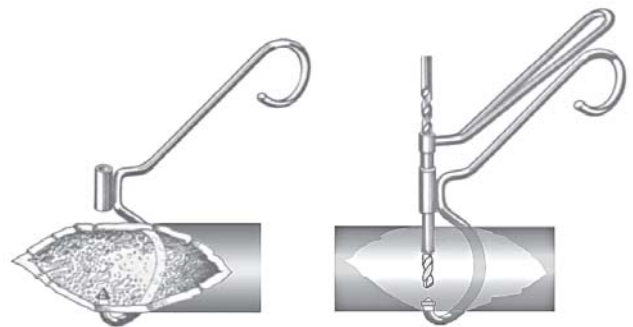

Innen Ø 6,5 mm
Inside Ø 6,5 mm
Interno Ø 6,5 mm
Interior Ø 6,5 mm
Intérieur Ø 6,5 mm

1118-BBC

Meßlehre für Kirschnerdrähte
Measuring Gauge for nails
Misuratore per chiodi Kirschner



1009-BA

0,5 mm



0,5 mm



0,5 mm



0,5 mm



1118-AH
50 mm

1118-AI
100 mm

1118-AL
150 mm

1118-AG
300 mm

Screw depth gauges, to select proper length of screw
 Misuratore di lunghezza per viti
 Instruments de mesure de profondeur pour déterminer la longueur de vis requise

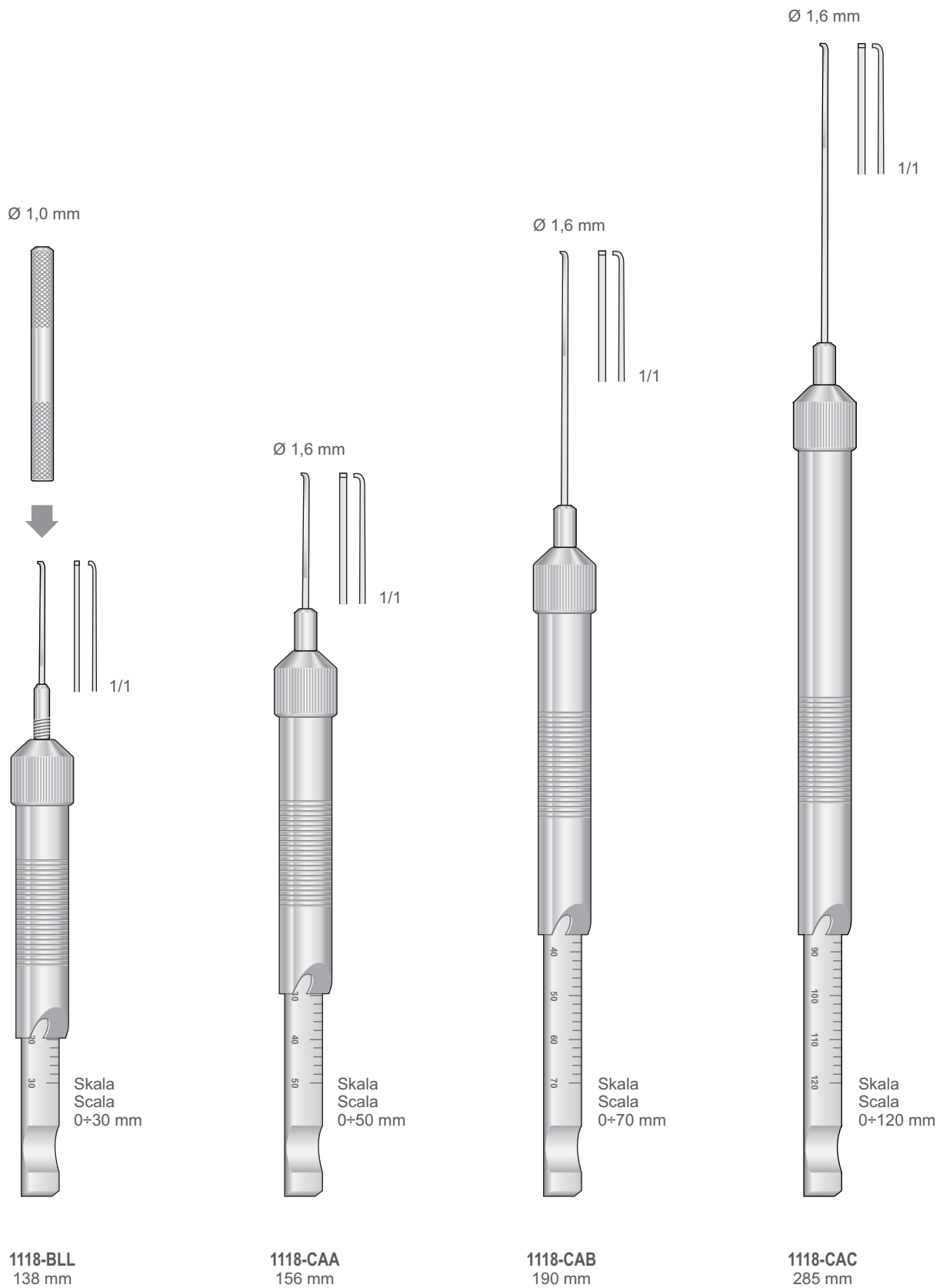

Meßbereich: 0 - 15 mm
 Measuring range: 0 - 15 mm
 Campo di misura: 0 - 15 mm
 Alcance de medición: 0 - 15 mm
 Etendue de mesure: 0 - 15 mm

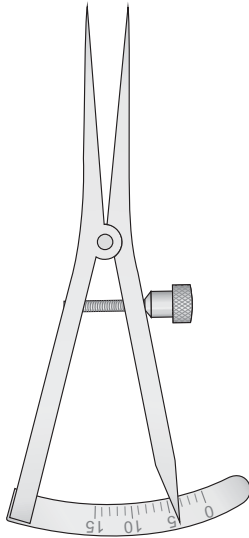

CASTROVIEJO
1417-BF
 90 mm

Meßbereich: 0 - 20 mm
 Measuring range: 0 - 20 mm
 Campo di misura: 0 - 20 mm
 Alcance de medición: 0 - 20 mm
 Etendue de mesure: 0 - 20 mm

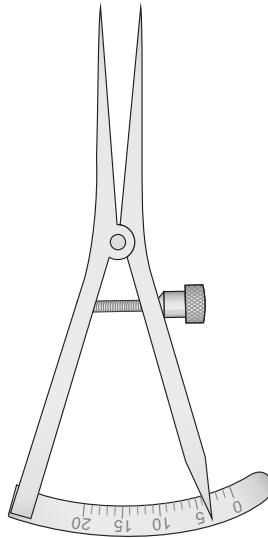

CASTROVIEJO
1417-BH
 90 mm

Meßbereich: 0 - 20 mm
 Measuring range: 0 - 20 mm
 Campo di misura: 0 - 20 mm
 Alcance de medición: 0 - 20 mm
 Etendue de mesure: 0 - 20 mm

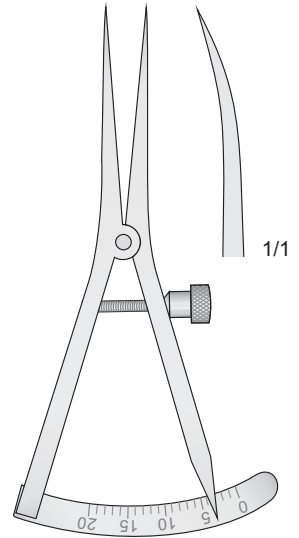

CASTROVIEJO
1417-BL
 90 mm

Meßbereich: 0 - 40 mm
 Measuring range: 0 - 40 mm
 Campo di misura: 0 - 40 mm
 Alcance de medición: 0 - 40 mm
 Etendue de mesure: 0 - 40 mm

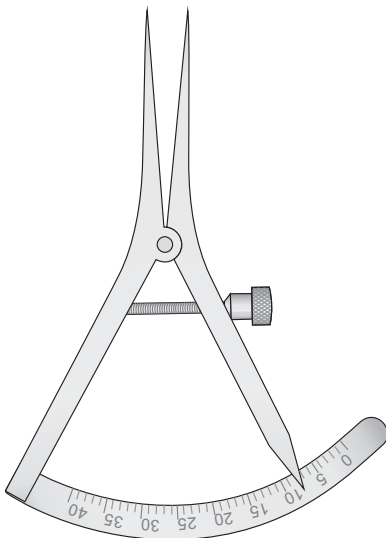

CASTROVIEJO
1417-BB
 90 mm

Meßbereich: 0 - 40 mm
 Measuring range: 0 - 40 mm
 Campo di misura: 0 - 40 mm
 Alcance de medición: 0 - 40 mm
 Etendue de mesure: 0 - 40 mm

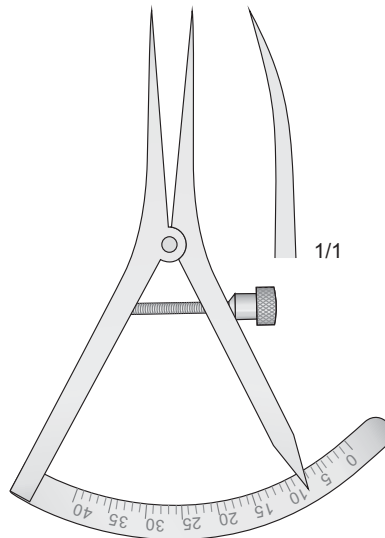

CASTROVIEJO
1417-BD
 90 mm

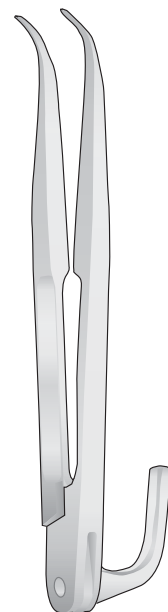

ZIELINSKY
0415-HCF
 110 mm

Meßbereich: 0 - 40 mm
 Measuring range: 0 - 40 mm
 Campo di misura: 0 - 40 mm
 Alcance de medición: 0 - 40 mm
 Etendue de mesure: 0 - 40 mm

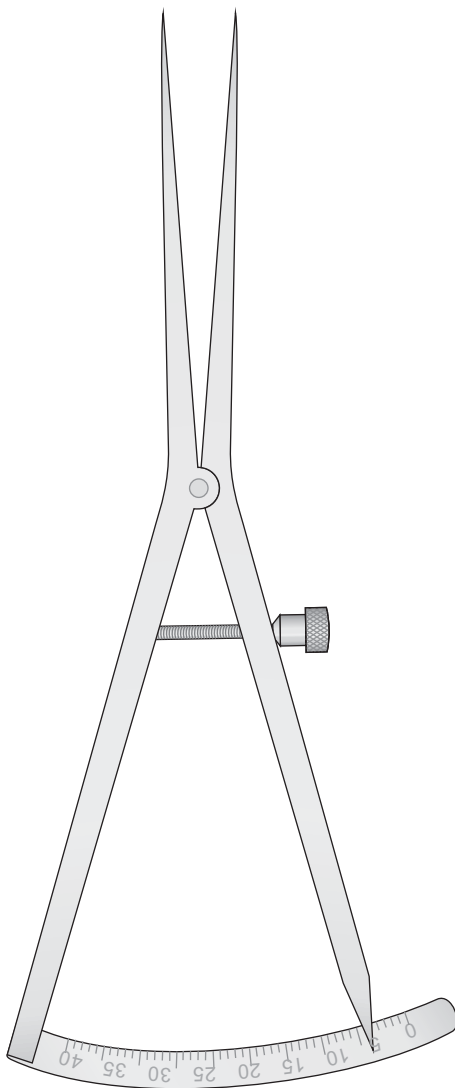

CASTROVIEJO
1417-BC
 170 mm

Meßbereich: 0 - 40 mm
 Measuring range: 0 - 40 mm
 Campo di misura: 0 - 40 mm
 Alcance de medición: 0 - 40 mm
 Etendue de mesure: 0 - 40 mm

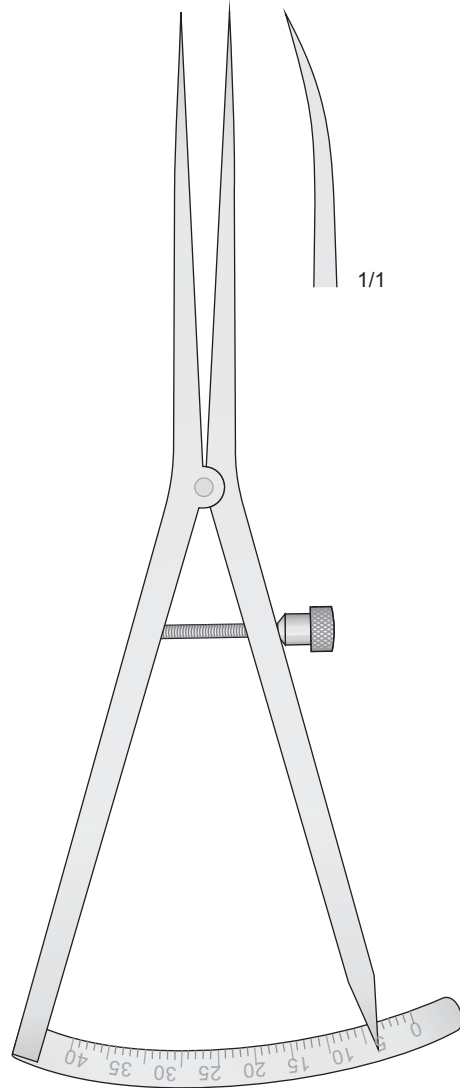

CASTROVIEJO
1417-BE
 170 mm

Meßbereich: 0 - 40 mm
 Measuring range: 0 - 40 mm
 Campo di misura: 0 - 40 mm
 Alcance de medición: 0 - 40 mm
 Etendue de mesure: 0 - 40 mm

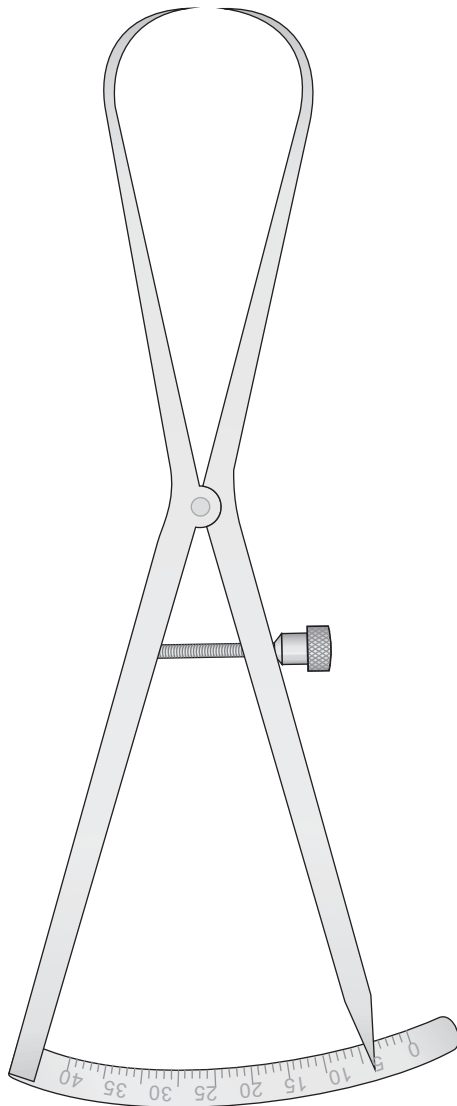

CASTROVIEJO
1417-BG
 170 mm

Meßbereich: 0 - 40 mm
 Measuring range: 0 - 40 mm
 Campo di misura: 0 - 40 mm
 Alcance de medición: 0 - 40 mm
 Etendue de mesure: 0 - 40 mm

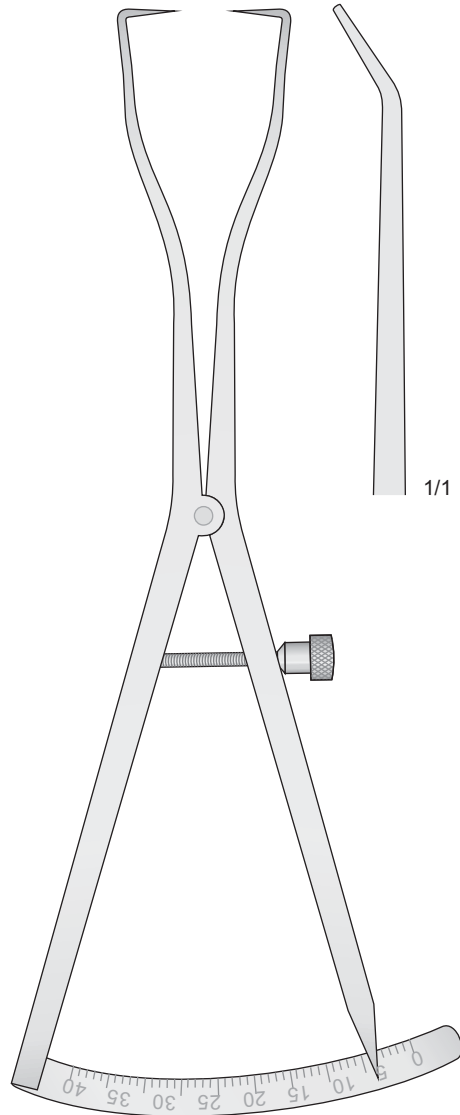

CASTROVIEJO
1417-BI
 170 mm

Forceps
for plattes

Biege und
schränkhebel

Pinze e chiavi
per placche

Pinzas
para placas

Pinces à courber
pour plaques

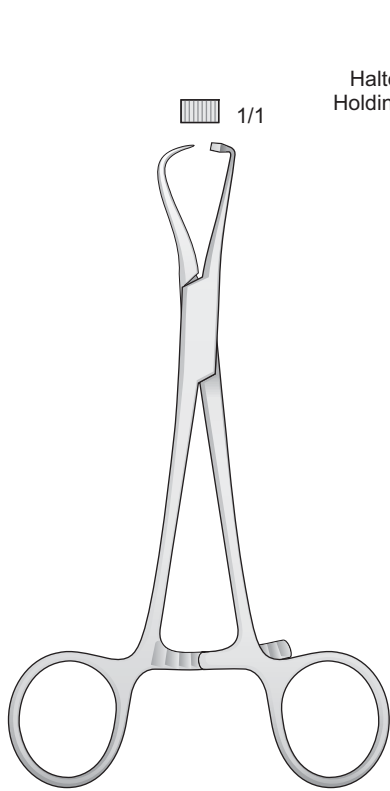

1118-HG
120 mm

Haltezange für platten
Holding forceps for plates

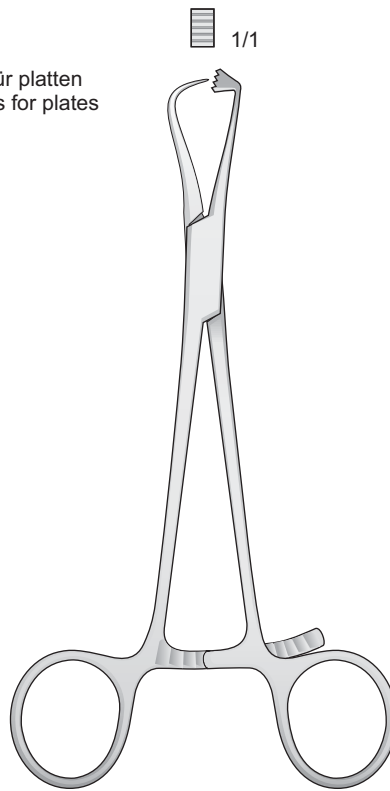

1118-HI
125 mm

For standard plates
Für Standard-Platten

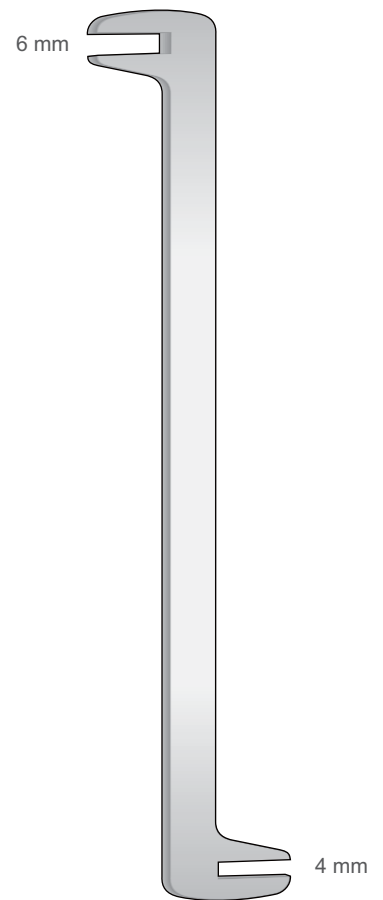

1118-BAF
250 mm

Für Standard-Platten
For standard plates

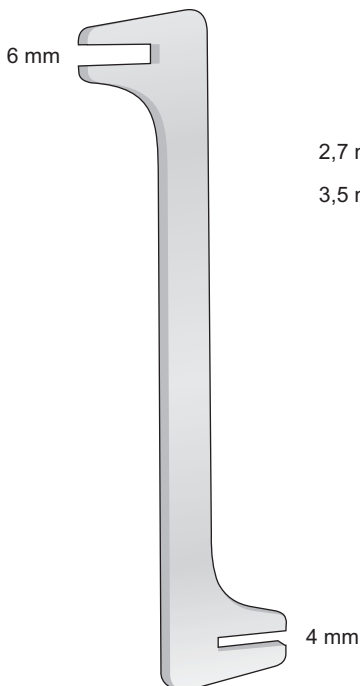

1118-BAB
180 mm

Biege und Schränkhebel für kleine platten
Bending irons, for small plates

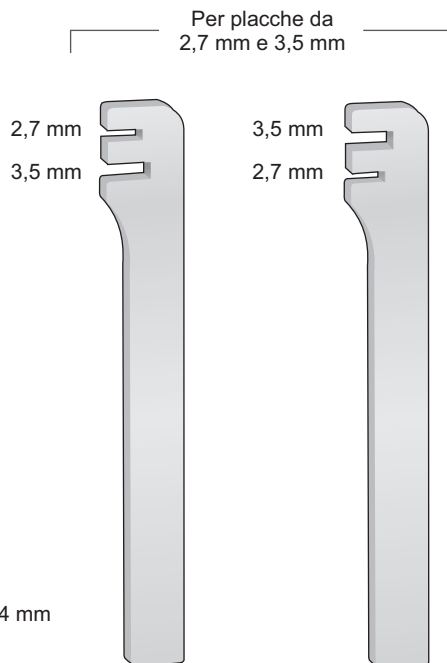

1118-BAD 100 mm
1118-BAC 140 mm

1118-BCD 100 mm
1118-BCC 140 mm

1118-BAE
100 mm

Forceps
for plattes

Zangen für
schränkhebel platten

Pinze
per placche

Pinzas
para placas

Pinces à courber
pour plaques

Biegezange - Bending pliers - Pinze piegaplacche - Pinces à plier

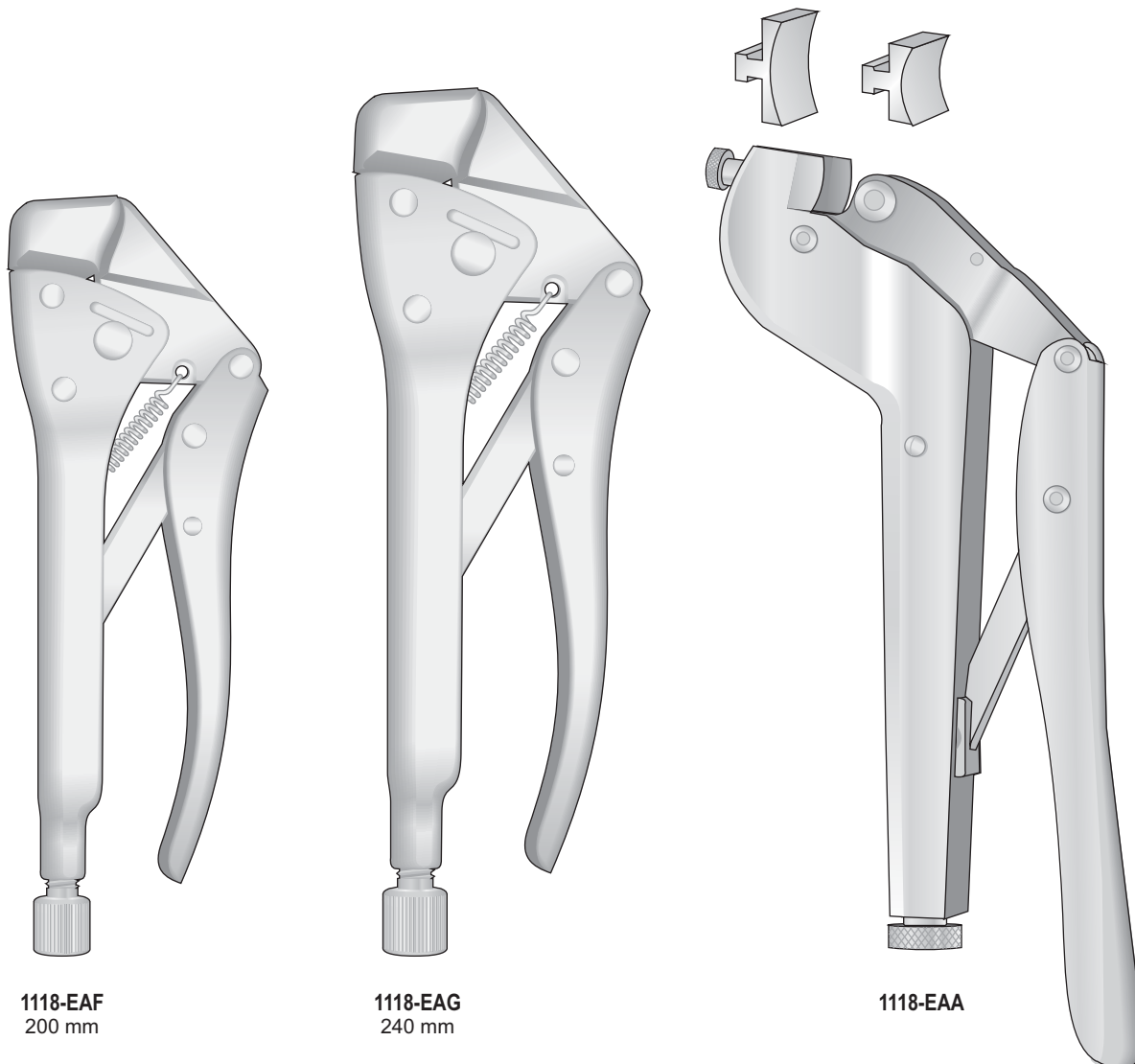

Biegepresse - Bending press - Pressa piegaplacche - Presse pour plier

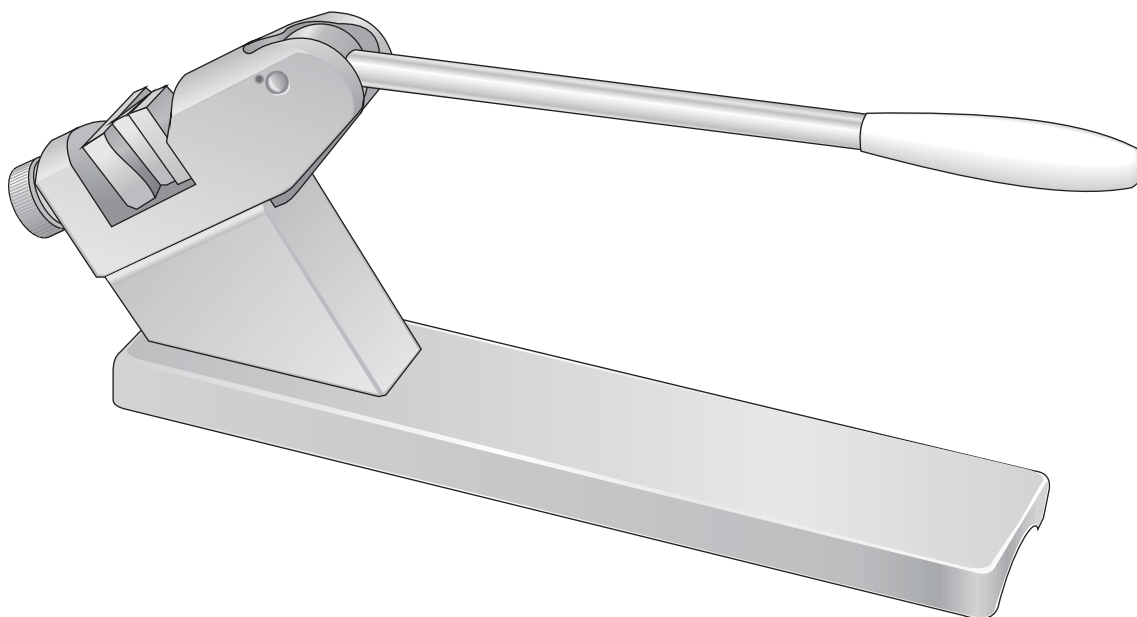

1118-EBA

0617-CA
0617-CB 0617-CC + 0617-CD 0617-CE 0617-CF 0617-CG
 Komplet, mit Fräsern Fig. 1-4 und Verlängerungsstück
 Complete, with burrs no. 1-4 and extension piece
 Completo, con fresa Fig. 1-4 e giunto di prolungamento
 Completo, con fresas no. 1-4 y pieza de prolongación
 Complet, avec fraises no. 1-4 et pièce de rallonge



Verlängerungsstück
 Extension Piece
 Giunto di prolungamento
 Pieza de prolongación
 Pièce de rallonge

HUDSON
0617-CC

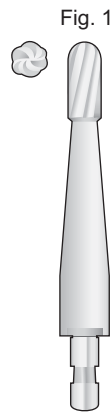

Fig. 1

HUDSON
0617-CD
 Ø 9 mm

Kegelfräser
 Conical Burr
 Fresa cuneiforme
 Fresa cónica
 Fraise conique



Fig. 2

HUDSON
0617-CE
 Ø 14 mm

Kegelfräser
 Conical Burr
 Fresa cuneiforme
 Fresa cónica
 Fraise conique

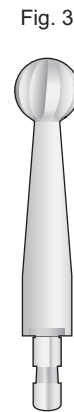

Fig. 3

HUDSON
0617-CF
 Ø 16 mm

Kugelfräser
 Spherical Burr
 Fresa sferica
 Fresa esférica
 Fraise spherique

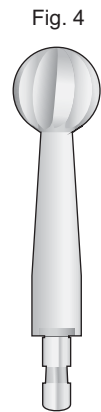
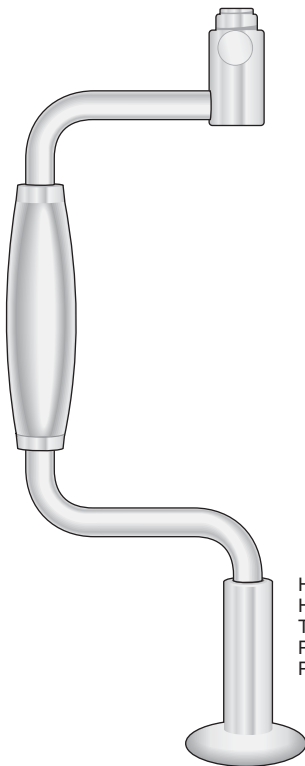

Fig. 4

HUDSON
0617-CG
 Ø 22 mm

Kugelfräser
 Spherical Burr
 Fresa sferica
 Fresa esférica
 Fraise spherique



Handbohrer allein
 Hand drill only
 Trapano solo
 Perforador suelto
 Perforateur seul

HUDSON
0617-CB
 280 mm

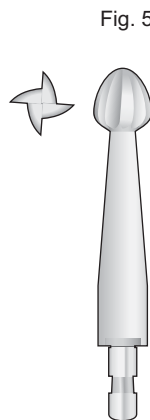

Fig. 5

ADSON
0617-CH
 Ø 15 mm

Bohrer
 Burr
 Punta
 Fresa
 Fraise



Fig. 6

Mc KENZIE
0617-CI
 Ø 13 mm

Bohrer
 Burr
 Punta
 Fresa
 Fraise



Fig. 7

CUSHING
0617-CL
 Ø 14 mm

Flachbohrer
 Flat Trepine
 Trapano piatto
 Taladro plano
 Fraise plate



Fig. 8

0617-DA
 Ø 2 mm

Spiralbohrer
 Twist Drill
 Punta a spirale
 Broca espiral
 Mèche hélicoidale

Bohrinstrumente
Pfrieme

Boring
instruments

Perforatori
a mano

Perforadores
para huesos

Instruments à perforer
alènes

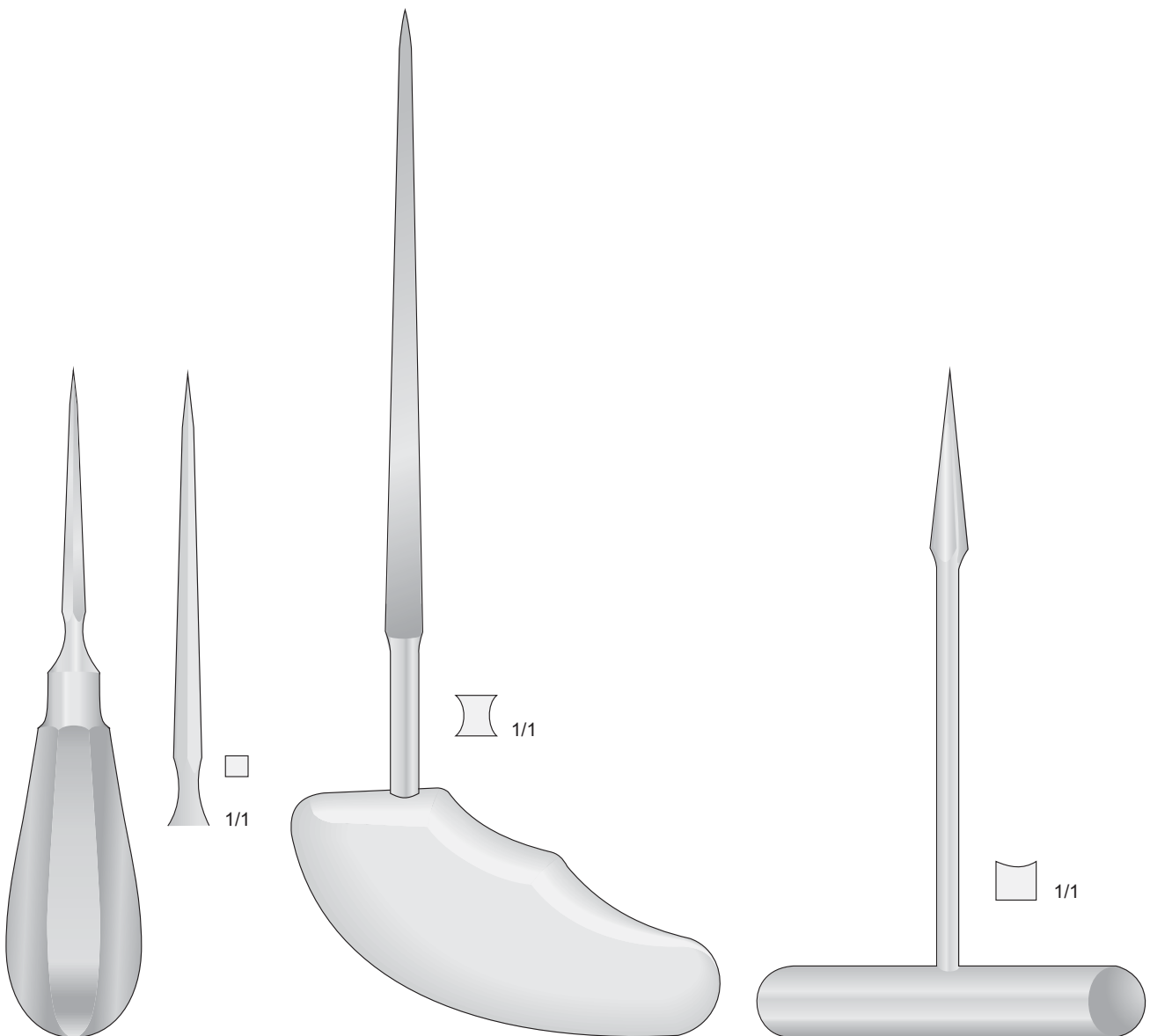

1917-HH
140 mm

PERTHES
1917-HI
210 mm

1917-HG
140 mm

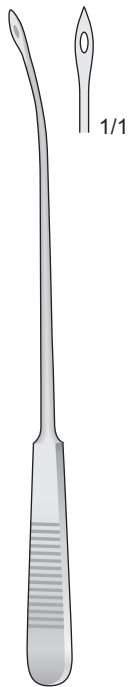

OBWEGESER
0414-DA
140 mm

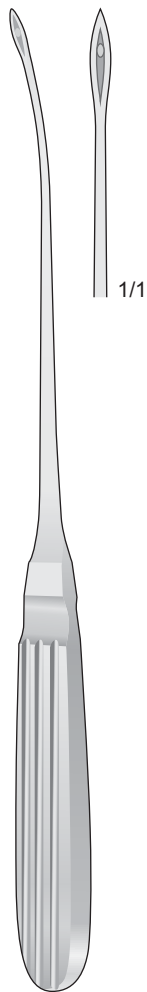

OBWEGESER
0414-DB
230 mm

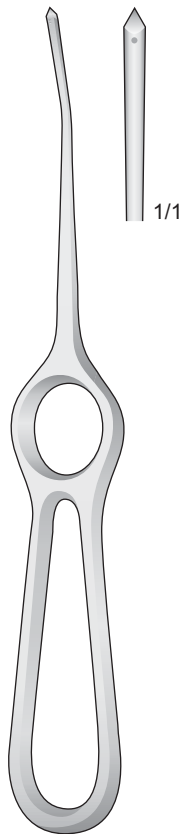

0414-DC
180 mm

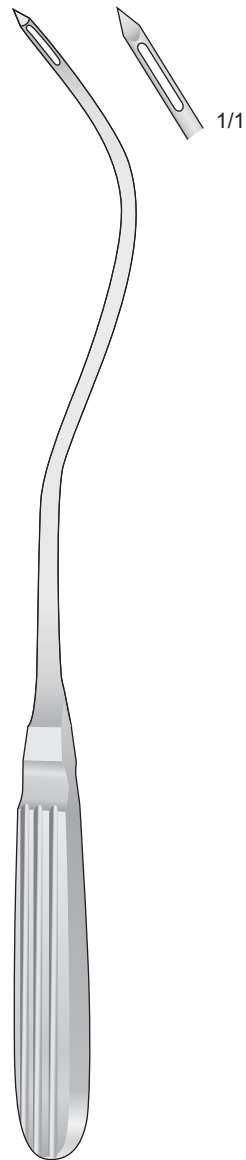

SANDERS-BROWN
0414-EE
290 mm

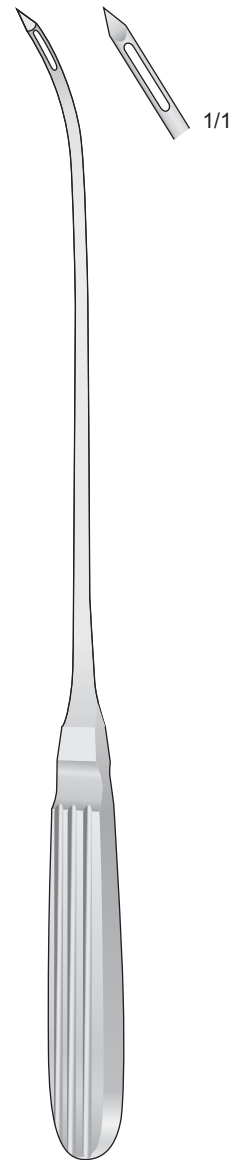

SANDERS-BROWN
0414-EL
300 mm

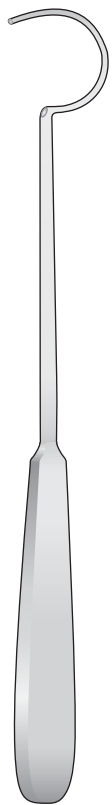

DEMEL
0212-BC/0212-BE

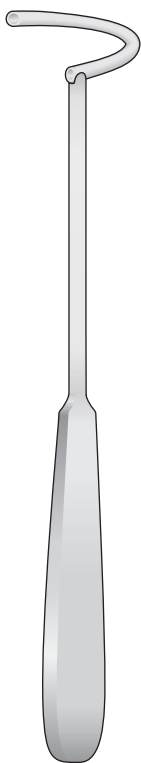
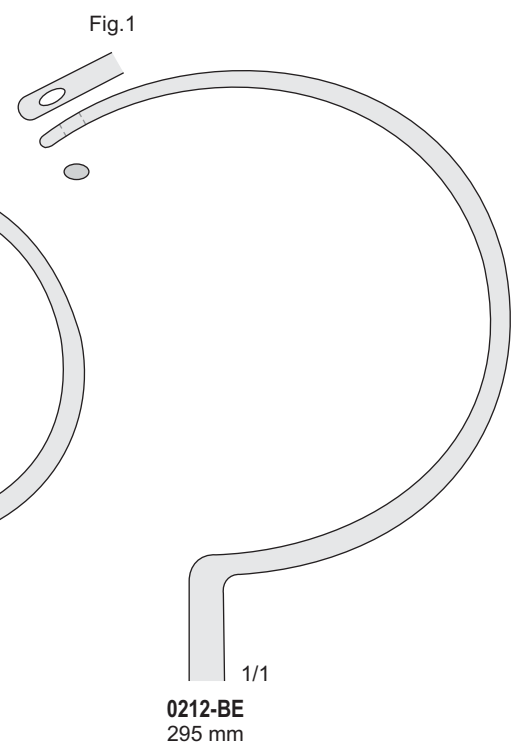
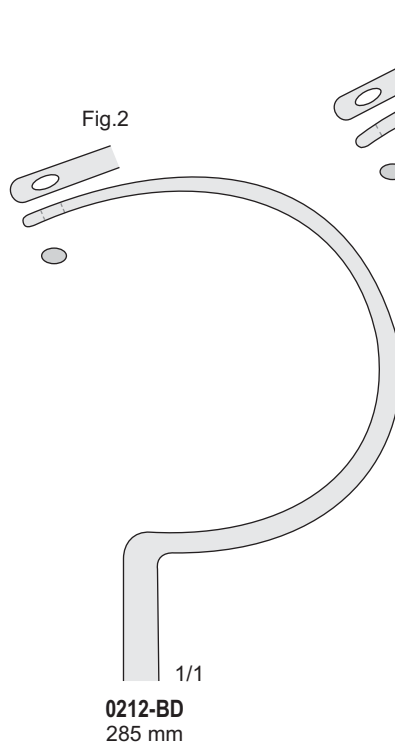
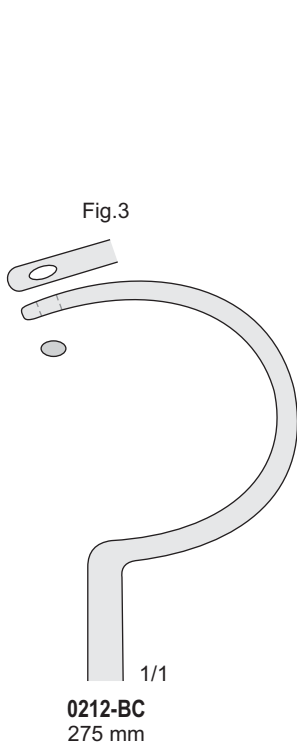

0212-BA
225 mm

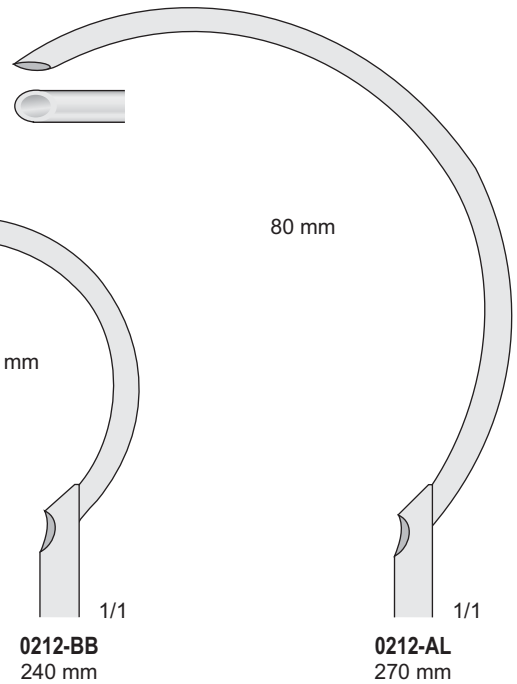
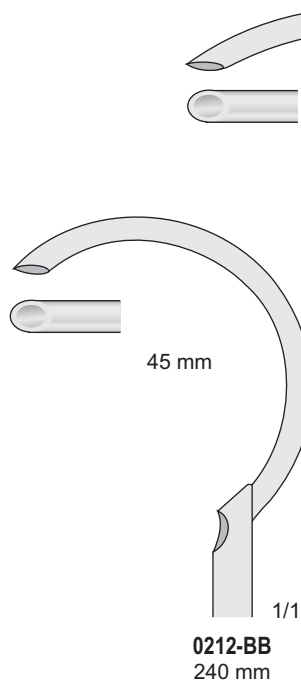
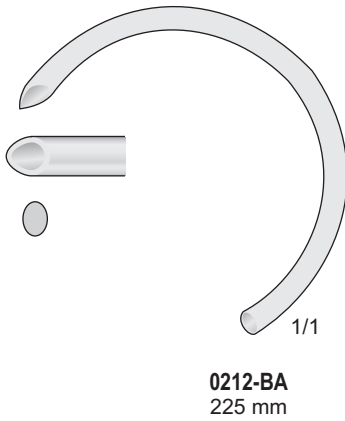

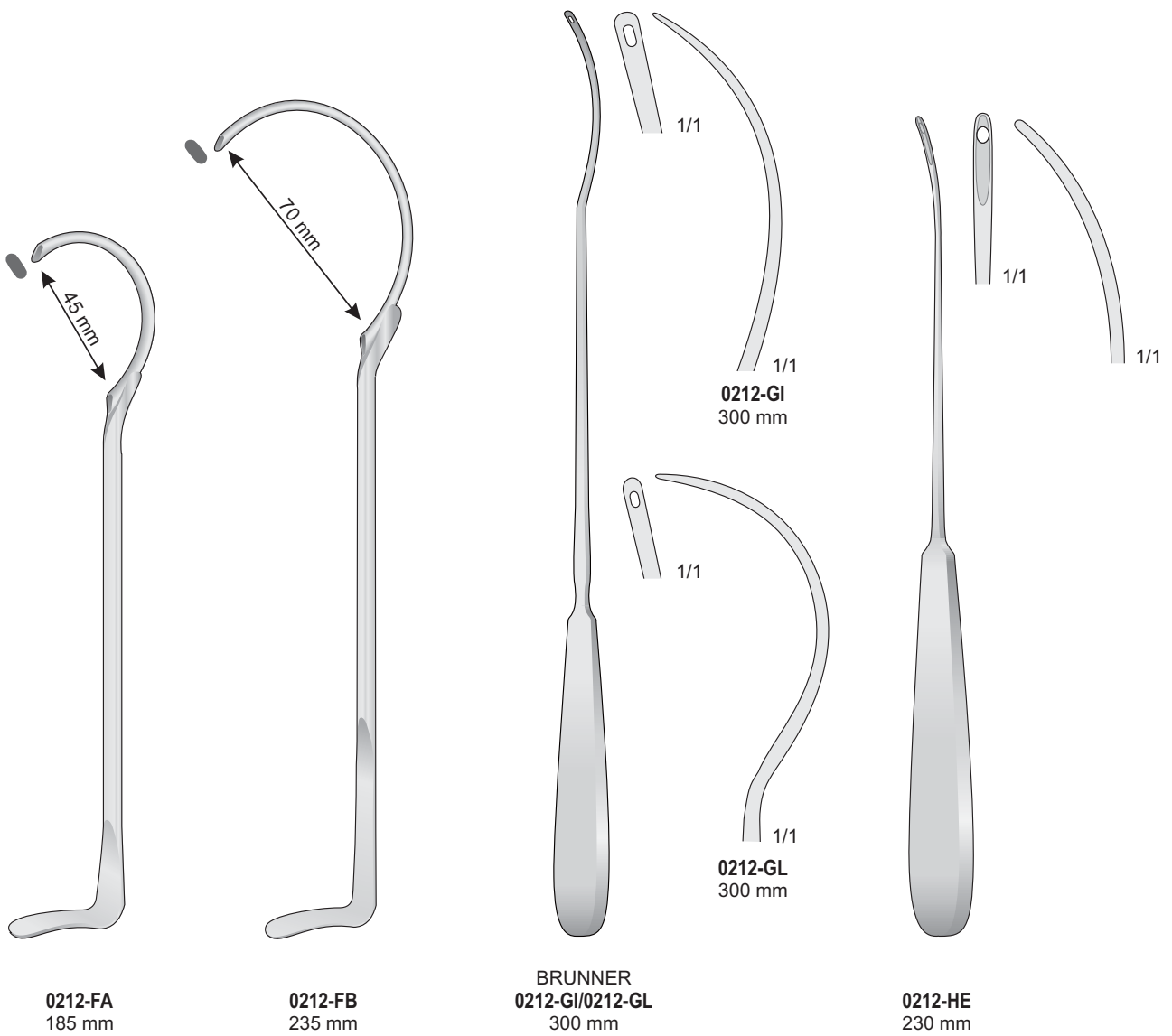

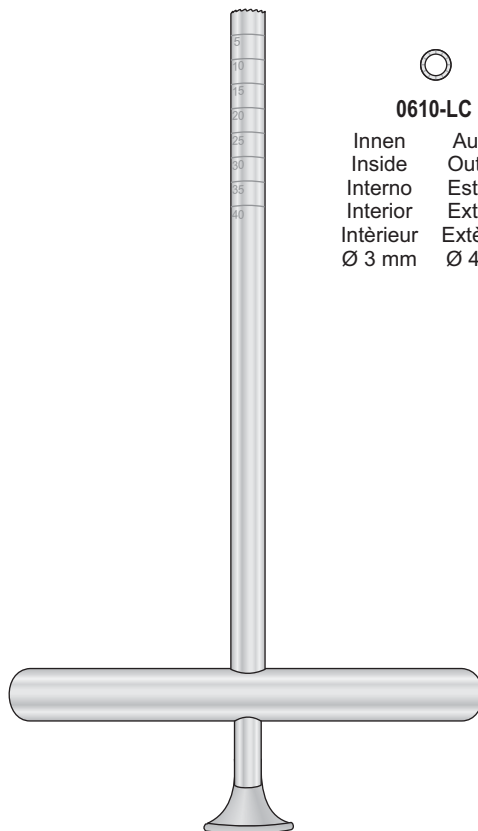

0610-LC

Innen	Außen
Inside	Outside
Interno	Esterno
Interior	Exterior
Intérieur	Extérieur
Ø 3 mm	Ø 4 mm



0610-LA

Innen	Außen
Inside	Outside
Interno	Esterno
Interior	Exterior
Intérieur	Extérieur
Ø 3,9 mm	Ø 5 mm



0610-LB

Innen	Außen
Inside	Outside
Interno	Esterno
Interior	Exterior
Intérieur	Extérieur
Ø 6,4 mm	Ø 8 mm

0610-LA/0610-LC
170 mm

Extraktionszangen
für bohrdrähte

Extraction pliers
for boring wires

Pinze per estrazione
fili metallici

Pinzas para extracción
de hilo metálico

Pinces pour
l'extraction des broches

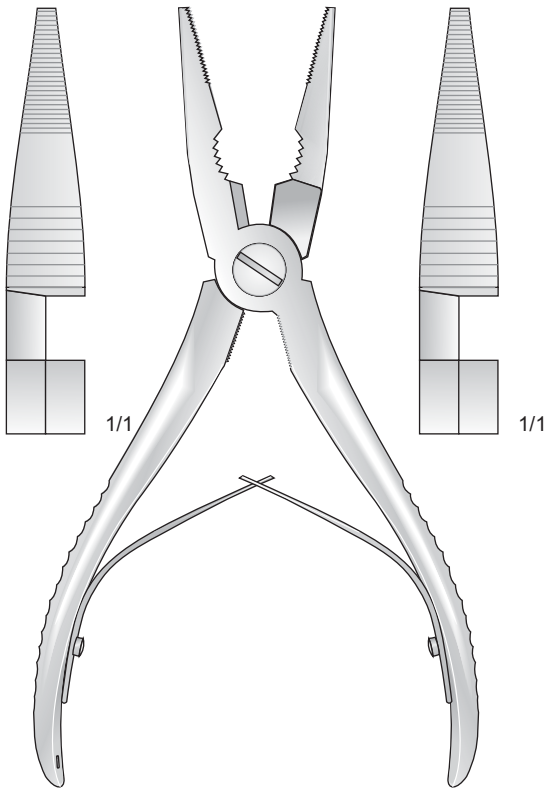

1123-BDF
175 mm

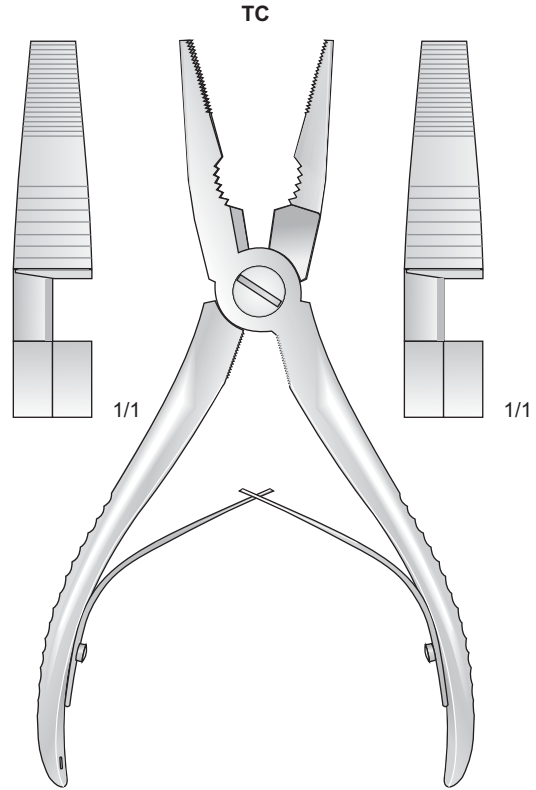

1123-BDG
165 mm

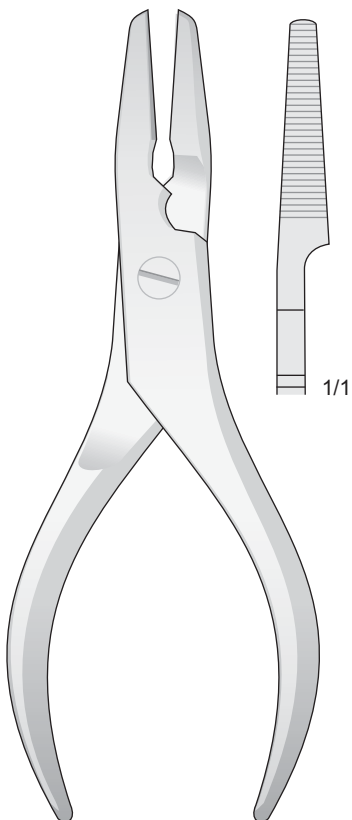

1123-BDE
160 mm

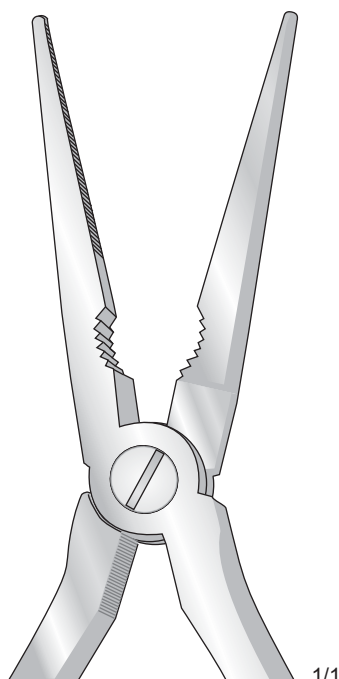

1123-BDH
200 mm

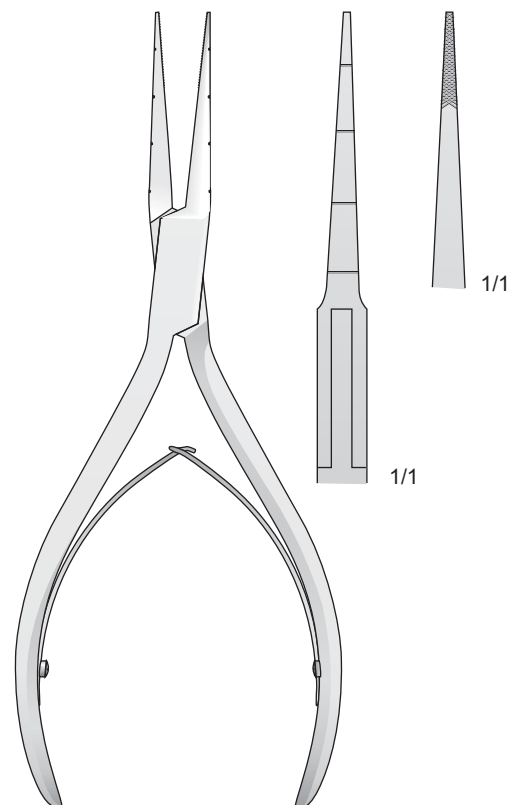

0415-LG
150 mm

Extraktionszangen
für bohrdrähte

Extraction pliers
for boring wires

Pinze per estrazione
fili metallici

Pinzas para extracción
de hilo metálico

Pinces pour
l'extraction des broches

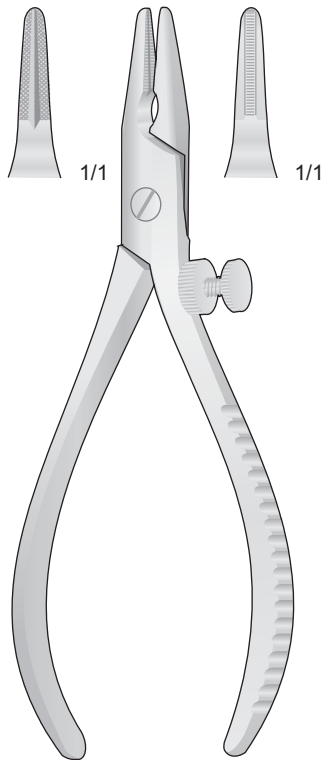

1123-BDA
140 mm

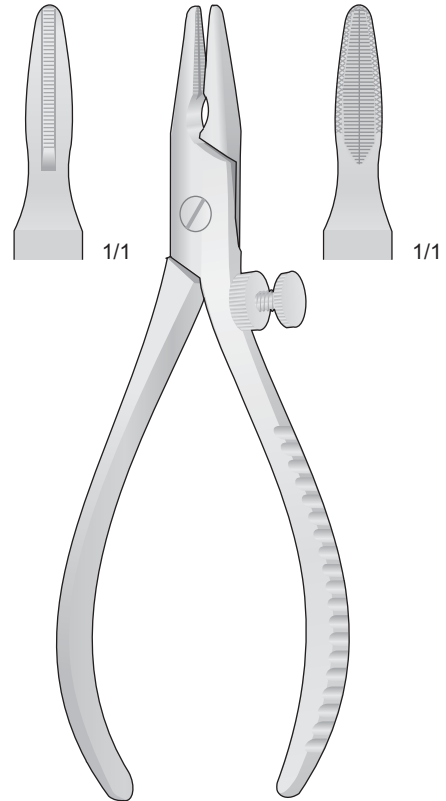

1123-BDB
180 mm

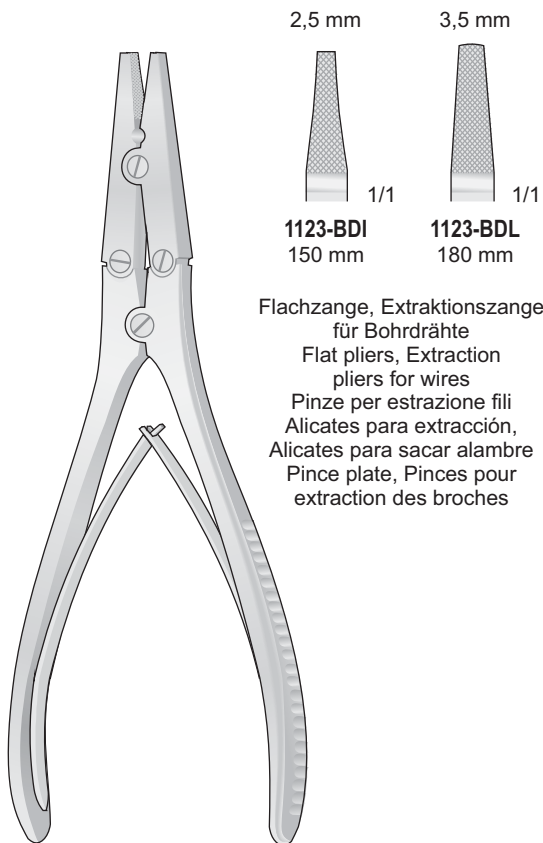

1123-BDI/1123-BDL

Flachzange, Extraktionszange
für Bohrdrähte
Flat pliers, Extraction
pliers for wires
Pinze per estrazione fili
Alicates para extracción,
Pince para sacar alambre
Pince plate, Pinces pour
extraction des broches

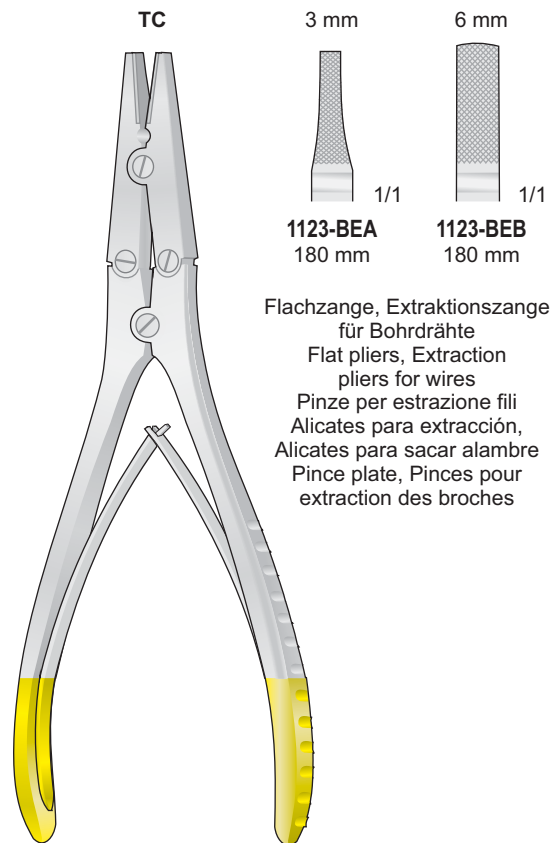

1123-BEA/1123-BEB

Flachzange, Extraktionszange
für Bohrdrähte
Flat pliers, Extraction
pliers for wires
Pinze per estrazione fili
Alicates para sacar alambre
Pince plate, Pinces pour
extraction des broches

Extraktionszangen
für bohrdrähte

Extraction pliers
for boring wires

Pinze per estrazione
fili metallici

Pinzas para extracción
de hilo metálico

Pinces pour
l'extraction des broches

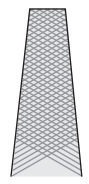

1/1

2108-CA

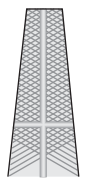

1/1

2108-CB

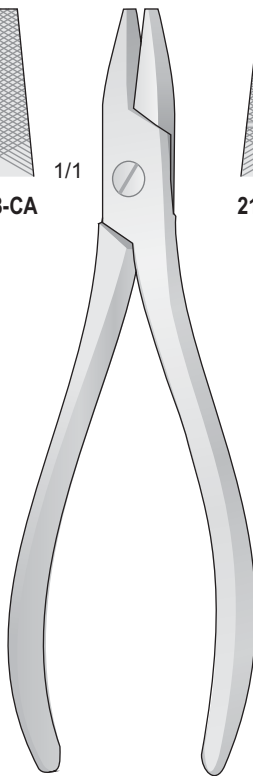

2108-CA/2108-CB
175 mm



1/1

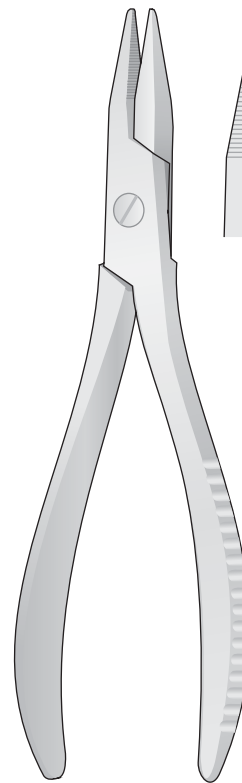

2108-CD
190 mm

Parallel-Flachzange - Flat-nosed pliers, parallel
Pinza a branche parallele - Alicates planos - Pincas plates



1/1



1/1

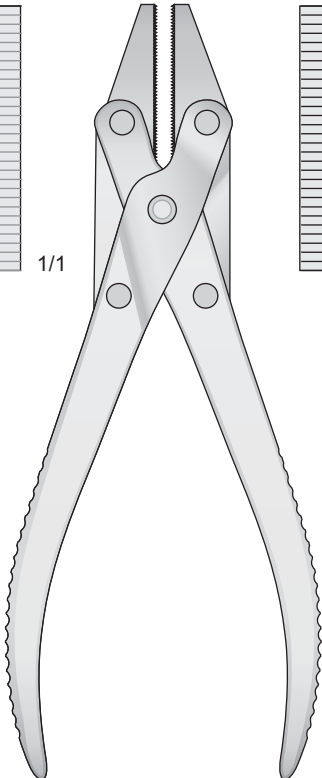

2108-CF
185 mm

Inox
Stainless Steel
Rostfrei

Parallel-Flachzange mit Seitenschneider
Flat-nose pliers parallel with lateral wire cutter
Pinza a branche parallele con tronchese



1/1



1/1

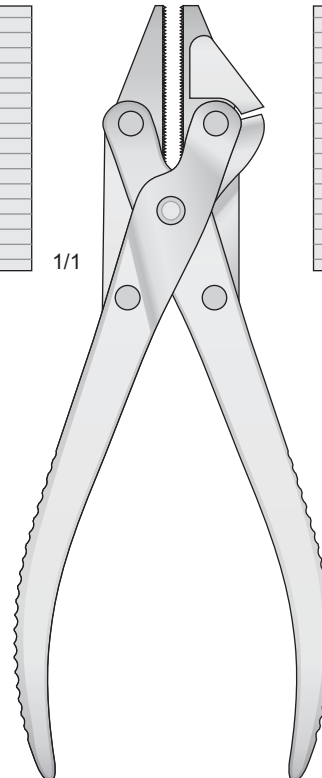

1123-IA
185 mm

Inox
Stainless Steel
Rostfrei

Extraktionszangen
für bohrdrähte

Extraction pliers
for boring wires

Pinze per estrazione
fili metallici

Pinzas para extracción
de hilo metálico

Pinces pour
l'extraction des broches

TC

Draht-und bleischere gezahnt - Wire cutting scissor serrated
Forbice universale dentellata - Tijeras para cortar hilo de acero dentadas

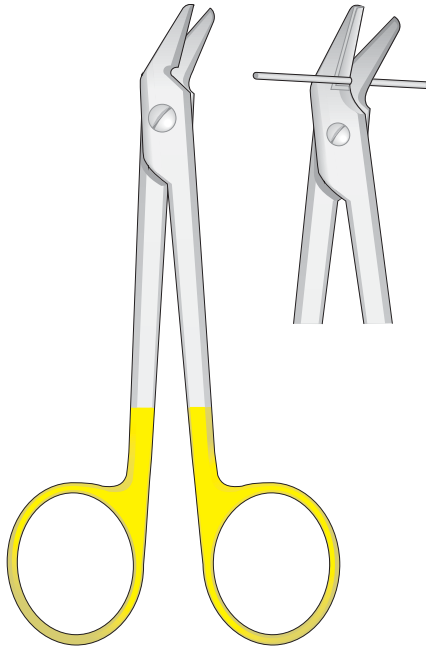

0415-BCA
120 mm

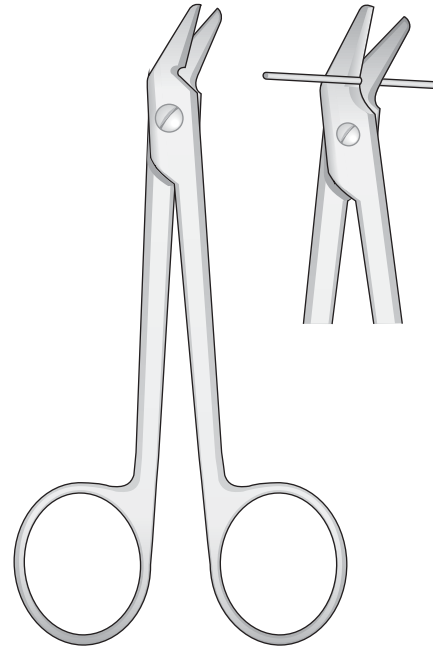

0415-LA
120 mm

TC

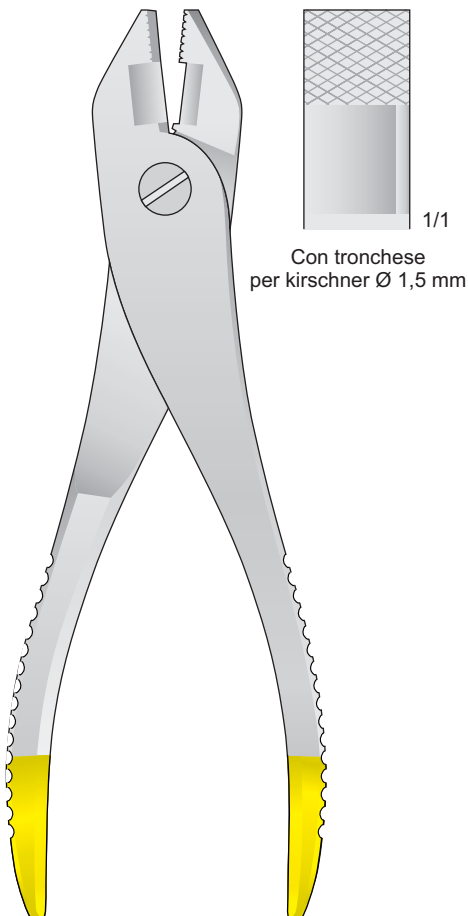

1123-BCF
220 mm

Con tronchese
per kirschner Ø 1,5 mm

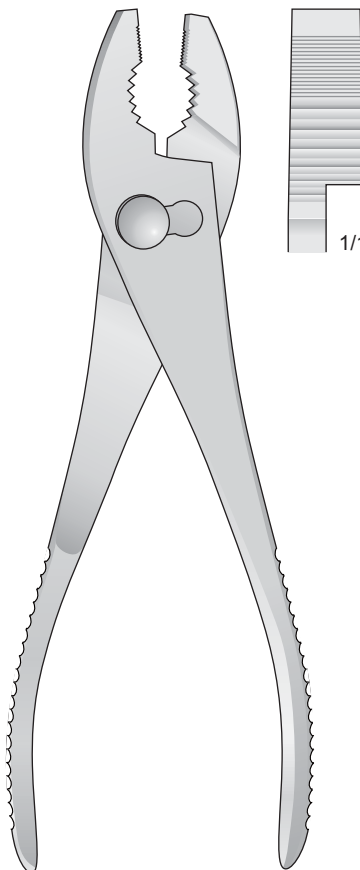

2108-EA
200 mm

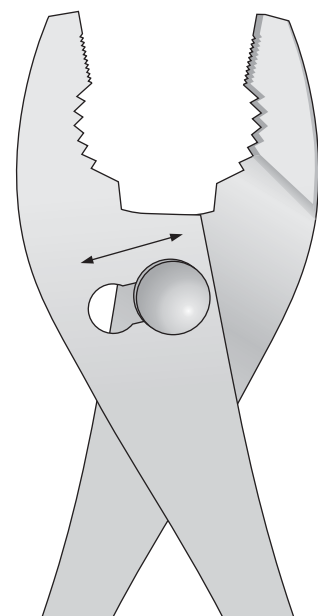

Komplett aus rostfreiem Stahl gefertigte und gehärtete Backen sorgen für einen guten Halt. Spannen und lösen erfolgt mit einer Hand



1118-EAH
180 mm

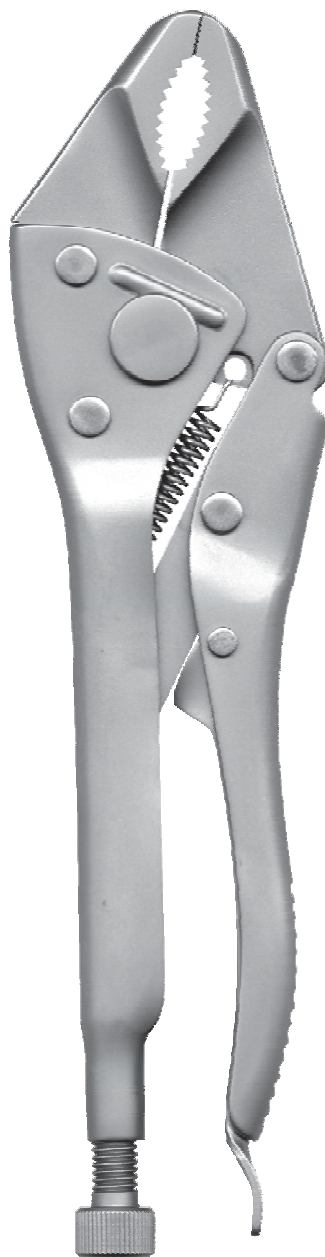

1118-EAI
200 mm



1118-EAL
240 mm

Nadelhalter, Stahldrahtzangen - Needle holders, steel wire forceps
 Port'aghi, pinze per fili d'acciaio - Porta agujas, pinzas para hilos de acero
 Porte aiguilles, pincès à saisir fils d'acier

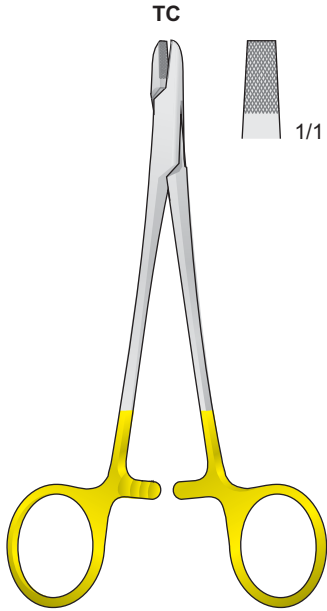

1508-FI
150 mm

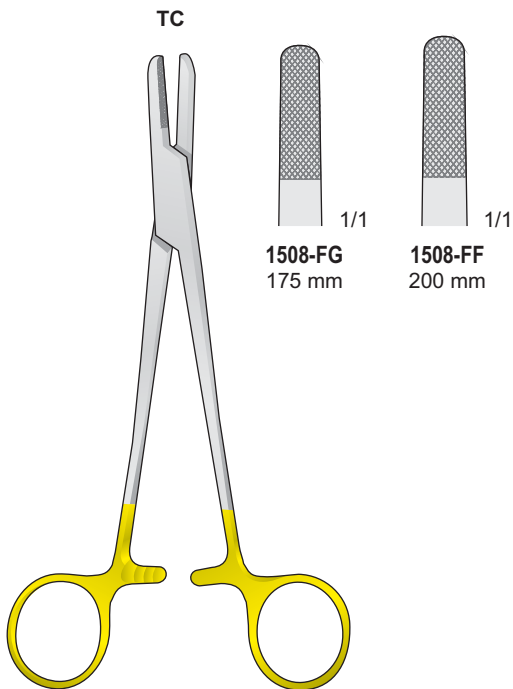

1508-FF/1508-FG

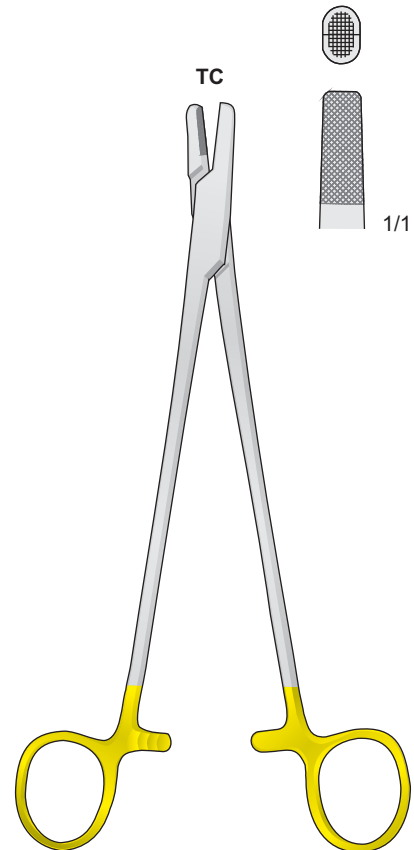

BAUMGARTNER
1508-FH
200 mm

Drahtschneidezangen **Wire cutting pliers** **Tronchesi per fili metallici** **Alicates para cortar alambre** **Pinces à couper le fil**

Für harten Draht bis \varnothing 0,4 mm - For hard wire with \varnothing 0,4 mm
 Per fili duri di \varnothing 0,4 mm - Para alambres duros de \varnothing 0,4 mm
 Pour fils durs avec \varnothing 0,4 mm

Für harten Draht bis \varnothing 1 mm - For hard wire with \varnothing 1 mm
 Per filo duro \varnothing 1 mm - Para alambres duro \varnothing 1 mm
 Pour fil dur avec \varnothing 1 mm

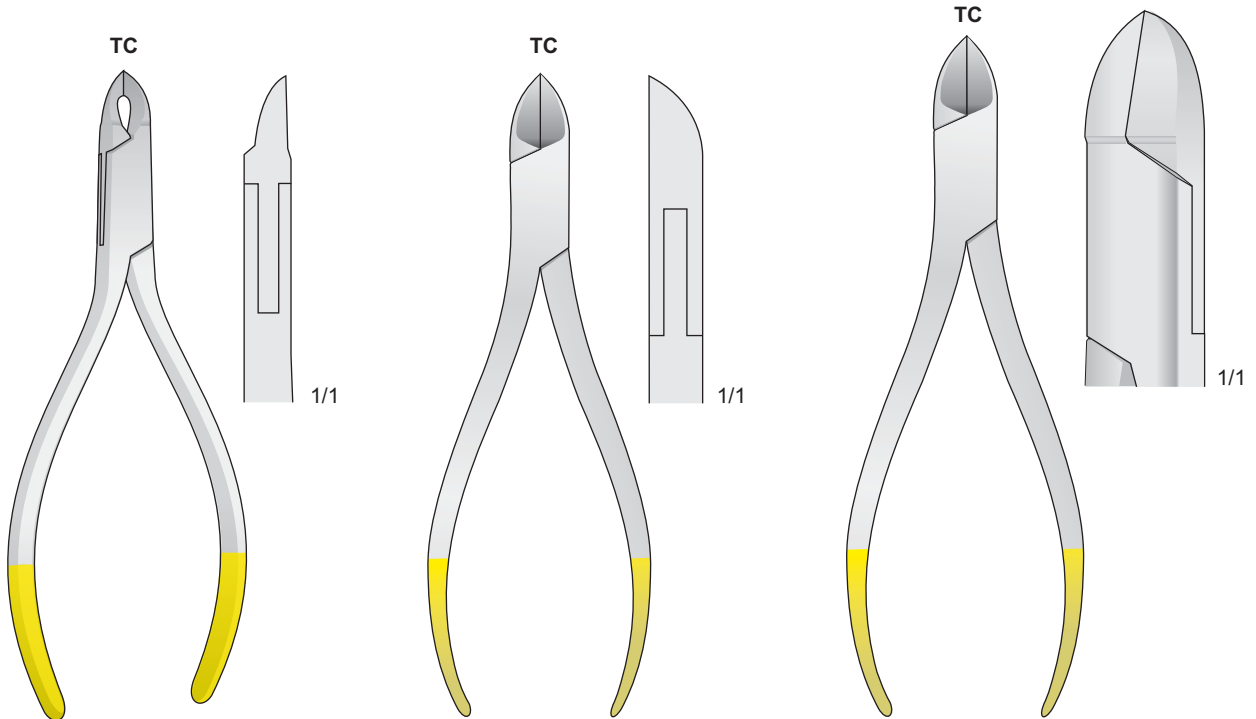

ANGLE
1123-LF1903
 130 mm

1123-LL
 130 mm

1123-LG1903
 150 mm

Für harten Draht bis \varnothing 1 mm - For hard wire with \varnothing 1 mm
 Per filo duro \varnothing 1 mm - Para alambres duro \varnothing 1 mm
 Pour fil dur avec \varnothing 1 mm

Für harten Draht bis \varnothing 1,7 mm
 For hard wire with \varnothing 1,7 mm
 Per filo duro \varnothing 1,7 mm
 Para alambres duro \varnothing 1,7 mm
 Pour fil dur avec \varnothing 1,7 mm

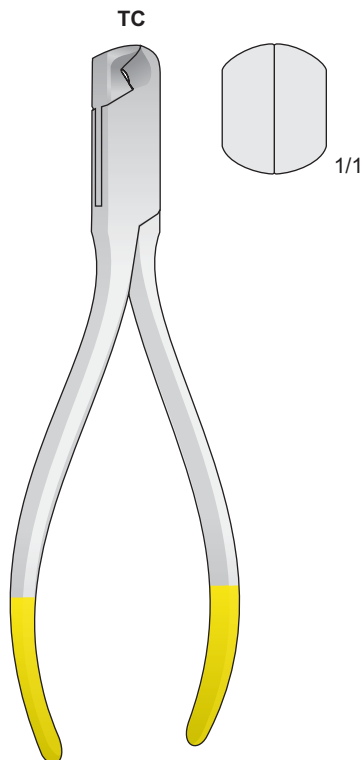

1123-LC1903
 145 mm



1123-IC
 185 mm

Für weichen draht Ø 2 mm
 Für harten draht Ø 1,5 mm
 For soft wire Ø 2 mm
 For hard wire Ø 1,5 mm
 Per filo leggero Ø 2 mm
 Per filo duro Ø 1,5 mm
 Para alambres ligero Ø 2 mm
 Para alambres duro 1,5 mm
 Pour fil léger Ø 2 mm
 Pour fil dur Ø 1,5 mm

Für weichen draht Ø 2 mm
 Für harten draht Ø 1,6 mm
 For soft wire Ø 2 mm
 For hard wire Ø 1,6 mm
 Per filo leggero Ø 2 mm
 Per filo duro Ø 1,6 mm
 Para alambres ligero Ø 2 mm
 Para alambres duro Ø 1,6 mm
 Pour fil léger Ø 2 mm
 Pour fil dur Ø 1,6 mm

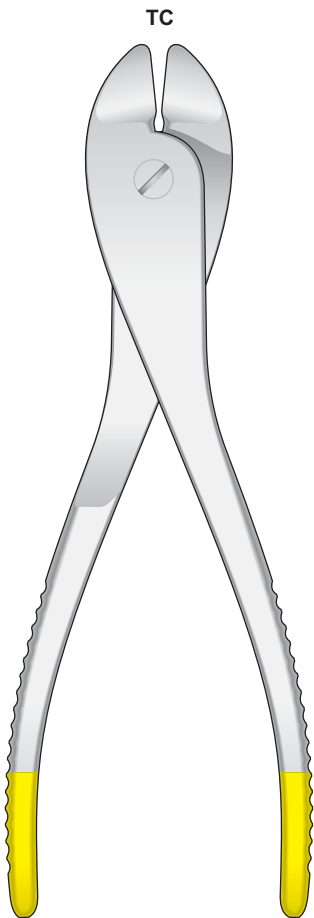

1123-BAB
185 mm

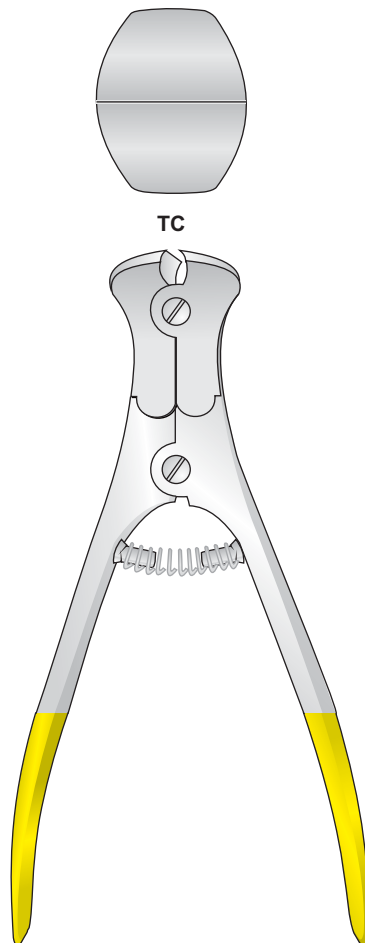

1123-BAC
145 mm

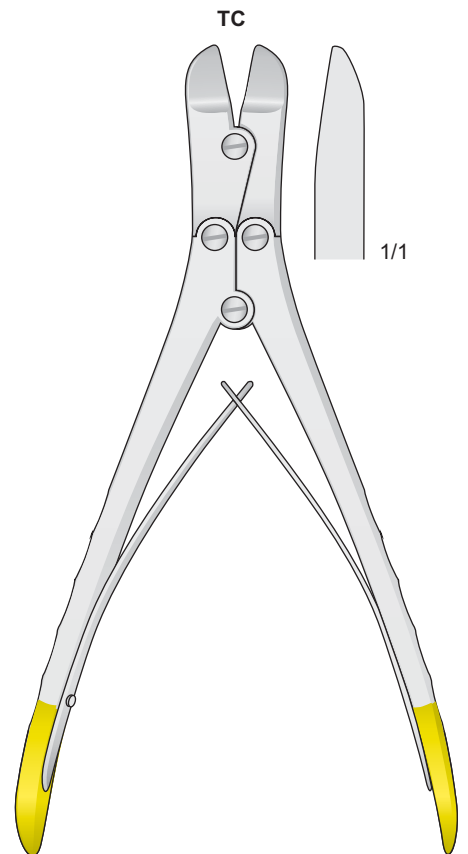

1123-BAD
170 mm

Für weichen draht Ø 3,5 mm
 Für harten draht Ø 2,5 mm
 For soft wire Ø 3,5 mm
 For hard wire Ø 2,5 mm
 Per filo leggero Ø 3,5 mm
 Per filo duro Ø 2,5 mm
 Para alambres ligero Ø 3,5 mm
 Para alambres duro Ø 2,5 mm
 Pour fil léger Ø 3,5 mm
 Pour fil dur Ø 2,5 mm

Für weichen draht Ø 3 mm
 Für harten draht Ø 2,2 mm
 For soft wire Ø 3 mm
 For hard wire Ø 2,2 mm
 Per filo leggero Ø 3 mm
 Per filo duro Ø 2,2 mm
 Para alambres ligero Ø 3 mm
 Para alambres duro Ø 2,2 mm
 Pour fil léger Ø 3 mm
 Pour fil dur Ø 2,2 mm

Für weichen draht Ø 2,5 mm
 Für harten draht Ø 2 mm
 For soft wire Ø 2,5 mm
 For hard wire Ø 2 mm
 Per filo leggero Ø 2,5 mm
 Per filo duro Ø 2 mm
 Para alambres ligero Ø 2,5 mm
 Para alambres duro Ø 2 mm
 Pour fil léger Ø 2,5 mm
 Pour fil dur Ø 2 mm

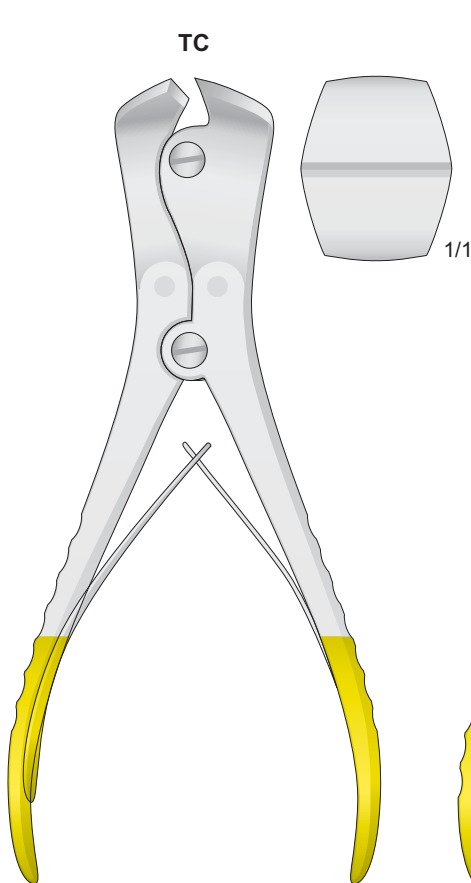

1123-BAE
215 mm

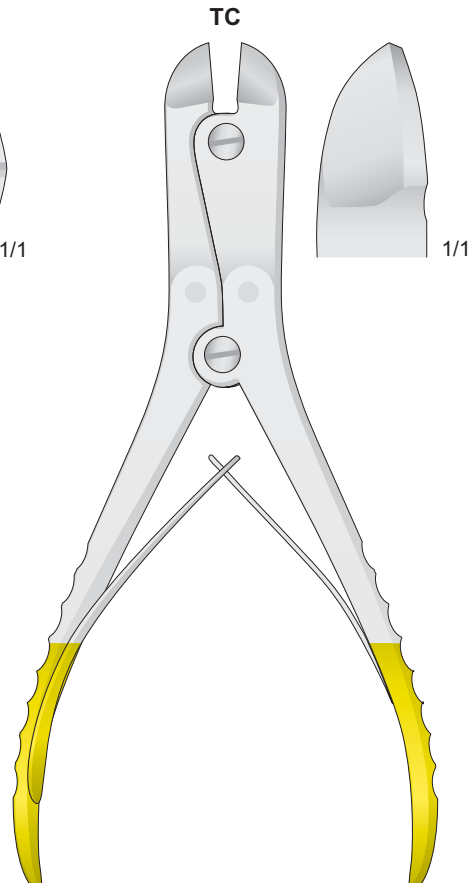

1123-BAG
230 mm

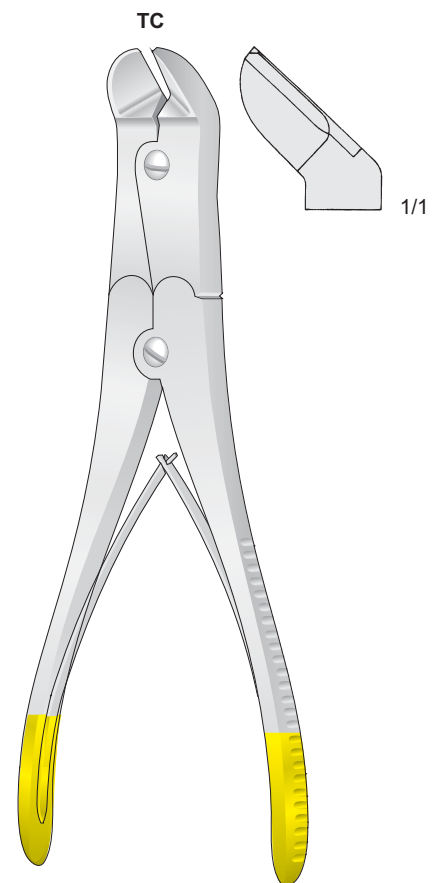

1123-BAF
230 mm

Für weichen Draht Ø 7 mm
 Für harten Draht Ø 6 mm
 For soft wire Ø 7 mm
 For hard wire Ø 6 mm
 Per filo leggero Ø 7 mm
 Per filo duro Ø 6 mm
 Para alambres ligero Ø 7 mm
 Para alambres duro Ø 6 mm
 Pour fil léger Ø 7 mm
 Pour fil dur Ø 6 mm

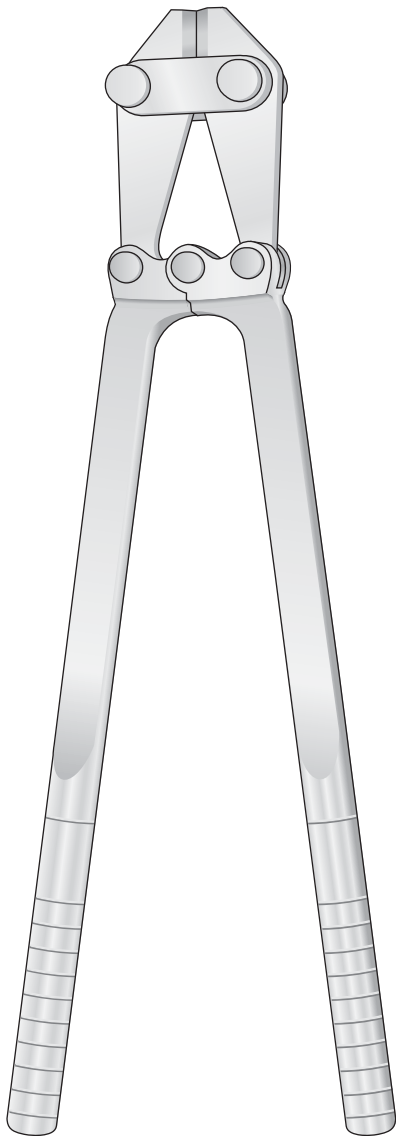

2106-LI
480 mm

Für weichen Draht Ø 7 mm
 Für harten Draht Ø 6 mm
 For soft wire Ø 7 mm
 For hard wire Ø 6 mm
 Per filo leggero Ø 7 mm
 Per filo duro Ø 6 mm
 Para alambres ligero Ø 7 mm
 Para alambres duro Ø 6 mm
 Pour fil léger Ø 7 mm
 Pour fil dur Ø 6 mm

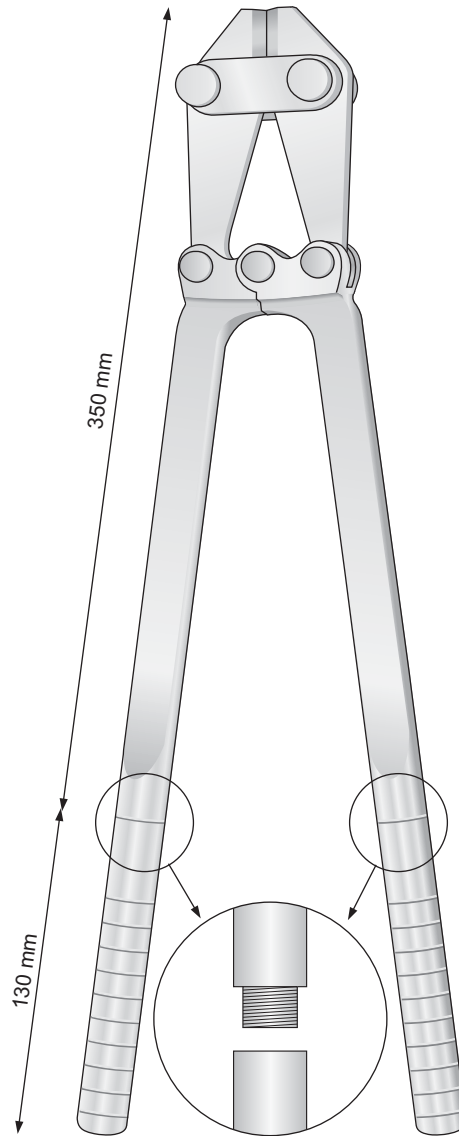

2106-LI12
480 mm

Für weichen Draht Ø 5 mm
 Für harten Draht Ø 4,5 mm
 For soft wire Ø 5 mm
 For hard wire Ø 4,5 mm
 Per filo leggero Ø 5 mm
 Per filo duro Ø 4,5 mm
 Para alambres ligero Ø 5 mm
 Para alambres duro Ø 4,5 mm
 Pour fil léger Ø 5 mm
 Pour fil dur Ø 4,5 mm

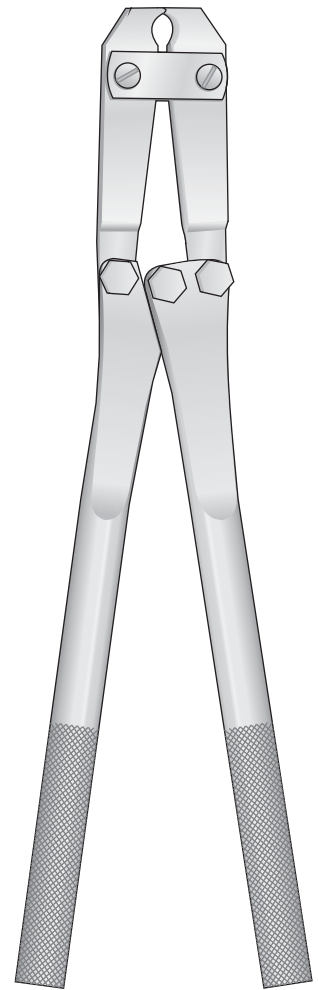

1123-BAH
375 mm

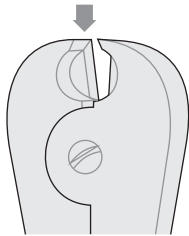

Für weiche Drähte bis Ø 2 mm
Per fili morbidi fino a Ø 2 mm
Pour fils mous jusqu'à Ø 2 mm

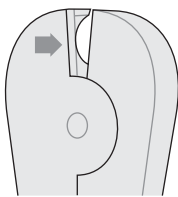

Für harte Drähte bis Ø 1,5 mm
Per fili duri fino a Ø 1,5 mm
Pour fils durs jusqu'à Ø 1,5 mm

TC



1123-BCG
180 mm

Von Kirschner-Drähten Ø 6 mm
For Kirschner wires Ø 6 mm
Per chiodi Kirschner Ø 6 mm

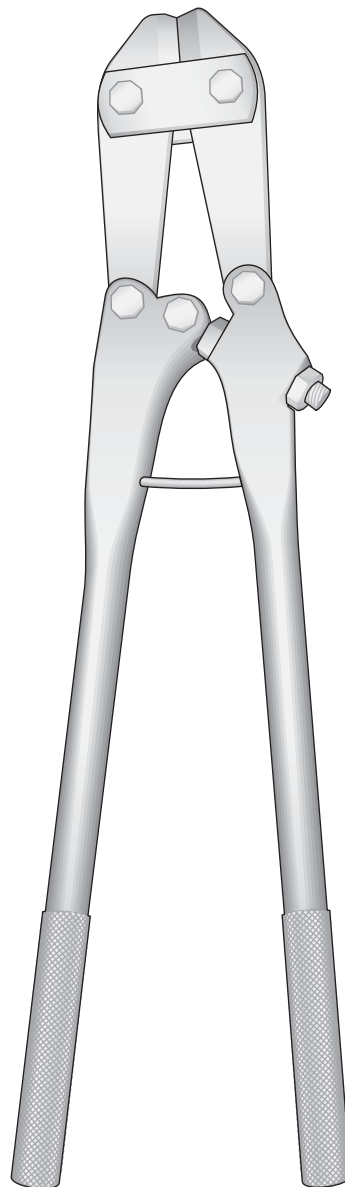

1123-BFA
450 mm

Von Kirschner-Drähten Ø 6 mm
For Kirschner wires Ø 6 mm
Per chiodi Kirschner Ø 6 mm

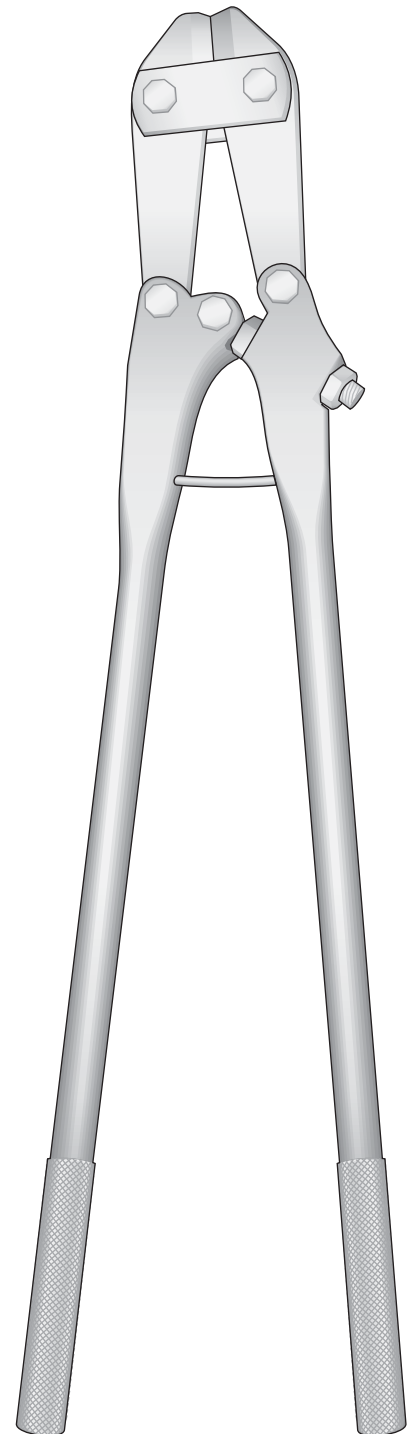

1123-BFB
560 mm

Gipsspreizer
Gipsabreisszangen

Plaster spreader
Plaster cast breakers

Strumenti
per gesso

Pinza para
arrancar vendajes

Pinces pour
appareils plâtrés

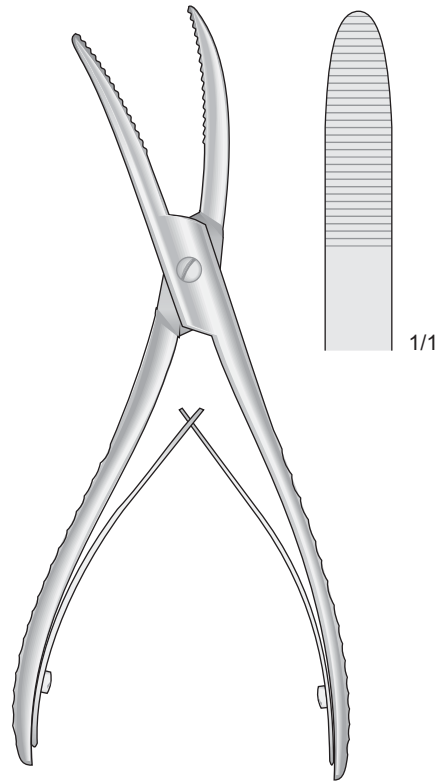

WOLFF
1123-BBD
180 mm

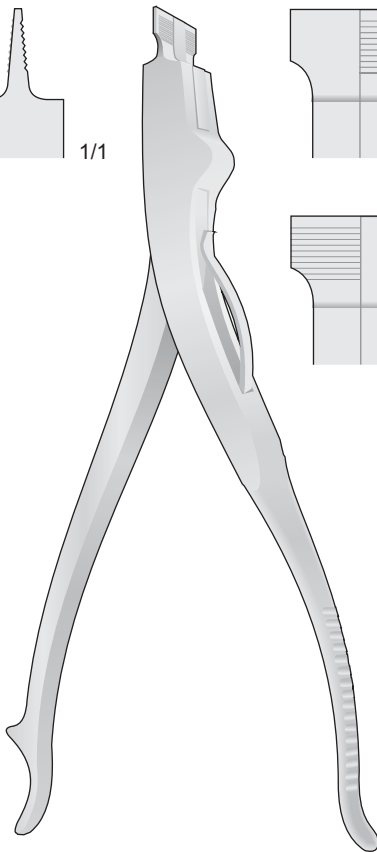
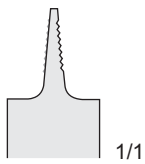
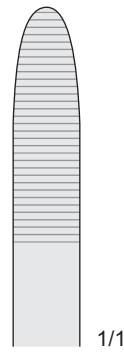

1123-BBF
220 mm

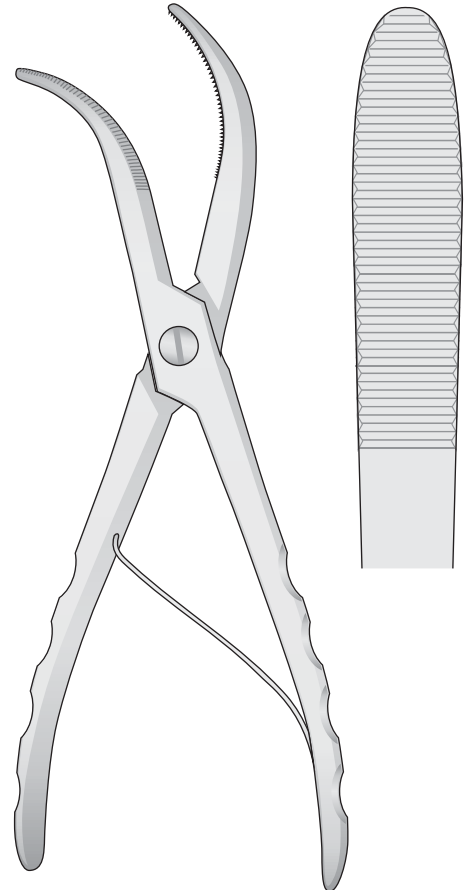
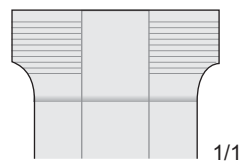
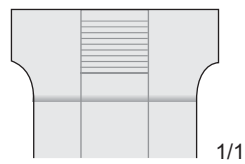

WOLFF
1123-BBE
250 mm

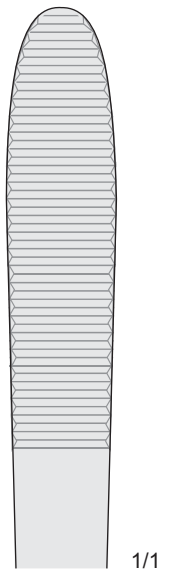

Gipsscheren

Plaster cast breakers

Strumenti per gesso

Pinza para arrancar vendajes

Appareils plâtrés

Gips - Schneidezangen
Cesoie per gesso

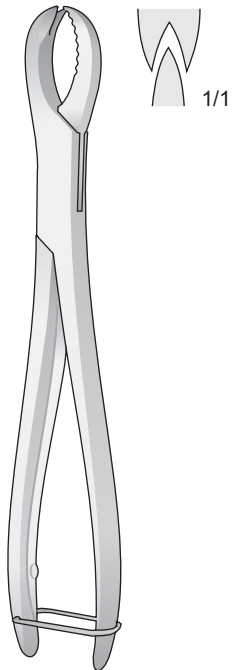

0210-DA
210 mm

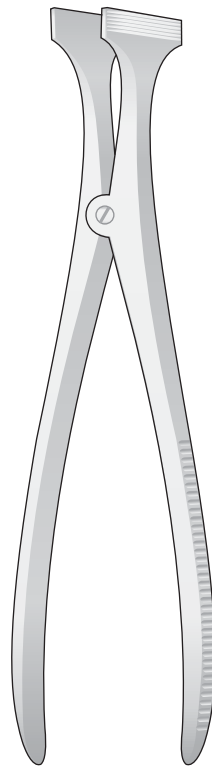

HENNIG
1123-BCD
270 mm

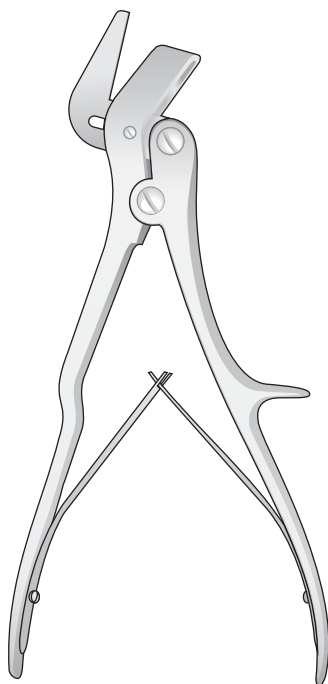
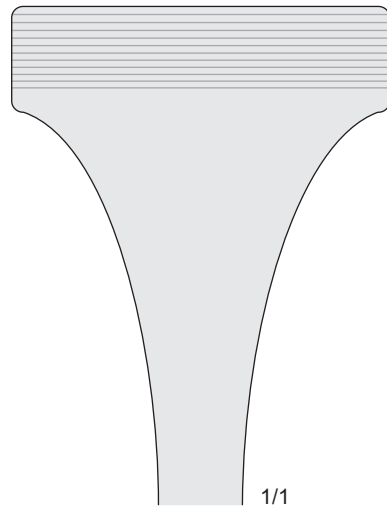

STILLE
1123-BCA
230 mm

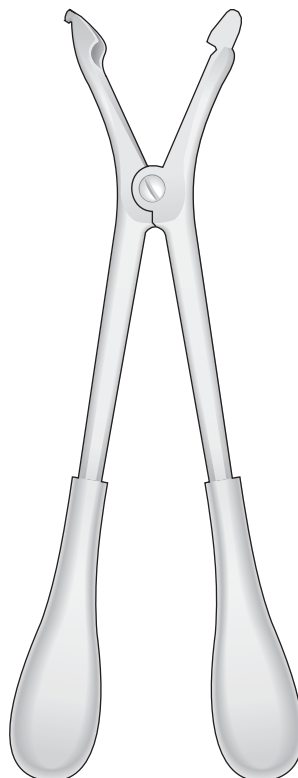

HAGLUND
1123-BCB
280 mm

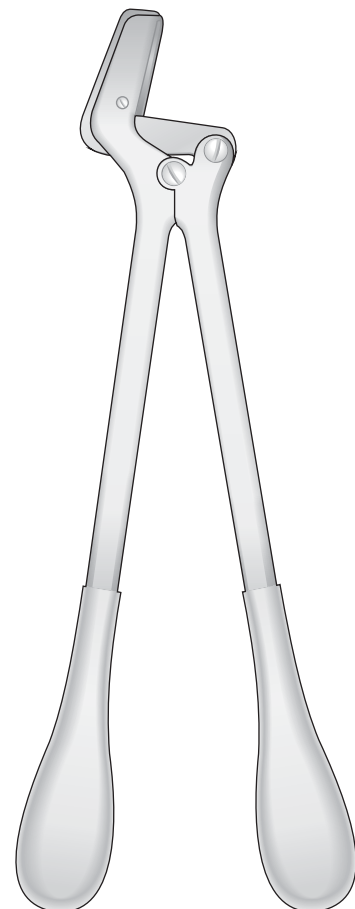

STILLE
1123-BCC
370 mm



Wundspreizer zur
Mikrodissektomie

Retractors for
Micro-Lumbar Discectomy

Divaricatori per
Dissectomia lombare

Separadors para
micro cirurgia

Ecarteurs pour
Micro chirurgie

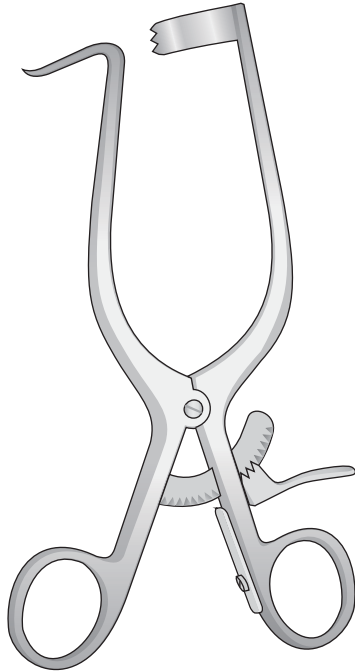

WILLIAMS
0221-EAB/0221-EAD
170 mm

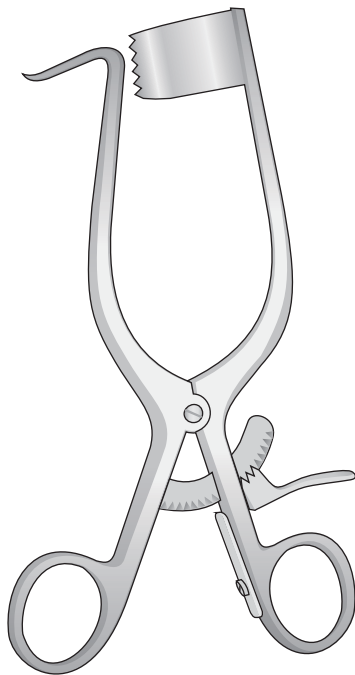

WILLIAMS
0221-EAE/0221-EAG
170 mm

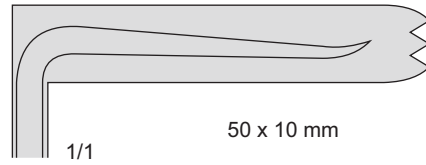

0221-EAB

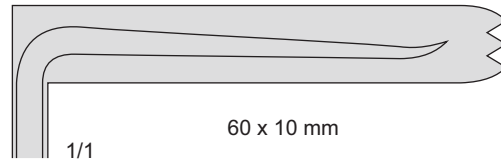

0221-EAC

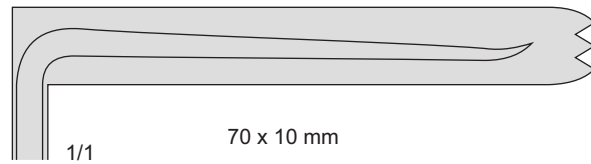

0221-EAD

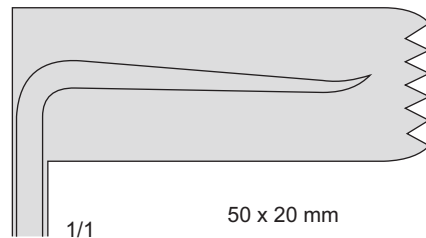

0221-EAE

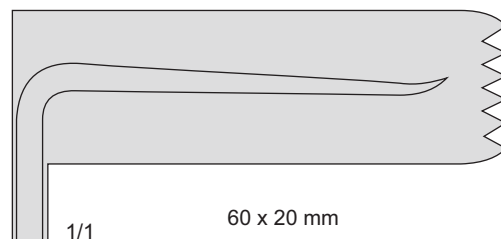

0221-EAF

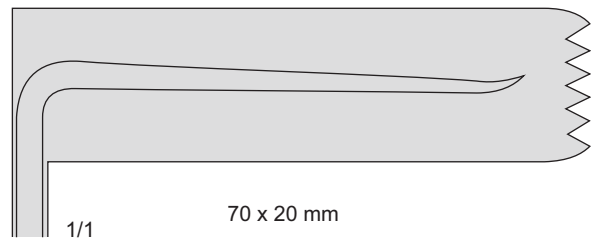

0221-EAG

Spitz - Sharp
Acuto - Agudas
Pointu

4 x 4 Zähne
4 x 4 Teeth
4 x 4 Denti
4 x 4 Dientes
4 x 4 Dents

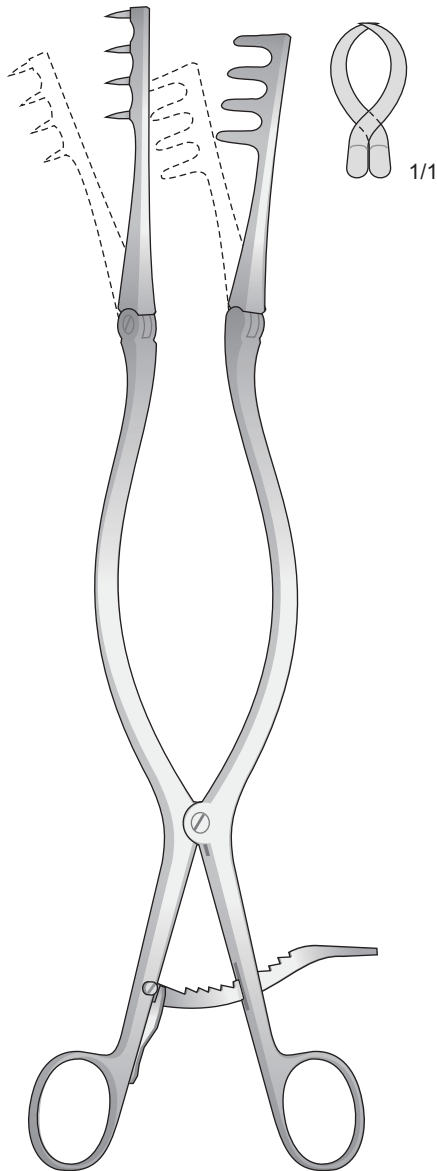

BECKMANN
0221-BCB
310 mm

Halbscharf - Sharp
Semi acuto - Agudas
Semi pointu

4 x 4 Zähne
4 x 4 Teeth
4 x 4 Denti
4 x 4 Dientes
4 x 4 Dents

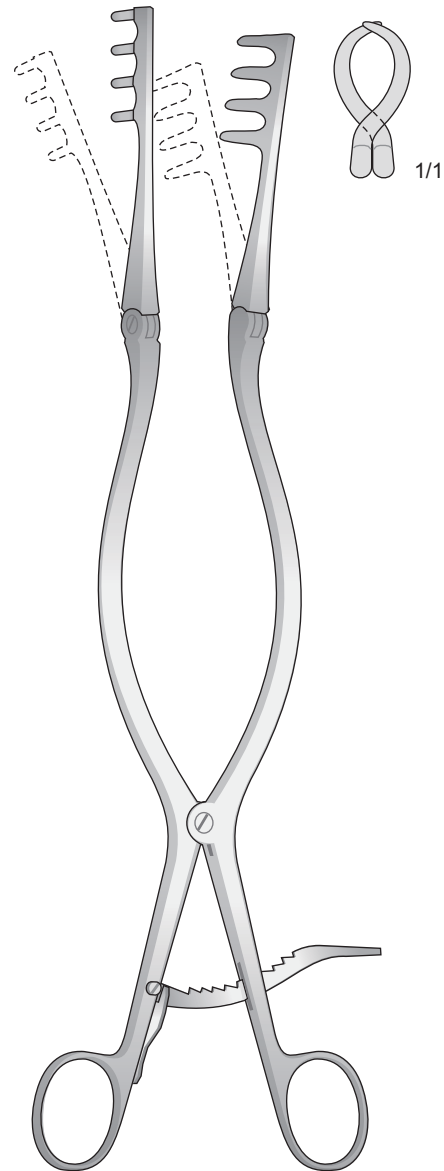

BECKMANN
0221-BCC
310 mm

Stumpf - Blunt - Smusso
Romas - Mousse

5 x 4 Zähne
5 x 4 Teeth
5 x 4 Denti
5 x 4 Dientes
5 x 4 Dents

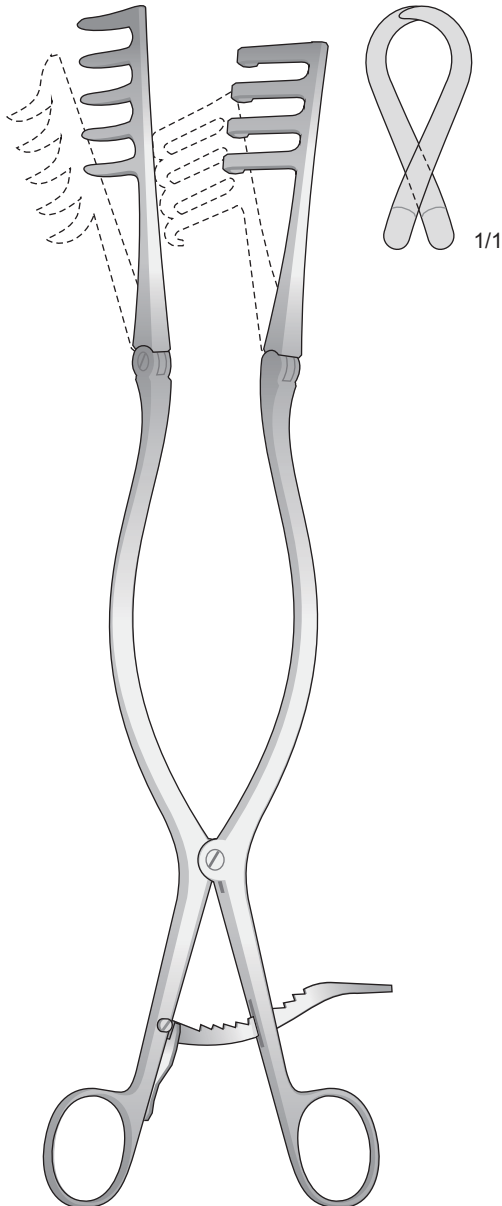

ADSON
0221-BCD
320 mm

Spitz - Sharp - Acuto
Agudas - Pointù

7 x 7 Zähne
7 x 7 Teeth
7 x 7 Denti
7 x 7 Dientes
7 x 7 Dents

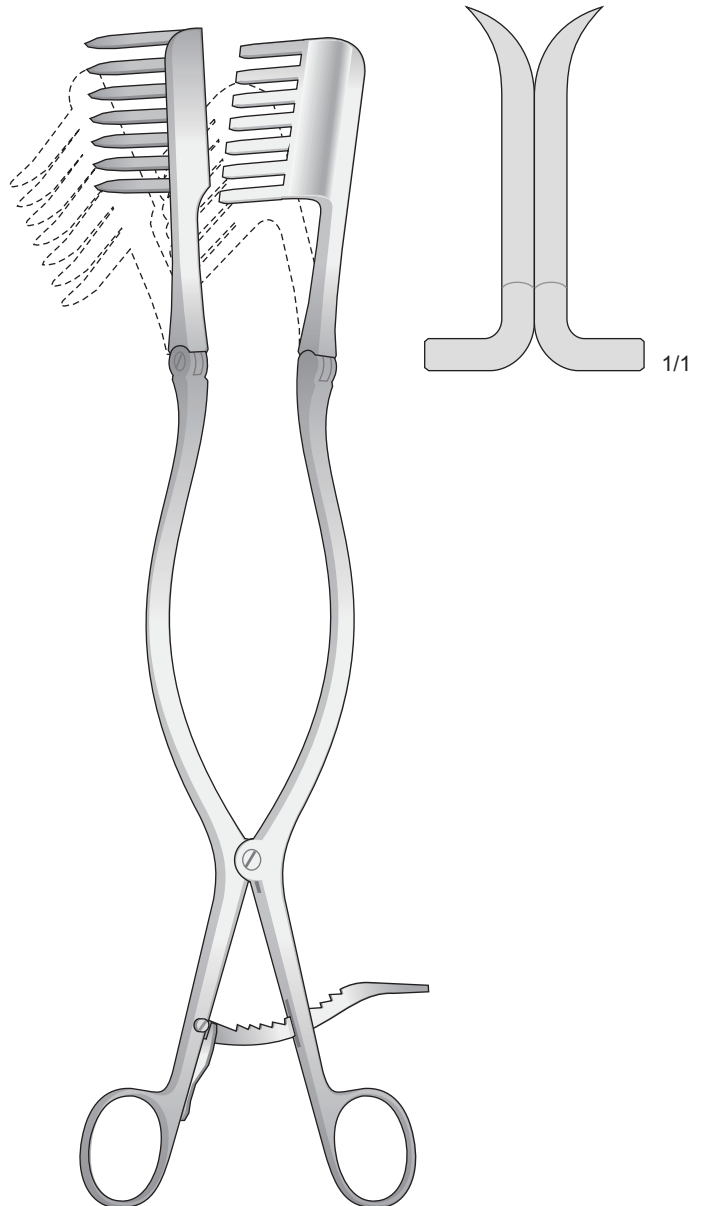

BECKMANN-EATON
0221-BCE
330 mm

Wundspreizer

Self retaining retractors

Divaricatori

Separadores

Ecarteurs

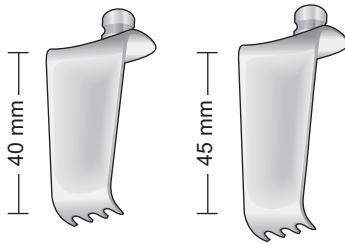

0221-DCB

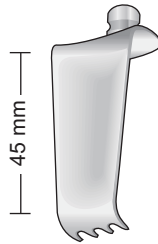

0221-DCC

CLOWARD Modif.
0221-DBL
Sperrer, allein
Retractor, only
Divaricatore, solo
Separador, suelto
Ecarteur, seul

CLOWARD modif.
0221-DCA
Komplett mit 5 Valven
Complete with 5 blades
Completo di 5 valve
Completo con 5 valvas
Complet avec 5 valves

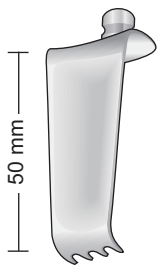

0221-DCD

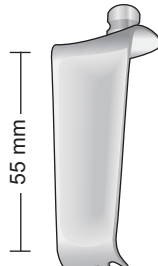

0221-DCE

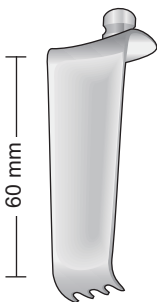

0221-DCF

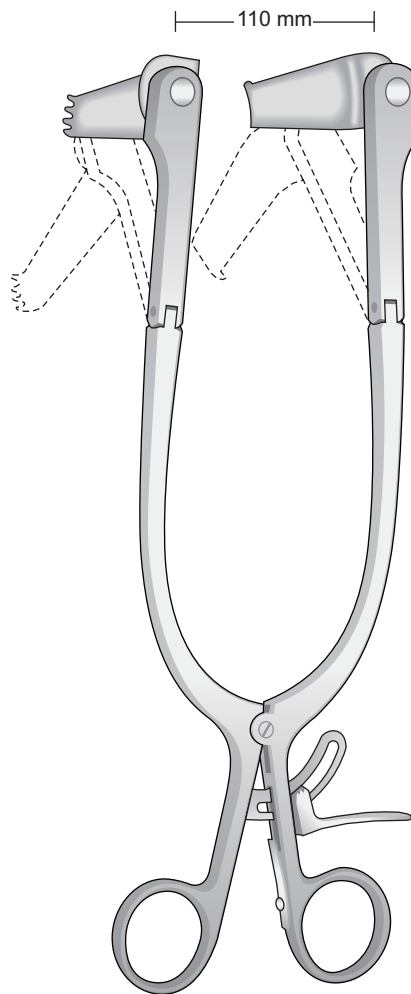

CLOWARD modif.
0221-DCA
250 mm

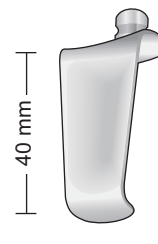

0221-DCG

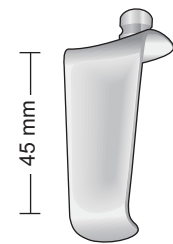

0221-DCH

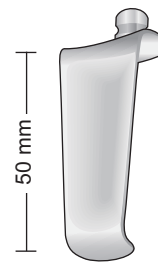

0221-DCI

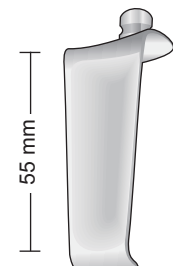

0221-DCL

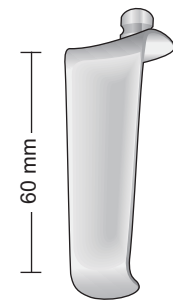

0221-DDA

Laminektomiespreizer

Laminectomy retractors

Divaricatori per laminectomia

Separadores para laminectomia

Ecarteurs pour laminectomie

Instrumente allein, ohne Blätter
Frame only - Strumento solo, senza valve
Cuadro solo - Cadre seul

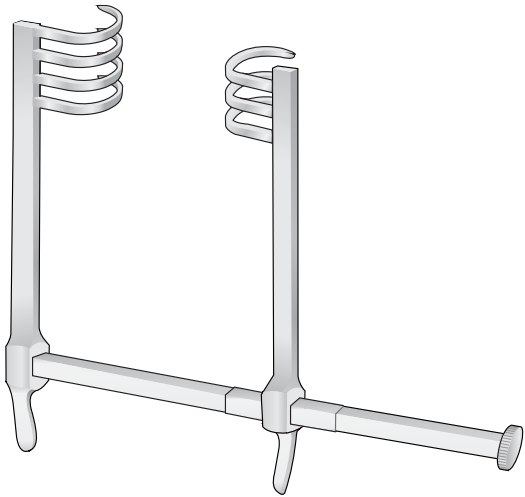

FRAZIER
0221-DF

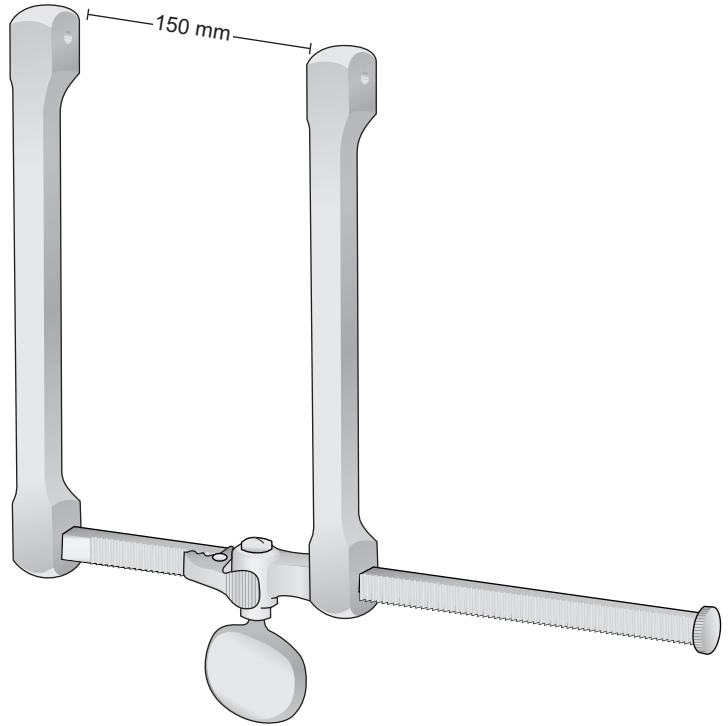

SCOVILLE
0221-BGB

Instrumente allein, ohne Blätter
Frame only
Strumento solo, senza valve
Cuadro solo
Cadre seul

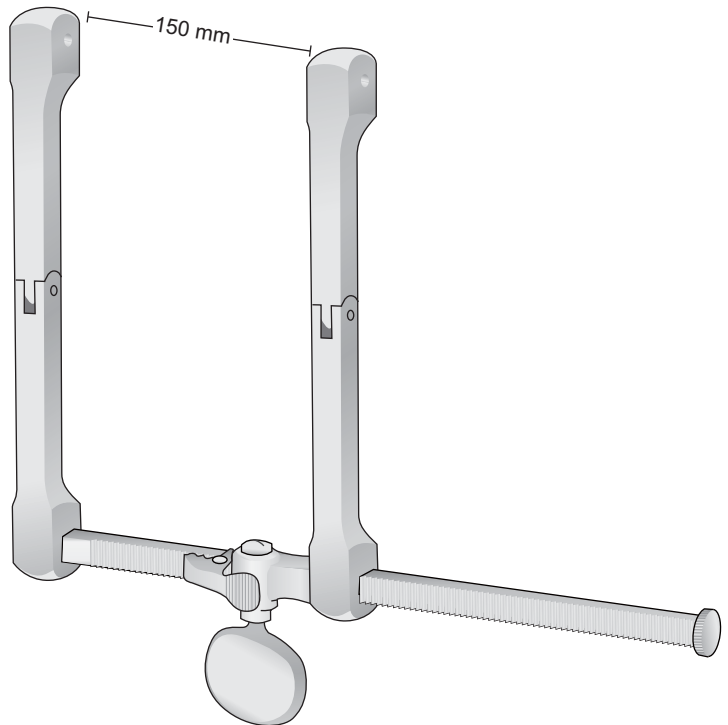

SCOVILLE-HAVERFIELD
0221-BGA

Laminektomiespreizer

Laminectomy retractors

Divaricatori per laminectomia

Separadores para laminectomia

Ecarteurs pour laminectomie

Spitz
Scharp
Acuto
Agudo
Pointù



SCOVILLE
0221-BGD
50 mm

Spitz
Scharp
Acuto
Agudo
Pointù

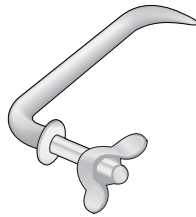

SCOVILLE
0221-BGE
70 mm

Stumpf
Blunt
Smusso
Romo
Mousse

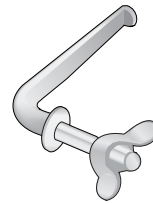

SCOVILLE
0221-BGF
50 mm

Stumpf
Blunt
Smusso
Romo
Mousse

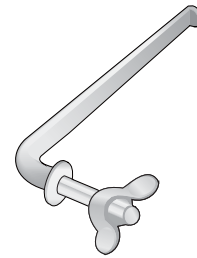

SCOVILLE
0221-BGG
70 mm

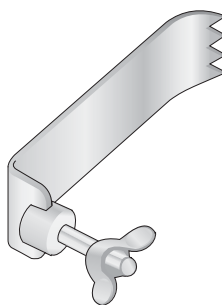

SCOVILLE
0221-BGH 50x25 mm
0221-BGI 50x50 mm
0221-BGL 57x38 mm
0221-BHA 64x25 mm
0221-BHB 64x50 mm
0221-BHC 67x30 mm
0221-BHD 75x25 mm
0221-BHE 75x50 mm
0221-BHF 88x25 mm
0221-BHG 100x50 mm

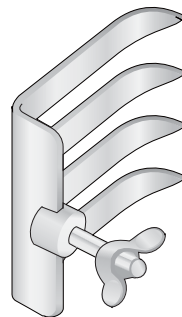

TAYLOR
0221-BHH 48x50 mm
0221-BHI 64x50 mm
0221-BHL 64x64 mm
0221-BIA 80x57 mm

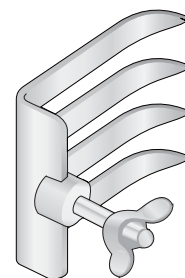

SCOVILLE
0221-BIB 41x38 mm
0221-BIC 67x44 mm

Wundspreizer für die
Lumbale Wirbelsäule

Retractors for lumbar
vertebral column

Divaricatori per
la colonna vertebrale

Separadores para
columna espinal

Ecarteurs pour
la colonne cervicale

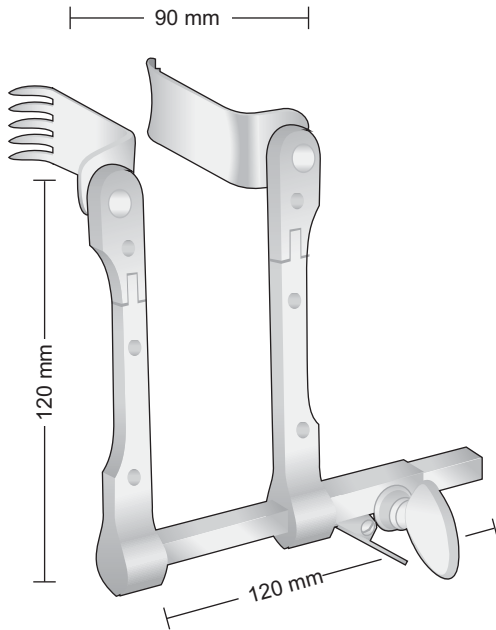

**CASPAR
0221-CFA**
Komplett mit 5 + 5 Blätter
Complete with 5 + 5 blade
Completo con 5 + 5 valve
Completo con 5 + 5 valvas
Complet avec 5 + 5 valves

0221-CEL
Sperrer allein
Retractor only
Divaricatore solo
Separador suelto
Ecarteur seul

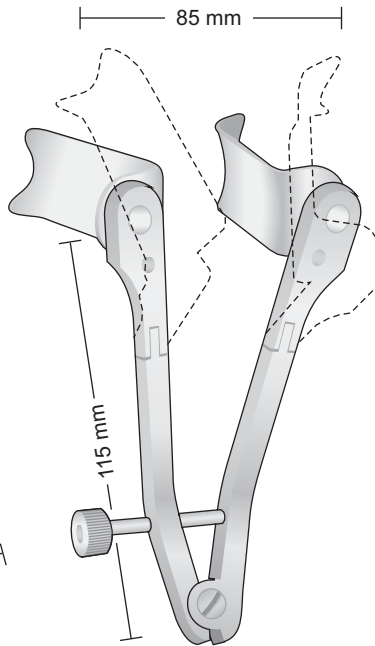

**CASPAR
0221-CHA**
Komplett mit 5 Blätter
Complete with 5 blade
Completo con 5 valve
Completo con 5 valvas
Complet avec 5 valves

0221-CGL
Sperrer allein
Retractor only
Divaricatore solo
Separador suelto
Ecarteur seul

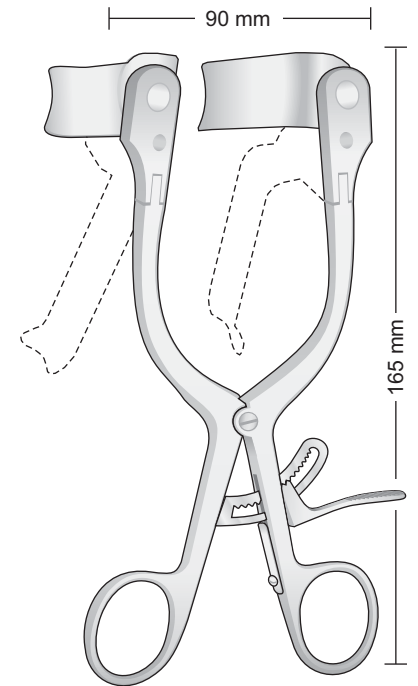

**CASPAR
0221-CIA**
Komplett mit 5 Blätter
Complete with 5 blade
Completo con 5 valve
Completo con 5 valvas
Complet avec 5 valves

0221-CHL
Sperrer allein
Retractor only
Divaricatore solo
Separador suelto
Ecarteur seul

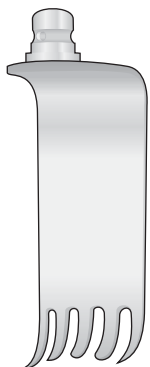

0221-CFB
40 x 23 mm
0221-CFC
45 x 23 mm
0221-CFD
50 x 23 mm
0221-CFE
55 x 23 mm
0221-CFF
60 x 23 mm



0221-CFG
40 x 23 mm
0221-CFH
45 x 23 mm
0221-CFI
50 x 23 mm
0221-CFL
55 x 23 mm
0221-CGA
60 x 23 mm



0221-CHB
45 x 23 mm
0221-CHC
50 x 23 mm
0221-CHD
55 x 23 mm
0221-CHE
60 x 23 mm
0221-CHF
65 x 23 mm

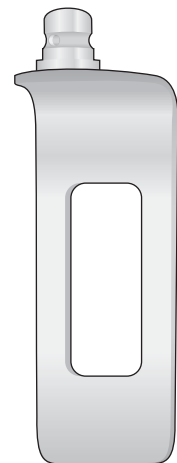

0221-CHG
50 x 25 mm
0221-CHH
60 x 25 mm

Wundspreizer für die
Lumbale Wirbelsäule

Retractors for lumbar
vertebral column

Divaricatori per
la colonna vertebrale

Separadores para
columna espinal

Ecarteurs pour
la colonne cervicale

Titan-valven
Titanium blades
Valve in titanio
Valvas in titanio
Valves en titane



0221-CIB19 25 x 24 mm
0221-CIC19 30 x 24 mm
0221-CID19 35 x 24 mm
0221-CIE19 40 x 24 mm
0221-CIF19 45 x 24 mm
0221-CIG19 25 x 24 mm
0221-CIH19 30 x 24 mm
0221-CII19 35 x 24 mm
0221-CIL19 40 x 24 mm
0221-CLA19 45 x 24 mm

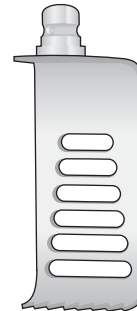

0221-CLB19 25 x 24 mm
0221-CLC19 30 x 24 mm
0221-CLD19 35 x 24 mm
0221-CLE19 40 x 24 mm
0221-CLF19 45 x 24 mm
0221-CLG19 50 x 24 mm
0221-CLH19 55 x 24 mm
0221-CLI19 60 x 24 mm
0221-CLL19 65 x 24 mm
0221-DAA19 70 x 24 mm



0221-DAB19 30 x 24 mm
0221-DAC19 35 x 24 mm
0221-DAD19 40 x 24 mm
0221-DAE19 45 x 24 mm
0221-DAF19 50 x 24 mm
0221-DAG19 55 x 24 mm
0221-DAH19 60 x 24 mm
0221-DAI19 65 x 24 mm
0221-DAL19 70 x 24 mm
0221-DBA19 75 x 24 mm

Pinzette zum wechseln der valven
mit kugelschnellverschluss
Blade ejector for changing the blades
with ball snap closure
Pinzetta per la sostituzione delle valve
con i bloccaggi rapidi a sfera
Pincas pour changer les valves munies
du système de verrouillage rapide à billes

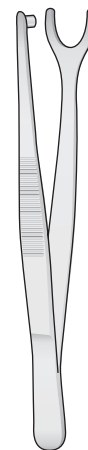

0221-CCL
115 mm

Wundspreizer zur
Mikrodissektomie

Retractors for
Micro-Lumbar Discectomy

Divaricatori per
microchirurgia lombare

Separadors para
micro chirurgia

Ecarteurs pour
Micro chirurgie

Oberfläche schwarz beschichtet
Surface black-coated

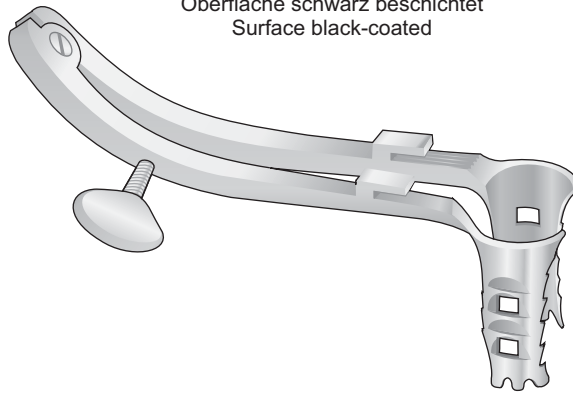

CASPAR
0221-CAB/0221-CAI

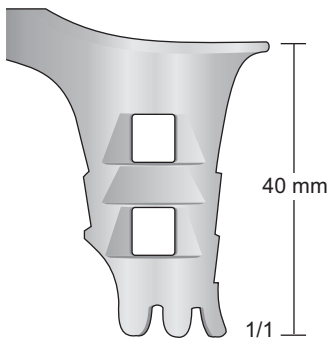

0221-CAB

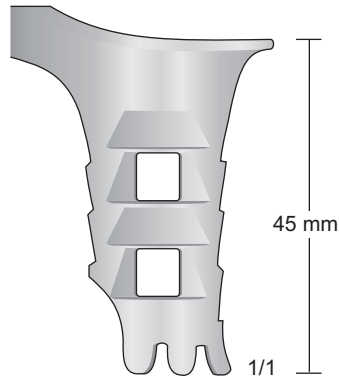

0221-CAC

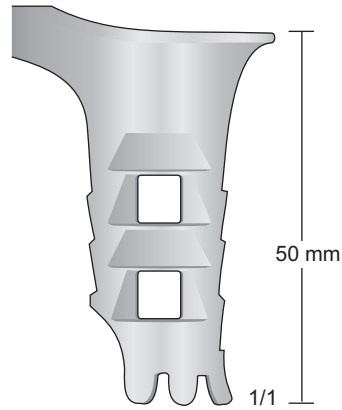

0221-CAD

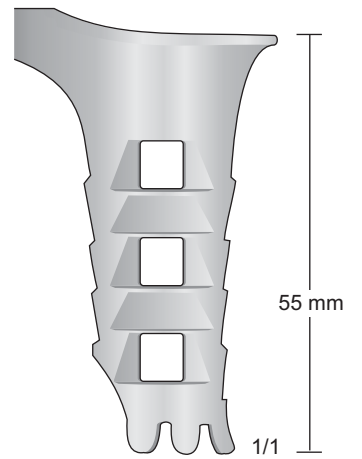

0221-CAE

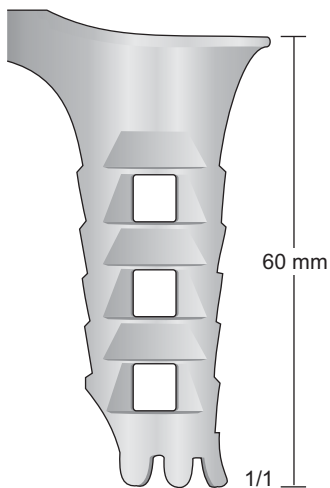

0221-CAF

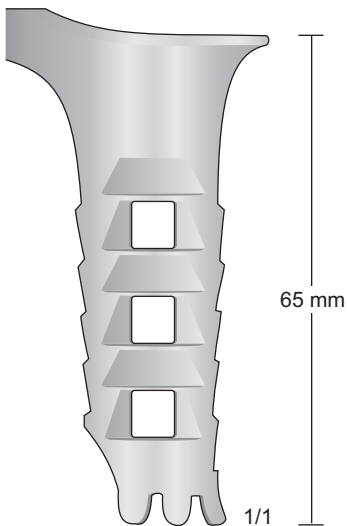

0221-CAG

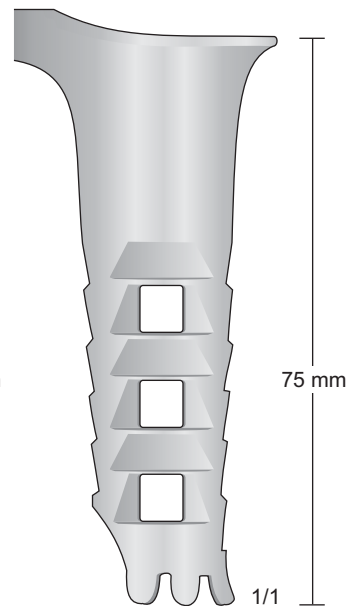

0221-CAH

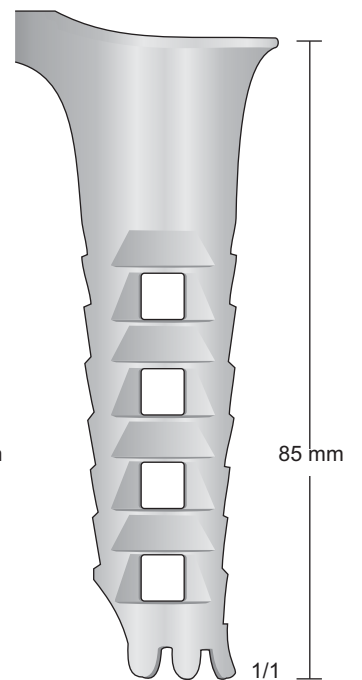

0221-CAI

Wundspreizer zur
Mikrodissektomie

Retractors for
Micro-Lumbar Discectomy

Divaricatori per
microchirurgia lombare

Separadors para
micro chirurgia

Ecarteurs pour
Micro chirurgie

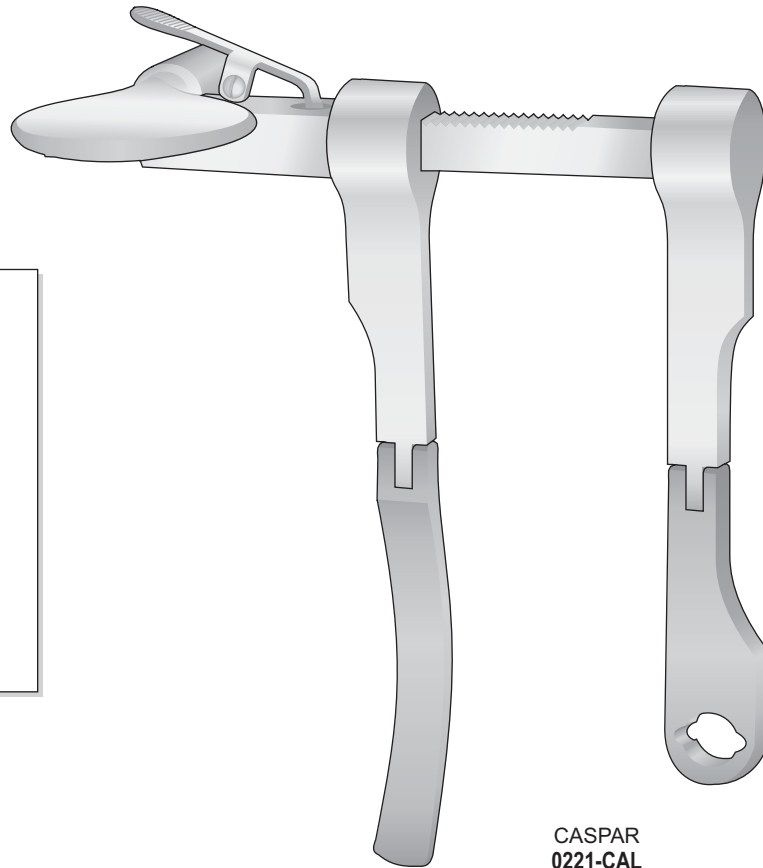

**CASPAR
0221-CBA**

Sperrer komplett mit
Retractor complete with
Divaricatore completo di
Separador completo con
Ecarteur complet avec

0221-CBB Valva anti-riflesso mm. 35
0221-CBC Valva anti-riflesso mm. 40
0221-CBD Valva anti-riflesso mm. 45
0221-CBE Valva anti-riflesso mm. 50
0221-CBF Valva anti-riflesso mm. 55
0221-CBG Valva anti-riflesso mm. 60

0221-CAL
Sperrer allein
Retractor only
Divaricatore solo
Separador suelto
Ecarteur seul

CASPAR
0221-CAL

Oberfläche schwarz Beschichtet
Surface Black-coated
Valve anti-riflesso
Surface noircie

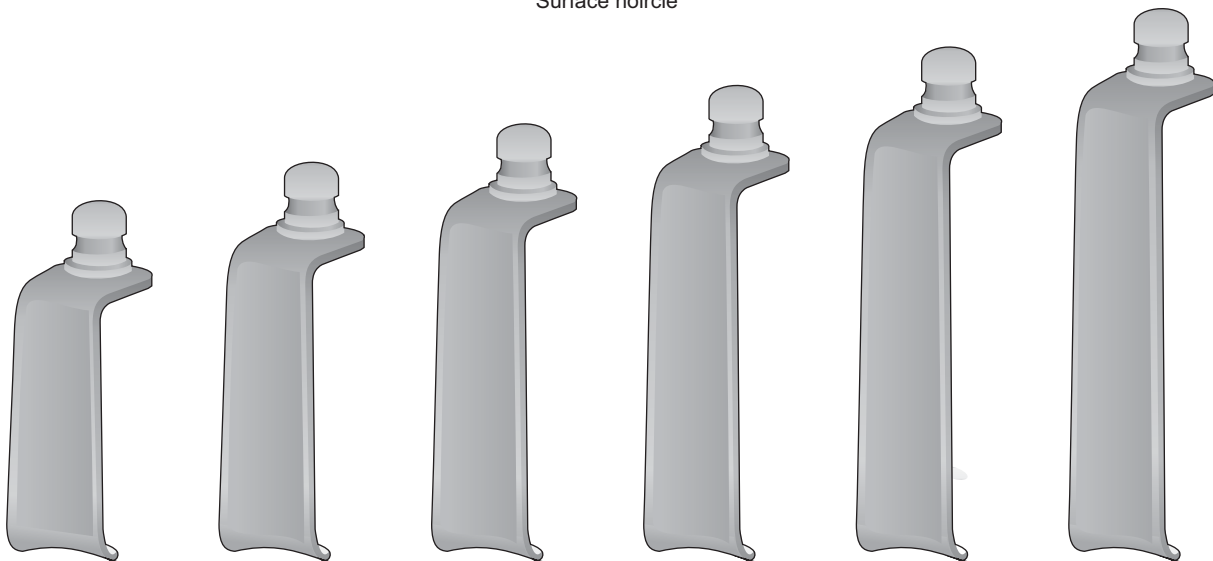

0221-CBB
35 mm

0221-CBC
40 mm

0221-CBD
45 mm

0221-CBE
50 mm

0221-CBF
55 mm

0221-CBG
60 mm

CASPAR
0606-BLA
 Distraktor komplett rechts
 Distractor complete right
 Distrattore completo destro
0606-BLB 1 Distraktor allein - 1 Distractor only
0606-BLC 1 Bohrbüchse - 1 Drilling Guide
0606-CAD 1 Spezialbohrer - 1 Special Drill
0606-CAF 2 Distraktionsschrauben - 2 Distraction Screws
0606-CAG 1 Schraubendreher - 1 Screw Driver

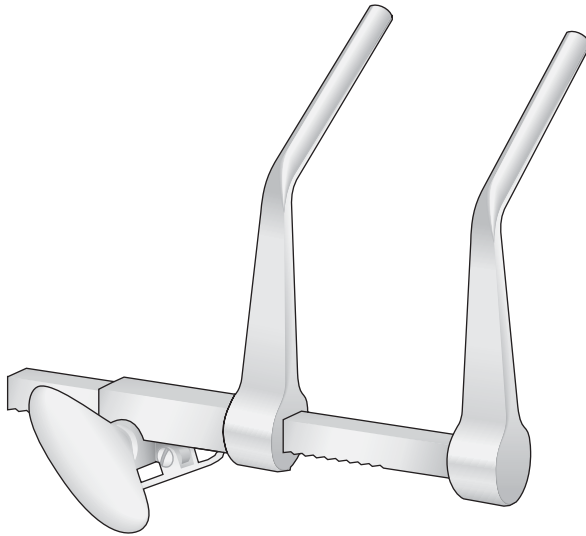

CASPAR
0606-BLB
 Distrattore destro, solo

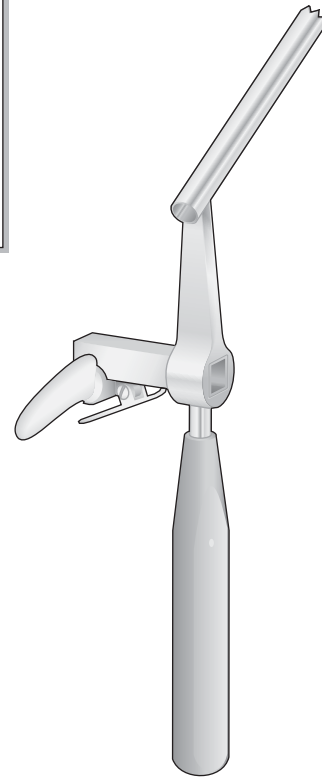

0606-BLC
 Guida punte destro, solo

CASPAR
0606-CAA
 Distraktor komplett links
 Distractor complete left
 Distrattore completo sinistro
0606-CAB 1 Distraktor allein - 1 Distractor only
0606-CAC 1 Bohrbüchse - 1 Drilling Guide
0606-CAD 1 Spezialbohrer - 1 Special Drill
0606-CAF 2 Distraktionsschrauben - 2 Distraction Screws
0606-CAG 1 Schraubendreher - 1 Screw Driver

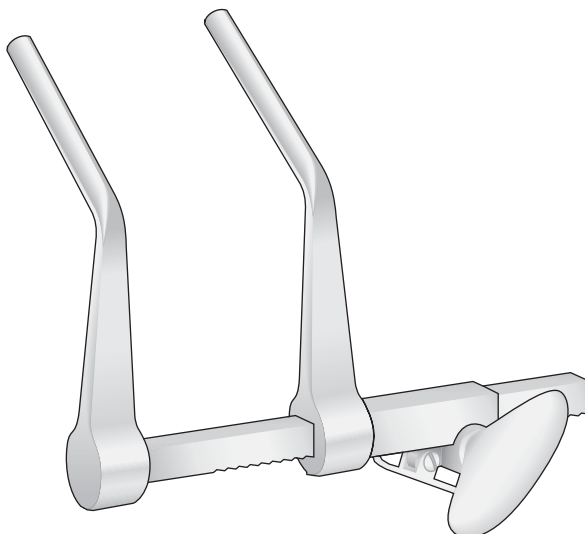

CASPAR
0606-CAB
 Distrattore sinistro, solo

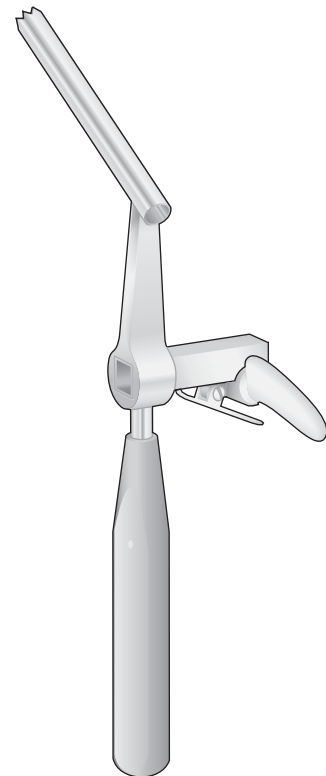

0606-CAC
 Guida punte sinistro, solo

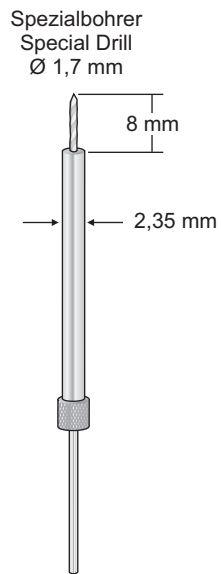

CASPAR
0606-CAD
145 mm

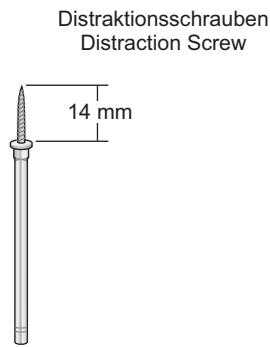

CASPAR
0606-CAE
70 mm

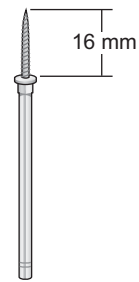

CASPAR
0606-CAF
70 mm

Schraubendreher
Screw Driver



CASPAR
0606-CAG
200 mm

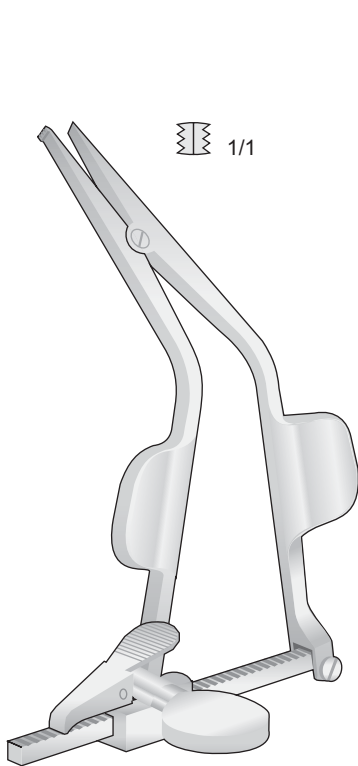

CLOWARD
0221-IG
150 mm

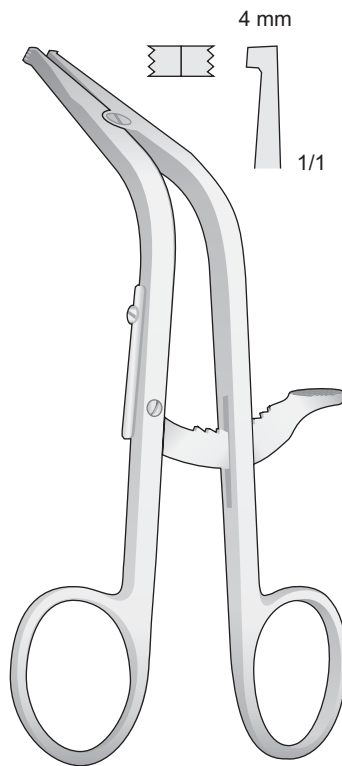

CLOWARD
0221-IE
160 mm

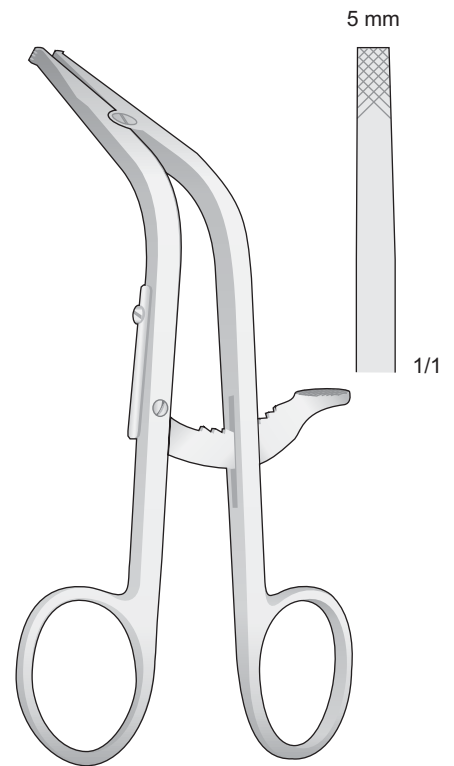

CLOWARD
0221-IF
160 mm

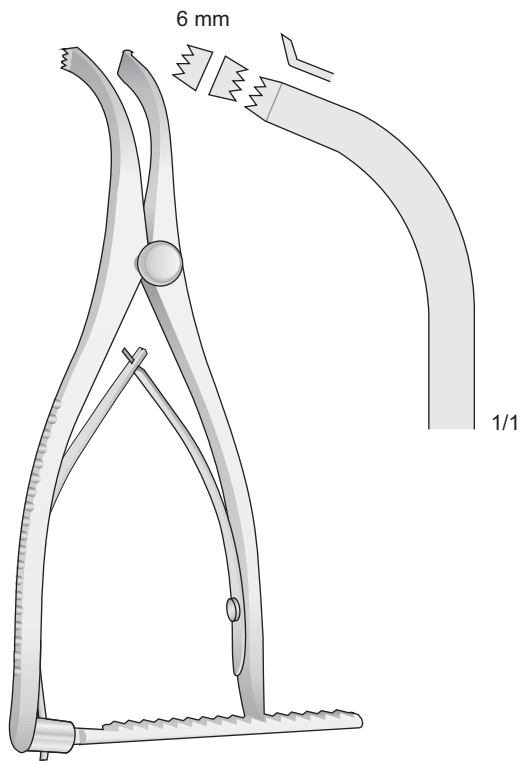

INGE
0221-IA
160 mm

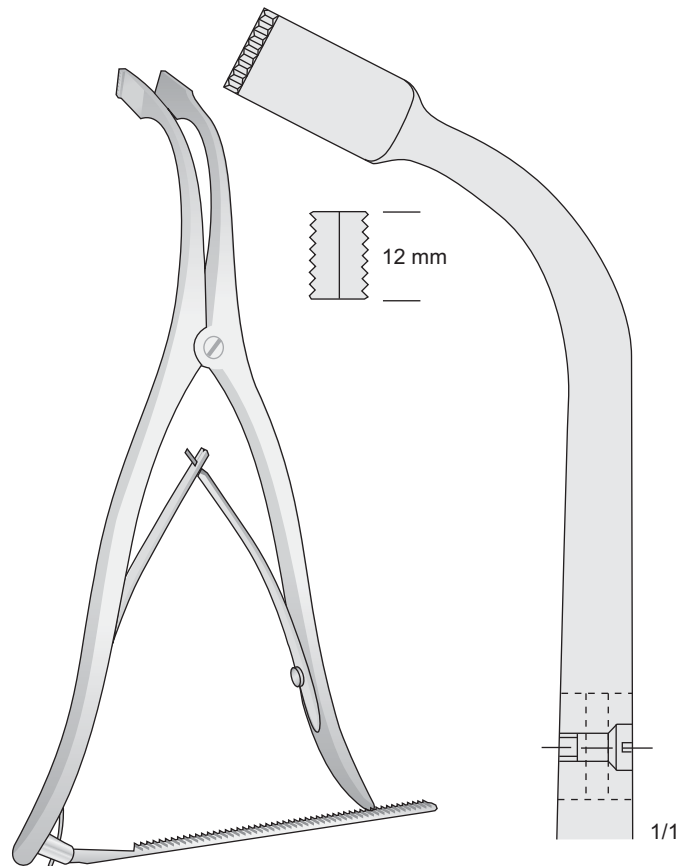

INGE
0221-IC
275 mm



1102-DGB
Conf. 10 pz.



1102-DGC
Conf. 10 pz.



1102-DGD
Conf. 1 pz.



1102-DGE
Conf. 10 pz.



1102-DGF
Conf. 10 pz.

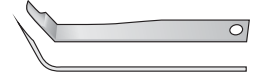

1102-DGG
Conf. 1 pz.



1102-DGH
Conf. 10 pz.



1102-DGI
Conf. 10 pz.



1102-DGL
Conf. 1 pz.



1310-B
100 mm



1310-C
150 mm



0202-EG
135 mm



0202-EI - 155 mm
0202-FA - 180 mm
0202-FC - 200 mm



CASPAR
0202-FA



0202-FC

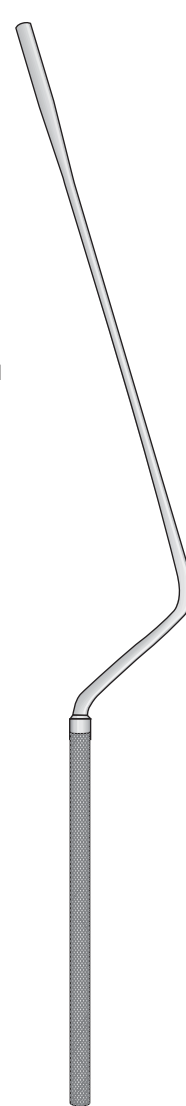

LANDOLT
0202-DI
250 mm



LANDOLT
0202-EA
210 mm

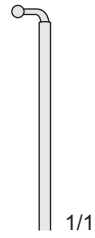

0219-DAA

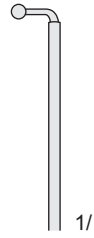

0219-DAB

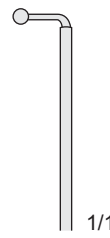

0219-DAC

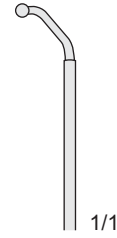

0219-DAD



CASPAR
0219-DAA/0219-DAD
245 mm

Mikro-Dissektoren

Micro Dissectors

Micro Dissettori

Micro Disecadores

Micro Dissecteurs



4,5 mm

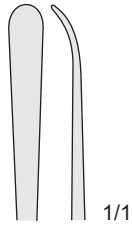

CASPAR
0606-DAB
230 mm

1 mm

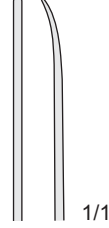

CASPAR
0606-DAC
200 mm

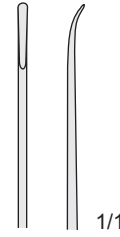

0606-DAD
230 mm

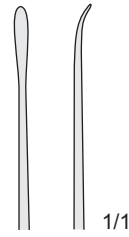

0606-DAE
230 mm

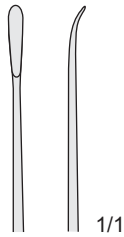

0606-DAF
230 mm

3 mm



0606-DAG
185 mm

3 mm

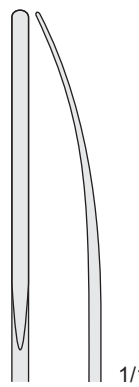

0606-DAH
215 mm

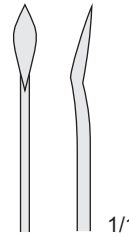

YASARGIL
0606-DAI
185 mm

0606-DAB/0606-DAI

Mikro-Dissektoren

Micro Dissectors

Micro Dissettori

Micro Discadores

Micro Dissecteurs

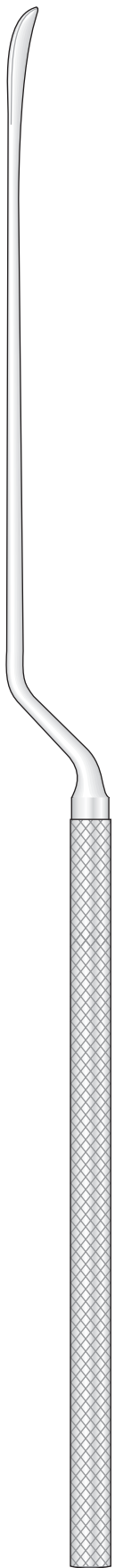

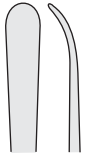
4,5 mm

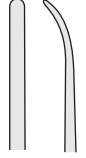
1/1
CASPAR
0606-DAL
230 mm

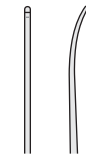
2 mm

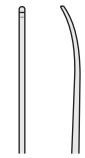
1/1
CASPAR
0606-DBA
230 mm

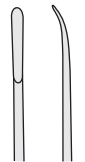
1 mm

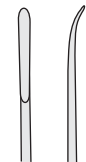
1/1
CASPAR
0606-DBB
210 mm

1 mm

1/1
CASPAR
0606-DBC
210 mm

1/1
0606-DBD
230 mm

1/1
0606-DBE
230 mm

0606-DAL/0606-DBE

Wundhaken

Retractors

Divaricatori

Separadores

Ecarteurs

Diritto



LOVE
0414-FG
210 mm

45°

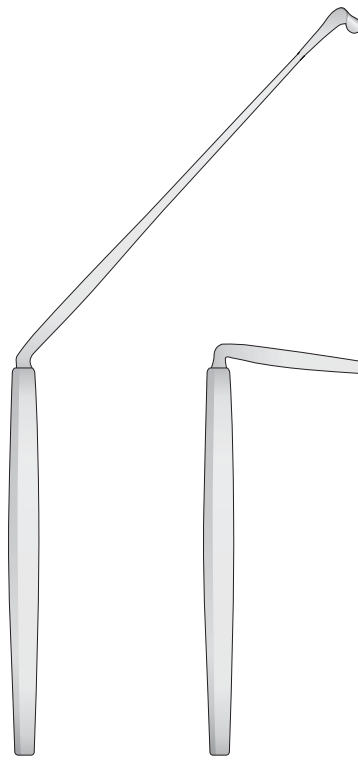

LOVE
0414-FH

90°

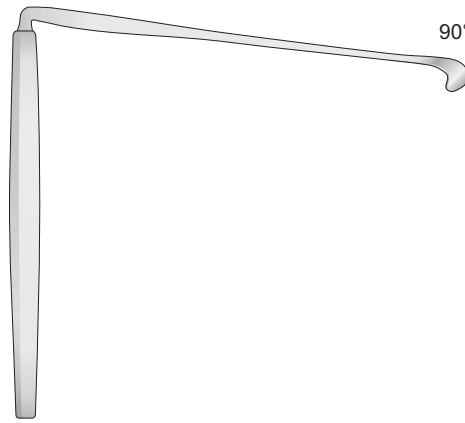

LOVE
0414-FI

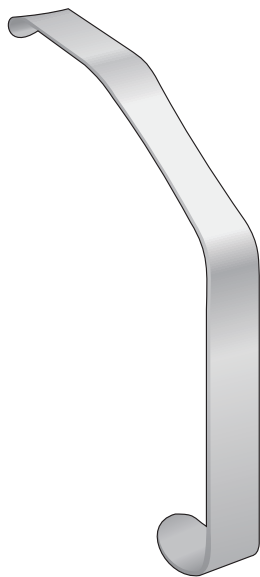

LOVE
0414-CBD - 18 mm
0414-CBE - 20 mm
0414-CBF - 22 mm
150 mm



LOVE
0414-BHE
210 mm

1/1

Nervwurzel
-haken

Nerve Root
Retractors

Retrattori
da radice

Separadores de
raiz de nervios

Retractors pour
racines nerveuses

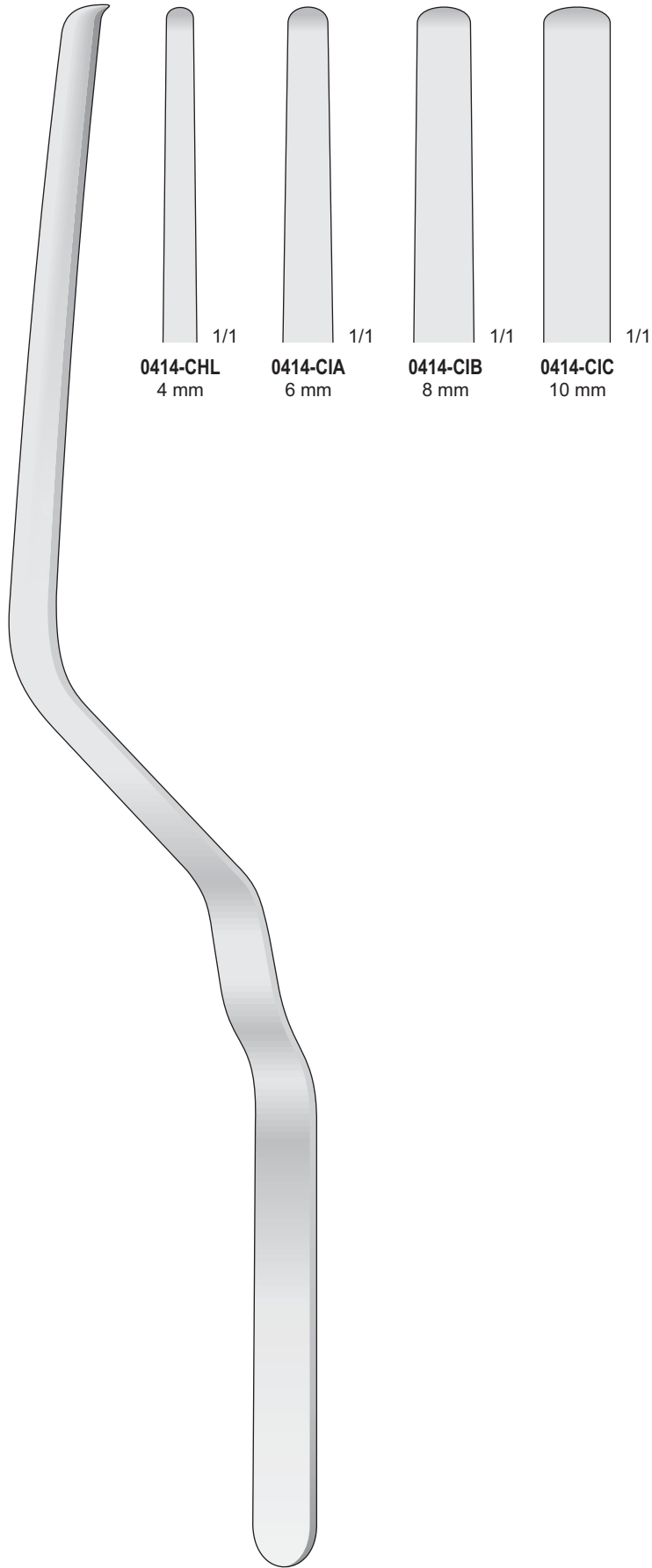

0414-CHL
4 mm

1/1

0414-CIA
6 mm

1/1

0414-CIB
8 mm

1/1

0414-CIC
10 mm

1/1

0414-CHL/0414-CIC
240 mm

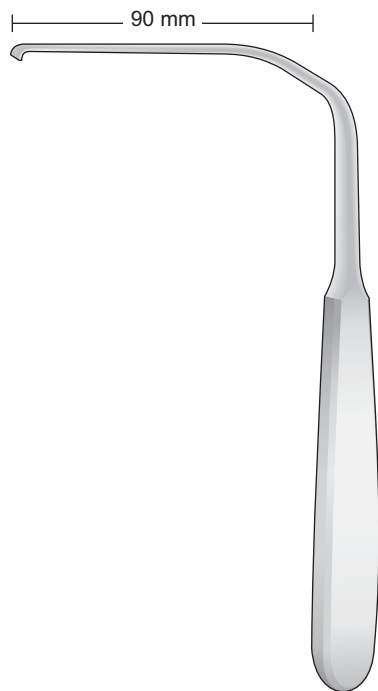
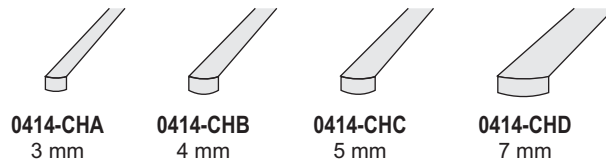

HESS
0414-CHA/0414-CHD
175 mm

Char. 6	= 2 mm
Char 7	= 2,5 mm
Char 8	= 2,7 mm
Char 9	= 3 mm
Char 10	= 3,3 mm
Char 12	= 4 mm
Char 15	= 5 mm

Isoliert

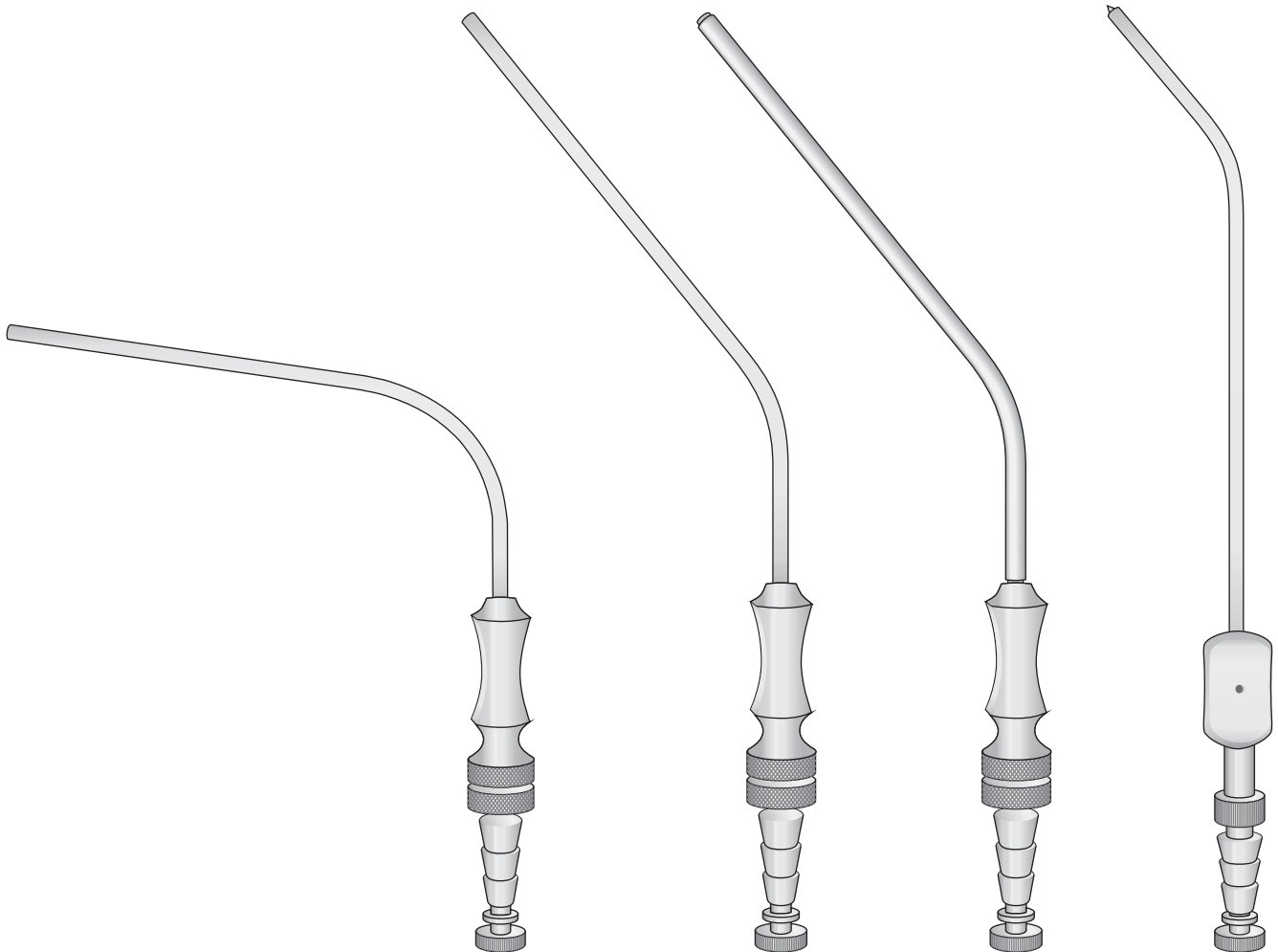

FERGUSON

0706-BEA	Ch. 6	2,0 mm
0706-BEB	Ch. 7	2,5 mm
0706-BEC	Ch. 9	3,0 mm
0706-BEC02	Ch. 10	3,3 mm
0706-BED	Ch. 12	4,0 mm
0706-BEE	Ch. 15	5,0 mm
	180 mm	

FRAZIER

0706-CEA	Ch. 6	2,0 mm
0706-CEB	Ch. 7	2,5 mm
0706-CEB02	Ch. 8	2,7 mm
0706-CEC	Ch. 9	3,0 mm
0706-CEC02	Ch. 10	3,3 mm
0706-CED	Ch. 12	4,0 mm
0706-CEE	Ch. 15	5,0 mm
	180 mm	

FRAZIER

0706-CFC	Ch. 12	180 mm
-----------------	--------	--------

PLESTER

0706-BFA	Ch. 6	2,0 mm
0706-BFB	Ch. 7	2,5 mm
0706-BFB02	Ch. 8	2,7 mm
0706-BFC	Ch. 9	3,0 mm
0706-BFC02	Ch. 10	3,3 mm
0706-BFD	Ch. 12	4,0 mm
0706-BFE	Ch. 15	5,0 mm
	200 mm	



1,5 mm □ 1/1 0402-BHH	2,0 mm □ 1/1 0402-BHI	2,2 mm □ 1/1 0402-BHL	2,5 mm □ 1/1 0402-BIA
3,0 mm □ 1/1 0402-BIB	3,5 mm □ 1/1 0402-BIC	4,0 mm □ 1/1 0402-BID	

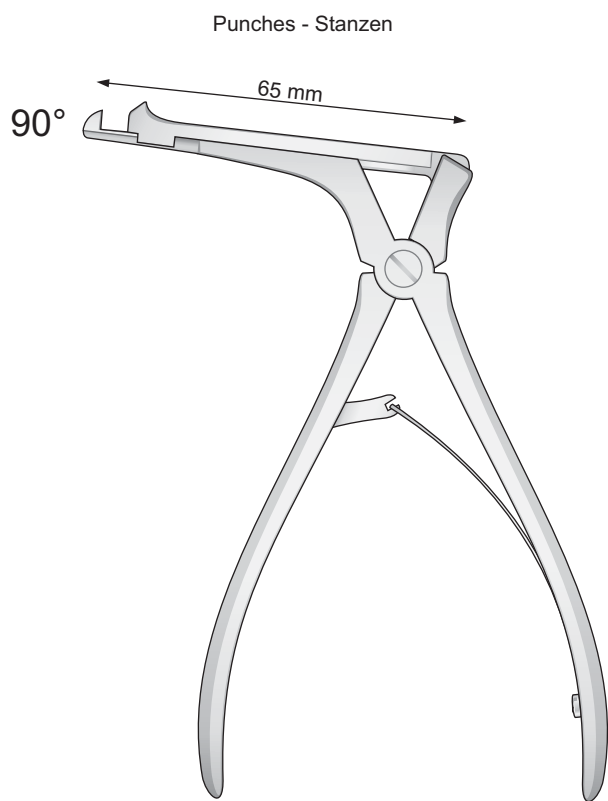

- 0402-BHH** 1,5 mm
- 0402-BHI** 2,0 mm
- 0402-BHL** 2,2 mm
- 0402-BIA** 2,5 mm
- 0402-BIB** 3,0 mm
- 0402-BIC** 3,5 mm
- 0402-BID** 4,0 mm

CITELLI
0402-BHH/0402-BID

Punches - Stanzen

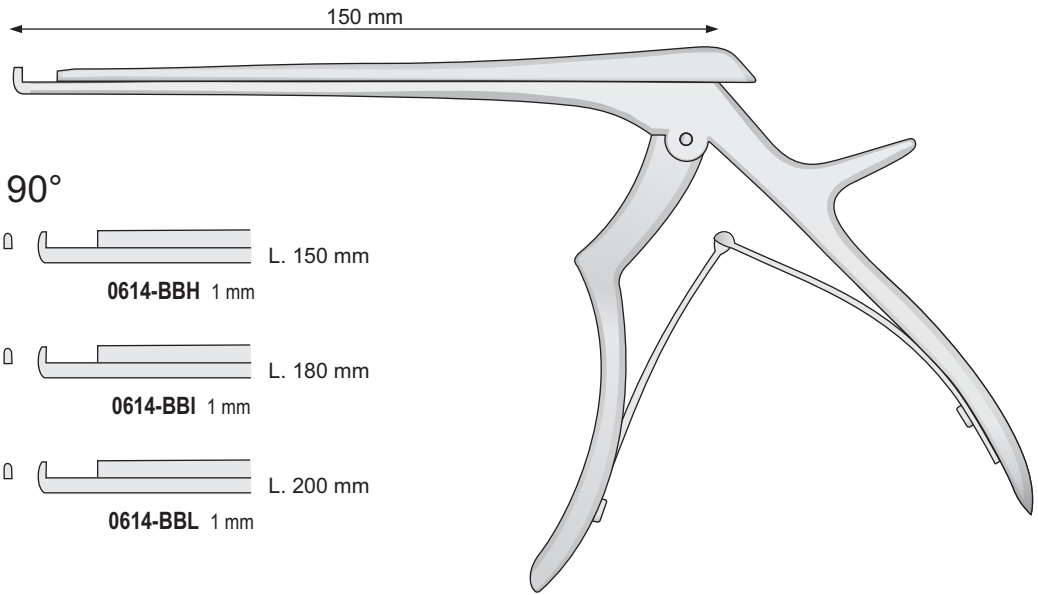

FERRIS-SMITH-KERRISON
0614-BBH/0614-BBL

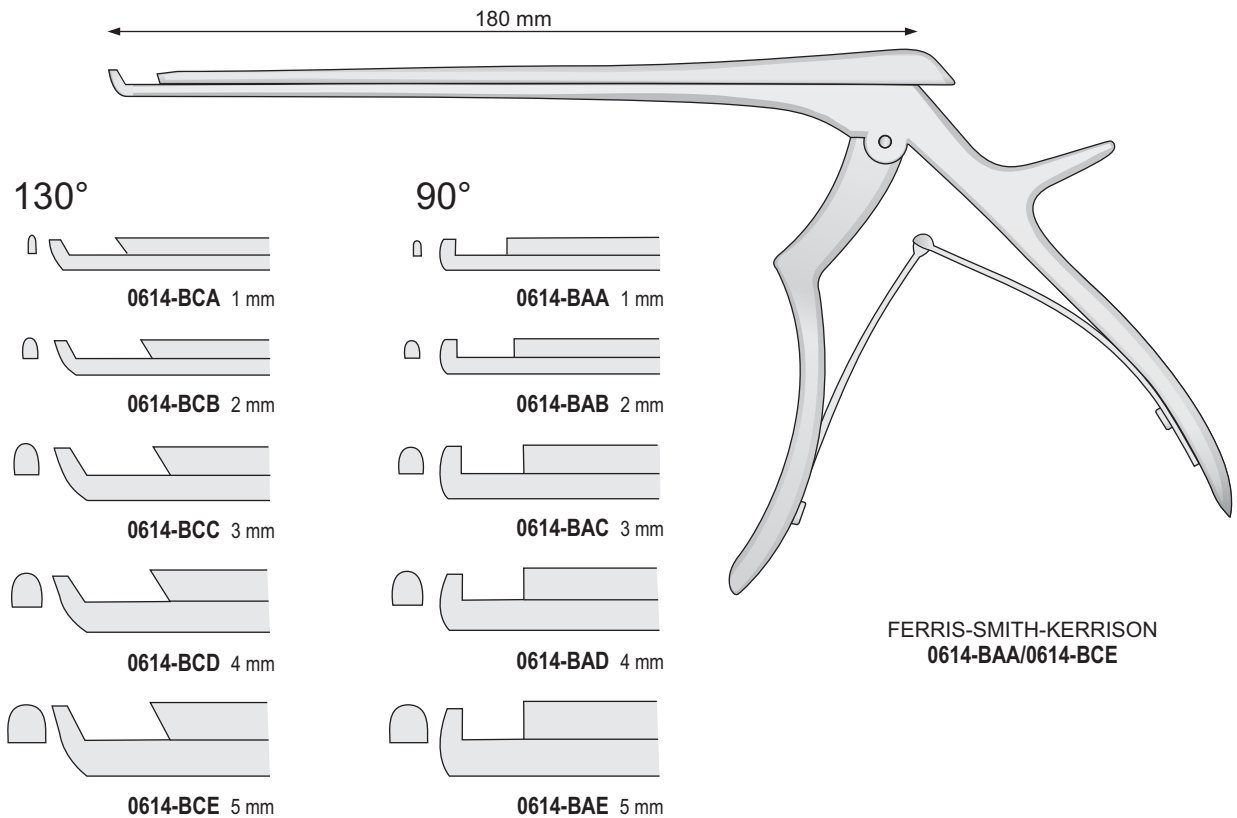

FERRIS-SMITH-KERRISON
0614-BAA/0614-BCE

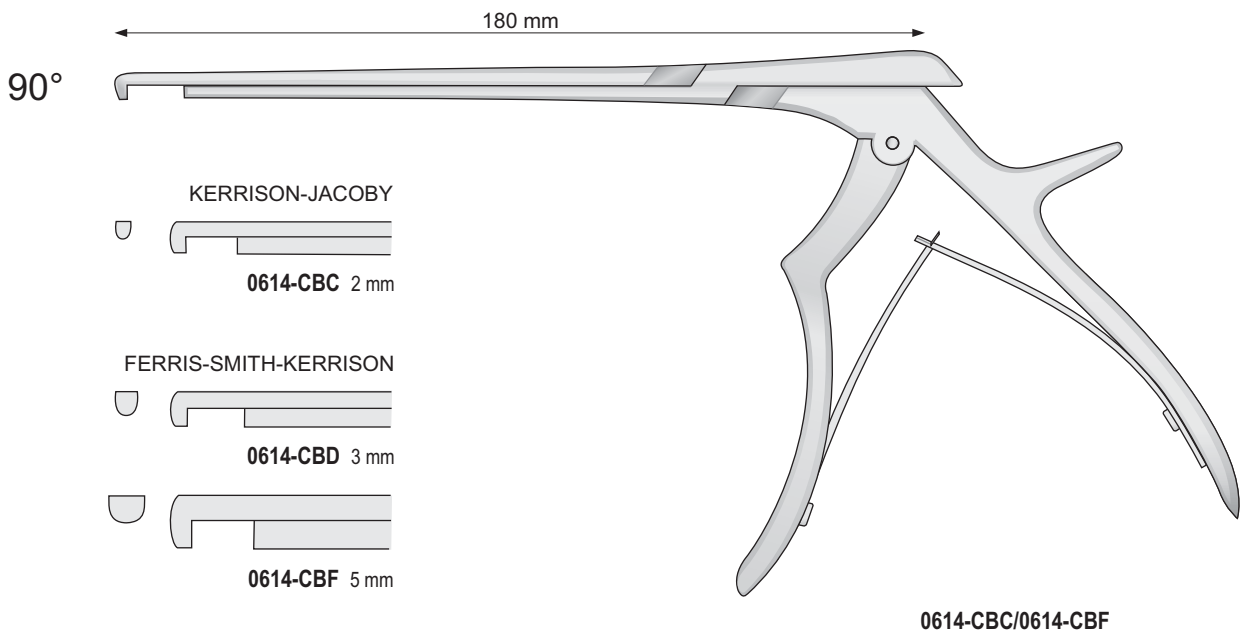
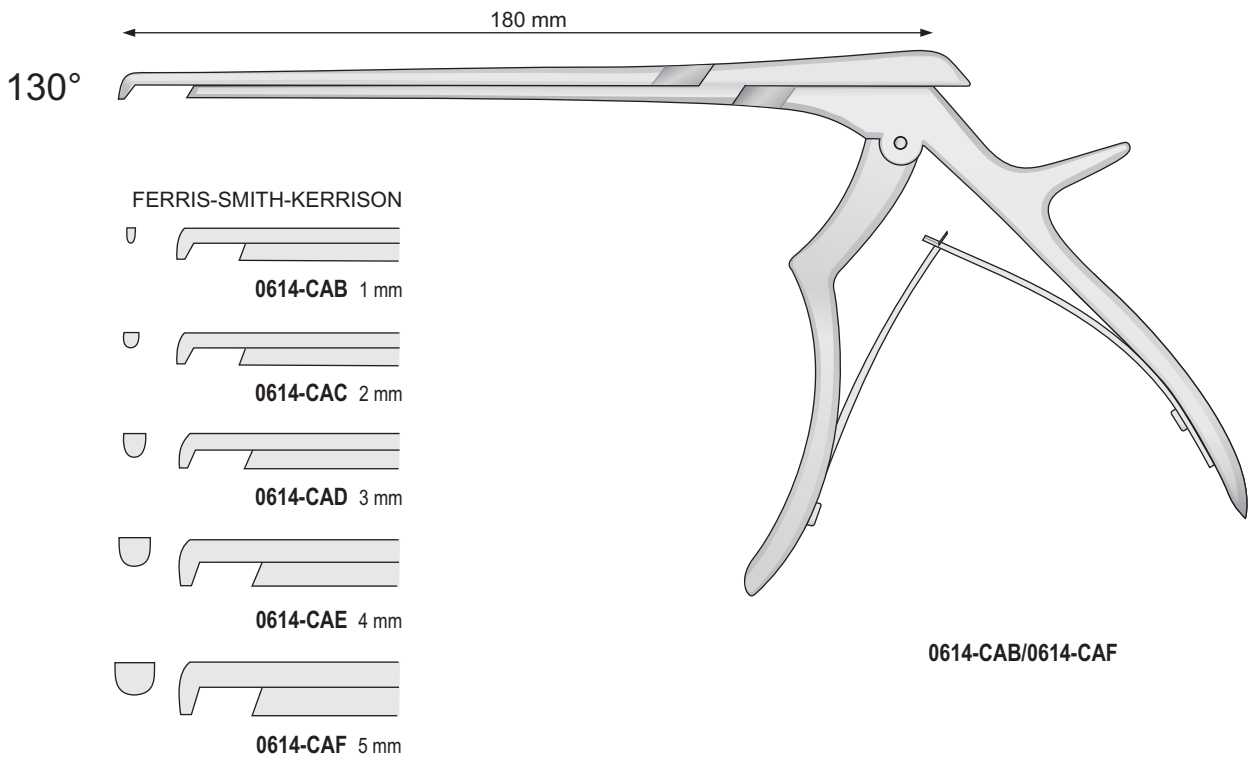

Laminektomie

Laminectomy

Laminectomia

Laminectomia

Laminectomie

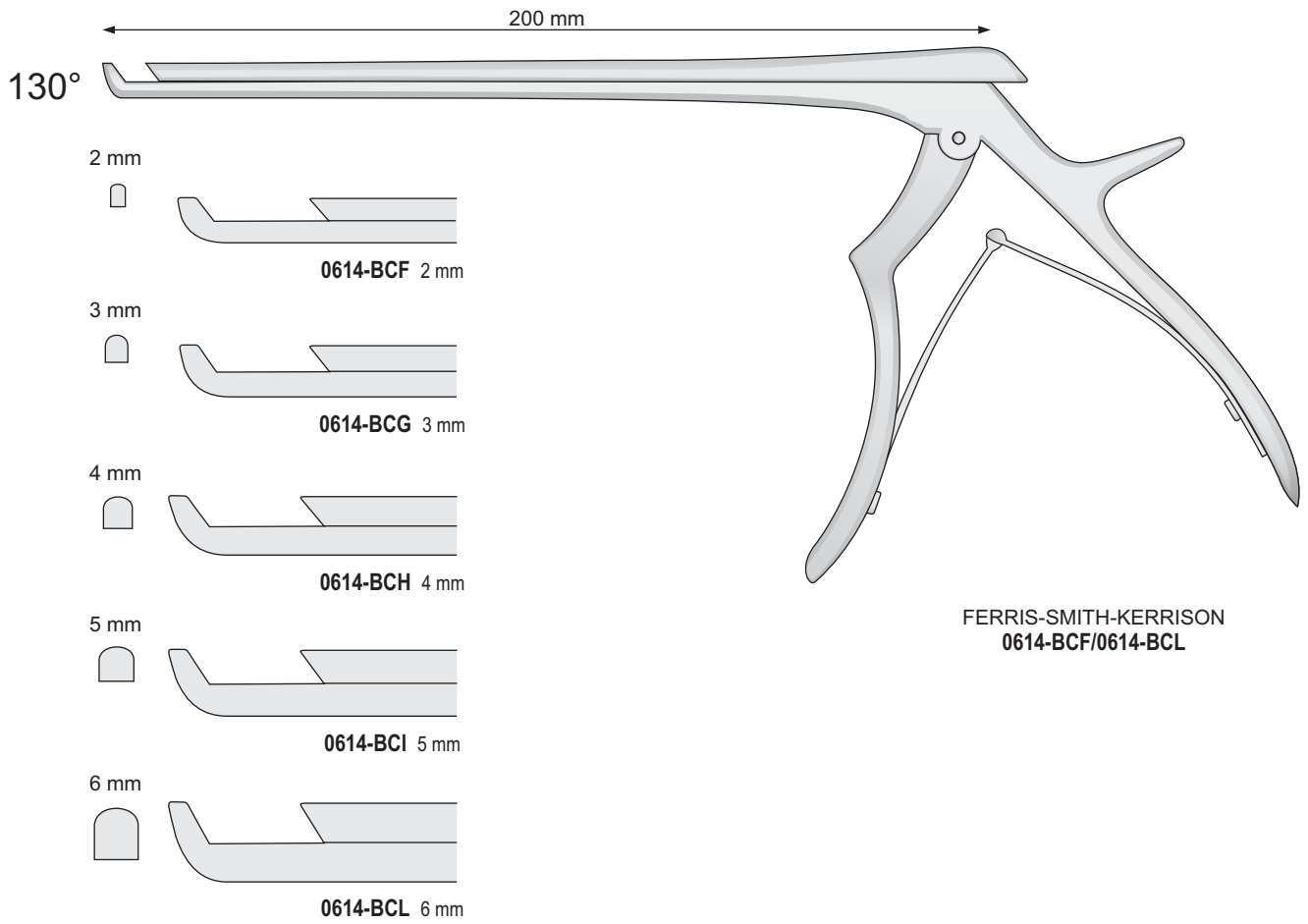

Laminotomo cervicale - Cervical Laminectomy

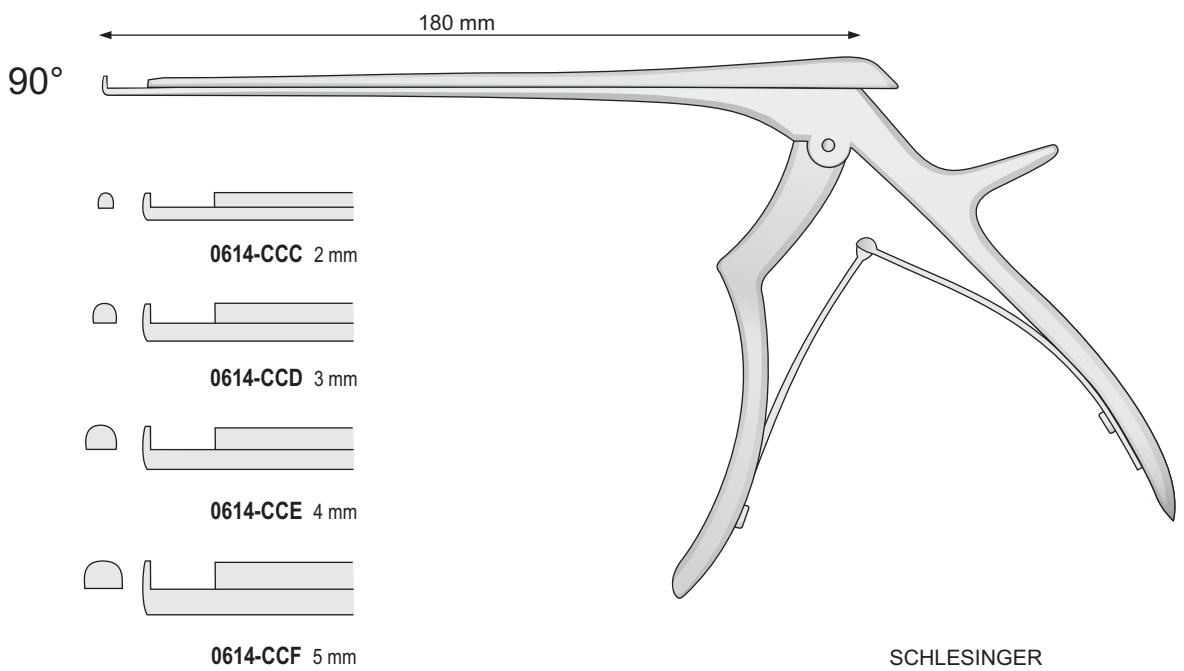

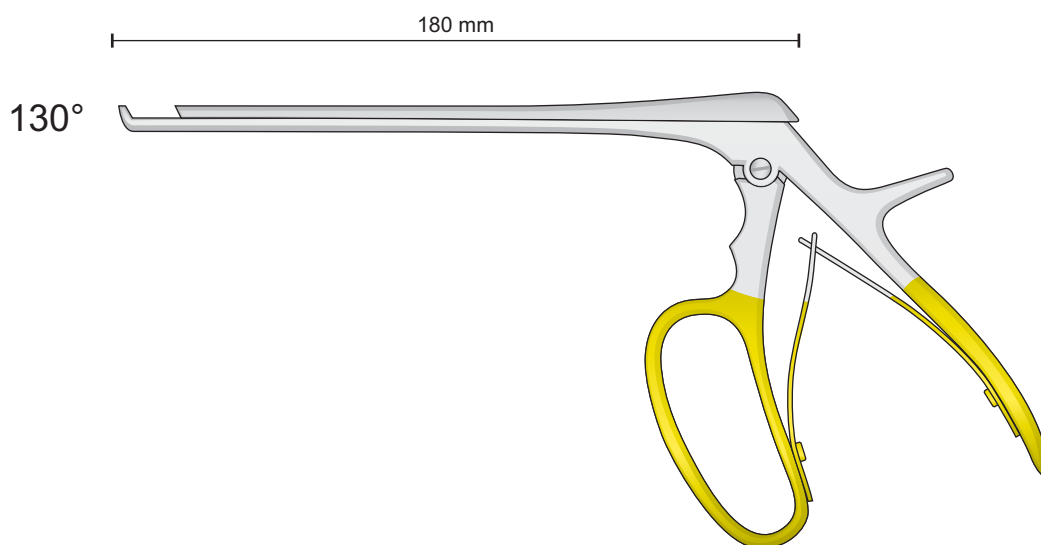
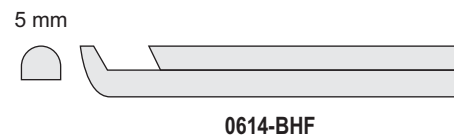
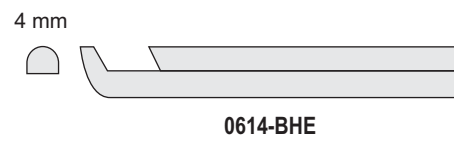
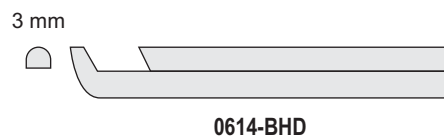
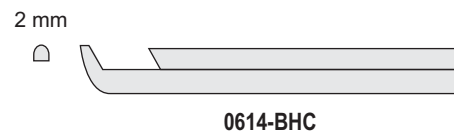
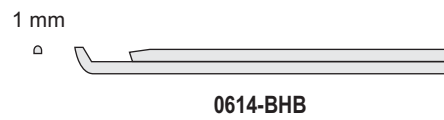

FERRIS - SMITH - KERRISON
0614-BHB/0614-BHF

Gerade
Straight
Diritta
Rectas
Droites

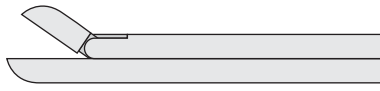

0614-BIA 2 x 10 mm

0614-BIB 3 x 10 mm

0614-BIC 4 x 10 mm

0614-BID 6 x 12 mm

Aufwärtsgebogen
Top curved
Curva verso l'alto
Curvos
Courbe vers le haut

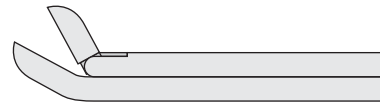

0614-BIE 2 x 10 mm

0614-BIF 3 x 10 mm

0614-BIG 4 x 10 mm

Abwärts gebogen
Bottom curved
Curva verso il basso
Curvos
Courbe vers le bas

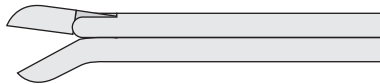

0614-BIH 2 x 10 mm

0614-BII 3 x 10 mm

0614-BIL 4 x 10 mm

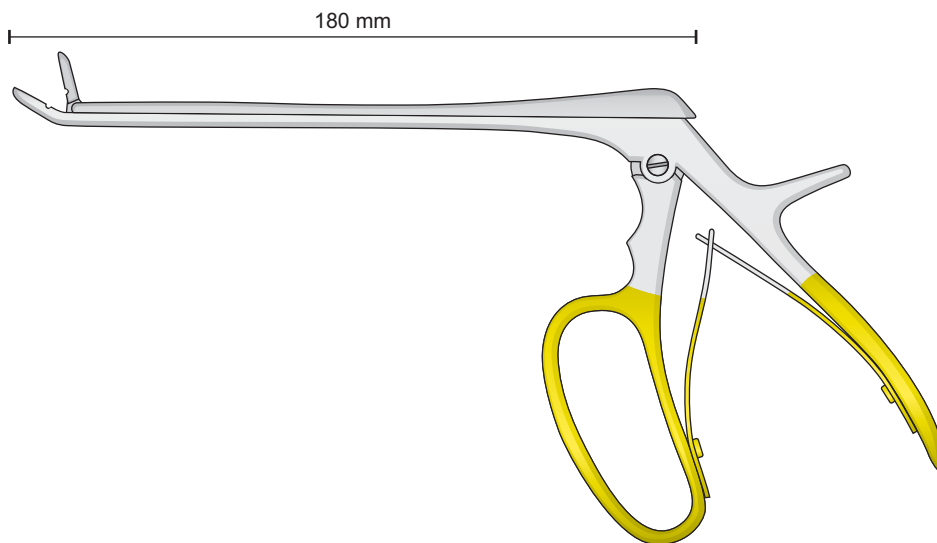

FERRIS - SMITH - CUSHING
0614-BIA/0614-BIL

Laminectomy
Rongeurs

Laminectomy
rongeurs

Pinze
per biopsia

Pinzas cortantes
para laminectomia

Pincas a
laminectomia

Gerade
Straight
Diritta
Rectas
Droites

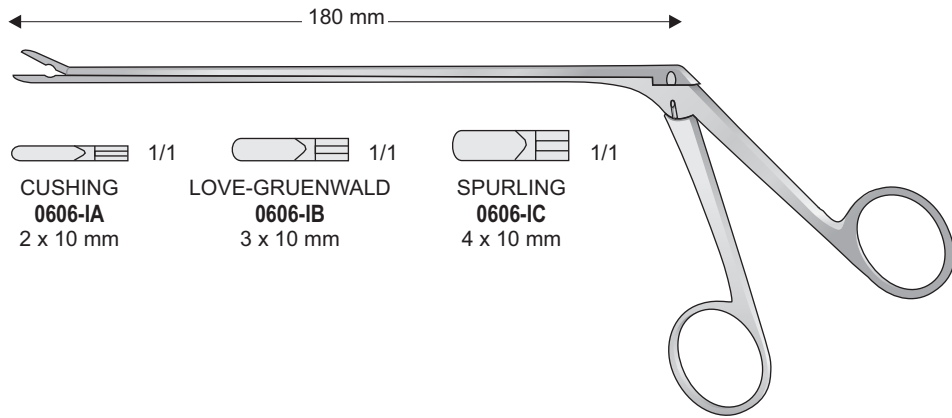

CUSHING 0606-IA 2 x 10 mm
LOVE-GRUENWALD 0606-IB 3 x 10 mm
SPURLING 0606-IC 4 x 10 mm

0606-IA/0606-IC

Aufwärtsgebogen
Top curved
Curva verso l'alto
Curvos
Courbe vers le haut

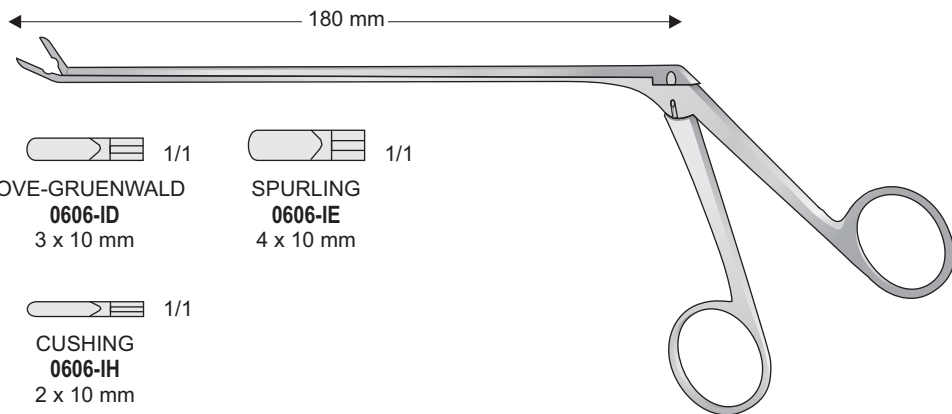

LOVE-GRUENWALD 0606-ID 3 x 10 mm
SPURLING 0606-IE 4 x 10 mm
CUSHING 0606-IH 2 x 10 mm

0606-ID/0606-IH

Abwärts gebogen
Bottom curved
Curva verso il basso
Curvos
Courbe vers le bas

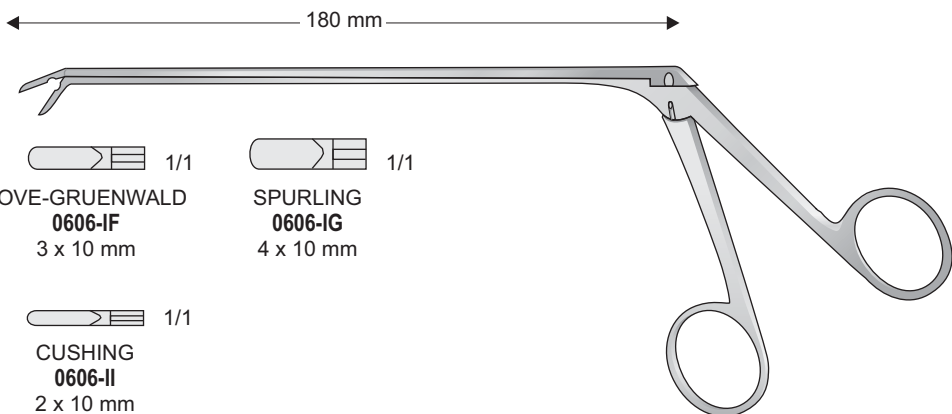

LOVE-GRUENWALD 0606-IF 3 x 10 mm
SPURLING 0606-IG 4 x 10 mm
CUSHING 0606-II 2 x 10 mm

0606-IF/0606-II

Laminectomy
Rongeurs

Laminectomy
rongeurs

Pinze
per biopsia

Pinzas cortantes
para laminectomia

Pinces a
laminectomia

Gerade
Straight
Diritta
Rectas
Droites

155 mm

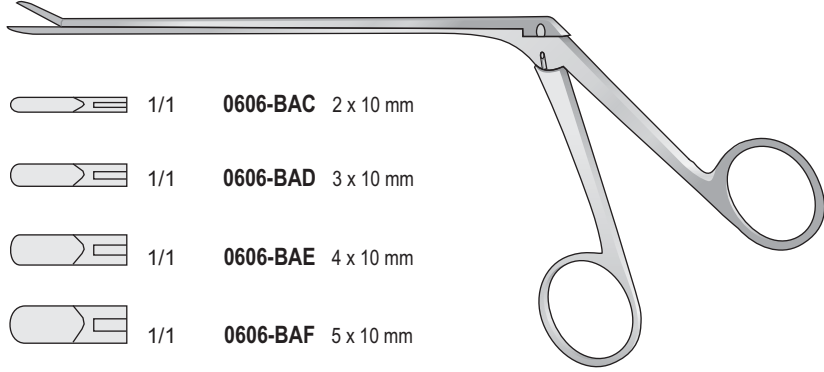

1/1 **0606-BAC** 2 x 10 mm

1/1 **0606-BAD** 3 x 10 mm

1/1 **0606-BAE** 4 x 10 mm

1/1 **0606-BAF** 5 x 10 mm

CASPAR
0606-BAC/0606-BAF

Aufwärtsgebogen
Top curved
Curva verso l'alto
Curvos
Courbe vers le haut

155 mm

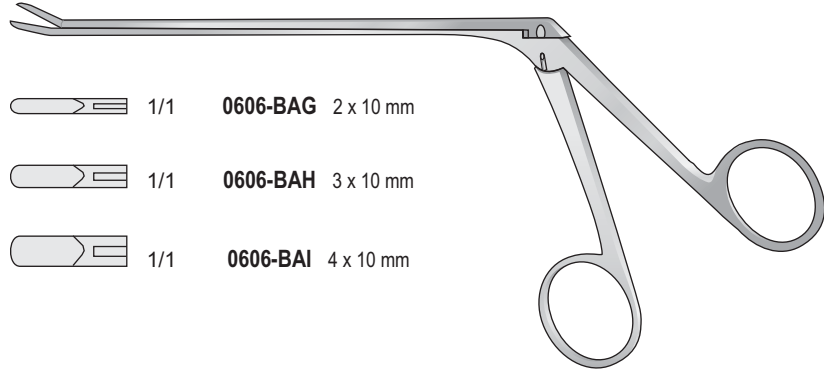

1/1 **0606-BAG** 2 x 10 mm

1/1 **0606-BAH** 3 x 10 mm

1/1 **0606-BAI** 4 x 10 mm

CASPAR
0606-BAG/0606-BAI

Abwärts gebogen
Bottom curved
Curva verso il basso
Curvos
Courbe vers le bas

155 mm

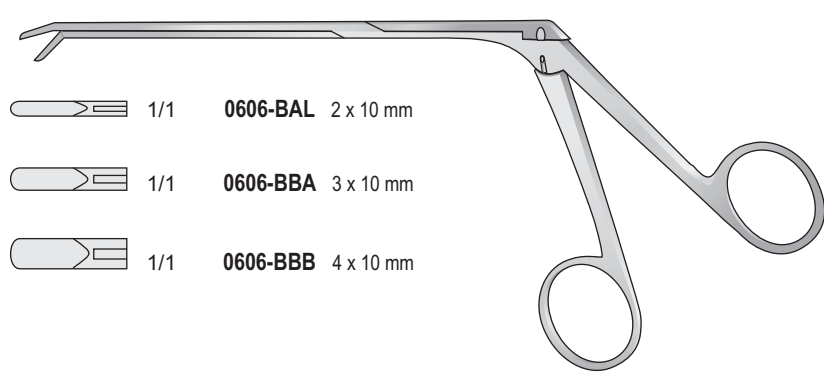

1/1 **0606-BAL** 2 x 10 mm

1/1 **0606-BBA** 3 x 10 mm

1/1 **0606-BBB** 4 x 10 mm

CASPAR
0606-BAL/0606-BBB

**Laminectomy
Rongeurs**

**Laminectomy
rongeurs**

**Pinze
per biopsia**

**Pinzas cortantes
para laminectomia**

**Pincas a
laminectomia**

Gerade
Straight
Diritta
Rectas
Droites

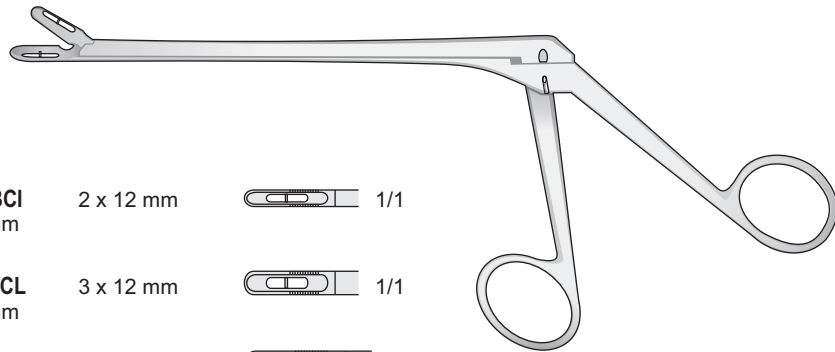

CASPAR

0606-BCA 140 mm	0606-BCD 160 mm	0606-BCI 185 mm	2 x 12 mm		1/1
0606-BCB 140 mm	0606-BCE 160 mm	0606-BCL 185 mm	3 x 12 mm		1/1
0606-BCC 140 mm	0606-BCF 160 mm	0606-BDA 185 mm	4 x 14 mm		1/1
	0606-BCG 160 mm	0606-BDB 185 mm	5 x 14 mm		1/1
	0606-BCH 160 mm	0606-BDC 185 mm	6 x 16 mm		1/1

CASPAR
0606-BCA/0606-BDC

Aufwärtsgebogen
Top curved
Curva verso l'alto
Curvos
Courbe vers le haut

150°

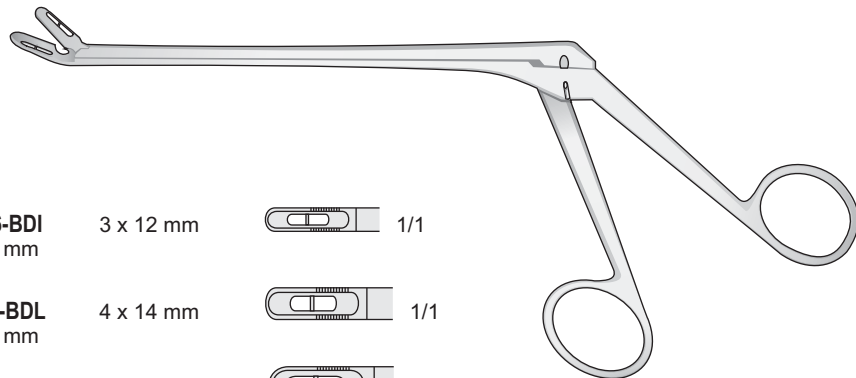

CASPAR

0606-BDD 140 mm	0606-BDF 160 mm	0606-BDI 185 mm	3 x 12 mm		1/1
0606-BDE 140 mm	0606-BDG 160 mm	0606-BDL 185 mm	4 x 14 mm		1/1
	0606-BDH 160 mm	0606-BEA 185 mm	5 x 14 mm		1/1

CASPAR
0606-BDD/0606-BEA

Abwärts gebogen
Bottom curved
Curva verso il basso
Curvos
Courbe vers le bas

150°

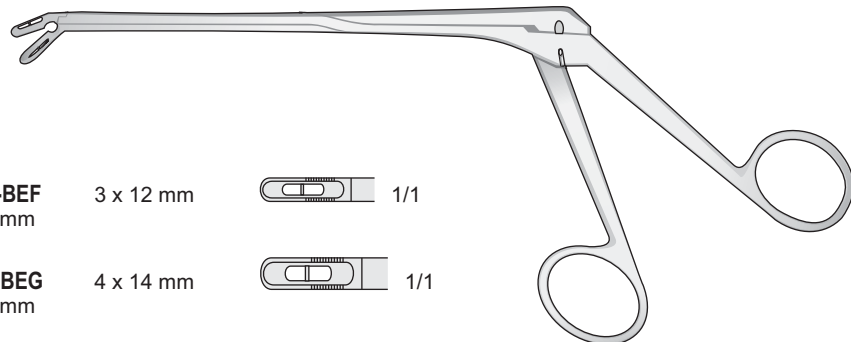

CASPAR

0606-BEB 140 mm	0606-BED 160 mm	0606-BEF 185 mm	3 x 12 mm		1/1
0606-BEC 140 mm	0606-BEE 160 mm	0606-BEG 185 mm	4 x 14 mm		1/1

CASPAR
0606-BEB/0606-BEG

Laminectomy
Rongeur

Laminectomy
rongeurs

Pinze
per biopsia

Pinzas cortantes
para laminectomia

Pincas a
laminectomia

Gerade
Straight
Diritta
Rectas
Droites

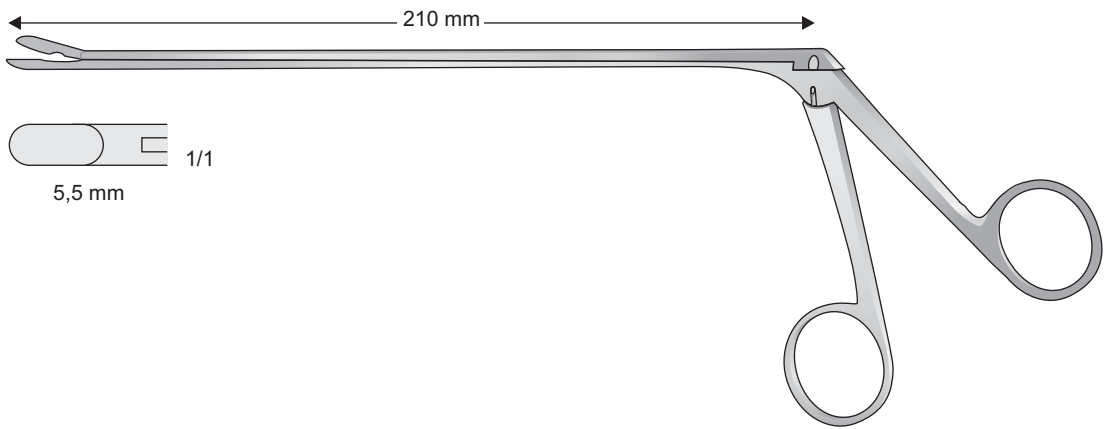

WAGNER
0606-LA

Gerade
Straight
Diritta
Rectas
Droites

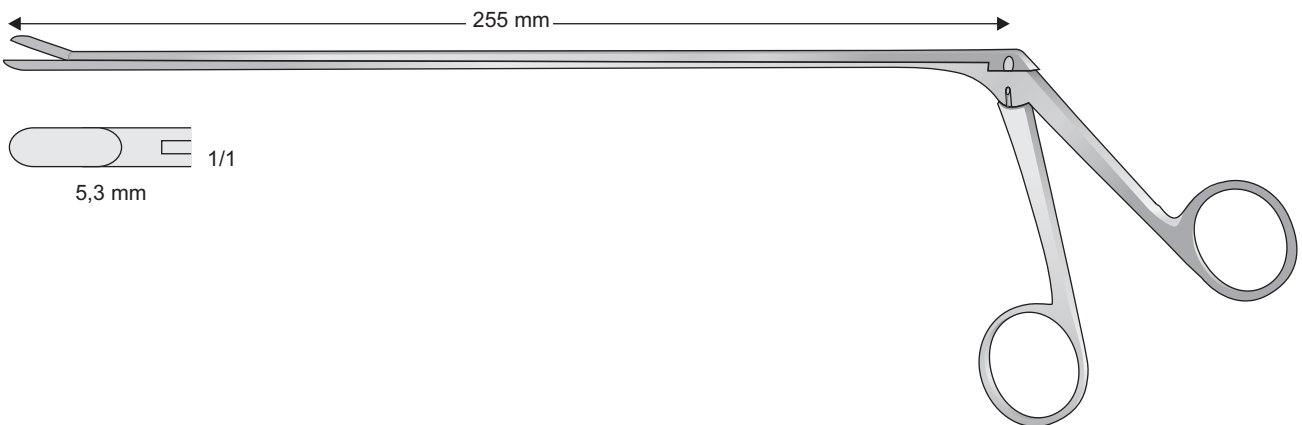

0606-LB

Aufwärtsgebogen
Top curved
Curva verso l'alto
Curvos
Courbe vers le haut

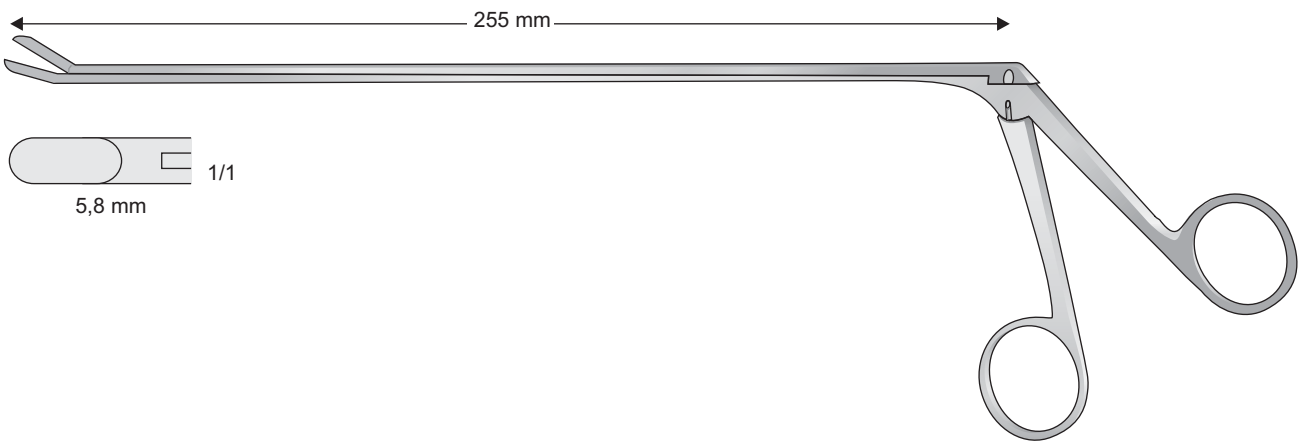

SYPERT
0606-LC

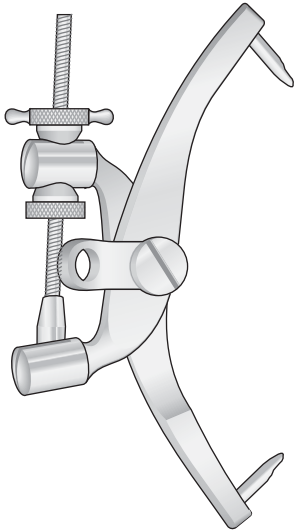

CRUTCHFIELD
0606-DLE

Drill points only
Vorbohrer dazu

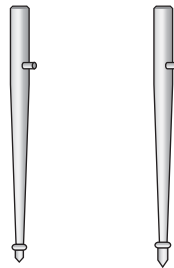

0606-DLF 0606-DLG

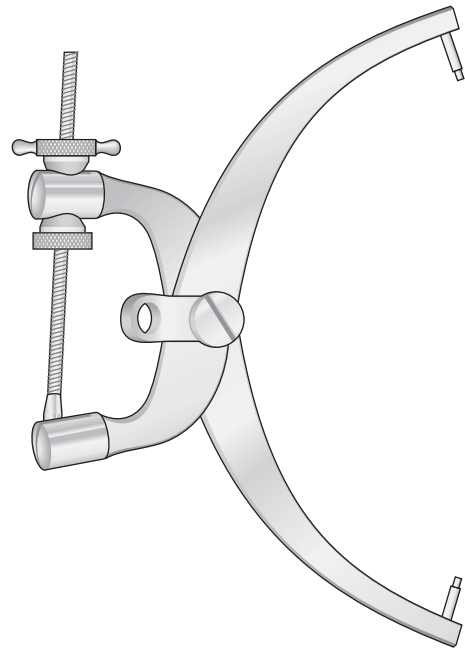

CRUTCHFIELD
0606-DLH



0606-DLI

Doppelschlüssel zu FF-398

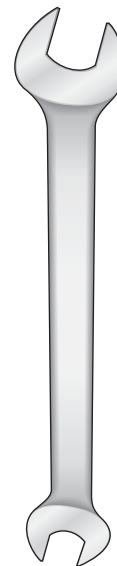

0606-DLL

Amputation
Amputazione

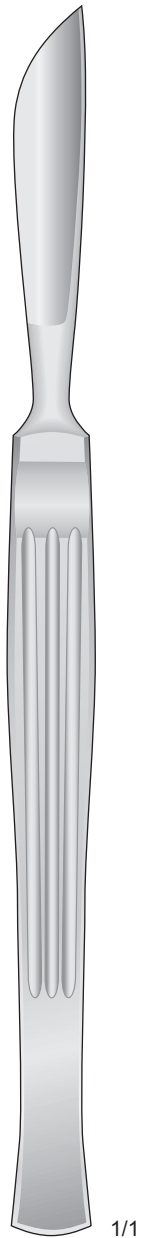

1310-DB/1310-FH



1310-FA
150 mm

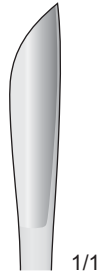

1310-FB
155 mm

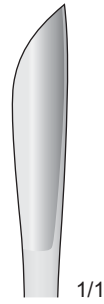

1310-DB
158 mm



1310-FC
160 mm

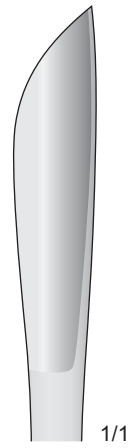

1310-FD
170 mm



1310-DF
175 mm



1310-FE
150 mm

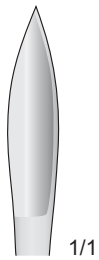

1310-FF
155 mm

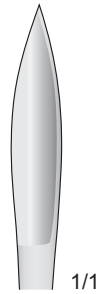

1310-DD
158 mm

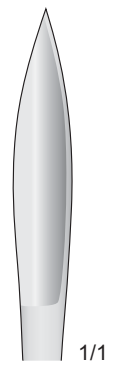

1310-FG
160 mm

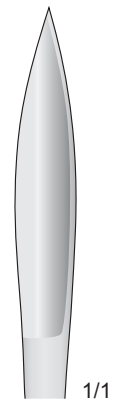

1310-FH
170 mm

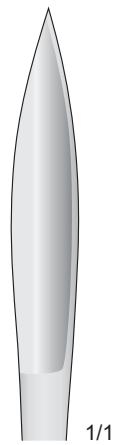

1310-DH
175 mm

Organmesser

Post mortem knives

Coltello per autopsia

Cuchillos para òrganos

Couteaux à autopsie

mm: Schnittlänge
Lenght of blades
Lunghezza della lama
Largo de hojas
Longueur de la lame

Metallheft
Metal handle
Manico in metallo
Mango metálico
Manche métal

Holzheft
Wooden handle
Manico in legno
Mango de madera
Manche bois

Metallheft
Metal handle
Manico in metallo
Mango metálico
Manche métal

Metallheft
Metal handle
Manico in metallo
Mango metálico
Manche métal

Resektionsmesser
Resection knives
Coltello per resezione
Cuchillos para resección
Couteaux à résection

Organmesser
Post mortem knives
Coltello per autopsia
Cuchillos para òrganos
Couteaux à autopsie

Organmesser
Post mortem knives
Coltello per autopsia
Cuchillos para òrganos
Couteaux à autopsie

Hirnmesser
Brain knives
Coltello per cervello
Cuchillos para cerebro
Couteaux à cerveau



LANGENBECK
0113-BA/0113-BB
55 mm

0113-BC
110 mm

0113-BD
170 mm

0113-BE
195 mm

VIRCHOW
0113-BF
160 mm

VIRCHOW
0113-BG
200 mm

VIRCHOW
0113-BH
240 mm

Knochenfeilen

Bone files

Lime per osso

Limas para huesos

Limes à os

Coppia
(2 pezzi)

1 paar
1 pair

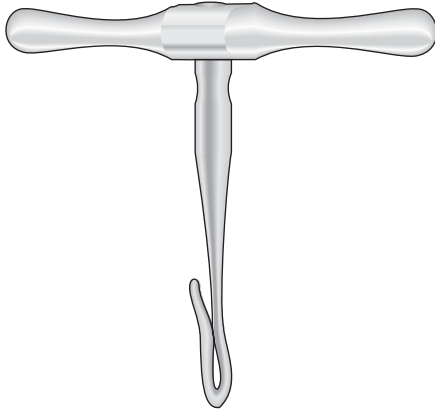

GIGLI
0610-BB

Rostfrei
Stainless
Inox
Acciaio

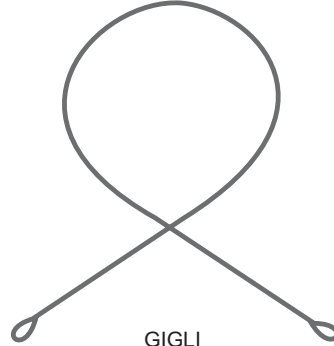

GIGLI
0610-BD
300 mm
0610-BE
500 mm

1118-DAA

Komplett mit 3 Sägen
Complete with 3 saws
Completa con 3 seghe
Completo con 3 sierras
Complet avec 3 scies

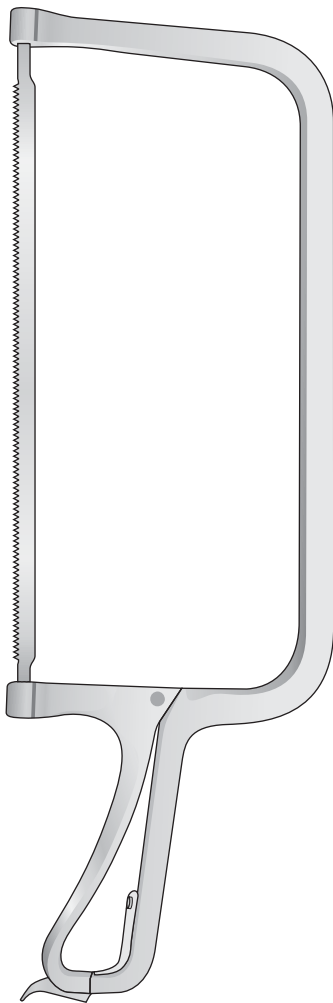

COLLIN
1118-DAA
390 mm

Fig.1

Fig.2

Fig.3



1118-DAB
280 mm

1118-DAC
280 mm

1118-DAD
280 mm

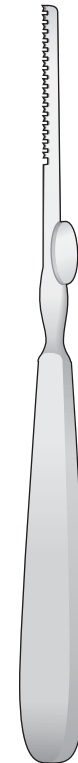

LINDEMANN
0610-CED
200 mm



1/1



LANGENBECK
0610-CEE
235 mm



Tuchklemmen

Towel clamps

Fissateli

Pinzas de campo

Pinces pour fixer les compresses

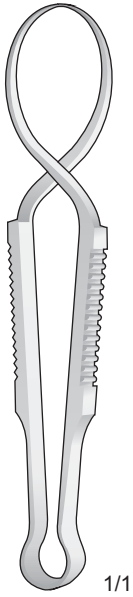

SCHAEDEL
0206-DI
85 mm

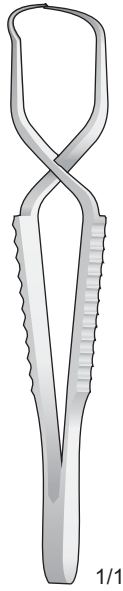

FAURE
0206-EA
85 mm

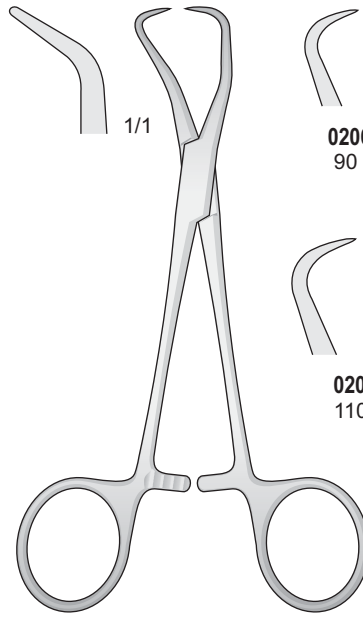

BACKHAUS
0206-EB/0206-EG

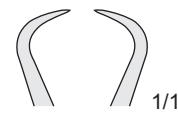

0206-EC
90 mm

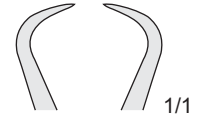

0206-EB
100 mm

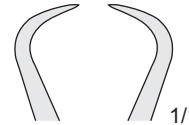

0206-EE
110 mm

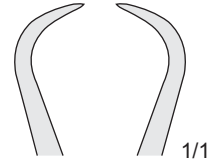

0206-EG
130 mm

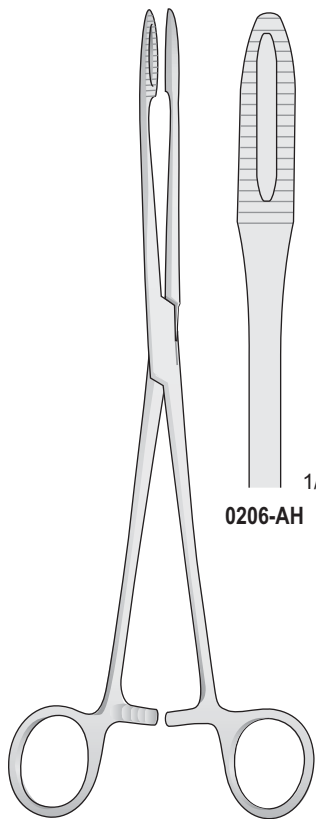

MAIER
0206-AH/0206-AI
265 mm

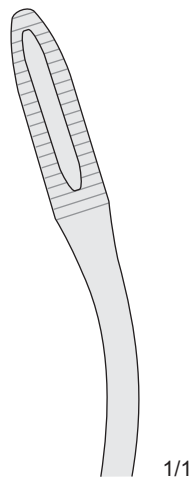

0206-AH

1/1

0206-AI

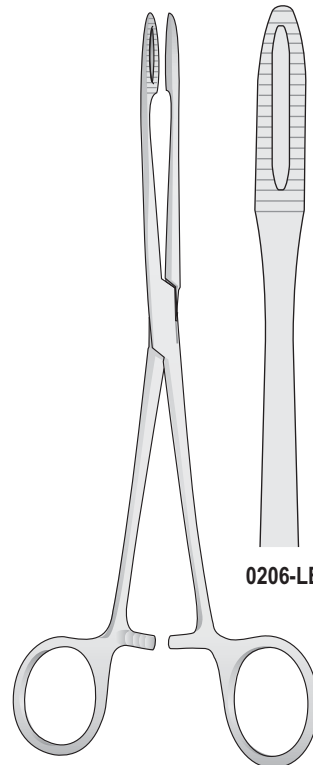

GROSS
0206-LE/0206-LF
200 mm

0206-LE

1/1

0206-LF

1/1

Irisscheren

Iris scissors

Forbici per iridectomia

Tijeras para iridectomía

Ciseaux à iridectomie

“Ribbon type”

Mit großen Ringen
With large rings
Forbici ad anelli grandi
Con anillos especialmente grandes
avec larges anneaux

Irisscheren - Iris scissors
Forbici per iridectomia - Tijeras para iridectomía
Ciseaux à iridectomie

Blepharoplasty
Blefaroplastica

Spitz - Sharp
Acuta - Aguda
Pointu

Spitz - Sharp
Acuta - Aguda
Pointu

Stumpf - Blunt
Smussa - Romas
Mousse

Spitz - Sharp
Acuta - Aguda
Pointu

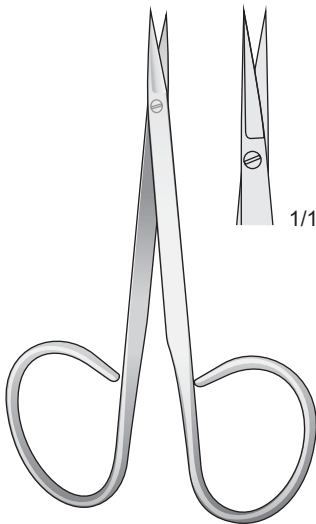

0607-CAA
95 mm

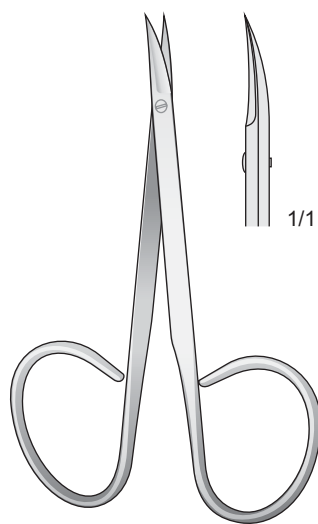

0607-CAB
95 mm

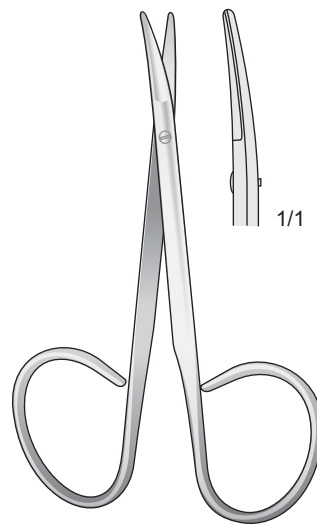

0607-CAC
95 mm

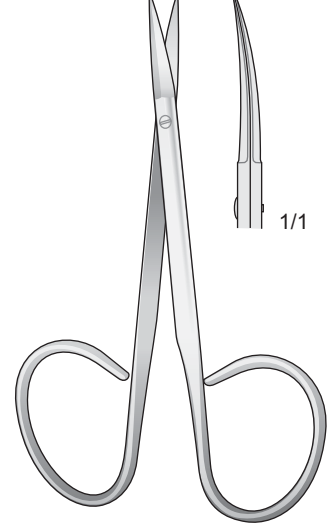

0607-CAD
105 mm

Strabismusscheren - Strabismus Scissors
Forbici da strabismo - Tijeras para estrabismo
Ciseaux à strabisme

Irisscheren - Iris scissors
Forbici per iridectomia - Tijeras para iridectomia
Ciseaux à iridectomie

Stumpf - Blunt
Smussa - Romas
Mousse

Stumpf - Blunt
Smussa - Romas
Mousse

Spitz - Sharp
Acuta - Aguda
Pointu

Spitz - Sharp
Acuta - Aguda
Pointu

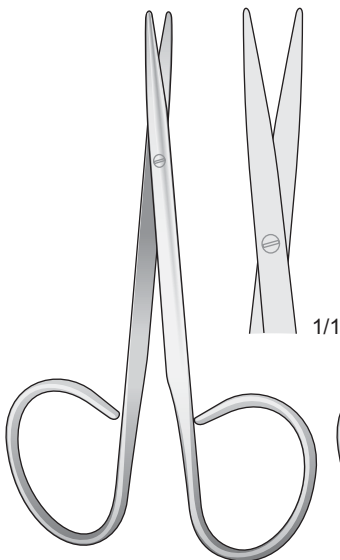

0607-CAE
100 mm

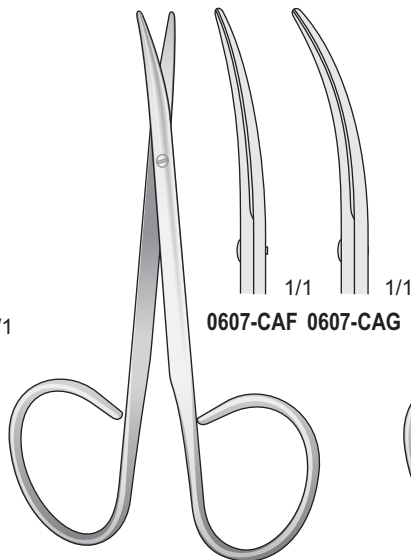

0607-CAF/0607-CAG
100 mm

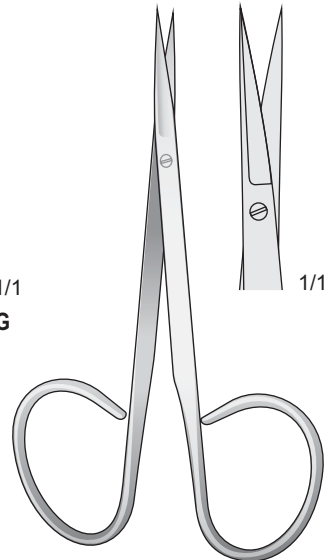

0607-CAH
105 mm

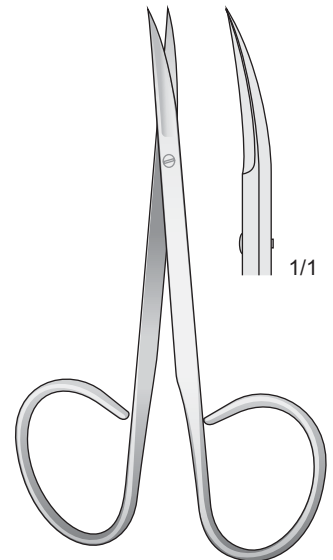

0607-CAI
105 mm

Feine Scheren

Delicate scissors

Forbici delicate

Tijeras finas

Ciseaux délicate

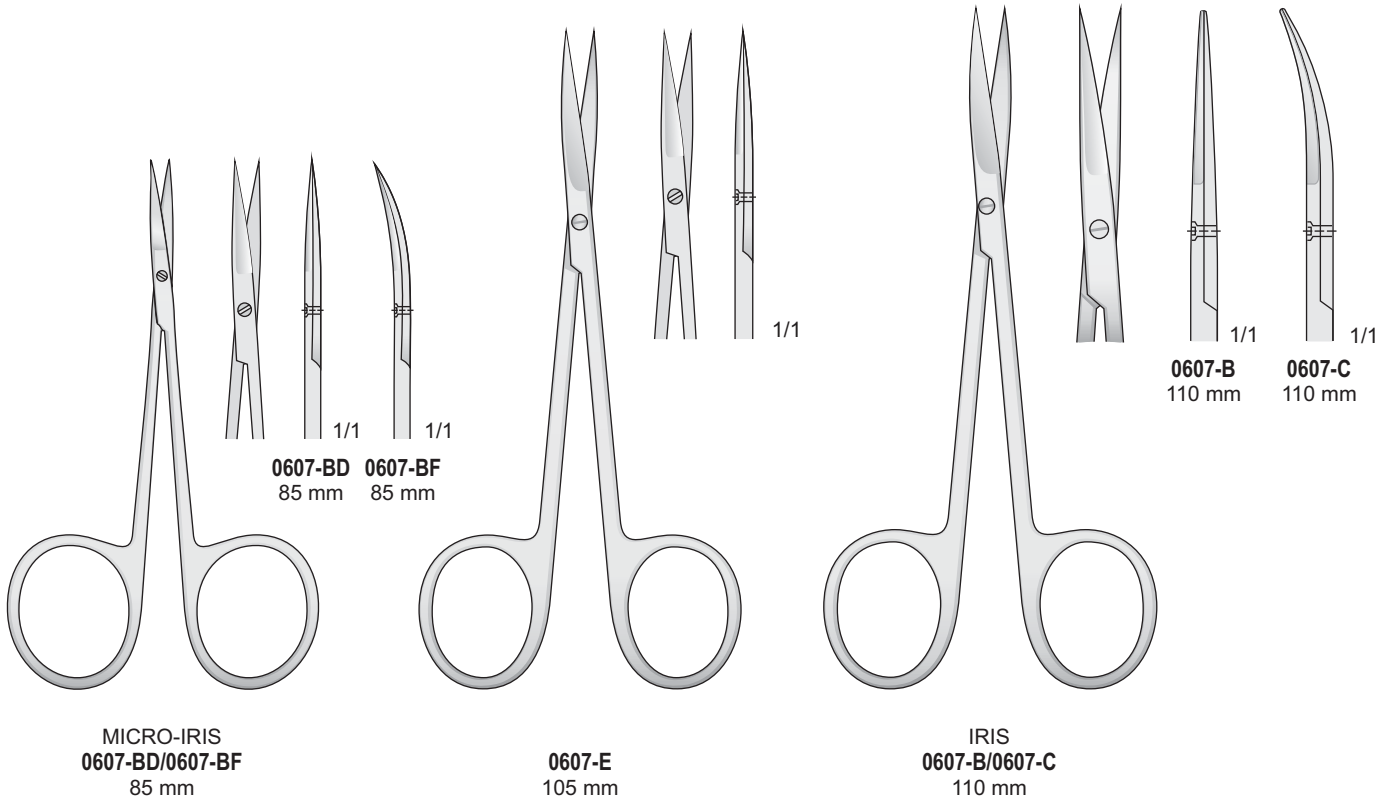

Spitz - Sharp
Acuta - Aguda
Pointu

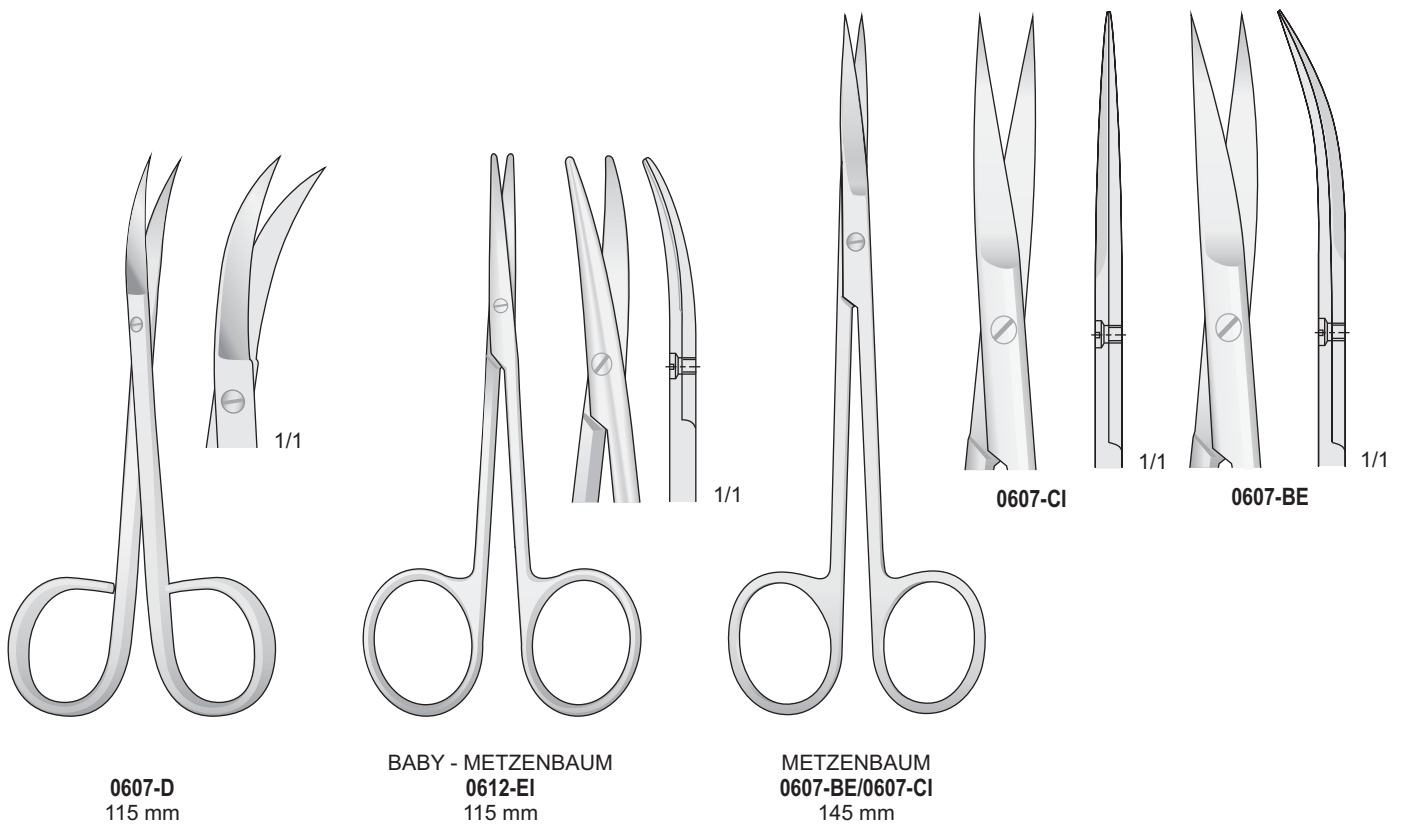

Feine Scheren

Delicate scissors

Forbici delicate

Tijeras finas

Ciseaux délicate

Stumpf - Blunt - Smusse
Romas - Mousses

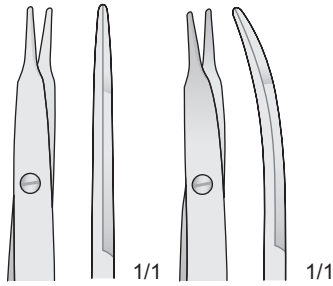

0607-FA

0607-FB

Spitz - Sharp - Acuta
Aguda - Pointu

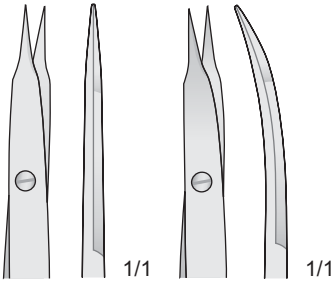

0607-FC

0607-FD

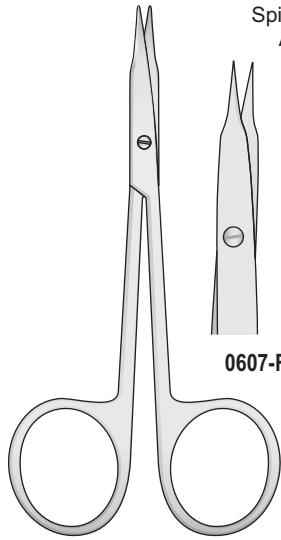

STEVENS
0607-FA/0607-FD
110 mm

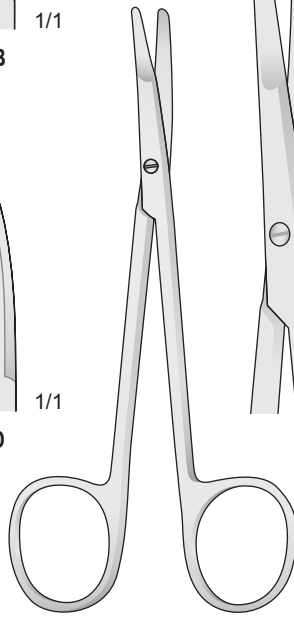

KILNER
0607-G03/0607-BL17

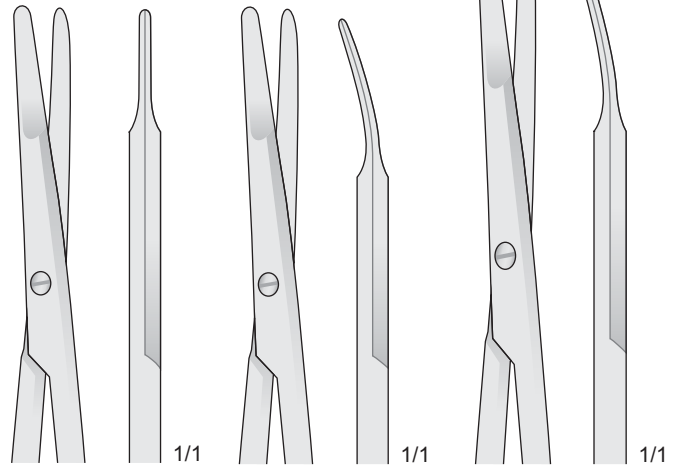

0607-BL17
135 mm

0607-BL03
135 mm

0607-G03
150 mm

Stumpf - Blunt - Smusse
Romas - Mousses

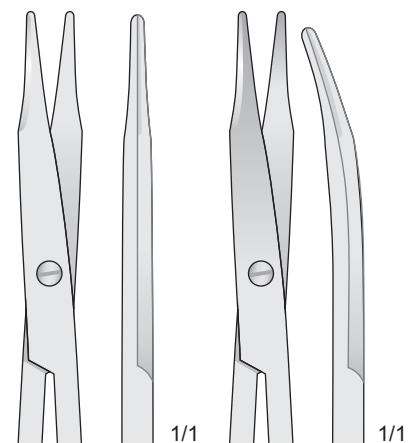

0607-FE
150 mm

0607-FF
150 mm

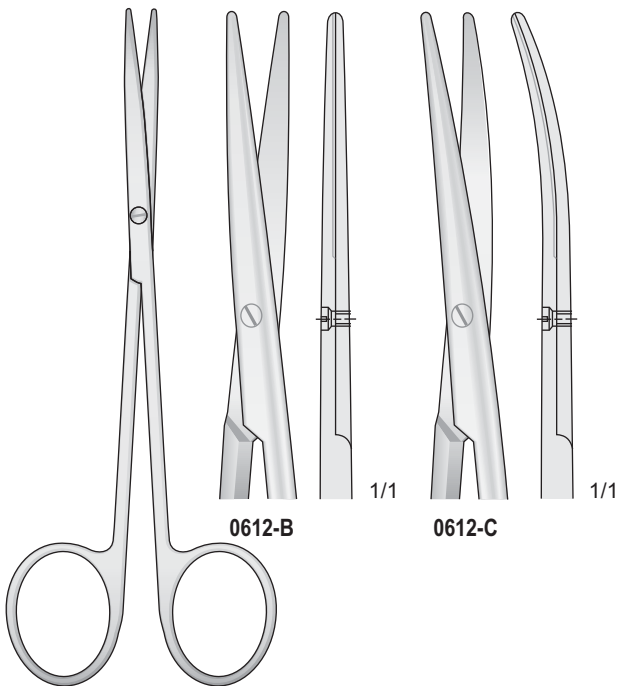

0612-B

0612-C

METZENBAUM
0612-B/0612-C
145 mm

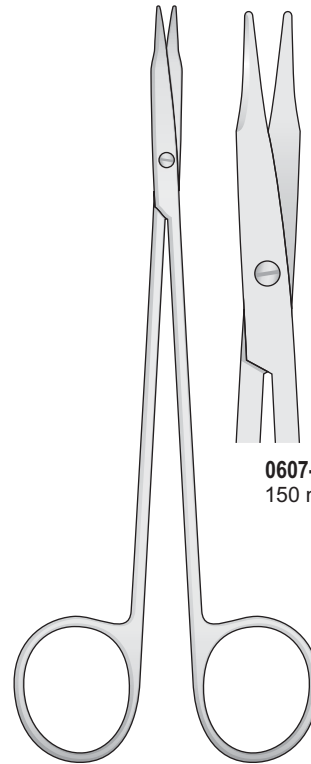

REYNOLDS
0607-FE/0607-FF

Mit Hartmetalleinsätzen - Tungsten-carbide scissors
 Con punta al carburo di tungsteno - Tijeras de tungsteno
 Avec plaquettes en carbure de tungstène

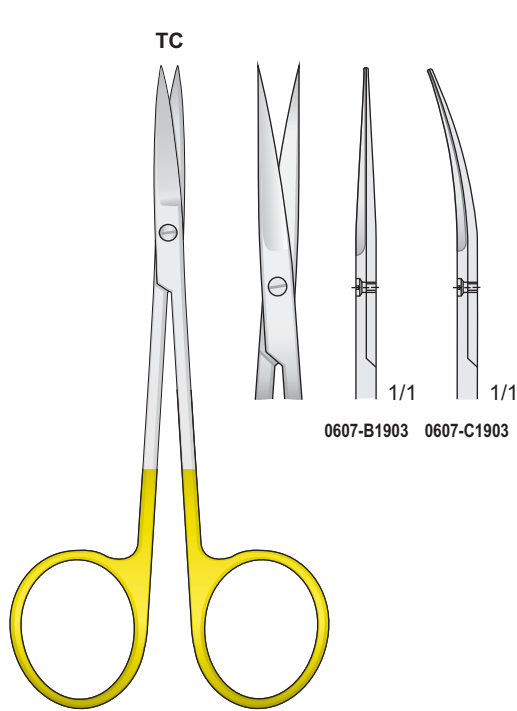

IRIS
 0607-B1903/0607-C1903
 115 mm

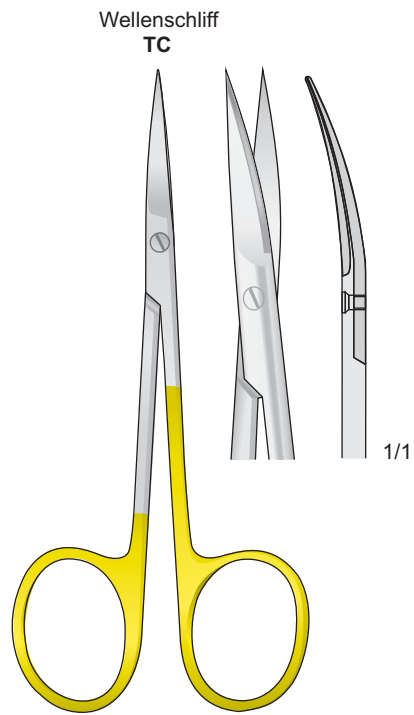

IRIS
 0612-BAA
 110 mm

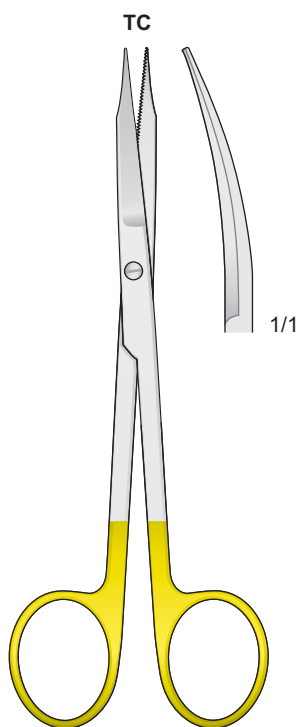

GOLDMAN-FOX
 070603-1903
 135 mm

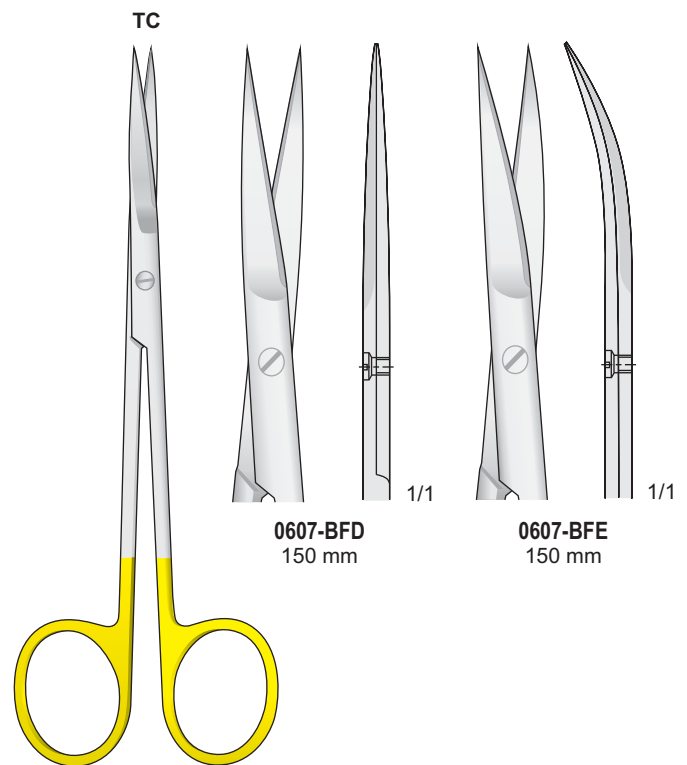

JOSEPH
 0607-BFD/0607-BFE
 150 mm

Mit Hartmetalleinsätzen - Tungsten-carbide scissors
 Con punta al carburo di tungsteno - Tijeras de tungsteno
 Avec plaquettes en carbure de tungstène

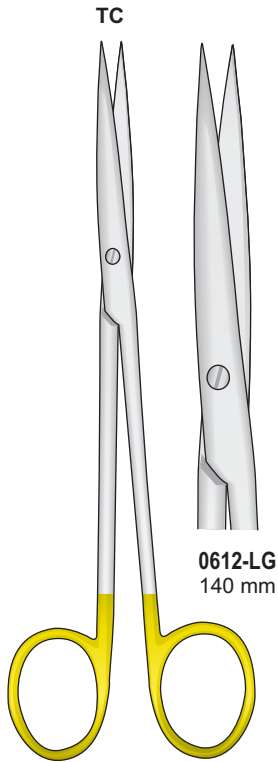

0612-LG
140 mm

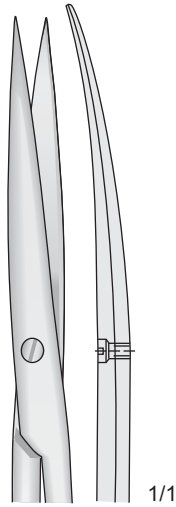

0612-LI
140 mm

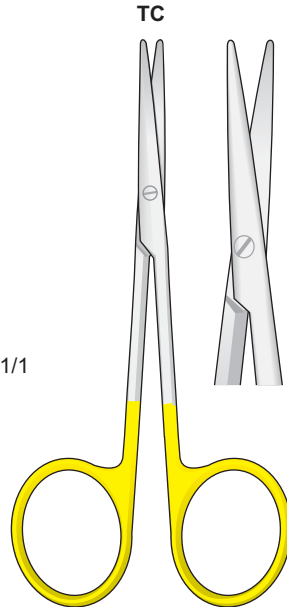

0612-BBI
115 mm

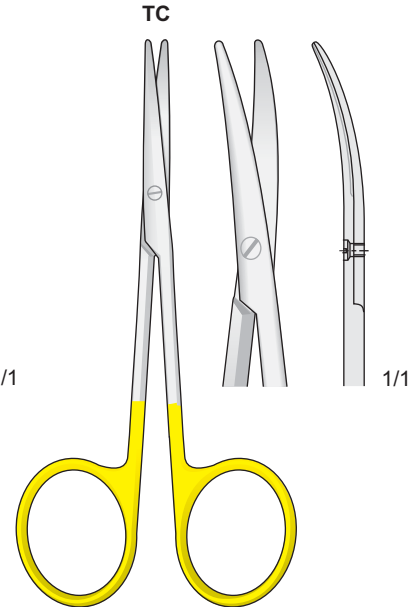

0612-BBL
115 mm

METZENBAUM-FINO
0612-LG/0612-LI

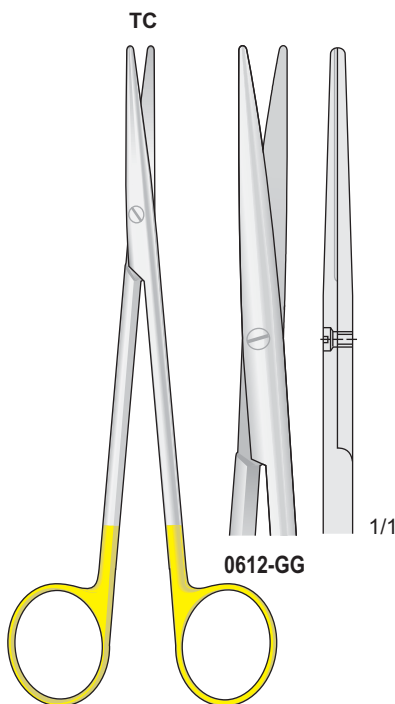

0612-GG

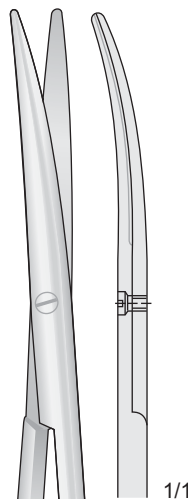

0612-GH

METZENBAUM
0612-GG/0612-GH
145 mm

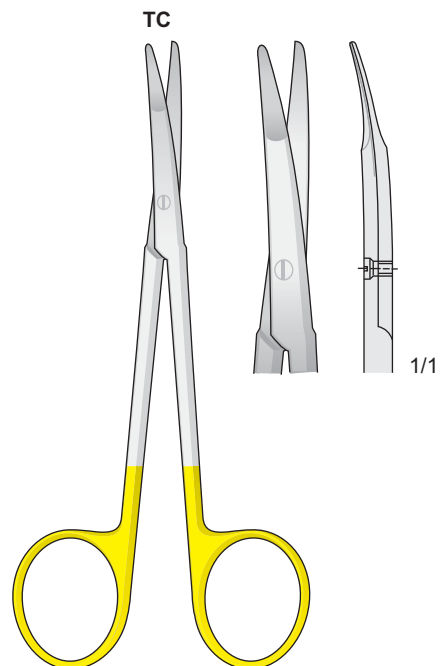

KILNER (RAGNELL)
0612-DFA
125 mm

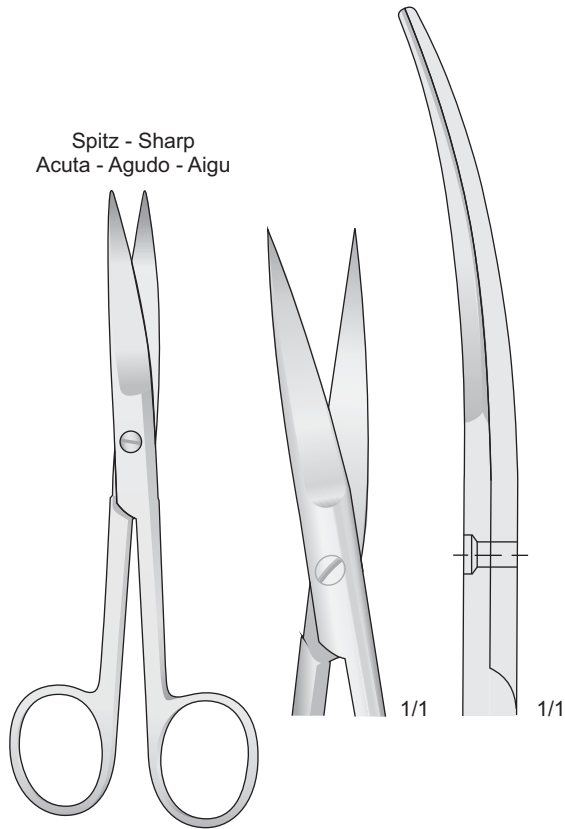

0612-EG
185 mm

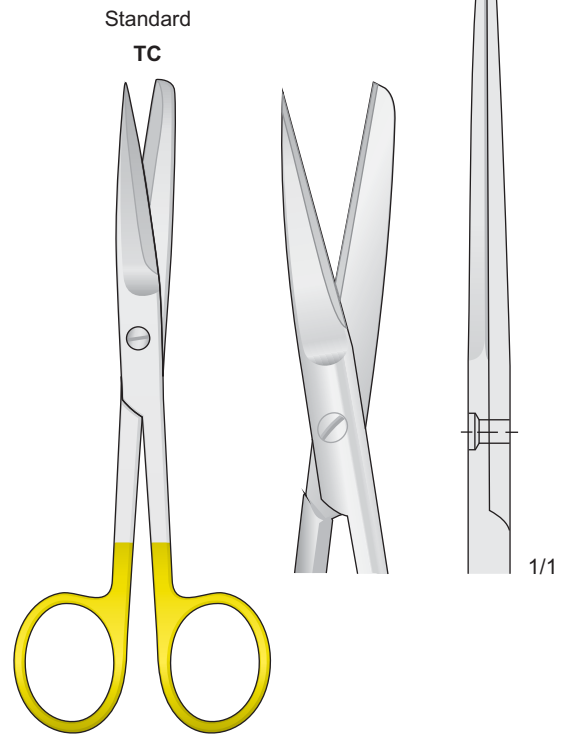

0612-FB
145 mm

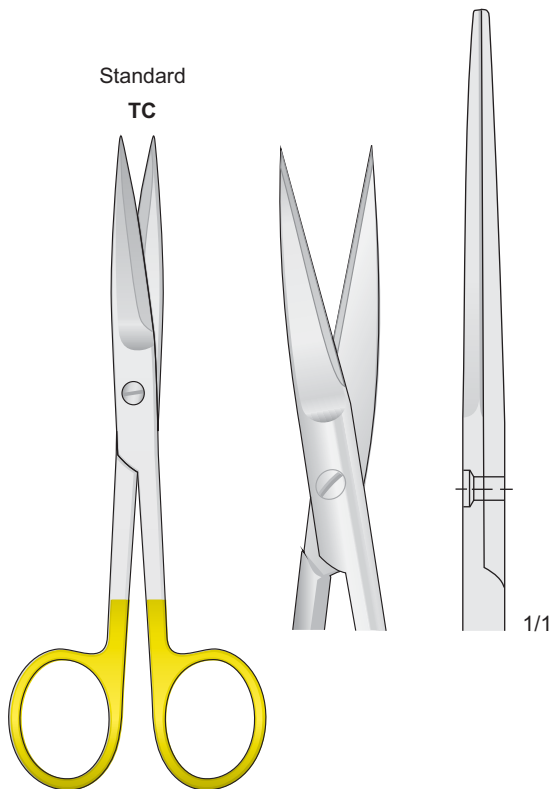

0612-FL
145 mm

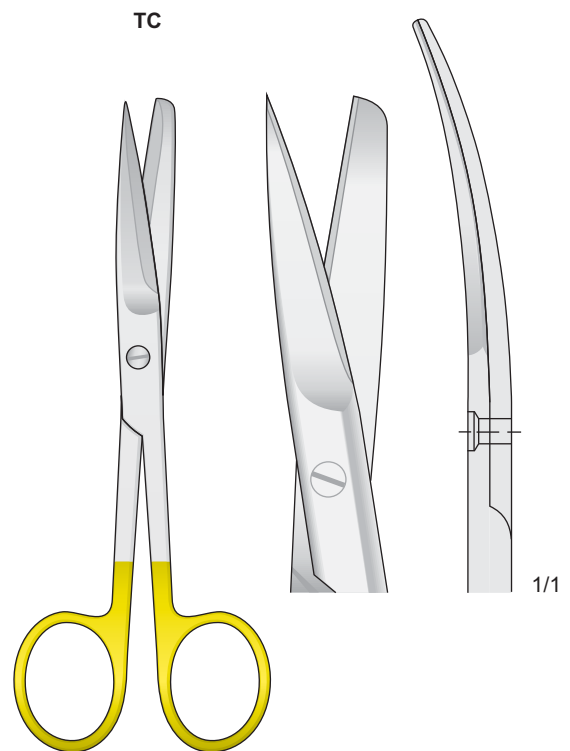

0612-BEL
145 mm

Chirurgischeklemmen

Tissue forceps

Pinze chirurgiche

Pinzas chirùrgicas

Pinces chirurgicales

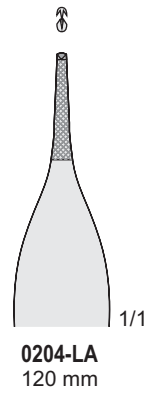
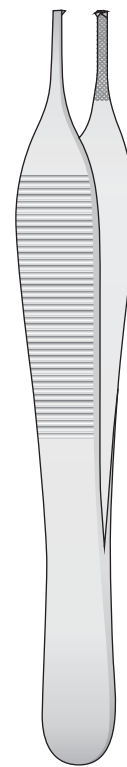
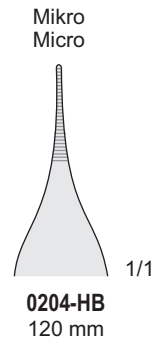
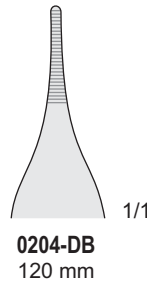
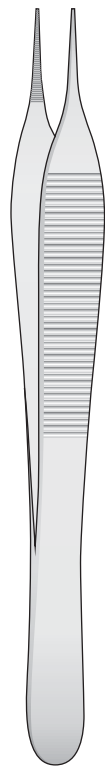
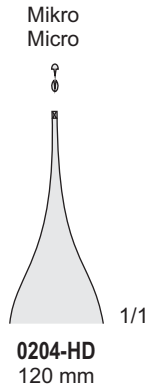
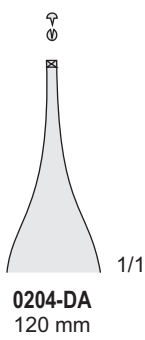
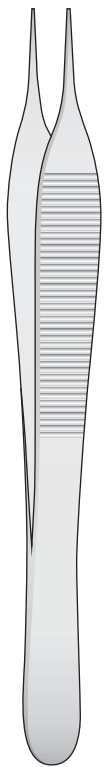

ADSON
0204-DA/0204-HD

ADSON
0204-DB/0204-HB

ADSON
0204-LA
120 mm

6 x 6 Zähne - 6 x 6 Teeths
6 x 6 Denti - 6 x 6 Dientes
6 x 6 Dents

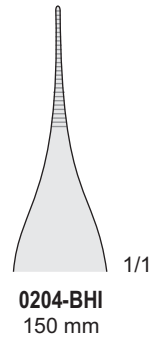
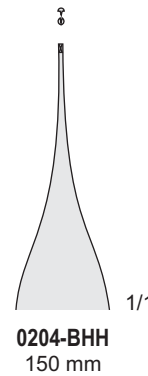
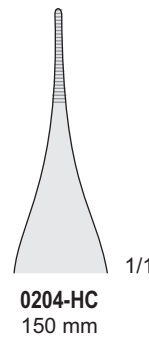
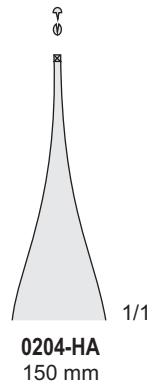
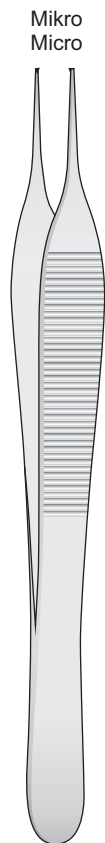
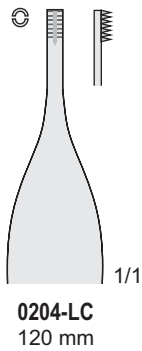
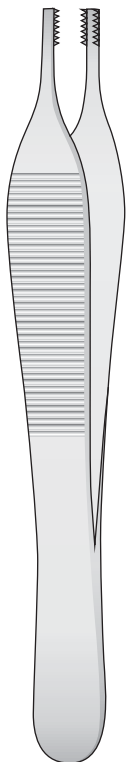

ADSON-BROWN
0204-LC
120 mm

ADSON
0204-HA/0204-BHI
150 mm

Micro pinzette

Forceps delicate

Micro pinzette

Pinzas finos

Micro pinces

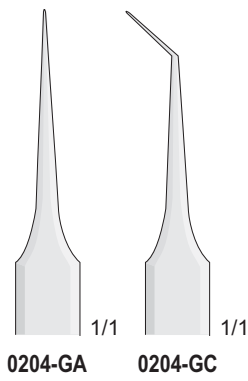
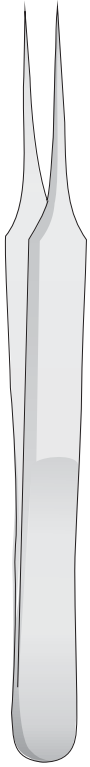

0204-GA/0204-GC
110 mm

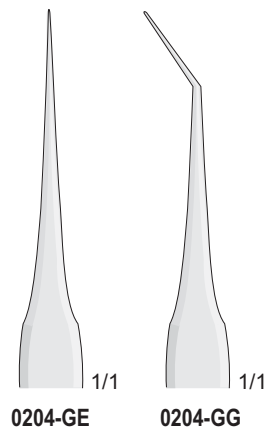
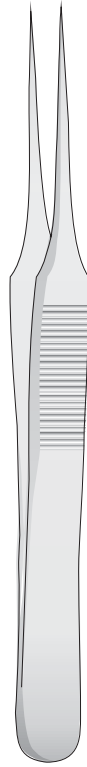

0204-GE/0204-GG
110 mm

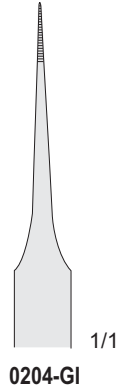
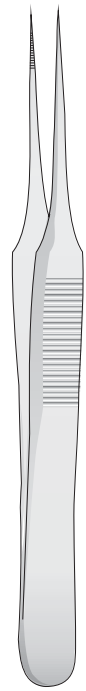

0204-GI
90 mm

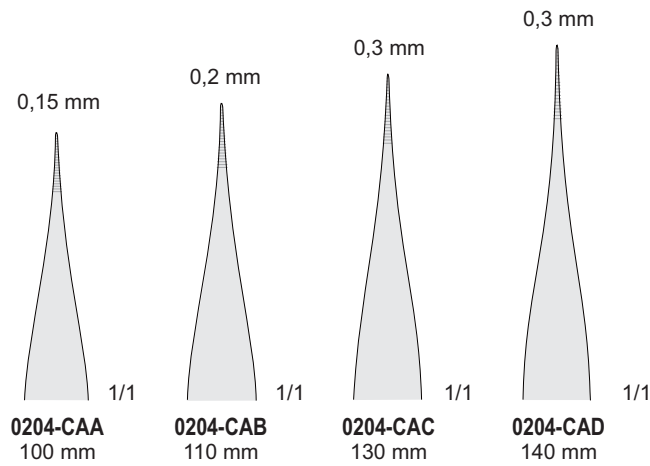
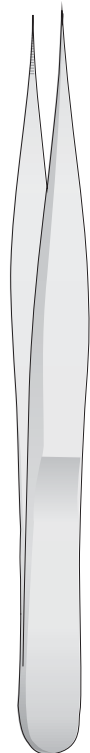

0204-CAA/0204-CAD



0204-CAF
115 mm

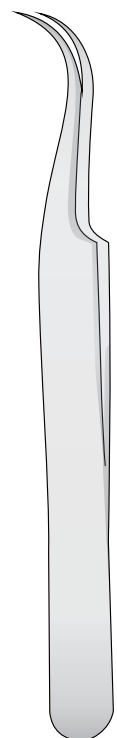

0204-CAG
115 mm

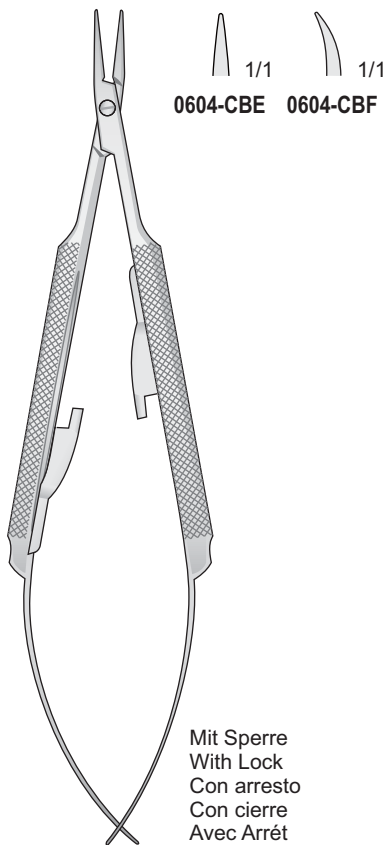

BARRAQUER
0604-CBE/0604-CBF
125 mm

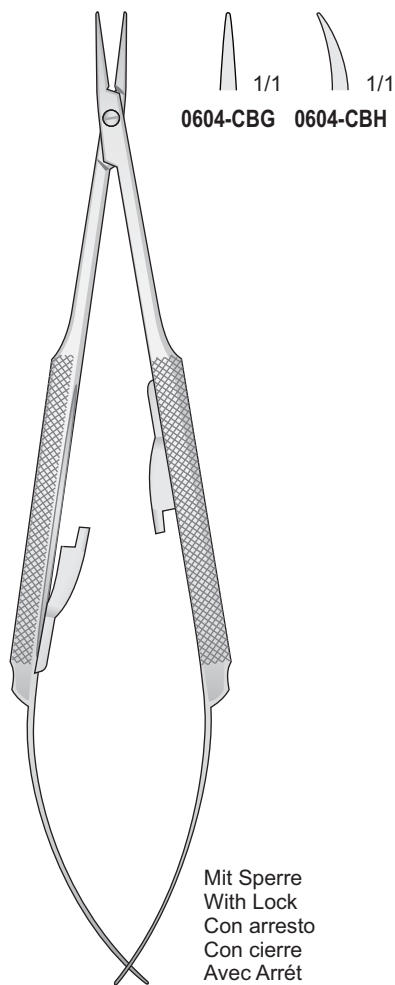

BARRAQUER
0604-CBG/0604-CBH
150 mm

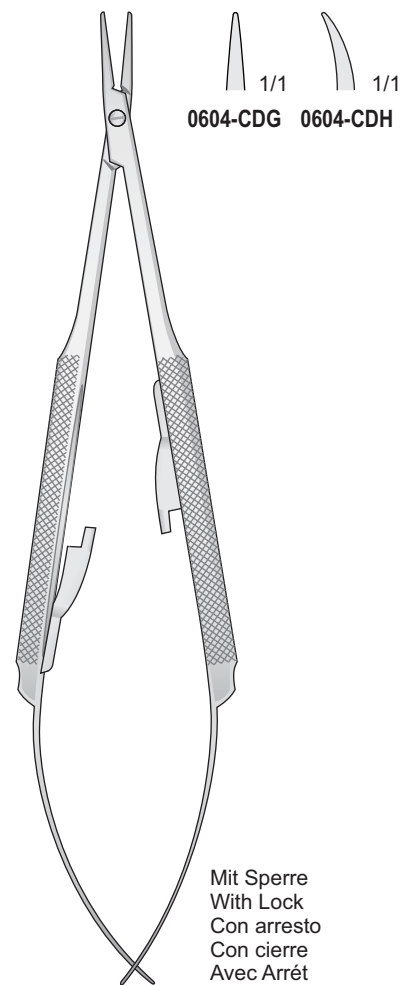

BARRAQUER
0604-CDG/0604-CDH
150 mm

Glattes Maul
Smooth jaws
Con morso liscio
Mandibula lisa
À mors lisses

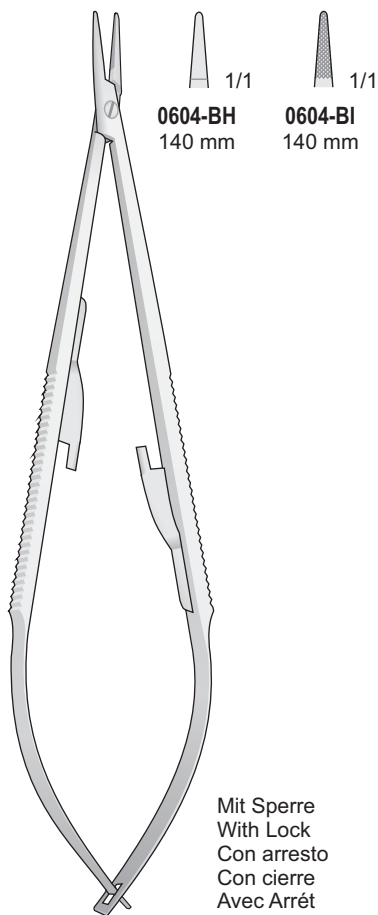

CASTROVIEJO
0604-BH/0604-BI
140 mm

TC

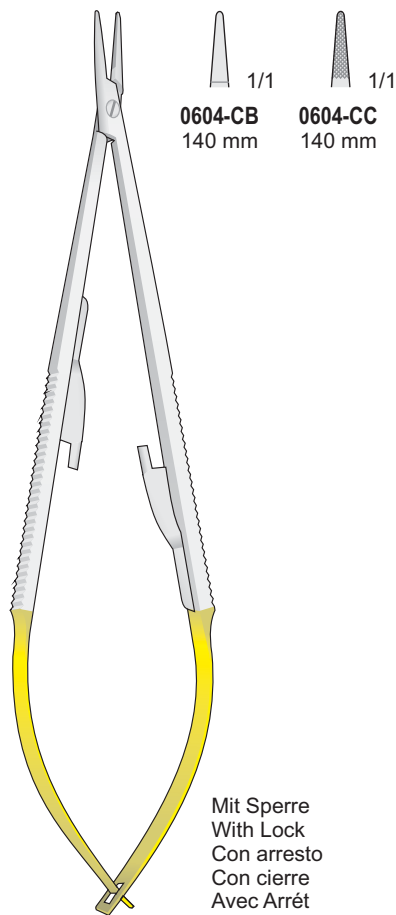

CASTROVIEJO
0604-CB/0604-CC
140 mm

TC

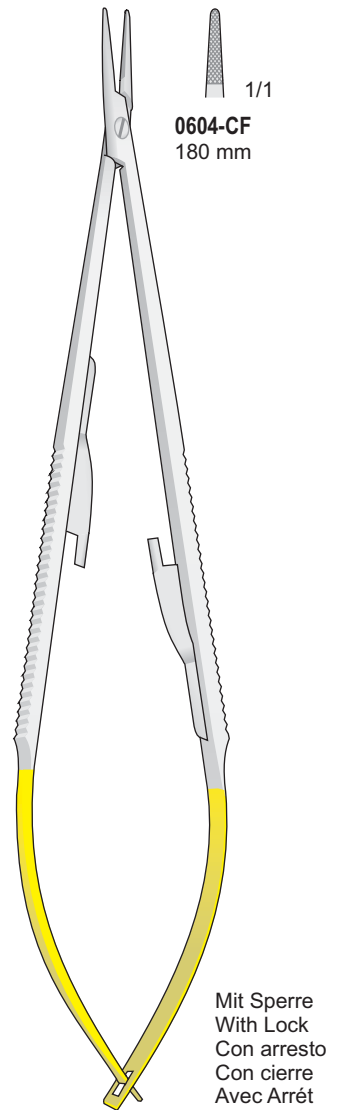

CASTROVIEJO
0604-CF
180 mm

Nadelhalter

Needle Holders

Port'aghi

Portaagujas

Porte aiguilles

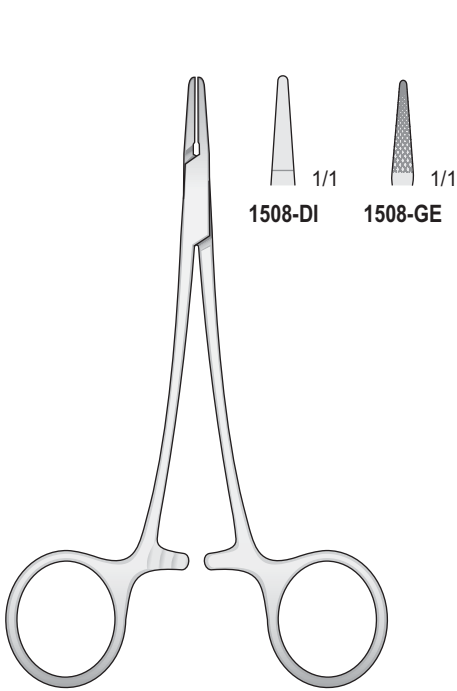

1508-DI 1/1
1508-GE 1/1

1508-DI/1508-GE
120 mm

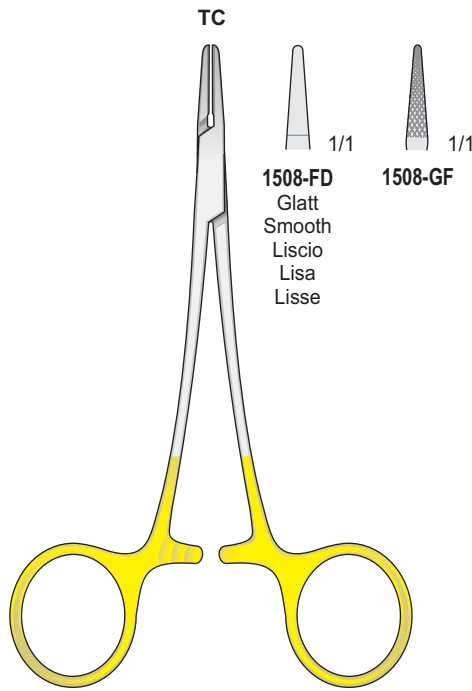

TC
1508-FD 1/1
1508-GF 1/1
1508-FD
Glatt
Smooth
Liscio
Lisa
Lisse

1508-FD/1508-GF
120 mm

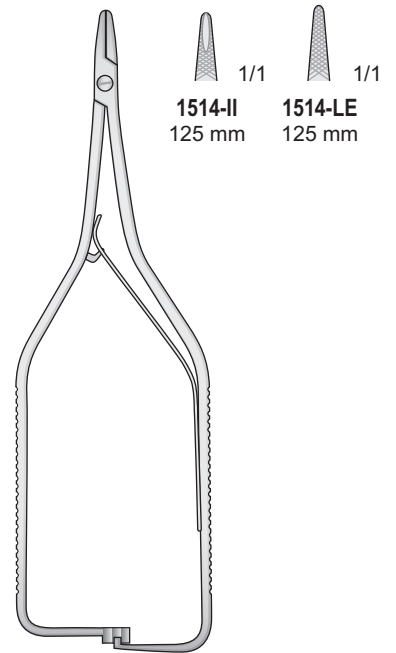

1514-II 1/1
1514-LE 1/1
1514-II
125 mm
1514-LE
125 mm

BOYNTON
1514-II/1514-LE
125 mm

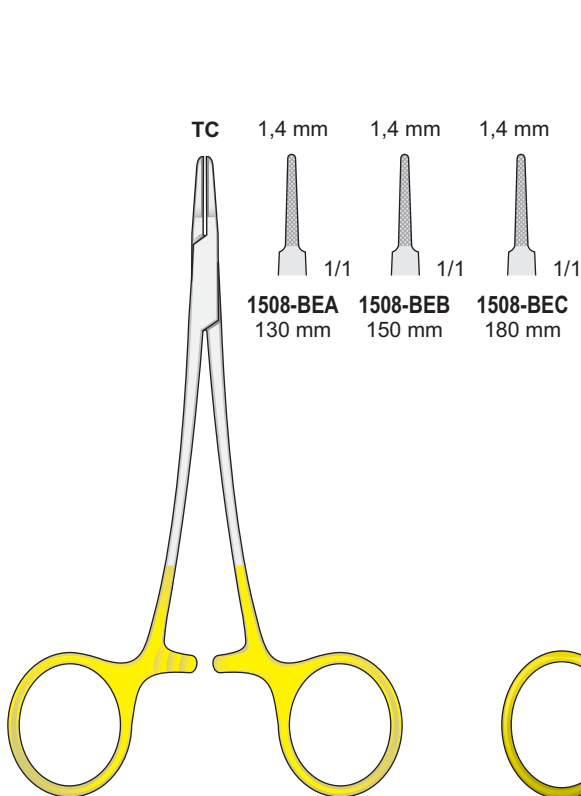

TC
1.4 mm 1.4 mm 1.4 mm
1508-BEA 1/1
1508-BEB 1/1
1508-BEC 1/1
1508-BEA
130 mm
1508-BEB
150 mm
1508-BEC
180 mm

MICRO-RYDER
1508-BEA/1508-BEC

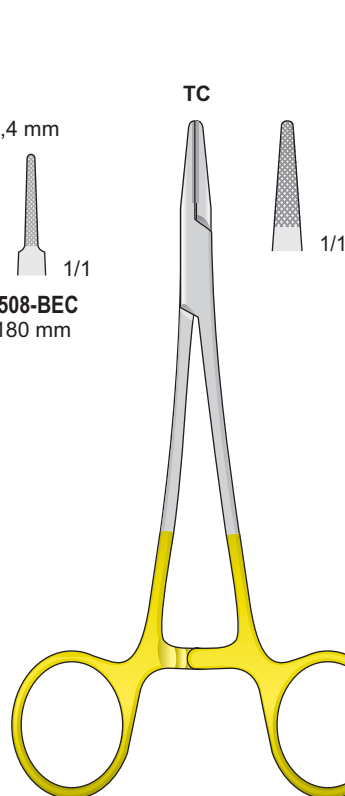

TC
1/1

HALSEY
1508-HD
130 mm

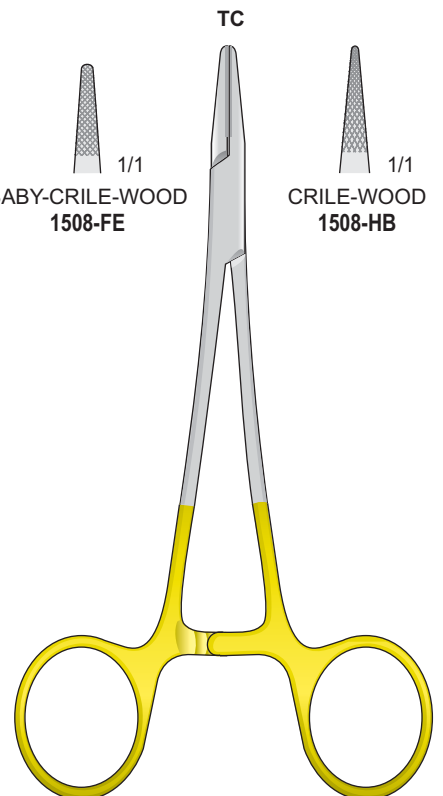

TC
1508-FE 1/1
1508-HB 1/1
BABY-CRILE-WOOD
1508-FE
CRILE-WOOD
1508-HB

CRILE-WOOD
1508-FE/1508-HB
150 mm

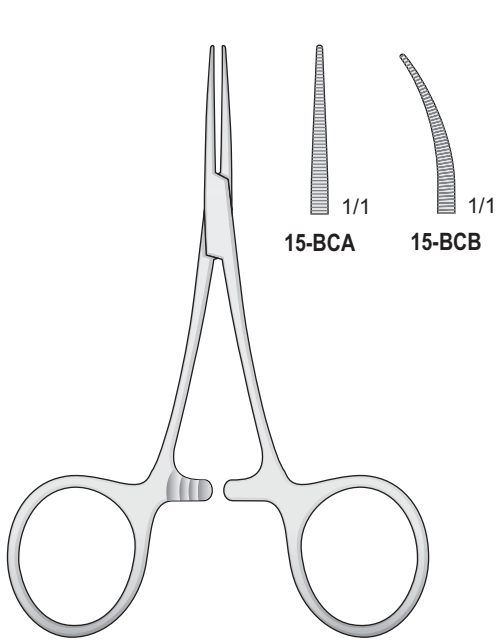

HARTMANN-BABY-MOSQUITO
15-BCA/15-BCB
95 mm

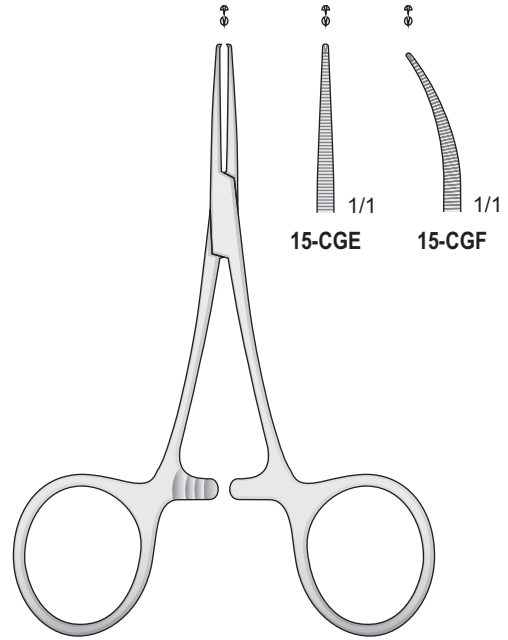

HARTMANN-BABY-MOSQUITO
15-CGE/15-CGF
95 mm

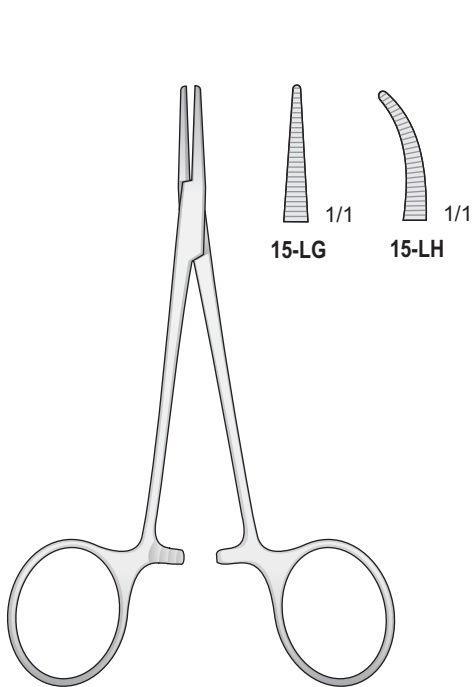

HALSTED-MOSQUITO
15-LG/15-LH
120 mm

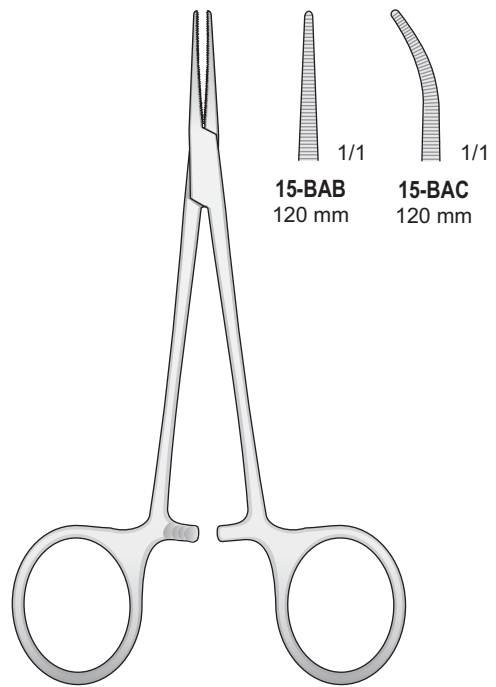

MICRO-HALSTED
15-BAB/15-BAC
120 mm

Gewebe und organ
Fasszangen

Gum and tissue
forceps

Pinze per afferrare
i tessuti

Pinzas para coger las
encias

Pinces pour saisir les
tissu

4 x 5 Zähne
4 x 5 Teeth
4 x 5 Denti
4 x 5 Dientes
4 x 5 Dents

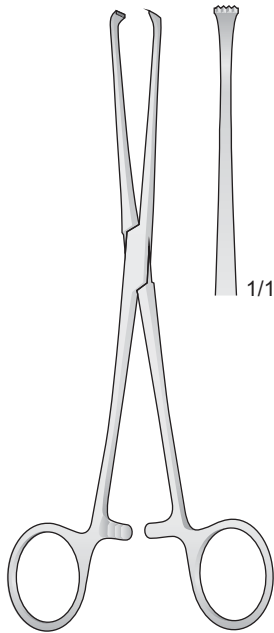

**BABY-ALLIS
15-BAA**
130 mm

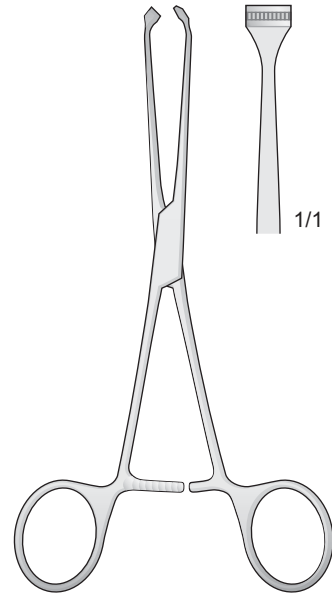

**ALLIS
15-FC**
150 mm

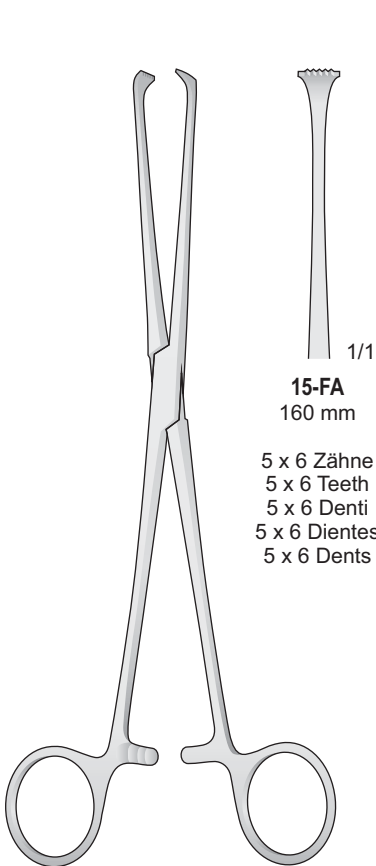

**ALLIS
15-FA/15-BDD**

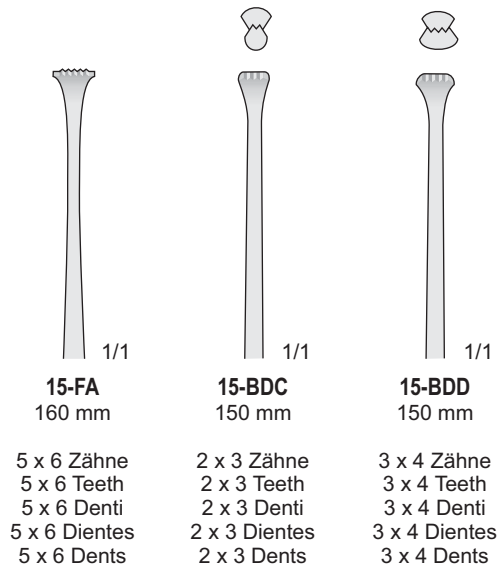

15-FA
160 mm

5 x 6 Zähne
5 x 6 Teeth
5 x 6 Denti
5 x 6 Dientes
5 x 6 Dents

15-BDC
150 mm

2 x 3 Zähne
2 x 3 Teeth
2 x 3 Denti
2 x 3 Dientes
2 x 3 Dents

15-BDD
150 mm

3 x 4 Zähne
3 x 4 Teeth
3 x 4 Denti
3 x 4 Dientes
3 x 4 Dents

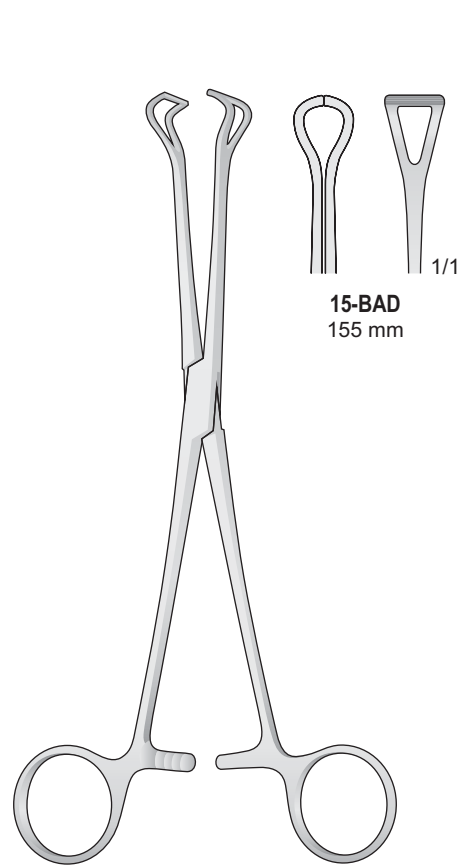

**BABCOCK
15-BAD**

15-BAD
155 mm

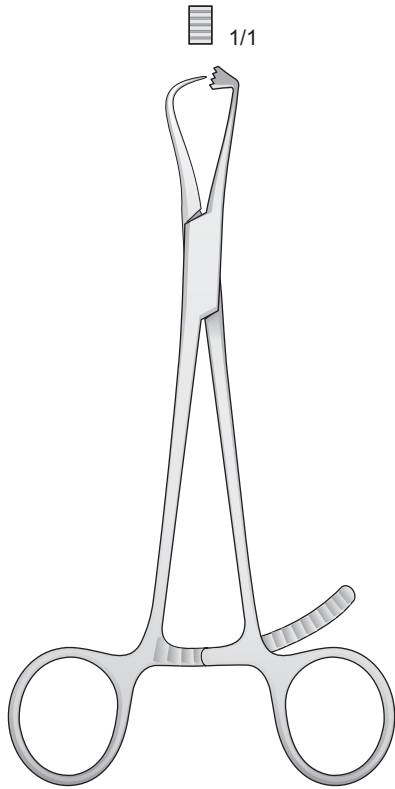

1118-HI11
125 mm

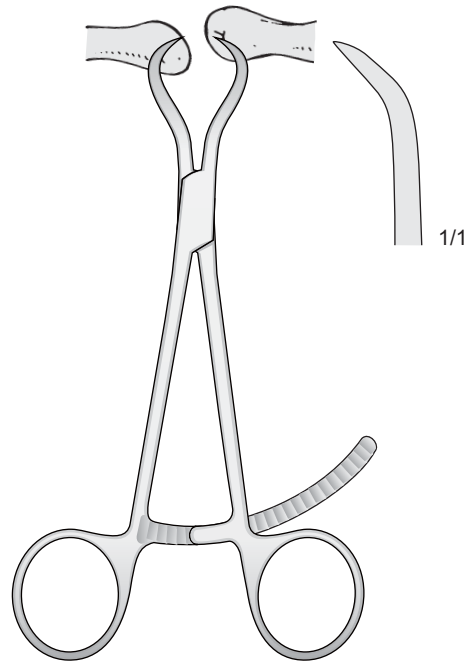

0614-GG11
135 mm

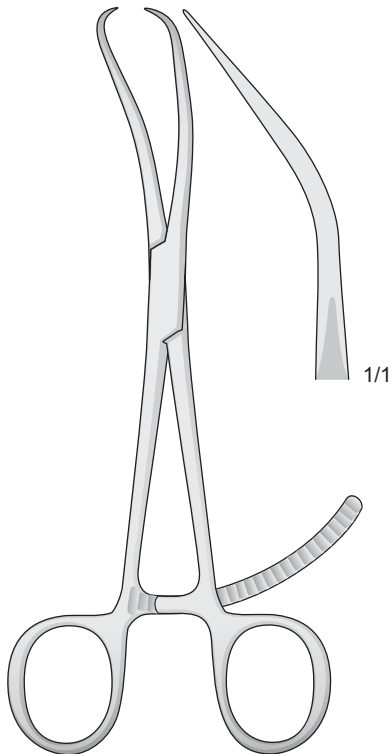

REILL
0614-GE11
170 mm

Pinza con cremagliera
Forceps with ratchet fixation
Zange mit Zahnsperre
Davier à crémaillère

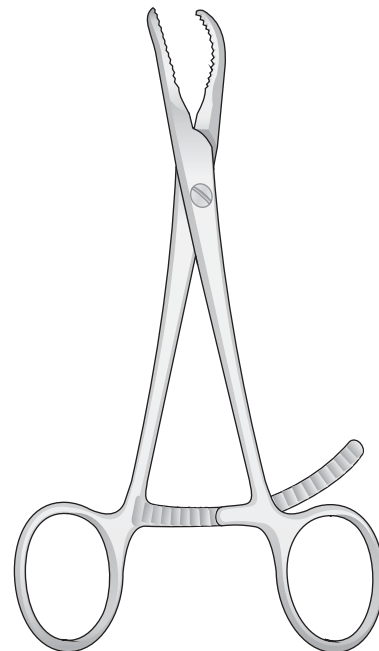

0614-EH11
140 mm



Nummernverzeichnis		Indice alfanumerico		Alfanumerical Index		Index alfabétique		Indice alfanumerico	
Article	Page	Article	Page	Article	Page	Article	Page	Article	Page
0113-BA	204	0219-GA	9	0219-DHI	12				
0113-BB	204	0219-GC	9	0219-DHL	12				
0113-BC	204	0219-GE	9						
0113-BD	204	0219-GF	9	0221-AH	19				
0113-BE	204	0219-GG	9	0221-AL	19				
0113-BF	204	0219-GL	8	0221-BB	18				
0113-BG	204	0219-IA	14	0221-BD	18				
0113-BH	204	0219-IB	14	0221-BE	16				
		0219-IC	14	0221-BF	16				
0202-DI	184	0219-BAB	4	0221-BG	16				
0202-EA	184	0219-BAC	4	0221-BH	16				
0202-EG	184	0219-BAD	4	0221-BI	20				
0202-EI	184	0219-BAE	4	0221-BL	21				
0202-FA	184	0219-BAF	4	0221-CA	20				
0202-FC	184	0219-BAG	4	0221-CB	21				
		0219-BAH	4	0221-CC	20				
0204-DA	216	0219-BAI	4	0221-CD	21				
0204-DB	216	0219-BBA	10	0221-CE	21				
0204-GA	217	0219-BBB	10	0221-CF	21				
0204-GC	217	0219-BBC	10	0221-CG	19				
0204-GE	217	0219-BCA	7	0221-CH	24				
0204-GG	217	0219-BCB	7	0221-CI	24				
0204-GI	217	0219-BCC	7	0221-DF	175				
0204-HA	216	0219-BCD	7	0221-FF	20				
0204-HB	216	0219-BCE	6	0221-FG	20				
0204-HC	216	0219-BCF	6	0221-GI	26				
0204-HD	216	0219-BCG	3	0221-GL	26				
0204-LA	216	0219-BCH	3	0221-HA	26				
0204-LC	216	0219-BCI	3	0221-HB	26				
0204-BHH	216	0219-BDB	13	0221-HC	26				
0204-BHI	216	0219-BDE	11	0221-HD	26				
0204-CAA	217	0219-BDF	11	0221-HE	26				
0204-CAB	217	0219-BDG	13	0221-HF	26				
0204-CAC	217	0219-BDH	11	0221-HG	23				
0204-CAD	217	0219-BDL	3	0221-HH	23				
0204-CAF	217	0219-BEA	3	0221-HI	23				
0204-CAG	217	0219-BEB	5	0221-HL	23				
		0219-BEC	5	0221-IA	183				
0206-AH	209	0219-BED	5	0221-IC	183				
0206-AI	209	0219-BEE	5	0221-IE	183				
0206-DI	209	0219-BEF	5	0221-IF	183				
0206-EA	209	0219-BEG	5	0221-IG	183				
0206-EB	209	0219-BEH	5	0221-LA	22				
0206-EC	209	0219-BEI	5	0221-LB	22				
0206-EE	209	0219-BIA	14	0221-LC	22				
0206-EG	209	0219-BIB	14	0221-LD	22				
0206-LE	209	0219-BIC	14	0221-BAA	17				
0206-LF	209	0219-CEG	15	0221-BAD	17				
		0219-CEH	15	0221-BAI	18				
0210-DA	168	0219-CEI	15	0221-BAL	18				
		0219-CEL	15	0221-BBA	23				
0212-AL	153	0219-CFA	10	0221-BBB	19				
0212-BA	153	0219-CFB	10	0221-BBC	19				
0212-BB	153	0219-CFC	10	0221-BBH	23				
0212-BC	153	0219-CFD	10	0221-BBI	23				
0212-BD	153	0219-CFE	10	0221-BBL	24				
0212-BE	153	0219-CGA	9	0221-BCA	24				
0212-FA	154	0219-CGB	9	0221-BCB	172				
0212-FB	154	0219-CGC	9	0221-BCC	172				
0212-GI	154	0219-CGD	9	0221-BCD	173				
0212-GL	154	0219-CHA	12, 15	0221-BCE	173				
0212-HE	154	0219-CHB	12, 15	0221-BGA	175				
		0219-CHC	12, 15	0221-BGB	175				
0219-CD	6	0219-DAA	185	0221-BGD	176				
0219-CE	6	0219-DAB	185	0221-BGE	176				
0219-DD	8	0219-DAC	185	0221-BGF	176				
0219-DE	8	0219-DAD	185	0221-BGG	176				
0219-DF	8	0219-DHF	12	0221-BGH	176				
0219-DG	8	0219-DHG	12	0221-BGI	176				
0219-ED	8	0219-DHH	12	0221-BGL	176				

Nummernverzeichnis		Indice alfanumerico		Alfanumerical Index		Index alfabétique		Indice alfanumerico	
Article	Page	Article	Page	Article	Page	Article	Page	Article	Page
0221-BHA	176	0221-CLE19	178	0414-BLF	77				
0221-BHB	176	0221-CLF19	178	0414-BLG	77				
0221-BHC	176	0221-CLG19	178	0414-BLH	77				
0221-BHD	176	0221-CLH19	178	0414-CBD	188				
0221-BHE	176	0221-CLI19	178	0414-CBE	188				
0221-BHF	176	0221-CLL19	178	0414-CBF	188				
0221-BHG	176	0221-DAA19	178	0414-CHA	190				
0221-BHH	176	0221-DAB19	178	0414-CHB	190				
0221-BHI	176	0221-DAC19	178	0414-CHC	190				
0221-BHL	176	0221-DAD19	178	0414-CHD	190				
0221-BIA	176	0221-DAE19	178	0414-CHL	189				
0221-BIB	176	0221-DAF19	178	0414-CIA	189				
0221-BIC	176	0221-DAG19	178	0414-CIB	189				
0221-BLA	25	0221-DAH19	178	0414-CIC	189				
0221-BLB	25	0221-DAI19	178						
0221-BLC	25	0221-DAL19	178	0415-AL	99				
0221-BLD	25	0221-DBA19	178	0415-LA	159				
0221-CAB	179	0221-DBF	17	0415-LG	156				
0221-CAC	179	0221-DBG	17	0415-BCA	159				
0221-CAD	179	0221-DBL	174	0415-HCF	145				
0221-CAE	179	0221-DCA	174						
0221-CAF	179	0221-DCB	174	0604-BH	219				
0221-CAG	179	0221-DCC	174	0604-BI	219				
0221-CAH	179	0221-DCD	174	0604-CB	219				
0221-CAI	179	0221-DCE	174	0604-CC	219				
0221-CAL	180	0221-DCF	174	0604-CF	219				
0221-CBA	180	0221-DCG	174	0604-CBE	218				
0221-CBB	180	0221-DCH	174	0604-CBF	218				
0221-CBC	180	0221-DCI	174	0604-CBG	218				
0221-CBD	180	0221-DCL	174	0604-CBH	218				
0221-CBE	180	0221-DDA	174	0604-CDG	218				
0221-CBF	180	0221-EAB	171	0604-CDH	218				
0221-CBG	180	0221-EAC	171						
0221-CCL	178	0221-EAD	171	0606-IA	198				
0221-CEL	177	0221-EAE	171	0606-IB	198				
0221-CFA	177	0221-EAF	171	0606-IC	198				
0221-CFB	177	0221-EAG	171	0606-ID	198				
0221-CFC	177			0606-IE	198				
0221-CFD	177	0402-BHH	192	0606-IF	198				
0221-CFE	177	0402-BHI	192	0606-IG	198				
0221-CFF	177	0402-BHL	192	0606-IH	198				
0221-CFG	177	0402-BIA	192	0606-II	198				
0221-CFH	177	0402-BIB	192	0606-LA	201				
0221-CFI	177	0402-BIC	192	0606-LB	201				
0221-CFL	177	0402-BID	192	0606-LC	201				
0221-CGA	177			0606-BAC	199				
0221-CGL	177	0414-B	45	0606-BAD	199				
0221-CHA	177	0414-C	45	0606-BAE	199				
0221-CHB	177	0414-D	45	0606-BAF	199				
0221-CHC	177	0414-DA	152	0606-BAG	199				
0221-CHD	177	0414-DB	152	0606-BAH	199				
0221-CHE	177	0414-DC	152	0606-BAI	199				
0221-CHF	177	0414-EE	152	0606-BAL	199				
0221-CHG	177	0414-EL	152	0606-BBA	199				
0221-CHH	177	0414-FG	188	0606-BBB	199				
0221-CHL	177	0414-FH	188	0606-BCA	200				
0221-CIA	177	0414-FI	188	0606-BCB	200				
0221-CIB19	178	0414-HL	46	0606-BCC	200				
0221-CIC19	178	0414-IA	46	0606-BCD	200				
0221-CID19	178	0414-IB	46	0606-BCE	200				
0221-CIE19	178	0414-IC	46	0606-BCF	200				
0221-CIF19	178	0414-ID	46	0606-BCG	200				
0221-CIG19	178	0414-BGI	47	0606-BCH	200				
0221-CIH19	178	0414-BGL	47	0606-BCI	200				
0221-CII19	178	0414-BHE	188	0606-BCL	200				
0221-CIL19	178	0414-BLA	77	0606-BDA	200				
0221-CLA19	178	0414-BLB	77	0606-BDB	200				
0221-CLB19	178	0414-BLC	77	0606-BDC	200				
0221-CLC19	178	0414-BLD	77	0606-BDD	200				
0221-CLD19	178	0414-BLE	77	0606-BDE	200				

Nummernverzeichnis		Indice alfanumerico		Alfanumerical Index		Index alfabétique		Indice alfanumerico	
Article	Page	Article	Page	Article	Page	Article	Page	Article	Page
0606-BDF	200	0607-CAC	210	0610-LB	155				
0606-BDG	200	0607-CAD	210	0610-LC	155				
0606-BDH	200	0607-CAE	210	0610-LD	35				
0606-BDI	200	0607-CAF	210	0610-LE	47				
0606-BDL	200	0607-CAG	210	0610-LF	47				
0606-BEA	200	0607-CAH	210	0610-BBA	52				
0606-BEB	200	0607-CAI	210	0610-BBB	52				
0606-BEC	200			0610-BBC	52				
0606-BED	200	0610-AB	53	0610-BBD	52				
0606-BEE	200	0610-AC	53	0610-BBE	52				
0606-BEF	200	0610-AD	53	0610-BBF	52				
0606-BEG	200	0610-AE	53	0610-BBG	52				
0606-BEH	69	0610-AF	53	0610-BBH	31				
0606-BEI	69	0610-AG	53	0610-BBI	31				
0606-BEL	69	0610-AH	53	0610-BBL	48				
0606-BLA	181	0610-AI	53	0610-BCA	52				
0606-BLB	181	0610-AL	123	0610-BCB	52				
0606-BLC	181	0610-BB	205	0610-BCC	52				
0606-CAA	181	0610-BC	29	0610-BCD	52				
0606-CAB	181	0610-BD	205	0610-BCE	52				
0606-CAC	181	0610-BE	205	0610-BCF	52				
0606-CAD	181, 182	0610-BF	41	0610-BCG	52				
0606-CAE	182	0610-BG	41	0610-BCH	31				
0606-CAF	181, 182	0610-BH	41	0610-BCI	31				
0606-CAG	181, 182	0610-CA	30	0610-BDA	54				
0606-DAB	186	0610-CH	30	0610-BDB	54				
0606-DAC	186	0610-CI	30	0610-BDC	54				
0606-DAD	186	0610-DA	30	0610-BDD	37				
0606-DAE	186	0610-EF	30	0610-BDE	38				
0606-DAF	186	0610-EG	30	0610-BDF	37				
0606-DAG	186	0610-EH	36	0610-BDG	51				
0606-DAH	186	0610-EI	30	0610-BDH	51				
0606-DAI	186	0610-EL	30	0610-BDI	51				
0606-DAL	187	0610-FB	32	0610-BDL	51				
0606-DBA	187	0610-FC	32	0610-BEA	56				
0606-DBB	187	0610-FD	32	0610-BEB	56				
0606-DBC	187	0610-FE	33	0610-BEC	56				
0606-DBD	187	0610-FF	33	0610-BED	56				
0606-DBE	187	0610-FG	35	0610-BEE	56				
0606-DLE	202	0610-FH	36	0610-BEF	56				
0606-DLF	202	0610-FI	34	0610-BEH	56				
0606-DLG	202	0610-FL	34	0610-BEI	56				
0606-DLH	202	0610-GA	53	0610-BEL	56				
0606-DLI	202	0610-GB	53	0610-BFA	56				
0606-DLL	202	0610-GC	53	0610-BFB	56				
		0610-GD	53	0610-BFC	56				
0607-B	211	0610-GE	53	0610-BFD	56				
0607-B1903	213	0610-GF	53	0610-BFE	56				
0607-C	211	0610-GG	53	0610-BFF	56				
0607-C1903	213	0610-GH	53	0610-BFG	44				
0607-D	211	0610-GI	53	0610-BFH	44				
0607-E	211	0610-GL	53	0610-BFI	44				
0607-G03	212	0610-HA	49	0610-BFL	44				
0607-BD	211	0610-HB	49	0610-BGA	55				
0607-BE	211	0610-HC	50	0610-BGB	55				
0607-BF	211	0610-HD	50	0610-BGC	55				
0607-BL03	212	0610-HE	50	0610-BGD	55				
0607-BL17	212	0610-HF	49	0610-BGE	36				
0607-CI	211	0610-HG	49	0610-BGI	36				
0607-EA	114	0610-HH	49	0610-BGL	36				
0607-FA	212	0610-HI	49	0610-BHA	55				
0607-FB	212	0610-HL	50	0610-BHB	55				
0607-FC	212	0610-IA	39	0610-BHC	55				
0607-FD	212	0610-IB	34	0610-BHD	55				
0607-FE	212	0610-IC	39	0610-BHG	35				
0607-FF	212	0610-ID	49	0610-BHH	50				
0607-BFD	213	0610-IE	49	0610-BHI	50				
0607-BFE	213	0610-IF	48	0610-BHL	35				
0607-CAA	210	0610-IG	48	0610-BIA	55				
0607-CAB	210	0610-LA	155	0610-BIB	55				

Nummernverzeichnis		Indice alfanumerico		Alfanumerical Index		Index alfabétique		Indice alfanumerico	
Article	Page	Article	Page	Article	Page	Article	Page	Article	Page
0610-BIC	55	0610-CIL	57	0611-EB	75				
0610-BID	55	0610-CLA	57	0611-EC	75				
0610-BII	51	0610-CLB	58	0611-ED	75				
0610-BIL	51	0610-CLC	58	0611-EE	75				
0610-BLA	55	0610-CLD	58	0611-EF	75				
0610-BLB	55	0610-CLE	58	0611-EG	75				
0610-BLC	55	0610-CLF	58	0611-EH	75				
0610-BLD	45	0610-CLG	58	0611-EI	75				
0610-BLE	45	0610-CLH	58	0611-EL	75				
0610-BLF	45	0610-CLI	58	0611-FD	74				
0610-BLG	45	0610-CLL	58	0611-FE	74				
0610-BLH	54	0610-DAA	58	0611-FI	74				
0610-BLI	54	0610-DAB	58	0611-FL	77				
0610-CAA	62	0610-DAC	58	0611-GA	77				
0610-CAB	61	0610-DAD	58	0611-GB	77				
0610-CAC	61	0610-DAE	58	0611-GC	77				
0610-CAD	61	0610-DAF	58	0611-GD	78				
0610-CAE	61	0610-DAG	58	0611-GE	78				
0610-CAF	62	0610-DAH	58	0611-IB	78				
0610-CAG	62	0610-DAI	58	0611-IC	78				
0610-CAH	62	0610-DBA	59	0611-ID	78				
0610-CAI	62	0610-DBB	59	0611-IE	85				
0610-CBB	61	0610-DBC	59	0611-IF	85				
0610-CBC	61	0610-DBD	59	0611-IG	85				
0610-CBD	61	0610-DBE	59	0611-IH	85				
0610-CCB	61	0610-DBF	59	0611-II	85				
0610-CCC	61	0610-DBG	59	0611-IL	85				
0610-CCD	61	0610-DBH	59	0611-LB	78				
0610-CDA	42	0610-DBI	60	0611-LC	78				
0610-CDC	42	0610-DBL	60	0611-LD	78				
0610-CDE	42	0610-DCA	60	0611-LE	75				
0610-CDG	43	0610-DCB	60	0611-LF	75				
0610-CDI	43	0610-DCC	60	0611-LG	75				
0610-CEA	43	0610-DCD	60	0611-LH	75				
0610-CED	205	0610-DCE	60	0611-LI	75				
0610-CEE	205	0610-DCF	60	0611-LL	75				
0610-CEH	40			0611-BAA	78				
0610-CEI	40	0611-AB	65	0611-BAB	78				
0610-CEJ	40	0611-AC	65	0611-BAC	78				
0610-CEL	40	0611-AD	71	0611-BAD	78				
0610-CFA	40	0611-AE	71	0611-BAE	66				
0610-CFB	40	0611-AF	71	0611-BAF	66				
0610-CFC	39	0611-AG	68	0611-BAG	66				
0610-CFE	40	0611-AL	65	0611-BAH	67				
0610-CFF	40	0611-AL17	65	0611-BAI	67				
0610-CFG	40	0611-BA12	65	0611-BAL	67				
0610-CFH	40	0611-BB	65	0611-BBA	78				
0610-CFI	40	0611-BB17	65	0611-BBB	68				
0610-CFL	41	0611-BC	65	0611-BBC	67				
0610-CGA	39	0611-BC17	65	0611-BBD	68				
0610-CGB	39	0611-BD	71	0611-BBE	71				
0610-CGC	39	0611-BE	71	0611-BBF	71				
0610-CGD	39	0611-BF	71	0611-BBG	71				
0610-CGE	39	0611-BG	74	0611-BBH	78				
0610-CGF	39	0611-BH	74	0611-BBI	71				
0610-CHD	80	0611-BI	74	0611-BBL	78				
0610-CHE	80	0611-CA	70	0611-BCG	71				
0610-CHF	80	0611-CB	70	0611-BCH	71				
0610-CHG	80	0611-CC	70	0611-BDC	71				
0610-CHH	80	0611-CD	71	0611-BDF	71				
0610-CHI	80	0611-CE	71	0611-BDG	71				
0610-CHL	80	0611-CL	75	0611-BDI	71				
0610-CIA	57	0611-DA	70	0611-BEH	41				
0610-CIB	57	0611-DB	70	0611-BEI	41				
0610-CIC	57	0611-DC	74	0611-BEL	41				
0610-CID	57	0611-DD	70	0611-BGA	76				
0610-CIE	57	0611-DE	75	0611-BGC	76				
0610-CIF	57	0611-DF	70	0611-BGE	76				
0610-CIG	57	0611-DG	75	0611-BGG	76				
0610-CIH	57	0611-EA	71	0611-BGI	76				
0610-CII	57								

Nummernverzeichnis		Indice alfanumerico		Alfanumerical Index		Index alfabétique		Indice alfanumerico	
Article	Page	Article	Page	Article	Page	Article	Page	Article	Page
0611-BHA	76	0611-CGL	74	0614-CB	101				
0611-BHC	76	0611-CHA	84	0614-CC	100				
0611-BHE	76	0611-CHC	82	0614-CD	100				
0611-BHG	76	0611-CIA	83	0614-CE	100				
0611-BHH	72	0611-CIB	83	0614-CF	102				
0611-BHI	76	0611-CIC	83	0614-CH	102				
0611-BHL	72	0611-CID	83	0614-CI	106				
0611-BIA	76	0611-CIE	83	0614-CL	106				
0611-BIB	72	0611-CIF	83	0614-DA	106				
0611-BIC	76	0611-CIG	85	0614-DB	106				
0611-BID	72	0611-CIH	85	0614-DC	106				
0611-BIE	72	0611-CII	85	0614-DD	102				
0611-BIF	72	0611-CIL	85	0614-DE	106				
0611-BIG	72	0611-DAH	80	0614-DF	106				
0611-BIH	72	0611-DAI	80	0614-DG	109				
0611-BII	72	0611-DAL	80	0614-DH	103				
0611-BIL	72	0611-DBA	80	0614-DI	109				
0611-BLA	81	0611-DBB	80	0614-DL	103				
0611-BLB	81	0611-DBC	80	0614-EA	113				
0611-BLC	81	0611-DEA	79	0614-EB	112				
0611-BLD	81	0611-DEB	79	0614-EC	112				
0611-BLE	81	0611-DEC	79	0614-ED	102				
0611-BLI	61	0611-DED	79	0614-EE	95				
0611-CAG	73	0611-DEE	79	0614-EF	103				
0611-CAH	73	0611-DEF	79	0614-EG	91				
0611-CAI	73	0611-DEG	79	0614-EH	91				
0611-CAL	73	0611-DEH	79	0614-EH11	223				
0611-CBA	82	0611-DEI	79	0614-EI	91				
0611-CBB	82	0611-DEL	79	0614-EL	91				
0611-CBC	82	0611-DFA	79	0614-FA	95				
0611-CBD	82	0611-DFB	79	0614-FB	95				
0611-CBE	82	0611-DFC	79	0614-FC	95				
0611-CBF	82	0611-DFD	79	0614-FD	95				
0611-CBG	82	0611-DFE	79	0614-FE	95				
0611-CCA	82	0611-DFG	79	0614-FF	92				
0611-CCB	82	0611-DFH	79	0614-FG	92				
0611-CCC	82	0611-DFI	79	0614-FH	92				
0611-CCD	82	0611-DFL	79	0614-FI	112				
0611-CCE	82	0611-DGA	79	0614-FL	112				
0611-CCF	82	0611-DGB	79	0614-GA	112				
0611-CCG	82	0611-DGC	79	0614-GB	112				
0611-CDA	81	0611-DGI	73	0614-GC	94				
0611-CDB	81			0614-GD	114				
0611-CDC	81	0612-B	212	0614-GE	90				
0611-CDD	81	0612-C	212	0614-GE11	223				
0611-CDE	81	0612-EG	215	0614-GF	93				
0611-CEA	81	0612-EI	211	0614-GG	90				
0611-CEB	81	0612-FB	215	0614-GG11	223				
0611-CEC	81	0612-FL	215	0614-GH	96				
0611-CED	81	0612-GG	214	0614-GI	90				
0611-CEE	81	0612-GH	214	0614-GL	96				
0611-CFA	84	0612-LG	214	0614-HB	93				
0611-CFB	84	0612-LI	214	0614-HC	93				
0611-CFC	84	0612-BAA	213	0614-HD	93				
0611-CFD	69	0612-BBI	214	0614-HE	93				
0611-CFE	69	0612-BBL	214	0614-HF	93				
0611-CFF	69	0612-BEL	215	0614-HG	95				
0611-CFG	69	0612-DFA	214	0614-HI	96				
0611-CFH	69			0614-HL	90				
0611-CFI	69	0614-BA	102	0614-IA	99				
0611-CFL	69	0614-BB	103	0614-IB	90				
0611-CGA	84	0614-BC	103	0614-IC	94				
0611-CGB	84	0614-BD	103	0614-IE	94				
0611-CGC	84	0614-BE	103	0614-IF	100				
0611-CGD	74	0614-BF	101	0614-IH	100				
0611-CGE	74	0614-BG	101	0614-II	100				
0611-CGF	74	0614-BH	101	0614-IL	100				
0611-CGG	74	0614-BI	101	0614-LA	98				
0611-CGH	74	0614-BL	101	0614-LB	98				
0611-CGI	74	0614-CA	106	0614-LC	98				

Nummernverzeichnis		Indice alfanumerico		Alfanumerical Index		Index alfabétique		Indice alfanumerico	
Article	Page	Article	Page	Article	Page	Article	Page	Article	Page
0614-LD	96	0614-BIF	197	0706-CFC	191				
0614-LE	96	0614-BIG	197	070603-1903	213				
0614-LG	98	0614-BIH	197	1009-AA	117				
0614-LH	98	0614-BII	197	1009-AB	117				
0614-LI	98	0614-BIL	197	1009-AC	117				
0614-LL	98	0614-BILB	108	1009-BA	143				
0614-BAA	193	0614-BLD	108	1009-BE	117				
0614-BAB	193	0614-BLE	108	1009-BF	117				
0614-BAC	193	0614-BLF	108	1009-BG	117				
0614-BAD	193	0614-BLG	108	1009-BH	117				
0614-BAE	193	0614-BLH	108	1009-BI	117				
0614-BAF	94	0614-BLI	108	1009-CA	117				
0614-BAG	96	0614-BLL	109	1009-CC	117				
0614-BAH	104	0614-CAA	110	1009-CF	117				
0614-BAI	112	0614-CAB	194	1009-CL	118				
0614-BAL	104	0614-CAC	194	1009-DA	117				
0614-BBA	97	0614-CAD	194	1009-DB	118				
0614-BBB	98	0614-CAE	194	1009-DC	118				
0614-BBC	97	0614-CAF	194	1009-DD	118				
0614-BBD	98	0614-CBC	194	1009-DE	118				
0614-BBE	97	0614-CBD	194	1009-DF	118				
0614-BBF	97	0614-CBF	194	1009-DG	118				
0614-BBG	97	0614-CBH	89	1009-DH	118				
0614-BBH	193	0614-CCA	100	1009-DI	118				
0614-BBI	193	0614-CCC	195	1009-DL	118				
0614-BBL	193	0614-CCD	195	1009-EA	117				
0614-BCA	193	0614-CCE	195	1009-EB	117				
0614-BCB	193	0614-CCF	195	1009-EC	117				
0614-BCC	193	0614-CDB	104	1009-ED	117				
0614-BCD	193	0614-CDC	104	1009-EE	117				
0614-BCE	193	0614-CDD	104	1009-EF	117				
0614-BCF	195	0614-CDE	104	1009-EG	117				
0614-BCG	195	0614-CDG	97	1009-EH	117				
0614-BCH	195	0614-CDH	97	1009-EI	117				
0614-BCI	195	0614-CEA	91	1009-EL	117				
0614-BCL	195	0614-CEB	91	1009-FA	120				
0614-BDA	89	0614-CEC	91	1009-FB	120				
0614-BDB	89	0614-CEC	99	1009-FC	120				
0614-BDD	89	0614-DAA	99	1009-FD	120				
0614-BDE	89	0617-CA	150	1009-FE	120				
0614-BDF	107	0617-CD	150	1009-FF	120				
0614-BDI	105	0617-CE	150	1009-FG	120				
0614-BDL	105	0617-CF	150	1009-FH	120				
0614-BEA	109	0617-CG	150	1009-FI	120				
0614-BEF	107	0617-CH	150	1009-GA	118				
0614-BEH	104	0617-CI	150	1009-GB	118				
0614-BEI	107	0617-CL	150	1009-GC	118				
0614-BEL	104	0617-DA	150	1009-GD	118				
0614-BFG	105	0706-BEA	191	1009-GE	118				
0614-BFH	105	0706-BEB	191	1009-GF	118				
0614-BFI	113	0706-BEB02	191	1009-GG	118				
0614-BFL	99	0706-BEC	191	1009-GH	118				
0614-BGA	110	0706-BEC02	191	1009-GI	118				
0614-BGB	110	0706-BED	191	1009-GL	118				
0614-BGH	105	0706-BEE	191	1009-HA	118				
0614-BGI	105	0706-BFA	191	1009-HB	118				
0614-BGL	105	0706-BFB	191	1009-HC	118				
0614-BHA	105	0706-BFB02	191	1009-HE	118				
0614-BHB	196	0706-BFC	191	1009-HF	118				
0614-BHC	196	0706-BFC02	191	1009-HG	118				
0614-BHD	196	0706-BFD	191	1009-HH	118				
0614-BHE	196	0706-BFE	191	1009-HI	118				
0614-BHF	196	0706-CEA	191	1009-IA	118				
0614-BHG	107	0706-CEB	191	1009-IC	118				
0614-BHI	112	0706-CEC	191	1009-IF	118				
0614-BIA	197	0706-CEC02	191	1009-LA	118				
0614-BIB	197	0706-CED	191	1009-LL	117				
0614-BIC	197	0706-CEE	191	1009-BAA	117				
0614-BID	197								
0614-BIE	197								

Nummernverzeichnis		Indice alfanumerico		Alfanumerical Index		Index alfabétique		Indice alfanumerico	
Article	Page	Article	Page	Article	Page	Article	Page	Article	Page
1009-BAC	117	1009-CFG	120	1118-EB	128				
1009-BBE	117	1009-CFI	120	1118-EC	128				
1009-BBF	117	1009-CGA	120	1118-ED	128				
1009-BBG	117	1009-CGC	120	1118-EE	128				
1009-BBH	117	1009-CGE	120	1118-EF	128				
1009-BBI	117	1009-CIA	120	1118-EG	128				
1009-BCA	117	1009-CIC	120	1118-EH	128				
1009-BCC	117	1009-CIE	120	1118-EI	128				
1009-BCCF	117	1009-CIG	120	1118-EL	128				
1009-BDA	117	1009-CII	120	1118-FA	128				
1009-BGA	120	1009-CLA	120	1118-FB	129				
1009-BGB	120	1009-CLD	121	1118-FC	129				
1009-BHF	122	1009-CLE	121	1118-FD	129				
1009-BHG	122	1009-CLF	121	1118-FE	129				
1009-BHH	122	1009-CLG	121	1118-FF	129				
1009-BHI	122	1009-CLH	121	1118-FG	129				
1009-BHL	122	1009-CLI	121	1118-FH	129				
1009-BIA	122	1009-DAA	122	1118-FI	129				
1009-BIB	122	1009-DAB	122	1118-FL	129				
1009-BIC	122	1009-DAG	123	1118-GA	129				
1009-BID	122	1009-DAH	123	1118-HD	140				
1009-BIE	122	1009-DAI	123	1118-HE	140				
1009-BIF	122	1009-DCC	138	1118-HF	140				
1009-BIG	122	1009-DDA	121	1118-HG	148				
1009-BIH	122	1009-DEB	121	1118-HI	148				
1009-BII	122	1009-DDC	121	1118-HI11	223				
1009-BIL	122	1009-DDD	121	1118-IA	140				
1009-BLA	122	1009-DDE	121	1118-IB	140				
1009-BLB	122	1009-DDF	121	1118-IC	140				
1009-BLC	122	1009-DDG	121	1118-ID	140				
1009-BLD	122			1118-IE	140				
1009-BLE	122	1014-B	29	1118-IF	140				
1009-BLF	122	1014-C	29	1118-LA	139				
1009-BLG	122			1118-LB	139				
1009-BLH	122	1102-DGB	184	1118-LC	139				
1009-BLI	122	1102-DGC	184	1118-LD	139				
1009-BLL	122	1102-DGD	184	1118-LE	142				
1009-CAC	138	1102-DGE	184	1118-LF	142				
1009-CAD	138	1102-DGF	184	1118-LG	142				
1009-CAE	138	1102-DGG	184	1118-LH	142				
1009-CAF	138	1102-DGH	184	1118-LI	142				
1009-CAG	138	1102-DGI	184	1118-BAA	123				
1009-CAH	138	1102-DGL	184	1118-BAB	148				
1009-CAI	138			1118-BAC	148				
1009-CAL	138	1118-AG	143	1118-BAD	148				
1009-CBA	138	1118-AH	143	1118-BAE	148				
1009-CBB	138	1118-AI	143	1118-BAF	148				
1009-CBC	138	1118-AL	143	1118-BAG	123				
1009-CCA	119	1118-BA	126	1118-BBA	138				
1009-CCB	119	1118-BB	126	1118-BBC	142				
1009-CCC	119	1118-BC	126	1118-BBD	142				
1009-CCD	119	1118-BD	126	1118-BBE	142				
1009-CCE	119	1118-BE	126	1118-BBF	142				
1009-CCF	119	1118-BF	126	1118-BBG	141				
1009-CCG	119	1118-BG	126	1118-BBH	141				
1009-CCH	119	1118-BH	126	1118-BBL	141				
1009-CCI	119	1118-CA	127	1118-BCA	131				
1009-CCL	119	1118-CB	127	1118-BCB	141				
1009-CDA	121	1118-CC	127	1118-BCC	148				
1009-CDB	121	1118-CD	127	1118-BCD	148				
1009-CDC	121	1118-CE	127	1118-BCE	141				
1009-CDD	119	1118-CF	127	1118-BCF	130				
1009-CDI	121	1118-CG	127	1118-BCG	130				
1009-CEA	121	1118-CH	127	1118-BCH	130				
1009-CEC	121	1118-CI	127	1118-BCI	137				
1009-CEE	121	1118-CL	127	1118-BDF	130				
1009-CEG	121	1118-DA	127	1118-BDG	130				
1009-CEI	121	1118-DC	126	1118-BDH	130				
1009-CFC	120	1118-DD	126	1118-BDI	130				
1009-CFE	120	1118-EA	128	1118-BDL	130				

Nummernverzeichnis		Indice alfanumerico		Alfanumerical Index		Index alfabétique		Indice alfanumerico	
Article	Page	Article	Page	Article	Page	Article	Page	Article	Page
1118-BEA	130	1118-DLE	125	1417-BH	145				
1118-BLL	144	1118-EAA	149	1417-BI	147				
1118-CAA	144	1118-EAF	149	1417-BL	145				
1118-CAB	144	1118-EAG	149	15-FA	222				
1118-CAC	144	1118-EAH	160	15-FC	222				
1118-CCC	134	1118-EAI	160	15-LG	221				
1118-CCE	134	1118-EAL	160	15-LH	221				
1118-CCH	132	1118-EBA	149	15-BAA	222				
1118-CCI	132	1123-IA	158	15-BAB	221				
1118-CCL	132	1123-IC	162	15-BAC	221				
1118-CDA	134	1123-LC1903	162	15-BAD	222				
1118-CDB	134, 135	1123-LF1903	162	15-BCA	221				
1118-CDC	134	1123-LG1903	162	15-BCB	221				
1118-CDD	132	1123-LL	162	15-BDC	222				
1118-CDE	134	1123-BAB	163	15-BDD	222				
1118-CDF	135	1123-BAC	163	15-CGE	221				
1118-CDG	132, 133	1123-BAD	163	15-CGF	221				
1118-CDH	133	1123-BAE	164	1508-DI	220				
1118-CDI	133	1123-BAF	164	1508-FD	220				
1118-CDL	133	1123-BAG	164	1508-FE	220				
1118-CEA	131	1123-BAH	165	1508-FF	161				
1118-CEB	132, 133	1123-BAI	111	1508-FG	161				
1118-CEC	131	1123-BAL	111	1508-FH	161				
1118-CEE	131	1123-BBA	111	1508-FI	161				
1118-DAA	205	1123-BBB	111	1508-FJ	161				
1118-DAB	205	1123-BBD	167	1508-GE	220				
1118-DAC	205	1123-BBE	167	1508-GF	220				
1118-DAD	205	1123-BBF	167	1508-HB	220				
1118-DBA	136	1123-BBG	111	1508-HD	220				
1118-DBB	136	1123-BCA	168	1508-BEA	220				
1118-DBC	136	1123-BCB	168	1508-BEB	220				
1118-DBD	136	1123-BCC	168	1508-BEC	220				
1118-DBE	136	1123-BCD	168	1514-II	220				
1118-DBF	136	1123-BCF	159	1514-LE	220				
1118-DBG	137	1123-BCG	166	1907-EA	70				
1118-DBH	137	1123-BDA	157	1907-EB	70				
1118-DBI	137	1123-BDB	157	1917-HG	151				
1118-DCA	135	1123-BDE	156	1917-HH	151				
1118-DCB	135	1123-BDF	156	1917-HI	151				
1118-DCC	135	1123-BDG	156	2106-LI	165				
1118-DCD	135	1123-BDH	156	2106-LI12	165				
1118-DCE	135	1123-BDI	157	2108-CA	158				
1118-DCF	135	1123-BDL	157	2108-CB	158				
1118-DCG	135	1123-BEA	157	2108-CD	158				
1118-DCL	135	1123-BEB	157	2108-CF	158				
1118-DDA	135	1123-BFA	166	2108-EA	159				
1118-DHA	124	1123-BFB	166	2207-BA	29				
1118-DHB	124	1310-B	184	2207-BC	29				
1118-DHC	124	1310-C	184	2207-BE	29				
1118-DHD	124	1310-DB	203						
1118-DHE	124	1310-DD	203						
1118-DHF	124	1310-DF	203						
1118-DHG	124	1310-DH	203						
1118-DHH	124	1310-FA	203						
1118-DHI	124	1310-FB	203						
1118-DHL	124	1310-FC	203						
1118-DIA	124	1310-FD	203						
1118-DIB	124	1310-FE	203						
1118-DIC	124	1310-FF	203						
1118-DID	124	1310-FG	203						
1118-DIE	124	1310-FH	203						
1118-DIF	125	1417-BB	145						
1118-DIG	125	1417-BC	146						
1118-DIH	125	1417-BD	145						
1118-DII	125	1417-BE	146						
1118-DIL	125	1417-BF	145						
1118-DLA	125	1417-BG	147						
1118-DLB	125								
1118-DLC	125								
1118-DLD	125								



ideal-tek
manufacturer & supplier of precision instruments 

Ideal-tek SA
via Motta 4
6828 Balerna
Switzerland

Phone: +41 91 683 32 29
Fax: +41 91 683 03 71
E-mail: info@ideal-tek.com