

Kanüle für Liposculture

Cannula for Liposculture

Cannule da Liposcultura

Cànulas de Liposcultura

Canules pour Liposculture





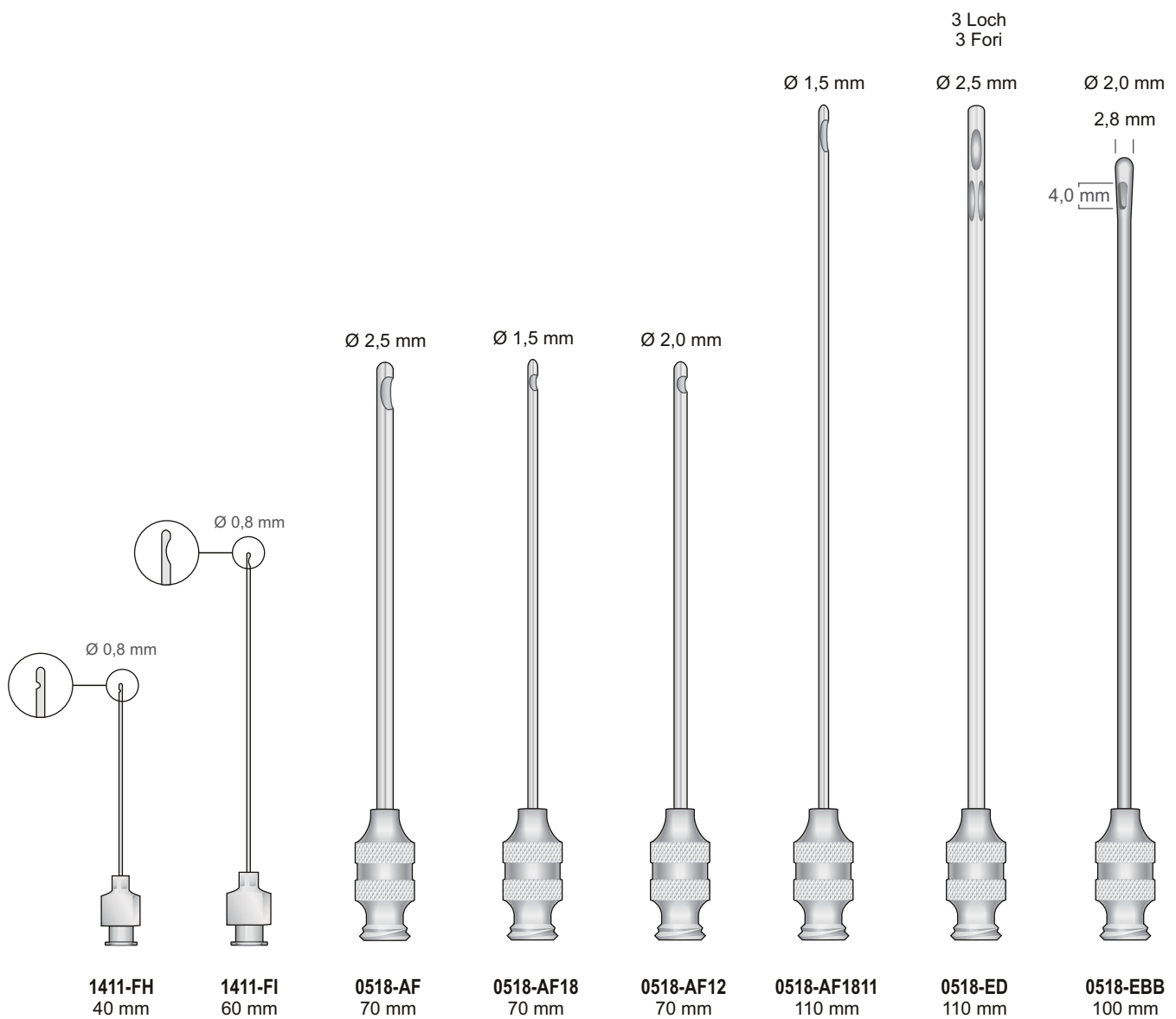

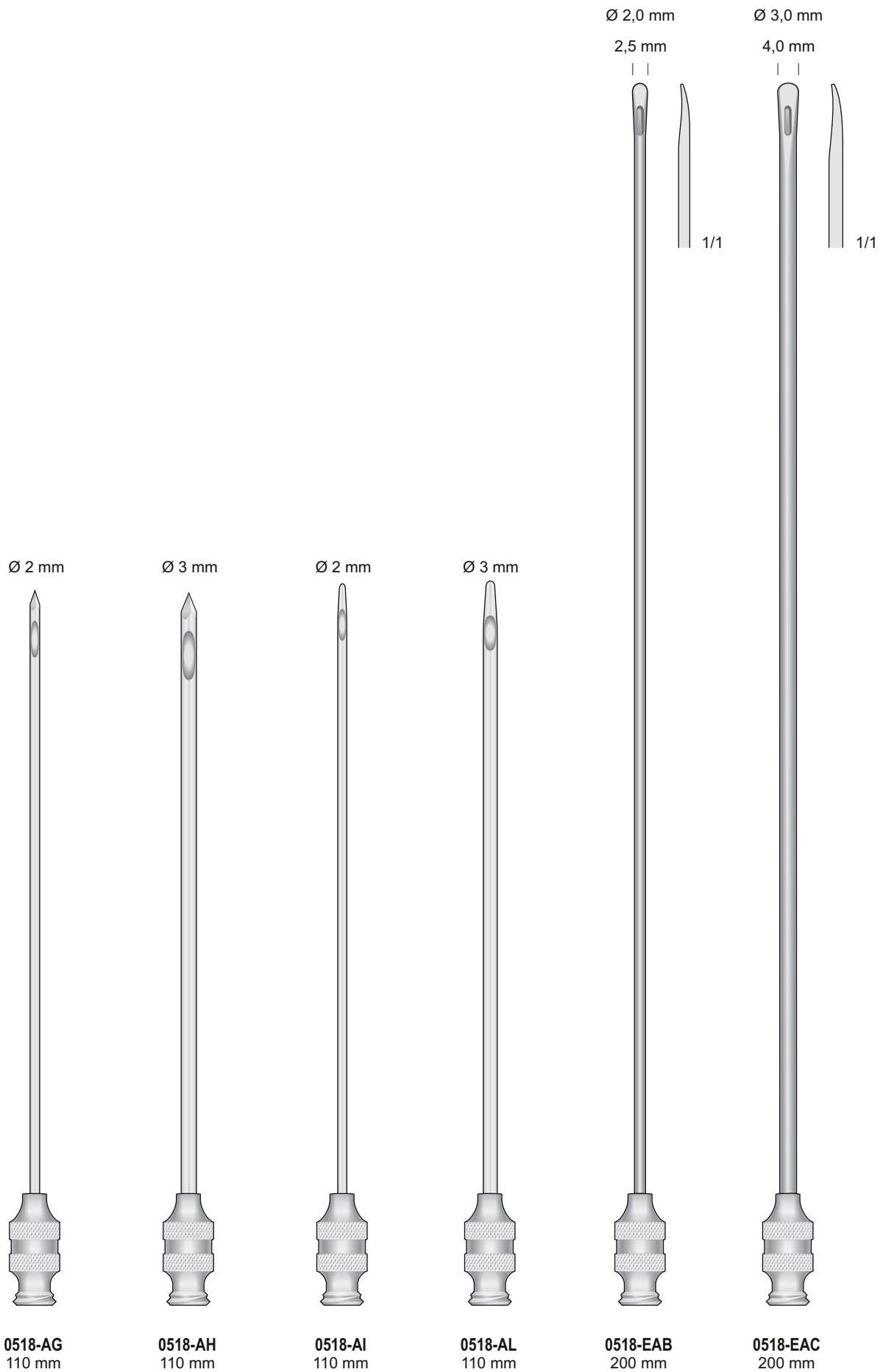

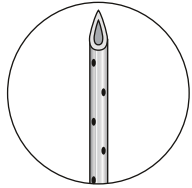

6 Loch
6 Openings
6 Fori
6 Bucos
6 Troues
Ø 1,3 mm

6 Loch
6 Openings
6 Fori
6 Bucos
6 Troues
Ø 1,5 mm

6 Loch - 6 Openings
6 Fori - 6 Bucos
6 Troues
Ø 1,5 mm

7 Loch
7 Openings
7 Fori
7 Bucos
7 Troues
Ø 1,5 mm

2 Loch
2 Openings
2 Fori
2 Bucos
2 Troues
Ø 2,0 mm

5 Loch
5 Openings
5 Fori
5 Bucos
5 Troues
Ø 2,0 mm

5 Loch
5 Openings
5 Fori
5 Bucos
5 Troues
Ø 1,5 mm

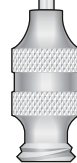
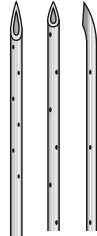
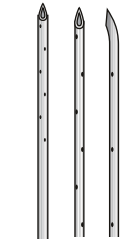

0518-DE
120 mm

0518-DF
200 mm

0518-DG
270 mm

0518-EB
100 mm

0518-FB
150 mm

0518-FC
150 mm

0518-FD
150 mm

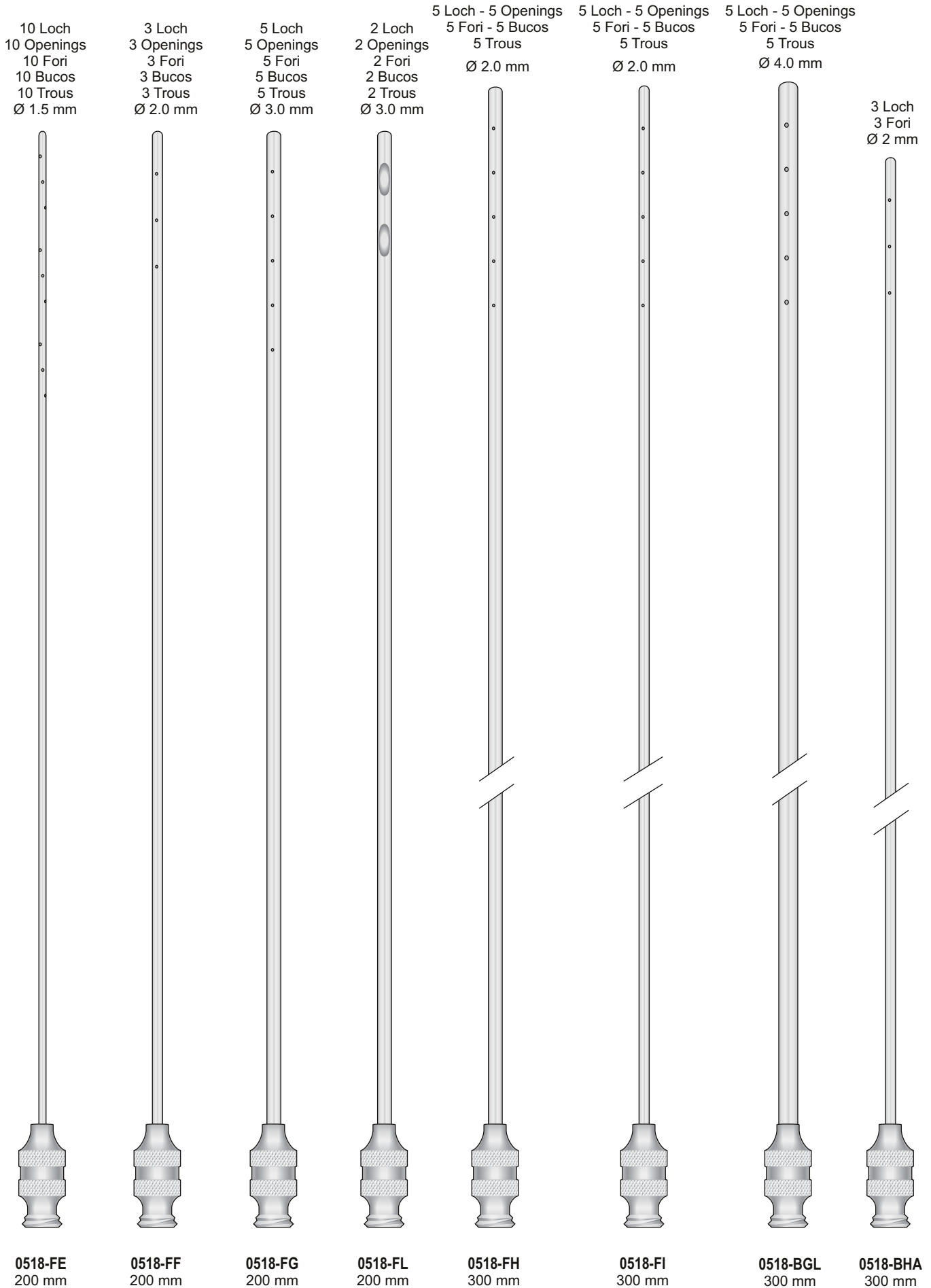

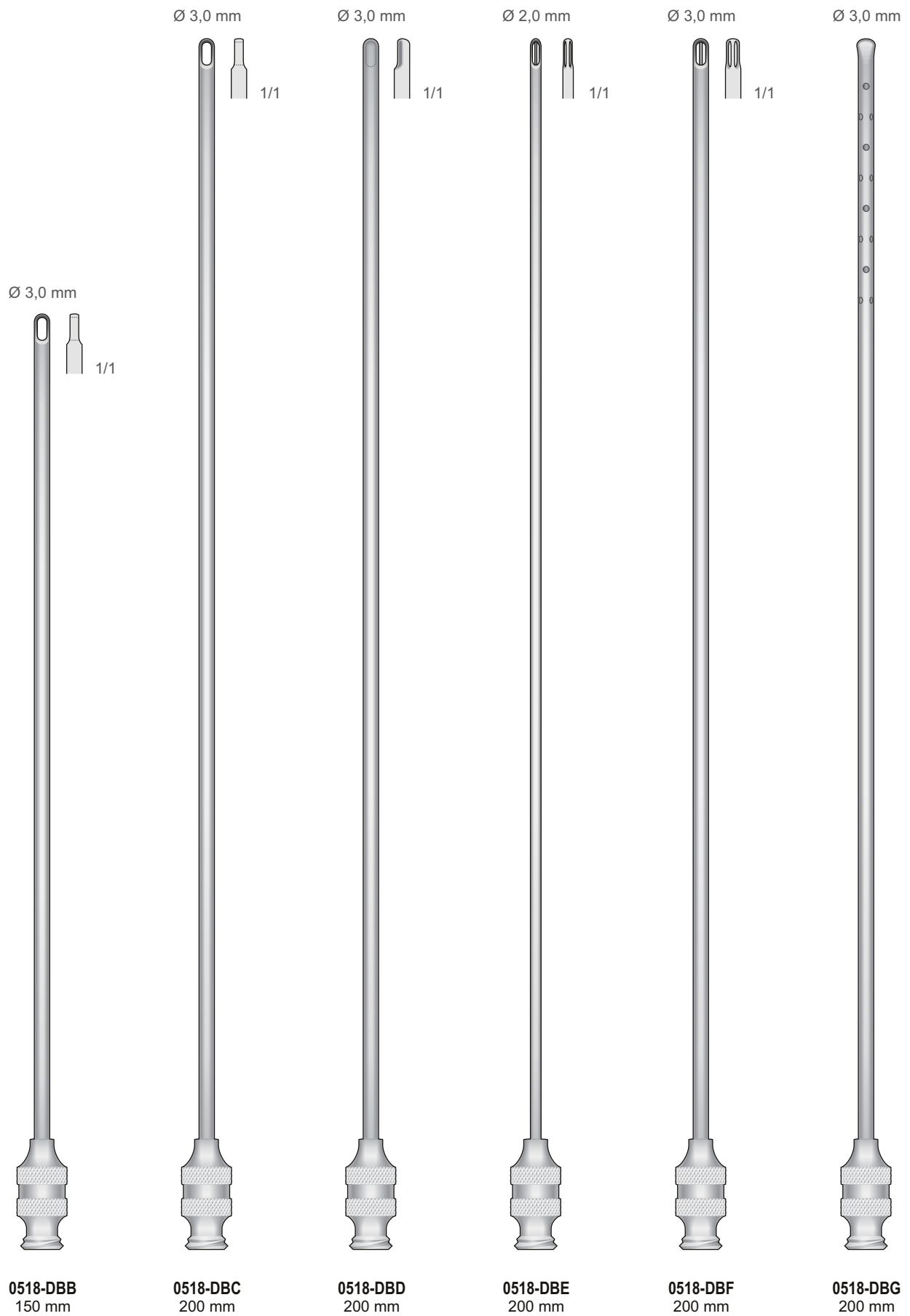

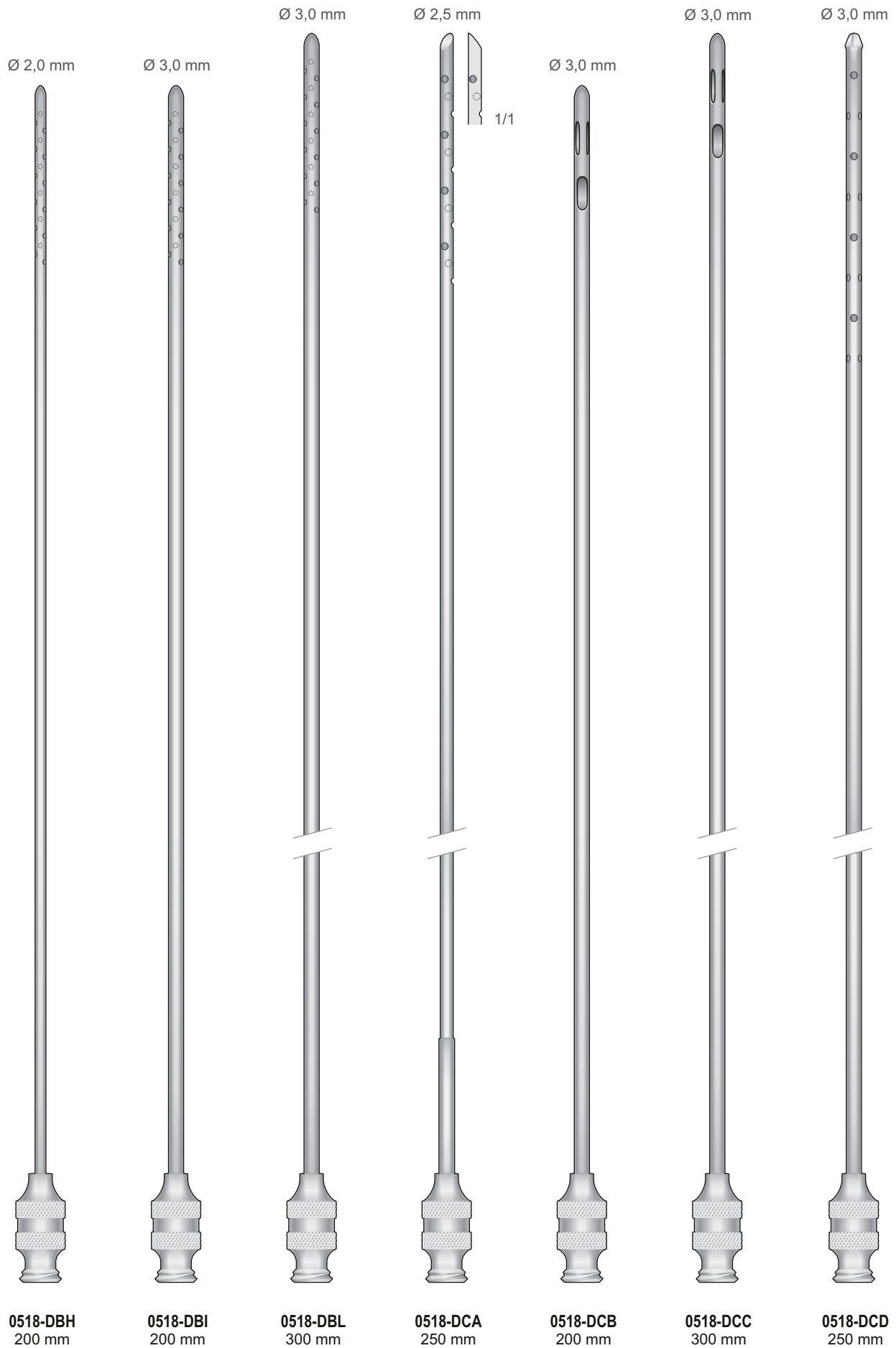

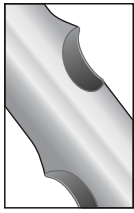

Loch
Foro
Ø 0,8 mm

Ø 1,5 mm Ø 2,5 mm Ø 2,0 mm

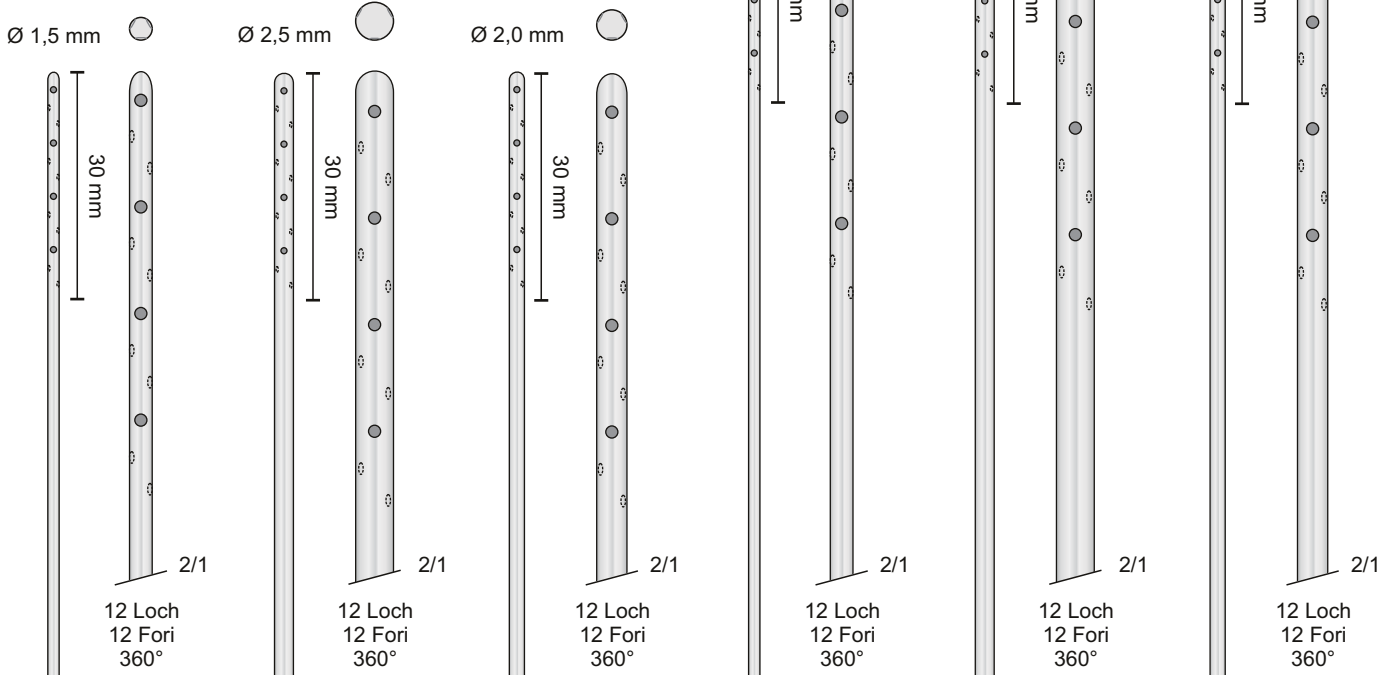

PELLE CERAVOLO 0518-EBL 150 mm
PELLE CERAVOLO 0518-ECA 150 mm
PELLE CERAVOLO 0518-ECB 150 mm
PELLE CERAVOLO 0518-ECC 200 mm
PELLE CERAVOLO 0518-ECD 200 mm
PELLE CERAVOLO 0518-ECE 200 mm

Luer Lock



0518-AE

Rostfreies Verbindungsteil zum Stahlgriff-Kanüle Luer Lock
Stainless Steel Connetor for handle-cannula Luer Lock
Raccordo inox per Manico-Cannula Luer Lock
Conector en acero para manija-canulas Luer Lock
Connecteur en acier pour Poignée-Canule Luer Lock

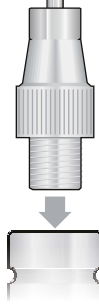

Stainless Steel
Ø 15 mm

Aluminium
Ø 18 mm

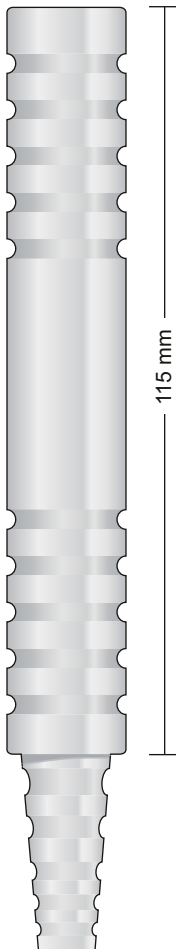

0518-DL
145 mm

Blue Aluminium
Ø 18 mm

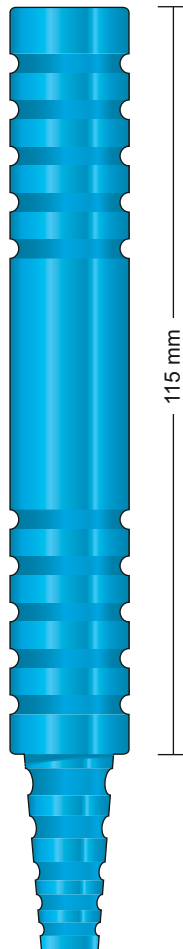

0518-FA
145 mm

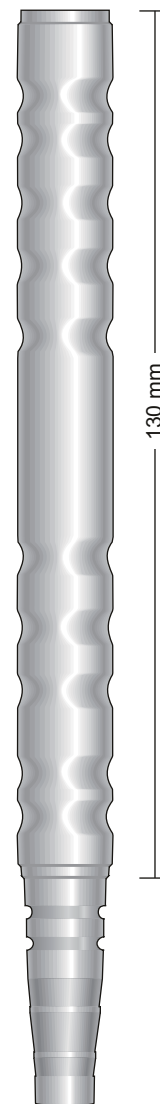

0518-EL
165 mm

Kit-Lipofilling



0518-FE
Micro Cannula da infiltrazione - Anestetico
200 mm - Ø 1,5 mm - 10 fori



0518-DBC
Cannule da Liposcultura - Prelievo
200 mm - Ø 3,0 mm



0518-DBD
Cannule da Liposcultura - Prelievo
200 mm - Ø 3,0 mm



0518-DBB
Cannule da Liposcultura - Prelievo
150 mm - Ø 3,0 mm



0518-AI
Micro Cannula da infiltrazione - 1 foro
110 mm - Ø 2,0 mm



0518-ED
Micro Cannula da prelievo - 3 fori
110 mm - Ø 2,5 mm



0518-AF1811
Micro Cannula da infiltrazione - 1 foro
110 mm - Ø 1,5 mm



0518-AF12
Micro Cannula da infiltrazione - 1 foro
70 mm - Ø 2,0 mm



0518-AF18
Micro Cannula da infiltrazione - 1 foro
70 mm - Ø 1,5 mm

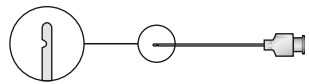

1411-FH
Micro Cannula palpebrale - 1 foro
40 mm - Ø 0,8 mm

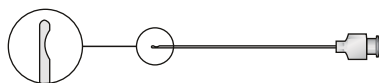

1411-FI
Micro Cannula palpebrale - 1 foro
60 mm - Ø 0,8 mm

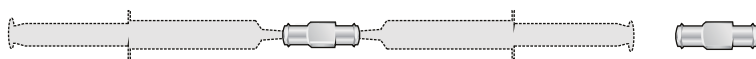

0518-AD
Trasferitore di grasso - 21,0 mm
Raccordo Luer Lock per siringhe



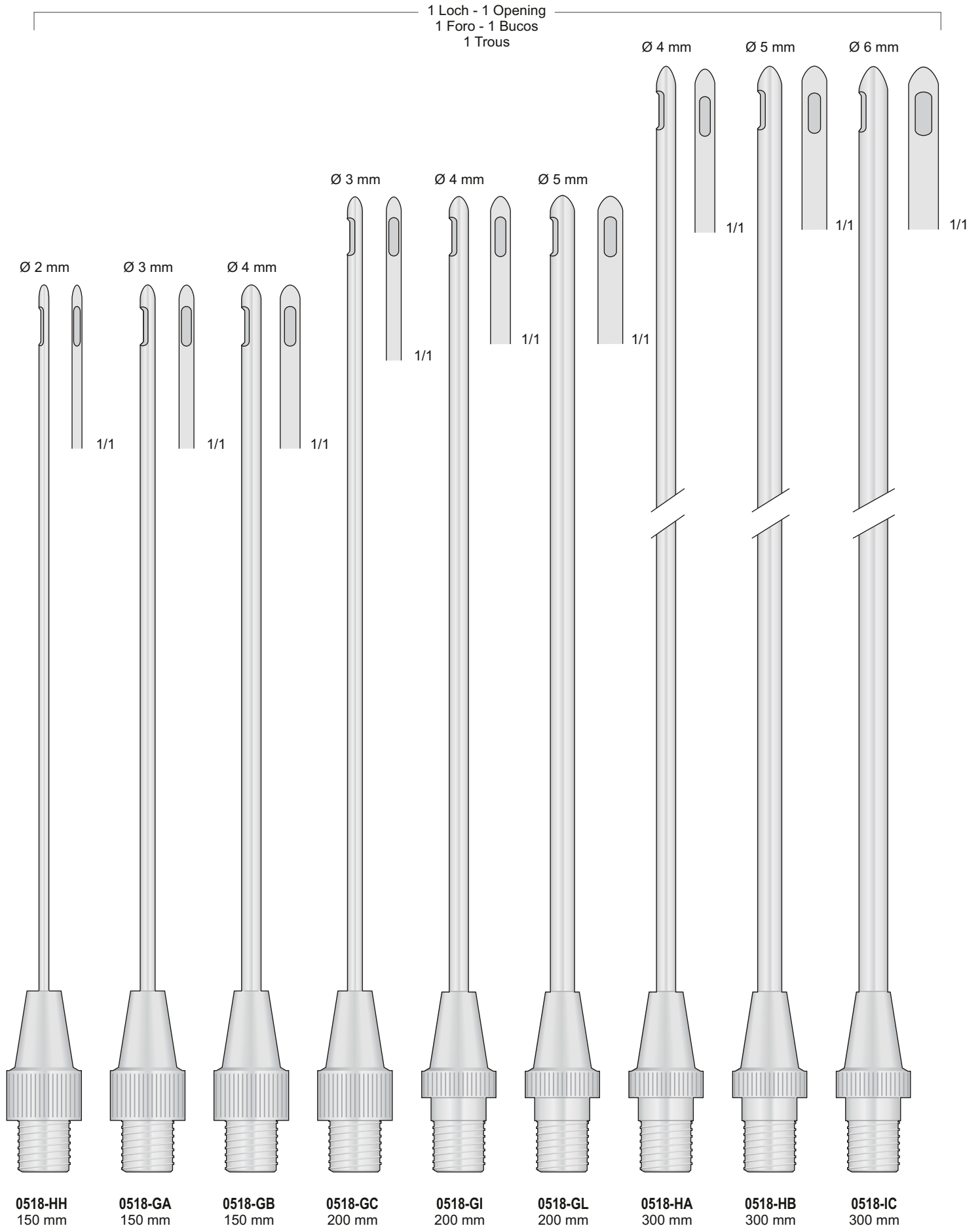

3 Loch - 3 Openings
3 Fori - 3 Bucos
3 Trous

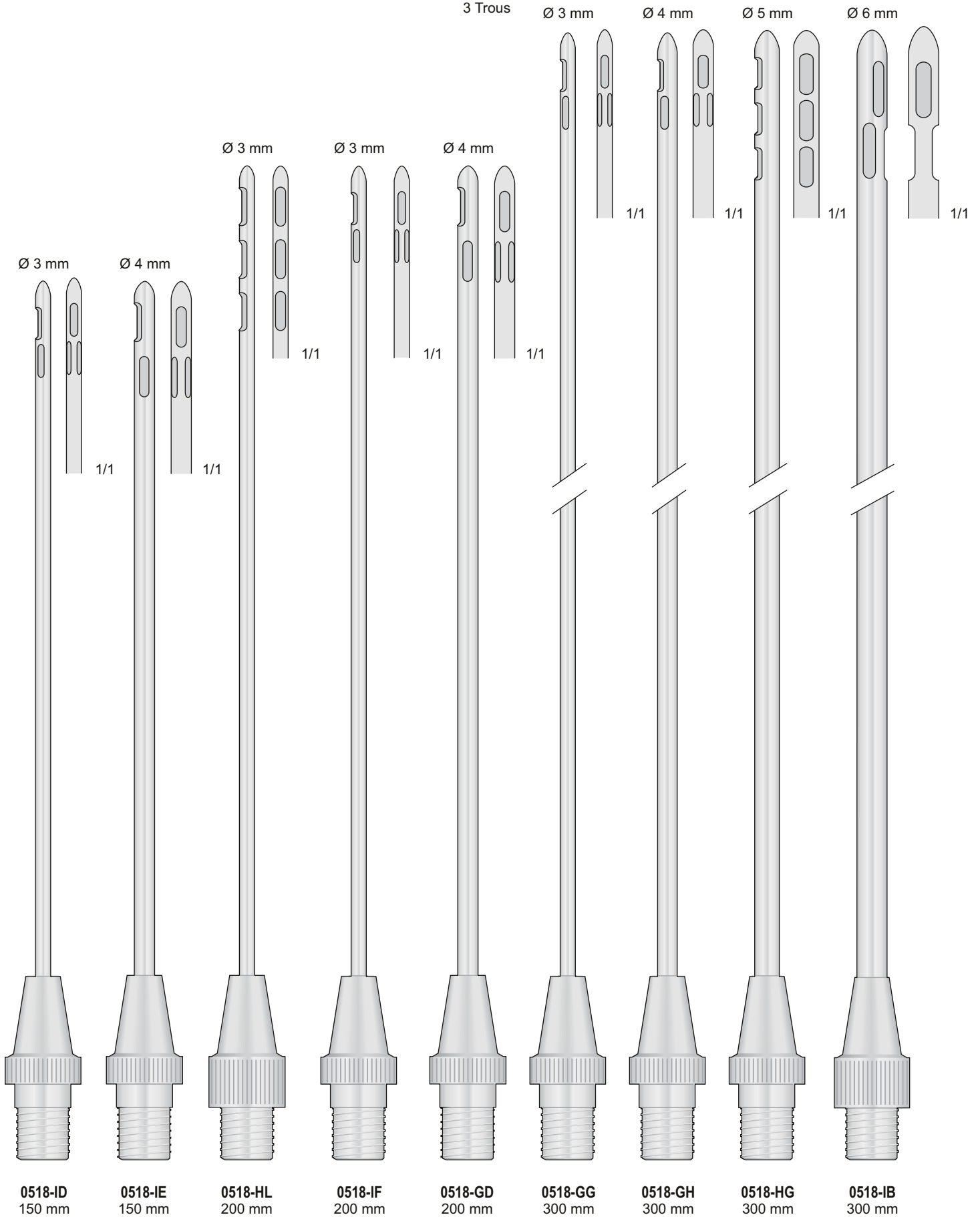

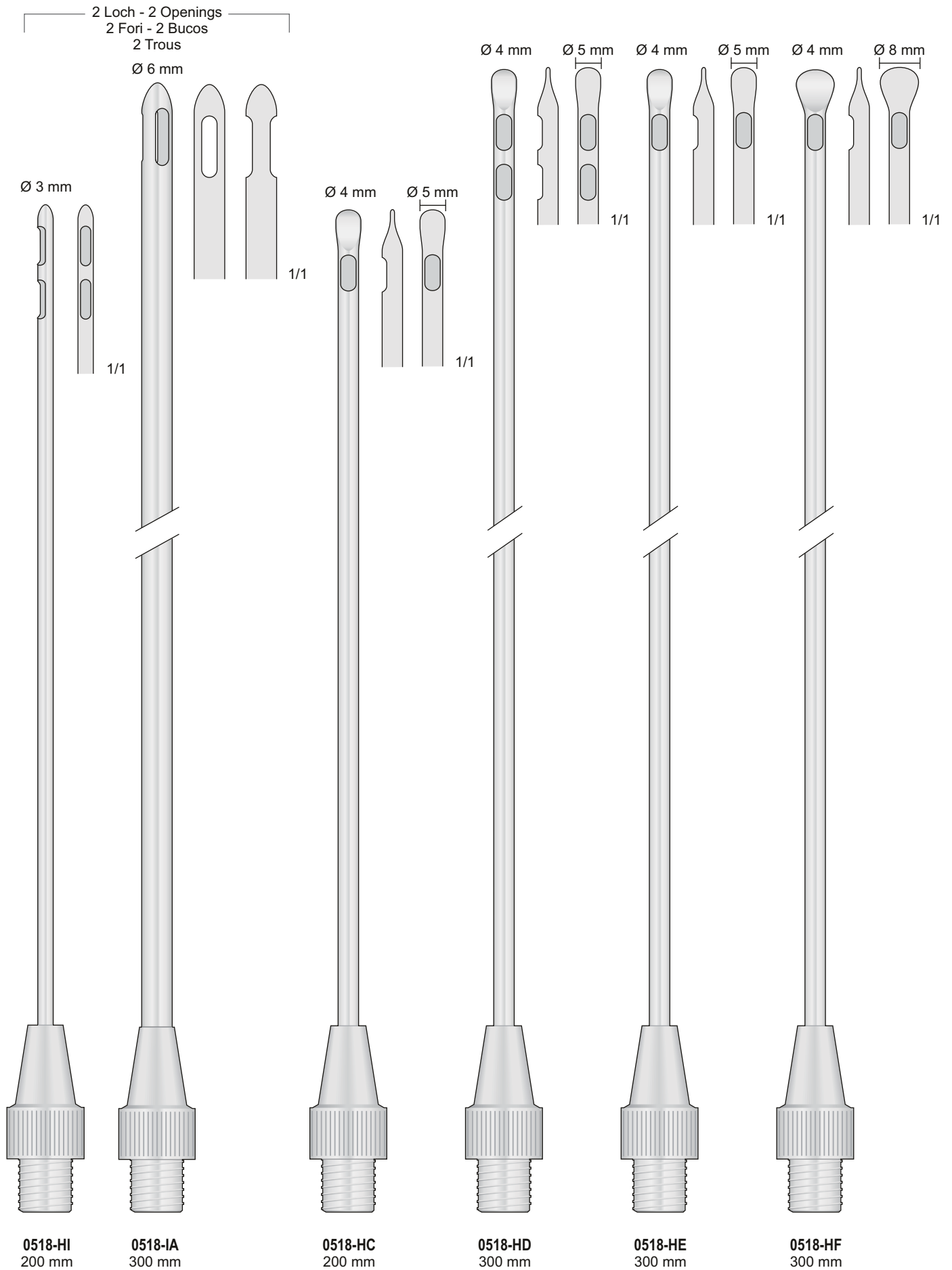

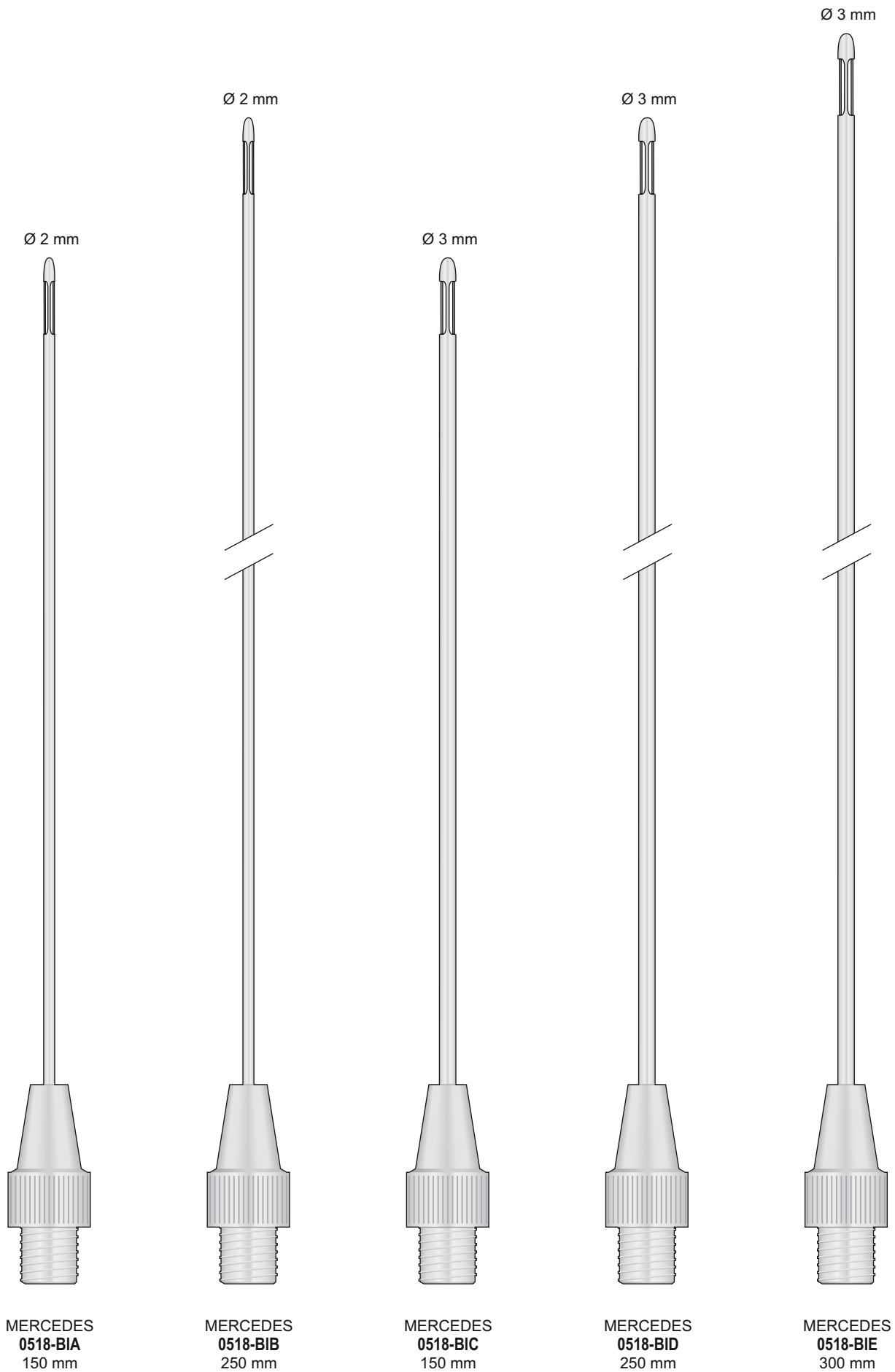

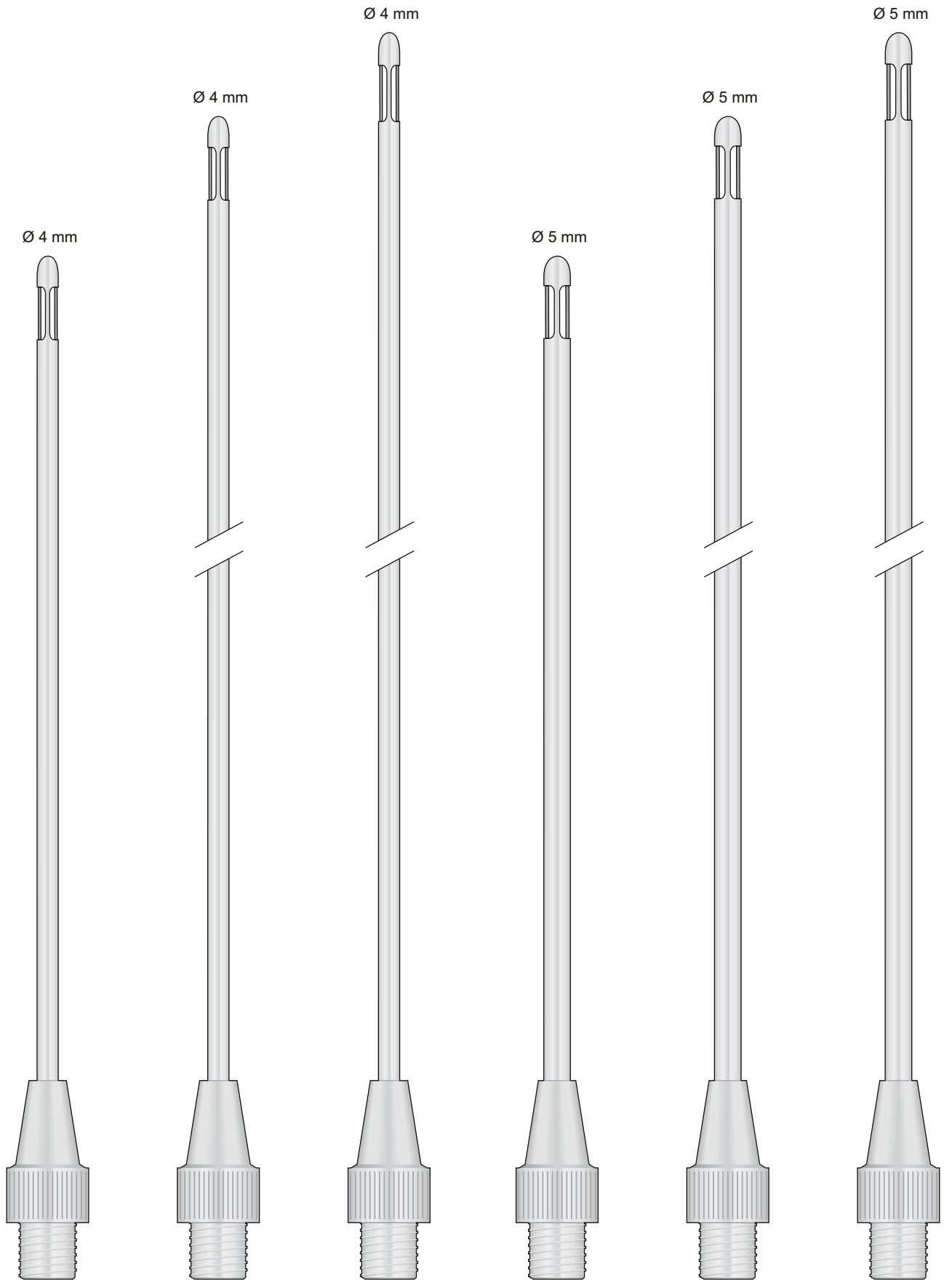

MERCEDES
0518-BIF
150 mm

MERCEDES
0518-BIG
250 mm

MERCEDES
0518-BIH
300 mm

MERCEDES
0518-BII
150 mm

MERCEDES
0518-BIL
250 mm

MERCEDES
0518-BLA
300 mm

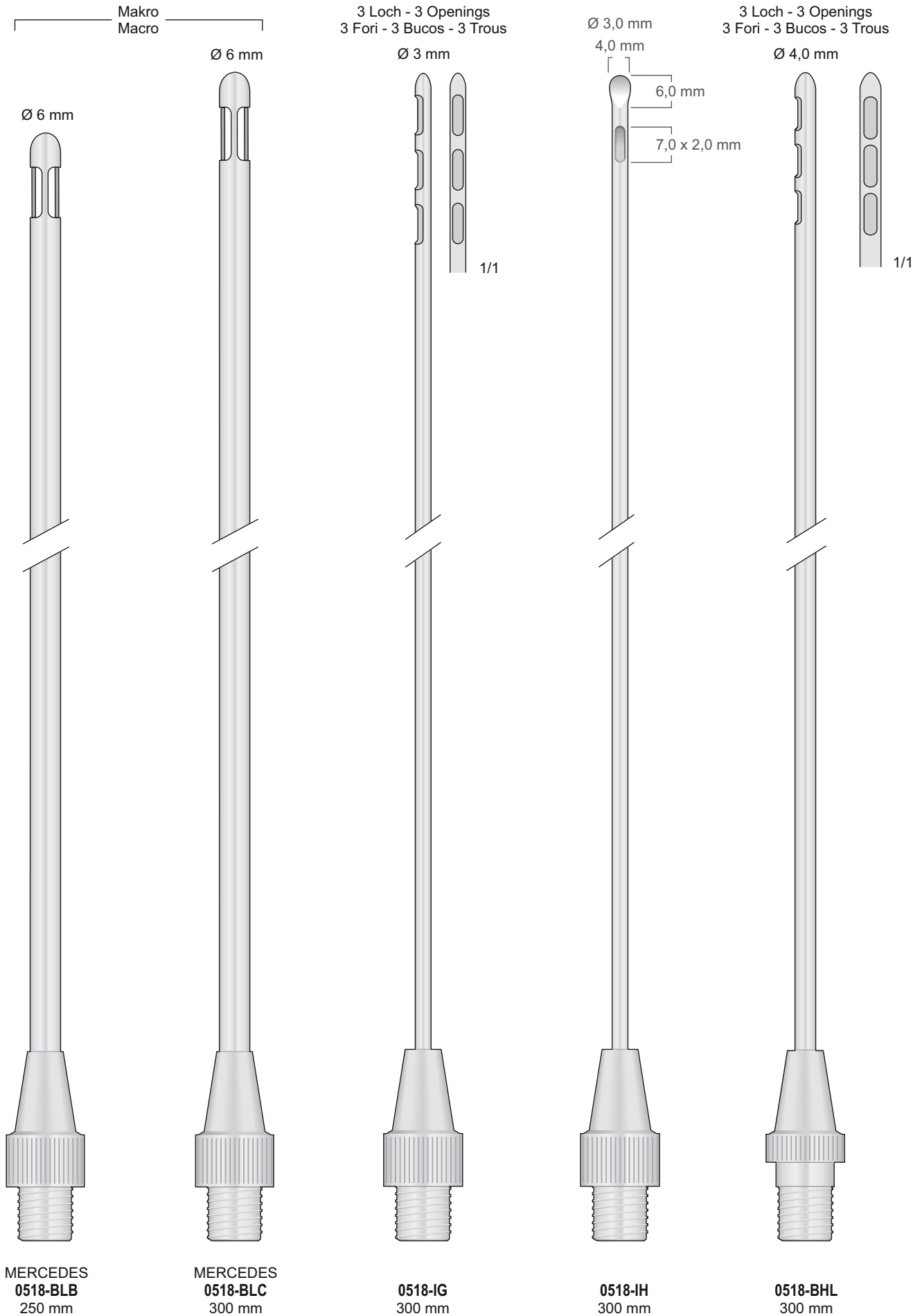

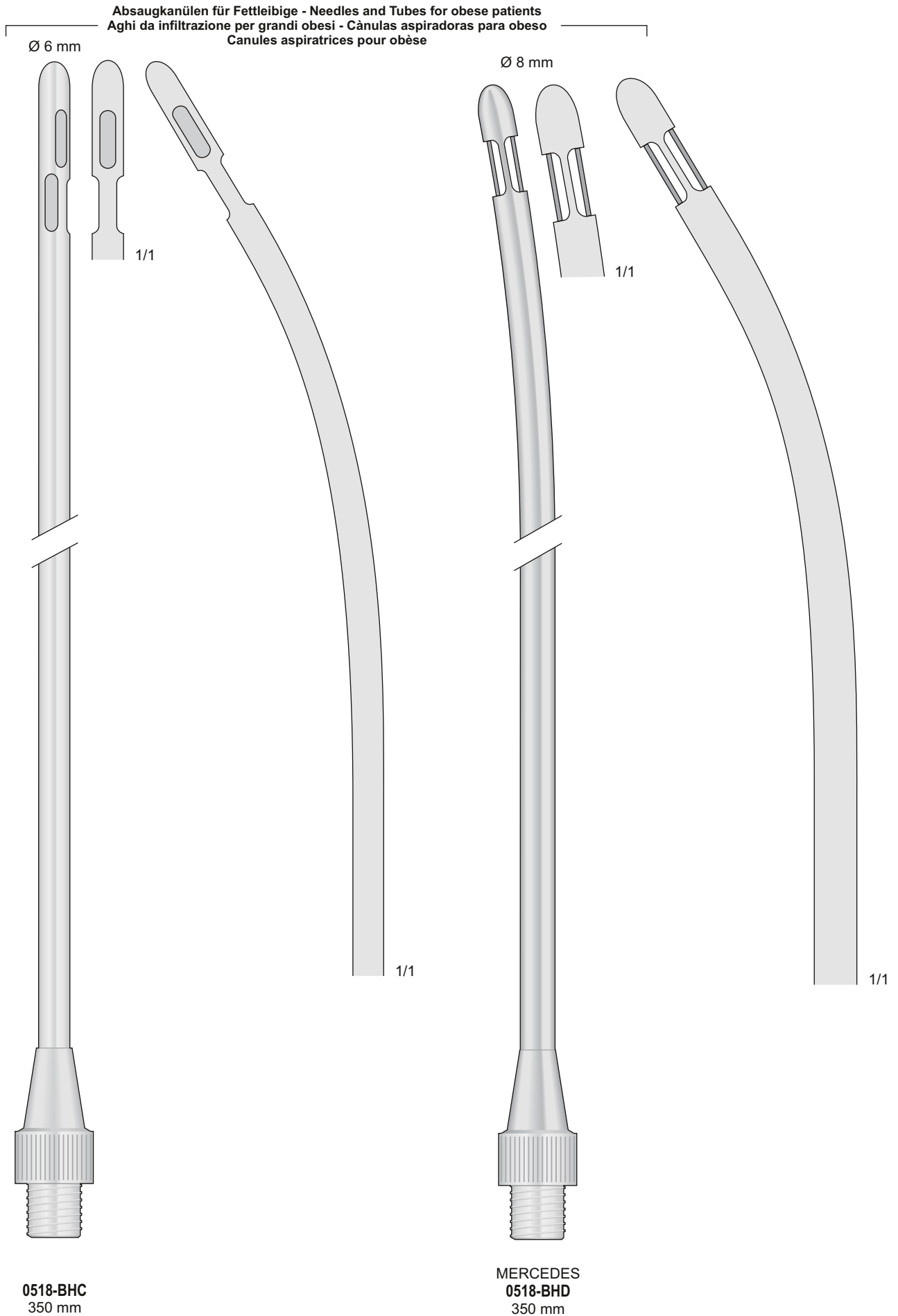

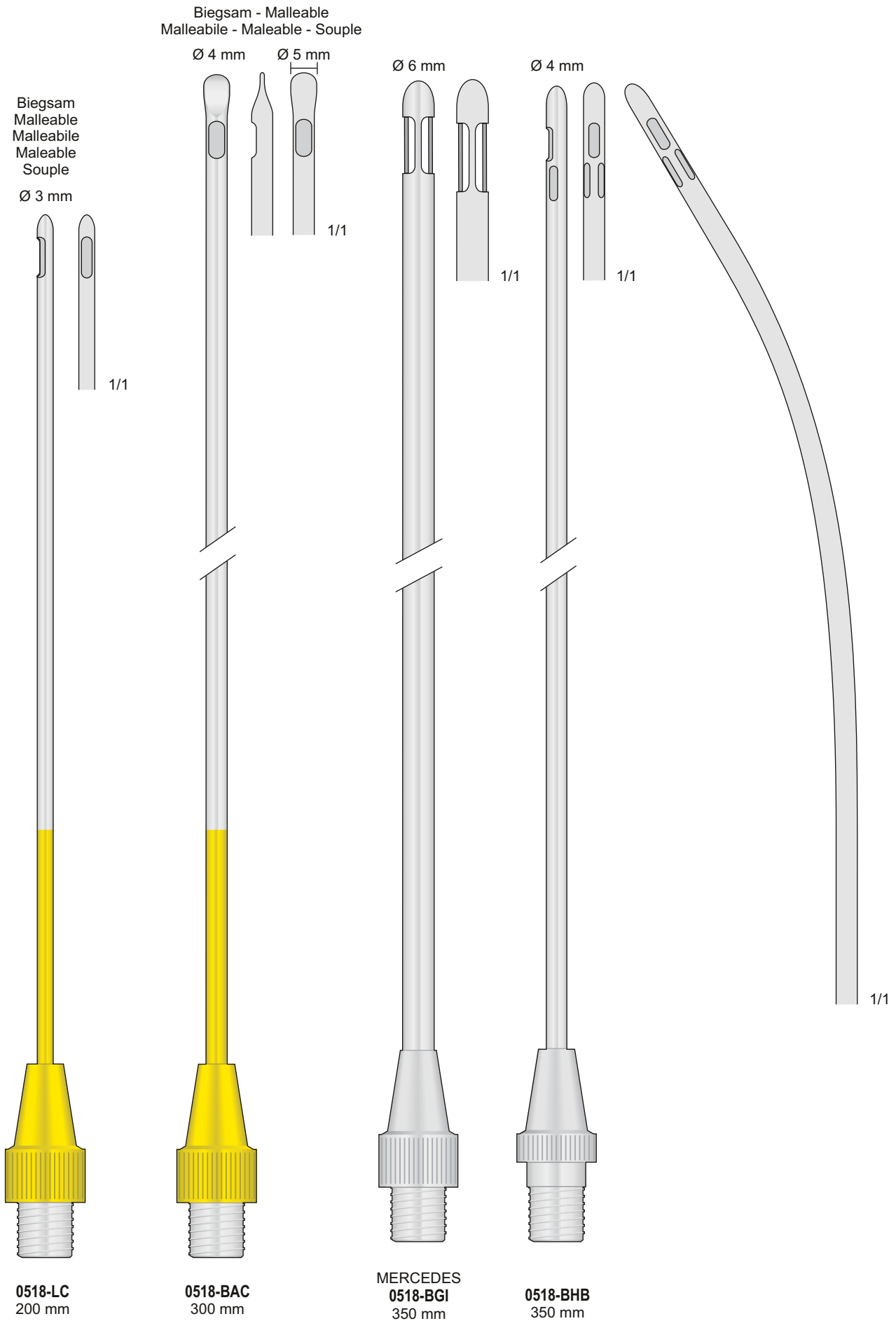

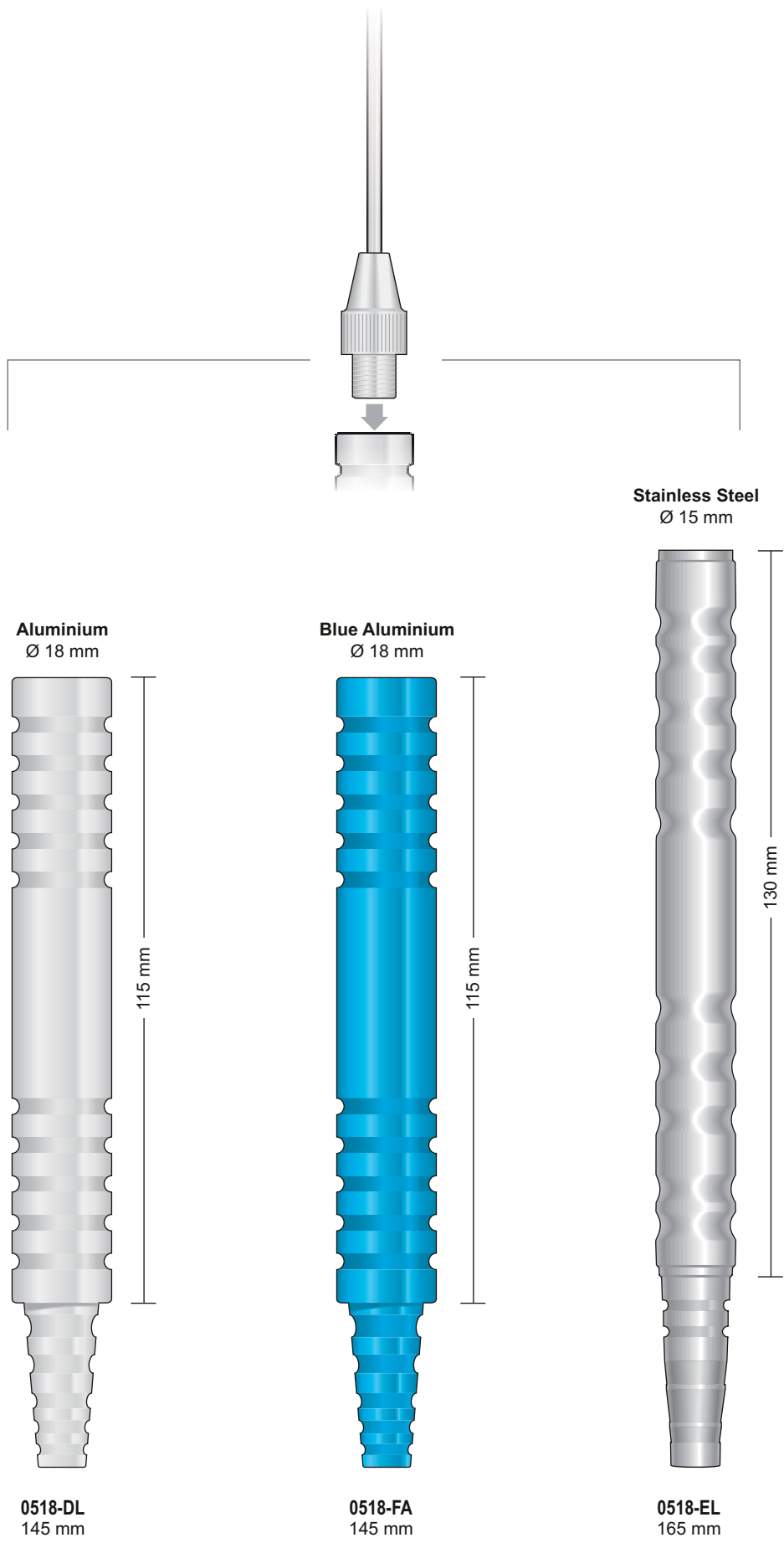

Adapter for Syringe
PIC 50ml
BD 50ml
HENKE 50ml
 or similar measure

Aluminium Blue



0518-AC



Luer Lock



1804-FA
 50 ml

Spritzenstop, zur Gewinnung
 eines Vakuums in der Spritze
 Stop for syringes,
 lock maintains vacuum in the syringe
 Stop per siringhe
 Stop pour siringe



0518-BBB
 115 mm



0518-BBC
 115 mm

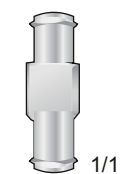

Luer Lock

Beschlag für zwei Spritzen
 Connection for two syringes
 Raccordo per due siringhe
 Herraje para dos jeringas
 Raccord pour deux seringues

0518-AD
 21 mm

Kit-Liposuction

0518-AC



Universal Adapter
for Syringe

Aluminium Blau
Aluminium Blue
Alluminio Blu
Aluminio Azul
Aluminium Bleu

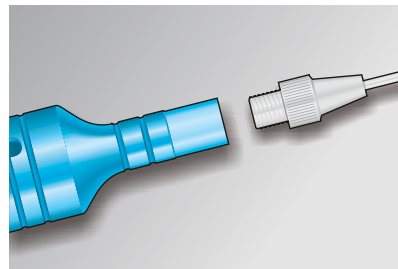

0518-BIE

0518-BIH

0518-EL

165 mm - Ø 15 mm

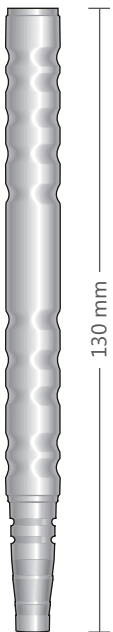

130 mm

Rostfrei
Stainless Steel
Acciaio Inox
Acero inoxidable
Acier inoxydable

0518-BIC

0518-BBC

115 mm

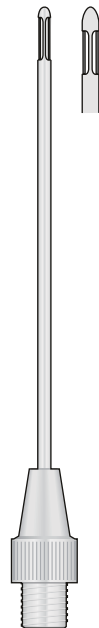

0518-BIC
Ø 3,0 mm
150 mm

MERCEDES
3 Loch
3 Openings
3 Fori
3 Bucos
3 Troues

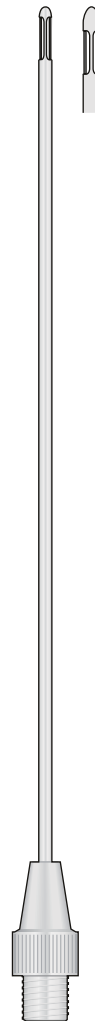

0518-BIE
Ø 3,0 mm
300 mm

MERCEDES
3 Loch
3 Openings
3 Fori
3 Bucos
3 Troues

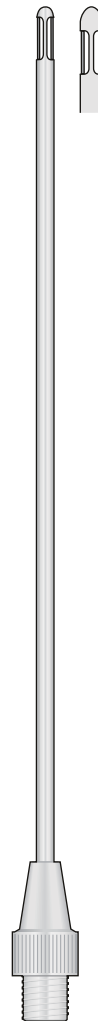

0518-BIH
Ø 4,0 mm
300 mm

MERCEDES
3 Loch
3 Openings
3 Fori
3 Bucos
3 Troues

0518-AC	22	0518-IA	15	0518-EBB	3
0518-AD	22	0518-IB	14	0518-EBL	9
0518-AE	10	0518-IC	13	0518-ECA	9
0518-AF	3	0518-ID	14	0518-ECB	9
0518-AF12	3	0518-IE	14	0518-ECC	9
0518-AF18	3	0518-IF	14	0518-ECD	9
0518-AF1811	3	0518-IG	18	0518-ECE	9
0518-AG	4	0518-IH	18		
0518-AH	4	0518-LC	20	1411-FH	3
0518-AI	4	0518-BAC	20	1411-FI	3
0518-AL	4	0518-BBB	22		
0518-DE	5	0518-BBC	22	1804-FA	22
0518-DF	5	0518-BGI	20		
0518-DG	5	0518-BGL	6		
0518-DL	10, 21	0518-BHA	6		
0518-EB	5	0518-BHB	20		
0518-ED	3	0518-BHC	19		
0518-EL	10, 21	0518-BHD	19		
0518-FA	10, 21	0518-BHL	18		
0518-FB	5	0518-BIA	16		
0518-FC	5	0518-BIB	16		
0518-FD	5	0518-BIC	16		
0518-FE	6	0518-BID	16		
0518-FF	6	0518-BIE	16		
0518-FG	6	0518-BIF	17		
0518-FH	6	0518-BIG	17		
0518-FI	6	0518-BII	17		
0518-FL	6	0518-BIL	17		
0518-GA	13	0518-BLA	17		
0518-GB	13	0518-BLB	18		
0518-GC	13	0518-BLC	18		
0518-GD	14	0518-DBB	7		
0518-GG	14	0518-DBC	7		
0518-GH	14	0518-DBD	7		
0518-GI	13	0518-DBE	7		
0518-GL	13	0518-DBF	7		
0518-HA	13	0518-DBG	7		
0518-HB	13	0518-DBH	8		
0518-HC	15	0518-DBI	8		
0518-HD	15	0518-DBL	8		
0518-HE	15	0518-DCA	8		
0518-HF	15	0518-DCB	8		
0518-HG	14	0518-DCC	8		
0518-HH	13	0518-DCD	8		
0518-HI	15	0518-EAB	4		
0518-HL	14	0518-EAC	4		



ideal-tek

manufacturer & supplier of precision instruments 



ideal-tek
manufacturer & supplier of precision instruments 

Ideal-tek SA
via Motta 4
6828 Balerna
Switzerland

Phone: +41 91 683 32 29
Fax: +41 91 683 03 71
E-mail: info@ideal-tek.com