

**Additions
and New Products**

chirurgie katalog

Surgical catalogue
Catalogo chirurgico
Catálogo cirugía
Catalogue chirurgie



SPENCER
1803-BE
120 mm

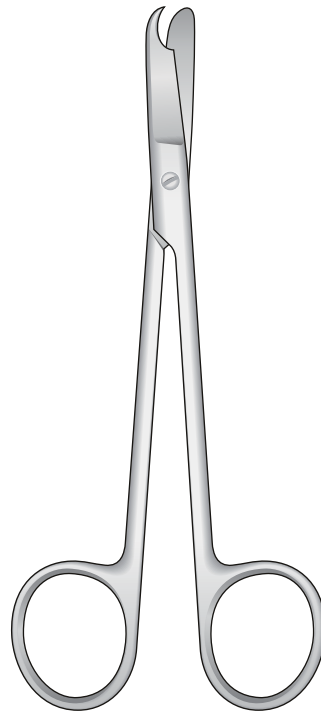

LITTAUER
1803-BF
140 mm

Diagnostik-Bestecke - Diagnostic Sets
Set Diagnostica - Set Diagnóstico
Trousse à Diagnostic

Halogen - Alogeno



0102-EL
Otoscopio completo con custodia

Etui für McINTOSH Fig. 1-3
Case for McINTOSH Fig. 1-3
Cassetta per laringoscopio McINTOSH Fig. 1-3
Estuche para McINTOSH Fig. 1-3
Etui pour McINTOSH Fig. 1-3



0101-05BAD

Feine Scheren

Delicate Scissors

Forbici delicate

Tijeras finas

Ciseaux délicate

“Ribbon type”

Mit großen Ringen
With large rings
Forbici ad anelli grandi
Con anillos especialmente grandes
avec larges anneaux

Iris scissors

Blepharoplasty
Blefaroplastica

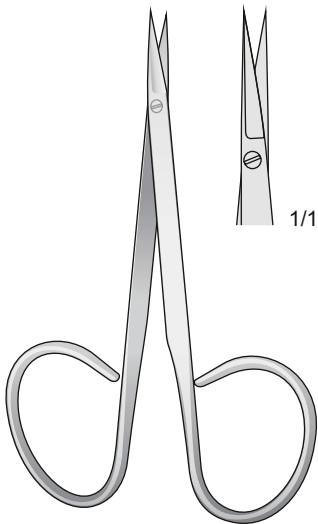

0607-CAA
95 mm

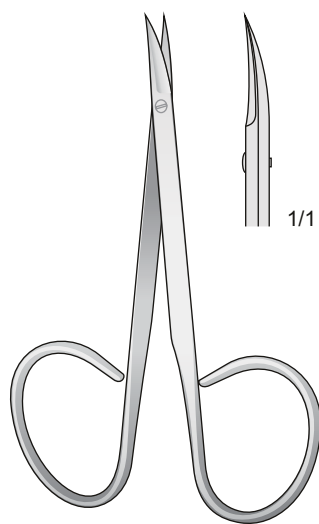

0607-CAB
95 mm

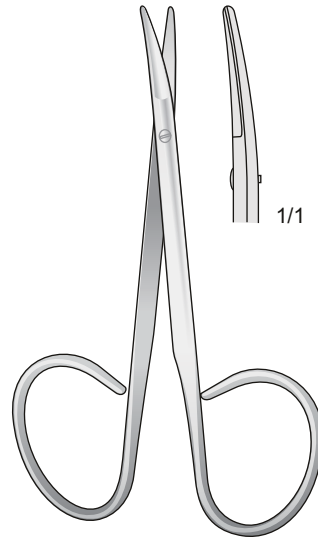

0607-CAC
95 mm

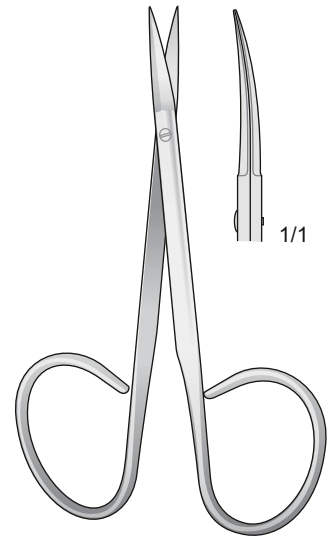

0607-CAD
105 mm

Iris scissors

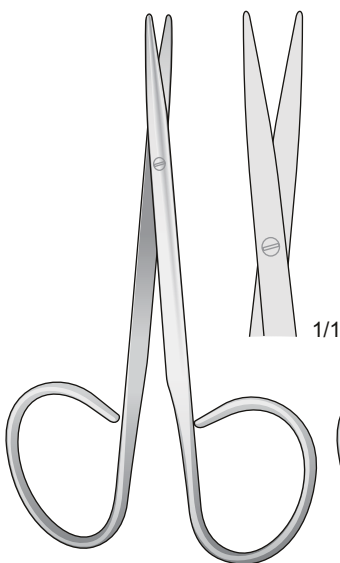

0607-CAE
100 mm

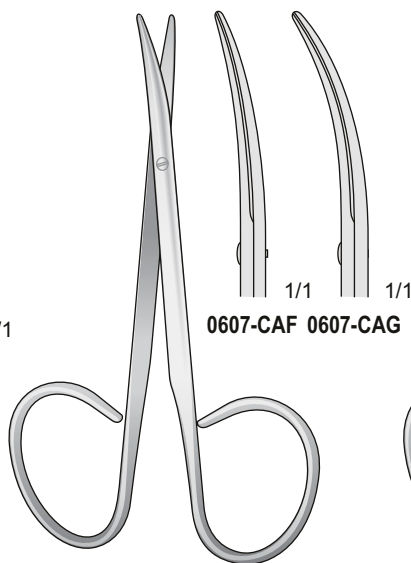

0607-CAF/0607-CAG
100 mm

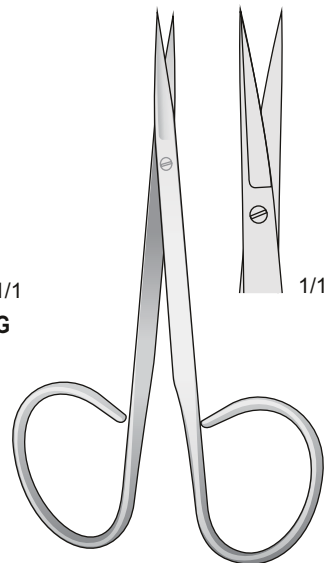

0607-CAH
105 mm

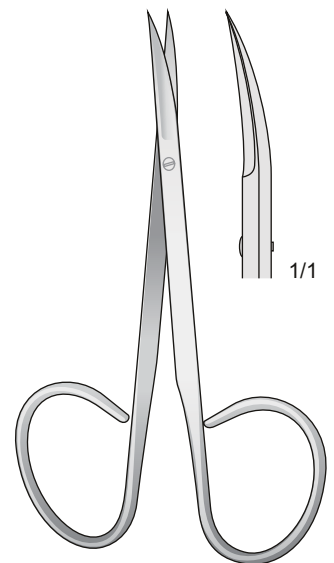

0607-CAI
105 mm

Feine Scheren

Delicate Scissors

Forbici delicate

Tijeras finas

Ciseaux délicate

"Ribbon type"

Mit großen Ringen
With large rings
Forbici ad anelli grandi
Con anillos especialmente grandes
avec larges anneaux

Spitz
Sharp
Acuta
Aguda
Pointu

Stumpf
Blunt
Smussa
Romas
Mousse

Gezahnt
Serrated
Dentellata
Dentadas
Dentelés

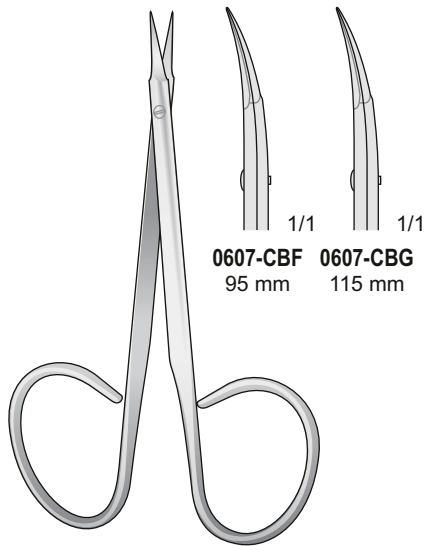

STITCH
0607-CBF/0607-CBG

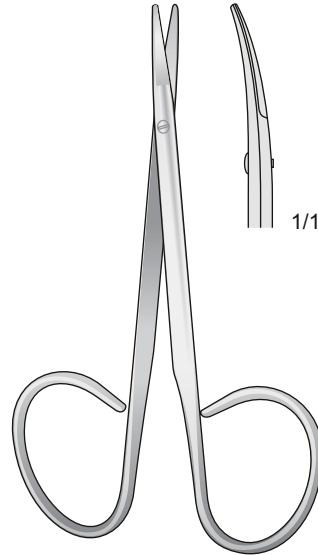

0607-CBH
100 mm

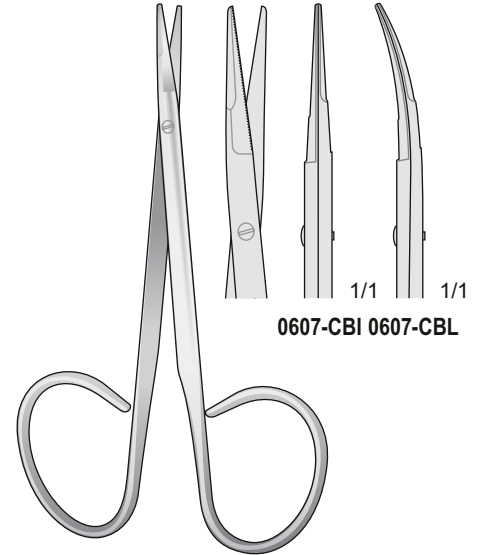

KAYE
0607-CBI/0607-CBL
105 mm

Stumpf - Blunt
Smussa - Romas
Mousse

Stumpf - Blunt
Smussa - Romas
Mousse

Spitz - Sharp
Acuta - Aguda
Pointu

Spitz - Sharp
Acuta - Aguda
Pointu

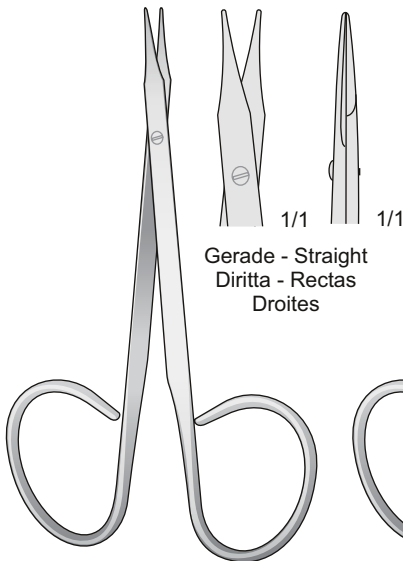

STEVENS
0607-CAL
100 mm

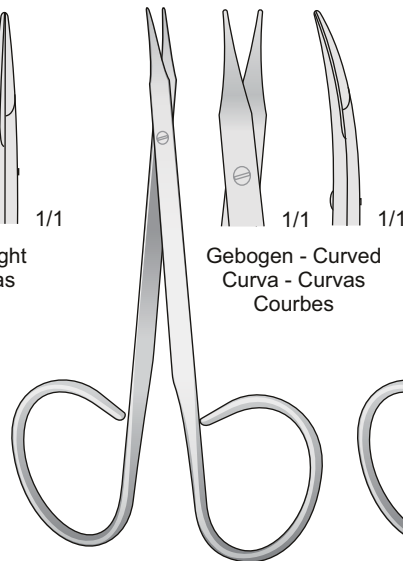

STEVENS
0607-CBA
100 mm

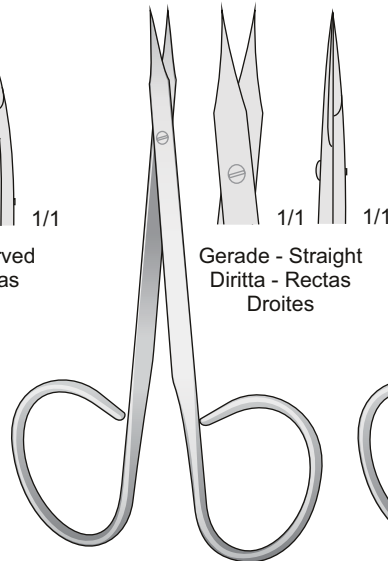

WALTON
0607-CBB
100 mm

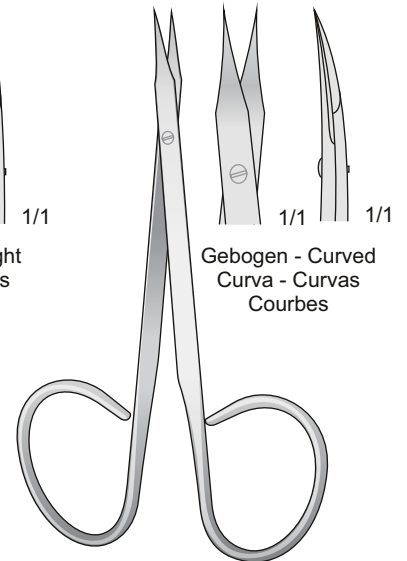

WALTON
0607-CBC
100 mm

Feine Scheren

Delicate Scissors

Forbici delicate

Tijeras finas

Ciseaux délicate

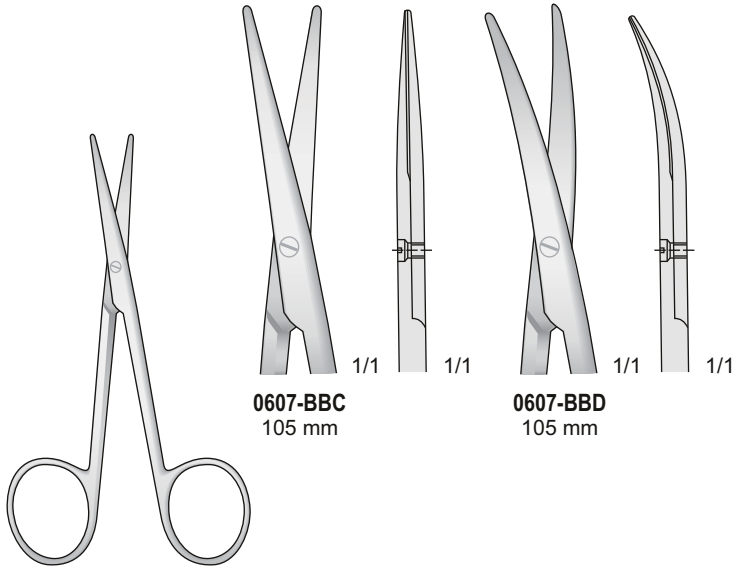

0607-BBC
105 mm

0607-BBD
105 mm

COTTLE-KNAPP
0607-BBC/0607-BBD
105 mm

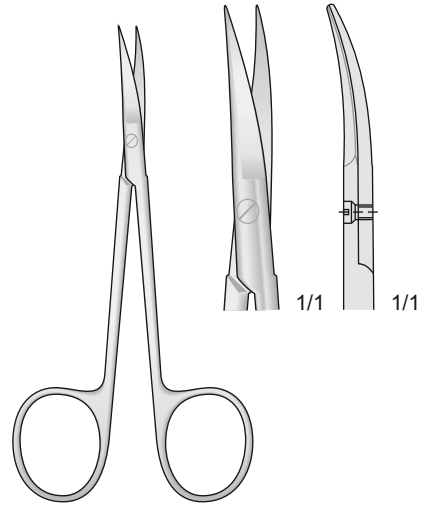

COTTLE
0607-FL
115 mm

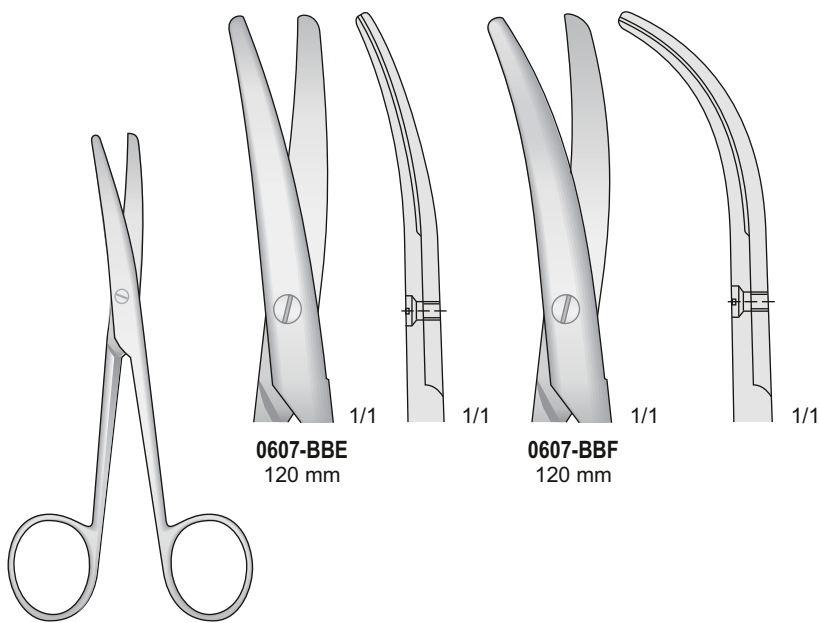

0607-BBE
120 mm

0607-BBF
120 mm

LANDOLT
0607-BBE/0607-BBF
120 mm

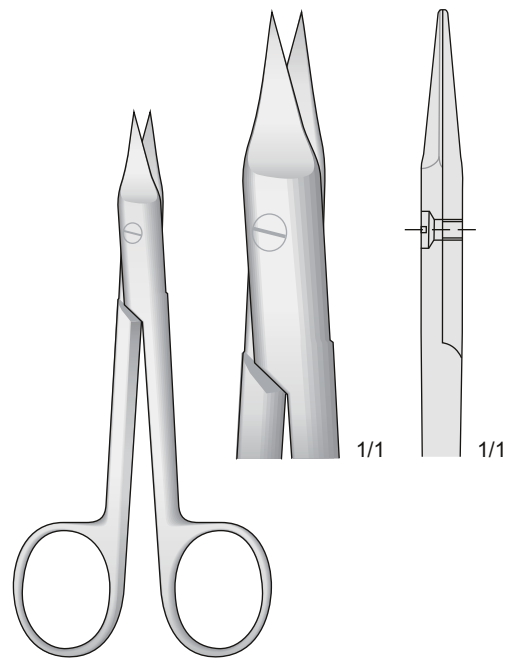

SYSTRUNK
0607-BBI
130 mm

Feine Scheren

Delicate Scissors

Forbici delicate

Tijeras finas

Ciseaux délicate

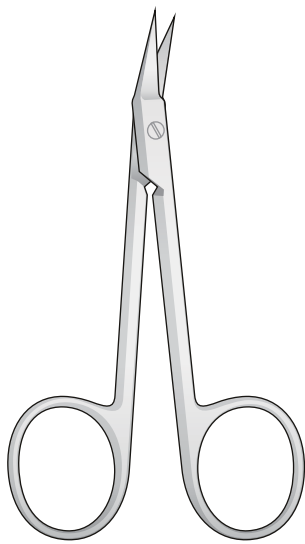

O'BRIEN
0607-BFB
95 mm

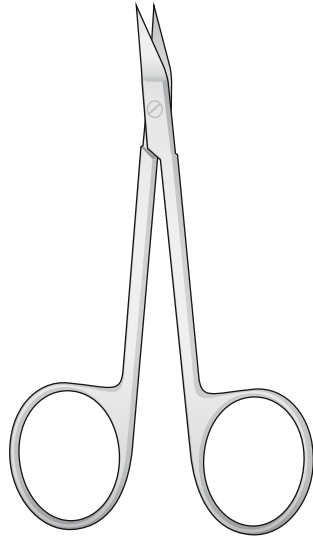

DANIELS
0607-CL
90 mm

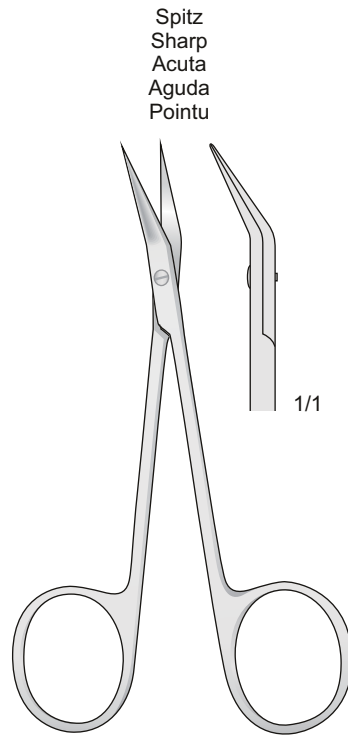

BIRO
0607-LE
100 mm

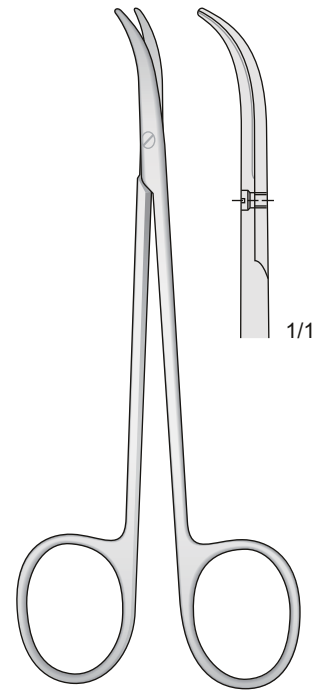

CINELLI
0607-LF
115 mm

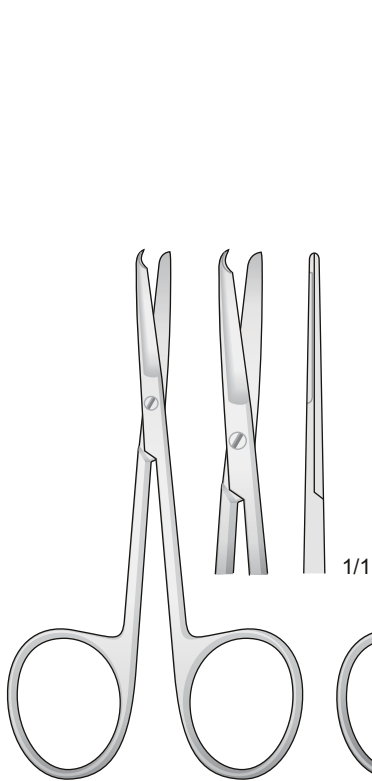

SPENCER
1803-L
90 mm

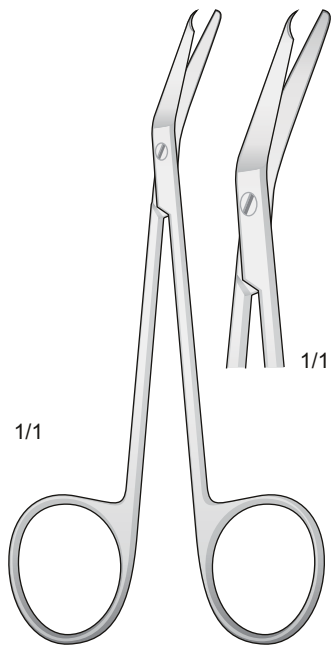

SPENCER
1803-BD
130 mm

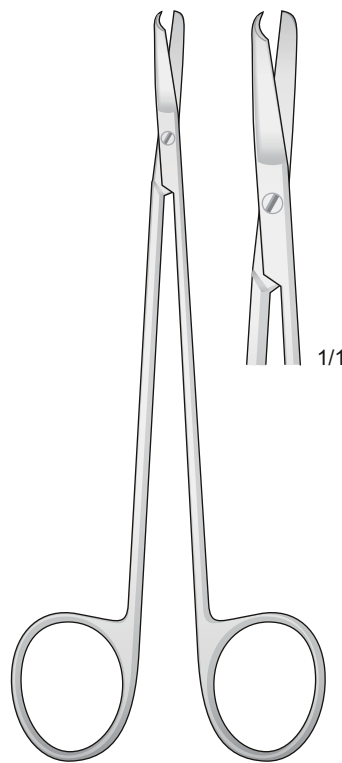

KELLY
1803-BG
150 mm

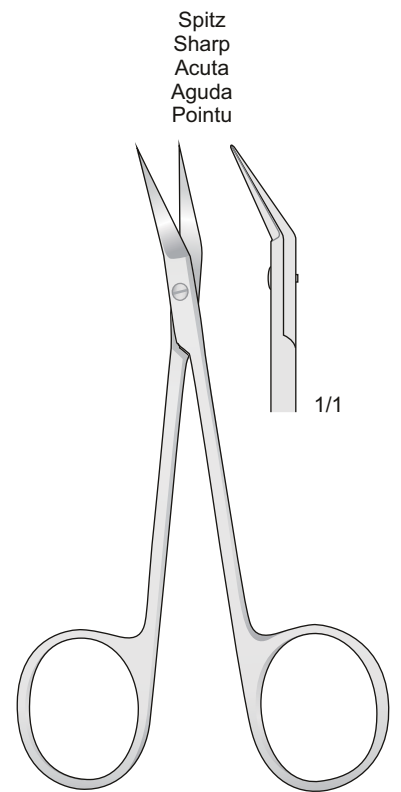

WILMER
0607-BCC
105 mm



0607-EF
190 mm

0607-EG
230 mm

0607-GF
250 mm

THOREK
0607-EF/0607-GF

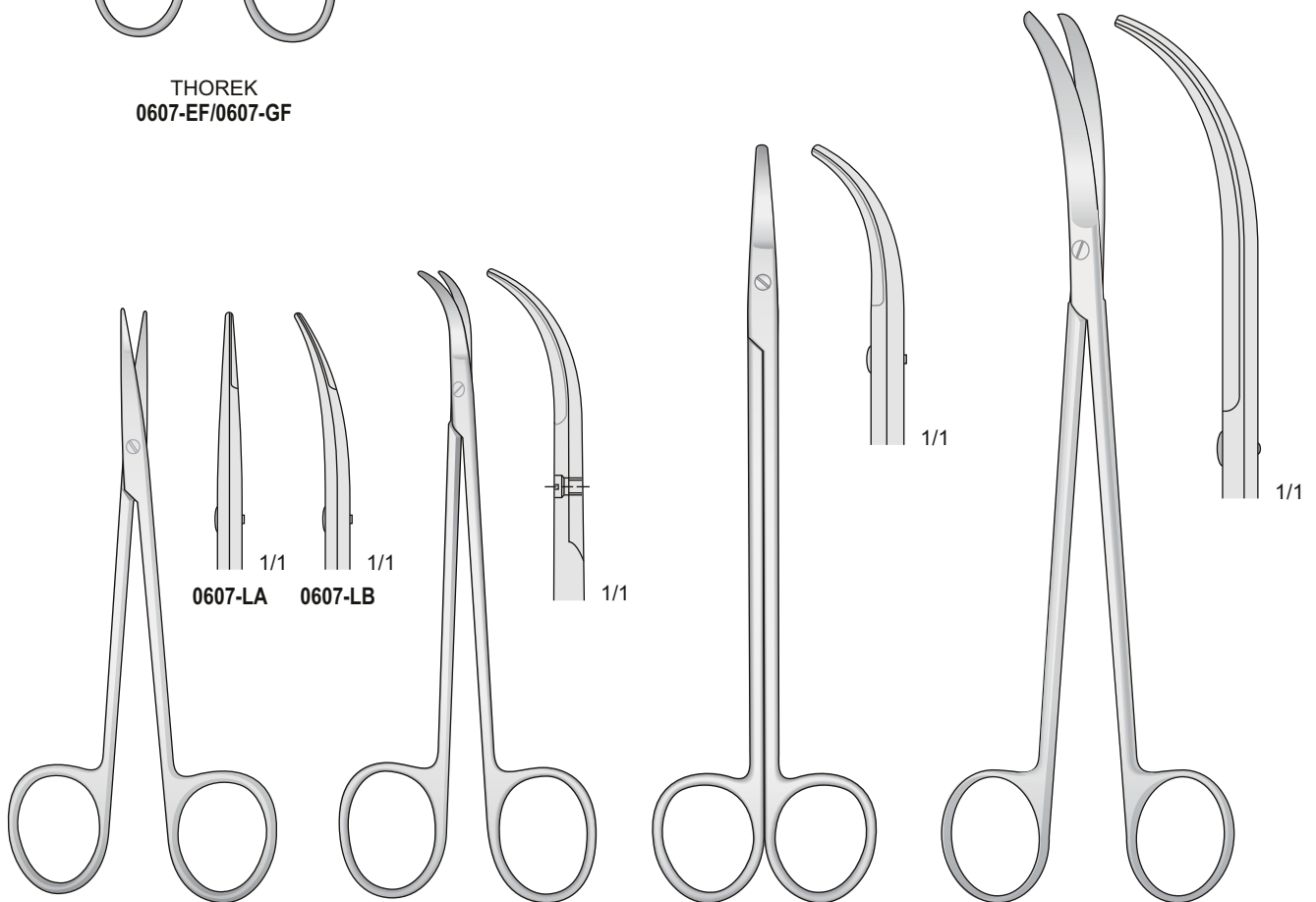

0607-LA

0607-LB

FOMON
0607-LD
135 mm

WALTON
0607-BEG
165 mm

JORGENSEN
0607-BED
230 mm

SHEA
0607-LA/0607-LB
120 mm

Feine Scheren

Delicate Scissors

Forbici delicate

Tijeras finas

Ciseaux délicate

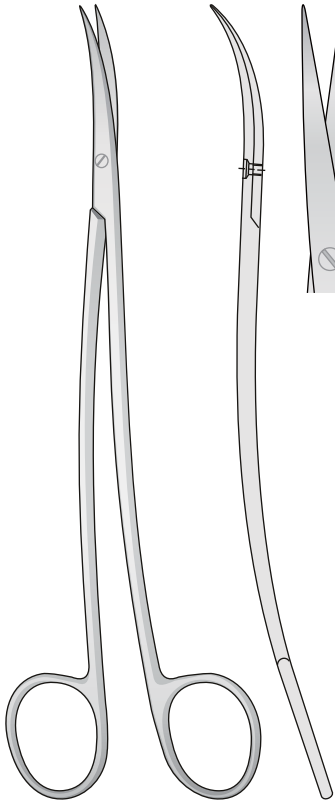

METZENBAUM-FINO
0612-BCD - 180 mm
0612-BCE - 200 mm
0612-BCF - 230 mm

Gezahnt - Sawedge
 Dentellate - Dentadas
 Dentelés

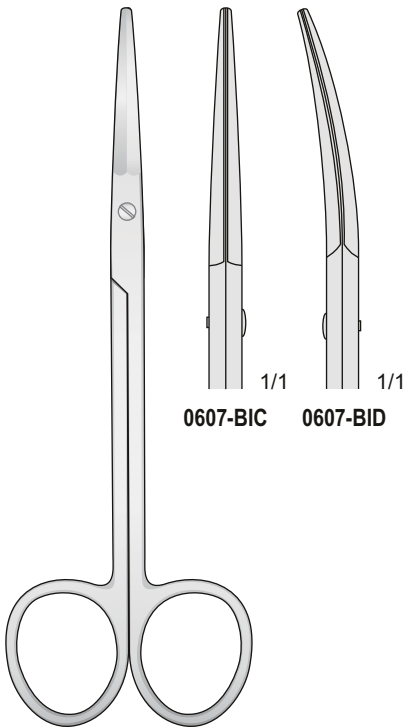

KAHN
0607-BIC/0607-BID
 145 mm

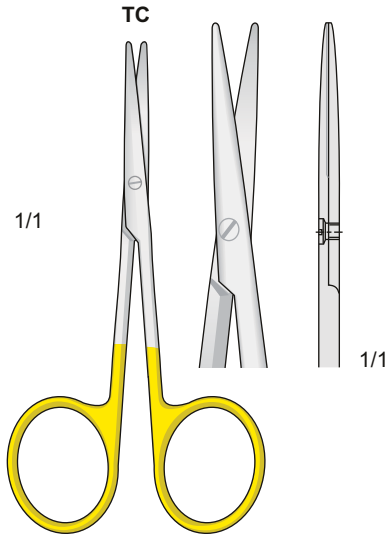

TC
LEXER-BABY
0612-BHG
 100 mm

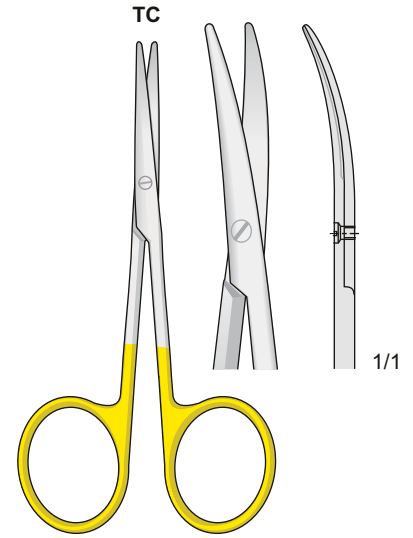

TC
LEXER-BABY
0612-BHH
 100 mm

Gezahnt - Sawedge
 Dentellate - Dentadas
 Dentelés

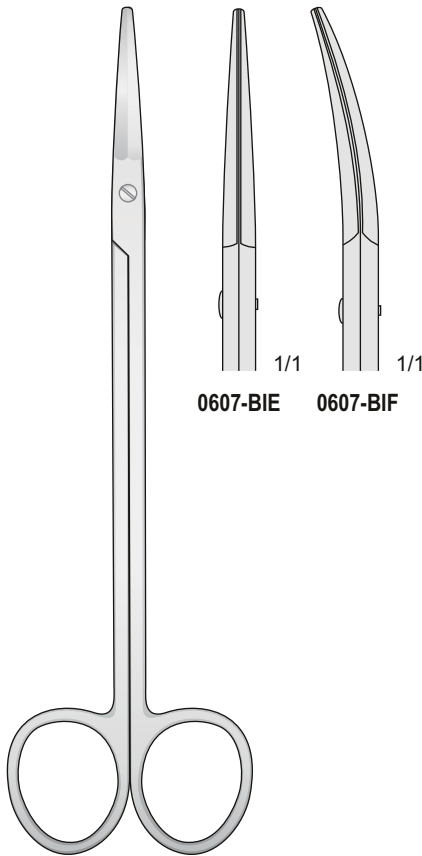

KAHN
0607-BIE/0607-BIF
 180 mm

Gezahnt - Sawedge
 Dentellate - Dentadas
 Dentelés

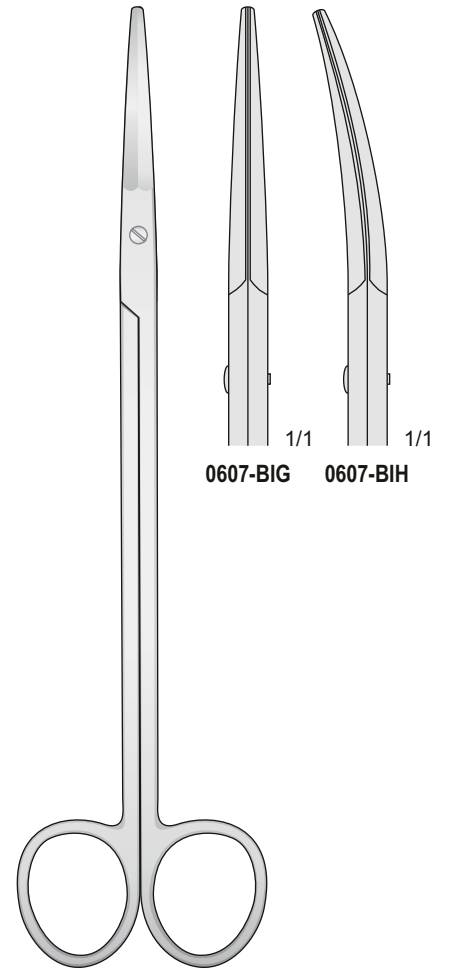

KAHN
0607-BIG/0607-BIH
 205 mm

Chirurgische Scheren

Operating scissors

Forbici chirurgiche

Tijeras para cirugía general

Ciseaux chirurgicaux

Eine Schneide gezahnt S-förmig gebogen
 One toothed cutting edge S-shaped
 Una lama dentata curva a forma S
 Una hoja dentada forma S
 Une lame dentelée courbés en S

TC

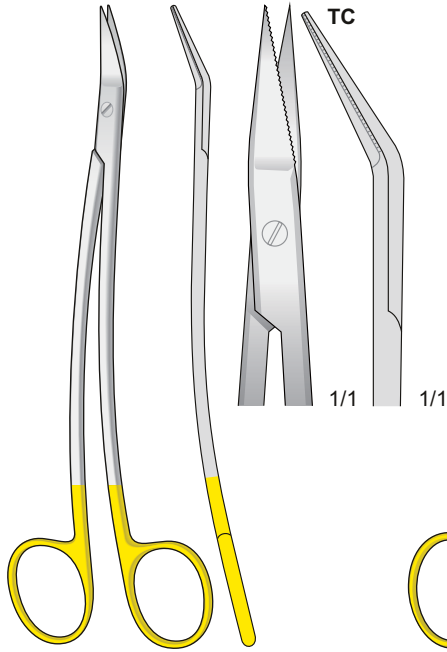

04050113-1903
175 mm

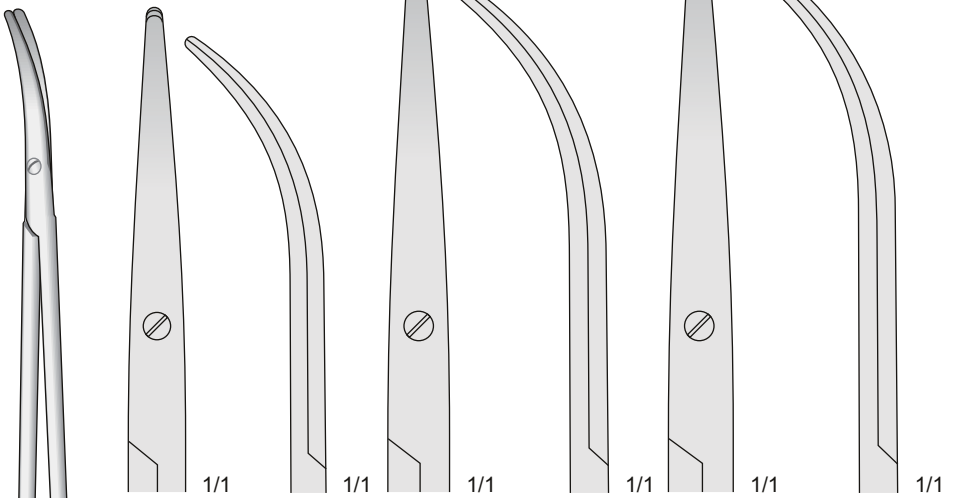

0612-BHB
200 mm

0612-BHC
230 mm

0612-BHD
280 mm

METZENBAUM-THOREK
0612-BHB/0612-BHD

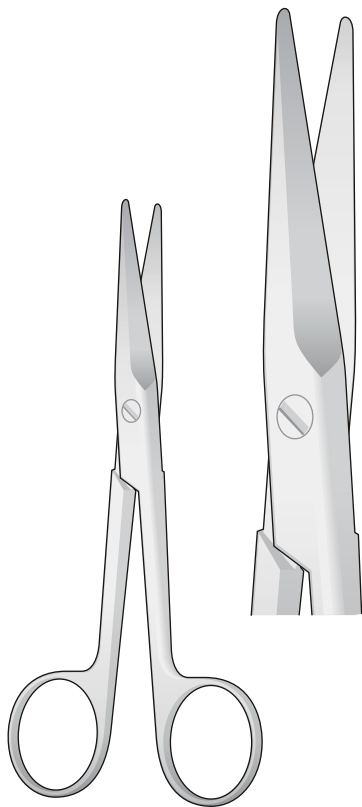

MAYO
0612-GE/0612-GF
155 mm

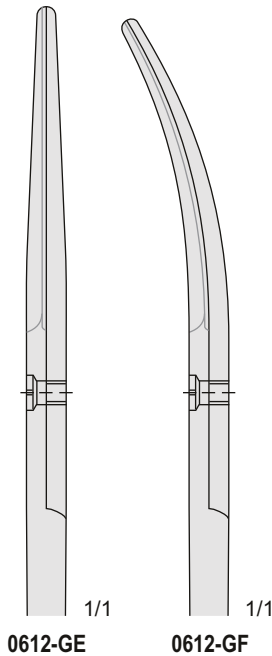

0612-GE

0612-GF

TC

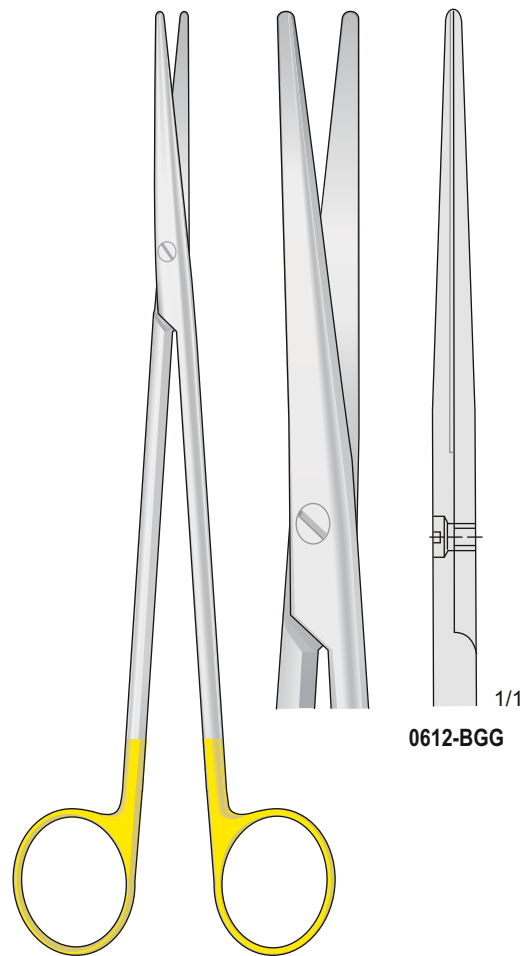

METZENBAUM
0612-BGG
280 mm

0612-BGG

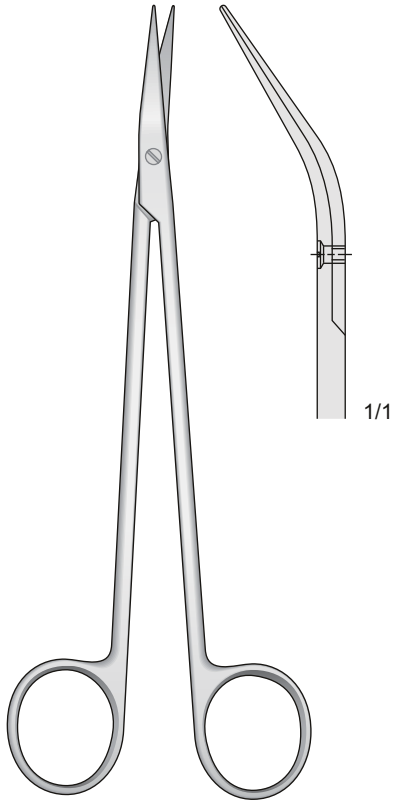

POTTS-SMITH
0607-BFF
175 mm

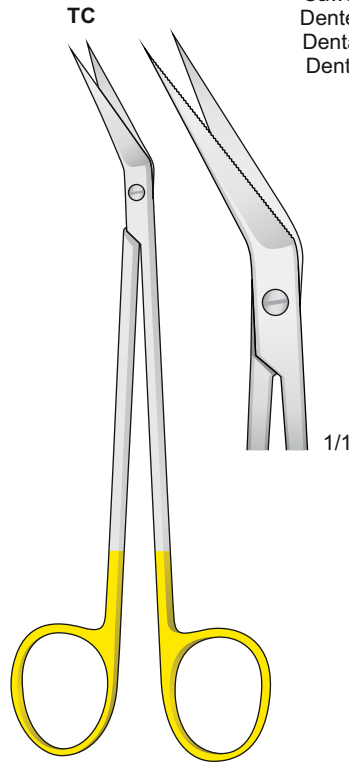

1110-BA
160 mm

Gezähnt
Sawedge
Dentellate
Dentadas
Dentelés

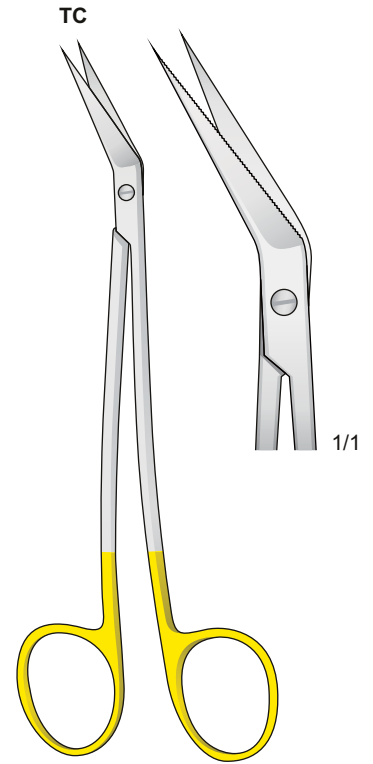

1110-BC
160 mm

Gefäßscheren
Vessel scissors

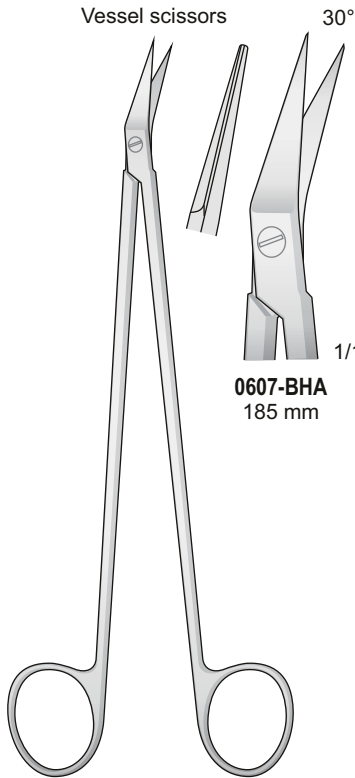

POTTS-DE MARTEL
0607-BHA/172
185 mm

30°



0607-BHA
185 mm

45°

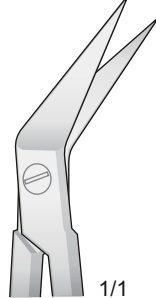

0607-BHB
185 mm

60°

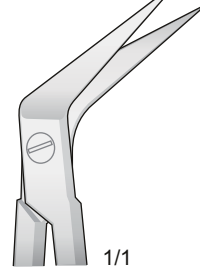

0607-BHC
185 mm

Coronararterien-Schere
Coronary artery scissors

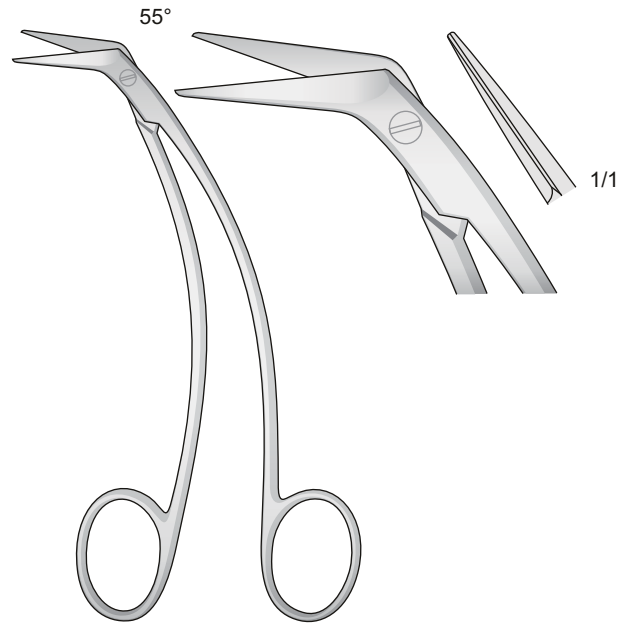

FAVOLORO
0607-BGE
140 mm

Gefäß Scheren

Vascular scissors

Forbici vascolari

Tijeras vasculares

Ciseaux vasculaires

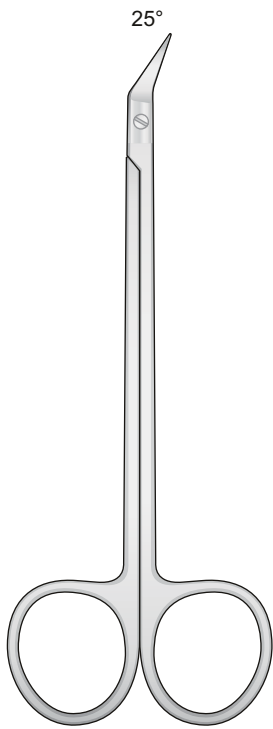

0607-BHD
135 mm

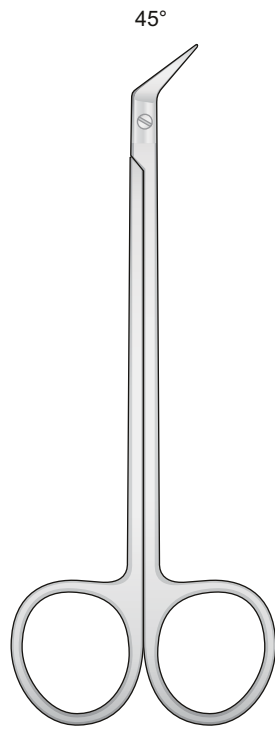

0607-BHE
135 mm

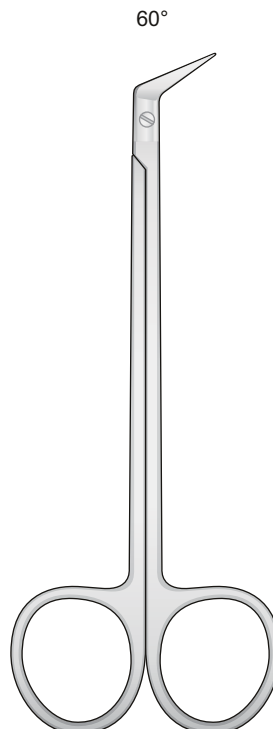

0607-BHF
135 mm

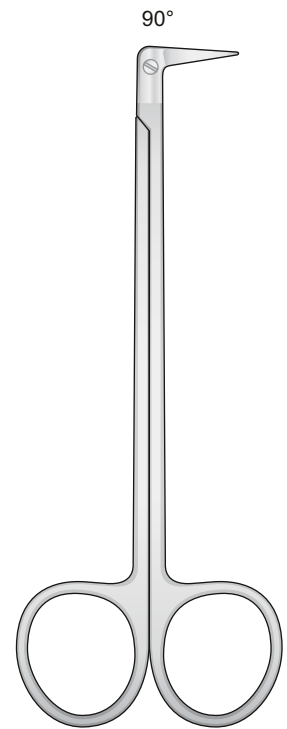

0607-BHG
135 mm

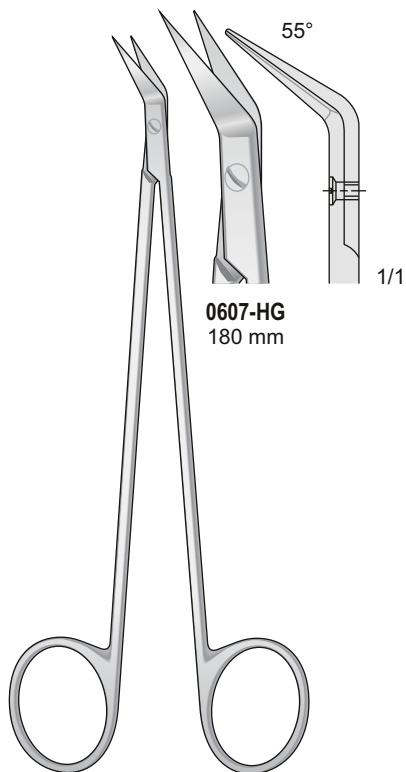

POTTS-SMITH
0607-HG
180 mm

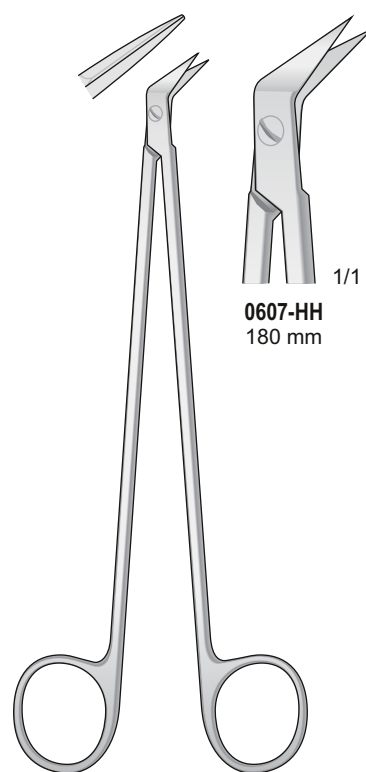

POTTS-SMITH
0607-HH
180 mm

Gezant - Serrated
Dentellata - Dentadas
Dentelés

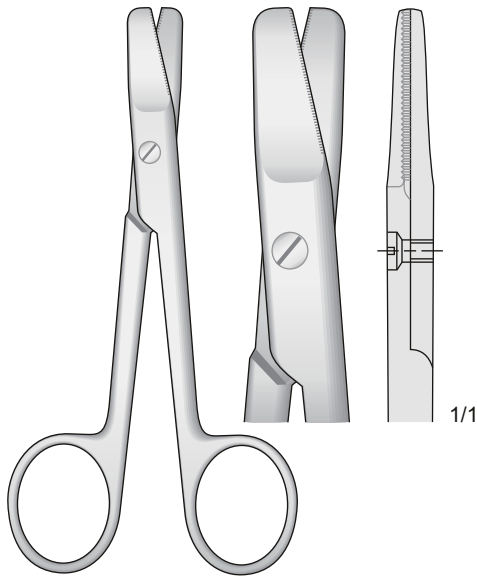

HARVEY
0607-BGC
125 mm

Spitz - Sharp
Acuta - Agudo - Aigu



METZENBAUM
0612-BCG/0612-BCH
145 mm

Kapselschere
Forbice da cartilagine
Cartilage Scissors

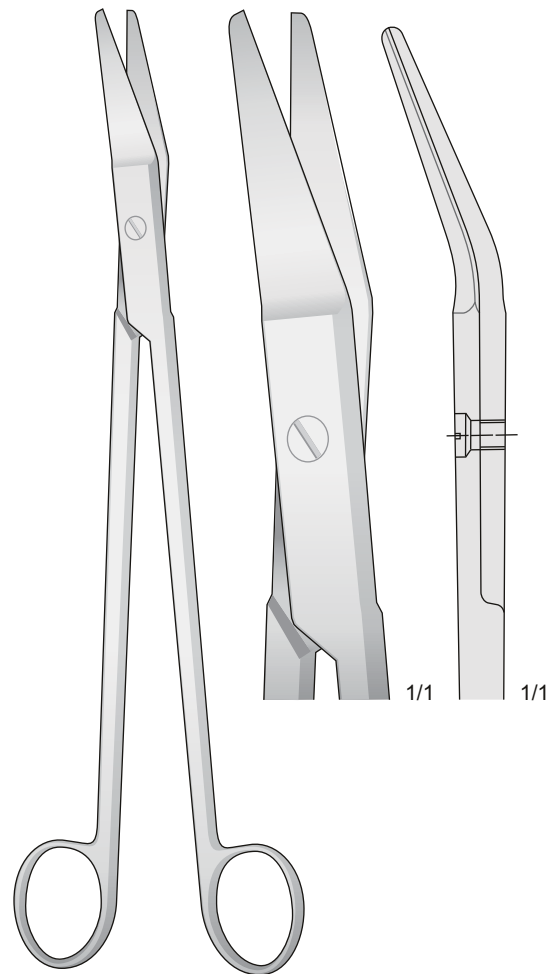

RESANO
0607-BDA
250 mm

Uterusschere
Uterine scissors

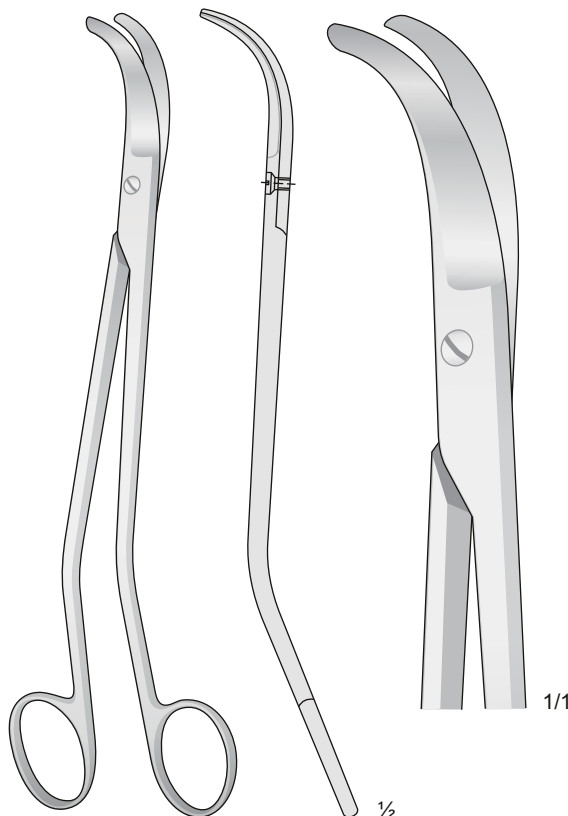

BOZEMANN
0607-BEF
220 mm

Verband Scheren

Bandage scissors

Forbici per bendaggi

Tijeras para vendajes

Ciseaux à bandages

Gezahnt - Serrated
Dentellata - Dentadas - Dentées

TC

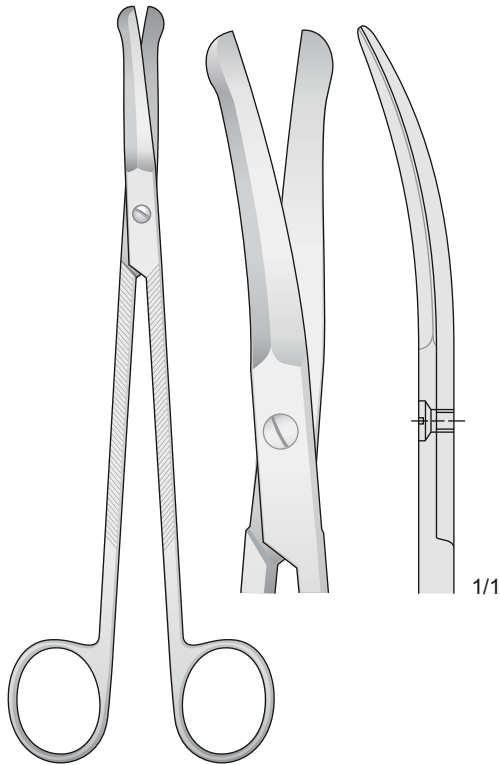

GOOD
0607-BDF
195 mm

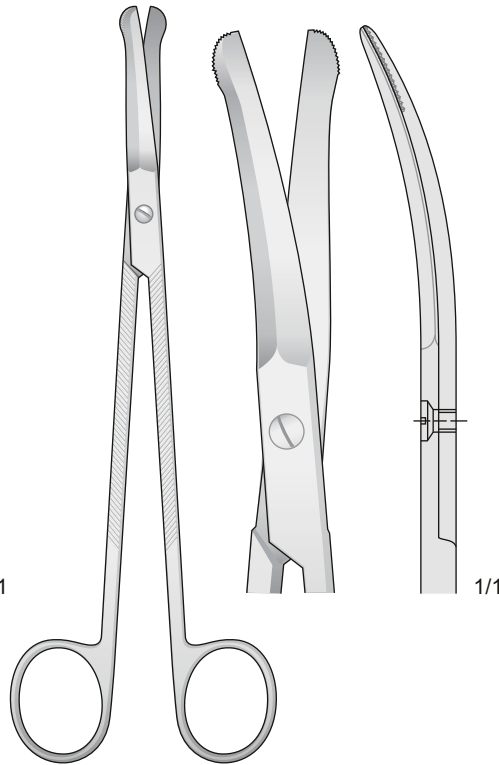

SCHWECKENDIEK
0607-BDG
195 mm

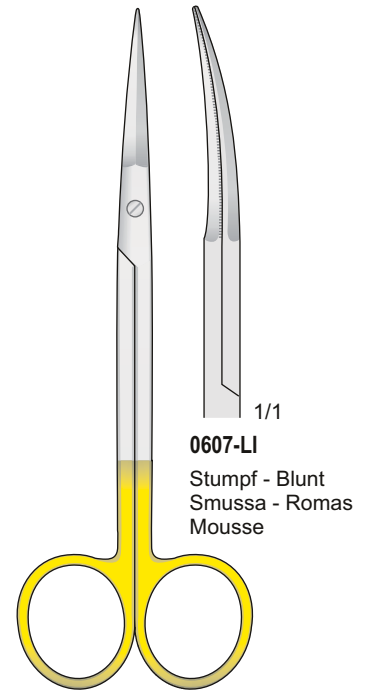

PECK-JOSEPH
0607-LI
140 mm

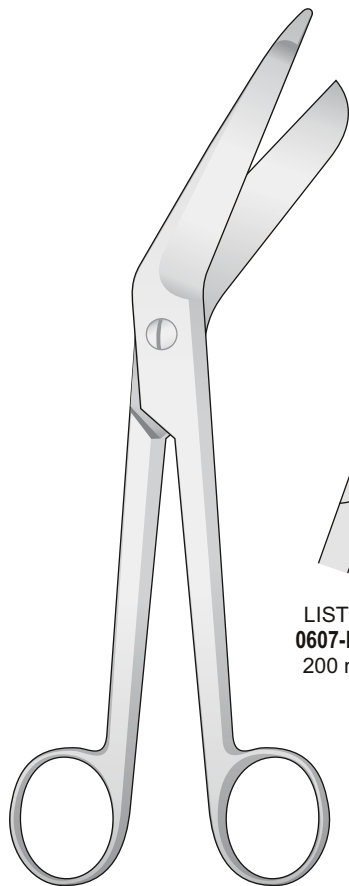

LISTER
0607-BDE
200 mm

BERGMANN
0607-BDH
230 mm

0607-BDE/0607-BDH

TC

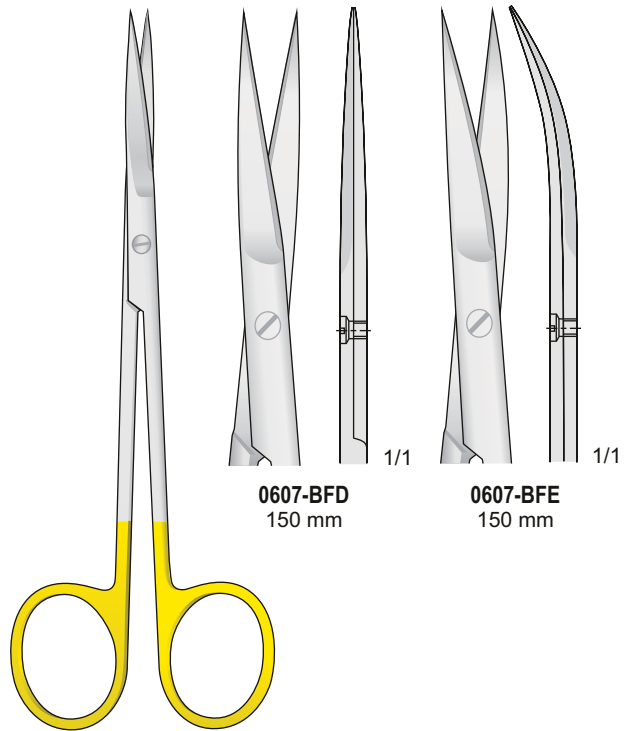

0607-BFD
150 mm

0607-BFE
150 mm

JOSEPH
0607-BFD/0607-BFE
150 mm

“Super-cut” scheren micro-schliff für tissue atrauma
 “Super-cut” scissors for gripping tissue and cutting interproximally
 Forbici “super-cut” estremamente taglienti per tessuti con riduzione del trauma
 Tijeras “super cortes” para cortar tissue-atrauma
 Ciseaux “super cut” coupe les tissus en reduisant les risques de traumatisme

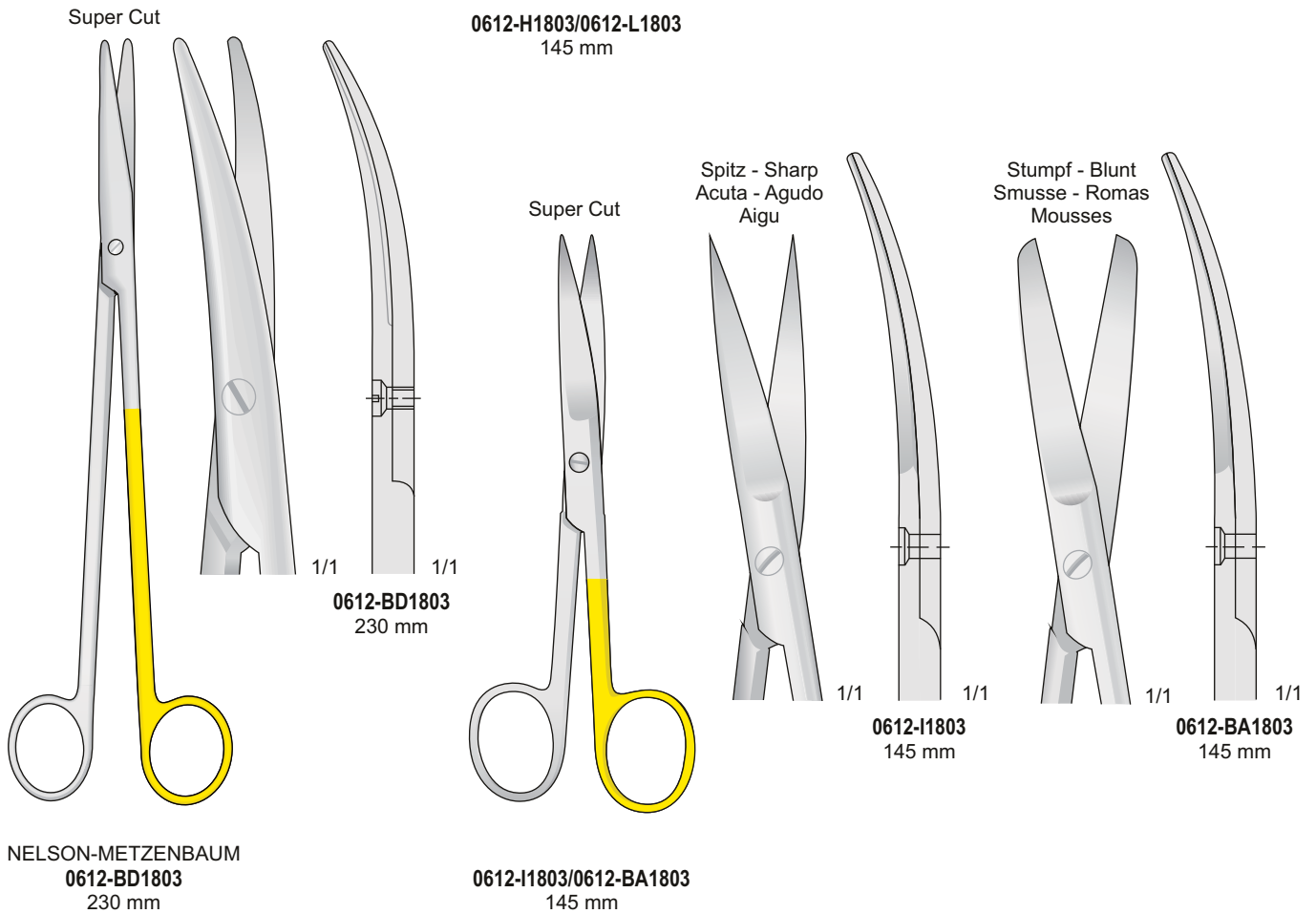
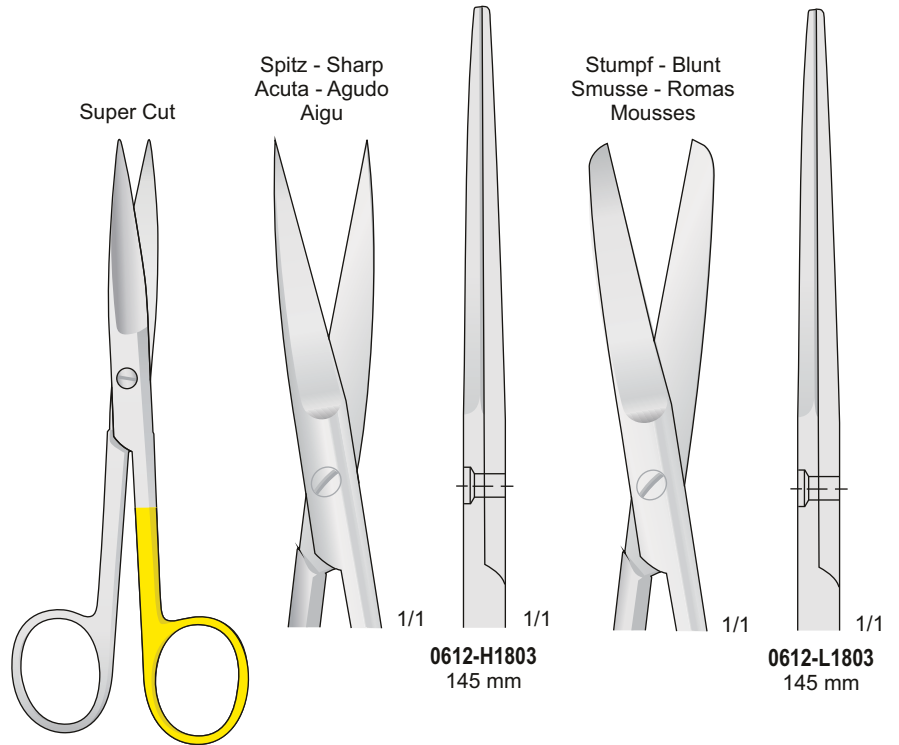

Mit Hartmetalleinsätzen
 Tungsten-carbide scissors
 Con punta al carburo di tungsteno
 Tijeras de tungsteno
 Avec plaquettes en carbure de tungstène

Mit eine Schneide gezahnt
 With one blade serrated
 Con una lama zigrinata
 Con una hoja dentada
 Avec lame dentèle

Super Cut
 TC

Mit eine Schneide gezahnt
 With one blade serrated
 Con una lama zigrinata
 Con una hoja dentada
 Avec lame dentèle

Super Cut
 TC

Mit eine Schneide gezahnt
 With one blade serrated
 Con una lama zigrinata
 Con una hoja dentada
 Avec lame dentèle

Super Cut
 TC

Mit eine Schneide gezahnt
 With one blade serrated
 Con una lama zigrinata
 Con una hoja dentada
 Avec lame dentèle

Super Cut

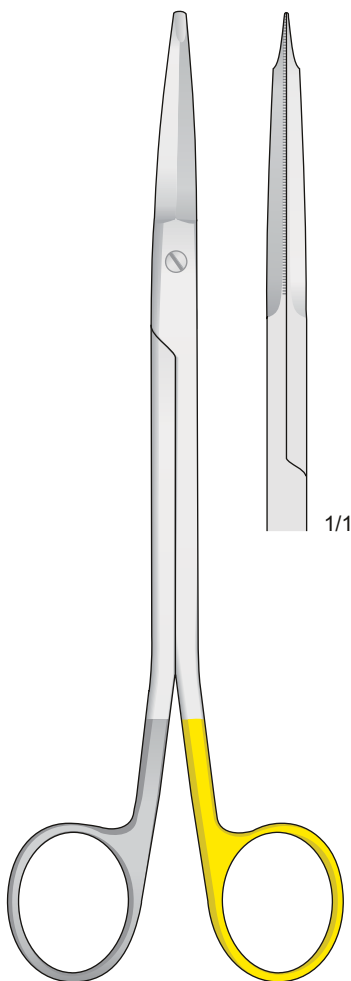

FREEMAN GORNEY
 0612-DBA
 180 mm

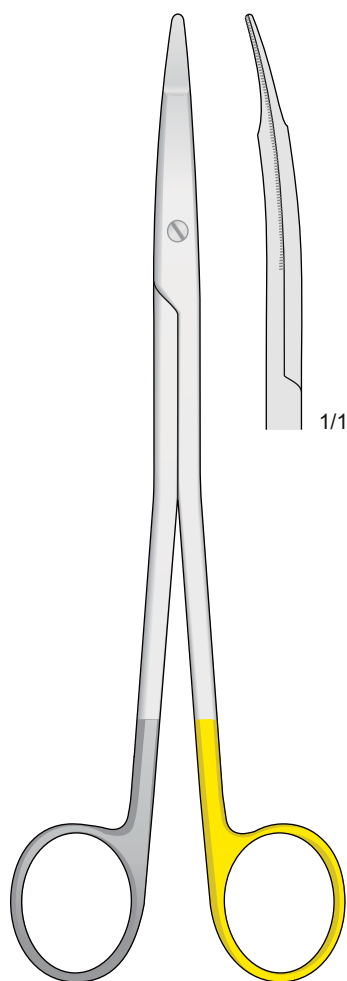

FREEMAN
 0612-DDA
 180 mm

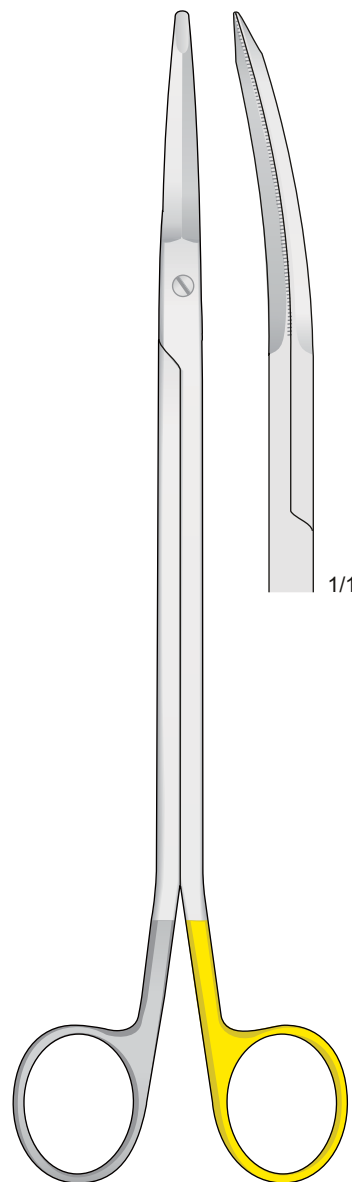

GORNEY
 0612-DCB
 230 mm

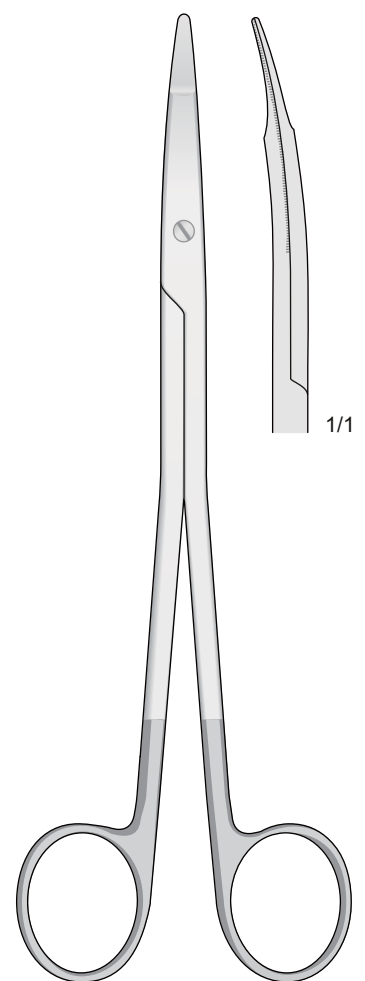

FREEMAN
 0612-DCI
 180 mm

Mit Hartmetalleinsätzen
 Tungsten-carbide scissors
 Con punta al carburo di tungsteno
 Tijeras de tungsteno
 Avec plaquettes en carbure de tungstène

Mit eine Schneide gezahnt
 With one blade serrated
 Con una lama zigrinata
 Con una hoja dentada
 Avec lame dentèle

TC

Mit eine Schneide gezahnt
 With one blade serrated
 Con una lama zigrinata
 Con una hoja dentada
 Avec lame dentèle

TC

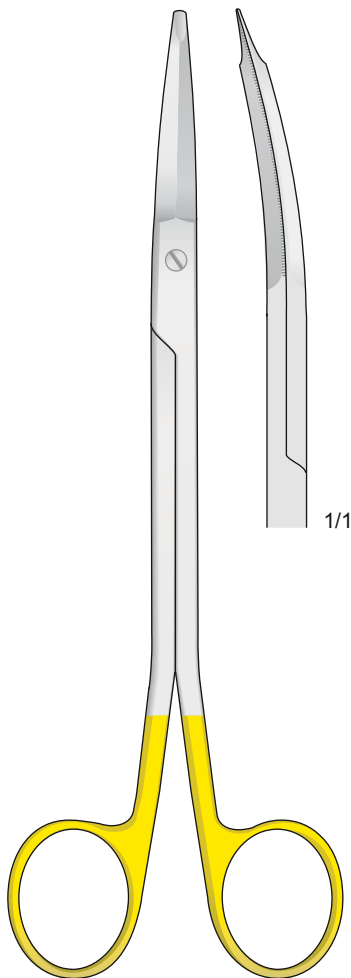

FREEMAN KAYE
 0612-DDF
 180 mm

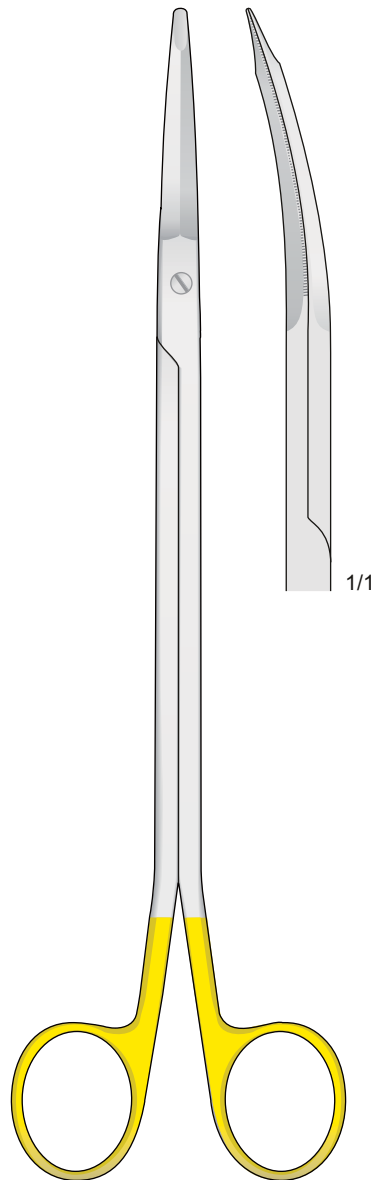

GORNEY
 0612-DBC
 230 mm

Mit eine Schneide gezahnt
 With one blade serrated
 Con una lama zigrinata
 Con una hoja dentada
 Avec lame dentèle

TC

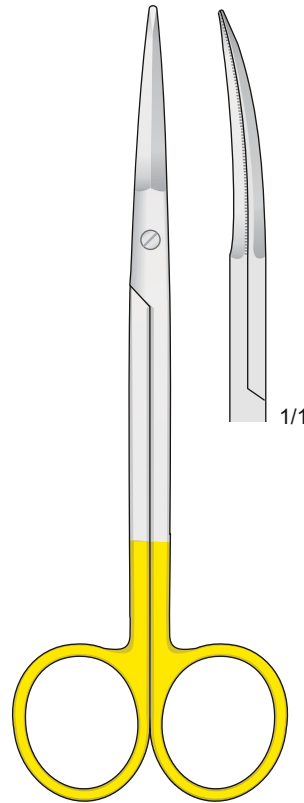

GREGORY
 0612-DDL
 140 mm

Mit eine Schneide gezahnt
 With one blade serrated
 Con una lama zigrinata
 Con una hoja dentada
 Avec lame dentèle

TC

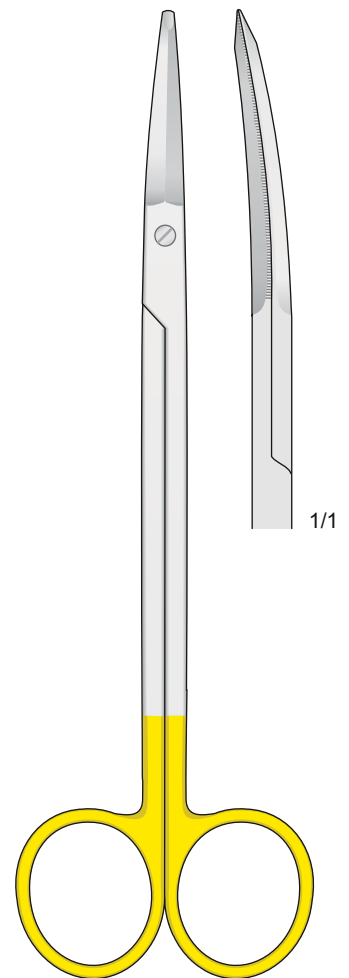

FACE-LIFT
 0612-DED
 180 mm

Chirurgischeklammen

Tissue forceps

Pinze chirurgiche

Pinzas chirurgicalas

Pinces chirurgicales

Pinzette mit Häkchen
Suturing Forceps
Pinzette per suture

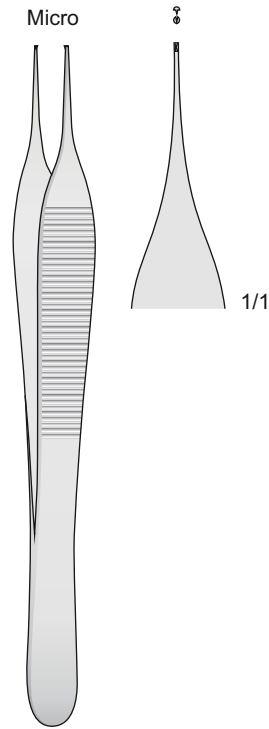

ADSON
0204-BHH
150 mm

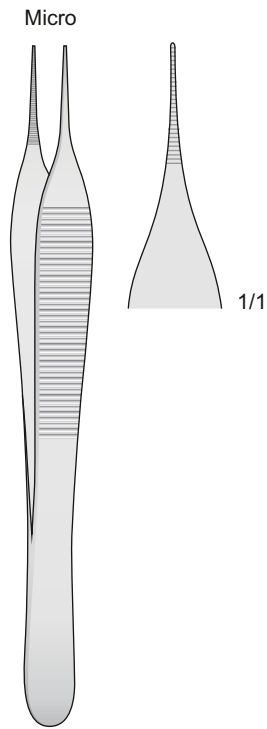

ADSON
0204-BHI
150 mm



ADSON
0204-DAA
125 mm

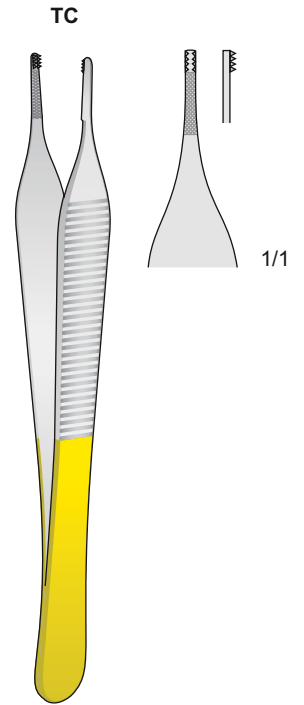

ADSON-BROWN
0204-CFD
120 mm

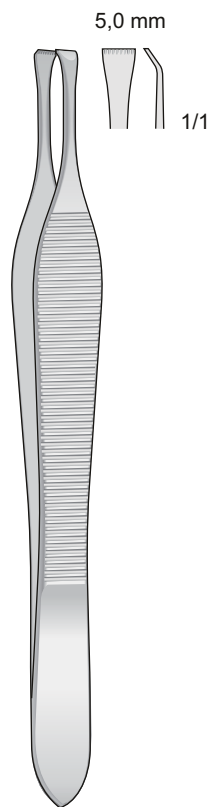

BEASLEY-BABCOCK
0204-FB
120 mm

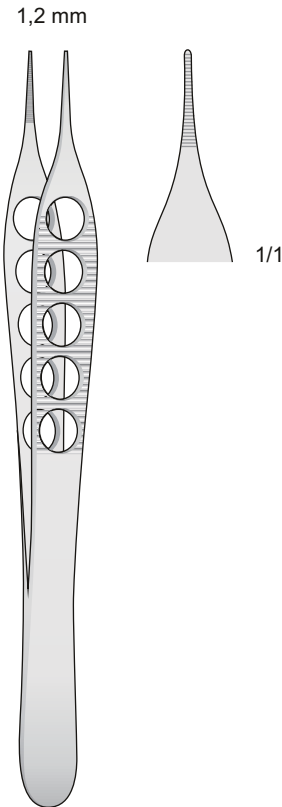

ADSON
0204-CAH
120 mm

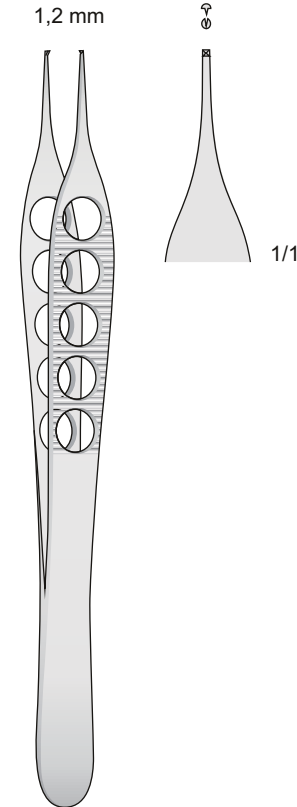

ADSON
0204-CAI
120 mm

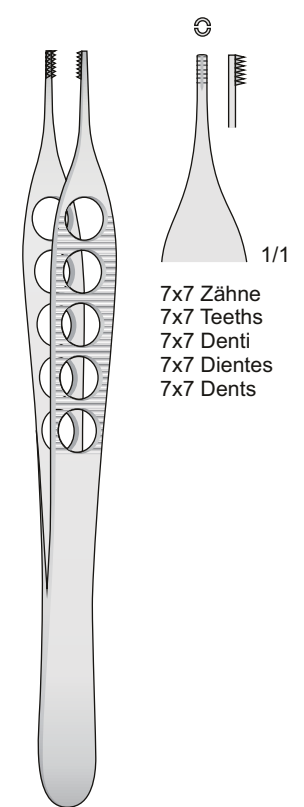

ADSON-BROWN
0204-CAL
120 mm

Chirurgischeklemmen

Tissue forceps

Pinze chirurgiche

Pinzas chirùrgicas

Pinces chirurgicales



Mikroprofil - Micro profile
 Profilo micro - Perfil micro - Profil micro
 2.0 mm

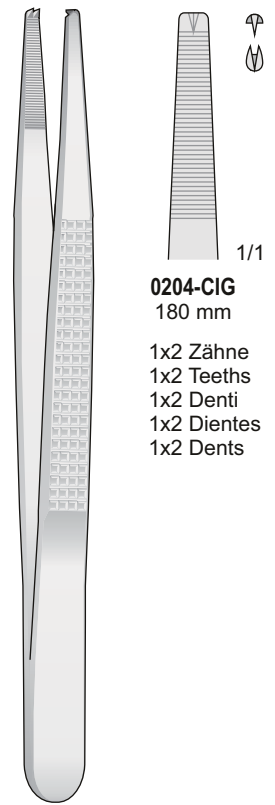
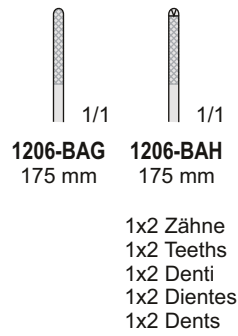
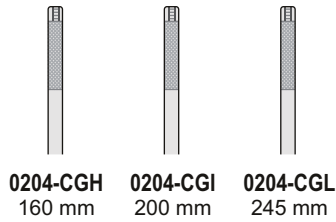

1/1
0204-CIG
 180 mm
 1x2 Zähne
 1x2 Teeths
 1x2 Denti
 1x2 Dientes

DE BAKAY
 0204-CGH/0204-CGL

GERALD
 1206-BAG/1206-BAH
 175 mm

BONNEY
 0204-CIG
 180 mm

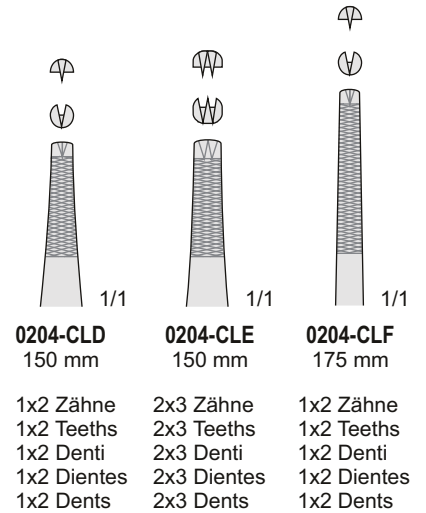
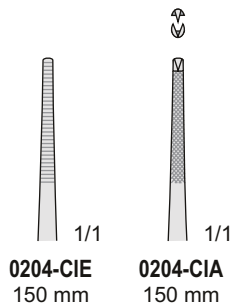
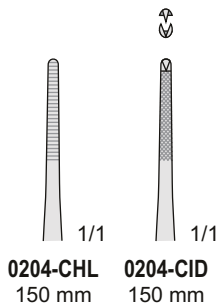

McINDOE
 0204-CHL/0204-CID
 150 mm

GILLIES
 0204-CIA/0204-CIE
 150 mm

LANE
 0204-CLD/0204-CLF

Pinzetten

Tissue forceps

Pinzette

Pinzas

Pinces

Titan - Titanium - Titanio - Titane

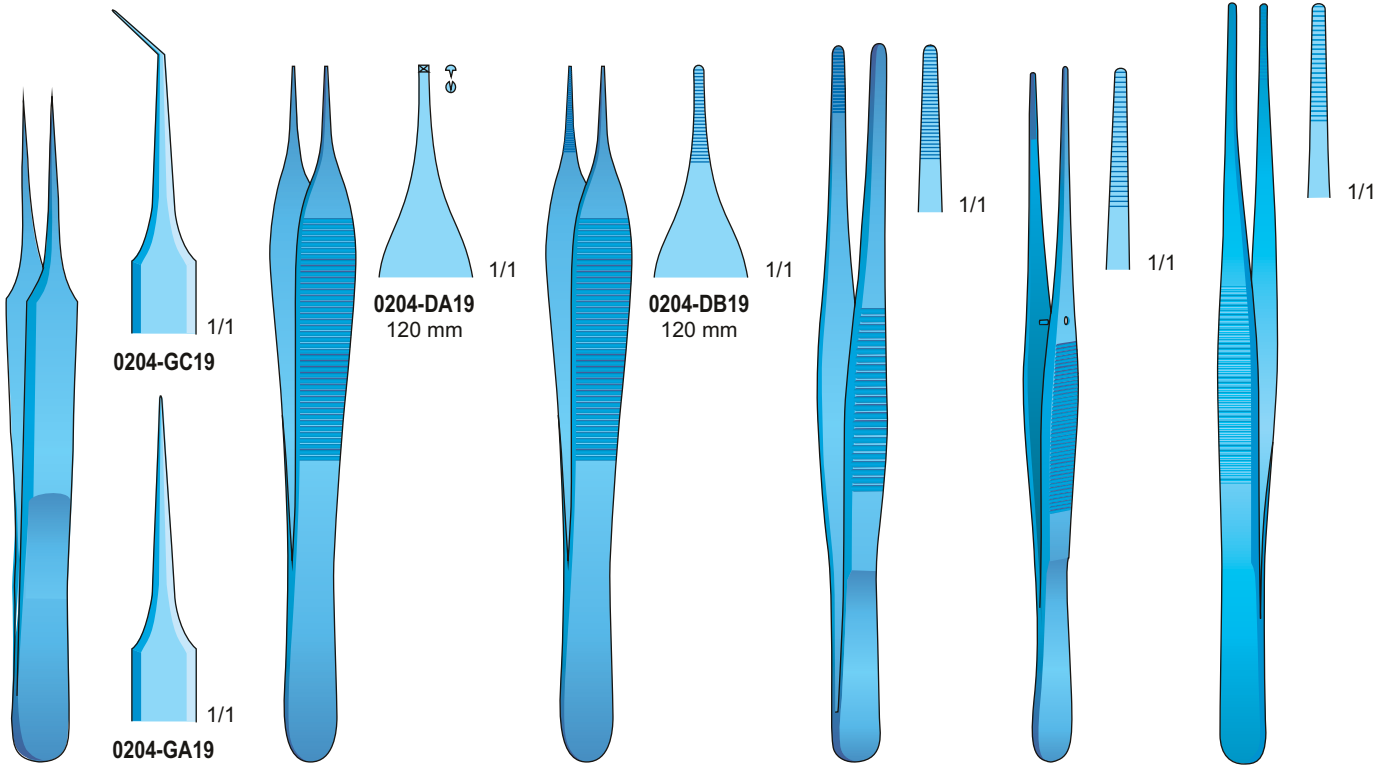

0204-GA19/0204-GC19
110 mm

ADSON
0204-DA19
120 mm

ADSON
0204-DB19
120 mm

0204-HF19
145 mm

0204-AL19
130 mm

0204-BG19
160 mm

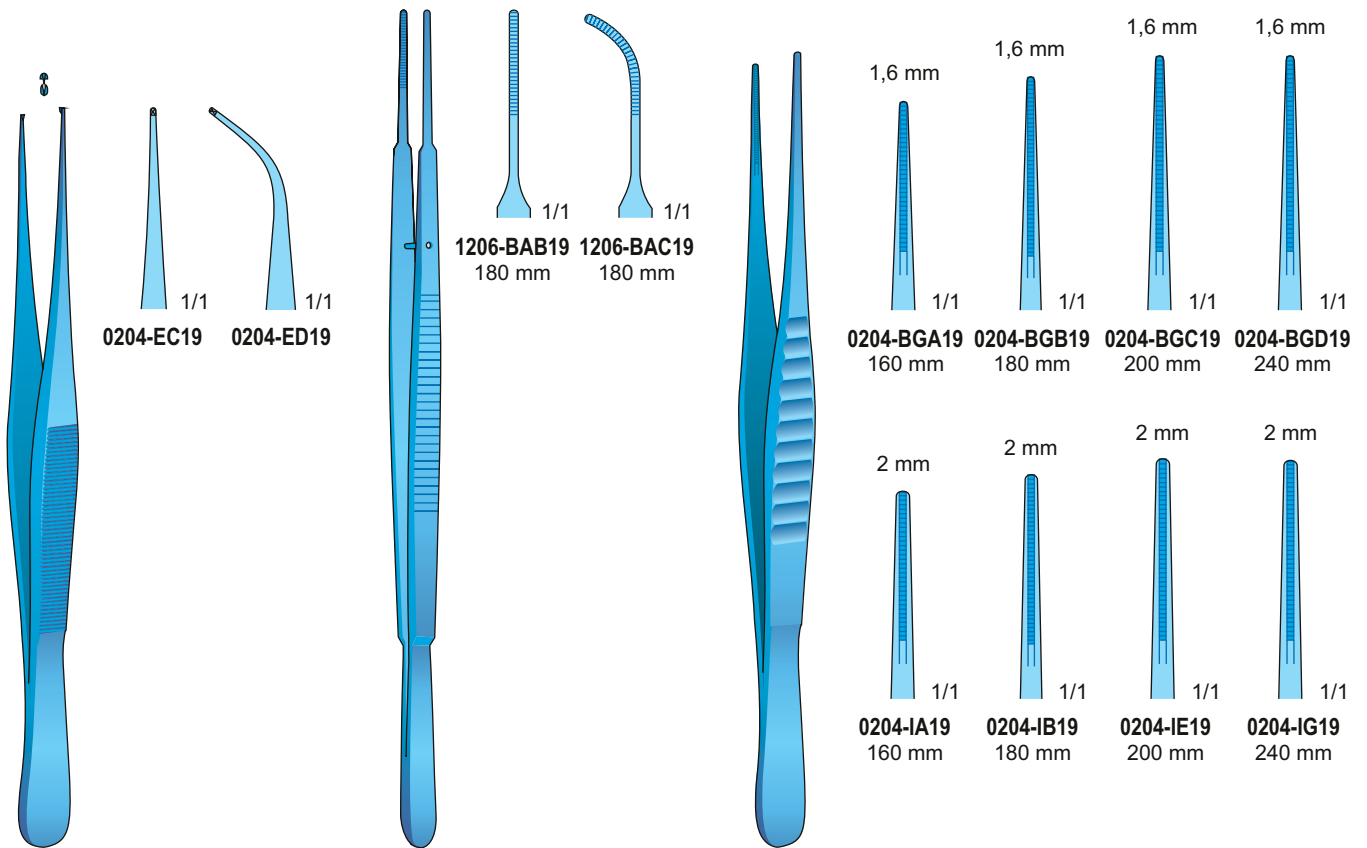

0204-EC19/0204-ED19
110 mm

GERALD
1206-BAB19/1206-BAC19
180 mm

DE BAKEY
0204-IA19/0204-IG19

1,6 mm
0204-BGA19
160 mm

1,6 mm
0204-BGB19
180 mm

1,6 mm
0204-BGC19
200 mm

1,6 mm
0204-BGD19
240 mm

2 mm
0204-IA19
160 mm

2 mm
0204-IB19
180 mm

2 mm
0204-IE19
200 mm

2 mm
0204-IG19
240 mm

Pinzetten

Tissue forceps

Pinzette

Pinzas

Pinces

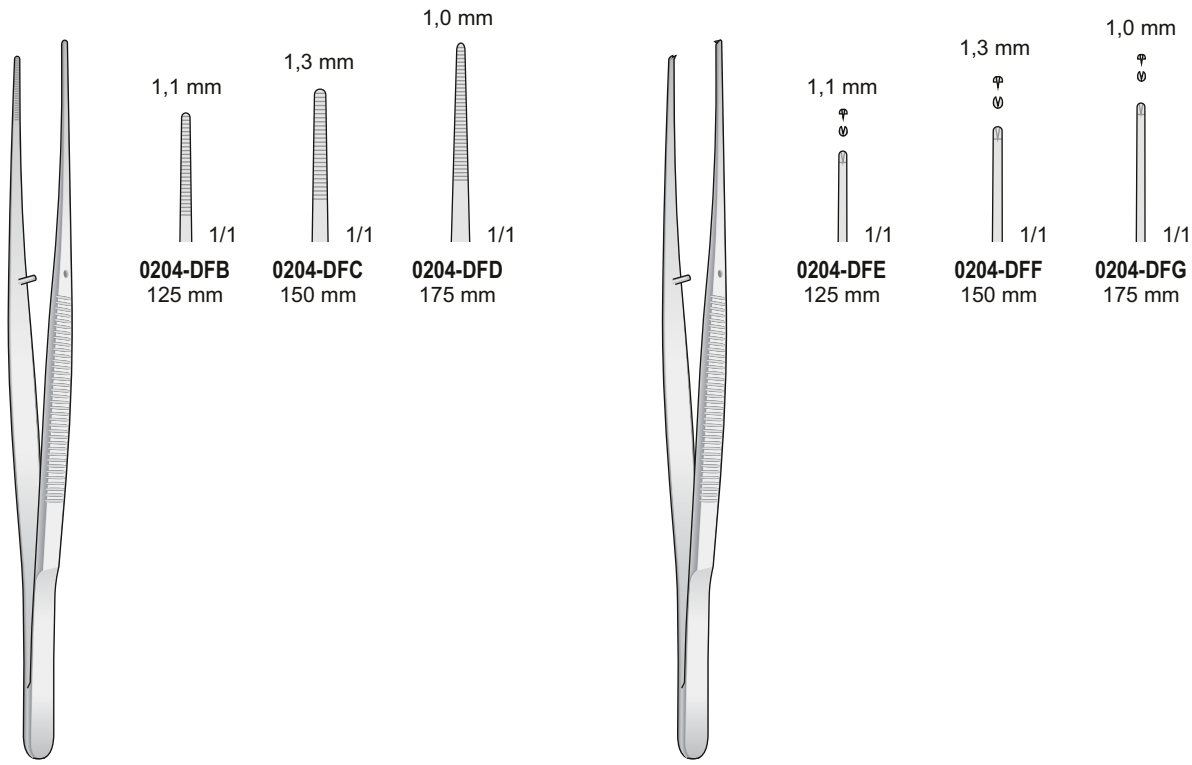

0204-DFB/0204-DFD

0204-DFE/0204-DFG

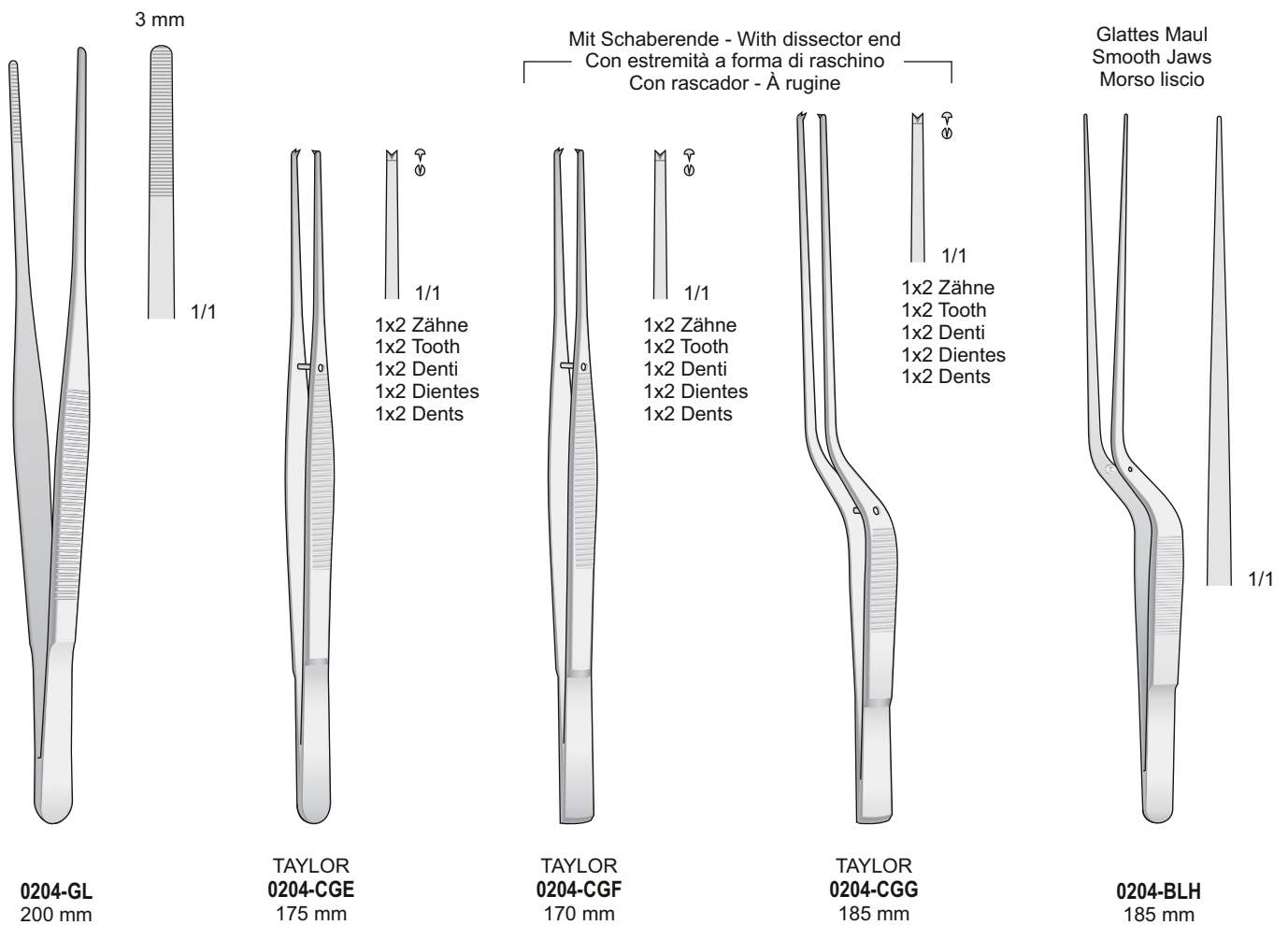

0204-GL
200 mm

TAYLOR
0204-CGE
175 mm

TAYLOR
0204-CGF
170 mm

TAYLOR
0204-CGG
185 mm

0204-BLH
185 mm

Isoliert - Insulated - Isolate - Aislante - Isolant
Monopolar - Monopolari

new

mit sterilisierfähiger Kunststoff-Isolierbeschichtung - with autoclavable plastic coated insulated handles
con rivestimento isolante in plastica sterilizzabile - con recubrimiento aislante de materia plástica esterilizable
à enduit plastique isolant, stérilisable

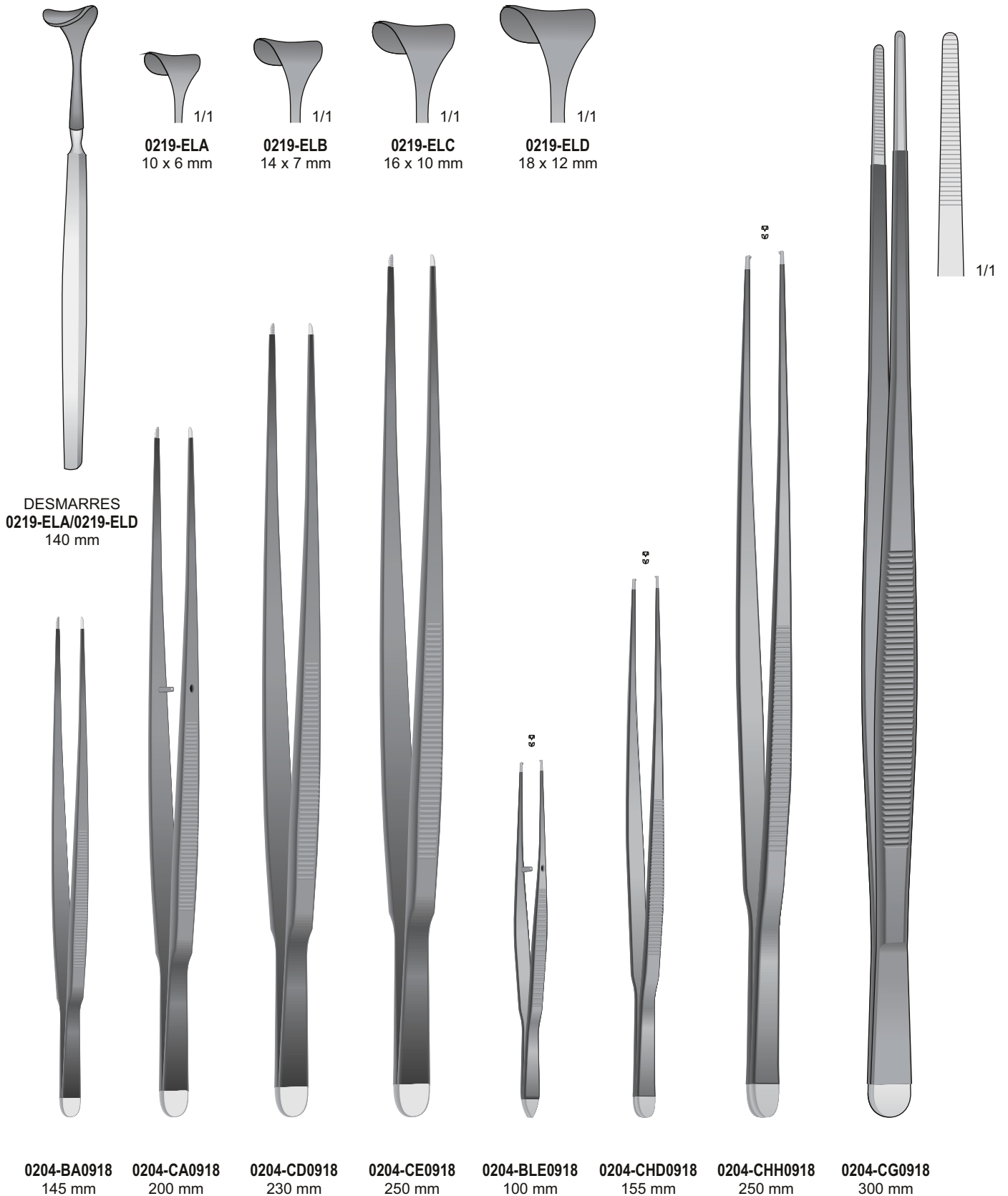

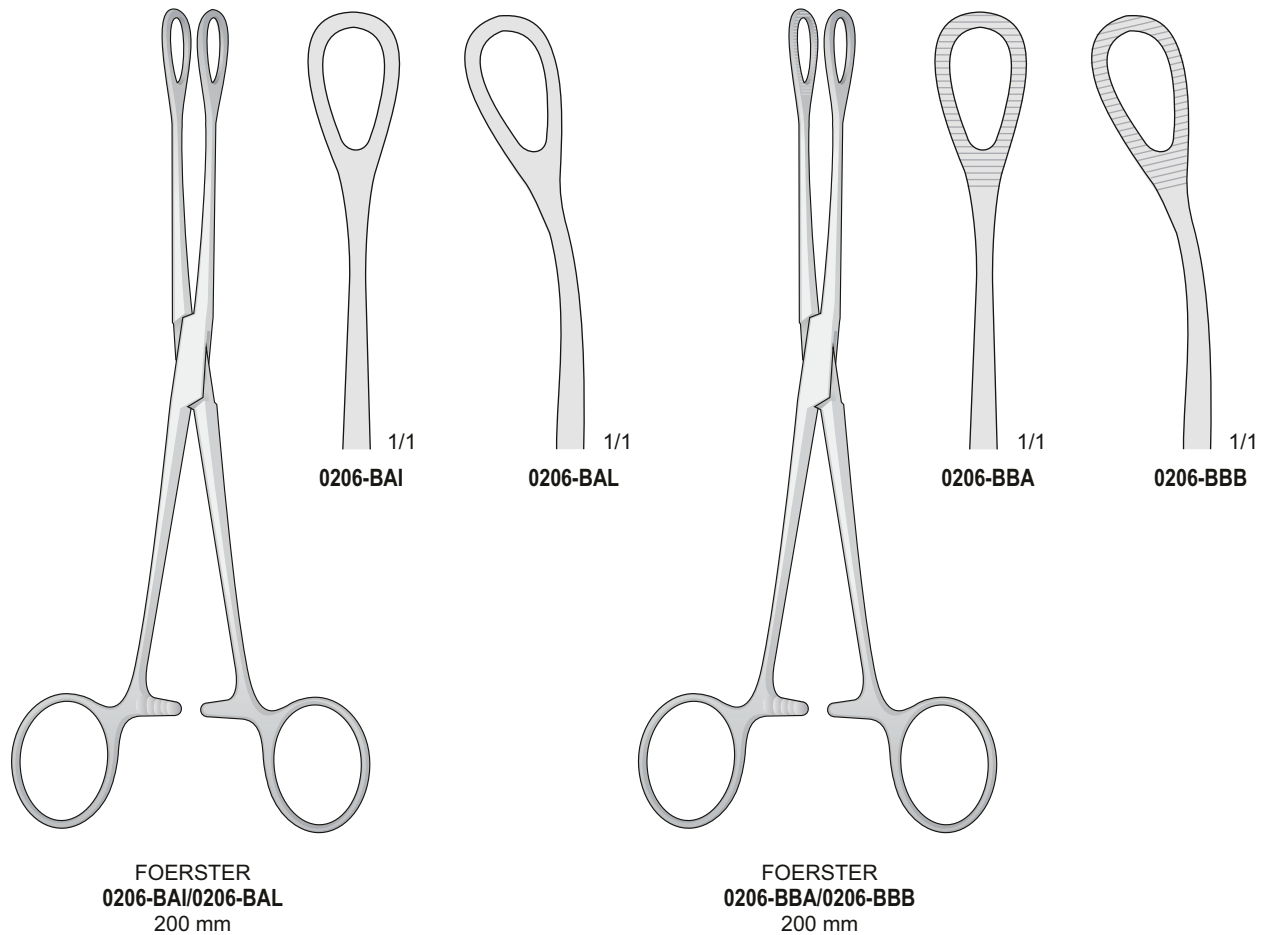
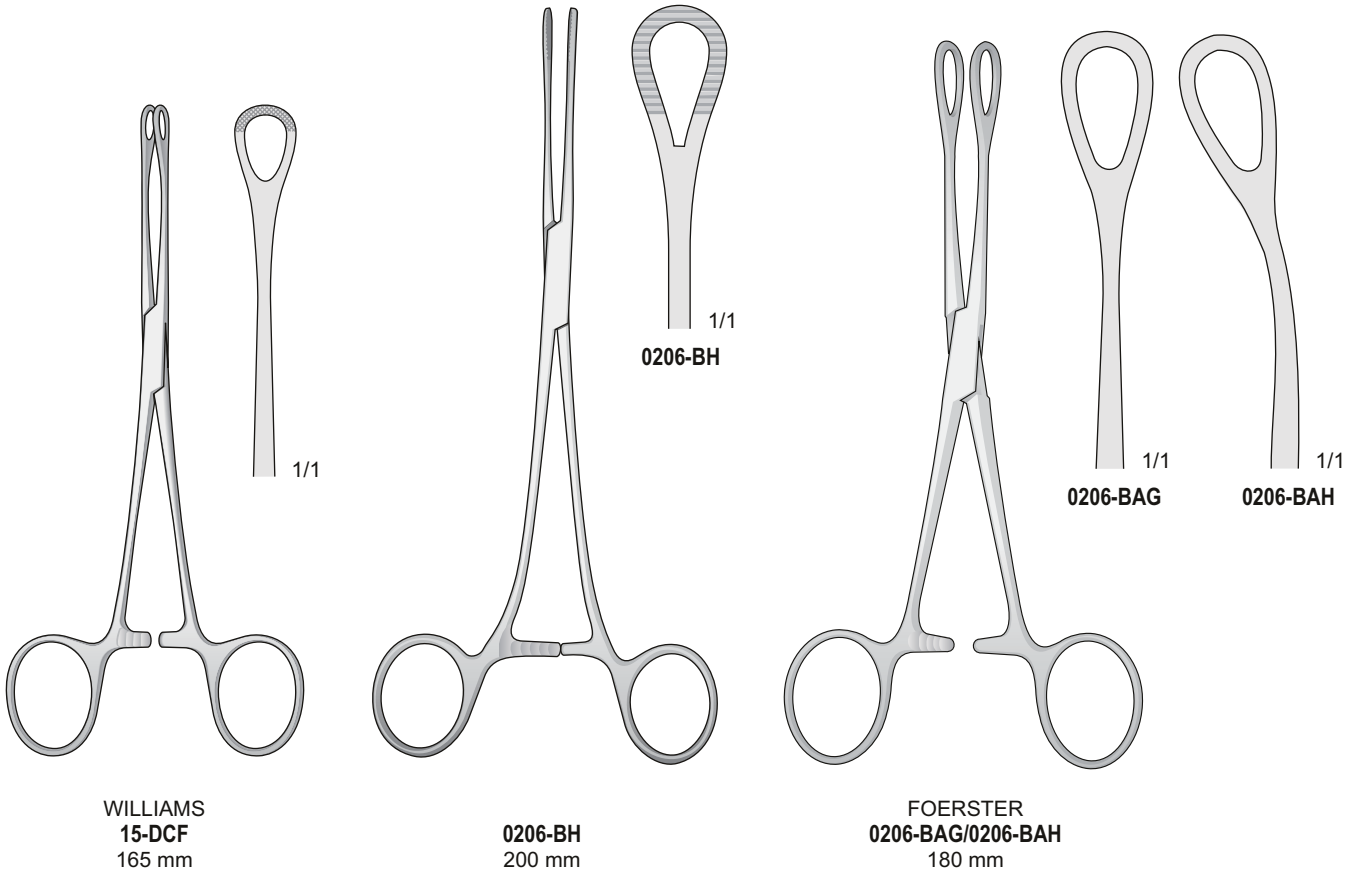

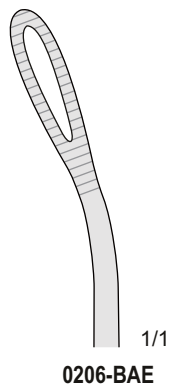
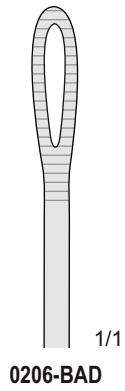
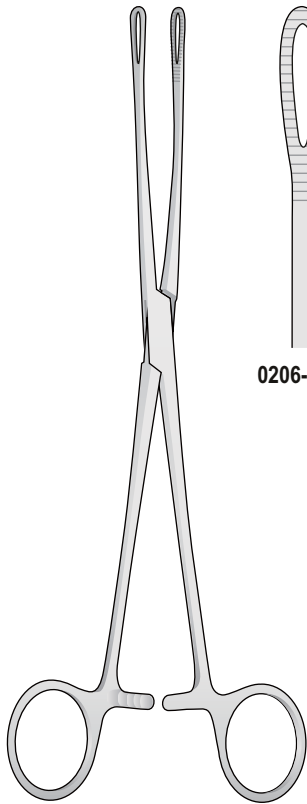

FOERSTER
0206-BAD/0206-BAE
250 mm

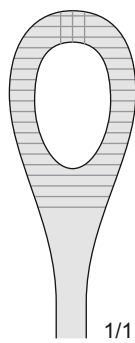
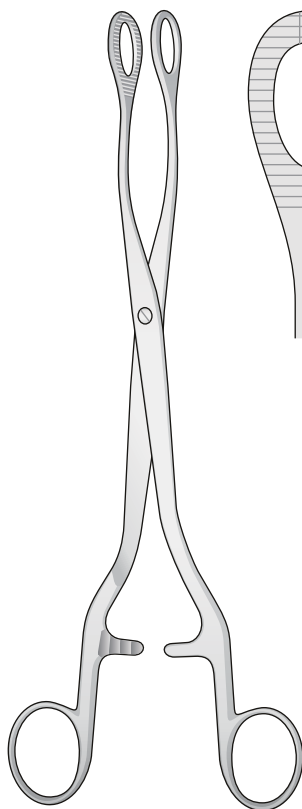

HEYWOOD-SMITH
0502-LI
250 mm

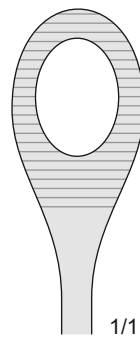
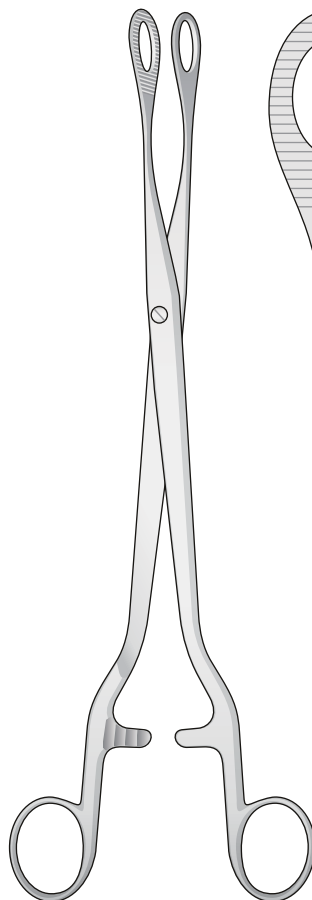

NOTO
0502-LL
280 mm

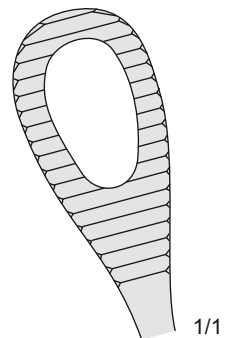
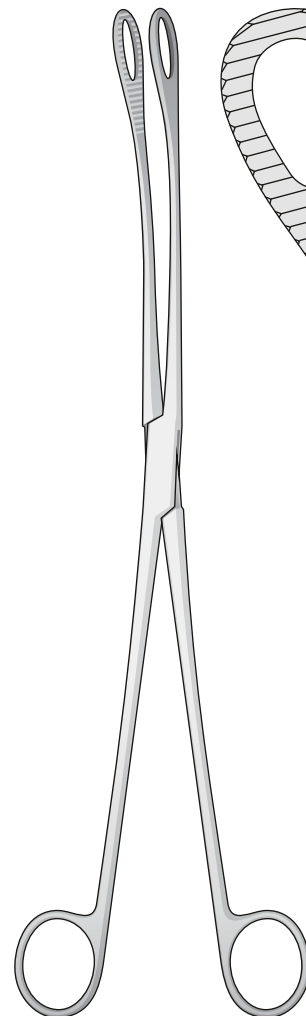

KELLY
0206-BAC
320 mm

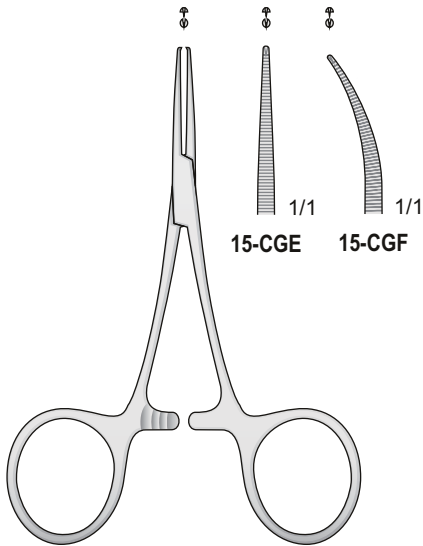

HARTMANN-BABY-MOSQUITO
15-CGE/15-CGF
95 mm

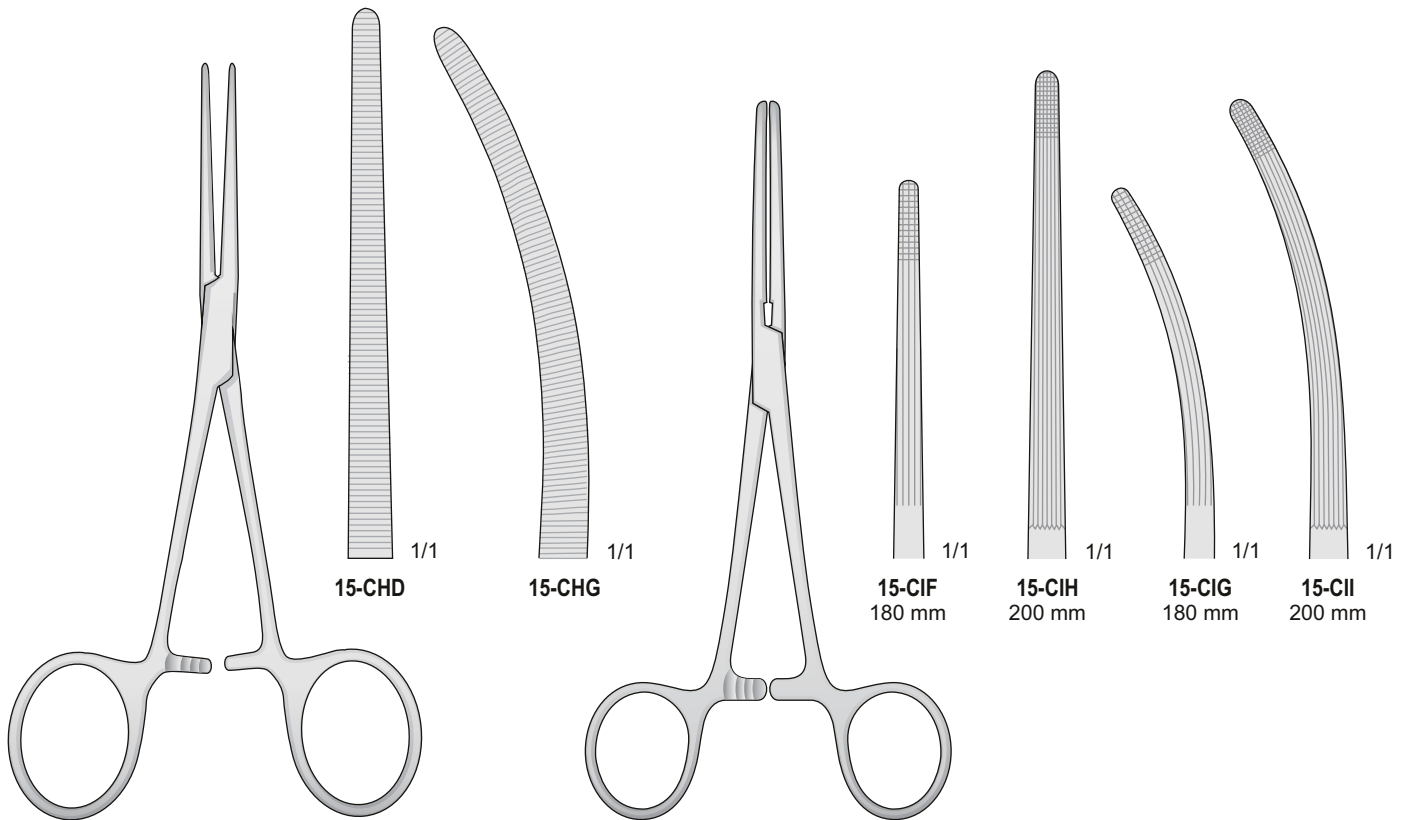

ROCHESTER-PEAN
15-CHD/15-CHG
225 mm

ROCHESTER-CARMALT
15-CIF/15-CII

Arterienklemmen

Hemostatic forceps

Pinze emostatiche

Pinzas hemostáticas

Pinces hémostatiques

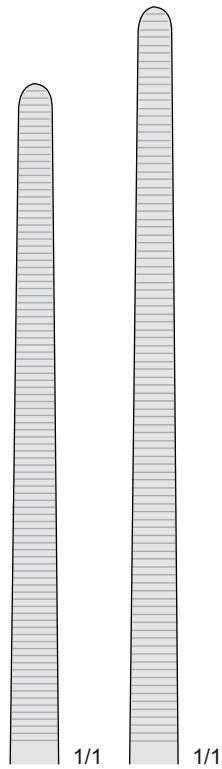

15-CHE
260 mm

15-CHF
280 mm

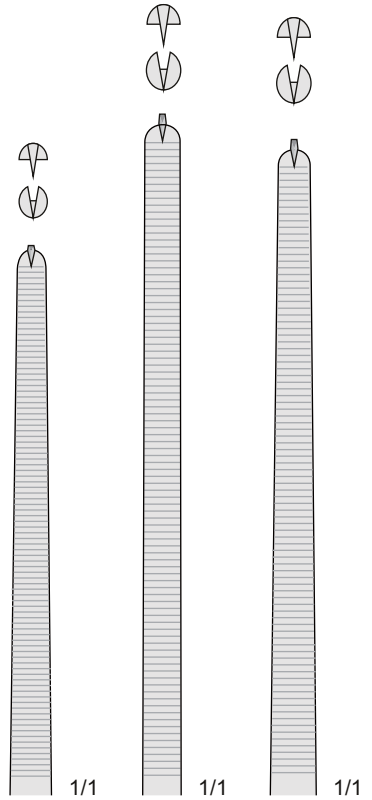

15-CHL
225 mm

15-CIA
260 mm

15-CIB
280 mm

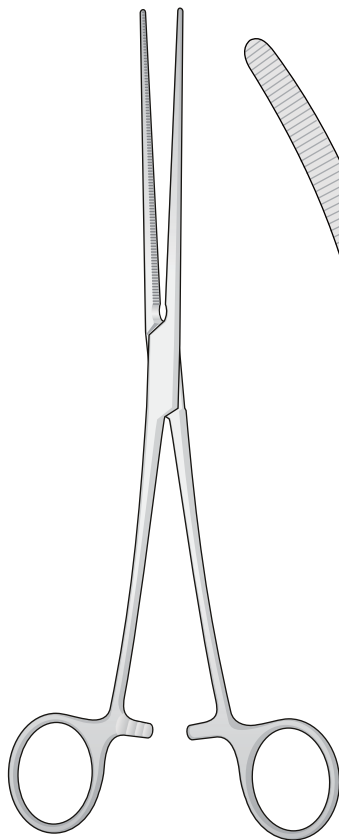

PEAN
15-CHE/15-CHI

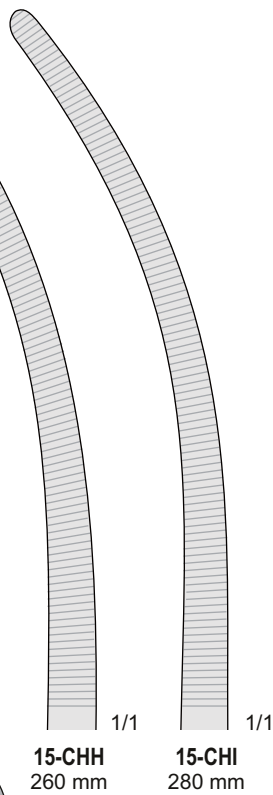

15-CHH
260 mm

15-CHI
280 mm

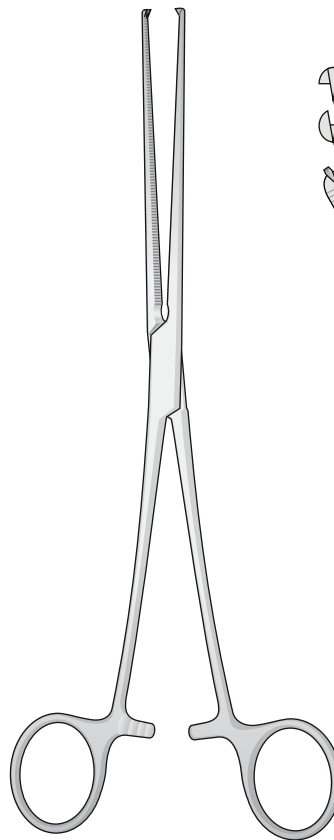

KOCHER-OCHSNER
15-CHL/15-CIE

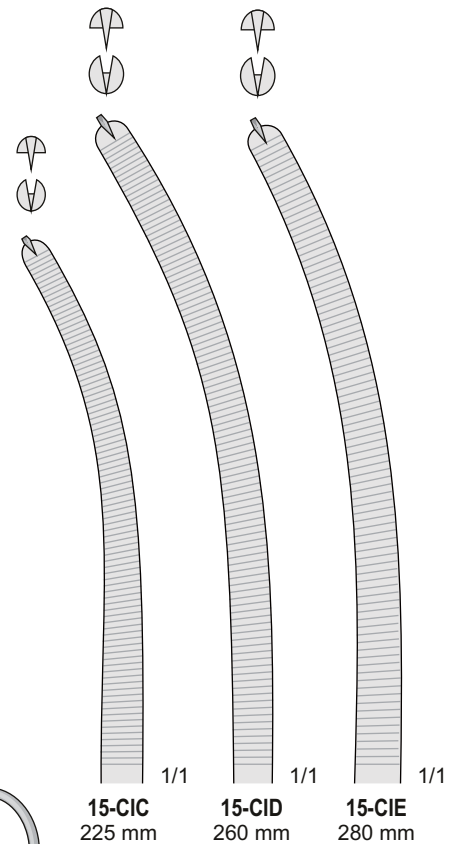

15-CIC
225 mm

15-CID
260 mm

15-CIE
280 mm

Arterienklemmen

Hemostatic forceps

Pinze emostatiche

Pinzas hemostáticas

Pinces hémostatiques

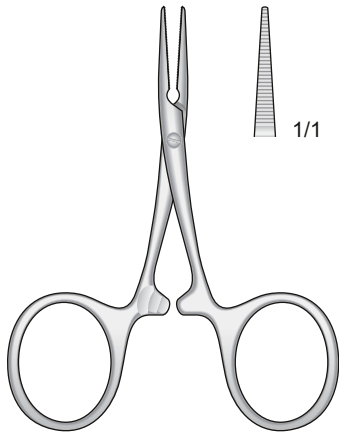

CARREL
15-DCD
85 mm

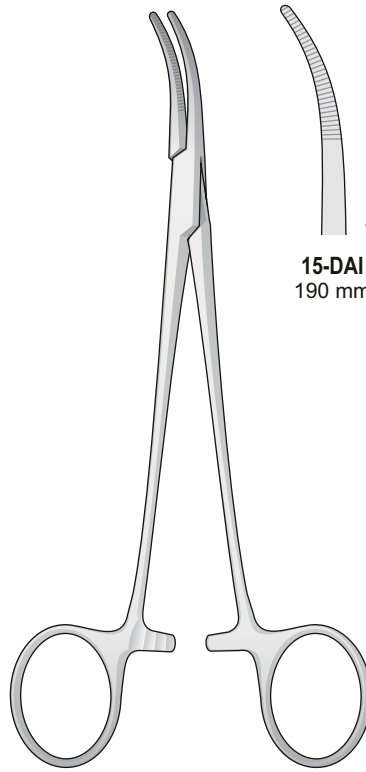

SCHNIDT
15-DAI/15-DAL
190 mm

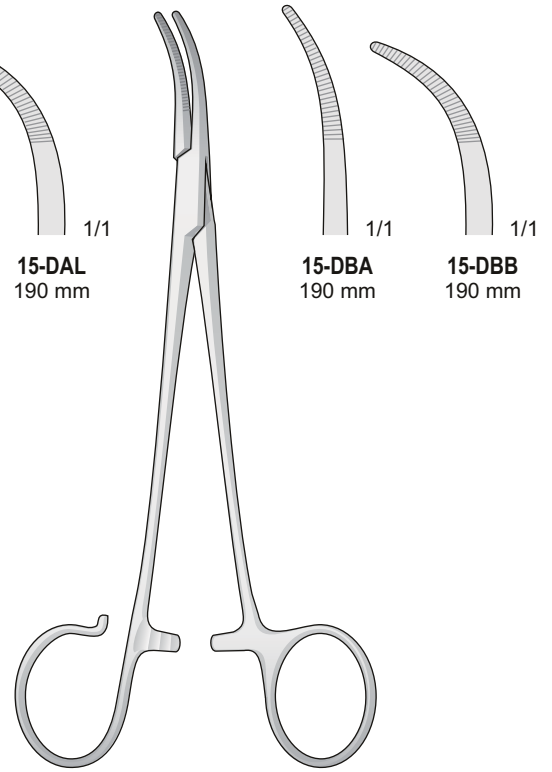

SCHNIDT
15-DBA/15-DBB
190 mm

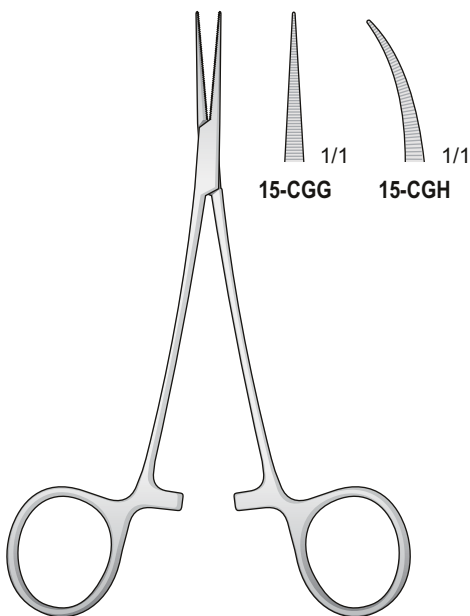

JACOBSON-MICRO
15-CGG/15-CGH
130 mm

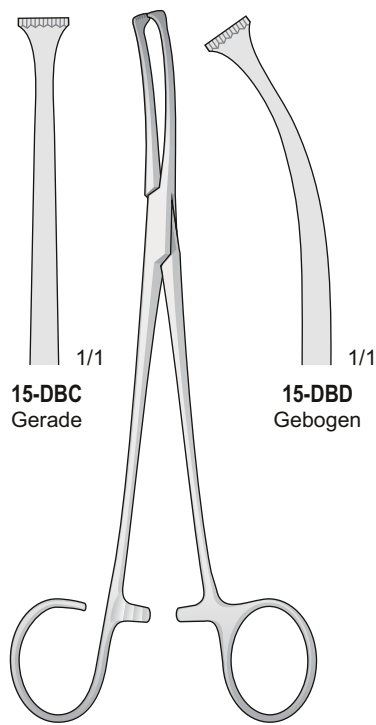

COLVER
15-DBC/15-DBD
190 mm

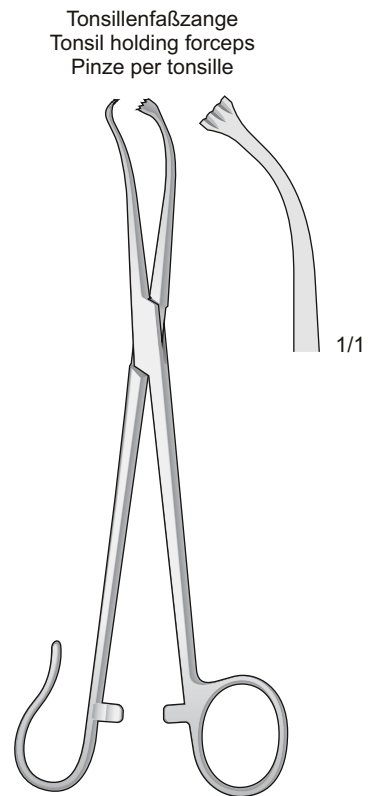

Tonsillenfaßzange
Tonsil holding forceps
Pinze per tonsille

WHITE
15-DBB
180 mm

Peritoneumklemmen

Peritoneal Clamp Forceps

Pinze per peitoneo

Pinzas para peitoneo

Pinces pour le péritoine

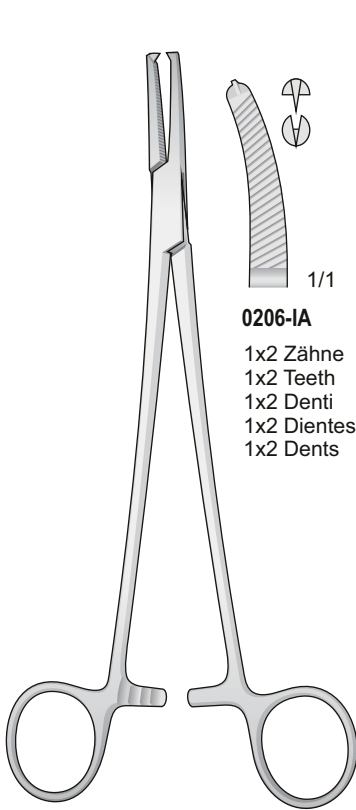

0206-IA

1x2 Zähne
1x2 Teeth
1x2 Denti
1x2 Dientes
1x2 Dents

0206-IB

1x2 Zähne
1x2 Teeth
1x2 Denti
1x2 Dientes
1x2 Dents

FAURE
0206-IA/0206-IB
200 mm

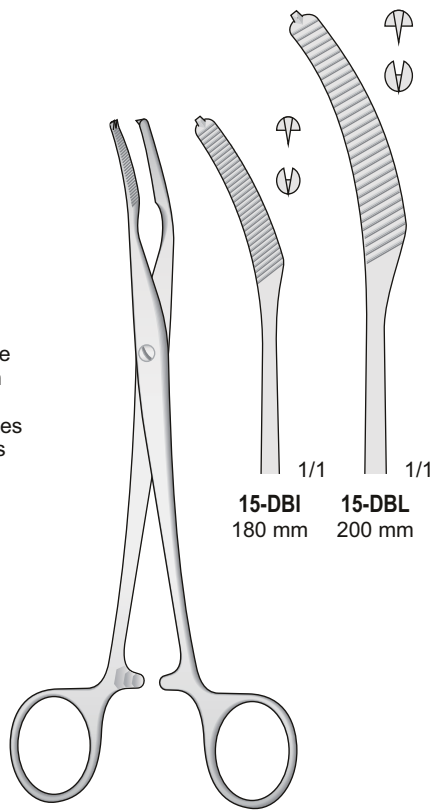

15-DBI
180 mm

15-DBL
200 mm

MIKULICZ
15-DBI/15-DBL

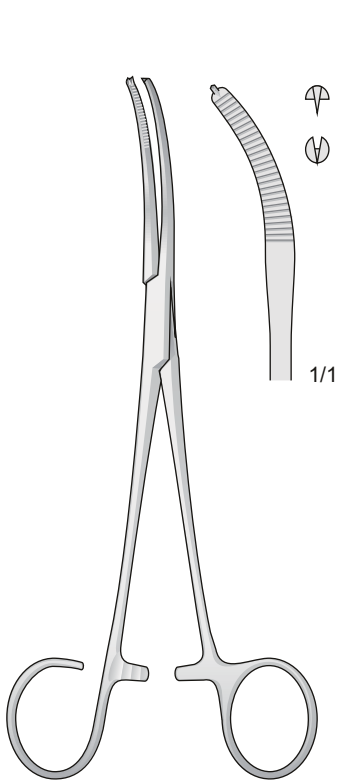

MIKULICZ
15-DCC
185 mm

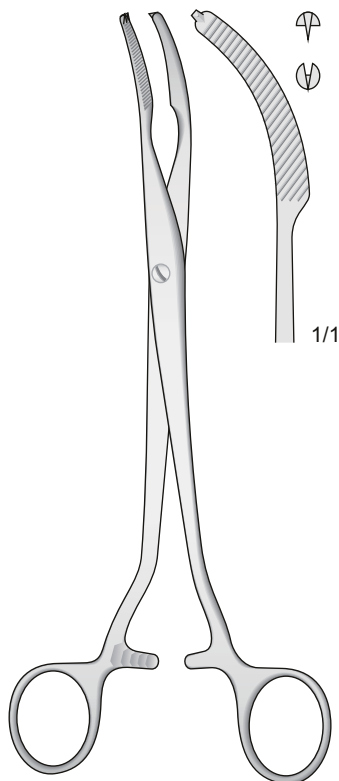

MIKULICZ
15-DCA
200 mm

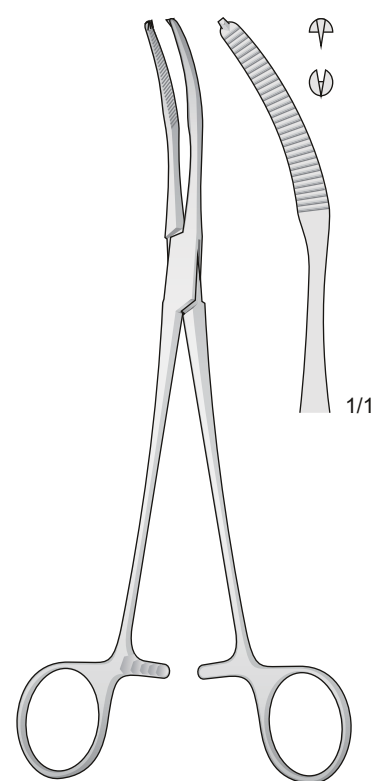

MIKULICZ
15-DCB
200 mm

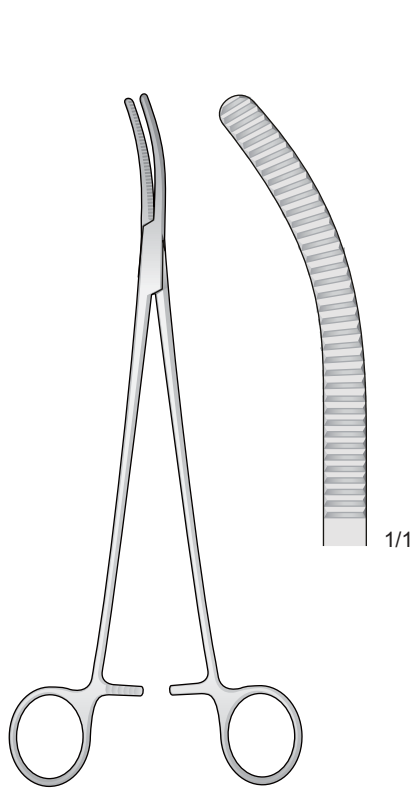

WERTHEIM
15-CIL
250 mm

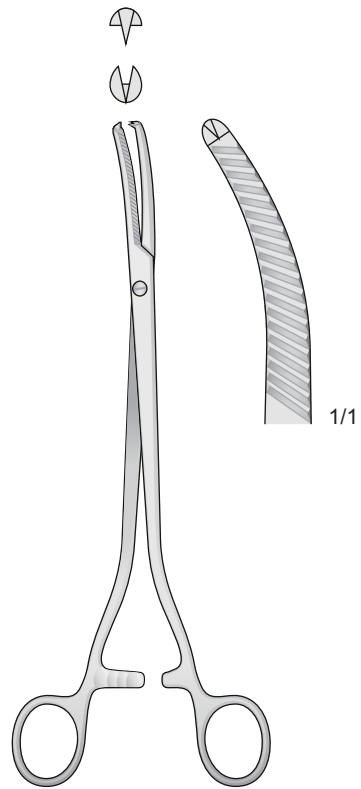

WERTHEIM
0602-CCC
230 mm

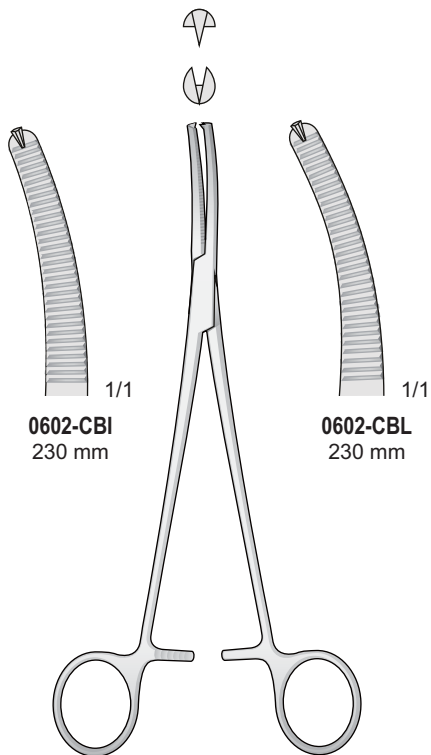

WERTHEIM
0602-CBI/0602-CBL
230 mm

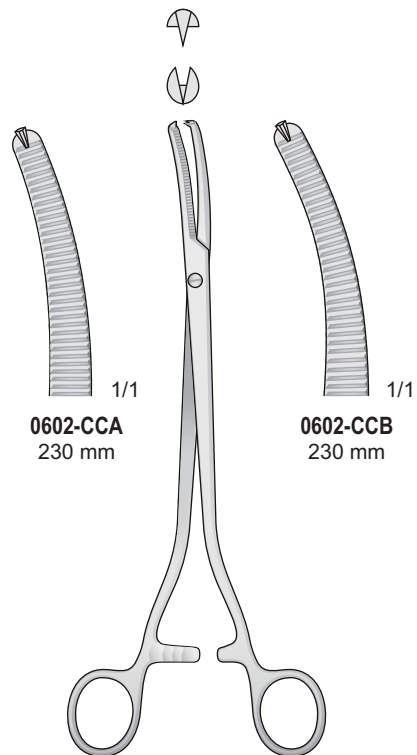

WERTHEIM
0602-CCA/0602-CCB
230 mm

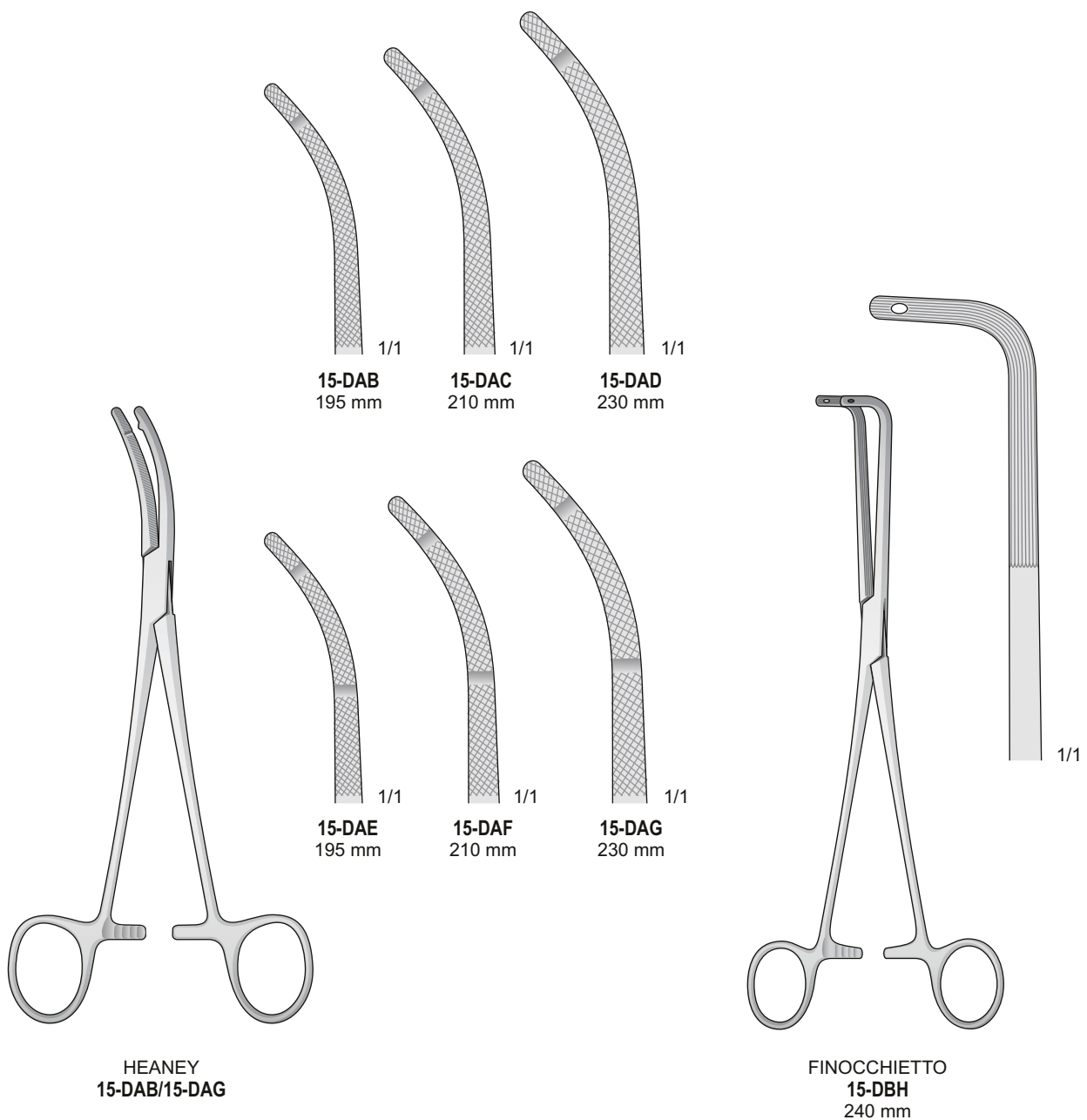

Arterienklemmen

Hemostatic forceps

Pinze emostatiche

Pinzas hemostáticas

Pinces hémostatiques

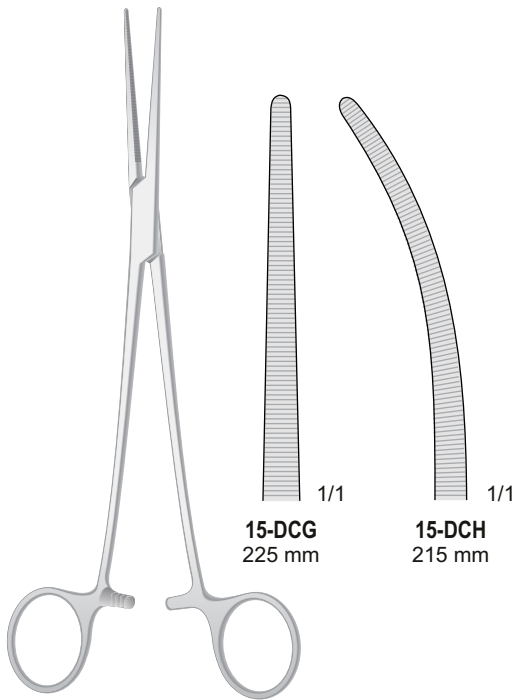

ROBERTS
15-DCG/15-DCH

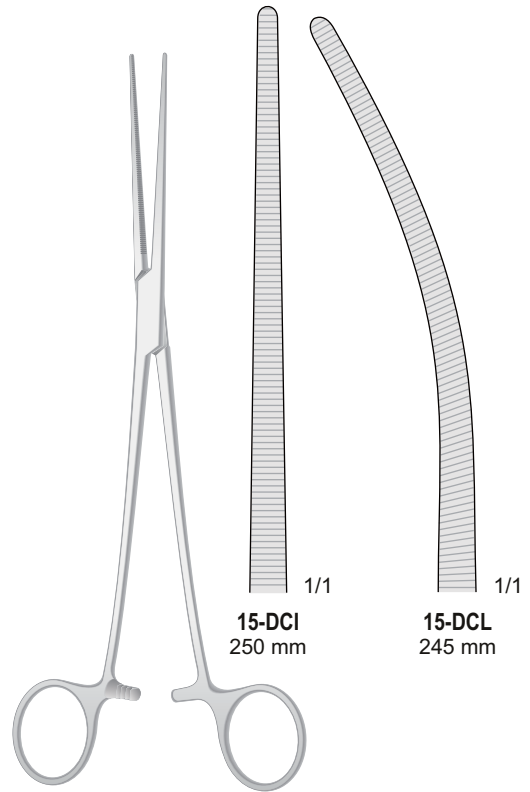

SAROT
15-DCI/15-DCL

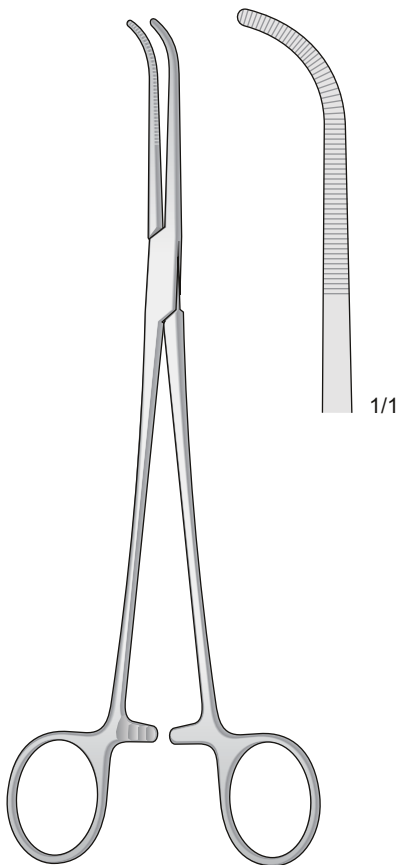

MIXTER
15-BBG
225 mm

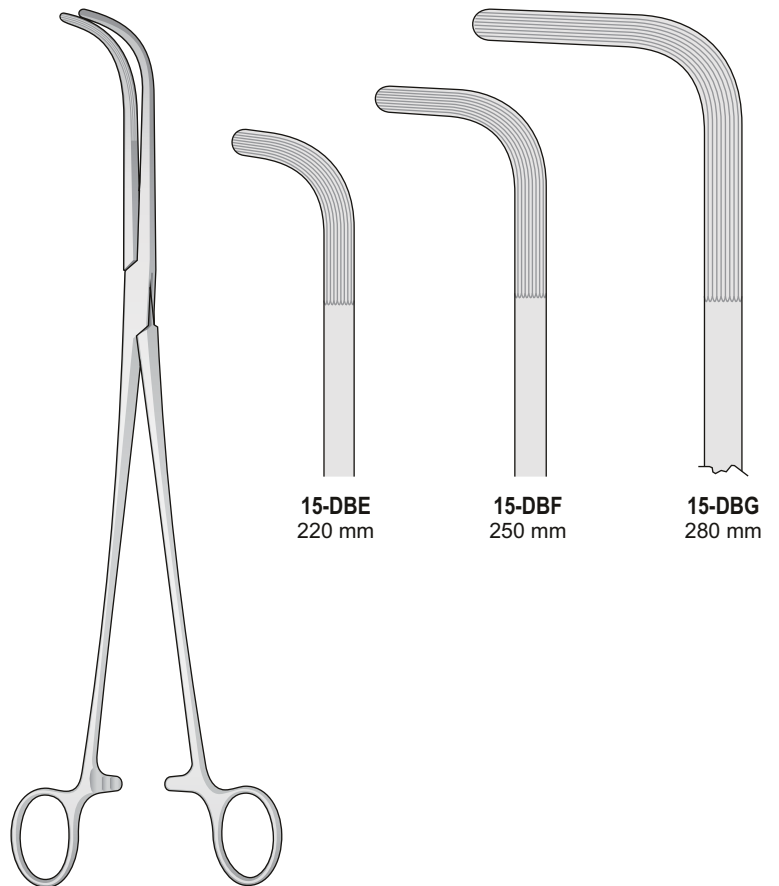

MIXTER
15-DBE/15-DBG

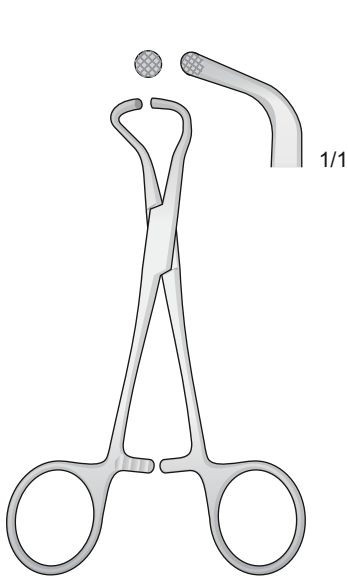

0206-HG
100 mm

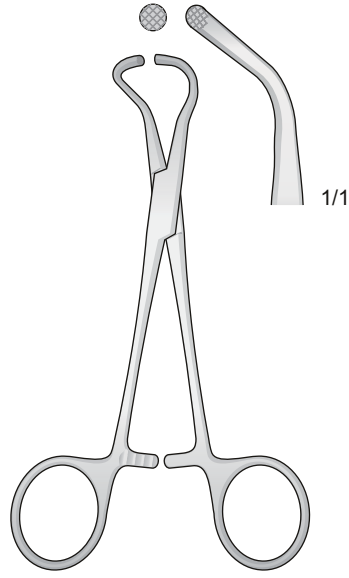

0206-HH
125 mm

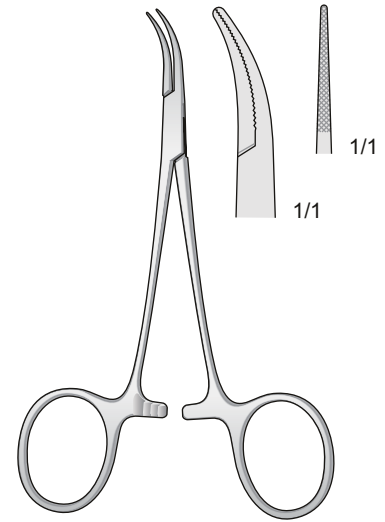

DANDY-MOSQUITO
15-DDC
120 mm

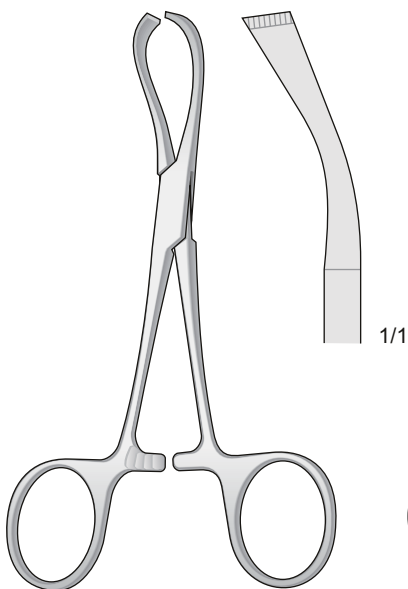

LORNA
0206-HB
130 mm

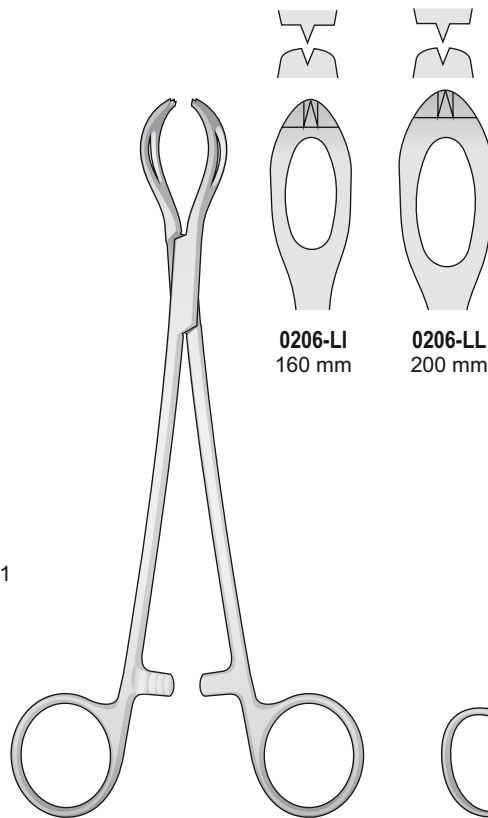

LANE
0206-LI/0206-LL

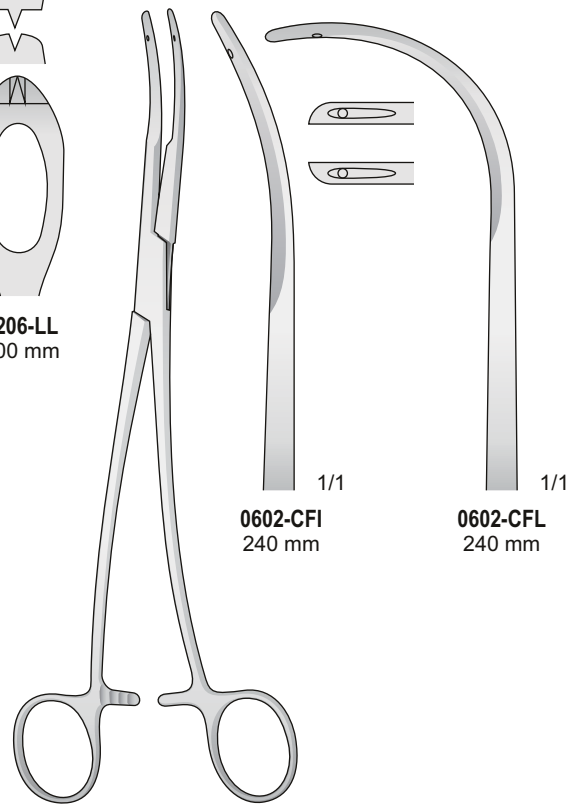

SEMB
0602-CFI/0602-CFL
240 mm

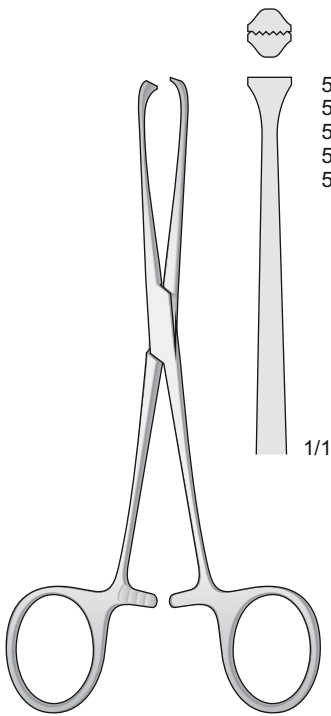

5x6 Zähne
5x6 Teeths
5x6 Denti
5x6 Dientes
5x6 Dents

1/1

BOYS-ALLIS
15-BCL
150 mm

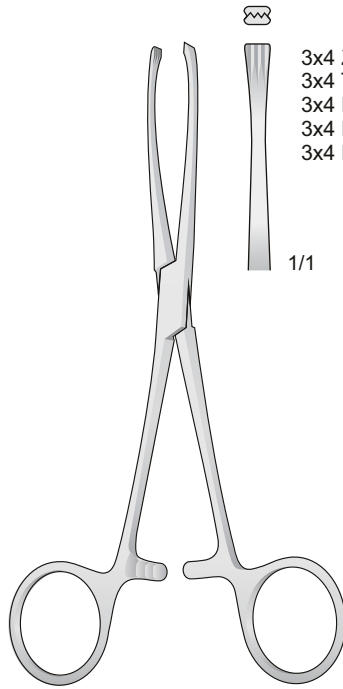

3x4 Zähne
3x4 Teeths
3x4 Denti
3x4 Dientes
3x4 Dents

1/1

JUDD-ALLIS
15-DCE
155 mm

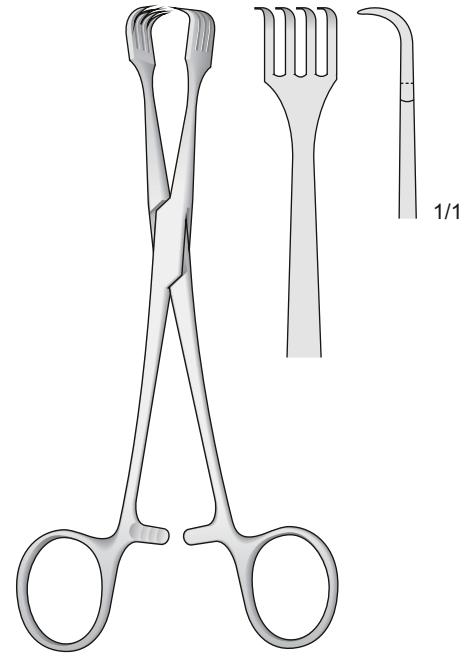

1/1

BRAUN
0206-FI
155 mm

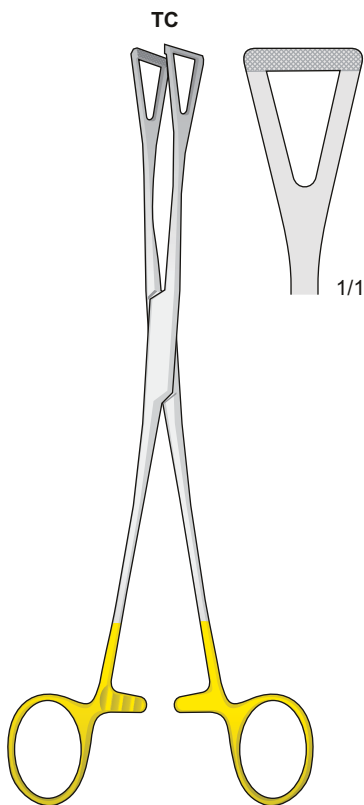

TC

1/1

DUVAL
15-DDA
200 mm

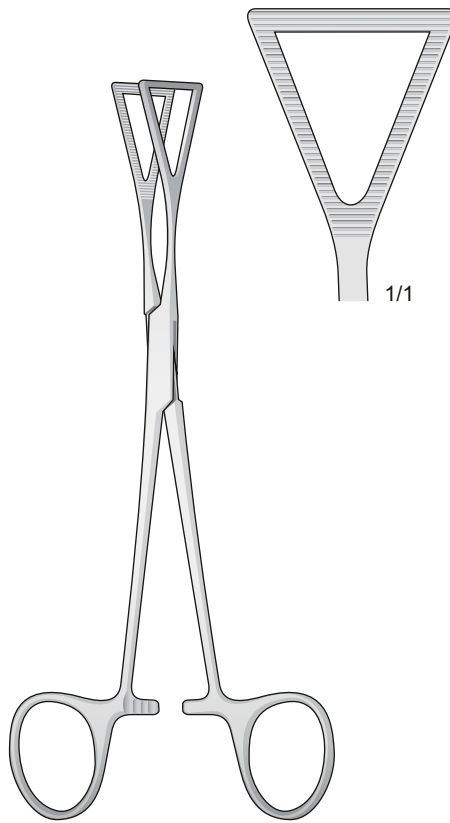

1/1

LOVELACE
15-CLI
200 mm

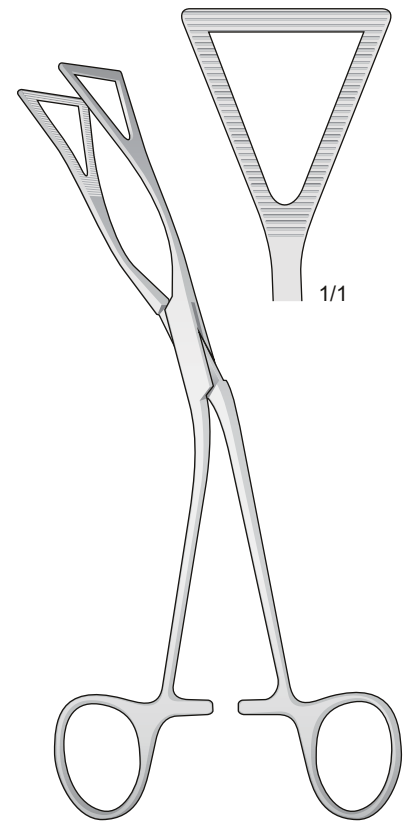

1/1

LOVELACE
15-CLL
200 mm

Arterienklemmen

Hemostatic forceps

Pinze emostatiche

Pinzas hemostáticas

Pinces hémostatiques



PEET
0417-EA
120 mm

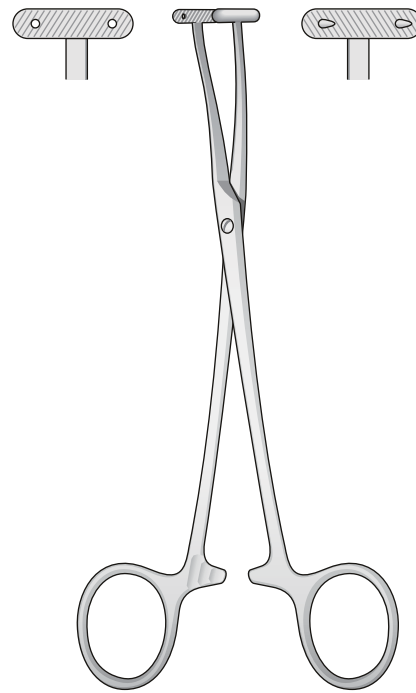

DE MARTEL
0602-BCA
180 mm



MIXTER
0502-DD
220 mm

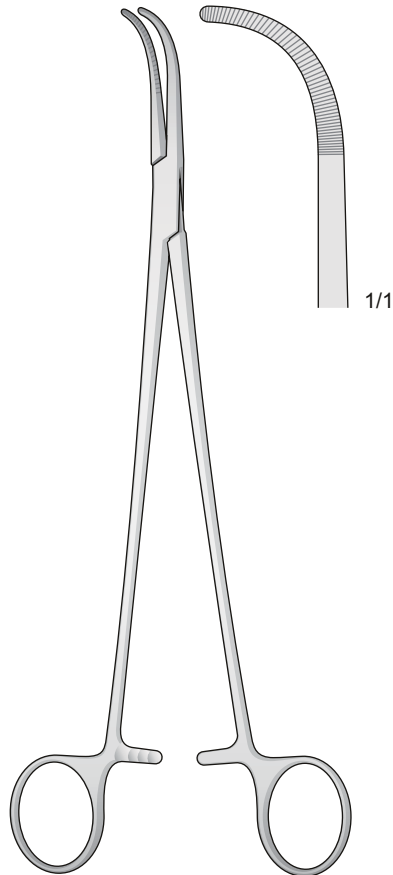

MIXTER
15-DAH
230 mm

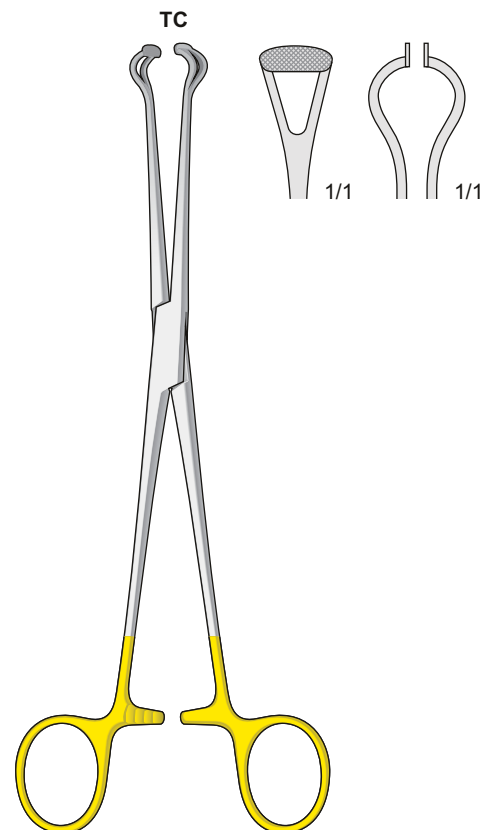

BABCOCK
15-DAA
210 mm

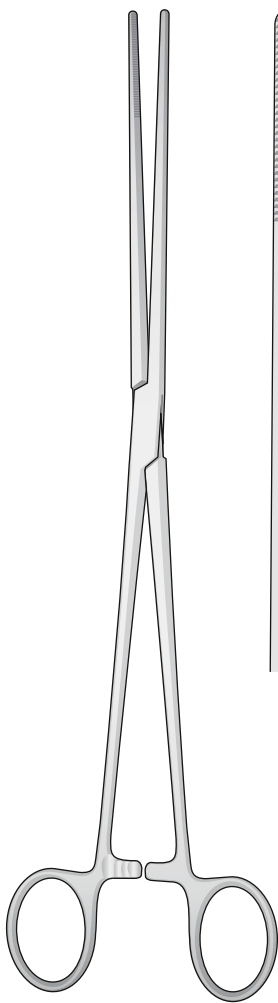

1/1

**BOZEMANN
0206-BBC**
260 mm

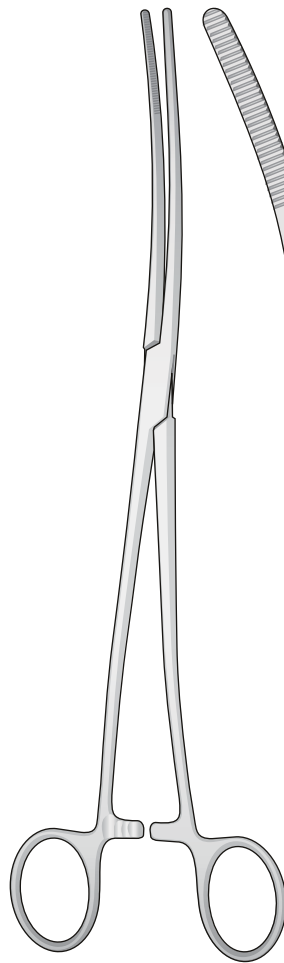

1/1

**BOZEMANN
0206-BBD**
260 mm

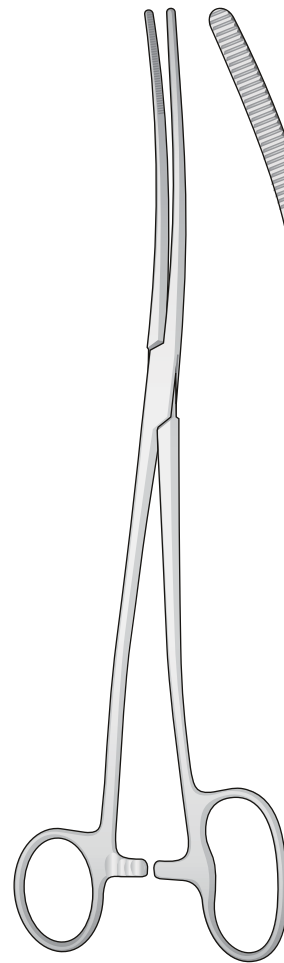

1/1

**BOZEMANN-DOUGLAS
0206-BBE**
260 mm

Atraumatische
Gefäßklemmen

Atraumatic
vessel clamps

Pinze
atraumatiche

Pinzas vasculares
atraumáticas

Pinces vasculaires
atrauma



De BAKEY

Atraumatiche



De BAKEY

Atraumatiche



0602-CCD
250 mm

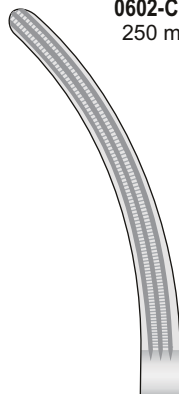

0602-CCE
245 mm

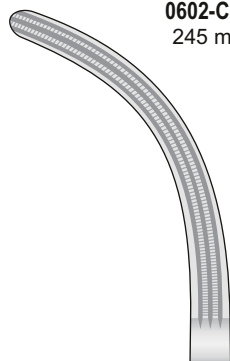

0602-CCF
240 mm

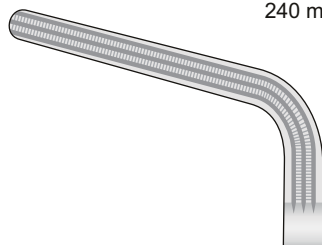

0602-CCG
230 mm

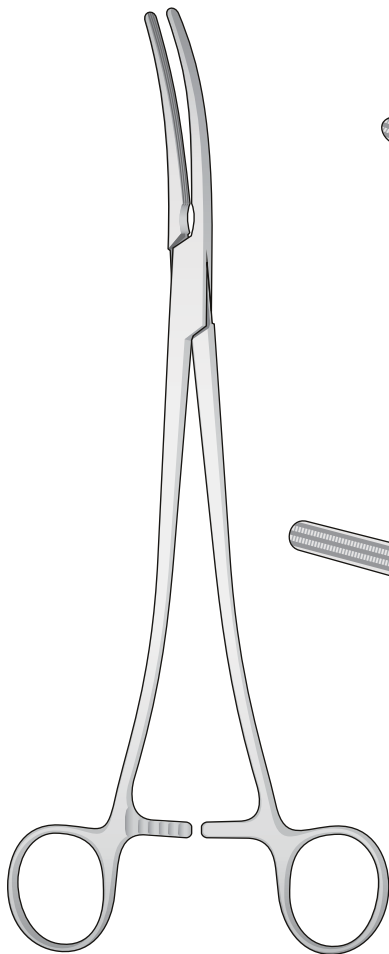

WERTHEIM
0602-CCD/0602-CCG

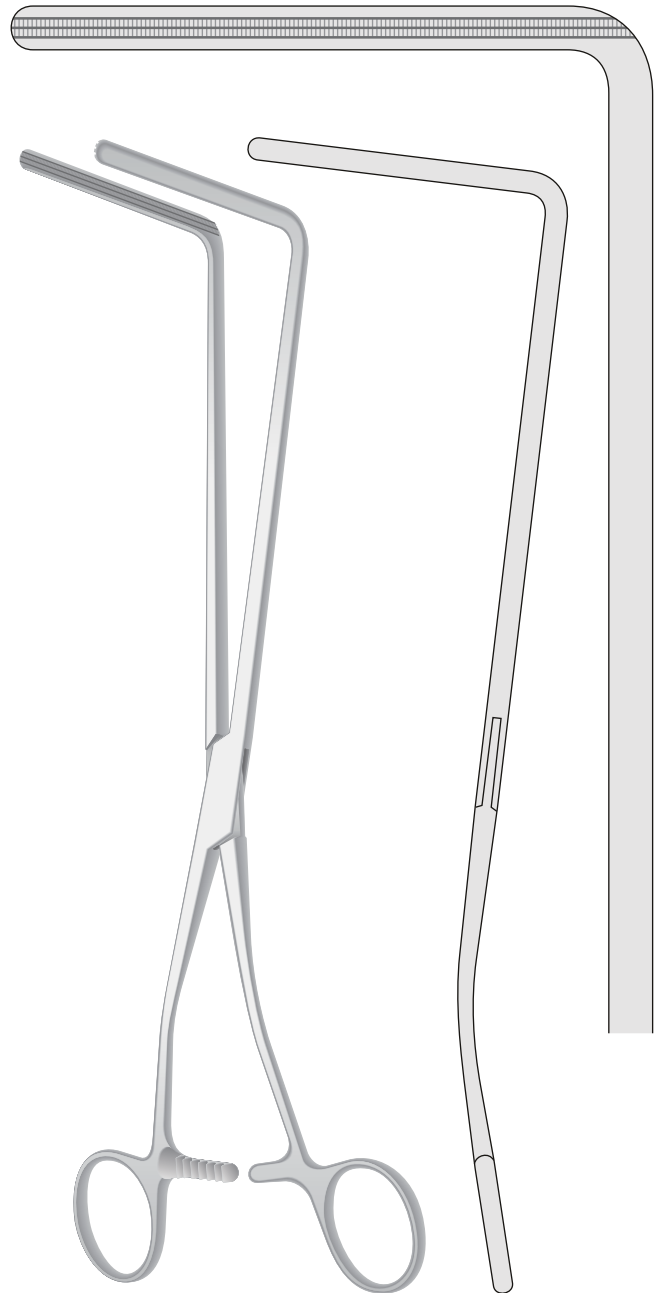

RESANO
0602-BDH
280 mm

1/1

Weich und elastisch
With soft and
elastic blades

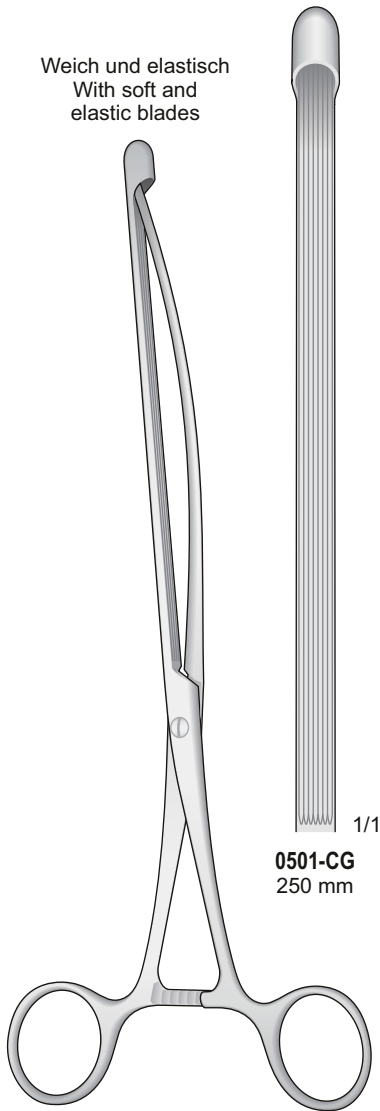

NUSSBAUM
0501-CG/0501-CH
250 mm

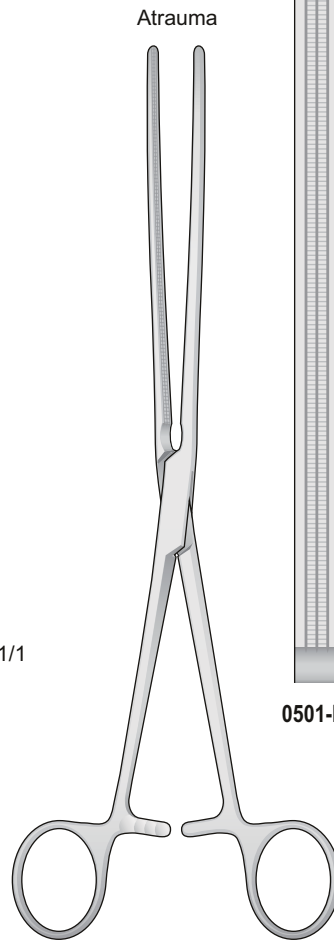
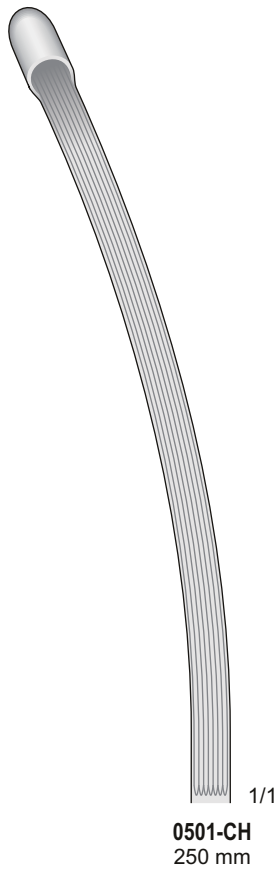
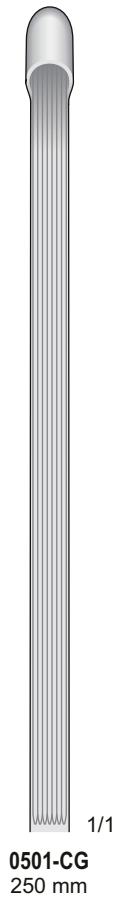

DOYEN
0501-DI/0501-DL
230 mm

Atrauma

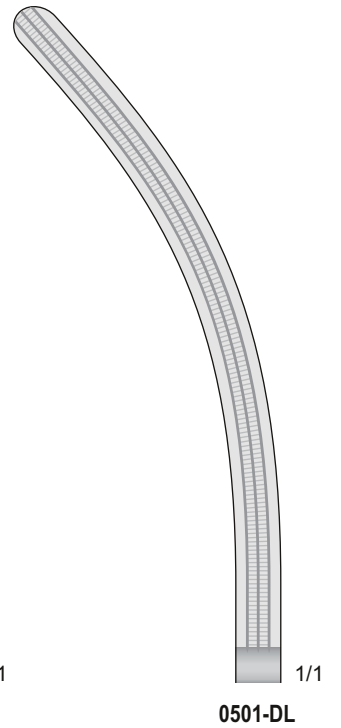
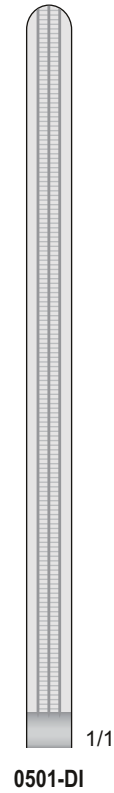

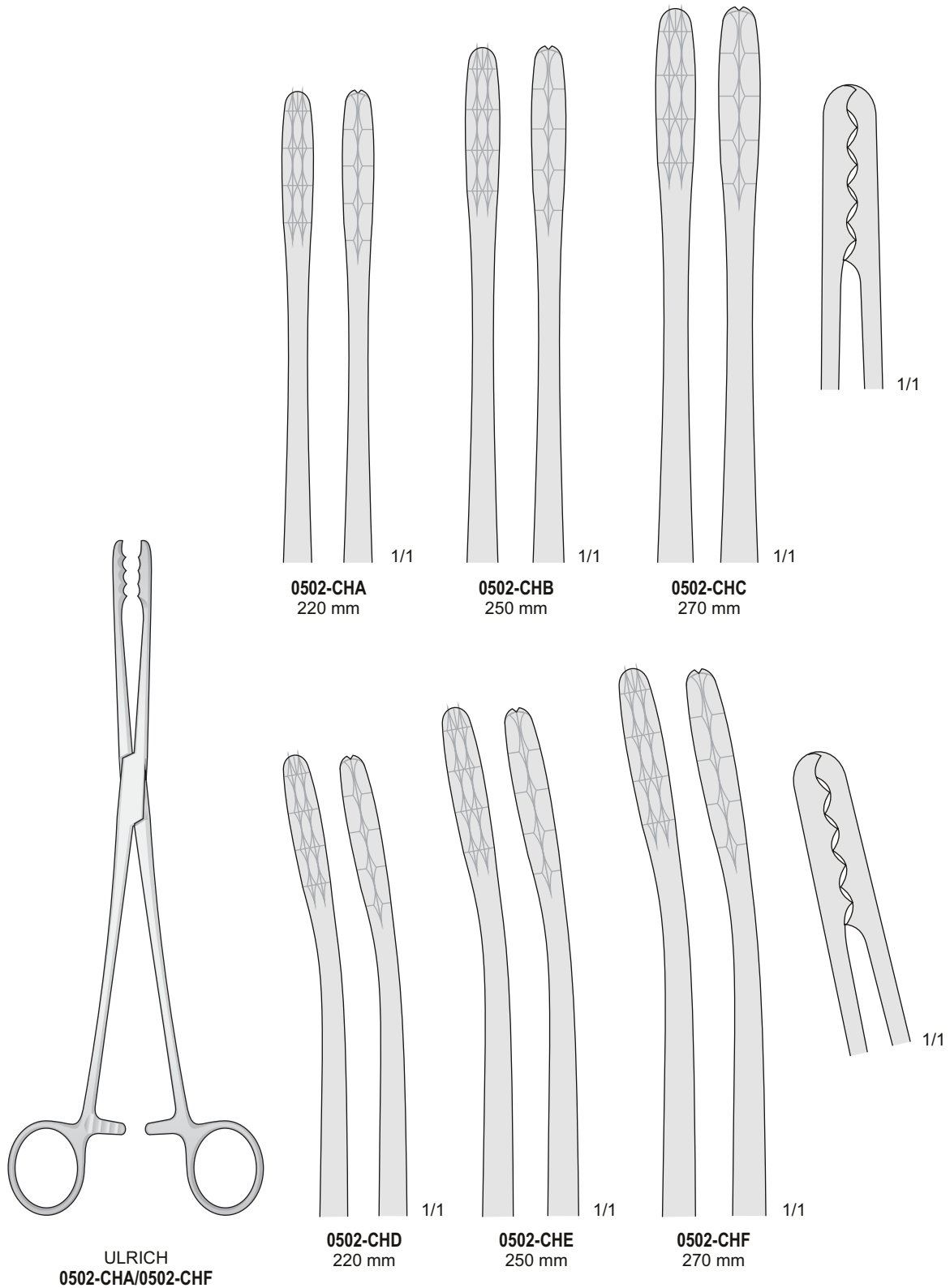

Fine-Arterienklemmen

Fine
Artery forceps

Pinze emostatiche
delicate

Pinzas hemostáticas
fino

Delicate
Pincas hémostáticas

Titan - Titanium - Titanio - Titane

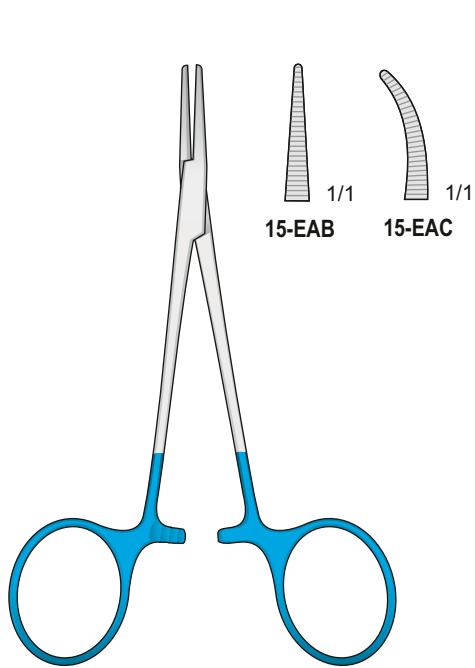

HALSTED-MOSQUITO
15-EAB/15-EAC
120 mm

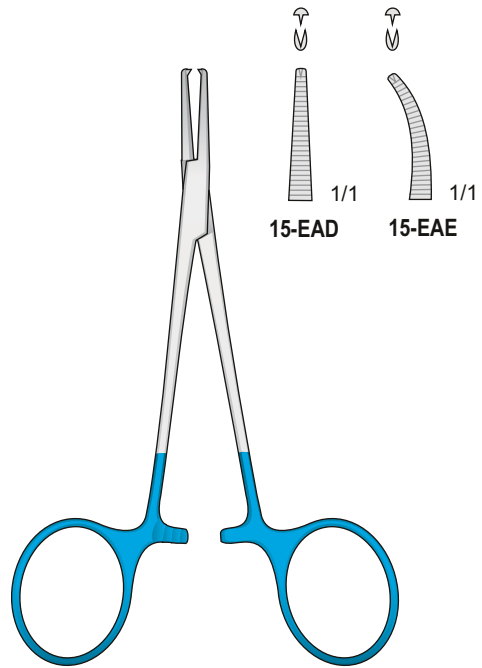

HALSTED-MOSQUITO
15-EAD/15-EAE
120 mm

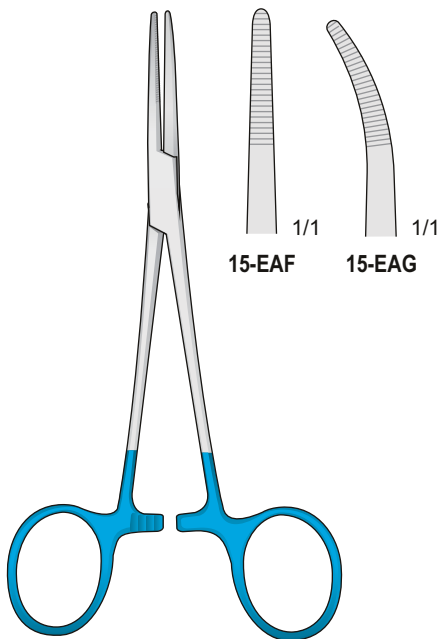

KELLY
15-EAF/15-EAG
140 mm

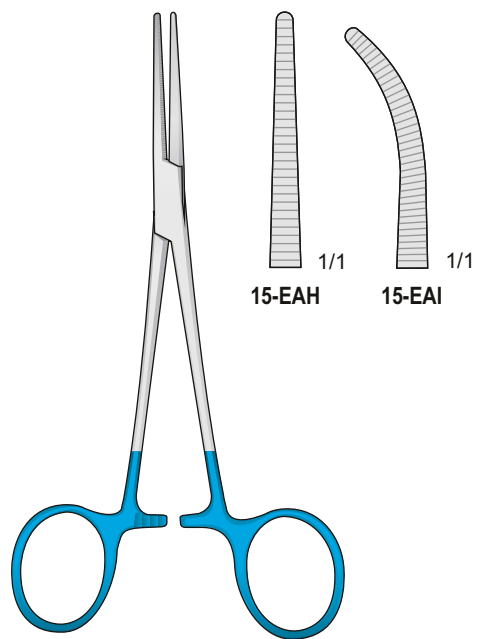

CRILE
15-EAH/15-EAI
140 mm

Venen-Stripper-
Instrumente

Vein Stripper
instruments

Strumenti per stripping
di vene

Instrumentos para
varices

Instruments pour
stripping veineux

0602-DLA
Krampfaderbesteck komplett
Varicose Vein Probe Set complete
Set completo sonda per varici
Juego para varices completo
Trousse à varices complète

Metall-Sondenspitzen
Probe tip, metal
Punta per sonda
in metallo
Punta metálica
Pointe en métal

Ø 3 mm

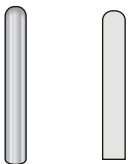

0602-DLE



0602-DLF/0602-DLI



Ø 6 mm

0602-DLF



Ø 9 mm

0602-DLG



Ø 12 mm

0602-DLH

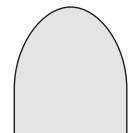

Ø 15 mm

0602-DLI

Oliven - Olives - Olive - Oliva - Olive

Griff Allein
Handle only
Manico solo
Mango solo
Manche seule

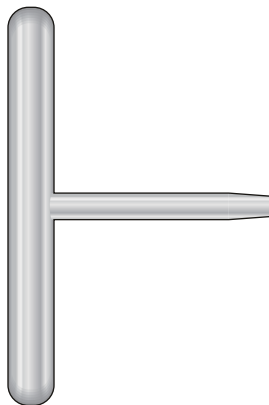

0602-EAA

Zugseil
Traction Cable
Cavo per trazione
Cable de tracción
Cable tracteur

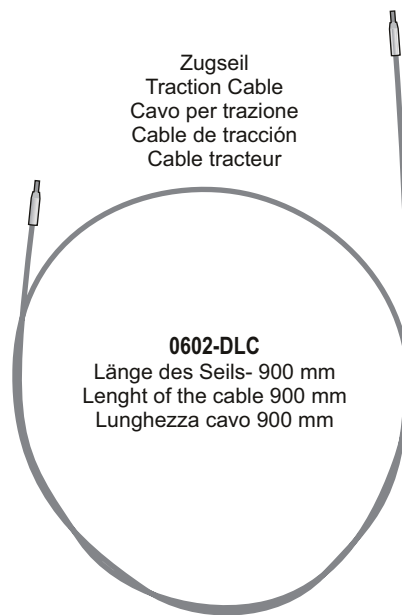

0602-DLC

Länge des Seils- 900 mm
Lenght of the cable 900 mm
Lunghezza cavo 900 mm

Nadelhalter

Needle Holders

Port'aghi

Portaagujas

Porte Aiguilles

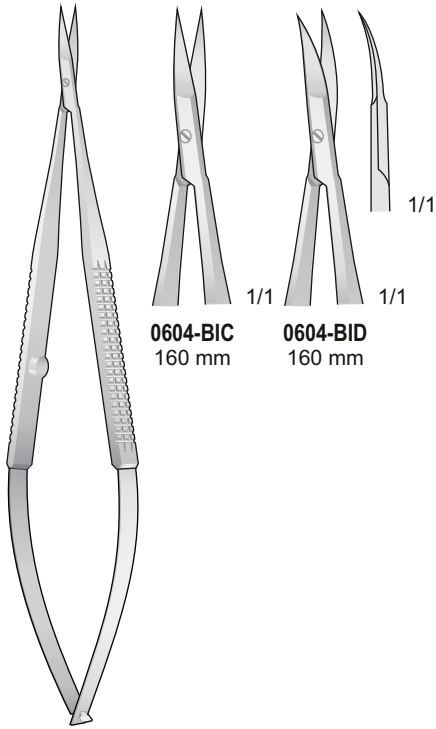

0604-BIC
160 mm

0604-BID
160 mm

0604-BIC/0604-BID
160 mm

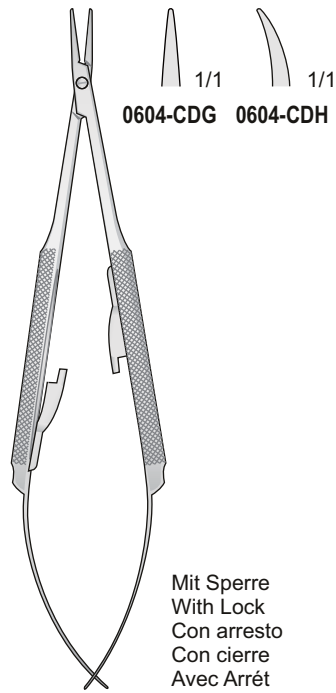

0604-CDG **0604-CDH**

Mit Sperre
With Lock
Con arresto
Con cierre
Avec Arrêt

BARRAQUER
0604-CDG/0604-CDH
150 mm

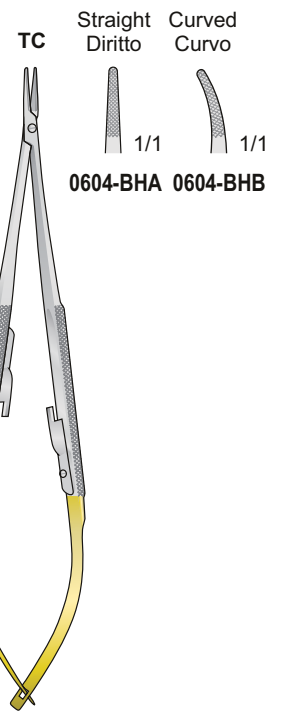

TC
Straight Diritto Curved Curvo
1/1 1/1
0604-BHA **0604-BHB**

CASTROVIEJO
0604-BHA/0604-BHB
140 mm

Nadelhalter mit Hartmetalleinlagen - Needle Holders with tungsten-carbide inserts
Portaghi con inserti al tungsteno - Portaagujas con plaquitas de carburo de tungsteno
Porte aiguilles avec plaquettes en carbure de tungstène

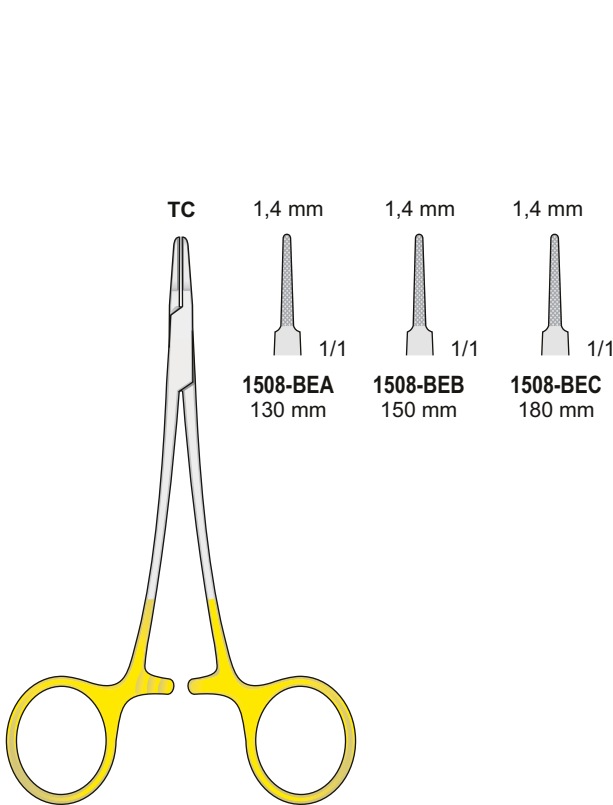

TC 1,4 mm 1,4 mm 1,4 mm
1/1 1/1 1/1
1508-BEA **1508-BEB** **1508-BEC**
130 mm 150 mm 180 mm

MICRO-RYDER
1508-BEA/1508-BEC

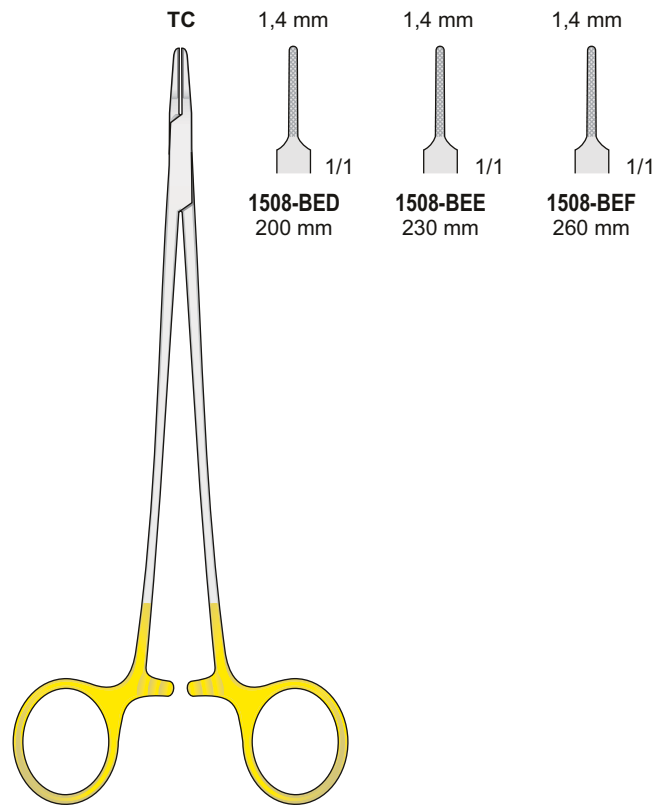

TC 1,4 mm 1,4 mm 1,4 mm
1/1 1/1 1/1
1508-BED **1508-BEE** **1508-BEF**
200 mm 230 mm 260 mm

MICRO-RYDER
1508-BED/1508-BEF

Nadelhalter

Needle Holders

Port'aghi

Portaagujas

Porte Aiguilles

Nadelhalter mit Hartmetalleinlagen - Needle Holders with tungsten-carbide inserts - Port'aghi con inserti al tungsteno
 Portaagujas con plaquitas de carburo de tungsteno - Porte aiguilles avec plaquettes en carbure de tungstène

Ein Ring abgewinkelt
 One ring angled
 Un anello angolato

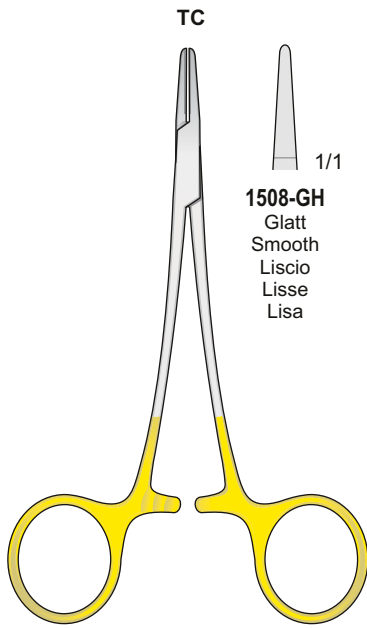

HALSEY
1508-GH
 130 mm

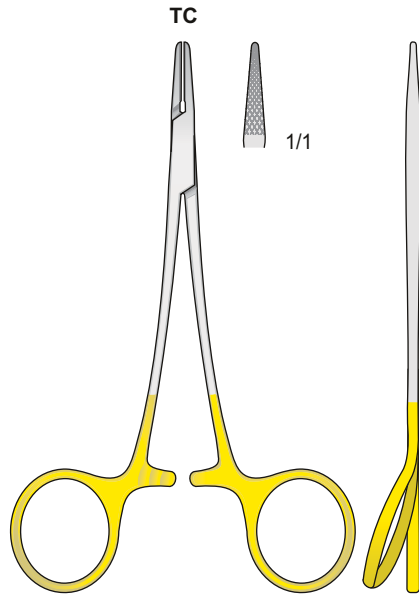

1508-LL
 120 mm

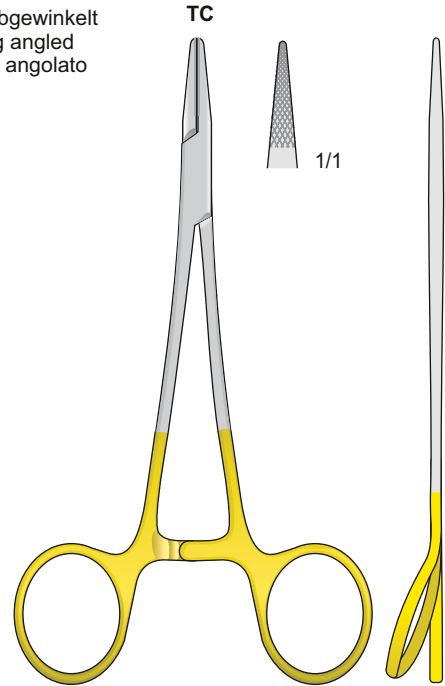

CRILE-WOOD
1508-BAA
 150 mm

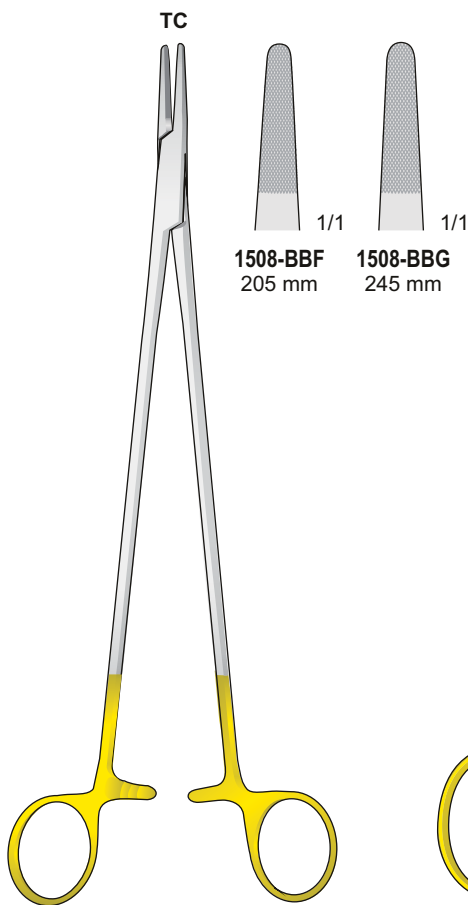

HEGAR
1508-BBF/1508-BBG

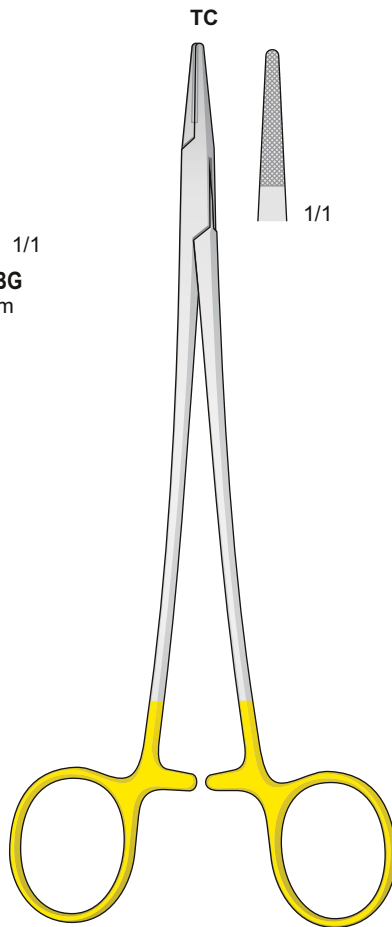

DE BAKEY
1508-BDF
 370 mm

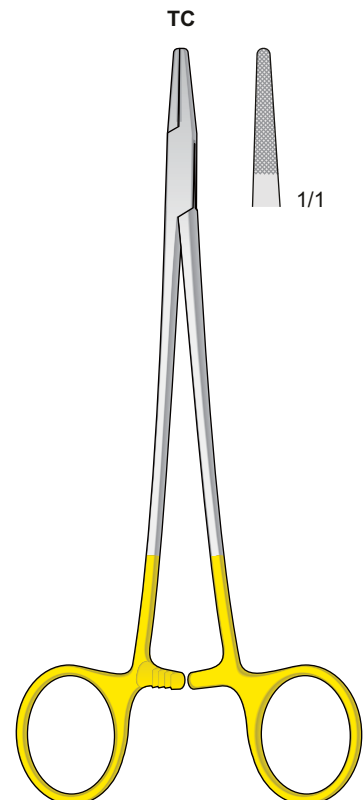

DeBAKEY
1508-BAL
 200 mm

Nadelhalter

Needle Holders

Port'aghi

Portaagujas

Porte Aiguilles

Für Linkshänder - Left Handed
Per mancini - Pour gauche - Para zurdos

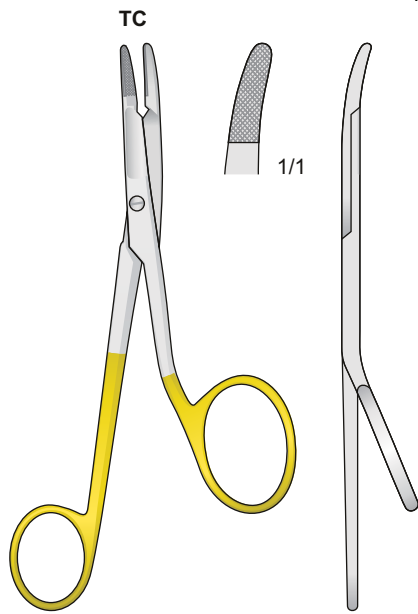

GILLIES
1514-LH11
160 mm

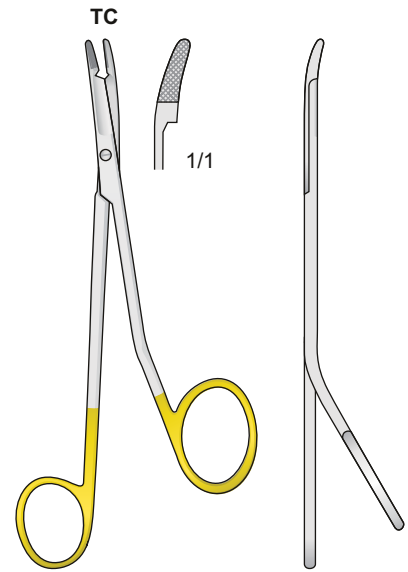

MINI-GILLIES
1514-LL11
145 mm

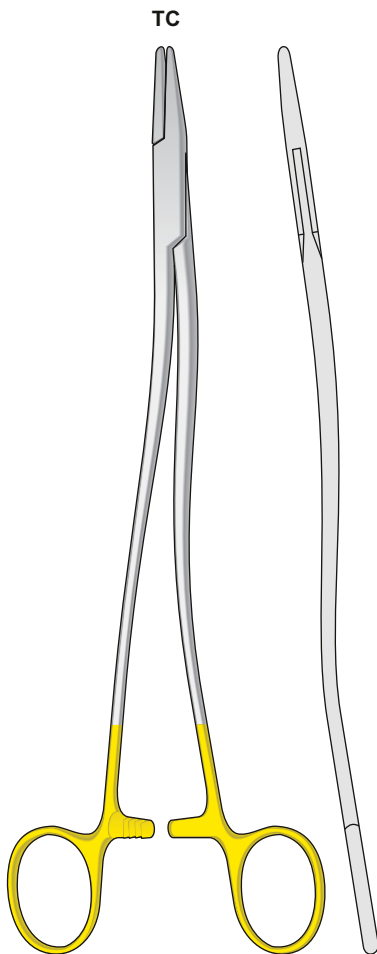

BOZEMANN
1508-BDG/139

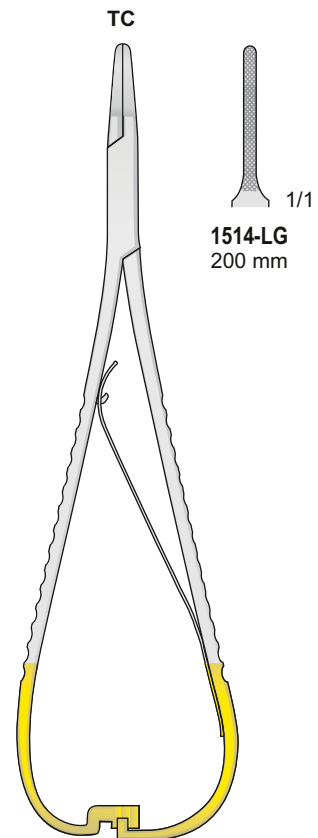
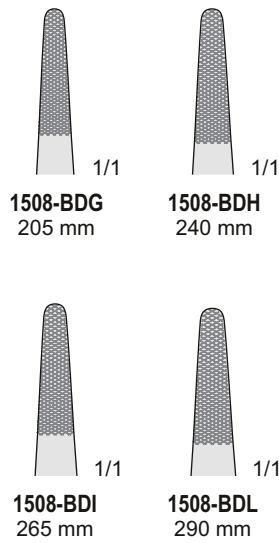

LICHTENBERG
1514-LG
175 mm

Kräftiges Modell
Heavy pattern
Modello robusto
Modèle robuste

TC

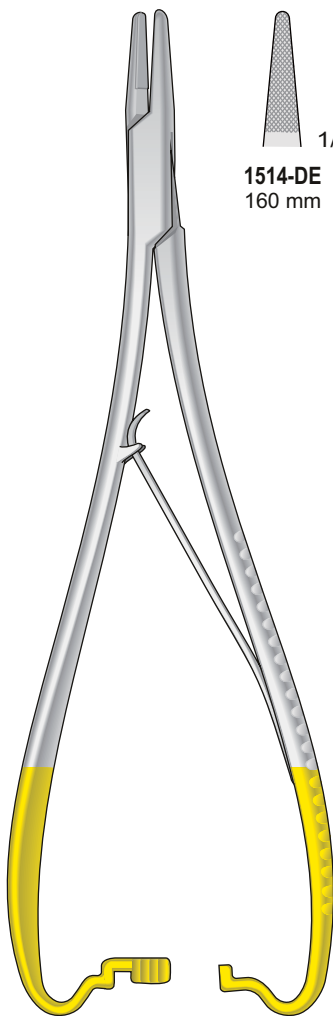

MATHIEU
1514-DE/1514-DG

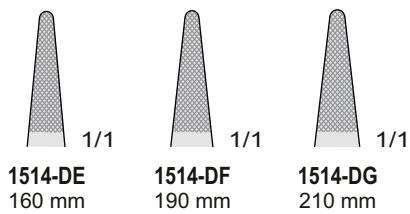

Atraumatische - Atraumatic
Atraumatiche - Atraumáticas
Atraumatique

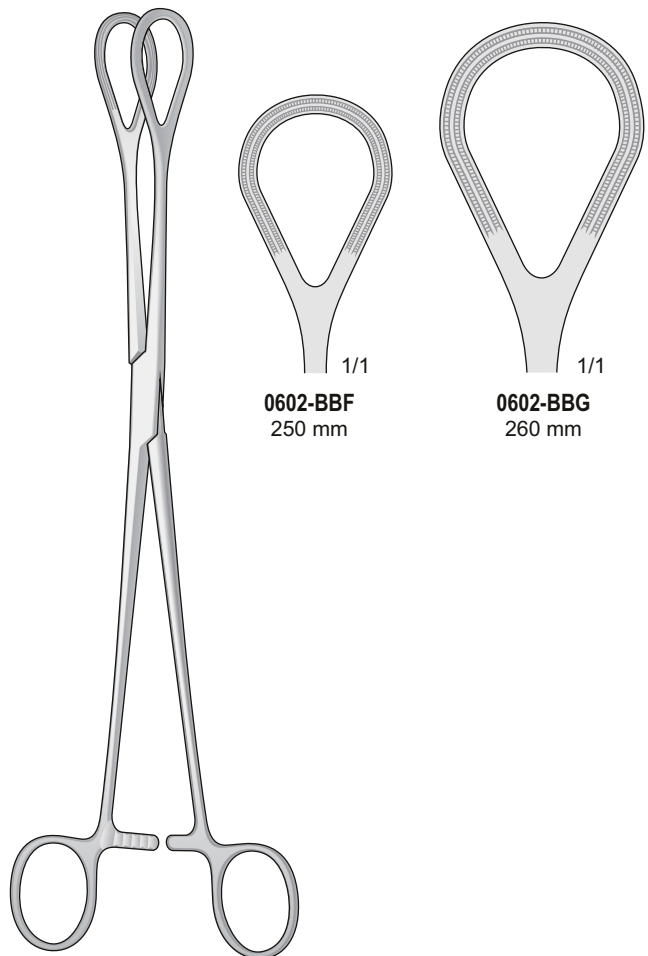

0602-BBF/0602-BBG

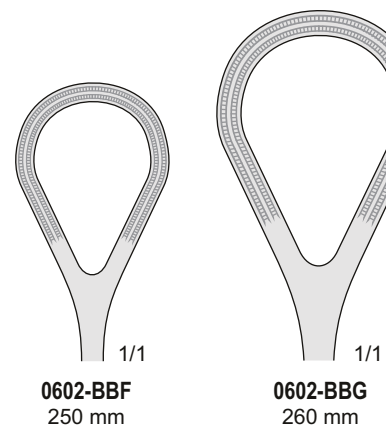

Wundhaken



MINI-LANGENBECK
0219-BIG/0219-BIL
160 mm

Retractors

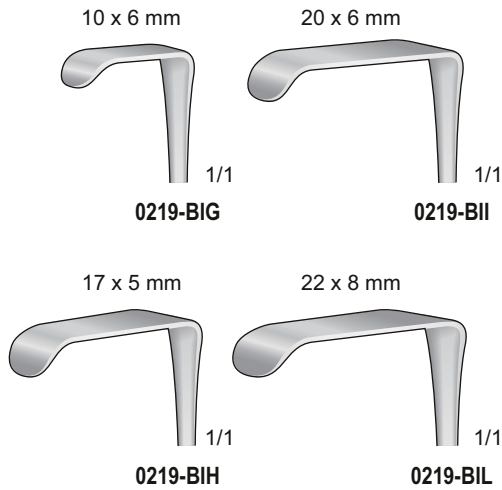

Divaricatori



CUSHING
0418-EAH/0418-EBC
240 mm

Separadores

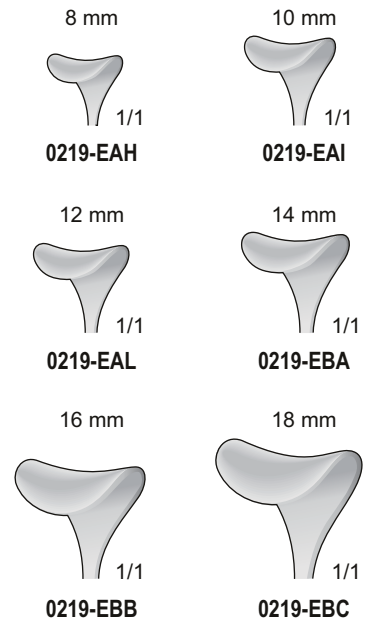

Ecarteurs

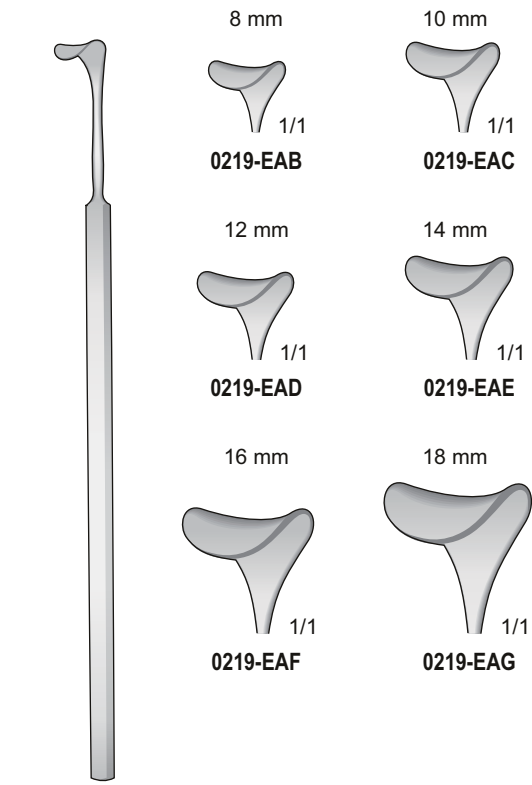

CUSHING
0219-EAB/BT-BT-406
200 mm

Wundhaken

Retractors

Divaricatori

Separadores

Ecarteurs



0219-CHA 80x42 mm
 0219-CHB 80x50 mm
 0219-CHC 80x60 mm

KOCHER
 0219-CHA/0219-CHC
 250 mm

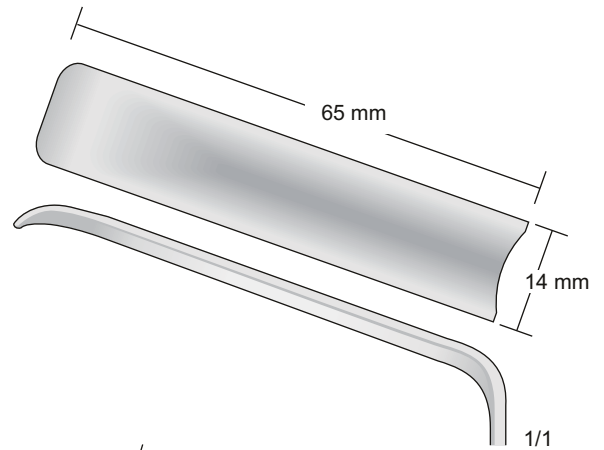

0219-CGF

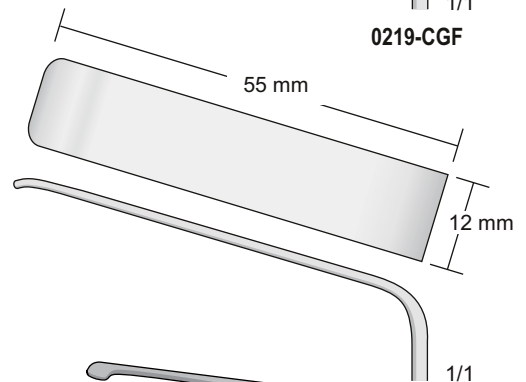

0219-CGE

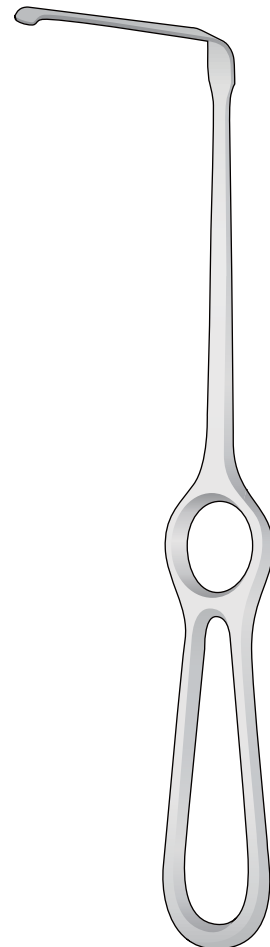

0219-CGE/0219-CGF
 235 mm

190x38 mm
190x57 mm

160x38 mm
160x57 mm

1/1

1/1

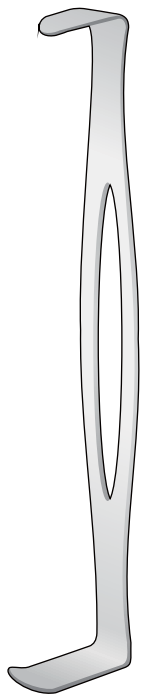

0219-CLC
21 x 24 mm
40 x 15 mm

PARKER-LANGENBECK
0219-CLC
210 mm

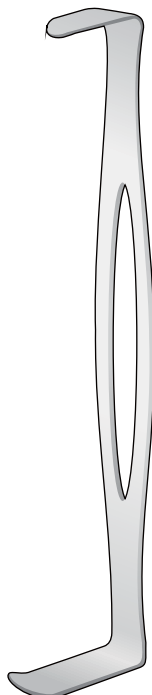

0219-CLD
25 x 24 mm
45 x 15 mm

PARKER-LANGENBECK
0219-CLD
210 mm



0219-DDH 160x38 mm
0219-DDI 160x57 mm
0219-DDL 190x38 mm
0219-DEA 190x57 mm

KELLY
0219-DDH/0219-DEA
270 mm

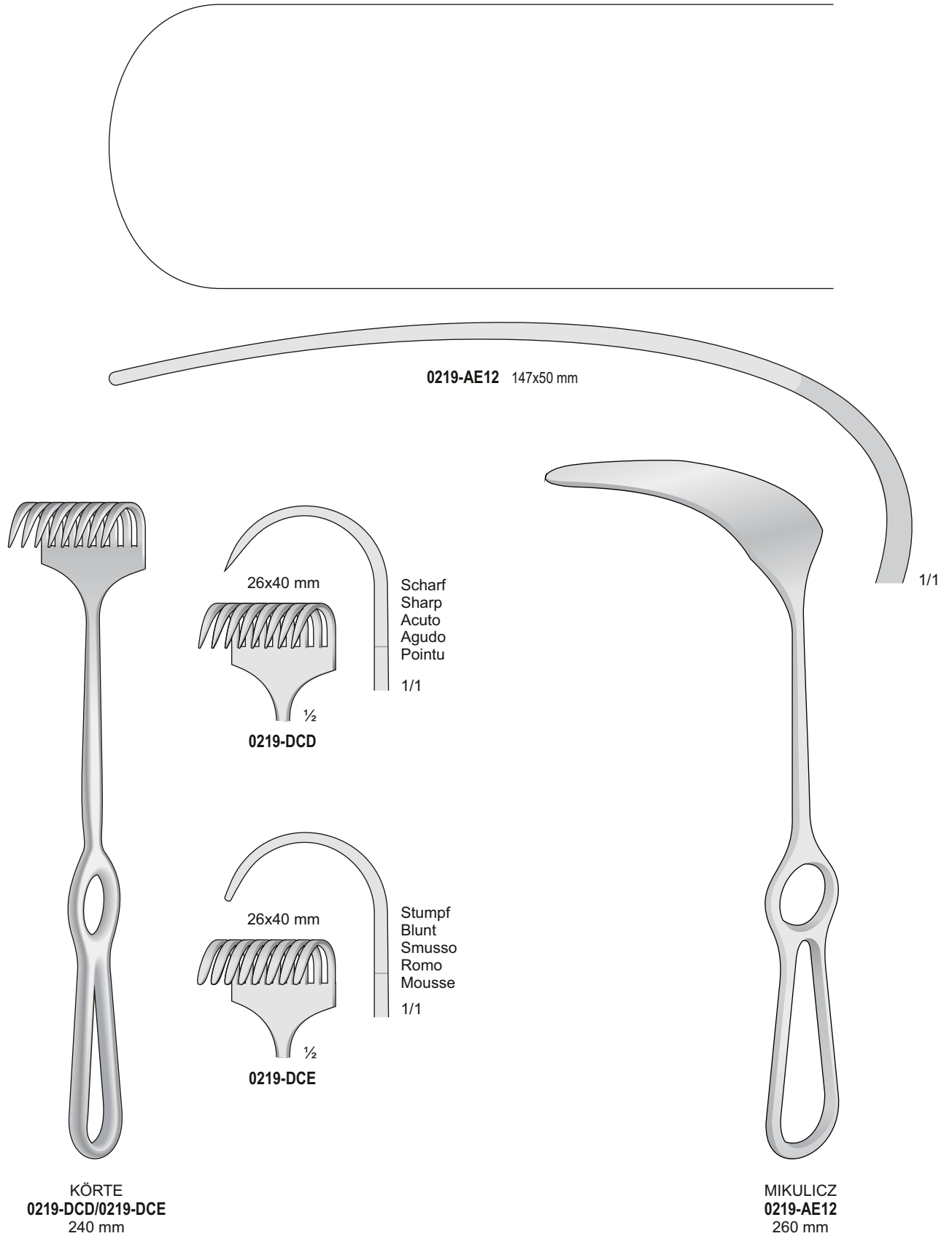

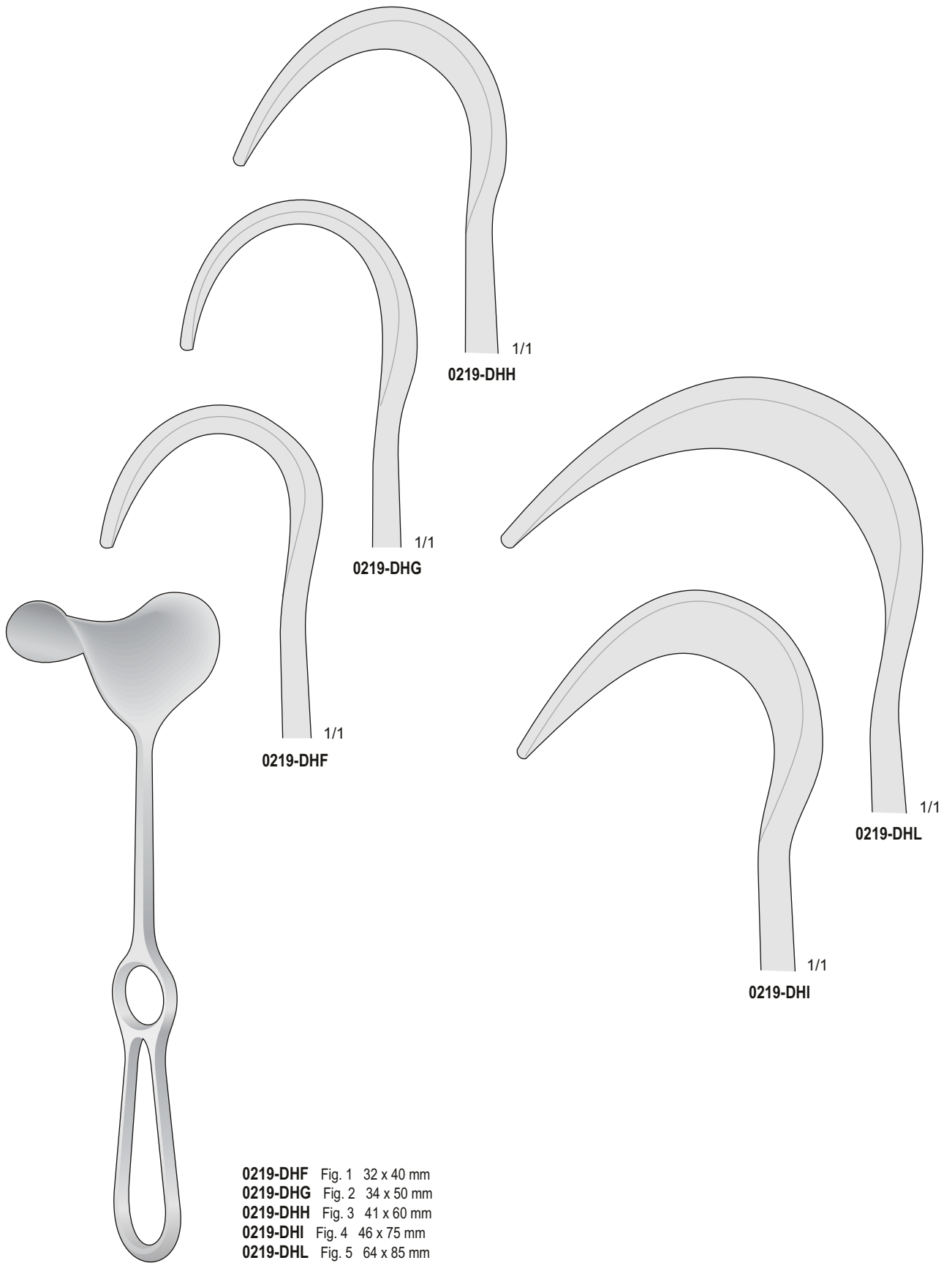

FRITSCH
0219-DHF/0219-DHL
240 mm

Pelvishaken
Pelvis retractors

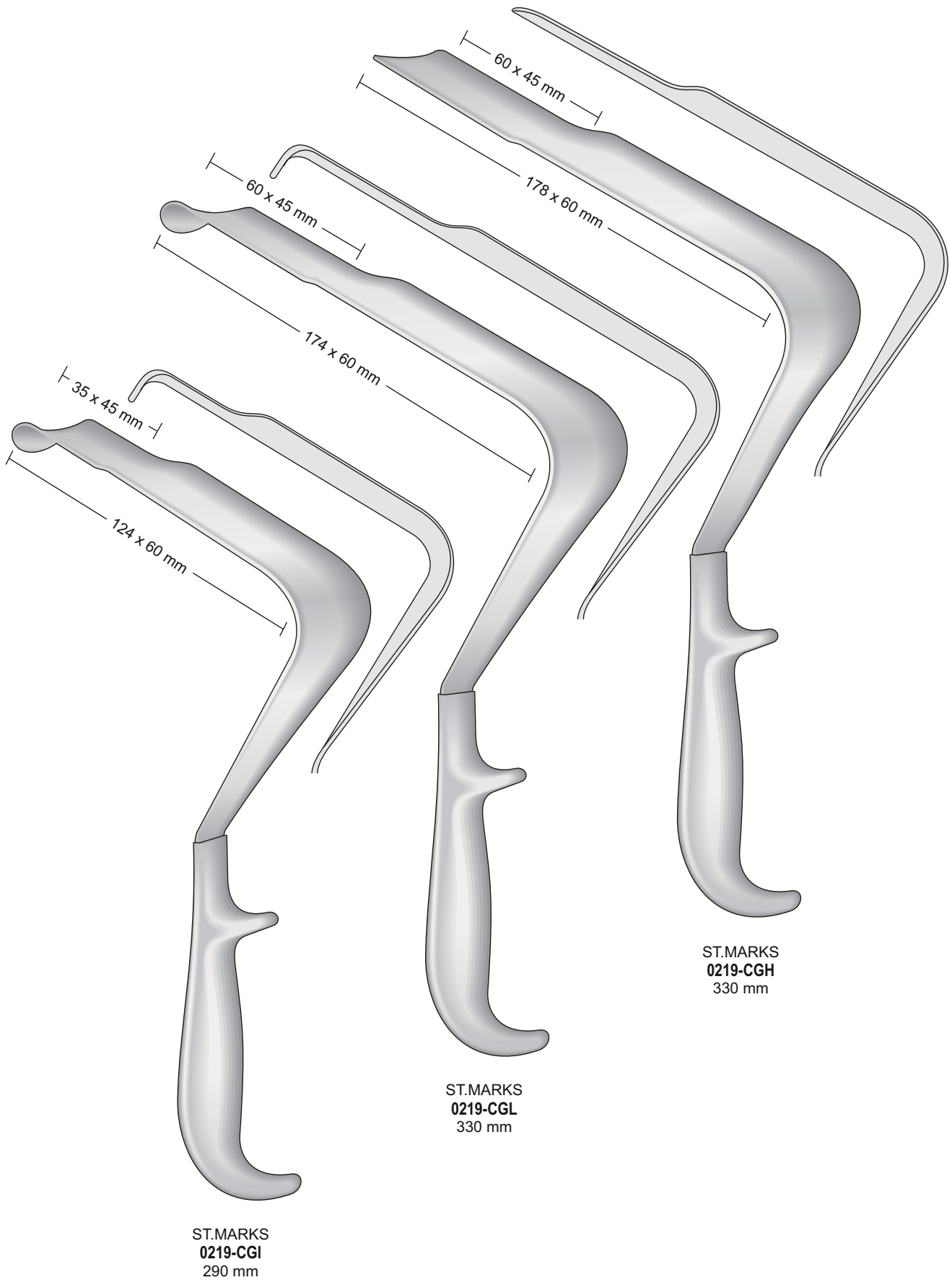

Wundhaken

Retractors

Divaricatori

Separadores

Ecarteurs

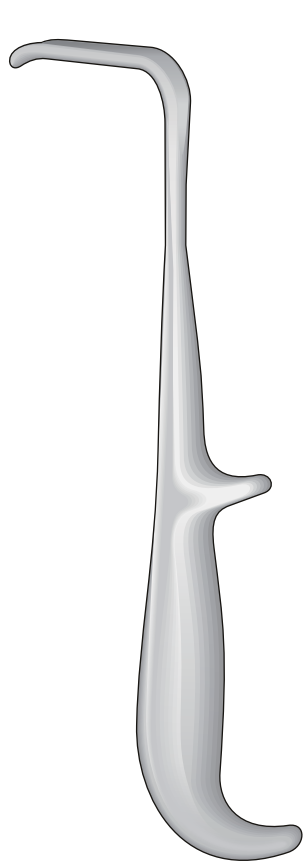
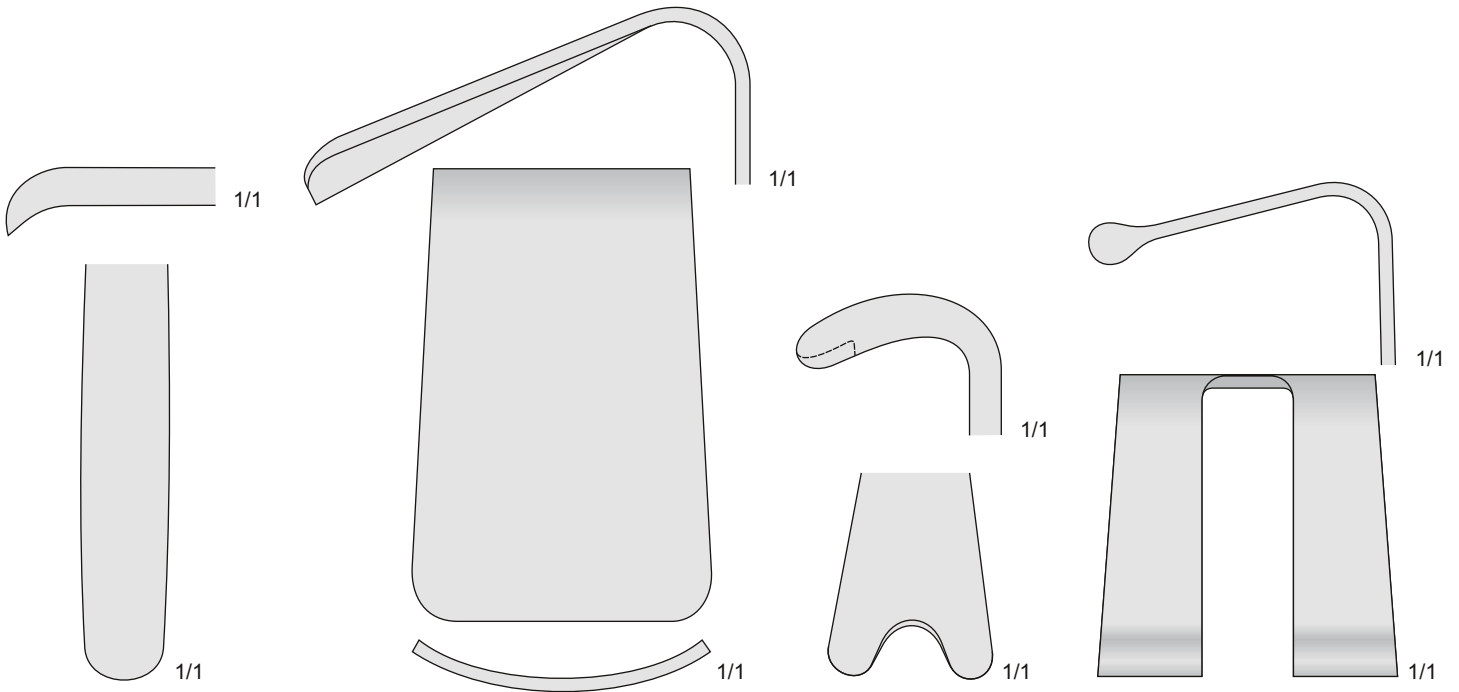

YOUNG
0219-DGG
215 mm

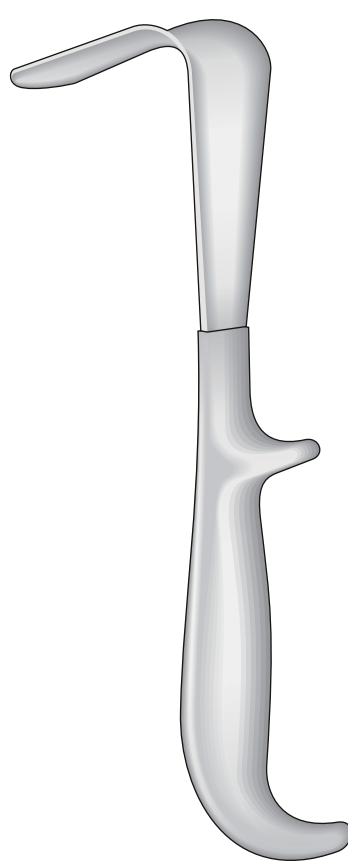

YOUNG
0219-DGH
210 mm

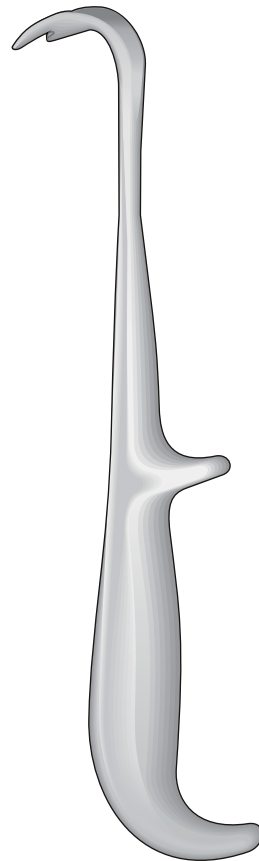

YOUNG
0219-DGI
220 mm

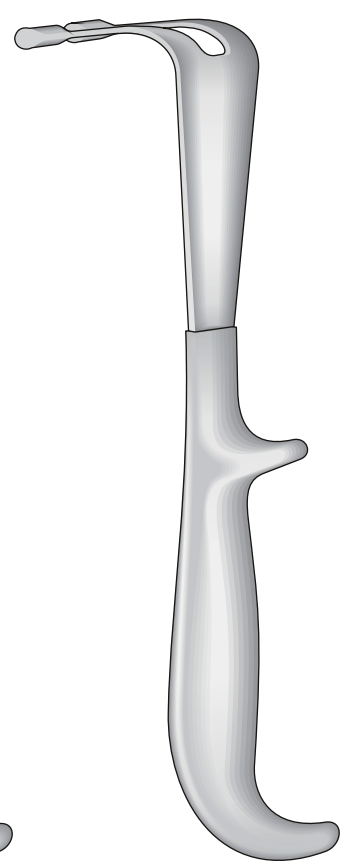

YOUNG
0219-DGL
210 mm

new

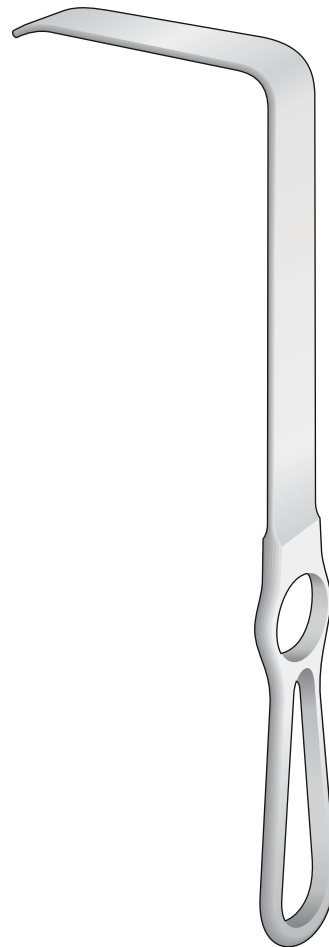
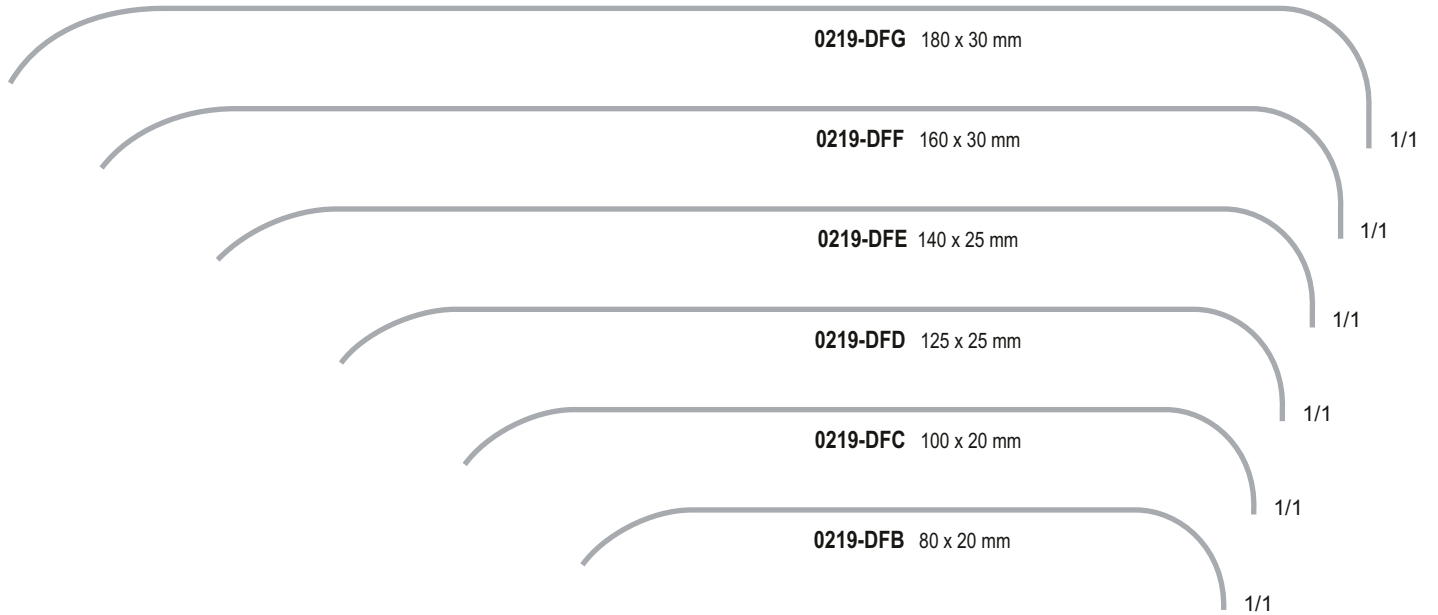

BRUNNER
0219-DFB/0219-DFG
250 mm

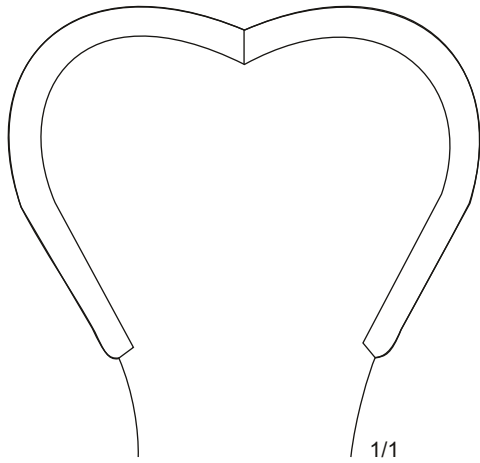

HARRINGTON-PEMBERTON
0219-DED 175 x 64 mm
295 mm

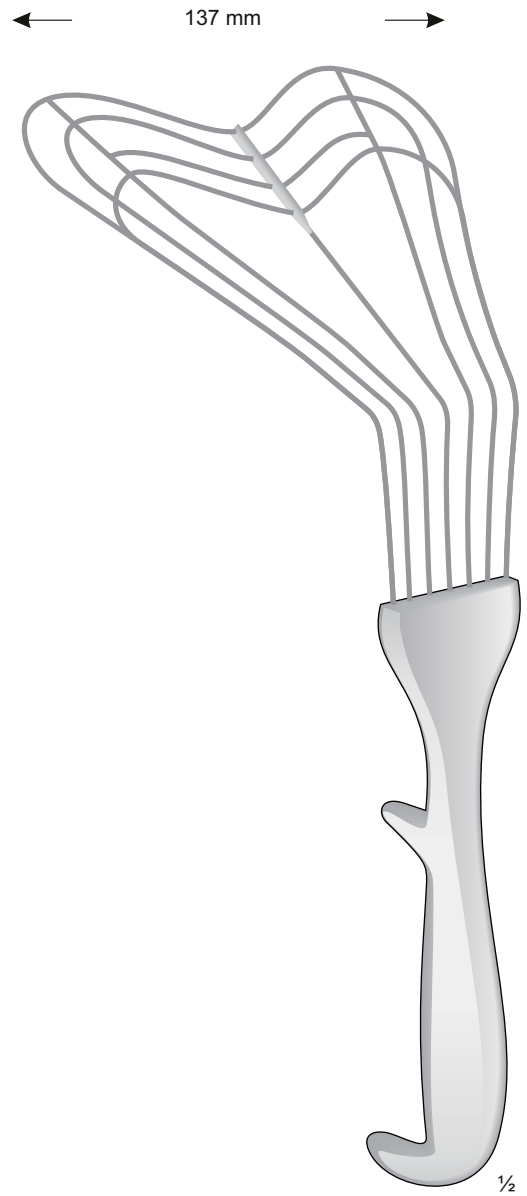

0219-DEG
300 mm

Bulldogklemmen

Bulldog Clamps

Pinze Bulldog

Pinzas Bulldog

Pinces Bulldog

Gefaßclips - Vessel Clips
Clamps vascolari - Clamps vasculares
Clamps vasculaires

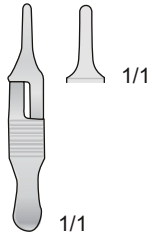

DIEFFENBACH
0212-LG
30 mm

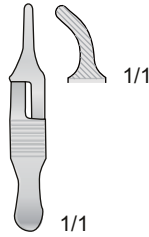

DIEFFENBACH
0212-LH
30 mm

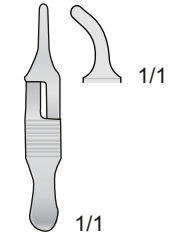

DIEFFENBACH
0212-LI
30 mm

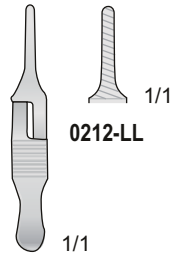

DIEFFENBACH
0212-LL
30 mm

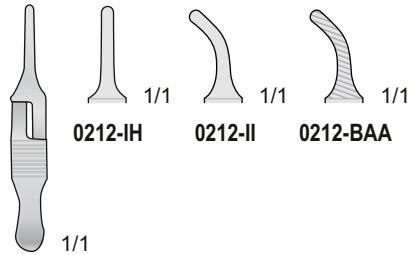

DIEFFENBACH
0212-IH/0212-BAA
35 mm

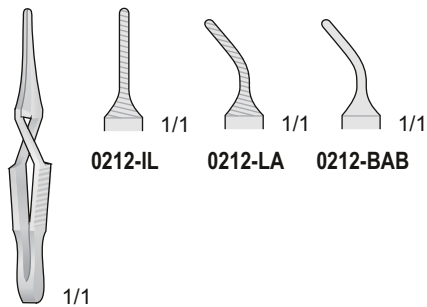

0212-IL/0212-BAB
40 mm

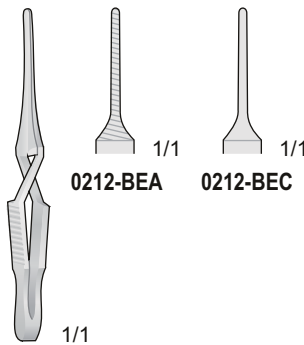

0212-BEA/0212-BEC
45 mm

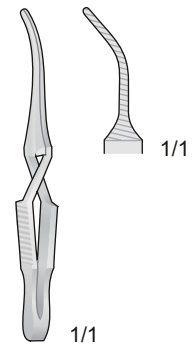

0212-BEB
45 mm

Komedoneninstrumente

Comedo Extractors

Schiaccia comedoni

Tire-comédons

Saca-comedones

0518-BFA

Komplettsset mit 3 Haken Stripper - Set complete with 3 Vein Stripper
 Set completo con 3 uncini per vene - Set completo con 3 sondas para verices
 Set complete avec 3 stripper a anneau

Fig. 1



0518-BFB
140 mm

Fig. 2

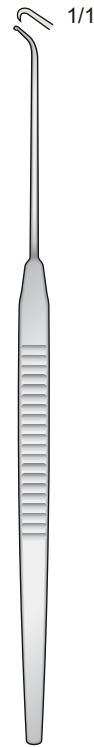

0518-BFC
140 mm

Fig. 3

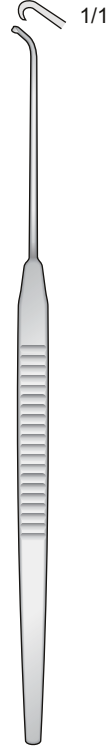

0518-BFD
140 mm

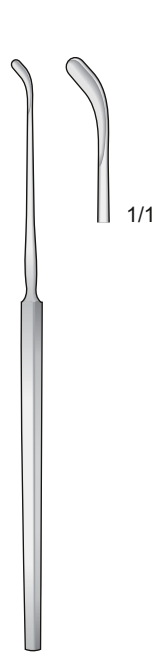

ZAUFAL
0402-CH 160 mm
0402-CI 200 mm

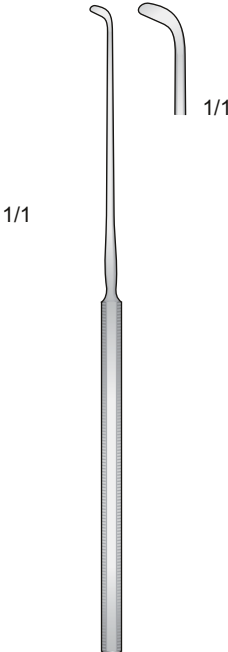

JANSEN-NEWHART
0402-EA 170 mm

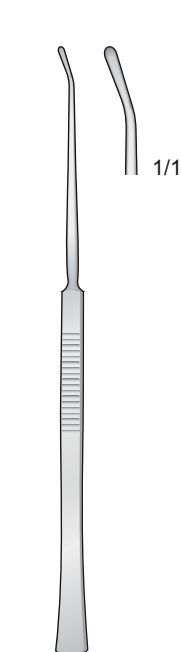

YANKAUER
0402-EB 160 mm

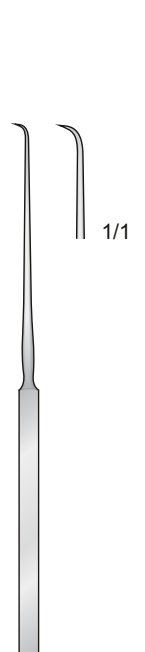

WAGENER
0402-EH 140 mm

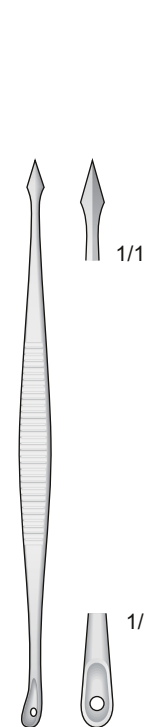

SAALFELD
0418-CG
100 mm

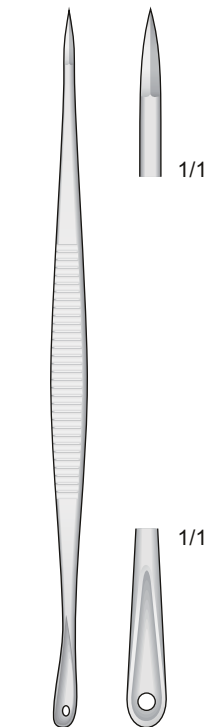

SAALFELD
0418-CH
140 mm

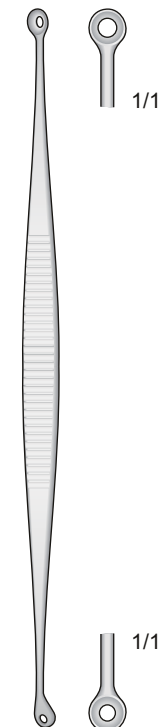

UNNA
0418-CI
140 mm

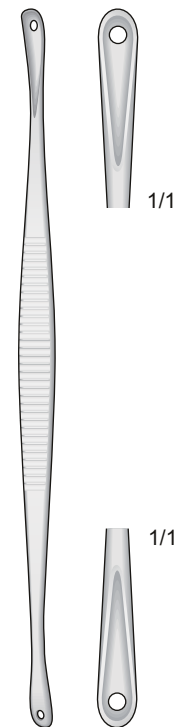

UNNA
0418-CL
140 mm

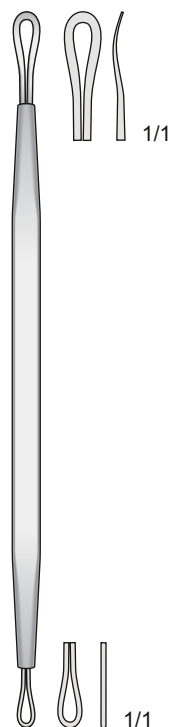

0518-CC
130 mm

Wund- und
Trachealhäkchen

Wound- and
Trachea Retractors

Divaricatori
per trachea

Ganchos y Separadores
para la tráquea

Crochets a plaies
et crochets à trachée

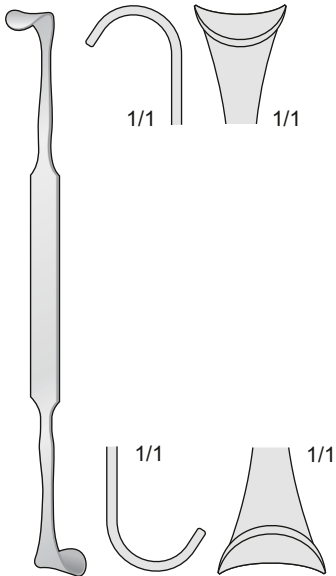

ROSE
0418-BF
130 mm

Links
Left
Sinistra
Izquierda
Gauche



Rechts
Right
Dextra
Derecha
Droit



Links
Left
Sinistra
Izquierda
Gauche



Rechts
Right
Dextra
Derecha
Droit

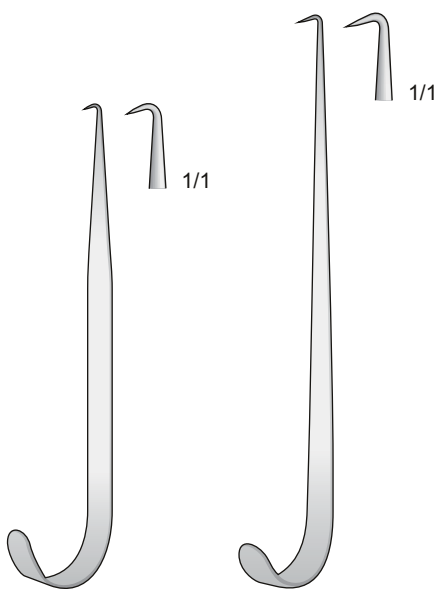

JACKSON
0418-BH
130 mm

JACKSON
0418-BI
150 mm



BOSE
0418-BA
160 mm

Scharf
Sharp
Acuto
Agudo
Pointu

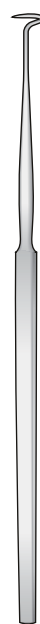

BOSE
0418-BB
160 mm

Stumpf
Blunt
Smusso
Romo
Mousse



BOSE
0418-BC
160 mm



BOSE
0418-BD
160 mm

Wund- und
Trachealhäkchen
Komedoneninstrumente

Wound- and
Trachea Retractors
Comedo Extractors

Divaricatori
per trachea
Schiaccia comedoni

Ganchos y Separadores
para la tráquea
Tire-comédons

Crochets a plaies
et crochets à trachée
Saca-comedones

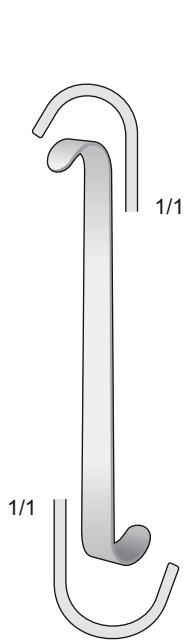

LUER
0418-BG
110 mm

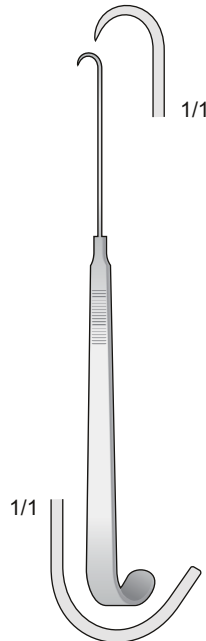

NEWS
0418-BL
150 mm

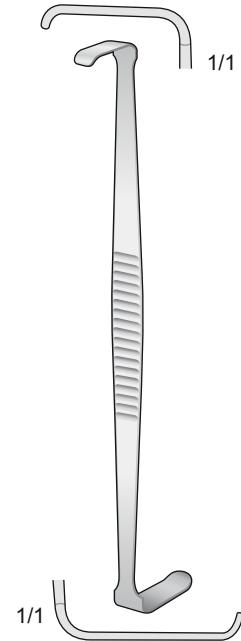

HOUSE
0418-CA
150 mm

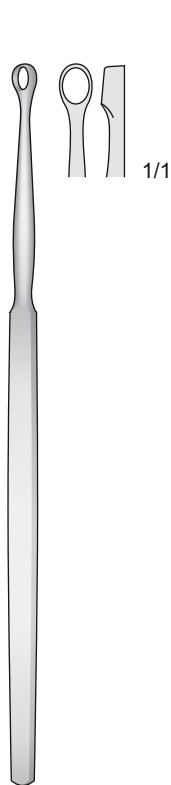

FOX
0418-DA/0418-DD
140 mm



WOLF
0418-DE/0418-DL
140 mm



Intimaspatel
Skalpelli-griffe

Nerve Spatulas
Scalpel handles

Separatori di nervi
Manici per bisturi

Espátula para la intima
Mangos de bisturios

Spatule pour la tunique interne
Manches de bistouris

new

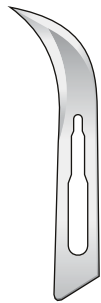

1102-BC04



1102-BF01



1102-BF03

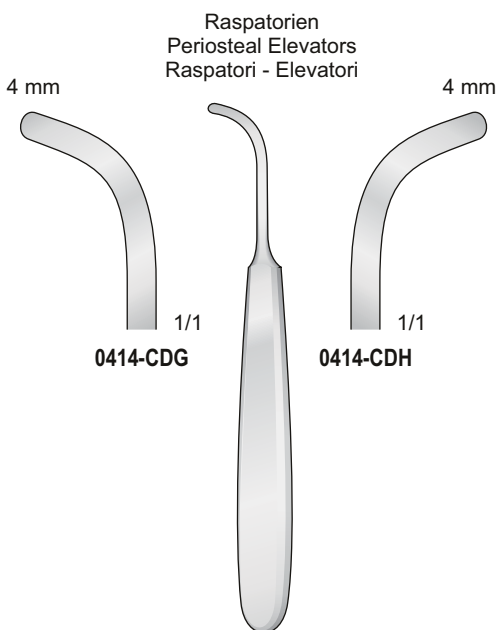

0414-CDG

0414-CDH

0414-CDG/0414-CDH
140 mm

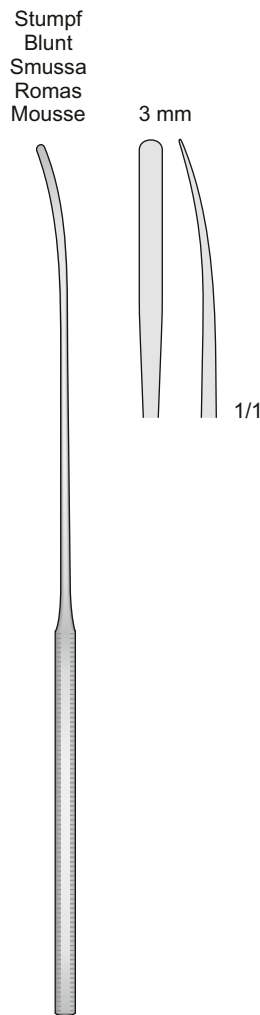

1014-DB
180 mm

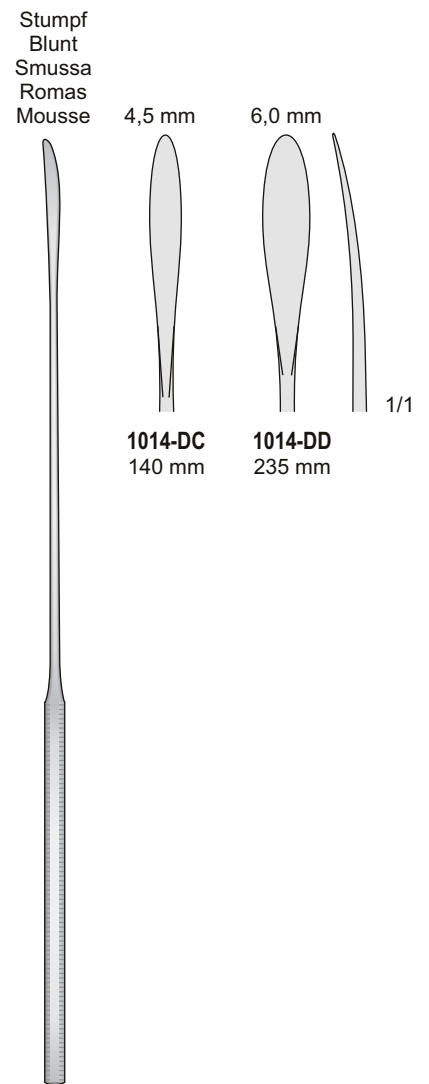

1014-DC
140 mm

1014-DD
235 mm

1014-DC/1014-DD

Nerwurzelnaken

Nerve Root Retractors

Retrattori da radice

Separadore para la raíz de nervio

Retractors pour racines nerveuses

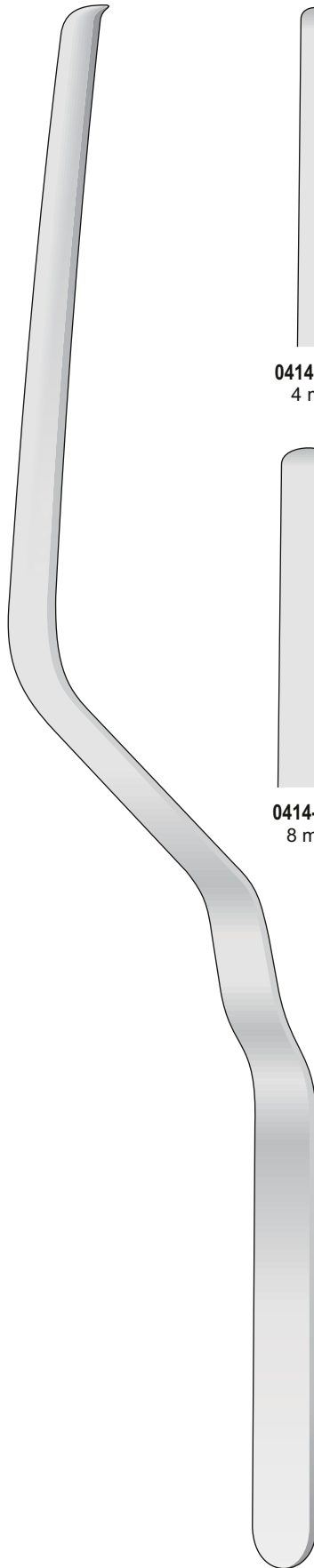

CASPAR
0414-CHL/0414-CIC
240 mm



1/1

0414-CHL
4 mm



1/1

0414-CIA
6 mm



1/1

0414-CIB
8 mm



1/1

0414-CIC
10 mm

Wundspreizer

Retractors

Divaricatori

Separadores

Ecarteurs

Femur-Wundspreizer für kinder
Femur Retractor for children
Divaricatore femorale per bambini

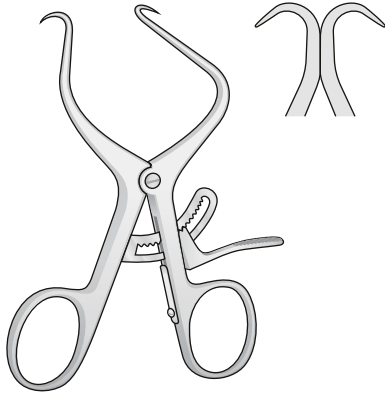

DE BAKEY
0221-DBF
100 mm

Femur-Wundspreizer
Femur Retractor
Divaricatore femorale

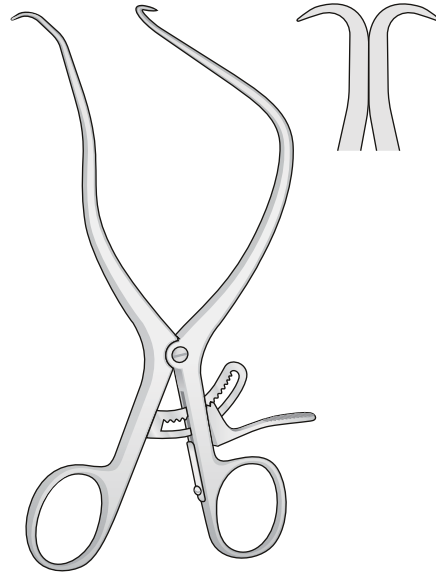

DE BAKEY
0221-DBG
170 mm

Wundspreizer
Retractors for shoulder
Divaricatori da spalla
Separadores
Ecarteurs

Stumpf - Blunt
Smusso - Romo
Mousse

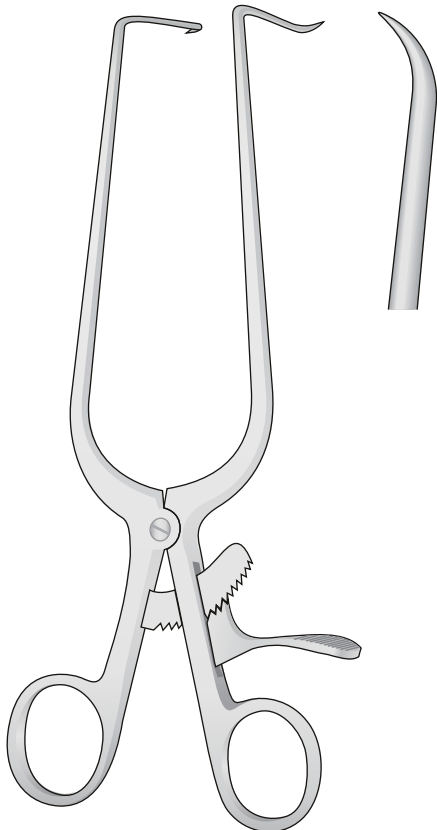

0221-BAA
215 mm

Stumpf - Blunt
Smusso - Romo
Mousse

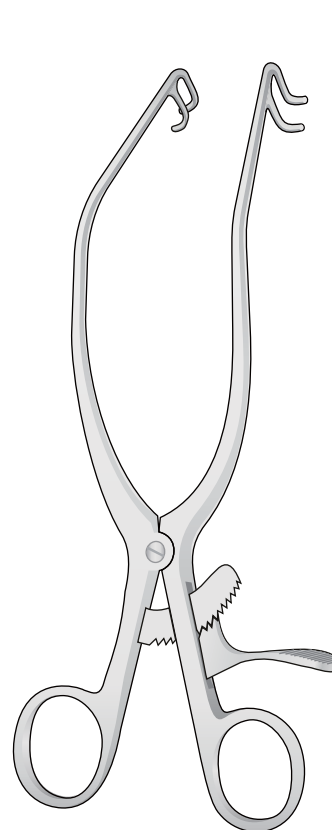

KÖLBEL
0221-BAD
180 mm

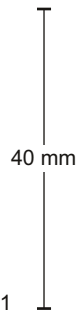

Wundspreizer

Retractors

Divaricatori

Separadores

Ecarteurs

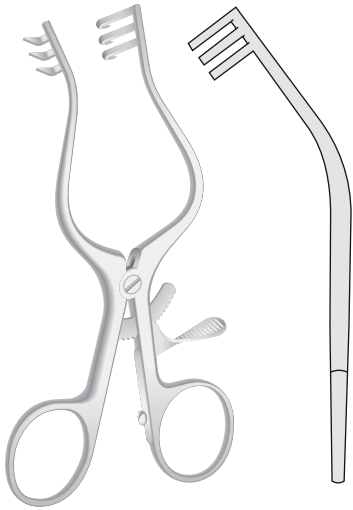
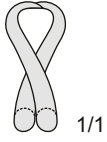

Scharf
Sharp
Acuto
Agudo
Pointu

WULLSTEIN
0221-BBD
130 mm

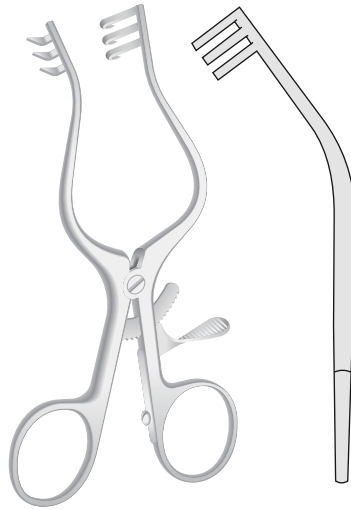
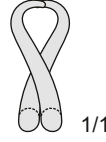

Stumpf
Blunt
Smusso
Romo
Mousse

WULLSTEIN
0221-BBE
130 mm

Scharf
Sharp
Acuto
Agudo
Pointu

Stumpf
Blunt
Smusso
Romo
Mousse

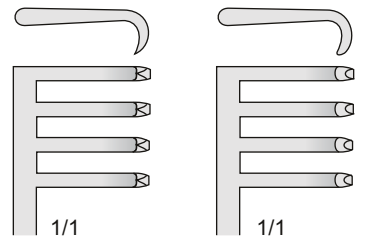

0221-BAE

0221-BAF

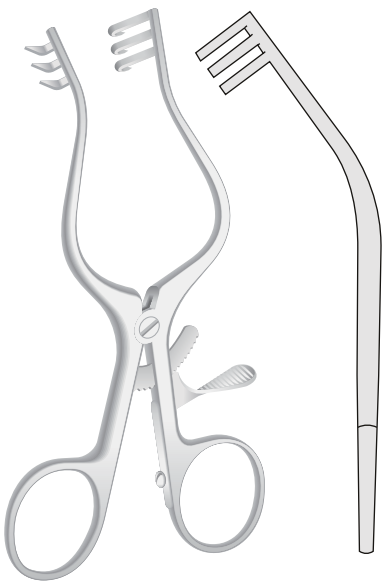
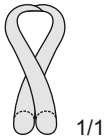

Scharf
Sharp
Acuto
Agudo
Pointu

WULLSTEIN
0221-BBF
160 mm

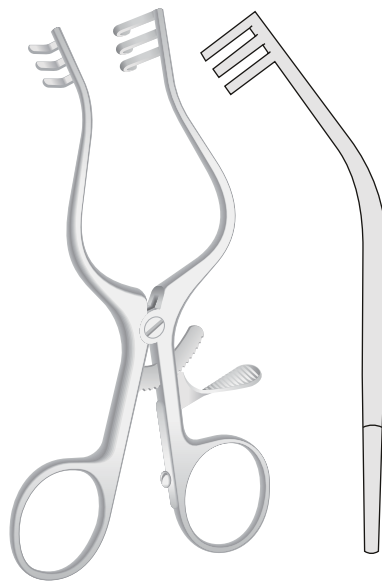

Stumpf
Blunt
Smusso
Romo
Mousse

WULLSTEIN
0221-BBG
160 mm



SCALP-CONTOUR
0221-BAE/0221-BAF
135 mm

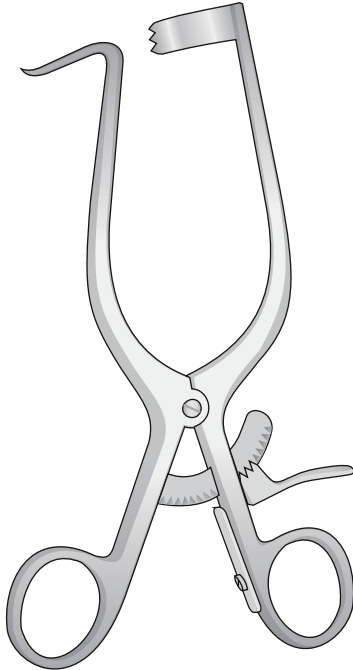

WILLIAMS
0221-EAB/0221-EAD
170 mm

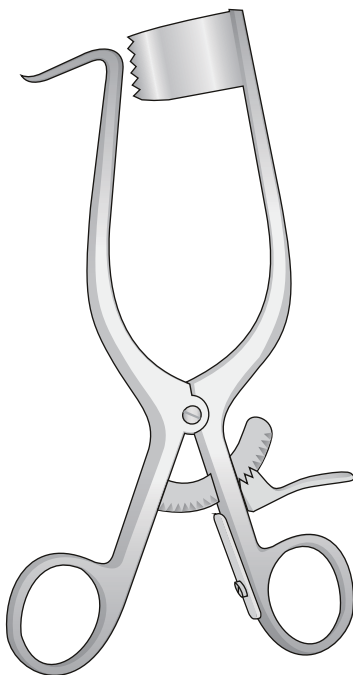

WILLIAMS
0221-EAE/0221-EAG
170 mm

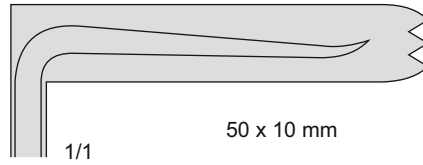

0221-EAB

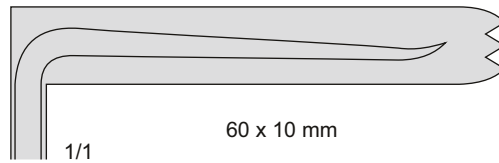

0221-EAC

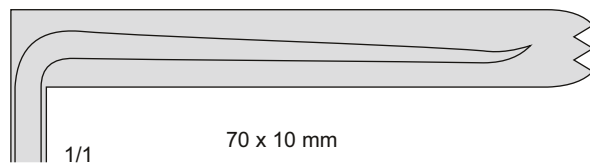

0221-EAD

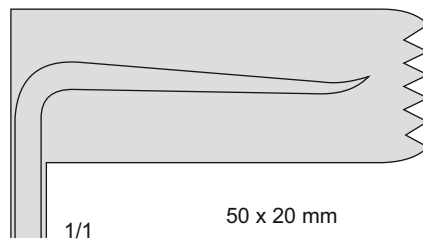

0221-EAE

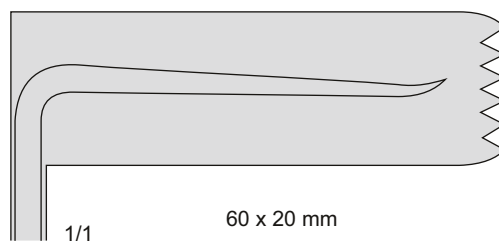

0221-EAF

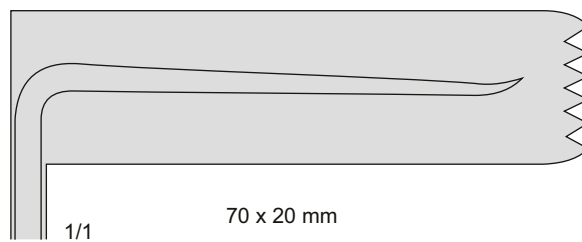

0221-EAG

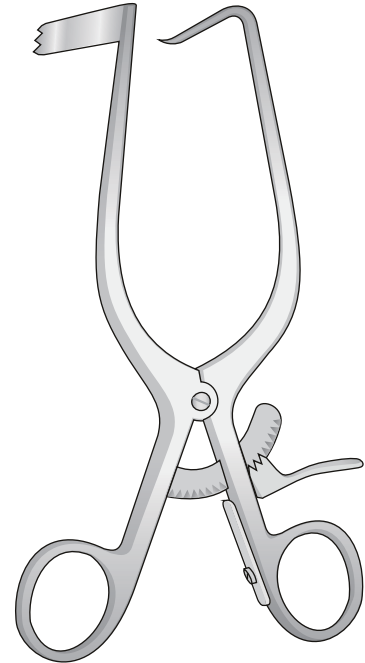
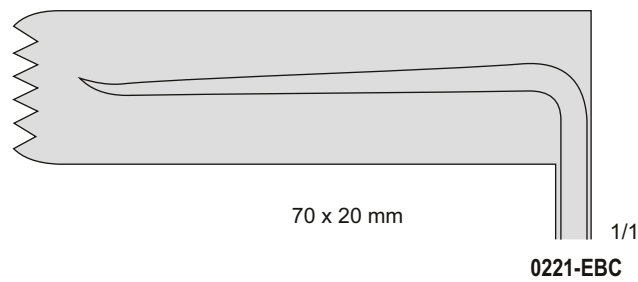
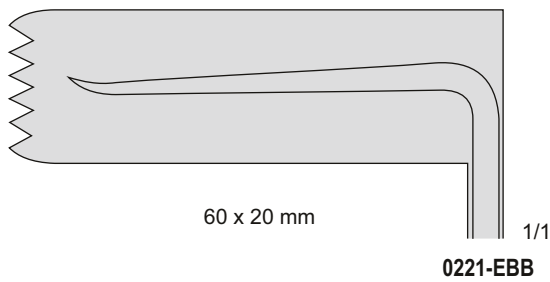
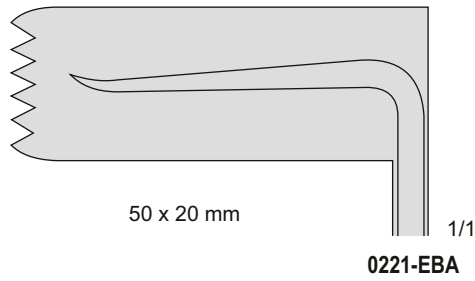
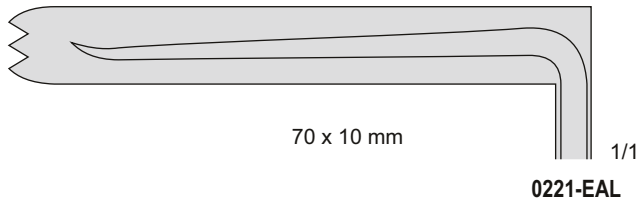
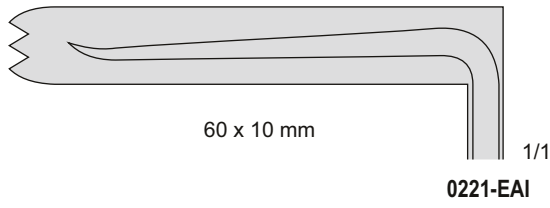
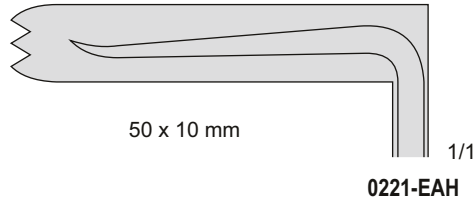

WILLIAMS
0221-EAH/0221-EAL
170 mm

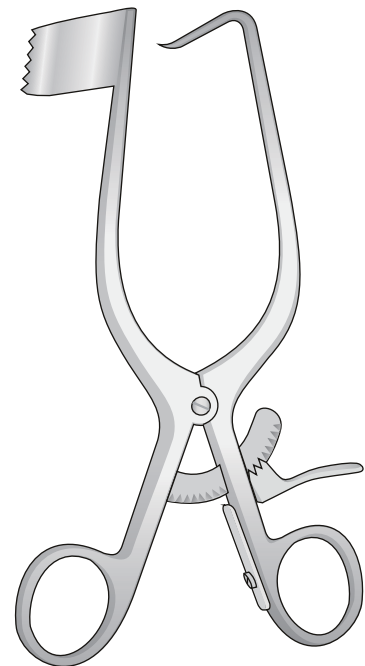

WILLIAMS
0221-EBA/0221-EBC
170 mm

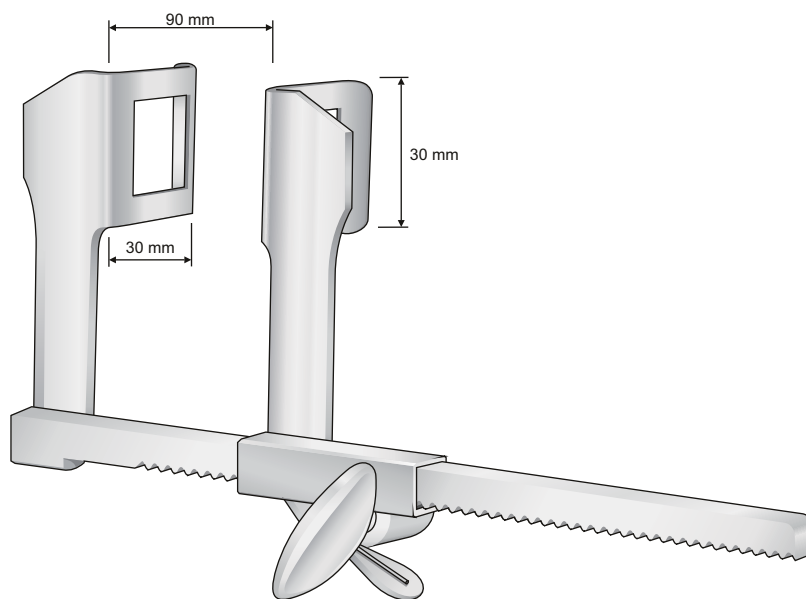

HAIGHT
0221-GH

CASPAR
0606-BLA
 Distraktor komplett rechts
 Distractor complete right
 Distrattore completo destro
0606-BLB 1 Distraktor allein - 1 Distractor only
0606-BLC 1 Bohrbüchse - 1 Drilling Guide
0606-CAD 1 Spezialbohrer - 1 Special Drill
0606-CAF 2 Distraktionsschrauben - 2 Distraction Screws
0606-CAG 1 Schraubendreher - 1 Screw Driver

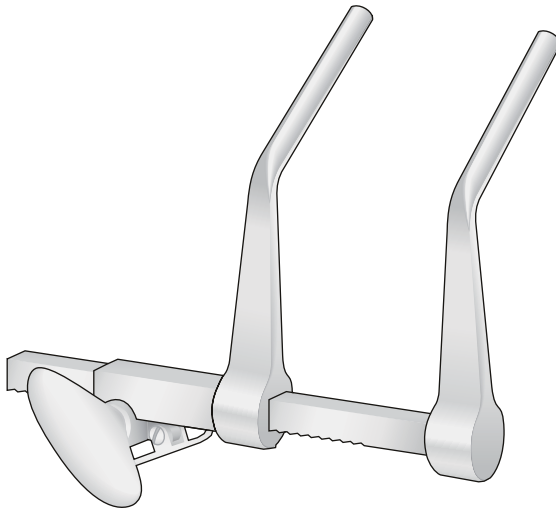

CASPAR
0606-BLB
 Distraktor rechts, Allein
 Distractor right, Only
 Distrattore destro, solo

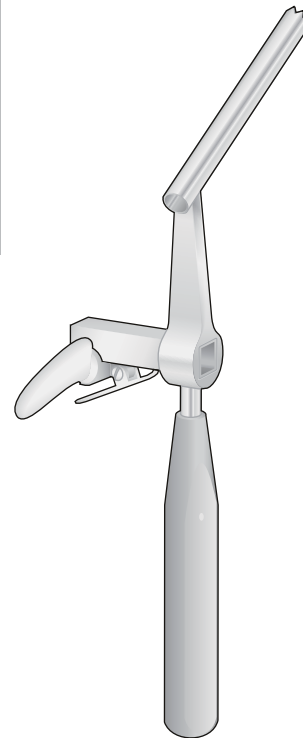

0606-BLC
 Bohrbüchse rechts, Allein
 Drilling Guide right, Only
 Guida punte destro, solo

CASPAR
0606-CAA
 Distraktor komplett links
 Distractor complete left
 Distrattore completo sinistro
0606-CAB 1 Distraktor allein - 1 Distractor only
0606-CAC 1 Bohrbüchse - 1 Drilling Guide
0606-CAD 1 Spezialbohrer - 1 Special Drill
0606-CAF 2 Distraktionsschrauben - 2 Distraction Screws
0606-CAG 1 Schraubendreher - 1 Screw Driver

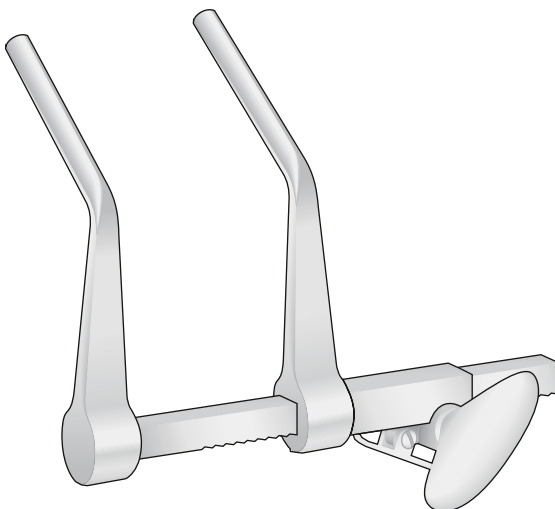

CASPAR
0606-CAB
 Distraktor links, Allein
 Distractor left, Only
 Distrattore sinistro, solo

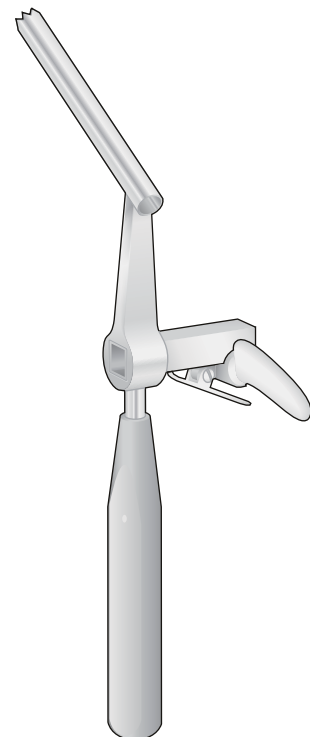

0606-CAC
 Bohrbüchse links, Allein
 Drilling Guide left, Only
 Guida punte sinistro, solo

Distraktor für cervicale Wirbelsäure

Distractor for cervicale vertebral column

Distrattore per colonna vertebrale

Screw Driver
Schraubendreher



CASPAR
0606-CAG
200 mm

Special Drill
Spezialbohrer
Ø 1,7 mm

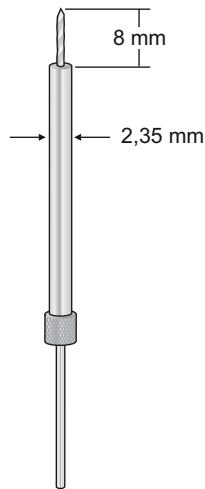

CASPAR
0606-CAD
145 mm

Distraction Screw
Distractionsschrauben

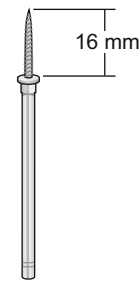

CASPAR
0606-CAF
70 mm

CASPAR	
0606-CAA	Distraktor komplett links Distractor complete left Distrattore completo sinistro
0606-CAB	1 Distraktor allein - 1 Distractor only
0606-CAC	1 Bohrbüchse - 1 Drilling Guide
0606-CAD	1 Spezialbohrer - 1 Special Drill
0606-CAF	2 Distractionsschrauben - 2 Distraction Screws
0606-CAG	1 Schraubendreher - 1 Screw Driver

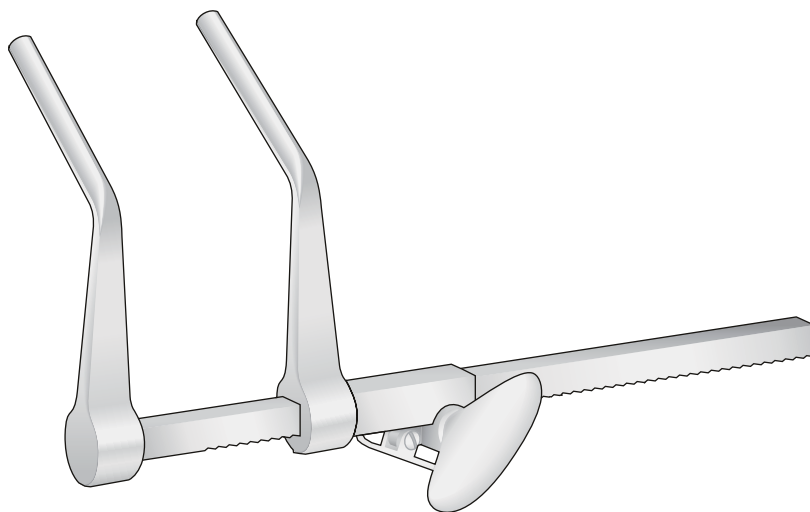

CASPAR
0606-CAB12
Distraktor links, Allein
Distractor left, Only
Distrattore sinistro, solo

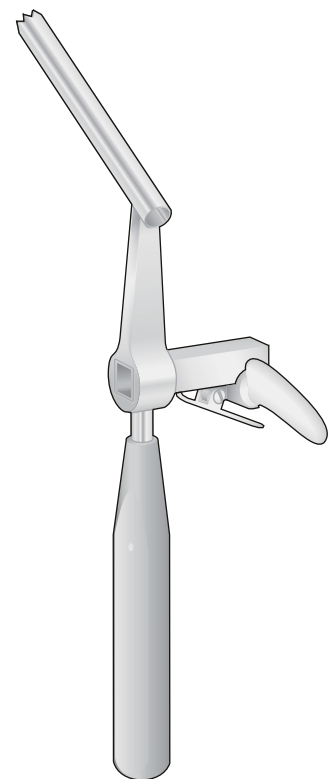

0606-CAC
Bohrbüchse links, Allein
Drilling Guide left, Only
Guida punte sinistro, solo

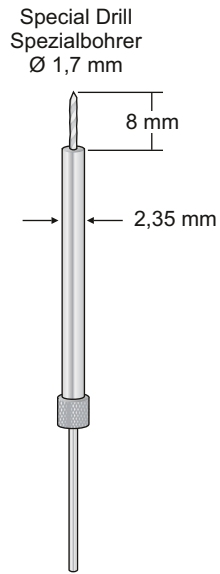

CASPAR
0606-CAD
145 mm

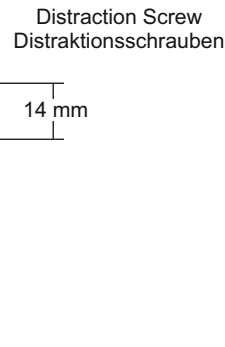

CASPAR
0606-CAE
70 mm

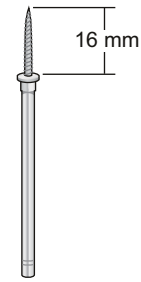

CASPAR
0606-CAF
70 mm

Screw Driver
Schraubendreher



CASPAR
0606-CAG
200 mm

Elevatoren

Elevators

Elevatori

Elevadores

Elevateurs



CHANDLER
0610-BBH/0610-BCI

A= 13,0 mm



0610-BBH
190 mm

1/1

A= 20,0 mm

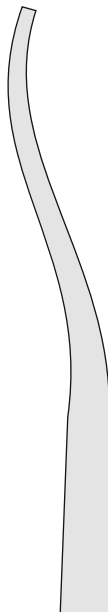

0610-BBI
200 mm

1/1

A= 25,5 mm

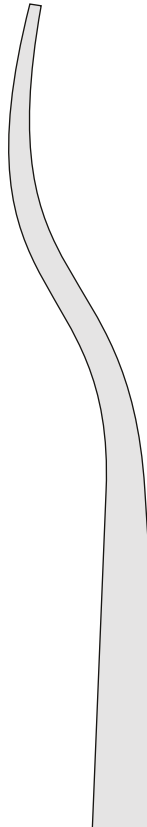

0610-BCH
230 mm

1/1

A= 31,5 mm

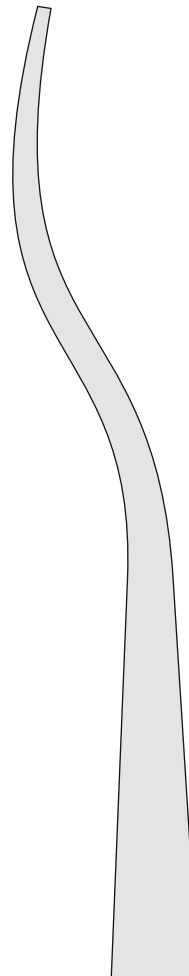

0610-BCI
255 mm

1/1

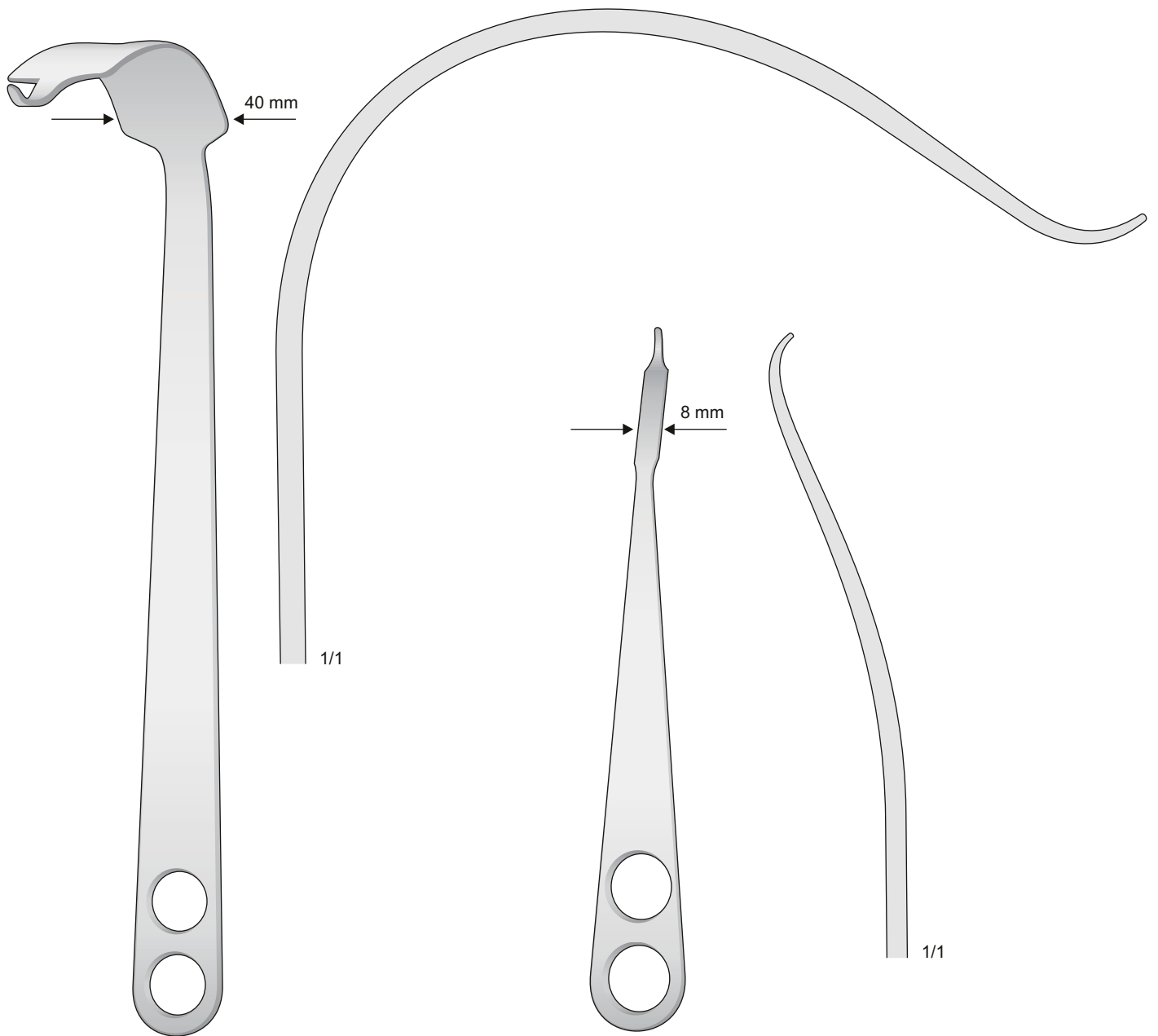

HOHMANN
0610-BDF
330 mm

HOHMANN
0610-BDD
225 mm

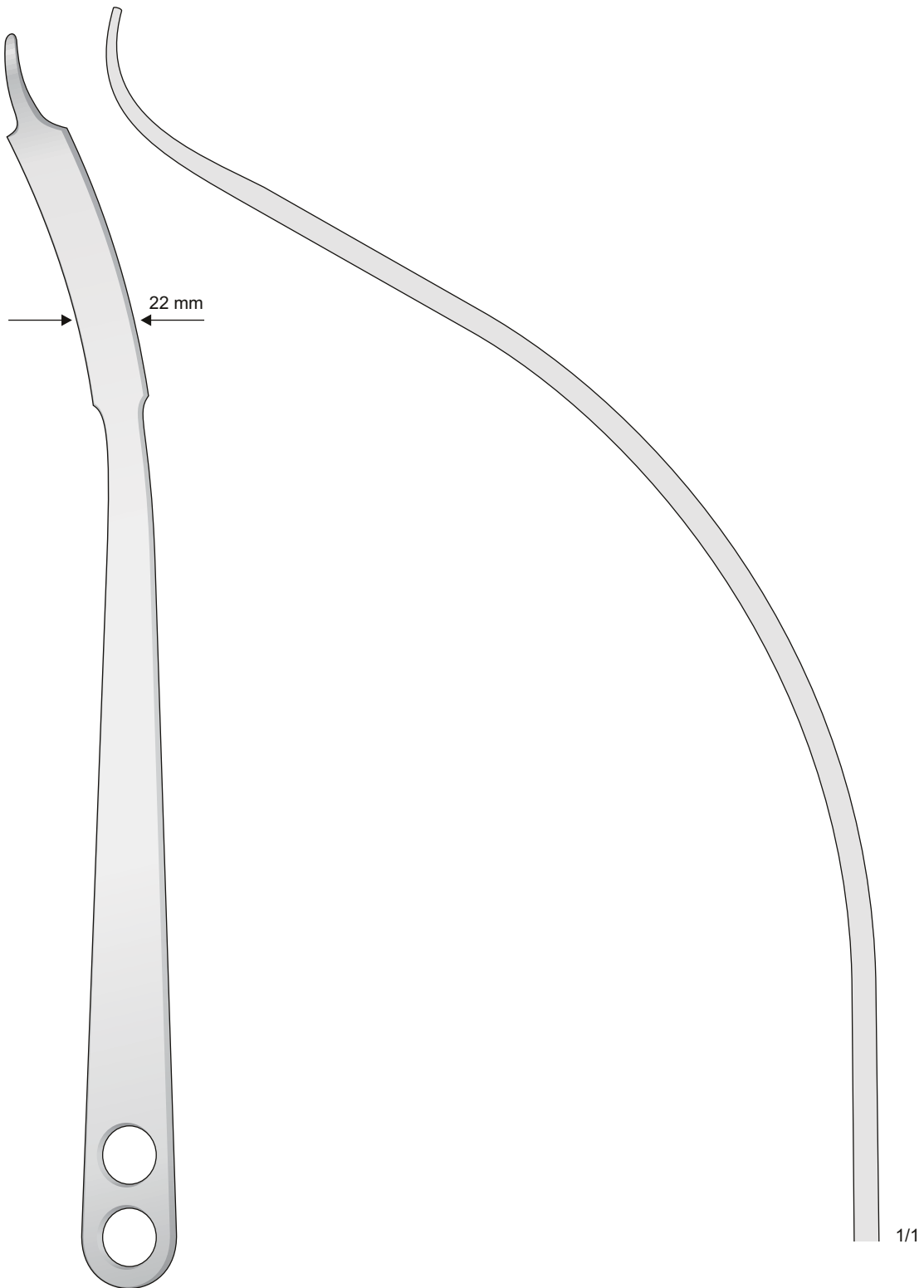

HOHMANN
0610-BDE
400 mm

1/1

Nasen Spekula
Zungendrucker

Nasal Specula
Tongue depressor

Specolo nasale
Abbasalingua

Speculum nasaux
Abaisse-langues

Especulos nasales
Bejalenguas

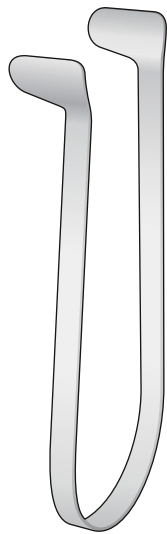

THUDICUM
1412-BIB/1412-BIH

Fig. 1

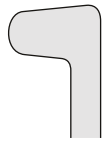

1412-BIB

Fig. 2

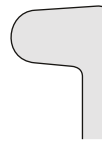

1412-BIC

Fig. 3



1412-BID

Fig. 4

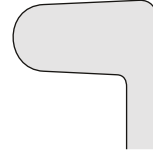

1412-BIE

Fig. 5

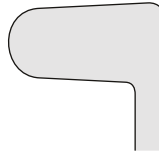

1412-BIF

Fig. 6

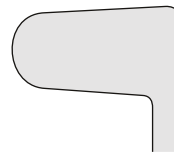

1412-BIG

Fig. 7

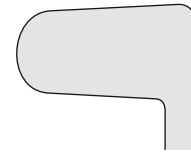

1412-BIH

Zungenspatel - Tongue Depressor
Adenotomie - Tonsillektomie

10 x 13 mm



LACK
1412-LD

13 x 19 mm



LACK
1412-LE

15 x 22 mm

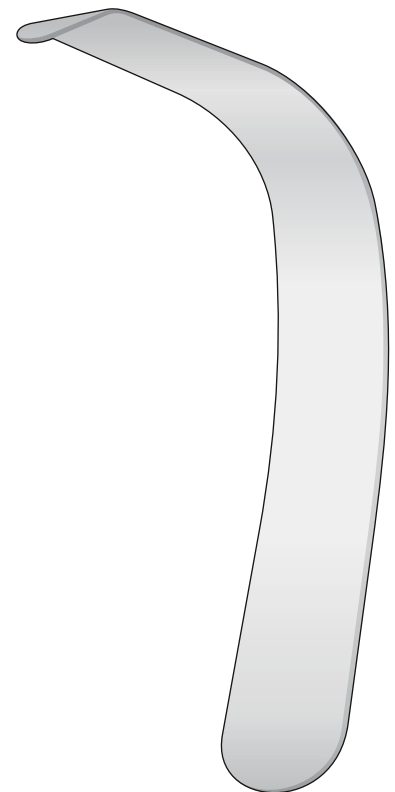

LACK
1412-LF

Osteotome
Hämmer

Osteotomes
Hammer

Osteotomi
Martello

Osteotomos
Martillo

Ostéotomes
Marteaux

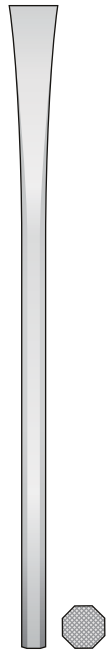

SHEEHAN
0611-DIA/0611-DII
160 mm

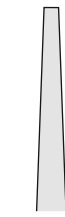

0611-DIA
2 mm



0611-DIB
4 mm



0611-DIC
6 mm



0611-DID
8 mm



0611-DIE
10 mm

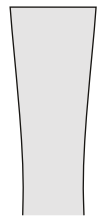

0611-DIF
12 mm

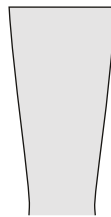

0611-DIG
15 mm

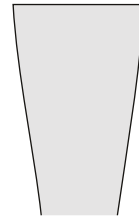

0611-DIH
18 mm

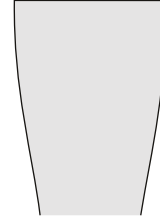

0611-DII
20 mm

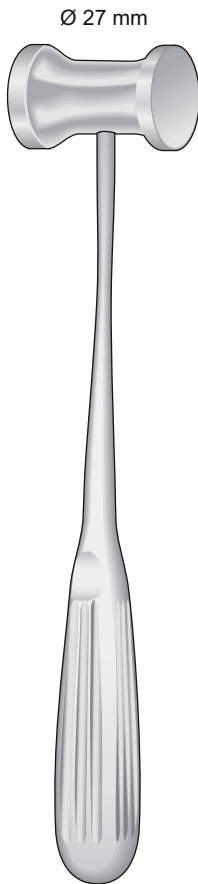

Ø 27 mm

HAJEK
0611-BCI
220 mm

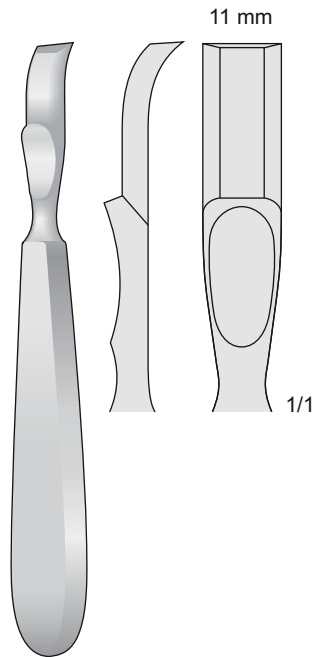

FARABEUF-COLLIN
0610-CFD
160 mm

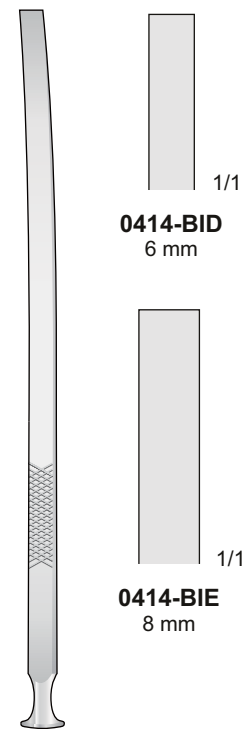

EPKER
0414-BID/0414-BIE
180 mm

0414-BID
6 mm

0414-BIE
8 mm

Hohlmeissel

Gouges

Sgorbie

Gubias

Gouges

8 mm

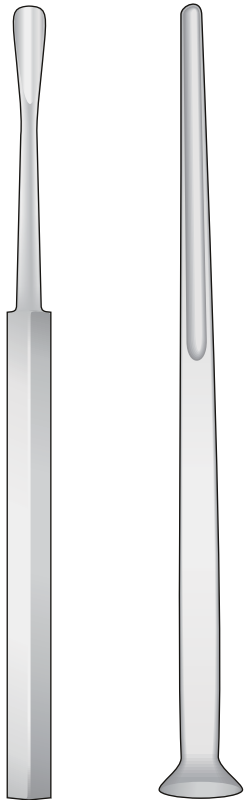

COSCIA
0611-DGI
180 mm

ALEXANDER
0611-CAG/0611-CAL
170 mm

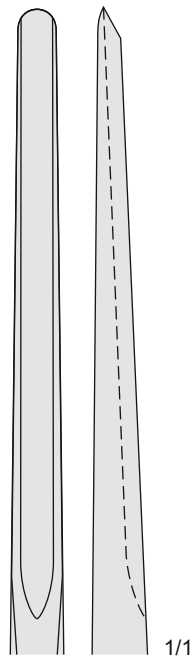

0611-CAG
5 mm

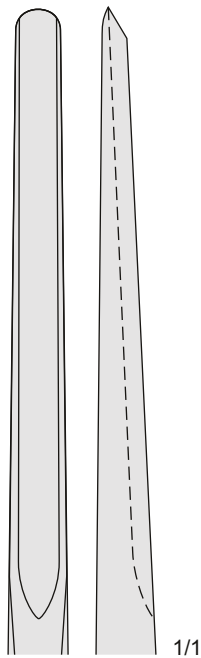

0611-CAH
7 mm

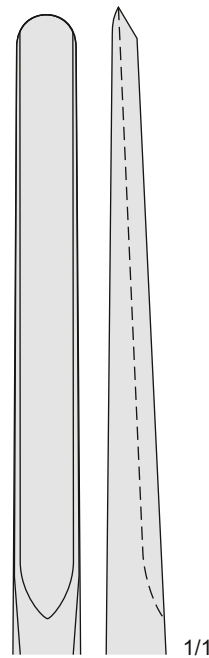

0611-CAI
9 mm

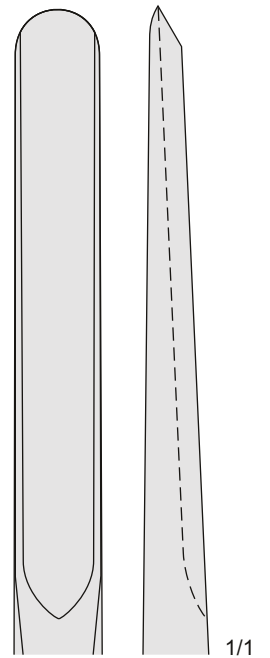

0611-CAL
11 mm

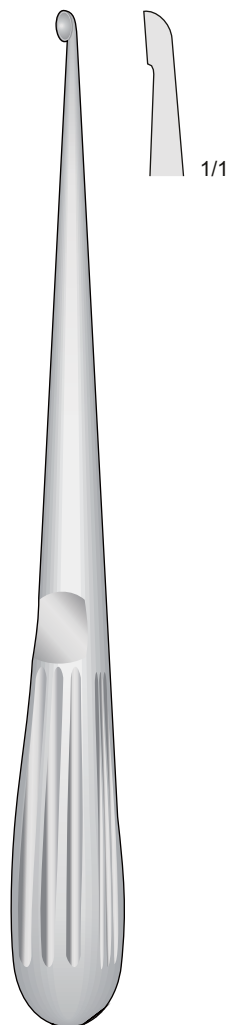

BRUNS
0610-CIA/0610-CLA
170 mm

Fig.5/0
2,2 mm



1/1

0610-CIA

Fig.4/0
2,5 mm



1/1

0610-CIB

Fig.3/0
2,8 mm



1/1

0610-CIC

Fig.2/0
3,3 mm



1/1

0610-CID

Fig.0
3,6 mm



1/1

0610-CIE

Fig.1
4,3 mm



1/1

0610-CIF

Fig.2
4,8 mm



1/1

0610-CIG

Fig.3
5,6 mm



1/1

0610-CIH

Fig.4
6,0 mm



1/1

0610-CII

Fig.5
6,7 mm



1/1

0610-CIL

Fig.6
8,8 mm



1/1

0610-CLA

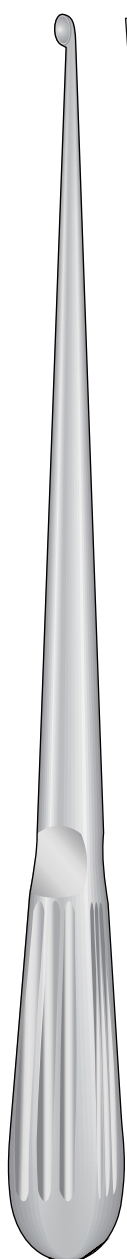

BRUNS
0610-CLB/0610-CLL
225 mm

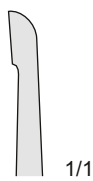

Fig.3/0
2,8 mm
1/1
0610-CLB

Fig.1
4,3 mm
1/1
0610-CLE

Fig.4
6,0 mm
1/1
0610-CLH

Fig.2/0
3,3 mm
1/1
0610-CLC

Fig.2
4,8 mm
1/1
0610-CLF

Fig.5
6,7 mm
1/1
0610-CLI

Fig.0
3,6 mm
1/1
0610-CLD

Fig.3
5,6 mm
1/1
0610-CLG

Fig.6
8,8 mm
1/1
0610-CLL

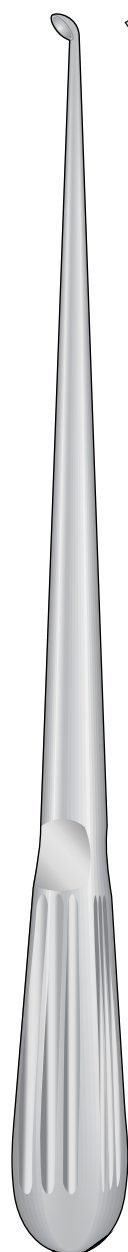

BRUNS
0610-DAA/0610-DAI
225 mm

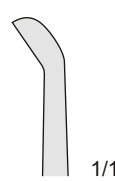

Fig.3/0
2,8 mm
1/1
0610-DAA

Fig.1
4,3 mm
1/1
0610-DAD

Fig.4
6,0 mm
1/1
0610-DAG

Fig.2/0
3,3 mm
1/1
0610-DAB

Fig.2
4,8 mm
1/1
0610-DAE

Fig.5
6,7 mm
1/1
0610-DAH

Fig.0
3,6 mm
1/1
0610-DAC

Fig.3
5,6 mm
1/1
0610-DAF

Fig.6
8,8 mm
1/1
0610-DAI

Scharfe Löffel

Sharp curettes

Cucchiai taglienti

Cucharillas cortantes

Curettes tranchantes

Mit Ferrozellgriff - With Ferrozell handle
 Con manico Ferrozell - Con mango de Ferrozell
 Avec poignée en Ferrozell

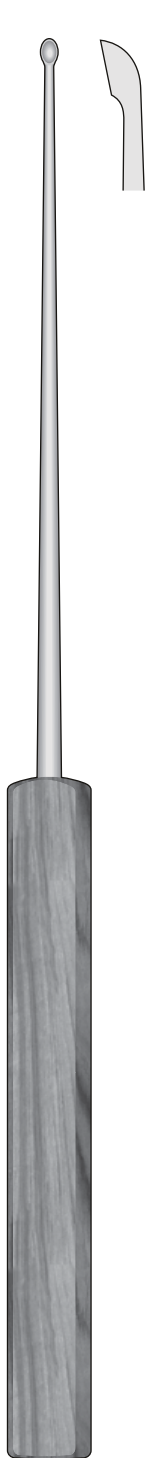

Fig.0000
2,8 mm
1/1
0610-DBA

Fig.0
5,2 mm
1/1
0610-DBC

Fig.000
3,6 mm
1/1
0610-DBB

Fig.3
10,0 mm
1/1
0610-DBD

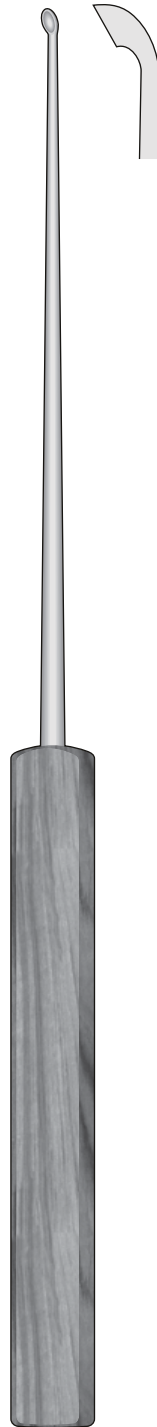

Fig.0000
2,8 mm
1/1
0610-DBE

Fig.0
5,2 mm
1/1
0610-DBG

Fig.000
3,6 mm
1/1
0610-DBF

Fig.3
10,0 mm
1/1
0610-DBH

SYPERT
0610-DBA/0610-DBD
380 mm

SYPERT
0610-DBE/0610-DBH
380 mm

Mit Ferrozellgriff - With Ferrozell handle
 Con manico Ferrozell - Con mango de Ferrozell
 Avec poignée en Ferrozell

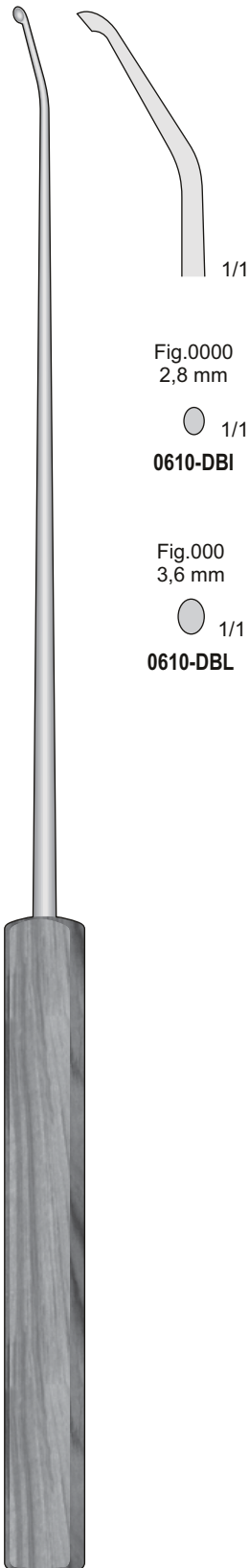

SYPERT
 0610-DBI/0610-DBL
 420 mm

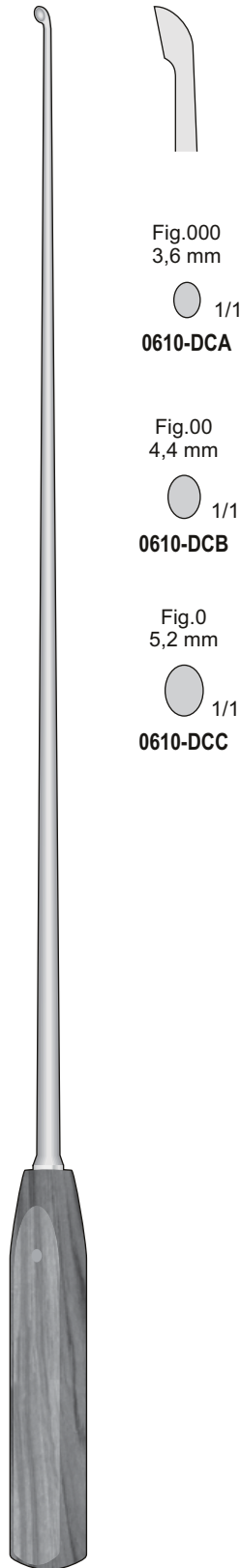

0610-DCA/0610-DCC
 410 mm

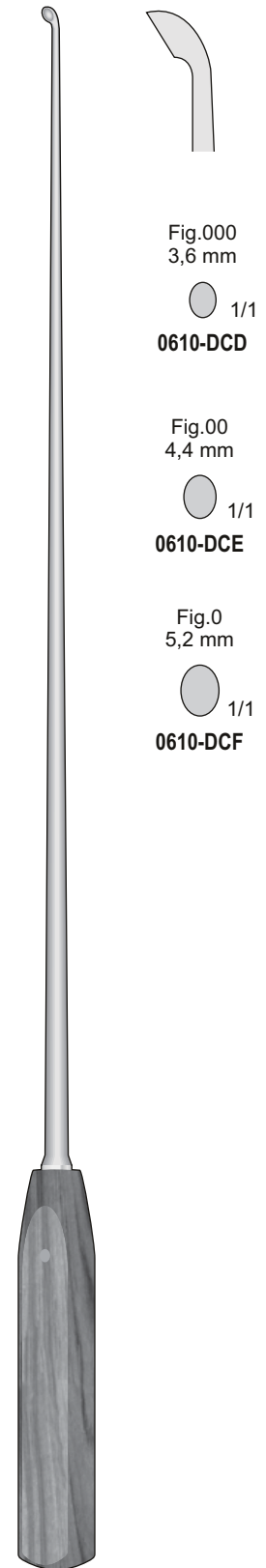

0610-DCD/0610-DCF
 410 mm

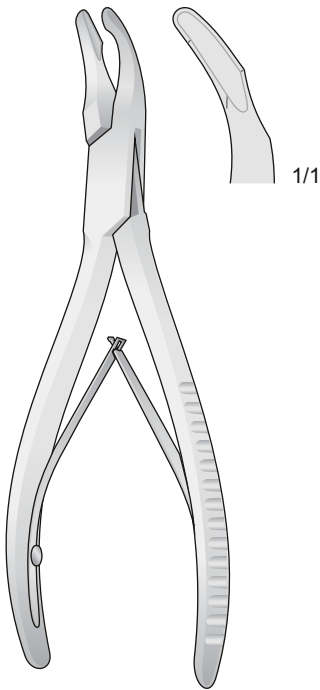

CLEVELAND
0614-CDB 140 mm
0614-CDC 170 mm

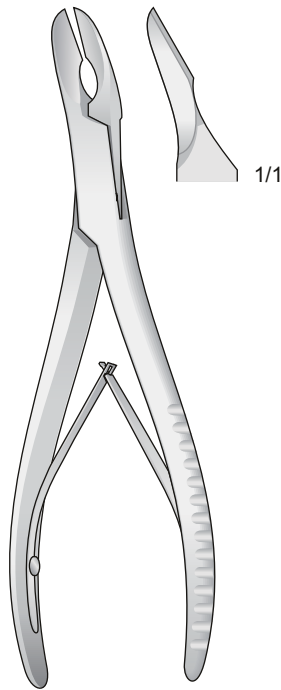

CLEVELAND
0614-CDD 150 mm
0614-CDE 170 mm

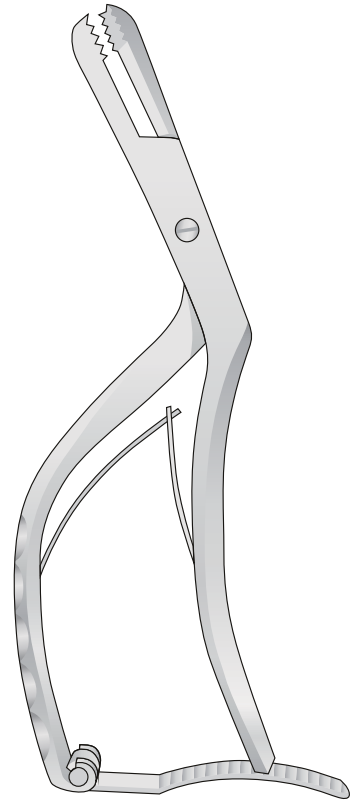

0614-BEA
200 mm

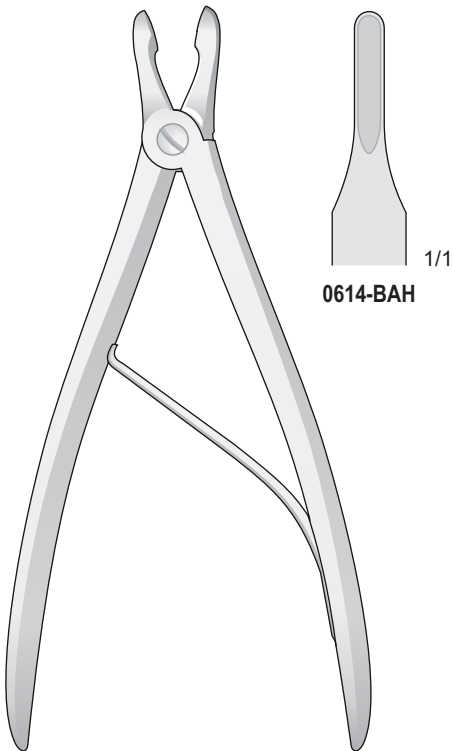

CUSHING
0614-BAH/0614-BAL
190 mm

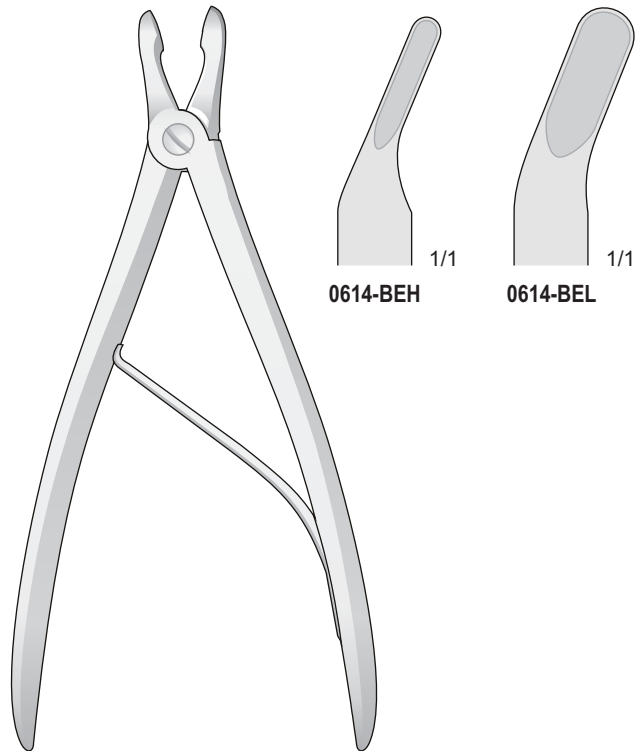
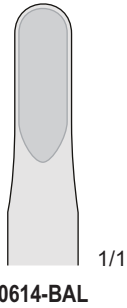

CUSHING
0614-BEH/0614-BEL
190 mm

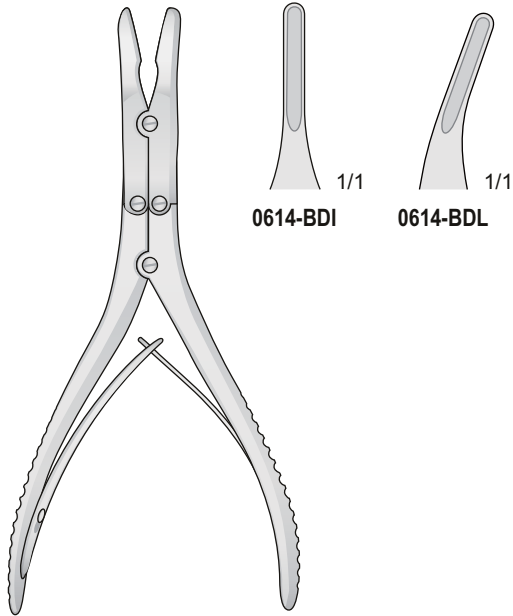

RUSKIN
0614-BDI/0614-BDL
150 mm

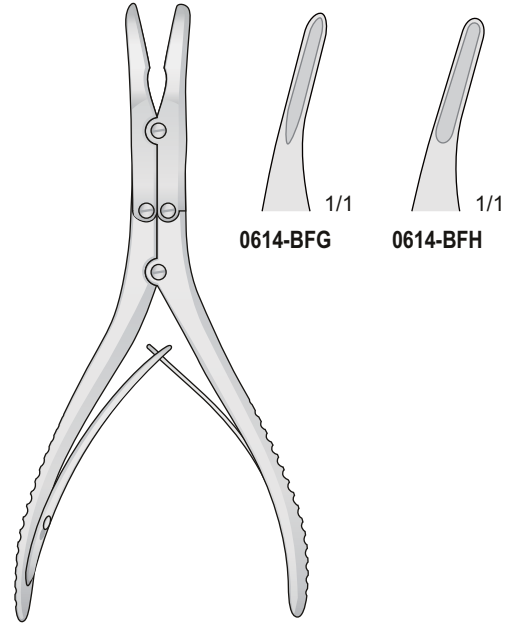

KLEINERT-KUTZ
0614-BFG/0614-BFH
155 mm

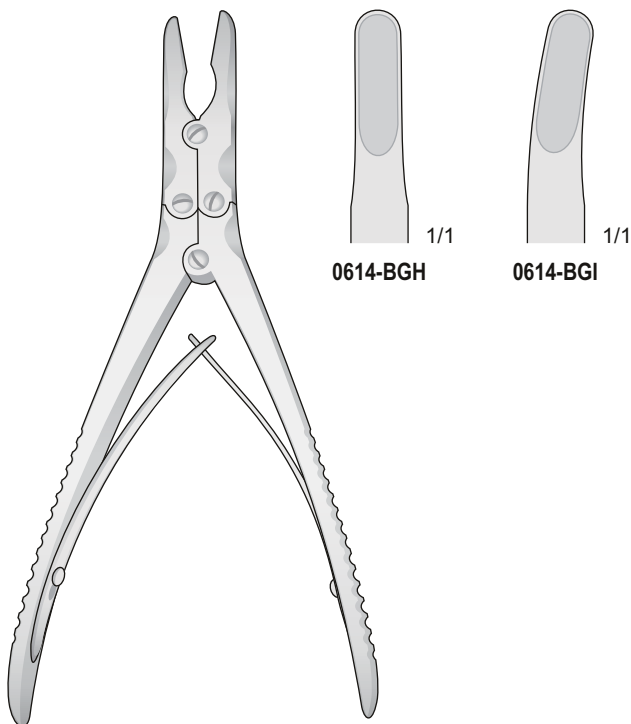

RUSKIN
0614-BGH/0614-BGI
185 mm

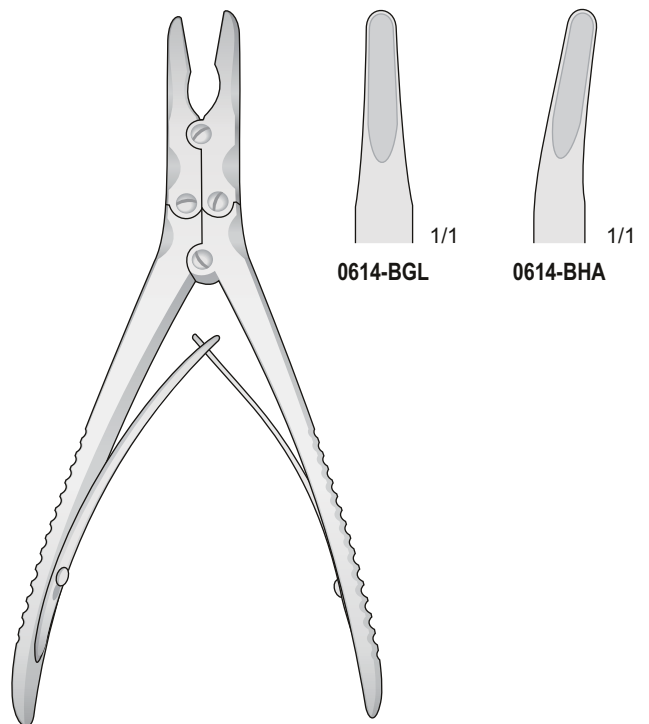

RUSKIN
0614-BGL/0614-BHA
185 mm

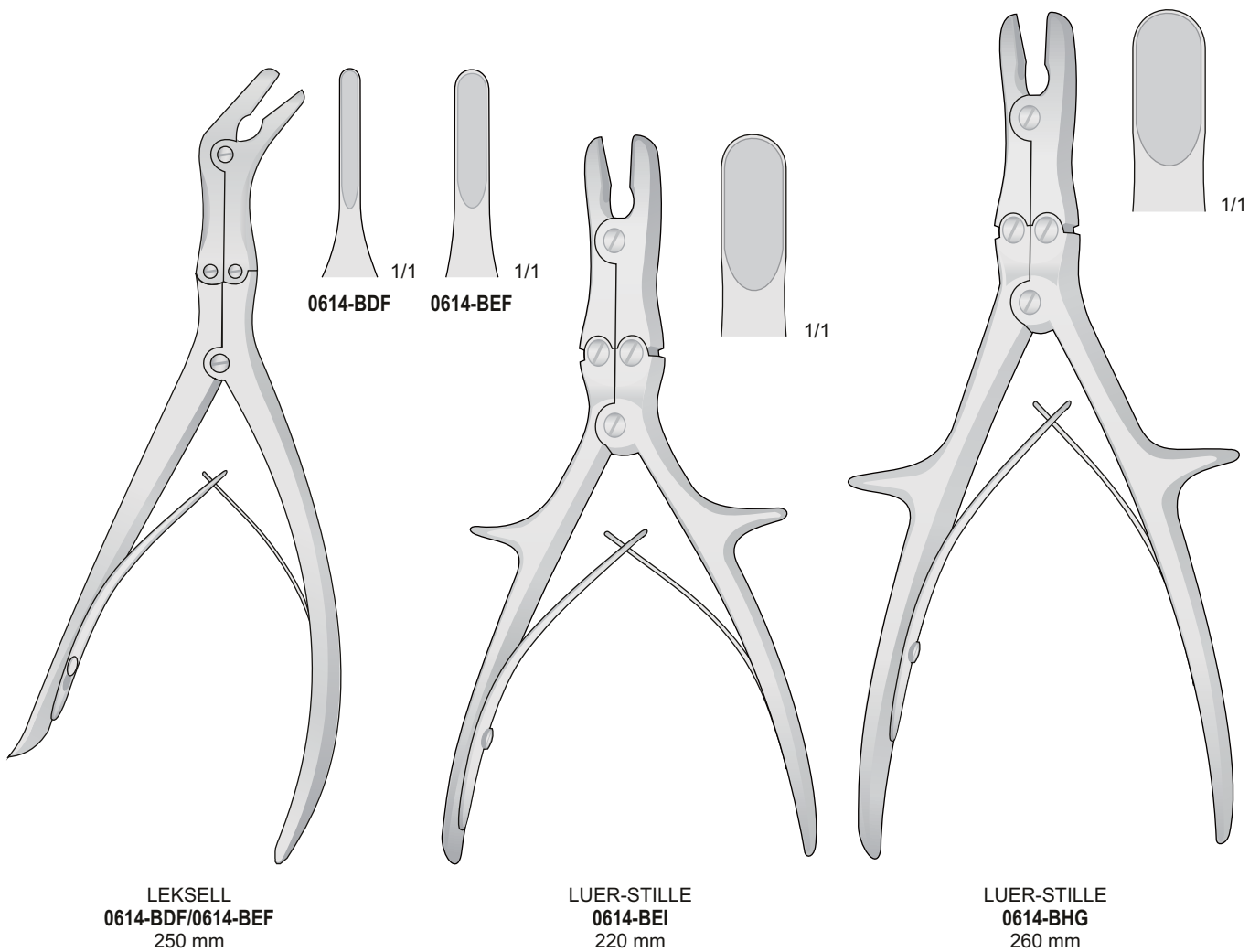

Knochensplitterzangen

Bone cutting Forceps

Pinze ossivore

Pinza cortantes para huesos

Pinces coupantes à os

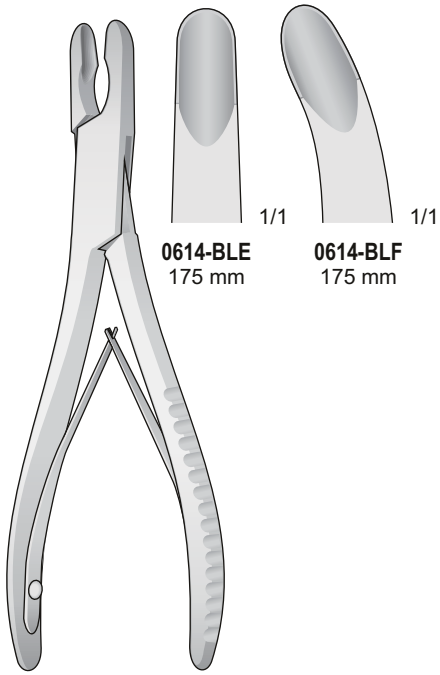

0614-BLE
175 mm

0614-BLF
175 mm

LUER
0614-BLE/0614-BLF
175 mm

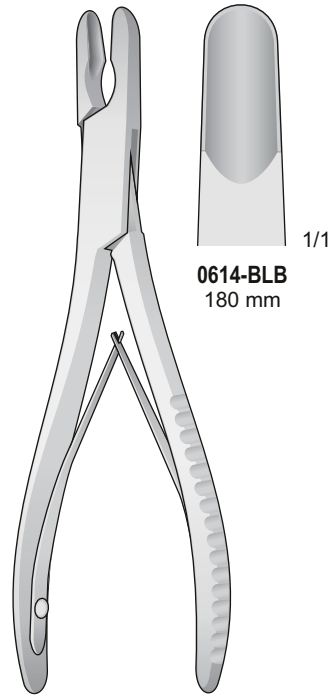

0614-BLB
180 mm

LUER
0614-BLB
180 mm

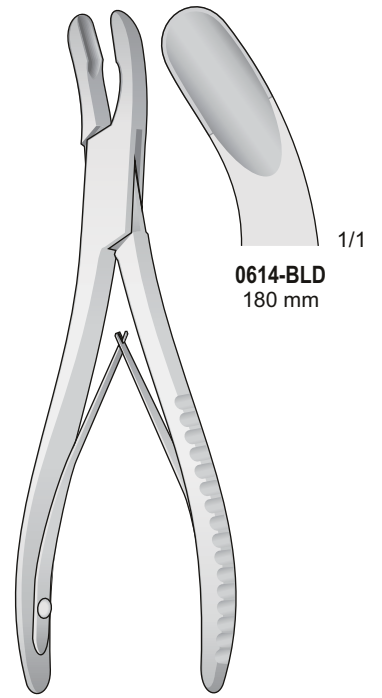

0614-BLD
180 mm

LUER
0614-BLD
180 mm

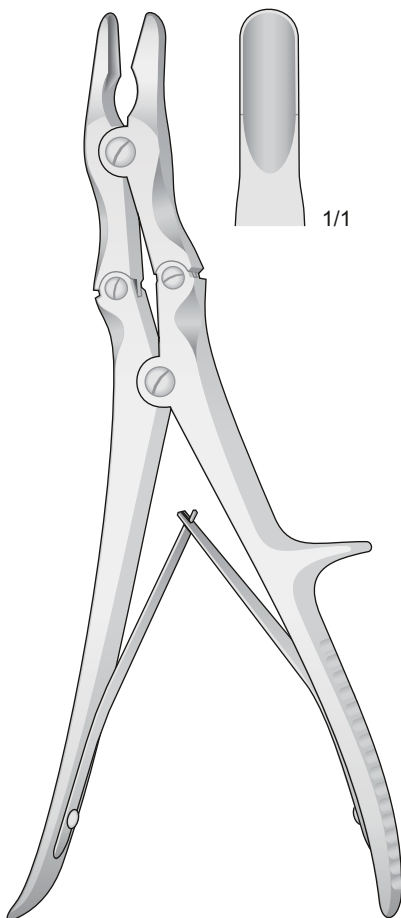

LEKSELL-STILLE
0614-BLG
240 mm

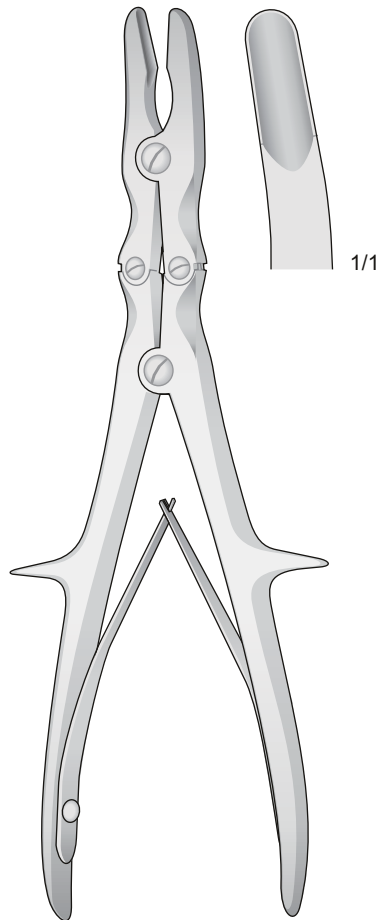

STILLE-RUSKIN
0614-BLH
240 mm

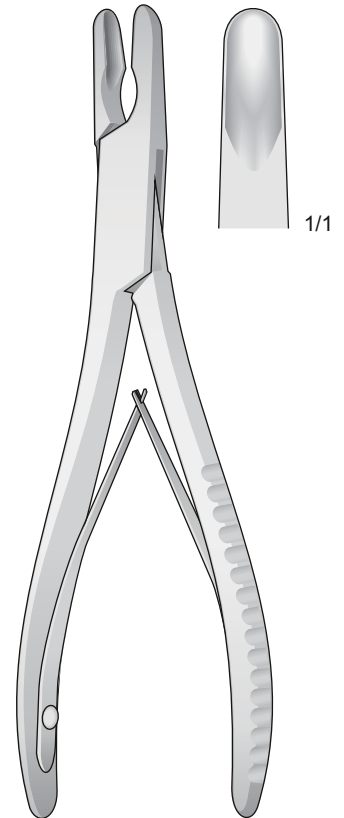

ADSON
0614-BLI
210 mm

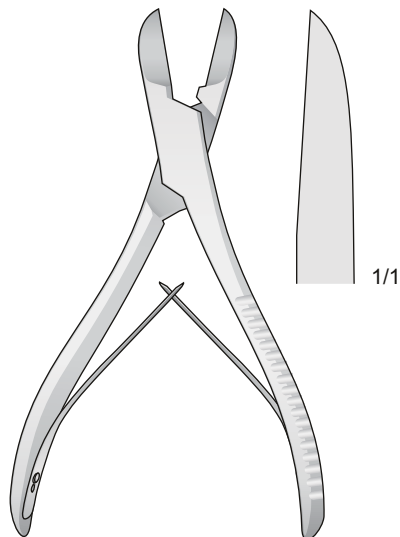

LISTON
1123-BBB
140 mm

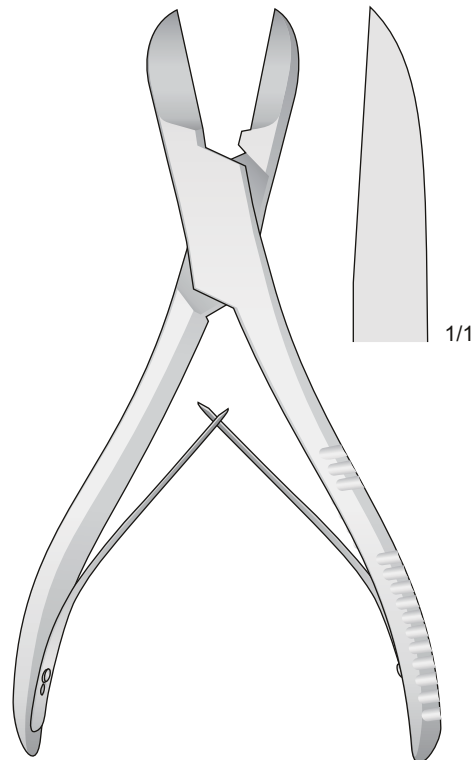

LISTON
1123-BBG
200 mm

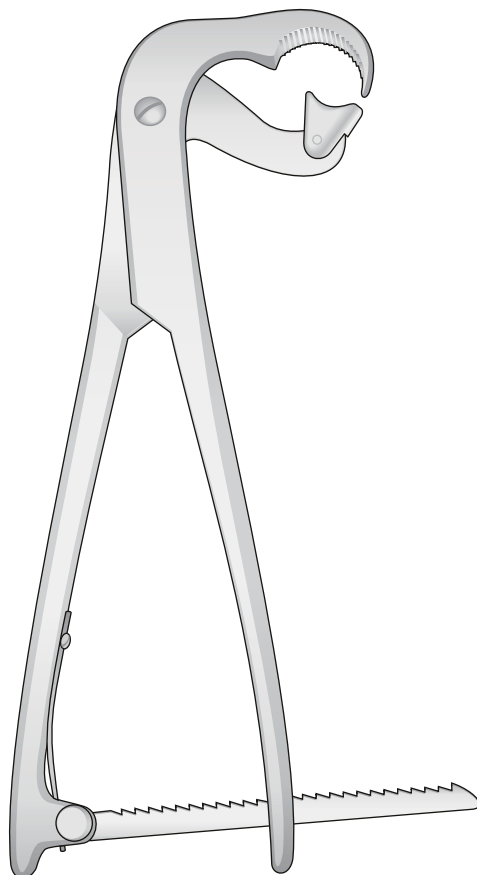

0614-BAG
275 mm

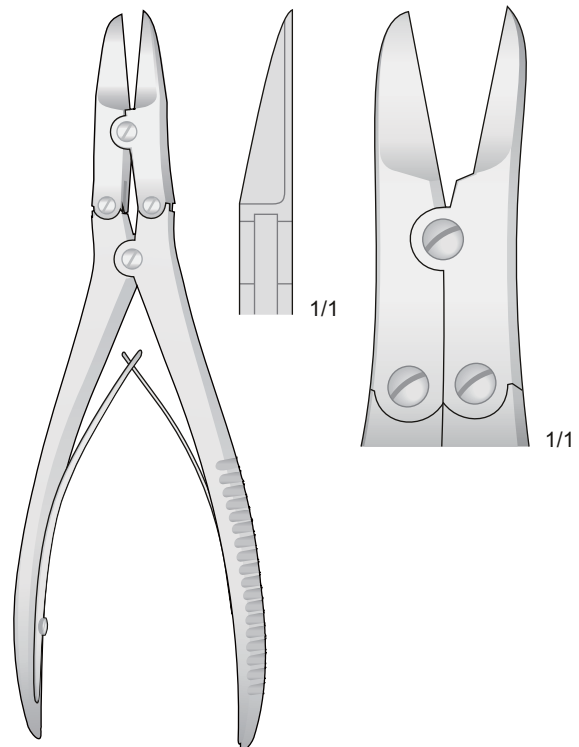

RUSKIN-LISTON
0614-BHI
190 mm

Knochenhaltezangen

Bone Holding Forceps

Pinze per osso

Pinza para hueso

Daviers porte-os

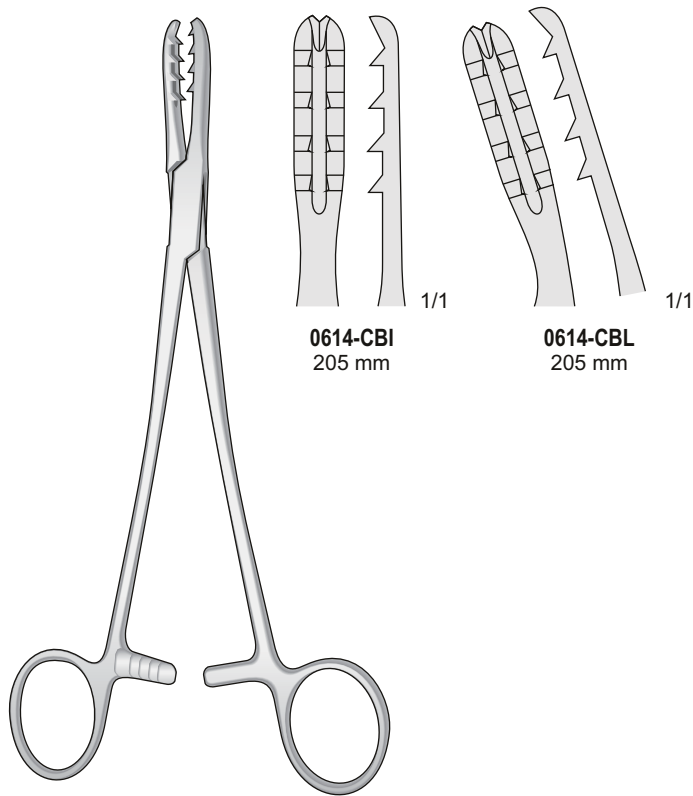

0614-CBI
205 mm

0614-CBL
205 mm

BIRCHER-GANSKE
0614-CBI/0614-CBL
205 mm

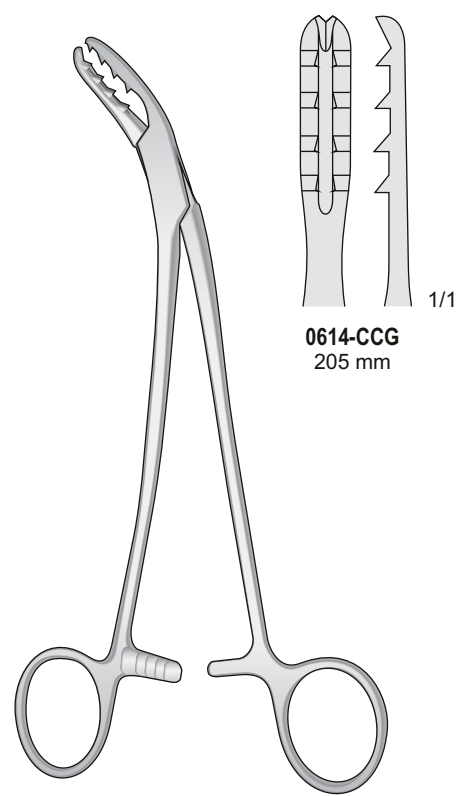

0614-CCG
205 mm

BIRCHER-GANSKE
0614-CCG
200 mm

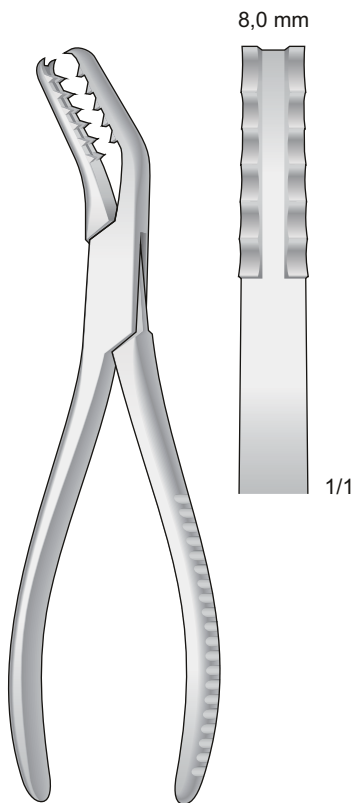

SEMB
0614-CDG
190 mm

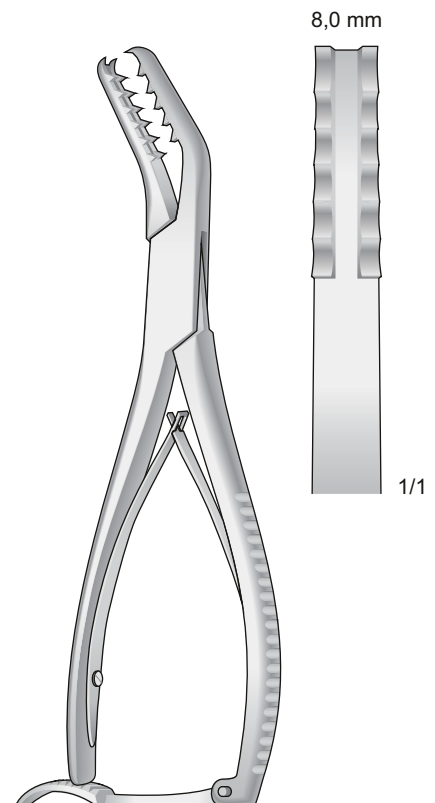

SEMB
0614-CDH
190 mm

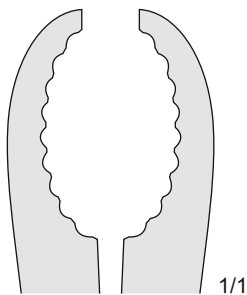

1/1

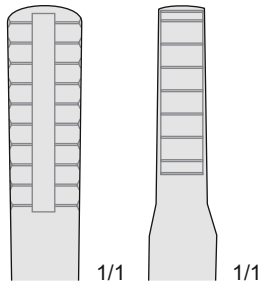

1/1

1/1

Ersatz für
Replacement for
Ricambio per
Repuesto para
0614-IA

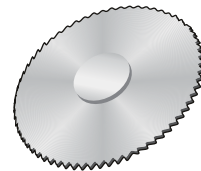

0614-IA17

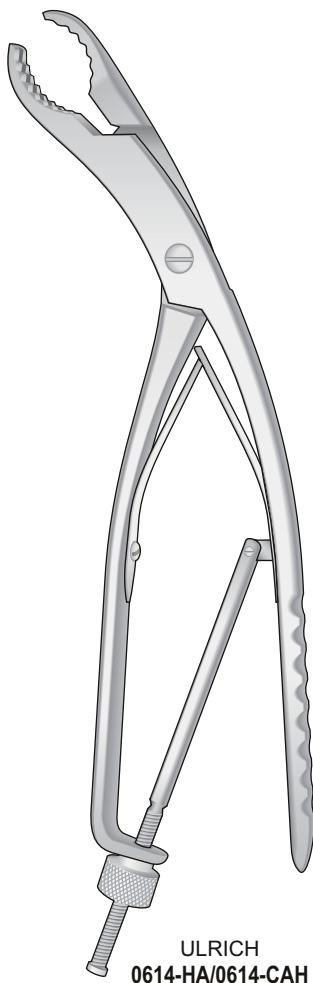

ULRICH
0614-HA/0614-CAH

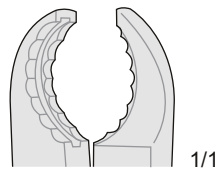

1/1

0614-CAG
220 mm

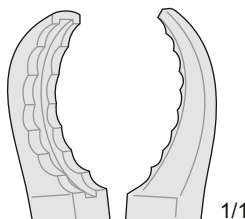

1/1

0614-CAH
240 mm

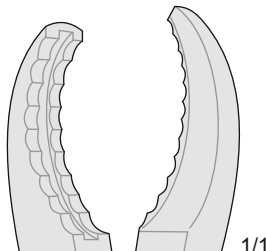

1/1

0614-HA
270 mm

Fingerringssägen
Forceps for opening rings
Pinza taglia anelli
Sierra para anillos
Scies pour bagues

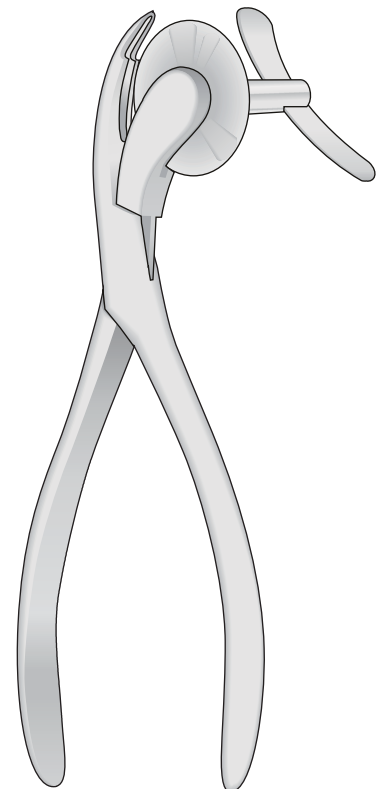

0614-IA
170 mm

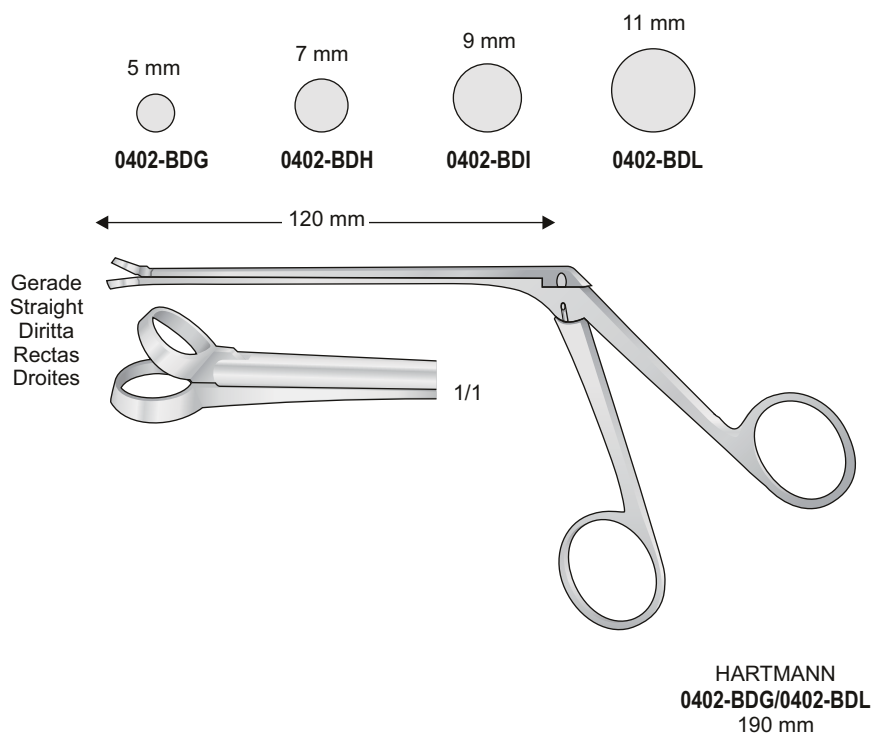
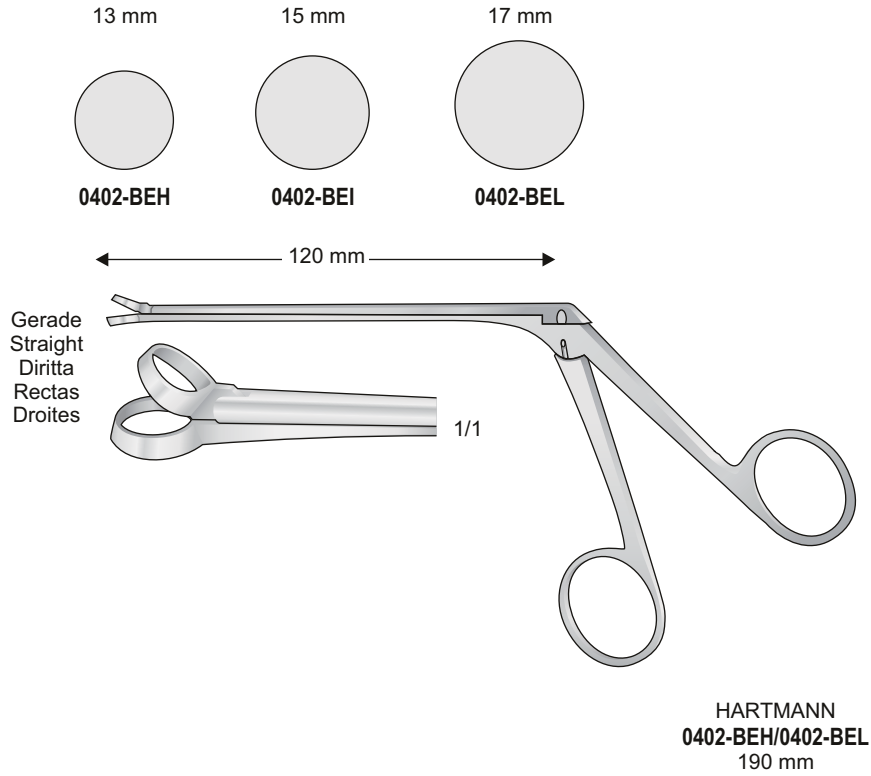

Sehnen Schäler
Tendon Stripper
Enucleatore per tendini
Enucleador de tendones
Décolleurs de tendons

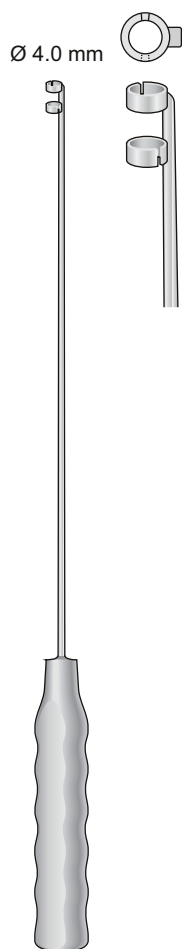

FISCHER
0614-CDF
310 mm

Sehneneinflechtklemmen - Tendon Interlacing Forceps
Pinze per intrecciare tendini - Pinzas para entrelazar tendones
Pincas pour entrelacer les tendons

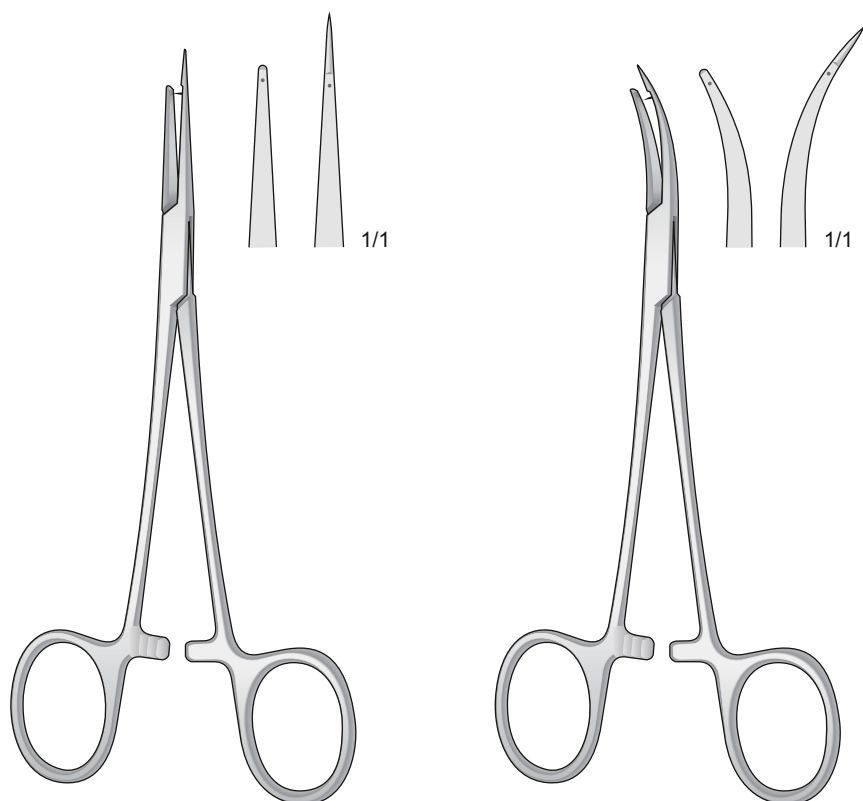

0614-CAI
150 mm

0614-CAL
150 mm

Rohrschaft. Mikro-Fazangchen - Micro ear forceps with tubular shaft

Mikro-Loffelzangchen
Micro cup shaped forceps
Micro pinze a cucchiaio

Mikro-Scheren
Micro scissors
Micro forbici

0,9 x 1,0 mm

○
Oval
Ovale
Ovales



0402-IG
Gerade - Straight
Diritta - Recta
Droit



BELLUCCI
0402-BAG
Gerade
Straight
Diritta
Recta
Droit

0,9 x 1,0 mm

○
Oval
Ovale
Ovales



0402-IH
Nach Oben Gebogen
Curved up
Curva in alto



BELLUCCI
0402-LC
Nach Oben Gebogen
Curved up
Curva in alto

0,8 x 1,3 mm

○
Oval
Ovale
Ovales



WULLSTEIN
0402-II
Gerade - Straight
Diritta - Recta
Droit



BELLUCCI
0402-LD
Links Gebogen
Curved to left
Curva a sinistra
Curvas a la izquierda
Courbes  gauche

0,8 x 1,3 mm

○
Oval
Ovale
Ovales



WULLSTEIN
0402-IL
Links Gebogen - Curved to left
Curva a sinistra - Curvas a la izquierda
Courbes  gauche



BELLUCCI
0402-LE
Rechts Gebogen
Curved to right
Curva a destra
Curvas a la derecha
Courbes  droite

0,8 x 1,3 mm

○
Oval
Ovale
Ovales



WULLSTEIN
0402-LA
Rechts Gebogen - Curved to right
Curva a destra - Curvas a la derecha
Courbes  droite



BELLUCCI
0402-LF
Orizzontale

1,0 mm

○
Rund
Round
Tonda



WULLSTEIN
0402-LB
Gerade - Straight
Diritta - Recta
Droit

1,7 x 2,5 mm

○
Oval
Ovale
Ovales



WULLSTEIN
0402-BAH
Gerade - Straight
Diritta - Recta
Droit

80 mm

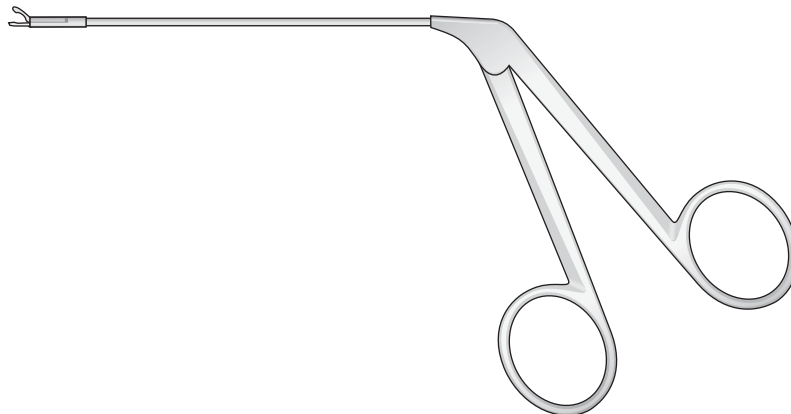

0402-IG/0402-BAH
80 mm

0,6 x 0,5 mm



0402-CAB
Gerade
Straight
Diritta
Recta
Droit

0,9 x 1,1 mm



0402-CAF
Gerade
Straight
Diritta
Recta
Droit

0,6 x 0,5 mm



0402-CAC
Links Gebogen
Curved to left
Curva a sinistra
Curvas a la izquierda
Courbes  gauche

0,9 x 1,1 mm



0402-CAG
Links Gebogen
Curved to left
Curva a sinistra
Curvas a la izquierda
Courbes  gauche

0,6 x 0,5 mm



0402-CAD
Rechts Gebogen
Curved to right
Curva a destra
Curvas a la derecha
Courbes  droite

0,9 x 1,1 mm



0402-CAH
Rechts Gebogen
Curved to right
Curva a destra
Curvas a la derecha
Courbes  droite

0,6 x 0,5 mm



0402-CAE
Nach Oben Gebogen
Curved up
Curva in alto

0,9 x 1,1 mm



0402-CAI
Nach Oben Gebogen
Curved up
Curva in alto

0,9 x 1,1 mm



0402-CAL
Nach Unten Gebogen
Curved down
Curva in basso

Schaft zerlegbar
Dismantable shaft
Asta smontabile
Vstago desmontable
Tige dmontable

80 mm

Superfein
Extremely delicate
Modello super fine
Superfina
Modle superfin

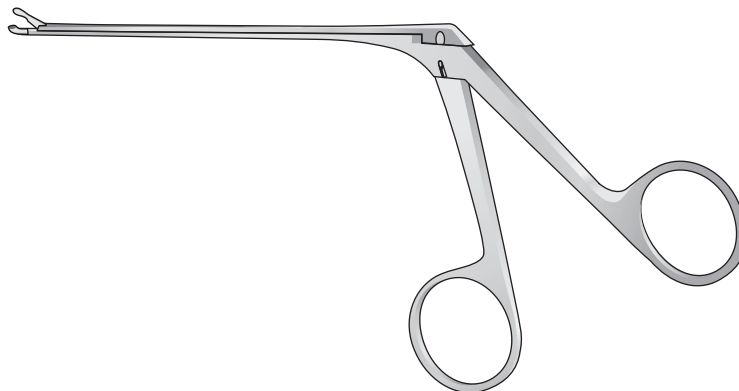

0402-CAB/0402-CAL
80 mm

6,0 x 0,8 mm



SCHUKNECHT
0402-CBD
Gerade
Straight
Diritta
Recta
Droit

4,0 x 0,5 mm

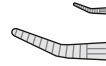

0402-CBG
Rechts Gebogen
Curved to right
Curva a destra
Curvas a la derecha
Courbes  droite

5,0 x 0,8 mm



GREVEN
0402-CBE
Gerade
Straight
Diritta
Recta
Droit

4,0 x 0,5 mm

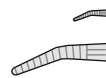

0402-CBH
Links Gebogen
Curved to left
Curva a sinistra
Curvas a la izquierda
Courbes  gauche

4,0 x 0,5 mm

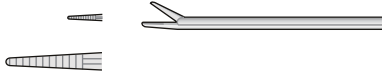

0402-CBF
Gerade
Straight
Diritta
Recta
Droit

4,0 x 0,5 mm

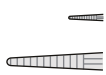

0402-CBI
Nach Oben Gebogen
Curved up
Curva in alto

4,0 x 0,5 mm

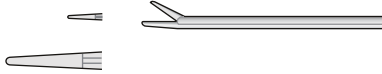

0402-BAA
Glattes Maul
Smooth jaws
Morso liscio
Mandibula lisa
Mors lisses

4,0 x 0,5 mm

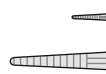

0402-CBL
Nach Unten Gebogen
Curved down
Curva in basso

Schaft zerlegbar
Dismantable shaft
Asta smontabile
Vstago desmontable
Tige dmontable

Superfein
Extremely delicate
Modello super fine
Superfina
Modle superfin

80 mm

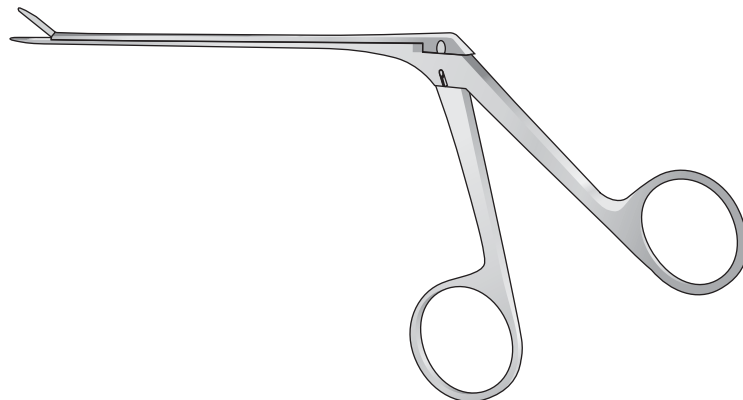

0402-BAA/0402-CBL
80 mm

Rohrschaft. Mikro-Faßzängchen
Micro ear forceps with tubular shaft

0,8 x 3,5 mm

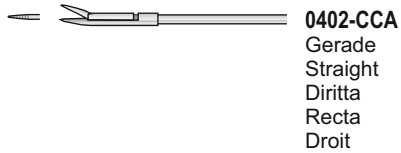

0,8 x 3,5 mm

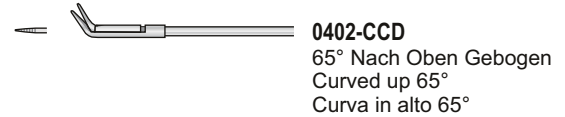

1,0 x 5,0 mm

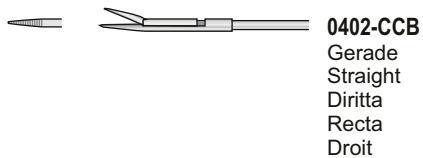

0,8 x 3,5 mm

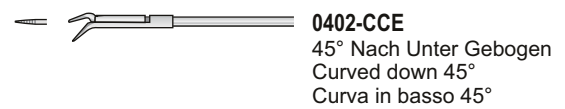

1,5 x 6,0 mm

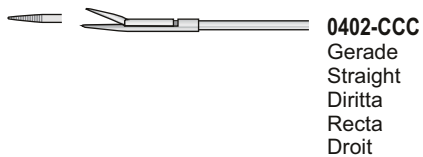

1,0 x 5,0 mm

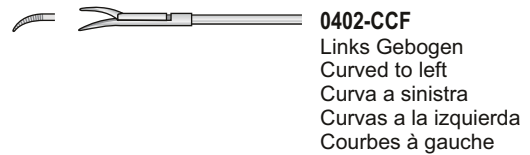

1,0 x 5,0 mm

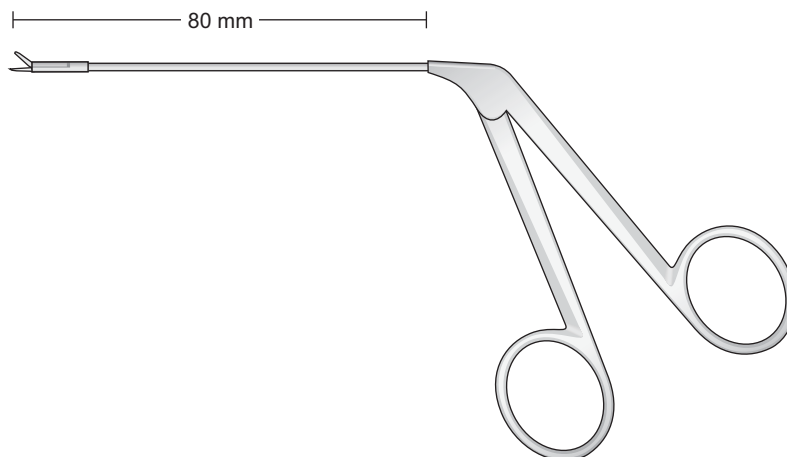
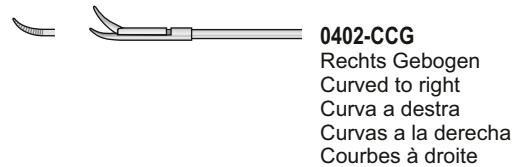

0402-CCA/0402-CCG
 80 mm



0606-EFA
Gerade
Straight
Rette
Rectas
Droits



0606-EFB
Gerade, horizontal schneidend
Straight, horizontally cutting
Rette, taglio orizzontale
Rectas, de corte horizontal
Droits, à coupe horizontale



0606-EFC
Nach links gebogen
Curved to left
Curve a sinistra
Acodadas hacia la izquierda
Courbes à gauche



0606-EFD
Nach rechts gebogen
Curved to right
Curve a destra
Acodadas hacia la derecha
Courbes à droite



0606-EFE
Nach oben abgewinkelt
Angled up
Angolate in alto
Angulada hacia arriba
Coudés vers le haut



0606-EFF
Nach unten abgewinkelt
Angled down
Angolate in basso
Angulada hacia abajo
Coudés vers le bas



0606-EFG
Gerefties maul, gerade
Serrated jaws, straight
Morsi zigrinati, retti
Boca estriada, recta
Mors striés, droits



0606-EFH
Gerefties maul, rechts gebogen
Serrated jaws, right
Morsi zigrinati, curvi a destra
Boca estriada, curva a la derecha
Mors striés, courbes à droite



0606-EFI
Gerefties maul, links gebogen
Serrated jaws, left
Morsi zigrinati, curvi a sinistra
Boca estriada, curva a la izquierda
Mors striés, courbes à gauche

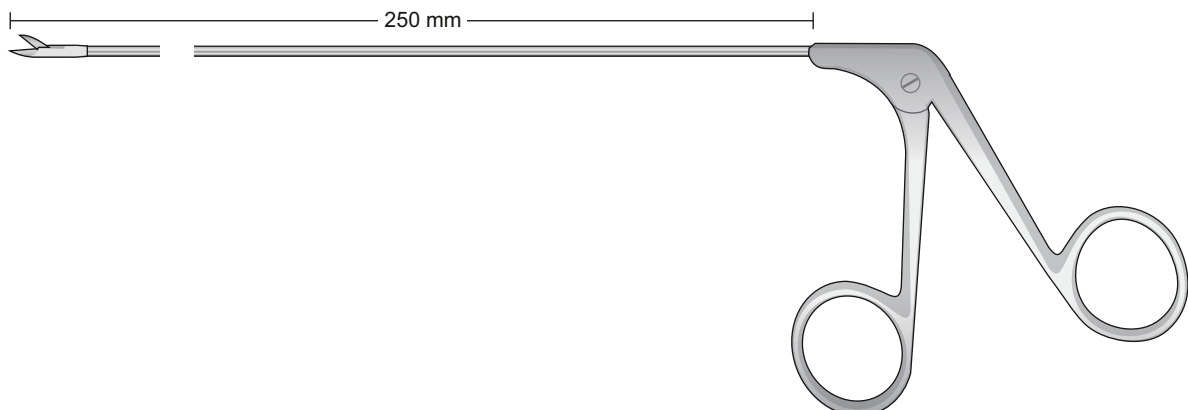

0606-EFA/0606-EFI
250 mm

Rhinologie
Rhinology
Rinologia
Rinología
Rhinologie

0606-EFL

Rundes Löffelmaul, gerade
 Round cup jaws, straight
 Morso a forma di cucchiaio rotondo, retto
 Boca redonda en forma de cucharilla, recta
 Mors ronds en cuiller, droits

0606-EGA

Rundes Löffelmaul, nach oben
 Round cup jaws, up
 Morso a forma di cucchiaio rotondo, in alto
 Boca redonda en forma de cucharilla, arriba
 Mors ronds en cuiller, courbes en haut

0606-EGB

Rundes Löffelmaul, rechts
 Round cup jaws, right
 Morso a forma di cucchiaio rotondo, destra
 Boca redonda en forma de cucharilla, a la derecha
 Mors ronds en cuiller, courbes à droite

0606-EGC

Rundes Löffelmaul, links
 Round cup jaws, left
 Morso a forma di cucchiaio rotondo, sinistra
 Boca redonda en forma de cucharilla, a la izquierda
 Mors ronds en cuiller, courbes à gauche

0606-EGD

Ovales Löffelmaul, gerade
 Oval cup jaws, straight
 Morso a forma di cucchiaio ovale, retto
 Boca ovalada en forma de cucharilla, recta
 Mors ovales en cuiller, droits

0606-EGE

Ovales Löffelmaul, nach oben
 Oval cup jaws, up
 Morso a forma di cucchiaio ovale, in alto
 Boca ovalada en forma de cucharilla, arriba
 Mors ovales en cuiller, courbes en haut

0606-EGF

Ovales Löffelmaul, rechts
 Oval cup jaws, right
 Morso a forma di cucchiaio ovale, destra
 Boca ovalada en forma de cucharilla, a la derecha
 Mors ovales en cuiller, courbes à droite

0606-EGG

Ovales Löffelmaul, links
 Oval cup jaws, left
 Morso a forma di cucchiaio ovale, sinistra
 Boca ovalada en forma de cucharilla, a la izquierda
 Mors ovales en cuiller, courbes à gauche

0606-EGH

Ovales Löffelmaul, gerade
 Oval cup jaws, straight
 Morso a forma di cucchiaio ovale, retto
 Boca ovalada en forma de cucharilla, recta
 Mors ovales en cuiller, droits

0606-EGI

Maulteile gefenstert
 Jaw fenestrated
 Morso fenestrato
 Boca fenestrada
 Mors ajourés

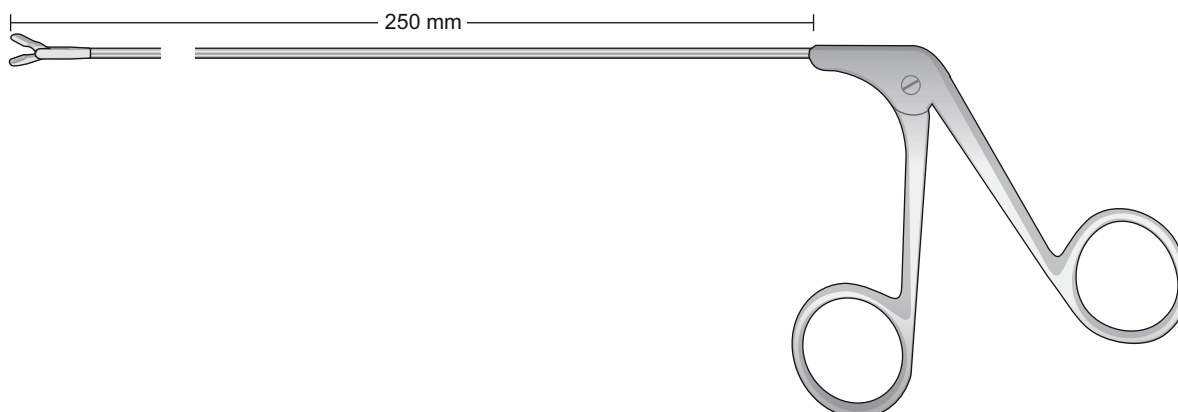

0606-EFL/0606-EGI
 250 mm

Laminectomy
rongeurs

Laminectomy
Rongeur

Pinze
per biopsia

Pinzas cortantes
para laminectomia

Pinces a
laminectomia

Gerade
Stright
Diritta
Rectas
Droites

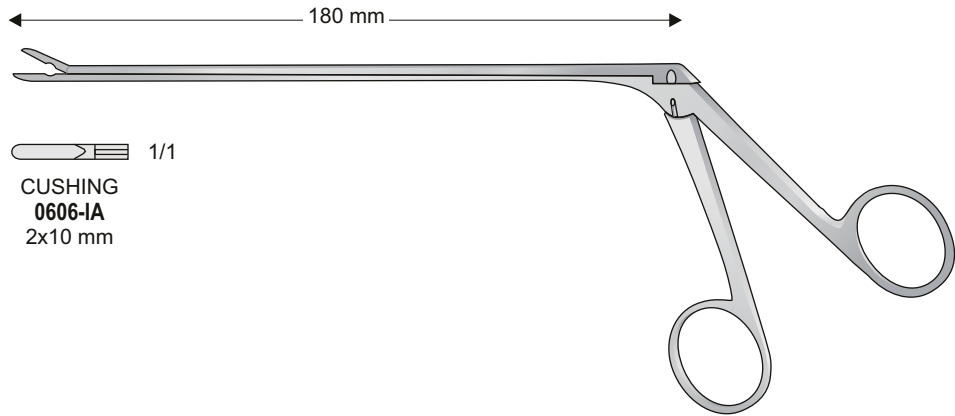

CUSHING
0606-IA
2x10 mm

CUSHING
0606-IA

Aufwärtsgebogen
Top curved
Curva verso l'alto
Curvos
Courbe vers le haut

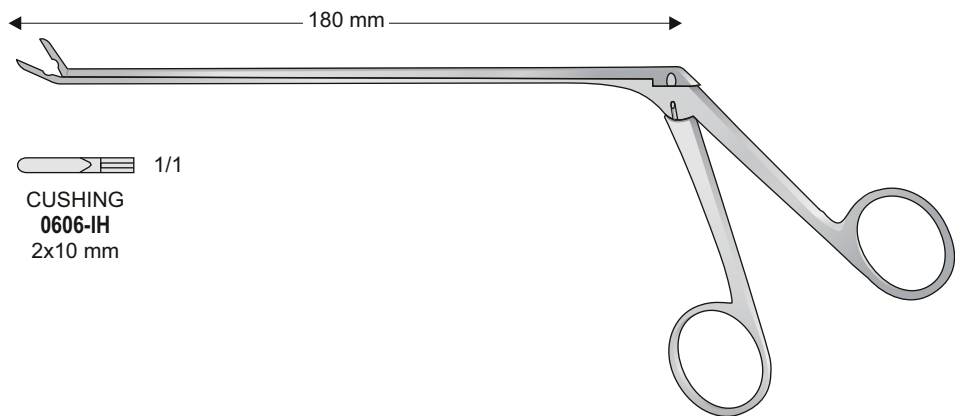

CUSHING
0606-IH
2x10 mm

CUSHING
0606-IH

Abwärts gebogen
Bottom curved
Curva verso il basso
Curvos
Courbe vers le bas

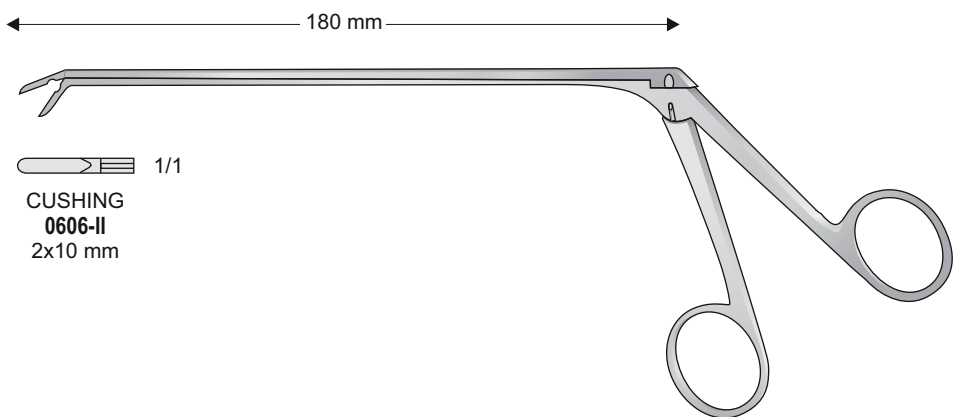

CUSHING
0606-II
2x10 mm

CUSHING
0606-II

Endospekula

Endocervical Specula

Endospecoli

Espéculos Endocervical

Endospéculum

Katheter-Einführungsinstrumente
Catheter introducing instruments
Strumenti per tendere ed introdurre i cateteri
Instrumentos para introducir catéteres
Mandrin pour introduire les sondes

Ø 1,2 mm

Endospekula für Harnröhre und
Cervix, ohne Sperre
Endospecula for cervix and urethra,
without ratchet

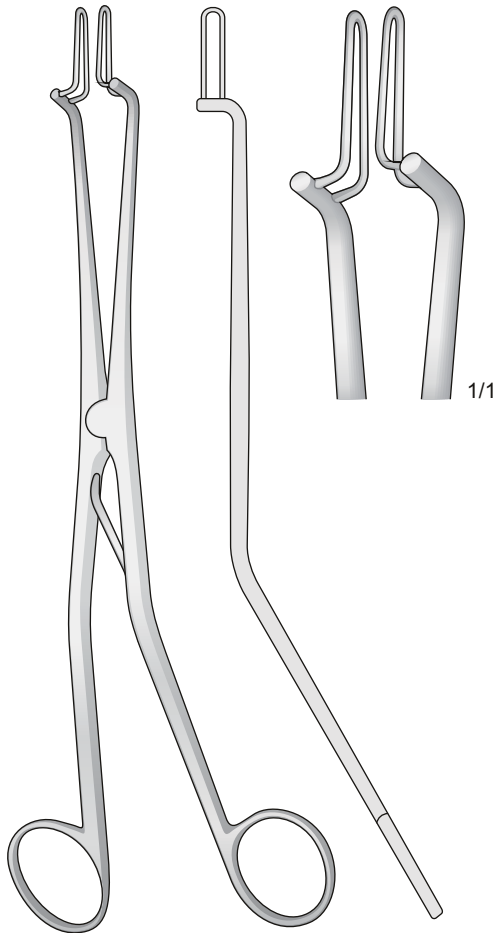

KOGAN
0502-BBA
240 mm

Endospekula für Harnröhre und
Cervix, mit Skalensperre und Fixierschraube
Endospecula for cervix and urethra,
with scale-ratchet and fixing screws
Con cremagliera a scala e vite di fissaggio
Con cremallera graduada y tornillo de fijacion
Avec crémaillère à échelle et vis à fixation

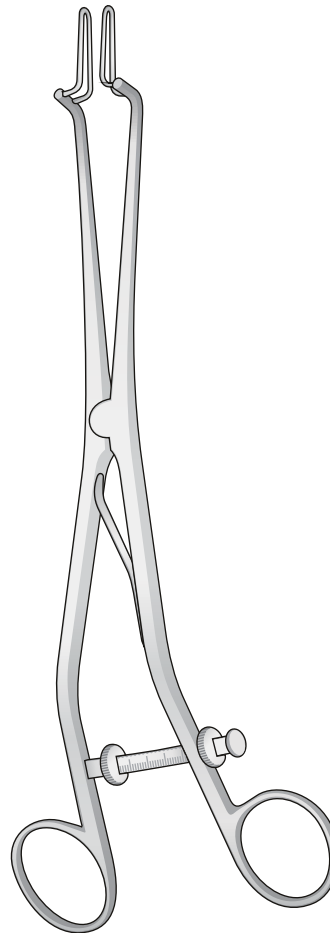

KOGAN
0502-BBB
240 mm

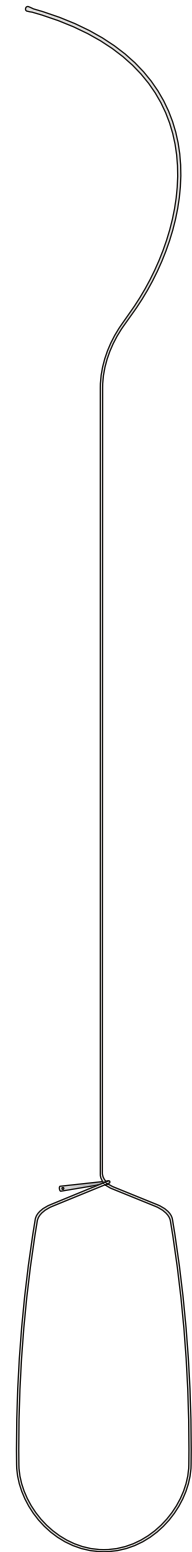

0501-LE
425 mm



Fig. 3

0502-BBL
90x40 mm

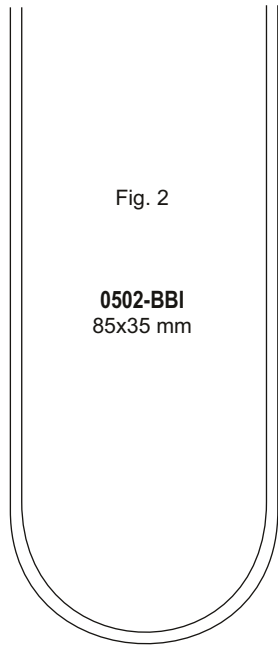

Fig. 2

0502-BBI
85x35 mm

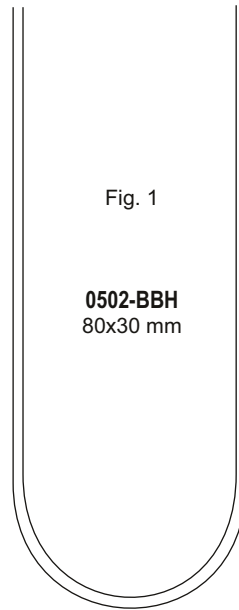
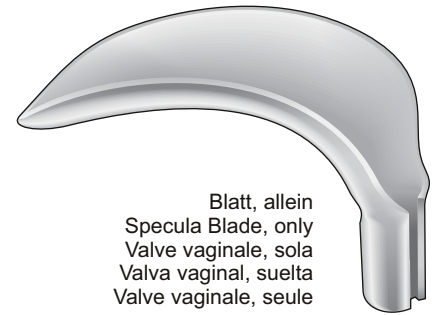

Fig. 1

0502-BBH
80x30 mm



Blatt, allein
Specula Blade, only
Valve vaginale, sola
Valva vaginal, suelta
Valve vaginale, seule

SCHERBAK
0502-BBH/0502-BBL

Blasenhalsperrer
Sounds Bladder
Dilatatore del collo vescicale
Sonda vesicales
Dilatateur pour le col vésical

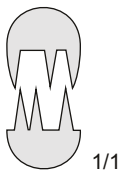
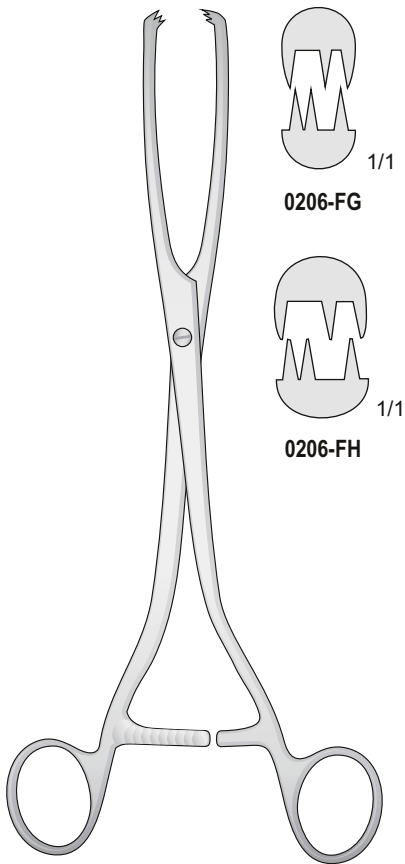

0206-FG

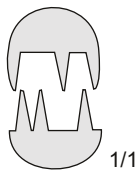

0206-FH

MUSEUX
0206-FG/0206-FH
265 mm

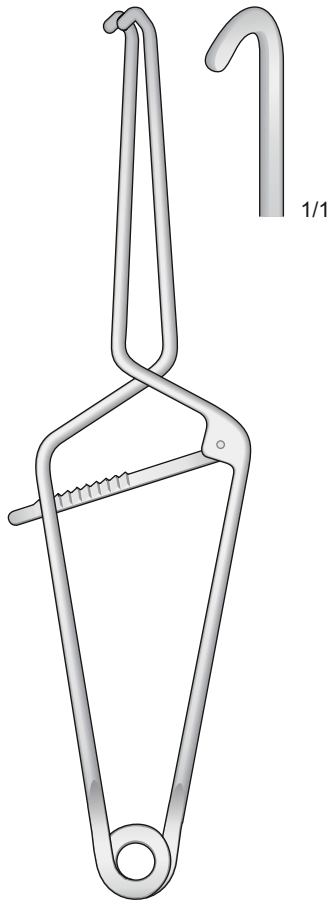

MILLIN
0502-BH
280 mm

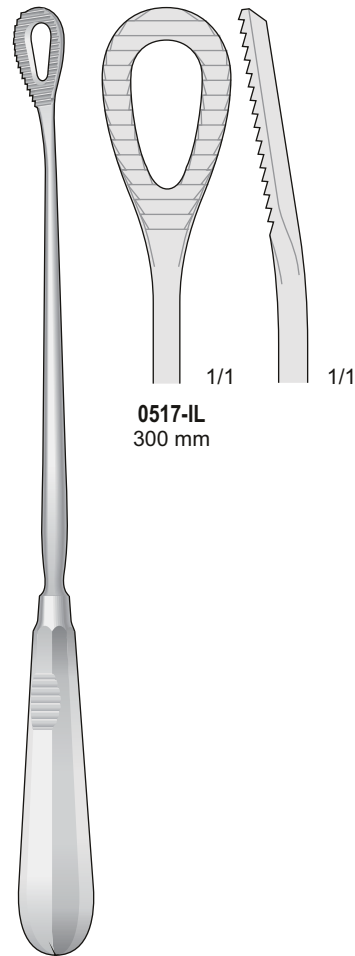

PESTALOZZA
0517-IL
300 mm

Biopsiekürette
Uterine Biopsy Curette
Curette per biopsia
Curetas para biopsia
Curettes pour biopsie

6,0 mm

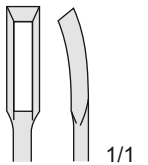

1/1

KEVORKIAN
0517-IH
300 mm

Vaginalspekula

Vaginal Specula

Specoli vaginali

Espéculos vaginales

Spéculums vaginaux

Gewicht zum Vaginalspekulum
Weight for Vaginal Speculum
Peso per specolo vaginale
Peso para espéculo vaginal
Poids pour spéculum vaginal

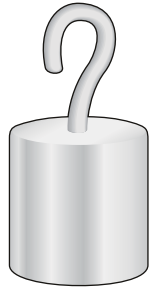

SCHERBAK
0502-CLE 10,5 mm 400 gr
0502-CLF 13 mm 800 gr

Blatt, allein
Specula Blade, only
Valve vaginale, sola
Valva vaginal, suelta
Valve vaginale, seule



SCHERBAK
0502-CLB/0502-CLC

Griff zum Vaginalspekulum
Handle for Vaginal Speculum
Manico per specolo vaginale
Mango para espéculo vaginal
Manche pour spéculum vaginal

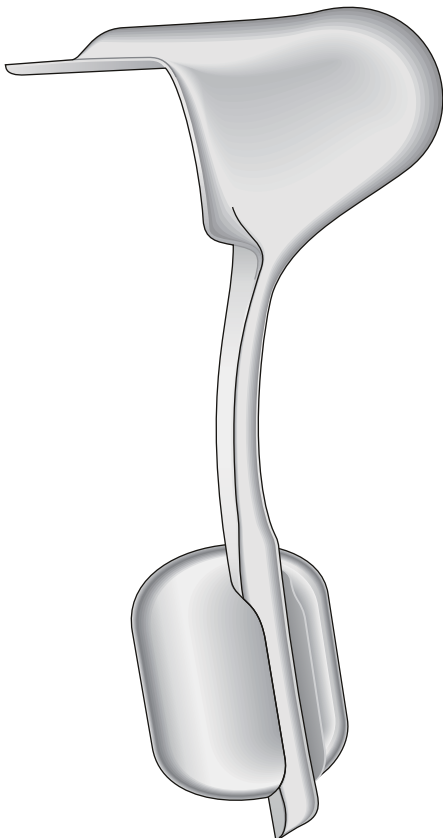

AUVARD
0502-CLA
230 mm



SCHERBAK
0502-CLD
200 mm

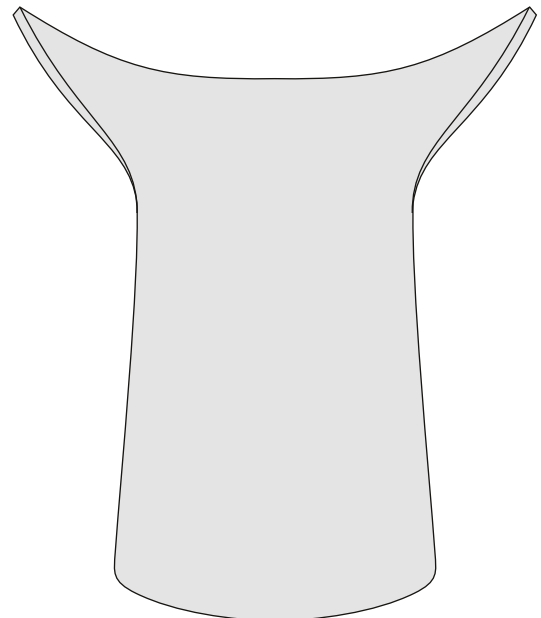

0502-CLC
81x45 - 70 mm

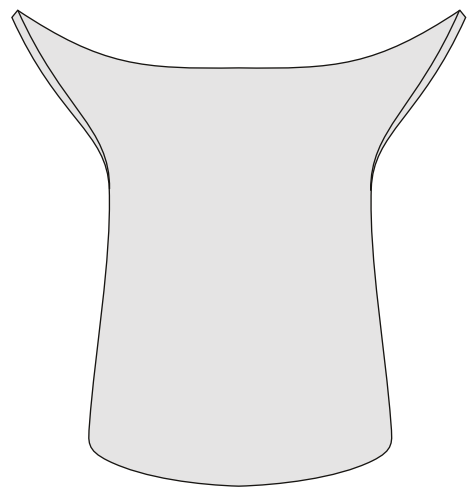

0502-CLB
62x40 - 60 mm

Geschwärzt
Surface Black-finish
Superficie anti-riflesso
Surface noircie



0517-FI
75 x 20 mm



0517-FL
100 x 22 mm



0517-GA
120 x 25 mm

0502-LE

Komplettset mit 14 Uterusdilatoren ohne Metalltui
Set con 14 dilatatori uterini senza scatola



0502-LF

Komplettset mit 26 Uterusdilatoren ohne Metalltui
Set con 26 dilatatori uterini senza scatola



0502-LG

Metalltui mit 14 Hegar Uterusdilatoren
Scatola con 14 dilatatori uterini Hegar



0517-BDE

Metalltui mit 13 Hegar Uterusdilatoren
Scatola con 13 dilatatori uterini Hegar

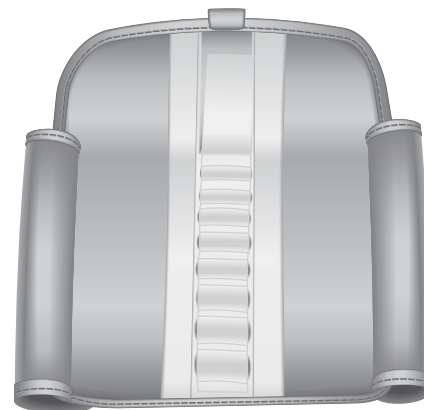

0517-BDD

mit 8 Uterusdilatoren
con 8 dilatatori uterini

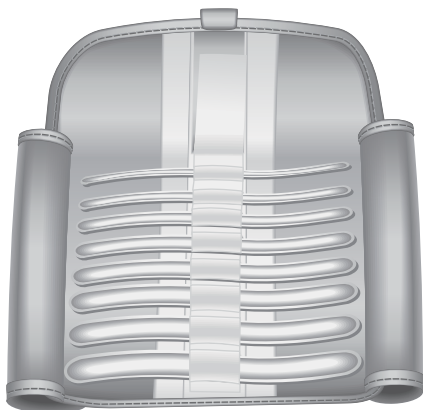

0517-BDF

für 8 Uterusdilatoren
per 8 dilatatori uterini

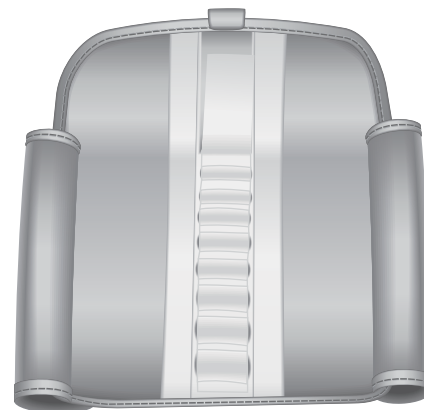

0502-LH

Metalltui mit 26 Hegar Uterusdilatoren
Scatola con 26 dilatatori uterini Hegar

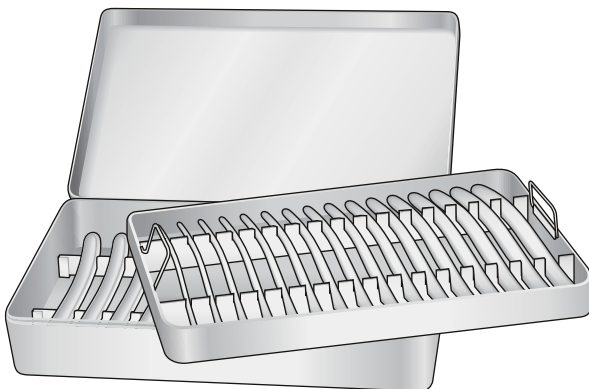

0218-BH

Metalltui leer für 26 Hegar Uterusdilatoren
Scatola vuota per 26 dilatatori uterini Hegar

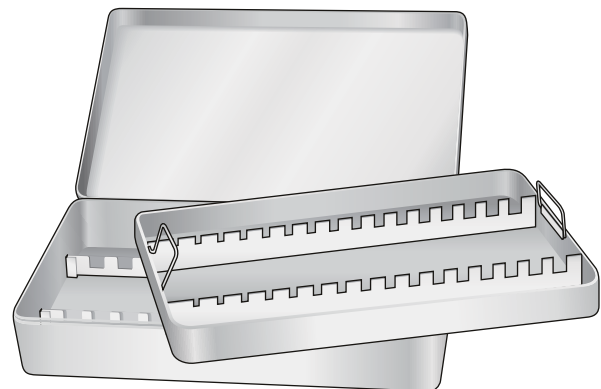

Uterusdepressor
Uterine Depressor
Depressore uterino
Depresor uterino
Dépresseur utérin



BRAUN
0517-HG
275 mm

Sterilisierzangen zum Fassen und
Halten Steriler Instrumente
Sterilizing forceps for picking
up and holding of sterile instruments
Pinze per prelevare strumenti sterilizzati
Pinzas para esterilizaci3n
Pinces pour instruments stérilisés

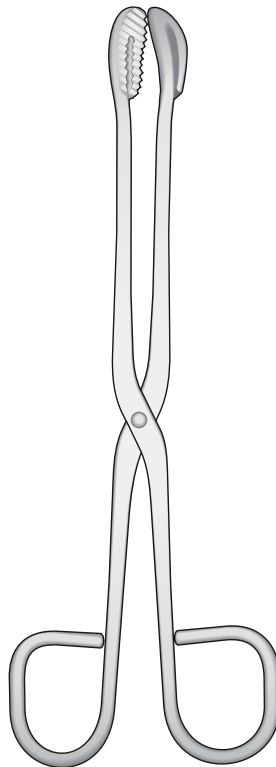

0718-BD 200 mm
0718-BE 300 mm

Pinza per rimozione
punti metallici

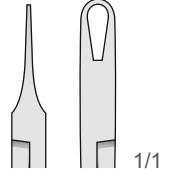

1/1

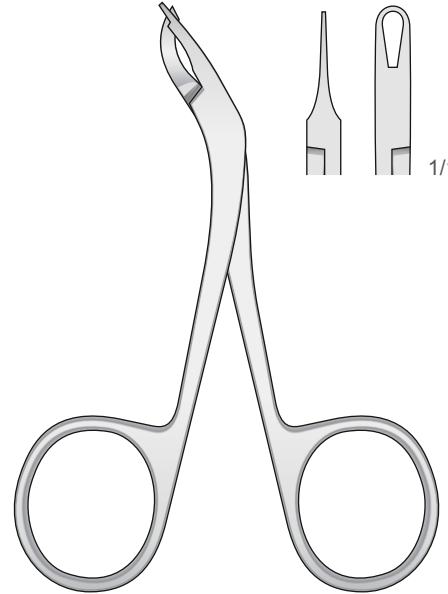

0206-GE
115 mm

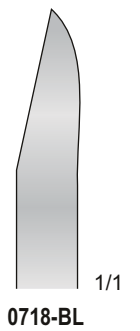
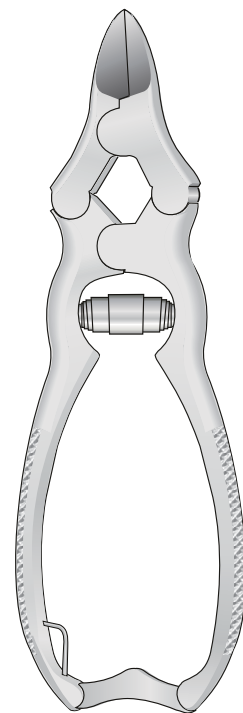

1/1

0718-BL

0718-BL
155 mm

Absaugkanülen

Suctions tubes

Cannule per aspirazione

Canules aspiratrices

Cànulas aspiradoras



- 1411-BFA 1,00 x 35 mm
- 1411-BFB 1,00 x 70 mm
- 1411-BFC 1,20 x 70 mm
- 1411-BFD 1,20 x 100 mm
- 1411-BFE 1,40 x 70 mm
- 1411-BFF 1,40 x 100 mm
- 1411-BFG 1,60 x 70 mm
- 1411-BFH 1,80 x 100 mm

MENGHINI
1411-BFA/1411-BFH



- 1411-BFI 1,40 x 168 mm
- 1411-BFL 1,80 x 168 mm

MENGHINI
1411-BFI/1411-BFL

Kanüle mit Trokardon
Trokar with mandrin
Cannula completa di mandrino
Canula con sonda de guida

Ø 4 mm

Ø Est. 5 mm
Ø Int. 4 mm

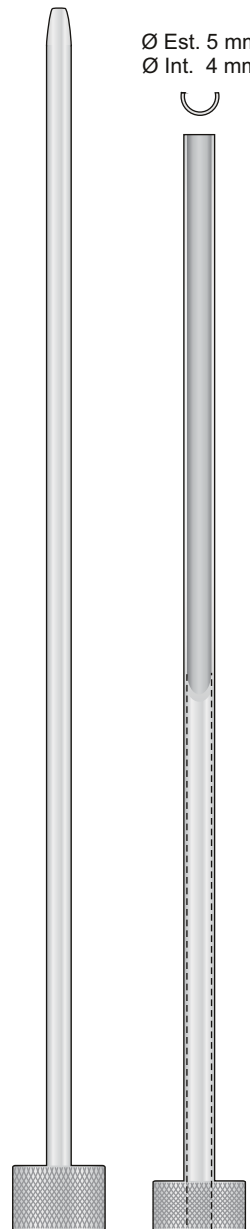

Silber



Saugkanüle, isoliert
mit Saugunterbrecher und Mandrin
Suction cannula, insulated
with finger cut-off and stylet

Ø 4 mm

Ch.12

Ø 3 mm

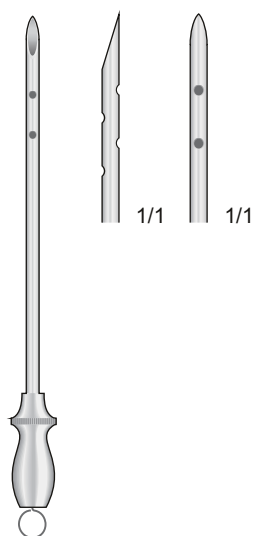

GILMET
1411-FL
85 mm



FERGUSON
0706-CFC
150 mm

SEIFFERT
1506-BG
180 mm

0610-BCL
200 mm

- Ø 1,5 mm
- Ø 1,7 mm
- Ø 2,0 mm



- 0706-CFD** Ø 1,5 mm
- 0706-CFE** Ø 1,7 mm
- 0706-CFF** Ø 2,0 mm

BARNES
0706-CFD/0706-CFF
100 mm

- Ø 1,0 mm
- Ø 1,5 mm

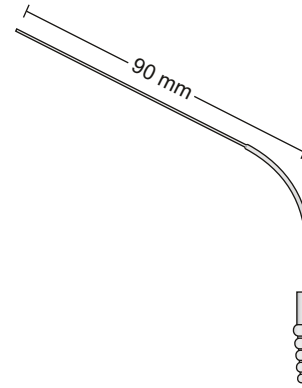

- 0706-CGF** Ø 1,0 mm
- 0706-CGG** Ø 1,5 mm

BARNES
0706-CGF/0706-CGG
125 mm

- Ø 2,0 mm

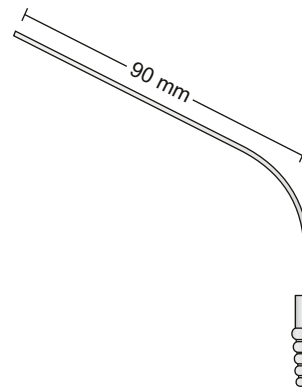

- 0706-CGH** Ø 2,0 mm

BARNES
0706-CGH
125 mm

- Ø 3,0 mm
- Ø 4,0 mm
- Ø 5,0 mm

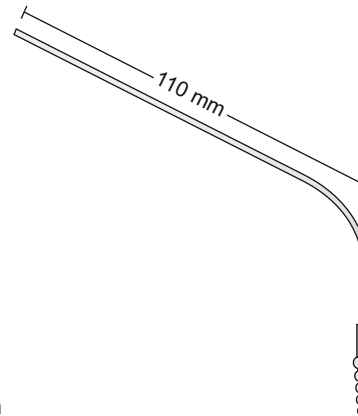

- 0706-CGI** Ø 3,0 mm
- 0706-CGL** Ø 4,0 mm
- 0706-CHA** Ø 5,0 mm

BARNES
0706-CGI/0706-CHA
150 mm

Ø 3.5 mm

Ø 2.0 mm

- 0706-CEI** Ø 2.0 mm / 3.5 mm
350 mm
- 0706-CEL** Ø 2.0 mm / 3.5 mm
500 mm

Olive
Ø 9 mm

0706-CEI/0706-CEL

250 mm

- 0706-CEF** Ø 2.0 mm
- 0706-CEG** Ø 2.5 mm
- 0706-CEH** Ø 3.0 mm

Olive
Ø 6-9 mm

0706-CEF/0706-CEH
250 mm

**Makro
Absaugkanülen**
**Macro
Suctions Tubes**
**Macro cannule
per aspirazione**
**Macro Canules
aspiratrices**
**Macro Cànulas
aspiradoras**

Suction Length	No.1 0,6 x 0,4	No.2 0,8 x 0,6	No.3 1,0 x 0,8	No.4 1,2 x 1,0	No.5 1,5 x 1,2	No.6 2,0 x 1,6	
SS = 80 mm	0706-DAB	0706-DAC	0706-DAD	0706-DAE	0706-DAF	0706-DAG	For Bypass
S = 100 mm	0706-DAH	0706-DAI	0706-DAL	0706-DBA	0706-DBB	0706-DBC	
M = 120 mm	0706-DBD	0706-DBE	0706-DBF	0706-DBG	0706-DBH	0706-DBI	
L = 145 mm	0706-DBL	0706-DCA	0706-DCB	0706-DCC	0706-DCD	0706-DCE	
LL = 160 mm	0706-DCF	0706-DCG	0706-DCH	0706-DCI	0706-DCL	0706-DDA	For Trans-sphenoidal
LLL = 175 mm	0706-DEB	0706-DEC	0706-DED	0706-DEE	0706-DEF	0706-DEG	For Trans-sphenoidal

Char. 1 = 0,3 mm
Char. 2 = 0,6 mm
Char. 3 = 1,0 mm
Char. 4 = 1,3 mm
Char. 5 = 1,6 mm
Char. 6 = 2,0 mm
Char. 7 = 2,3 mm
Char. 8 = 2,6 mm
Char. 9 = 3,0 mm
Char. 10 = 3,3 mm

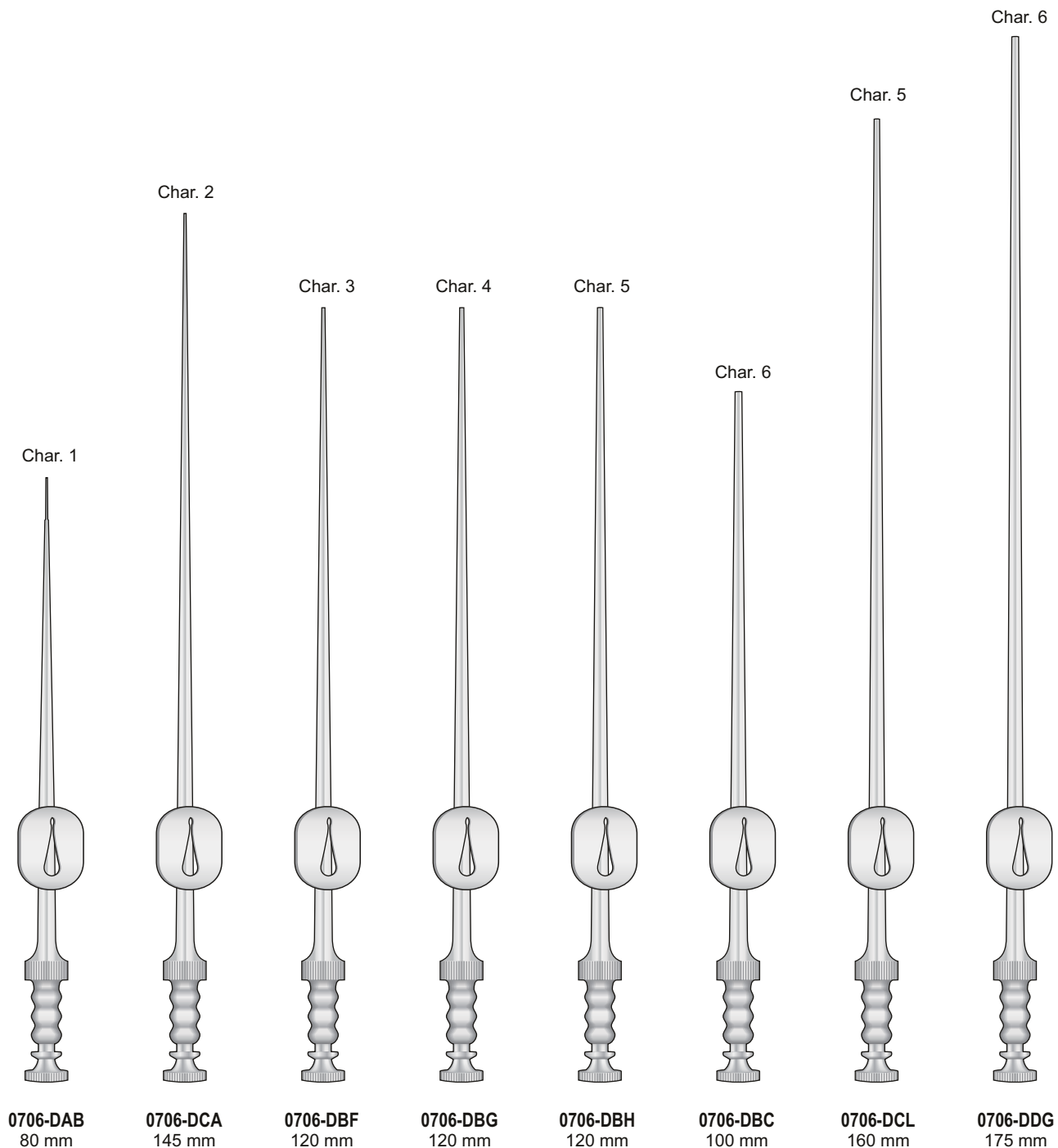

**Makro
Absaugkanülen**

**Macro
Suctions Tubes**

**Macro cannule
per aspirazione**

**Macro Canules
aspiratrices**

**Macro Cànulas
aspiradoras**

Suction Length	No.7 2,5 x 1,9	No.8 3,0 x 2,2	No.9 3,5 x 2,5	No.10 4,0 x 3,0
M = 120 mm	0706-DDH	0706-DDI	0706-DDL	0706-DEA
L = 145 mm	0706-DEB	0706-DEC	0706-DED	0706-DEE
LL = 160 mm	0706-DEF	0706-DEG	0706-DEH	0706-DEI
LLL = 175 mm	0706-DEL	0706-DFA	0706-DFB	0706-DFC

For Trans-sphenoidal
For Trans-sphenoidal

Char. 1 = 0,3 mm
Char. 2 = 0,6 mm
Char. 3 = 1,0 mm
Char. 4 = 1,3 mm
Char. 5 = 1,6 mm
Char. 6 = 2,0 mm
Char. 7 = 2,3 mm
Char. 8 = 2,6 mm
Char. 9 = 3,0 mm
Char. 10 = 3,3 mm

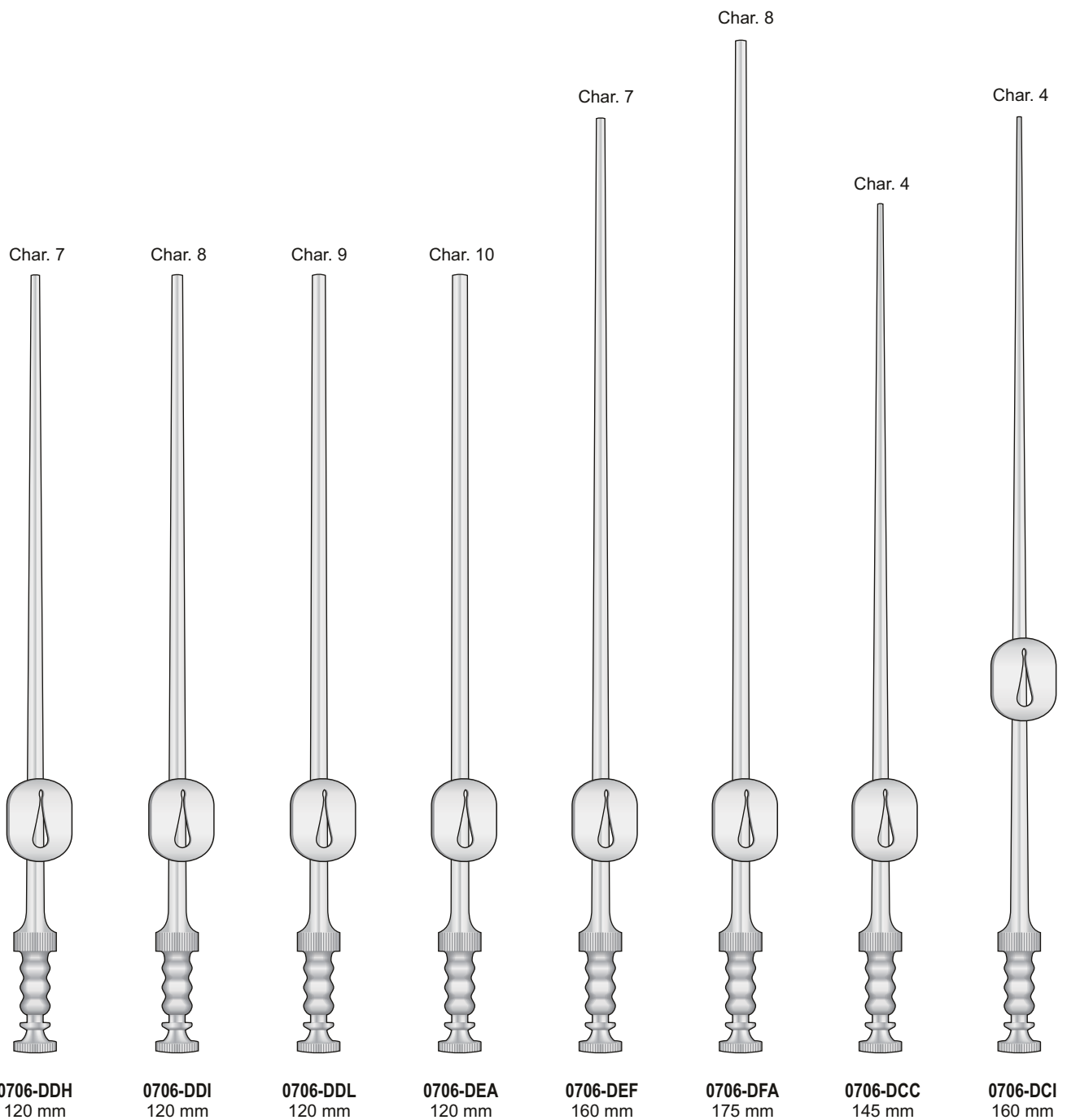

**Makro
Absaugkanülen**

**Macro
Suctions Tubes**

**Macro cannule
per aspirazione**

**Macro Canules
aspiratrices**

**Macro Cànulas
aspiradoras**

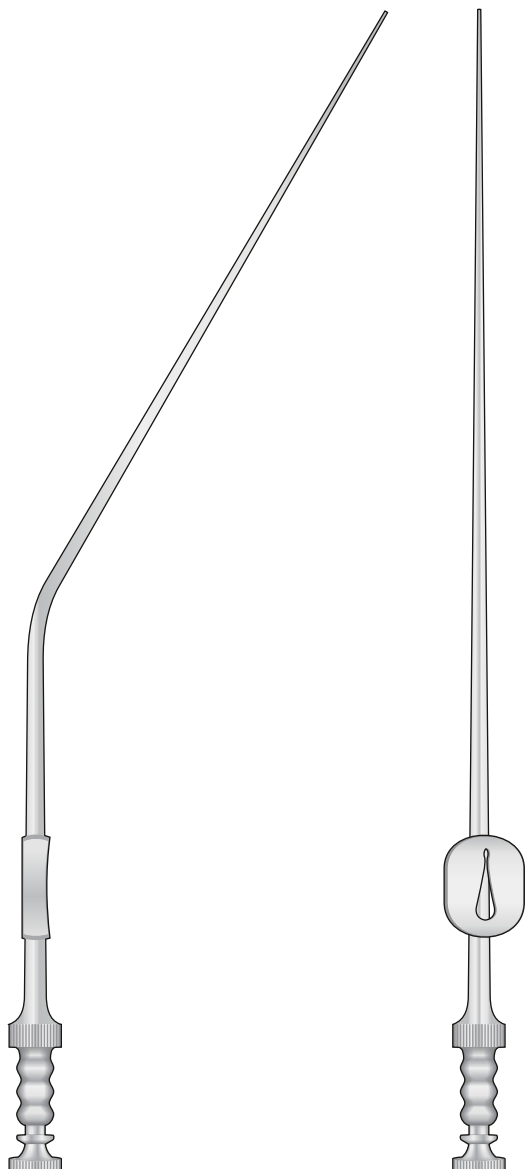

Char. 3	= 1,0 mm
Char. 4	= 1,3 mm
Char. 5	= 1,6 mm
Char. 6	= 2,0 mm
Char. 7	= 2,3 mm
Char. 8	= 2,6 mm
Char. 9	= 3,0 mm
Char. 10	= 3,3 mm
Char. 11	= 3,6 mm
Char. 12	= 4,0 mm

	Lenght 160 mm	Lenght 180 mm	Lenght 205 mm
Char. 3	0706-DFD	0706-DGD	0706-DHD
Char. 4	0706-DFE	0706-DGE	0706-DHE
Char. 5	0706-DFF	0706-DGF	0706-DHF
Char. 6	0706-DFG	0706-DGG	0706-DHG
Char. 7	0706-DFH	0706-DGH	0706-DHH
Char. 8	0706-DFI	0706-DGI	0706-DHI
Char. 9	0706-DFL	0706-DGL	0706-DHL
Char. 10	0706-DGA	0706-DHA	0706-DIA
Char. 11	0706-DGB	0706-DHB	0706-DIB
Char. 12	0706-DGC	0706-DHC	0706-DIC

Kanülenreinigungs
bürsten

Cleaning brush
for tubes

Scovolini per
pulizia cannule

Cepillo para
limpiar cánulas

Brosse de nettoyage
pour canules



COOLEY
0706-CFA
300 mm

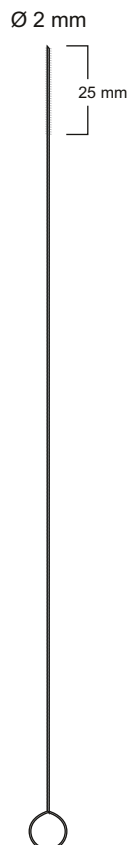

0706-BIC
215 mm

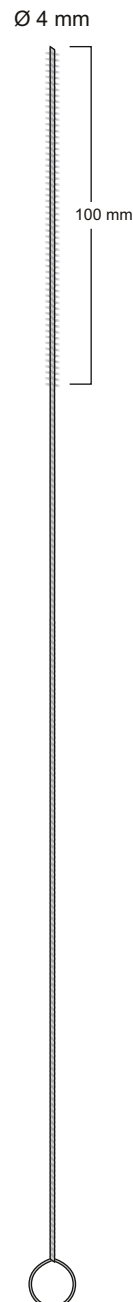

0706-BID
300 mm

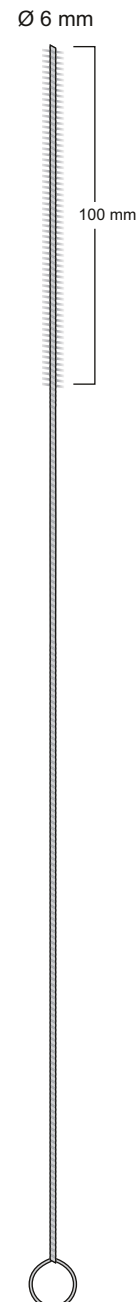

0706-BIF
300 mm

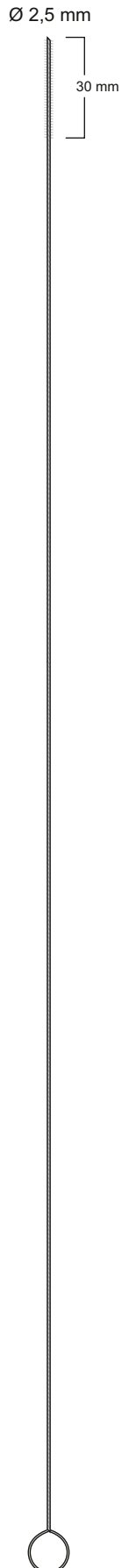

0706-BIG
500 mm

Organmesser

Post mortem knives

Coltello per autopsia

Cuchillos para òrganos

Couteaux à autopsie

mm: Schnittlänge
Lenght of blades
Lunghezza della lama
Largo de hojas
Longueur de la lame

Metallheft
Metal handle
Manico in metallo
Mango metálico
Manche métal

Holzheft
Wooden handle
Manico in legno
Mango de madera
Manche bois

Metallheft
Metal handle
Manico in metallo
Mango metálico
Manche métal

Metallheft
Metal handle
Manico in metallo
Mango metálico
Manche métal

Resektionsmesser
Resection knives
Coltello per resezione
Cuchillos para resección
Couteaux à résection

Organmesser
Post mortem knives
Coltello per autopsia
Cuchillos para òrganos
Couteaux à autopsie

Organmesser
Post mortem knives
Coltello per autopsia
Cuchillos para òrganos
Couteaux à autopsie

Hirnmesser
Brain knives
Coltello per cervello
Cuchillos para cerebro
Couteaux à cerveau



1/1

0113-BA
55 mm

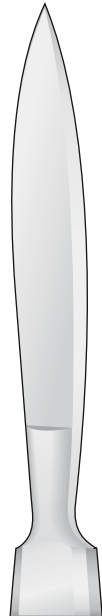

1/1

0113-BB
55 mm



0113-BC
110 mm

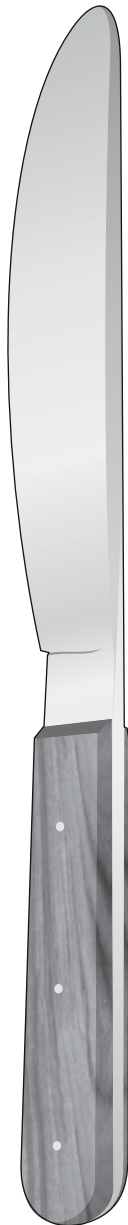

0113-BD
170 mm



0113-BE
195 mm



1/1



VIRCHOW
0113-BF
160 mm



VIRCHOW
0113-BG
200 mm



VIRCHOW
0113-BH
240 mm

LANGENBECK
0113-BA/0113-BB
55 mm

Dermatome komplett mit 1 auswechselbarer Klinge und 2 Spannplatten
 Dermatome complete with 1 interchangeable blade and 2 skin plates
 Dermatomo a mano, con una lama intercambiabile, completo di 2 placche per stendere la pelle
 Dermatomo completo, con 1 hoja intercambiabile y 2 placas para extender la piel
 Dermatome avec 1 lame interchangeable et 2 plaques pour tendre la peau

Einstellbar von 0,1 bis 3,0 mm
 Adjustable from 0,1 to 3,0 mm
 Regolazione da 0,1 a 3,0 mm
 Regulable de 0,1 hasta 3,0 mm
 Réglable en épaisseur de 0,1 à 3,0 mm

Einstellbar von 0,1 bis 4,0 mm
 Adjustable from 0,1 to 4,0 mm
 Regolazione da 0,1 a 4,0 mm
 Regulable de 0,1 hasta 4,0 mm
 Réglable en épaisseur de 0,1 à 4,0 mm

Für handelsübliche Rasierklingen
 For usual razor blades
 Per lamette standard
 Para hojas de afeitar usuales
 Pour lames de rasoir modèle standard

Spanplatte
 Skin Fixing Plate
 Placca per stendere la pelle
 Placa para extender la piel
 Plaque pour tendre la peau



SCHINK
0405-BA

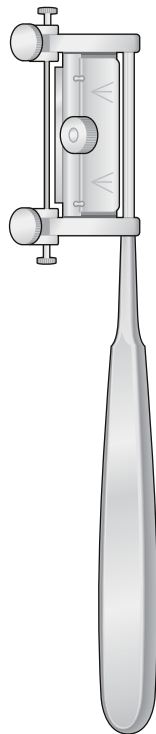

SILVER
0405-BB
190 mm

Ersatzklinge, allein
 Spare Blade only
 Lama di ricambio sola
 Hoja de repuesto
 Lame de rechange, seule



SILVER
0405-BC
43 mm

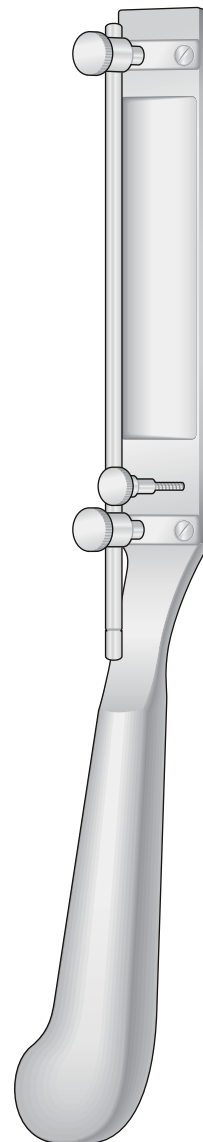

SCHINK
0405-BD
300 mm

Ersatzklinge, allein
 Spare Blade only
 Lama di ricambio sola
 Hoja de repuesto
 Lame de rechange, seule



SCHINK
0405-BE
102 mm

Dermatome

Dermatomes

Dermatomi

Dermátomos

Dermatomes

Dermatome komplett mit 1 auswechselbarer Klinge und 2 Spannplatten
 Dermátome complete with 1 interchangeable blade and 2 skin plates

Dermatomo a mano, con una lama intercambiabile, completo di 2 placche per stendere la pelle
 Dermátomo completo, con 1 hoja intercambiabile y 2 placas para extender la piel
 Dermátome avec 1 lame interchangeable et 2 plaques pour tendre la peau

Einstellbar von 0,1 bis 1,5 mm
 Adjustable from 0,1 to 1,5 mm
 Regolazione da 0,1 a 1,5 mm
 Regulable de 0,1 hasta 1,5 mm
 Réglable en épaisseur de 0,1 à 1,5 mm

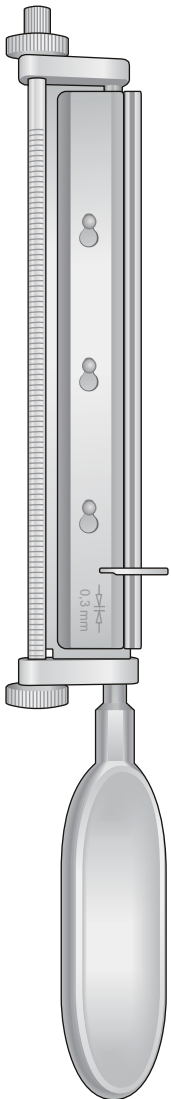

WATSON
0405-BF
 300 mm

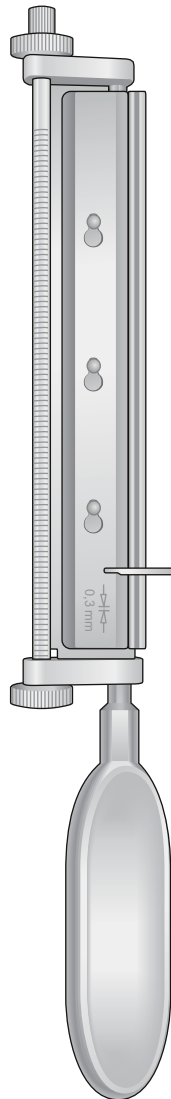

COBBETT
0405-BG
 300 mm

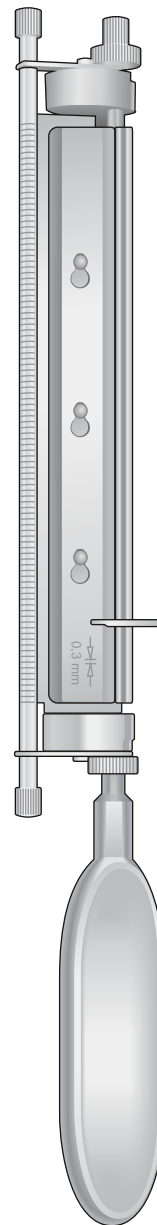

HUMBY
0405-BH
 320 mm

Ersatzklinge, allein
 Spare Blade only
 Lama di ricambio sola
 Hoja de repuesto
 Lame de rechange, seule



HUMBY
0405-BI
 157 mm

Wund- und
Meniskushaken

Retractors and
Knee Retractors

Ddivaricatori
per menisco

Separadores
para rodilla

Ecarteurs
pour genou

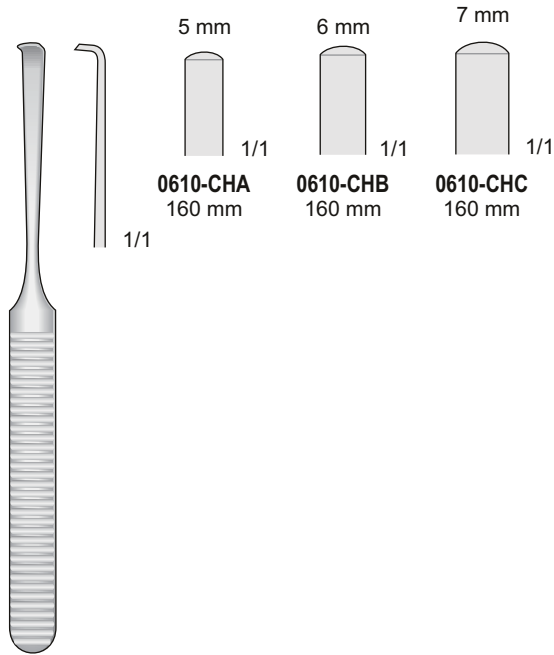

0610-CHA/0610-CHC
160 mm

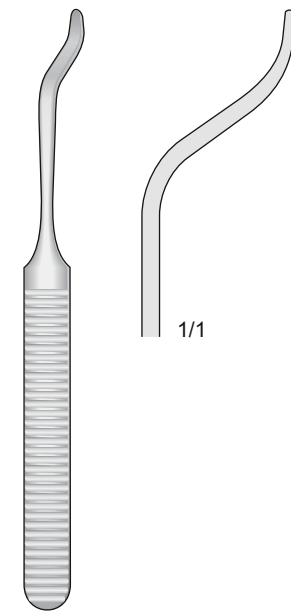

1014-HI
160 mm

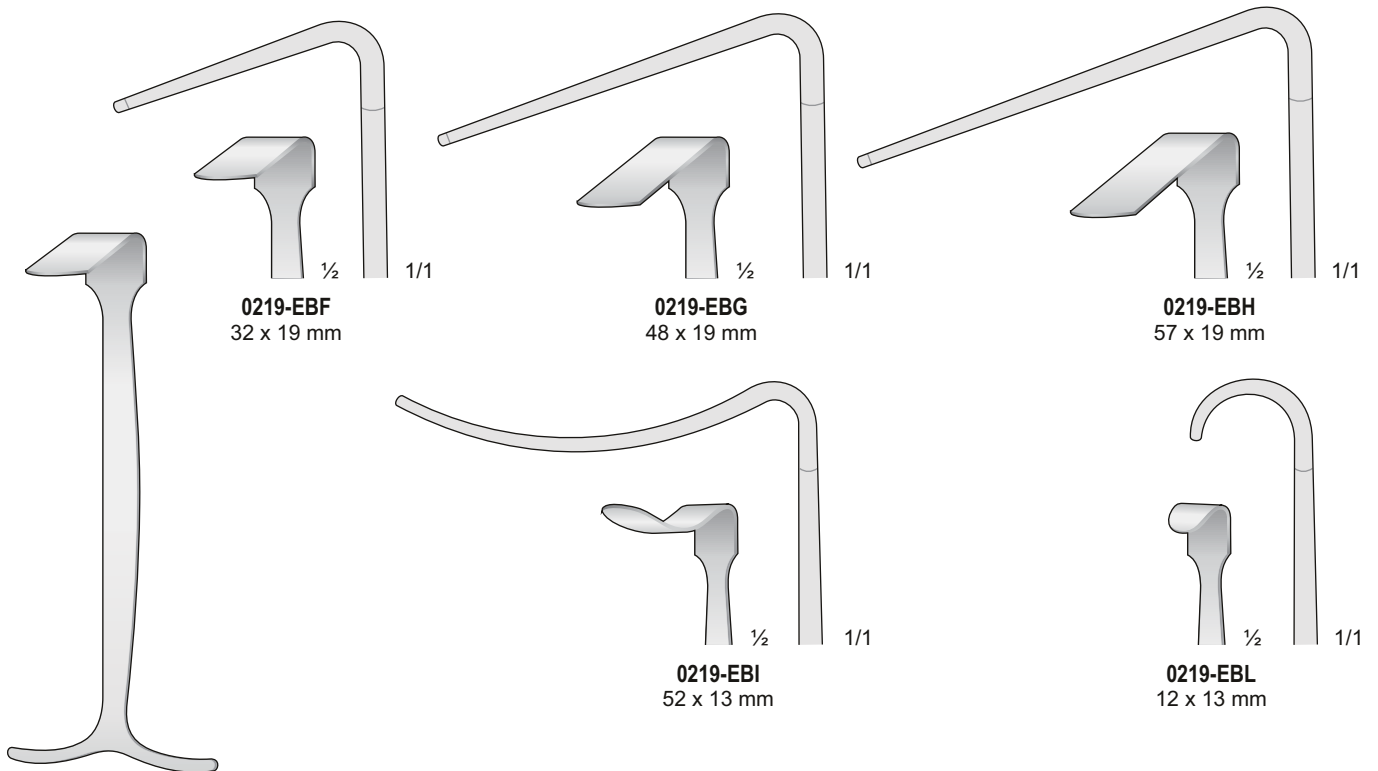

SMILLIE
0219-EBF/0219-EBL
140 mm

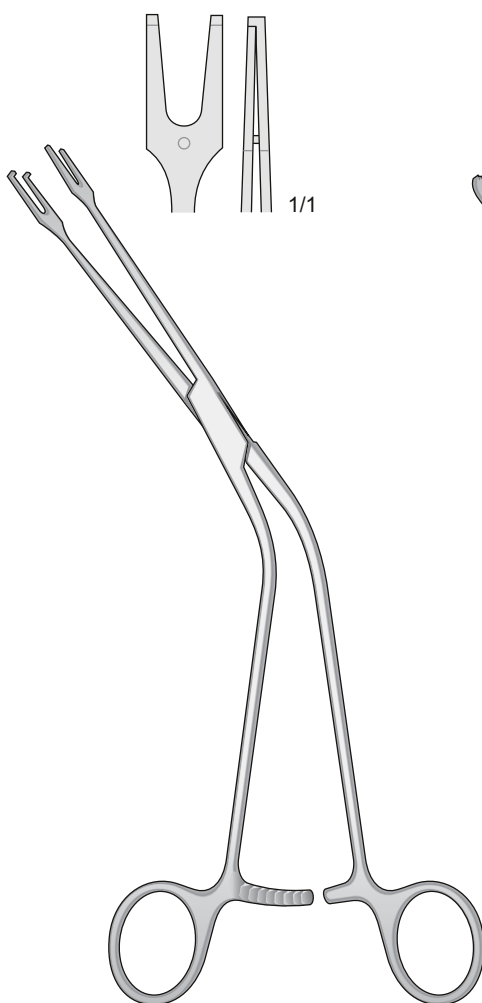

MILLIN
0602-CCH
245 mm

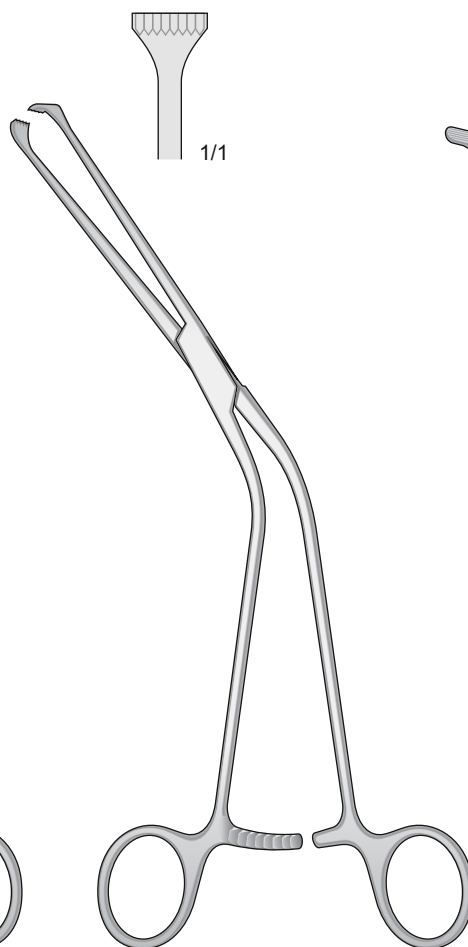

MILLIN
0602-CCI
220 mm

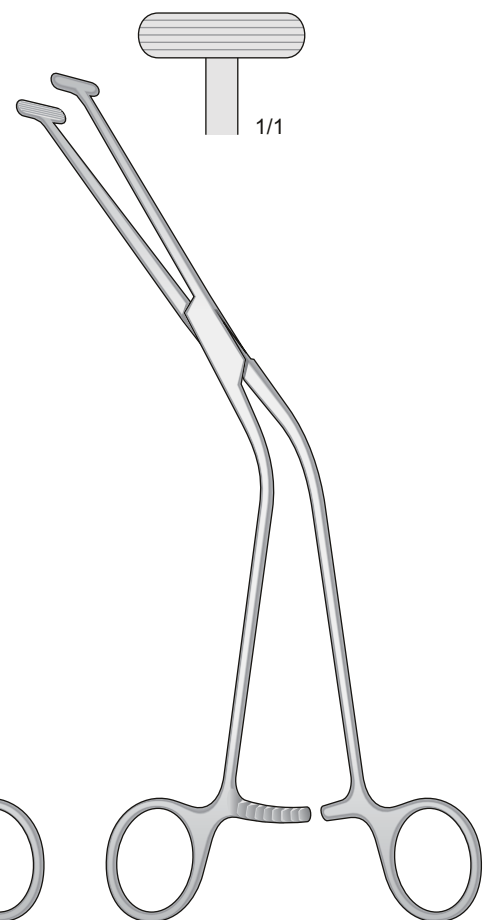

MILLIN
0602-CCL
245 mm

Atraumatische - Atraumatic
Atraumatiche - Atraumáticas
Atraumatiques

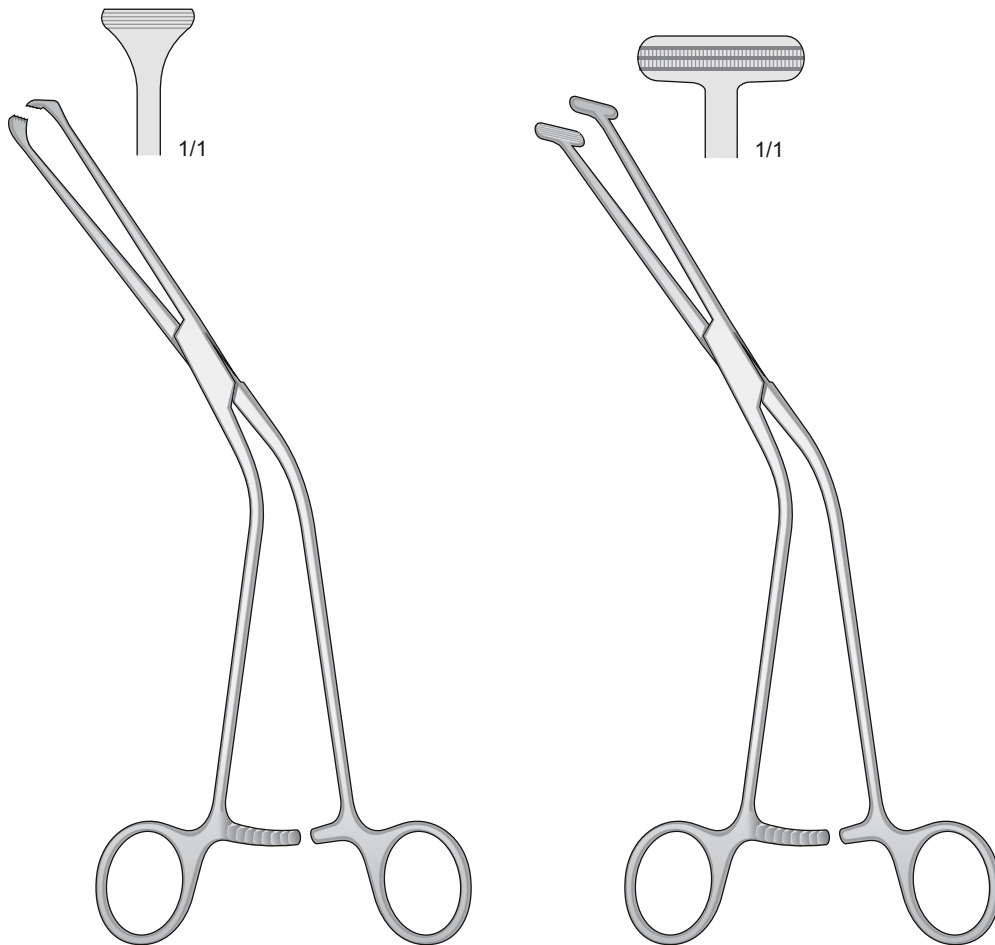

MILLIN
0602-CDA
220 mm

MILLIN
0602-CDB
245 mm

- 0218-BE** Metalletui leer für 8 Hegar Uterusdilatoren
Scatola vuota per 8 dilatatori uterini Hegar
- 0218-BF** Metalletui leer für 13 Hegar Uterusdilatoren
Scatola vuota per 13 dilatatori uterini Hegar
- 0218-BG** Metalletui leer für 14 Hegar Uterusdilatoren
Scatola vuota per 14 dilatatori uterini Hegar

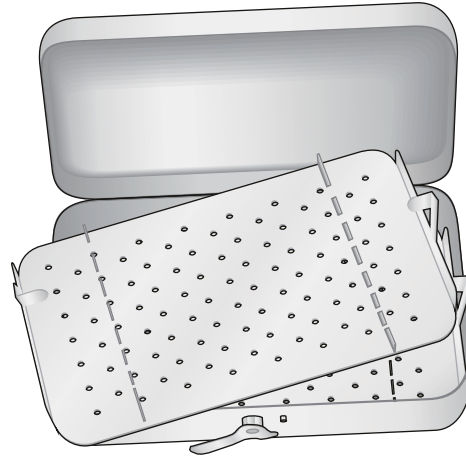

Lagerungsgestell für 15 Stück Nadeln
Rack for 15 needles
Piastra per 15 aghi oftalmici

150 x 100 x 2 mm

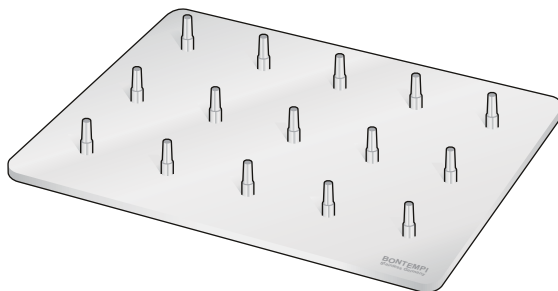

0218-CA
150 x 100 x 2 mm



0218-DC
180 x 85 x 20 mm

Ohrspekulaständer
Ear specula storage rack
Supporto per specoli auricolari
Supporte para espéculos auriculares
Support pour spéculums auriculaires

150 x 100 x 2 mm

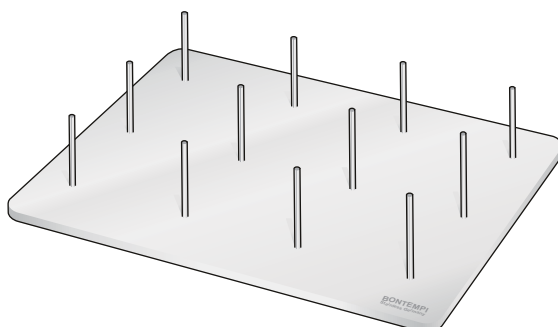

0218-CB
150 x 100 x 2 mm



0218-DB
180 x 85 x 30 mm

Steril
Container

Sterilizing
containers

Contenitori per
sterilizzare

Contenedores
para esterilización

Containers
pour stérilizer

new

Tray Inox mit Silikoneinrichtung - Stainless Steel Cassettes with Silicone Racks
Tray Inox con griglia in silicone - Recipientes de acero con equipo de silicona
Cassettes en acier avec aménagement en silicone

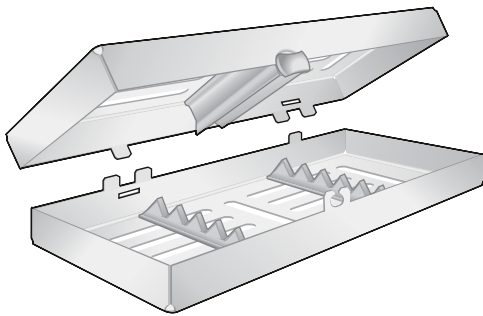

0218-FL | Für 5 Instrumente
185 x 75 x 35 mm | For 5 Instruments
Per 5 strumenti
Para 5 instrumentos
Pour 5 instruments

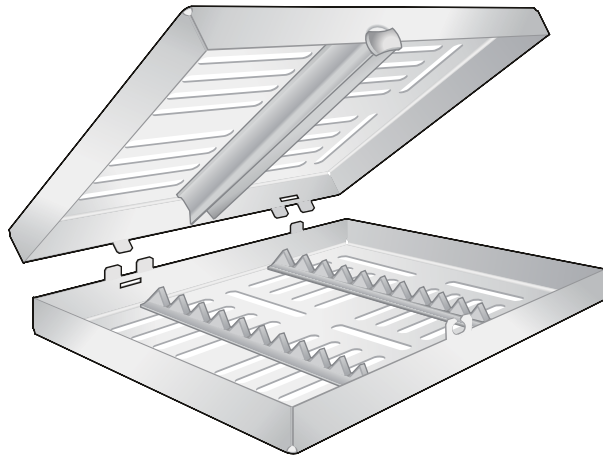

0218-GA | Für 10 Instrumente
185 x 135 x 35 mm | For 10 Instruments
Per 10 strumenti
Para 10 instrumentos
Pour 10 instruments

0218-GB | Für 20 Instrumente
290 x 185 x 35 mm | For 20 Instruments
Per 20 strumenti
Para 20 instrumentos
Pour 20 instruments

Plastica - Autoclavabile

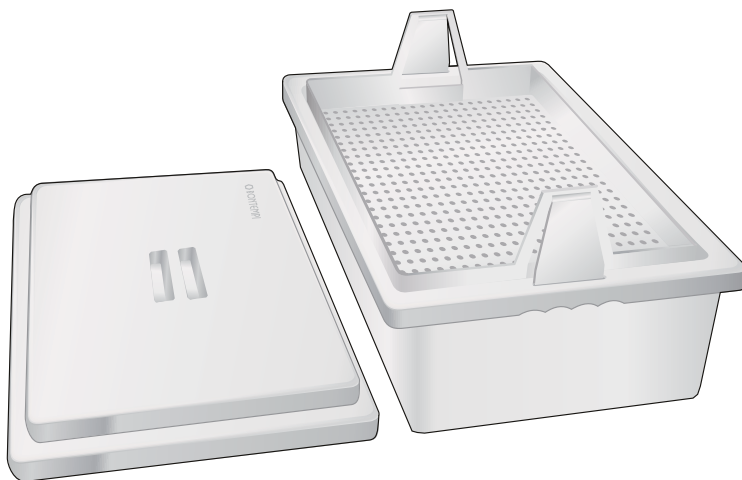

0218-BAF
350 x 240 x 120 mm

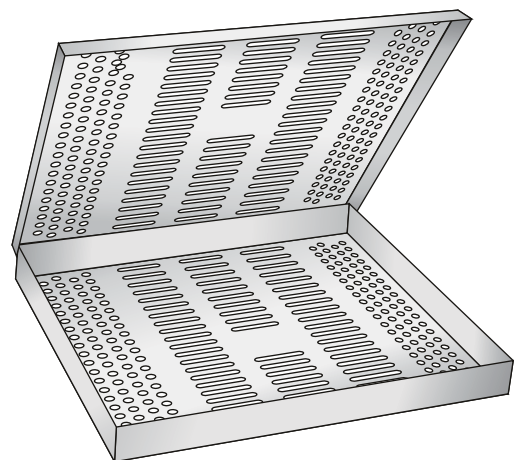

0218-ED
270 x 190 x 25 mm

Indice alfanumerico		Alfanumerical Index		Nummernverzeichnis		Index alfabétique		Indice alfanumerico	
Article	Page	Article	Page	Article	Page	Article	Page	Article	Page
0101-05BAD	3	0206-FG	95	0219-DDI	47				
0102-EL	3	0206-FH	95	0219-DDL	47				
0113-BA	106	0206-FI	33	0219-DEA	47				
0113-BB	106	0206-GE	99	0219-DED	53				
0113-BC	106	0206-HB	32	0219-DEG	53				
0113-BD	106	0206-HG	32	0219-DFB	52				
0113-BE	106	0206-HH	32	0219-DFC	52				
0113-BF	106	0206-IA	28	0219-DFD	52				
0113-BG	106	0206-IB	28	0219-DFE	52				
0113-BH	106	0206-LI	32	0219-DFG	52				
0204-AL19	20	0206-LL	32	0219-DFH	51				
0204-BA0918	22	0206-BAC	24	0219-DGG	51				
0204-BG19	20	0206-BAD	24	0219-DGH	51				
0204-CA0918	22	0206-BAE	24	0219-DGI	51				
0204-CD0918	22	0206-BAG	23	0219-DGL	51				
0204-CE0918	22	0206-BAH	23	0219-DHF	49				
0204-CG0918	22	0206-BAI	23	0219-DHG	49				
0204-DA19	20	0206-BAL	23	0219-DHH	49				
0204-DB19	20	0206-BBA	23	0219-DHI	49				
0204-EC19	20	0206-BBB	23	0219-DHL	49				
0204-ED19	20	0206-BBC	35	0219-EAB	45				
0204-FB	18	0206-BBD	35	0219-EAC	45				
0204-GA19	20	0206-BBE	35	0219-EAD	45				
0204-GC19	20	0212-IH	54	0219-EAE	45				
0204-GL	21	0212-II	54	0219-EAF	45				
0204-HF19	20	0212-IL	54	0219-EAG	45				
0204-IA19	20	0212-LA	54	0219-EAH	45				
0204-IB19	20	0212-LG	54	0219-EAI	45				
0204-IE19	20	0212-LH	54	0219-EAL	45				
0204-IG19	20	0212-LI	54	0219-EBA	45				
0204-BGA19	20	0212-LL	54	0219-EBB	45				
0204-BGB19	20	0212-BAA	54	0219-EBC	45				
0204-BGC19	20	0212-BAB	54	0219-EBF	109				
0204-BGD19	20	0212-BEA	54	0219-EBG	109				
0204-BHH	18	0212-BEB	54	0219-EBH	109				
0204-BHI	18	0212-BEC	54	0219-EBI	109				
0204-BLE0918	22	0218-BE	112	0219-EBL	109				
0204-BLH	21	0218-BF	112	0219-ELA	22				
0204-CAH	18	0218-BG	112	0219-ELB	22				
0204-CAI	18	0218-BH	98	0219-ELC	22				
0204-CAL	18	0218-CA	112	0219-ELD	22				
0204-CFD	18	0218-CB	112	0221-GH	64				
0204-CGE	21	0218-DB	112	0221-BAA	60				
0204-CGF	21	0218-DC	112	0221-BAD	60				
0204-CGG	21	0218-ED	113	0221-BAE	61				
0204-CGH	19	0218-ED	113	0221-BAF	61				
0204-CGI	19	0218-FL	113	0221-BBD	61				
0204-CGL	19	0218-GA	113	0221-BBE	61				
0204-CHD0918	22	0218-GB	113	0221-BBF	61				
0204-CHH9018	22	0218-BAF	113	0221-BBG	61				
0204-CHL	19	0219-AE12	48	0221-DBF	60				
0204-CIA	19	0219-BIG	45	0221-DBG	60				
0204-CID	19	0219-BIH	45	0221-EAB	62				
0204-CIE	19	0219-BII	45	0221-EAC	62				
0204-CIG	19	0219-BIL	45	0221-EAD	62				
0204-CLD	19	0219-CGE	46	0221-EAE	62				
0204-CLE	19	0219-CGF	46	0221-EAF	62				
0204-CLF	19	0219-CGH	50	0221-EAG	62				
0204-DAA	18	0219-CGI	50	0221-EAH	63				
0204-DFB	21	0219-CGL	50	0221-EAI	63				
0204-DFC	21	0219-CHA	46	0221-EAL	63				
0204-DFD	21	0219-CHB	46	0221-EBA	63				
0204-DFE	21	0219-CHC	46	0221-EBB	63				
0204-DFG	21	0219-CHC	46	0221-EBC	63				
0206-BH	23	0219-CLC	47	0402-CH	55				
		0219-CLD	47	0402-CI	55				
		0219-CLD	47	0402-EA	55				
		0219-DCD	48	0402-EB	55				
		0219-DCE	48						
		0219-DDH	47						

Indice alfanumerico		Alfanumerical Index		Nummernverzeichnis		Index alfabétique		Indice alfanumerico	
Article	Page	Article	Page	Article	Page	Article	Page	Article	Page
0402-EH	55	0418-BC	56	0602-BBF	44				
0402-IG	87	0418-BD	56	0602-BBG	44				
0402-IH	87	0418-BF	56	0602-BCA	34				
0402-II	87	0418-BG	57	0602-BDH	36				
0402-IL	87	0418-BH	56	0602-CBI	29				
0402-LA	87	0418-BI	56	0602-CBL	29				
0402-LB	87	0418-BL	57	0602-CCA	29				
0402-LC	87	0418-CA	57	0602-CCB	29				
0402-LD	87	0418-CG	55	0602-CCC	29				
0402-LE	87	0418-CH	55	0602-CCD	36				
0402-LF	87	0418-CI	55	0602-CCE	36				
0402-BAA	89	0418-CL	55	0602-CCF	36				
0402-BAG	87	0418-DA	57	0602-CCG	36				
0402-BAH	87	0418-DB	57	0602-CCH	110				
0402-BDG	85	0418-DC	57	0602-CCI	110				
0402-BDH	85	0418-DD	57	0602-CCL	110				
0402-BDI	85	0418-DE	57	0602-CDA	111				
0402-BDL	85	0418-DF	57	0602-CDB	111				
0402-BEH	85	0418-DG	57	0602-CFI	32				
0402-BEI	85	0418-DH	57	0602-CFL	32				
0402-BEL	85	0418-DI	57	0602-DLA	81				
0402-CAB	88	0418-DL	57	0602-DLC	81				
0402-CAC	88			0602-DLE	81				
0402-CAD	88	0501-CG	37	0602-DLF	81				
0402-CAE	88	0501-CH	37	0602-DLG	81				
0402-CAF	88	0501-DI	37	0602-DLH	81				
0402-CAG	88	0501-DL	37	0602-DLI	81				
0402-CAH	88	0501-LE	94	0602-EAA	81				
0402-CAI	88								
0402-CAL	88	0502-BH	95	0604-BHA	41				
0402-CBD	89	0502-DD	34	0604-BHB	41				
0402-CBE	89	0502-LE	98	0604-BIC	41				
0402-CBF	89	0502-LF	98	0604-BID	41				
0402-CBG	89	0502-LG	98	0604-CDG	41				
0402-CBH	89	0502-LH	98	0604-CDH	41				
0402-CBI	89	0502-LI	24						
0402-CBL	89	0502-LL	24	0606-IA	93				
0402-CCA	90	0502-LB	94	0606-IH	93				
0402-CCB	90	0502-LC	94	0606-II	93				
0402-CCC	90	0502-LD	95	0606-BLA	65				
0402-CCD	90	0502-LE	95	0606-BLB	65				
0402-CCE	90	0502-LF	95	0606-BLC	65				
0402-CCF	90	0502-LG	38	0606-CAA	65, 66				
0402-CCG	90	0502-LH	38	0606-CAB	65, 66				
		0502-LI	38	0606-CAB12	66				
0405-BA	107	0502-LJ	38	0606-CAC	65, 66				
0405-BB	107	0502-LK	38	0606-CAD	65, 66, 67				
0405-BC	107	0502-LM	38	0606-CAE	67				
0405-BD	107	0502-LN	96	0606-CAF	65, 66, 67				
0405-BE	107	0502-LO	96	0606-CAG	65, 66, 67				
0405-BF	108	0502-LP	96	0606-EFA	91				
0405-BG	108	0502-LQ	96	0606-EFB	91				
0405-BH	108	0502-LR	96	0606-EFC	91				
0405-BI	108	0502-LS	96	0606-EFD	91				
		0502-LT	96	0606-EFE	91				
04050113-1903	10	0502-LU	97	0606-EFF	91				
		0502-LV	97	0606-EFG	91				
0414-BID	72	0502-LW	97	0606-EFH	91				
0414-BIE	72	0502-LX	99	0606-EFI	91				
0414-CDG	58	0502-LY	95	0606-EFL	92				
0414-CDH	58	0502-LZ	95	0606-EGA	92				
0414-CHL	59	0502-MA	98	0606-EGB	92				
0414-CIA	59	0502-MB	98	0606-EGC	92				
0414-CIB	59	0502-MC	98	0606-EGD	92				
0414-CIC	59	0502-MD	98	0606-EGE	92				
		0502-ME	55	0606-EGF	92				
0417-EA	34	0502-MF	55	0606-EGG	92				
		0502-MG	55	0606-EGH	92				
0418-BA	56	0502-MH	55	0606-EGI	92				
0418-BB	56	0502-MI	55						

Indice alfanumerico		Alfanumerical Index		Nummernverzeichnis		Index alfabétique		Indice alfanumerico	
Article	Page	Article	Page	Article	Page	Article	Page	Article	Page
0607-CL	7	0610-BCI	68	0612-H1803	15				
0607-EF	8	0610-BCL	100	0612-I1803	15				
0607-EG	8	0610-BDD	69	0612-L1803	15				
0607-GF	8	0610-BDE	70	0612-BA1803	15				
0607-FL	6	0610-BDF	69	0612-BD1803	15				
0607-HG	12	0610-CFD	72	0612-GE	10				
0607-HH	12	0610-CHA	109	0612-GF	10				
0607-LA	8	0610-CHB	109	0612-BAA11	3				
0607-LB	8	0610-CHC	109	0612-BCD	9				
0607-LD	8	0610-CIA	74	0612-BCE	9				
0607-LE	7	0610-CIB	74	0612-BCF	9				
0607-LF	7	0610-CIC	74	0612-BCG	13				
0607-LI	14	0610-CID	74	0612-BCH	13				
0607-BBC	6	0610-CIE	74	0612-BGG	10				
0607-BBD	6	0610-CIF	74	0612-BHB	10				
0607-BBE	6	0610-CIG	74	0612-BHC	10				
0607-BBF	6	0610-CIH	74	0612-BHD	10				
0607-BBI	6	0610-CII	74	0612-BHG	9				
0607-BCC	7	0610-CIL	74	0612-BHH	9				
0607-BDA	13	0610-CLA	74	0612-DBA	15				
0607-BDE	14	0610-CLB	75	0612-DBC	17				
0607-BDF	14	0610-CLC	75	0612-DCI	15				
0607-BDG	14	0610-CLD	75	0612-DDA	15				
0607-BDH	14	0610-CLE	75	0612-DEB	15				
0607-BED	8	0610-CLF	75	0612-DDF	17				
0607-BEF	13	0610-CLG	75	0612-DDL	17				
0607-BEG	8	0610-CLH	75	0612-DED	17				
0607-BFB	7	0610-CLI	75						
0607-BFD	14	0610-CLL	75	0614-HA	84				
0607-BFE	14	0610-DAA	75	0614-IA	84				
0607-BFF	11	0610-DAB	75	0614-IA17	84				
0607-BGC	13	0610-DAC	75	0614-BAG	82				
0607-BGE	11	0610-DAD	75	0614-BAH	78				
0607-BHA	11	0610-DAE	75	0614-BAL	78				
0607-BHB	11	0610-DAF	75	0614-BDF	80				
0607-BHC	11	0610-DAG	75	0614-BDI	79				
0607-BHD	12	0610-DAH	75	0614-BDL	79				
0607-BHE	12	0610-DAI	75	0614-BEA	78				
0607-BHF	12	0610-DBA	76	0614-BEF	80				
0607-BHG	12	0610-DBB	76	0614-BEH	78				
0607-BIC	9	0610-DBC	76	0614-BEI	80				
0607-BID	9	0610-DBD	76	0614-BEL	78				
0607-BIE	9	0610-DBE	76	0614-BFG	79				
0607-BIF	9	0610-DBF	76	0614-BFH	79				
0607-BIG	9	0610-DBG	76	0614-BGH	79				
0607-BIH	9	0610-DBH	76	0614-BGI	79				
0607-CAA	4	0610-DBI	77	0614-BGL	79				
0607-CAB	4	0610-DBL	77	0614-BHA	79				
0607-CAC	4	0610-DCA	77	0614-BHG	80				
0607-CAD	4	0610-DCB	77	0614-BHI	82				
0607-CAE	4	0610-DCC	77	0614-BLB	81				
0607-CAF	4	0610-DCD	77	0614-BLD	81				
0607-CAG	4	0610-DCE	77	0614-BLE	81				
0607-CAH	4	0610-DCF	77	0614-BLF	81				
0607-CAI	4			0614-BLG	81				
0607-CAL	5	0611-BCI	72	0614-BLH	81				
0607-CBA	5	0611-CAG	73	0614-BLI	81				
0607-CBB	5	0611-CAH	73	0614-CAG	84				
0607-CBC	5	0611-CAI	73	0614-CAH	84				
0607-CBD	5	0611-CAL	73	0614-CAI	86				
0607-CBE	5	0611-DGI	73	0614-CAL	86				
0607-CBF	5	0611-DIA	72	0614-CBI	83				
0607-CBG	5	0611-DIB	72	0614-CBL	83				
0607-CBH	5	0611-DIC	72	0614-CCG	83				
0607-CBI	5	0611-DID	72	0614-CDB	78				
0607-CBL	5	0611-DIE	72	0614-CDC	78				
		0611-DIF	72	0614-CDD	78				
0610-BBH	68	0611-DIG	72	0614-CDE	78				
0610-BBI	68	0611-DIH	72	0614-CDF	86				
0610-BCH	68	0611-DII	72						

Indice alfanumerico		Alfanumerical Index		Nummernverzeichnis		Index alphabétique		Indice alfanumerico	
Article	Page	Article	Page	Article	Page	Article	Page	Article	Page
0614-CDG	83	0706-DEI	103	1411-BFL	100				
0614-CDH	83	0706-DEL	103	1412-LD	71				
0706-BIC	105	0706-DFA	103	1412-LE	71				
0706-BID	105	0706-DFB	103	1412-LF	71				
0706-BIF	105	0706-DFC	103	1412-BIB	71				
0706-BIG	105	0706-DFD	104	1412-BIC	71				
0706-CEF	101	0706-DFE	104	1412-BID	71				
0706-CEG	101	0706-DFF	104	1412-BIE	71				
0706-CEH	101	0706-DFG	104	1412-BIF	71				
0706-CEI	101	0706-DFH	104	1412-BIG	71				
0706-CEL	101	0706-DFI	104	1412-BIH	71				
0706-CFA	105	0706-DFL	104						
0706-CFC	100	0706-DFL	104	15-BBG	31				
0706-CFD	101	0706-DGA	104	15-BCL	33				
0706-CFE	101	0706-DGB	104	15-BCL	33				
0706-CFF	101	0706-DGC	104	15-CEG	25				
0706-CGF	101	0706-DGD	104	15-CGE	25				
0706-CGG	101	0706-DGE	104	15-CGF	25				
0706-CGH	101	0706-DGF	104	15-CGG	27				
0706-CGI	101	0706-DGG	104	15-CGH	27				
0706-CGL	101	0706-DGH	104	15-CHD	25				
0706-CHA	101	0706-DGI	104	15-CHE	26				
0706-DAB	102	0706-DGL	104	15-CHF	26				
0706-DAC	102	0706-DHA	104	15-CHG	25				
0706-DAD	102	0706-DHB	104	15-CHH	26				
0706-DAD	102	0706-DHC	104	15-CHI	26				
0706-DAE	102	0706-DHD	104	15-CHL	26				
0706-DAF	102	0706-DHE	104	15-CIA	26				
0706-DAG	102	0706-DHF	104	15-CIB	26				
0706-DAH	102	0706-DHG	104	15-CIC	26				
0706-DAI	102	0706-DHH	104	15-CID	26				
0706-DAL	102	0706-DHI	104	15-CIE	26				
0706-DBA	102	0706-DHL	104	15-CIF	25				
0706-DBB	102	0706-DIA	104	15-CIG	25				
0706-DBC	102	0706-DIB	104	15-CIH	25				
0706-DBD	102	0706-DIC	104	15-CII	25				
0706-DBE	102			15-CIL	29				
0706-DBF	102	0718-BD	99	15-CLI	33				
0706-DBG	102	0718-BE	99	15-CLL	33				
0706-DBH	102	0718-BL	99	15-DAA	34				
0706-DBI	102			15-DAB	30				
0706-DBL	102	1014-DB	58	15-DAC	30				
0706-DCA	102	1014-DC	58	15-DAD	30				
0706-DCB	102	1014-DD	58	15-DAE	30				
0706-DCC	102, 103	1014-HI	109	15-DAF	30				
0706-DCD	102			15-DAG	30				
0706-DCE	102	1102-BC04	58	15-DAH	34				
0706-DCF	102	1102-BF01	58	15-DAI	27				
0706-DCG	102	1102-BF03	58	15-DAL	27				
0706-DCH	102			15-DBA	27				
0706-DCI	102, 103	1110-BA	11	15-DBB	27				
0706-DCL	102	1110-BC	11	15-DBC	27				
0706-DDA	102			15-DBD	27				
0706-DBB	102	1123-BBB	82	15-DBE	31				
0706-DDC	102	1123-BBG	82	15-DBF	31				
0706-DDD	102			15-DBG	31				
0706-DDE	102	1206-BAB19	20	15-DBH	30				
0706-DDF	102	1206-BAC19	20	15-DBI	28				
0706-DDG	102	1206-BAG	19	15-DBL	28				
0706-DDH	103	1206-BAH	19	15-DCA	28				
0706-DDI	103			15-DCB	28				
0706-DDL	103	1411-FL	100	15-DCC	28				
0706-DEA	103	1411-BFA	100	15-DCD	27				
0706-DEB	103	1411-BFB	100	15-DCE	33				
0706-DEC	103	1411-BFC	100	15-DCF	23				
0706-DED	103	1411-BFD	100	15-DCG	31				
0706-DEE	103	1411-BFE	100	15-DCH	31				
0706-DEF	103	1411-BFF	100	15-DCI	31				
0706-DEG	103	1411-BFG	100	15-DCL	31				
0706-DEH	103	1411-BFH	100	15-DDA	33				
		1411-BFI	100	15-DBB	27				

Indice alfanumerico		Alfanumerical Index		Nummernverzeichnis		Index alphabétique		Indice alfanumerico	
Article	Page	Article	Page	Article	Page	Article	Page	Article	Page
15-DDC	32								
15-EAB	39								
15-EAC	39								
15-EAD	39								
15-EAE	39								
15-EAF	39								
15-EAG	39								
15-EAH	39								
15-EAI	39								
1506-BG	100								
1508-GH	42								
1508-LL	42								
1508-BAA	42								
1508-BAL	42								
1508-BBF	42								
1508-BBG	42								
1508-BDF	42								
1508-BDG	43								
1508-BDH	43								
1508-BDI	43								
1508-BDL	43								
1508-BEA	41								
1508-BEB	41								
1508-BEC	41								
1508-BED	41								
1508-BEE	41								
1508-BEF	41								
1514-DE	44								
1514-DF	44								
1514-DG	44								
1514-LG	43								
1514-LH11	43								
1514-LL11	43								
1803-L	7								
1803-BD	7								
1803-BE	3								
1803-BF	3								
1803-BG	7								



ideal-tek
manufacturer & supplier of precision instruments 

Ideal-tek SA
via Motta 4
6828 Balerna
Switzerland

Phone: +41 91 683 32 29
Fax: +41 91 683 03 71
E-mail: info@ideal-tek.com