



ideal-tek

manufacturer & supplier of precision instruments 

Gynecology
Gynäkologie
Ginecologia
Ginecologia
Gynécologie



Pinze per
calcoli renali

Kidney stone
forceps

Nierensteinzangen

Pinces pour
les calculs renaux

Pinzas para
cálculos renales

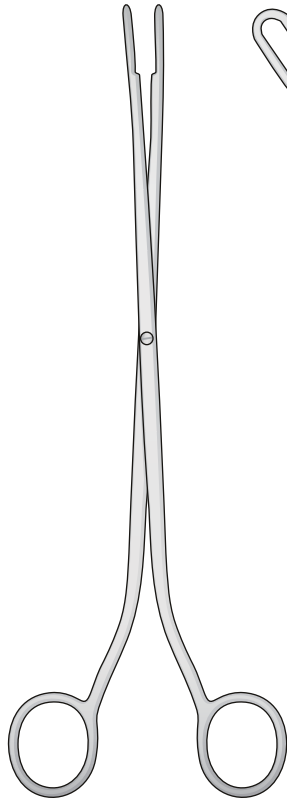

DESJARDINS
0502-BB/0502-BE
225 mm

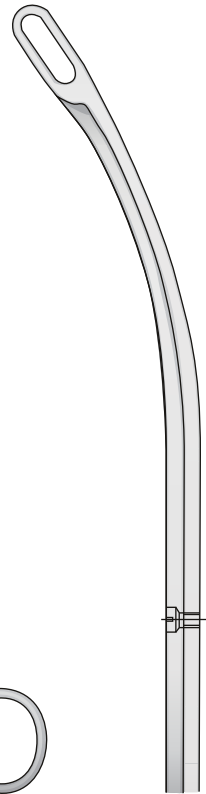

Fig. 1



0502-BB

Fig. 2



0502-BC

Fig. 3



0502-BD

Fig. 4



0502-BE

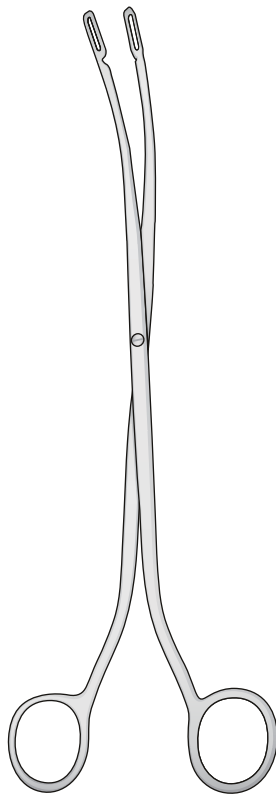

RANDALL
0502-DG/0502-DL
225 mm

Fig. 1

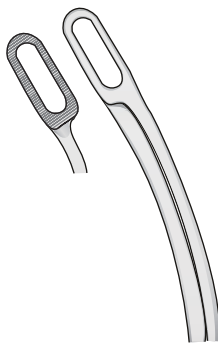

0502-DG

Fig. 2



0502-DH

Fig. 3



0502-DI

Fig. 4

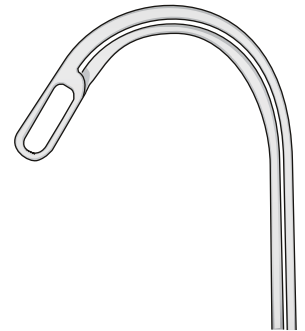

0502-DL

Cateteri
Sonde metalliche

Catheters metal

Katheterspanner
Metallkatheter

Sondes métalliques

Catéteres
Sondas metálicas

Strumenti per tendere ed introdurre i cateteri
Catheter introducing instruments
Katheter-Einführungsinstrumente
Mandrin pour introduire les sondes
Instrumentos para introducir catéteres

Ø 1,2 mm

Ø 3 mm

Ø 3 mm

Ø 2,7 mm

Per uomini
For men
Für Männer
Pour hommes
Para hombres

Charr.

0501-GA	8
0501-GC	10
0501-GD	12
0501-GE	14
0501-GF	16
0501-GG	18
0501-GH	20

Per donne
For woman
Für Frauen
Pour femmes
Para mujeres

Charr.

0501-HA	6
0501-HC	8
0501-HE	10
0501-HG	12
0501-HH	14
0501-HI	16
0501-HL	18

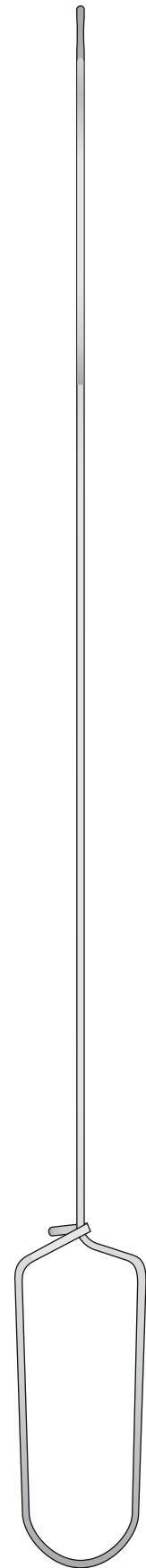
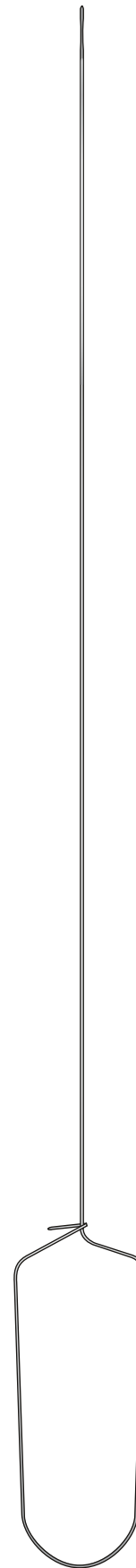
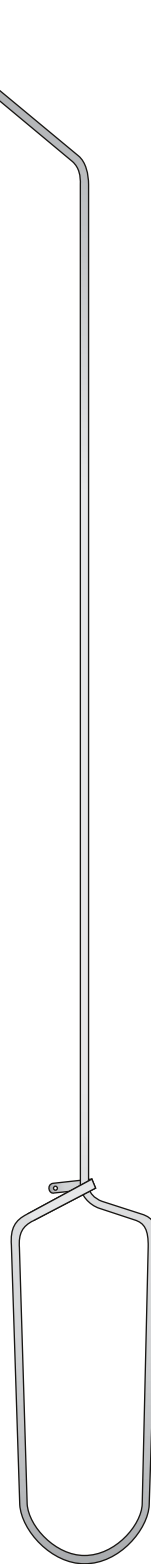
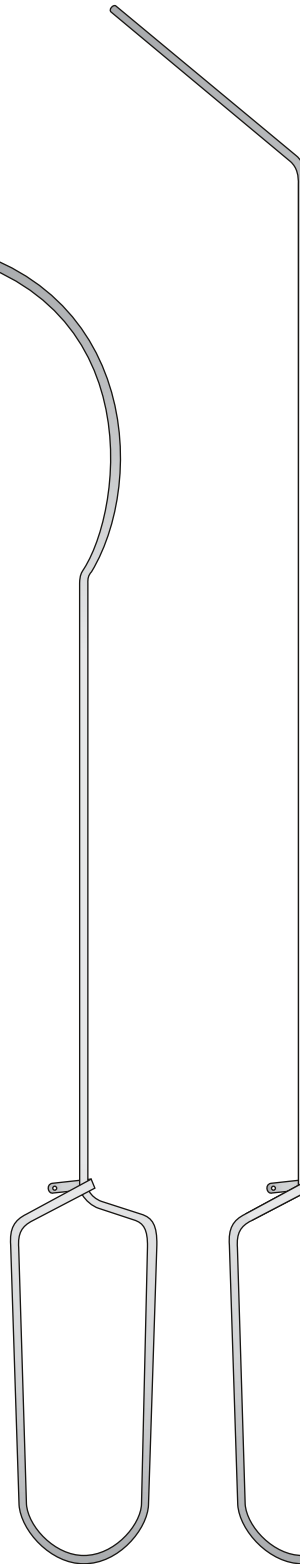
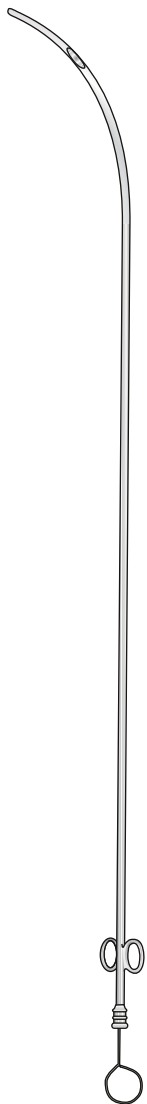

0501-GA/0501-GH
290 mm

0501-HA/0501-HL
160 mm

GUYON
0501-LA
365 mm

BENIQUE
0501-LB
410 mm

0501-LD
460 mm

0501-LC
460 mm

Dilatatori per
vie biliari

Gall duct
dilators

Gallengang-
Dilatatoren

Dilatateurs pour
les voies biliaires

Dilatadores para
conductos biliares

0602-DCB - 190 mm - Ø 3 mm
 0602-DCC - 190 mm - Ø 4 mm
 0602-DCD - 190 mm - Ø 5 mm
 0602-DCE - 190 mm - Ø 6 mm
 0602-DCF - 190 mm - Ø 7 mm
 0602-DCG - 190 mm - Ø 8 mm
 0602-DCH - 190 mm - Ø 9 mm
 0602-DCI - 190 mm - Ø 10 mm
 0602-DCL - 190 mm - Ø 11 mm

0602-DDB - 300 mm - Ø 1 mm
 0602-DDC - 300 mm - Ø 2 mm
 0602-DDD - 300 mm - Ø 3 mm
 0602-DDE - 300 mm - Ø 4 mm
 0602-DDF - 300 mm - Ø 5 mm
 0602-DDG - 300 mm - Ø 6 mm
 0602-DDH - 300 mm - Ø 7 mm
 0602-DDI - 300 mm - Ø 8 mm
 0602-DDL - 300 mm - Ø 9 mm
 0602-DEA - 300 mm - Ø 10 mm
 0602-DEB - 300 mm - Ø 11 mm
 0602-DEC - 300 mm - Ø 12 mm
 0602-DED - 300 mm - Ø 13 mm

0602-DCA

Set di 9 pezzi con custodia
 Set of 9 pieces in canvas pocket
 Satz à 9 Stück in Leinentuchtasche
 Jeu de 9 pièces dans une poche en toile
 Juego de 9 unidades en bolsa de tela

0602-DDA

Set di 13 pezzi
 Set of 13 pieces
 Satz à 13 Stück
 Jeu de 13 pièces
 Juego de 13 unidades

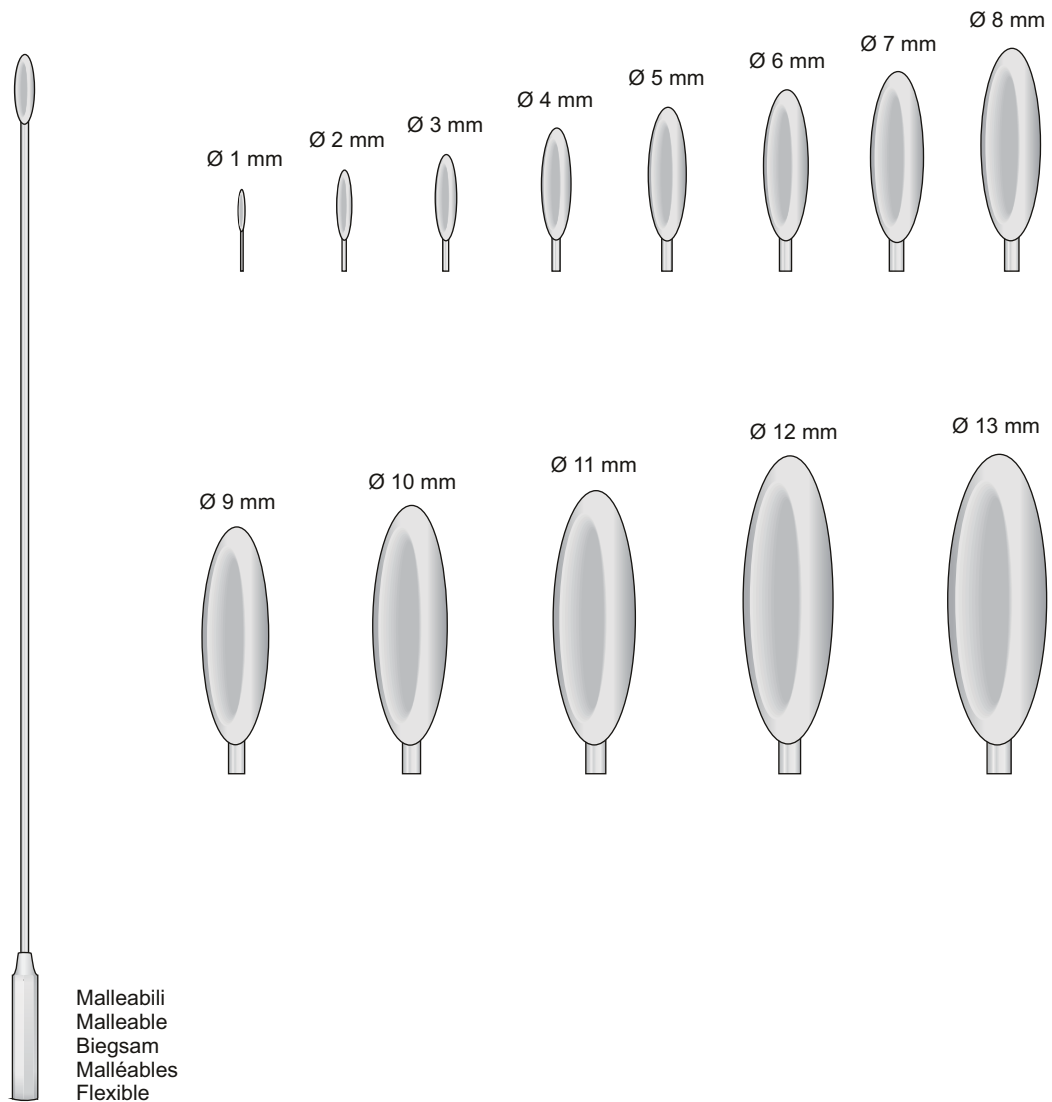

Malleabili
 Malleable
 Biegsam
 Malléables
 Flexible

BAKES
 0602-DCB/0602-DED

Dilatatori per
vie biliari

Gall duct
dilators

Gallengang-
Dilatatoren

Dilateurs pour
les voies biliaires

Dilatadores para
conductos biliares



DITTEL
0502-CFB/0502-CGH
220 mm

	Charr.
0502-CFB	8
0502-CFC	9
0502-CFD	10
0502-CFE	11
0502-CFF	12
0502-CFG	14
0502-CFH	16
0502-CFI	18
0502-CFL	20
0502-CGA	22
0502-CGB	24
0502-CGC	25
0502-CGD	26
0502-CGE	27
0502-CGF	28
0502-CGG	29
0502-CGH	30

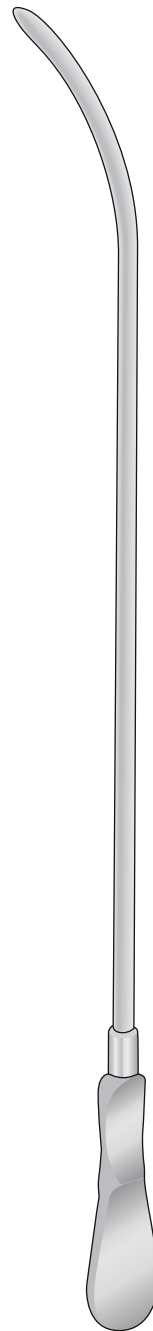

DITTEL
0502-CAB/0502-CCD
345 mm

	Charr.
0502-CAB	8
0502-CAC	9
0502-CAD	10
0502-CAE	11
0502-CAF	12
0502-CAG	13
0502-CAH	14
0502-CAI	15
0502-CAL	16
0502-CBA	17
0502-CBB	18
0502-CBC	19
0502-CBD	20
0502-CBE	21
0502-CBF	22
0502-CBG	23
0502-CBH	24
0502-CBI	25
0502-CBL	26
0502-CCA	27
0502-CCB	28
0502-CCC	29
0502-CCD	30

Dilatatori per
vie biliari

Gall duct
dilators

Gallengang-
Dilatatoren

Dilateurs pour
les voies biliaires

Dilatadores para
conductos biliares

0502-EL - Ø 10 mm  1/1

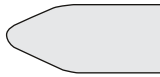
0502-EI - Ø 9 mm  1/1

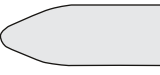
0502-EH - Ø 8 mm  1/1

0502-EG - Ø 7 mm  1/1

0502-EF - Ø 6 mm  1/1

0502-EE - Ø 5 mm  1/1

0502-ED - Ø 4 mm  1/1

0502-EC - Ø 3 mm  1/1

0502-EC/0502-EL
190 mm

0502-CFA

Set completo con 19 pezzi - Ch.12 / Ch.30
 Set complete with 19 pieces - Ch.12 / Ch.30
 Komplettsset mit 19 Stück - Ch.12 / Ch.30
 Set complet avec 19 pièces - Ch.12 / Ch.30
 Set completo con 19 piezas - Ch.12 / Ch.30

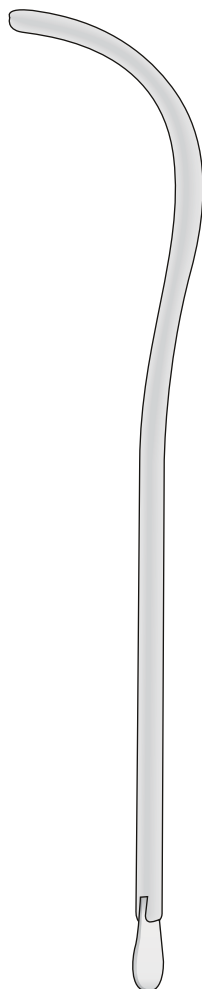

GUYON
 0502-CDB/0502-CEL
 255 mm

Ben. Charr.

0502-CDB	24	12
0502-CDC	26	13
0502-CDD	28	14
0502-CDE	30	15
0502-CDF	32	16
0502-CDG	34	17
0502-CDH	36	18
0502-CDI	38	19
0502-CDL	40	20
0502-CEA	42	21
0502-CEB	44	22
0502-CEC	46	23
0502-CED	48	24
0502-CEE	50	25
0502-CEF	52	26
0502-CEG	54	27
0502-CEH	56	28
0502-CEI	58	29
0502-CEL	60	30

Sonde per dotto biliare, Elastiche
 Gall Stone Probes, Elastic
 Gallensteinsonden, Federnd
 Explorateurs pour calculs biliaires, Élastiques
 Exploradores para cálculos biliares, Elásticos

Ø 4,3 mm

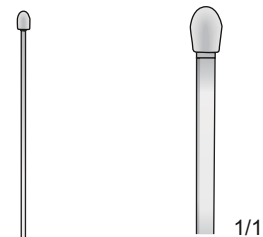

1/1
0502-BI

Ø 6,0 mm

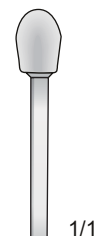

1/1
0502-BL

Ø 7,0 mm

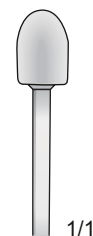

1/1
0502-CA

DESJARDINS
 0502-BI/0502-CA
 280 mm

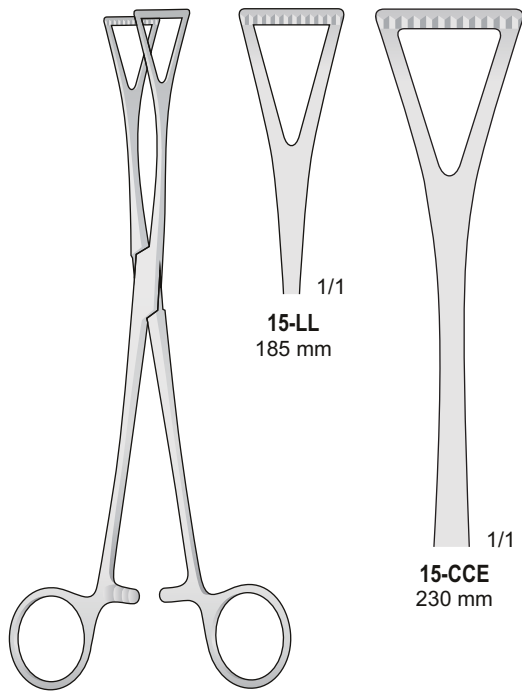

DUVAL
15-LL/15-CCE

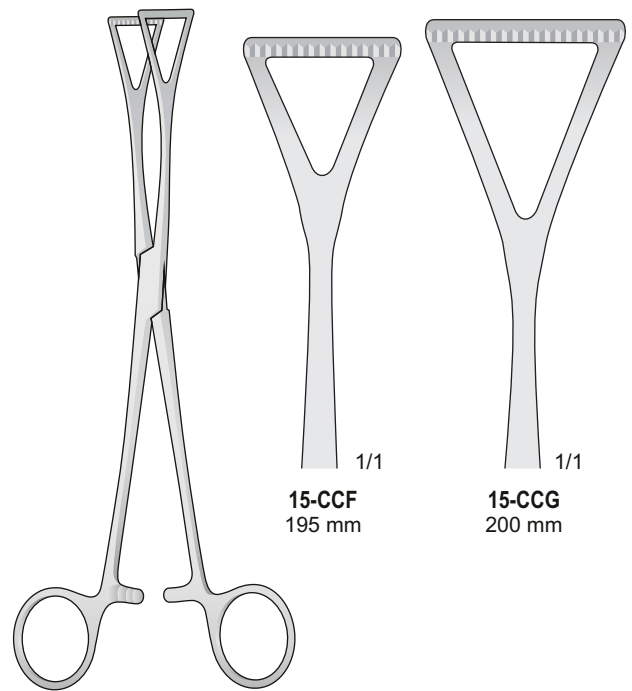

DUVAL-COLLIN
15-CCF/15-CCG

Pinze per peduncoli renali - Kidney pedicle clamp forceps - Nierenstielklemmen
Pincas-clamps pour pédicules rénaux - Pinzas-clamps para pedúncolos renales

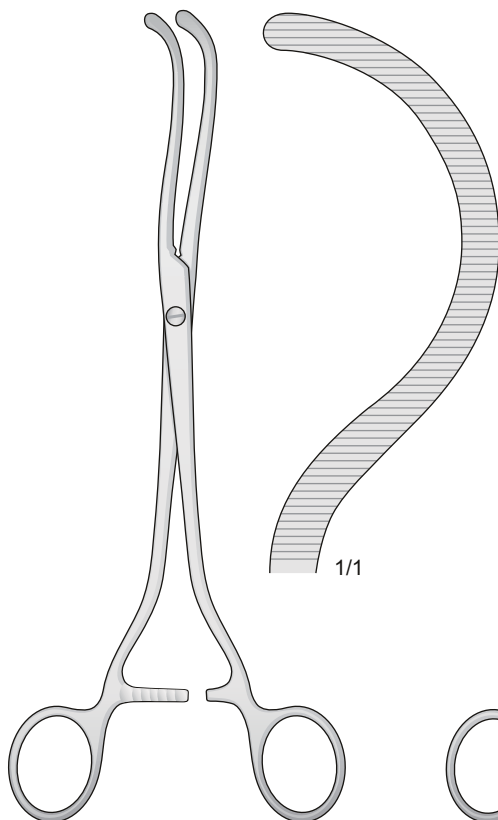

BRAUN
0502-DA
245 mm

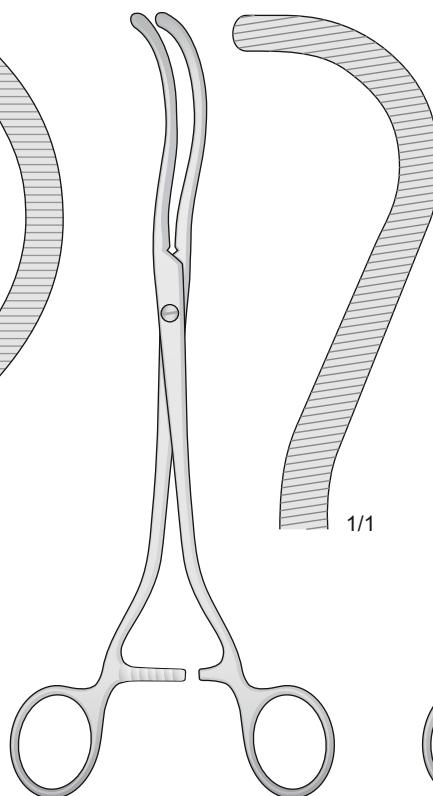

GUYON
0502-DB
235 mm

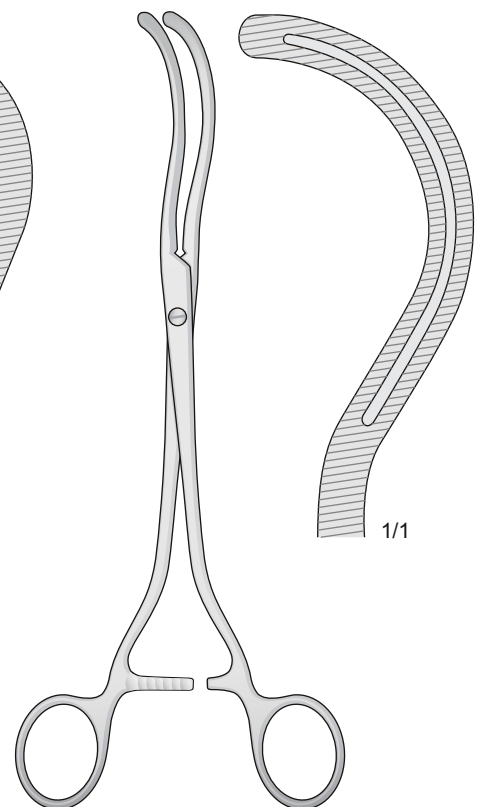

STILLE
0502-DC
240 mm

Pinze per
peduncoli renali

Kidney pedicle
forceps

Nierenklemmen

Pinces-clamps pour
pédicules rénaux

Pinzas para
pedúnculos renales

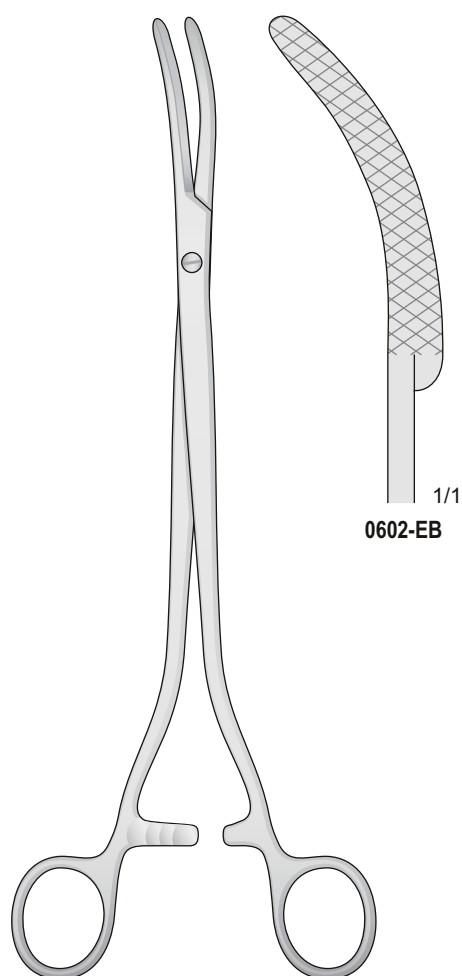

0602-EB

WERTHEIM
0602-EB
260 mm

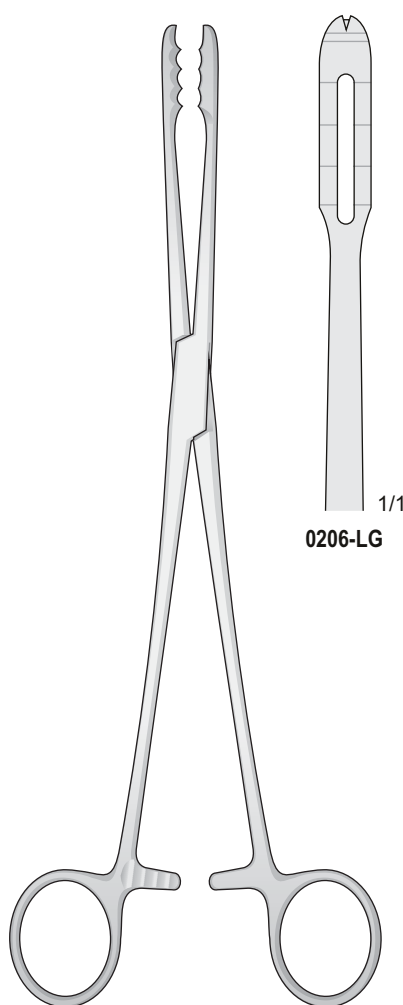

0206-LG

0206-LG/0206-LH
265 mm

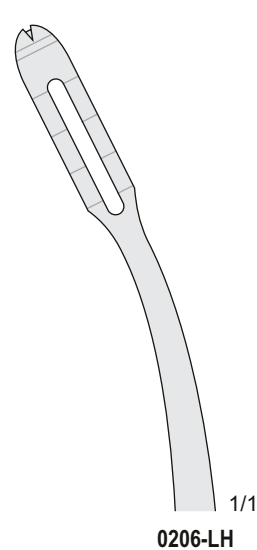

0206-LH

Pinze per
peduncoli renali

Kidney pedicle
forceps

Nierenklemmen

Pinces-clamps pour
pédicules rénaux

Pinzas para
pedúnculos renales

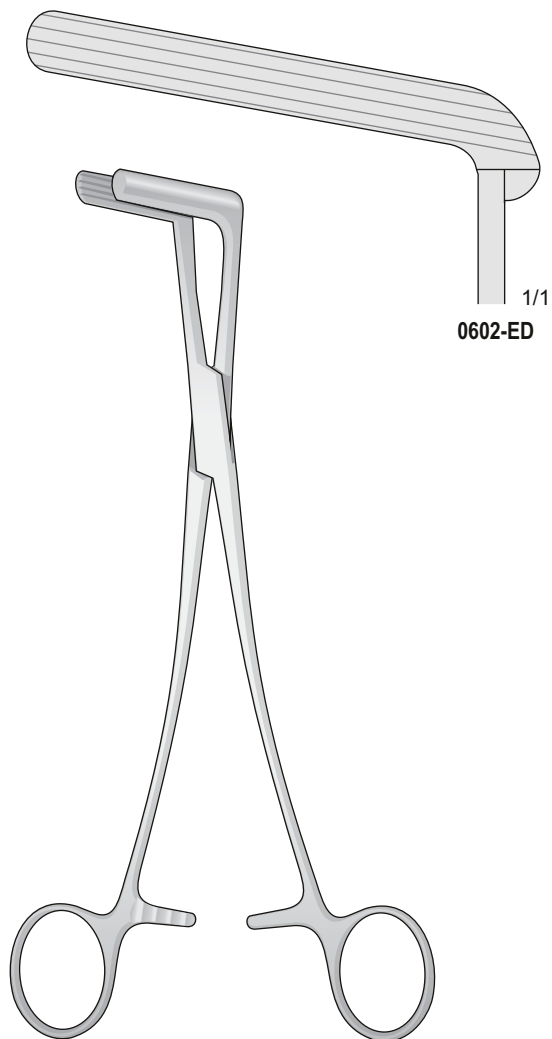

0602-ED

WERTHEIM
0602-ED
235 mm

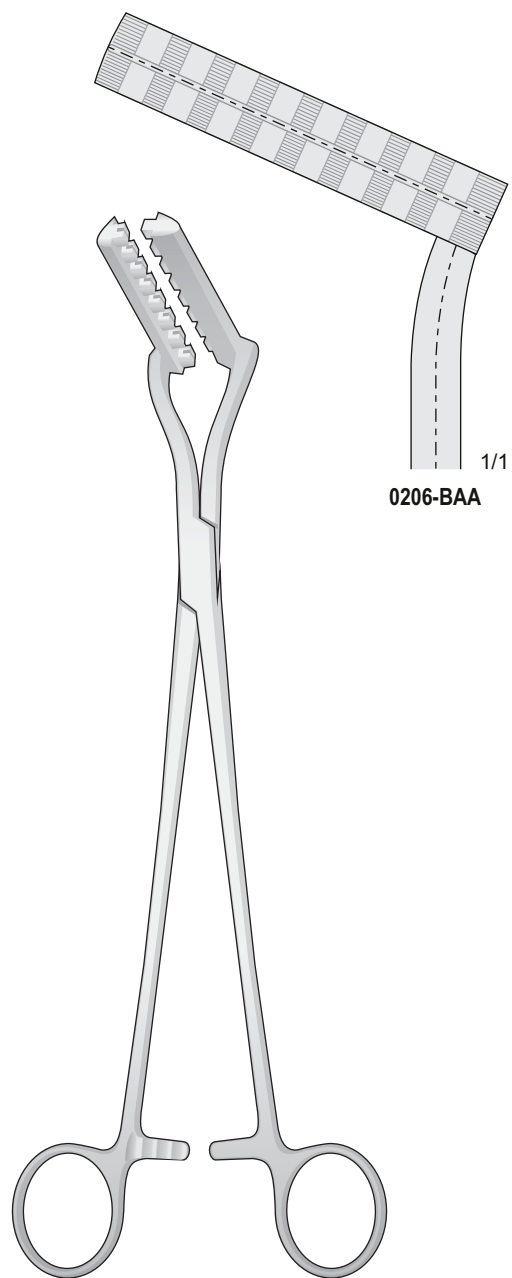

0206-BAA

0206-BAA
280 mm

Pinze da placenta
e aborto

Placenta
and ovum forceps

Placentar
und Abortuszangen

Pinces à faux
germes

Pinzas para
aborte

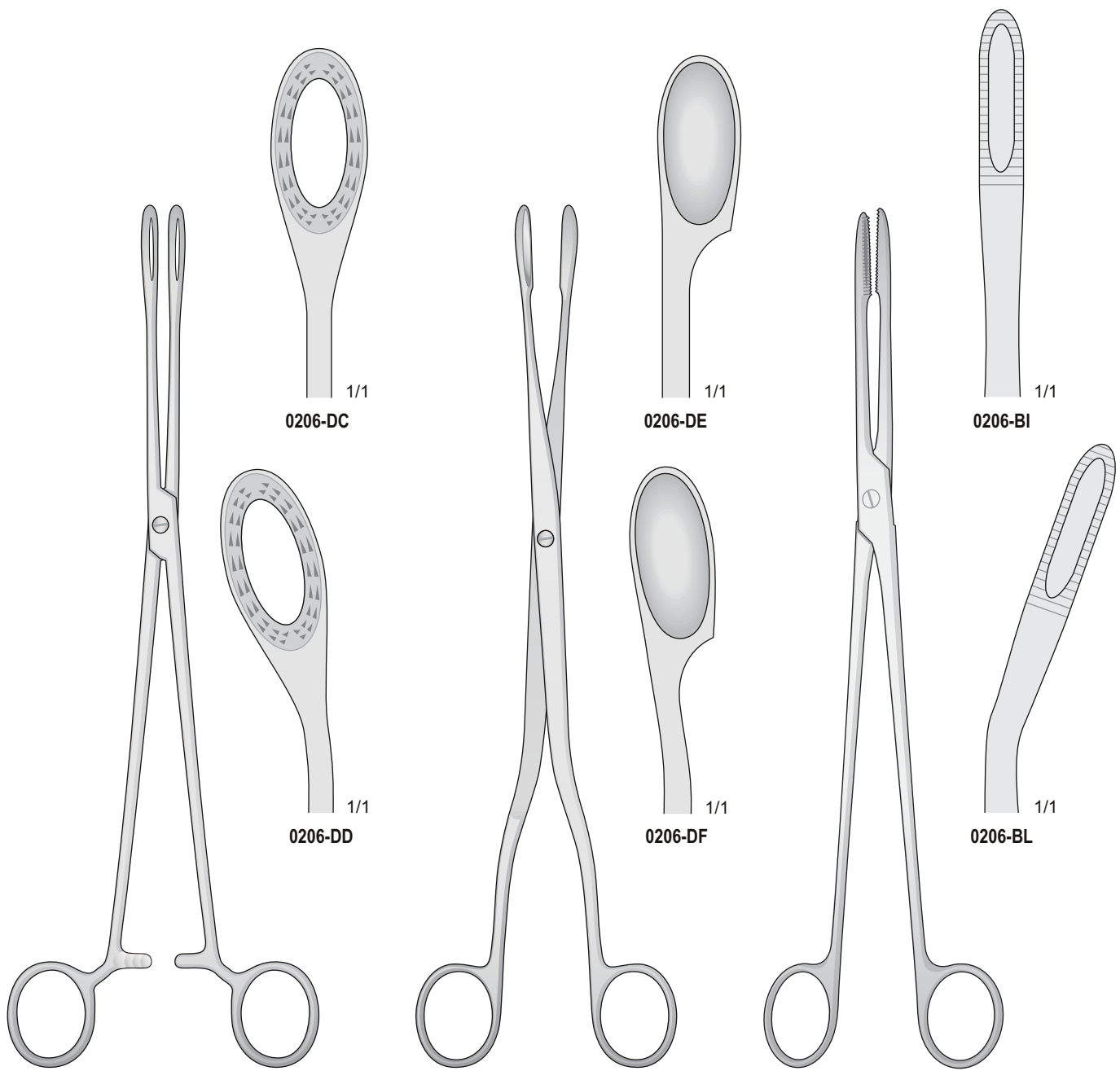

0206-DC/0206-DD
280 mm

WINTER
0206-DE/0206-DF
280 mm

0206-BI/0206-BL
280 mm

Pinze per tamponi
Pinze emostatiche

Cotton Swab forceps
Artery forceps

Tupferzangen
Arterienklemmen

Pinces à tampons
Pinces hemostâtiques

Pinzas para tampones
Pinzas hemostáticas

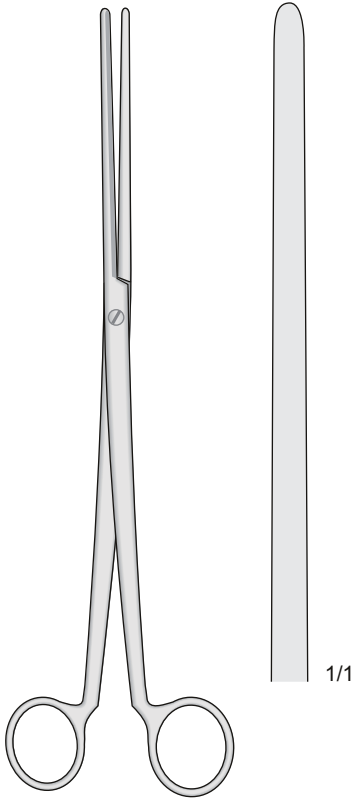

COLLIN
0206-AD
260 mm

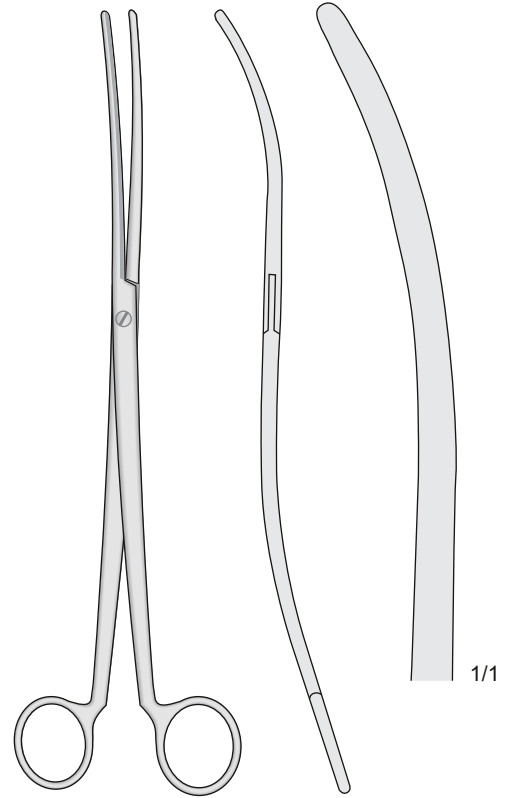

COLLIN
0206-AE
260 mm

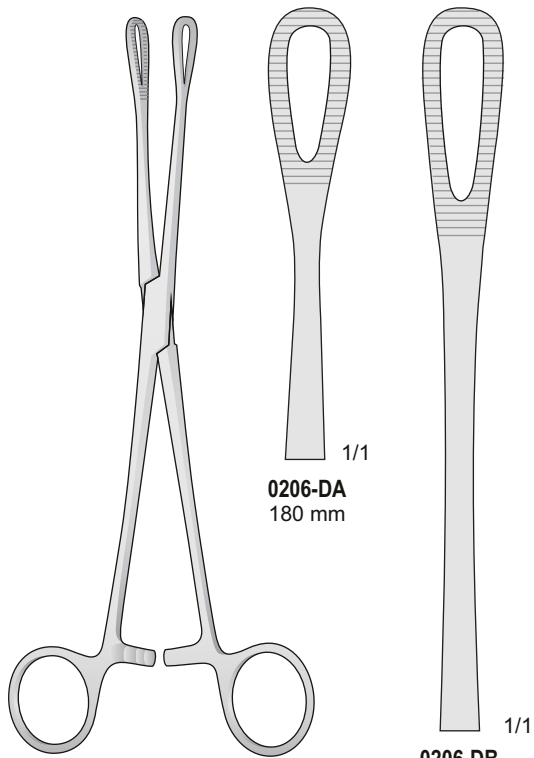

RAMPLEY
0206-DA/0206-DB

0206-DB
245 mm

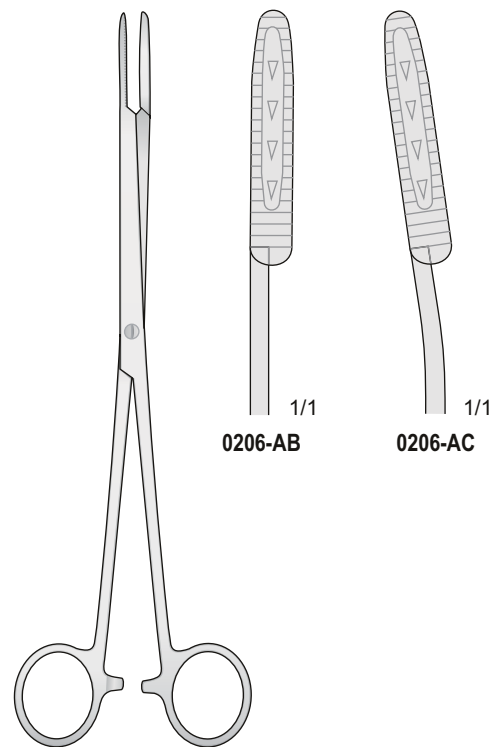

MAIER
0206-AB/0206-AC
245 mm

0206-AB

0206-AC

Speculum vaginali

Vaginal specula

Scheidenspekula

Spéculums vaginaux

Espéculos vaginales

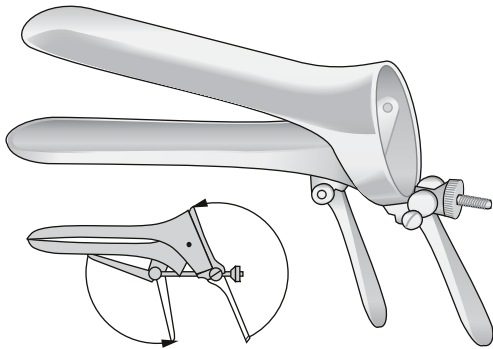

CUSCO
0517-EL Fig. 0 77x17 mm
0517-EI Fig. 1 75x33 mm
0517-EH Fig. 2 86x36 mm
0517-EG Fig. 3 97x36 mm

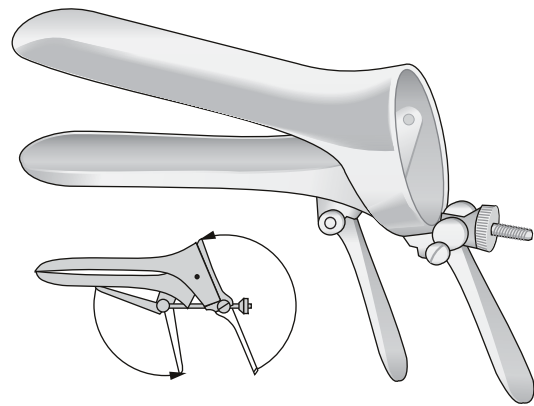

CUSCO
SCHWEIZER MODELL
0517-GB Fig.1 90x23 mm
0517-GC Fig.2 100x24 mm
0517-GD Fig.3 105x27 mm

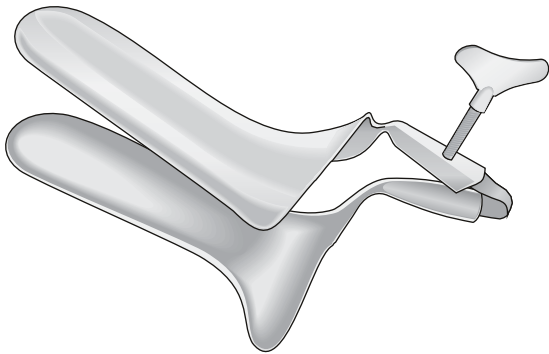

COLLIN-STANDARD
0517-HC Fig. 1 90x29 mm
0517-HD Fig. 2 95x35 mm
0517-HE Fig. 3 110x40 mm

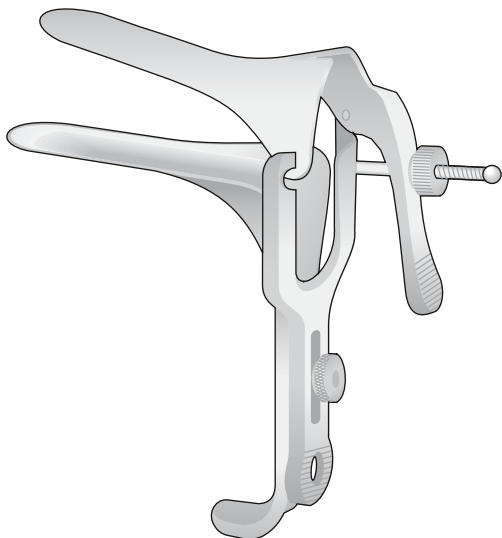

GRAVE
0517-LB 75x20 mm
0517-LC 95x30 mm
0517-LD 105x33 mm

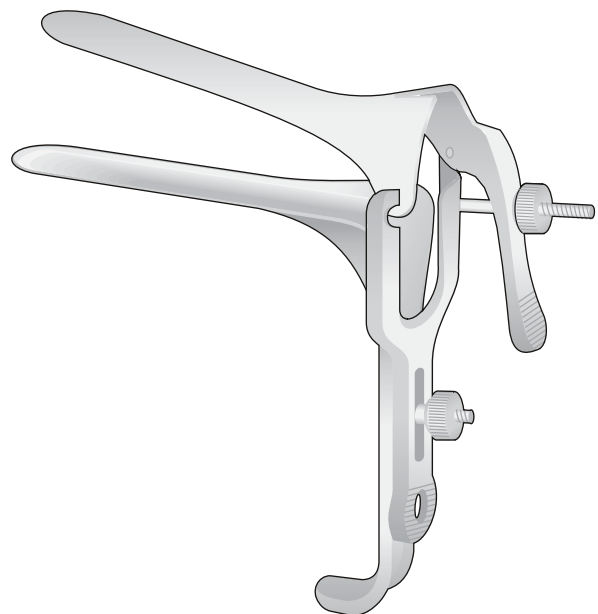

PEDERSON
0517-LG 100x22 mm
0517-LH 120x25 mm

Speculum e valve vaginali

Vaginal specula

Scheidenspekula und halter

Spéculums et valves vaginaux

Espéculos vaginales



KALLMORGEN
0502-BAB - 70 x 40 mm
170 mm

0502-BAC - 70 x 33 mm
170 mm

0502-BAA
Set 2 pezzi - Set 2 pieces
Set 2 stück - Set 2 pièces
Set 2 piezas
70 x 40 mm
70 x 33 mm

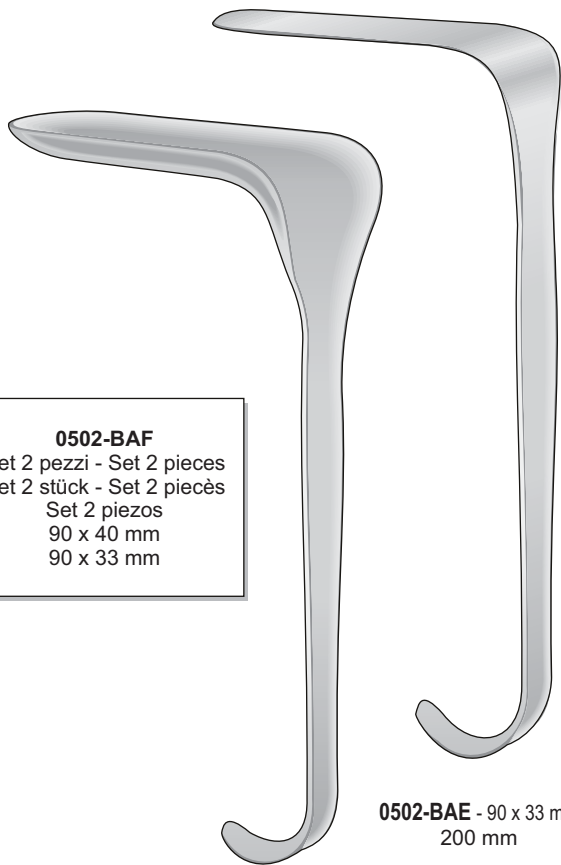

KALLMORGEN
0502-BAD - 90 x 40 mm
200 mm

0502-BAE - 90 x 33 mm
200 mm

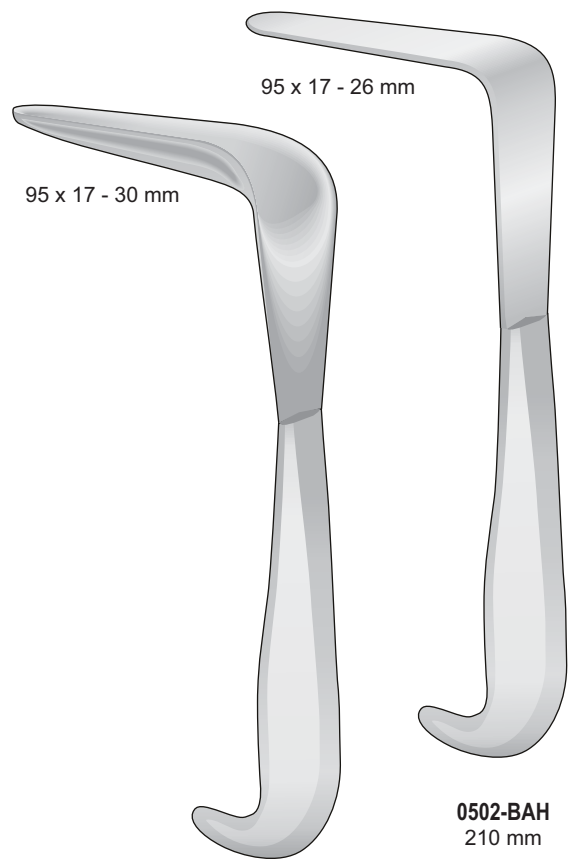

MATHIEU
0502-BAG
210 mm

0502-BAH
210 mm

95 x 17 - 30 mm

95 x 17 - 26 mm

0502-BAF
Set 2 pezzi - Set 2 pieces
Set 2 stück - Set 2 pièces
Set 2 piezas
90 x 40 mm
90 x 33 mm

Speculum e valve vaginali

Vaginal specula

Scheidenspekula und halter

Spéculums et valves vaginaux

Espéculos vaginales

Speculum
Spekula
Specula
Spéculums
Espéculos



KRISTELLER

- Fig. 1 **0502-BCA** - 70 x 27 mm
- Fig. 2 **0502-BCB** - 75 x 30 mm
- Fig. 3 **0502-BCC** - 90 x 36 mm

Valva
Halter
Retractors
Valves
Valvas



KRISTELLER

- Fig. 1 **0502-BCD** - 75 x 23 mm
- Fig. 2 **0502-BCE** - 80 x 26 mm
- Fig. 3 **0502-BCF** - 95 x 32 mm

Speculum + Valva
Specula + Retractor
Spekula + Halter
Spéculum + Valve
Espéculo + Valva



- Fig. 1 **0502-BCG**
- Fig. 2 **0502-BCH**
- Fig. 3 **0502-BCI**

Speculum
Spekula
Specula
Spéculums
Espéculos



KRISTELLER

- Fig. 00 **0502-BDA** - 110 x 18 mm
- Fig. 0 **0502-BDB** - 110 x 21 mm
- Fig. 1 **0502-BDC** - 110 x 27 mm
- Fig. 2 **0502-BDD** - 110 x 30 mm
- Fig. 3 **0502-BDE** - 110 x 36 mm

Valva
Halter
Retractors
Valves
Valvas



KRISTELLER

- Fig. 00 **0502-BDF** - 115 x 14 mm
- Fig. 0 **0502-BDG** - 115 x 17 mm
- Fig. 1 **0502-BDH** - 115 x 23 mm
- Fig. 2 **0502-BDI** - 115 x 26 mm
- Fig. 3 **0502-BDL** - 115 x 32 mm

Speculum + Valva
Specula + Retractor
Spekula + Halter
Spéculum + Valve
Espéculo + Valva

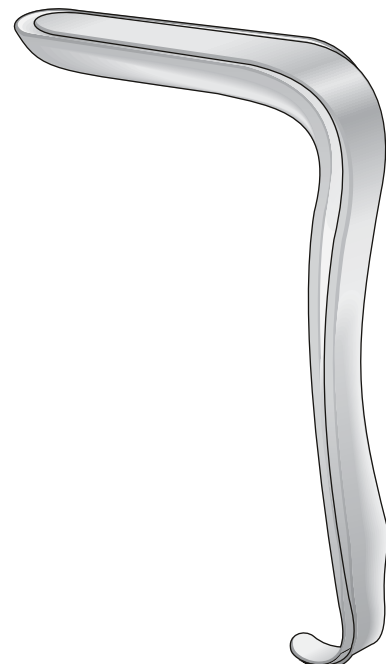

- Fig. 00 **0502-BEA**
- Fig. 0 **0502-BEB**
- Fig. 1 **0502-BEC**
- Fig. 2 **0502-BED**
- Fig. 3 **0502-BEE**

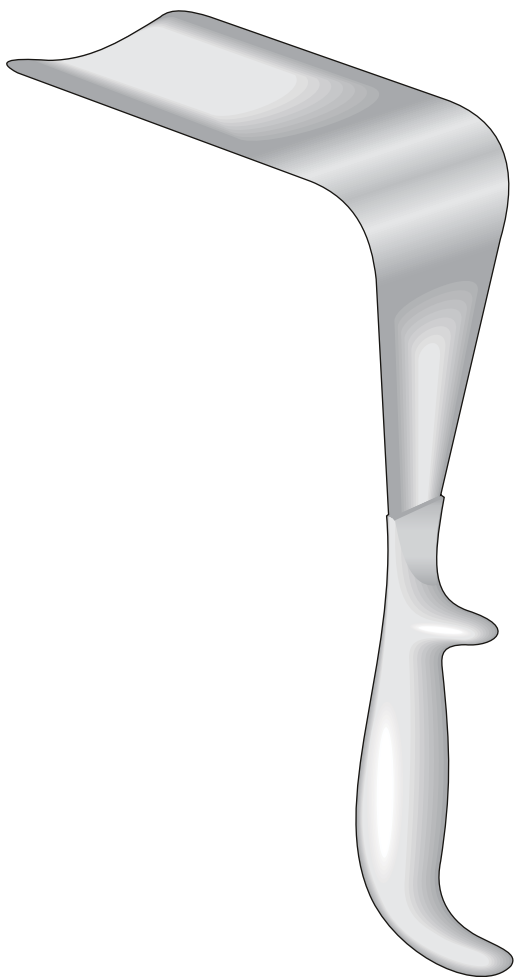

DOYEN
0502-BFA/0502-BGG
240 mm

- | | |
|--------|-------------------------------|
| Fig. 1 | 0502-BFA - 60 x 35 mm |
| Fig. 2 | 0502-BFB - 90 x 35 mm |
| Fig. 3 | 0502-BFC - 120 x 35 mm |
| Fig. 1 | 0502-BFG - 60 x 45 mm |
| Fig. 2 | 0502-BFH - 90 x 45 mm |
| Fig. 3 | 0502-BFI - 120 x 45 mm |
| Fig. 4 | 0502-BGA - 160 x 45 mm |
| Fig. 1 | 0502-BGC - 60 x 60 mm |
| Fig. 2 | 0502-BGD - 90 x 60 mm |
| Fig. 3 | 0502-BGE - 120 x 60 mm |
| Fig. 4 | 0502-BGG - 160 x 60 mm |

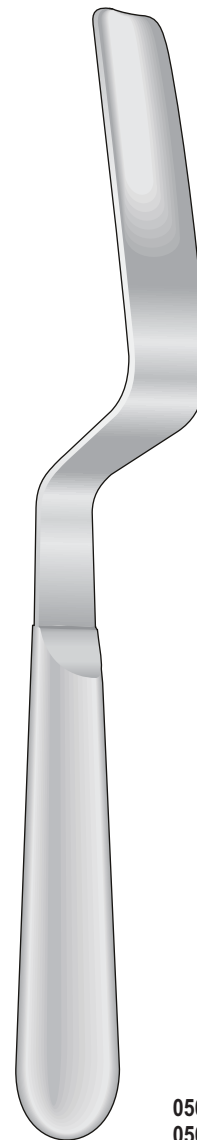

LANDAU
0502-BLA/0502-BLB
290 mm

- | |
|-------------------------------|
| 0502-BLA - 100 x 28 mm |
| 0502-BLB - 100 x 38 mm |



BREISKY

- 0502-BHA** - 100 x 20 mm
- 0502-BHB** - 100 x 25 mm
- 0502-BHC** - 100 x 30 mm
- 0502-BHD** - 100 x 35 mm
- 0502-BHE** - 100 x 40 mm
- 290 mm

BREISKY

- 0502-BHF** - 130 x 20 mm
- 0502-BHG** - 130 x 25 mm
- 0502-BHH** - 130 x 30 mm
- 0502-BHI** - 130 x 35 mm
- 0502-BHL** - 130 x 40 mm
- 320 mm

BREISKY

- 0502-BIE** - 160 x 40 mm
- 350 mm

BREISKY

- 0502-BIL** - 180 x 40 mm
- 370 mm

Dilatatori uterini

Uterine dilators

Uterus-Dilatatoren

Dilateurs du col de l'utérus

Dilatadores uterinos

Hegar Dilatatori - Hegar Dilators - Hegar Dilatatoren - Hegar Dilateur - Hegar Dilatadores

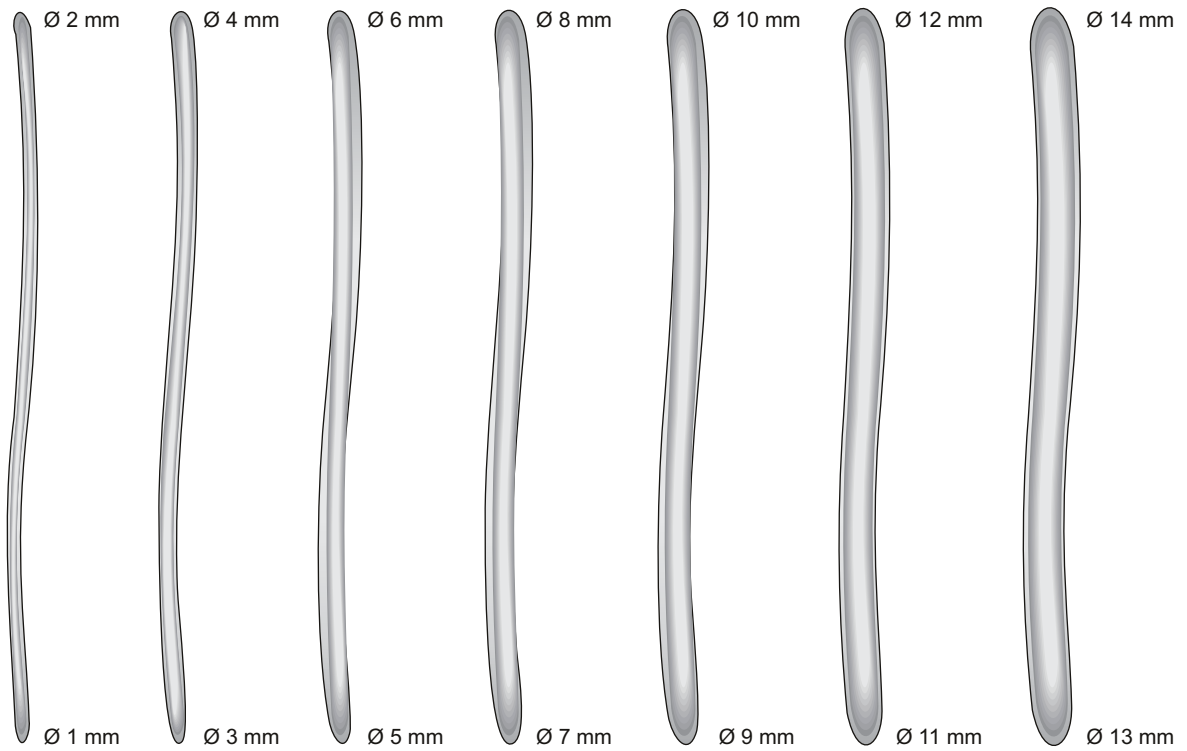

0517-BCA
200 mm

0517-BCB
200 mm

0517-BCC
200 mm

0517-BCD
200 mm

0517-BCE
200 mm

0517-BCF
200 mm

0517-BCG
200 mm

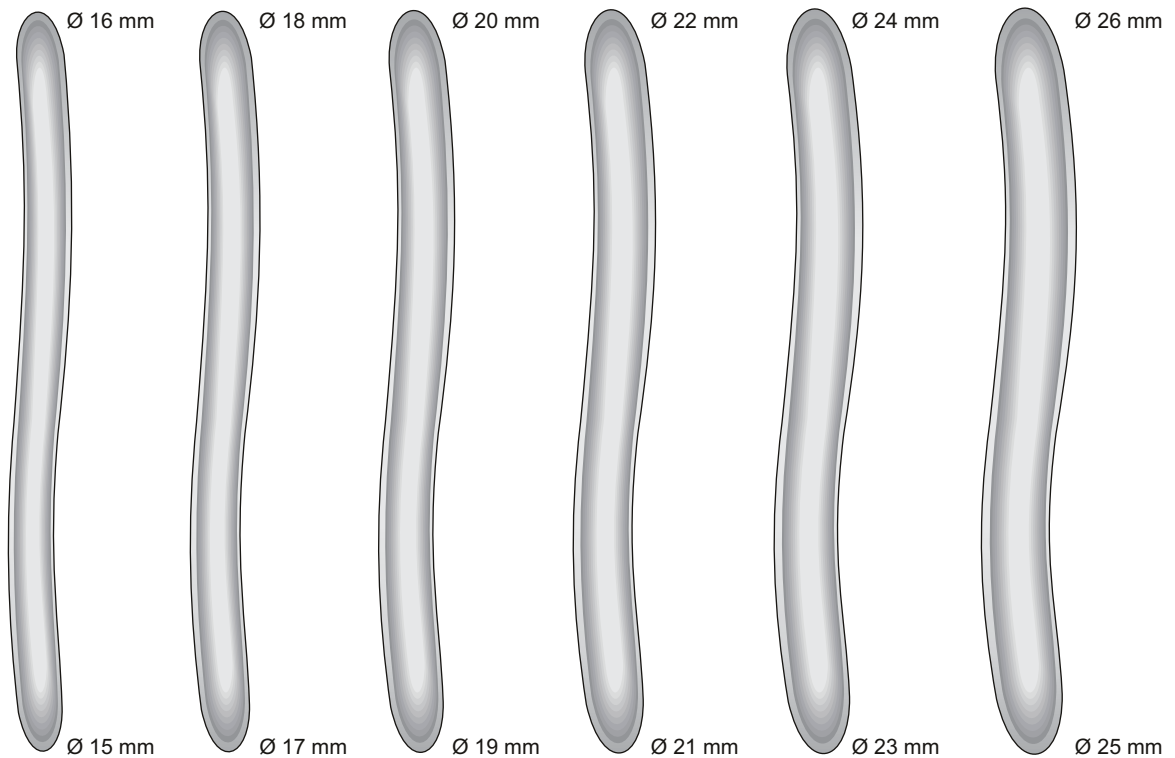

0517-BCH
200 mm

0517-BCI
200 mm

0517-BCL
200 mm

0517-BDA
200 mm

0517-BDB
200 mm

0517-BDC
200 mm

Pratt Dilatori - Pratt Dilators - Pratt Dilatoren
Pratt Dilateur - Pratt Diladores

0517-BBA
Set completo dilatatori 8 pezzi
Set complete with 8 pieces
Satz-Dilatator, komplett, 8 Stück
Jeu complet avec 8 pieces
Juego completo con 8 piezas

Fig.	mm
13/15	4,5/5,0
17/19	5,6/6,3
21/23	7,0/7,6
25/27	8,3/9,0
29/31	9,6/10,3
33/35	11,0/11,6
37/39	12,3/13,0
41/43	13,6/14,3

La misura è in French
Breite in French

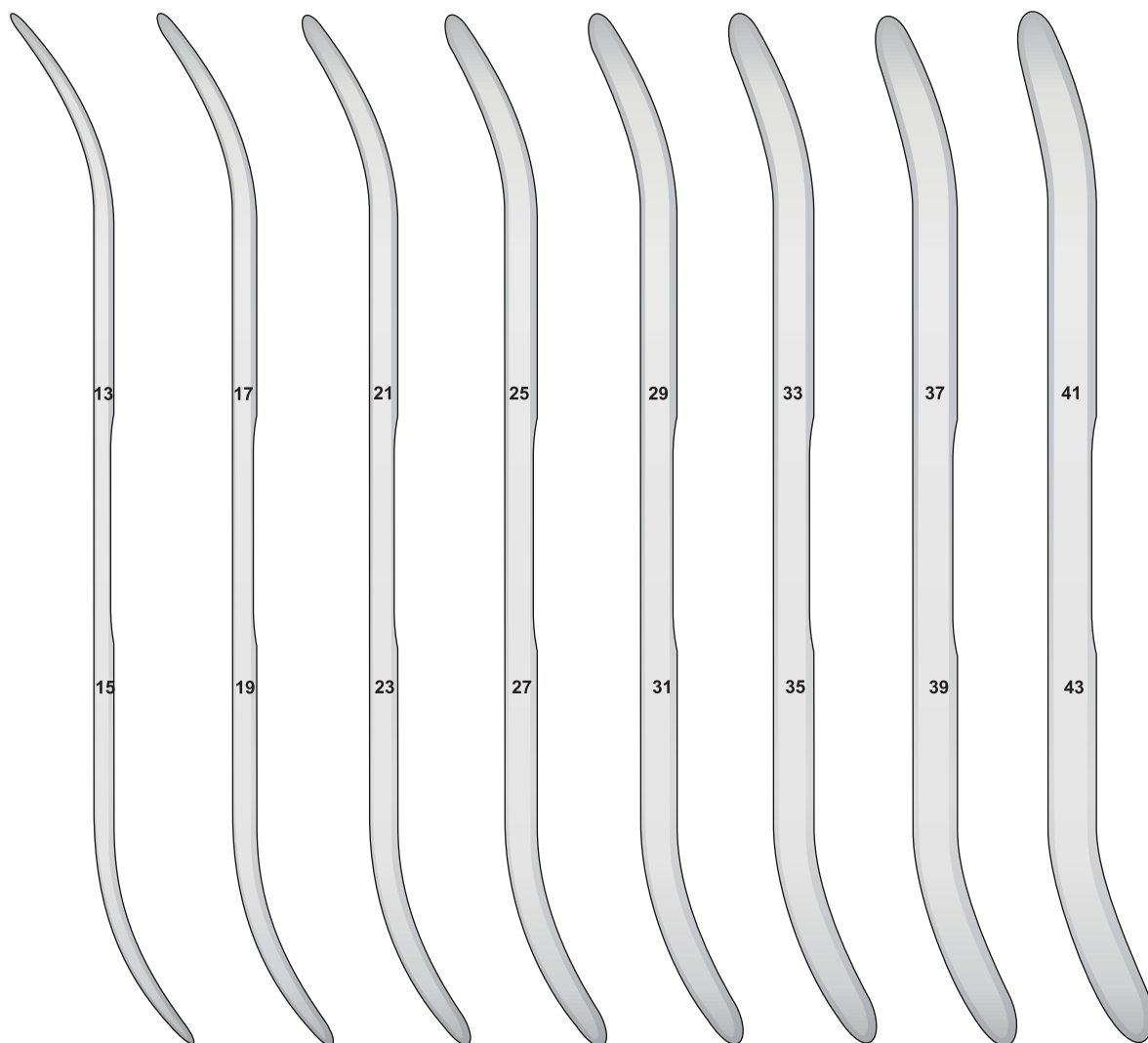

0517-BBB
260 mm

0517-BBC
260 mm

0517-BBD
260 mm

0517-BBE
260 mm

0517-BBF
260 mm

0517-BBG
260 mm

0517-BBH
260 mm

0517-BBI
260 mm

Dilatatori uterini

Uterine dilators

Uterus-Dilatatoren

Dilatateurs du col de l'utérus

Dilatadores uterinos



0502-FB 1 mm
 0502-FC 2 mm
 0502-FD 3 mm
 0502-FE 4 mm
 0502-FF 5 mm
 0502-FG 6 mm
 0502-FH 7 mm
 0502-FI 8 mm
 0502-FL 9 mm
 0502-GA 10 mm
 0502-GB 11 mm
 0502-GC 12 mm
 0502-GD 13 mm

0502-GE 14 mm
 0502-GF 15 mm
 0502-GG 16 mm
 0502-GH 17 mm
 0502-GI 18 mm
 0502-GL 19 mm
 0502-HA 20 mm
 0502-HB 21 mm
 0502-HC 22 mm
 0502-HD 23 mm
 0502-HE 24 mm
 0502-HF 25 mm
 0502-HG 26 mm

0502-HH 1½ mm
 0502-HI 2½ mm
 0502-HL 3½ mm
 0502-IA 4½ mm
 0502-IB 5½ mm
 0502-IC 6½ mm
 0502-ID 7½ mm
 0502-IE 8½ mm
 0502-IF 9½ mm
 0502-IG 10½ mm
 0502-IH 11½ mm
 0502-II 12½ mm
 0502-IL 13½ mm

0502-LA 14½ mm
 0502-LB 15½ mm
 0502-LC 16½ mm
 0502-LD 17½ mm

HEGAR
 0502-FB/0502-LD
 185 mm

Fig. 9/10
 Ø 4,5/5,0 mm

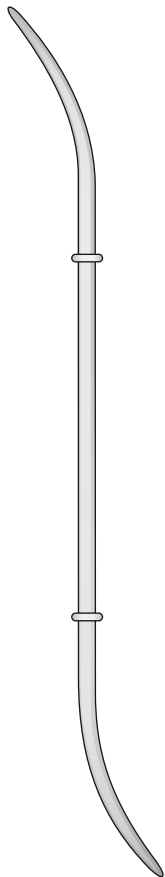

HANK
 0517-BGB
 260 mm

Fig. 11/12
 Ø 5,5/6,0 mm

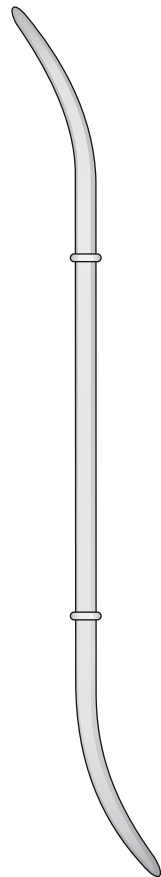

HANK
 0517-BGC
 260 mm

Fig. 13/14
 Ø 6,5/7,0 mm

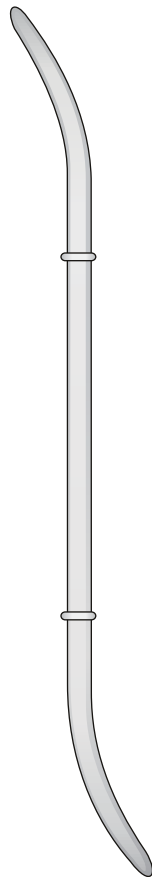

HANK
 0517-BGD
 260 mm

Fig. 15/16
 Ø 7,5/8,0 mm

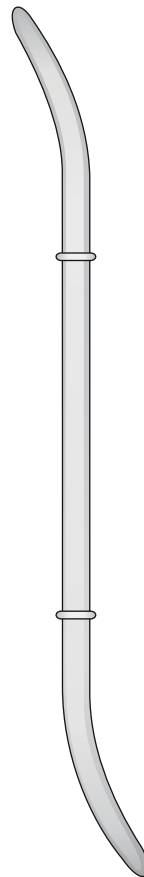

HANK
 0517-BGE
 260 mm

Fig. 17/18
 Ø 8,5/9,0 mm

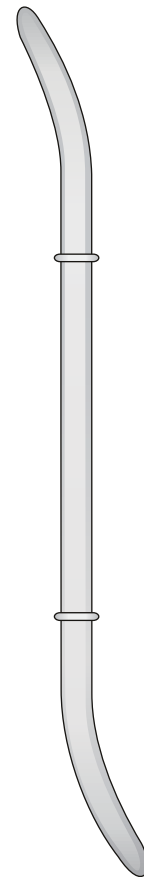

HANK
 0517-BGF
 260 mm

Fig. 19/20
 Ø 9,5/10 mm

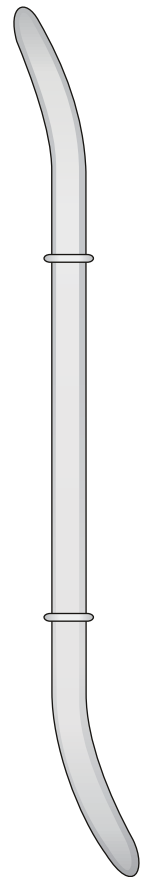

HANK
 0517-BGG
 260 mm

Isterometri

Uterine sounds

Uterussonden

Hystéromètres

Histerómetros

Graduati in centimetri
 Graduated in centimeters
 Zentimetereinteilung
 Gradué en centimètres
 Graduado en centímetros

Malleabile
 Malleable
 Biigsam
 Malléables
 Maleables

Malleabile
 Malleable
 Biigsam
 Malléables
 Maleables

Rigido
 Rigid
 Fest
 Rigides
 Rígidos

Malleabile
 Malleable
 Biigsam
 Malléables
 Maleables

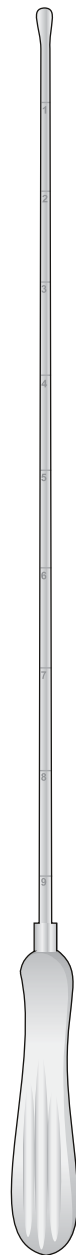
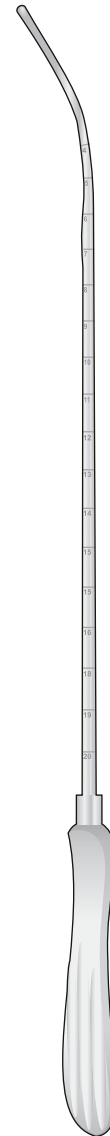
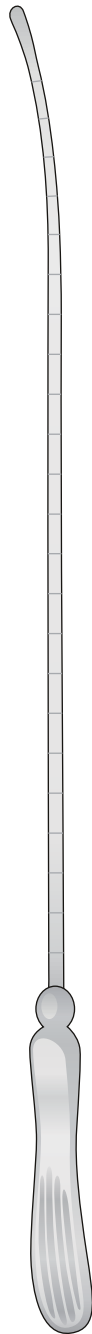
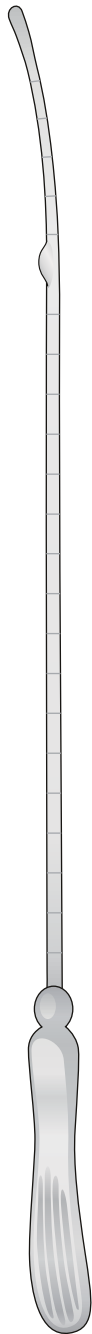
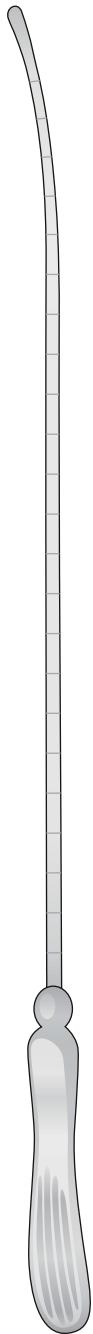

0517-BAA
 Ø 2 mm
0517-BAB
 Ø 3 mm
0517-BAC
 Ø 4 mm

0517-BAE
 Ø 3 mm
0517-BAF
 Ø 4 mm

SIMS
0517-BAA/0517-BAC
 320 mm

SIMPSON
0517-BAD Ø 3 mm
 320 mm

SIMS
0517-BAE/0517-BAF
 320 mm

VALLEIX
0517-BAH Ø 4 mm
 265 mm

MARTIN
0517-BAG Ø 3 mm
 300 mm

MAYO
0517-BAI Ø 5 mm
 330 mm

Amniotomo per la
vescica amniotica
Amniotome for the
amniotic bladder
Amniotom für die
Amnionblase
Amniotome pour la
vésicule amniotique
Amniotomo para la
vesícula amniótica

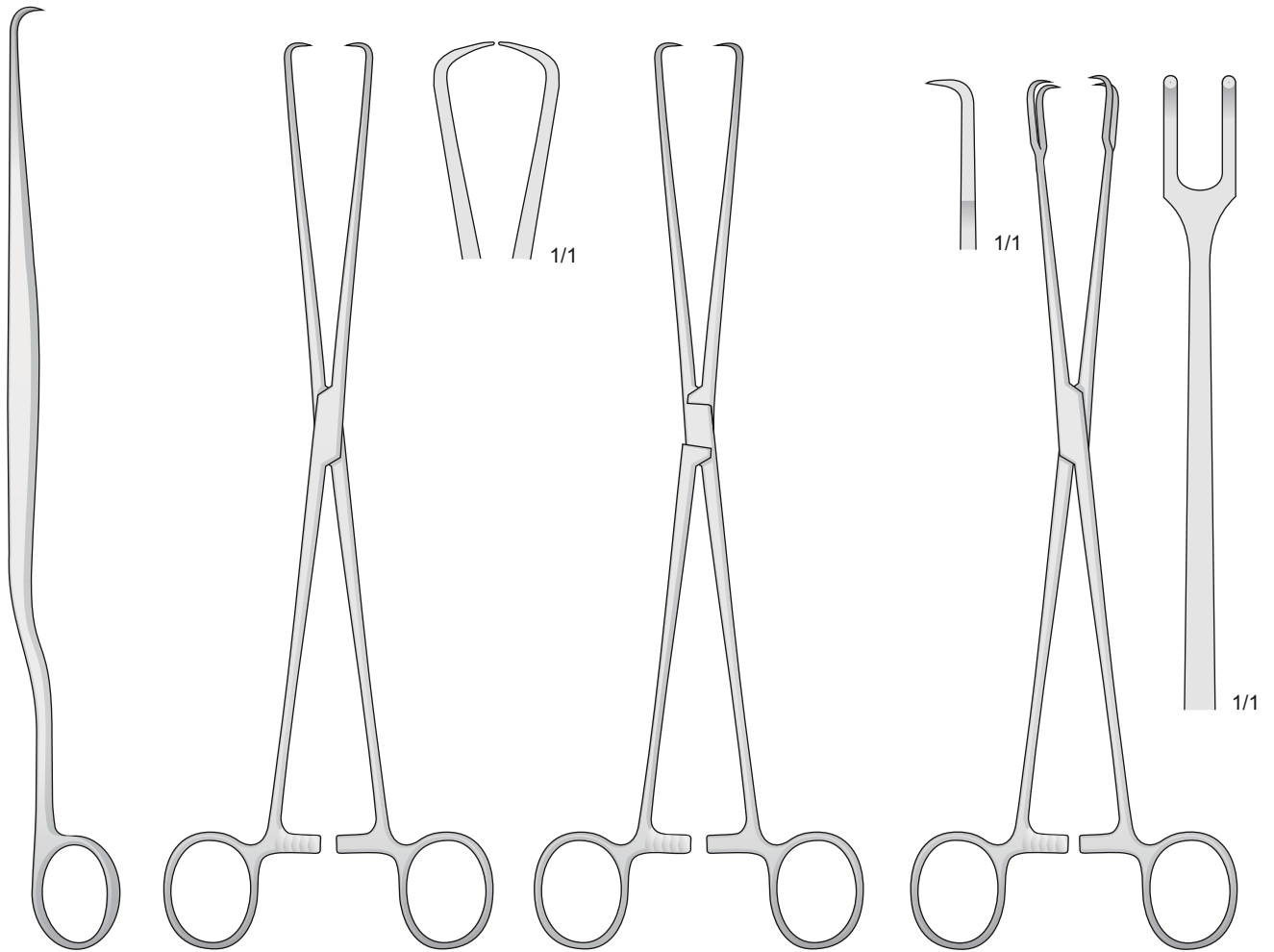

BEACHAM
0206-FF
260 mm

BRAUN
0206-EL
250 mm

POZZI
0206-GA
250 mm

SCHROEDER
0206-FL
240 mm

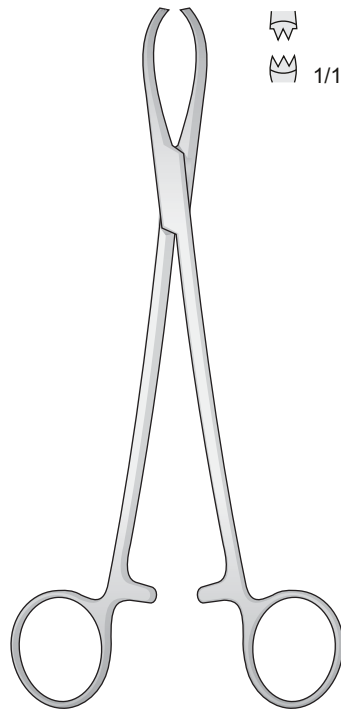

LITTLEWOOD
0502-CF
185 mm

Con curvatura laterale
Curved Sideway
Seitwärts Gebogen
Courbes sur le côté
Curvas laterales

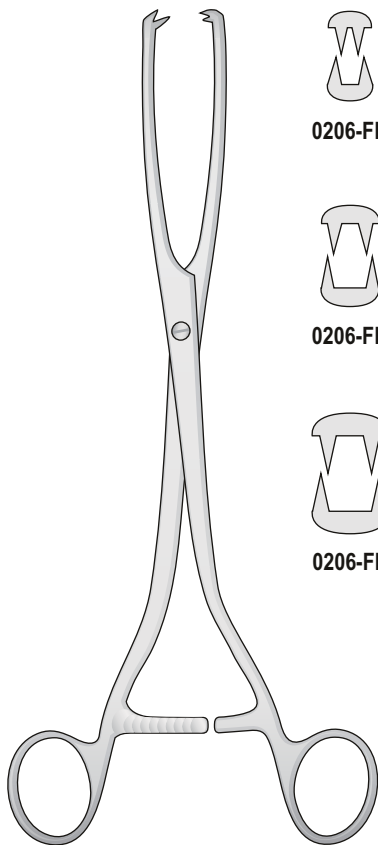

0206-FB



0206-FD

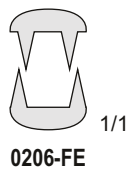

0206-FE

MUSEUX
0206-FB/0206-FE
240 mm

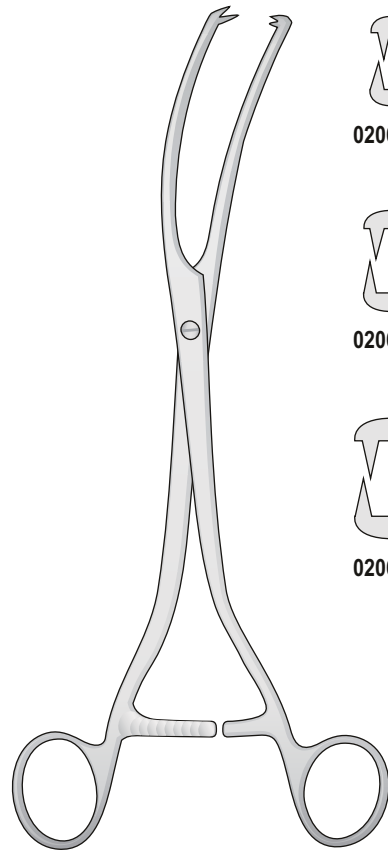

0206-GB



0206-GC

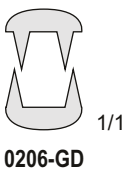

0206-GD

MUSEUX
0206-GB/0206-GD
240 mm

Strumenti per fibromi
Strumenti per oper. Micro-tube

Myoma instruments
Instruments for
Micro tubal operation

Myom Instrumente
Instrumente für
Mikro-Tubenoperationen

Instruments
pour fibromes
Myomes

Instrumentos
para fibroma

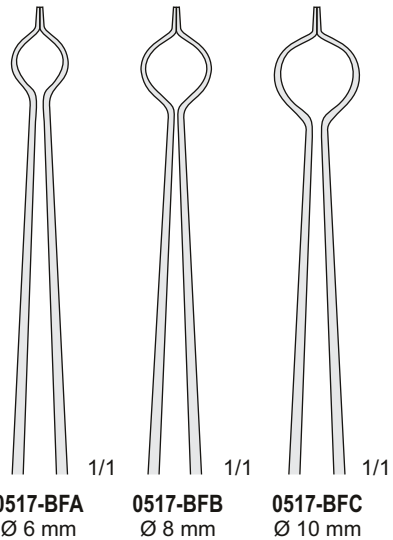
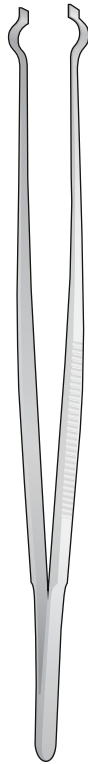

Pinzette per la presa delle tube
Tubal seizing forceps
Tubenfasspinzetten
Pinces pour saisir les tubes

NEUBÜSER
0517-BFA/0517-BFC
200 mm

Elevatori per miomi
Myoma screw
Myomheber
Tracteur pour fibromes
Tiramiomas para fibromas



DOYEN
0502-BF
150 mm

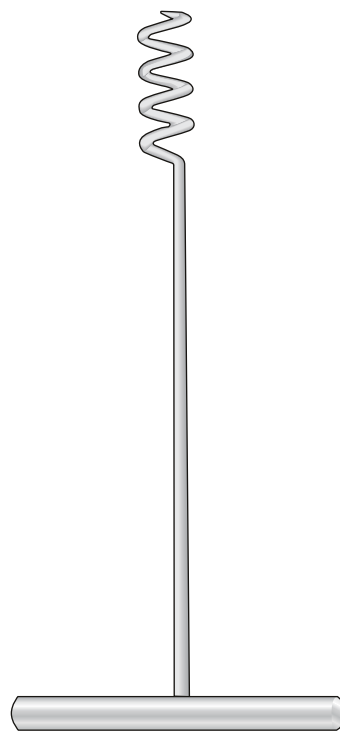

DOYEN
0502-BG
170 mm

Curette di aspirazione
per biopsia

Uterine biopsy
aspirating curettes

Uterus Biopsie
Saugküretten

Curettes aspirantes
à biopsie de l'utérus

Curetas aspiradoras para
la biopsia uterina

Curette per biopsia endouterina
Endometrial Biopsy curette
Endometrium-Strickkürette
Curette pour biopsie intra-utérines
Cureta para biopsia endo-uterina

Curette per biopsia endocervicale
Endocervical Biopsy Curettes
Endocervix-Biopsieküretten
Curettes pour biopsies
endo-cervicales

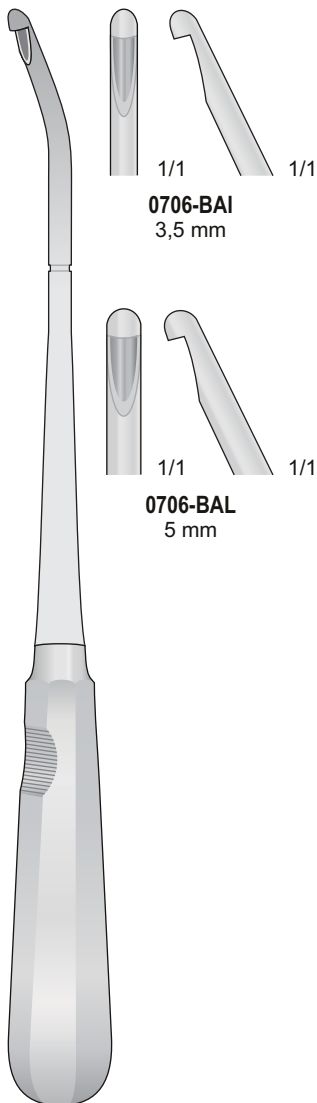

MÜNCHEN
0706-BAI/0706-BAL
270 mm

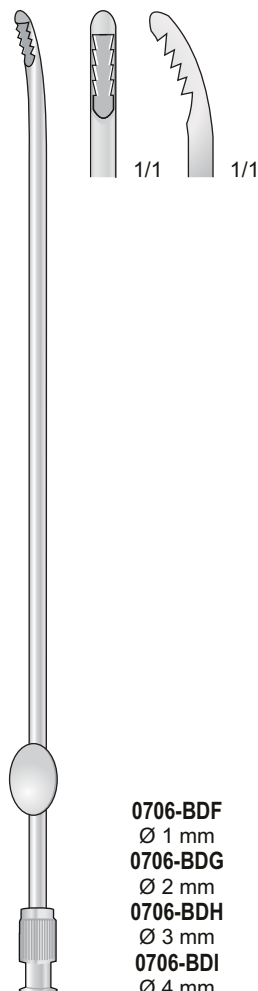

NOVAK
0706-BDF/0706-BDI
230 mm

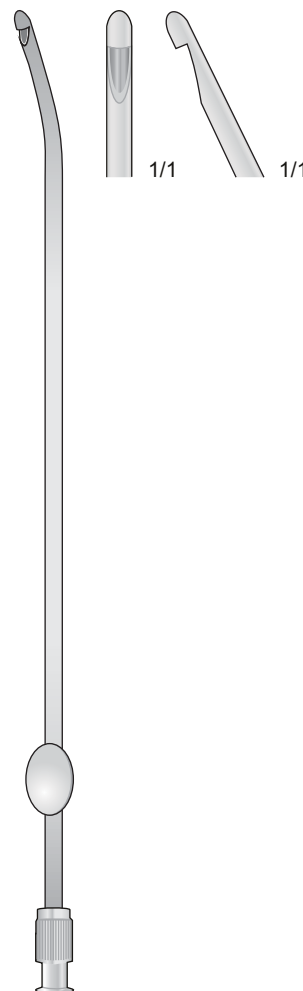

RANDALL
0706-BDL
230 mm

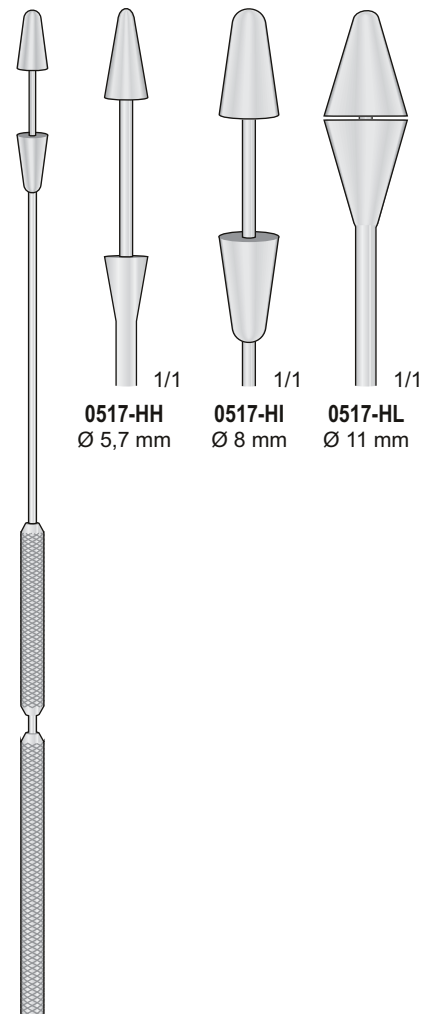

GUSBERG
0517-HH/0517-HL
240 mm

0706-BDF
Ø 1 mm
0706-BDG
Ø 2 mm
0706-BDH
Ø 3 mm
0706-BDI
Ø 4 mm

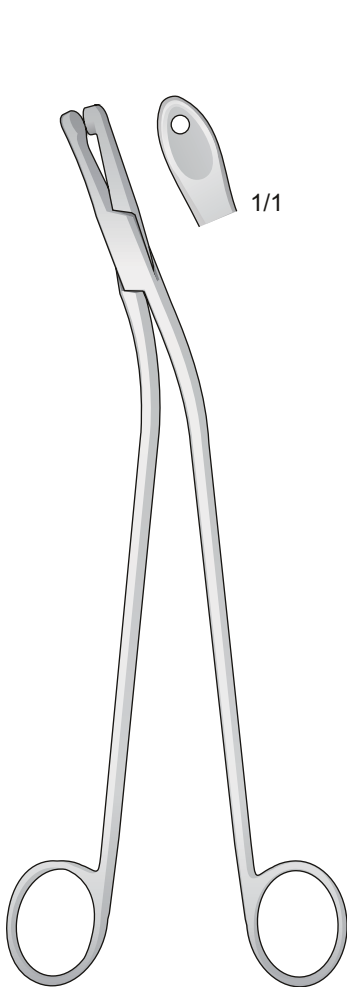

GELLHORN
0606-DA
230 mm

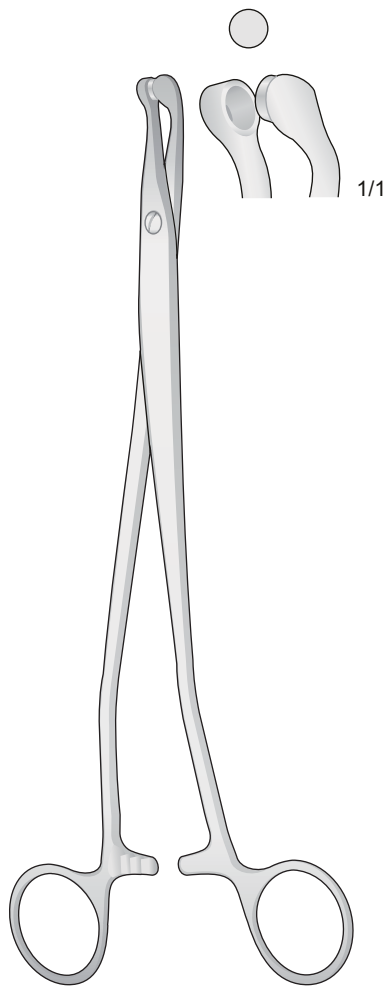

THOMS-GAYLOR
0606-DC
240 mm

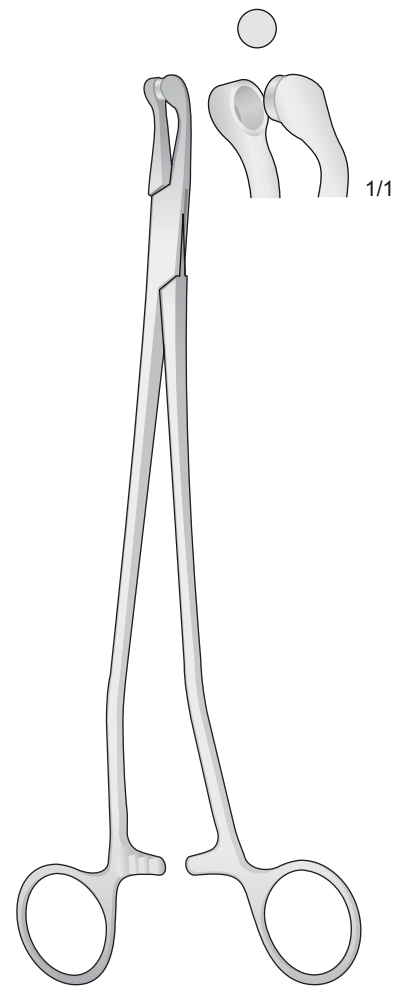

THOMS-GAYLOR
0606-DD 220 mm
0606-DE 240 mm

Pinze per biopsie

Biopsy forceps

Biopsiezangen

Pinces à biopsies

Pinzas para biopsia

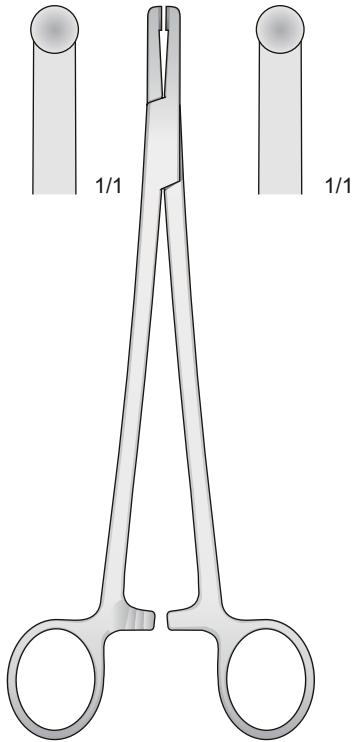

0402-BFA
205 mm

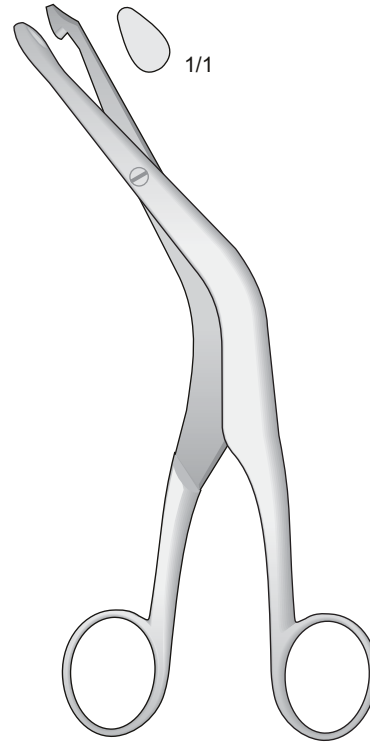

FAURE
0606-DB
210 mm

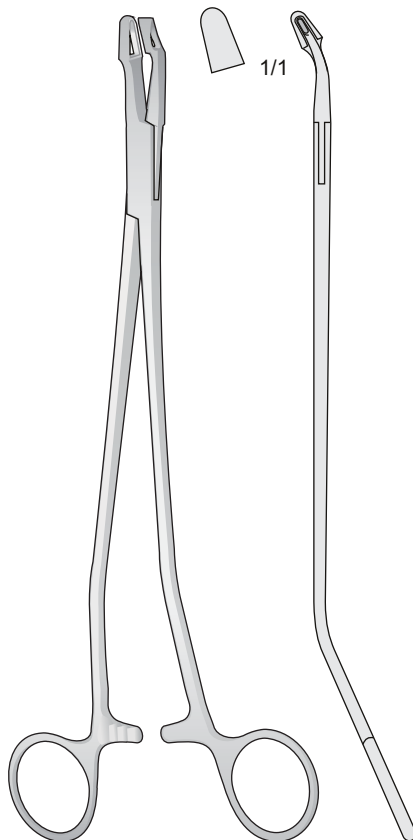

VAN DOREN
0606-DL
250 mm

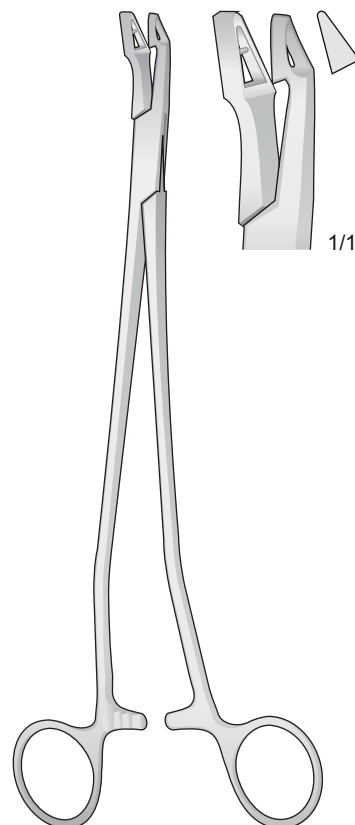

VAN DOREN
0606-DI
240 mm

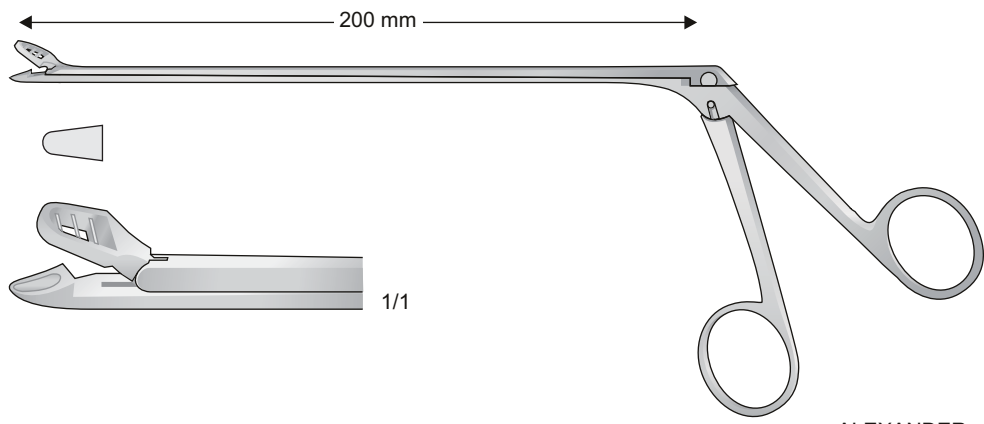

ALEXANDER
0606-GE

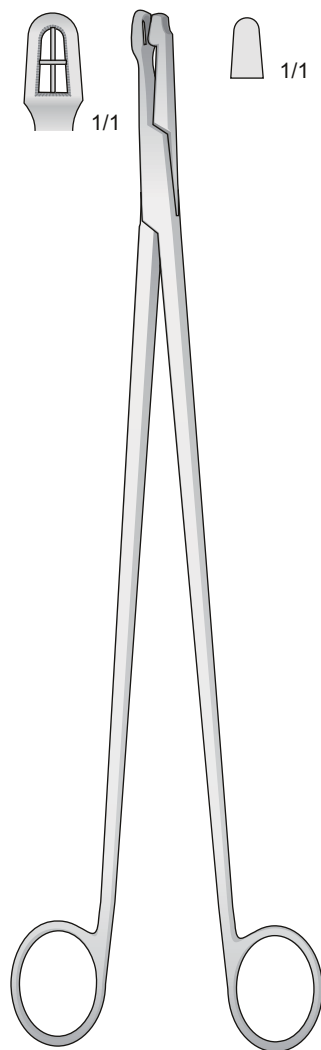

SCHUBERT
0606-DF 210 mm
0606-DG 290 mm

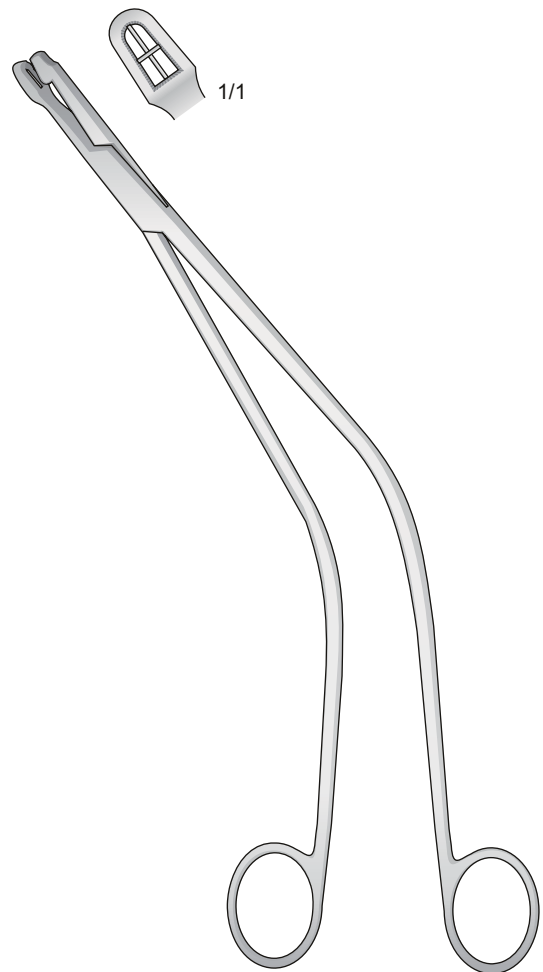

SCHUBERT
0606-DH
260 mm

Pinze per biopsie

Biopsy forceps

Biopsiezangen

Pinces à biopsies

Pinzas para biopsia

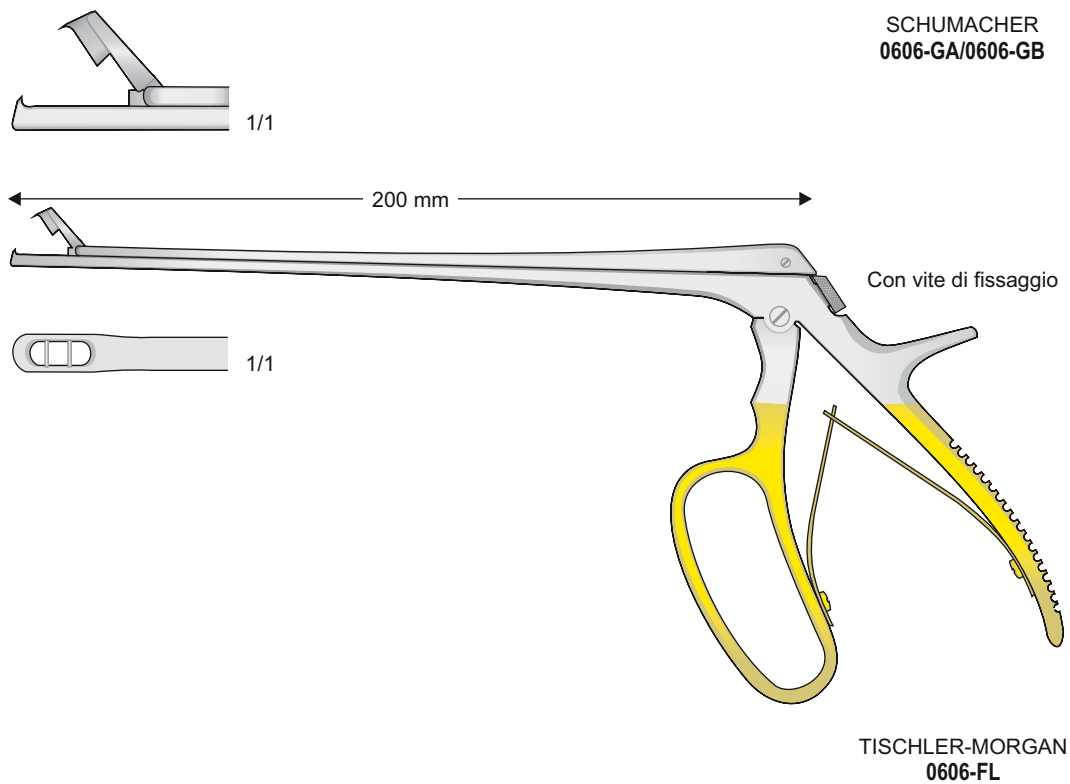
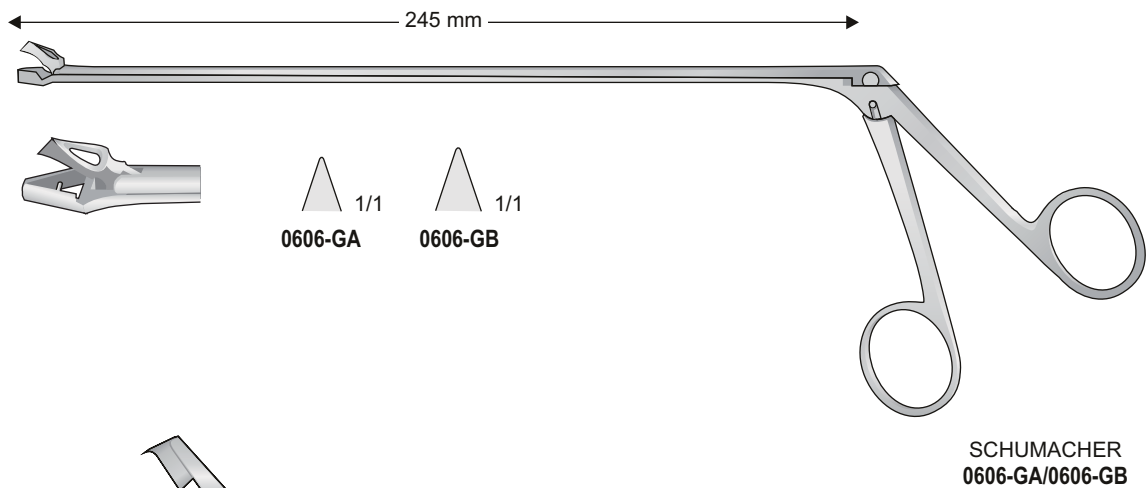
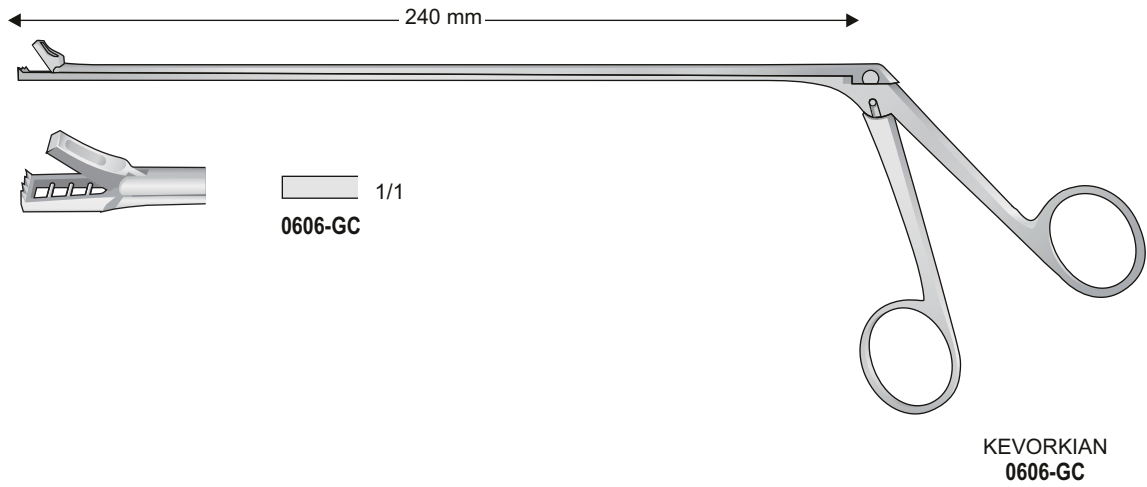

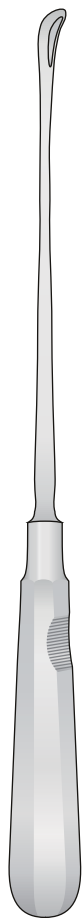

LUER-KÖRTE
0502-CB/0502-CD
260 mm

5,5 mm

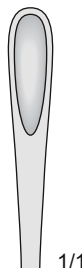

0502-CB
1/1

7 mm

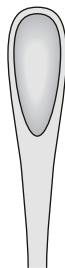

0502-CC
1/1

11 mm

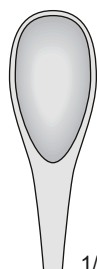

0502-CD
1/1

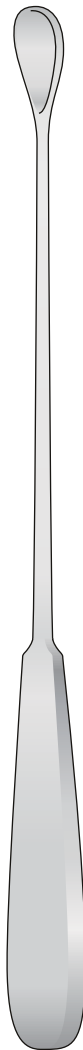

GOURDET
0517-IA/0517-IE
280 mm

Smusse - Blunt
Stumpf - MousSES
Romo

6 mm

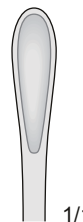

0517-IA
1/1

8 mm



0517-IB
1/1

10 mm



0517-IC
1/1

12 mm



0517-ID
1/1

14 mm



0517-IE
1/1

Curette uterine

Uterine curettes

Uterusküretten

Utérines curettes

Curetas uterinas

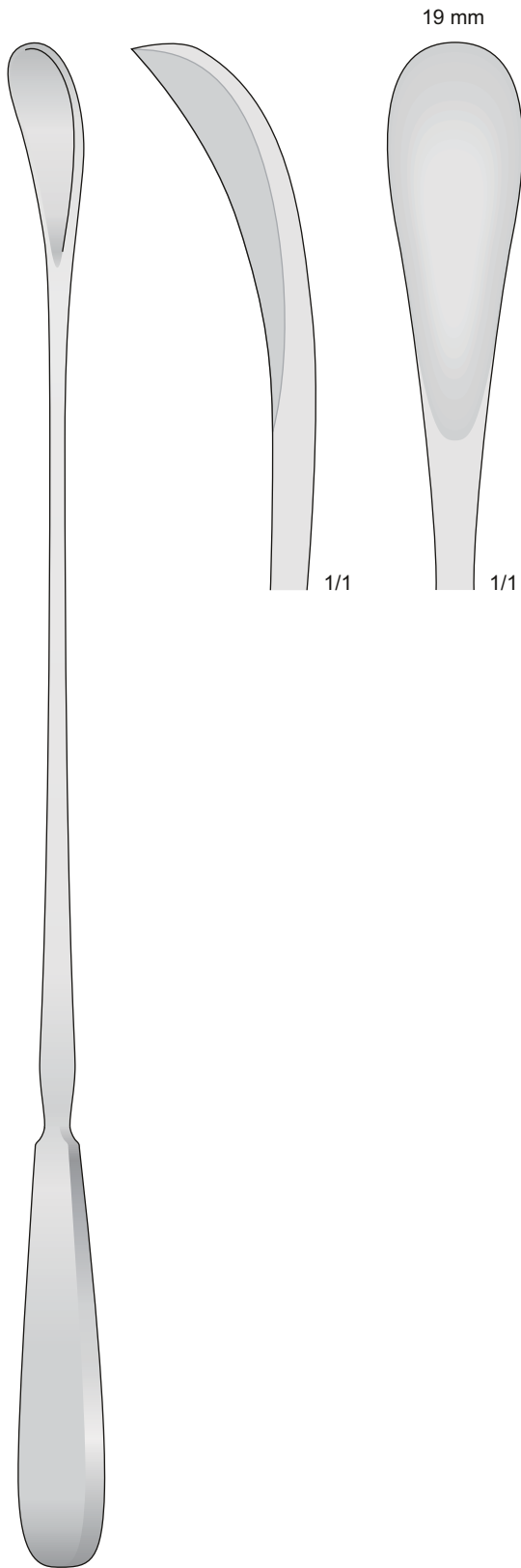

WALLICH
0517-LA
420 mm

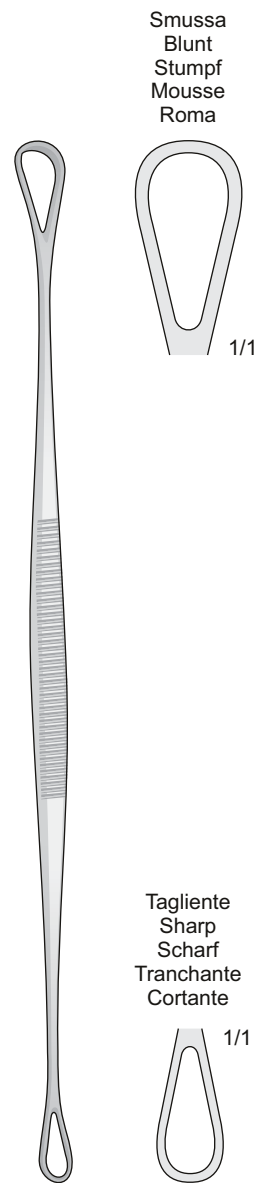

BLAKE
0517-II
275 mm

Tagliente
Sharp
Scharf
Tranchante
Cortante

Taglienti
Scharp
Scharf
Tranchantes
Cortantes

Smussa
Blunt
Stumpf
Mousse
Romas

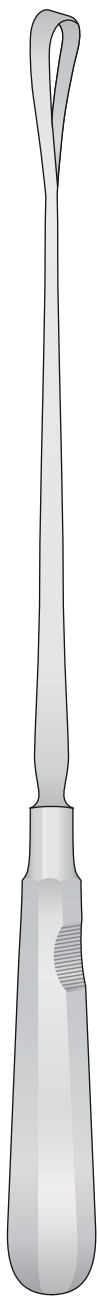

RECAMIER
0517-BB/0517-CI
310 mm

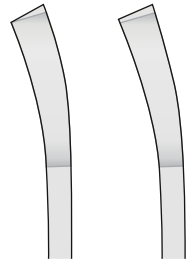
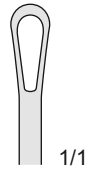
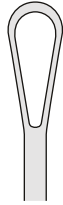

Fig. 1



1/1

Fig. 2



1/1

Fig. 3



1/1

Fig. 4

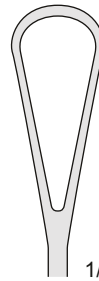

1/1

Fig. 5

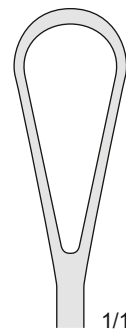

1/1

Fig. 6

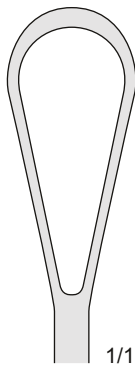

1/1

Fig. 7

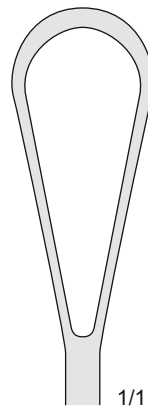

1/1

Fig. 8

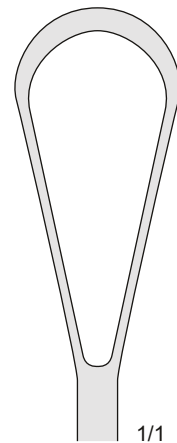

1/1

Fig.	Larghezza Width Breite	Taglienti-rigide Sharp-rigid Scharf-fest Tranchantes-rigides Cortantes-rigidas	Smusse-rigide Blunt-rigid Stumpf-fest Mousse-rigides Romas-rigidas
1	4 mm	0517-BB	0517-CB
2	6 mm	0517-BC	0517-CC
3	8 mm	0517-BD	0517-CD
4	10 mm	0517-BE	0517-CE
5	12 mm	0517-BF	0517-CF
6	14 mm	0517-BG	0517-CG
7	16 mm	0517-BH	0517-CH
8	18 mm	0517-BI	0517-CI

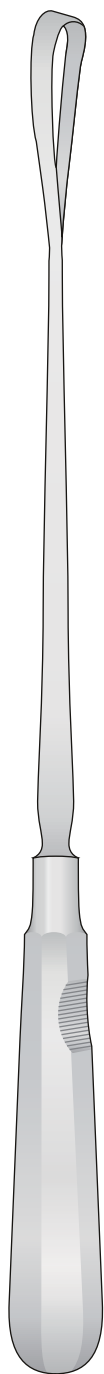

BUMM
0517-DB/0517-EC
310 mm

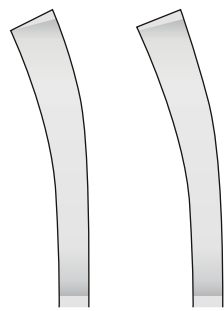

Tagliente
Scharp
Scharf
Tranchantes
Cortantes

Smussa
Blunt
Stumpf
Mousse
Romas

Malleabile
Malleable
Biegsam
Souples
Maleables

Fig. 3

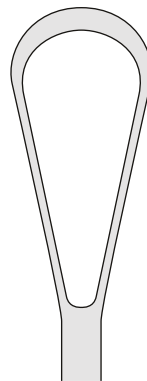
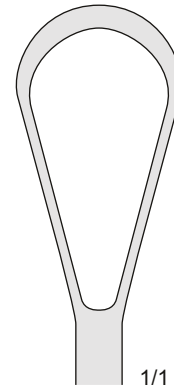

Fig. 4



1/1

Fig.	Larghezza Width Breite	Taglienti Sharp Scharf Tranchantes Cortantes	Smusse Blunt Stumpf Mousse Romas
3	18 mm	0517-DB	0517-EB
4	20 mm	0517-DC	0517-EC

Fig.	Larghezza Breite Width	Smusse malleabili - Blunt malleable Stumpf biegsam - Mousse malléables Romas maleables
0	16 mm	0517-BEA
1	18 mm	0517-BEB
2	19,5 mm	0517-BEC
3	21,5 mm	0517-BED
4	23,5 mm	0517-BEE
5	26 mm	0517-BEF
6	28,5 mm	0517-BEG

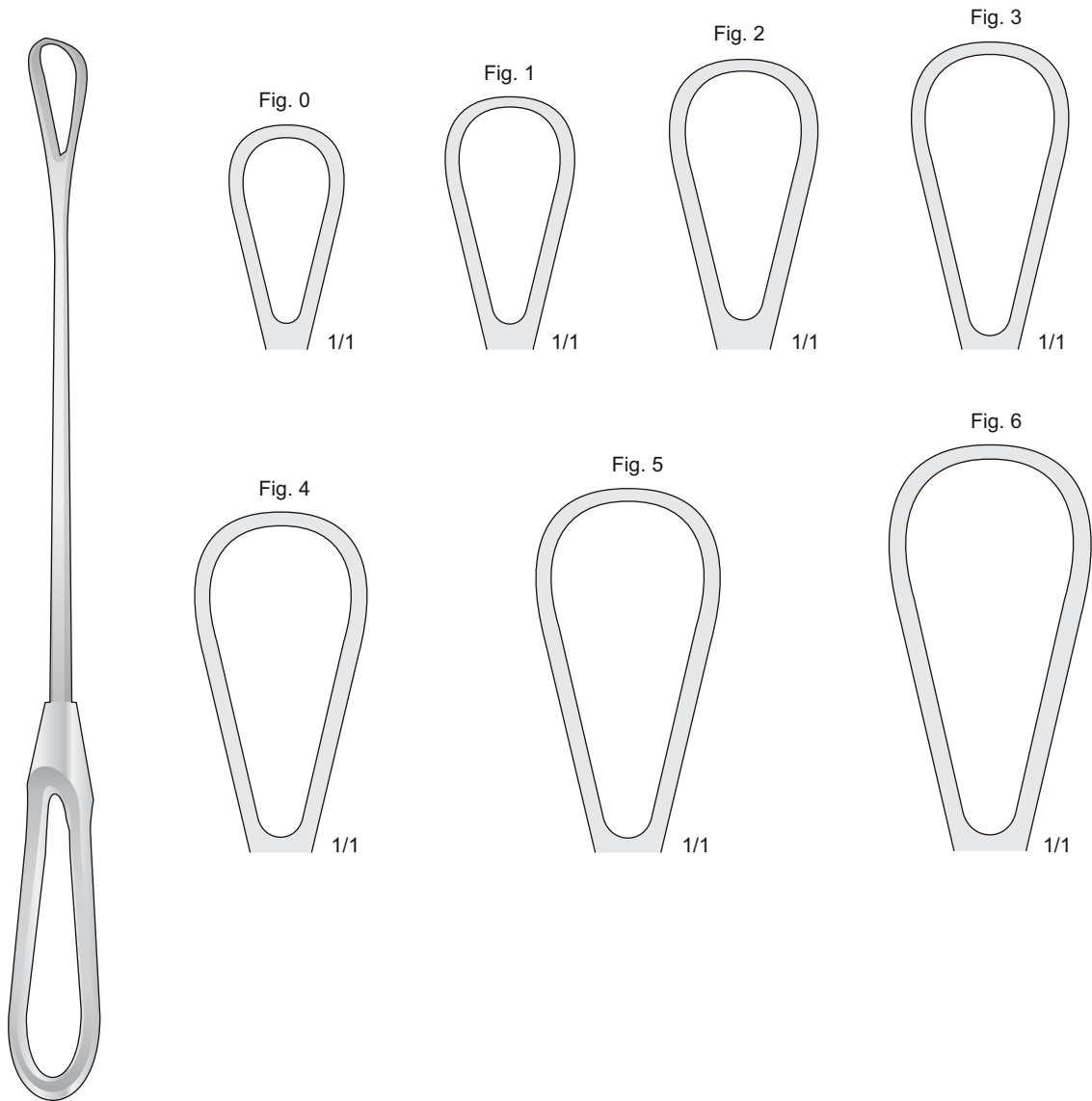

BUMM
0517-BEA/0517-BEG
290 mm

Speculum vaginali
e forcipe

Vaginal specule
and Midwifery forceps

Scheidenspekulum
und Geburtszange

Speculum
et forceps

Pinzas para el utero
y obstétricos

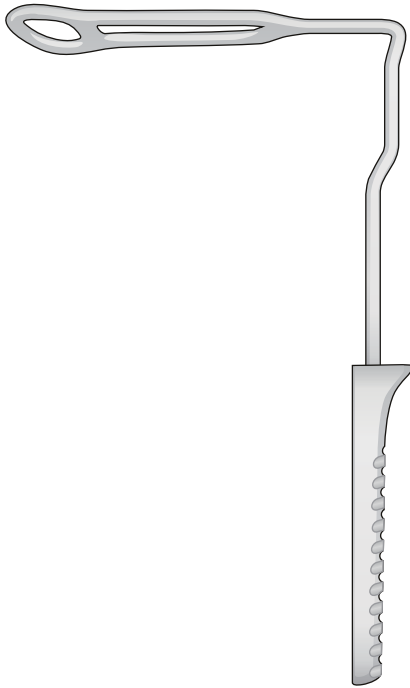

GENTOFT
0517-FA
210 mm

Set 2 pezzi
Set 2 pieces
Set 2 Stück
Set 2 pièces
Set 2 piezas
0517-FA + 0517-FB

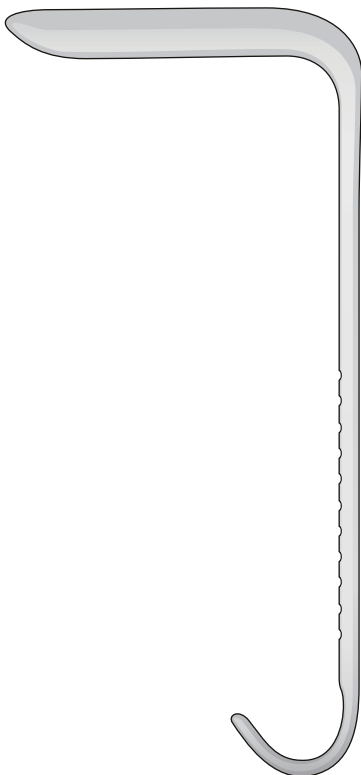

FENO
0517-FB
230 mm

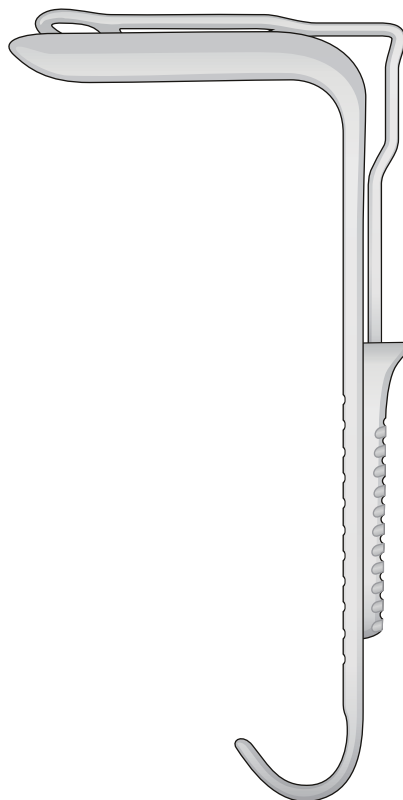

0517-FD
230 mm

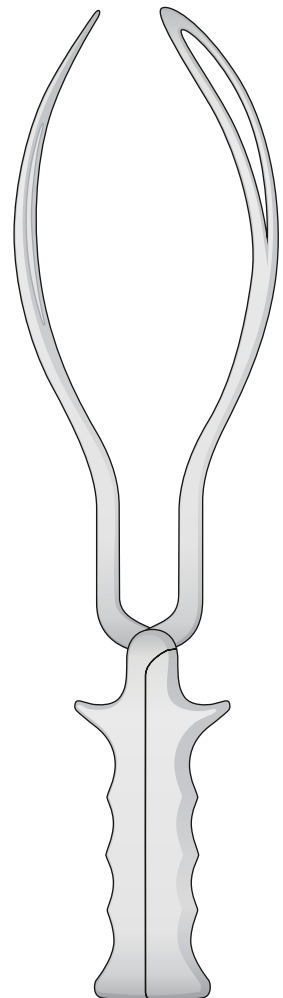

SIMPSON-BRAUN
0517-FC
365 mm

Katheter-Einführungsinstrumente
 Catheter introducing instruments
 Strumenti per tendere ed introdurre i cateteri
 Instrumentos para introducir catéteres
 Mandrin pour introduire les sondes

Ø 1,2 mm

Endospekula für Harnröhre und
 Cervix, ohne Sperre
 Endospecula for cervix and urethra,
 without ratchet

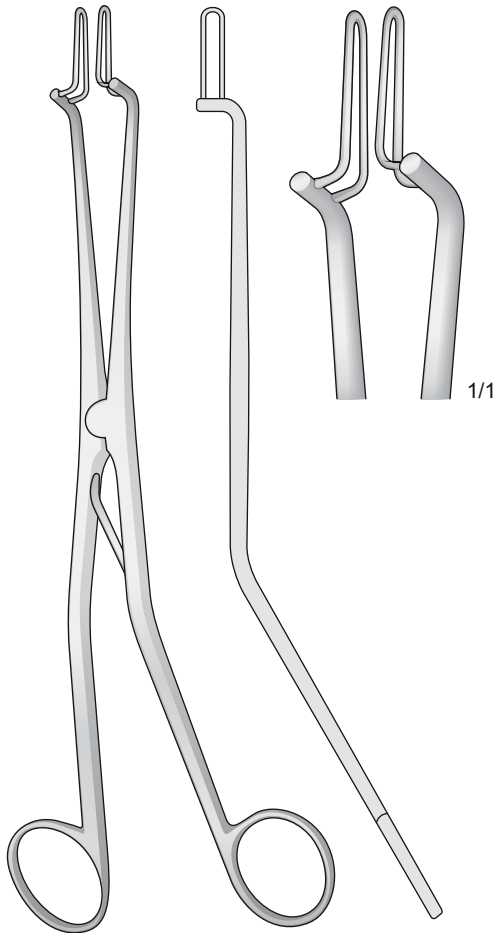

KOGAN
 0502-BBA
 240 mm

Endospekula für Harnröhre und
 Cervix, mit Skalensperre und Fixierschraube
 Endospecula for cervix and urethra,
 with scale-ratchet and fixing screws
 Con cremagliera a scala e vite di fissaggio
 Con cremallera graduada y tornillo de fijación
 Avec crémaillère à échelle et vis à fixation

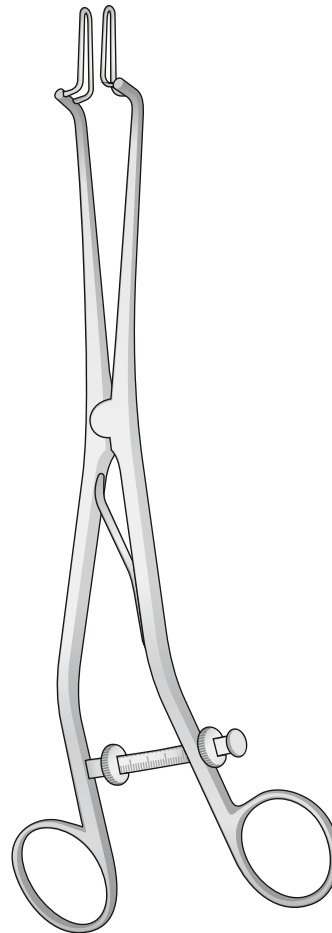

KOGAN
 0502-BBB
 240 mm

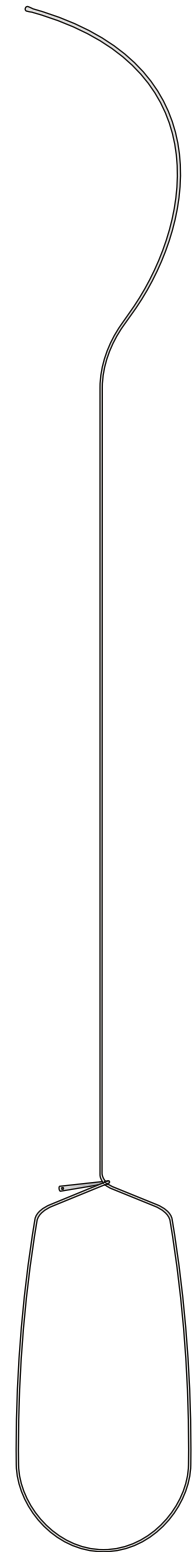

0501-LE
 425 mm

Scheidenspekula

Vaginal specula

Speculum vaginali

Espéculos vaginales

Spéculum vaginaux



Fig. 3

0502-BBL
90x40 mm

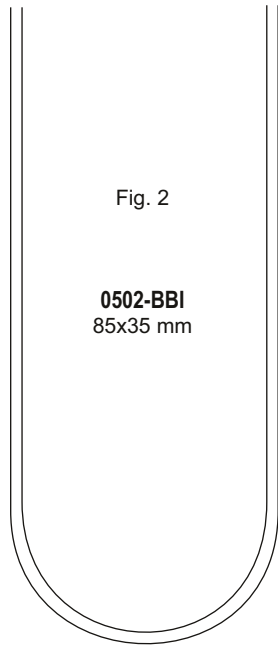

Fig. 2

0502-BBI
85x35 mm

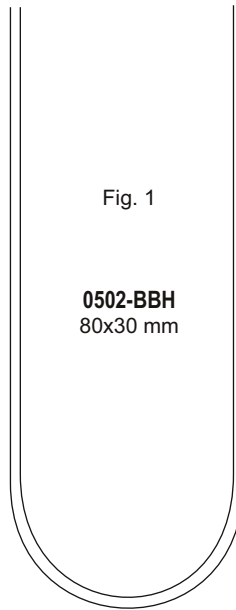
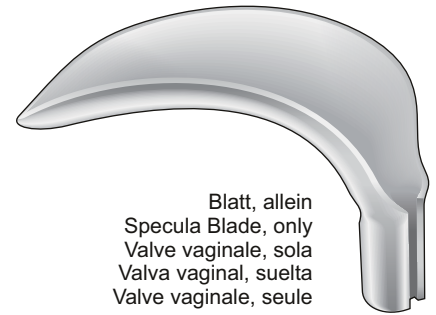

Fig. 1

0502-BBH
80x30 mm



Blatt, allein
Specula Blade, only
Valve vaginale, sola
Valva vaginal, suelta
Valve vaginale, seule

SCHERBAK
0502-BBH/0502-BBL

Blasenhalsperrer
Sounds Bladder
Dilatatore del collo vescicale
Sonda vesicales
Dilatateur pour le col vésical

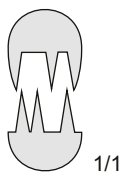
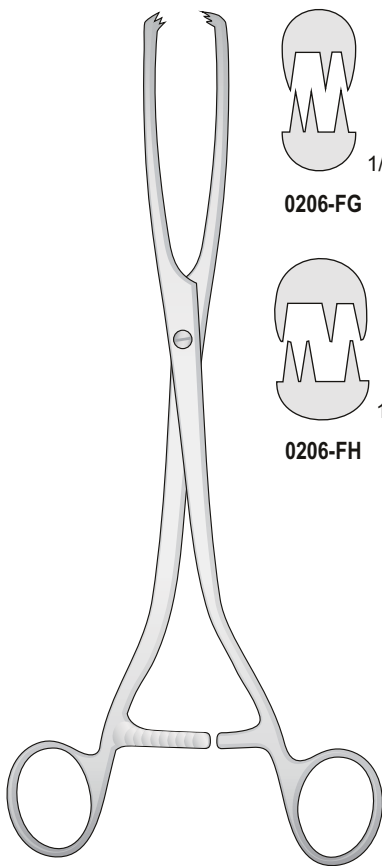

0206-FG

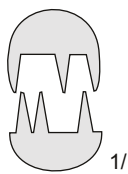

0206-FH

MUSEUX
0206-FG/0206-FH
265 mm

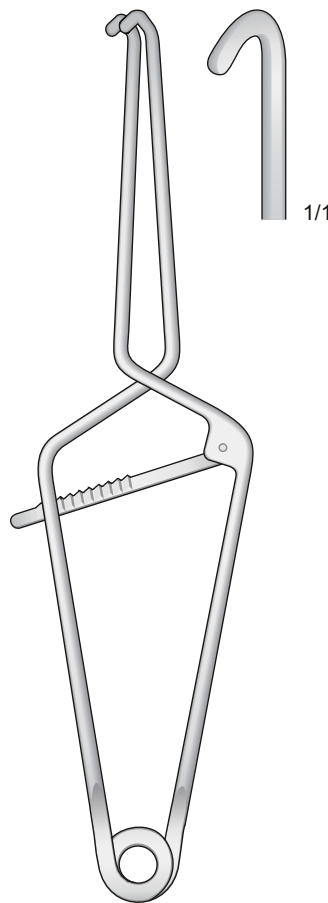

MILLIN
0502-BH
280 mm

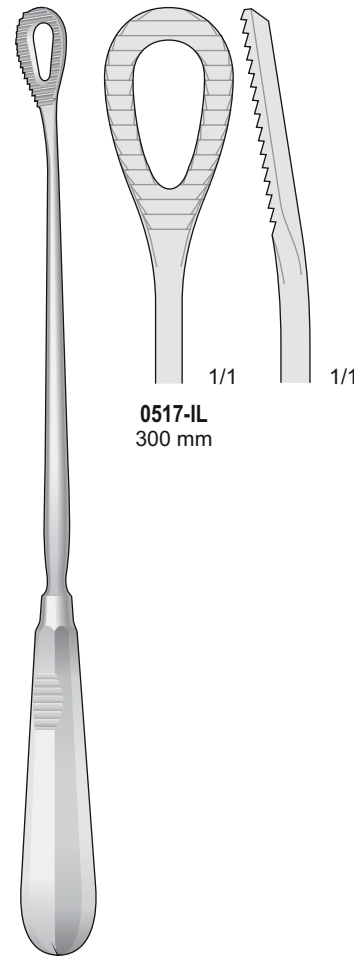

PESTALOZZA
0517-IL
300 mm

Biopsiekürette
Uterine Biopsy Curette
Curette per biopsia
Curettes para biopsia
Curettes pour biopsie

6,0 mm

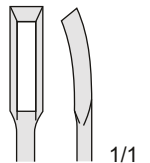

KEVORKIAN
0517-IH
300 mm

Vaginalspekula

Vaginal Specula

Specoli vaginali

Espéculos vaginales

Spéculum vaginaux

Gewicht zum Vaginalspekulum
Weight for Vaginal Speculum
Peso per specolo vaginale
Peso para espéculo vaginal
Poids pour spéculum vaginal

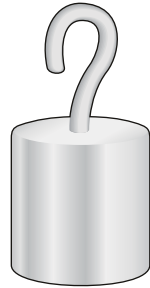

SCHERBAK
0502-CLE 10,5 mm 400 gr
0502-CLF 13 mm 800 gr

Blatt, allein
Specula Blade, only
Valve vaginale, sola
Valva vaginal, suelta
Valve vaginale, seule



SCHERBAK
0502-CLB/0502-CLC

Griff zum Vaginalspekulum
Handle for Vaginal Speculum
Manico per specolo vaginale
Mango para espéculo vaginal
Manche pour spéculum vaginal

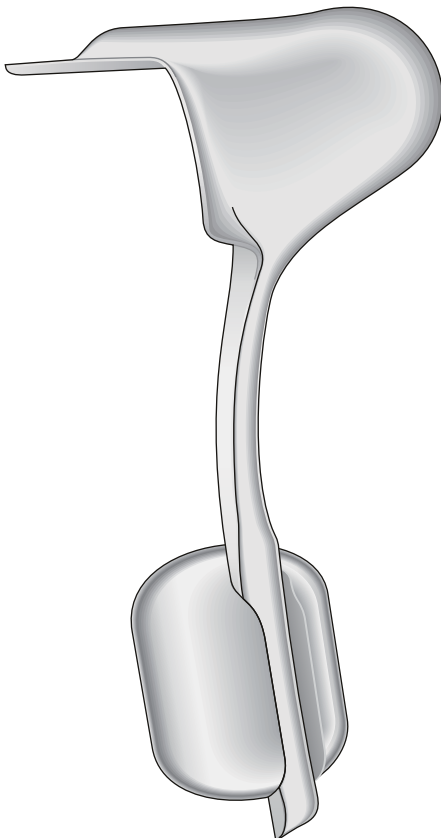

AUVARD
0502-CLA
230 mm



SCHERBAK
0502-CLD
200 mm

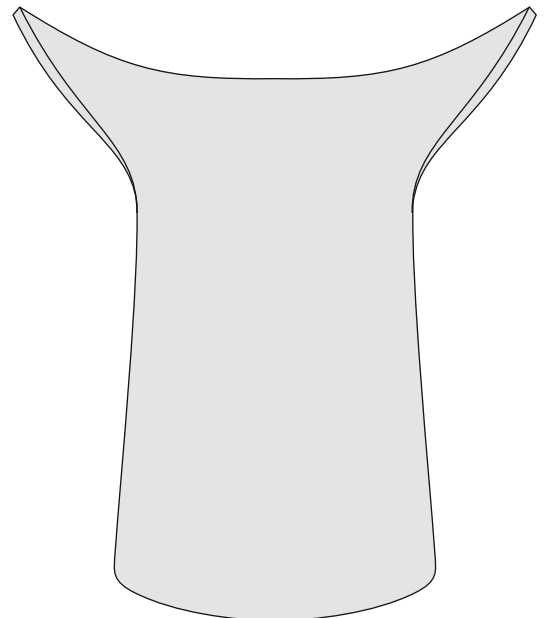

0502-CLC
81x45 - 70 mm

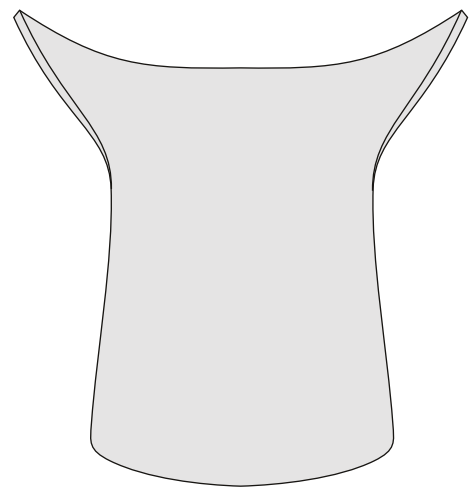

0502-CLB
62x40 - 60 mm

Geschwärzt
Surface Black-finish
Superficie anti-riflesso
Surface noircie



0517-FI
75 x 20 mm



0517-FL
100 x 22 mm



0517-GA
120 x 25 mm

0502-LE

Komplettset mit 14 Uterusdilatoren ohne Metalltui
Set con 14 dilatatori uterini senza scatola



0502-LF

Komplettset mit 26 Uterusdilatoren ohne Metalltui
Set con 26 dilatatori uterini senza scatola



0502-LG

Metalltui mit 14 Hegar Uterusdilatoren
Scatola con 14 dilatatori uterini Hegar



0517-BDE

Metalltui mit 13 Hegar Uterusdilatoren
Scatola con 13 dilatatori uterini Hegar

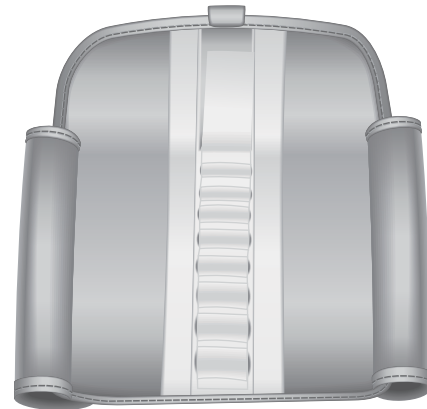

0517-BDD

mit 8 Uterusdilatoren
con 8 dilatatori uterini

0517-BDF

für 8 Uterusdilatoren
per 8 dilatatori uterini

0502-LH

Metalltui mit 26 Hegar Uterusdilatoren
Scatola con 26 dilatatori uterini Hegar

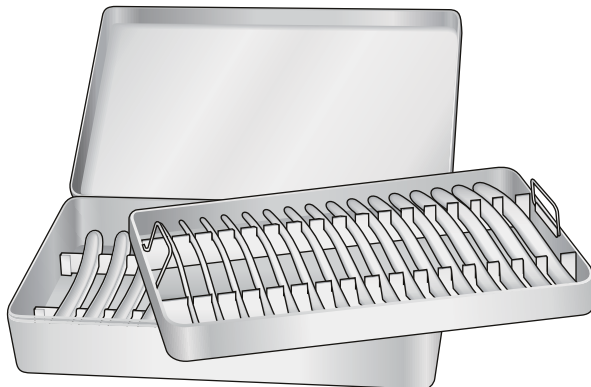

0218-BH

Metalltui leer für 26 Hegar Uterusdilatoren
Scatola vuota per 26 dilatatori uterini Hegar

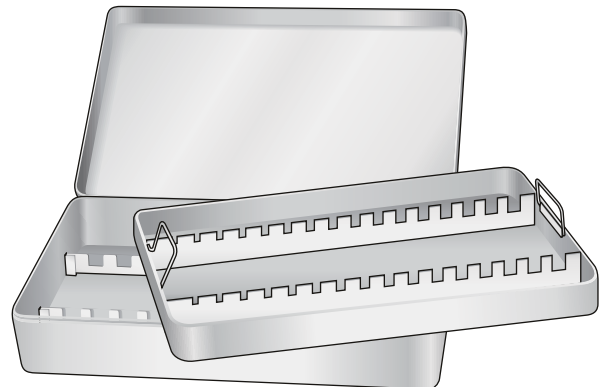

Uterusdepressor
Uterine Depressor
Depressore uterino
Depresor uterino
Dépresseur utérin



BRAUN
0517-HG
275 mm

Sterilisierzangen zum Fassen und
Halten Steriler Instrumente
Sterilizing forceps for picking
up and holding of sterile instruments
Pinze per prelevare strumenti sterilizzati
Pinzas para esterilización
Pincas pour instruments stérilisés

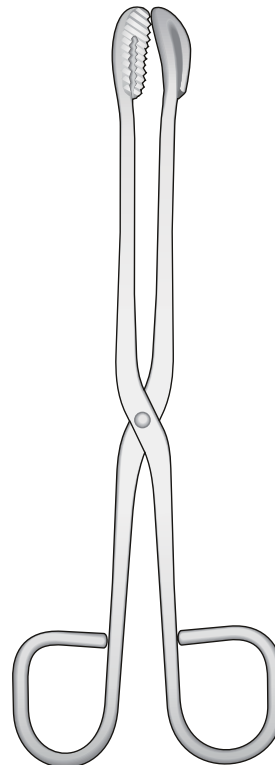

0718-BD 200 mm
0718-BE 300 mm



ideal-tek
manufacturer & supplier of precision instruments 

Ideal-tek SA
via Motta 4
6828 Balerna
Switzerland

Phone: +41 91 683 32 29
Fax: +41 91 683 03 71
E-mail: info@ideal-tek.com