

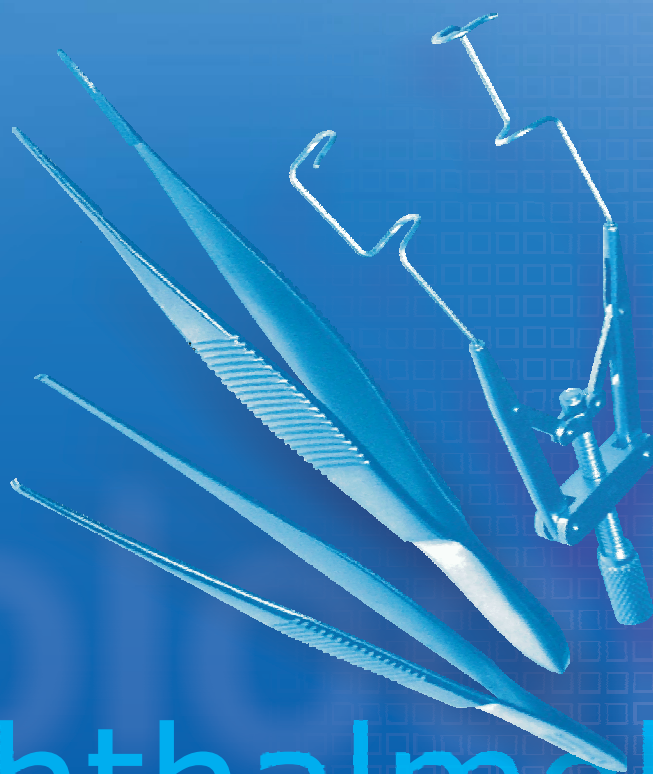

ideal-tek

manufacturer & supplier of precision instruments 



oftalmologia
chirurgie ophthalmic

ophthalmologie
ophthalmology

- Ophthalmologie
- Ophthalmology
- Oftalmologia
- Oftalmologia
- Ophthalmologie



Augenheilkunde
Ophthalmology
Oftalmologia
Oftalmologia
Ophthalmologie

Fremdkörpernadel - Foreign Body needle - Lancette per corpi estranei
Cuchillos para cuerpos extraños - Couteaux à corps étrangers

Spatel
Spatulas
Spatole
Espátulas
Spatules

Golf Club

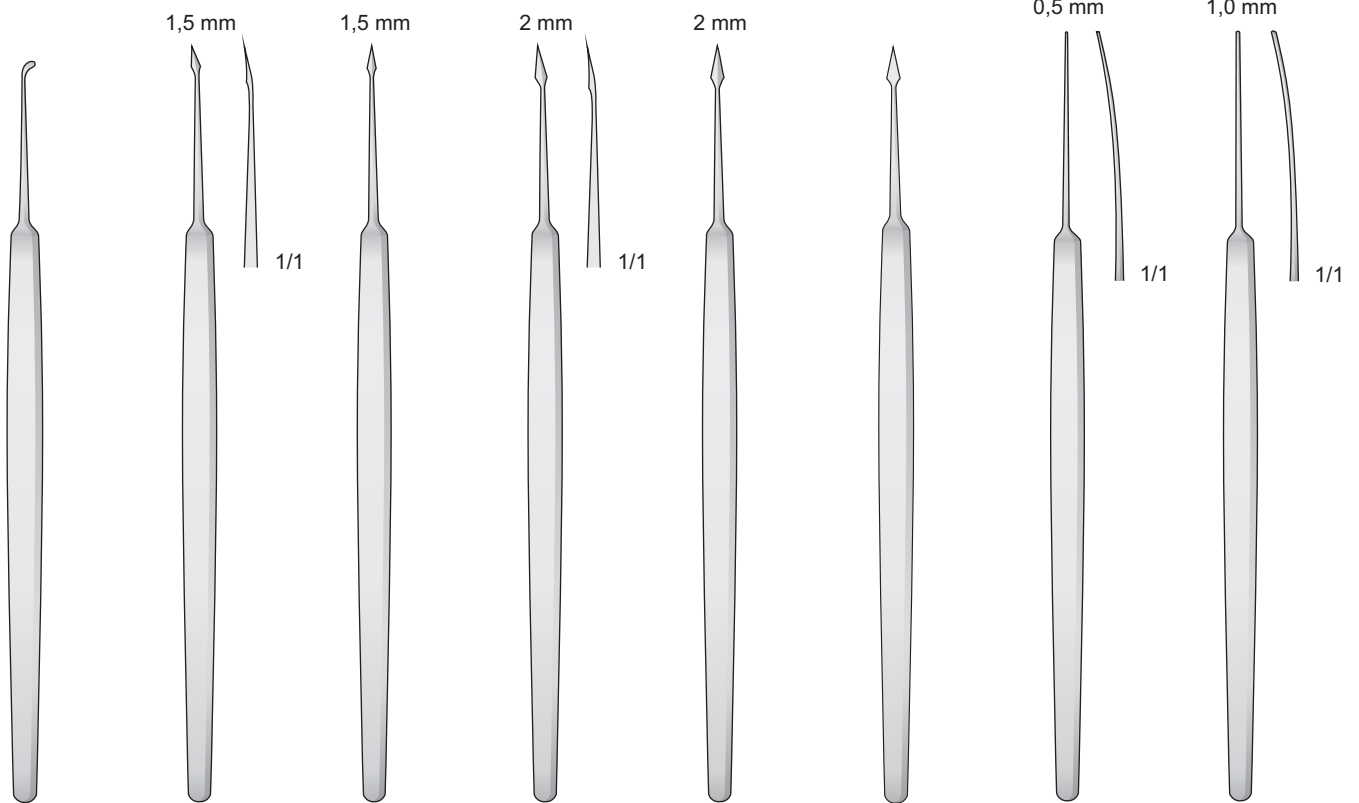

LA FORCE
1310-AL
120 mm

1310-BF
125 mm

1310-BL
125 mm

1310-BH
125 mm

1310-DL
125 mm

1310-EL
125 mm

1310-BAH
130 mm

1310-BAI
130 mm

Messer

Knives

Coltellini

Cuchillee

Couteaux

Starmesser
 Cataract Knives
 Coltellini per cataratta
 Cuchillos para cataratas
 Couteaux à cataracte

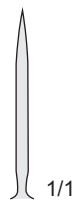

Gr. 0
 GRAEFE
1310-BEH
 35 mm

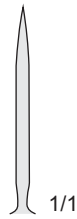

Gr. 1
 GRAEFE
1310-BEI
 35 mm

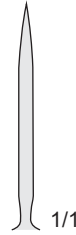

Gr. 2
 GRAEFE
1310-BEL
 35 mm

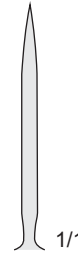

Gr. 3
 GRAEFE
1310-BFA
 35 mm

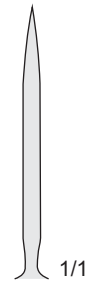

Gr. 4
 GRAEFE
1310-BI
 35 mm

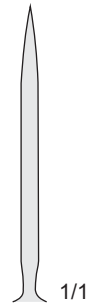

Gr. 5
 GRAEFE
1310-CA
 35 mm

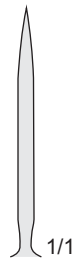

Gr. 1
 ARRUGA
1310-BFB

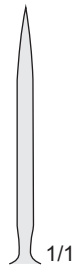

Gr. 2
 ARRUGA
1310-BFC

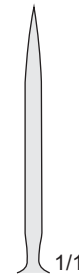

Gr. 3
 ARRUGA
1310-BFD

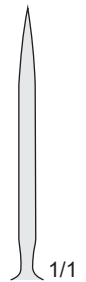

Gr. 4
 ARRUGA
1310-BFE

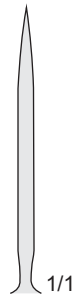

DEUTSCHMANN
1310-BFF

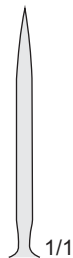

SMITH-GREEN
1310-BFG

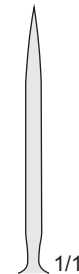

SMITH-GREEN
1310-BFH

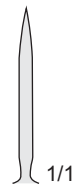

WHEELER
1310-BFI



1310-BI/1310-BFI
 140 mm



1310-DA/1310-EA

Fig. 2



1/1

1310-DA
120 mm

Fig. 3



1/1

1310-DC
125 mm

Fig. 4



1/1

1310-DE
130 mm

Fig. 7



1/1

1310-DG
120 mm

Fig. 8



1/1

1310-DG02
120 mm

Fig. 9



1/1

1310-DI
125 mm

Fig. 10



1/1

1310-EA
130 mm

Lanzenmesser

Keratomes

Cheratotomo

Querátomos

Kérátomes

Keratome-Lanze
Keratomes
Coltelli lanceolari
Cuchillos lanceolares
Couteaux lancéolaires

Gerade
Straight

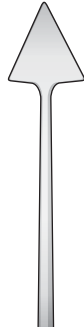

1310-BFL

Gerade
Straight

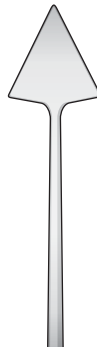

1310-BGA

Gerade
Straight

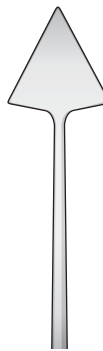

1310-BGB



Leicht Gebogen

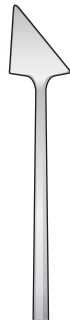

1310-BGC

Leicht Gebogen



1310-BGD

Leicht Gebogen

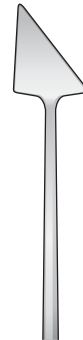

1310-BGE

Leicht Gebogen

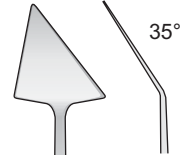

1310-BGF

Stark Gebogen

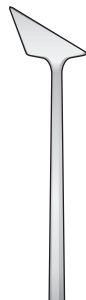

1310-BGG

Stark Gebogen

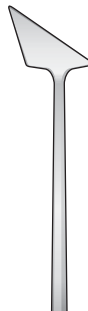

1310-BGH

Stark Gebogen

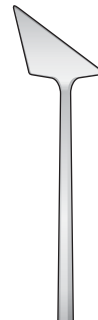

1310-BGI

Stark Gebogen

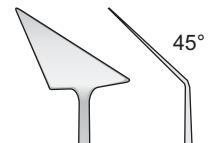

1310-BGL

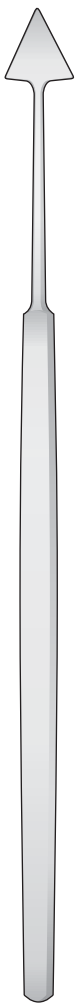

JAEGER
1310-BFL/1310-BGL

Lanzenmesser

Keratomes

Cheratotomo

Querátomos

Kérátomes

Mit Facettenschliff
 With facets along the cutting edge
 Con filo tagliente
 Con filos facetados
 Avec tranchant à facette

Gerade
Straight

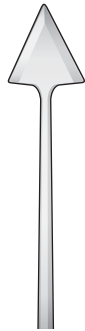

1310-BHA

Gerade
Straight

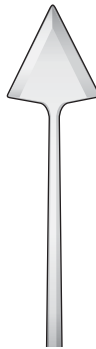

1310-BHB

Gerade
Straight

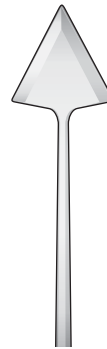

1310-BHC



Leicht Gebogen

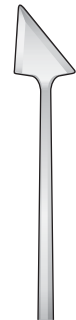

1310-BHD

Leicht Gebogen

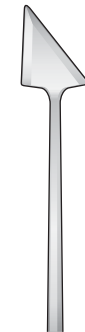

1310-BHE

Leicht Gebogen

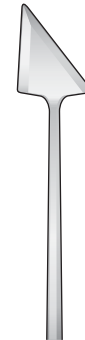

1310-BHF

Leicht Gebogen

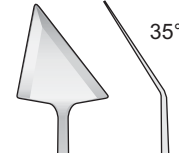

1310-BHG

Stark Gebogen

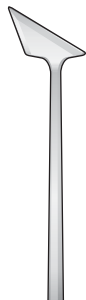

JAEGER-GRIESHABER
1310-BHH
1,4 mm

Stark Gebogen

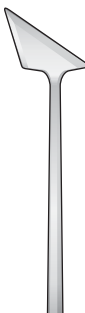

JAEGER-GRIESHABER
1310-BHI
2,5 mm

Stark Gebogen

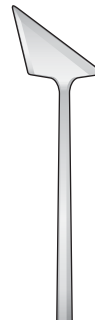

JAEGER-GRIESHABER
1310-BHL
3,6 mm

Stark Gebogen

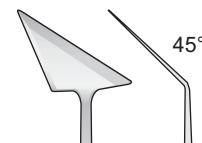

JAEGER-GRIESHABER
1310-BIA
4,7 mm

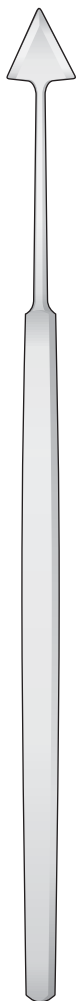

JAEGER-GRIESHABER
1310-BHA/1310-BIA

Messer

Knives

Coltellini

Cuchillee

Couteaux

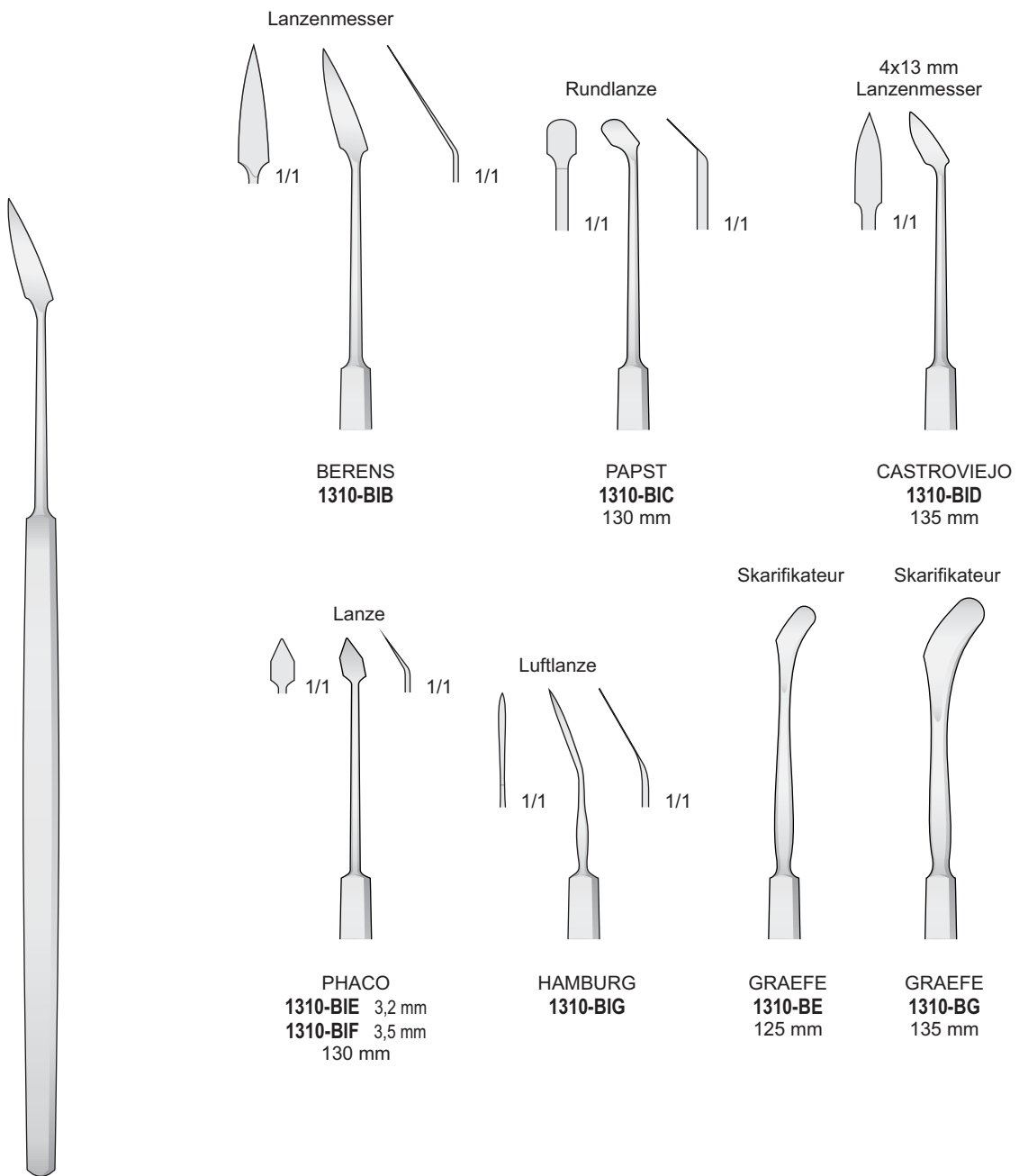

1310-BE/1310-BIF

Tränenfistelmesser



WEBER
1310-BIH

Tränenfistelmesser

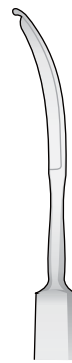

WEBER
1310-BII

Tränenfistelmesser

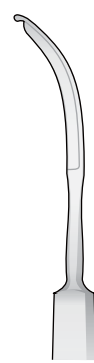

WEBER
1310-BIL

Irismesser



KNAPP
1310-BLA

Irismesser



KNAPP
1310-BLB

Irismesser



KNAPP
1310-BLC

Irismesser



ZIEGLER
1310-BLD
3 mm

Irismesser



ZIEGLER
1310-AG
5 mm

Irismesser



ZIEGLER
1310-AI
6 mm

Irismesser



ZIEGLER
1310-BA
7 mm



1310-AG/1310-BLD

Messer

Knives

Coltellini

Cuchillee

Couteaux

Nachstarmesser



KUHNT
1310-BLE

Nachstarmesser



KUHNT
1310-BLF

Irismesser
3,5 mm



ZIEGLER
1310-BLG
110 mm

Hornhautmesser

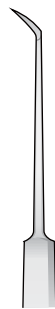

SATO
1310-BLH
120 mm

Irismesser



WECKER
1310-BLI

Irismesser



SICHEL
1310-BLL
130 mm

Irismesser



HAAB
1310-CAA

Irismesser



GRAEFE
1310-CAB
130 mm



1310-BLE/1310-CAB

Hornhautschaber - Corneal Scarifier
 Scarificatore corneale - Legra para la córnea - Rugine pour la cornée



KUHNT
1310-CAC
 120 mm
 Fig. 1



KUHNT
1310-CAD
 120 mm
 Fig. 2



KUHNT
1310-CAE
 120 mm
 Fig. 3



KUHNT
1310-CAF
 120 mm
 Fig. 4

Hornhautdissektor
 Corneal Dissector
 Dissettore corneale
 Disecador para la córnea
 Dissecteur cornéal



PATON
1310-CAG
 120 mm



TOOK
1310-CAH
 120 mm

Hornhautmesser
 Corneal Knife
 Coltello corneale
 Cuchillo para la córnea
 Couteau cornéal



DESMARRES
1310-LF
 135 mm

Hornhautmesser
 Corneal Knife
 Coltello corneale
 Cuchillo para la córnea
 Couteau cornéal



DESMARRES
1310-LG
 135 mm

Hornhautmesser
 Corneal Knife
 Coltello corneale
 Cuchillo para la córnea
 Couteau cornéal



DESMARRES
1310-CBA
 135 mm

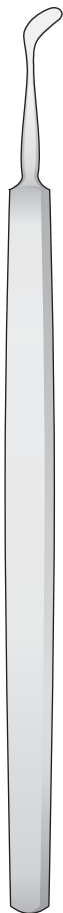

1310-CAC/1310-CBA

Messer

Knives

Coltellini

Cuchillee

Couteaux



1310-CBB/1310-CBG

Hornhautmesser
Corneal Knife
Coltello corneale
Cuchillo para la córnea
Couteau corneal



Gebogen
Curved
Curvo
Curvas
Courbes

GILL
1310-CBB
120 mm

Synechiotom
Links
Left
Sinistro
A la izquierda
À Gauche

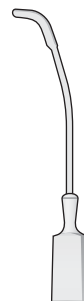

AXENFELD
1310-CBC

Synechiotom
Rechts
Right
Destra
A la derecha
À Droite

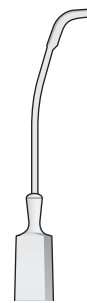

AXENFELD
1310-CBD

Messer



ANDERSON-CRITCHETT
1310-CBE
130 mm

Sklerotom

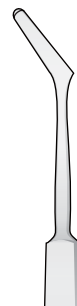

GUYTON-LUNDSGAARD
1310-CBF

Sklerarmesser
Scleral Knife



BONN
1310-CBG

Messer

Knives

Coltellini

Cuchillee

Couteaux

Irismesser



**BARKAN
1310-CBH**
120 mm

Irismesser



**SCHEIE
1310-CBI**
130 mm

Fixierspieß
Fixation Fork



**BURCH
1310-CBL**
125 mm

Cataract needle



**STARNADEL
1310-CCA**

Gerade, Klein
Straight, Small

Cataract needle



**STARNADEL
1310-CCB**

Gebogen, Klein
Curved, Small

Diszisionsnadel
Discission needle
Ago da discissione
Aguja para discisión
Aiguille à discision



**BOWMANN
1310-CCC**

Gerade
Straight
Diritto
Recta
Droit

Diszisionsnadel
Discission needle
Ago da discissione
Aguja para discisión
Aiguille à discision



**BOWMANN
1310-CCD**

Gebogen
Curved
Curvo
Curvas
Courbes



1310-CBH/1310-CCD

Messer

Knives

Coltellini

Cuchillee

Couteaux

Fremdkörperinstrumente - Foreign Body instruments
 Strumenti per corpi estranei - Instrumentos para cuerpos extraños
 Instruments à corps étrangers

Fremdkörpernadel
 Foreign Body needle
 Ago per corpi estranei

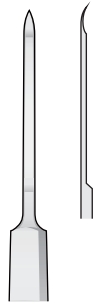

SCHWEIZER
1310-CCE
 120 mm

Fremdkörpernadel
 Foreign Body needle
 Ago per corpi estranei

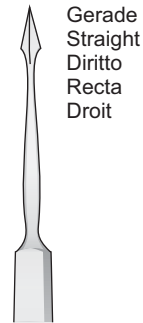

1310-CCF
 130 mm

Fremdkörpernadel
 Foreign Body needle
 Ago per corpi estranei

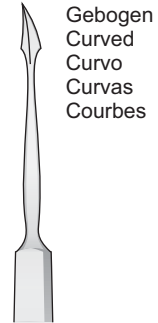

1310-CCG
 130 mm

Fremdkörpernadel
 Foreign Body needle
 Ago per corpi estranei

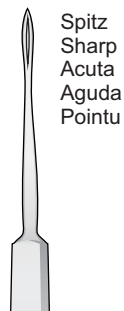

LEVINSON
1310-CCH
 130 mm

Fremdkörpernadel
 Foreign Body needle
 Ago per corpi estranei

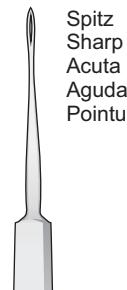

ALVIS
1310-CCI
 120 mm

Fremdkörperhaken
 Foreign Body Hook
 Uncino per corpi estranei



FRANCIS
1310-CCL
 120 mm

Fremdkörpernadel
 Foreign Body needle
 Ago per corpi estranei



ELLIS
1310-AH
 120 mm

Fremdkörpernadel
 Foreign Body needle
 Ago per corpi estranei



PLANGE
1310-CDA
 120 mm

Flachmeißel
 Foreign Body Chisel
 Scalpello per corpi estranei



NICATI
1310-CDB
 120 mm

1310-AH/1310-CDB











Messer

Knives

Coltellini

Cuchillee

Couteaux

	<p>Hohlmeißel Gouge Sgorbia Gubias Gouge</p>  <p>Spitz Sharp Acuta Aguda Pointu</p> <p>WALTON 1310-CDC</p>	<p>Hohlmeißel Gouge Sgorbia Gubias Gouge</p>  <p>Rund Round Rotonda Redonda Rond</p> <p>WALTON 1310-CDD</p>		<p>Cystotom Cystotome Cistotomo Quistótomo Kistitome</p>  <p>Gerade Straight Diritto Recta Droit</p> <p>GRAEFE 0219-BA</p>	<p>Cystotom, Links Cystotome, Left Cistotomo, Sinistro Quistótomo, A la izquierda Kistitome, A gauche</p>  <p>Gebogen Curved Curvo Curvas Courbes</p> <p>GRAEFE 0219-BC</p>
	<p>Hohlmeißel Gouge Sgorbia Gubias Gouge</p>  <p>Rund Round Rotonda Redonda Rond</p> <p>WALTON 1310-CDE</p>	<p>Meißel Spud Scalpello Cinceles Ciseaux-burin</p>  <p>3,0 mm 1/1</p> <p>ROLLET 1310-CDF</p>		<p>Cystotom Cystotome Cistotomo Quistótomo Kistitome</p>  <p>Biegsam Malleable Malleabile Maleable Souple</p> <p>BECKER 0219-BD</p>	<p>Cystotom, Rechts Cystotome, Right Cistotomo, Destro Quistótomo, A la derecha Kistitome, A droite</p>  <p>Gebogen Curved Curvo Curvas Courbes</p> <p>GRAEFE 0219-BE</p>

1310-CDC/1310-CDF
120 mm

0219-BA/0219-BE
130 mm

Instrumentarium für die Staroperation
 Instruments for cataract operations
 Strumenti per cataratta
 Instrumental para operación de cataratas
 Instrumentation pour opérations de cataracte

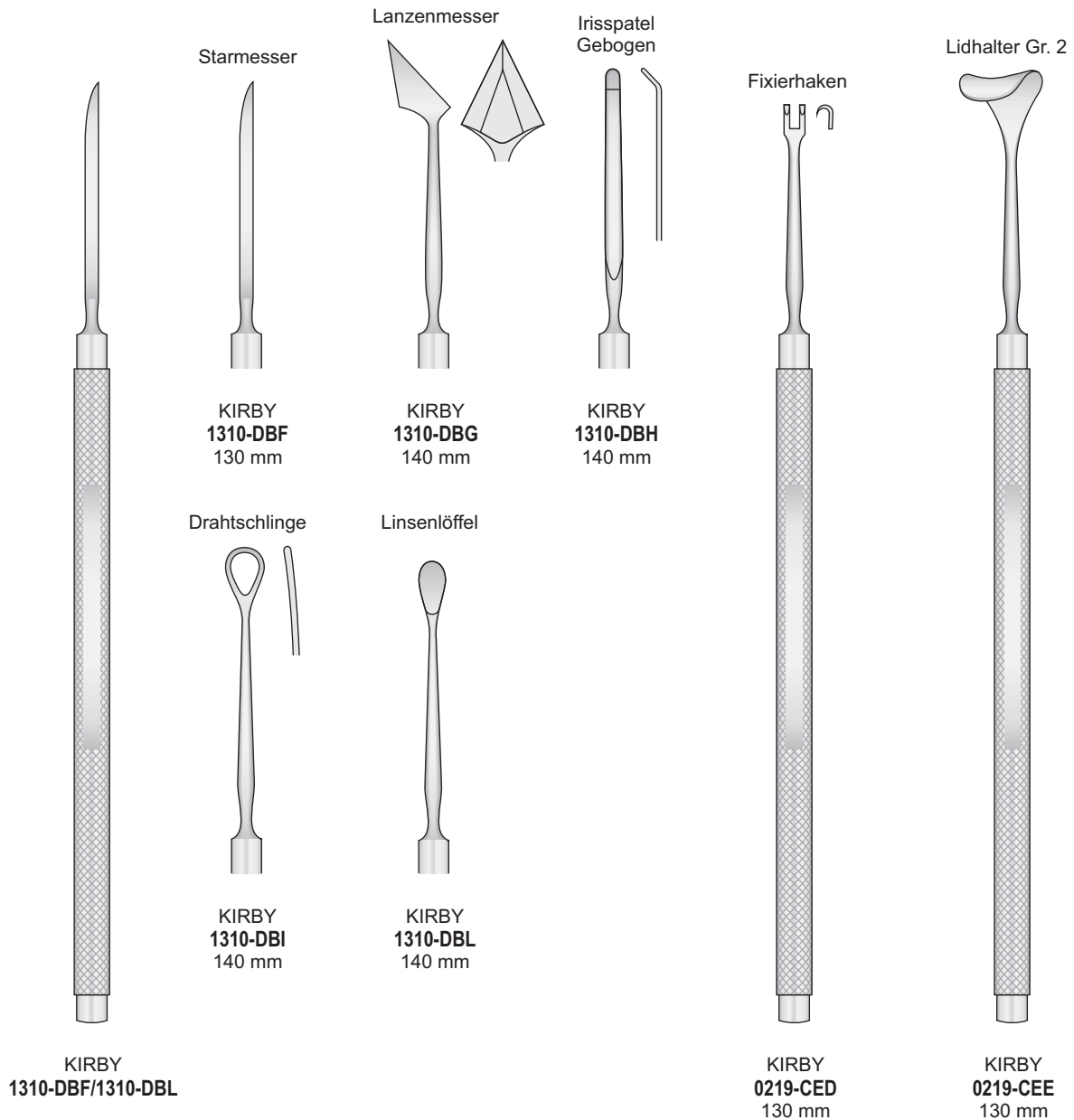

Keratoplastikmesser
Keratoplasty Knives
Bisturi per cheratoplastica
Cuchillo para queratoplástica
Couteau kératoplastique

Keratoplastikmesser
Keratoplasty Knives



PAUFIQUE
1310-DCD
105 mm

Keratoplastikmesser
Rund
Keratoplasty Knives

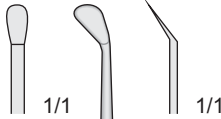

BARRAQUER
1310-DCE
130 mm

Keratoplastikmesser
Keratoplasty Knives
7 x 1 mm



BARRAQUER
1310-DCF
130 mm

Fremdkörper - Doppelinstrument
 Foreign Body Instruments
 Strumenti per corpi estranei
 Instrumentos para cuerpos extraños
 Instruments à corps étrangers

Runder Schiebegriff
 Round sliding handle
 Manico rotondo
 terminali scorrevoli
 Mango redondo corredizo
 Manche rond à glissière

Nadel / Flachmeißel
 Needle / Spud
 Ago / scalpello
 Agujas / Cinceles
 Aiguilles / Ciseaux-burin



DIX
 1310-DII
 95 mm

Runder Schiebegriff
 Round sliding handle
 Manico rotondo
 terminali scorrevoli
 Mango redondo corredizo
 Manche rond à glissière

Nadel / Plangespatel
 Needle / Spatula
 Ago / spatola
 Agujas / Espátula
 Aiguilles / Spatule



DIX
 1310-DIL
 95 mm

Runder Schiebegriff
 Round sliding handle
 Manico rotondo
 terminali scorrevoli
 Mango redondo corredizo
 Manche rond à glissière

Nadel / Hohlmeißel
 Needle / Gouge
 Ago / sgorbia
 Agujas / Gubias
 Aiguilles / Gouge



DIX
 1310-DLA
 95 mm

Plastikmesser
Plastic-Surgery Knife
Bisturi per chirurgia plastica
Cuchillo para cirugia plàstica
Couteau pour plastiques

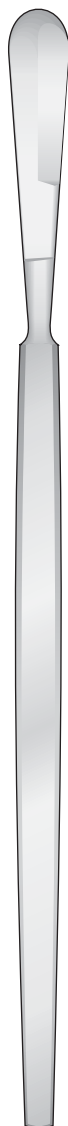

BLASCOVICS
1310-DCL

Plastikmesser
Plastic-Surgery Knife
Bisturi per chirurgia plastica
Cuchillo para cirugia plàstica
Couteau pour plastiques



ELSCHNIG
1310-DDA

Fadenlösemesser
Knife for removal of sutures
Bisturi per rimozione di suture



1310-DBB

Messer

Knives

Coltellini

Cuchillee

Couteaux

Fremdkörper - Doppelinstrument
 Foreign Body Instruments
 Strumenti per corpi estranei
 Instrumentos para cuerpos extraños
 Instruments à corps étrangers

Nadel, allein
 Needle only
 Ago, solo
 Aguja suelta
 Gouge seule

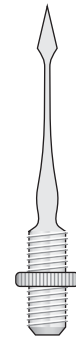

DIX
 1310-DLF

Flachmeißel, allein
 Spud only
 Scalpello, solo
 Cincel suelto
 Ciseaux-burin seuls

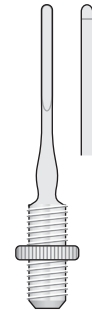

DIX
 1310-DLG

Hohlmeißel, allein
 Gouge only
 Sgorbia, sola
 Gubia suelta
 Gouge seule

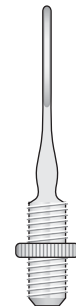

DIX
 1310-DLH

Nadel und Flachmeißel, umschraubbar
 Needle and Spud, in reversible screw-handle
 Ago e scalpello con manico reversibile
 Aguja y Cincel, reversible, con rosca
 Aiguille et Ciseaux-burin, rentrant dans le manche



DIX
 1310-DLD

Nadel und Hohlmeißel, umschraubbar
 Needle and Gouge, in reversible screw-handle
 Ago e Sgorbia con manico reversibile
 Aguja y Gubia, reversible, con rosca
 Aiguille et Gouge, rentrant dans le manche



DIX
 1310-DLE

Chalazionslöffel

Chalazion Curettes

Cucchiai da calazio

Cucharillas para chalazión

Curettes à chalazion

0,5 mm



1310-CIG
130 mm

1,0 mm



1310-CIH
130 mm

1,5 mm



1310-CII
130 mm

Löffel



MEYHOEFER
1310-CIG/1310-CLF
130 mm

1,8 mm



1310-CIL
130 mm

2,0 mm



1310-CLA
130 mm

2,5 mm



1310-CLB
130 mm

3,0 mm



1310-CLC
130 mm

3,5 mm



1310-CLD
130 mm

4,0 mm



1310-CLE
130 mm

4,5 mm



1310-CLF
130 mm

Chalazionslöffel

Chalazion Curettes

Cucchiai da calazio

Cucharillas para chalazión

Curettes à chalazion

Löffel
1,0 mm



HEBRA
1310-CLG
130 mm

Löffel
2,0 mm



HEBRA
1310-CLH
130 mm

Löffel
2,5 mm



HEBRA
1310-CLI
130 mm

Löffel
3,0 mm



HEBRA
1310-CLL
130 mm

Löffel
3,5 mm

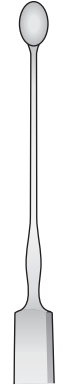

HEBRA
1310-DAA
130 mm

Löffel
1,5 mm



SKEELE
1310-DAB
130 mm

Löffel
2,0 mm



SKEELE
1310-DAC
130 mm

Löffel
2,5 mm



SKEELE
1310-DAD
130 mm

Löffel
3,0 mm



SKEELE
1310-DAE
130 mm



1310-CLG/1310-DAE
130 mm

Löffel

Spoons

Cucchiai

Cucharillas

Curettes

Exenterations Löffel
 Enucleation Spoon
 Cucchiai da enucleazione
 Cucharillas para exenteración
 Curettes pour l'exentération

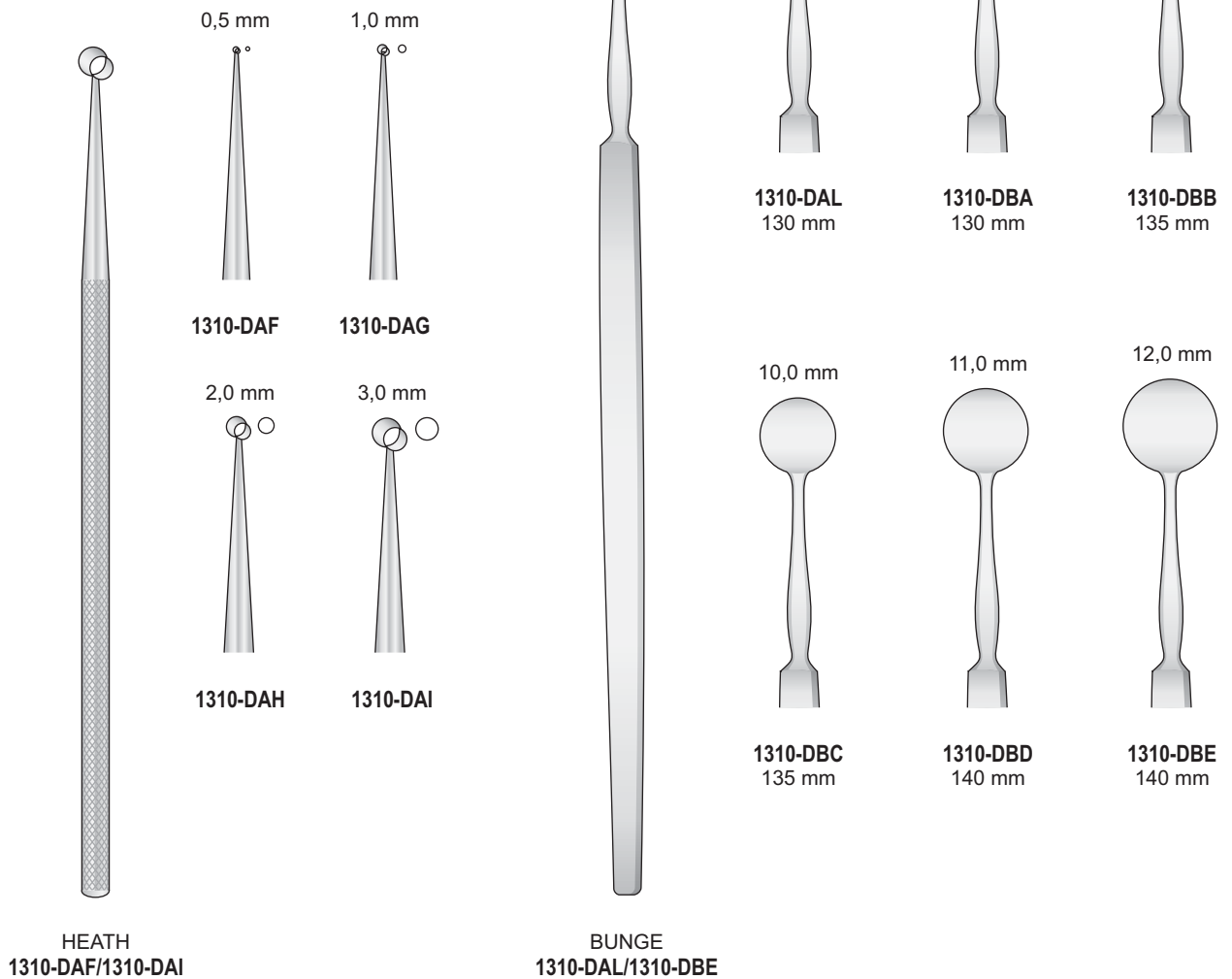

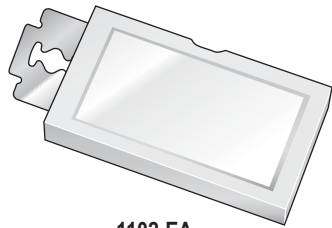

1102-EA
 Packung 10 Klingen
 Package 10 blades
 Scatola da 10 lame
 Cajita de 10 hojas
 Boite de 10 lames

Mini-Klingen, Steril
 Mini Blades, Sterile
 Micro lame, sterili



1102-DGE
 Pack. 10 St.
 Conf. 10 pz.



1102-DGF
 Pack. 10 St.
 Conf. 10 pz.



1102-DGH
 Pack. 10 St.
 Conf. 10 pz.

Steril
 Sterile

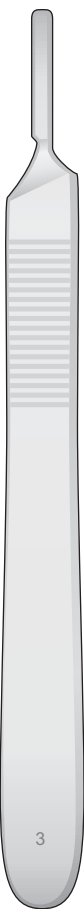

1201-02D
 Fig. 3



1201-02H10
 Fig. 7k



1102-BB
 Fig. 11



1102-BF
 Fig. 15

Packung 100 Klingen
 Package 100 blades
 Scatola da 100 lame
 Cajita de 100 hojas
 Boite de 100 lames



1310-B
 100 mm



1310-C
 150 mm



0202-EG
 135 mm

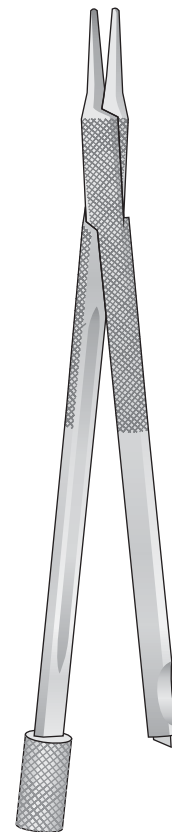

1310-BC
 120 mm

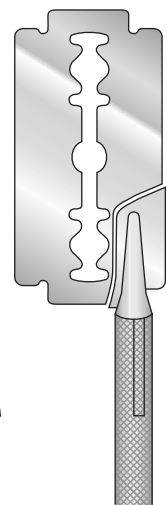



Hohlmeißelzange
Nasenspeculum

Bone rongeurs
Nasal Speculum

Pinze ossivore
Speculum nasali

Pinza-gubias
Espéculos nasales

Pinces-Gouges
Spéculums nasaux

Nasenspeculum
Nasal speculum
Speculum nasali
Espéculos nasales
Spéculums nasaux

Hohlmeißelzange
Rongeur
Pinza per dacrio-rinostomia

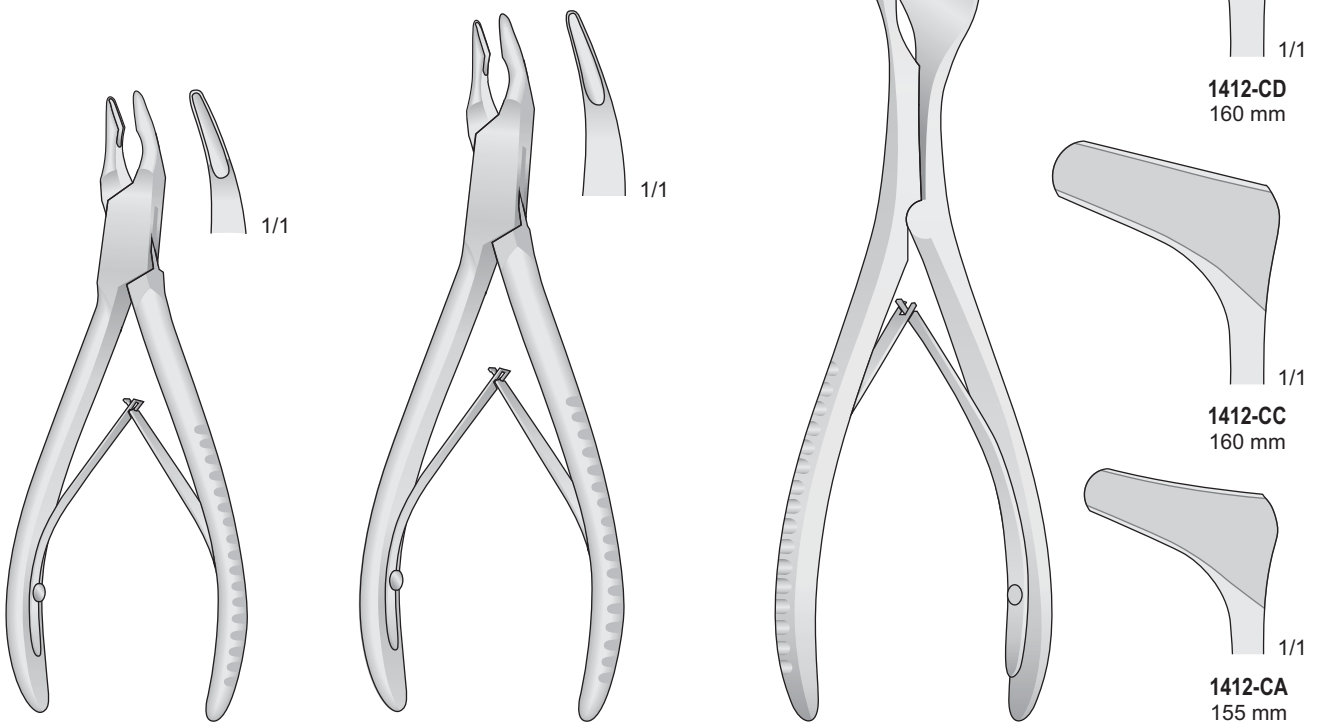

MINI FRIEDMANN
0614-BF
120 mm

FRIEDMANN
0614-BH
140 mm

HARTMANN
1412-CA/1412-CD

1412-CD
160 mm

1412-CC
160 mm

1412-CA
155 mm

Knochenstanzen

Bone nibbling rongeurs

Pinze ossivore

Pinza cortantes para huesos

Pinces à os

Pinze per dacrio-cisto-rinostomia

Punches - Stanzen

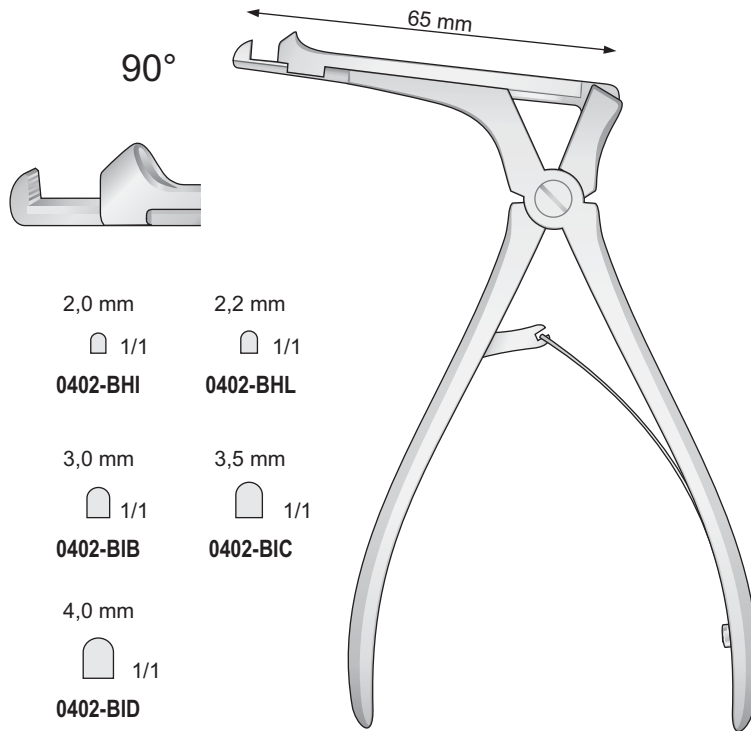

- | | | |
|------------------------------------|------------------------------------|------------------------------------|
| 1,5 mm
□ 1/1
0402-BHH | 2,0 mm
□ 1/1
0402-BHI | 2,2 mm
□ 1/1
0402-BHL |
| 2,5 mm
□ 1/1
0402-BIA | 3,0 mm
□ 1/1
0402-BIB | 3,5 mm
□ 1/1
0402-BIC |
| | 4,0 mm
□ 1/1
0402-BID | |

- 0402-BHH** 1,5 mm
- 0402-BHI** 2,0 mm
- 0402-BHL** 2,2 mm
- 0402-BIA** 2,5 mm
- 0402-BIB** 3,0 mm
- 0402-BIC** 3,5 mm
- 0402-BID** 4,0 mm

CITELLI
0402-BHH/0402-BID

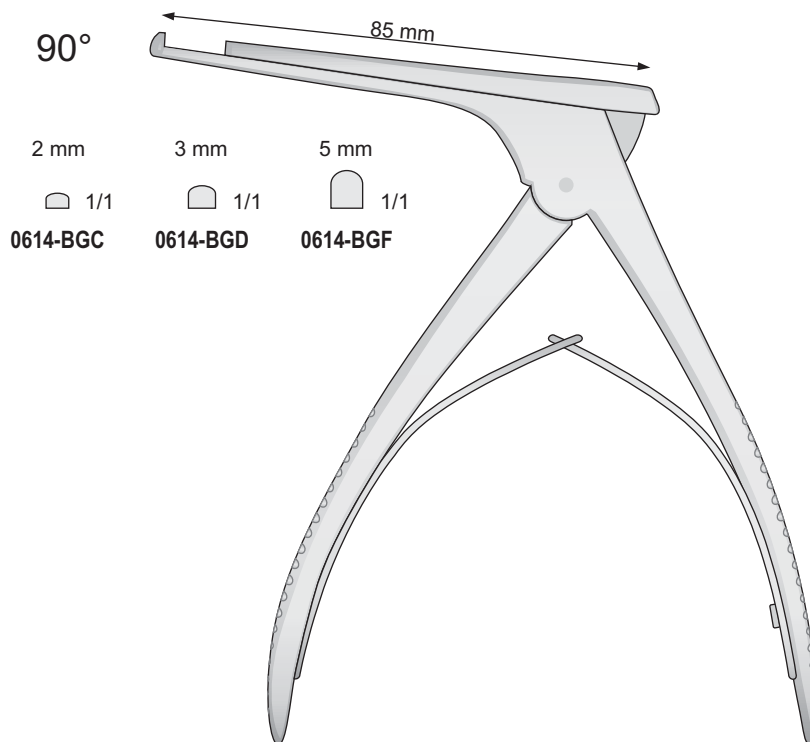

- | | | |
|----------------------------------|----------------------------------|----------------------------------|
| 2 mm
□ 1/1
0614-BGC | 3 mm
□ 1/1
0614-BGD | 5 mm
□ 1/1
0614-BGF |
|----------------------------------|----------------------------------|----------------------------------|

KERRISON
0614-BGC 2 mm
0614-BGD 3 mm
0614-BGF 5 mm

Chirurgische Hammer
Haken

Surgical mallet
Hooks

Martello chirurgico
Uncini

Martillo quirurgico
Ganchos

Maillet chirurgical
Crochets

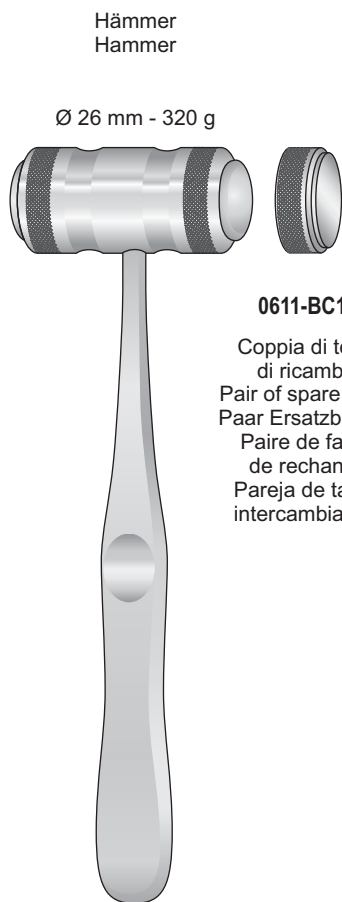

0611-BC17

Coppia di teste
di ricambio
Pair of spare faces
Paar Ersatzbacken
Paire de faces
de rechange
Pareja de tapas
intercambiables

MEAD
0611-BC
190 mm

Haken
Hooks
Uncini doppi da calazio
Ganchos
Crochets

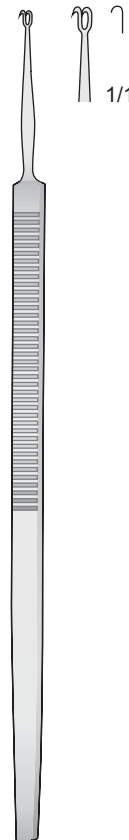

GUTHRIE
0219-CAD
160 mm

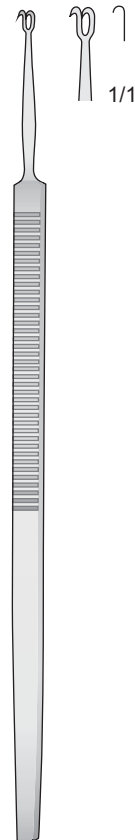

GUTHRIE
0219-CAE
160 mm

Augenlöffel

Eye Spoons

Cucchiai, Curette

Cucharillas para ojo

Curettes oculaires

Löffel - Spoon
Cucchiaio - Cucharillas
Curettes



GRAEFE
1310-CHI
130 mm

Löffel - Spoon
Cucchiaio - Cucharillas
Curettes



GRAEFE
1310-CHL
130 mm

Löffel - Spoon
Cucchiaio - Cucharillas
Curettes



HESS
1310-CIC

Löffel - Spoon
Cucchiaio - Cucharillas
Curettes



DAVIEL
1310-CIA
125 mm

Löffel - Spoon
Cucchiaio - Cucharillas
Curettes



DAVIEL
1310-CIB
125 mm

E nukleationslöffel
Enucleation Spoon
Cucchiaio da enucleazione
Espátula para enucleación
Spatule échancrée pour l'enucléation



WELLS
1310-CIF
150 mm

Löffel - Spoon
Cucchiaio - Cucharillas
Curettes



ELSCHNIG
1310-CID

Links
Left
Sinistro
A la izquierda
À gauche

Löffel - Spoon
Cucchiaio - Cucharillas
Curettes

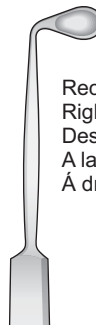

ELSCHNIG
1310-CIE

Rechts
Right
Destro
A la derecha
À droite

1310-CHI/1310-CIF

Kystotom und Löffel
Cystotome and Spoon
Cistotomo e cucchiaio
Quiistótomo y cucharilla
kystitome et curette



MOORFIELD
1310-DHC
130 mm

Doppellöffel
Double Spoon
Cucchiaio doppio
Cucharilla doble
Curette couble

3,0 mm / 4,0 mm



MEYHOEFER
1310-DHD
130 mm

Löffel & Gerader Spatel
Spoon and Straight Spatula
Cucchiaio e spatola retta
Cucharilla y espátula recta
Curette avec spatule droite



LÖFFEL
1310-DHE
140 mm

Löffel & Gebogener Spatel
Spoon and Curved Spatula
Cucchiaio e spatola curva
Cucharilla y espátula curva
Curette avec spatule courbe



LÖFFEL
1310-DHF
140 mm

Löffel vorwärts
Cucchiaio da calazio
tagliente, verso l'alto

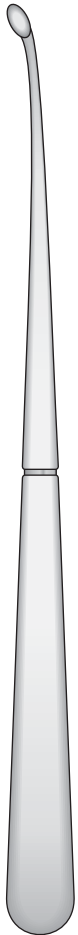

AXENFELD
0610-BGF
120 mm

Löffel rückwärts
Cucchiaio da calazio
tagliente, verso il basso

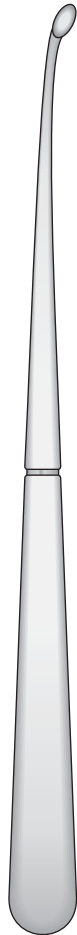

AXENFELD
0610-BGG
120 mm

Chalazion-Doppellöffel
Chalazion Curette
Cucchiaio da calazio
doppio, tagliente



AXENFELD
0610-BGH
130 mm

Irisretraktor
Iris Retractor
Retrattori per iride
Separador para iris
Rétracteur à iris

Rechts - Right - Destro
A la derecha - À droite



1/1



GROSS
1310-DDD
135 mm

Irisretraktor
Iris Retractor
Retrattori per iride
Separador para iris
Rétracteur à iris

Links - Left - Sinistro
A la izquierda - À gauche



1/1



GROSS
1310-DDE
135 mm

Irishäkchen - Iris Hook - Uncini da iride
Ganchos para iris - Crochets à iris

Schielhaken
Strabismus Hooks
Uncini da strabismo
Ganchos para estrabismo
Crochets à strabisme

Irisretraktor
Iris Retractor
Retrattori per iride
Separador para iris
Rétracteur à iris

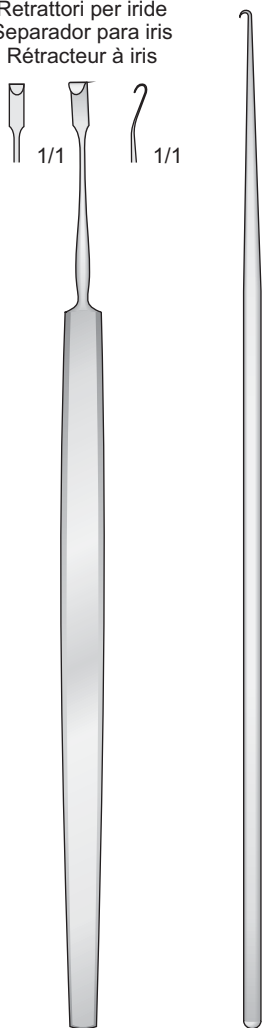
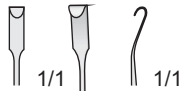

BRAND
1310-DDF

MOD.TÜBINGEN
1310-DDG
140 mm

MOD.BONN
1310-DDH
140 mm

Scharf
Sharp
Acuto
Agudo
Pointu



GRÄFE
1310-DDI
120 mm

Stumpf
Blunt
Smusso
Romo
Mousse



GRÄFE
1310-DDL
120 mm



JAEGER
0219-CDC/0219-CDD
130 mm

Fig. 1



0219-CDC

Fig. 2



0219-CDD

Haken







Hooks

Uncini

Ganchos

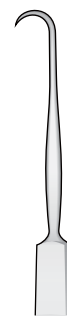
Crochets

Tränensackhäkchen
 Hooks for lachrymal sac
 Uncini divaricatori per il sacco lacrimale
 Ganchos para saco lacrimal
 Crochets pour le sac lacrymal

	Scharf Sharp Acuto Agudo Pointu	Scharf Sharp Acuto Agudo Pointu	Scharf Sharp Acuto Agudo Pointu	Scharf Sharp Acuto Agudo Pointu	4 Zähne 4 Teeth 4 Denti 4 Dientes 4 Dents	4 Zähne 4 Teeth 4 Denti 4 Dientes 4 Dents
	Irishäkchen Iris Hook Uncini da iride Ganchos para iris Crochets à iris	Irishäkchen Iris Hook Uncini da iride Ganchos para iris Crochets à iris	Häkchen Hook Uncino Ganchos Crochets	Häkchen Hook Uncino Ganchos Crochets	Stumpf Blunt Smusso Romo Mousse	Scharf Sharp Acuto Agudo Pointu
						
	O'CONNOR 0219-CDA 120 mm	WIENER 0219-CDB 130 mm	GUTHRIE 0219-CDE 120 mm	GUTHRIE 0219-CDF 130 mm	KNAPP 0219-CDG 135 mm	ROLLET 0219-CDH 135 mm

0219-CDA/0219-CDH

Haken
Wundhaken

Hooks
Retractor

Uncini
Divaricatori

Ganchos
Separador

Crochets
Ecarteur

Lokalisator

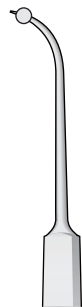

MEYER-SCHWICKERATH
1310-CDG

Linsenhäkchen



GRAEFE
1310-CHG
130 mm

Irisretraktor

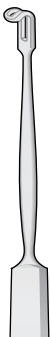

Mc GANNEN
1310-CHH
130 mm



1310-CDG/1310-CHH

Fixazionshaken
Fixation Claw
Uncino doppio
da fissazione
Garra Fijadora
Griffe à fixation



1310-CDH Rechts - Right - Destro
A la derecha - À droite
1310-CDI Links - Left - Sinistro
A la izquierda - À gauche

FIXIERKRALLE
1310-CDH/1310-CDI
105 mm

2 Zähne
2 Teeth
2 Denti
2 Dientes
2 Dents

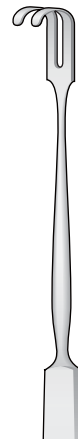

AXENFELD
0219-CDI 0219-CDL
Scharf Stumpf
Sharp Blunt
Acuto Smusso
Agudo Romo
Pointu Mousse

3 Zähne
3 Teeth
3 Denti
3 Dientes
3 Dents



AXENFELD
0219-CEA 0219-CEB
Scharf Stumpf
Sharp Blunt
Acuto Smusso
Agudo Romo
Pointu Mousse

Häkchen
Hooks
Uncini
Ganchos
Crochets

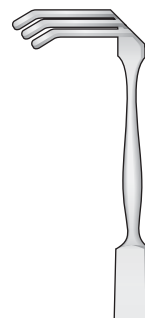

PAUL
0219-CEC
125 mm

Wundlöffel
Protector
Protettore
Protector
Protecteur



ARRUGA
1310-CDL

Haken

Hooks

Uncini

Ganchos

Crochets

Schielhaken
Strabismus Hook
Uncino da strabismo
Ganchos para estrabismo
Crochets à strabisme

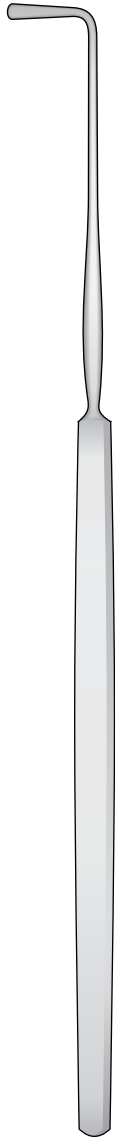

1310-EB/1310-CEF

Linsenhaken

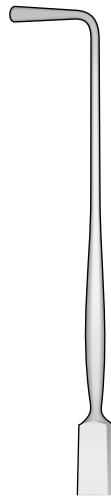

STEVENS
1310-CEA
140 mm

Muskelhaken



CULLER
1310-CAL
120 mm

Linsenhaken



STEVENS
1310-CEB
120 mm

Linsenhaken



JAMESON
1310-CEC
130 mm

Muskelhaken
Oblique Muscle Hook



Curved shaft with
flat 4,5 mm Hook

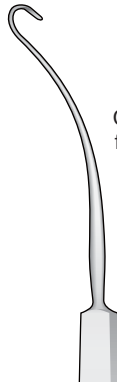

SCOBEE
1310-DLB
135 mm

Schielhaken

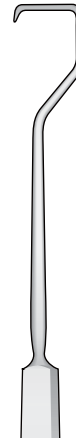

MALBRAN
1310-CEE
140 mm

Schielhaken



GREEN
1310-CED
130 mm

Schielhaken, kurz



GRAEFE
1310-CEF
130 mm

Schielhaken



GRAEFE
1310-EB
130 mm

Schielhaken



GRAEFE
1310-EC
140 mm

Schielhaken



GRAEFE
1310-ED
150 mm

Haken

Hooks

Uncini

Ganchos

Crochets

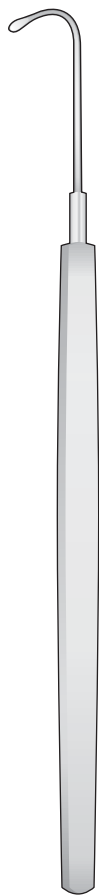

1310-EDF
130 mm



WORST
1310-EDE
135 mm



1310-EDG
140 mm

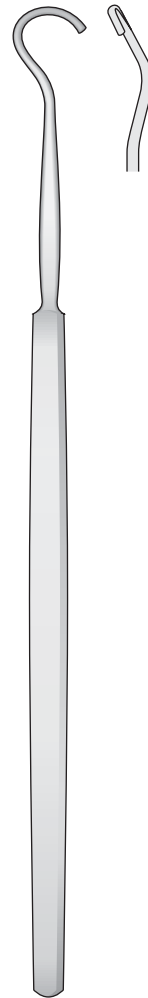

ARRUGA
1310-FL11
140 mm

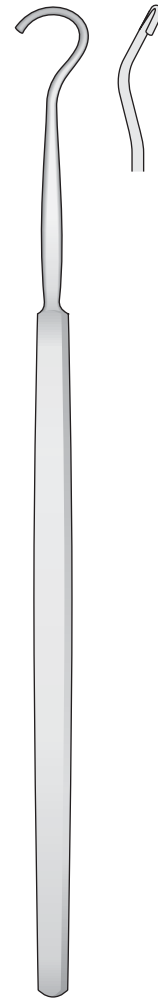

ARRUGA
1310-FL
140 mm

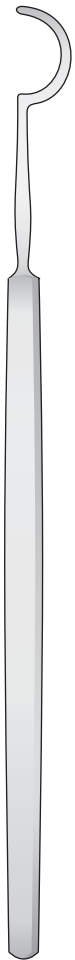

HESS
1310-CHF

Crochet à strabisme
Strabismus Hooks

Starhaken
Lens Hook
Uncino intracapsulare
Ganchos intracapsular
Crochets intracapsulaires

Links
Left
Sinistro
Izquierda
Gauche

Rechts
Right
Destro
Derecha
Droite

Expressionshaken
Expression Hook
Anello per il cristallino
Expresor para cristalino
Expresseur pour la
lentille cristalline

U-Bindungsnadel
Links
Left
Sinistro
A la izquierda
À gauche



WOODRUFF
0212-FE
130 mm

U-Bindungsnadel
Rechts
Right
Destro
A la derecha
À droite

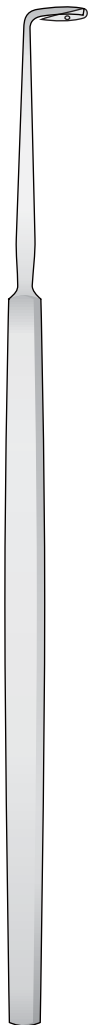

WOODRUFF
0212-FF
130 mm

U-Bindungsnadel
Links
Left
Sinistro
A la izquierda
À gauche



DE LA ROZA
0212-FG
120 mm

U-Bindungsnadel
Rechts
Right
Destro
A la derecha
À droite

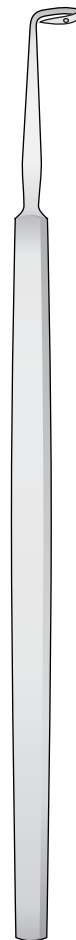

DE LA ROZA
0212-FH
120 mm

Augennadel



HESSBERG
0212-FI
150 mm

Augennadel



JACOBI
0212-FL
140 mm

Pigtail-Sonden
Pigtail Probes

Mit Haken
With Hook
Con Uncino
Con Ganchos
Avec Crochets



1310-DHA

Mit Öhr
With eye
Con occhiello
Con ojo
Avec oeil



1310-DHB

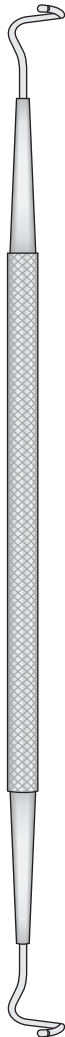

1310-DHA/1310-DHB
150 mm



SEIFFERT
1506-BG
180 mm

Haltende Instrumente
Holding Instruments
Porta tamponi



HEILDELBERG
1506-GA
180 mm



HEILDELBERG
1506-GB
170 mm



Flachmeißel
Bone chisel Flat
Scalpello
Cinzel
Ciseaux-burins

5,0 mm



WEST
0611-BDD
160 mm

Hohlmeißel
Bone chisel Hollow
Scalpello
Cinzel
Ciseaux-burins

5,0 mm



WEST
0611-BDE
160 mm

Elevatorien
Elevator
Elevatore
Elevadores
Elévateurs

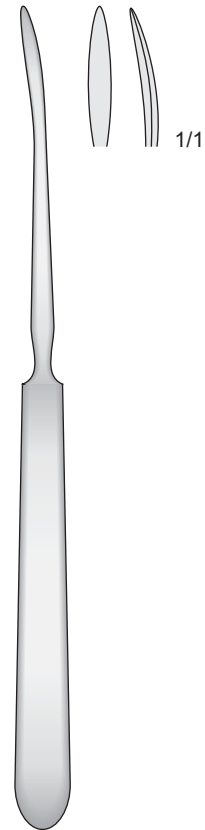

LUENEBURG
0617-BA
115 mm

Intra-Okular
Instrumente

Intra Ocular
Instruments

Strumenti
Intra-oculari

Instrumentos
intra-oculares

Instruments
intra-oculaires

Vitrektomie Instrumente
Vitrectomy Instruments

0,9 mm
Schaft und Arbeitsende
mit nicht-reflektierender
schwarzer Beschichtung
20 gauge
Shaft and working tip
with non-reflective black finish

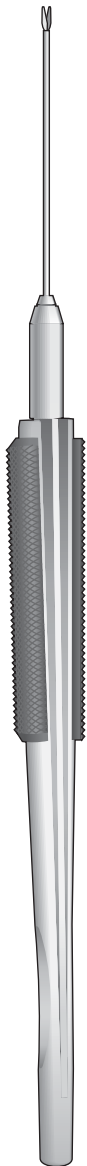

1206-EAB
Faßzange, glatt
Grasping Forceps, smooth

1206-EAC
Faßzange, glatt, 45°
Grasping Forceps, smooth, 45°

1206-EAD
Faßzange, gerieft
Grasping Forceps, serrated

1206-EAE
Faßzange, gerieft, 30°
Grasping Forceps, serrated, 30°

1206-EAF
Faßzange, gerieft
Grasping Forceps, serrated

1206-EAG
Faßzange, gerieft
Grasping Forceps, serrated

1206-EAH
Faßzange, 1x2 Zähne
Grasping Forceps, 1x2 Teeth

1206-EAI
Faßzange, innen diamantbeschichtet
Grasping Forceps, diamond coated inside

1206-EAL
Faßzange, Punkt 0,3 mm
Grasping Forceps, 0,3 mm, end-gripping

1206-EBA
Faßzange, Punkt 0,44 mm
Grasping Forceps, 0,44 mm, end-gripping

1206-EBB
Faßzange
Grasping Forceps

1206-EBC
Faßzange, 45°
Grasping Forceps, 45°

1206-EBD
Faßzange, glatt, 45°
Grasping Forceps, smooth, 45°

1206-EBE
Faßzange, glatt, 45°
Grasping Forceps, smooth, 45°

1206-EBF
Faßzange, glatt, 60°
Grasping Forceps, smooth, 60°

1206-EBG
Faßzange, glatt, 90°
Grasping Forceps, smooth, 90°

1206-EBH
Faßzange, gerieft, 60°
Grasping Forceps, serrated, 60°

1206-EBI
Faßzange, gerieft, 90°
Grasping Forceps, serrated, 90°

1206-EBL
Löffelzange
Spoon Forceps

1206-ECA
Schere, gerade
Scissors, straight

1206-ECB
Schere, abgewinkelt, 30°
Scissors, angled, 30°

1206-ECC
Schere, abgewinkelt, 60°
Scissors, angled, 60°

1206-ECD
Schere mit Schippe, gewinkelt, 60°
Scissors with scoop tip, angled, 60°

1206-ECE
Schere, abgewinkelt, 90°
Scissors, angled, 90°

1206-EAB/1206-ECE

Implantations-
Instrumente

Instrument for
implantation

Strumenti per
impianti

Ganchos para
lente intraoculares

Crochet à iris
et à lentille

Linsenmanipulatoren
Lens manipulators
Manipolatori del IOL
Manipuladores de lentes
Micro-Manipulateurs d'implant

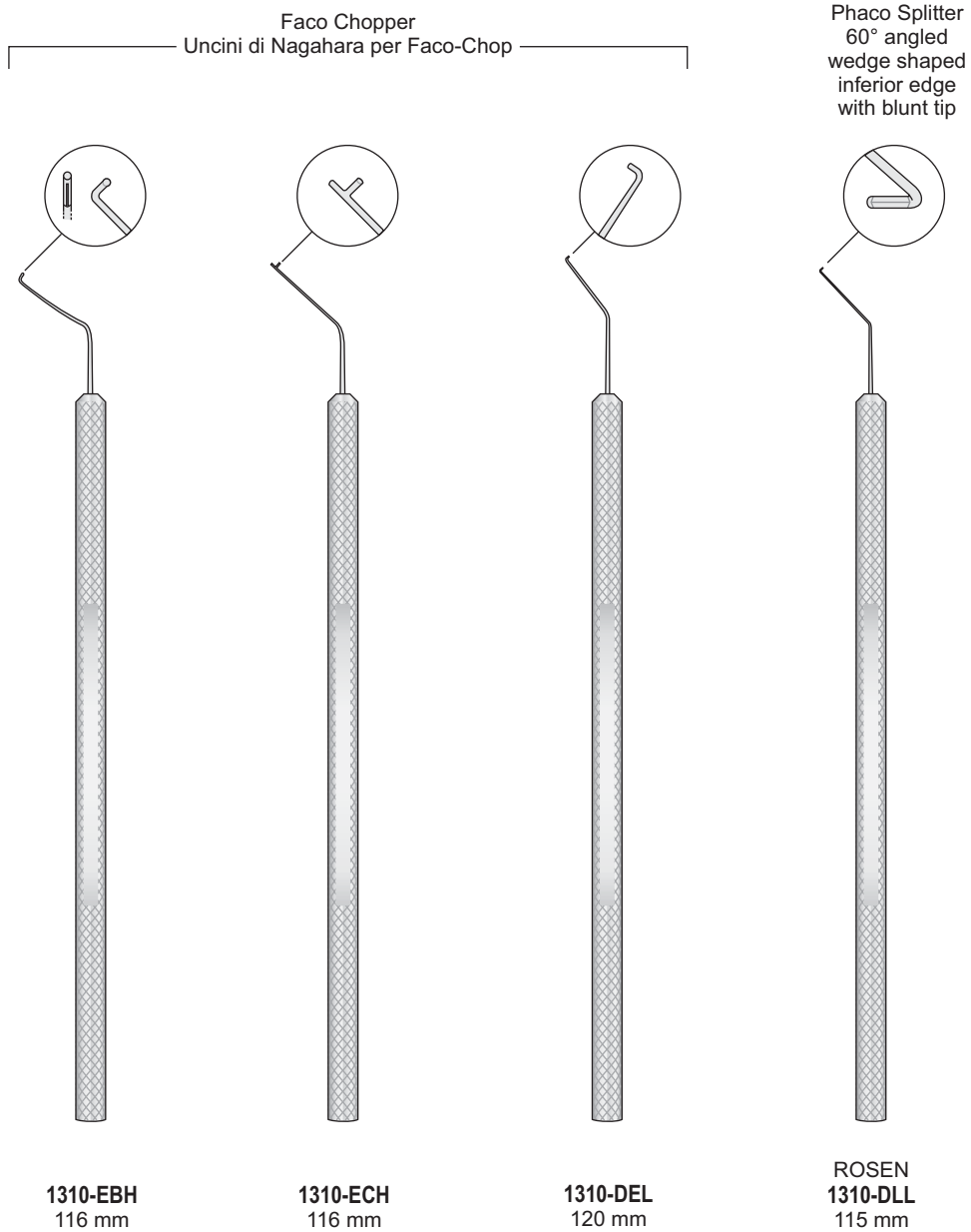

Implantations-
Instrumente

Instrument for
implantation

Strumenti per
impianti

Ganchos para
lente intraoculares

Crochet à iris
et à lentille

Linsenmanipulatoren
Lens manipulators
Manipolatori del IOL
Manipuladores de lentes
Micro-Manipulateurs d'implant

Irishaken 0,5 mm
Stumpf, Gebogen



JAFFE-KNOLLE
1310-DEA
120 mm

Linsenspatel 0,5 mm
Glatt, Flach, Gebogen

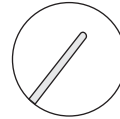

JAFFE
1310-DEB
120 mm

Kragen-Kopf
Polierer, Gerade

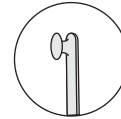

GRAEATHER
1310-DEC
120 mm

Kragen-Kopf
Polierer, Gebogen



GRAEATHER
1310-DED
120 mm

Linsenrotierer
Stumpf, Gebogen



BECHERT
1310-DEE
120 mm

Irishaken 0,5 mm
Stumpf, Gerade



JAFFE-KNOLLE
1310-DEF
120 mm

Linsenspatel 0,5 mm
Breit, Flach, Gebogen

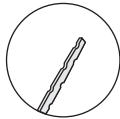

HIRSCHMANN
1310-DEG
115 mm

Linsenhaken
Gebogen



HIRSCHMANN
1310-DEH
120 mm

Linsenhaken 0,2 mm
Stumpf, Gerade

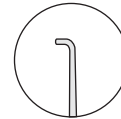

SINSKEY
1310-DEI
120 mm

Linsenhaken 0,2 mm
Stumpf, Gebogen



SINSKEY
1310-DEL
120 mm

Linsenhaken 0,25 mm
Stumpf, Gerade



LESTER
1310-DFA
115 mm

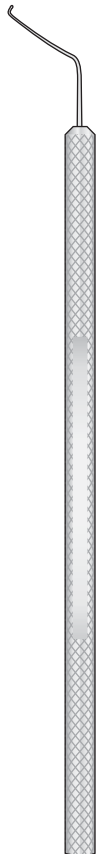

Dilatatoren

Dilators

Dilatatori

Dilatadores

Dilatateurs

Tränenkanaldilatatoren - Lacrymal dilators - Dilatatori lacrimali - Dilatadores lacrimales - Dilatateurs lacrymal

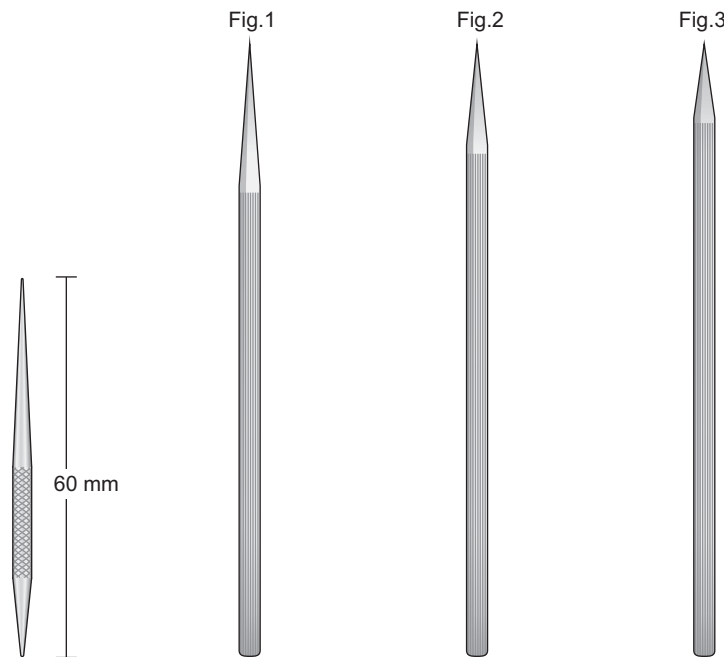

WILDER 1310-LH01 60 mm
 WILDER 1310-LH 110 mm
 WILDER 1310-LI 110 mm
 WILDER 1310-LL 110 mm

Doppelsonde
Lacrimal Dilator



CASTROVIEJO 1310-DDC 135 mm
 MULDOON 1310-DGA 95 mm

Trabekularsonde
Trabecular Probes
Trabeculotomo
Estiletos Trabeculares
Sondes trabeculaires

Dilatator

Links
Left
Sinistro
A la izquierda
À gauche



MACKENSEN 1310-DGB 95 mm

Rechts
Right
Destro
A la derecha
À droite

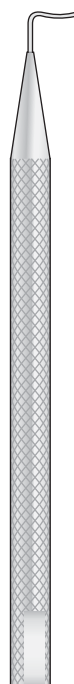

MACKENSEN 1310-DGC 95 mm

Trabekularsonde
Trabecular Probes
Trabeculotomo
Estiletos Trabeculares
Sondes trabeculaires

Links
Left
Sinistro
A la izquierda
À gauche



HARMS 1310-DGD

Rechts
Right
Destro
A la derecha
À droite

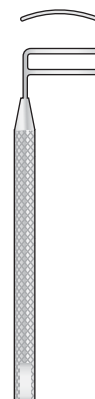

HARMS 1310-DGE

Retrogradsonde
Retrograde Probe
Retrattore

Rechts
Right
Destro
A la derecha
À droite

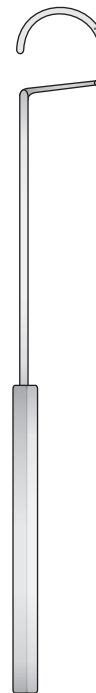

KELLNAR 1310-DGF

Links
Left
Sinistro
A la izquierda
À gauche



KELLNAR 1310-DGG

Lachrymal Probes comparative scale

Fig.	0000	000	00	0	1	2
Ø in mm.	0.5	0.6	0.7	0.8	0.9	1.1

Fig.	3	4	5	6	7	8
Ø in mm.	1.3	1.4	1.5	1.6	1.8	1.9

Silber
Silver
Argento
Plata
Argent



Silber
Silver
Argento
Plata
Argent



BOWMAN

1506-DA 00/0 1506-DE 5/6
1506-DB 1/2 1506-DF 7/1
1506-DD 3/4 1506-DH 6/H

BOWMAN

Spatel

Spatulas

Spatole

Espátulas

Spatules

Irisspatel - Iris Spatulas
Spatole da iride - Espátulas para iris
Spatules pour l'iris

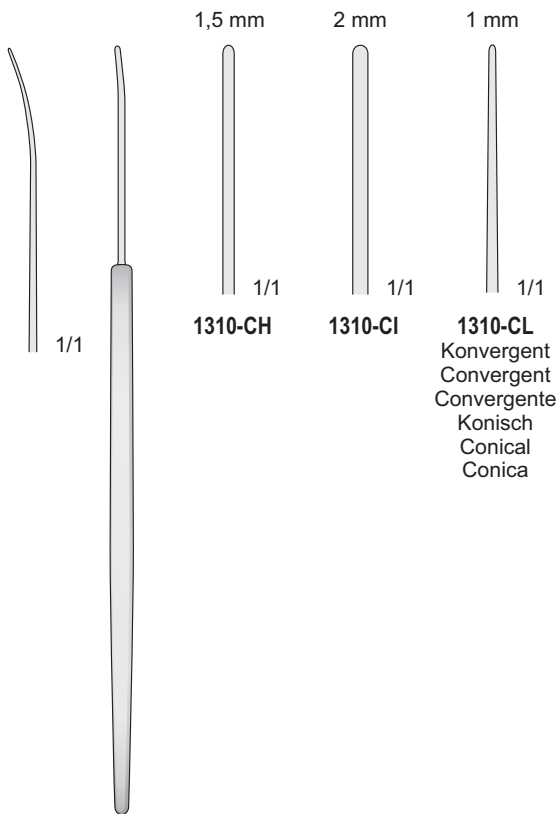

WECKER
1310-CH/1310-CL
130 mm

1,5 mm 1/1
1310-CH

2 mm 1/1
1310-CI

1 mm 1/1
1310-CL
Konvergent
Convergent
Convergente
Konisch
Conical
Conica

Retraktor
Retractor
Retrattore
Separador
Ecarteur

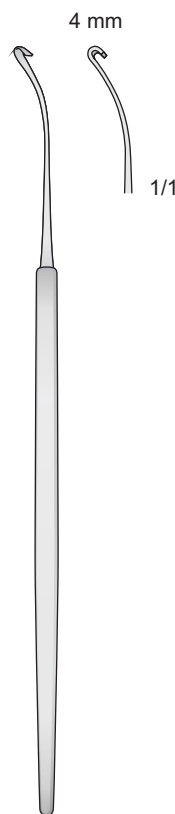

1310-EE
130 mm

4 mm 1/1

Haken, Stumpf
Hooks, Blunt
Uncini, smussi
Ganchos, Romo
Crochets, Mousse

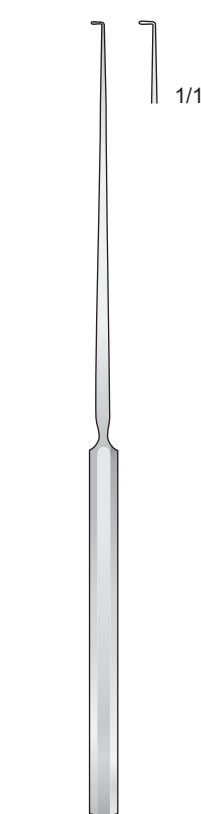

0402-CD
140 mm

Haken, Stumpf
Hooks, Blunt
Uncini, smussi
Ganchos, Romo
Crochets, Mousse

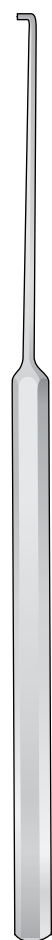

1310-LE
165 mm

**Spatel
Irisretraktor**

**Spatulas
Iris Retractor**

**Spatole
Retrattori per iride**

**Espátulas
Separador para iris**

**Spatules
Rétracteur à iris**



1310-AD
Links
Left
Sinistro
Izquierda
Gauche



1310-AE
Rechts
Right
Destro
Derecha
Droite



B
1310-HE 0,2 mm
1310-HG 0,3 mm
125 mm

Schaber
Scarifiers
Scarificatori
Legras
Rugines

1310-AD/1310-AE
140 mm



1310-BB
125 mm



1310-BD
120 mm



1310-LD
120 mm

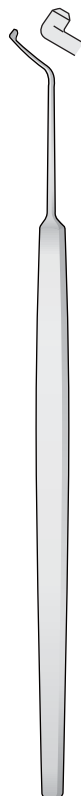

1310-HF
130 mm



CASTROVIEJO
1310-CB/1310-CG
130 mm

Zyklodialyse Spatel
Cyclodialysis Spatula
Spatola per ciclodialisi, piatta
Espátula para ciclodialisis
Spatule pour cyclodialyse



1310-CB
130 mm

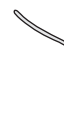

1310-CC
130 mm



1310-CD
130 mm



1310-CE
130 mm

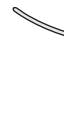

1310-CF
130 mm



1310-CG
130 mm

Spatel

Spatulas

Spatole

Espátulas

Spatules

Augenklappe - Aluminium
 Eye shield - Aluminium
 Occlusori - Alluminio
 Protector de ojos - Aluminio
 Protecteur des jeux - Aluminium

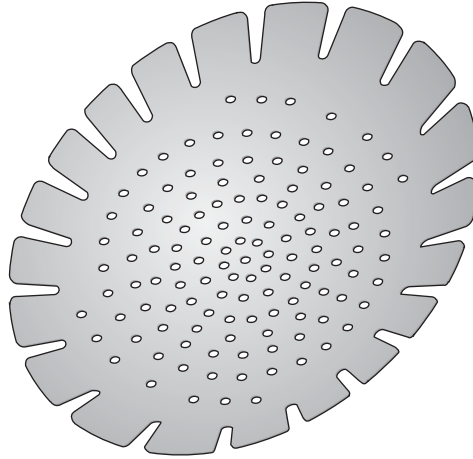

1411-CA
75 mm

Vitreo Spatulas

Platinum
Spatula



KIMURA
1310-EI
150 mm

1,5 mm

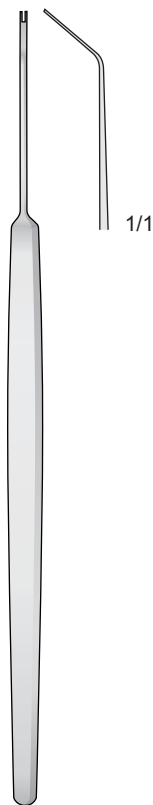

1310-BAL
130 mm

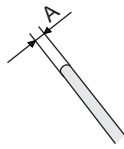

A
1310-BBA 0,6 mm
1310-BBB 1,0 mm
1310-BBC 1,5 mm
 130 mm



CASTROVIEJO
1310-BBA/1310-BBC
130 mm

Bilateral Ball

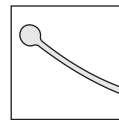

BARRAQUER
1310-ECD
120 mm

Right Ball

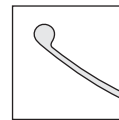

BARRAQUER
1310-ECE
120 Mm

Left Ball

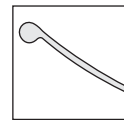

BARRAQUER
1310-ECF
120 Mm

Spatel

Spatulas

Spatole

Espátulas

Spatules

Zyklodialyse Spatel - Cyclodialysis Spatula
 Spatola per ciclodialisi, piatta - Espátula para ciclodialisis
 Spatule pour cyclodialyse

Spatel
 Spatula
 Spatola
 Espátulas
 Spatules

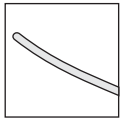

ELSCHNIG
1310-CGD
 130 mm

Spatel
 Spatula
 Spatola
 Espátulas
 Spatules
 10 mm

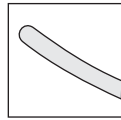

CASTROVIEJO
1310-CGH
 130 mm

Spatel
 Spatula
 Spatola
 Espátulas
 Spatules
 15 mm

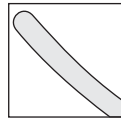

CASTROVIEJO
1310-CGI
 140 mm

Irisspatel
 Iris Spatulas
 Micro Spatole da iride
 Espátulas para iris
 Spatules pour l'iris

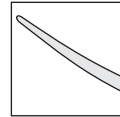

BARRAQUER
1310-CGE
 120 mm

Irisspatel
 Iris Spatulas
 Micro Spatole da iride
 Espátulas para iris
 Spatules pour l'iris



TROUTMAN-BARRAQUER
1310-CGF 0.25 mm x 15 mm
1310-CGG 0.5 mm x 15 mm
 90 mm

Spatel

Spatulas

Spatole

Espátulas

Spatules

Zyklodialyse Spatel - Cyclodialysis Spatula
 Spatola per ciclodialisi, piatta - Espátula para ciclodialisis
 Spatule pour cyclodialyse

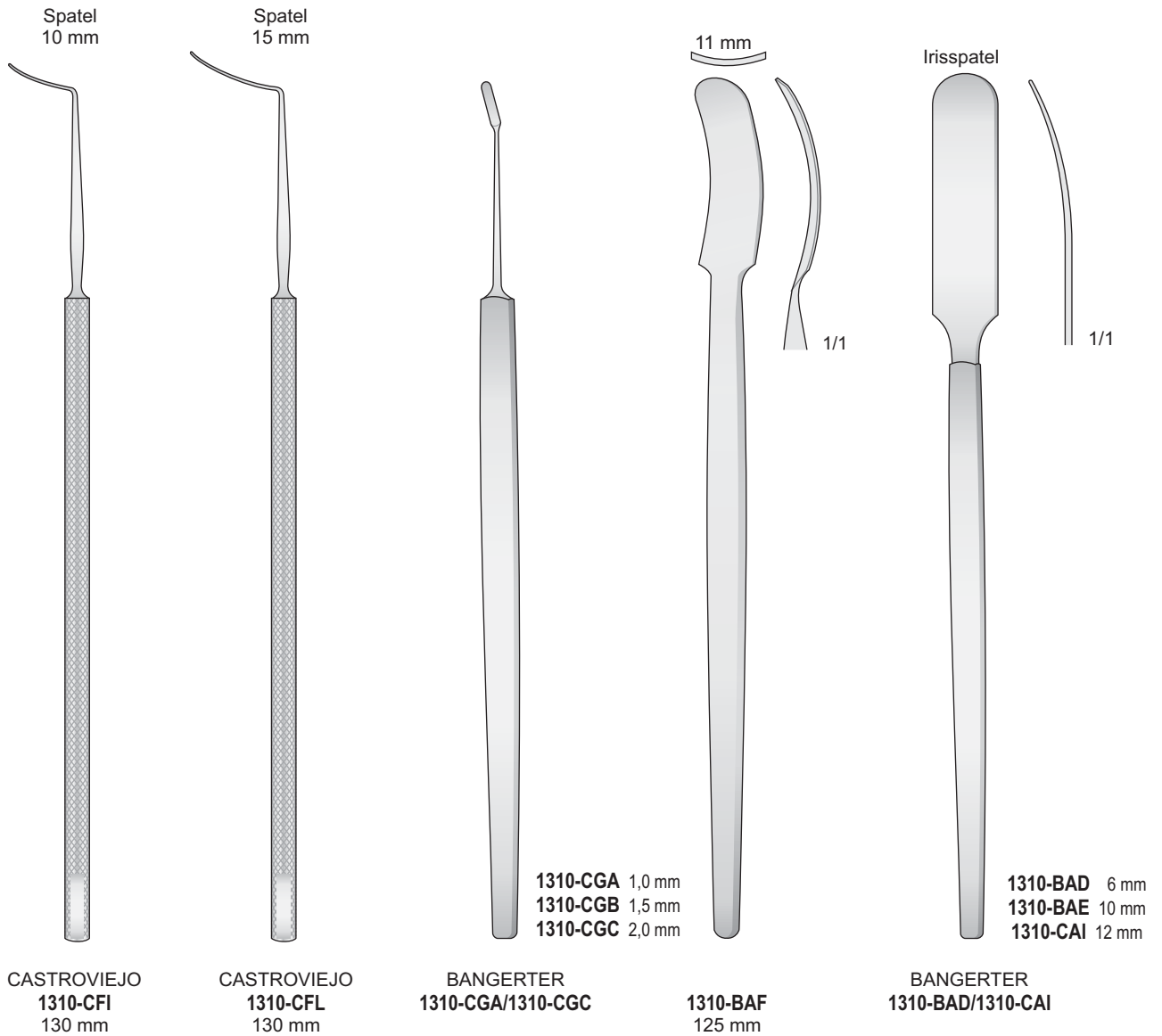

Starschlingen

Lens Loops

Anse per cristallino

Asas de lentes

Anses

Gerieft
Serrated
Zigrinato
Estriada
Striée

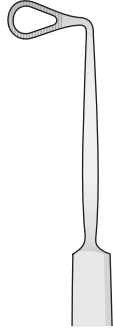

ELSCHNIG
1310-CGL
130 mm

Gerieft
Serrated
Zigrinato
Estriada
Striée

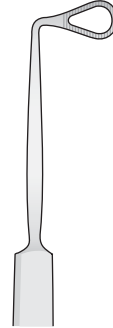

ELSCHNIG
1310-CHA
130 mm

Gerieft - Serrated
Zigrinato - Estriada
Striée

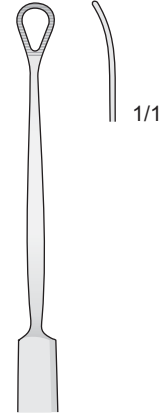

LEWIS
1310-CHB
135 mm

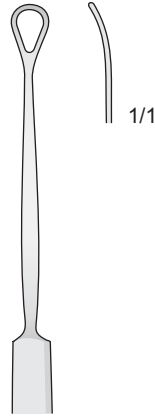

LEWIS
1310-CHC
135 mm

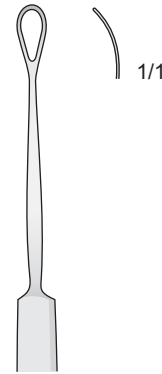

WEBER
1310-EG
130 mm

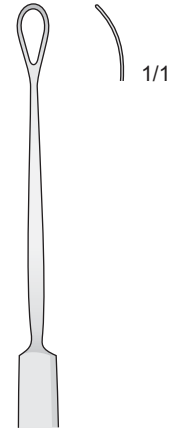

WEBER
1310-EH
140 mm

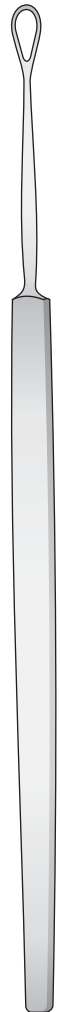

WEBER
1310-EG
130 mm

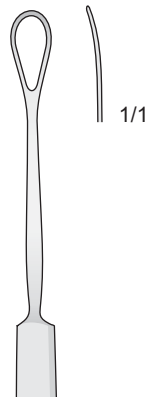

NEW ORLEANS
1310-CHD
130 mm

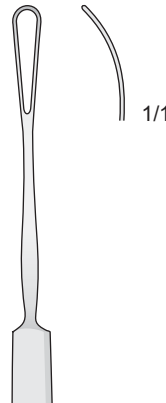

SNELLEN
1310-EF
135 mm

Gerieft - Serrated
Zigrinato - Estriada
Striée

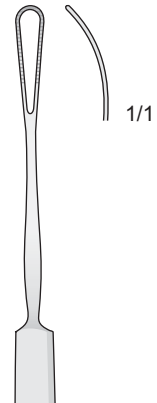

ARLT
1310-CHE
135 mm

Linsenschieber, Doppelt
 Lens Expressor double-ended
 Uncino per il cristallino, doppio
 Expresor para el cristallino, doble
 Expresseur pour la lentille cristalline, double

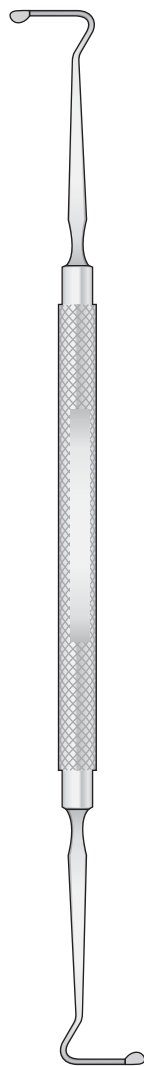

KIRBY
 1310-DCA
 140 mm

Iris Retractor
 and Lens Expressor

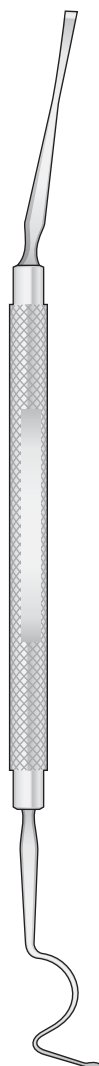

RIZZUTI
 1310-DCB
 145 mm

Lens Loop
 and Muscle Hook

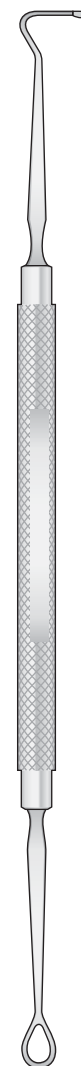

KIRBY
 1310-DCC
 140 mm

Spatel

Spatulas

Spatole

Espátulas

Spatules

Zyklodialyse Spatel - Cyclodialysis Spatula
 Spatola per ciclodialisi, piatta - Espátula para ciclodialisis
 Spatule pour cyclodialyse

Doppelspatel
 Double Spatula
 Spatola doppia
 Espátula doble
 Spatule double
 Doppelinstrument

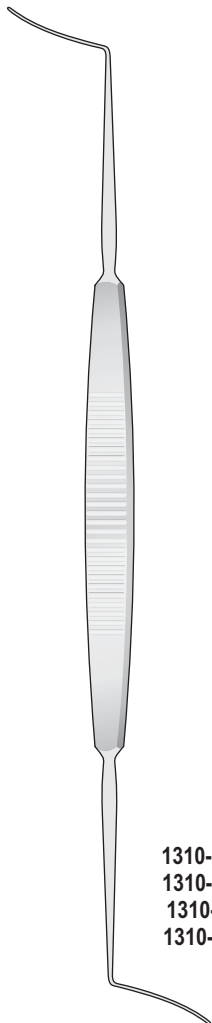

1310-DHG 0,25 mm
 1310-DHH 0,50 mm
 1310-DHI 0,75 mm
 1310-DHL 1,00 mm

CASTROVIEJO
 1310-DHG/1310-DHL
 140 mm

Doppelspatel
 Double Spatula
 Spatola doppia
 Espátula doble
 Spatule double
 Doppelinstrument



CASTROVIEJO
 1310-DIA
 120 mm

Irisspatel und Schielhaken
 Iris Spatula and Squint Hook
 Spatola e uncino da strabismo
 Espátula para iris y gancho
 para estrabismo
 Spatule pour l'iris et
 crochet à strabisme
 Doppelinstrument



KNAPP
 1310-DIB
 120 mm

Doppelspatel
 Double Spatula
 Spatola doppia
 Espátula doble
 Spatule double
 Doppelinstrument



WHEELER
 1310-DIC
 120 mm

Graduiert
 Graduated
 Graduata
 Graduada
 Graduée
 Doppelinstrument



LINDNER
 1310-DID
 130 mm

Spatel

Spatulas

Spatole

Espátulas

Spatules

Iris spatel
Iris Spatula
Spatola da iride
Espátula para iris
Spatule pour l'iris

Doppelinstrument



SMITH-FISCHER
1310-DIE

Spatel und Schielhaken
Spatula and Squint Hook
Spatola e uncino da strabismo
Espátula y gancho para estrabismo
Spatule et crochet à strabisme

Doppelinstrument



McREYNOLDS
1310-DIF
120 mm

Doppelspatel
Double Spatula
Spatola doppia
Espátula doble
Spatule double

Doppelinstrument



GREEN
1310-DIG
120 mm

Nadel und Spatel
Needle and Spatula
Ago e spatola
Aguja y Espátula
Aiguille et spatule

Doppelinstrument



FISCHER
1310-DIH
130 mm

Spatel, Kauter

Spatulas, Cauteries

Spatole, Cauterio

Espátulas, Cauterios

Spatules, Cautéres

Kauter - Cautery
Cauterio - Cauterio
Cautére

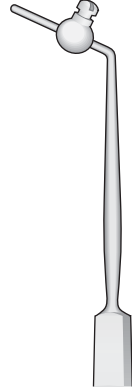

WILLS-HOSPITAL
1310-CFC

Kauter - Cautery
Cauterio - Cauterio
Cautére

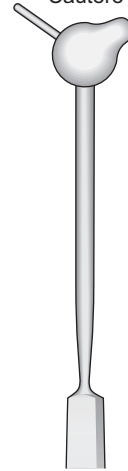

WADSWORTH-TODD
1310-CFD

Kauter - Cautery
Cauterio - Cauterio
Cautére

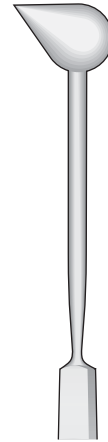

PRINCE
1310-CFE

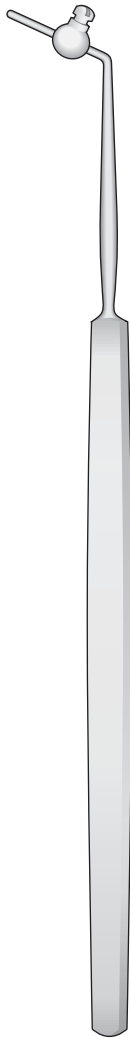

1310-CH/1310-CFH

Linsenexpressor



BERENS
1310-CFF
120 mm

Spatel - Spatula
Spatola - Espátulas
Spatules



Gebogen
Curved
Curva
Curvas
Courbes

WECKER
1310-CH
130 mm

Spatel - Spatula
Spatola - Espátulas
Spatules

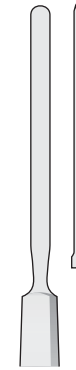

Gerade
Straight
Diritta
Rectas
Droites

WECKER
1310-CI
130 mm

Irisspatel
Iris Spatula
Spatola per iride
Espátula para iris
Spatule pour l'iris



MODELL FRANKFURT
1310-CFG
130 mm

Irisspatel
Iris Spatula
Spatola per iride
Espátula para iris
Spatule pour l'iris

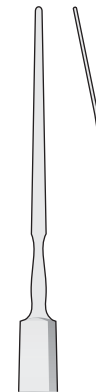

Konisch
Conico

WECKER
1310-CL
130 mm

Irisspatel
Iris Spatula
Spatola per iride
Espátula para iris
Spatule pour l'iris

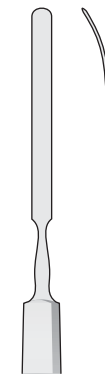

CULLER
1310-CFH
130 mm

Spatel

Spatulas

Spatole

Espátulas

Spatules

Orbitspatel - Orbit Spatula - Spatola da orbita - Espátula para órbita - Spatule orbitale

Fig.1 12 mm

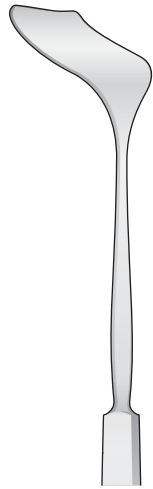

SAUTTER
1310-CEH
145 mm

Fig.2 15 mm

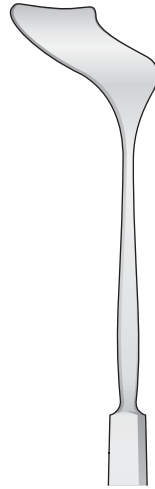

SAUTTER
1310-CEI
145 mm

Fig.3 17 mm

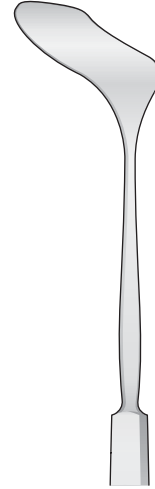

SAUTTER
1310-CEL
145 mm

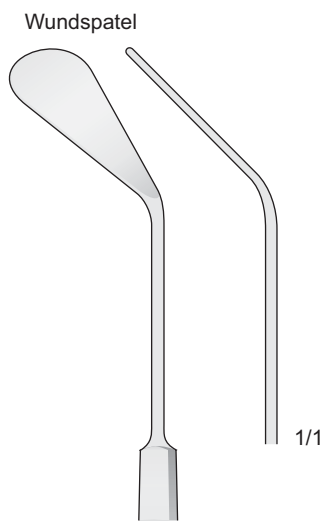
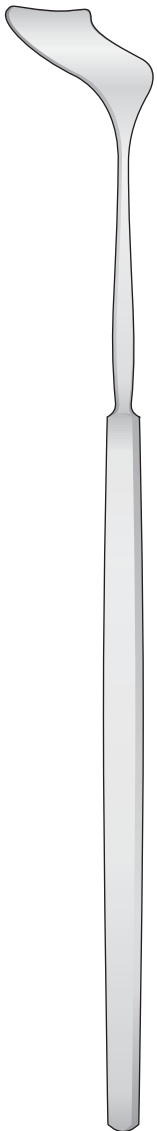

MODELL ESSEN
1310-CFA
140 mm

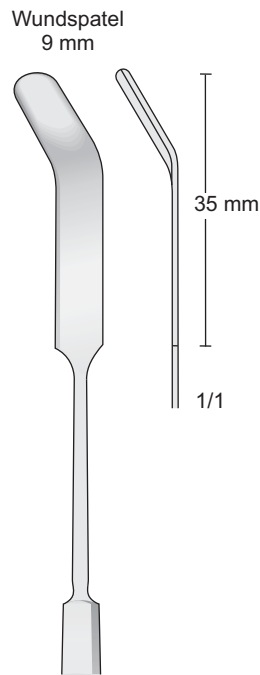

MODELL GIESSEN
1310-CFB
160 mm

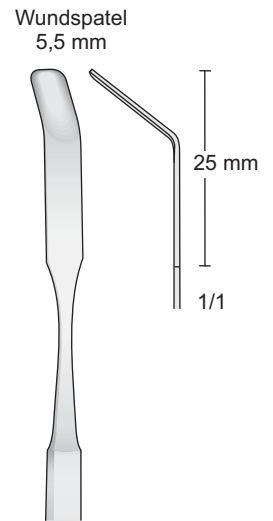

1310-DLC
140 mm

Keratoplastikspatel

Keratoplasty
Spatula

Spatole per
cheratoplastica

Espátula para
queratoplástica

Spatule pour
kératoplastie



PATON
1310-DCH
140 mm



CASTROVIEJO
1310-DCI
140 mm

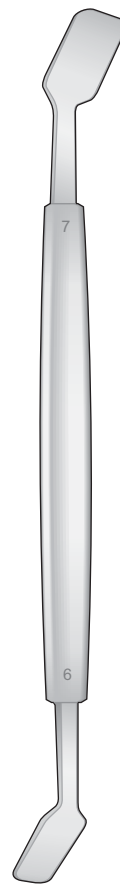

1310-EFC
6,0 mm / 7,0 mm
118 mm



1310-EFB
4,0 mm / 5,0 mm
118 mm

Meßinstrument
Measuring Instrument
Strumenti per misurazione
Instrumentos para medir
Instruments à mesurer

Lidinstrumente

Lid Instruments

Strumenti per palpebre

Instrumentos para párpados

Instruments à paupières

Lidpresser
Lid Expressor
Strumento per palpebra
Expressor de párpados
Expresseur de paupières

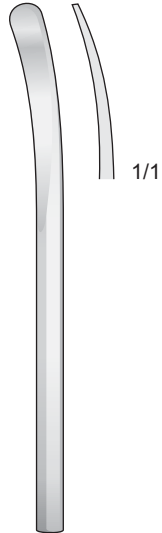

0418-AI
90 mm

Lidplatte
Lid Plate
Placca per palpebre
Placa para párpados
Plaque à paupières

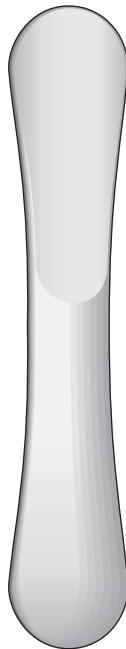

JAEGER 1412-AL
110 mm

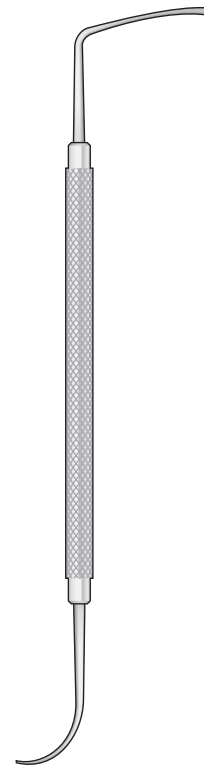

AMENABAR 1310-BEG

Markierungsgabel
Bi-Prong Marker
Forcelle per strabismo
Marcador bifurcado
Marquer Fourchette

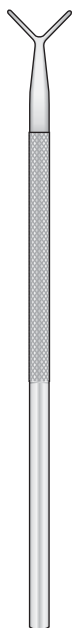

1310-EFA
100 mm



FINK 1310-BEC
90 mm

Lidhalter - Lid Retractor
Retrattore palpebrale - Retractor de párpados
Releveur de paupières

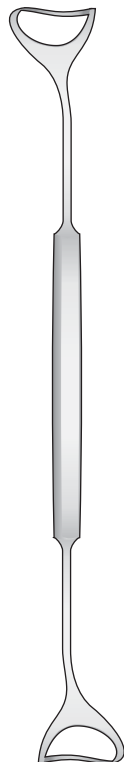

KLAR EVATEUR BT-09
160 mm

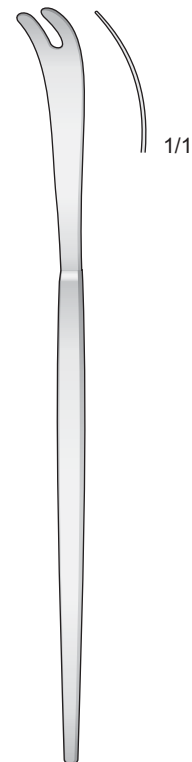

SCHEPENS 1310-BED
155 mm

Lidhalter

Lid Retractors

Retrattori palpebrali

Retradores de párpados

Retracteur de paupières

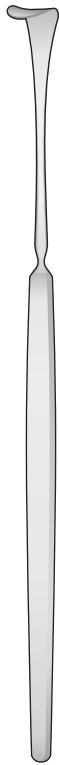

CONWAY
1310-BEE
140 mm



DESMARRES
1310-BEF
140 mm

Für Säuglinge
For infants
Per bambini
Pour enfants
Para niños

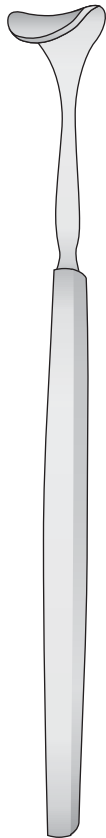

DESMARRES
0219-HA/0219-HL
140 mm



0219-HA
140 mm



0219-HC
140 mm



0219-HE
140 mm

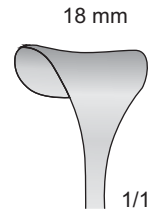

0219-HH
160 mm



0219-HB
140 mm



0219-HD
140 mm



0219-HF
140 mm

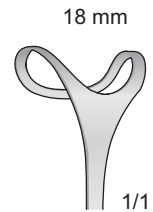

0219-HL
140 mm

Schlingen

Loops

Anse

Asas

Anses

Strabismus Schlingen
 Strabismus Loops
 Anse da strabismo
 Asas para estrabismo
 Anses à strabisme

1,3 mm

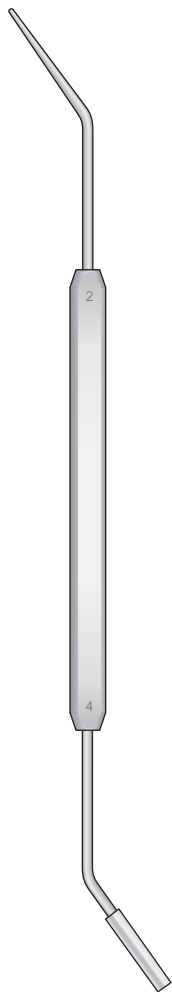

2,6 mm

1310-EFG Fig. 2/4
150 mm

2,0 mm

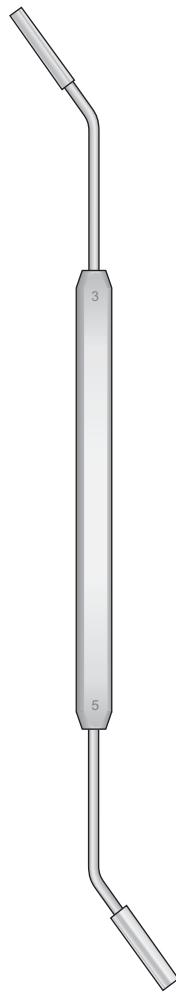

3,3 mm

1310-EFH Fig. 3/5
150 mm

4,0 mm

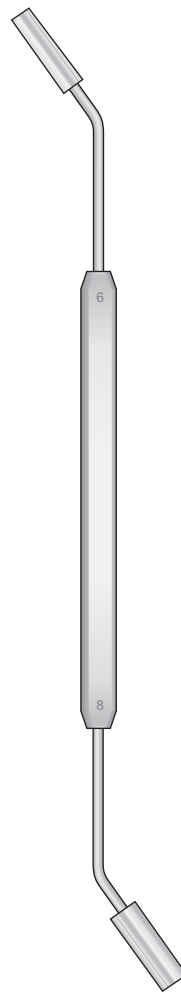

5,2 mm

1310-EFI Fig. 6/8
150 mm

4,6 mm

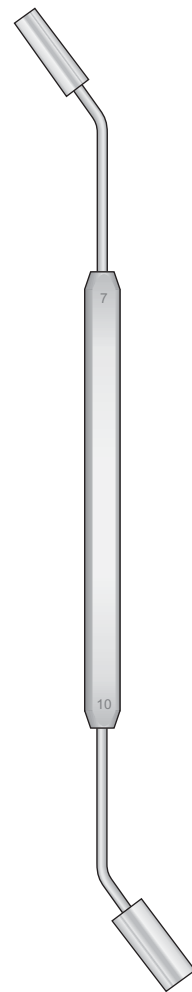

6,6 mm

1310-EFL Fig. 7/10
150 mm



Federschere - Capsulotomy Scissors
 Forbici per cataratta - Tijeras de catarata
 Ciseaux pour la cataracte

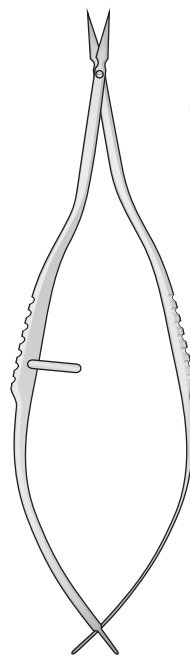

VANNAS
 0604-HL/0604-IB
 85 mm

Irispinzetten - Iris Forceps
 Pinzetta da iride - Pinzas para iris
 Pinces pour l'iris

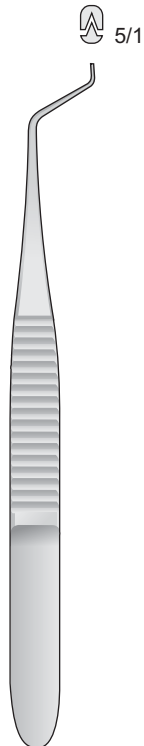

0604-BBL
 90 mm

Muskelpinzette - Muscle Forceps
 Pinze muscolari - Pinza muscular
 Pince musculaire

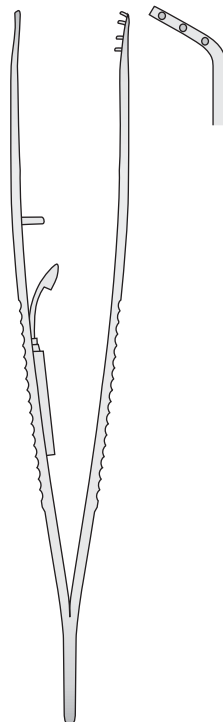

0604-BCA
 95 mm

Fadenpinzetten - Suture Forceps
 Pinze per sutura - Pinzas para sutura
 Pinces à sutures

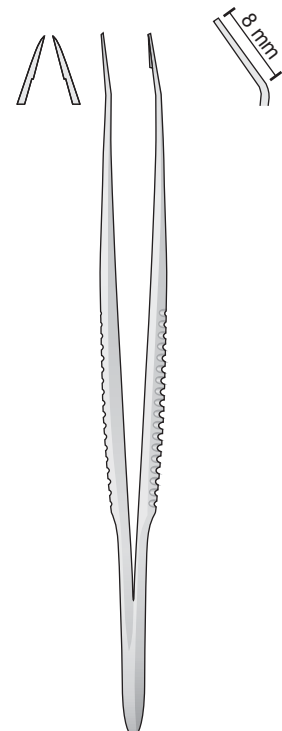

Mc PHERSON
 0604-BCD
 95 mm

Iridektomiescheren
Iridectomy Scissors
Forbici per iridectomia
Tijeras para iridectomía
Ciseaux à iridectomie

Stumpf - Spitz
Blunt - Sharp
Smussa - Acuta
Romas - Agudas
Musses - Pointus

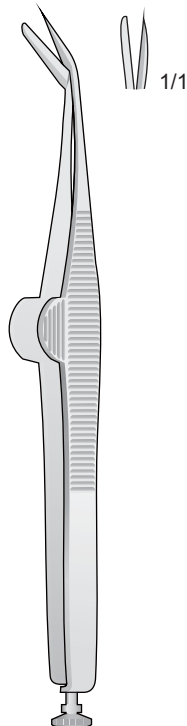

WECKER
0604-CDB
110 mm

Spitz - Stumpf
Sharp - Blunt
Acuta - Smussa
Agudas - Romas
Pointus - Musses

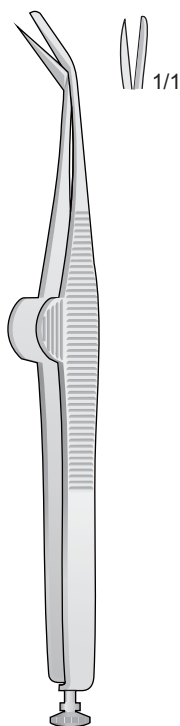

WECKER
0604-CDC
110 mm

Stumpf - Stumpf
Blunt - Blunt
Smussa - Smussa
Romas - Romas
Musses - Musses

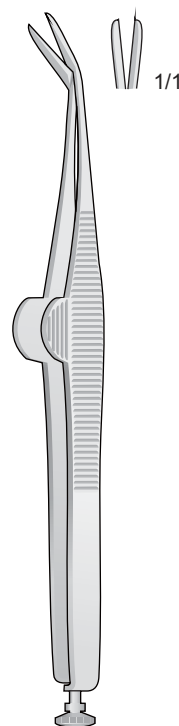

WECKER
0604-CDD
110 mm

Spitz - Spitz
Sharp - Sharp
Acuta - Acuta
Agudas - Agudas
Pointus - Pointus

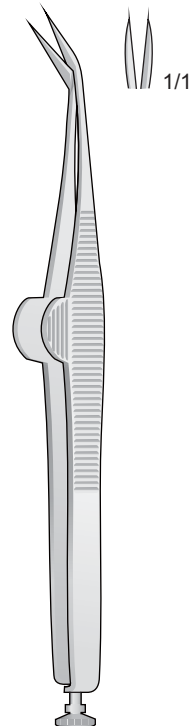

WECKER
0604-CDE
110 mm

Scheren

Scissors

Forbici

Tijeras

Ciseaux

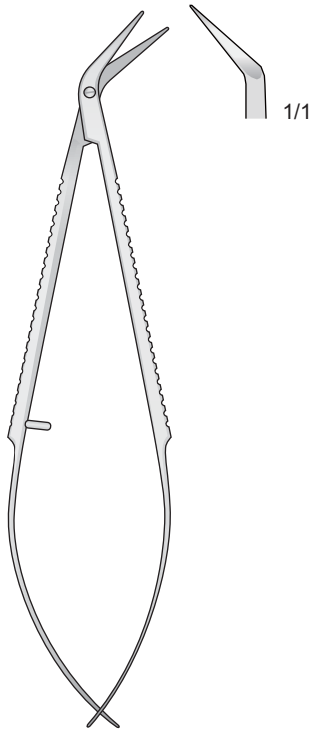

0604-AD
110 mm

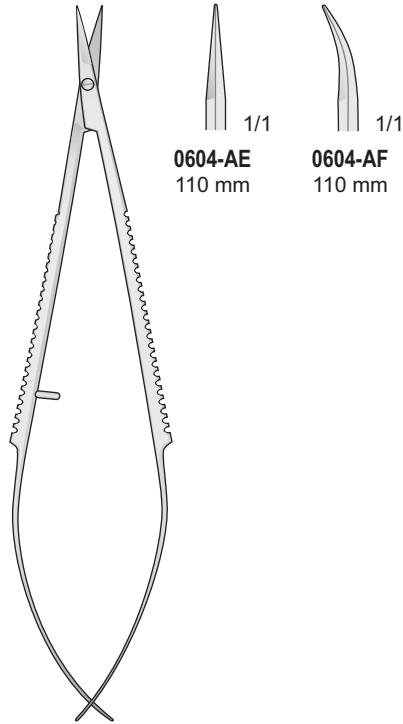

0604-AE/0604-AF
110 mm

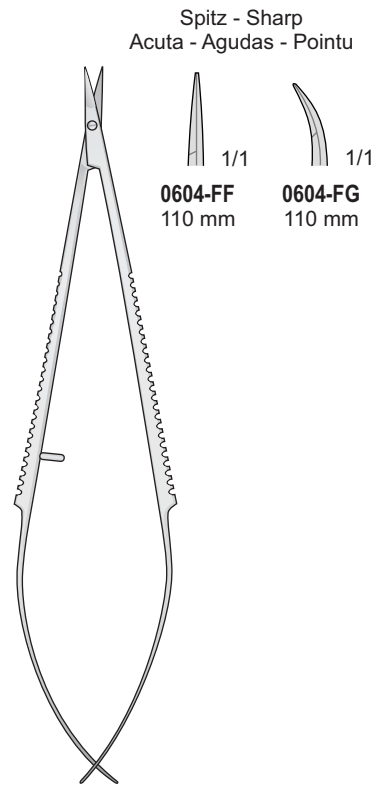

0604-FF/0604-FG
110 mm

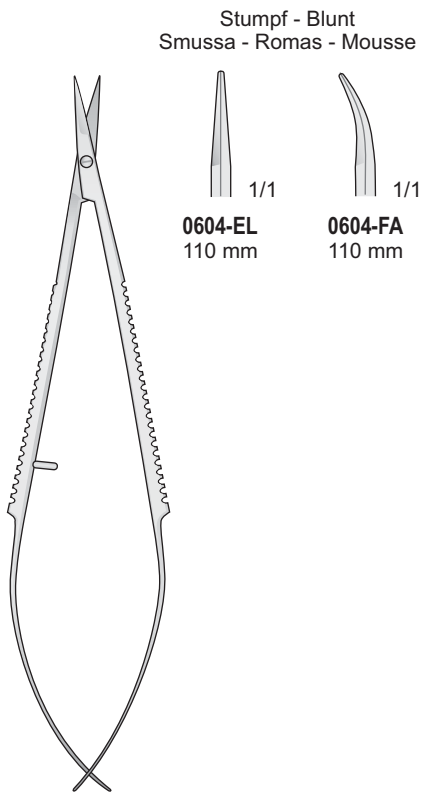

0604-EL/0604-FA
110 mm

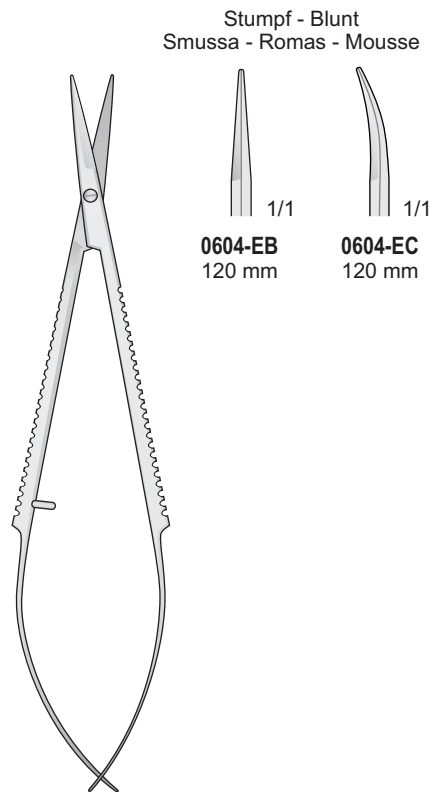

0604-EB/0604-EC
120 mm

Scheren

Scissors

Forbici

Tijeras

Ciseaux

Hornhautscheren - Corneal Scissors
 Forbici corneali - Tijeras para córnea
 Ciseaux pour la cornée

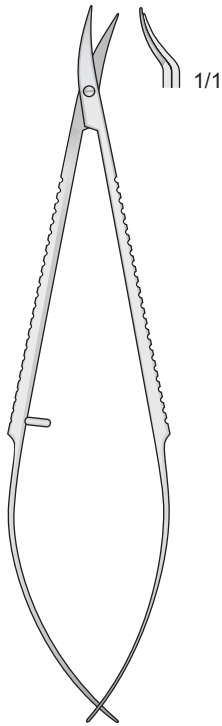

TROUTMAN
0604-GL
 110 mm

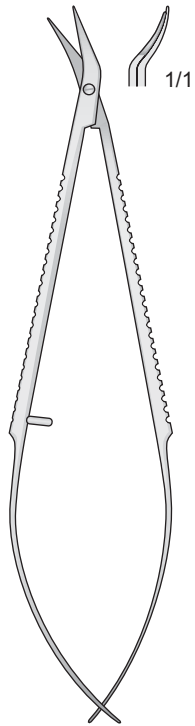

TROUTMAN
0604-HA
 110 mm

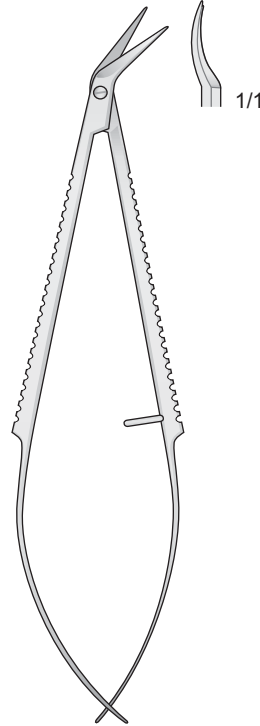

CASTROVIEJO
0604-GG
 110 mm

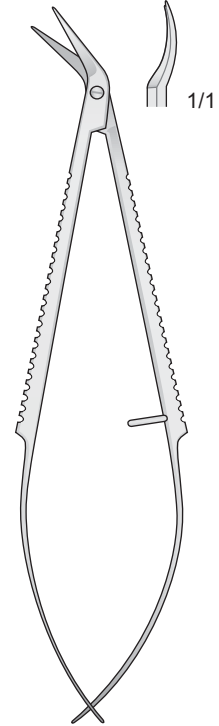

CASTROVIEJO
0604-GH
 110 mm

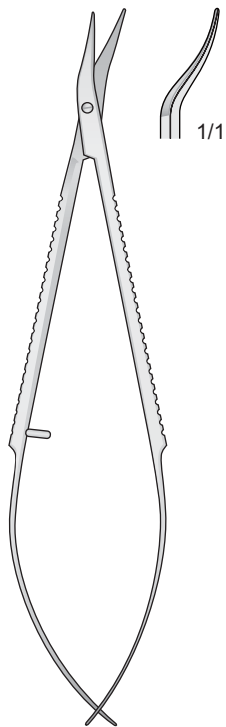

CASTROVIEJO
0604-GI
 110 mm

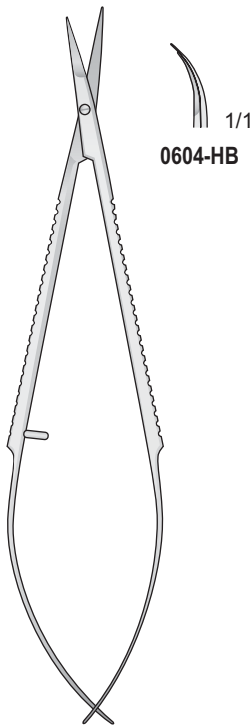

0604-HB/0604-HC
 110 mm



0604-HC 1/1

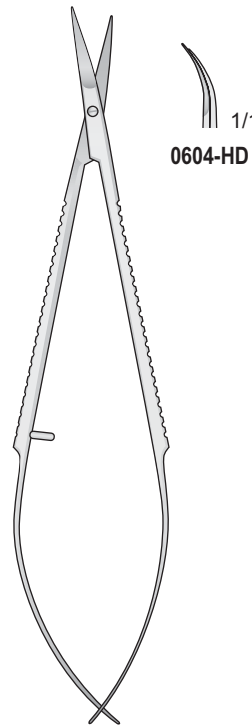

0604-HD/0604-HE
 110 mm

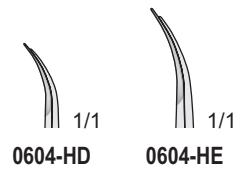

0604-HE 1/1

Scheren, Pinzetten

Scissors, Forceps

Forbici, Pinzette

Tijeras, Pinzas

Ciseaux, Pincers

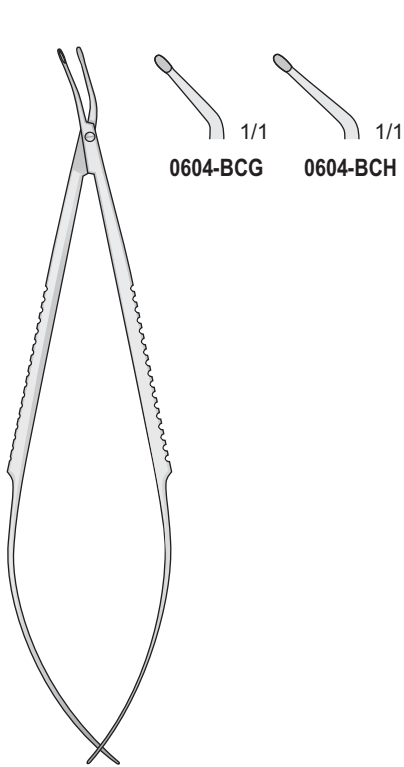

0604-BCG/0604-BCH
110 mm

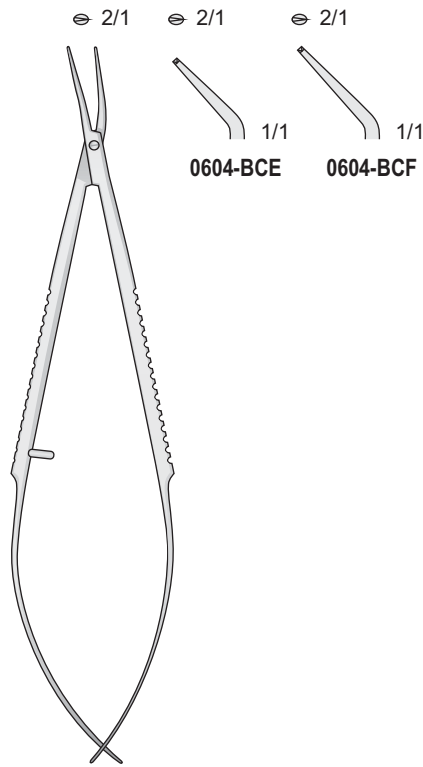

0604-BCE/0604-BCF
110 mm

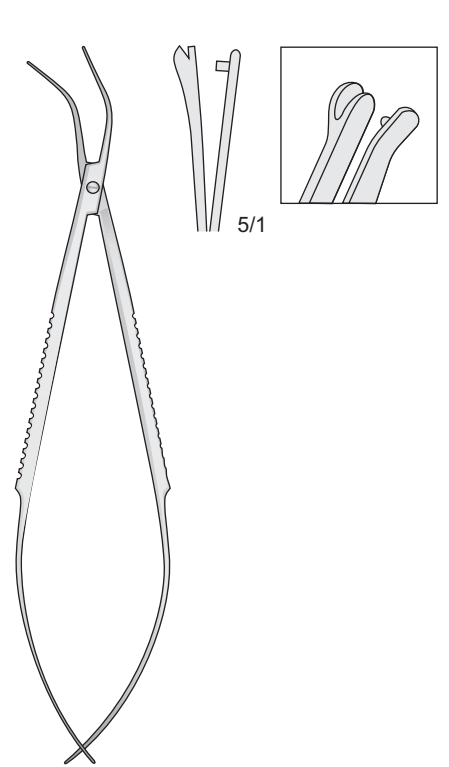

0604-BDA
110 mm

Linsenimplantation - Lens implantation - Pinze per impianto lenti
Implatación del cristalino - Pincers pour l'implantation

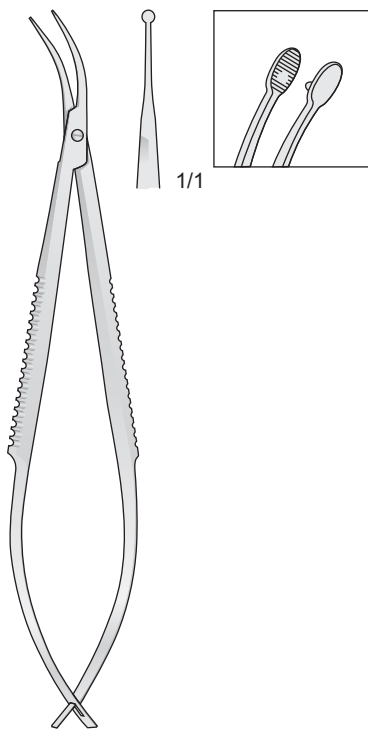

0604-BDC
110 mm

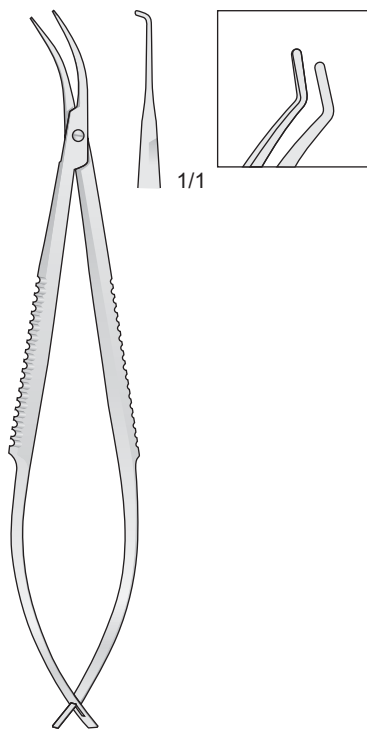

0604-BDE
110 mm

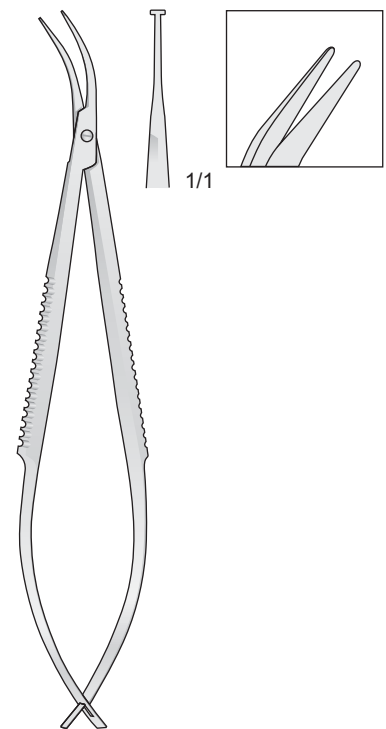

0604-BDG
110 mm

Scheren

Scissors

Forbici

Tijeras

Ciseaux

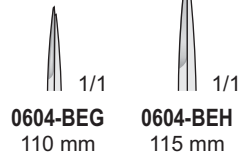
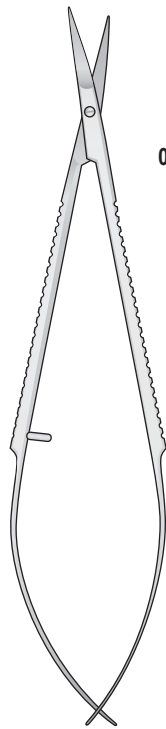

0604-BEG/0604-BEH

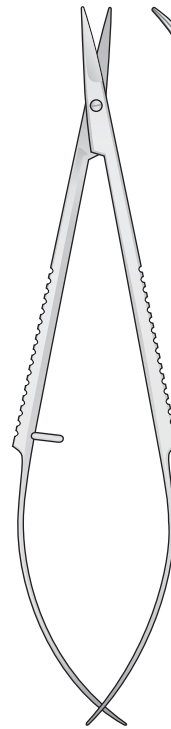

0604-GC
110 mm

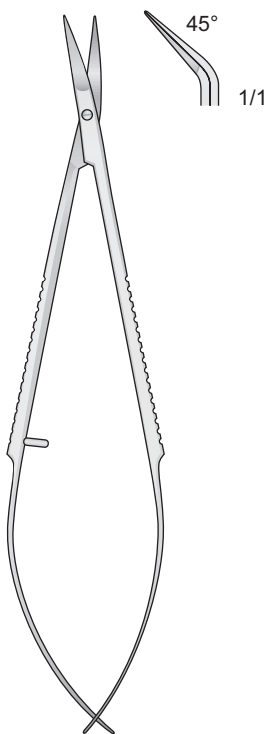
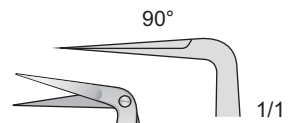

0604-BB
110 mm

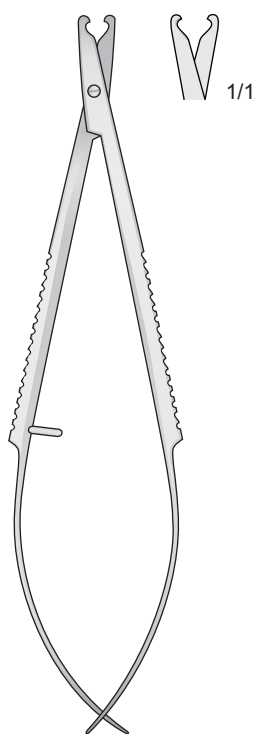

0604-GB
110 mm

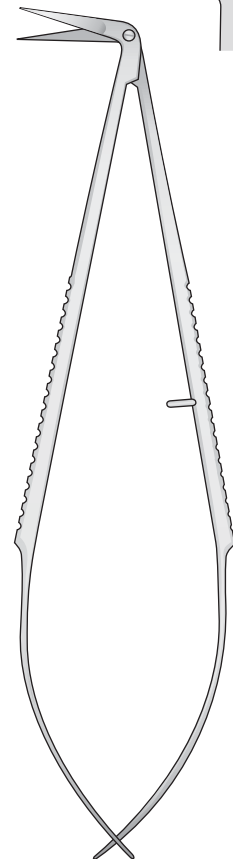

0604-EA
150 mm

Sehnenscheren,
Hornhautscheren

Tenotomy Scissors,
Corneal Scissors

Forbici per tenotomia,
Forbici corneali

Tijeras para tenotomia,
Tijeras para córnea

Ciseaux à ténatomie,
Ciseaux pour la cornée

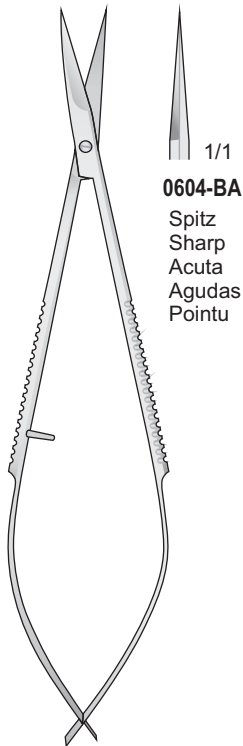

1/1
0604-BA
Spitz
Sharp
Acuta
Agudas
Pointu

NOYES
0604-BA
120 mm

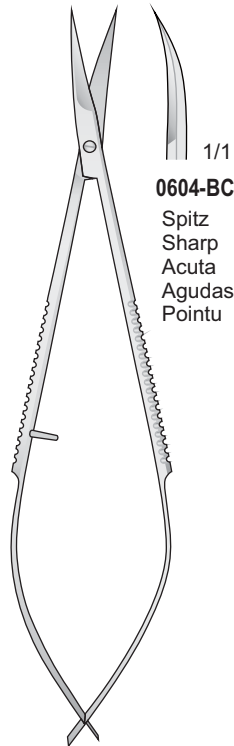

1/1
0604-BC
Spitz
Sharp
Acuta
Agudas
Pointu

NOYES
0604-BC
120 mm

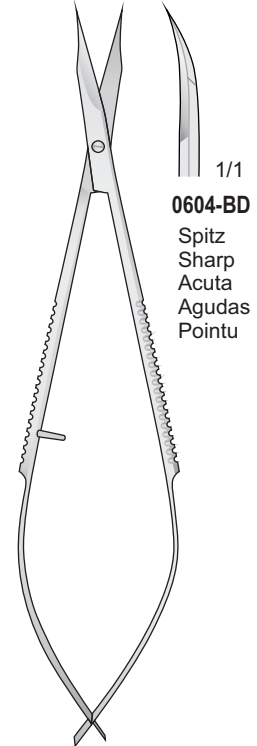

1/1
0604-BD
Spitz
Sharp
Acuta
Agudas
Pointu

WESTCOTT
0604-BD
120 mm

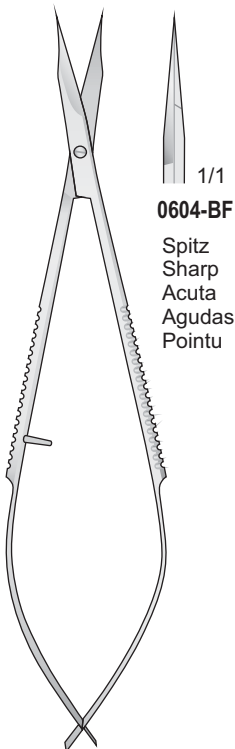

1/1
0604-BF
Spitz
Sharp
Acuta
Agudas
Pointu

WESTCOTT
0604-BF
120 mm

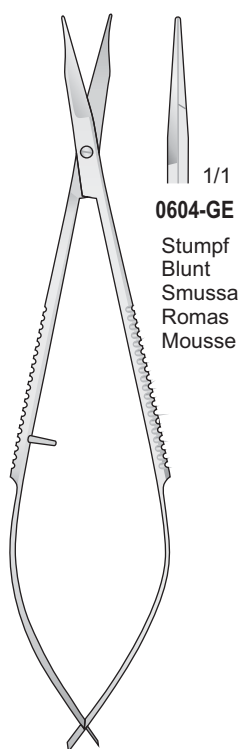

1/1
0604-GE
Stumpf
Blunt
Smussa
Romas
Mousse

WESTCOTT
0604-GE
120 mm

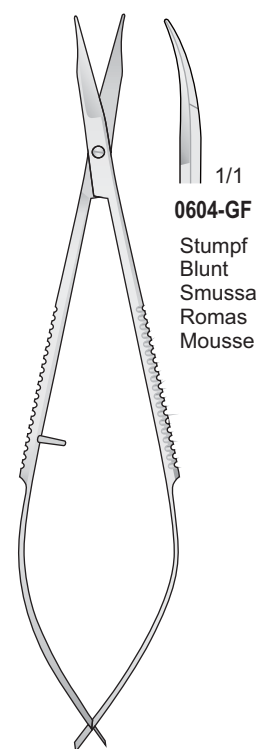

1/1
0604-GF
Stumpf
Blunt
Smussa
Romas
Mousse

WESTCOTT
0604-GF
120 mm

Scheren

Scissors

Forbici

Tijeras

Ciseaux

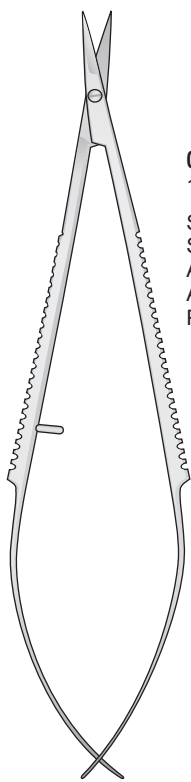

 1/1
0604-AB
 130 mm
 Spitz
 Sharp
 Acuta
 Agudas
 Pointu

 1/1
0604-AC
 130 mm
 Spitz
 Sharp
 Acuta
 Agudas
 Pointu

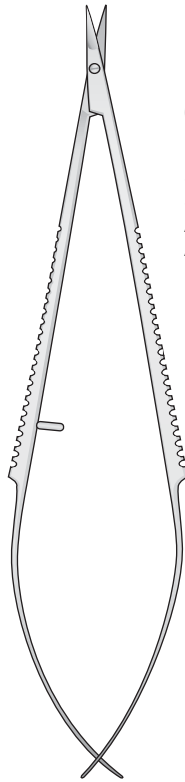

 1/1
0604-FH
 130 mm
 Spitz
 Sharp
 Acuta
 Agudas
 Pointu

 1/1
0604-FI
 130 mm
 Spitz
 Sharp
 Acuta
 Agudas
 Pointu

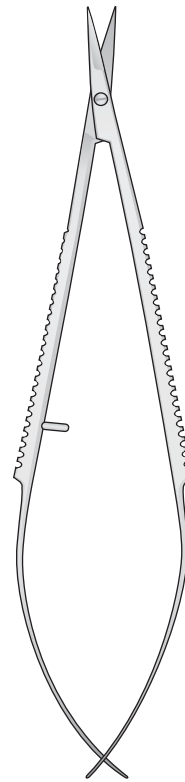

 1/1
0604-FB
 130 mm
 Stumpf
 Blunt
 Smussa
 Romas
 Mousse

 1/1
0604-FC
 130 mm
 Stumpf
 Blunt
 Smussa
 Romas
 Mousse

0604-AB/0604-AC
 130 mm

0604-FH/0604-FI
 130 mm

0604-FB/0604-FC
 130 mm

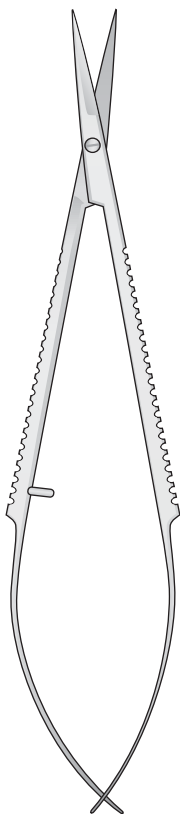

 1/1
0604-AH
 135 mm
 Stumpf
 Blunt
 Smussa
 Romas
 Mousse

 1/1
0604-AL
 135 mm
 Stumpf
 Blunt
 Smussa
 Romas
 Mousse

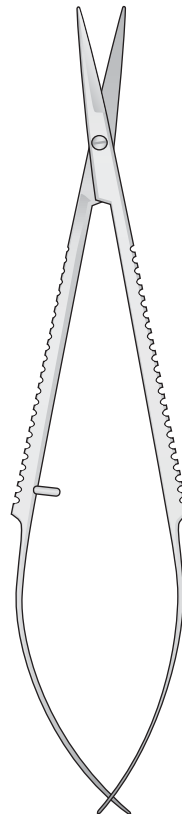

 1/1
0604-ED
 135 mm
 Stumpf
 Blunt
 Smussa
 Romas
 Mousse

 1/1
0604-EE
 135 mm
 Stumpf
 Blunt
 Smussa
 Romas
 Mousse

0604-AH/0604-AL
 135 mm

0604-ED/0604-EE
 135 mm

Spitz - Sharp
Acuta - Agudas - Pointu



1/1

0604-FL
160 mm



1/1

0604-GA
160 mm

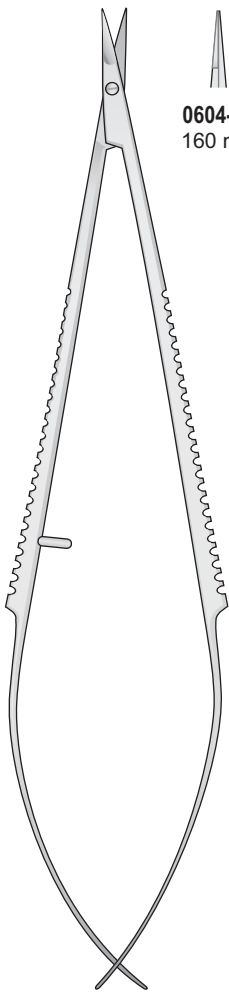

0604-FL/0604-GA
160 mm

Stumpf - Blunt
Smussa - Romas - Mousse



1/1

0604-FD
160 mm



1/1

0604-FE
160 mm

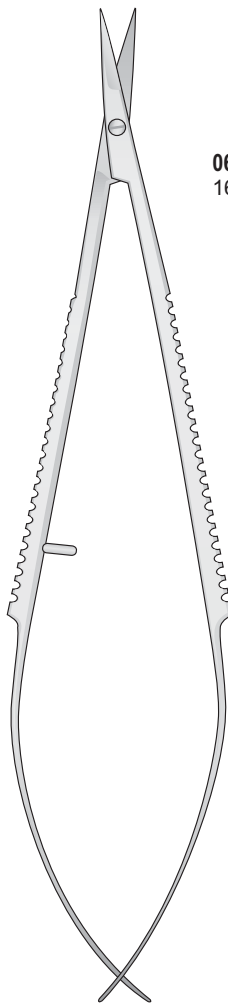

0604-FD/0604-FE
160 mm

Spitz - Sharp
Acuta - Agudas - Pointu



1/1

0604-EH
160 mm



1/1

0604-EI
160 mm

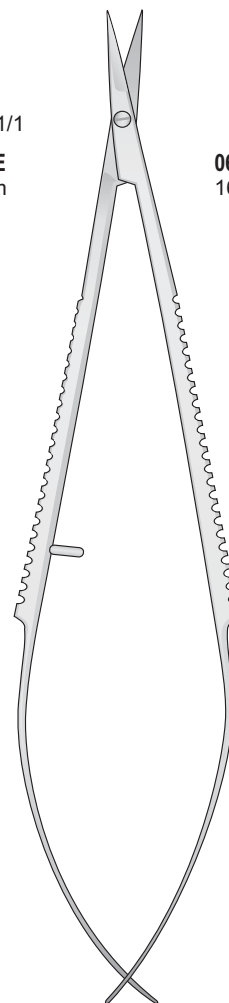

0604-EH/0604-EI
160 mm

Scheren

Scissors

Forbici

Tijeras

Ciseaux

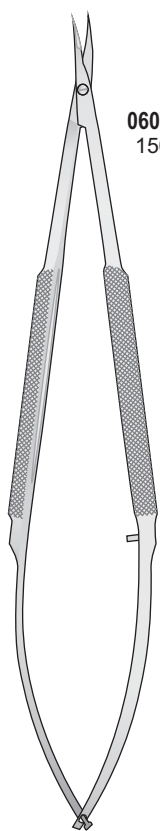

1/1
0604-BDH
150 mm

1/1
0604-BDI
150 mm

0604-BDH/0604-BDI
150 mm

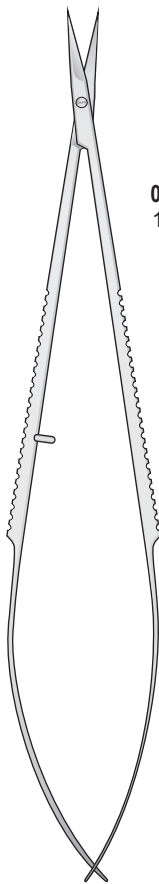

Spitz - Sharp
Acuta - Agudas - Pointu

1/1
0604-AG
160 mm

1/1
0604-AI
160 mm

0604-AG/0604-AI
160 mm

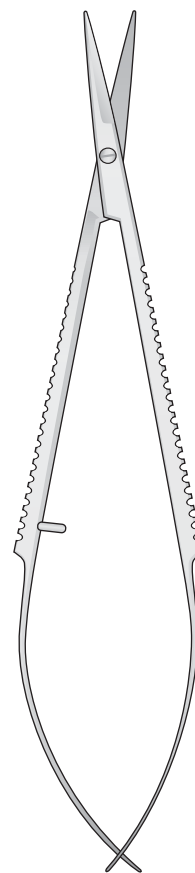

Stumpf - Blunt
Smussa - Romas - Mousse

1/1
0604-EF
160 mm

1/1
0604-EG
160 mm

0604-EF/0604-EG
160 mm

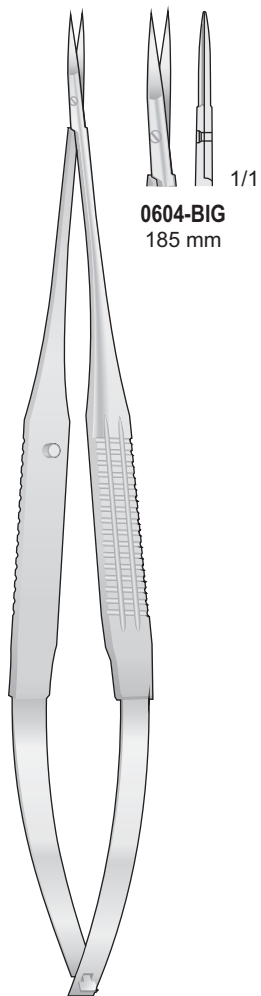

0604-BIG
185 mm

YASARGIL
0604-BIG
185 mm

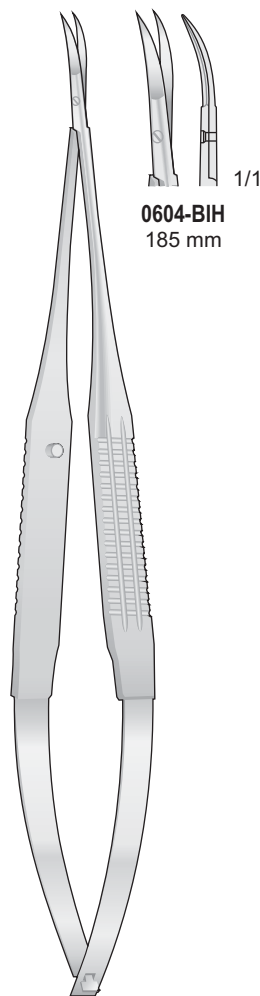

0604-BIH
185 mm

JACOBSON
0604-BIH
185 mm

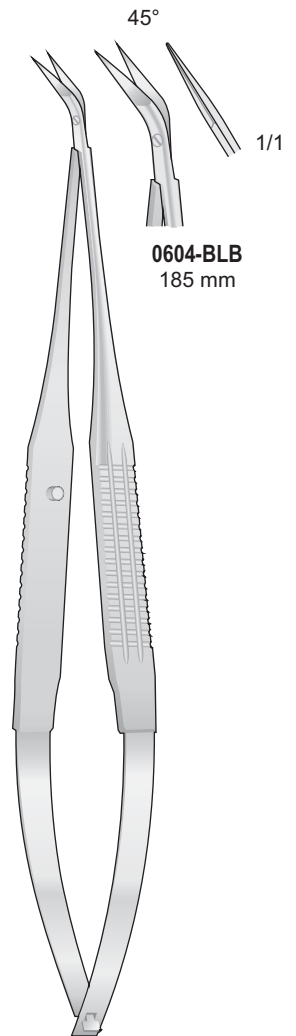

0604-BLB
185 mm

POTTS-YASARGIL
0604-BLB
185 mm

Irisscheren

Iris scissors

Forbici per iridectomia

Tijeras para iridectomía

Ciseaux à iridectomie

“Ribbon type”

Mit großen Ringen
With large rings
Forbici ad anelli grandi
Con anillos especialmente grandes
avec larges anneaux

Irisscheren - Iris scissors
Forbici per iridectomia - Tijeras para iridectomía
Ciseaux à iridectomie

Blepharoplasty
Blefaroplastica

Spitz - Sharp
Acuta - Aguda
Pointu

Spitz - Sharp
Acuta - Aguda
Pointu

Stumpf - Blunt
Smussa - Romas
Mousse

Spitz - Sharp
Acuta - Aguda
Pointu

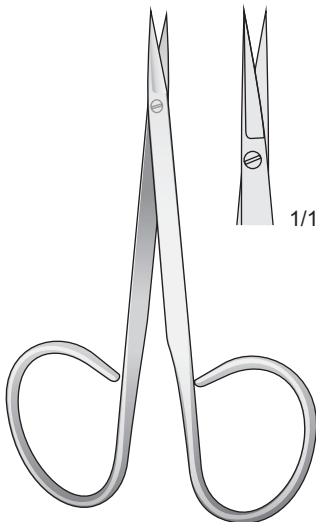

0607-CAA
95 mm

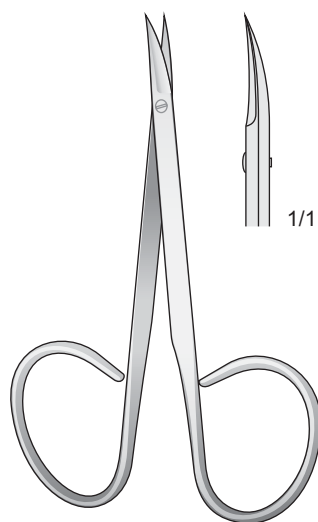

0607-CAB
95 mm

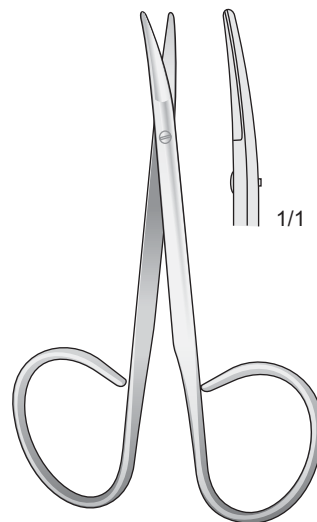

0607-CAC
95 mm

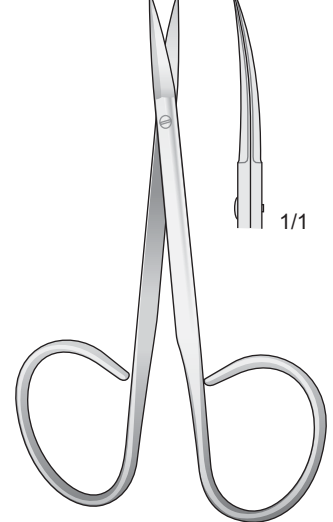

0607-CAD
105 mm

Strabismusscheren - Strabismus Scissors
Forbici da strabismo - Tijeras para estrabismo
Ciseaux à strabisme

Irisscheren - Iris scissors
Forbici per iridectomia - Tijeras para iridectomia
Ciseaux à iridectomie

Stumpf - Blunt
Smussa - Romas
Mousse

Stumpf - Blunt
Smussa - Romas
Mousse

Spitz - Sharp
Acuta - Aguda
Pointu

Spitz - Sharp
Acuta - Aguda
Pointu

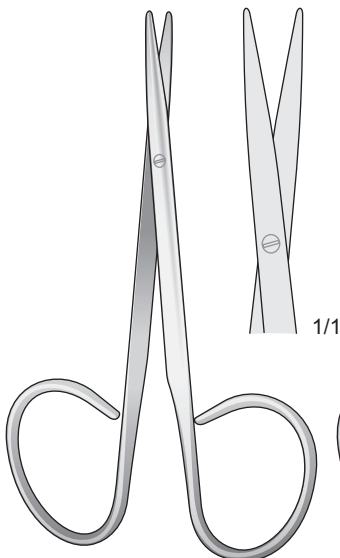

0607-CAE
100 mm

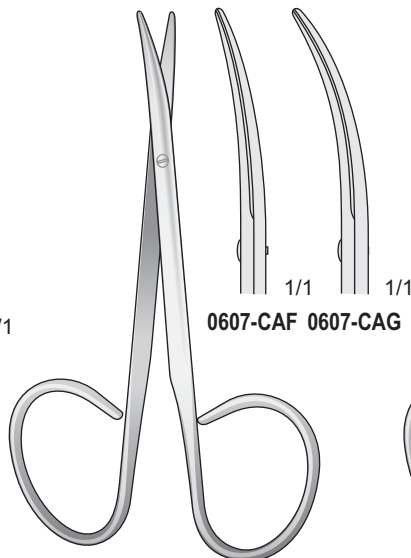

0607-CAF/0607-CAG
100 mm

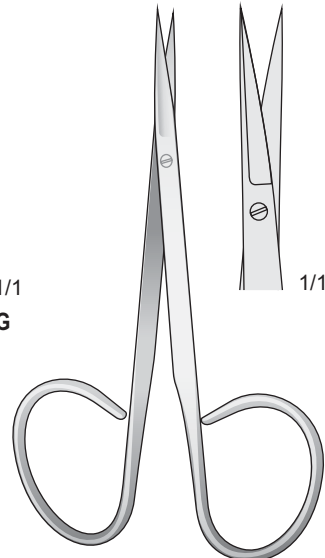

0607-CAH
105 mm

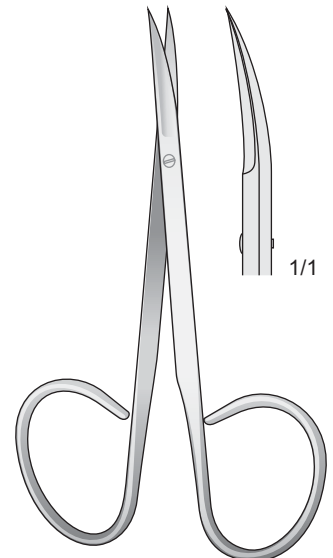

0607-CAI
105 mm

Scheren

Scissors

Forbici

Tijeras

Ciseaux

"Ribbon type"

Mit großen Ringen
With large rings
Forbici ad anelli grandi
Con anillos especialmente grandes
avec larges anneaux

Spitz - Sharp
Acuta - Aguda
Pointu

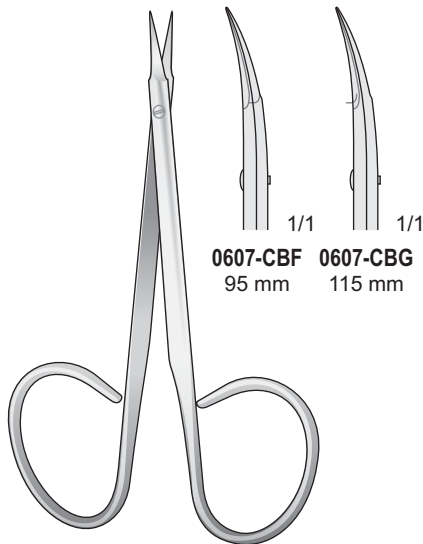

0607-CBF 95 mm
0607-CBG 115 mm

STITCH
0607-CBF/0607-CBG

Stumpf - Blunt
Smussa - Romas
Mousse

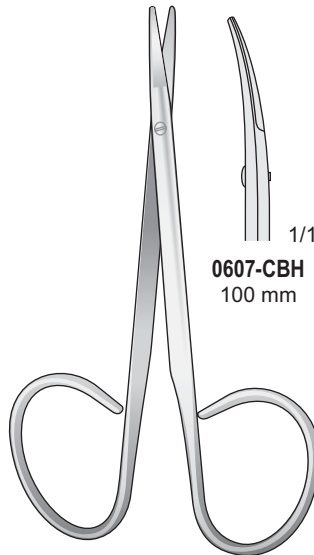

0607-CBH
100 mm

0607-CBH
100 mm

Gezahnt - Serrated
Dentellata - Dentadas
Dentelés

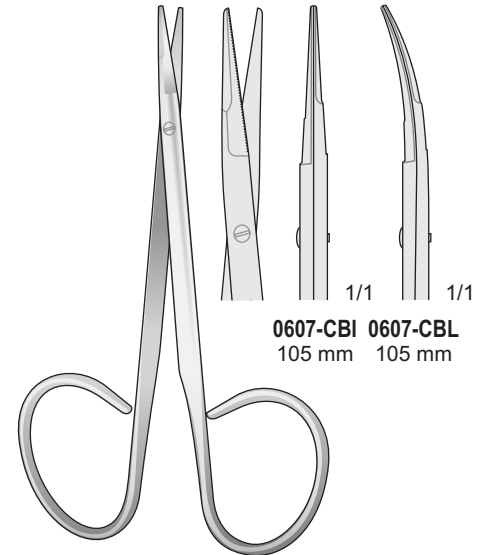

0607-CBI 105 mm
0607-CBL 105 mm

KAYE
0607-CBI/0607-CBL
105 mm

Sehnenscheren - Tenotomy Scissors
Forbici per tenotomia - Tijeras para tenotomia
Ciseaux à ténatomie

Stumpf - Blunt
Smussa - Romas
Mousse

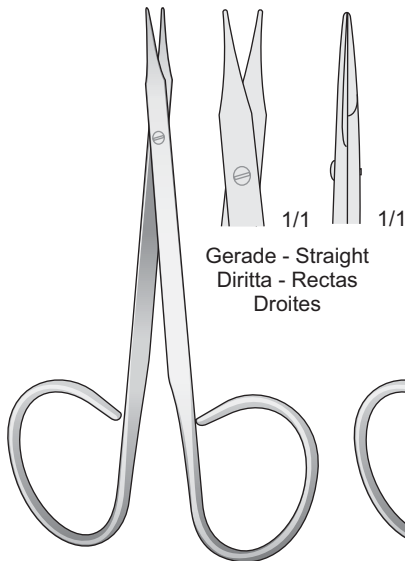

Gerade - Straight
Diritta - Rectas
Droites

STEVENS
0607-CAL
100 mm

Stumpf - Blunt
Smussa - Romas
Mousse

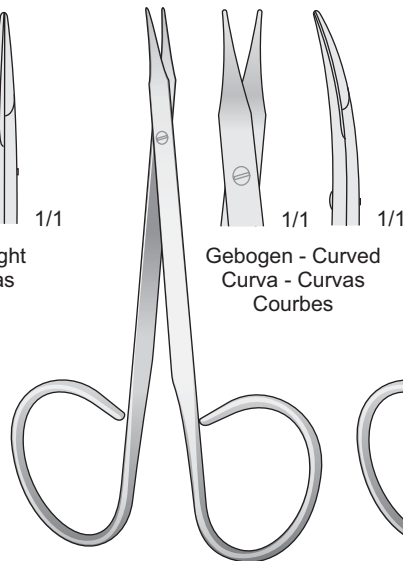

Gebogen - Curved
Curva - Curvas
Courbes

STEVENS
0607-CBA
100 mm

Spitz - Sharp
Acuta - Aguda
Pointu

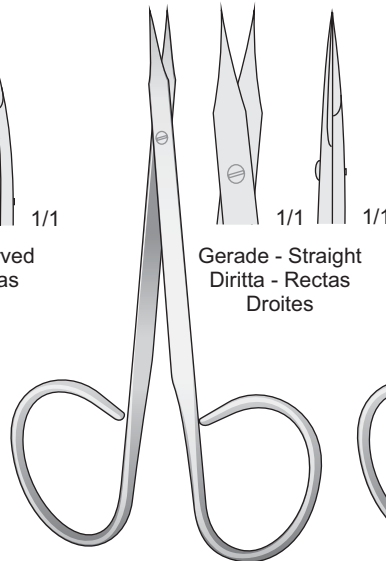

Gerade - Straight
Diritta - Rectas
Droites

WALTON
0607-CBB
100 mm

Spitz - Sharp
Acuta - Aguda
Pointu

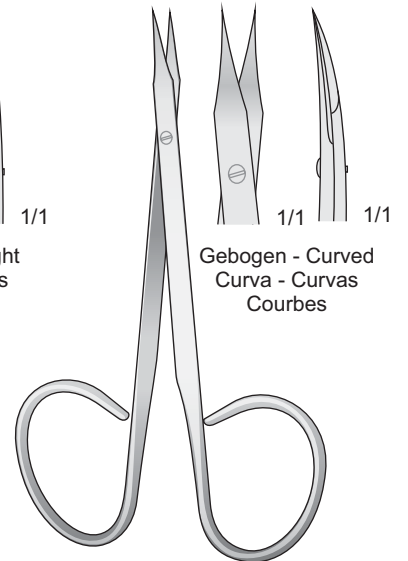

Gebogen - Curved
Curva - Curvas
Courbes

WALTON
0607-CBC
100 mm

Scheren

Scissors

Forbici

Tijeras

Ciseaux

Spitz - Pointed
Acuta - Agudas - Pointus

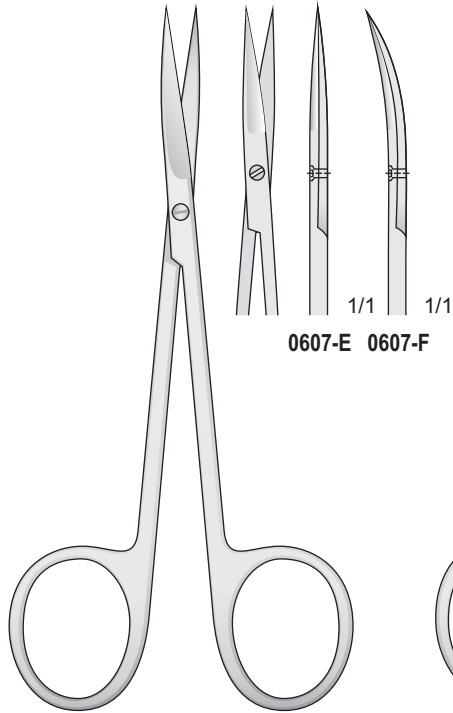

0607-E/0607-F
105 mm

Spitz
Pointed
Acuta
Agudas
Pointus

Gerade
Straight
Diritta
Rectas
Droits

Gebogen
Curved
Curve
Curvas
Courbes

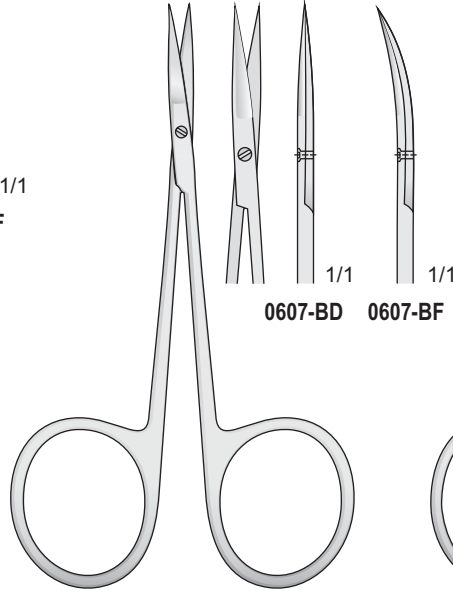

MICRO-IRIS
0607-BD/0607-BF
85 mm

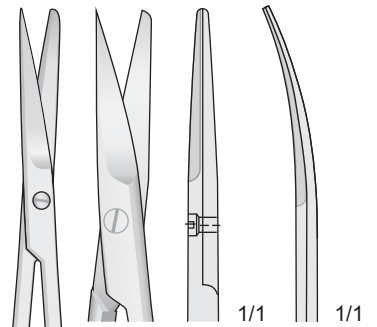

0607-BAD/0607-BAF
110 mm

Spitz - Pointed
Acuta - Agudas - Pointus

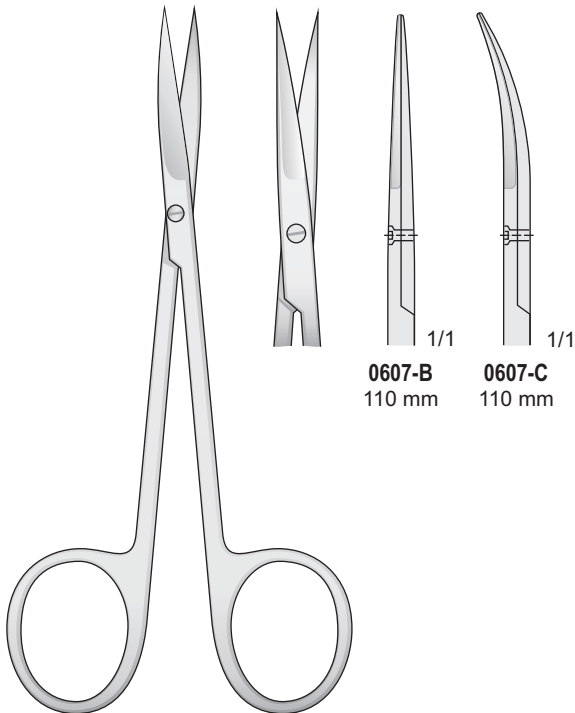

IRIS
0607-B/0607-C
110 mm

Stumpf - Blunt
Smussa - Romas - Mousse

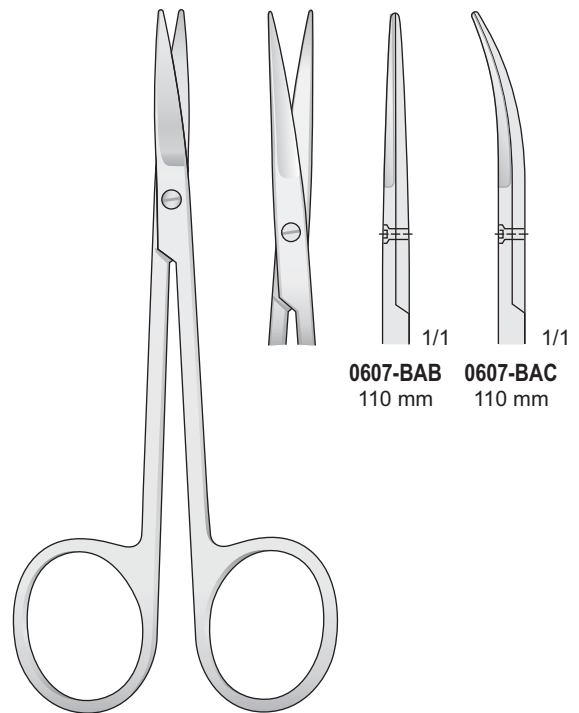

0607-BAB/0607-BAC
110 mm

Scheren

Scissors

Forbici

Tijeras

Ciseaux

Sehnenscheren - Tenotomy Scissors
 Forbici per tenotomia - Tijeras para tenotomia
 Ciseaux à ténonomie

Stumpf - Blunt
 Smussa - Romas - Mousse

Spitz - Pointed
 Acuta - Agudas - Pointus

Forbici per sclerectomia

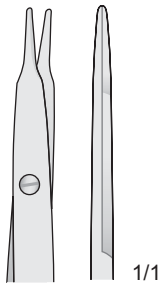
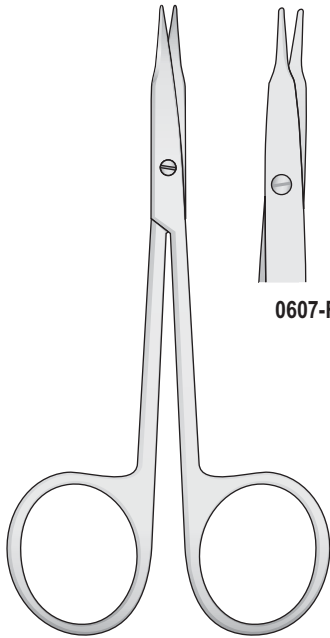

0607-FA

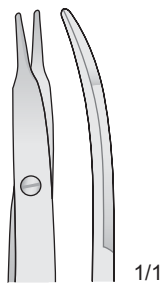

0607-FB

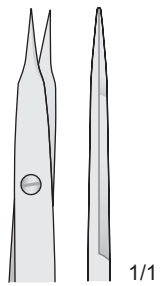

0607-FC

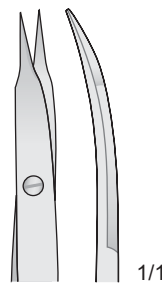

0607-FD

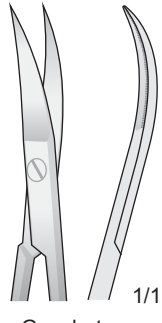
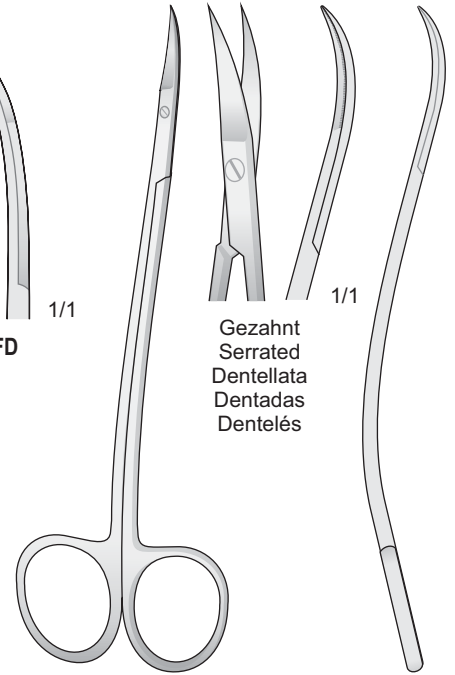

Gezahnt
 Serrated
 Dentellata
 Dentadas
 Dentelés

STEVENS
 0607-FA/0607-FD
 110 mm

LA GRANGE
 1107-B
 115 mm

Stumpf - Blunt
 Smussa - Romas - Mousse

Spitz - Pointed
 Acuta - Agudas - Pointus

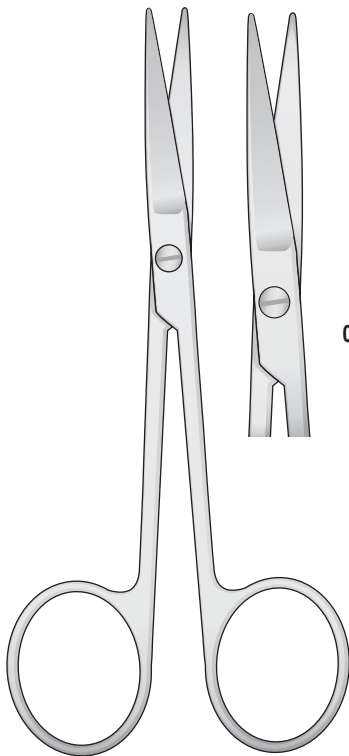

0607-CB

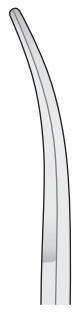

0607-CC

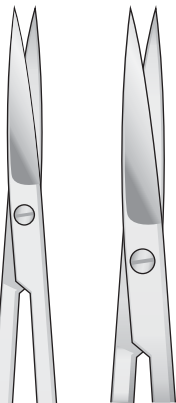

0607-CD

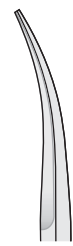

0607-CE

0607-CB/0607-CC
 115 mm

0607-CD/0607-CE
 110 mm

Scheren

Scissors

Forbici

Tijeras

Ciseaux

Conjunctival and utility Scissors

Enucleationsscheren - Enucleation Scissors
 Forbice da enucleazione - Tijeras para enucleación
 Ciseaux à énucléation

Stumpf
 Blunt
 Smussa
 Romas
 Mousse

Spitz
 Sharp
 Acuta
 Aguda
 Pointu

Leicht Gebogen
 Medium Curved

Stark Gebogen
 Strong Curved

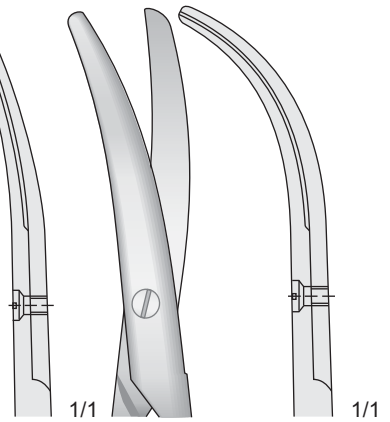
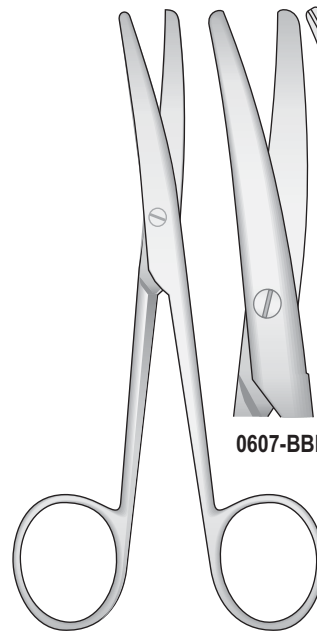
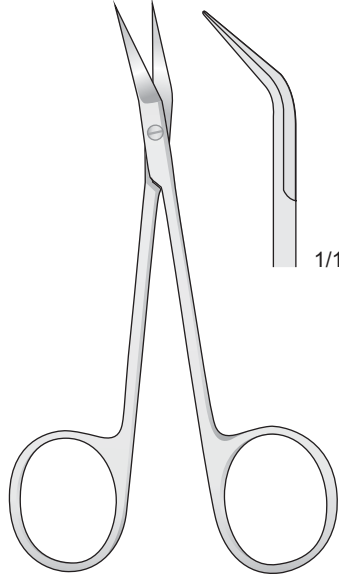
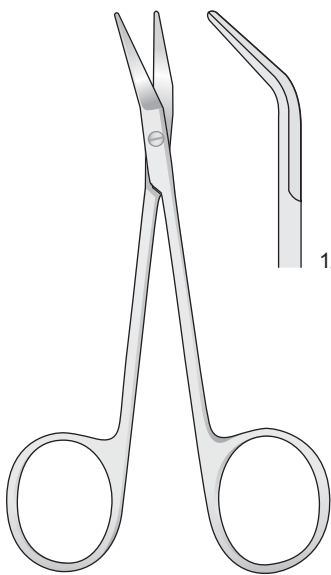

GRAEFE
 0607-DA
 100 mm

WILMER
 0607-BCC
 105 mm

LANDOLT
 0607-BBE/0607-BBF
 120 mm

Ligaturscheren - Ligature Scissors
 Forbici per legature - Tijeras para ligaduras
 Ciseaux à ligatures

Stitch Scissors

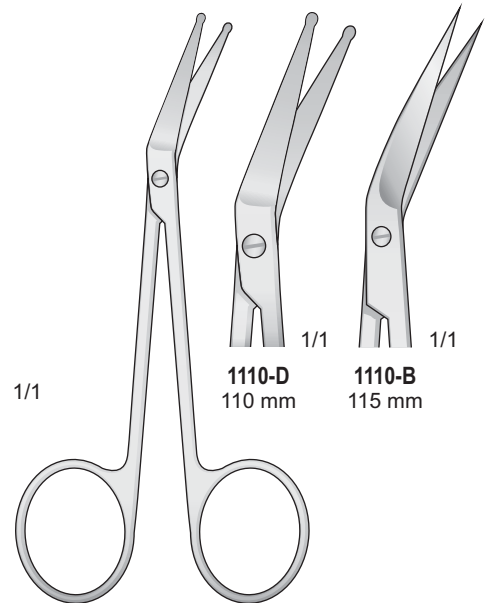
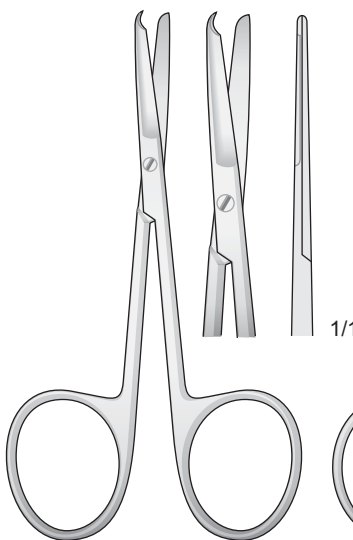
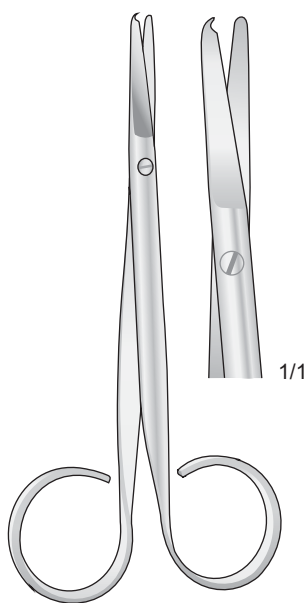
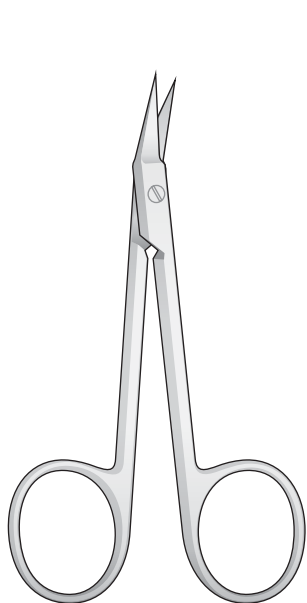

O'BRIEN
 0607-BFB
 95 mm

SPENCER
 1803-B
 110 mm

SPENCER
 1803-L
 90 mm

LOCKLIN MOD.
 1110-B/1110-D

Scheren

Scissors

Forbici

Tijeras

Ciseaux

Strabismusscheren - Strabismus Scissors
Forbici da strabismo - Tijeras para Estrabismo - Ciseaux à strabisme

TC

TC

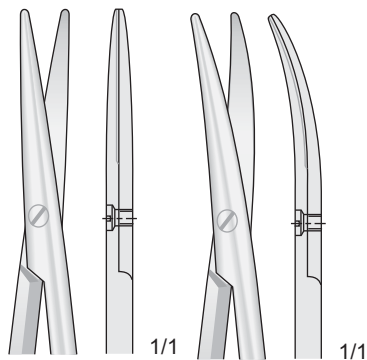
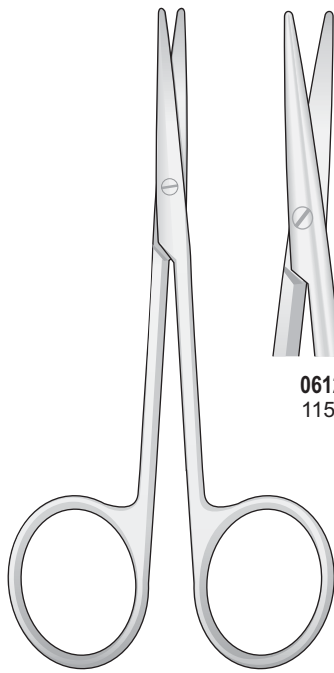

0612-EH
115 mm

0612-EI
115 mm

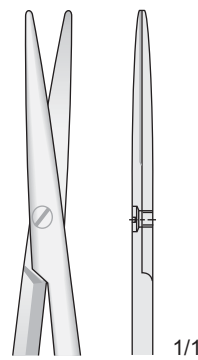
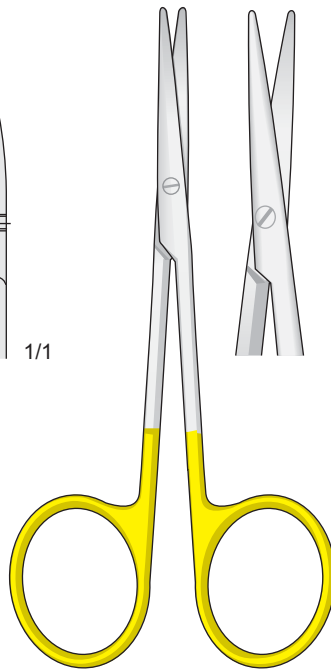

0612-BBI
115 mm

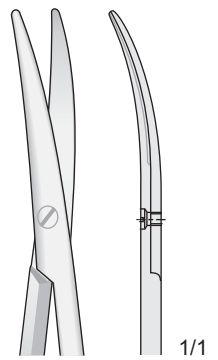
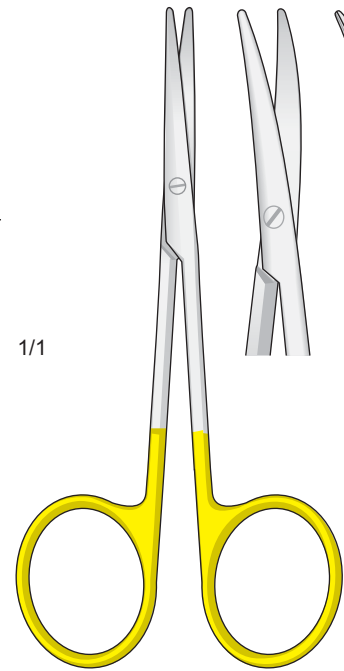

0612-BBL
115 mm

BABY - METZENBAUM
0612-EH/0612-EI
115 mm

Chirurgische Scheren - Operating Scissors
Forbici chirurgiche - Tijeras para cirugia - Ciseaux chirurgicaux

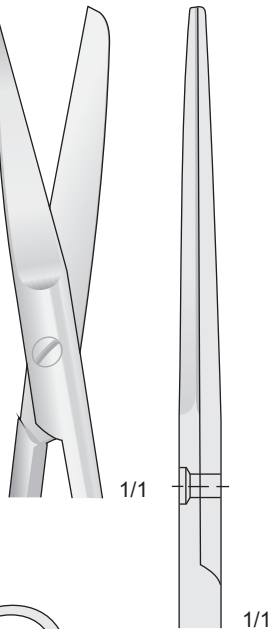
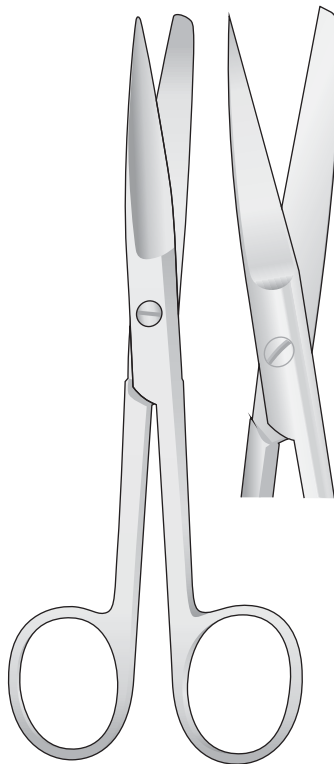

0612-CL
145 mm

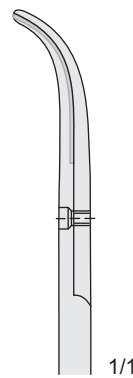
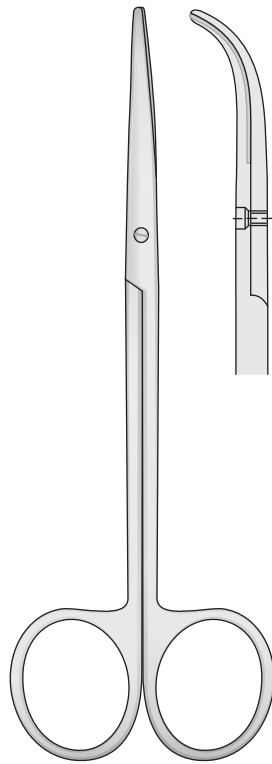

0607-EE
140 mm

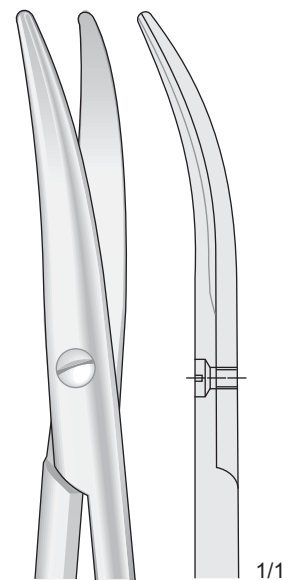
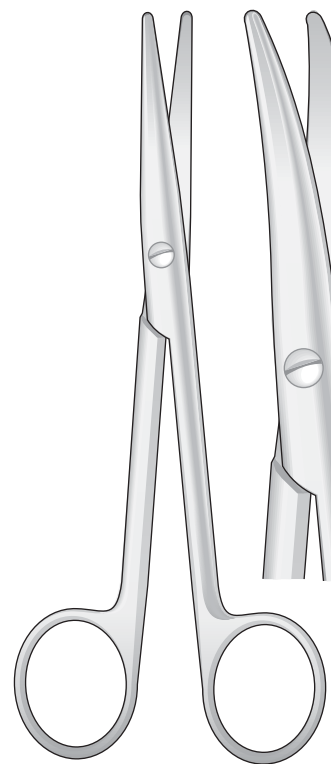

STILLE
0612-BBB
150 mm

Fixier Pinzetten

Fixation Forceps

Pinzette da fissazione

Pinzas de fijación

Pinces à fixer

Scleral Fixation Forceps
1x2 curved teeth

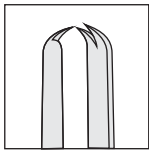

KUHNT
0204-CFF
110 mm

Scleral Fixation Forceps
1x2 angular teeth

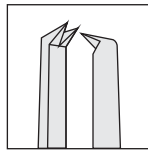

ELSCHNIG
0204-CFG 0,6 mm
0204-CFH 0,9 mm
105 mm

Scleral Fixation Forceps
1x2 curved teeth

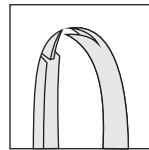

BRACKEN
0204-CFI 0,6 mm
105 mm

Corneal Fixation Forceps
1x2 curved teeth

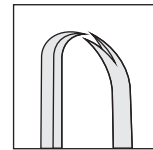

BRACKEN-FARKAS
0204-CFL 0,12 mm
105 mm

Fixation Forceps
Multiple Teeth

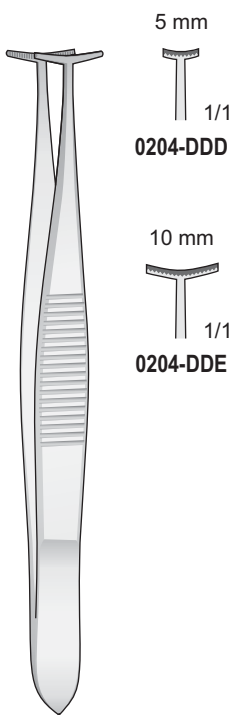

GREEN
0204-DDD/0204-DDE
100 mm

Fixierpinzetten
Fixation forceps
Pinze da Fissazione
Pinzas de fijación
Pinces à fixer

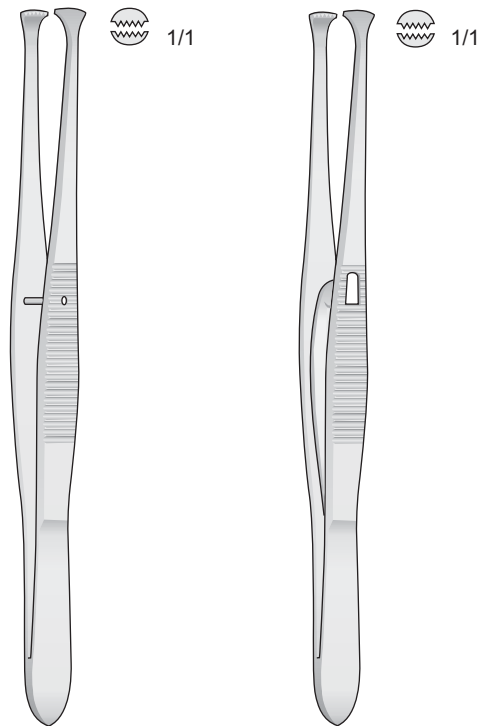

GRAEFE
0204-BDF
110 mm

GRAEFE
0204-BDG
110 mm

Superior Rectus Forceps
with 1x2 heavy teeth

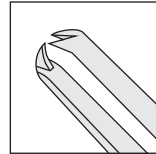

TROUTMAN
0604-BBI
95 mm

Superior Rectus Forceps
with 1x2 heavy teeth

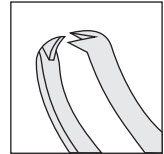

TENNANT-TROUTMAN
0204-BIL
107 mm

Chirurgische Pinzetten

Tissue Forceps

Pinzette chirurgiche

Pinzas quirúrgicas

Pinces à griffes

1,2 mm

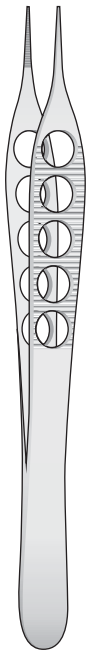

ADSON
0204-CAH
120 mm

1,2 mm

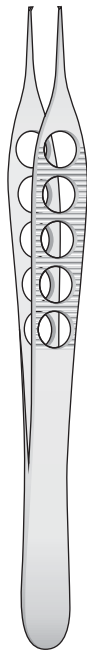

ADSON
0204-CAI
120 mm

7x7 denti

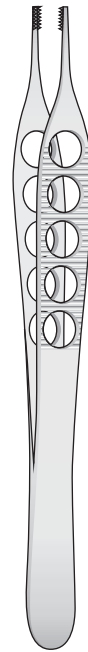

ADSON-BROWN
0204-CAL
120 mm

Tissue Forceps
1x2 Teeth

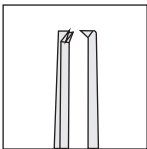

Tissue Forceps
1x2 Teeth of 0,5 mm

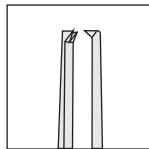

Tissue Forceps
1x2 Teeth of 1,0 mm

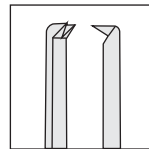

Tissue & Utility Forceps
1x2 Teeth of 1,5 mm

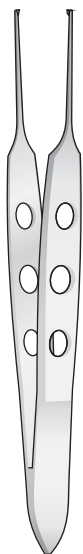
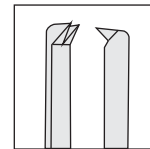

BISHOP-HARMON
1206-BHG 0,3 mm
1206-BHH 0,6 mm
85 mm



0204-DF Straight
0204-DG Curved
100 mm

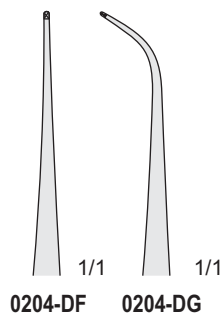

0204-EC Straight
0204-ED Curved
110 mm

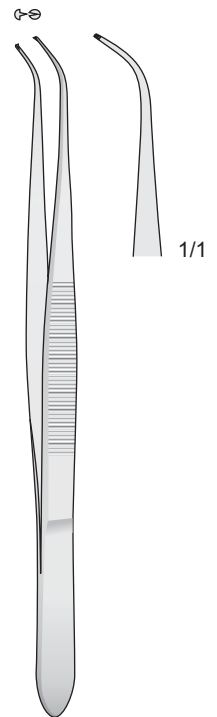
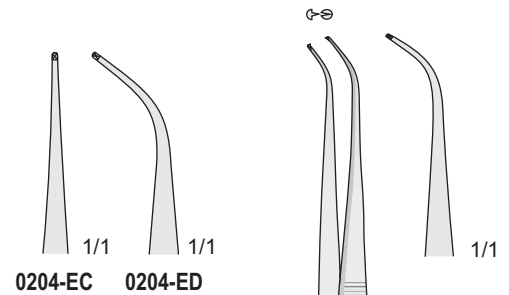

PERRY
0204-AG
125 mm

Feine Anatomische
Pinzetten

Delicate Dressing
Forceps

Pinzette anatomica
delicate

Pinzas de disección
finas

Pinces à dissection
à mors très fins

Titan - Titanium - Titanio - Titane

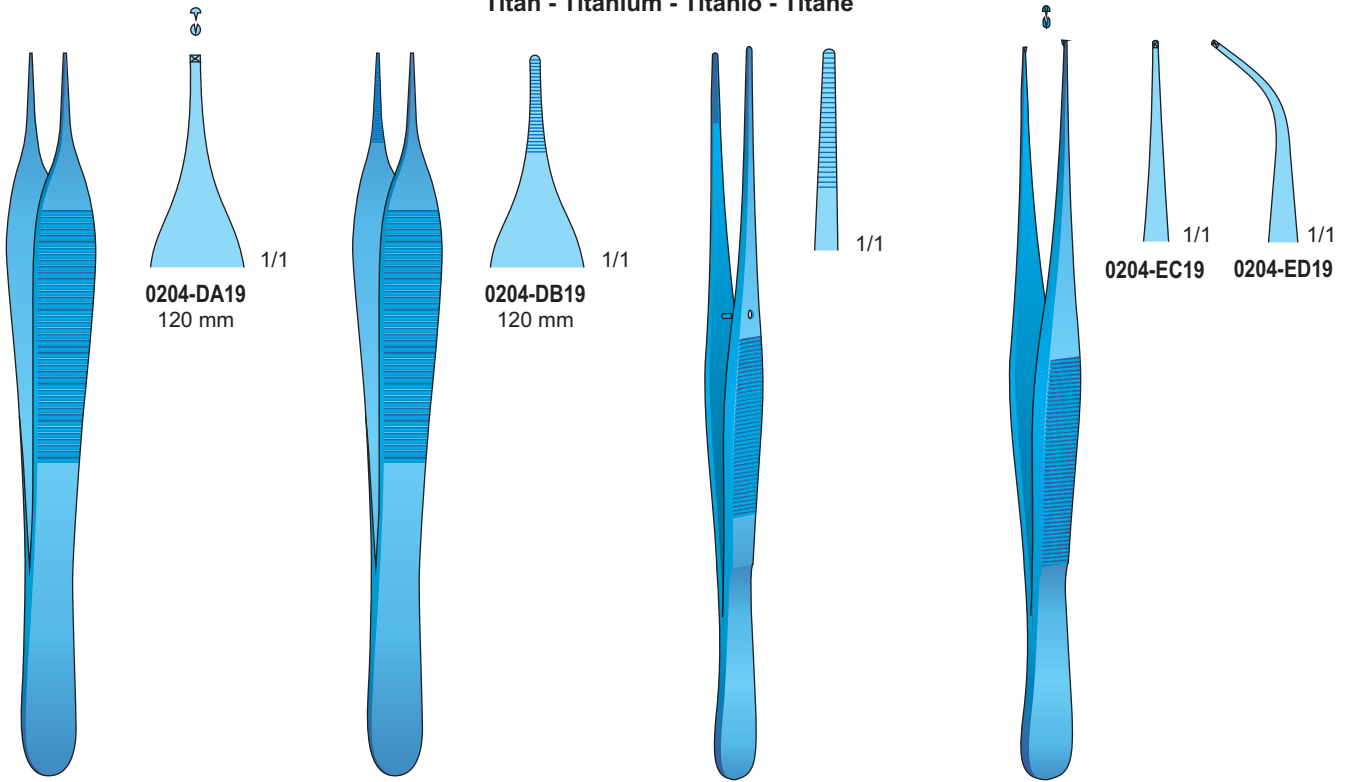

ADSON
0204-DA19
120 mm

ADSON
0204-DB19
120 mm

0204-AL19
130 mm

0204-EC19/0204-ED19
110 mm

Iris Pinzetten - Iris Forceps - Pinze da iride - Pinza para iris - Pince à iris

Dressing Forceps
criss-cross serrated tips

Dressing Forceps
serrated, 0,5 mm tips

Dressing Forceps
serrated, 1,0 mm tips

Dressing & Utility Forceps
serrated, 1,5 mm tips

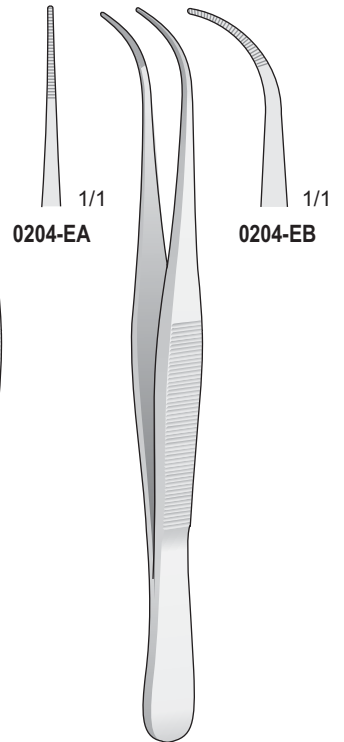
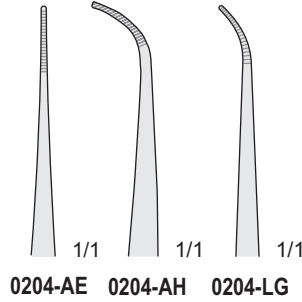
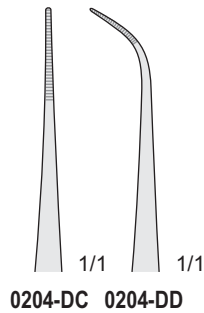
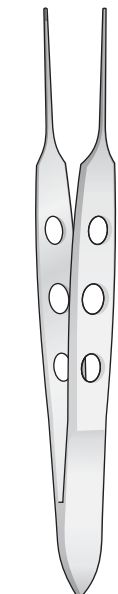
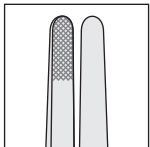

BISHOP-HARMON
1206-BHF
85 mm

0204-DC/0204-DD
100 mm

GRAEFE
0204-AE/0204-LG
100 mm

0204-EA
110 mm

0204-EB
110 mm

Hornhautpinzette

Corneal Forceps

Pinzette corneali

Pinzas para corneal

Pinces à cornée

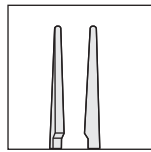

1206-BFA
Corneoscleral
Forceps
ultra fine 5 mm

Gerade
Straight
Diritta
Rectas
Droites

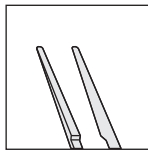

1206-BFB
Corneoscleral
Forceps
ultra fine 5 mm

Gebogen
Curved
Curva
Curvas
Courbes

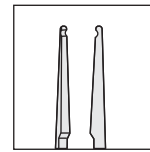

1206-BFC
Corneoscleral
Forceps
Pierse teeth of 0,1 mm

Gerade
Straight
Diritta
Rectas
Droites

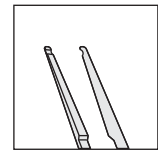

1206-BFD
Corneoscleral
Forceps
Pierse teeth of 0,1 mm

Gebogen
Curved
Curva
Curvas
Courbes



1206-BFA/1206-BFB
100 mm

1206-BFC/1206-BFD
100 mm

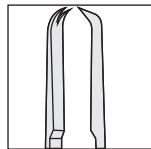

1206-BFE
Corneoscleral
Forceps
1x2 Teeth of 0,12 mm

Gerade, 45°
Straight, 45°
Diritta, 45°
Rectas, 45°
Droites, 45°

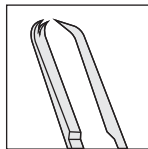

1206-BFF
Corneoscleral
Forceps
1x2 Teeth of 0,12 mm

Gebogen, 45°
Curved, 45°
Curva, 45°
Curvas, 45°
Courbes, 45°

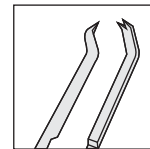

1206-BFG
Corneoscleral
Forceps
5 mm Long Platform
0,12 mm Teeth, 45°

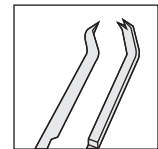

1206-BFH
Corneoscleral
Forceps
5 mm Long Platform
1x1 Pierse teeth, 0,1 mm

1206-BFE/1206-BFH
100 mm

1206-BFG/1206-BFH
100 mm

Faden Pinzette, Nahtpinzetten, Fixierpinzetten
 Tying Forceps, Suturing Forceps, Fixation Forceps
 Pinzette da sutura, Pinzette serrafili, Pinzette da fissazione
 Pinzas para sutura, Pinzas da fijación
 Pinces à sutures, Pinces à monofilament, Pinces à fixer

Gerade
 Straight
 Diritta
 Rectas
 Droites

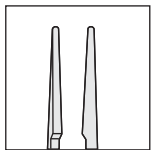

1206-BFI
 Corneal Tying
 Forceps
 extra fine 5 mm

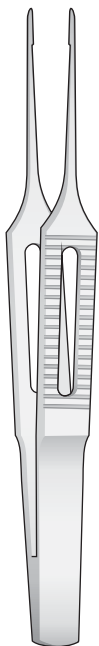

1206-BFI
 85 mm

Gerade
 Straight
 Diritta
 Rectas
 Droites

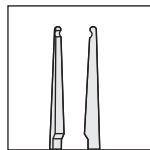

1206-BFL
 Corneal Fixation
 Forceps
 1x1 Pierce teeth of 0,1 mm



1206-BFL
 85 mm

Gerade, 45°
 Straight, 45°
 Diritta, 45°
 Rectas, 45°
 Droites, 45°

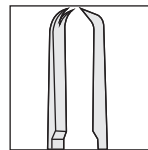

1206-BGA
 Corneal Suturing
 Forceps
 1x2 Teeth of 0,12 mm

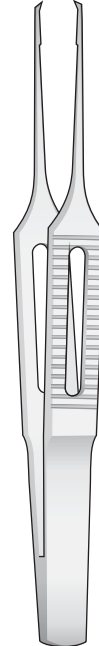

1206-BGA
 85 mm

Gerade, 90°
 Straight, 90°
 Diritta, 90°
 Rectas, 90°
 Droites, 90°

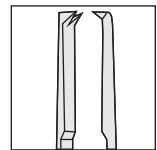

1206-BGB
 Corneal Utility
 Forceps
 1x2 Teeth of 0,12 mm

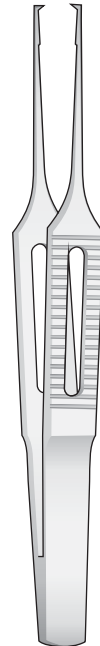

1206-BGB
 85 mm

Hornhautpinzette

Corneal Forceps

Pinzette corneali

Pinzas para corneal

Pinces à cornée

Faden Pinzette, Nahtpinzetten, Fixierpinzetten
 Tying Forceps, Suturing Forceps, Fixation Forceps
 Pinzette da sutura, Pinzette serrafili, Pinzette da fissazione
 Pinzas para sutura, Pinzas da fijación
 Pinces à sutures, Pinces à monofilament, Pinces à fixer

Gebogen
 Curved
 Curva
 Curvas
 Courbes

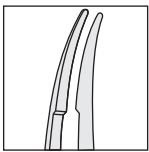

1206-BGC
 Corneal Tying
 Forceps
 extra fine 5 mm



1206-BGC
 85 mm

Gebogen
 Curved
 Curva
 Curvas
 Courbes

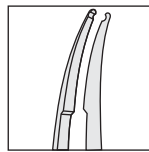

1206-BGD
 Corneal Fixation
 Forceps
 1x1 Pierce teeth of 0,1 mm

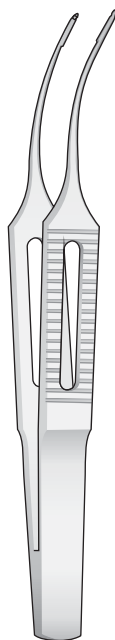

1206-BGD
 85 mm

Gebogen, 45°
 Curved, 45°
 Curva, 45°
 Curvas, 45°
 Courbes, 45°

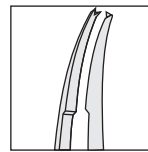

1206-BGE
 Corneal Suturing
 Forceps
 1x2 Teeth of 0,12 mm

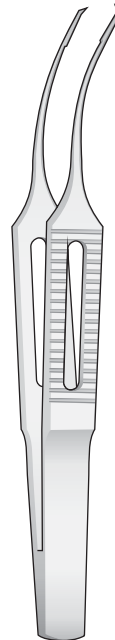

1206-BGE
 85 mm

Gebogen, 90°
 Curved, 90°
 Curva, 90°
 Curvas, 90°
 Courbes, 90°

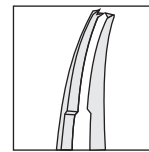

1206-BGF
 Corneal Utility
 Forceps
 1x2 Teeth of 0,12 mm

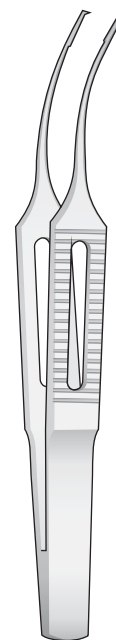

1206-BGF
 85 mm

Faden Pinzette, Nahtpinzetten, Fixierpinzetten
 Tying Forceps, Suturing Forceps, Fixation Forceps
 Pinzette da sutura, Pinzette serrafili, Pinzette da fissazione
 Pinzas para sutura, Pinzas da fijación
 Pinces à sutures, Pinces à monofilament, Pinces à fixer

Angled

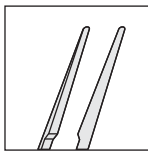

1206-BGG
 Corneal Tying
 Forceps
 extra fine 7 mm

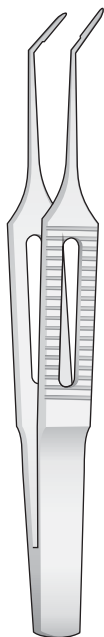

1206-BGG
 85 mm

Angled

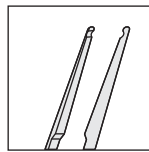

1206-BGH
 Corneal Fixation
 Forceps
 1x1 Pierse teeth of 0,1 mm

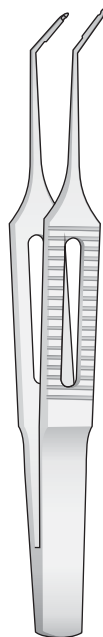

1206-BGH
 85 mm

Angled, 45°

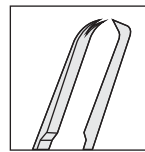

1206-BGI
 Corneal Suturing
 Forceps
 1x2 Teeth of 0,12 mm

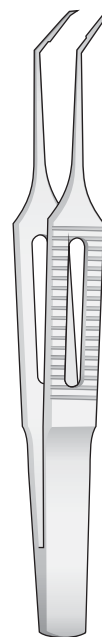

1206-BGI
 85 mm

Angled, 90°

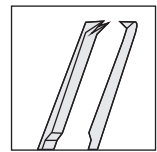

1206-BGL
 Corneal Utility
 Forceps
 1x2 Teeth of 0,12 mm



1206-BGL
 85 mm

Hornhautpinzette

Corneal Forceps

Pinzette corneali

Pinzas para corneal

Pinces à cornée

Corneal Forceps
extra fine 5 mm long jaws

Mit Fadenplatte
With tying platform
Con piano prendifilo
Con piattaforma
Avec plateaux pour monofil

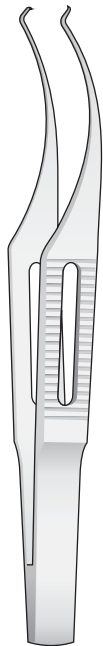
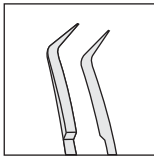

COLIBRI
1206-BHA smooth tips, for tying
1206-BHB pointed tips, for suture removal
83 mm

Corneal Fixation Forceps
1x1 Pierce teeth of 0.1 mm

Mit Fadenplatte
With tying platform
Con piano prendifilo
Con piattaforma
Avec plateaux pour monofil

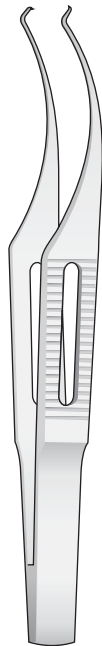
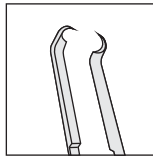

COLIBRI
1206-BHC
83 mm

Corneal Suturing Forceps
1x2 Teeth of 0.12 mm, 45°

Mit Fadenplatte
With tying platform
Con piano prendifilo
Con piattaforma
Avec plateaux pour monofil

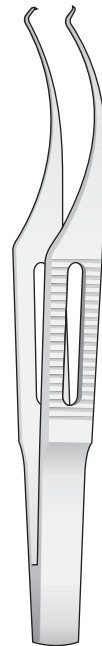
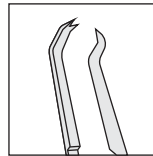

COLIBRI
1206-BHD
83 mm

Corneal Utility Forceps
1x2 Teeth of 0.12 mm, 90°

Mit Fadenplatte
With tying platform
Con piano prendifilo
Con piattaforma
Avec plateaux pour monofil

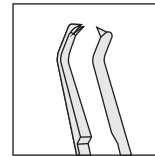

COLIBRI
1206-BHE
83 mm

Corneal Utility Forceps
1x2 teeth set at 90°, smooth

Ohne Fadenplatte
Jaws without platform
Senza piano prendifilo
Sin plataforma
Sans plateaux

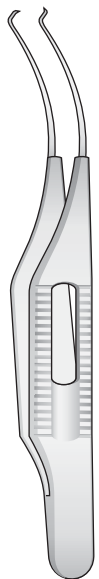
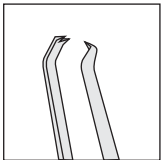

BARRAQUER
1310-EAB
75 mm

Corneal Suturing Forceps
1x2 teeth set at 90°, smooth

Mit Fadenplatte
With tying platform
Con piano prendifilo
Con plataforma
Avec plateaux pour monofil

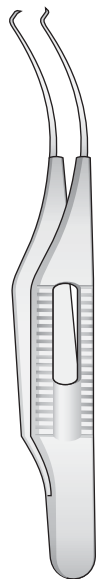
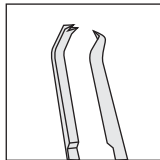

BARRAQUER
1310-EAD
75 mm

Corneal Fixation Forceps
1x2 teeth set at 45°, smooth

Ohne Fadenplatte
Jaws without platform
Senza piano prendifilo
Sin plataforma
Sans plateaux

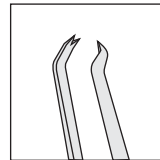

TROUTMAN
1310-EAF
75 mm

Corneal Suturing Forceps
1x2 teeth set at 45°, smooth

Mit Fadenplatte
With tying platform
Con piano prendifilo
Con plataforma
Avec plateaux pour monofil

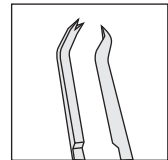

TROUTMAN
1310-EAH
75 mm

Mikro Pinzetten

Micro Forceps

Micro pinzette

Micro pinzas

Micro pinces

Fixier Pinzetten
Fixation Forceps
Pinza da fissazione
Pinzas de fijación
Pincès à fixer

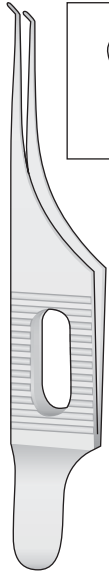
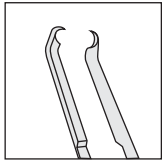
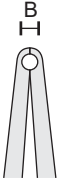

B
1310-GB 0,2 mm
1310-GC 0,3 mm
1310-GD 0,4 mm

PIERSE
1310-GB/1310-GD
80 mm

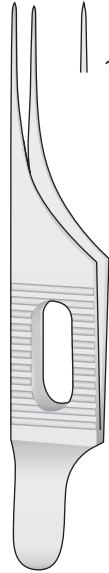

COLIBRI
1310-GE
80 mm

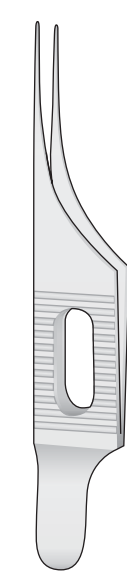

A
1310-GF 0,25 mm
1310-GG 0,4 mm
1310-GH 0,6 mm
1310-GI 0,8 mm

COLIBRI
1310-GF/1310-GI
75 mm

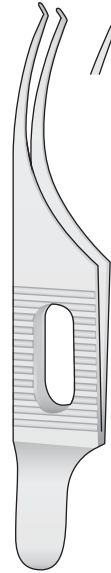

A
1310-GL 0,25 mm
1310-HA 0,4 mm
1310-HB 0,6 mm
1310-HC 0,8 mm

COLIBRI
1310-GL/1310-HC
80 mm

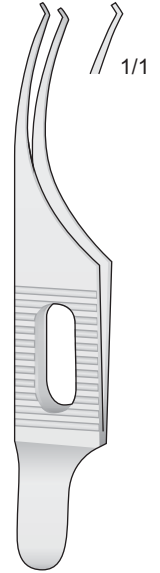

COLIBRI
1310-GA
80 mm

Hornhautpinzette
Corneal Forceps
Pinzette corneali
Pinzas para corneal
Pincès à cornée

5/1

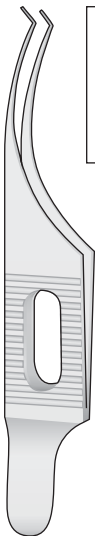
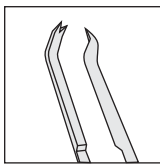

1310-HD
70 mm

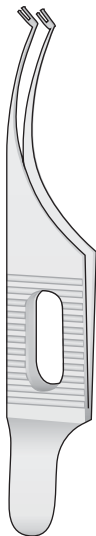

POLACK
1310-EBA
70 mm

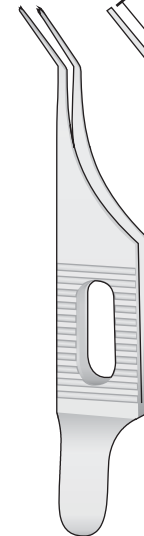

L
1310-IH 8 mm
1310-II 10 mm
1310-IL 12 mm

1310-IH/1310-IL
70 mm

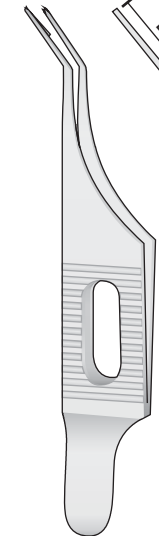

L
1310-HH 8 mm
1310-HI 10 mm

1310-HH/1310-HI
70 mm

Mikro Pinzetten

Micro Forceps

Micro pinzette

Micro pinzas

Micro pinces

Irispinzetten
Iris Forceps
Pinzette da iride
Pinzas para iris
Pinces pour l'iris

Gezahnt
Serrated
Zigrinata
Dentadas
Dentelés

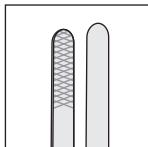

GRAEFE
1206-BHI Straight
1206-BHL Curved
65 mm

Irispinzetten
Iris Forceps
Pinzette da iride
Pinzas para iris
Pinces pour l'iris

1x2 Zähne
1x2 Teeth
1x2 Denti
1x2 Dientes
1x2 Dents

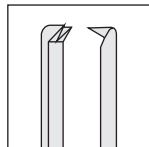

GRAEFE
1206-BIA Straight
1206-BIB Curved
65 mm

Irispinzetten
Iris Forceps
Pinzette da iride
Pinzas para iris
Pinces pour l'iris

Gebogen
Curved
Curva
Curvas
Courbes

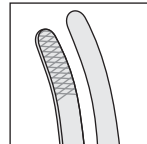

GILL
1310-EBC Serrated
1310-EBD 1x2 Teeth
75 mm

Irispinzetten
Iris Forceps
Pinzette da iride
Pinzas para iris
Pinces pour l'iris

Doppelgebogen
Double Curved
Curva doppia
Curves double
Double Courbes

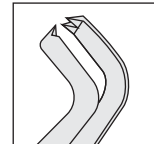

BOTVIN
1310-EBE Serrated
1310-EBF 1x2 Teeth
70 mm

Mikro Pinzetten

Micro Forceps

Micro pinzette

Micro pinzas

Micro pinces

Micro Iris Forceps
straight, ultra fine shanks
with 1x2 teeth, 0,12 mm

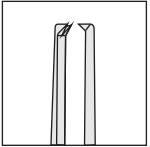

BONN
1206-BIC 75 mm
1206-BID 95 mm

Micro Iris Forceps
angled 6 mm, ultra fine shanks
with 1x2 teeth, 0,12 mm

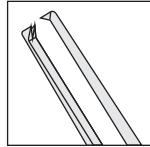

BONN
1206-BIE 72 mm

Micro Iris Forceps
straight, ultra fine shanks
with micro serrations

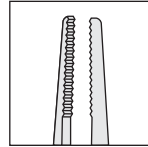

BONN
1206-BIF 73 mm

Micro Iris Forceps
angled 6 mm, ultra fine shanks
with micro serrations

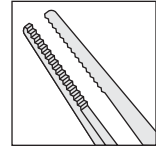

BONN
1206-BIG 72 mm

Conjunctival Fixation Forceps
straight, 0,6 mm teeth

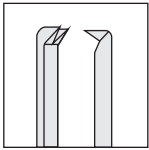

LESTER
1206-BIH 1x2 Teeth
1206-BII 2x3 Teeth
95 mm

Conjunctival Fixation Forceps
2x3 teeth of 0,6 mm set at 90°
with tying platform

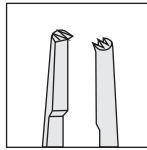

THORPE
1206-BIL
95 mm

Conjunctival Fixation Forceps
with 5 mm long tying platform,
cross serrated tips

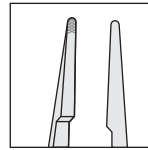

McGREGOR
1206-BLA
110 mm

Conjunctival Fixation Forceps
with longitudinally serrated jaws
and cross serrated tips

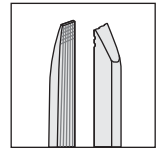

BONACCOLTO
0204-CFE
110 mm

Hornhaut und
Fixierpinzetten

Corneal and
Fixation Forceps

Pinzette per
fissazione corneale

Pinzas para
fijación corneal

Pinces à
fixation cornéenne

Fixierpinzetten für Radiale Keratotomie
Radial Keratotomy Fixation Forceps
Pinze per cheratotomia radiale
Pinzas para queratomia radial
Pinces à fixer pour k eratotomie radiaire

Corneal Fixation Forceps
U-shaped,
3 mm spread,
0,12 mm Teeth at each tip

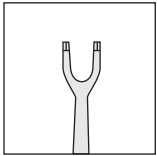

BORES
1206-BLB Straight
1206-BLC Angled
107 mm

Corneal Fixation Forceps
with lock, U-shaped,
8 mm spread,
0,12 mm Teeth at each tip

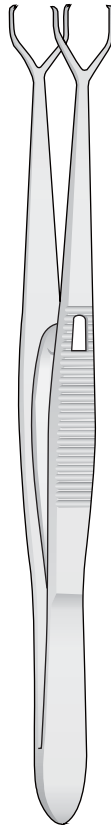
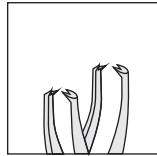

ARROWSMITH
1206-BLD Straight
1206-BLE Angled
107 mm

Corneal Fixation Forceps
with lock, U-shaped,
13 mm spread,
0,12 mm Teeth at each tip

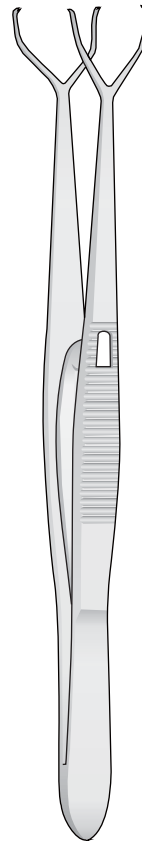
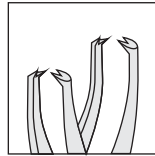

KREMER
1206-BLF Straight
1206-BLG Angled
107 mm

Incision Spreading Forceps,
with controlled jaw opening,
0,5 mm square tips
w/micro serrations

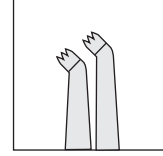

BORES
1206-BLH
110 mm

Micro pinzette con solo piano prendifilo

Pinzetta serrafili con solo piano prendifilo fine

Tying Forceps (short model)
ultra fine 5 mm long platform
for 9-0 to 11-0 sutures

Tying Forceps (Type M-2)
extra fine 6 mm long platform
for 8-0 to 11-0 sutures

Tying Forceps
delicate 5 mm long platform
for 7-0 to 9-0 sutures

Tying & Utility Forceps
standard 7 mm long platform
for sutures below 7-0

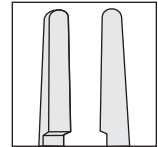
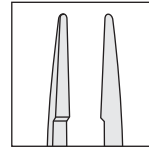
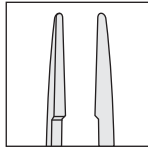
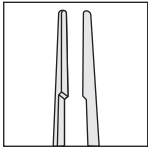

BONN
1206-BLI
73 mm

MICRO
1206-BLL
85 mm

St.MARTIN
1206-CAA
85 mm

PAUFIQUE
1206-CAB
88 mm

Mit Fadenplatte ohne Zähne
 With platform without teeth
 Con piano prendifilo, senza denti
 Con mini placas sin dientes
 Avec plateaux pour fils, sans dents

Straight Tying Forceps
 with ultra fine 6 mm long platform
 for 9-0 to 11-0 sutures
 with guide pin

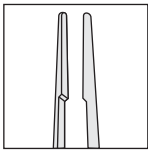

TENNANT
 1206-CDL
 110 mm

Curved Tying Forceps
 with ultra fine 6 mm long platform
 for 9-0 to 11-0 sutures
 with guide pin

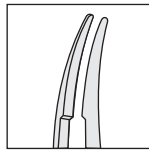

TENNANT
 1206-CEA
 110 mm

Angled Tying Forceps
 with ultra fine 8 mm long platform
 for 9-0 to 11-0 sutures
 with guide pin

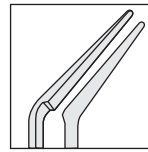

KELMANN-McPHERSON
 1206-CEB
 110 mm

Fragment Forceps
 ultra thin, angled 11 mm
 smooth jaws
 with guide pin

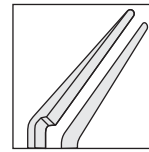

GASKIN
 1206-CEC
 110 mm

Hornhautpinzette
Corneal Forceps
Pinze corneali
Pinzas para córnea
Pinces à cornée

Mit Fadenplatte, mit 1x2 Zähnen
With tying platform, with 1x2 teeth
Con piano prendifilo, con 1x2 denti
Con mini placas, con 1x2 dientes
Avec plateaux pour fils, avec 1x2 dents

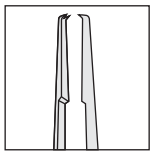

MC PHERSON
1206-CDF
105 mm

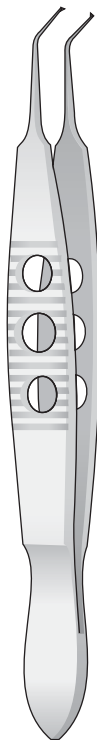
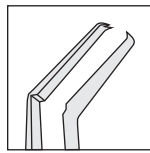

MC PHERSON
1206-CDG
105 mm

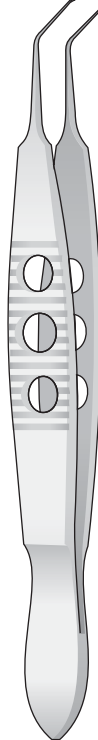
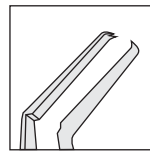

KELMANN - MC PHERSON
1206-CDH
105 mm

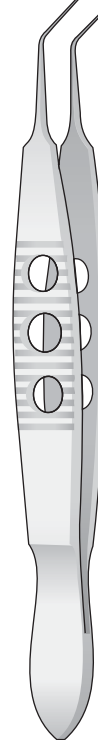
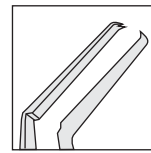

HOFFER - MC PHERSON
1206-CDI
105 mm

Nahtpinzetten mit Fadenplatte, 1x2 Zähne
 Suturing Forceps with Tying Platform, 1x2 Teeth
 Pinzette da sutura con piano prendifilo, 1x2 Denti
 Pinzas para sutura con mini placas, 1x2 Dientes
 Pinces à sutures avec plateaux pour fils, 1x2 Dents

1206-CCF 0,12 mm
 1206-CCG 0,30 mm
 1206-CCH 0,50 mm

Suturing Forceps (on wide handle)
 1x2 teeth set at 45°, with straight
 tying platform

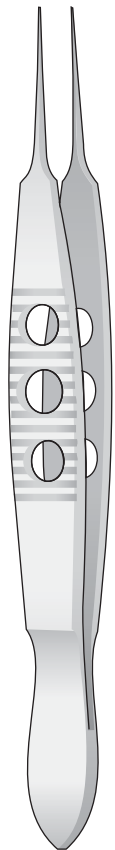
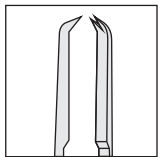

CASTROVIEJO
 1206-CCF/1206-CCH
 110 mm

Suturing Forceps
 1x2 teeth of 0,12 mm set at 45°,
 with tying platform and guide pin

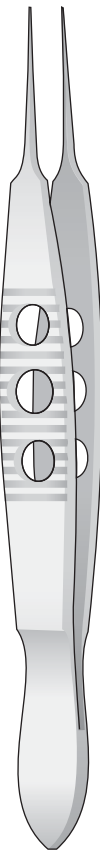
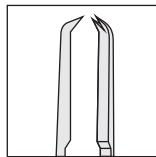

SNIDER-CASTROVIEJO
 1206-CCI
 110 mm

Suturing Forceps
 1x2 teeth of 0,12 mm set at 90°,
 very delicate platform

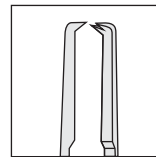

JAFFE
 1206-CCL
 110 mm

Suturing Forceps
 1x2 teeth of 0,12 mm set at 90°,
 extra delicate platform

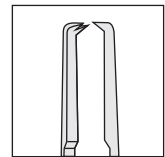

TENNANT
 1206-CDA
 100 mm

Mit Fadenplatte ohne Zähne
 With platform without teeth
 Con piano prendifilo, senza denti
 Con mini placas sin dientes
 Avec plateaux pour fils, sans dents

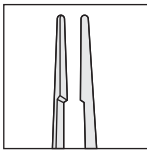

MC PHERSON
 1206-CDB
 105 mm

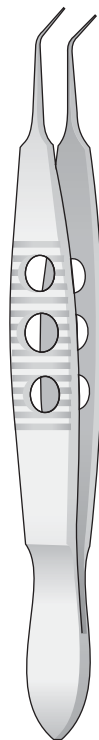
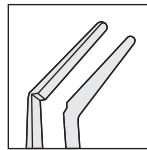

MC PHERSON
 1206-CDC
 105 mm

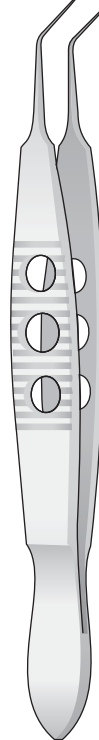
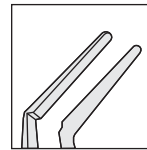

KELMANN - MC PHERSON
 1206-CDD
 105 mm

Strabismuspinzette
Fadenpinzetten

Strabismus Forceps
Tying Forceps

Pinza da strabismo
Pinzette da sutura

Pinza para estrabismo
Pinzas para sutura

Pince à strabisme
Pincès à sutures

Fadenpinzette ohne Zähne
Tying Forceps without Teeth
Pinzetta da sutura senza denti
Pinza para sutura sin dientes
Pince à sutures sans dents

Nahtpinzette mit Fadenplatte
Suturing Forceps with Tying platform
Pinza da sutura con piatto prendifilo
Pinza para sutura con mini-placas
Pince à sutures avec plateaux pour fils

extra delicate 7 mm long platform
for 8-0 to 11-0 sutures

extra delicate 6 mm long platform
for 9-0 to 11-0 sutures

Strabismuspinzette
Strabismus Forceps
Pinza da strabismo
Pinza para estrabismo
Pince à strabisme

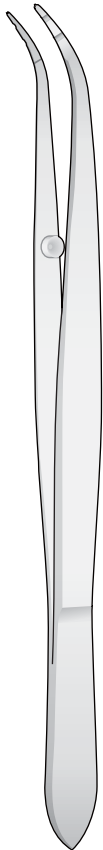

1206-BAA
110 mm

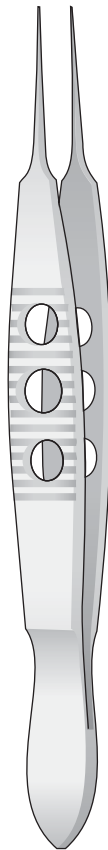
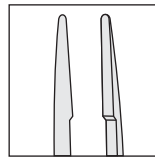

JAFFE
1206-CCB Straight
1206-CCC Curved
110 mm

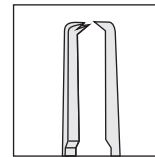

1x2 Zähne
1x2 Teeth
1x2 Denti
1x2 Dientes
1x2 Dents



TENNANT
1206-CCD Straight
1206-CCE Curved
100 mm

1x2 Zähnen mit Fadenplatte
 1x2 Teeth with platform
 1x2 Denti con piano prendifilo
 1x2 Dientes con mini-placas
 1x2 Dents avec plateaux pour fils

1206-CBE 0,12 mm
1206-CBF 0,30 mm
1206-CBG 0,50 mm
1206-CBH 0,90 mm

Suturing Forceps (long model)
 1x2 teeth of 0,12 mm set at 90°,
 with ultra fine platform

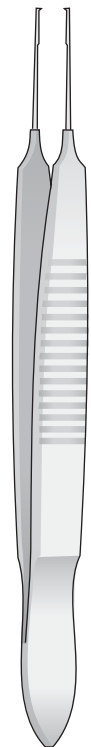
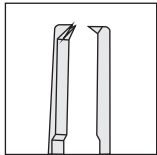

BONN
1206-CBD
 95 mm

Suturing Forceps (standard handle)
 1x2 teeth set at 45°,
 with straight tying platform

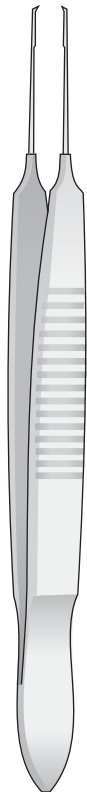
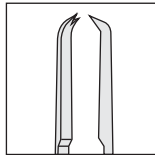

CASTROVIEJO
1206-CBE/1206-CBH
 100 mm

Suturing Forceps (standard handle)
 1x2 teeth set at 45°,
 with angled tying platform

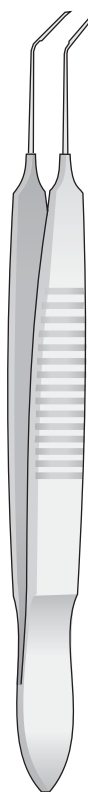
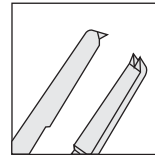

CASTROVIEJO
1206-CBI 0.30 mm
1206-CBL 0.50 mm
 100 mm

Suturing Forceps
 1x2 teeth of 0,12 mm set at 90°,
 with extra fine platform

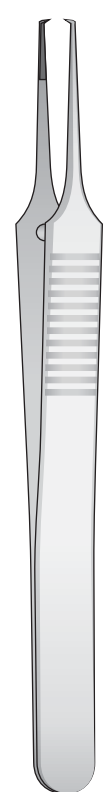
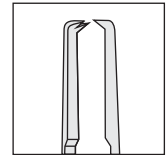

TROUTMAN
1206-CCA
 100 mm

Fadenpinzetten

Tying Forceps

Pinzette da sutura

Pinzas para sutura

Pinces à sutures

Tying Forceps (long model)
ultra fine 5 mm long platform
for 9-0 to 11-0 sutures

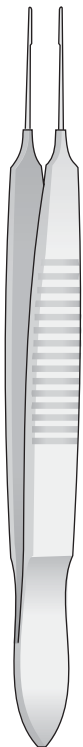
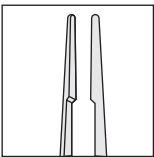

BONN
1206-CAH
95 mm

Tying Forceps
delicate 6 mm long platform
for 7-0 to 9-0 sutures

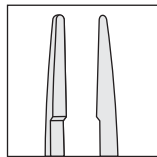

HARMS
1206-CAI Straight
1206-CAL Curved
100 mm

Tying Forceps
delicate 7 mm angled platform
for 7-0 to 9-0 sutures

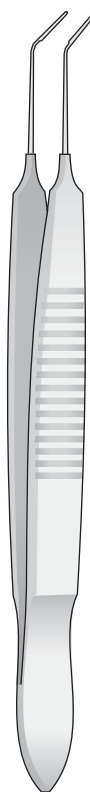
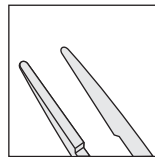

HARMS
1206-CBA
100 mm

Tying Forceps
extra fine 6 mm long platform,
for 8-0 to 11-0 sutures

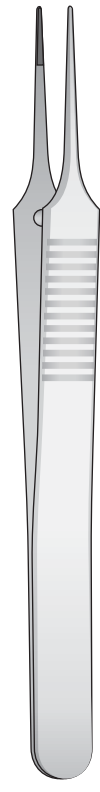
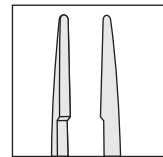

TROUTMAN
1206-CBB Straight
1206-CBC Curved
100 mm

Nahtpinzetten mit Fadenplatte 1x2 Zähnen
 Suturing Forceps with Tying platform 1x2 Teeth
 Pinzette da sutura con piano prendifilo 1x2 Denti
 Pinzas para sutura con mini-placas 1x2 Dientes
 Pinces à sutures avec plateaux pour fils 1x2 Dents

Suturing Forceps (short model)
 1x2 teeth of 0,12 mm set at 90°
 with ultra fine platform

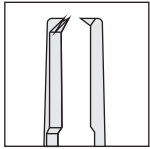

BONN
1206-CAC
 73 mm

Suturing Forceps (M-types)
 1x2 teeth set at 45°
 with extra fine platform

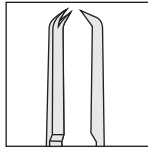

MICRO
1206-CAD 0,12 mm
1206-CAE 0,30 mm
 85 mm

Suturing Forceps
 1x2 teeth of 0,3 mm set at 45°
 with delicate platform

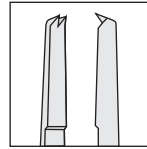

St.MARTIN
1206-CAF
 85 mm

Allzweck Pinzette
 mit Fadenplatte
 Universal Suturing Forceps
 1x2 teeth of 0,7 mm set at 45°
 with heavy platform

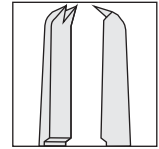

PAUFIQUE
1206-CAG
 88 mm

Nahtpinzetten

Suturing Forceps

Pinzette da sutura

Pinzas para sutura

Pinces à sutures

1x2 Zähne
1x2 Teeth
1x2 Denti
1x2 Dientes
1x2 Dents

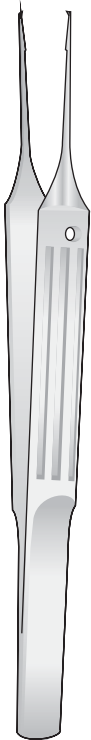
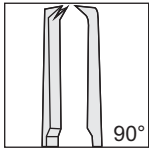

BONN
1206-CED 85 mm
1206-CEE 110 mm

1x2 Zähne
1x2 Teeth
1x2 Denti
1x2 Dientes
1x2 Dents

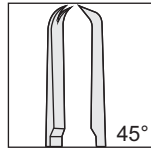

CASTROVIEJO
1206-CEF 110 mm

1x2 Zähne
1x2 Teeth
1x2 Denti
1x2 Dientes
1x2 Dents

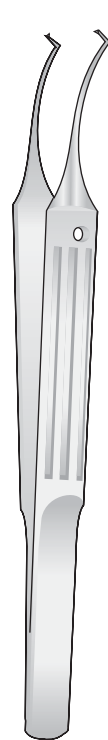
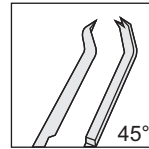

TROUTMAN
1206-CEG 110 mm

1x2 Zähne
1x2 Teeth
1x2 Denti
1x2 Dientes
1x2 Dents

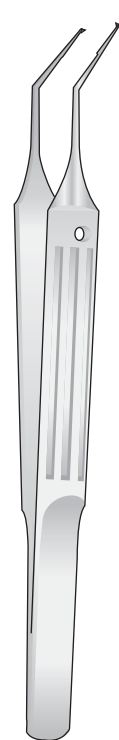
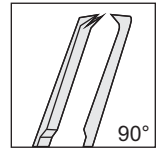

KELMANN **HOFFER**
1206-CEH 1206-CEI
angled 8 mm angled 11 mm
110 mm 110 mm

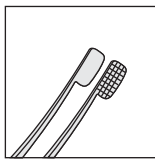

Nucleus Fracture Forceps
extremely thin paddle shaped jaws
with cross serrated outer surfaces

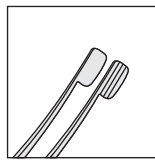

Nucleus Cracking Forceps
extremely thin paddle shaped jaws
with longitudinally serrated outer surfaces

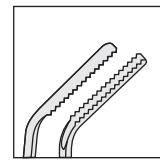

Nucleus Removal Forceps
angled 10 mm long delicate jaws
with multiple parallel teeth

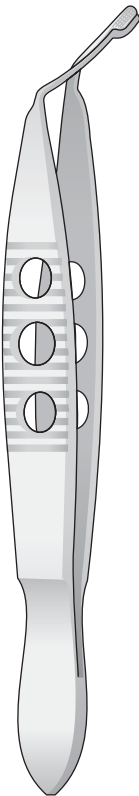

KRAFF
1206-CFD
105 mm

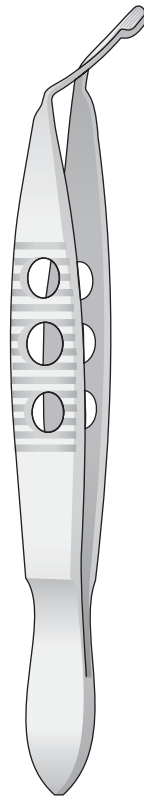

ERNEST-CALF
1206-CFE
105 mm

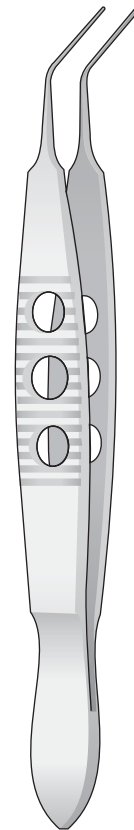

KANSAS
1206-CFF
105 mm

Pinzetten

Forceps

Pinzette

Pinzas

Pinces

Capsule, Capsulorhexis

Kapsulorhexispinzette
 Capsulorhexis Forceps
 Pinzette per capsuloressi
 Pinzas para capsuloressi
 Pinces capsulorhexis

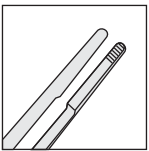

Foreign Body Forceps
 angled 60°, very slim
 10 mm long shanks
 with 3 mm long platform

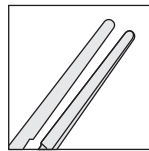

Fragment Forceps
 angled 45°, very slim
 11 mm long shanks
 with smooth platform

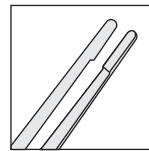

Capsule Tag Forceps
 angled, very slim
 11 mm long shanks
 with 1,5 mm long platform

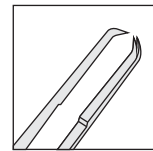

Capsule Flap Forceps
 angled, very slim 11 mm long shanks
 with 5 mm platform and very delicate
 1x2 teeth of 0,1 mm - 45°

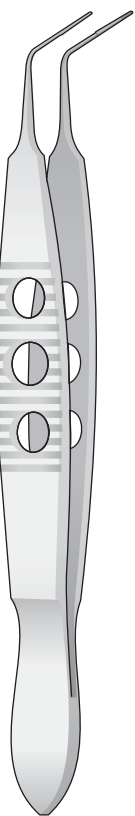

OSHER
 1206-CFH
 105 mm

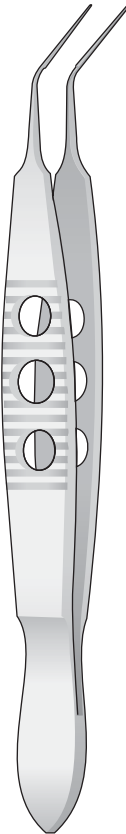

GASKIN
 1206-CFI
 105 mm

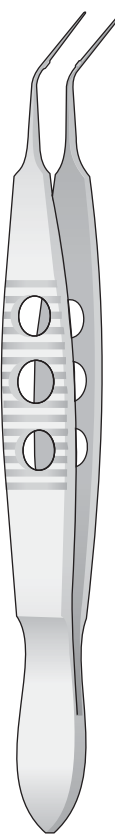

KRAFF
 1206-CFL
 105 mm

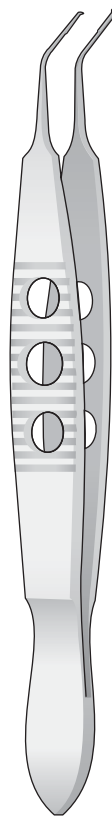

WITSCHEL
 1206-CGA
 105 mm

Pinzetten

Forceps

Pinzette

Pinzas

Pinces

Lens Holding Forceps
angled 7,5 mm long smooth jaws

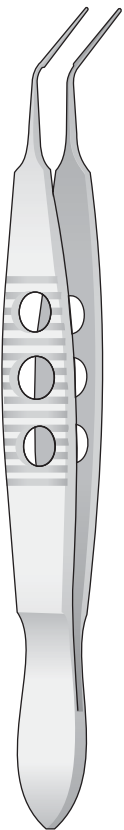
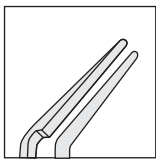

KELMAN-McPHERSON
1206-CGG
105 mm

Lens Holding Forceps
angled 7.5 mm long smooth jaws
with diagonal groove inside tips

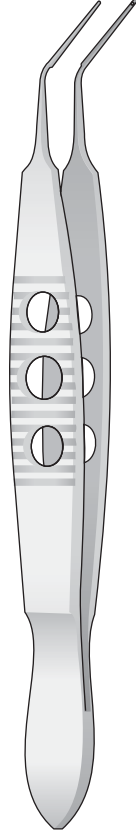
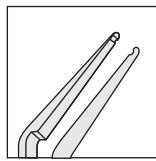

HABERLE-McPHERSON
1206-CGH
105 mm

Lens Holding Forceps
angled 10 mm long smooth jaws

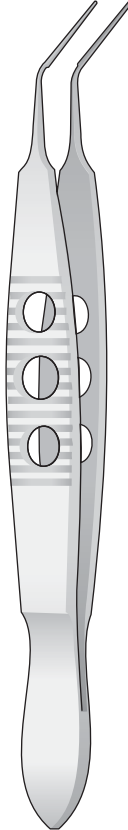
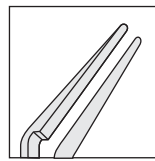

BECHERT-McPHERSON
1206-CGI
105 mm

Lens Holding Forceps
"diamond dusted" tips with one
flat and one convex surface to
securely hold biconvex IOL's

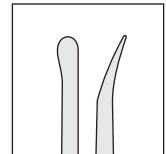

YOSHITOMI-NEUHANN
1206-CGL 75 mm
1206-CHA 95 mm

Pinzetten

Forceps

Pinzette

Pinzas

Pinces

Capsule, Capsulorhexis

Kapsulorhexispinzette
Capsulorhexis Forceps
Pinzette per capsuloressi
Pinzas para capsuloressi
Pinces capsulorhexis

Capsulorhexis Forceps
angled, extra thin
11 mm long shanks
with ultra fine grasping tips

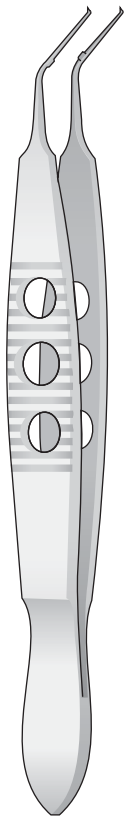
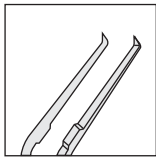

UTRATA
1206-CGB On flat serrated handle
1206-CGC On round knurled handle
105 mm

Capsulorhexis Forceps
angled, extra thin
11 mm long shanks
with cystotome shaped tips

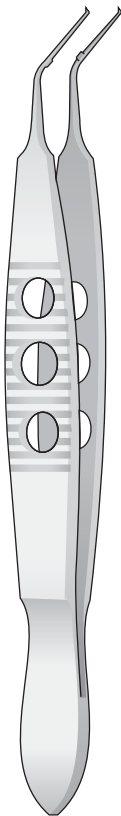
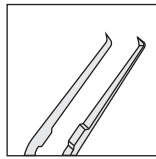

NEVYAS
1206-CGD
105 mm

Capsulorhexis Forceps
angled, very slim
11 mm long shanks
with ultra fine rounded tips

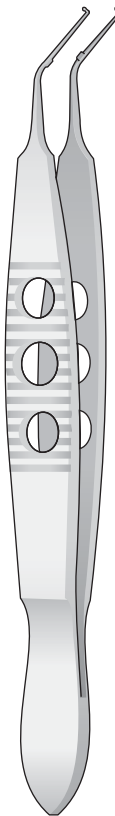
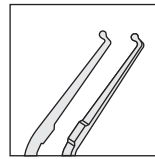

JAFFE
1206-CGE
105 mm

Capsulorhexis Forceps
valuted, very slim
11 mm long shanks
with ultra fine grasping tips

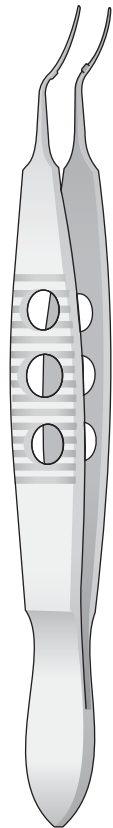
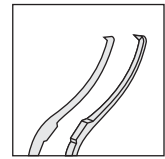

LEHNER
1206-CGF
105 mm

Pinzetten

Forceps

Pinzette

Pinzas

Pinces

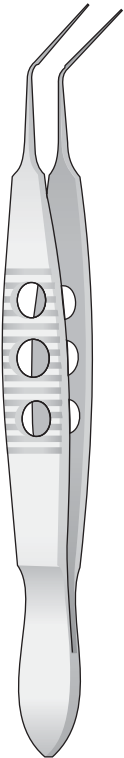
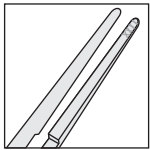

SHEETS-McPHERSON
1206-CHB
105 mm

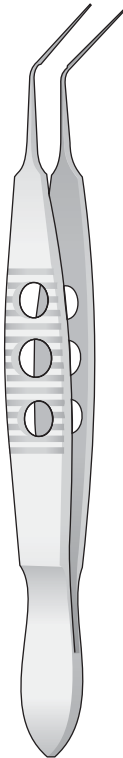
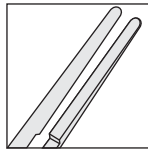

GASKIN
1206-CHC
105 mm

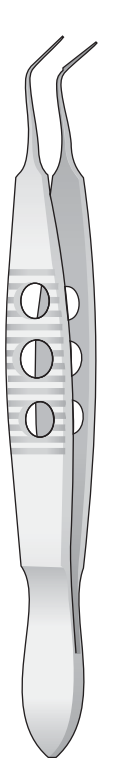
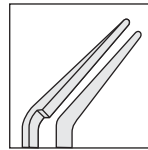

DODICK
1206-CHD
105 mm

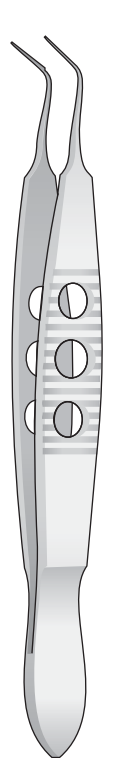
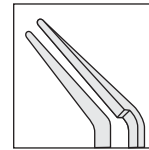

DODICK
1206-CHE
105 mm

Linsenimplantation

Lens implantation

Pinzette per impianti

Pinzas para implantación

Pince pour l'implantation

IOL - LIO
 Implantationspinzette
 Implantation Forceps
 Pinze da impianto
 Pinzas para implantación
 Pincés pour implantation

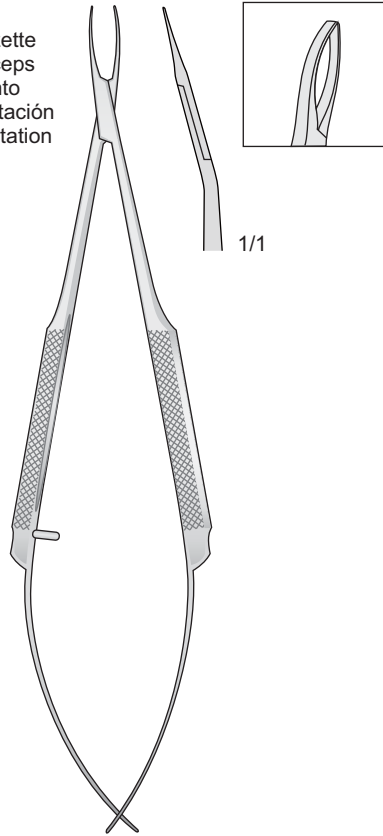

0604-BAA
125 mm

LIO Implantationspinzette
 Lens folding Forceps,
 clamp form - LIO
 Pinze per piegare e inserire LIO
 Pinzas para implantación de lentes LIO
 Pincés à plier forme sabot LIO

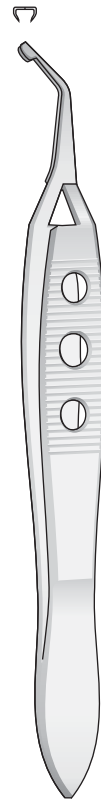

1206-CLG
110 mm

IOL Implantationspinzette
 IOL Implantation Forceps
 Pinzette per impianti IOL
 Pinzas para implantación de lentes IOL
 Pincés à implantation
 des cristallino

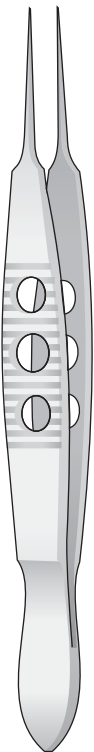

LIVERNOIS
1206-CHF Straight
1206-CHG Angled
 105 mm

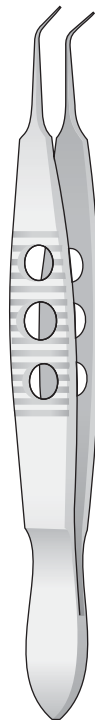
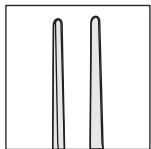

STEINERT
1206-CHH
 105 mm

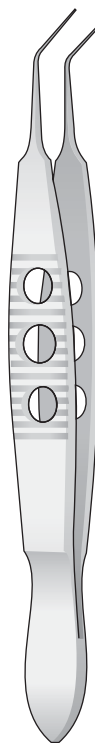
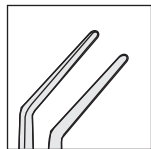

FAULKNER
1206-CHI
 105 mm

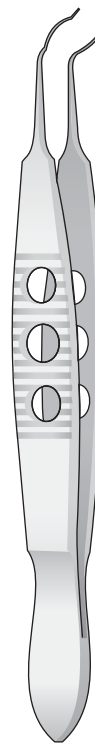
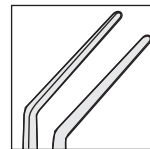

OSHIKA-FAULKNER
1206-CHL Without guide pin
1206-CIA With guide pin
 105 mm

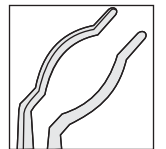

IOL Implantationspinzette
 IOL Implantation Forceps
 Pinzette per impianti IOL
 Pinzas para implantación de lentes IOL
 Pince à implantation
 des cristallino

Pickup and
 Folding Forceps
 angled shanks,
 L-shaped jaws
 with concave
 inside surfaces

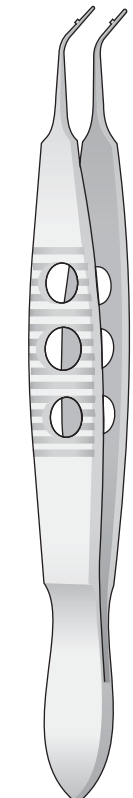
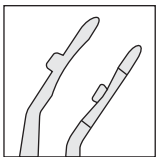

LIVERNOIS
1206-CIB
 105 mm

Soft IOL
 Inserting Forceps
 cross-action,
 angled shanks,
 low profile jaws
 with straight
 inside surfaces

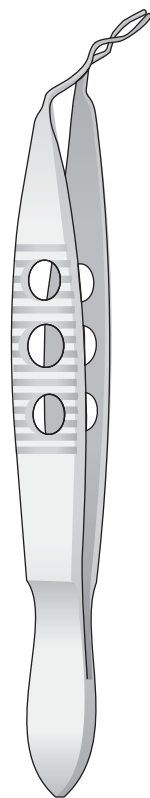
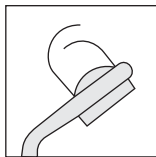

CALF II
1206-CIC
 105 mm

Soft IOL
 Inserting Forceps
 cross-action,
 angled shanks,
 low profile jaws
 with concave
 inside surfaces

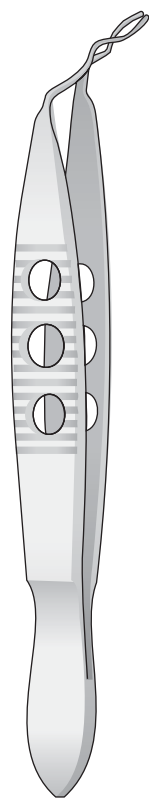
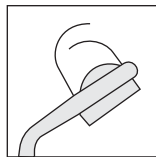

CALF III
1206-CID
 105 mm

Soft IOL
 Inserting Forceps
 cross-action,
 angled shanks,
 short low profile jaws
 with concave
 inside surfaces

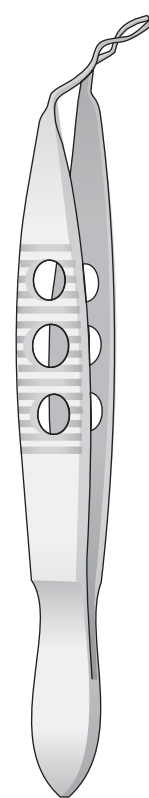
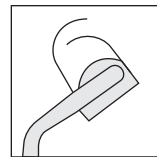

CALF IV
1206-CIE
 105 mm

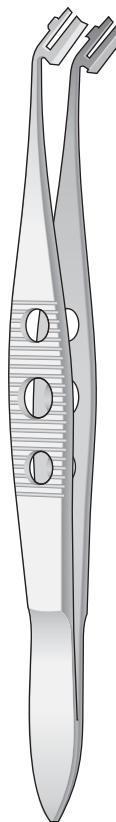
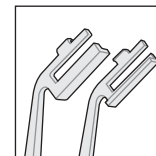

1206-CLD
 110 mm

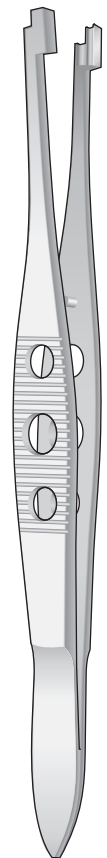
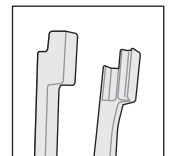

1206-CLF
 115 mm

Pinzetten

Forceps

Pinzette

Pinzas

Pinces

6 Zähne
6 Teeth
6 Denti
6 Dents
6 Dientes

Für Erwachsene
For adults
Per adulti
Para adultos
Pour adultes

6 Zähne
6 Teeth
6 Denti
6 Dents
6 Dientes

4 Zähne
4 Teeth
4 Denti
4 Dents
4 Dientes

Für Kinder
For children
Per bambini
Para niños
Pour enfants

4 Zähne
4 Teeth
4 Denti
4 Dents
4 Dientes



Rechts
Right
Destra
Derecha
À droite

**JAMESON
1206-DDB**
100 mm



Links
Left
Sinistra
Izquierda
À gauche

**JAMESON
1206-DDC**
100 mm

Strabismuspinzette
Starbismus Forceps
Pinze da strabismo
Pinzas para estrabismo
Pinces à strabisme

Muskelpinzetten
Muscle Forceps
Pinzette muscolari
Pinzas musculares
Pinces musculaire



Rechts
Right
Destra
Derecha
À droite

**JAMESON
1206-DDD**
100 mm



Links
Left
Sinistra
Izquierda
À gauche

**JAMESON
1206-DDE**
100 mm

Chalazionpinzetten
Chalazion Forceps
Pinzette da calazio
Pinzas para chalazión
Pinces à chalazion

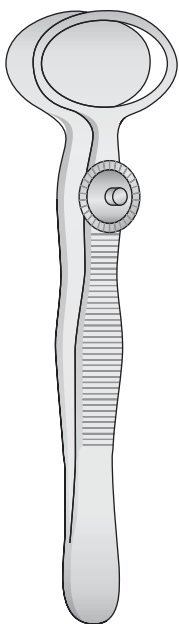

**DESMARRES
0204-BDA/0204-BDC**
90 mm

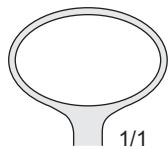

1/1
0204-BDA
20 mm

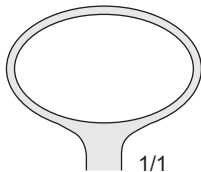

1/1
0204-BDB
26 mm

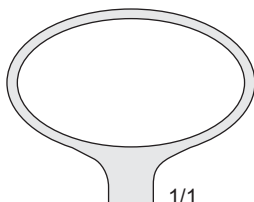

1/1
0204-BDC
31 mm

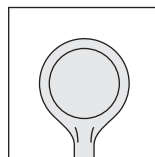

**LAMBERT
0204-CGA**
90 mm

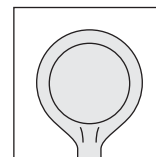

**HUNT
0204-CGB**
95 mm

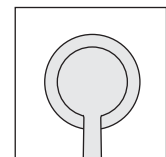

**AYERS
0204-CGD**
90 mm

Entropiumpinzetten,
Cilienpinzetten

Entropium Forceps,
Cilia Forceps

Pinzette da entropion,
Pinzette depilatorie

Pinzas para entropión,
Pinzas depilatoria

Pinces à entropion,
Pinces à cils

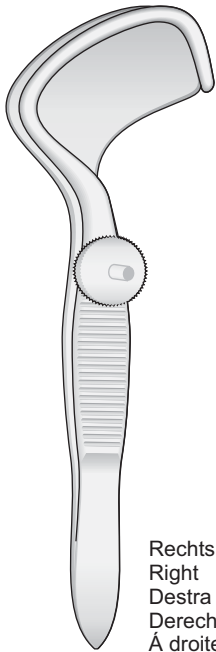

Rechts
Right
Dextra
Derecha
À droite

SNELLEN
0204-CLG
95 mm

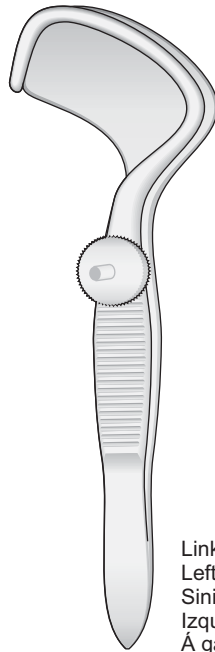

Links
Left
Sinistra
Izquierda
À gauche

SNELLEN
0204-CLH
95 mm



Rechts
Right
Dextra
Derecha
À droite

SNELLEN
0204-CLI
95 mm

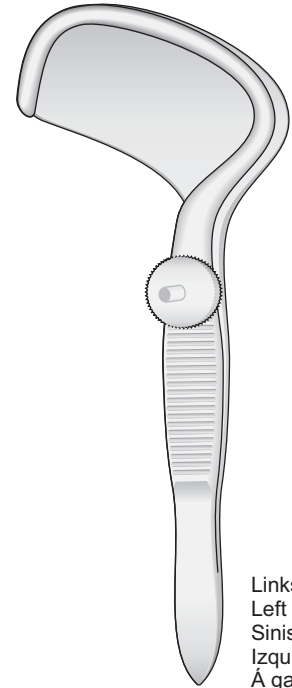

Links
Left
Sinistra
Izquierda
À gauche

SNELLEN
0204-CLL
95 mm

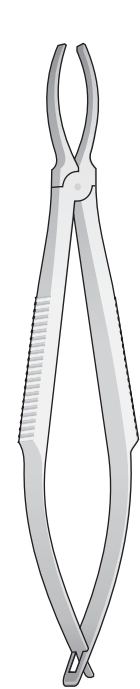
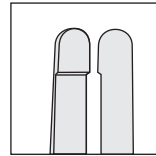
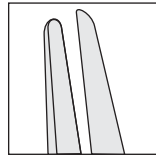
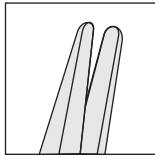
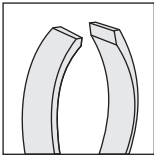

GRADLE
0604-BDB
95 mm

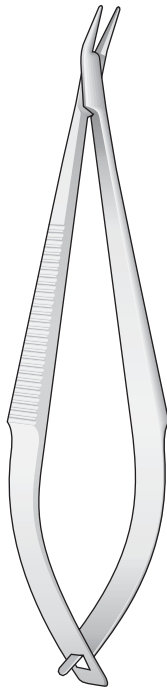

BEAUPRE
0604-BBH
110 mm

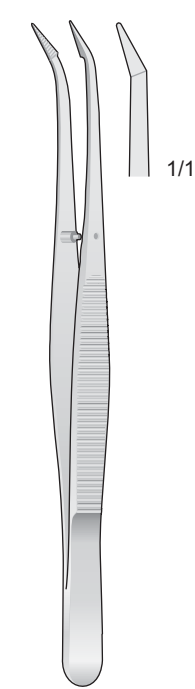

BARRAQUER
0518-GF
105 mm

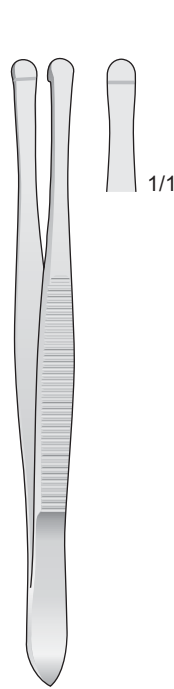

BEER
0518-EI
90 mm

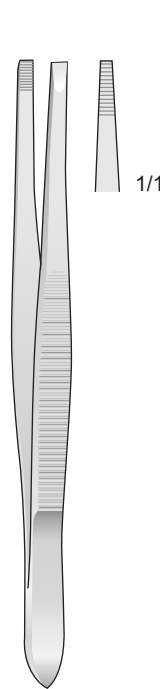

0518-EF
90 mm

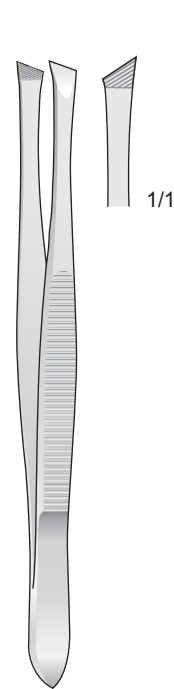

0518-EG
90 mm

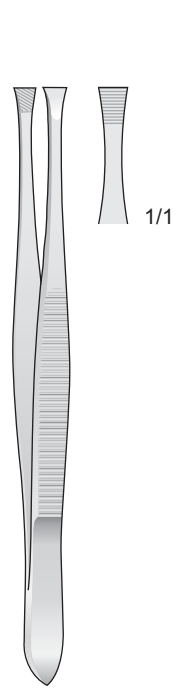

LITTAUER
0518-GE
85 mm

Pinzetten

Forceps

Pinzette

Pinzas

Pinces

Fadenpinzetten
Suturing Forceps
Pinzette da sutura
Pinzas para sutura
Pinces à sutures

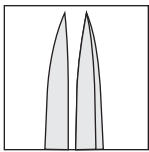

1206-CIF

Foreign Body Forceps
with sharp pointed tips

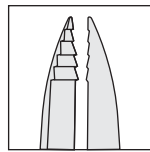

1206-CIG

Corneal and Splinter Forceps
with sharp points and
reverse cut teeth

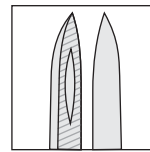

1206-CIH

Suture and Conjunctiva Forceps
serrated jaws with
longitudinally groove

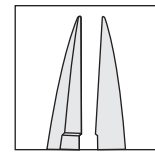

1206-CII

Tying and Stitch Removal Forceps
with delicate platform and sharp
points for removing 10-0 sutures

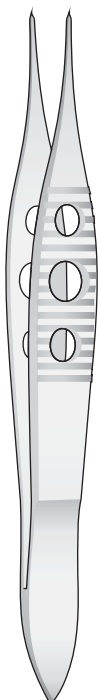

VOLKER
1206-CIF
90 mm

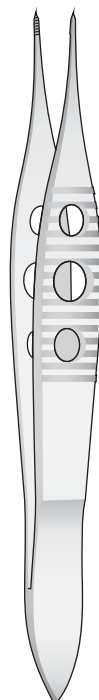

VOLKER-THORPE
1206-CIG
90 mm



VOLKER-MOORFIELD
1206-CIH
90 mm



VOLKER-PATON
1206-CII
90 mm

Pinzetten

Forceps

Pinzette

Pinzas

Pinces

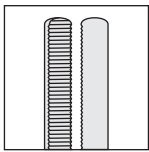

1206-CIL
Dressing Forceps
serrated, 1,0 mm tips

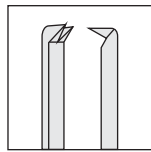

1206-CLA
Tissue Forceps
1x2 teeth of 1,0 mm

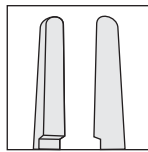

1206-CLB
Tying Forceps
6 mm smooth platform

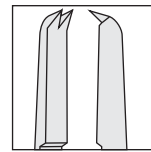

1206-CLC
Suturing Forceps
1x2 teeth of 1,0 mm set at 45°
with 6 mm long platform

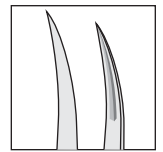

1206-CLE
Cilien- und
Fremdkörperpinzette
Cilia and foreign
body forceps

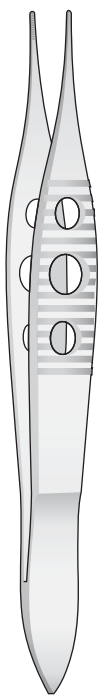

VOLKER-ADSON
1206-CIL
90 mm

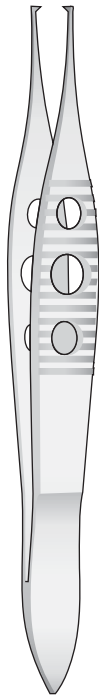

VOLKER-ADSON
1206-CLA
90 mm



VOLKER-HARMS
1206-CLB
90 mm



VOLKER-CASTROVIEJO
1206-CLC
90 mm

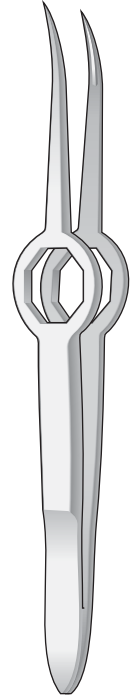

SHAAF
1206-CLE
95 mm

Pinzetten

Forceps

Pinzette

Pinzas

Pinces

Mikro Pinzetten
Micro forceps
Micro pinzette
Pinzas finos
Micro pincers

Mikro Pinzetten
Micro forceps
Micro pinzette
Pinzas finos
Micro pincers

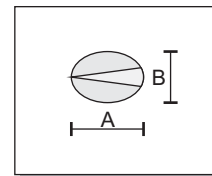
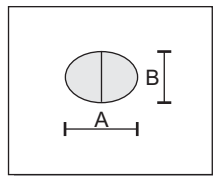

1x2 Zähne
1x2 Teeth
1x2 Denti
1x2 Dientes
1x2 Dents

1x2 Zähne
1x2 Teeth
1x2 Denti
1x2 Dientes
1x2 Dents

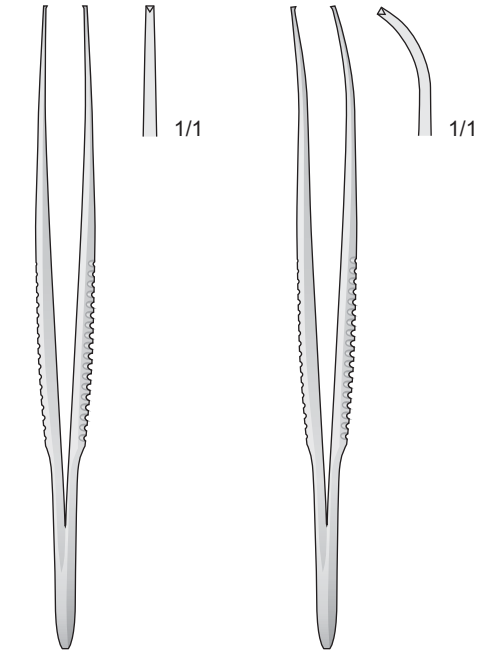
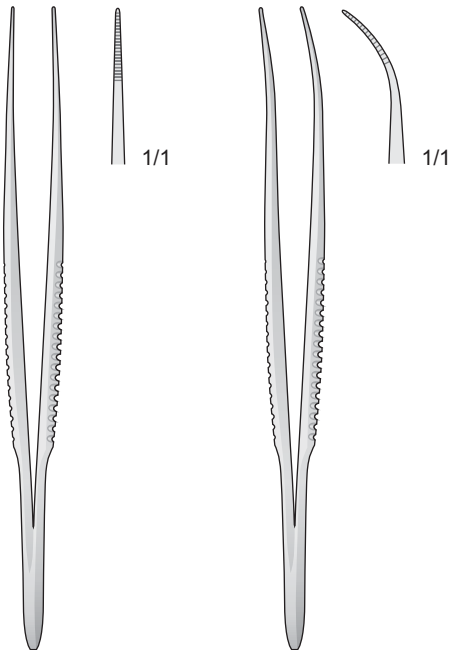

A	B			A	B		
0,5	0,4	1206-CE	1206-CL	0,4	0,25	1206-DE	1206-EA
0,6	0,5	1206-CF	1206-DA	0,5	0,35	1206-DF	1206-EB
0,9	0,7	1206-CG	1206-DB	0,7	0,55	1206-DG	1206-EC
1,3	1	1206-CH	1206-DC	1	0,8	1206-DH	1206-ED
1,6	1,3	1206-CI	1206-DD	1,2	0,9	1206-DI	1206-EE
		95 mm	95 mm			95 mm	95 mm

Pinzetten

Forceps

Pinzette

Pinzas

Pinces

Spitz - Sharp - Acuta
Agudas - Pointu

0,3 mm 0,3 mm

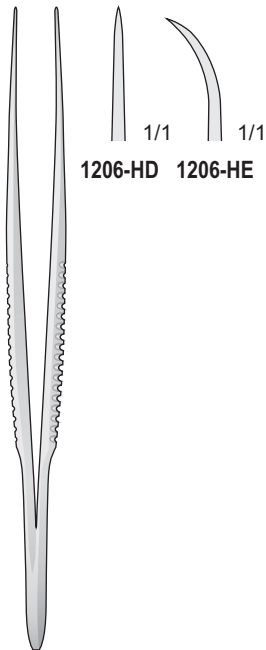

1206-HD 1206-HE

1206-HD/1206-HE
95 mm

Stumpf - Blunt - Smussa
Romas - Mousse

0,4 mm 0,4 mm

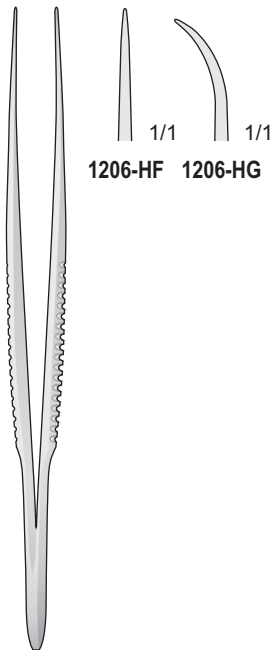

1206-HF 1206-HG

1206-HF/1206-HG
95 mm

Spitz - Sharp - Acuta
Agudas - Pointu

0,3 mm 0,3 mm

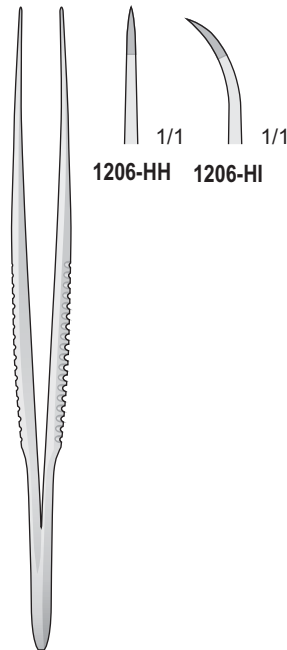

1206-HH 1206-HI

1206-HH/1206-HI
95 mm

Stumpf - Blunt - Smussa
Romas - Mousse

0,4 mm 0,4 mm

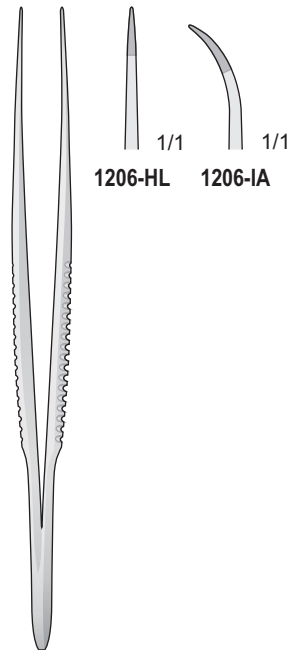

1206-HL 1206-IA

1206-HL/1206-IA
95 mm

Pinzetten

Forceps

Pinzette

Pinzas

Pinces

Mikro Pinzetten
Micro forceps
Micro pinzette
Pinzas finos
Micro pinces

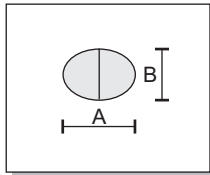

Mikro Pinzetten
Micro forceps
Micro pinzette
Pinzas finos
Micro pinces

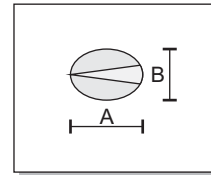

1x2 Zähne
1x2 Teeth
1x2 Denti
1x2 Dientes
1x2 Dents

1x2 Zähne
1x2 Teeth
1x2 Denti
1x2 Dientes
1x2 Dents

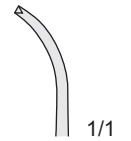
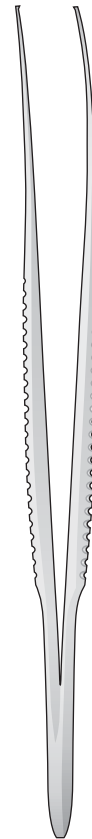
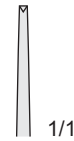
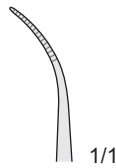
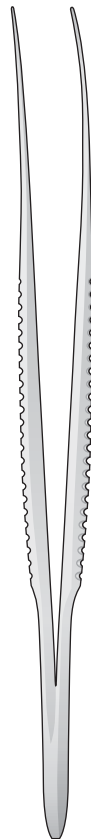
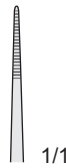
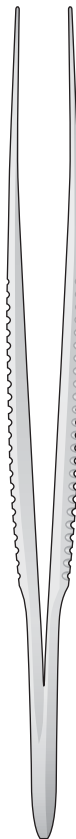

A	B			A	B		
0,5	0,4	1206-BL	1206-BD	0,4	0,25	1206-EG	1206-FC
0,6	0,5	1206-CA	1206-BE	0,5	0,35	1206-EH	1206-FD
0,9	0,7	1206-CB	1206-BF	0,7	0,55	1206-EI	1206-FE
1,3	1	1206-CC	1206-BG	1	0,8	1206-EL	1206-FF
1,6	1,3	1206-CD	1206-BH	1,2	0,9	1206-FA	1206-FG
		125 mm	125 mm			125 mm	125 mm

Pinzetten

Forceps

Pinzette

Pinzas

Pinces

Spitz - Sharp - Acuta
Agudas - Pointu

0,4 mm 0,4 mm

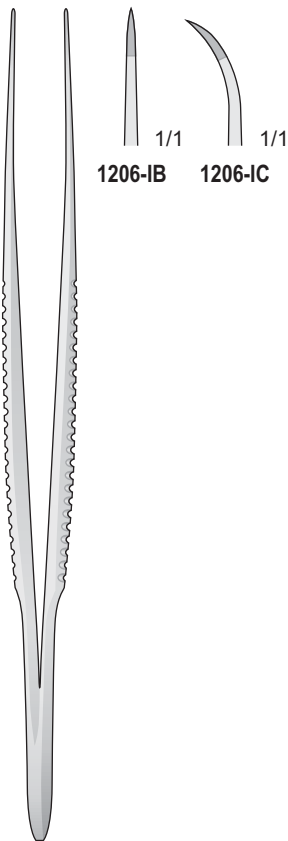

1206-IB

1206-IC

Stumpf - Blunt - Smussa
Romas - Mousse

0,5 mm 0,5 mm

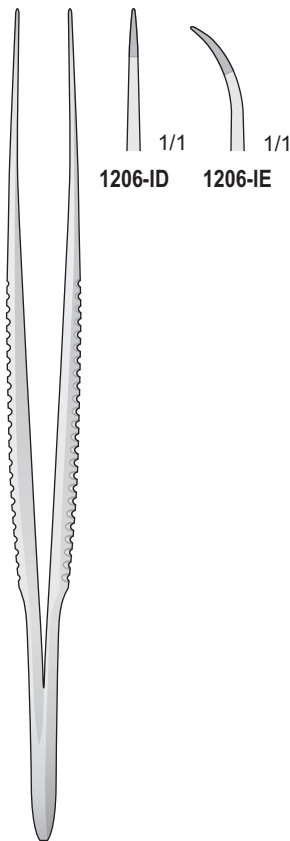

1206-ID

1206-IE

Spitz - Sharp - Acuta
Agudas - Pointu

0,3 mm 0,3 mm

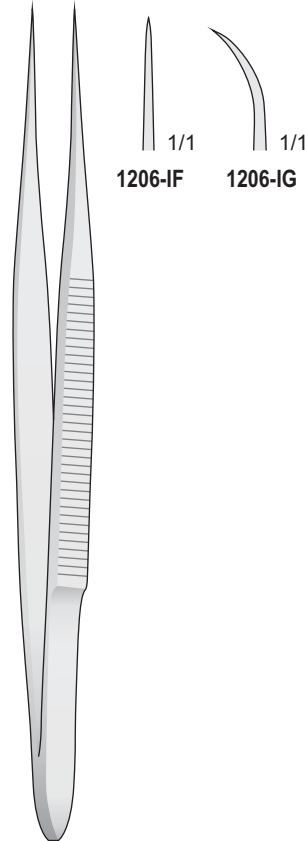

1206-IF

1206-IG

Stumpf - Blunt - Smussa
Romas - Mousse

0,4 mm 0,4 mm

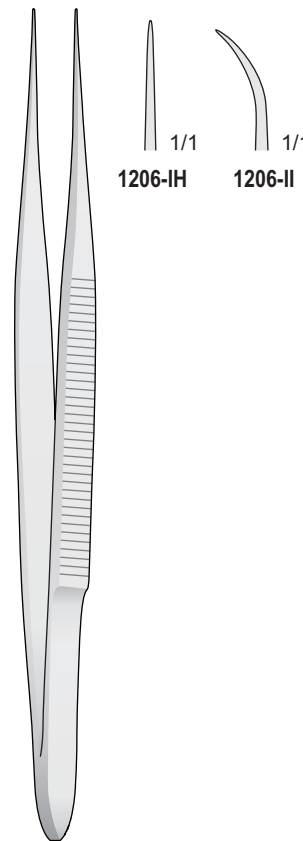

1206-IH

1206-II

1206-IB/1206-IC
125 mm

1206-ID/1206-IE
125 mm

1206-IF/1206-IG
125 mm

1206-IH/1206-II
125 mm

Pinzetten

Forceps

Pinzette

Pinzas

Pinces

Mikro Pinzetten
Micro forceps
Micro pinzette
Pinzas finos
Micro pincés

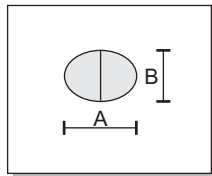

Mikro Pinzetten
Micro forceps
Micro pinzette
Pinzas finos
Micro pincés

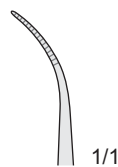
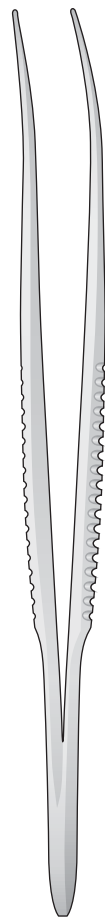
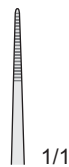
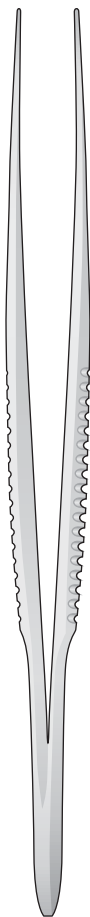
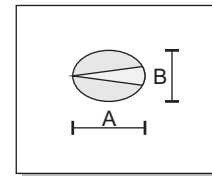

1x2 Zähne
1x2 Teeth
1x2 Denti
1x2 Dientes
1x2 Dents

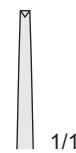

1x2 Zähne
1x2 Teeth
1x2 Denti
1x2 Dientes
1x2 Dents

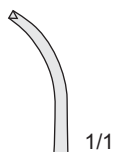
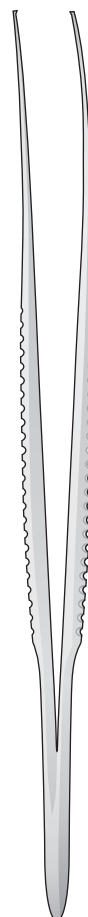

A	B			A	B		
0,5	0,4	1206-AB	1206-AE	0,4	0,25	1206-FI	1206-GE
0,6	0,5	1206-AC	1206-AF	0,5	0,35	1206-FL	1206-GF
0,9	0,7	1206-AD	1206-AG	0,7	0,55	1206-GA	1206-GG
1,3	1	1206-AH	1206-BA	1	0,8	1206-GB	1206-GH
1,6	1,2	1206-AI	1206-BB	1,2	0,9	1206-GC	1206-GI
1,8	1,4	1206-AL	1206-BC				
		150 mm	150 mm			150 mm	150 mm

Pinzetten

Forceps

Pinzette

Pinzas

Pinces

Spitz - Sharp - Acuta
Agudas - Pointu

0,3 mm 0,3 mm

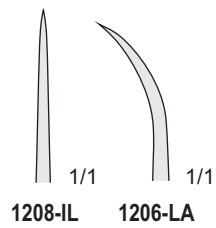

1208-IL 1206-LA

Stumpf - Blunt - Smussa
Romas - Mousse

0,3 mm 0,3 mm

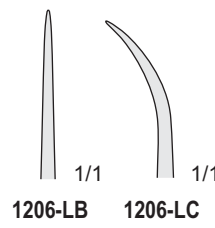

1206-LB 1206-LC

Spitz - Sharp - Acuta
Agudas - Pointu

0,3 mm 0,3 mm

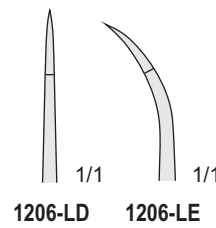

1206-LD 1206-LE

Stumpf - Blunt - Smussa
Romas - Mousse

0,3 mm 0,3 mm

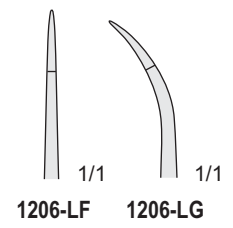

1206-LF 1206-LG



1208-IL/1206-LA
150 mm

1206-LA/1206-LC
150 mm

1206-LD/1206-LE
150 mm

1206-LF/1206-LG
150 mm

Uhrmacherpinzetten

Jewelers utility Forceps

Pinze da orologiaio

Pinzas de relojero

Pinces d'horloger



0,15 mm

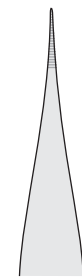

1/1

0204-CAA
100 mm

0,2 mm

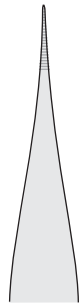

1/1

0204-CAB
110 mm

0,3 mm

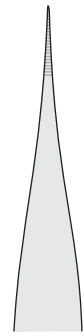

1/1

0204-CAE
120 mm

0,3 mm



0204-CAA/0204-CAE

0204-CAF
115 mm

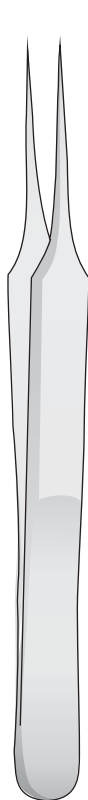

0,3 mm

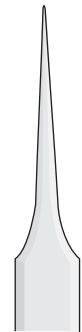

1/1

0204-GA

0,3 mm



1/1

0204-GC

0204-GA/0204-GC
110 mm



0,3 mm

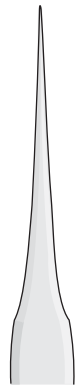

1/1

0204-GE
110 mm

0,5 mm

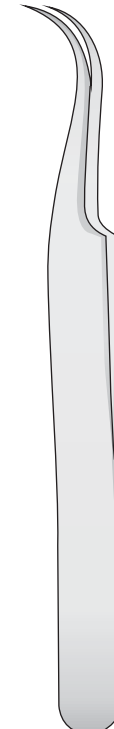

0204-CAG
115 mm



Glattes Maul - Smooth jaws - Morso liscio - Bocas lisas - Mors lisses

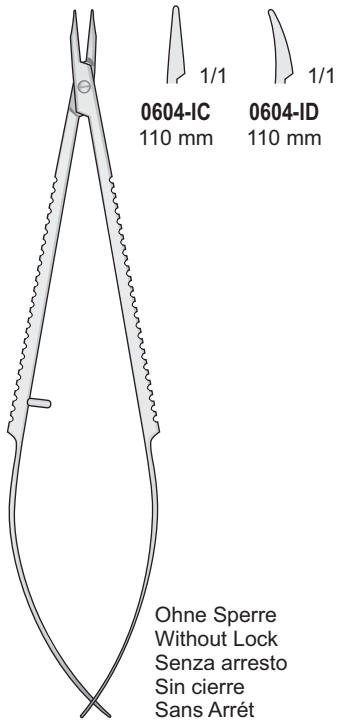

CASTROVIEJO
0604-IC/0604-ID
110 mm

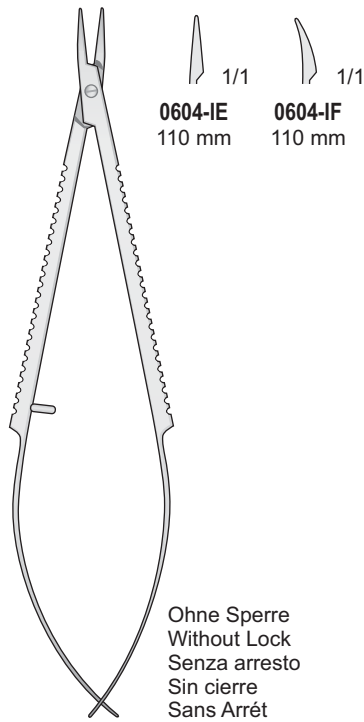

CASTROVIEJO
0604-IE/0604-IF
110 mm

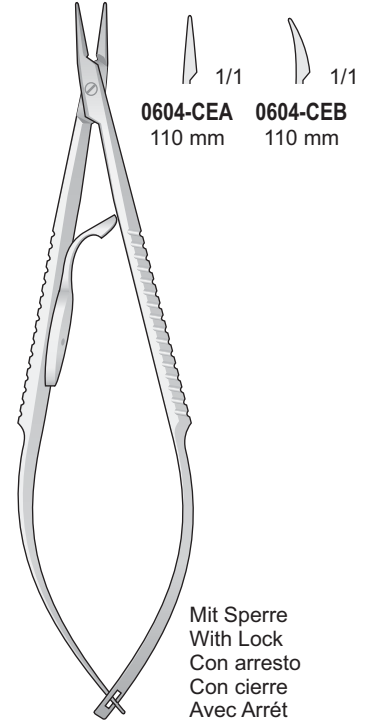

CASTROVIEJO
0604-CEA/0604-CEB
110 mm

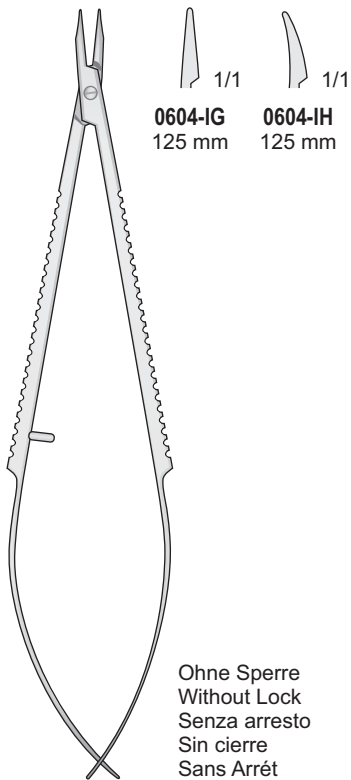

CASTROVIEJO
0604-IG/0604-IH
125 mm

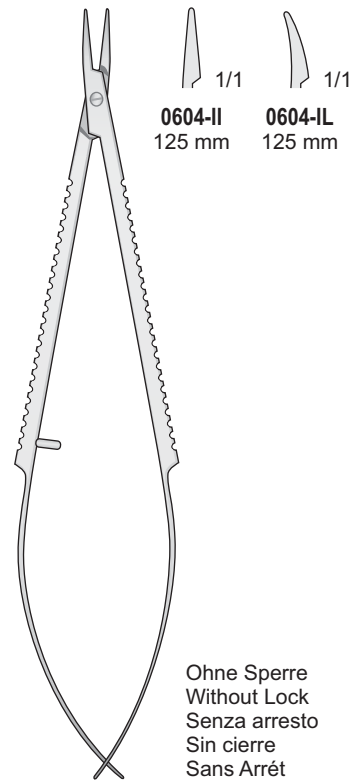

CASTROVIEJO
0604-II/0604-IL
125 mm

Glattes Maul - Smooth jaws - Morso liscio - Bocas lisas - Mors lisses

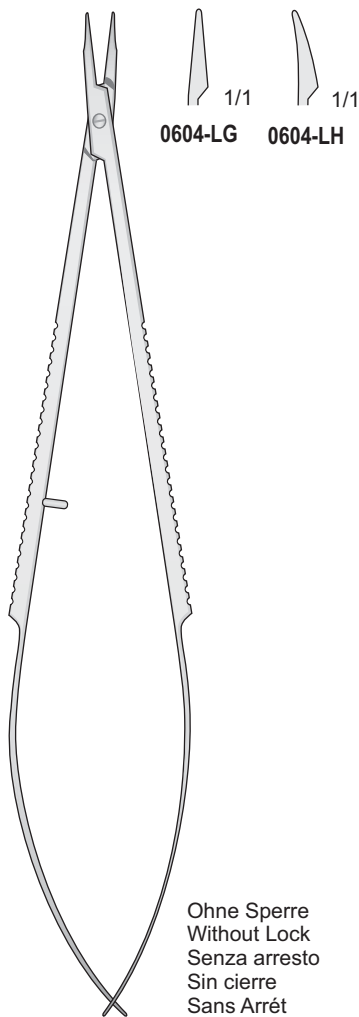

CASTROVIEJO
0604-LG/0604-LH
160 mm

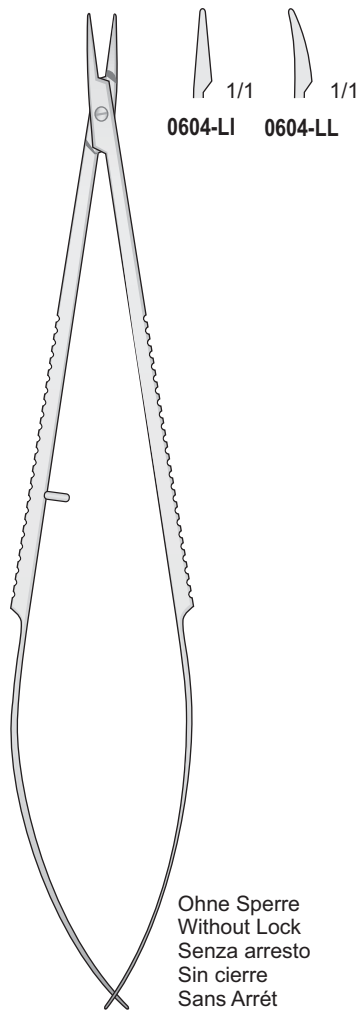

CASTROVIEJO
0604-LI/0604-LL
160 mm

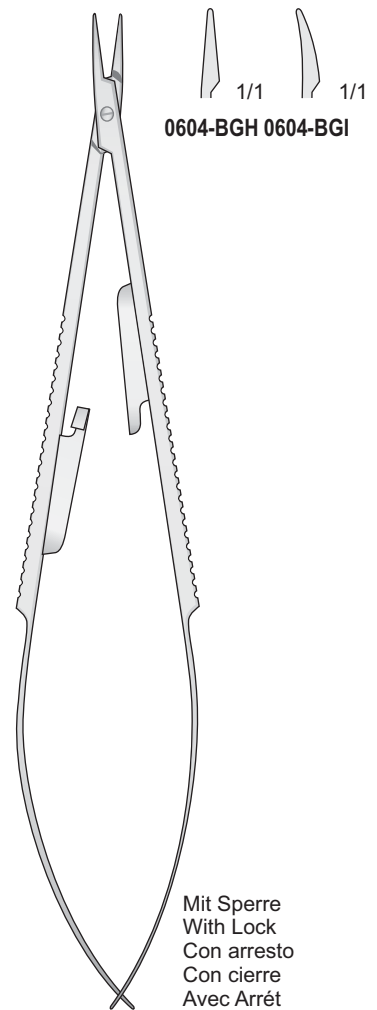

CASTROVIEJO
0604-BGH/0604-BGI
160 mm

Glattes Maul - Smooth jaws - Morso liscio - Bocas lisas - Mors lisses

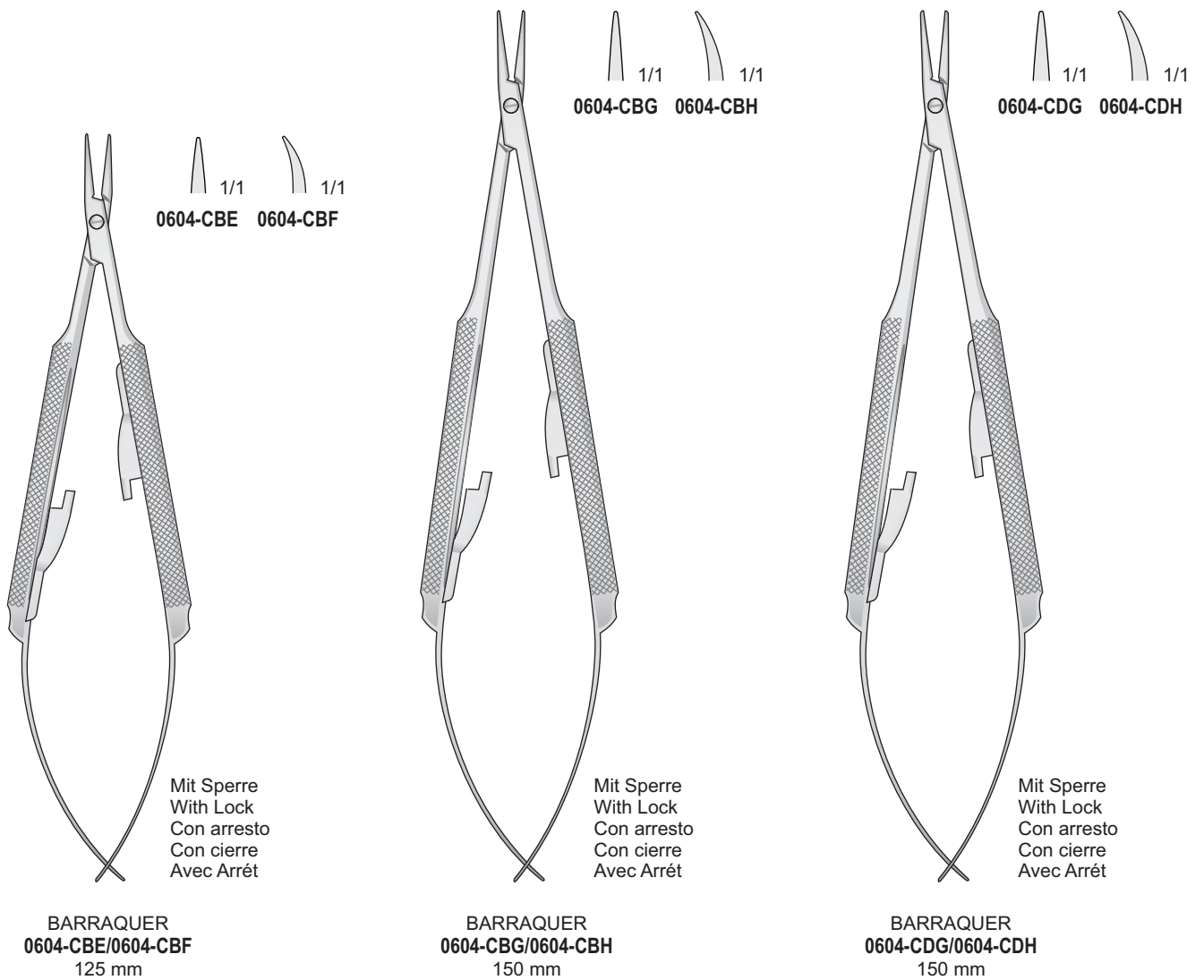

Mikro-Nadelhalter

Micro Needle Holders

Micro Port'aghi

Micro Portaaguja

Micro Porte aiguilles

Glattes Maul - Smooth jaws - Morso liscio - Bocas lisas - Mors lisses

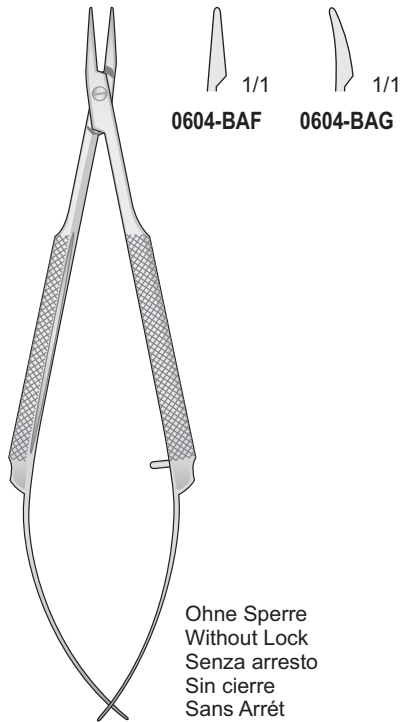

0604-BAF 0604-BAG

Ohne Sperre
Without Lock
Senza arresto
Sin cierre
Sans Arrêt

CASTROVIEJO
0604-BAF/0604-BAG
110 mm

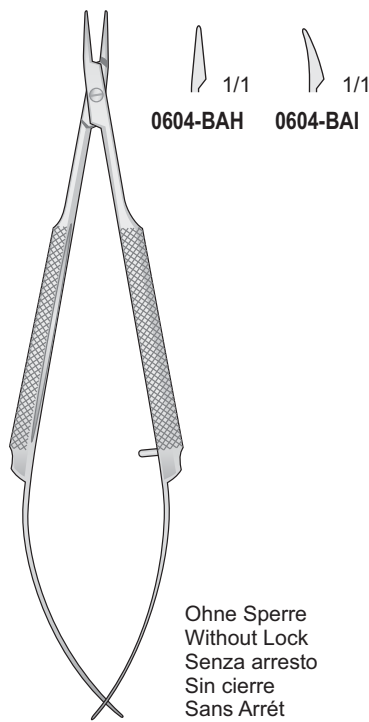

0604-BAH 0604-BAI

Ohne Sperre
Without Lock
Senza arresto
Sin cierre
Sans Arrêt

CASTROVIEJO
0604-BAH/0604-BAI
110 mm

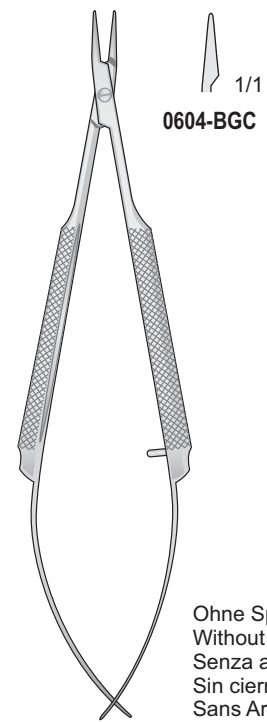

0604-BGC

Ohne Sperre
Without Lock
Senza arresto
Sin cierre
Sans Arrêt

CASTROVIEJO
0604-BGC
110 mm

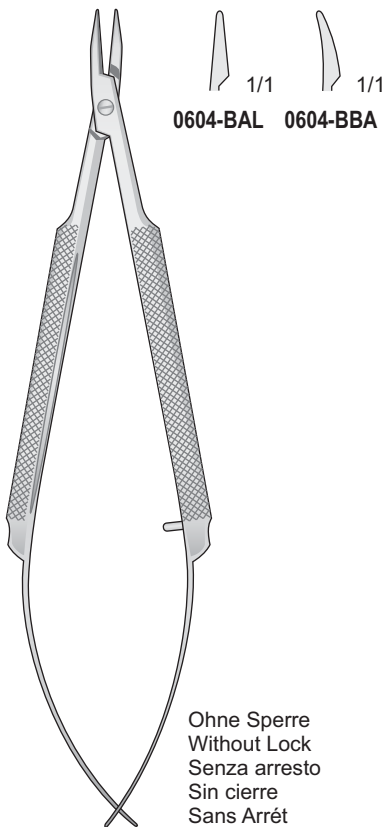

0604-BAL 0604-BBA

Ohne Sperre
Without Lock
Senza arresto
Sin cierre
Sans Arrêt

CASTROVIEJO
0604-BAL/0604-BBA
125 mm

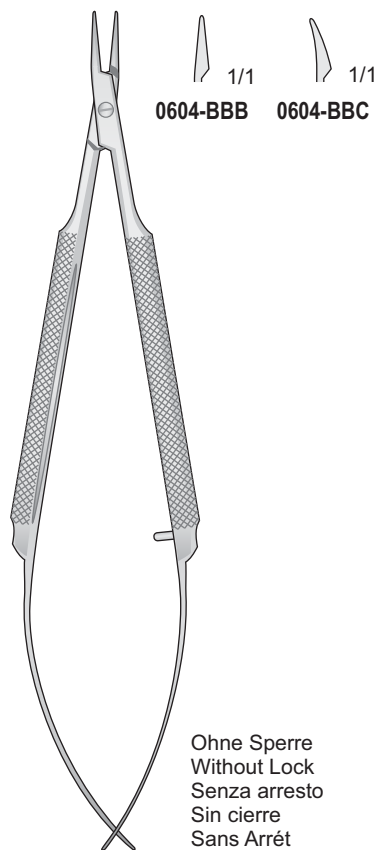

0604-BBB 0604-BBC

Ohne Sperre
Without Lock
Senza arresto
Sin cierre
Sans Arrêt

CASTROVIEJO
0604-BBB/0604-BBC
125 mm

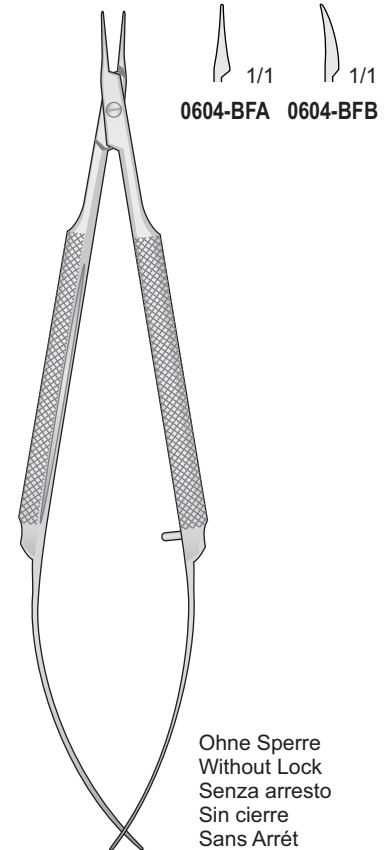

0604-BFA 0604-BFB

Ohne Sperre
Without Lock
Senza arresto
Sin cierre
Sans Arrêt

BARRAQUER
0604-BFA/0604-BFB
125 mm

Glattes Maul - Smooth jaws - Morso liscio - Bocas lisas - Mors lisses

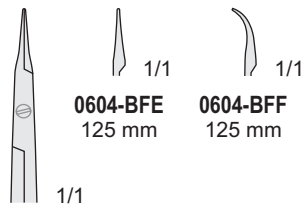
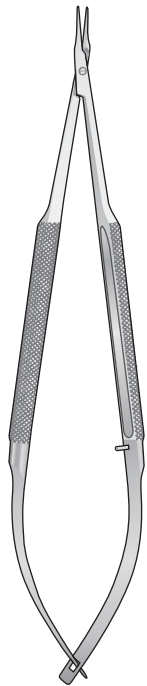

Ohne Sperre
Without Lock
Senza arresto
Sin cierre
Sans Arrêt

BARRAQUER
0604-BFE/0604-BFF
125 mm

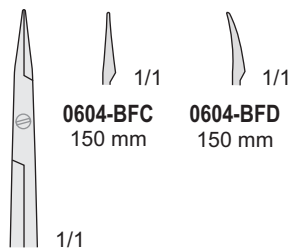
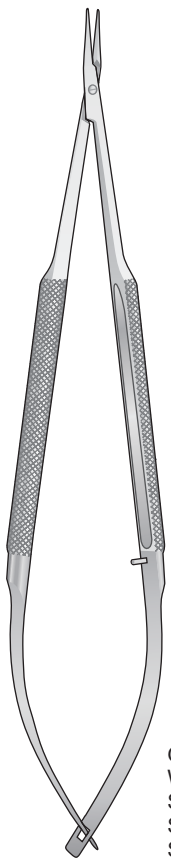

Ohne Sperre
Without Lock
Senza arresto
Sin cierre
Sans Arrêt

BARRAQUER
0604-BFC/0604-BFD
150 mm

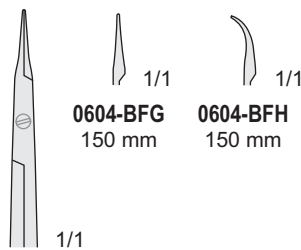
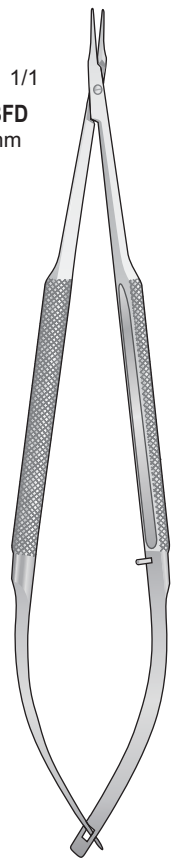

Ohne Sperre
Without Lock
Senza arresto
Sin cierre
Sans Arrêt

REILL
0604-BFG/0604-BFH
150 mm

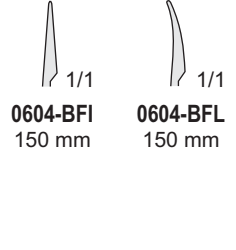
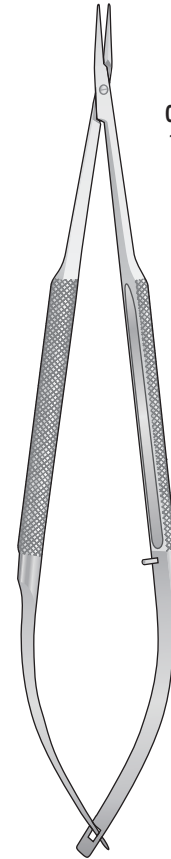

Ohne Sperre
Without Lock
Senza arresto
Sin cierre
Sans Arrêt

CASTROVIEJO
0604-BFI/0604-BFL
150 mm

Glattes Maul - Smooth jaws - Morso liscio - Bocas lisas - Mors lisses

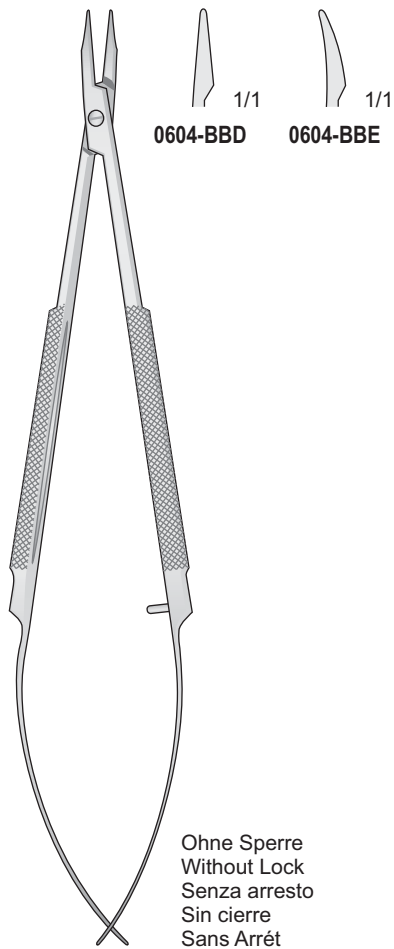

CASTROVIEJO
0604-BBD/0604-BBE
150 mm

Ohne Sperre
Without Lock
Senza arresto
Sin cierre
Sans Arrêt

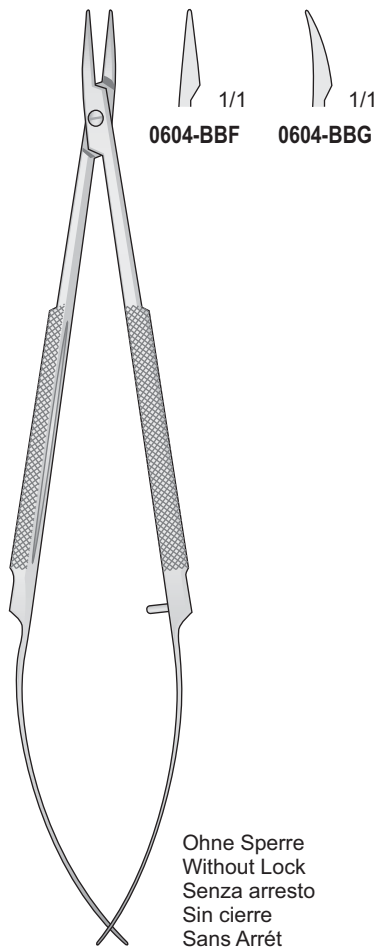

CASTROVIEJO
0604-BBF/0604-BBG
150 mm

Ohne Sperre
Without Lock
Senza arresto
Sin cierre
Sans Arrêt

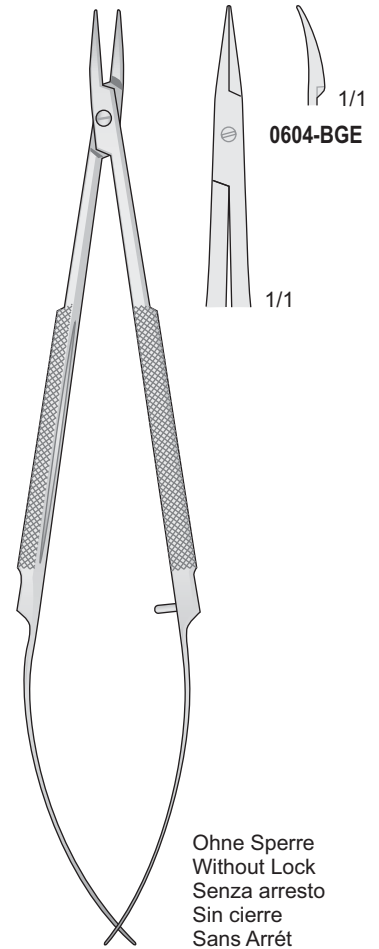

CASTROVIEJO
0604-BGE
150 mm

Ohne Sperre
Without Lock
Senza arresto
Sin cierre
Sans Arrêt

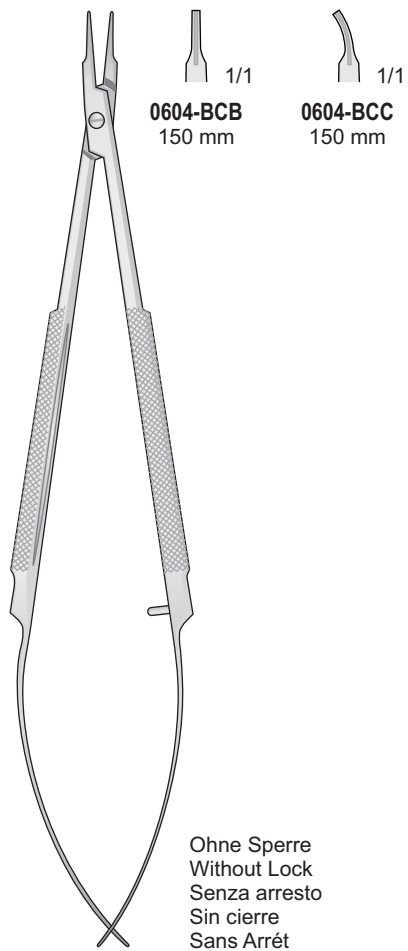

BARRAQUER
0604-BCB/0604-BCC
150 mm

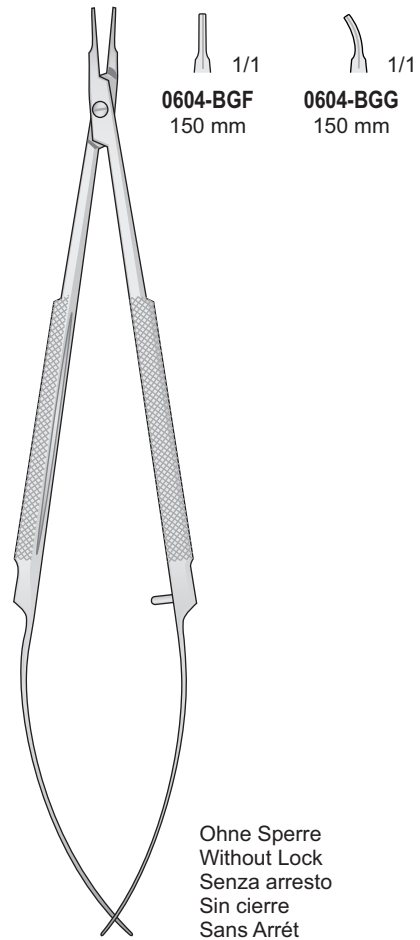

BARRAQUER
0604-BGF/0604-BGG
150 mm

Bulldogklemmen

Bulldog Clamps

Pinze Bulldog

Clamps Bulldog

Clamps Bulldog

Gefäßklemme - Serrefine
 Pinze serrafili - Serra-fina
 Serre fils

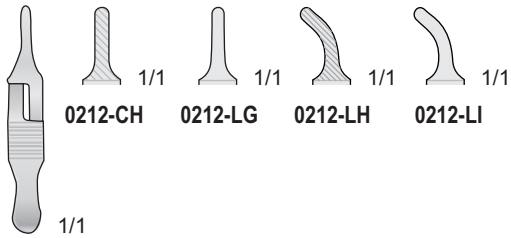

DIEFFENBACH
 0212-CH/0212-LI
 30 mm

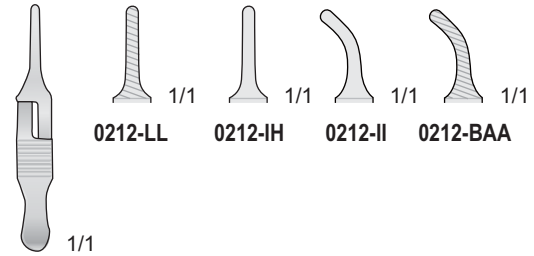

DIEFFENBACH
 0212-IH/0212-BAA
 30 mm

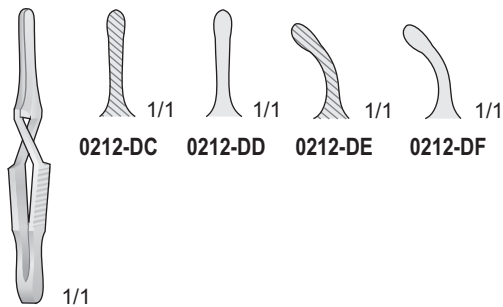

DIEFFENBACH
 0212-DC/0212-DF
 40 mm

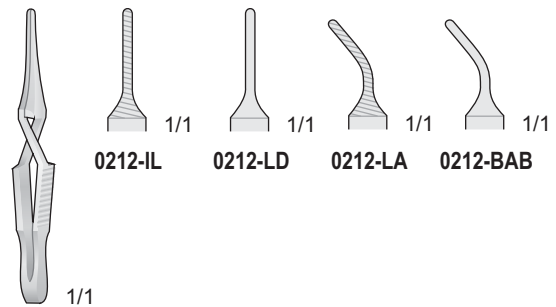

0212-IL/0212-BAB
 40 mm

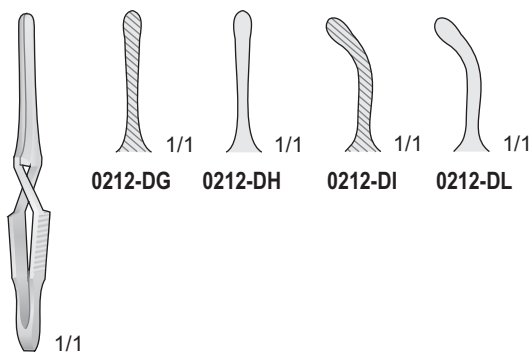

DIEFFENBACH
 0212-DG/0212-DL
 45 mm

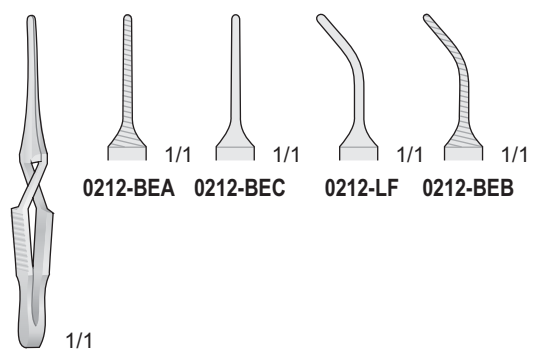

0212-LF/0212-BEC
 45 mm

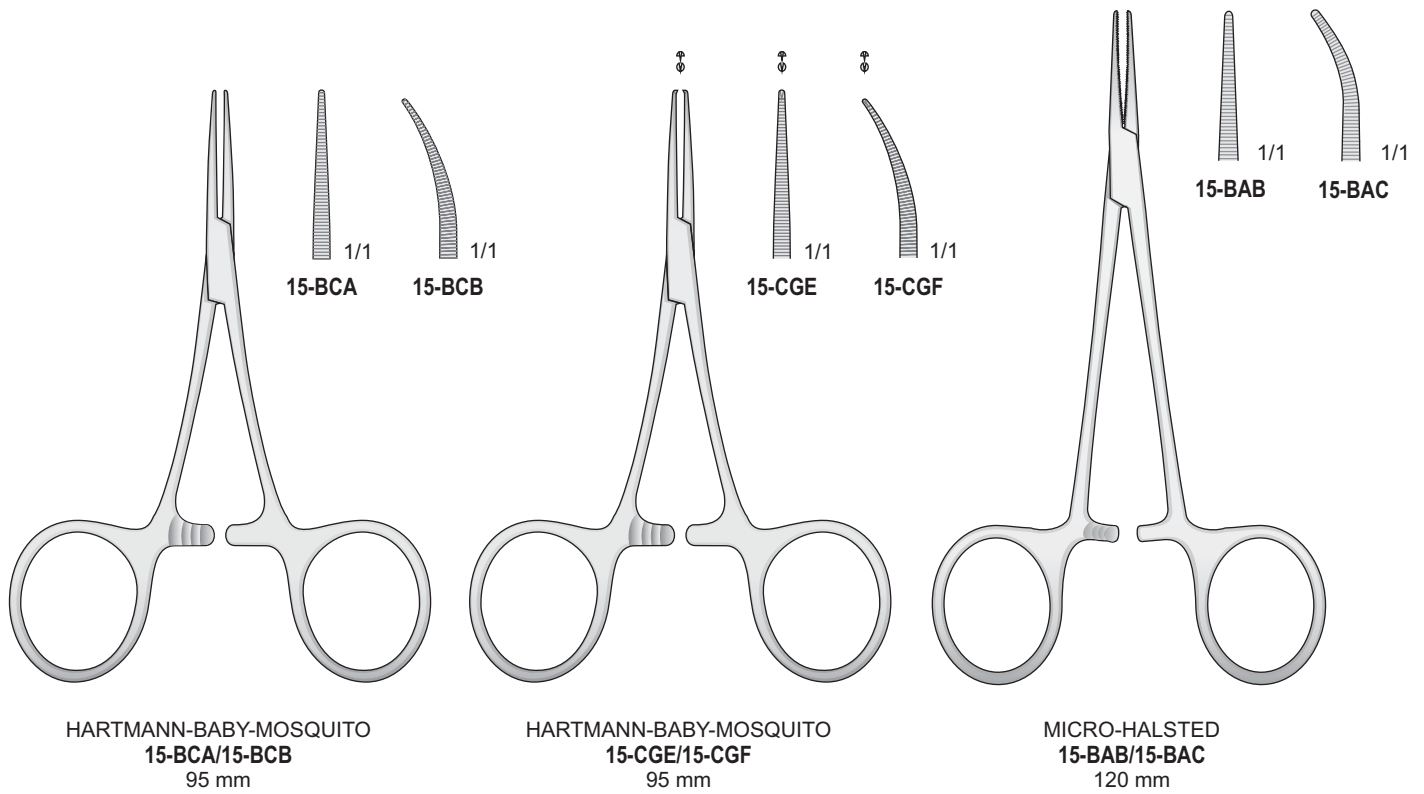

1x2 Zähne
1x2 Teeth
1x2 Denti
1x2 Dientes
1x2 Dents

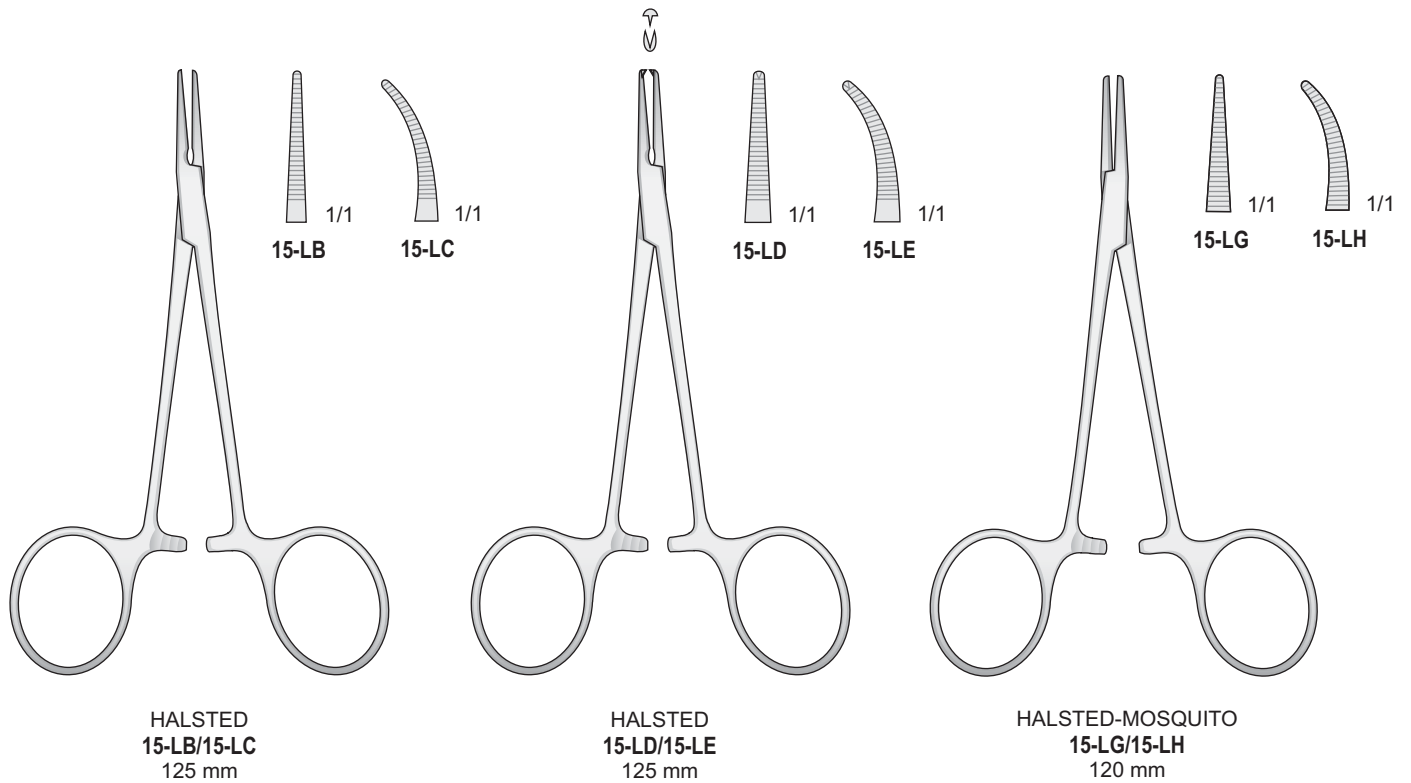

Arterienklemmen
Tuchklemmen

Hemostatic Forceps
Towel Forceps

Pinze emostatiche
Pinze fissateli

Pinzas hemostáticas
Pinzas da campo

Pinces hémostatiques
Pinces à champs

5x6 Zähne
5x6 Teeth
5x6 Denti
5x6 Dientes
5x6 Dents

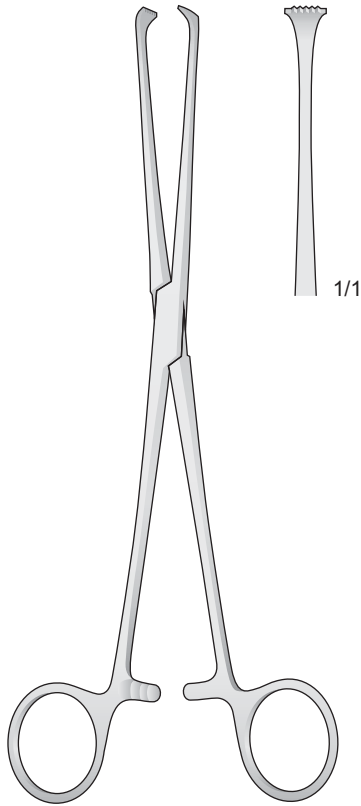

ALLIS
15-FA
160 mm

4x5 Zähne
4x5 Teeth
4x5 Denti
4x5 Dientes
4x5 Dents

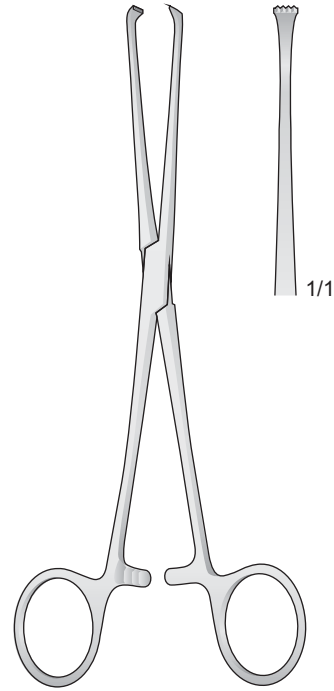

BABY-ALLIS
15-BAA
130 mm

Tuchklemmen - Towel Forceps
Pinze fissateli - Pinzas de campo
Pinces à champs

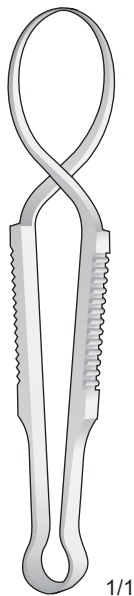

SCHAEDEL
0206-DI
85 mm

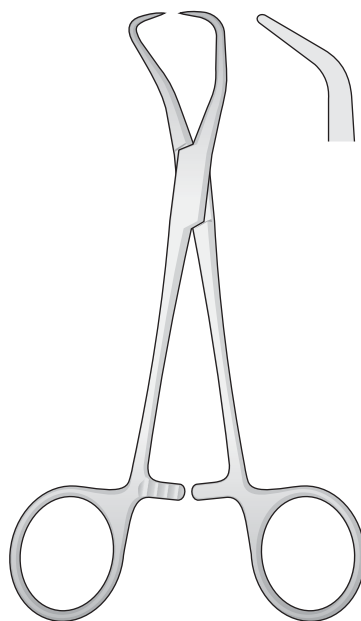

BACKHAUS
0206-EC/0206-EG

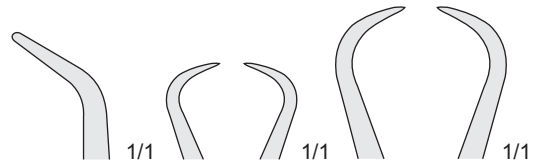

0206-EC
90 mm

0206-EG
130 mm

Zirkel - Calipers
Compassi - Compases
Compases

Maßstab, millimeter - Ruler, graduated - Decimetro
Regla - Reglette graduée

Meßbereich: 0 - 80 mm - Measuring range: 0 - 80 mm
Campo di misura: 0 - 80 mm - Alcance de medición: 0 - 80 mm
Etendue de mesure: 0 - 80 mm

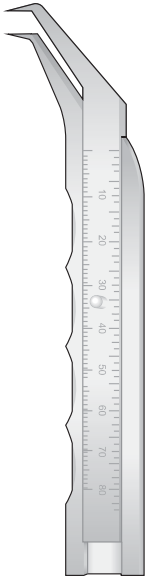

1417-EA
125 mm



1417-EC
120 mm

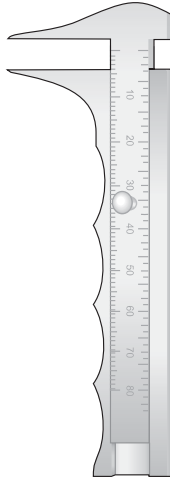

1417-EF
95 mm



1118-AE
80 mm



1118-AH
50 mm



1118-AI
100 mm



1118-AL
150 mm

Meßbereich: 0 - 15 mm
Measuring range: 0 - 15 mm
Campo di misura: 0 - 15 mm
Alcance de medición: 0 - 15 mm
Etendue de mesure: 0 - 15 mm

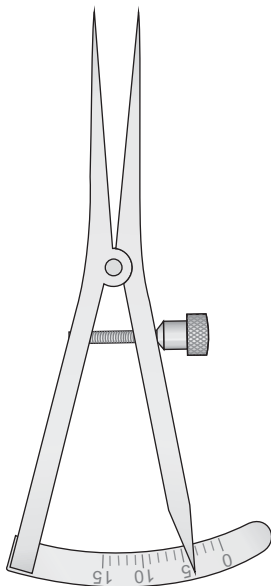

CASTROVIEJO
1417-BF
90 mm

Meßbereich: 0 - 20 mm
Measuring range: 0 - 20 mm
Campo di misura: 0 - 20 mm
Alcance de medición: 0 - 20 mm
Etendue de mesure: 0 - 20 mm

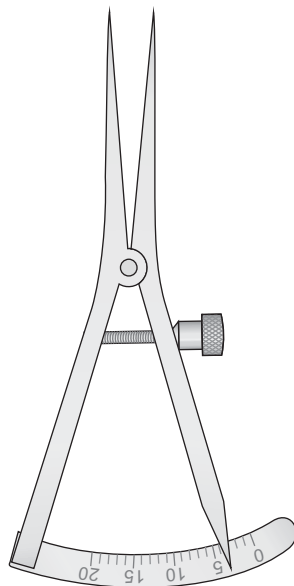

CASTROVIEJO
1417-BH
90 mm

Meßbereich: 0 - 20 mm
Measuring range: 0 - 20 mm
Campo di misura: 0 - 20 mm
Alcance de medición: 0 - 20 mm
Etendue de mesure: 0 - 20 mm

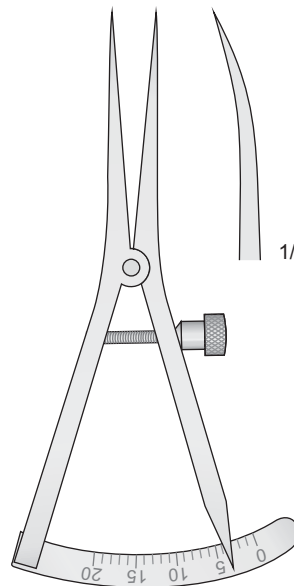

CASTROVIEJO
1417-BL
90 mm

Meßbereich: 0 - 20 mm
Measuring range: 0 - 20 mm
Campo di misura: 0 - 20 mm
Alcance de medición: 0 - 20 mm
Etendue de mesure: 0 - 20 mm

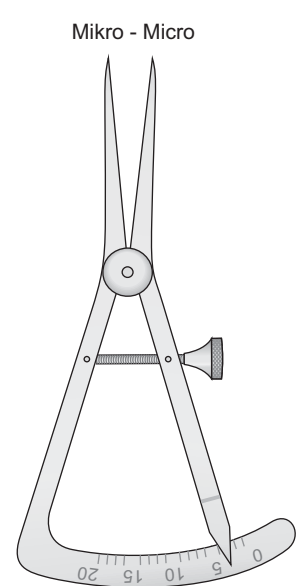

CALIPER
1417-CA
80 mm



Fixierringe
Bulbus Ringe

Fixation Rings
Bulb Rings

Anelli da fissazione
Anelli per bulbo

Anillos fijadoras
Anillos para bulbo

Anneaux de fixation
Anneaux pour le bulbe

Flieringa-Fixierring - Flieringa-Fixation Rings
Anelli da fissazione - Anillos fijadoras
Anneaux de fixation flieringa

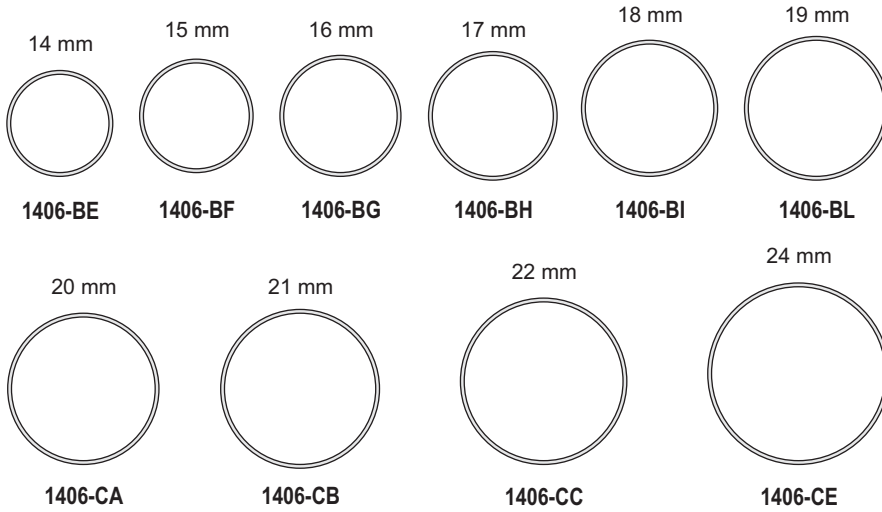

1406-CF
Komplettset mit 8 Stück
Set complete with 8 pieces
Set completo di 8 pezzi
Set completo con 8 piezas
Set complet avec 8 pièces
Ø 15 mm - Ø 22 mm

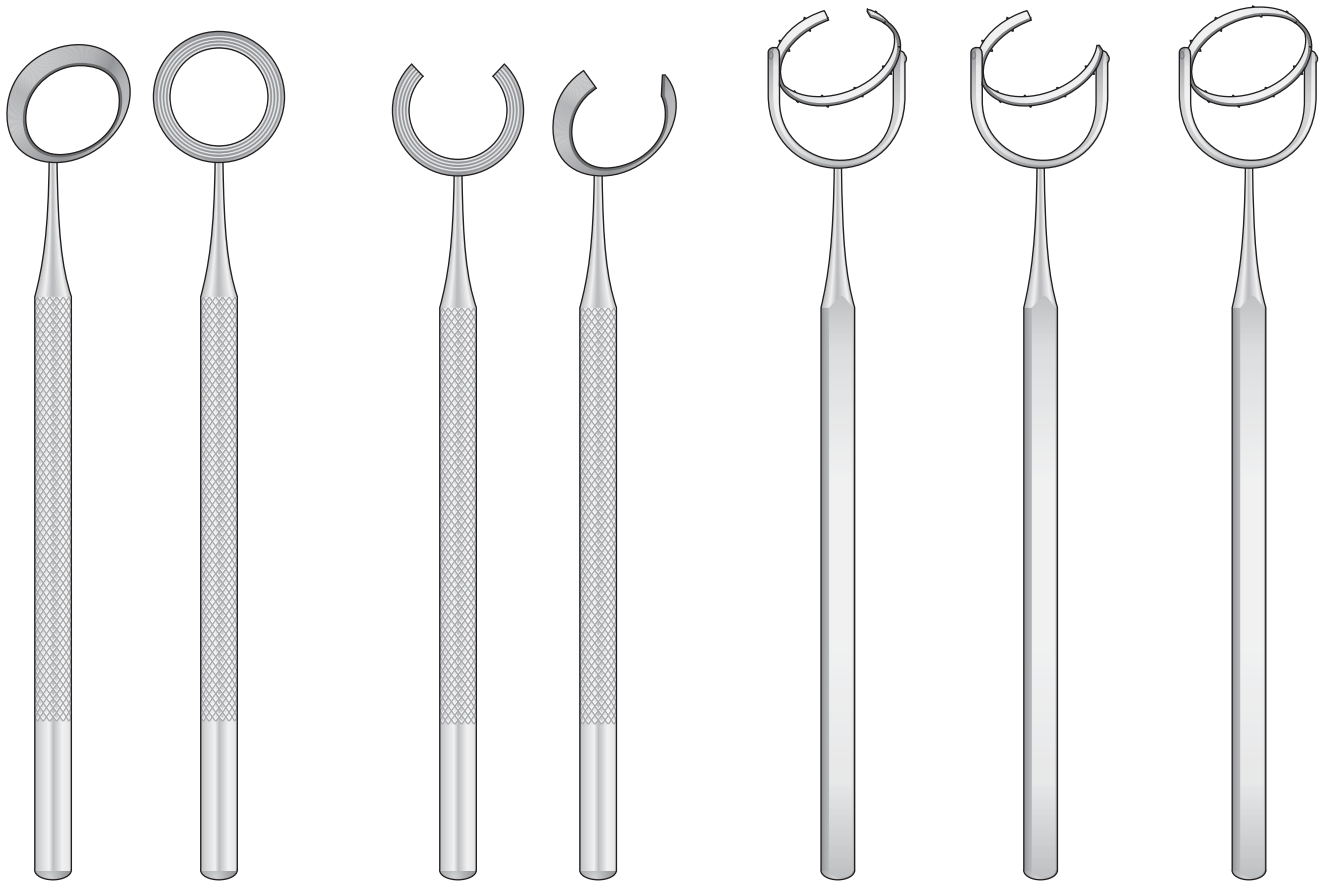

1405-EA

1405-EB

FINE-THORNTON
1405-EC Ø 13 mm
1405-ED Ø 16 mm

GIMBEL
1405-FE

HOFMANN-THORNTON
1405-FH Ø 16 mm

Fixierring - Rings for astigmatism
Anelli da astigmatismo - Anillos para astigmatismo
Anneaux pour astigmatisme

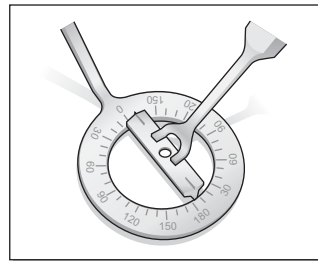

Atraumatische
Non traumatic
Atraumatiche
Atraumaticas
Atraumatique

Fixationsringe
Fixation Rings
Anelli da fissazione
Anillos fijadoras
Anneaux de fixation

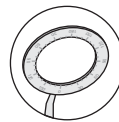

Meßring
Measuring ring
Anello per misurazione
Anillos para medir
Anneaux à mesurer



Axis Marker
used with Mendez
Marcatore assiale
da usare con
anello Mendez

Hornhaut Markierer
Corneal Markers
Marcatori corneali
Marcadores corneales
Marquers cornéens

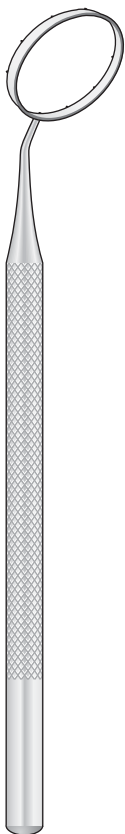

THORNTON
1405-FG Ø 16 mm

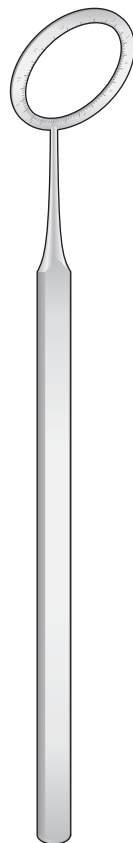

VILLASEÑOR-NAVARRO
1405-FI Ø 13,5 mm

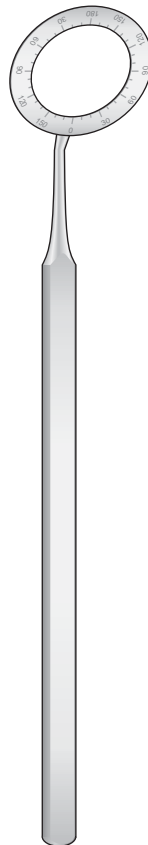

MENDEZ
1405-FL Ø 12 mm

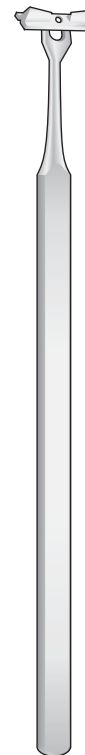

BORES
1405-GA

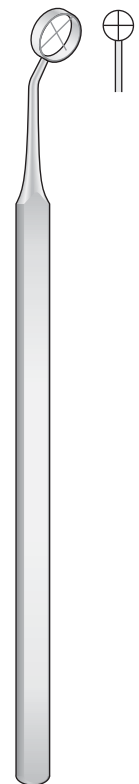

HOFFER
1405-FF 9 mm

Instrumente für
Radiale Keratotomie

Instruments for
Radial Keratotomy

Strumenti per
cheratotomia radiale

Instrumental para
queratoma radial

Instruments pour la
kératotomie radiale

Hornhaut Markierer
Corneal Markers
Marcatori corneali
Marcadores corneales
Marqueurs cornéens

Astigmatic Keratotomy
Cheratotomo da astigmatismo



1405-EH

1405-EI

Radial Marker
Marcatore radiale

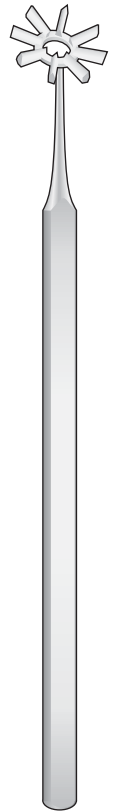
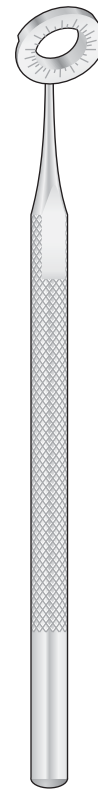
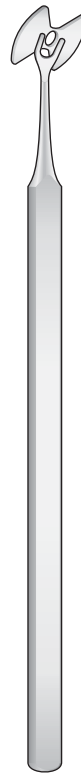
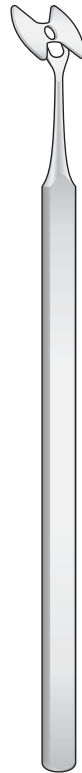
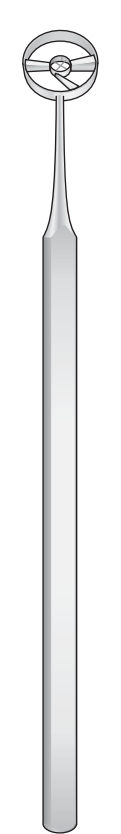
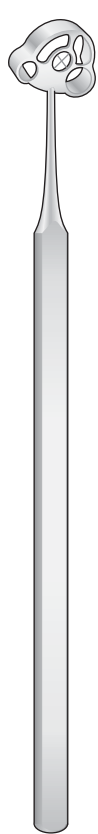
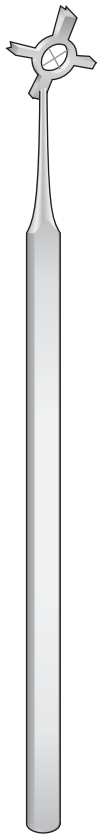
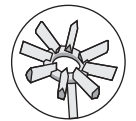
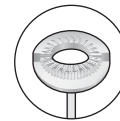
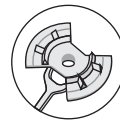
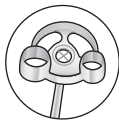

MENDEZ
1405-EE

CHAYET
1405-EF

LU
1405-EG

NANO
1405-EH
1405-EI

THORNTON
1405-EL With Target
1405-FA Without Target

THORNTON
1405-FB 6 Blades
1405-FC 8 Blades

Hornhautmarkierer

Corneal Marker

Marcatore corneale

Marcadores corneales

Marquers cornéens

Korrektur des astigmatismus
Incision marker for correction astigmatism
Marcatore per correzione astigmatismo

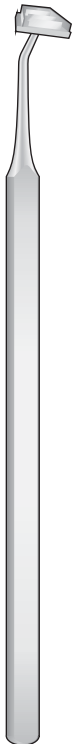

1405-GB 2,5 mm wide
1405-GC 3,0 mm wide
1405-GD 4,0 mm wide
1405-GE 5,0 mm wide

NORDAN-RUIZ
1405-GB/1405-GE

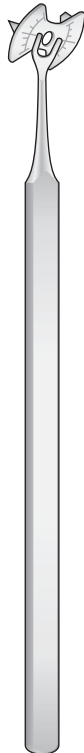

LINDSTROM
1405-GF 6 mm optic zone
1405-GG 7 mm optic zone

Double Corneal Ruler
Marcatore corneale
doppio

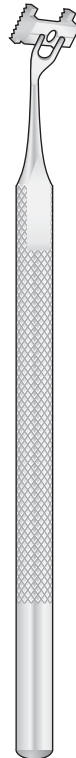
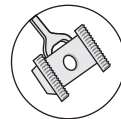

THORNTON
1405-GH for 6-8 mm optic zone
1405-GI for 5-7 mm optic zone

T-Incision Marker
Marcatore per astigmatismo
doppio T

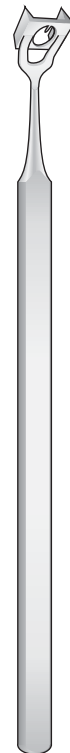
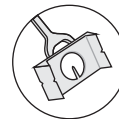

1405-GL 5 mm spread
1405-HA 6 mm spread
1405-HB 7 mm spread
1405-HC 8 mm spread

HOFMANN
1405-GL/1405-HC

Für Optisches Zentrum - Optic Zone Marker - Marcatori della zona ottica

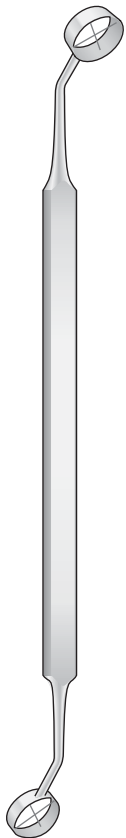

McDONALD
1405-HD
6,5 mm / 7,0 mm

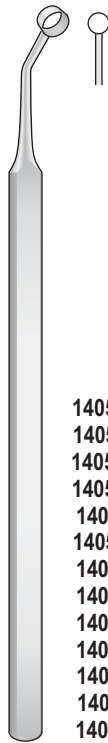

BORES
1405-HE/1405-IG

- 1405-HE 2,75 mm
- 1405-HF 3,0 mm
- 1405-HG 3,25 mm
- 1405-HH 3,5 mm
- 1405-HI 3,75 mm
- 1405-HL 4,0 mm
- 1405-IA 4,25 mm
- 1405-IB 4,5 mm
- 1405-IC 4,75 mm
- 1405-ID 5,0 mm
- 1405-IE 6,0 mm
- 1405-IF 7,0 mm
- 1405-IG 8,0 mm

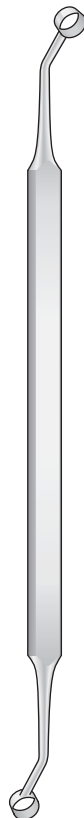

BERKELEY
1405-IH/1405-LA

- 1405-IH
3,0 mm / 3,25 mm
- 1405-II
3,5 mm / 3,75 mm
- 1405-IL
4,0 mm / 4,25 mm
- 1405-LA
4,5 mm / 5,0 mm

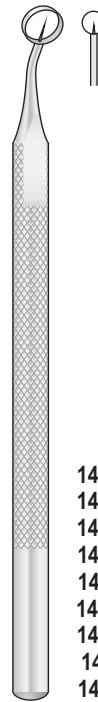

THORNTON
1405-LB/1405-LL

- 1405-LB 3,0 mm
- 1405-LC 3,25 mm
- 1405-LD 3,5 mm
- 1405-LE 3,75 mm
- 1405-LF 4,0 mm
- 1405-LG 4,25 mm
- 1405-LH 4,5 mm
- 1405-LI 4,75 mm
- 1405-LL 5,0 mm

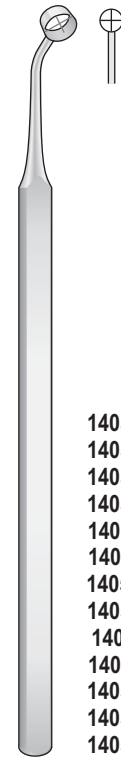

HOFFER
1405-BAA/1405-BBC

- 1405-BAA 3,0 mm
- 1405-BAB 3,25 mm
- 1405-BAC 3,5 mm
- 1405-BAD 3,75 mm
- 1405-BAE 4,0 mm
- 1405-BAF 4,25 mm
- 1405-BAG 4,5 mm
- 1405-BAH 4,75 mm
- 1405-BAI 5,0 mm
- 1405-BAL 5,5 mm
- 1405-BBA 6,0 mm
- 1405-BBB 7,0 mm
- 1405-BBC 8,0 mm

Hornhautmarkierer

Corneal Marker

Marcatore corneale

Marcadores corneales

Marquers cornéens

Radial Marker
Marcatori radiali

6 Klinden
6 Blades
6 Lame
6 Hojas
6 Lames

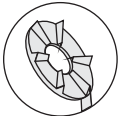

**BORES
1405-BBL**
6 Blades

8 Klinden
8 Blades
8 Lame
8 Hojas
8 Lames

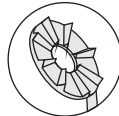

**BORES
1405-BCA**
8 Blades

Marker
with Ø Rings
3-6-9 mm

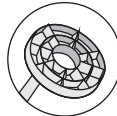

**THURMOND
1405-BCB**

Hornhaut Markierer
Corneal Marker
Marcatori corneali
Marcadores corneales
Marquers cornéens

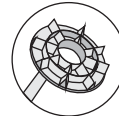

**ARROWSMITH
1405-BCC**
3-5 mm Rings



**ARROWSMITH
1405-BCD**
3-6 mm Rings

Astigmatism Marker
 Marcatori da astigmatismo

2 Concentric
 Rings
 6,5 / 7,5 mm
 7,0 mm

3 Concentric
 Rings
 5,5 / 6,5 / 7,5 mm

Triple Marker
 with 3 Rings
 Marcatore
 con 3 anelli

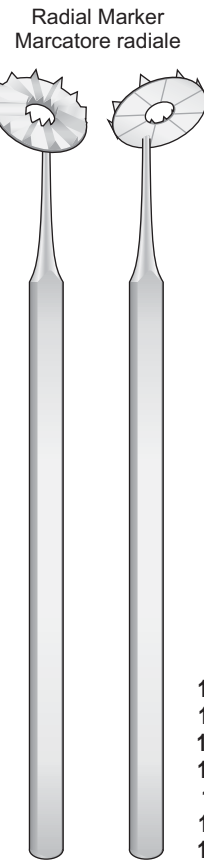
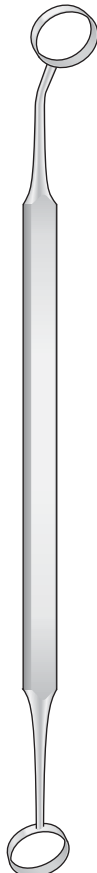
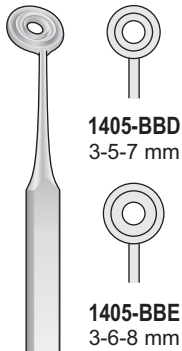

Radial Marker
 Marcatore radiale

- 1405-BCE 3 Blades
- 1405-BCF 4 Blades
- 1405-BCG 6 Blades
- 1405-BCH 8 Blades
- 1405-BCI 10 Blades
- 1405-BCL 12 Blades
- 1405-BDA 16 Blades

Marker for corneal
 8 Radial Blades

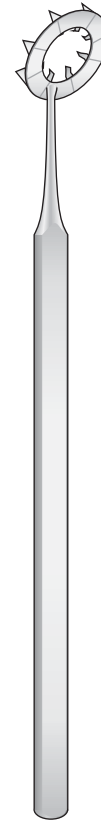

Incision Ruler

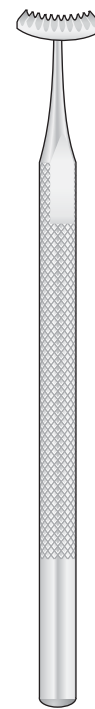

Small incision
 Marker

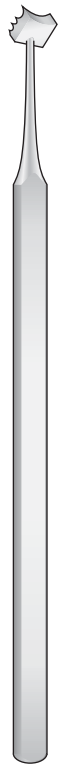

1405-BBD 3-5-7 mm
 1405-BBE 3-6-8 mm

ELLIS 1405-BBF
 ELLIS 1405-BBG

ANIS 1405-BCE/1405-BDA

ANIS 1405-BDB

THORNTON LINDSTROM 1405-BDC
 THORNTON LINDSTROM 1405-BDD

Lidsperrer,
Wundspreizer

Eye Speculums,
Retractors

Blefarostati,
Divaricatori

Blefarostatos,
Separador

Blépharostats,
Ecarteurs

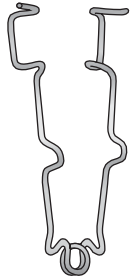

BOWMANN
1310-BAG
70 mm

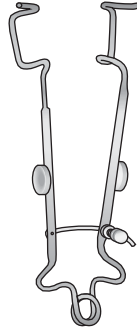

GRAEFE
1310-BBD 70 mm
1310-BBE 90 mm

1310-BBD
Kinder
Children
Bambini
Niños
Enfants

1310-BBE
Erwachsene
Adults
Adulti
Adultos
Adultes

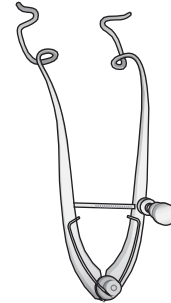

KNAPP-CLARK
1310-BBF
80 mm

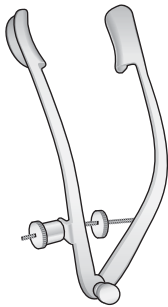

LANCASTER
1310-BBG
70 mm

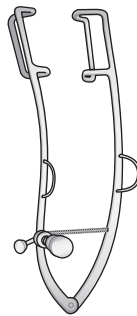

WEISS
1310-BBH Offen 70 mm
1310-BBI Offen 90 mm

1310-BBH
Kinder
Children
Bambini
Niños
Enfants

1310-BBI
Erwachsene
Adults
Adulti
Adultos
Adultes

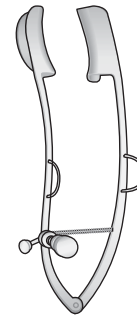

WEISS
1310-BBL Geschl. 70 mm
1310-BCA Geschl. 90 mm

1310-BBL
Kinder
Children
Bambini
Niños
Enfants

1310-BCA
Erwachsene
Adults
Adulti
Adultos
Adultes

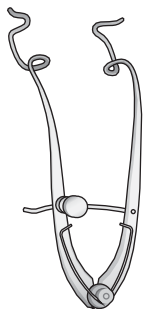

KNAPP-CLARK
1310-BCB
80 mm

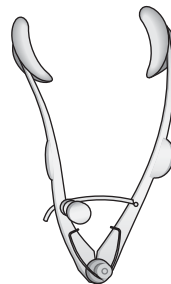

LISTER-BURCH
0221-AE
80 mm

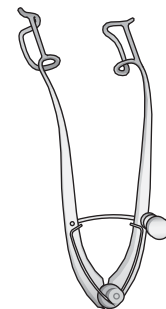

WILLIAMS
0221-AG
80 mm

Lidsperrer,
Wundspreizer

Eye Speculums,
Retractors

Blefarostati,
Divaricatori

Blefarostatos,
Separador

Blépharostats,
Ecarteurs

Wire Speculums

Wire Speculums
with solid blades

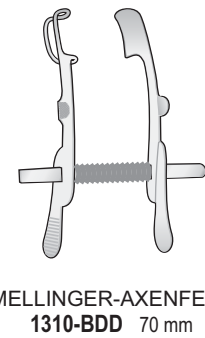
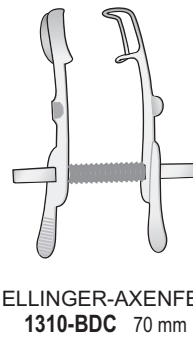
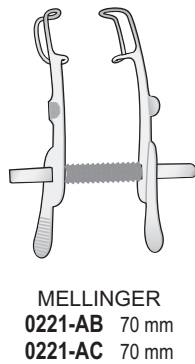
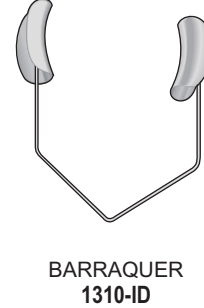
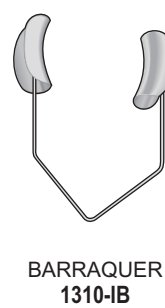
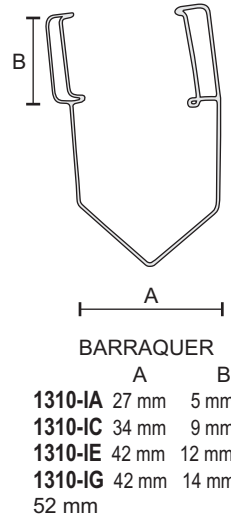
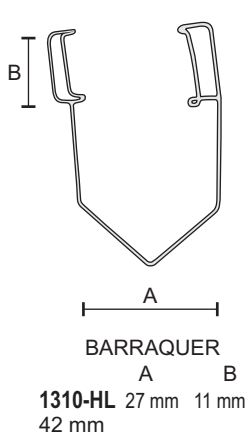

Klein
Small
Piccolo

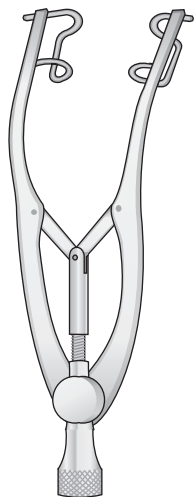

Mittel
Medium
Medio

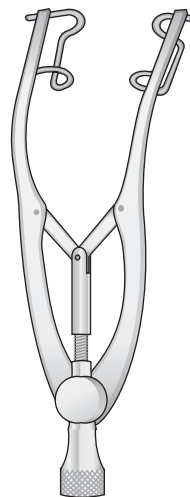

Gross
Large
Grande

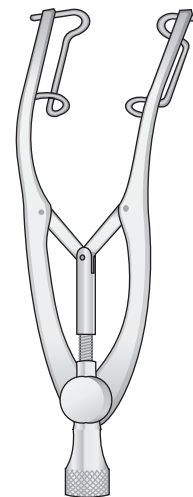

Lidsperre,
Wundspreizer

Eye Speculums,
Retractors

Blefarostati,
Divaricatori

Blefarostatos,
Separador

Blépharostats,
Ecarteurs

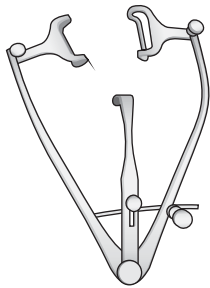

PARK
1310-BCC

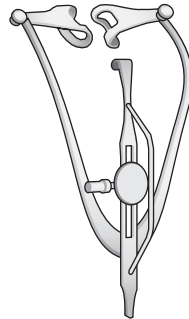

PARK-GUYTON
1310-BCD
80 mm

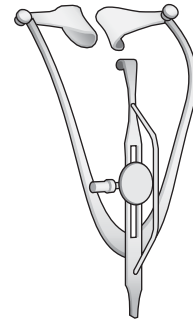

PARK-MAUMENEE
1310-BCE
80 mm

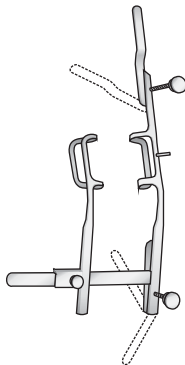

ARRUGA
1310-BCF
70 mm

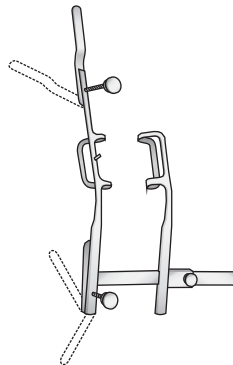

ARRUGA
1310-BCG
70 mm

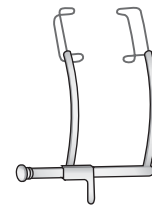

MURDOK
1310-BCH
50 mm

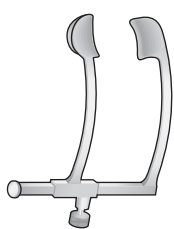

COOK
1310-BCI
40 mm

Kinder
Children
Bambini
Niños
Enfants

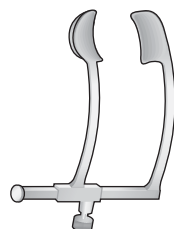

COOK
1310-BCL
40 mm

Klein
Small
Piccolo

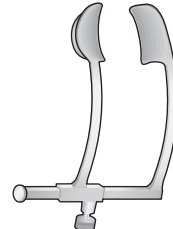

COOK
1310-BDA
40 mm

Mittel
Medium
Medio

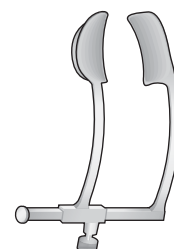

COOK
1310-BDB
40 mm

Gross
Large
Grande

Lidsperrer,
Wundspreizer

Eye Speculums,
Retractors

Blefarostati,
Divaricatori

Blefarostatos,
Separador

Bléfarostats,
Écarteurs

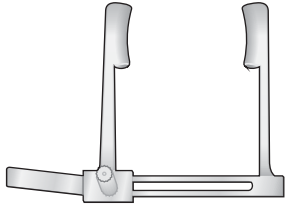

PROST
1310-LC
35 mm

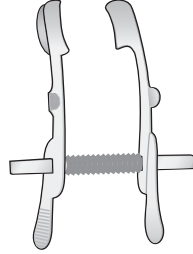

MELLINGER-BEARD
1310-BDE/1310-BDF



SAUER
1310-BDG
30 mm

1310-BDE

Kinder
Children
Bambini
Niños
Enfants

1310-BDF

Erwachsene
Adults
Adulti
Adultos
Adultes

Tränensack-Wundspreizer - Lacrimal Sac Retractor - Divaricatore per sacco lacrimale
Separador para saco lacrimal - Écarteurs pour le sac lacrymal



3x3 Zähne
3x3 Dents
3x3 Denti
3x3 Dientes
3x3 Dents

Stumpf
Blunt
Smusso
Romas
Mousse

STEVENSON
1310-BDH



3x3 Zähne
3x3 Dents
3x3 Denti
3x3 Dientes
3x3 Dents

Spitz
Sharp
Acuta
Aguda
Pointu

MÜLLER
1310-BDI
70 mm

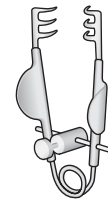

3x3 Zähne
3x3 Dents
3x3 Denti
3x3 Dientes
3x3 Dents

Spitz
Sharp
Acuta
Aguda
Pointu

AGRICOLA
1310-BDL

Wundspreizer
Retractors
Divaricatori
Separadores
Écarteurs

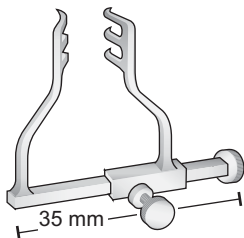

Spitz
Sharp
Acuta
Aguda
Pointu

GOLDSTEIN
1310-BEA
30 mm

Wundspreizer
Retractors
Divaricatori
Separadores
Écarteurs

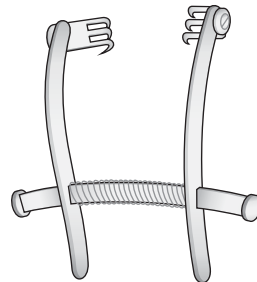

Spitz
Sharp
Acuta
Aguda
Pointu

AXENFELD
1310-BEB
80 mm

4x4 Zähne
4x4 Dents
4x4 Denti
4x4 Dientes
4x4 Dents



Stumpf
Blunt
Smusso
Romas
Mousse

0221-AI
100 mm

Lidsperrer,
Augenkanülen

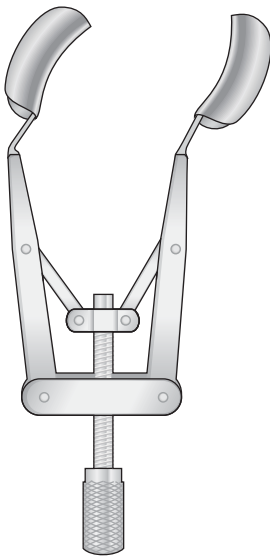

KERSHNER
1310-ECA
80 mm

Eye Speculums,
Eye Cannulas

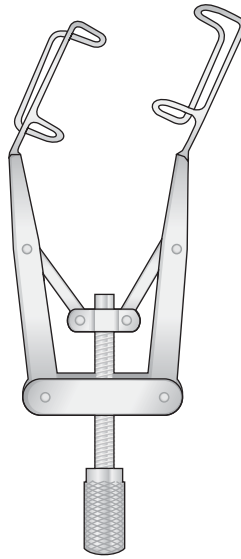

KERSHNER
1310-ECB
80 mm

Blefarostati,
Aghi cannula

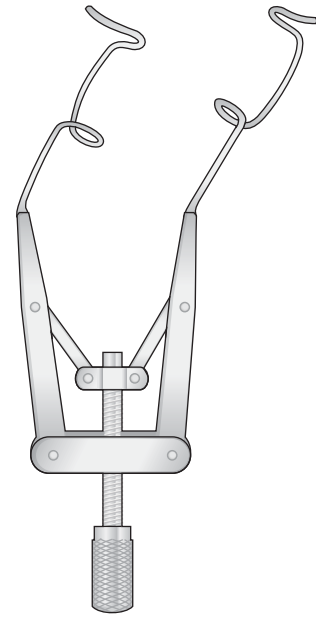

LIEBERMANN-TENNANT
1310-ECC
80 mm

Blépharostats,
Canules oculaires

Spülkanüle - Irrigating Cannula

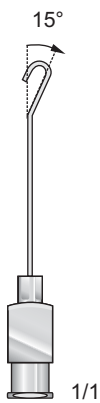

1411-FB
45 mm

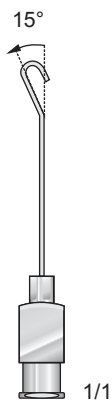

1411-FC
45 mm



1411-FA
30 mm



1411-FD
35 mm

Zystotom-Kanüle
Cystotome - cannula
Cistotomo - cannula
Cánulas - cistótomos
Canules à cystotome

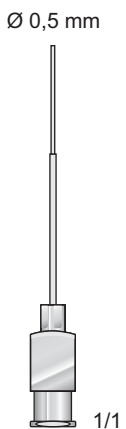

1411-FE
50 mm

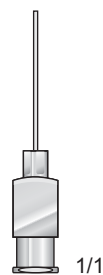

ANEL
1411-FF
30 mm

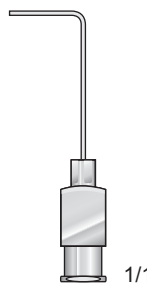

ANEL
1411-FG
30 mm

Acciaio Inox malleabile

Ø int. 0,45 mm
Ø est. 0,65 mm

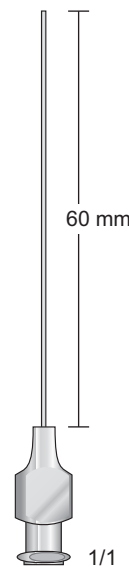

1411-IE
73 mm

Acciaio Inox malleabile

Ø int. 0,6 mm
Ø est. 0,8 mm

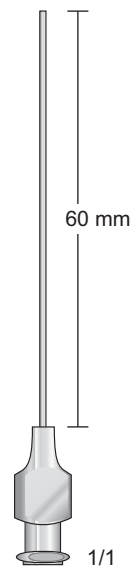

1411-IF
73 mm

Augenkanülen

Eye Cannulas

Aghi cannule

Cánulas para ojos

Canulés oculaires

Irrigating Cannula - Lacrimal Cannula



WELSH
1411-CAA 25 gauge left

WELSH
1411-BLL 25 gauge straight

WELSH
1411-CAB 25 gauge right

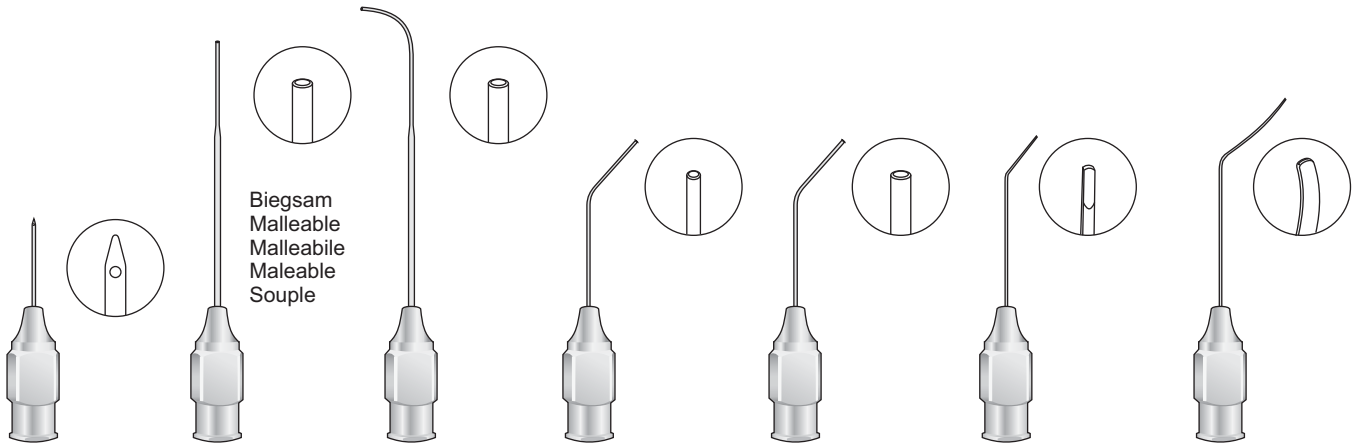

SHAHINIAN
1411-BIA 23 gauge

1411-BIB 23 gauge

1411-BIC 23 gauge

1411-BIH 30 gauge
1411-BII 27 gauge

1411-BIL 22 gauge
1411-BLA 19 gauge

RAININ
1411-BLB 30 gauge
1411-BLC 27 gauge

RANDOLPH
1411-BLD 21 gauge
1411-BLE 19 gauge

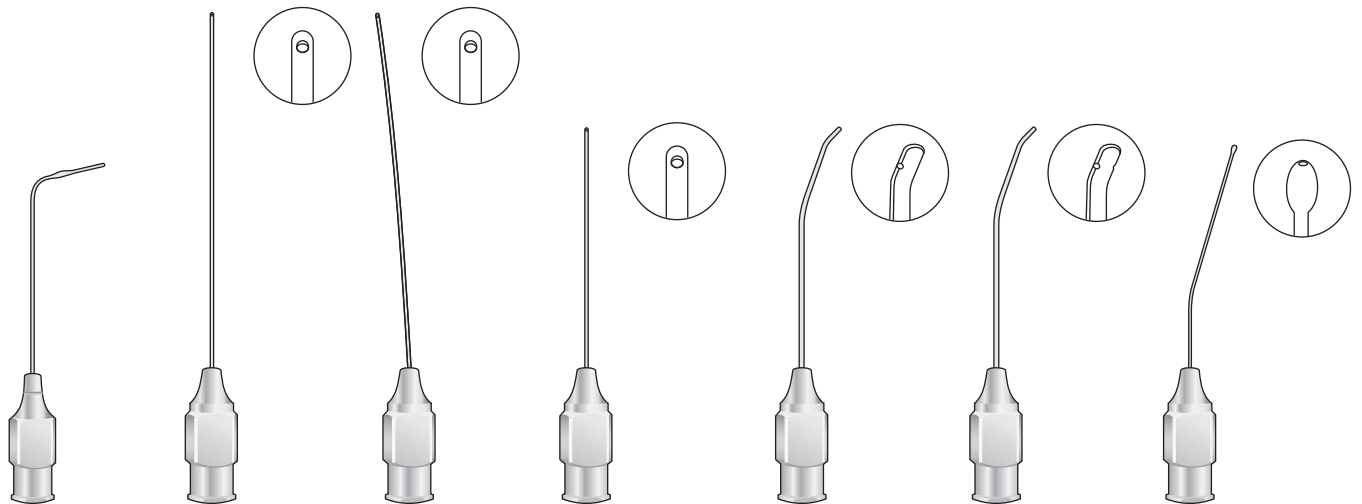

TULEVECH
1411-BID 23 gauge

McINTYRE
1411-BIE 23 gauge

McINTYRE
1411-BIF 23 gauge

WEST
1411-BIG 23 gauge

KELMAN
1411-BLF right
1411-BLG left
19 gauge

SHEETS
1411-BLH 19 gauge

TROUTMAN
1411-BLI 25 gauge

Augenkanülen

Eye Cannulas

Aghi cannule

Cánulas para ojos

Canulés oculaires

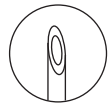

ATKINSON
1411-CAC 23 gauge
35 mm



McINTYRE
1411-CAD 19 gauge



McINTYRE
1411-CAE

Komplett
Complete
Completo
Completo
Complets

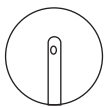

McINTYRE
1411-CAF 0,20 mm
1411-CAG 0,25 mm
1411-CAH 0,30 mm

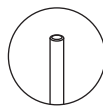

McINTYRE
1411-CAI
23 gauge

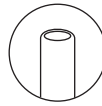

McINTYRE
1411-CAL
19 gauge

Rechts
Right
Destra
Derecha
Droite



GESS
1411-CBA

Links
Left
Sinistra
Izquierda
Gauche



GESS
1411-CBB



1411-CIG
 Rechts
 Right
 Destro
 Derecha
 Droite



NISHI
1411-CIG/1411-CIH

1411-CIH
 Links
 Left
 Sinistro
 Izquierda
 Gauche



THURMOND
1411-CII
 19 gauge

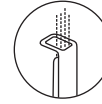

Irrigating Capsule
 Retractor



NISHI
1411-CIL

Irrigating Iris Hook



McINTYRE
1411-CLE
 23 gauge

Lens manipulating
 Cannula



YOUENS
1411-CLF
 30 gauge

Infusion Cannula
 with silicone tubing
 and adaptor

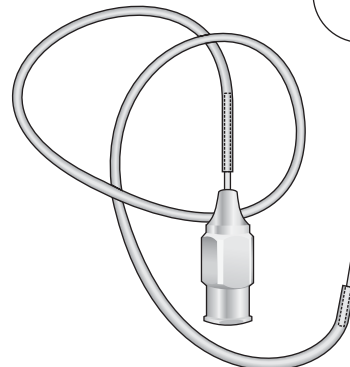
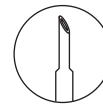

HESLIN
1411-CLG 25 gauge
1411-CLH 23 gauge

Irrigating - Aspirating Cannula

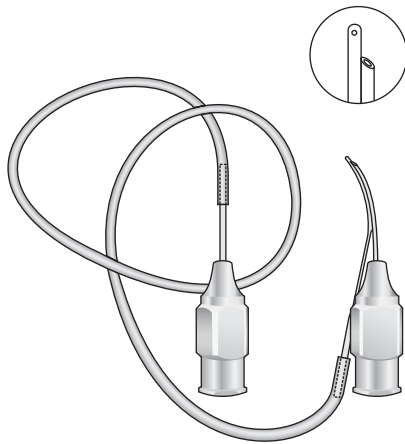

SIMCOE
1411-CBC

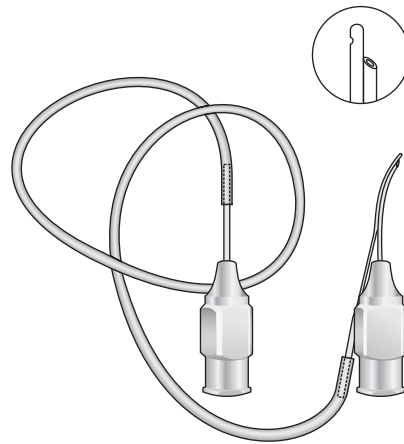

SWISS
1411-CBD

Reversed

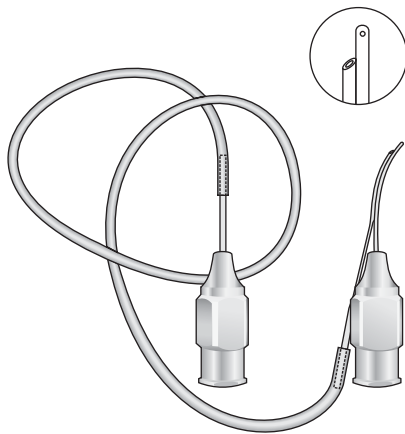

SIMCOE
1411-CBE

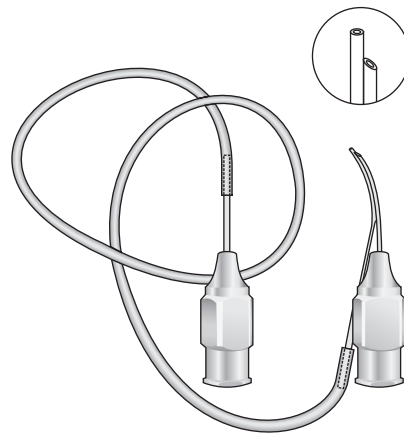

AMBROSIO
1411-CBF smooth
1411-CBG rough

Irrigating - Aspirating Cannula

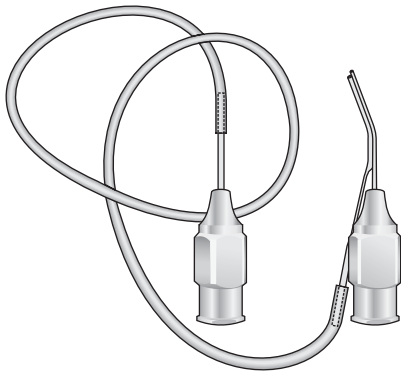
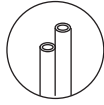

GILLS
1411-CBH
23 gauge

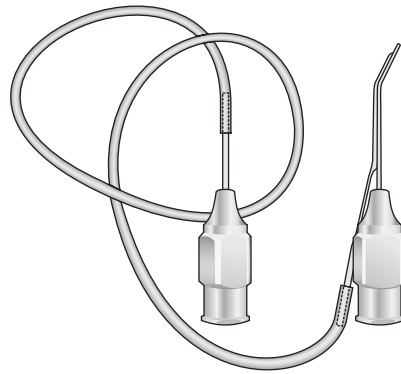

MORRISON
1411-CBI
23 gauge Aspirating Tube
25 gauge Irrigating Tube



GRANDON
1411-CBL



GRANDON
1411-CCA

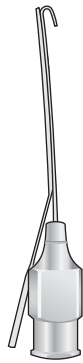

GRANDON
1411-CCB

Silicone Tubing
for I/A Cannulas

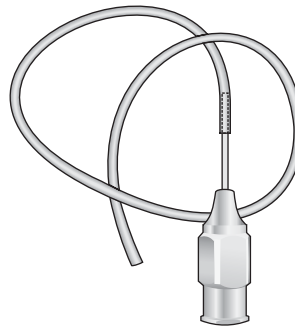

1411-CCC Tubing and adaptor
1411-CCD tubing only

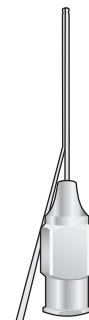
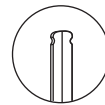

JENSEN-THOMAS
1411-CCE

Augenkanülen

Eye Cannulas

Aghi cannule

Cánulas para ojos

Canulés oculaires

Zystotom-Kanüle
Cystotome - cannula
Cistotomo - cannula
Cánulas - cistótomos
Canules à cystotome



KELMAN
1411-CCF
22 gauge



KRATZ
1411-CCG
22 gauge



KELMAN
1411-CCH
22 gauge



KELMAN
1411-CCI
22 gauge



1411-CCL small size
1411-CDA micro size
22 gauge



KNOLLE-KELMAN
1411-CDB
22 gauge



McINTYRE
1411-CDC
23 gauge



LIEPPMAN
1411-CDD
22 gauge



GRAETHER
1411-CDE straight
1411-CDF angled
22 gauge



SHAMMAS
1411-CDG
22 gauge



DREWS
1411-CDH
25 gauge

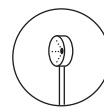

KRAFF
1411-CDI
25 gauge



KRATZ
1411-CDL
22 gauge



RUBMAN-KATZIN
1411-CEA
22 gauge

Augenkanülen

Eye Cannulas

Aghi cannule

Cánulas para ojos

Canulés oculaires



SHAPIRO
1411-CEB
23 gauge

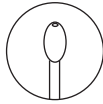

JENSEN
1411-CEC 25 gauge
1411-CED 23 gauge

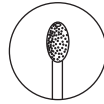

JENSEN
1411-CEE 25 gauge
1411-CEF 23 gauge



KNOLLE
1411-CEG 30 gauge
1411-CEH 23 gauge



SIMCOE
1411-CEI 13 mm
1411-CEL 21 mm



1411-CFA
25 gauge



SIMCOE
1411-CGB 13 mm
1411-CGC 21 mm
23 gauge

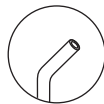

KNOLLE
1411-CFB 30 gauge
1411-CFC 23 gauge

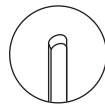

BRACKEN
1411-CFD
19 gauge

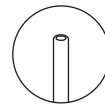

SALZ
1411-CFE

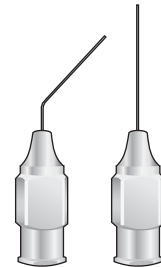
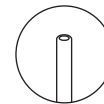

McINTYRE
1411-CFF/1411-CFL

1411-CFF 23 gauge, straight
1411-CFG 23 gauge, angled
1411-CFH 26 gauge, straight
1411-CFI 26 gauge, angled
1411-CFL 30 gauge, angled

Augenkanülen

Eye Cannulas

Aghi cannule

Cánulas para ojos

Canulés oculaires

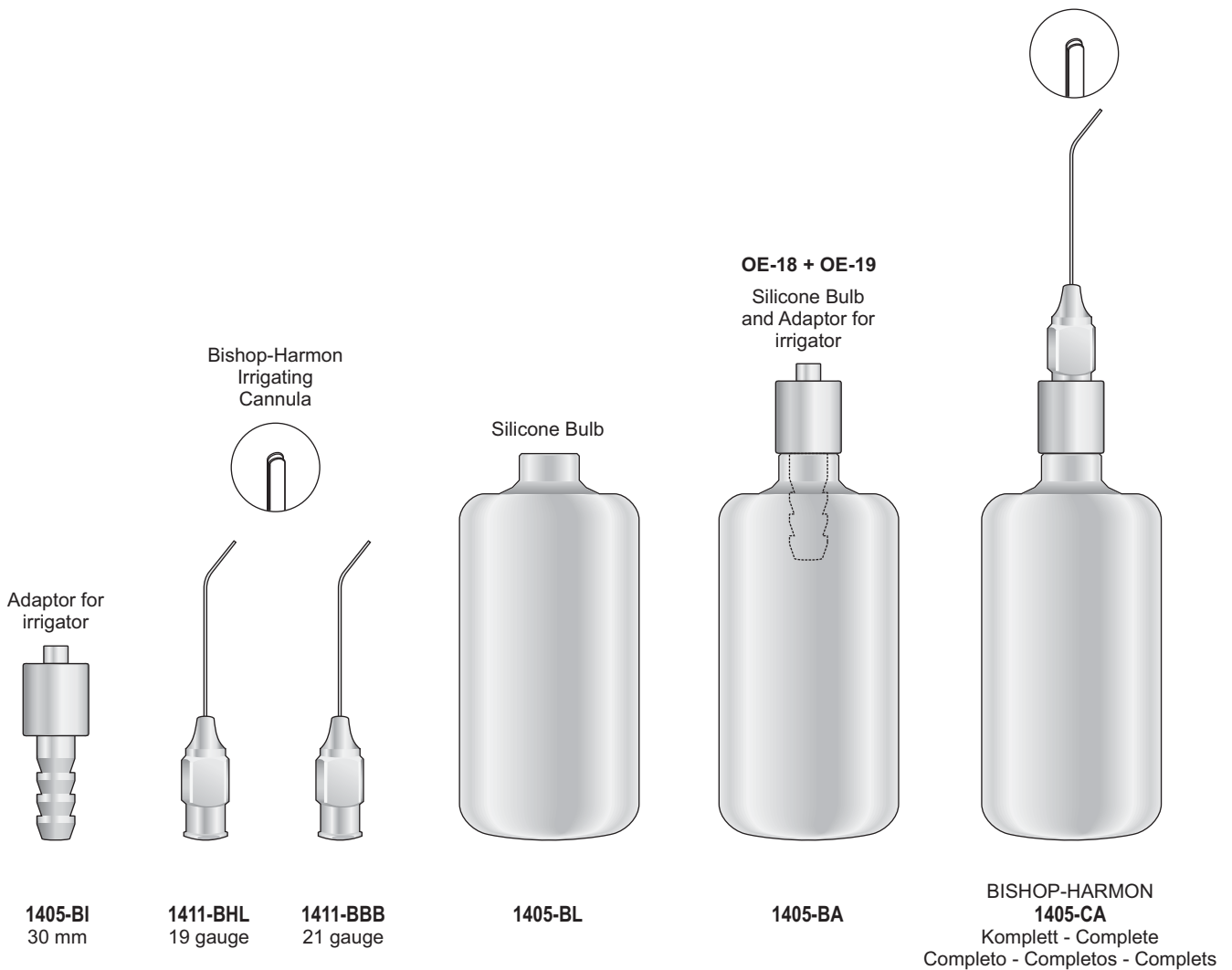

Irrigating - Aspirating Cannula

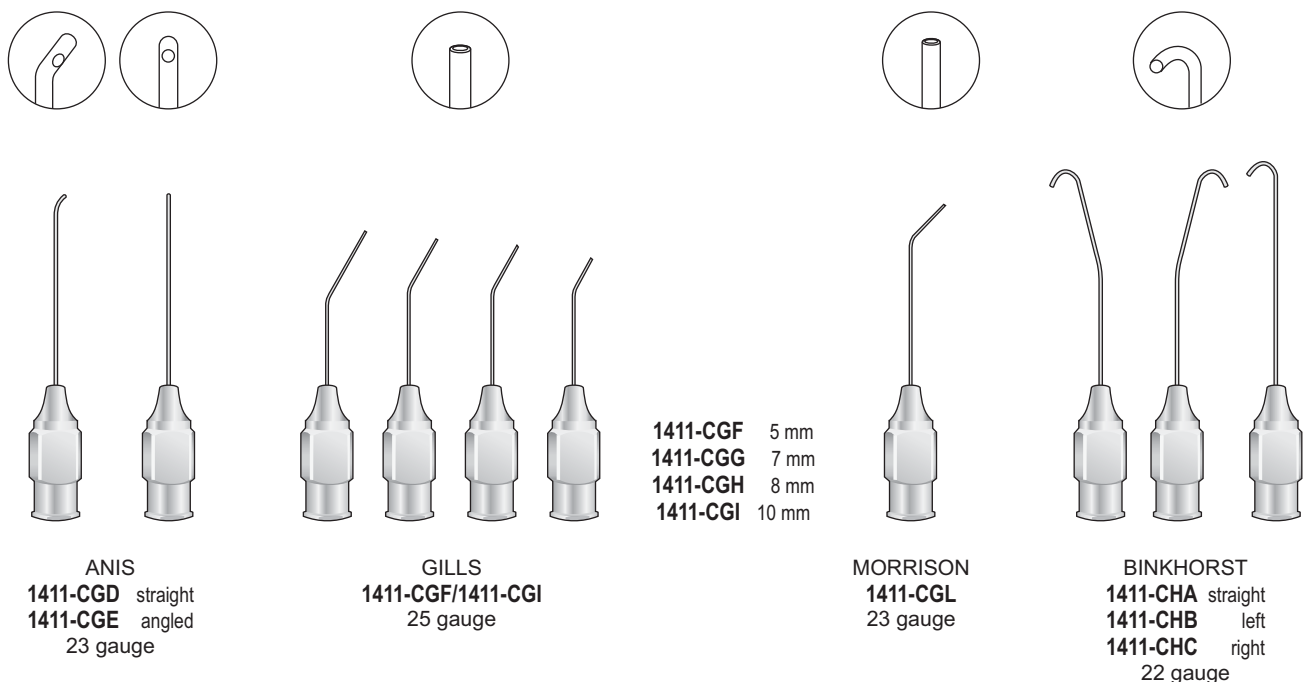

Augenkanülen

Eye Cannulas

Aghi cannule

Cánulas para ojos

Canulés oculaires

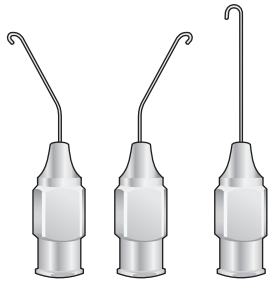

WILBRANDT-BINKHORST
1411-CHD straight
1411-CHE left
1411-CHF right
 23 gauge

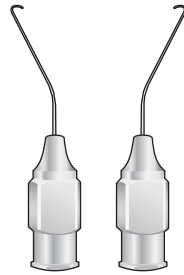

McINTYRE-BINKHORST
1411-CHG right
1411-CHH straight
1411-CHI left
 26 gauge

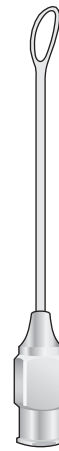
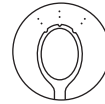

KNOLLE-PEARCE
1411-CHL
 23 gauge

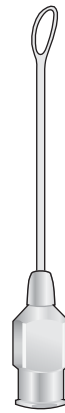
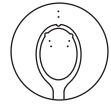

DREWS
1411-CIA
 23 gauge

Serrated Loop

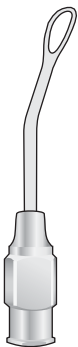
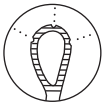

SHETTS
1411-CIB
 20 gauge

Nucleus Loop
 3 mm Wide,
 Serrated



HOFMANN
1411-CIC

Irrigating
 Lens nucleus Loop,
 Serrated

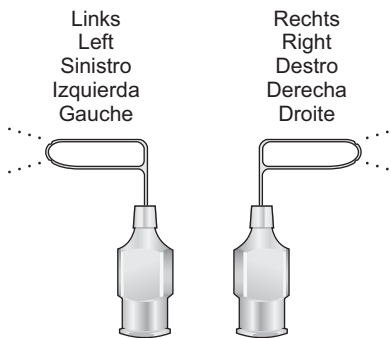

SIMCOE
1411-CID right
1411-CIE left
 25 gauge

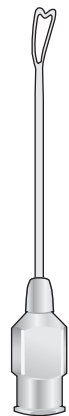

ANIS
1411-CIF
 23 gauge

Lens manipulating
Cannula

Ø 2mm



Irrigating Lens
manipulator



Irrigating Capsule
Retractor



SALTZ
1411-CLA
20 gauge



KRATZ
1411-CLB
30 gauge

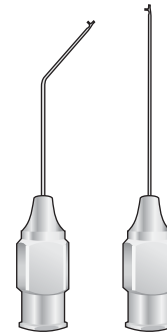

KUGLEN
1411-CLC straight
1411-CLD angled
25 gauge

Instrumentständer - Instrument Storage Rack
Supporto per strumenti - Suporte para instrumentos
Support pour instruments

Lagerungsgestell für 15 Stück Nadeln
Rack for 15 needles
Piastra per 15 aghi oftalmici

150 x 100 x 2 mm

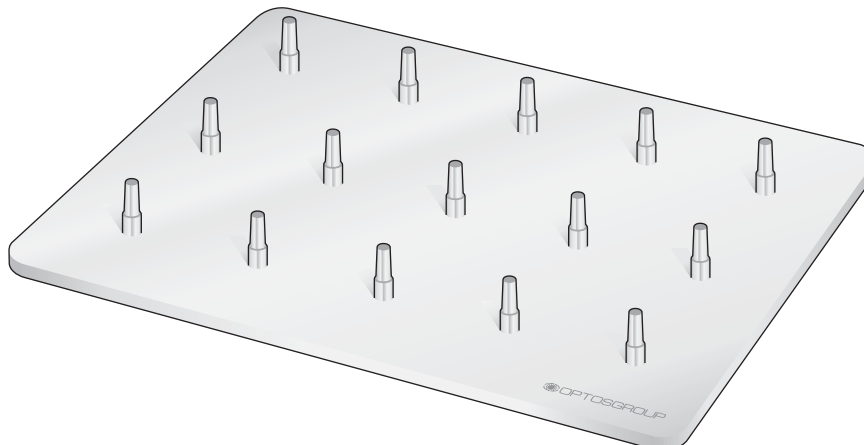

0218-CA

Augenkanülen

Eye Cannulas

Aghi cannule

Cánulas para ojos

Canulés oculaires

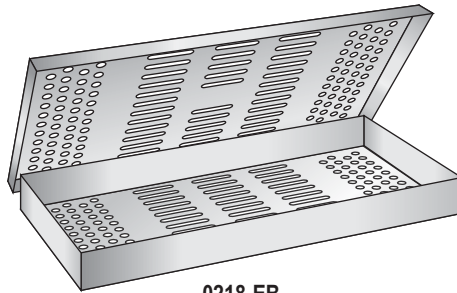
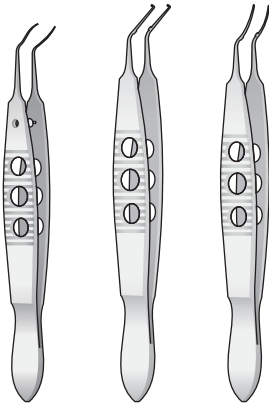
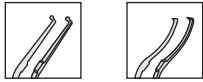

0218-EB
275 x 130 x 25 mm

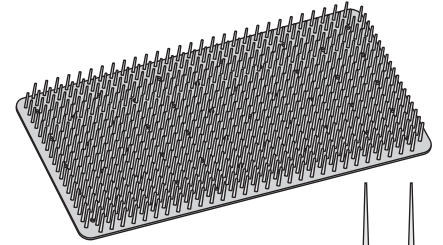

1918-BAD
260 x 120 mm

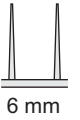

1206-CIA JAFFE 100 mm
1206-CGE LEHNER 105 mm
1206-CGF LEHNER 105 mm

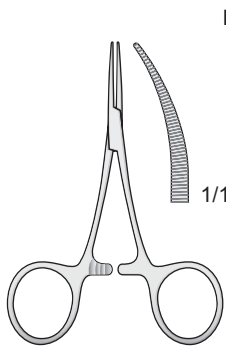

Irisspatel

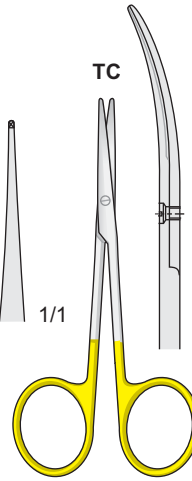
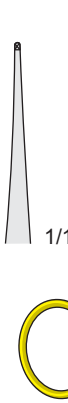
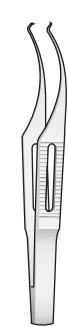

TC

Meßbereich
Measuring range
Campo di misura
Alcance de medición
Etendue de mesure
0 - 20 mm

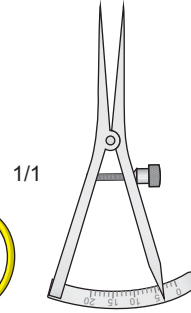

1/1

HARTMANN-BABY-MOSQUITO
15-BCB
95 mm

TROUTMAN-BARRAQUER
1310-CGG
Fig.2 90 mm

1206-HL
95 mm

1206-BFI
85 mm

COLIBRI
1206-BHC
83 mm

0204-EC
110 mm

0612-BBL
115 mm

CASTROVIEJO
1417-BH
90 mm

GRAEFE
1206-CLG 110 mm
0204-AH 100 mm

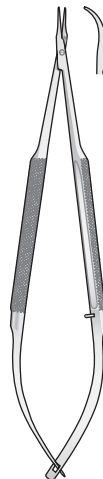
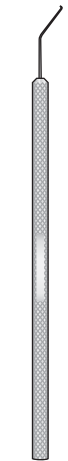

1/1



1/1



1/1

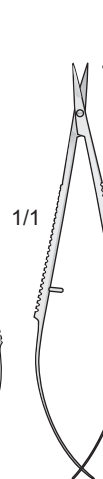

1/1



1/1



SISKEY
1310-DEL 120 mm
1310-DEH 120 mm
1310-EBH 116 mm

BARRAQUER
0604-BFF 125 mm
BARRAQUER
0604-BFB 125 mm
0604-BAA 125 mm

VANNAS
0604-IA 85 mm
0604-FA 110 mm

LIEBERMANN-TENNANT
1310-ECC

BISHOP-HARMON
1405-CA

Kataract Instrumentensets

Cataract Set

Set per cataratta

Set para cataracta

Set pour le cataracte

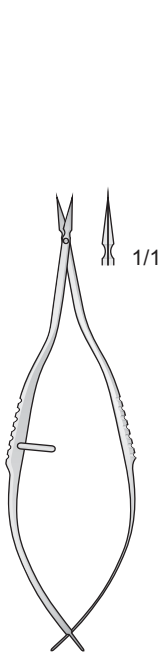

VANNAS
0604-HL
85 mm

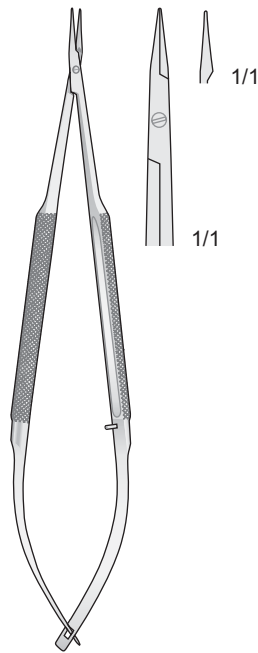

BARRAQUER
0604-BFC
150 mm



St. MARTIN
1206-CAA
85 mm

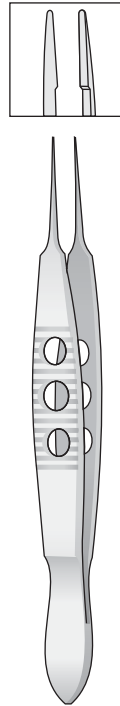

JAFFE
1206-CCB Straight
1206-CCC Curved
110 mm

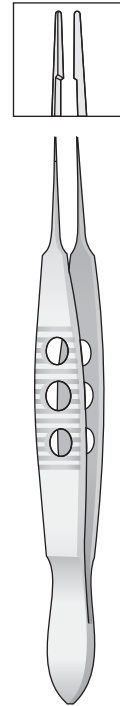

MC PHERSON
1206-CDB
105 mm

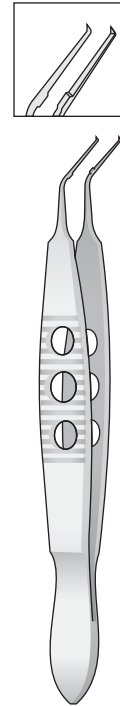

UTRATA
1206-CGB/1206-CGC
105 mm

Linsenhaken 0,2 mm
Stumpf, Gerade

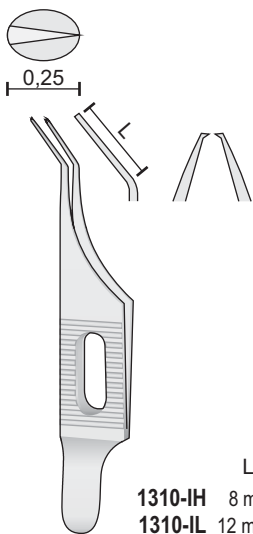
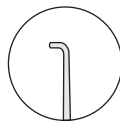

1310-IH/1310-IL
70 mm



TROUTMAN-BARRAQUER
1310-CGF 0.25 mm x 15 mm
1310-CGG 0.5 mm x 15 mm
90 mm



SINSKEY
1310-DEI
120 mm

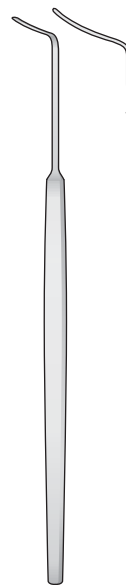

CASTROVIEJO
1310-CD
130 mm

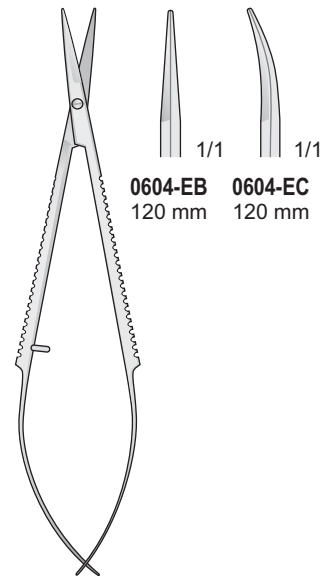

0604-EB/0604-EC
120 mm

Schielinstrumentensets

Strabismus Set

Set Strabismo

Set para estrabismo

Set à strabisme

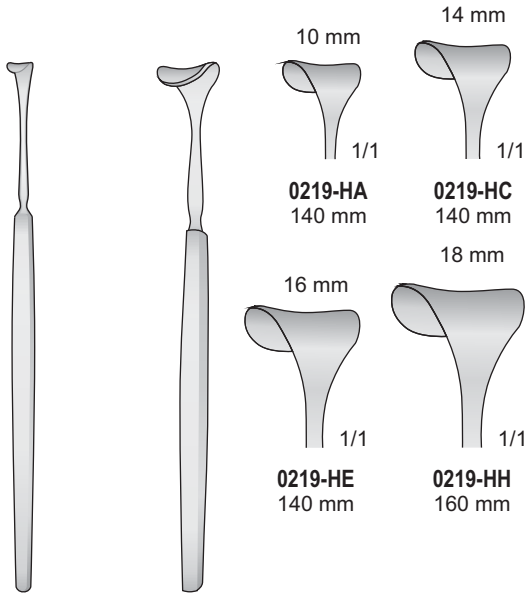

DESMARRES
1310-BEF
130 mm

DESMARRES
0219-HA/0219-HH
140 mm

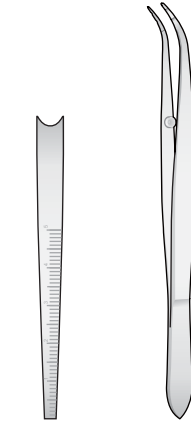

1118-AE
80 mm

1206-BAA
110 mm

Per adulti

6 Zähne
6 Teeth
6 Denti
6 Dents
6 Dientes

Per bambini

4 Zähne
4 Teeth
4 Denti
4 Dents
4 Dientes

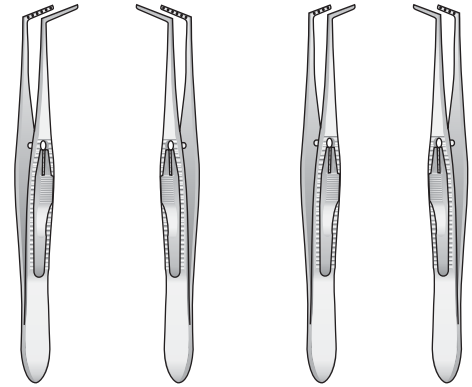

JAMESON
1206-DDB
100 mm

JAMESON
1206-DDC
100 mm

JAMESON
1206-DDD
100 mm

JAMESON
1206-DDE
100 mm

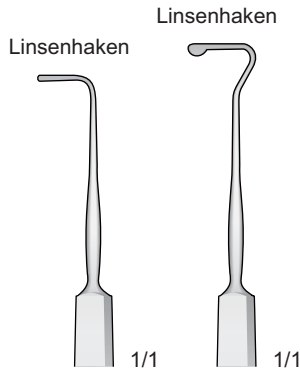

Linsenhaken

1310-CEB
120 mm

1310-CEC
130 mm

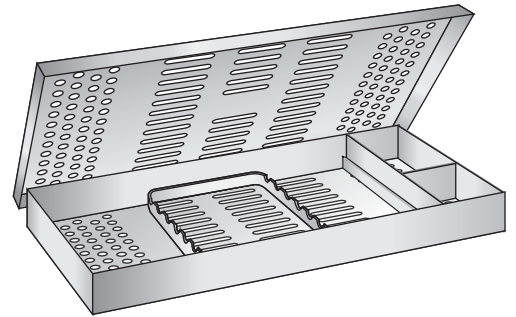

0218-EC 285 x 190 x 25 mm Con griglia e scomparti

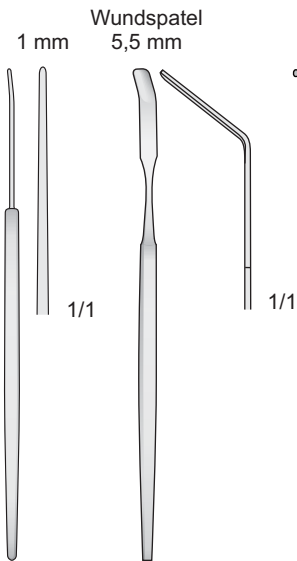

WECKER
1310-CH
130 mm

1310-DLC
140 mm

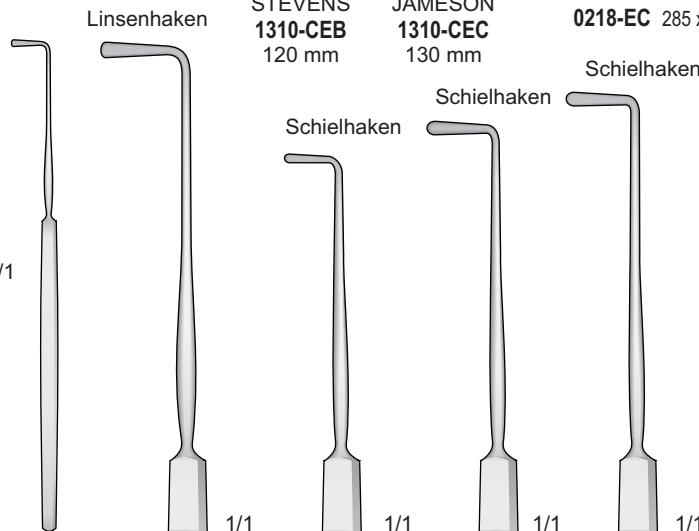

STEVENS
1310-CEA
140 mm

GRAEFE
1310-EB
130 mm

GRAEFE
1310-EC
140 mm

GRAEFE
1310-ED
150 mm

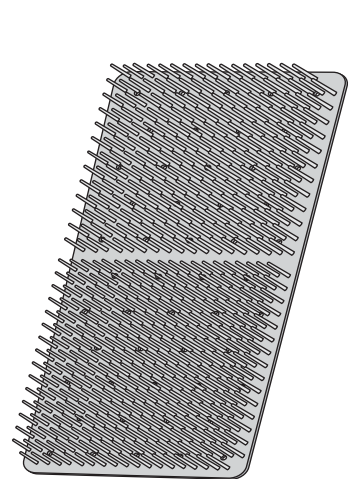

1918-BAE
270 x 180 mm

Schielinstrumentensets

Strabismus Set

Set Strabismo

Set para estrabismo

Set à strabisme

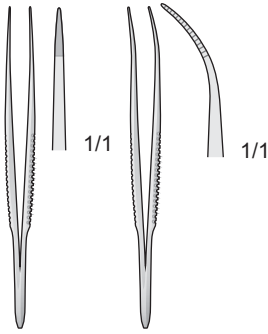

1206-HL
95 mm

1206-CL
95 mm

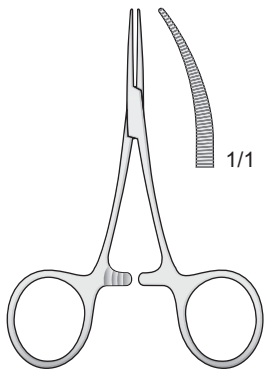

HARTMANN-BABY-MOSQUITO
15-BCB
95 mm

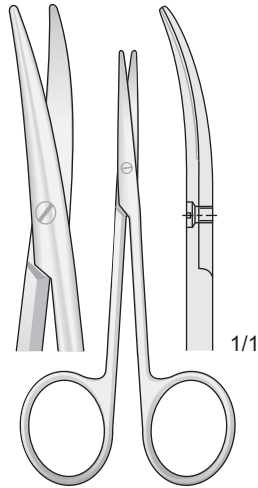

BABY - METZENBAUM
0612-EI
115 mm

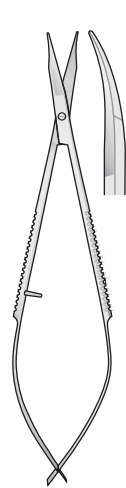

WESTCOTT
0604-GF
120 mm

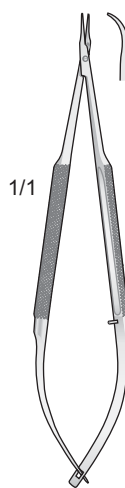

BARRAQUER
0604-BFF
125 mm



BARRAQUER
0604-CBF
120 mm

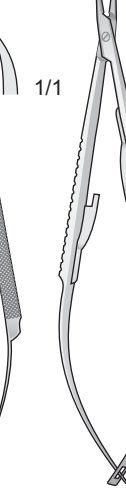

0604-CEE
135 mm



LIEBERMANN-TENNANT
1310-ECC
80 mm

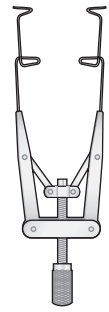

Strabismus Loops Weiss, Double
Anse da strabismo
Anses à strabisme de weiss, double

1,3 mm 2,0 mm 4,0 mm 4,7 mm

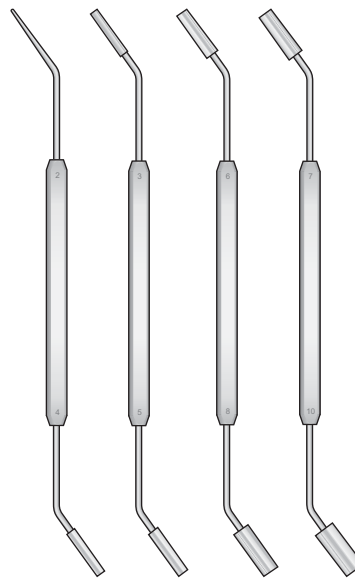

2,6 mm 3,3 mm 5,2 mm 6,6 mm

Crochet à strabisme
Strabismus Hooks

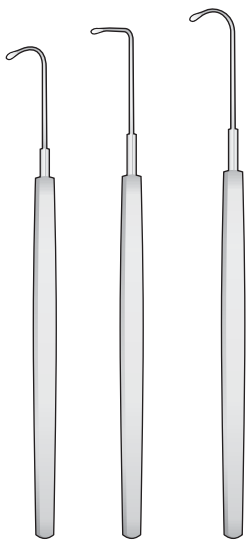

WORST

1310-EDF 130 mm
1310-EDE 135 mm
1310-EDG 140 mm

Muskelhaken

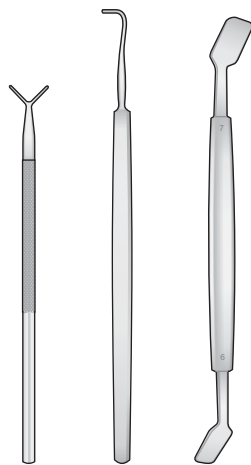

CULLER

1310-EFA 100 mm
1310-CAL 120 mm
1310-EFC 6,0/7,0 mm
118 mm



1310-EFB 4,0/5,0 mm
118 mm

Meßbereich
Measuring range
Campo di misura
Alcance de medición
Etendue de mesure
0 - 20 mm

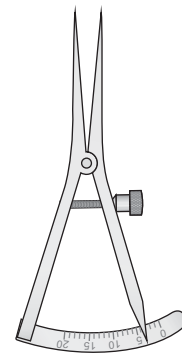

CASTROVIEJO

1417-BH
90 mm

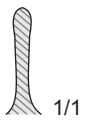

0212-DC 1/1

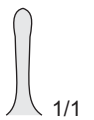

0212-DD 1/1



DIEFFENBACH

0212-DC/0212-DD
40 mm



ideal-tek

manufacturer & supplier of precision instruments 

Wasserlösliche Schmiermittel von chirurgische Instrumenten
 Lubricant Oil for surgical instruments
 Olio lubrificante per strumenti chirurgici
 Lubrificante para instrumentos
 Entretien pour instruments

RODHOIL

Schmiermittel mit hoher Dichte. Es sichert den perfekten Gebrauch und die Leichtgängigkeit aller chirurgischen Instrumente. Man gibt es auf die Verbindungen und Gelenke und in alle beweglichen Teile, die Reibungen unterworfen sind.

RODHOIL

Lubricant to high density. It assures the perfect utility and fluency of all the surgical instruments. For apply in to loosens, join and in all the parts in subject movement subject to attrition.

RODHOIL

Lubrificante ad alta densità. Assicura la perfetta funzionalità e scorrevolezza di tutti gli strumenti chirurgici. Da applicare negli snodi, giunture e in tutte le parti in movimento soggette ad attrito.



0402-141117
50 cc

Das wasserlösliche Schmiermittel verlängert die Lebensdauer von chirurgische Instrumenten
 Soluble lubricant extends useful life of surgical instruments
 Lubrificante anticorrosivo e detergente per strumenti chirurgici
 Lubrificante soluble en agua, so uso prolonga la duracion de los instrumentos quirurgicos
 Lubrifiant soluble dans l'eau prolonge la vie des instruments chirurgicaux

CLEANLACT

Reinigungskonzentrat für chirurgische Instrumente. Es wirkt antibakteriell, nicht-ätzend und schmierig. Es garantiert die perfekte Erhaltung aller Instrumente aus Stahl, entfernt eventuelle Flecken, Ränder, und Bräunungen von Sterilisationen, Desinfektionen und Reinigungen mit hartem Wasser. Es sollte regelmäßig verwendet werden.

CLEANLACT

Product concentrated for surgical instruments. It explains an action anti-corrosive, antibacterium and lubricant. It guarantees the perfect maintenance of all the instruments in steel eliminating eventual stains and burnishes to sterilization, disinfection and to washings with hard waters. It used periodically.

CLEANLACT

Prodotto concentrato per strumenti chirurgici. Esplica un azione anticorrosiva batteriostatica e lubrificante. Garantisce il perfetto mantenimento di tutti gli strumenti in acciaio eliminando eventuali macchie, aloni e brunture dovute a sterilizzazioni, disinfezioni e a lavaggi con acque dure. Va usato periodicamente.



0402-FA12
500 cc

0402-B11
1000 cc

Schleifsteine
Sharpening stones
Pietre di Arkansas per affilatura strumenti
Materiales para afilar
Pierres d'affutage

Schleifstein-Öl
Oil for grinding stones
Olio per affilatura strumenti
Huile d'affutage



0402-CLL
ARKANSAS
conica n° 299



0402-1411
30 cc



0402-LG
ARKANSAS
piatta n° 8

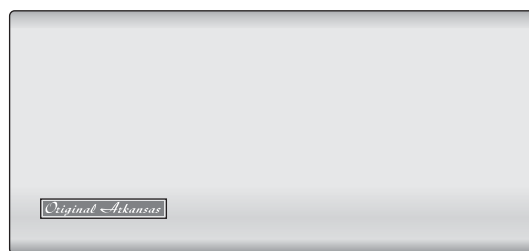

0402-G-01
ARKANSAS n° 6A



0402-E
ARKANSAS
piatta n° 4

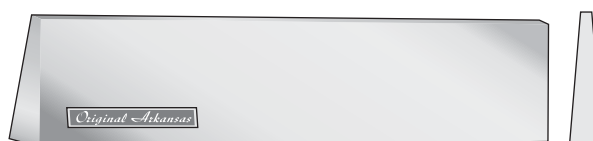

0402-CC-01
ARKANSAS

Sterilbehälter für Nadeln - Box for needles
 Scatola per sterilizzazione aghi da sutura
 Boite pour aiguilles de suture - Estuche para agujas



0218-B
 Ø 78 mm h 15 mm

Jarin glass with lid in stainless steel
 Vaso in vetro con coperchio in acciaio inox
 Pot en verre avec couvercle en acier inox

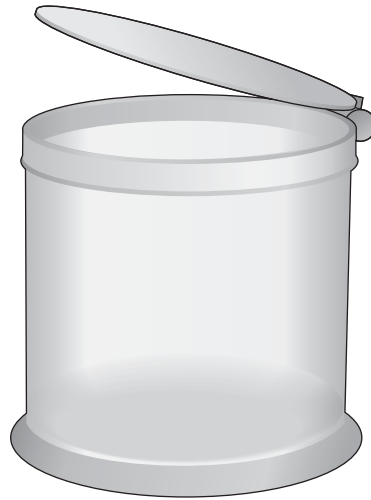

211503-G Ø 100x100 mm
211503-I Ø 120x120 mm

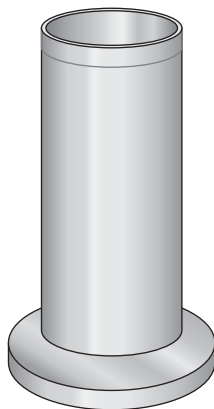

0318-FB Ø 50 mm h 100 mm
0318-FC Ø 50 mm h 150 mm
0318-FF Ø 80 mm h 180 mm



211503-BA Ø 100x100 mm
211503-BC Ø 120x120 mm

Runder Sterilbehälter mit Ausguss
 Lotion bowis capsules
 Capsule inox con fondo piano e becco
 Capsule en acier inox

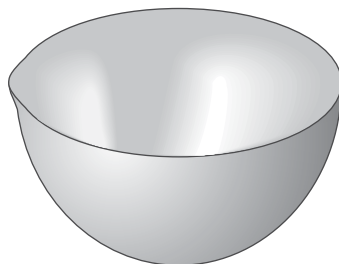

0318-AB Ø 40 mm 15 cc
0318-AC Ø 60 mm 75 cc
0318-AD Ø 80 mm 225 cc
0318-AE Ø 100 mm 325 cc

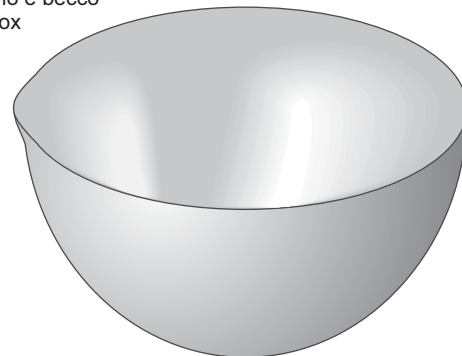

0318-IA Ø 180 mm 1000 cc
0318-IB Ø 200 mm 1450 cc
0318-IC Ø 220 mm 2000 cc
0318-ID Ø 240 mm 3300 cc

**Steriliser und
Bereitschaftskästen**

**Sterilizing
and Storing
cases**

**Scatole per la
sterilizzazione
e conservazione**
Rostfrei - Stainless steel - Inox
Inoxidable

**Cajas para la
esterilización
y conservación**

**Boîtes à
stérilisation
et conservation**

Bacinella a 7 scomparti

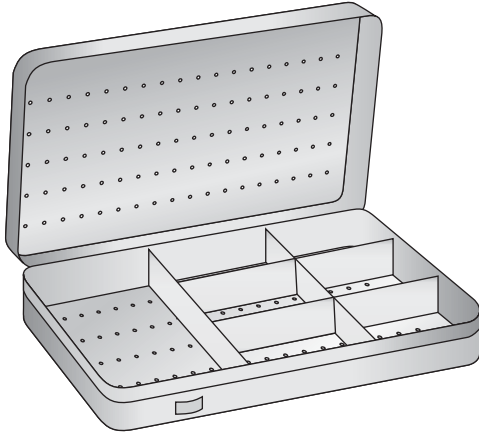

0218-CH
150 x 90 x 20 mm

Bacinella a 3 scomparti

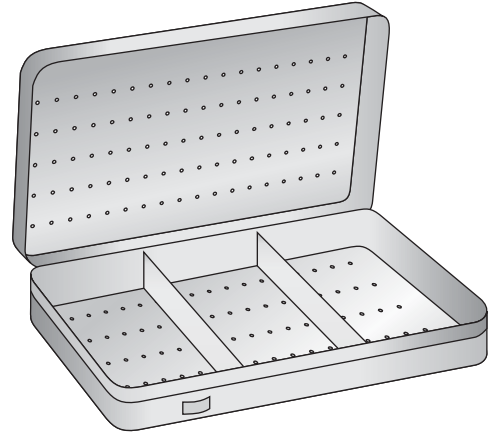

0218-CD
150 x 90 x 20 mm

Bacinella a 10 scomparti

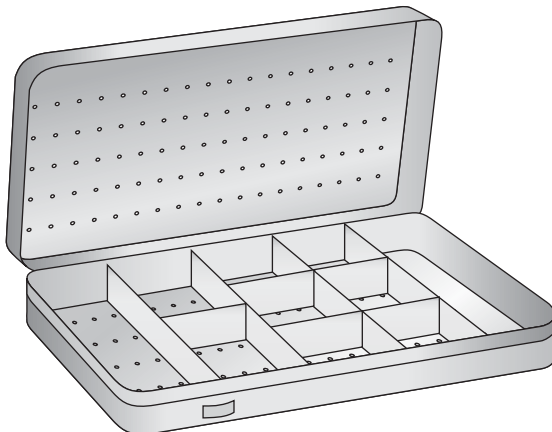

0218-CI
220 x 120 x 20 mm

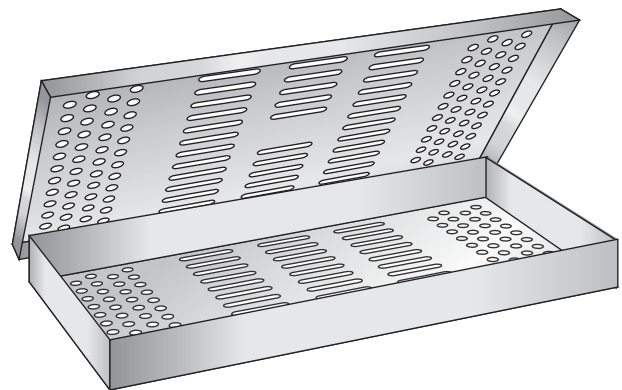

0218-EB
275 x 130 x 25 mm

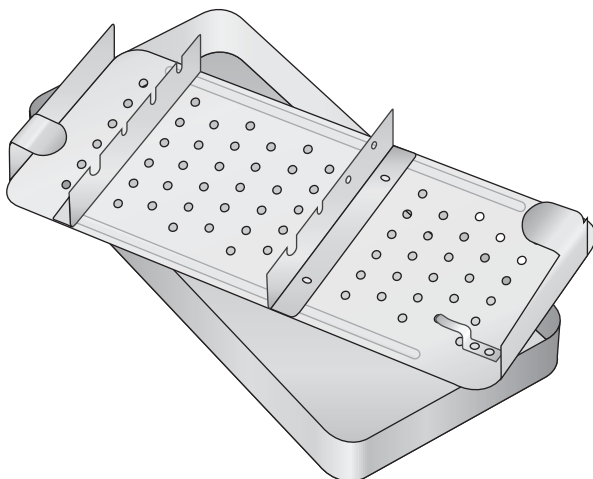

0218-DA
180 x 90 x 35 mm 2 ripiani

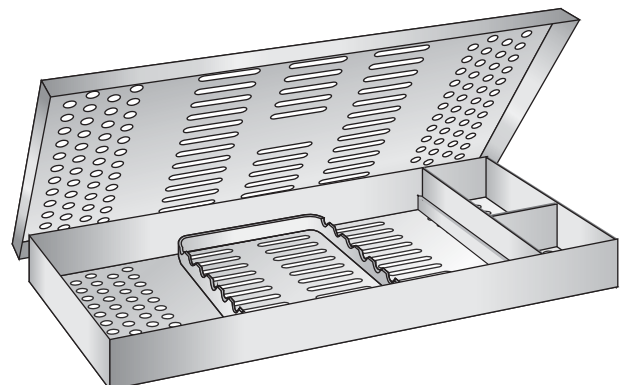

0218-EA 275 x 130 x 25 mm Con griglia e scomparti
0218-EC 285 x 190 x 25 mm Con griglia e scomparti

Tray Inox mit Silikoneinrichtung - Stainless Steel Cassettes with Silicone Racks
 Tray Inox con griglia in silicone - Recipientes de acero con equipo de silicona
 Cassettes en acier avec aménagement en silicone

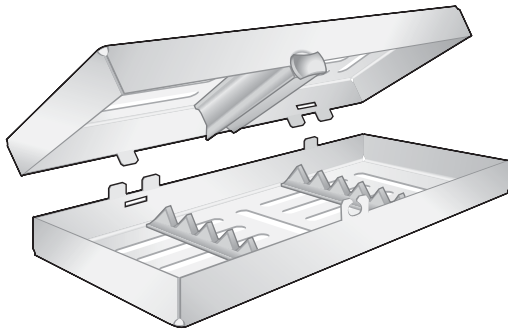

0218-FL Für 5 Instrumente
 For 5 Instruments
 Per 5 strumenti
 Para 5 instrumentos
 Pour 5 instruments
 185 x 75 x 35 mm

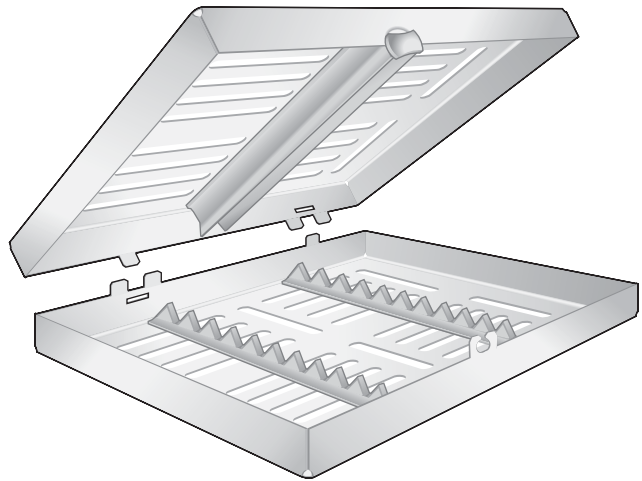

0218-GA Für 10 Instrumente
 For 10 Instruments
 Per 10 strumenti
 Para 10 instrumentos
 Pour 10 instruments
 185 x 135 x 35 mm

0218-GB Für 20 Instrumente
 For 20 Instruments
 Per 20 strumenti
 Para 20 instrumentos
 Pour 20 instruments
 290 x 185 x 35 mm

Nierenschalen
 Kidney bowls
 Bacinelle reniformi
 Riñoneras
 Bassins réniformes



0217-CA 200 mm
0217-CF 250 mm
0217-CI 280 mm

Schalen
 Trays
 Vassoi porta-strumenti
 Bandejas
 Bassins

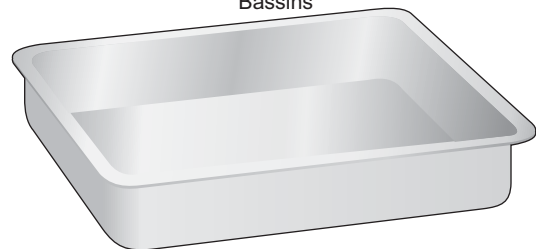

2118-CA 210 x 110 x 25 mm
2118-CG 250 x 180 x 30 mm
2118-DA 300 x 220 x 30 mm

Silikon Matte

Matte en silicone

Tappeti in aghi di silicone

Tapete en agujas de silicona

Tapis en silicone

Sterilisierbar
Autoclavable
Autoclavabili

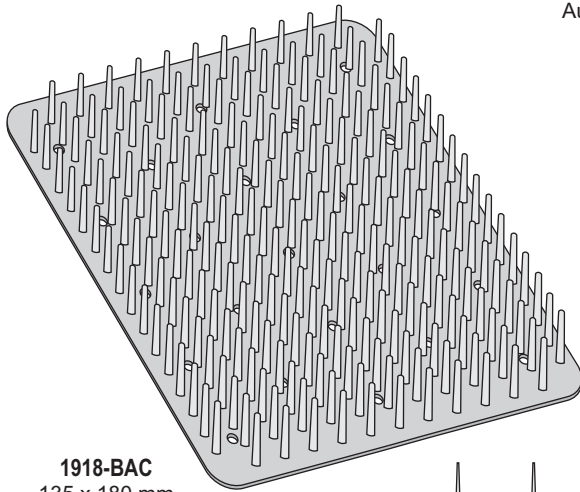

1918-BAC
135 x 180 mm

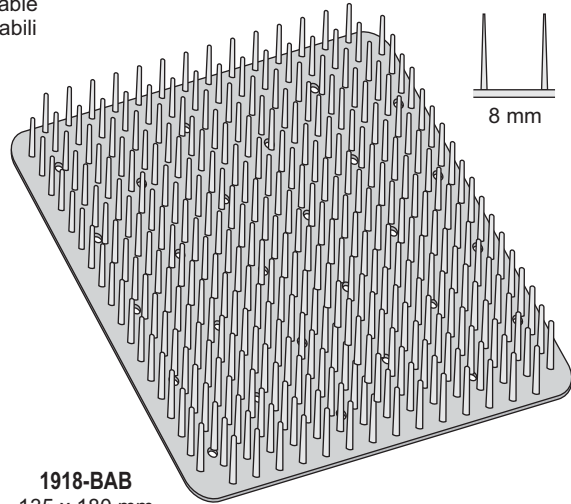
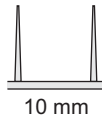

1918-BAB
135 x 180 mm

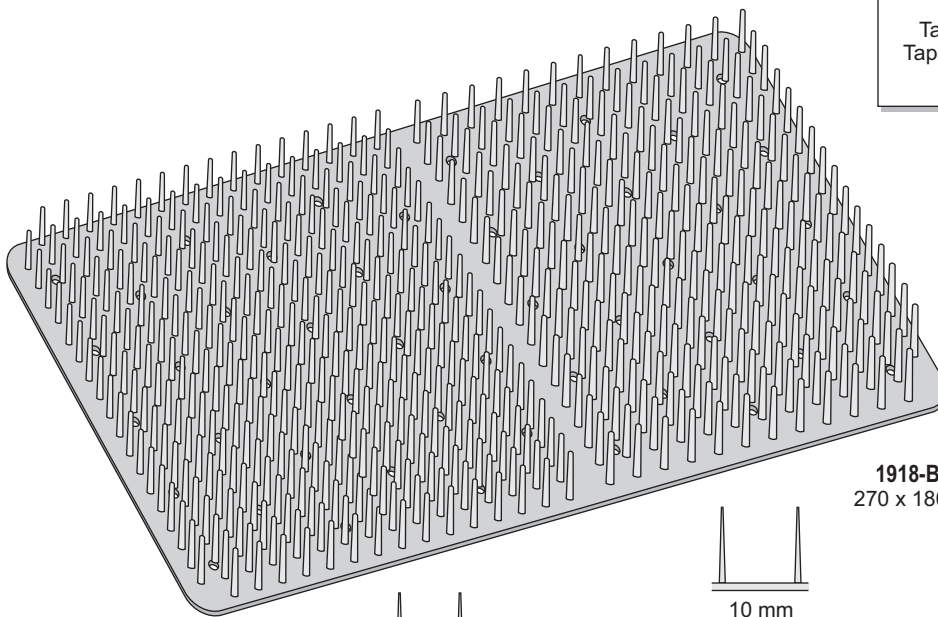

1918-BAE
270 x 180 mm

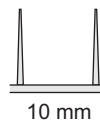

Silikon matte
Matte en silicone
Tappeti in aghi di silicone
Tapete en agujas de silicona
Tapis en Silicone

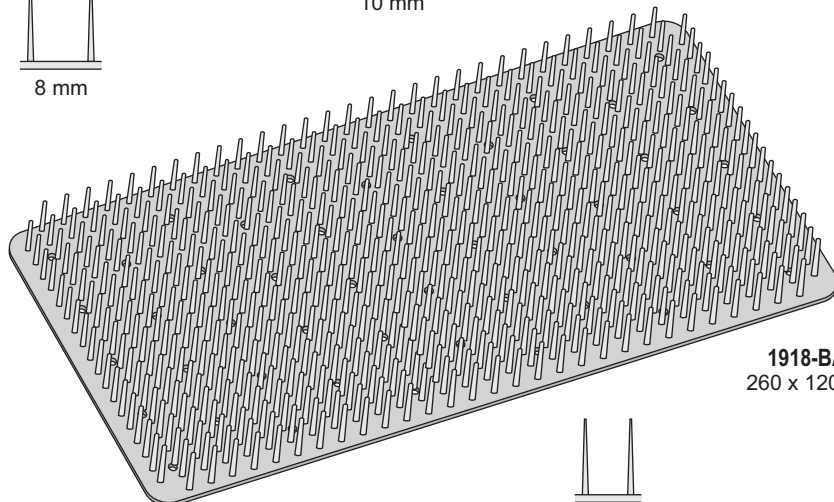

1918-BAD
260 x 120 mm



Sterilisierzangen zum Fassen und Halten Steriler Instrumente
 Sterilizing forceps for picking up and holding of sterile instruments
 Pinze per prelevare strumenti sterilizzati



0718-AC
145 mm

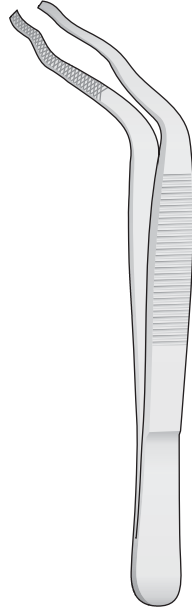

DAVIS
0718-AD
160 mm

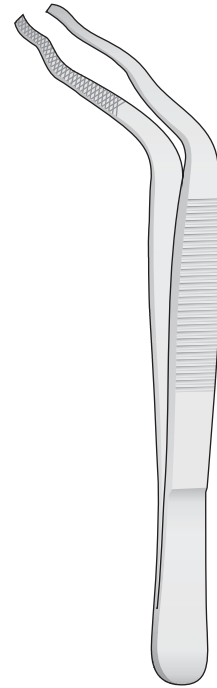

DAVIS
0718-AE
200 mm

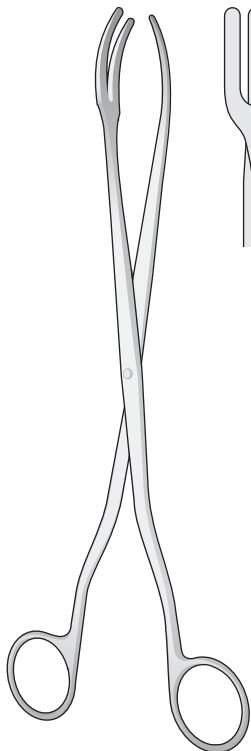

0718-BA
200 mm

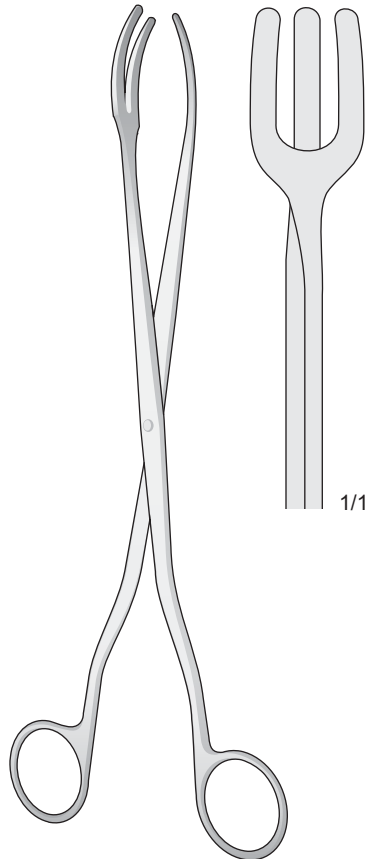

0718-BB
300 mm

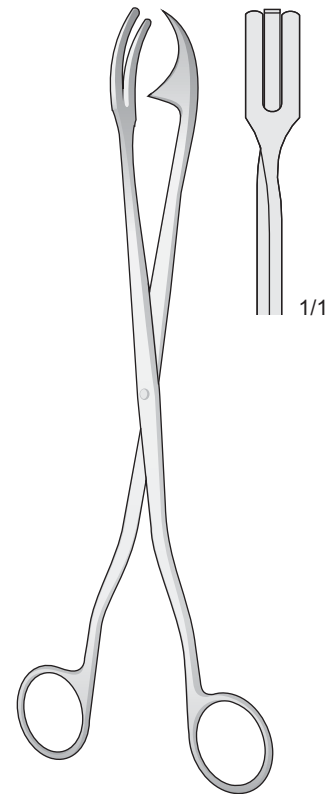

ROGGE
0718-AG
230 mm



Indice alfanumerico		Alfanumerical Index		Nummernverzeichnis		Index alfabétique		Indice alfanumerico	
Article	Page	Article	Page	Article	Page	Article	Page	Article	Page
0202-EG	24	0212-FL	38	0221-AG	147	0204-AE	83	0221-AI	149
0204-AG	82	0212-IH	132	0221-FD	146	0204-AH	83, 161	0318-AB	169
0204-AL19	83	0212-II	132	0318-AC	169	0204-DA19	83	0318-AC	169
0204-DB19	83	0212-IL	132	0318-AD	169	0204-DC	83	0318-AD	169
0204-DD	83	0212-LA	132	0318-AE	169	0204-DF	82	0318-AE	169
0204-DG	82	0212-LB	132	0318-FB	169	0204-DG	82	0318-FB	169
0204-EA	83	0212-LC	132	0318-FC	169	0204-EA	83	0318-FC	169
0204-EB	83	0212-LD	132	0318-FF	169	0204-EB	83	0318-FF	169
0204-EC	82, 161	0212-LF	132	0318-IA	169	0204-EC	82, 161	0318-IA	169
0204-EC19	83	0212-LG	132	0318-IB	169	0204-ED	82	0318-IB	169
0204-ED	82	0212-LH	132	0318-IC	169	0204-ED19	83	0318-IC	169
0204-ED19	83	0212-LI	132	0318-ID	169	0204-GA	122	0402-B11	167
0204-GA	122	0212-LJ	132	0402-E	168	0204-GC	122	0402-E	168
0204-GC	122	0212-LK	132	0402-G01	168	0204-GE	122	0402-G01	168
0204-LG	83	0212-LM	132	0402-CD	46	0204-BDA	112	0402-CD	46
0204-BDA	112	0212-LN	132	0402-FA12	167	0204-BDB	112	0402-FA12	167
0204-BDB	112	0212-LO	132	0402-LG	168	0204-BDC	112	0402-LG	168
0204-BDC	112	0212-LP	132	0402-BHH	28	0204-BDF	81	0402-BHH	28
0204-BDF	81	0212-LQ	132	0402-BHI	28	0204-BDG	81	0402-BHI	28
0204-BDG	81	0212-LR	132	0402-BHL	28	0204-BIL	81	0402-BHL	28
0204-BIL	81	0212-LS	132	0402-BIA	28	0204-CAA	122	0402-BIA	28
0204-CAA	122	0212-LT	132	0402-BIB	28	0204-CAB	122	0402-BIB	28
0204-CAB	122	0212-LU	132	0402-BIC	28	0204-CAE	122	0402-BIC	28
0204-CAE	122	0212-LV	132	0402-BID	28	0204-CAF	122	0402-BID	28
0204-CAF	122	0212-LW	132	0402-CLL	168	0204-CAG	122	0402-CLL	168
0204-CAG	122	0212-LX	132	0402-1411	168	0204-CAH	82	0402-1411	168
0204-CAH	82	0212-LY	132	0402-141117	167	0204-CAI	82	0418-AI	58
0204-CAI	82	0212-LZ	132	0418-AI	58	0204-CAL	82	0518-EF	113
0204-CAL	82	0219-AL	58	0518-EF	113	0204-CFE	93	0518-EF	113
0204-CFE	93	0219-BA	15	0518-EG	113	0204-CFF	80	0518-EG	113
0204-CFF	80	0219-BC	15	0518-EI	113	0204-CFG	80	0518-EI	113
0204-CFG	80	0219-BD	15	0518-GE	113	0204-CFH	80	0518-GE	113
0204-CFH	80	0219-BE	15	0518-GF	113	0204-CFI	80	0604-AB	70
0204-CFI	80	0219-HA	59, 163	0604-AC	70	0204-CFL	80	0604-AC	70
0204-CFL	80	0219-HB	59	0604-AD	65	0204-CGA	112	0604-AD	65
0204-CGA	112	0219-HC	59, 163	0604-AE	65	0204-CGB	112	0604-AE	65
0204-CGB	112	0219-HD	59	0604-AF	65	0204-CGD	112	0604-AF	65
0204-CGD	112	0219-HE	59, 163	0604-AG	72	0204-CLG	113	0604-AG	72
0204-CLG	113	0219-HF	59	0604-AH	70	0204-CLH	113	0604-AH	70
0204-CLH	113	0219-HG	59, 163	0604-AI	72	0204-CLI	113	0604-AI	72
0204-CLI	113	0219-HI	59	0604-AL	70	0204-CLL	113	0604-AL	70
0204-CLL	113	0219-HJ	59, 163	0604-BA	69	0204-DDD	81	0604-BA	69
0204-DDD	81	0219-HK	59	0604-BB	68	0204-DDE	81	0604-BB	68
0204-DDE	81	0219-HL	59	0604-BC	69	0206-DI	134	0604-BC	69
0206-DI	134	0219-HM	29	0604-BD	69	0206-EC	134	0604-BD	69
0206-EC	134	0219-HN	29	0604-BF	69	0206-EG	134	0604-BF	69
0206-EG	134	0219-HO	29	0604-EA	68	0212-CH	132	0604-EA	68
0212-CH	132	0219-HP	29	0604-EB	65, 162	0212-DC	132, 164	0604-EB	65, 162
0212-DC	132, 164	0219-HQ	29	0604-EC	65, 162	0212-DD	132, 164	0604-EC	65, 162
0212-DD	132, 164	0219-HR	29	0604-ED	70	0212-DE	132	0604-ED	70
0212-DE	132	0219-HS	29	0604-EE	70	0212-DF	132	0604-EE	70
0212-DF	132	0219-HT	29	0604-EF	72	0212-DG	132	0604-EF	72
0212-DG	132	0219-HU	29	0604-EG	72	0212-DH	132	0604-EG	72
0212-DH	132	0219-HV	29	0604-EH	71	0212-DI	132	0604-EH	71
0212-DI	132	0219-HW	29	0604-EI	71	0212-DL	132	0604-EI	71
0212-DL	132	0219-HX	29	0604-EL	65	0212-DM	132	0604-EL	65
0212-DM	132	0219-HY	29	0604-FA	65, 161	0212-DO	132	0604-FA	65, 161
0212-DO	132	0219-HZ	29	0604-FB	70	0212-EP	132	0604-FB	70
0212-EP	132	0221-AB	146	0604-FC	70	0212-FG	38	0604-FC	70
0212-FG	38	0221-AC	146	0604-FD	71	0212-FH	38	0604-FD	71
0212-FH	38	0221-AD	146			0212-FI	38		
0212-FI	38	0221-AE	147						
		0221-AF	146						

Indice alfanumerico		Alfanumerical Index		Nummernverzeichnis		Index alfabétique		Indice alfanumerico	
Article	Page	Article	Page	Article	Page	Article	Page	Article	Page
0604-FE	71	0604-BFC	129, 162	0607-CBI	75				
0604-FF	65	0604-BFD	129	0607-CBL	75				
0604-FG	65	0604-BFE	129						
0604-FH	70	0604-BFF	129, 161, 164	0610-BGF	32				
0604-FI	70	0604-BFG	129	0610-BGG	32				
0604-FL	71	0604-BFH	129	0610-BGH	32				
0604-GA	71	0604-BFI	129						
0604-GB	68	0604-BFL	129	0611-BC	29				
0604-GC	68	0604-BGC	128	0611-BC17	29				
0604-GE	69	0604-BGE	130	0611-BDD	40				
0604-GF	69, 164	0604-BGF	131	0611-BDE	40				
0604-GG	66	0604-BGG	131						
0604-GH	66	0604-BGH	126	0612-CL	79				
0604-GI	66	0604-BGI	126	0612-EH	79				
0604-GL	66	0604-BIG	73	0612-EI	79, 164				
0604-HA	66	0604-BIH	73	0612-BBB	79				
0604-HB	66	0604-BLB	73	0612-BBI	79				
0604-HC	66	0604-CBE	127	0612-BBL	79, 161				
0604-HD	66	0604-CBF	127, 164						
0604-HE	66	0604-CBG	127	0614-BF	27				
0604-HL	63, 162	0604-CBH	127	0614-BH	27				
0604-IA	63, 161	0604-CDB	64	0614-BGC	28				
0604-IB	63	0604-CDC	64	0614-BGD	28				
0604-IC	125	0604-CDD	64	0614-BGF	28				
0604-ID	125	0604-CDE	64						
0604-IE	125	0604-CDG	127	0617-BA	40				
0604-IF	125	0604-CDH	127						
0604-IG	125	0604-CEA	125	0718-AC	173				
0604-IH	125	0604-CEB	125	0718-AD	173				
0604-II	125	0604-CEE	164	0718-AE	173				
0604-IL	125			0718-AG	173				
0604-LG	126	0607-B	76	0718-BA	173				
0604-LH	126	0607-C	76	0718-BB	173				
0604-LI	126	0607-E	76						
0604-LL	126	0607-F	76	1102-BB	24				
0604-BAA	110, 161	0607-BD	76	1102-BF	24				
0604-BAF	128	0607-BF	76	1102-EA	24				
0604-BAG	128	0607-CB	77	1102-DGE	24				
0604-BAH	128	0607-CC	77	1102-DGF	24				
0604-BAI	128	0607-CD	77	1102-DGH	24				
0604-BAL	128	0607-CE	77						
0604-BBA	128	0607-DA	78	1107-B	77				
0604-BBB	128	0607-EE	79						
0604-BBC	128	0607-FA	77	1110-B	78				
0604-BBD	130	0607-FB	77	1110-D	78				
0604-BBE	130	0607-FC	77						
0604-BBF	130	0607-FD	77	1118-AE	135, 163				
0604-BBG	130	0607-BAB	76	1118-AH	135				
0604-BBH	113	0607-BAC	76	1118-AI	135				
0604-BBI	81	0607-BAD	76	1118-AL	135				
0604-BBL	63	0607-BAF	76						
0604-BCA	63	0607-BBE	78	1201-02D	24				
0604-BCB	131	0607-BBF	78	1201-02H10	24				
0604-BCC	131	0607-BCC	78						
0604-BCD	63	0607-BFB	78	1206-AB	120				
0604-BCE	67	0607-CAA	74	1206-AC	120				
0604-BCF	67	0607-CAB	74	1206-AD	120				
0604-BCG	67	0607-CAC	74	1206-AE	120				
0604-BCH	67	0607-CAD	74	1206-AF	120				
0604-BDA	67	0607-CAE	74	1206-AG	120				
0604-BDB	113	0607-CAF	74	1206-AH	120				
0604-BDC	67	0607-CAG	74	1206-AI	120				
0604-BDE	67	0607-CAH	74	1206-AL	120				
0604-BDG	67	0607-CAI	74	1206-BA	120				
0604-BDH	72	0607-CAL	75	1206-BB	120				
0604-BDI	72	0607-CBA	75	1206-BC	120				
0604-BEG	68	0607-CBB	75	1206-BD	118				
0604-BEH	68	0607-CBC	75	1206-BE	118				
0604-BFA	128	0607-CBF	75	1206-BF	118				
0604-BFB	128, 161	0607-CBG	75	1206-BG	118				

Indice alfanumerico		Alfanumerical Index		Nummernverzeichnis		Index alfabétique		Indice alfanumerico	
Article	Page	Article	Page	Article	Page	Article	Page	Article	Page
1206-BH	118	1206-BAA	100, 163	1206-CBL	101				
1206-BL	118	1206-BFA	84	1206-CCA	101				
1206-CA	118	1206-BFB	84	1206-CCB	100, 162				
1206-CB	118	1206-BFC	84	1206-CCC	100, 162				
1206-CC	118	1206-BFD	84	1206-CCD	100				
1206-CD	118	1206-BFE	84	1206-CCE	100				
1206-CE	116	1206-BFF	84	1206-CCF	99				
1206-CF	116	1206-BFG	84	1206-CCG	99				
1206-CG	116	1206-BFH	84	1206-CCH	99				
1206-CH	116	1206-BFI	85, 161	1206-CCI	99				
1206-CI	116	1206-BFL	85	1206-CCL	99				
1206-CL	116, 164	1206-BGA	85	1206-CDA	99				
1206-DA	116	1206-BGB	85	1206-CDB	98, 162				
1206-DB	116	1206-BGC	86	1206-CDC	98				
1206-DC	116	1206-BGD	86	1206-CDD	98				
1206-DD	116	1206-BGE	86	1206-CDF	97				
1206-DE	116	1206-BGF	86	1206-CDG	97				
1206-DF	116	1206-BGG	87	1206-CDH	97				
1206-DG	116	1206-BGH	87	1206-CDI	97				
1206-DH	116	1206-BGI	87	1206-CDL	96				
1206-DI	116	1206-BGL	87	1206-CEA	96				
1206-EA	116	1206-BHA	88	1206-CEB	96				
1206-EB	116	1206-BHB	88	1206-CEC	96				
1206-EC	116	1206-BHC	88, 161	1206-CED	104				
1206-ED	116	1206-BHD	88	1206-CEE	104				
1206-EE	116	1206-BHE	88	1206-CEF	104				
1206-EG	118	1206-BHF	83	1206-CEG	104				
1206-EH	118	1206-BHG	82	1206-CEH	104				
1206-EI	118	1206-BHH	82	1206-CEI	104				
1206-EL	118	1206-BHI	91	1206-CFD	105				
1206-FA	118	1206-BHL	91	1206-CFE	105				
1206-FC	118	1206-BIA	91	1206-CFF	105				
1206-FD	118	1206-BIB	91	1206-CFH	106				
1206-FE	118	1206-BIC	92	1206-CFI	106				
1206-FF	118	1206-BID	92	1206-CFL	106				
1206-FG	118	1206-BIE	92	1206-CGA	106				
1206-FI	120	1206-BIF	92	1206-CGB	108, 162				
1206-FL	120	1206-BIG	92	1206-CGC	108, 162				
1206-GA	120	1206-BIH	93	1206-CGD	108				
1206-GB	120	1206-BII	93	1206-CGE	108, 161				
1206-GC	120	1206-BIL	93	1206-CGF	108, 161				
1206-GE	120	1206-BLA	93	1206-CGG	107				
1206-GF	120	1206-BLB	94	1206-CGH	107				
1206-GG	120	1206-BLC	94	1206-CGI	107				
1206-GH	120	1206-BLD	94	1206-CGL	107				
1206-GI	120	1206-BLE	94	1206-CHA	107				
1206-HD	117	1206-BLF	94	1206-CHB	109				
1206-HE	117	1206-BLG	94	1206-CHC	109				
1206-HF	117	1206-BLH	94	1206-CHD	109				
1206-HG	117	1206-BLI	95	1206-CHE	109				
1206-HH	117	1206-BLL	95	1206-CHF	110				
1206-HI	117	1206-CAA	95, 162	1206-CHG	110				
1206-HL	117, 161, 164	1206-CAB	95	1206-CHH	110				
1206-IA	117	1206-CAC	103	1206-CHI	110				
1206-IB	119	1206-CAD	103	1206-CHL	110				
1206-IC	119	1206-CAE	103	1206-CIA	110, 161				
1206-ID	119	1206-CAF	103	1206-CIB	111				
1206-IE	119	1206-CAG	103	1206-CIC	111				
1206-IF	119	1206-CAH	102	1206-CID	111				
1206-IG	119	1206-CAI	102	1206-CIE	111				
1206-IH	119	1206-CAL	102	1206-CIF	114				
1206-II	119	1206-CBA	102	1206-CIG	114				
1206-IL	121	1206-CBB	102	1206-CIH	114				
1206-LA	121	1206-CBC	102	1206-CII	114				
1206-LB	121	1206-CBD	101	1206-CIL	115				
1206-LC	121	1206-CBE	101	1206-CLA	115				
1206-LD	121	1206-CBF	101	1206-CLB	115				
1206-LE	121	1206-CBG	101	1206-CLC	115				
1206-LF	121	1206-CBH	101	1206-CLD	111				
1206-LG	121	1206-CBI	101	1206-CLE	115				

Indice alfanumerico		Alfanumerical Index		Nummernverzeichnis		Index alfabétique		Indice alfanumerico	
Article	Page	Article	Page	Article	Page	Article	Page	Article	Page
1206-CLF	111	1310-EE	46	1310-BCH	148				
1206-CLG	110, 161	1310-EF	51	1310-BCI	148				
1206-DDB	112, 163	1310-EG	51	1310-BCL	148				
1206-DDC	112, 163	1310-EH	51	1310-BDA	148				
1206-DDD	112, 163	1310-EI	48	1310-BDB	148				
1206-DDE	112, 163	1310-EL	3	1310-BDC	146				
1206-EAB	41	1310-FL	37	1310-BDD	146				
1206-EAC	41	1310-FL11	37	1310-BDE	149				
1206-EAD	41	1310-GA	90	1310-BDF	149				
1206-EAE	41	1310-GB	90	1310-BDG	149				
1206-EAF	41	1310-GC	90	1310-BDH	149				
1206-EAG	41	1310-GD	90	1310-BDI	149				
1206-EAH	41	1310-GE	90	1310-BDL	149				
1206-EAI	41	1310-GF	90	1310-BEA	149				
1206-EAL	41	1310-GG	90	1310-BEB	149				
1206-EBA	41	1310-GH	90	1310-BEC	58				
1206-EBB	41	1310-GI	90	1310-BED	58				
1206-EBC	41	1310-GL	90	1310-BEE	59				
1206-EBD	41	1310-HA	90	1310-BEF	59, 163				
1206-EBE	41	1310-HB	90	1310-BEG	58				
1206-EBF	41	1310-HC	90	1310-BEH	4				
1206-EBG	41	1310-HD	90	1310-BEI	4				
1206-EBH	41	1310-HE	47	1310-BEL	4				
1206-EBI	41	1310-HF	47	1310-BFA	4				
1206-EBL	41	1310-HG	47	1310-BFB	4				
1206-ECA	41	1310-HH	90	1310-BFC	4				
1206-ECB	41	1310-HI	90	1310-BFD	4				
1206-ECC	41	1310-HL	146	1310-BFE	4				
1206-ECD	41	1310-IA	146	1310-BFF	4				
1206-ECE	41	1310-IB	146	1310-BFG	4				
		1310-IC	146	1310-BFH	4				
1310-B	24	1310-ID	146	1310-BFI	4				
1310-C	24	1310-IE	146	1310-BFL	6				
1310-AD	47	1310-IG	146	1310-BGA	6				
1310-AE	47	1310-IH	90, 162	1310-BGB	6				
1310-AG	9	1310-II	90	1310-BGC	6				
1310-AH	14	1310-IL	90, 162	1310-BGD	6				
1310-AI	9	1310-LC	149	1310-BGE	6				
1310-AL	3	1310-LD	47	1310-BGF	6				
1310-BA	9	1310-LE	46	1310-BGG	6				
1310-BB	47	1310-LF	11	1310-BGH	6				
1310-BC	24	1310-LG	11	1310-BGI	6				
1310-BD	47	1310-LH	44	1310-BGL	6				
1310-BE	8	1310-LH01	44	1310-BHA	7				
1310-BF	3	1310-LI	44	1310-BHB	7				
1310-BG	8	1310-LL	44	1310-BHC	7				
1310-BH	3	1310-BAD	50	1310-BHD	7				
1310-BI	4	1310-BAE	50	1310-BHE	7				
1310-BL	3	1310-BAF	50	1310-BHF	7				
1310-CA	4	1310-BAG	147	1310-BHG	7				
1310-CB	47	1310-BAH	3	1310-BHH	7				
1310-CC	47	1310-BAI	3	1310-BHI	7				
1310-CD	47, 162	1310-BAL	48	1310-BHL	7				
1310-CE	47	1310-BBA	48	1310-BIA	7				
1310-CF	47	1310-BBB	48	1310-BIB	8				
1310-CG	47	1310-BBC	48	1310-BIC	8				
1310-CH	46, 55, 163	1310-BBD	147	1310-BID	8				
1310-CI	46, 55	1310-BBE	147	1310-BIE	8				
1310-CL	46, 55	1310-BBF	147	1310-BIF	8				
1310-DA	5	1310-BBG	147	1310-BIG	8				
1310-DC	5	1310-BBH	147	1310-BIH	9				
1310-DE	5	1310-BBI	147	1310-BII	9				
1310-DG	5	1310-BBL	147	1310-BIL	9				
1310-DG02	5	1310-BCA	147	1310-BLA	9				
1310-DI	5	1310-BCB	147	1310-BLB	9				
1310-DL	3	1310-BCC	148	1310-BLC	9				
1310-EA	5	1310-BCD	148	1310-BLD	9				
1310-EB	36, 163	1310-BCE	148	1310-BLE	10				
1310-EC	36, 163	1310-BCF	148	1310-BLF	10				
1310-ED	36, 163	1310-BCG	148	1310-BLG	10				

Indice alfanumerico		Alfanumerical Index		Nummernverzeichnis		Index alfabétique		Indice alfanumerico	
Article	Page	Article	Page	Article	Page	Article	Page	Article	Page
1310-BLH	10	1310-CGI	49	1310-DDL	33				
1310-BLI	10	1310-CGL	51	1310-DEA	43				
1310-BLL	10	1310-CHA	51	1310-DEB	43				
1310-CAA	10	1310-CHB	51	1310-DEC	43				
1310-CAB	10	1310-CHC	51	1310-DED	43				
1310-CAC	11	1310-CHD	51	1310-DEE	43				
1310-CAD	11	1310-CHE	51	1310-DEF	43				
1310-CAE	11	1310-CHF	37	1310-DEG	43				
1310-CAF	11	1310-CHG	35	1310-DEH	43, 161				
1310-CAG	11	1310-CHH	35	1310-DEI	43, 162				
1310-CAH	11	1310-CHI	30	1310-DEL	43, 161				
1310-CAI	50	1310-CHL	30	1310-DFA	43				
1310-CAL	36, 164	1310-CIA	30	1310-DGA	44				
1310-CBA	11	1310-CIB	30	1310-DGB	44				
1310-CBB	12	1310-CIC	30	1310-DGC	44				
1310-CBC	12	1310-CID	30	1310-DGD	44				
1310-CBD	12	1310-CIE	30	1310-DGE	44				
1310-CBE	12	1310-CIF	30	1310-DGF	44				
1310-CBF	12	1310-CIG	21	1310-DGG	44				
1310-CBG	12	1310-CIH	21	1310-DHA	39				
1310-CBH	13	1310-CII	21	1310-DHB	39				
1310-CBI	13	1310-CIL	21	1310-DHC	31				
1310-CBL	13	1310-CLA	21	1310-DHD	31				
1310-CCA	13	1310-CLB	21	1310-DHE	31				
1310-CCB	13	1310-CLC	21	1310-DHF	31				
1310-CCC	13	1310-CLD	21	1310-DHG	53				
1310-CCD	13	1310-CLE	21	1310-DHH	53				
1310-CCE	14	1310-CLF	21	1310-DHI	53				
1310-CCF	14	1310-CLG	22	1310-DHL	53				
1310-CCG	14	1310-CLH	22	1310-DIA	53				
1310-CCH	14	1310-CLI	22	1310-DIB	53				
1310-CCI	14	1310-CLL	22	1310-DIC	53				
1310-CCL	14	1310-DAA	22	1310-DID	53				
1310-CDA	14	1310-DAB	22	1310-DIE	54				
1310-CDB	14	1310-DAC	22	1310-DIF	54				
1310-CDC	15	1310-DAD	22	1310-DIG	54				
1310-CDD	15	1310-DAE	22	1310-DIH	54				
1310-CDE	15	1310-DAF	23	1310-DII	19				
1310-CDF	15	1310-DAG	23	1310-DIL	19				
1310-CDG	35	1310-DAH	23	1310-DLA	19				
1310-CDH	35	1310-DAI	23	1310-DLB	36				
1310-CDI	35	1310-DAL	23	1310-DLC	56, 163				
1310-CDL	35	1310-DBA	23	1310-DLD	20				
1310-CEA	36, 163	1310-DBB	23	1310-DLE	20				
1310-CEB	36, 163	1310-DBC	23	1310-DLF	20				
1310-CEC	36, 163	1310-DBD	23	1310-DLG	20				
1310-CED	36	1310-DBE	23	1310-DLH	20				
1310-CEE	36	1310-DBF	16	1310-DLL	42				
1310-CEF	36	1310-DBG	16	1310-EAB	89				
1310-CEH	56	1310-DBH	16	1310-EAD	89				
1310-CEI	56	1310-DBI	16	1310-EAF	89				
1310-CEL	56	1310-DBL	16	1310-EAH	89				
1310-CFA	56	1310-DCA	52	1310-EBA	90				
1310-CFB	56, 163	1310-DCB	52	1310-EBC	91				
1310-CFC	55	1310-DCC	52	1310-EBD	91				
1310-CFD	55	1310-DCD	17	1310-EBE	91				
1310-CFE	55	1310-DCE	17	1310-EBF	91				
1310-CFF	55	1310-DCF	17	1310-EBH	42, 161				
1310-CFG	55	1310-DCH	57	1310-ECA	150				
1310-CFH	55	1310-DCI	57	1310-ECB	150				
1310-CFI	50	1310-DCL	18	1310-ECC	150, 161, 164				
1310-CFL	50	1310-DDA	18	1310-ECD	48				
1310-CGA	50	1310-DCB	18	1310-ECE	48				
1310-CGB	50	1310-DDC	44	1310-ECF	48				
1310-CGC	50	1310-DDD	32	1310-ECH	42				
1310-CGD	49	1310-DDE	32	1310-EDE	37, 164				
1310-CGE	49	1310-DDF	33	1310-EDF	37, 164				
1310-CGF	49, 162	1310-DDG	33	1310-EDG	37, 164				
1310-CGG	49, 161, 162	1310-DDH	33	1310-EFA	58, 164				
1310-CGH	49	1310-DDI	33	1310-EFB	57, 164				

Indice alfanumerico		Alfanumerical Index		Nummernverzeichnis		Index alfabétique		Indice alfanumerico	
Article	Page	Article	Page	Article	Page	Article	Page	Article	Page
1310-EFC	57, 164	1405-BAB	143	1411-BLE	151				
1310-EFG	60, 164	1405-BAC	143	1411-BLF	151				
1310-EFH	60, 164	1405-BAD	143	1411-BLG	151				
1310-EFI	60, 164	1405-BAE	143	1411-BLH	151				
1310-EFL	60, 164	1405-BAF	143	1411-BLI	151				
1405-BA	158	1405-BAG	143	1411-BLL	151				
1405-BI	158	1405-BAH	143	1411-CAA	151				
1405-BL	158	1405-BAI	143	1411-CAB	151				
1405-CA	158, 161	1405-BAL	143	1411-CAC	152				
1405-EA	139	1405-BBA	143	1411-CAD	152				
1405-EB	139	1405-BBB	143	1411-CAE	152				
1405-EC	139	1405-BBC	143	1411-CAF	152				
1405-ED	139	1405-BBD	145	1411-CAG	152				
1405-EE	141	1405-BBE	145	1411-CAH	152				
1405-EF	141	1405-BBF	145	1411-CAI	152				
1405-EG	141	1405-BBG	145	1411-CAL	152				
1405-EH	141	1405-BBL	144	1411-CBA	152				
1405-EI	141	1405-BCA	144	1411-CBB	152				
1405-EL	141	1405-BCB	144	1411-CBC	154				
1405-FA	141	1405-BCC	144	1411-CBD	154				
1405-FB	141	1405-BCD	144	1411-CBE	154				
1405-FC	141	1405-BCE	145	1411-CBF	154				
1405-FE	139	1405-BCF	145	1411-CBG	154				
1405-FF	140	1405-BCG	145	1411-CBH	155				
1405-FG	140	1405-BCH	145	1411-CBI	155				
1405-FH	139	1405-BCI	145	1411-CBL	155				
1405-FI	140	1405-BCL	145	1411-CCA	155				
1405-FL	140	1405-BDA	145	1411-CCB	155				
1405-GA	140	1405-BDB	145	1411-CCC	155				
1405-GB	142	1405-BDC	145	1411-CCD	155				
1405-GC	142	1405-BDD	145	1411-CCE	155				
1405-GD	142	1406-BE	139	1411-CCF	156				
1405-GE	142	1406-BF	139	1411-CCG	156				
1405-GF	142	1406-BG	139	1411-CCH	156				
1405-GG	142	1406-BH	139	1411-CCI	156				
1405-GH	142	1406-BI	139	1411-CCL	156				
1405-GI	142	1406-BL	139	1411-CDA	156				
1405-GL	142	1406-CA	139	1411-CDB	156				
1405-HA	142	1406-CB	139	1411-CDC	156				
1405-HB	142	1406-CC	139	1411-CDD	156				
1405-HC	142	1406-CE	139	1411-CDE	156				
1405-HD	143	1406-CE	139	1411-CDF	156				
1405-HE	143	1406-CF	139	1411-CDG	156				
1405-HF	143	1411-CA	48	1411-CDH	156				
1405-HG	143	1411-FA	150	1411-CDI	156				
1405-HH	143	1411-FB	150	1411-CDL	156				
1405-HI	143	1411-FC	150	1411-CEA	156				
1405-HL	143	1411-FD	150	1411-CEB	157				
1405-IA	143	1411-FE	150	1411-CEC	157				
1405-IB	143	1411-FF	150	1411-CED	157				
1405-IC	143	1411-FG	150	1411-CEE	157				
1405-ID	143	1411-IE	150	1411-CEF	157				
1405-IE	143	1411-IF	150	1411-CEG	157				
1405-IF	143	1411-BBB	158	1411-CEH	157				
1405-IG	143	1411-BHL	158	1411-CEI	157				
1405-IH	143	1411-BIA	151	1411-CEL	157				
1405-II	143	1411-BIB	151	1411-CFA	157				
1405-IL	143	1411-BIC	151	1411-CFB	157				
1405-LA	143	1411-BID	151	1411-CFC	157				
1405-LB	143	1411-BIE	151	1411-CFD	157				
1405-LC	143	1411-BIF	151	1411-CFE	157				
1405-LD	143	1411-BIG	151	1411-CFF	157				
1405-LE	143	1411-BIH	151	1411-CFG	157				
1405-LF	143	1411-BII	151	1411-CFH	157				
1405-LG	143	1411-BIL	151	1411-CFI	157				
1405-LH	143	1411-BIL	151	1411-CFL	157				
1405-LI	143	1411-BLA	151	1411-CGA	157				
1405-LL	143	1411-BLB	151	1411-CGB	157				
1405-LLA	143	1411-BLC	151	1411-CGC	157				
		1411-BLD	151	1411-CGD	158				

Indice alfanumerico		Alfanumerical Index		Nummernverzeichnis		Index alphabétique		Indice alfanumerico	
Article	Page	Article	Page	Article	Page	Article	Page	Article	Page
1411-CGE	158	1506-GA	39						
1411-CGF	158	1506-GB	39						
1411-CGG	158								
1411-CGH	158	1803-B	78						
1411-CGI	158	1803-L	78						
1411-CGL	158								
1411-CHA	158	1918-BAB	172						
1411-CHB	158	1918-BAC	172						
1411-CHC	158	1918-BAD	161, 172						
1411-CHD	159	1918-BAE	163, 172						
1411-CHE	159								
1411-CHF	159	211503-G	169						
1411-CHG	159	211503-I	169						
1411-CHH	159	211503-BA	169						
1411-CHI	159	211503-BC	169						
1411-CHL	159								
1411-CIA	159	2118-CA	171						
1411-CIB	159	2118-CG	171						
1411-CIC	159	2118-DA	171						
1411-CID	159								
1411-CIE	159								
1411-CIF	159								
1411-CIG	153								
1411-CIH	153								
1411-CII	153								
1411-CIL	153								
1411-CLA	160								
1411-CLB	160								
1411-CLC	160								
1411-CLD	160								
1411-CLE	153								
1411-CLF	153								
1411-CLG	153								
1411-CLH	153								
1412-AL	58								
1412-CA	27								
1412-CC	27								
1412-CD	27								
1417-BF	135								
1417-BH	135, 161, 164								
1417-BL	135								
1417-CA	135								
1417-EA	135								
1417-EC	135								
1417-EF	135								
15-FA	134								
15-LB	133								
15-LC	133								
15-LD	133								
15-LE	133								
15-LG	133								
15-LH	133								
15-BAA	134								
15-BAB	133								
15-BAC	133								
15-BCA	133								
15-BCB	133, 161, 164								
15-CGE	133								
15-CGF	133								
1506-BG	39								
1506-DA	45								
1506-DB	45								
1506-DD	45								
1506-DE	45								
1506-DF	45								
1506-DH	45								



ideal-tek
manufacturer & supplier of precision instruments 

Ideal-tek SA
via Motta 4
6828 Balerna
Switzerland

Phone: +41 91 683 32 29
Fax: +41 91 683 03 71
E-mail: info@ideal-tek.com