



Katalog der Kieferorthopädie
Catalogue of Orthodontics
Catalogo di Ortodonzia
Catálogo de Ortodoncia
Catalogue de l'Orthodontie



Drahtschneidezange
Wire Cutting Pliers
Tronchesi
Alicates para cortar
Pince coupante



Schneidezangen
Ligaturen-Cutter

Cutters
Ligature Cutters

Tronchesi
Tronchesi per legature

Alicates de corte
Alicates para cortar ligaduras

Pincers coupantes
Pincers coupe-ligatures

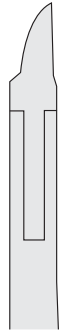

1/1

○ Max Ø 0.3 mm (.012")

Ligaturen Schneidezange
Ligature Cutters
Solo per rimuovere le legature
Alicates para cortar ligaduras
Pince à sectionner les ligatures

Für weichen und harten Draht
For soft and hard Wire
Per fili sottili e morbidi
Para alambre blando y duro
Pour fil léger e dur

ANGLE
1123-LF
130 mm

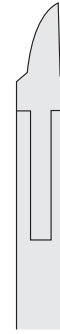

1/1



Mit Hartmetalleinsätzen
With Hard Metal Inserts
Con punte in metallo duro
Con puntas de metal duro
Avec mors en métal dur

○ Max Ø 0.4 mm (.016")

Ligaturen Schneidezange
Ligature Cutters
Solo per rimuovere le legature
Alicates para cortar ligaduras
Pince à sectionner les ligatures

Für weichen und harten Draht
For soft and hard Wire
Per fili sottili e morbidi
Para alambre blando y duro
Pour fil léger e dur

ANGLE
1123-LF1903
130 mm

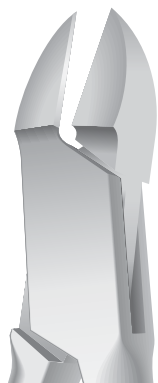

1/1

○ Max Ø 1.0 mm (.040")

Seitenschneider
Side Cutters
Taglio laterale
De corte lateral
Coupante latérale

Für harten Draht
For hard Wire
Per fili grossi e duri
Para alambre duro
Pour fil dur

1123-LG
150 mm

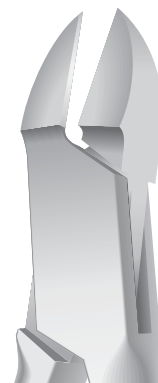

1/1



Mit Hartmetalleinsätzen
With Hard Metal Inserts
Con punte in metallo duro
Con puntas de metal duro
Avec mors en métal dur

○ Max Ø 1.0 mm (.040")

Seitenschneider
Side Cutters
Taglio laterale
De corte lateral
Coupante latérale

Für harten Draht
For hard Wire
Per fili grossi e duri
Para alambre duro
Pour fil dur

1123-LG1903
150 mm

Schneidezangen
Ligaturen-Cutter

Cutters
Ligature Cutters

Tronchesi
Tronchesi per legature

Alicates de corte
Alicates para cortar ligaduras

Pincers coupantes
Pincers coupe-ligatures

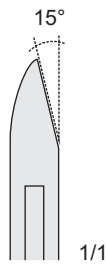
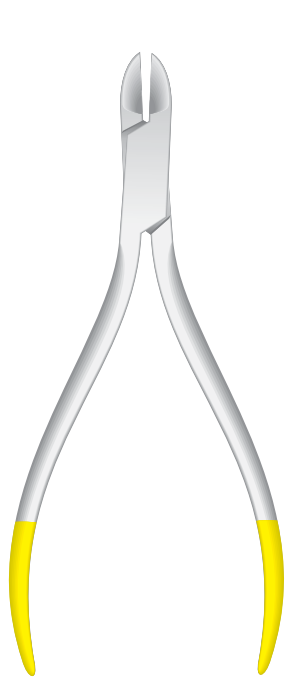

Mit Hartmetalleinsätzen
With Hard Metal Inserts
Con punte in metallo duro
Con puntas de metal duro
Avec mors en métal dur

- Max Ø 0.7 mm (.028")
- 0.56 x 0.71 mm (.022" x .028")
- ⊗ 0.53 x 0.64 mm (.021" x .025")

Für harten Draht
For hard Wire
Per fili duri, grossi e intrecciati
Para alambre duro
Pour fil dur

1123-LA
125 mm

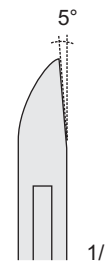

Mit Hartmetalleinsätzen
With Hard Metal Inserts
Con punte in metallo duro
Con puntas de metal duro
Avec mors en métal dur

- Max Ø 0.7 mm (.028")
- 0.56 x 0.71 mm (.022" x .028")
- ⊗ 0.53 x 0.64 mm (.021" x .025")

Für harten Draht
For hard Wire
Per fili duri, grossi e intrecciati
Para alambre duro
Pour fil dur

1123-LB
125 mm

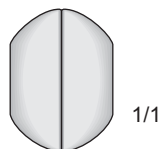
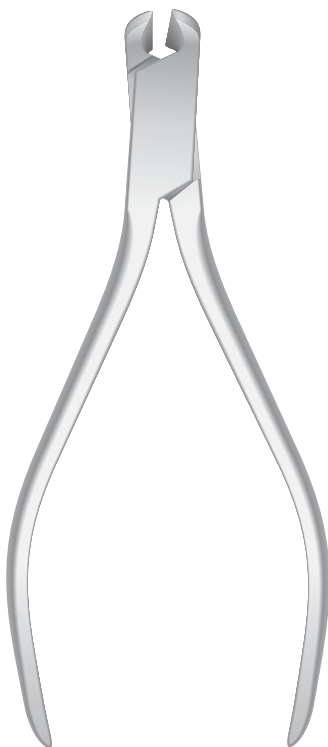

Kopfschneider
End Cutters
Tronchese frontale
Cortafrios frontal
Pince coupante droite

- Max Ø 1.0 mm (.040")

Für harten Draht
For hard Wire
Per fili duri e grossi
Para alambre duro
Pour fil dur

1123-LC
145 mm

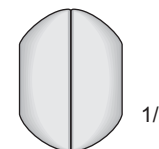

Mit Hartmetalleinsätzen
With Hard Metal Inserts
Con punte in metallo duro
Con puntas de metal duro
Avec mors en métal dur

Kopfschneider
End Cutters
Tronchese frontale
Cortafrios frontal
Pince coupante droite

- Max Ø 1.0 mm (.040")

Für harten Draht
For hard Wire
Per fili duri e grossi
Para alambre duro
Pour fil dur

1123-LC1903
145 mm

**Ligaturen
Schneidezangen -Mini**

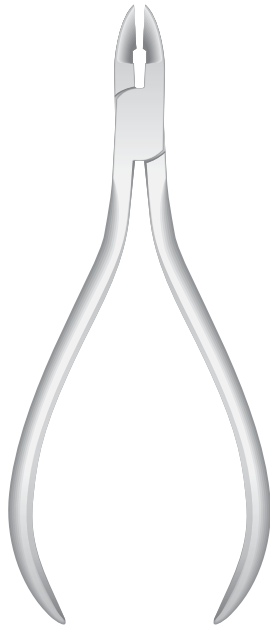

1123-IG
125 mm

**Mini
Ligature Cutters**

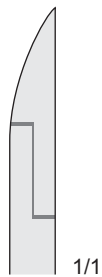

Mit Hartmetalleinsätzen
With Hard Metal Inserts
Con punte in metallo duro
Con puntas de metal duro
Avec mors en métal dur

○ Max Ø 0.2 mm (.010")

Ligaturen Schneidezange
Ligature Cutters
Solo per rimuovere le legature
Alicates para cortar ligaduras
Pince à sectionner les ligatures

Für weichen Draht
For soft Wire
Per fili sottili e morbidi
Para alambre blando
Pour fil léger

**Mini Alicates
para cortar ligaduras**

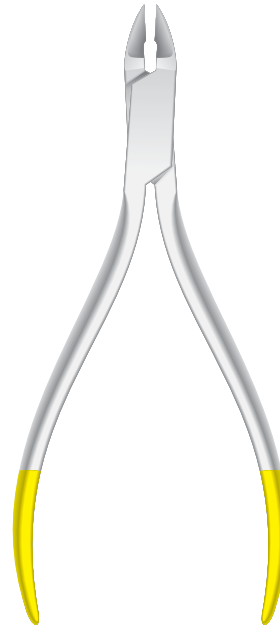

1123-LD
125 mm

**Mini Pincers
coupe-ligatures**

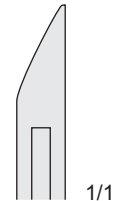

Mit Hartmetalleinsätzen
With Hard Metal Inserts
Con punte in metallo duro
Con puntas de metal duro
Avec mors en métal dur

○ Max Ø 0.3 mm (.012")

Ligaturen Schneidezange
Ligature Cutters
Solo per rimuovere le legature
Alicates para cortar ligaduras
Pince à sectionner les ligatures

Für weichen Draht
For soft Wire
Per fili sottili e morbidi
Para alambre blando
Pour fil léger



1123-LI
175 mm

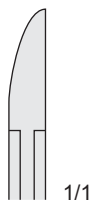

Mit Hartmetalleinsätzen
With Hard Metal Inserts
Con punte in metallo duro
Con puntas de metal duro
Avec mors en métal dur

○ Max Ø 0.3 mm (.012")

Long Handle
Con manici lunghi

Ligaturen Schneidezangen -Mini
Mini Ligature Cutter
Solo per rimuovere le legature
Alicate de corte mini
Pince coupante mini

Für weichen Draht
For soft Wire
Per fili sottili e morbidi
Para alambre blando
Pour fil léger



1123-LH
120 mm

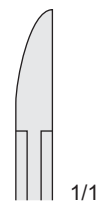

Mit Hartmetalleinsätzen
With Hard Metal Inserts
Con punte in metallo duro
Con puntas de metal duro
Avec mors en métal dur

○ Max Ø 0.3 mm (.012")

Ligaturen Schneidezangen -Mini
Mini Ligature Cutter
Solo per rimuovere le legature
Alicate de corte mini
Pince coupante mini

Für weichen Draht
For soft Wire
Per fili sottili e morbidi
Para alambre blando
Pour fil léger

Schneidezangen
Ligaturen-Cutter

Cutters
Ligature Cutters

Tronchesi
Tronchesi per legature

Alicates de corte
Alicates para cortar ligaduras

Pincas coupantes
Pincas coupe-ligatures

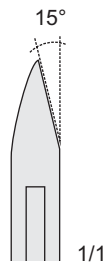
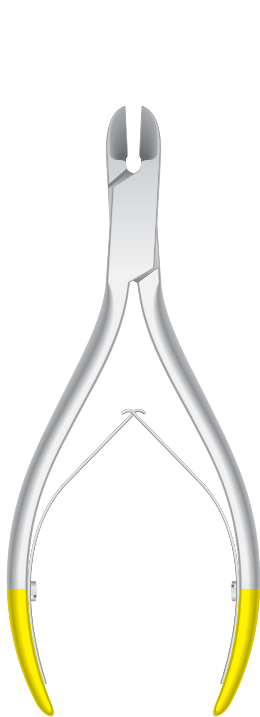

Mit Hartmetalleinsätzen
With Hard Metal Inserts
Con punte in metallo duro
Con puntas de metal duro
Avec mors en métal dur

- Max Ø 0.5 mm (.020")
- 0.41 x 0.56 mm (.016" x .022")

Ligature Cutter
Angled 15°

Für weichen und harten Draht
For soft and hard Wire
Per fili duri, sottili e medi
Para alambre blando y duro
Pour fil léger e dur

1123-LE
125 mm

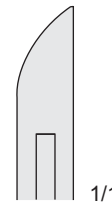

Mit Hartmetalleinsätzen
With Hard Metal Inserts
Con punte in metallo duro
Con puntas de metal duro
Avec mors en métal dur

- Max Ø 0.5 mm (.020")
- 0.41 x 0.56 mm (.016" x .022")

Für weichen und harten Draht
For soft and hard Wire
Per fili duri, sottili e medi
Para alambre blando y duro
Pour fil léger e dur

1123-LL
120 mm

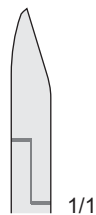

Mit Hartmetalleinsätzen
With Hard Metal Inserts
Con punte in metallo duro
Con puntas de metal duro
Avec mors en métal dur

- Max Ø 0.4 mm (.016")

Ligaturen-Cutter
Ligature Cutter

Für weichen und harten Draht
For soft and hard Wire
Per filo leggero e duro
Para alambre blando y duro
Pour fil léger e dur

1123-II
115 mm

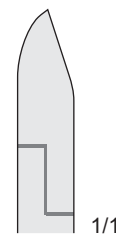

Mit Hartmetalleinsätzen
With Hard Metal Inserts
Con punte in metallo duro
Con puntas de metal duro
Avec mors en métal dur

- Max Ø 0.7 mm (.028")
- 0.56 x 0.71 mm (.022" x .028")
- ⊗ 0.53 x 0.64 mm (.021" x .025")

Bogen-Cutter
Arch Cutter

Für weichen und harten Draht
For soft and hard Wire
Per fili duri, grossi e intrecciati
Para alambre blando y duro
Pour fil léger e dur

1123-IL
120 mm

**Distal-Schneider
mit Drahtfangvorrichtung**

**Distal Cutters with
wire holding device**

**Tronchesi distali con
trattenuta del filo**

**Alicates de corte
distal con dispositivo
retenedor del alambre**

**Pinces à couper distale
avec dispositif de
rétention**

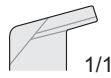

Mit Hartmetalleinsätzen
With Hard Metal Inserts
Con punte in metallo duro
Con puntas de metal duro
Avec mors en métal dur

- Max Ø 0.5 mm (.020")
- 0.41 x 0.56 mm (.016" x .022")
- ⊗ Max Ø 0.4 mm (.0155")

Distal-Schneider mit Drahtfangvorrichtung
Distal Cutter with wire holding device
Tronchesi distale con trattenuta del filo
Alicates de corte distal con dispositivo
retenedor del alambre
Pinces à couper distale avec
dispositif de rétention

Für weichen und harten Draht
For soft and hard Wire
Per fili duri, sottili e medi
Para alambre blando y duro
Pour fil léger e dur

1123-0418G
125 mm

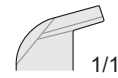

Mit Hartmetalleinsätzen
With Hard Metal Inserts
Con punte in metallo duro
Con puntas de metal duro
Avec mors en métal dur

- Max Ø 0.5 mm (.020")
- 0.41 x 0.56 mm (.016" x .022")
- ⊗ Max Ø 0.4 mm (.0155")

Distal-Schneider mit Drahtfangvorrichtung
Distal Cutter with wire holding device
Tronchesi distale con trattenuta del filo
Alicates de corte distal con dispositivo
retenedor del alambre
Pinces à couper distale avec
dispositif de rétention

Für weichen und harten Draht
For soft and hard Wire
Per fili duri, sottili e medi
Para alambre blando y duro
Pour fil léger e dur

1123-0418B
125 mm

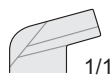
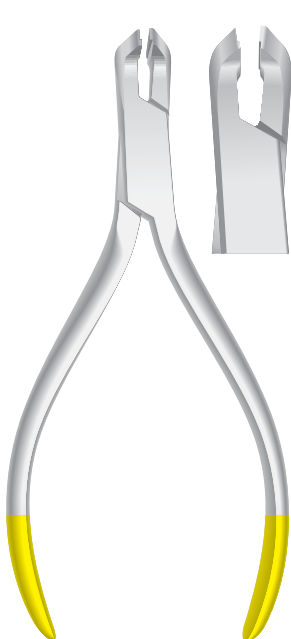

Mit Hartmetalleinsätzen
With Hard Metal Inserts
Con punte in metallo duro
Con puntas de metal duro
Avec mors en métal dur

- Max Ø 0.4 mm (.016")
- 0.41 x 0.41 mm (.016" x .016")

Distal-Schneider mit Drahtfangvorrichtung
Distal Cutter with wire holding device
Tronchesi distale con trattenuta del filo
Alicates de corte distal con dispositivo
retenedor del alambre
Pinces à couper distale avec
dispositif de rétention

Für weichen und harten Draht
For soft and hard Wire
Per fili duri e sottili
Para alambre blando y duro
Pour fil léger e dur

1123-0418C
125 mm

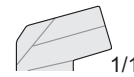

Mit Hartmetalleinsätzen
With Hard Metal Inserts
Con punte in metallo duro
Con puntas de metal duro
Avec mors en métal dur

- Max Ø 0.5 mm (.020")
- 0.41 x 0.56 mm (.016" x .022")
- ⊗ Max Ø 0.4 mm (.0155")

Distal-Schneider mit Drahtfangvorrichtung
Distal Cutter with wire holding device
Tronchesi distale con trattenuta del filo
Alicates de corte distal con dispositivo
retenedor del alambre
Pinces à couper distale avec
dispositif de rétention

Für weichen und harten Draht
For soft and hard Wire
Per fili duri, sottili e medi
Para alambre blando y duro
Pour fil léger e dur

1123-0418E
125 mm

**Distal-Schneider
mit Drahtfangvorrichtung**

**Distal Cutter with
wire holding device**

**Tronchesi distali con
trattenuta del filo**

**Alicates de corte
distal con dispositivo
retenedor del alambre**

**Pinces à couper distale
avec dispositif de
rétention**

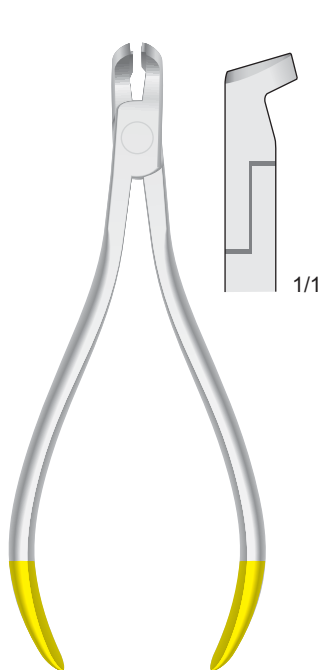

Mit Hartmetalleinsätzen
With Hard Metal Inserts
Con punte in metallo duro
Con puntas de metal duro
Avec mors en métal dur

- Max Ø 0.5 mm (.020")
- 0.41 x 0.56 mm (.016" x .022")
- ⌘ Max Ø 0.4 mm (.0155")

Distal-Schneider mit Drahtfangvorrichtung
Distal Cutter with wire holding device
Tronchesi distale con trattenuta del filo
Alicates de corte distal con dispositivo
retenedor del alambre
Pinces à couper distale avec
dispositif de rétention

Für weichen und harten Draht
For soft and hard Wire
Per fili duri, sottili e medi
Para alambre blando y duro
Pour fil léger e dur

1123-0418F
120 mm

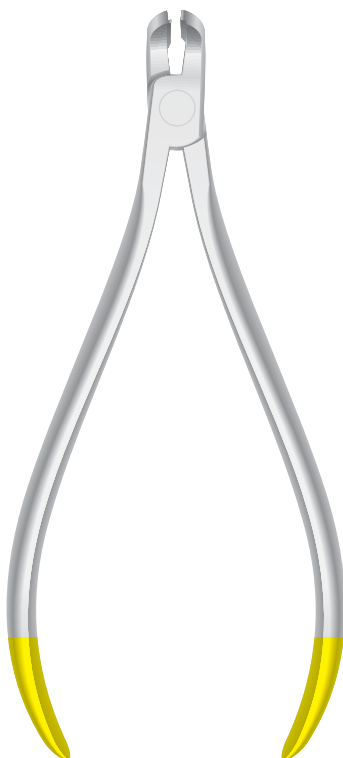

Mit Hartmetalleinsätzen
With Hard Metal Inserts
Con punte in metallo duro
Con puntas de metal duro
Avec mors en métal dur

- Max Ø 0.5 mm (.020")
- 0.41 x 0.56 mm (.016" x .022")
- ⌘ Max Ø 0.4 mm (.0155")

Distal-Schneider mit Drahtfangvorrichtung
Distal Cutter with wire holding device
Tronchesi distale con trattenuta del filo
Alicates de corte distal con dispositivo
retenedor del alambre
Pinces à couper distale avec
dispositif de rétention

Long Handle
Con manici lunghi

Für weichen und harten Draht
For soft and hard Wire
Per fili duri, sottili e medi
Para alambre blando y duro
Pour fil léger e dur

1123-0418D
150 mm

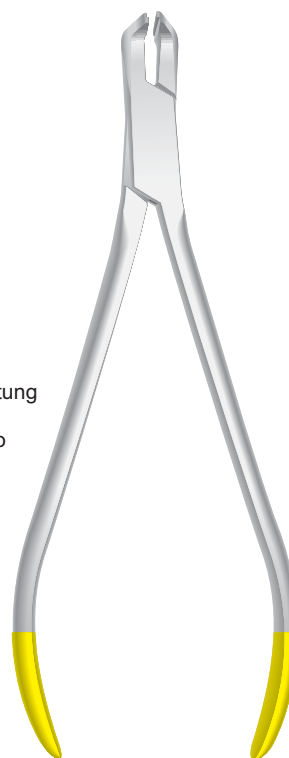

Mit Hartmetalleinsätzen
With Hard Metal Inserts
Con punte in metallo duro
Con puntas de metal duro
Avec mors en métal dur

- Max Ø 0.5 mm (.020")
- 0.41 x 0.56 mm (.016" x .022")
- ⌘ Max Ø 0.4 mm (.0155")

Distal-Schneider mit Drahtfangvorrichtung
Distal Cutter with wire holding device
Tronchesi distale con trattenuta del filo
Alicates de corte distal con dispositivo
retenedor del alambre
Pinces à couper distale avec
dispositif de rétention

Für weichen und harten Draht
For soft and hard Wire
Per fili duri, sottili e medi
Para alambre blando y duro
Pour fil léger e dur

1123-0418G11
150 mm

Kieferorthopädie Zangen
Orthodontics Pliers
Pinze per ortodonzia
Alicates para ortodoncia
Pinces pour Orthodontie





0415-DB
125 mm

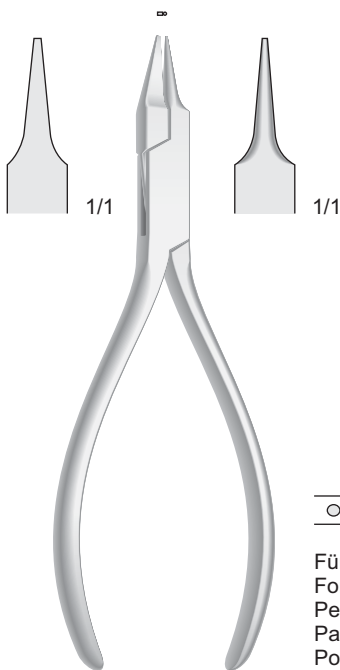

0415-FF
135 mm

○ Max Ø 0.5 mm (.020")

Für weichen Draht
For soft Wire
Per filo leggero
Para alambre blando
Pour fil léger



0415-FH
130 mm

○ Max Ø 0.5 mm (.020")

Für weichen Draht
For soft Wire
Per filo leggero
Para alambre blando
Pour fil léger

Light Wire-Biegezange,
Begg Typ

Begg-type light wire
Bending Pliers

Pinze a becco
di uccello

Alicates para doblar,
tipo Begg

Pinces à courber
type Begg

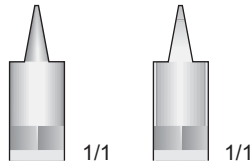

○ Max Ø 0.6 mm (.024")

Lightwire-Zange mit Schneider
Light wire Plier with cutter
Pinza per filo leggero
con tronchese
Alicates para alambre ligero
con dispositivo para cortar
Pince pour light wire avec trancher

0415-BAG
135 mm

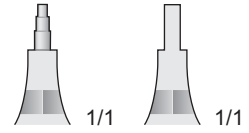

○ Max Ø 0.4 mm (.016")

Lightwire-Zange mit Schneider
Light wire Plier with cutter
Pinza per filo leggero
con tronchese
Alicates para alambre ligero
con dispositivo para cortar
Pince pour light wire avec trancher

0415-BAI
135 mm

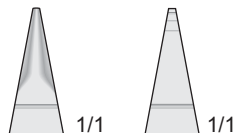

○ Max Ø 0.7 mm (.028")

0415-CG
130 mm

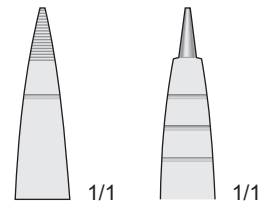

○ Max Ø 0.7 mm (.028")

JARABAK
0415-GD
140 mm

Light Wire-Biegezange,
Begg Typ

Begg-type light wire
Bending Pliers

Pinze a becco
di uccello

Alicates para doblar,
tipo Begg

Pincers à courber
type Begg

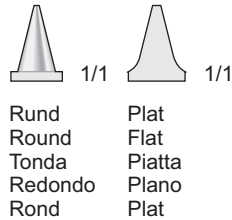

○ Max Ø 0.7 mm (.028")

Für weichen und harten Draht
For soft and hard Wire
Per filo leggero e duro
Para alambre blando y duro
Pour fil léger e dur

ANGLE
0415-AB
125 mm

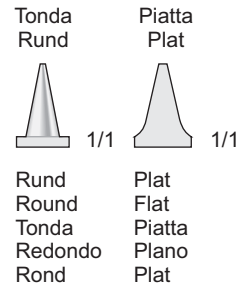

Mit Hartmetalleinsätzen
With Hard Metal Inserts
Con punte in metallo duro
Con puntas de metal duro
Avec mors en métal dur

○ Max Ø 0.7 mm (.028")

Für weichen und harten Draht
For soft and hard Wire
Per filo leggero e duro
Para alambre blando y duro
Pour fil léger e dur

ANGLE
0415-AB1903
125 mm

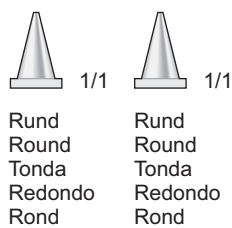

○ Max Ø 0.7 mm (.028")

Für weichen und harten Draht
For soft and hard Wire
Per filo leggero e duro
Para alambre blando y duro
Pour fil léger e dur

0415-AC
125 mm

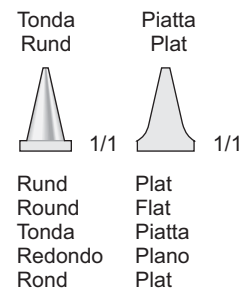

○ Max Ø 0.7 mm (.028")

Für weichen und harten Draht
For soft and hard Wire
Per filo leggero e duro
Para alambre blando y duro
Pour fil léger e dur

ANGLE
0415-AH
125 mm

Spezialzangen

Special Pliers
Utility Pliers

Pinze di utilità
Pinze speciali

Alicates especiales

Pinces spéciales

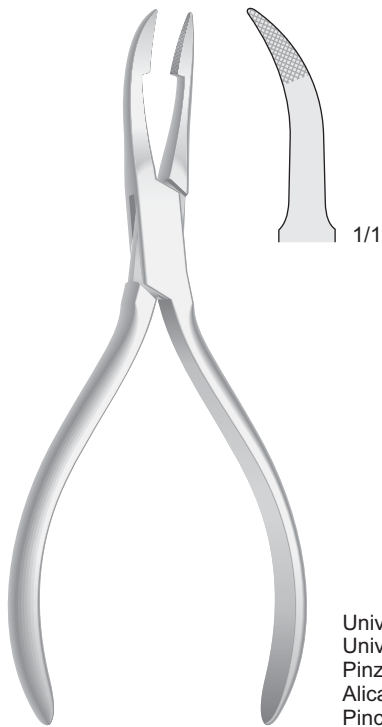

WEINGART
0415-AD
145 mm

Universalzange
Universal Pliers
Pinze universali
Alicates universales
Pince universelle

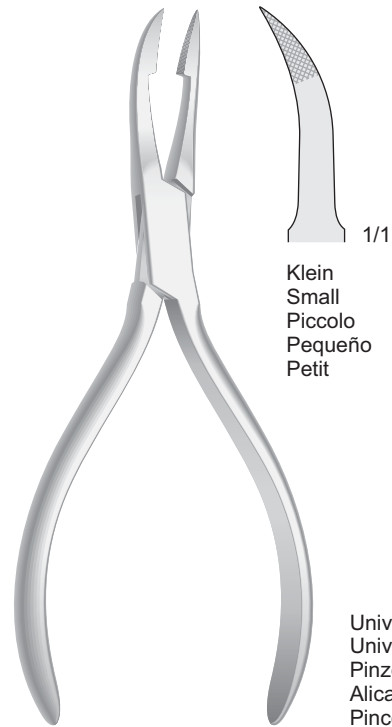

WEINGART
0415-AD18
145 mm

Klein
Small
Piccolo
Pequeño
Petit

Universalzange
Universal Pliers
Pinze universali
Alicates universales
Pince universelle

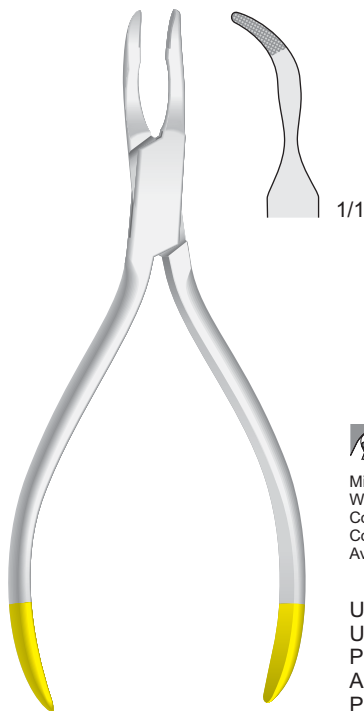

WEINGART
0415-BBC
140 mm



Mit Hartmetalleinsätzen
With Hard Metal Inserts
Con punte in metallo duro
Con puntas de metal duro
Avec mors en métal dur

Universalzange
Universal Pliers
Pinze universali
Alicates universales
Pince universelle



WEINGART
0415-BBD
140 mm

Universalzange
Universal Pliers
Pinze universali
Alicates universales
Pince universelle

Spezialzangen

Special Pliers
Utility Pliers

Pinze di utilità
Pinze speciali

Alicates especiales

Pinces spéciales



HOW
0415-AF/0415-AFS
145 mm

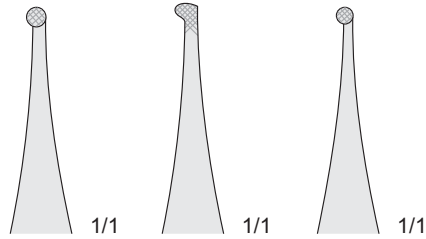

0415-AF 145 mm **0415-AF11** 145 mm **0415-AF18** 145 mm

Klein
Small
Piccolo
Pequeño
Petit

Universalzange für die Multibandtechnik
Universal Forceps for Multiband Technique
Pinze di utilità per archi
Alicates para formar bandas
Pinces à former les rubans



HOW
0415-AG/0415-AGS
140 mm

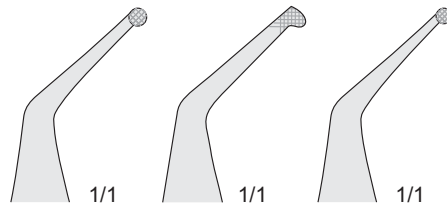

0415-AG 145 mm **0415-AG11** 145 mm **0415-AG18** 145 mm

Klein
Small
Piccolo
Pequeño
Petit

Universalzange für die Multibandtechnik
Universal Forceps for Multiband Technique
Pinze di utilità per archi
Alicates para formar bandas
Pinces à former les rubans



1/1

○ Max Ø 0.5 mm (.020")

Für weichen und harten Draht
For soft and hard Wire
Per filo leggero e duro
Para alambre blando y duro
Pour fil léger e dur

ADERER
0415-EE
115 mm

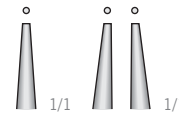

○ Max Ø 0.6 mm (.024")

Für weichen und harten draht
For soft and hard wire
Per filo leggero e duro
Para alambre blando y duro
Pour fil mou et dur

ADERER
0415-BCD
125 mm



1/1

Modello robusto
Modelo robusto
Modèle fort

○ Max Ø 0.9 mm (.036")

Für weichen und harten Draht
For soft and hard Wire
Per filo leggero e duro
Para alambre blando y duro
Pour fil léger e dur

ADERER
0415-CF
125 mm



1/1

○ Max Ø 0.7 mm (.028")

Für weichen und harten Draht
For soft and hard Wire
Per filo leggero e duro
Para alambre blando y duro
Pour fil léger e dur

ADERER
0415-EA
125 mm

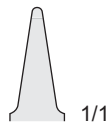

○ Max Ø 0.7 mm (.028")

Für weichen und harten Draht
For soft and hard Wire
Per filo leggero e duro
Para alambre blando y duro
Pour fil léger e dur

ADAMS
0415-EH
125 mm



TC

1,0 x 1,0 mm

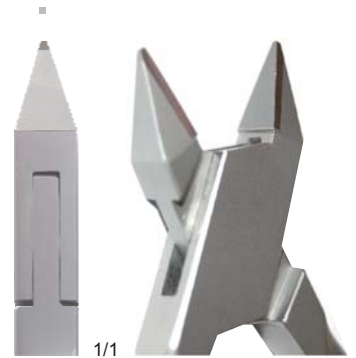

○ Max Ø 1.0 mm (.040")

Pinza da ortodonzia tipo ASH
in acciaio inossidabile con inserti al
Carburo di Tungsteno.
I becchi sono temprati per una presa
ottimale sul filo d'acciaio.

0415-BEF
135 mm

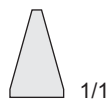

○ Max Ø 0.7 mm (.028")

Für weichen und harten Draht
For soft and hard Wire
Per filo leggero e duro
Para alambre blando y duro
Pour fil léger e dur

ADAMS
0415-ED
125 mm

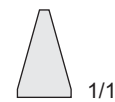

○ Max Ø 0.7 mm (.028")

Für weichen und harten Draht
For soft and hard Wire
Per filo leggero e duro
Para alambre blando y duro
Pour fil léger e dur

ADAMS
0415-ED1903
125 mm



Mit Hartmetalleinsätzen
With Hard Metal Inserts
Con punte in metallo duro
Con puntas de metal duro
Avec mors en métal dur

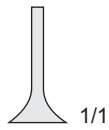

- Max Ø 0.7 mm (.028")
- 0.56 x 0.71 mm (.022" x .028")

Für Vierkant-Drähte
For Edgewise wires
Per fili quadrati
Para alambres rectangulares
Pour fils rectangulaire

ANGLE-TWEED
0415-GA
130 mm



Diametro del filo fino a .025

10 mm

1/1

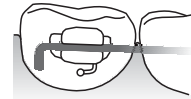
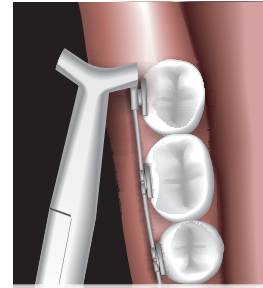

Per ottenere la piegatura del filo verso il basso:
posizionare la pinza Hammerhead parallela alla base del dente, con il lato femmina rivolto verso il basso.

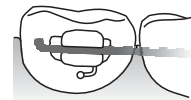

Per ottenere la piegatura del filo verso il dente:
posizionare la pinza Hammerhead perpendicolare alla base del dente, con il lato femmina rivolto verso il dente.

HAMMERHEAD
0415-BED
155 mm

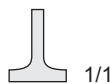

- Max Ø 0.7 mm (.028")
- 0.56 x 0.71 mm (.022" x .028")

Für Vierkant-Drähte
For Edgewise wires
Per fili quadrati
Para alambres rectangulares
Pour fils rectangulaire

ANGLE-TWEED
0415-HG
125 mm

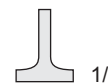

Mit Hartmetalleinsätzen
With Hard Metal Inserts
Con punte in metallo duro
Con puntas de metal duro
Avec mors en métal dur

- Max Ø 0.7 mm (.028")
- 0.56 x 0.71 mm (.022" x .028")

Für Vierkant-Drähte
For Edgewise wires
Per fili quadrati
Para alambres rectangulares
Pour fils rectangulaire

ANGLE-TWEED
0415-HG1903
125 mm



TORQUE
0415-BEB01
125 mm



TORQUE
0415-BEB02
125 mm

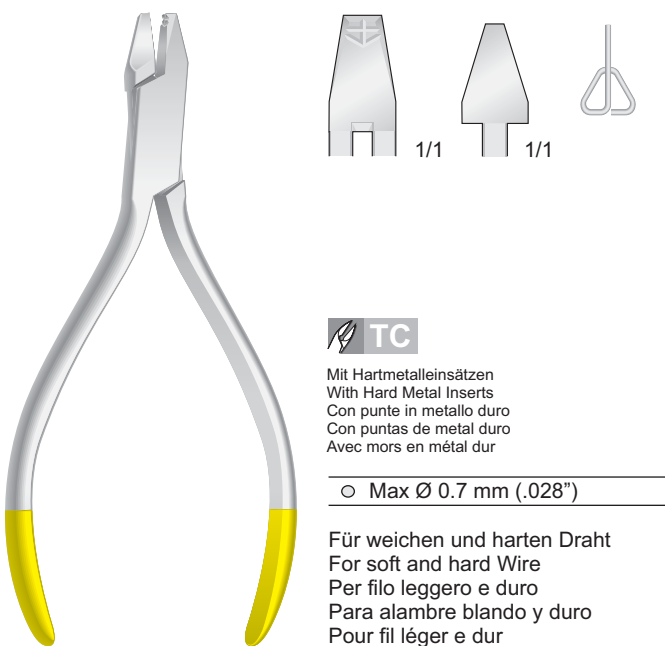

0415-BBA
125 mm

TC

Mit Hartmetalleinsätzen
With Hard Metal Inserts
Con punte in metallo duro
Con puntas de metal duro
Avec mors en métal dur

○ Max Ø 0.7 mm (.028")

Für weichen und harten Draht
For soft and hard Wire
Per filo leggero e duro
Para alambre blando y duro
Pour fil léger e dur

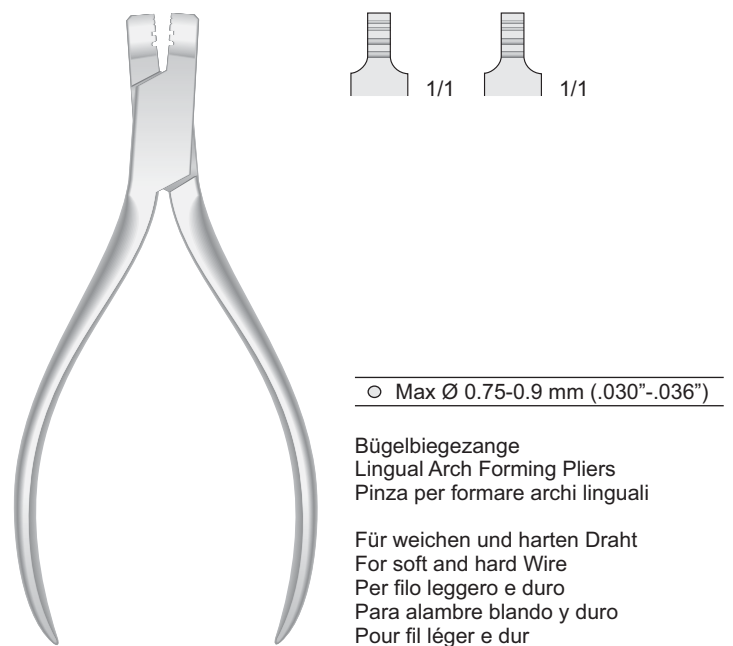

0415-BAH
125 mm

○ Max Ø 0.75-0.9 mm (.030"-.036")

Bügelbiegezange
Lingual Arch Forming Pliers
Pinza per formare archi linguali

Für weichen und harten Draht
For soft and hard Wire
Per filo leggero e duro
Para alambre blando y duro
Pour fil léger e dur

Schlaufen und
Bogenbiegeezangen

Loop and Arch
Forming Pliers

Pinze per anse
e per formare archi

Alicates para ansas
para formar arcos

Pinces à former les
anses et les arcs



TWEED
0415-BBF
135 mm

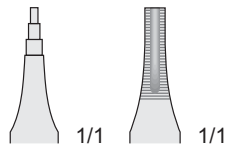

○ Max Ø 0.7 mm (.028")

Für weichen und harten Draht
For soft and hard Wire
Per filo leggero e duro
Para alambre blando y duro
Pour fil léger e dur



TWEED
0415-HA/0415-HAA

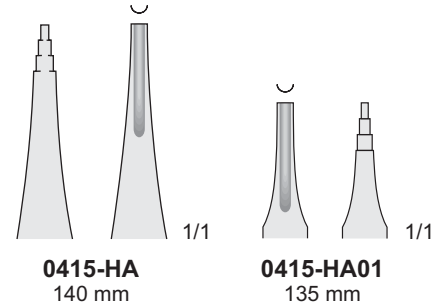

○ Max Ø 0.5 mm (.020")

Für weichen und harten Draht
For soft and hard Wire
Per filo leggero e duro
Para alambre blando y duro
Pour fil léger e dur



DE LA ROSA
0415-HL/0415-HLA
125 mm

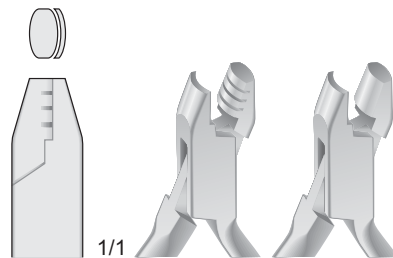

0415-HL 0415-HL01

0415-HL
Mit Führungsrillen 016" - .018" - .022"
With Groove Guides 016" - .018" - .022"
Con guide per 016" - .018" - .022"
Con guida para 016" - .018" - .022"
Avec guidage de 016" - .018" - .022"

Konturenzangen
Arch contouring Pliers
Pinze per formare archi
Alicates para formar arcos
Pinces pour former les arcs

Pinze per formare loop



NANCE
0415-IB
125 mm

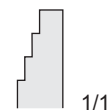

○ Max Ø 0.7 mm (.028")

Schlaufen-Biegezange
Loop Bending Pliers
Pinza per anse
Alicates para formar ansas
Pince à former les anses

Schlaufen und
Bogenbiegezaugen

Loop and Arch
Forming Pliers

Pinze per anse
e per formare archi

Alicates para ansas
para formar arcos

Pinces à former les
anses et les arcs



TWEED
0415-HC
135 mm

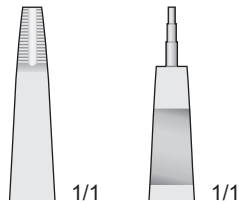

○ Max Ø 0.7 mm (.028")

Mit auswechselbarer Hartmetallspitze
With Replacable tool steel tips
Con vite per stop e punta sostituibile
Con punta de acero duro recambiable
Avec embout en métal dur interchangeable

Für weichen und harten Draht
For soft and hard Wire
Per filo leggero e duro
Para alambre blando y duro
Pour fil léger e dur



0415-HC17

Ersatzspitzen
Replacements tips
Punta di ricambio
Punta de recambio
Embout de rechange



TWEED
0415-HE
140 mm

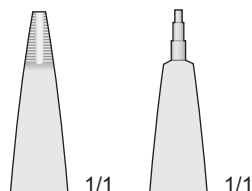

○ Max Ø 0.7 mm (.028")

Für weichen und harten Draht
For soft and hard Wire
Per filo leggero e duro
Para alambre blando y duro
Pour fil léger e dur



YOUNG
0415-HD
130 mm

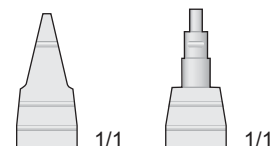

○ Max Ø 0.7 mm (.028")

Für weichen und harten Draht
For soft and hard Wire
Per filo leggero e duro
Para alambre blando y duro
Pour fil léger e dur

Hohlkehlzangen

Loop Forming
Pliers, Gauge

Pinze scanlate,
concave e convesse

Alicates
acanalados

Pinces a mors
concave et rond



HOLLOW-CHOP
0415-GL
140 mm

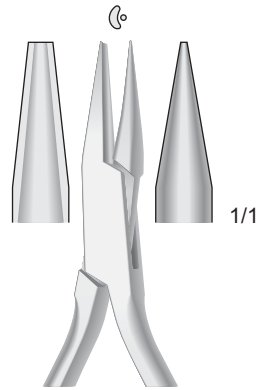

0415-GI
140 mm

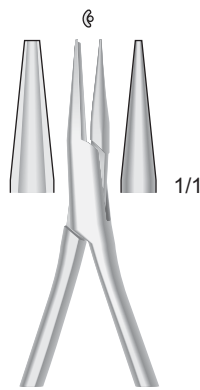

0415-FL
125 mm

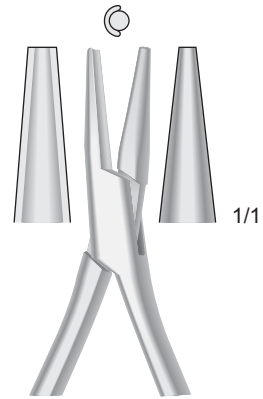

0415-GH
130 mm

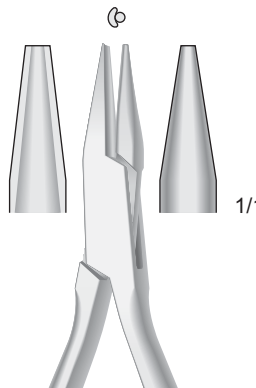

0415-GB
135 mm

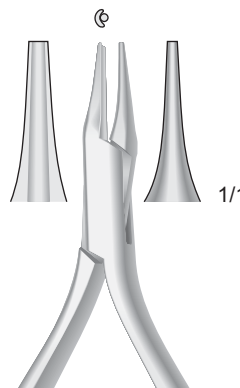

0415-GF
135 mm

○ Max Ø 0.5 mm (.020")

Für weichen und harten Draht
For soft and hard Wire
Per filo leggero e duro
Para alambre blando y duro
Pour fil léger e dur



HOLLOW-CHOP
0415-GL01
130 mm

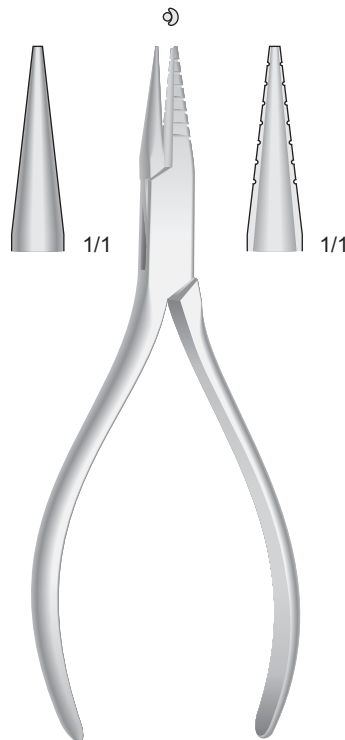

SCHWARZ
0415-FI
140 mm

Hohlkehlzangen mit Graduierung
Bending Pliers with graduation
Pinza scanlata con graduazione
Alicate de media caña con graduación
Pince à plier moyenne fine

○ Max Ø 1.0 mm (.039")

Für weichen und harten Draht
For soft and hard Wire
Per filo leggero e duro
Para alambre blando y duro
Pour fil léger e dur

Hohlkehlzangen

Loop Forming
Pliers, Gauge

Pinze scanalate,
concave e convesse

Alicates
acanalados

Pinces a mors
concave et rond

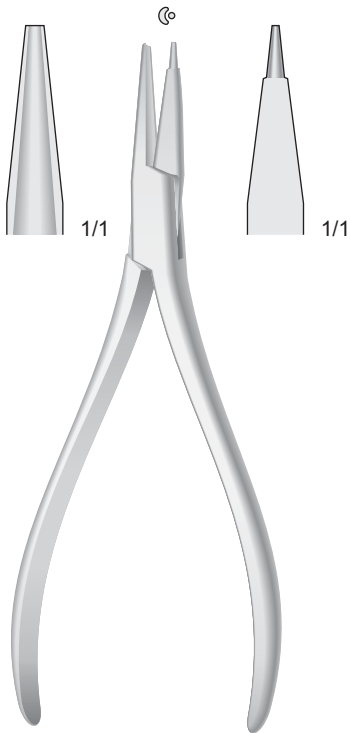

JARABAK
0415-GD01
140 mm

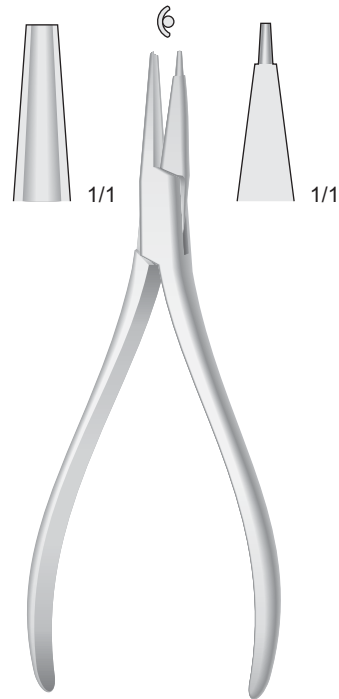

ANDERSEN
0415-GE
130 mm

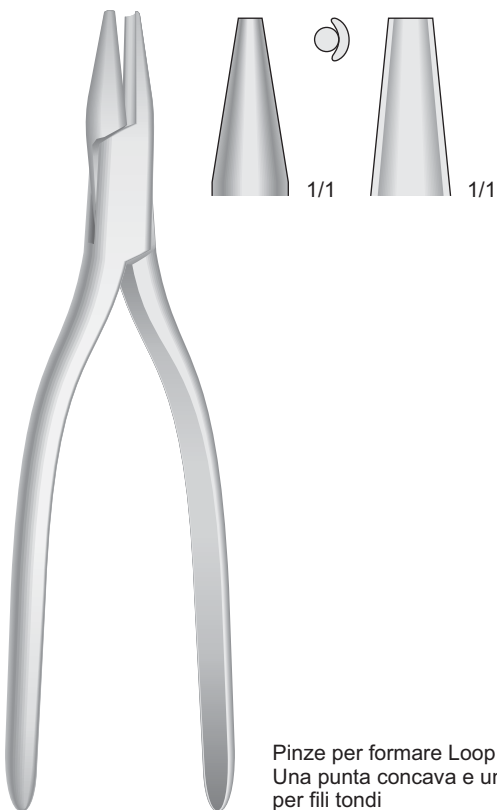

MC KELLOPS
0415-GC
160 mm

Pinze per formare Loop
Una punta concava e una conica
per fili tondi

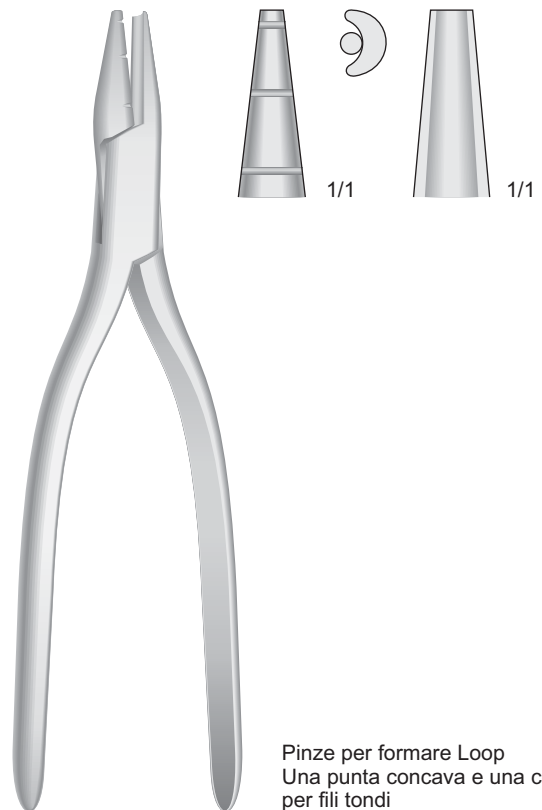

MC KELLOPS
0415-GG
160 mm

Pinze per formare Loop
Una punta concava e una conica
per fili tondi

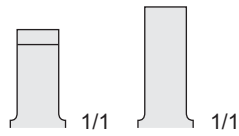

ADERER
0415-DF
130 mm

Frontzahn Bandabnehmezange
Anterior Band removing Plier
Pinza per togliere le bande anteriori
Alicates para quitar bandas anteriores
Pince à enlever les bagues antérieures

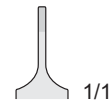

0415-EI
125 mm

Bracket-Abnehmezangen
Bracket Removing Pliers
Pinze per rimuovere gli attacchi
diretti (Asporta Brackets)
Alicates para quitar Brackets
Pince à ôter les Brackets

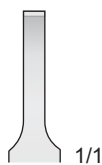

0415-FG
135 mm

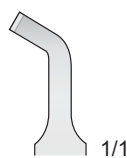

Abgewinkelt 45°
Angulated 45°
Angolata 45°
Angulado 45°
Pliée 45°

0415-HI
135 mm

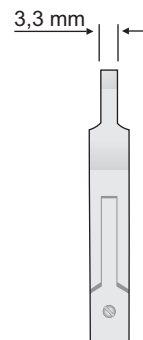

0415-BBH
135 mm



Mit Hartmetalleinsätzen
With Hard Metal Inserts
Con punte in metallo duro
Con puntas de metal duro
Avec mors en métal dur

Bandabnehmzangen

Removing Pliers

Pinze per rimuovere le bande

Alicates para remover bandas

Pince à enlever les bagues

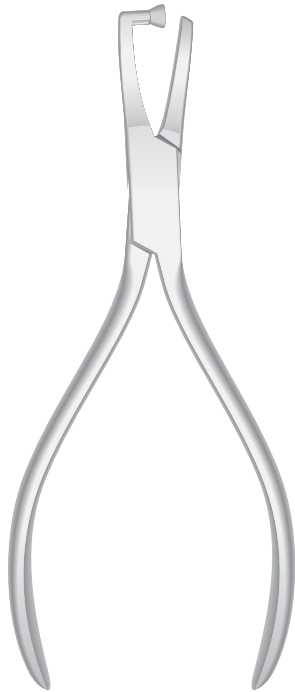

ADERER
DP-36T
135 mm



Bandabnehmzange
Band remover
Pinza per rimuovere le bande
Alicates para quitar bandas
Pinces à détacher les bagues

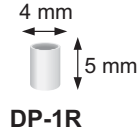

DP-1R

Ersatz-Plastikschutzkappen für:
Replacements Plastic tips for:
Punte di ricambio in teflon per:
Puntas de recambio de plástico para:
Pointes plastiques interchangeables pour:
DP-36, DP-36TC, DP-37

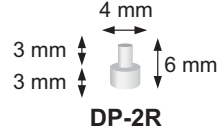

DP-2R

Ersatz-Plastikschutzkappen für:
Replacements Plastic tips for:
Punte di ricambio in teflon per:
Puntas de recambio de plástico para:
Pointes plastiques interchangeables pour:
DP-36T

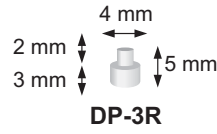

DP-3R

Ersatz-Plastikschutzkappen für:
Replacements Plastic tips for:
Punte di ricambio in teflon per:
Puntas de recambio de plástico para:
Pointes plastiques interchangeables pour:
DP-36T

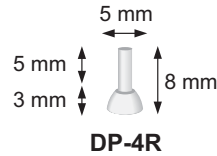

DP-4R

Ersatz-Plastikschutzkappen für:
Replacements Plastic tips for:
Punte di ricambio in teflon per:
Puntas de recambio de plástico para:
Pointes plastiques interchangeables pour:
DP-36T

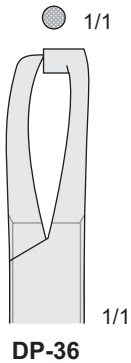

DP-36

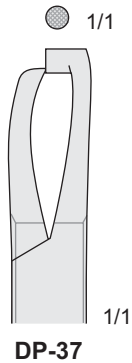

DP-37

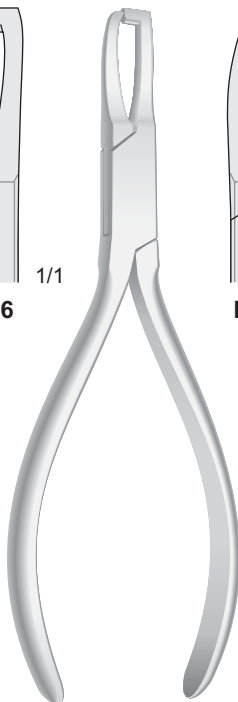

OLIVER
DP-36/DP-37
140 mm

Bandabnehmzange
Band remover
Pinza per rimuovere le bande
Alicates para quitar bandas
Pinces à détacher les bagues

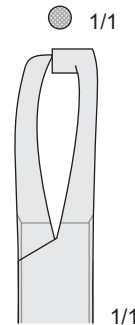

DP-36TC

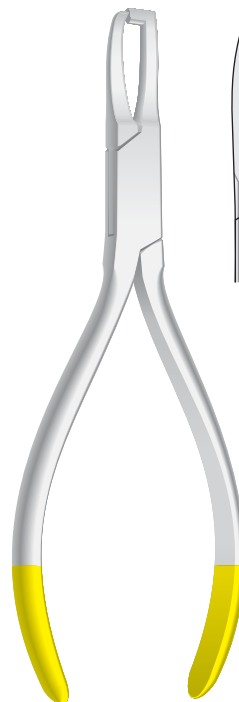

OLIVER
DP-36TC
140 mm



Mit Hartmetalleinsätzen
With Hard Metal Inserts
Con punte in metallo duro
Con puntas de metal duro
Avec mors en métal dur

Bandabnehmzange
Band remover
Pinza per rimuovere le bande
Alicates para quitar bandas
Pinces à détacher les bagues

Flachzangen

Nose Flat Pliers

Pinze a punte piatte

Alicates planos

Pinces à mors plats

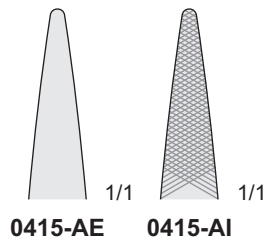

0415-AE/0415-AI
140 mm

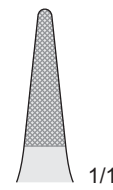

Mit Hartmetalleinsätzen
With Hard Metal Inserts
Con punte in metallo duro
Con puntas de metal duro
Avec mors en métal dur

0415-AI1903
140 mm



FISCHER
0415-BA
150 mm

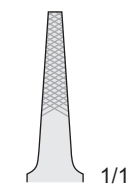
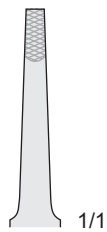

0415-BB
135 mm

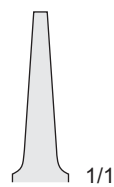

0415-BC
135 mm

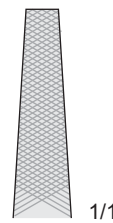

0415-BD
140 mm

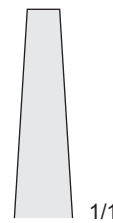

0415-BE
140 mm

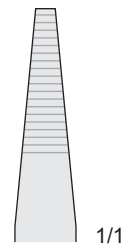

0415-DA
140 mm

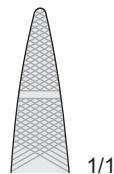

GOSLEE
0415-BG
135 mm

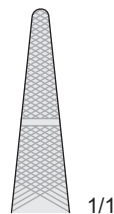

GOSLEE
0415-BH
140 mm

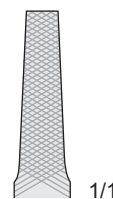

0415-BL
140 mm

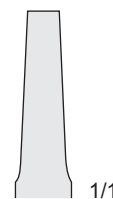

0415-CA
140 mm

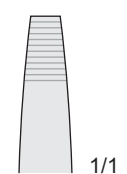

0415-DC
140 mm

Flachzangen

Nose Flat Pliers

Pinze a punte piatte

Alicates planos

Pinces à mors plats



GOSLEE
0415-BI/0415-BIA
140 mm

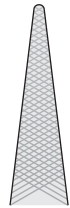

0415-BI
140 mm



1/1

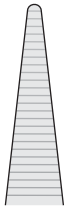

0415-BIA
140 mm

1/1



0415-BF/0415-BFL
150 mm

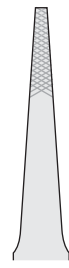

0415-BF

1/1

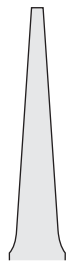

0415-BF11

1/1



OLIVER
0415-DL
130 mm



1/1



0415-CH
125 mm

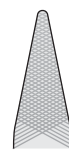

1/1

○ Max Ø 0.7 mm (.028")

Für weichen und harten Draht
For soft and hard Wire
Per filo leggero e duro
Para alambre blando y duro
Pour fil léger e dur

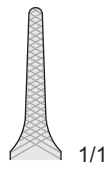

0415-CB

Drahtbiegezange
Wire bending Pliers
Pinza piegafili
Alicates para
doblar alambre
Pinces à courber
les fils

PEESO
0415-CB
135 mm

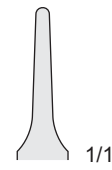

0415-CD

Drahtbiegezange
Wire bending Pliers
Pinza piegafili
Alicates para
doblar alambre
Pinces à courber
les fils

PEESO
0415-CD
135 mm

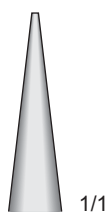

Feines Modell
Fine model
Modello fine

Rundzange
Round Pliers
Pinze con
punta tonda
Alicates de
pico redondo
Pinces à
mors ronds

0415-CC
140 mm

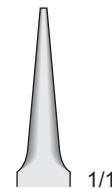

Rundzange
Round Pliers
Pinze con
punta tonda
Alicates de
pico redondo
Pinces à
mors ronds

LANGENBECK
0415-CC12
140 mm



○ Max Ø 1.0 mm (.039")

Schlaufenbiegezeuge
Loop Bending Pliers
Pinze per ansa
Alicates para ansas
Pinces à former les anses

0415-II
140 mm

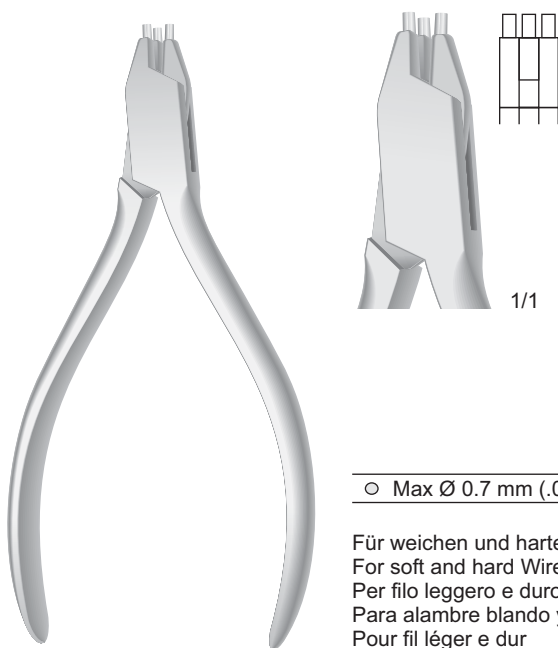

○ Max Ø 0.7 mm (.028")

Für weichen und harten Draht
For soft and hard Wire
Per filo leggero e duro
Para alambre blando y duro
Pour fil léger e dur

0415-IH
125 mm

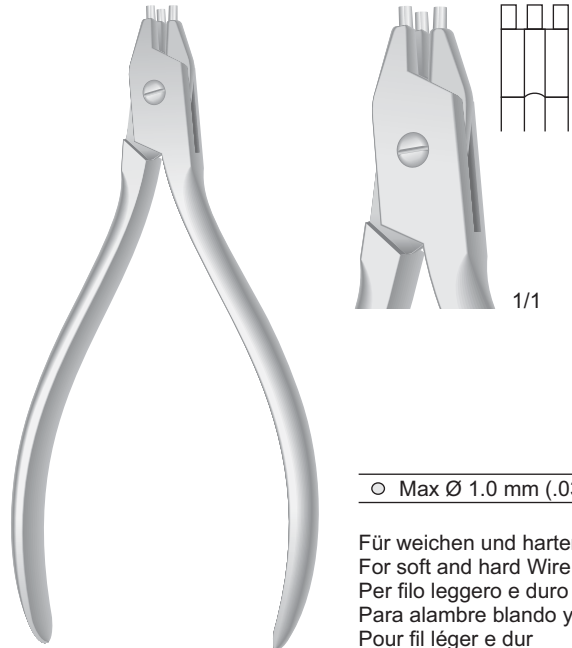

○ Max Ø 1.0 mm (.039")

Für weichen und harten Draht
For soft and hard Wire
Per filo leggero e duro
Para alambre blando y duro
Pour fil léger e dur

0415-IH01
130 mm

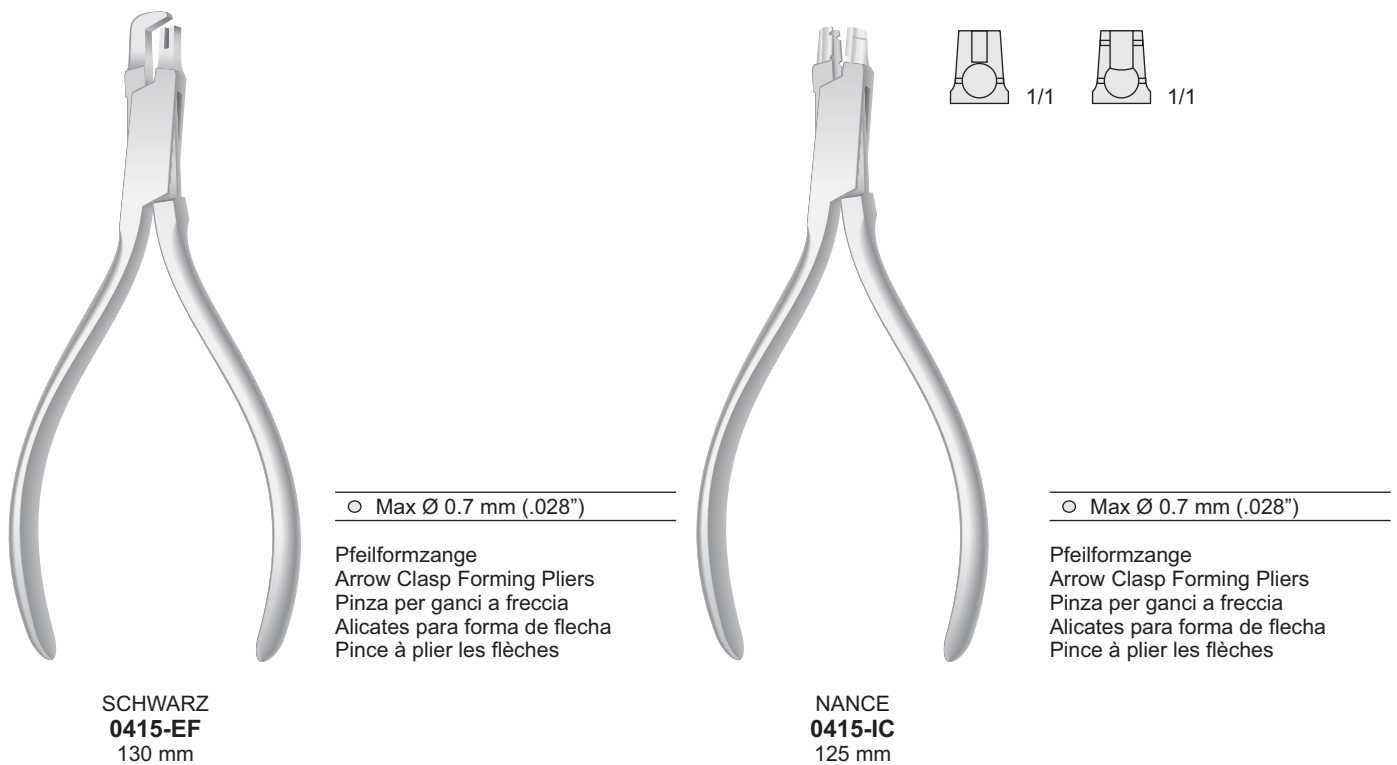
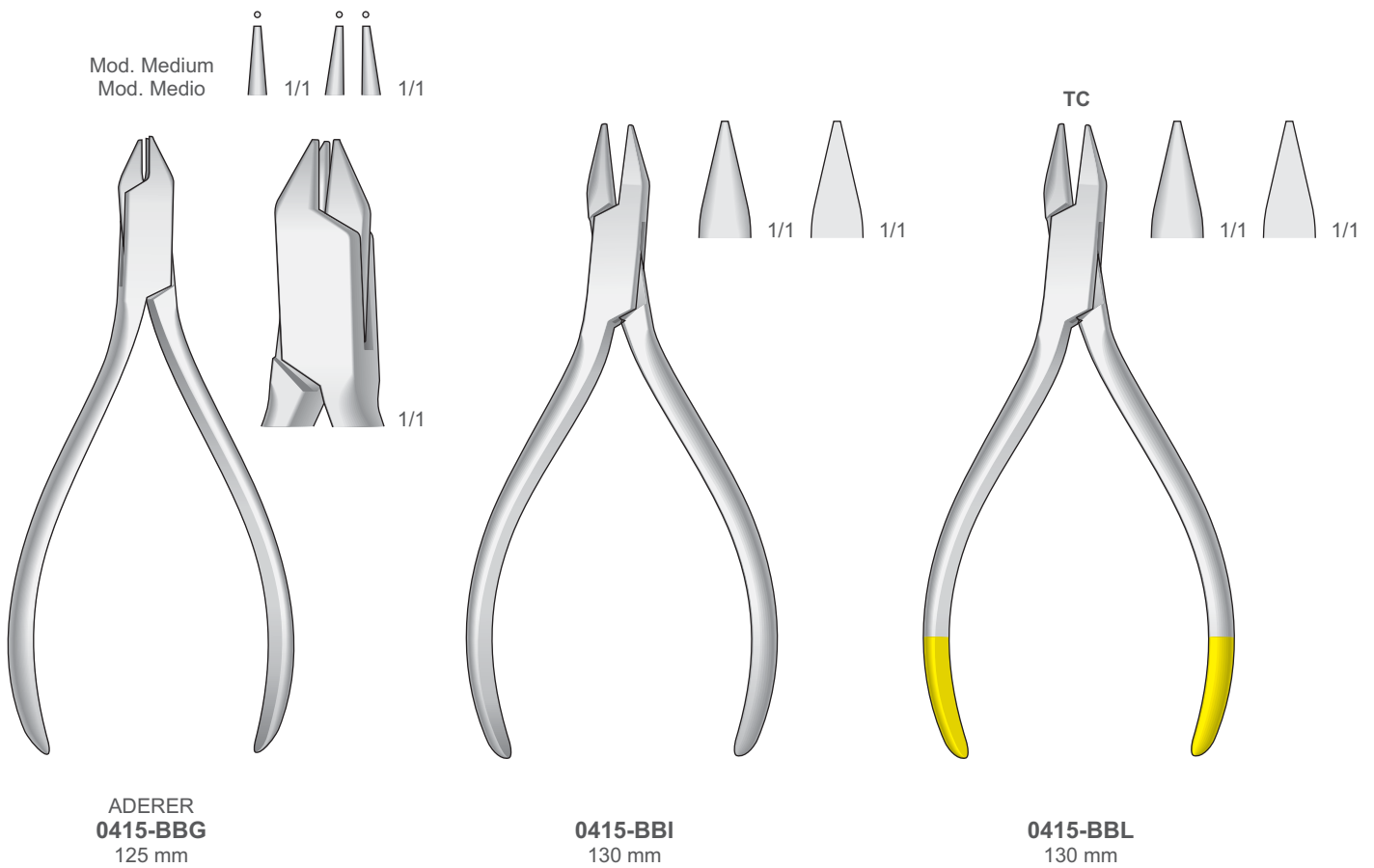



Für Adams-Klammern
For Adams-Clasp
Pinza per formare ganci di Adams
Para ganchos de Adams
Pour Crochets de Adams

○ Max Ø 0.7 mm (.028")

Für weichen und harten Draht
For soft and hard Wire
Per filo leggero e duro
Para alambre blando y duro
Pour fil léger e dur

ADAMS-NANCE
0415-EG
135 mm



○ Max Ø 1.0 mm (.039")

Für weichen und harten Draht
For soft and hard Wire
Per filo leggero e duro
Para alambre blando y duro
Pour fil léger e dur

ADERER
0415-EB
145 mm



○ Max Ø 1.0 mm (.039")

Für weichen und harten Draht
For soft and hard Wire
Per filo leggero e duro
Para alambre blando y duro
Pour fil léger e dur

MALLOTHY
0415-EC
125 mm

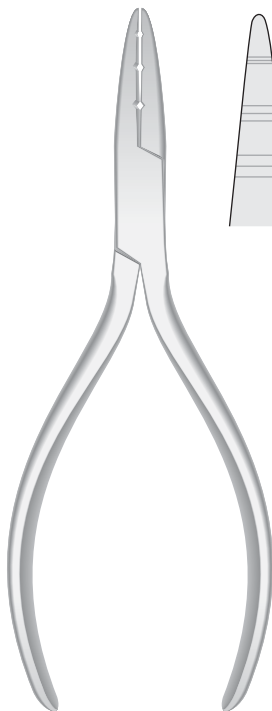

1/1

○ Max Ø 1.0 mm (.039") ○

Für weichen und harten Draht
For soft and hard Wire
Per filo leggero e duro
Para alambre blando y duro
Pour fil léger e dur

ADERER
0415-HH
140 mm



1/1

1/1

○ Max Ø 1.0 mm (.039")

Für weichen und harten Draht
For soft and hard Wire
Per filo leggero e duro
Para alambre blando y duro
Pour fil léger e dur

0415-IL
130 mm

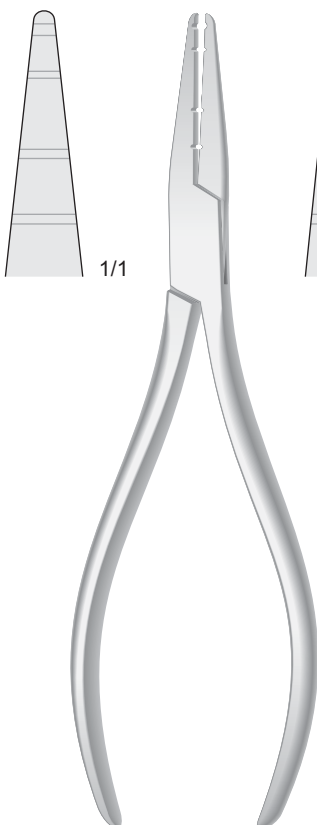

1/1

1/1

○ Max Ø 1.0 mm (.039")

Für weichen und harten Draht
For soft and hard Wire
Per filo leggero e duro
Para alambre blando y duro
Pour fil léger e dur

ADERER
0415-LF
170 mm

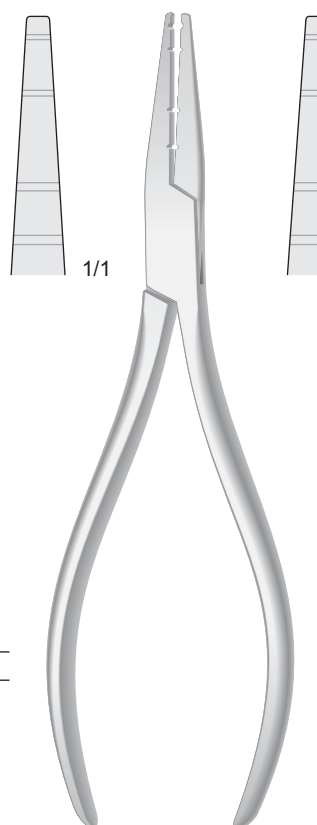

1/1

1/1

○ Max Ø 1.0 mm (.039")

Für weichen und harten Draht
For soft and hard Wire
Per filo leggero e duro
Para alambre blando y duro
Pour fil léger e dur

0415-LH
165 mm

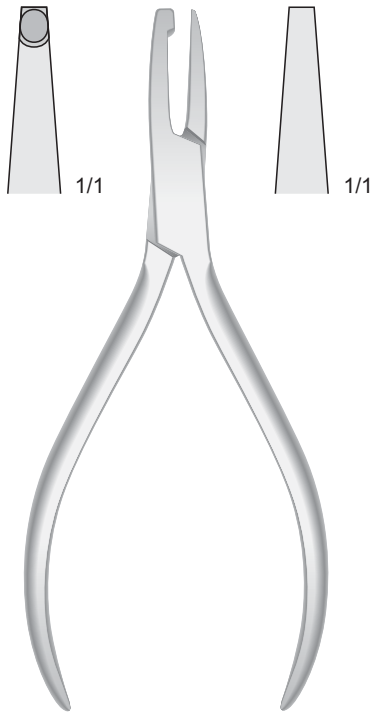

0415-EL
140 mm



REYNOLDS
0415-DD
130 mm



GORDON
0415-DE
135 mm

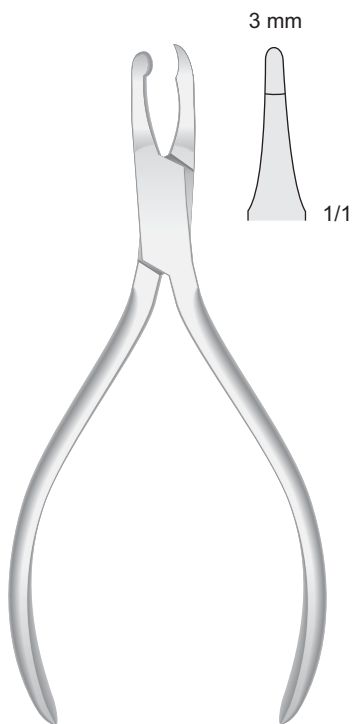

JOHNSON
0415-FB
135 mm

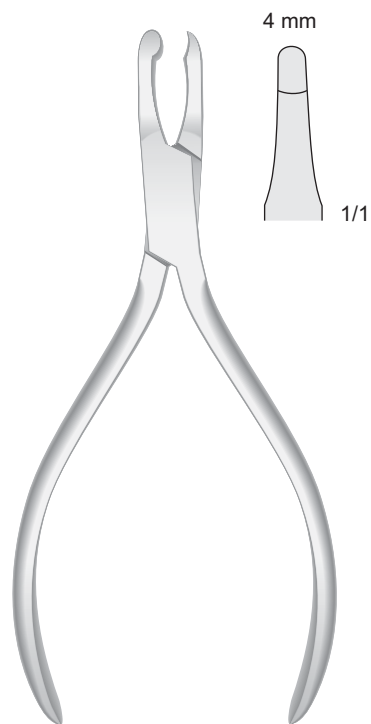

JOHNSON
0415-FD
135 mm

Konturen Zangen

Contouring Pliers

Pinze per contornare

Alicates para contornear

Pinces à contours

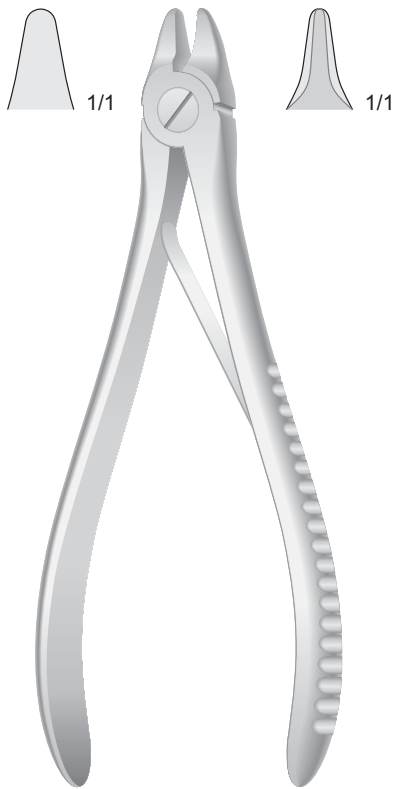

PEESO
0415-LI
155 mm



PEESO
0415-LL
155 mm



1123-IC
185 mm

○ Max Ø 1.6 mm (.063")

Für weichen und harten Draht
For soft and hard Wire
Per filo leggero e duro
Para alambre blando y duro
Pour fil léger e dur



TRIPLEX
0415-LD
165 mm

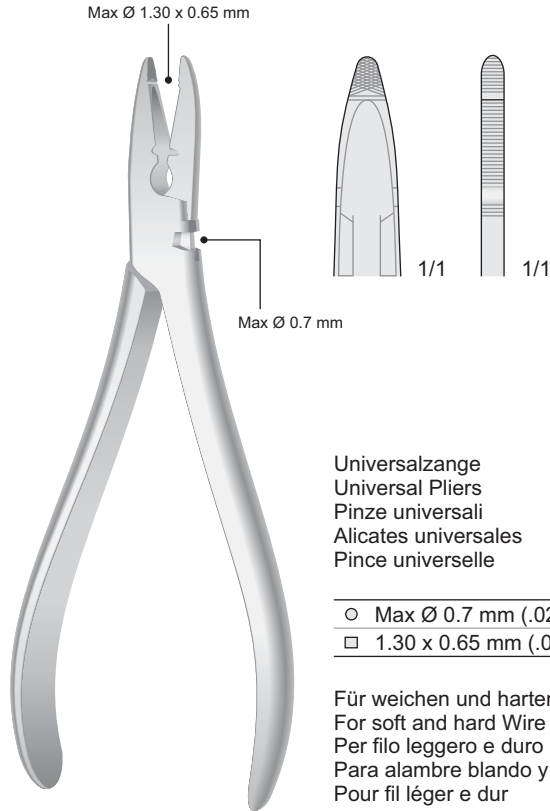

Universalzange
 Universal Pliers
 Pinze universali
 Alicates universales
 Pince universelle

- Max Ø 0.7 mm (.028")
- 1.30 x 0.65 mm (.052" x .026")

Für weichen und harten Draht
 For soft and hard Wire
 Per filo leggero e duro
 Para alambre blando y duro
 Pour fil léger e dur

WALDSACHS
0415-IE
 150 mm

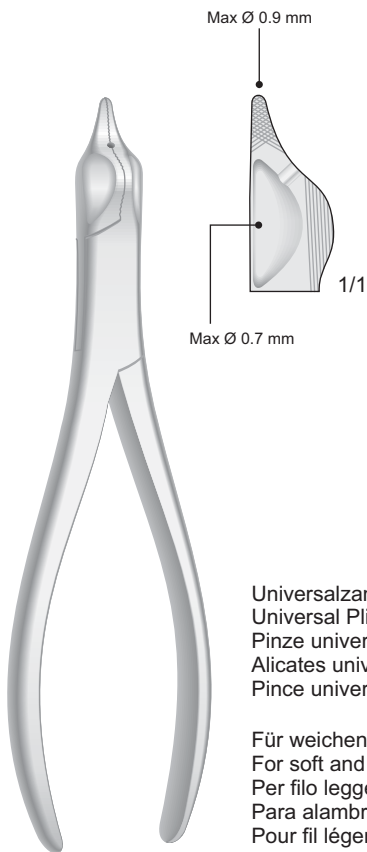

Universalzange
 Universal Pliers
 Pinze universali
 Alicates universales
 Pince universelle

Für weichen und harten Draht
 For soft and hard Wire
 Per filo leggero e duro
 Para alambre blando y duro
 Pour fil léger e dur

0415-HB
 150 mm

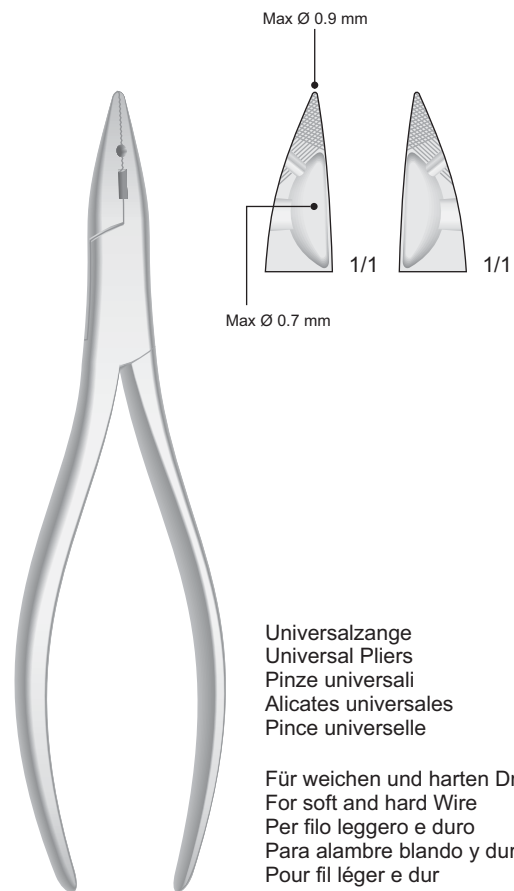

Universalzange
 Universal Pliers
 Pinze universali
 Alicates universales
 Pince universelle

Für weichen und harten Draht
 For soft and hard Wire
 Per filo leggero e duro
 Para alambre blando y duro
 Pour fil léger e dur

0415-HF
 160 mm

Drahtbiegeezangen

Wire bending Pliers

Pinze per piegare fili

Alicates para doblar alambres

Pinces à plier les fils

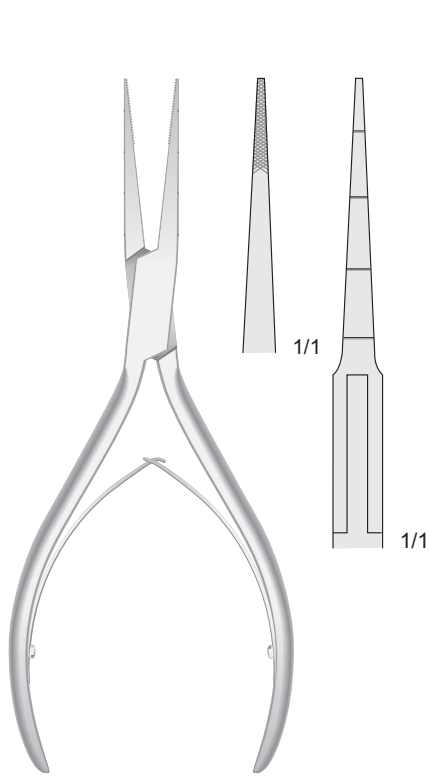

0415-LG
150 mm

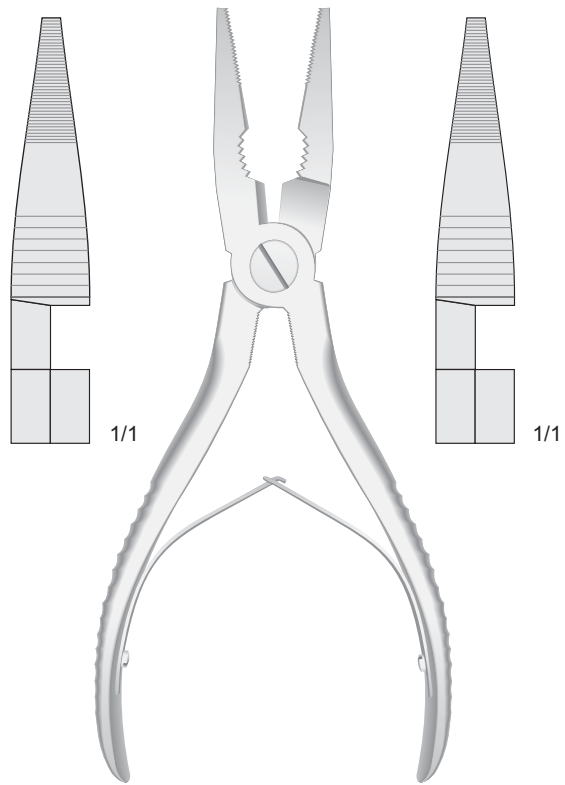

1123-BDF
175 mm

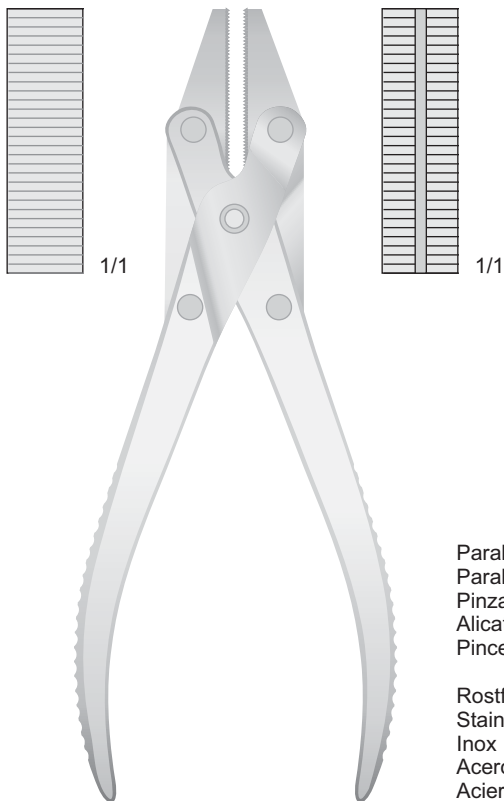

2108-CF
185 mm

Parallel-Flachzange
Parallel Flat pliers
Pinza a branche parallele
Alicates planos
Pinces plates

Rostfrei
Stainless Steel
Inox
Acero
Acier

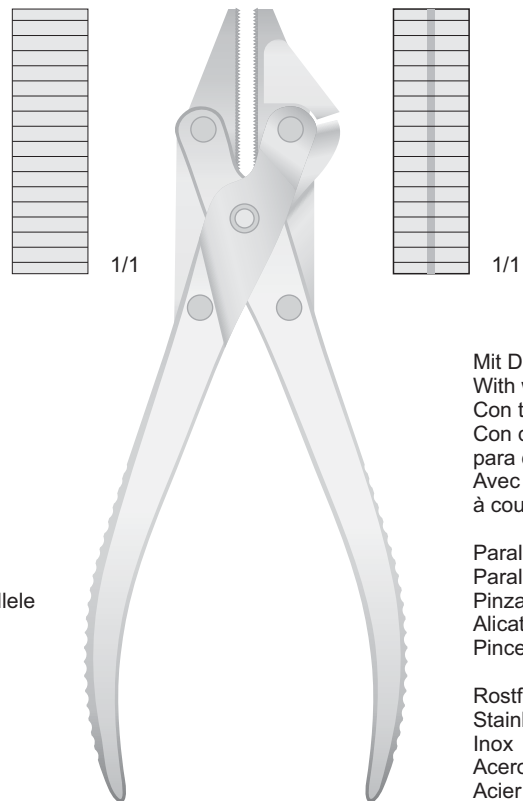

1123-IA
185 mm

Mit Drahtschneider
With wire Cutter
Con tronchese
Con dispositivo
para cortar
Avec dispositif
à couper

Parallel-Flachzange
Parallel Flat pliers
Pinza a branche parallele
Alicates planos
Pinces plates

Rostfrei
Stainless Steel
Inox
Acero
Acier

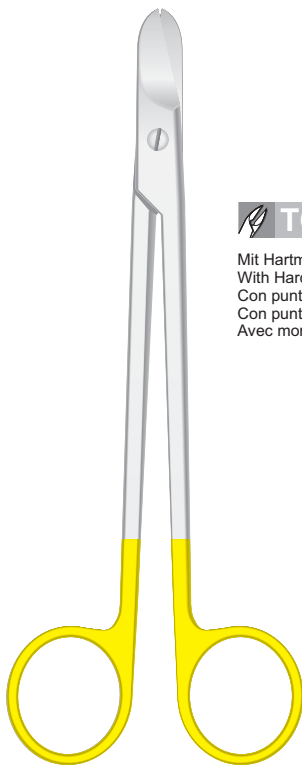

Mit Hartmetalleinsätzen
With Hard Metal Inserts
Con punte in metallo duro
Con puntas de metal duro
Avec mors en métal dur

SMITH
0607-BGA
160 mm

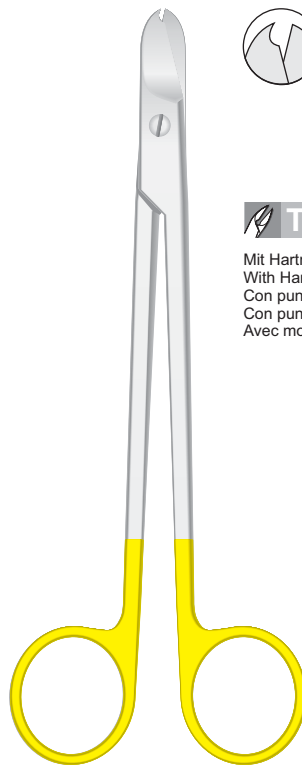

Mit Hartmetalleinsätzen
With Hard Metal Inserts
Con punte in metallo duro
Con puntas de metal duro
Avec mors en métal dur

SMITH
0607-BGB
160 mm

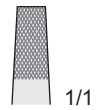

Mit Hartmetalleinsätzen
With Hard Metal Inserts
Con punte in metallo duro
Con puntas de metal duro
Avec mors en métal dur

1508-FI
150 mm

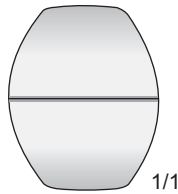
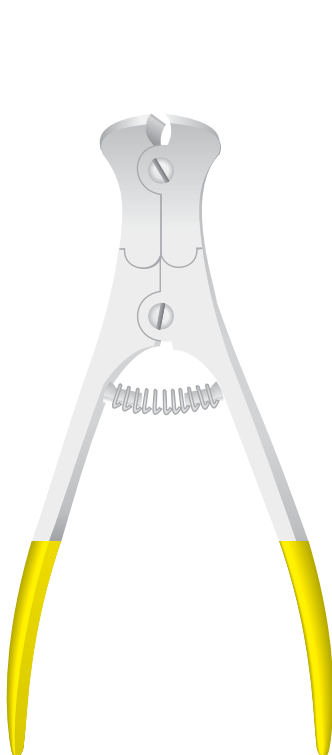

Mit Hartmetalleinsätzen
With Hard Metal Inserts
Con punte in metallo duro
Con puntas de metal duro
Avec mors en métal dur

○ Max Ø 2.0 mm (.078")

Für weichen Draht
For soft Wire
Per filo leggero
Para alambre blando
Pour fil léger

○ Max Ø 1.5 mm (.059")

Für harten Draht
For hard Wire
Per filo duro
Para alambre duro
Pour fil dur

1123-BAC
145 mm

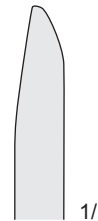

Mit Hartmetalleinsätzen
With Hard Metal Inserts
Con punte in metallo duro
Con puntas de metal duro
Avec mors en métal dur

○ Max Ø 2.0 mm (.078")

Für weichen Draht
For soft Wire
Per filo leggero
Para alambre blando
Pour fil léger

○ Max Ø 1.5 mm (.059")

Für harten Draht
For hard Wire
Per filo duro
Para alambre duro
Pour fil dur

1123-BAD
170 mm

Scheren

Scissors

Forbici

Tijeras

Ciseaux

Scheren für dünne Stahl-und Edelmetallbleche - Scissors for thin steel and precious metal sheets
 Forbici per lamine sottili di acciaio e metalli preziosi - Tijeras para láminas delgadas de acero y metales preciosos
 Ciseaux pour couper les feuilles de métaux

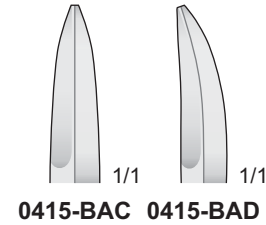
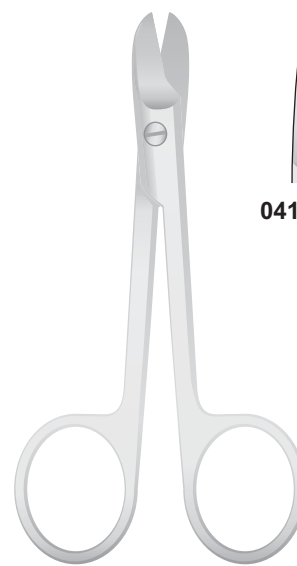
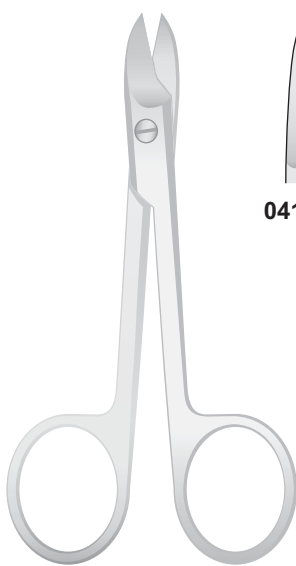

Spitz
 Sharp
 Acute
 Agudas
 Pointus

Stumpf
 Blunt
 Smusse
 Romas
 Mousses

BEEBE
0415-LB/0415-LC
 110 mm

BEEBE
0415-BAC/0415-BAD
 110 mm

Scheren für dünne Stahl-und Edelmetallbleche - Scissors for thin steel and precious metal sheets
 Forbici per lamine sottili di acciaio e metalli preziosi - Tijeras para láminas delgadas de acero y metales preciosos
 Ciseaux pour couper les feuilles de métaux

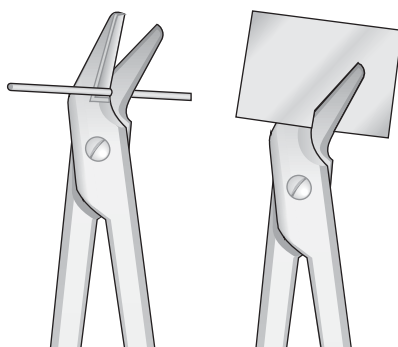
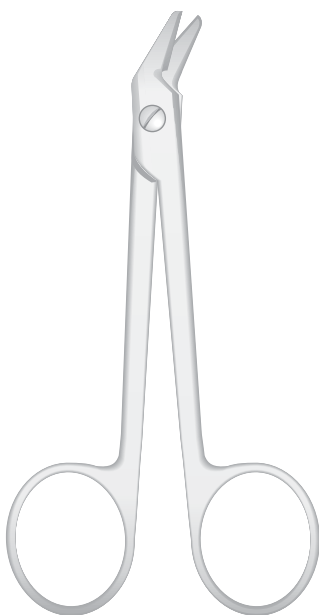

Draht-und Blechscherre gezahnt
 Wire cutting scissor serrated
 Forbice universale dentellata
 Tijeras para cortar hilo
 de acero dentadas
 Coupe-fils dentelés

0415-LA
 120 mm

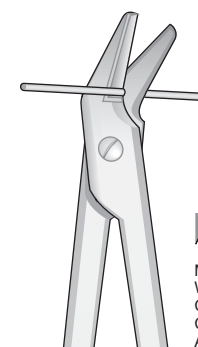
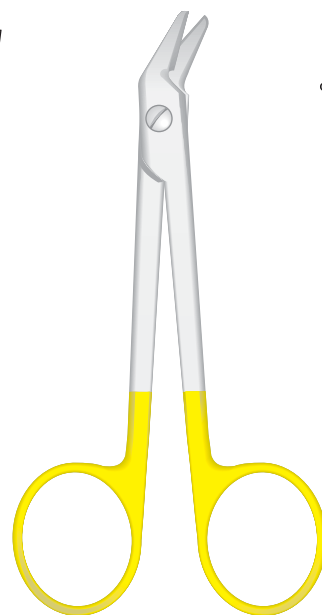

 **TC**
 Mit Hartmetalleinsätzen
 With Hard Metal Inserts
 Con punte in metallo duro
 Con puntas de metal duro
 Avec mors en métal dur

○ Max Ø 1.2 mm (.048")

Für weichen Draht
 For soft Wire
 Per filo leggero
 Para alambre blando
 Pour fil léger

0415-BCA
 120 mm

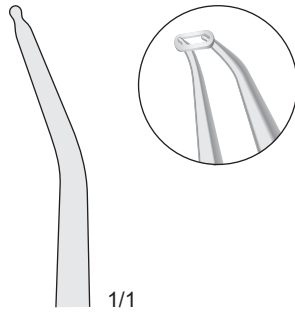

1/1

Separierzange, zum Einbringen von Gummi-Separierligaturen
 Separating forceps, for inserting elastic separators
 Pinze per legature per separatori elastci
 Pinza para ligaduras estira elásticos
 Pince à serrer les ligatures

0406-CA
155 mm

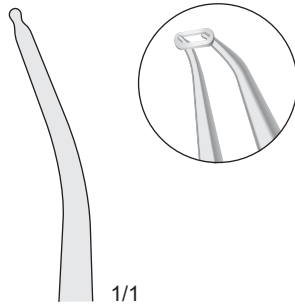
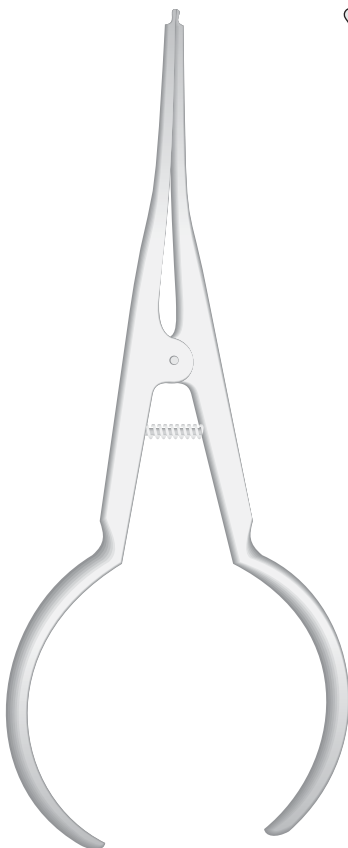

1/1

Separierzange, zum Einbringen von Gummi-Separierligaturen
 Separating forceps, for inserting elastic separators
 Pinze per legature per separatori elastci
 Pinza para ligaduras estira elásticos
 Pince à serrer les ligatures

0406-CB
170 mm

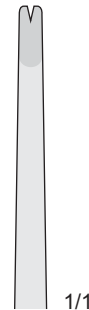
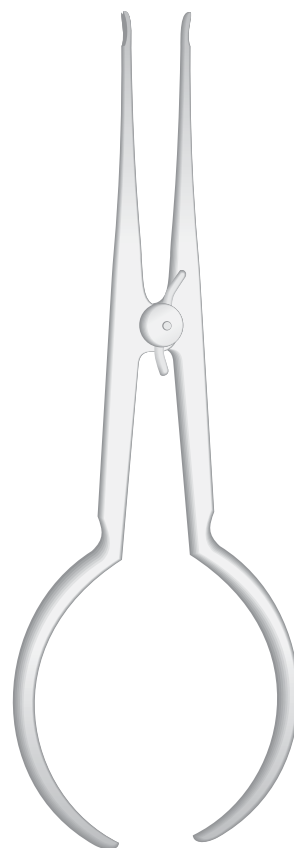

1/1

Ligaturenspannzange
 Ligature Tying Plier
 Pinza per legature
 Pinza para ligaduras
 Pince à serrer les ligatures

0406-FA
170 mm



1514-HG/1514-HH

SMAHA
1514-HG/1514-HH
140 mm

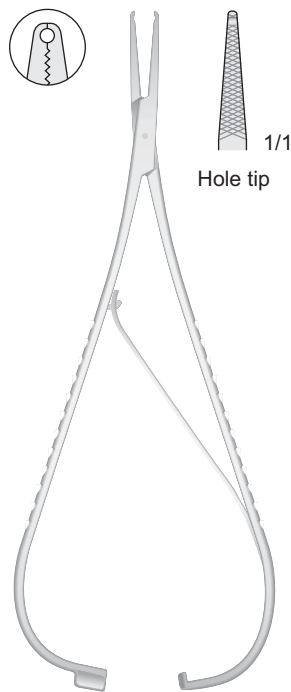

Hole tip

SMAHA
1514-GI
135 mm

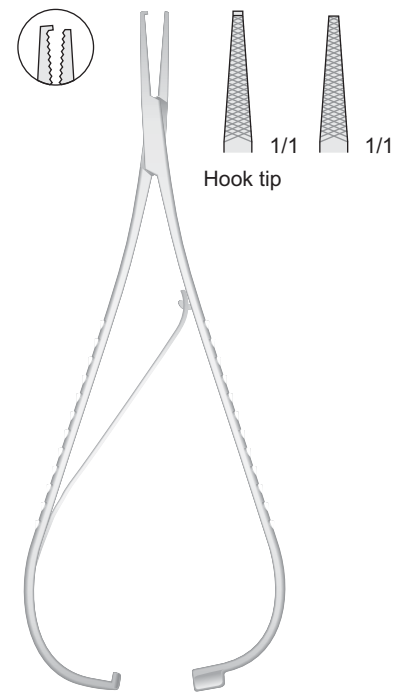

Hook tip

SMAHA
1514-GL
135 mm

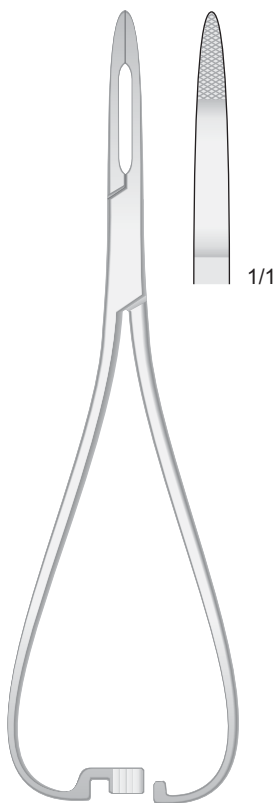

0415-IG
165 mm

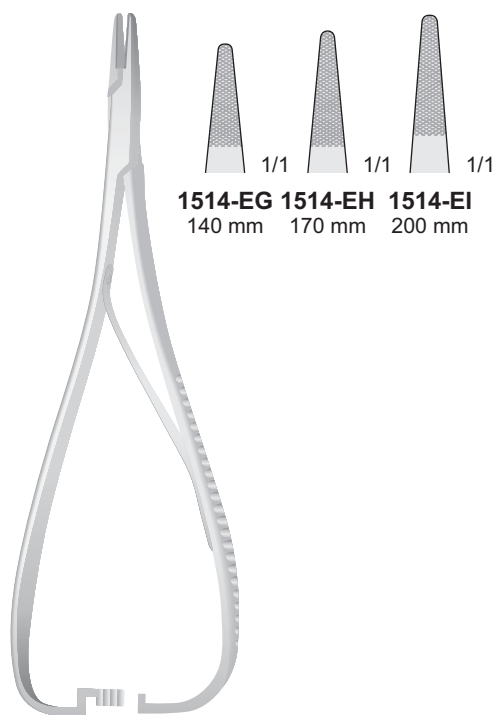

1514-EG 1514-EH 1514-EI
140 mm 170 mm 200 mm

MATHIEU
1514-EG/1514-EI

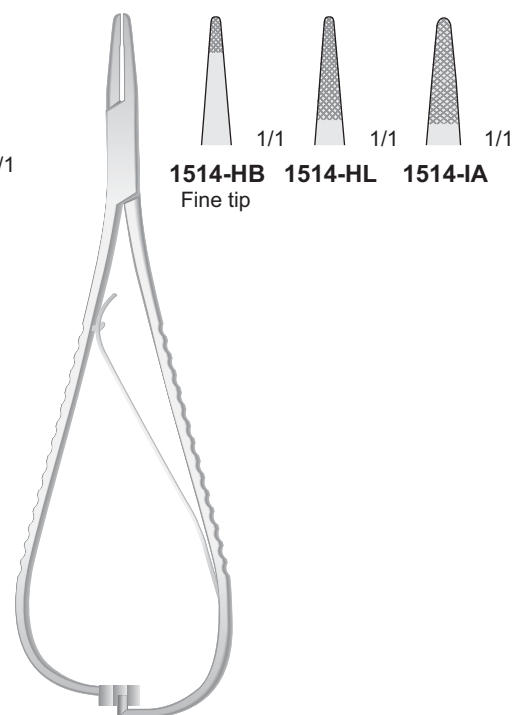

1514-HB 1514-HL 1514-IA
Fine tip

MATHIEU
1514-HB/1514-IA
140 mm



In alluminio
leggero anodizzato

Bracketpositioner
Bracket Positioning Gauge
Posizionatore per
attacchi D.B. Posteriori
Posicionador de Brackets
Jauge à Brackets

0415-BAA
170 mm

Bandandrücker
Band Pusher
Spingibande
in acciaio inox
Empujador de bandas
Instruments pour
poser les bagues

Con punta dentellata



MERSHON
0415-FA
140 mm

Scaler/Pusher, zum Setzen und Abnehmen
von Bändern sowie zum Entfernen
vom Zement und Kleberesten
Scaler/Pusher, for positioning and removing
bands and for removing cement
and adhesive residues
Strumento di utilità, ablatore di cemento
e posizionatore di bande
Instrumentos para adaptar bandas

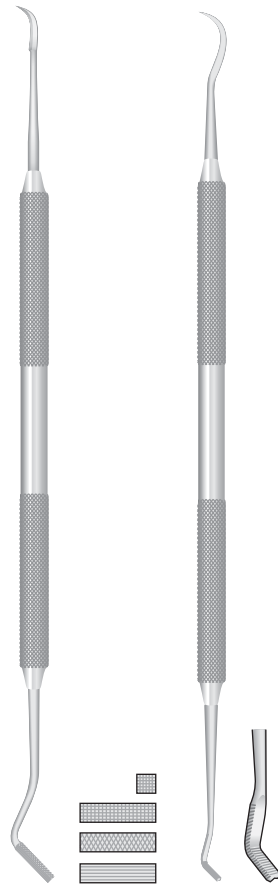

0415-FE
175 mm

Direzionatori
di legature

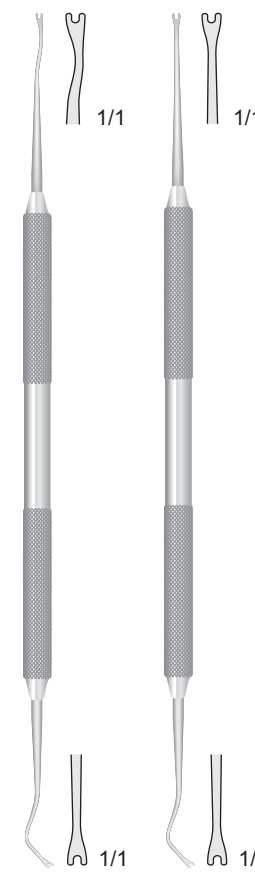

Ligaturen-Setzer
Twirl on instrument
Applicatore per
legature elastiche
Instrumentos para
aplicar las ligaduras
Instrument pour
appliquer
les ligatures

SHURE
0415-BCE
175 mm

1506-B
170 mm

1506-C
170 mm

1506-D
160 mm



PEAN-MURPHY
0206-CC
130 mm

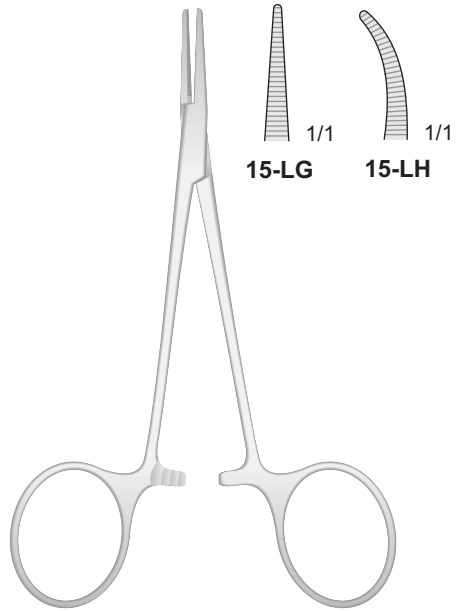

HALSTED-MOSQUITO
15-LG/15-LH
120 mm

Bracketset Pinzette
Forceps for positioning Brackets
Pinzette per riposizionare
gli attacchi diretti
(posizionamento dei Bracket)
Pinza para colocar Brackets
Précelle pour positionner
les Brackets



03141111050705
150 mm



MILLER
0417-HI
145 mm



0415-FC
130 mm



0415-BCG
110 mm



0415-BCH
125 mm



0415-BCI
145 mm

Dental-Schieblehre für Praxis und Labor
 Gauge Caliper for practice and laboratory
 Calibri dentali per studio e laboratorio
 Calibrador dental para el gabinete y el laboratorio
 Gauge calibreur pour cabinet et laboratoire

Meßbereich: 0 - 10 mm
 Measuring range: 0 - 10 mm
 Campo di misura: 0 - 10 mm
 Alcance de medición: 0 - 10 mm
 Etendue de mesure: 0 - 10 mm



IWANSON
0415-HCA
 100 mm



ZIELINSKY
0415-HCF
 110 mm

Meßbereich: 0 - 100 mm
 Measuring range: 0 - 100 mm
 Campo di misura: 0 - 100 mm
 Alcance de medición: 0 - 100 mm
 Etendue de mesure: 0 - 100 mm

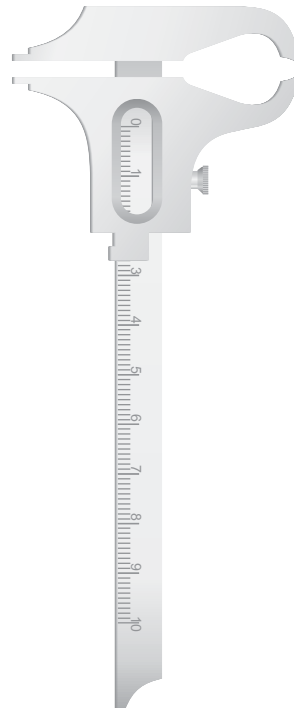

BOLEY
0415-HDA
 140 mm

Inches - mm



1118-AL
 150 mm

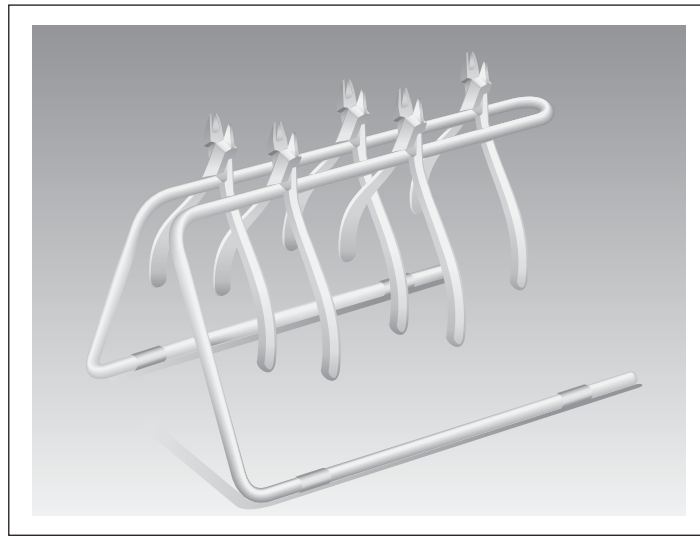

Zangenständer
 Plier Stand
 Supporto per pinze
 Soportes para alicates
 Supports de pinces

Rostfrei - Stainless Steel
 Acciaio Inox - Acero - Acier

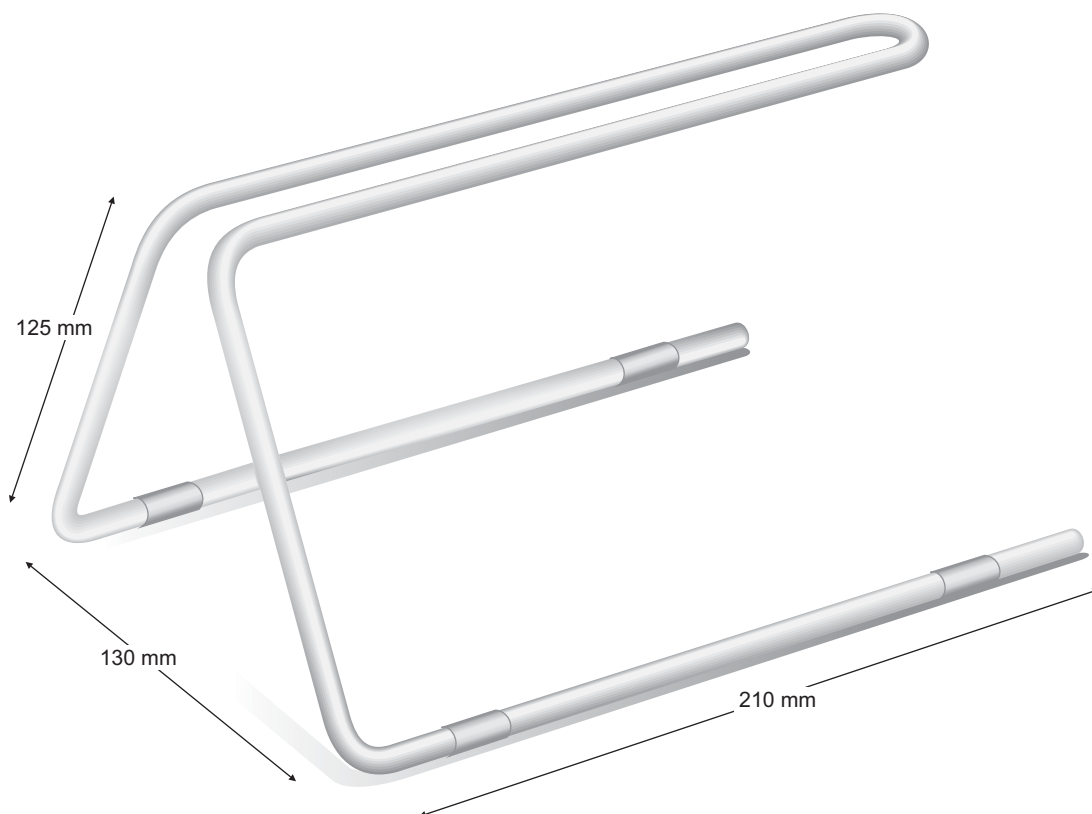

0415-BEA

Zubehör - Laboratorium
Accessories - Laboratory
Accessori - Laboratorio
Accesorios - Laboratorio
Accessoires - Laboratoire

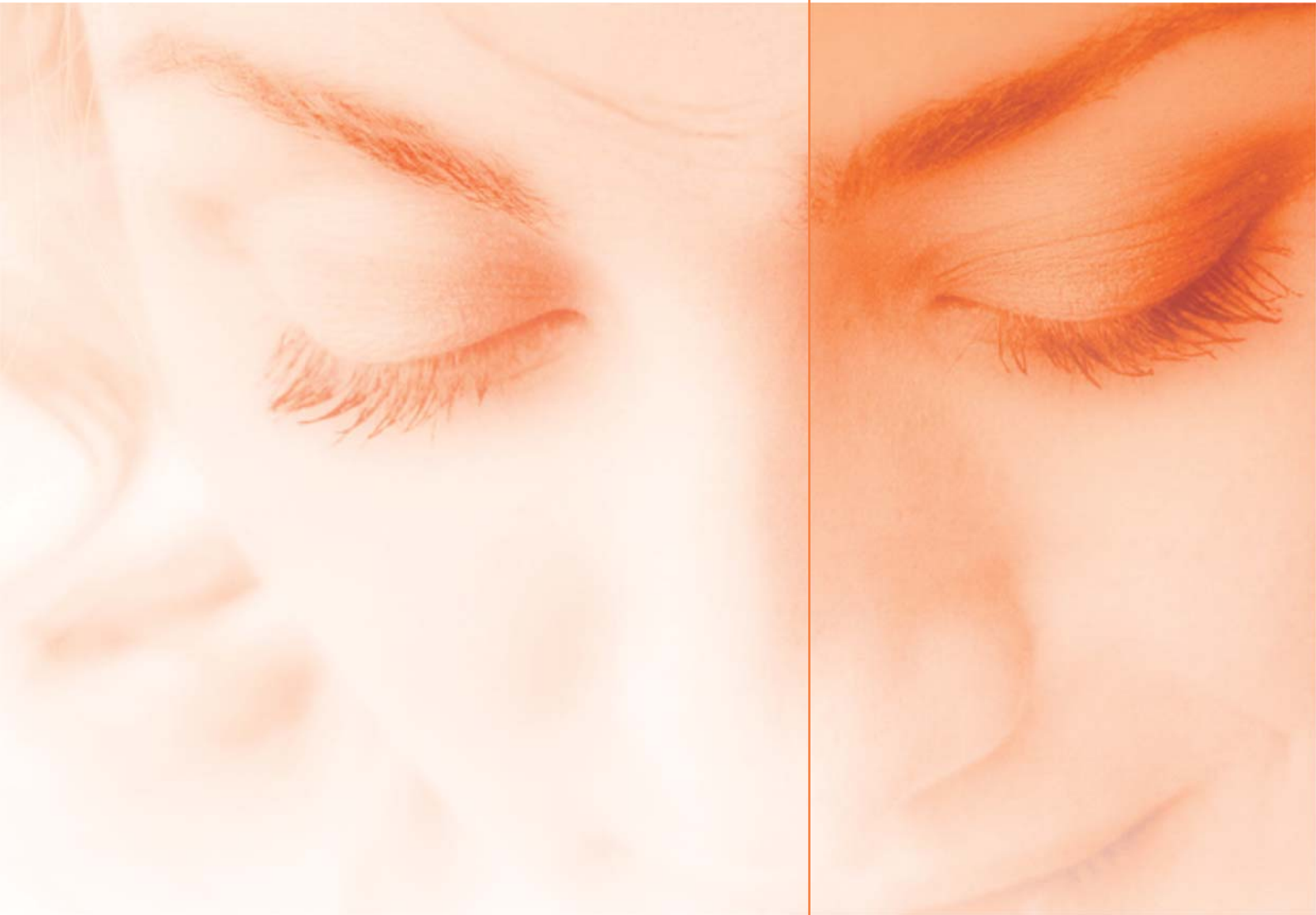



KERLING
0415-DI01
145 mm

Kupferringabnehmezange
Copper ring removing Pliers
Pinza per togliere anelli di rame
Pinza para sacar anillos de cobre
Pince à enlever les bgues en cuivre



FURRER
0415-DI
145 mm

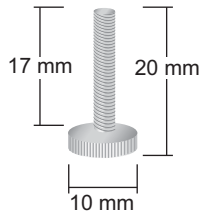

0415-DI17
Schraube
Replacement Screw
Vite di ricambio
Tornillos de recambio
Rechange

Kupferringabnehmezange
Copper ring removing Pliers
Pinza per togliere anelli di rame
Pinza para sacar anillos de cobre
Pince à enlever les bgues en cuivre

Teleskopkronenzangen - Pliers for telescope crowns
Pinze per corone telescopiche - Alicates para coronas telescópicas
Pinces pour couronnes telescopes

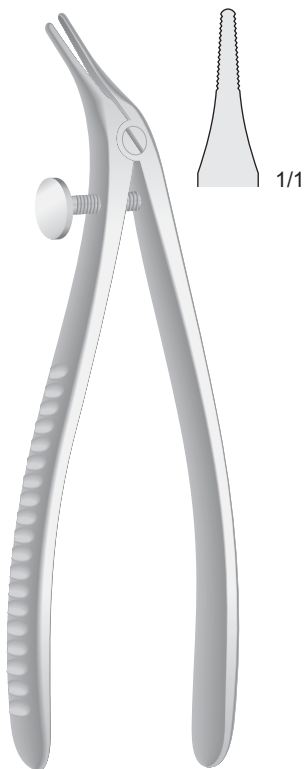

BÖHM
0415-CI
150 mm

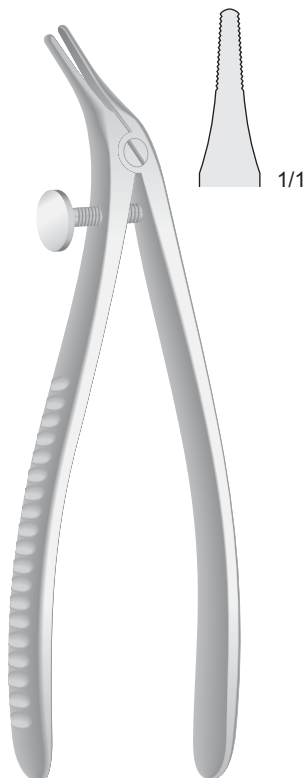

BÖHM
0415-CL
150 mm



0415-CE
120 mm



0415-CE03 **0415-CE17**
Schlüssel
Key
Chiavetta
Llave
Clé
Diamantierte Einsätze, paarweise
Diamond inserts, in pairs
Coppia di punte diamantate
Puntas diamantadas, a pares
Pointes diamantées, par paires

Instrumente
für Prothetik

Instruments
for prosthetics

Strumenti
per protesi

Instrumentos
para prótesis

Instruments
pour la prothèse



FAHNENSTOCK
0315

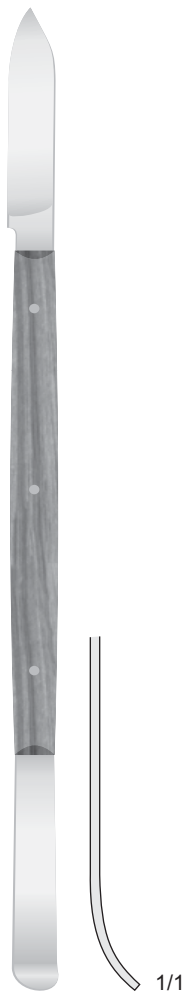

FAHNENSTOCK
0307



LESSMANN
031511

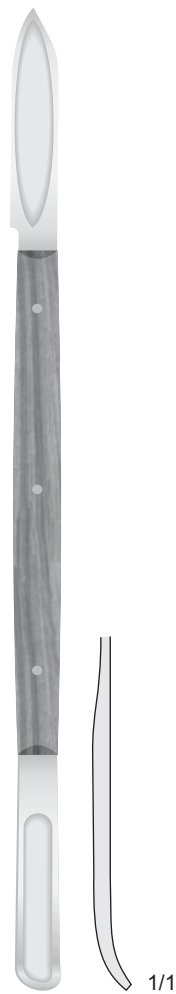

LESSMANN
030711



031518

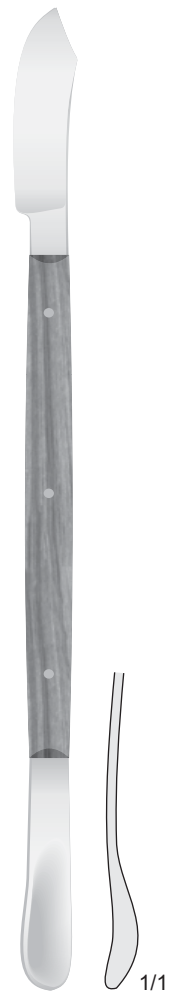

030718

Instrumente
für Prothetik

Instruments
for prosthetics

Strumenti
per protesi

Instrumentos
para prótesis

Instruments
pour la prothèse

Flexibel
Flexible
Flessibili
Flexibel

Spatola inox
Spatel inox



0312
175 mm



1801-B
200 mm



1801-C
200 mm



1801-D
200 mm



18BI-I
185 mm

Olio lubrificante per strumenti chirurgici

RODHOIL

Schmiermittel mit hoher Dichte. Es sichert den perfekten Gebrauch und die Leichtgängigkeit aller chirurgischen Instrumente. Man gibt es auf die Verbindungen und Gelenke und in alle beweglichen Teile, die Reibungen unterworfen sind.

RODHOIL

Lubrificant to high density. It assures the perfect utility and fluency of all the surgical instruments. For apply in to loosens, join and in all the parts in subject movement subject to attrition.

RODHOIL

Lubrificante ad alta densità. Assicura la perfetta funzionalità e scorrevolezza di tutti gli strumenti chirurgici. Da applicare negli snodi, giunture e in tutte le parti in movimento soggette ad attrito.



0402-141117
50 cc

Das wasserlösliche Schmiermittel verlängert die Lebensdauer von chirurgischen Instrumenten

Soluble lubricant extends useful life of surgical instruments

Lubrificante anticorrosivo e detergente per strumenti chirurgici

Lubrificante soluble en agua, so uso prolonga

la duraciòn de los instrumentos quirùrgicos

Lubrifiant soluble dans l'eau prolonge la vie

des instruments chirurgicaux

CLEANLACT

Reinigungskonzentrat für chirurgische Instrumente. Es wirkt antibakteriell, nicht-ätzend und schmierig. Es garantiert die perfekte Erhaltung aller Instrumente aus Stahl, entfernt eventuelle Flecken, Ränder, und Bräunungen von Sterilisationen, Desinfektionen und Reinigungen mit hartem Wasser. Es sollte regelmäßig verwendet werden.

CLEANLACT

Product concentrated for surgical instruments. It explains an action anti-corrosive, antibacterium and lubricant. It guarantees the perfect maintenance of all the instruments in steel eliminating eventual stains and burnishes to sterilization, disinfection and to washings with hard waters. It used periodically.

CLEANLACT

Prodotto concentrato per strumenti chirurgici. Esplica un azione anticorrosiva batteriostatica e lubrificante. Garantisce il perfetto mantenimento di tutti gli strumenti in acciaio eliminando eventuali macchie, aloni e bruniture dovute a sterilizzazioni, disinfezioni e a lavaggi con acque dure. Va usato periodicamente.



0402-FA12
500 cc

0402-B11
1000 cc

Steril
Container

Sterilizing
containers

Contenitori per
sterilizzare

Contenedores
para esterilizaci3n

Containers
pour st3rilizer

Schalen
Trays
Vassoi porta-strumenti
Bandejas
Bassins



2118-CA 210 x 110 x 25 mm
2118-CG 250 x 180 x 30 mm
2118-DA 300 x 220 x 30 mm

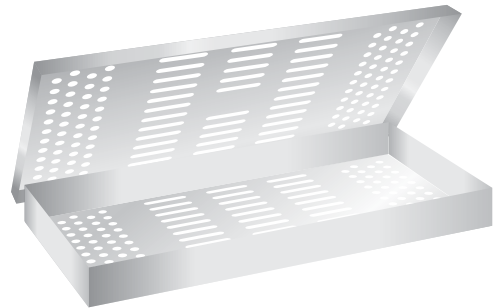

0218-EB
275 x 130 x 25 mm

Rectengular drum
Cestelli rettangolari
Panier rectangulaire

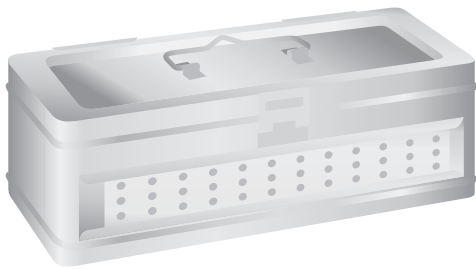

0318-dc 300 x 150 x 60 mm
0318-DD 300 x 150 x 90 mm
0318-DE 300 x 150 x 180 mm

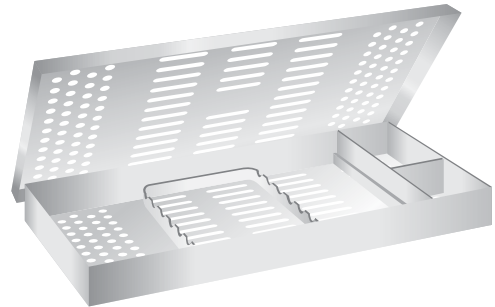

0218-EA 275 x 130 x 25 mm Con griglia e scomparti
0218-EC 285 x 190 x 25 mm Con griglia e scomparti

Silikonmatte
Matte en silicone
Tappeti in aghi di silicone
Tapete en agujas de silicona
Tapis en Silicone

Sterilisierbar
Autoclavable
Autoclavabili

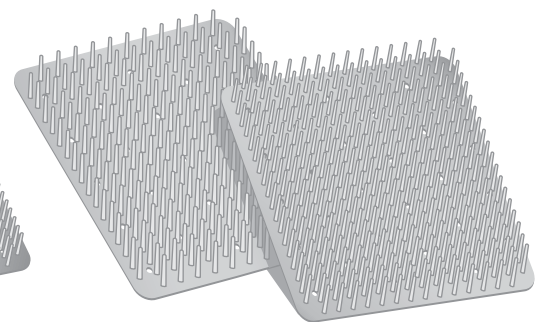
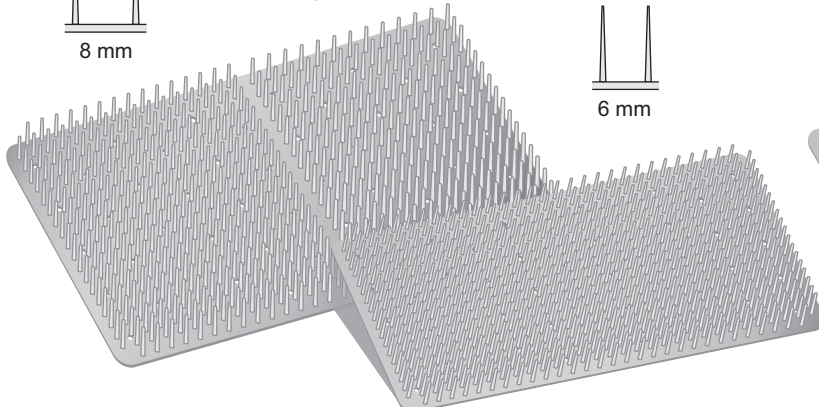
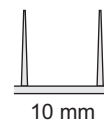
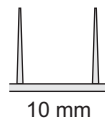
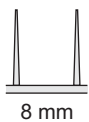

1918-BAE
270 x 180 mm

1918-BAD
260 x 120 mm

1918-BAC
135 x 180 mm

1918-BAB
135 x 180 mm

Alfabetisches Inhaltsverzeichnis
Alphabetical Index
Indice alfabetico
Indice alfabetico
Index alphabetique

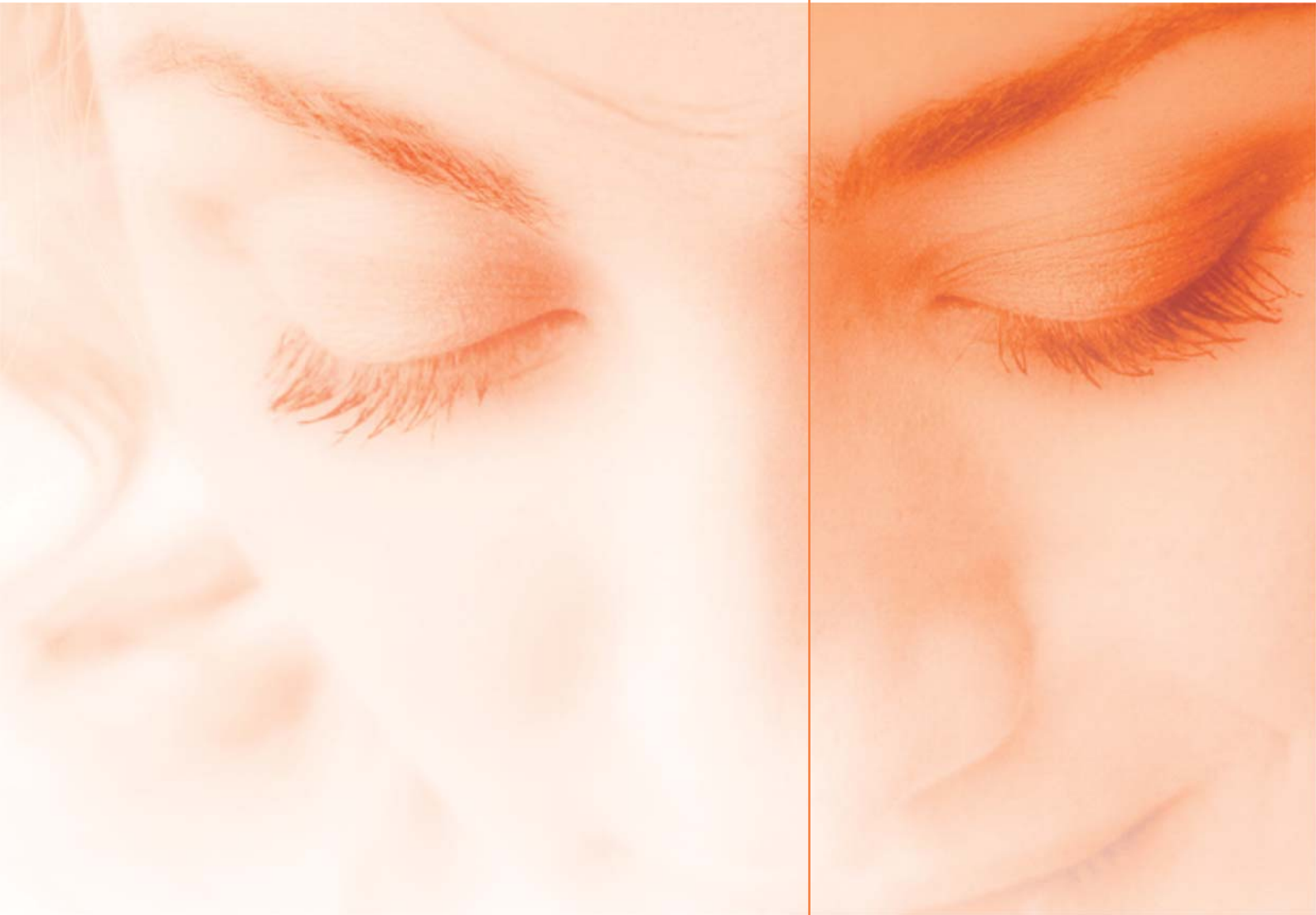

A

ADAMS , Drahtbiegezange	17
ADAMS-NANCE , Drahtbiegezange	31
ADERER , Drahtbiegezange	16, 31, 32
- Abnehmezange	24, 25
ANDERSEN , Hohlkehlzangen	23
ANGLE , Light Wire-Biegezange, Begg Typ	13
- Schneidezangen Ligaturen-Cutter	3
ANGLE-TWEED , Bogenbiegezangen	18

B

BEEBE , Scheren	38
BÖHM , Kroneninstrumente	47
BOLEY , Meßinstrumente	43

C

COLLEGE , Zahnpinzette	42
-------------------------------	----

D

DE LA ROSA , Konturenzangen	20
------------------------------------	----

F

FAHNENSTOCK , Wachsmesser	48
FISCHER , Flachzangen	26
FURRER , Kroneninstrumente	47

G

GORDON , Konturenzangen	33
GOSLEE , Flachzangen	26, 27

H

HALSTED-MOSQUITO , Ligaturen Instrumente	42
HOLLOW-CHOP , Hohlkehlzangen	22
HOW , Universalzange für die Multibandtechnik	15

I

IWANSON , Meßinstrumente	43
---------------------------------	----

J

JARABAK , Drahtbiegezange	12
- Hohlkehlzangen	23
JOHNSON , Konturenzangen	33

K

KERLING , Kroneninstrumente	47
------------------------------------	----

L

LANGENBECK , Drahtbiegezange	28
LESSMANN , Wachsmesser	48

M

MALLOTHY , Drahtbiegezange	31
MATHIEU , Ligaturen Instrumente	40
McKELLOPS , Hohlkehlzangen	23
MERSHON , Instrumente	41

MILLER , Artikulationspapierpinzette	42
---	----

N

NANCE , Schlaufen-Biegezange	20
- Drahtbiegezange	30

O

OLIVER , Bandabnehmezangen	25
- Flachzangen	27

P

PEAN-MURPHY , Ligaturen Instrumente	42
PEESO , Konturenzangen	34
- Drahtbiegezange	28

R

REYNOLDS , Konturenzangen	33
----------------------------------	----

S

SCHWARZ , Drahtbiegezange	30
- Hohlkehlzangen mit Graduierung	22
SHURE , Instrumente	41
SMAHA , Ligaturen Instrumente	40
SMITH , Drahtschneidezangen	37

T

TRIPLEX , Konturenzangen	34
TWEED , Bogenbiegezangen	18, 20, 21

W

WALDSACHS , Drahtbiegezange	35
WEINGART , Universalzange	14

Y

YOUNG , Bogenbiegezangen	21
---------------------------------	----

Z

ZIELINSKY , Meßinstrumente	43
-----------------------------------	----

Alphabetisches Inhaltsverzeichnis	Alphabetical Index	Indice alfabetico	Indice alfabetico	Index alphabétique
A				
ADAMS , Wire Bending Pliers	17			
ADAMS-NANCE , Wire Bending Pliers	31			
ADERER , Wire Bending Pliers	16, 31, 32			
- Removing Pliers	24, 25			
ANDERSEN , Loop Forming Pliers, Gauge	23			
ANGLE , Begg-type light wire Bending Pliers	13			
- Ligature Cutters	3			
ANGLE-TWEED , Arch Forming Pliers	18			
B				
BEEBE , Scissors	38			
BÖHM , Crown Instruments	47			
BOLEY , Measuring Instruments	43			
C				
COLLEGE , Dressing Pliers	42			
D				
DE LA ROSA , Arch Forming Pliers	20			
F				
FAHNENSTOCK , Wax Knives	48			
FISCHER , Nose Flat Pliers	26			
FURRER , Crown Instruments	47			
G				
GORDON , Contouring Pliers	33			
GOSLEE , Nose Flat Pliers	26, 27			
H				
HALSTED-MOSQUITO , Ligating Instruments	42			
HOLLOW-CHOP , Loop Forming Pliers, Gauge	22			
HOW , Universal Forceps for Multiband Technique	15			
I				
IWANSON , Measuring Instruments	43			
J				
JARABAK , Begg-type light wire Bending Pliers	12			
- Loop Forming Pliers, Gauge	23			
JOHNSON , Contouring Pliers	33			
K				
KERLING , Crown Instruments	47			
L				
LANGENBECK , Wire Bending Pliers	28			
LESSMANN , Wax Knives	48			
M				
MALLOTHY , Wire Bending Pliers	31			
MATHIEU , Ligating Instruments	40			
McKELLOPS , Loop Forming Pliers, Gauge	23			
MERSHON , Utility Instruments	41			
		MILLER , Forceps for articulating paper		42
N				
		NANCE , Arch Forming Pliers		20
		- Wire Bending Pliers		30
O				
		OLIVER , Band Remover		25
		- Nose Flat Pliers		27
P				
		PEAN-MURPHY , Ligating Instruments		42
		PEESO , Contouring Pliers		34
		- Wire Bending Pliers		28
R				
		REYNOLDS , Contouring Pliers		33
S				
		SCHWARZ , Wire Bending Pliers		30
		- Bending Pliers with graduation		22
		SHURE , Utility Instruments		41
		SMAHA , Ligating Instruments		40
		SMITH , Wire Cutting Scissors		37
T				
		TRIPLEX , Contouring Pliers		34
		TWEED , Arch Forming Pliers		18, 20, 21
W				
		WALDSACHS , Wire Bending Pliers		35
		WEINGART , Universal Pliers		14
Y				
		YOUNG , Arch Forming Pliers		21
Z				
		ZIELINSKY , Measuring Instruments		43

A

ADAMS , Pinze per piegare fili	17
ADAMS-NANCE , Pinze per piegare fili	31
ADERER , Pinze per piegare fili	16, 31, 32
- Pinze per rimozione	24, 25
ANDERSEN , Pinze scanalate concave e convesse	23
ANGLE , Pinze a becco di uccello	13
- Tronchesi per legature	3
ANGLE-TWEED , Pinze per formare archi	18

B

BEEBE , Forbici	38
BÖHM , Pinza per corone	47
BOLEY , Strumenti per misura	43

C

COLLEGE , Pinzetta di utilità	42
--------------------------------------	----

D

DE LA ROSA , Pinze per formare archi	20
---	----

F

FAHNENSTOCK , Coltelli per cera	48
FISCHER , Pinze a punte piatte	26
FURRER , Pinza per corone	47

G

GORDON , Pinze per contornare	33
GOSLEE , Pinze a punte piatte	26, 27

H

HALSTED-MOSQUITO , Strumenti per legature	42
HOLLOW-CHOP , Pinze scanalate concave e convesse	22
HOW , Pinze di utilità per archi	15

I

IWANSON , Strumenti per misura	43
---------------------------------------	----

J

JARABAK , Pinze a becco di uccello	12
- Pinze scanalate concave e convesse	23
JOHNSON , Pinze per contornare	33

K

KERLING , Pinza per corone	47
-----------------------------------	----

L

LANGENBECK , Pinze per piegare fili	28
LESSMANN , Coltelli per cera	48

M

MALLOTHY , Pinze per piegare fili	31
MATHIEU , Strumenti per legature	40
McKELLOPS , Pinze scanalate concave e convesse	23
MERSHON , Strumenti di utilità	41

MILLER , Pinzetta per carta articolazione	42
--	----

N

NANCE , Pinza per formare archi	20
- Pinze per piegare fili	30

O

OLIVER , Pinza per rimuovere le bande	25
- Pinze a punte piatte	27

P

PEAN-MURPHY , Strumenti per legature	42
PEESO , Pinza per contornare	34
- Pinze per piegare fili	28

R

REYNOLDS , Pinze per contornare	33
--	----

S

SCHWARZ , Pinze per piegare fili	30
- Pinze scanalate con gradazione	22
SHURE , Strumento di utilità	41
SMAHA , Strumenti per legature	40
SMITH , Forbici per fili metallici	37

T

TRIPLEX , Pinze per contornare	34
TWEED , Pinze per formare archi	18, 20, 21

W

WALDSACHS , Pinze per piegare fili	35
WEINGART , Pinze universali	14

Y

YOUNG , Pinze per formare archi	21
--	----

Z

ZIELINSKY , Strumenti per misura	43
---	----

Alphabetisches Inhaltsverzeichnis	Alphabetical Index	Indice alfabetico	Indice alfabetico	Index alphabétique
A				
ADAMS , Alicates para doblar alambre	17			
ADAMS-NANCE , Alicates para doblar alambre	31			
ADERER , Alicates para doblar alambre	16, 31, 32			
- Alicates para remover	24, 25			
ANDERSEN , Alicates acanalados	23			
ANGLE , Alicates para doblar, tipo Begg	13			
- Alicates para cortar ligaduras	3			
ANGLE-TWEED , Alicates para doblar arcos	18			
B				
BEEBE , Tijeras	38			
BÖHM , Alicates para coronas	47			
BOLEY , Instrumentos para medir	43			
C				
COLLEGE , Pinza para curaciones	42			
D				
DE LA ROSA , Alicates para doblar arcos	20			
F				
FAHNENSTOCK , Cuchillos para cera	48			
FISCHER , Alicates planos	26			
FURRER , Alicates para coronas	47			
G				
GORDON , Alicates para contornear	33			
GOSLEE , Alicates planos	26, 27			
H				
HALSTED-MOSQUITO , Instrumentos para ligaduras	42			
HOLLOW-CHOP , Alicates acanalados	22			
HOW , Alicates para doblar arcos	15			
I				
IWANSON , Instrumentos para medir	43			
J				
JARABAK , Alicates para doblar, tipo Begg	12			
- Alicates acanalados	23			
JOHNSON , Alicates para contornear	33			
K				
KERLING , Alicates para coronas	47			
L				
LANGENBECK , Alicates para doblar alambre	28			
LESSMANN , Cuchillos para cera	48			
M				
MALLOTHY , Alicates para doblar alambre	31			
MATHIEU , Instrumentos para ligaduras	40			
McKELLOPS , Alicates acanalados	23			
MERSHON , Instrumentos	41			
		MILLER , Pinza para papel de articular		42
N				
		NANCE , Alicates para doblar arcos		20
		- Alicates para doblar alambre		30
O				
		OLIVER , Alicates para remover bandas		25
		- Alicates planos		27
P				
		PEAN-MURPHY , Instrumentos para ligaduras		42
		PEESO , Alicates para contornear		34
		- Alicates para doblar alambre		28
R				
		REYNOLDS , Alicates para contornear		33
S				
		SCHWARZ , Alicates para doblar alambre		30
		- Alicate de media caña con graduación		22
		SHURE , Instrumentos		41
		SMAHA , Instrumentos para ligaduras		40
		SMITH , Alicates para cortar alambre		37
T				
		TRIPLEX , Alicates para contornear		34
		TWEED , Alicates para doblar arcos		18, 20, 21
W				
		WALDSACHS , Alicates para doblar alambre		35
		WEINGART , Alicates Universales		14
Y				
		YOUNG , Alicates para doblar arcos		21
Z				
		ZIELINSKY , Instrumentos para medir		43

Alphabetisches Inhaltsverzeichnis	Alphabetical Index	Indice alfabetico	Indice alfabetico	Index alphabétique
A				
ADAMS , Pincés à pliers les fils	17			
ADAMS-NANCE , Pincés à pliers les fils	31			
ADERER , Pincés à pliers les fils	16, 31, 32			
- Pincés à ôter enlever	24, 25			
ANDERSEN , Pincés a mors concave et rond	23			
ANGLE , Pincés à courber type Begg	13			
- Pincés coupe-ligatures	3			
ANGLE-TWEED , Pincés à courber les arcs	18			
B				
BEEBE , Ciseaux	38			
BÖHM , Pincés à couronnes	47			
BOLEY , Instruments à mesurer	43			
C				
COLLEGE , Précelle pour coton	42			
D				
DE LA ROSA , Pincés à courber les arcs	20			
F				
FAHNENSTOCK , Couteaux à cire	48			
FISCHER , Pincés à mors plats	26			
FURRER , Pincés à couronnes	47			
G				
GORDON , Pincés à contours	33			
GOSLEE , Pincés à mors plats	26, 27			
H				
HALSTED-MOSQUITO , Instruments à ligature	42			
HOLLOW-CHOP , Pincés à mors concave et rond	22			
HOW , Pincés à courbes les arcs	15			
I				
IWANSON , Instruments à mesurer	43			
J				
JARABAK , Pincés à courber type Begg	12			
- Pincés à mors concave et rond	23			
JOHNSON , Pincés à contours	33			
K				
KERLING , Pincés à couronnes	47			
L				
LANGENBECK , Pincés à pliers les fils	28			
LESSMANN , Couteaux à cire	48			
M				
MALLOTHY , Pincés à pliers les fils	31			
MATHIEU , Instruments à ligature	40			
McKELLOPS , Pincés à mors concave et rond	23			
MERSHON , Instruments	41			
		MILLER , Pince pour papier à articuler		42
N				
		NANCE , Pincés à courber les arcs		20
		- Pincés à pliers les fils		30
O				
		OLIVER , Pincés à détacher les bagues		25
		- Pincés à mors plats		27
P				
		PEAN-MURPHY , Instruments à ligature		42
		PEESO , Pincés à contours		34
		- Pincés à pliers les fils		28
R				
		REYNOLDS , Pincés à contours		33
S				
		SCHWARZ , Pincés à pliers les fils		30
		- Pincés à plier moyenne fine		22
		SHURE , Instruments		41
		SMAHA , Instruments à ligature		40
		SMITH , Ciseaux à couper le fil		37
T				
		TRIPLEX , Pincés à contours		34
		TWEED , Pincés à courbes les arcs		18, 20, 21
W				
		WALDSACHS , Pincés à pliers les fils		35
		WEINGART , Pince universelle		14
Y				
		YOUNG , Pincés à courbes les arcs		21
Z				
		ZIELINSKY , Instruments à mesurer		43

Nummernverzeichnis
Alphanumerical Index
Indice alfanumerico
Indice alfanumerico
Index alphanumerique



Nummernverzeichnis		Alphanumerical Index		Indice alfanumerico		Indice alfanumerico		Index alphanumerique	
Article	Page	Article	Page	Article	Page	Article	Page	Article	Page
0206-CC	42	0415-CI	47	0415-IL	32	1123-0418C	7		
0218-EA	51	0415-CL	47	0415-LA	38	1123-0418D	8		
0218-EB	51	0415-DA	26	0415-LB	38	1123-0418E	7		
0218-EC	51	0415-DB	11	0415-LC	38	1123-0418F	8		
0307	48	0415-DC	26	0415-LD	34	1123-0418G	7		
030711	48	0415-DD	33	0415-LF	32	1123-0418G11	8		
030718	48	0415-DE	33	0415-LG	36	15-LG	42		
0312	49	0415-DF	24	0415-LH	32	15-LH	42		
0315	48	0415-DG	25	0415-LI	34	1506-B	41		
031511	48	0415-DG19	25	0415-LL	34	1506-C	41		
031518	48	0415-DG1903	25	0415-LBA	41	1506-D	41		
03141111050705	42	0415-DH	25	0415-LBB	38	1508-FI	37		
0318-DC	51	0415-DI	47	0415-LBC	38	1514-EG	40		
0318-DD	51	0415-DI01	47	0415-LBD	38	1514-EH	40		
0318-DE	51	0415-DI17	47	0415-LBE	12	1514-EI	40		
0402-B11	50	0415-DL	27	0415-LBAH	19	1514-GI	40		
0402-FA12	50	0415-EA	16	0415-LBAI	12	1514-GL	40		
0402-141117	50	0415-EB	31	0415-LBBA	19	1514-HB	40		
0406-CA	39	0415-EC	31	0415-LBBC	14	1514-HG	40		
0406-CB	39	0415-ED	17	0415-LBBD	14	1514-HH	40		
0406-FA	39	0415-ED1903	17	0415-LBBF	20	1514-HL	40		
0415-AB	13	0415-EE	16	0415-LBBG	30	1514-IA	40		
0415-B17	25	0415-EF	30	0415-LBBH	24	18BI-I	49		
0415-AB1903	13	0415-EG	31	0415-LBBI	30	1801-B	49		
0415-AC	13	0415-EH	17	0415-LBBL	30	1801-C	49		
0415-C17	25	0415-EI	24	0415-LBCA	38	1801-D	49		
0415-AD	14	0415-EL	33	0415-LBCD	16	2108-CF	36		
0415-D17	25	0415-FA	41	0415-LBCE	41	2118-CA	51		
0415-AD18	14	0415-FB	33	0415-LBCG	42	2118-CG	51		
0415-AE	26	0415-FC	42	0415-LBCH	42	2118-DA	51		
0415-E17	25	0415-FD	33	0415-LBCI	42	1918-BAB	51		
0415-AF	15	0415-FE	41	0415-LBCJ	44	1918-BAC	51		
0415-AF11	15	0415-FF	11	0415-LBEA	19	1918-BAD	51		
0415-AF18	15	0415-FG	24	0415-LBEB01	19	1918-BAE	51		
0415-AG	15	0415-FH	11	0415-LBEB02	19				
0415-AG11	15	0415-FI	22	0415-LBED	18				
0415-AG18	15	0415-FJ	22	0415-LBEF	17				
0415-AH	13	0415-FL	22	0415-LBFA	43				
0415-AI	26	0415-GA	18	0415-LBFC	43				
0415-AI1903	26	0415-GB	22	0415-LBFD	43				
0415-BA	26	0415-GC	23	0417-HI	42				
0415-BB	26	0415-GD	12	0607-BGA	37				
0415-BC	26	0415-GD01	23	0607-BGB	37				
0415-BD	26	0415-GE	23	1118-AL	43				
0415-BE	26	0415-GF	22	1123-IA	36				
0415-BF	27	0415-GG	23	1123-IC	34				
0415-BF11	27	0415-GH	22	1123-IG	5				
0415-BG	26	0415-GI	22	1123-II	6				
0415-BH	26	0415-GJ	22	1123-IL	6				
0415-BI	27	0415-GK	22	1123-LA	4				
0415-BI01	27	0415-GL	22	1123-LB	4				
0415-BL	26	0415-GL01	22	1123-LC	4				
0415-CA	26	0415-HA	20	1123-LC1903	4				
0415-CB	28	0415-HA01	20	1123-LD	5				
0415-CC	28	0415-HB	35	1123-LE	6				
0415-CC12	28	0415-HC	21	1123-LF	3				
0415-CD	28	0415-HC17	21	1123-LF1903	3				
0415-CE	47	0415-HD	21	1123-LG	3				
0415-CE03	47	0415-HE	21	1123-LG1903	3				
0415-CE17	47	0415-HF	35	1123-LH	5				
0415-CF	16	0415-HG	18	1123-LI	5				
0415-CG	12	0415-HG1903	18	1123-LL	6				
0415-CH	27	0415-HH	32	1123-LBA	37				
		0415-HI	24	1123-LBAD	37				
		0415-HL	20	1123-LBDF	36				
		0415-HL01	20	1123-0418B	7				
		0415-IB	20						
		0415-IC	30						
		0415-IE	35						
		0415-IG	40						
		0415-IH	29						
		0415-IH01	29						
		0415-II	29						



Ideal-tek SA
via Motta 4
6828 Balerna
Switzerland

Phone: +41 91 683 32 29
Fax: +41 91 683 03 71
E-mail: info@ideal-tek.com