



Veterinärchirurgie  
Veterinary Surgery  
Chirurgia Veterinaria  
Cirugía Veterinaria  
Chirurgie vétérinaire







 ideal-tek

Diagnostik, Skalpellklingen  
Diagnostics, Knives and Scalpel blades  
Diagnostica, Bisturi e lame  
Diagnóstico, Hojas de bisturias  
Diagnostic, Lames de bistouris



## Mc Intosh

Griffe aus Rostfreiem Edelstahl  
Handles of stainless steel  
Manico in Acciaio Inossidabile  
Manico de acero inoxidable  
Manche Acier inoxydable

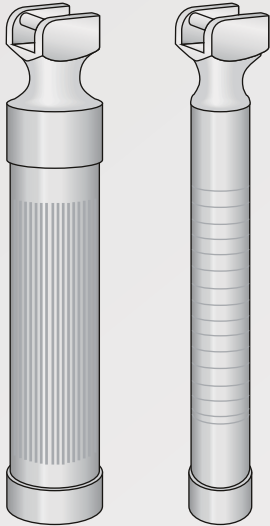

**0101-HA**  
Ø 30 mm

**0101-IA**  
Ø 18 mm

Mc INTOSH

**0101-18BAD** - Set D lame

**0101-18BAE** - Set E lame

**0101-18BAF** - Set F lame

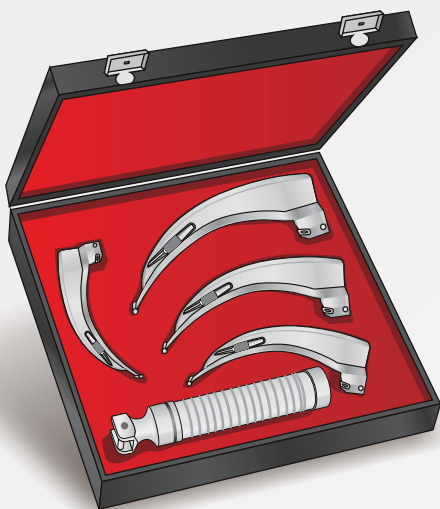

**0101-02BAA**  
2,5 Volt  
300 mA

Für Spatel **0101-BAA**  
For blades **0101-BAA**  
Per lame **0101-BAA**  
Para hojas **0101-BAA**  
Pour spatules **0101-BAA**

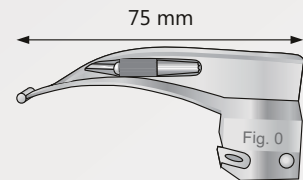

**0101-BAA**



**0101-02BAB**  
2,5 Volt  
300 mA

Für Spatel **0101-BAB ÷ 0101-BAE**  
For blades **0101-BAB ÷ 0101-BAE**  
Per lame **0101-BAB ÷ 0101-BAE**  
Para hojas **0101-BAB ÷ 0101-BAE**  
Pour spatules **0101-BAB ÷ 0101-BAE**

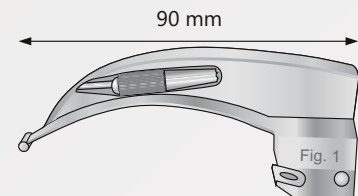

**0101-BAB**

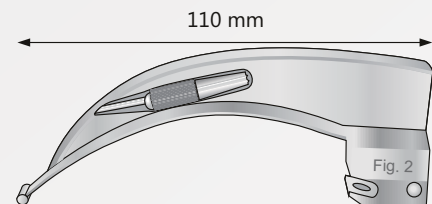

**0101-BAC**

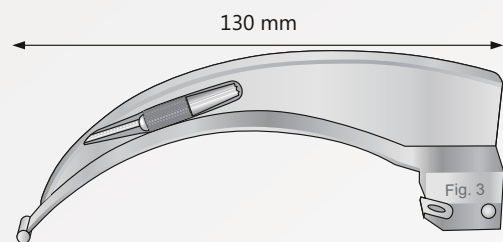

**0101-BAD**

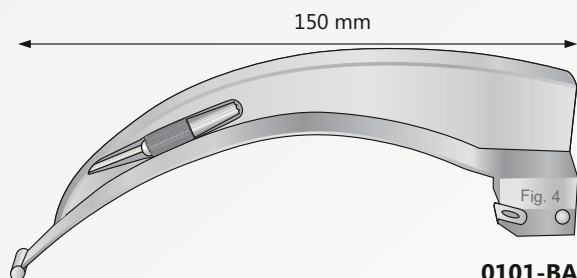

**0101-BAE**

Griffe aus Rostfreiem Edelstahl  
Handles of stainless steel  
Manico in Acciaio Inossidabile  
Manico de acero inoxidable  
Manche Acier inoxydable

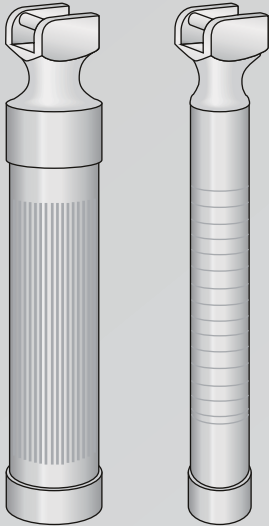

**0101-HA**  
Ø 30 mm

**0101-IA**  
Ø 18 mm

MILLER

**0101-18CAD** - Set D lame

**0101-18CAE** - Set E lame

**0101-18CAF** - Set F lame



**0101-02BAA**  
2,5 Volt  
300 mA

Für Spatel **0101-CAA ÷ 0101-CAD**  
For blades **0101-CAA ÷ 0101-CAD**  
Per lame **0101-CAA ÷ 0101-CAD**  
Para hojas **0101-CAA ÷ 0101-CAD**  
Pour spatules **0101-CAA ÷ 0101-CAD**

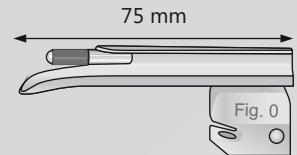

**0101-CAA**



**0101-02BAB**  
2,5 Volt  
300 mA

Für Spatel **0101-CAE**  
For blades **0101-CAE**  
Per lama **0101-CAE**  
Para hojas **0101-CAE**  
Pour spatules **0101-CAE**

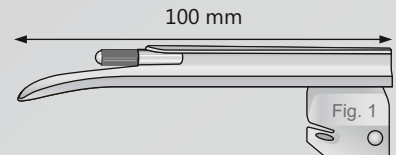

**0101-CAB**

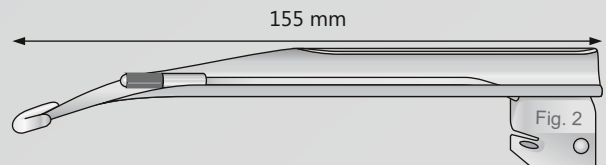

**0101-CAC**

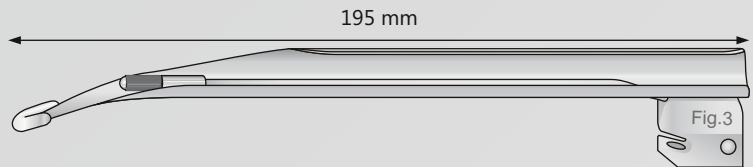

**0101-CAD**

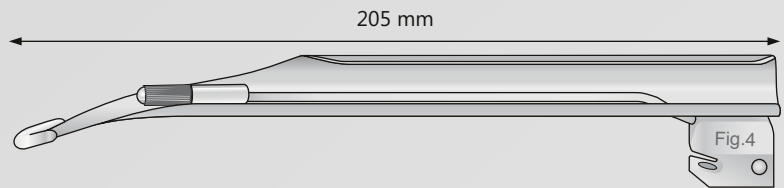

**0101-CAE**



## Negus-Guedel

Griffe aus Rostfreiem Edelstahl  
Handles of stainless steel  
Manico in Acciaio Inossidabile  
Manico de acero inoxidable  
Manche Acier inoxydable

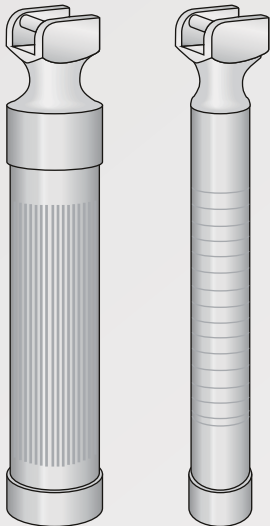

**0101-HA**  
Ø 30 mm

**0101-IA**  
Ø 18 mm



**0101-02BAA**  
2,5 Volt  
300 mA

Für Spatel **0101-EAB**  
For blades **0101-EAB**  
Per lame **0101-EAB**  
Para hojas **0101-EAB**  
Pour spatules **0101-EAB**

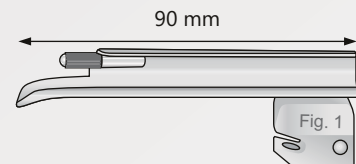

**0101-EAB**



**0101-02BAB**  
2,5 Volt  
300 mA

Für Spatel **0101-EAC ÷ 0101-EAE**  
For blades **0101-EAC ÷ 0101-EAE**  
Per lame **0101-EAC ÷ 0101-EAE**  
Para hojas **0101-EAC ÷ 0101-EAE**  
Pour spatules **0101-EAC ÷ 0101-EAE**

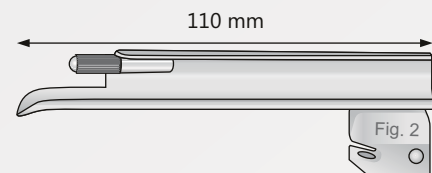

**0101-EAC**

NEGUS-GUEDEL

**0101-18EAD** - Set D lame

**0101-18EAE** - Set E lame

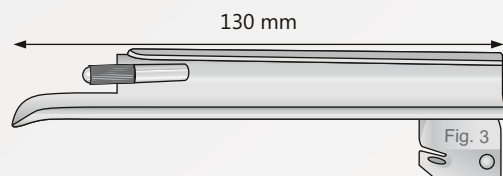
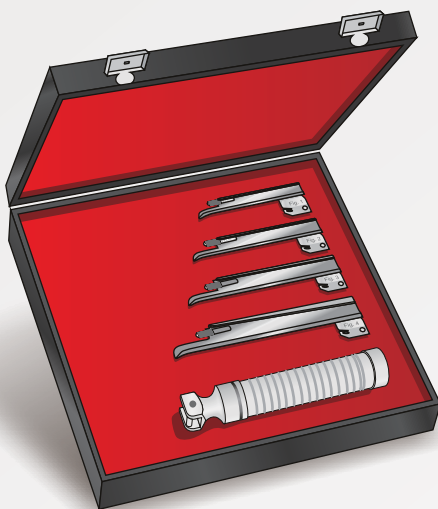

**0101-EAD**

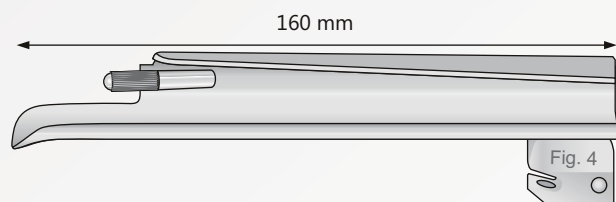

**0101-EAE**

Kaltlichtgriff  
 Fiberoptic Handle  
 Manico Fibre ottiche  
 Mango de fibra óptica  
 Manche fibre optic



Halogenlampe  
 Halogen lamp  
 Lampada alogene  
 Lâmpara Houlógeno  
 Lampe halogène



**0101-LA08**    **0101-BDA**  
 Ø 30 mm    640 mA

Mc INTOSH  
**0101-18FAD** - Set D lame  
**0101-18FAE** - Set E lame  
**0101-18FAF** - Set F lame

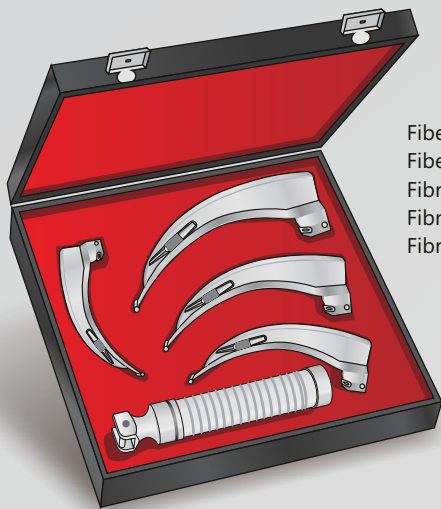

Fiberoptik  
 Fiber Optic  
 Fibre ottiche  
 Fibra óptica  
 Fibre optic

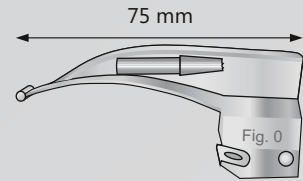

**0101-FAA**

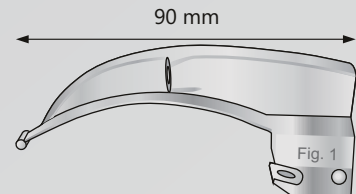

**0101-FAB**

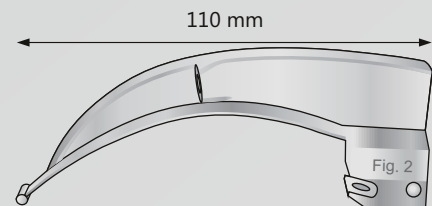

**0101-FAC**

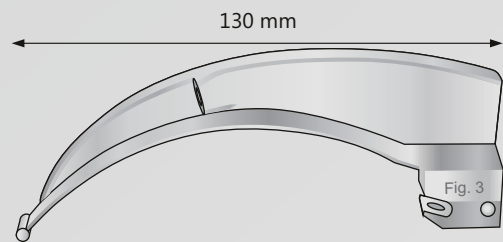

**0101-FAD**

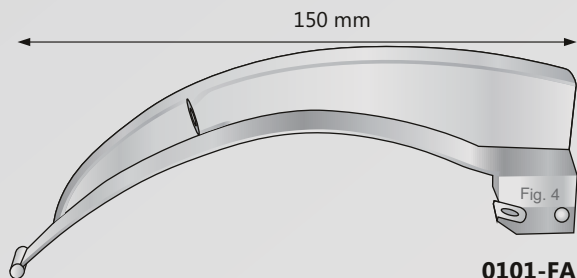

**0101-FAE**





**Miller**  
**Fiber Optic**

Kaltlichtgriff  
Fiberoptic Handle  
Manico Fibre ottiche  
Mango de fibra óptica  
Manche fibre optic



Halogenlampe  
Halogen lamp  
Lampada alogene  
Làmpara Houlógeno  
Lampe halogène



**0101-LA08**   **0101-BDA**  
Ø 30 mm   640 mA

MILLER

**0101-18CFD** - Set D lame

**0101-18CFE** - Set E lame

**0101-18CFF** - Set F lame

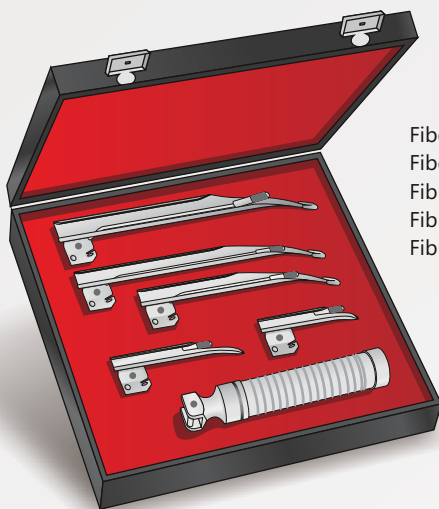

Fiberoptik  
Fiber Optic  
Fibre ottiche  
Fibra óptica  
Fibre optic

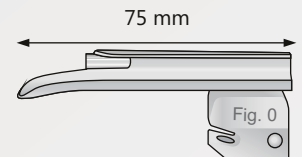

**0101-CFA**

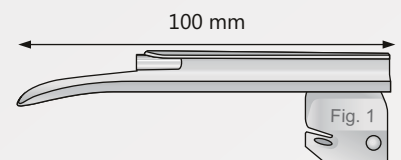

**0101-CFB**

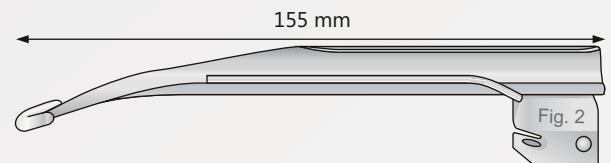

**0101-CFC**

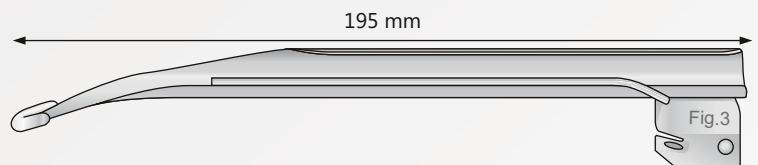

**0101-CFD**

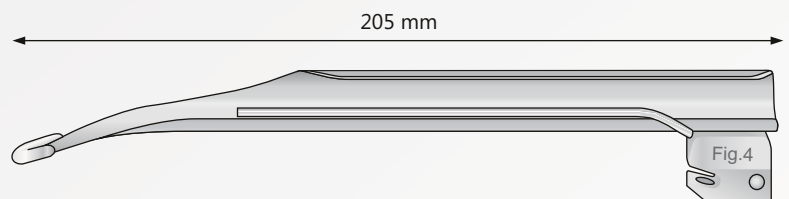

**0101-CFE**

Oto-Ophthalmoskop und Zubehör  
 Oto-Ophthalmoscope and accessories  
 Otoscopi, Oftalmoscopi ed accessori  
 Oto-ofthalmoscopia y accesorios  
 Oto-Ophthalmoscopie et accessoires

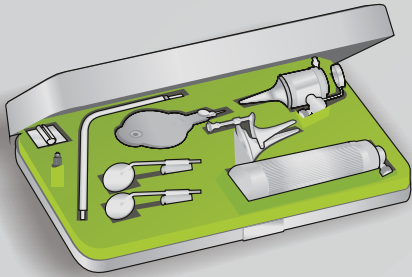

**0102-EB**

Oto-Ophthalmoskop-Nasenspekulum und 2 Kehlkopfspiegel  
 Oto-Ophthalmoscope-Nasal specula and 2 Laryngeal mirror  
 Set oto-ofthalmoscopia-speculum nasale e 2 specchietti laringei  
 Set Oto-ofthalmoscopia y espéculo nasal con 2 espejos laríngeos  
 Trousse à Oto-Ophthalmoscopie-spéculum nasal avec 2 miroirs



**0102-EE17**

Satz zu 3  
 Set of 3  
 Set 3 pezzi  
 Jeu de 3  
 Jeu de 3



# 1 - Ø 3,0 mm  
 # 2 - Ø 4,5 mm  
 # 3 - Ø 5,5 mm

**0102-DC17 Speculum in Nylon**

Satz zu 3  
 Set of 3  
 Set 3 pezzi  
 Jeu de 3  
 Jeu de 3

Schwarz  
 Black  
 Nero  
 Negro  
 Noir



**GOWLLANDS**

**0102-EG**

Veterinär-Otoskop  
 Veterinary otoscope  
 Otoscopio per veterinaria  
 Otoscopio para veterinaria  
 Oscope, pour Veterinair

Halogen  
 Halogen  
 Alogeno  
 Halógena  
 Halogène



**0102-EG17**

Halogenlampe  
 Halogen lamp  
 Lampada alogene  
 Lâmpara Houlógeno  
 Lampe halogène



DUPLAY  
**0102-EB17**  
 Nasenspekulum  
 Nasal specula  
 Speculum nasale  
 Espéculo nasal  
 Spèculum nasal

Rechange for:

**0102-EG**  
**0102-EI**  
**0102-EL**



**0102-EL**

Otoskop komplett mit Koffer  
 Oscope complete with case  
 Otoscopio completo con custodia  
 Otoscopio completo con el caso  
 Oscope avec étui

Halogen  
 Halogen  
 Alogeno  
 Halógena  
 Halogène



**0102-EI**

Veterinär-Oto-Ophthalmoskop  
 Veterinary Oto-Ophthalmoscope  
 Oto-ofthalmoscopia alogeno per veterinaria  
 Oto-ofthalmoscopia halogen para veterinario  
 Trousse Oto-Ophthalmoscope, pour Veterinair

Halogen  
 Halogen  
 Alogeno  
 Halógena  
 Halogène

Nickel-Chrom Griffe  
 Nickel-Chromium Handle  
 Manico in Nichel-Cromo  
 Manija de níquel-cromo  
 Poignée nickel-chrome



DEJERINE  
**0102-BA**  
 200 mm

Mit Nadel  
 With Needle  
 Con ago  
 Con aguja  
 Avec aiguille

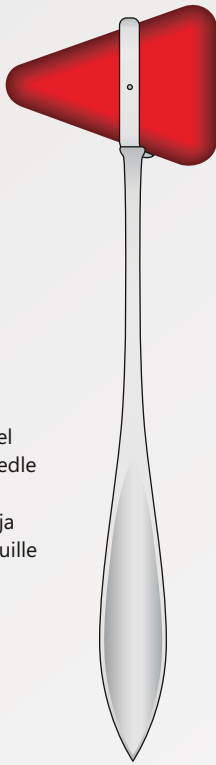

TAYLOR  
**0102-BE**  
 200 mm

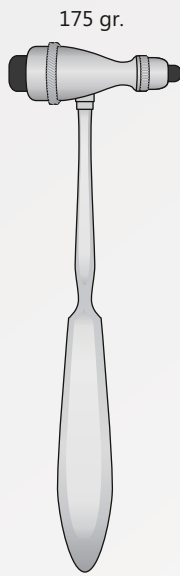

TROEMNER  
**0102-BG**  
 140 mm

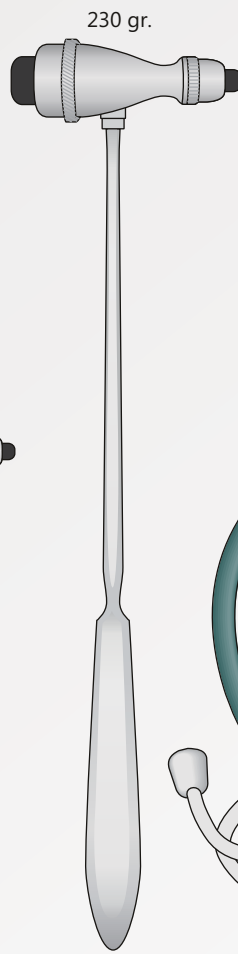

TROEMNER  
**0102-BI**  
 240 mm

Professional  
 Con 4 olive di ricambio



**0102-FA**

Zungenzangen  
Tongueforceps  
Pinze tiralingua  
Pinzas tira-lengua  
Pincas tire-langue

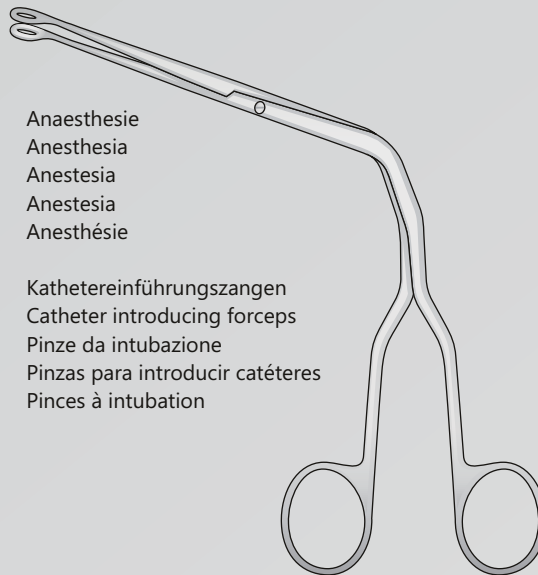
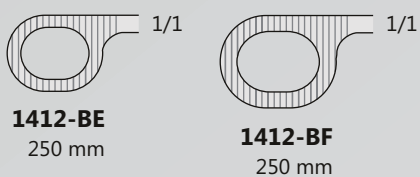

Anaesthesie  
Anesthesia  
Anestesia  
Anestesia  
Anesthésie

Kathetereinführungszangen  
Catheter introducing forceps  
Pinze da intubazione  
Pinzas para introducir catéteres  
Pincas à intubation

MAGILL  
1412-BC/1412-BF



**1412-EE**  
1 Paar ersatzgummi  
1 Pair of rubber pads  
Gommini di ricambio 2 pezzi  
1 Paar placas de caucho  
1 Paire de mors caoutchouc



**1412-EH**  
1 Paar ersatzgummi  
1 Pair of rubber pads  
Gommini di ricambio 2 pezzi  
1 Paar placas de caucho  
1 Paire de mors caoutchouc

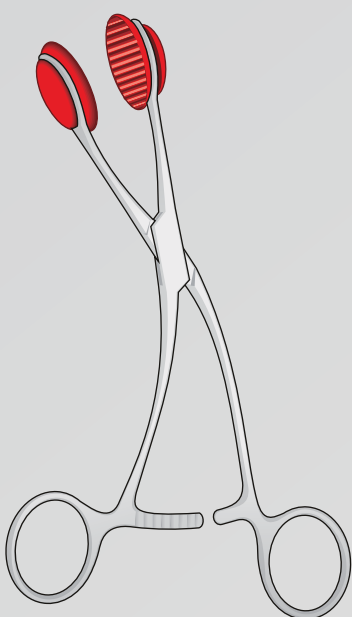

YOUNG  
**1412-EF**  
160 mm

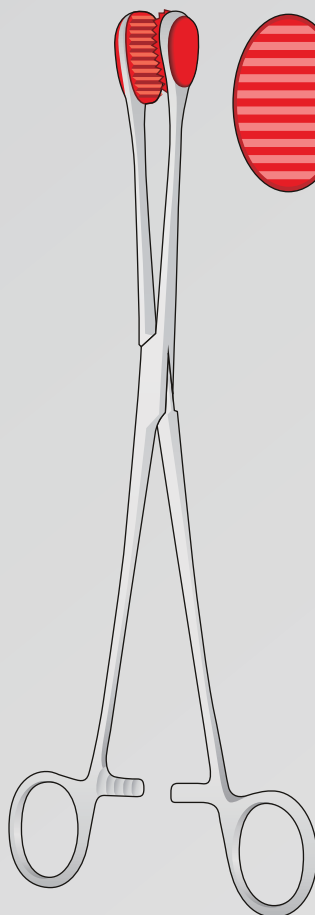

CHILD  
**1412-EG**  
240 mm

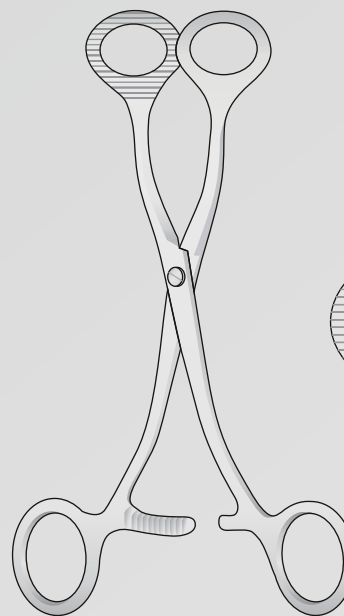

COLLIN  
**1412-BA/1412-DA**

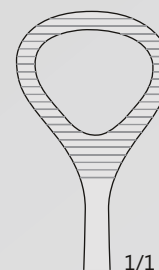

**1412-DA**  
165 mm

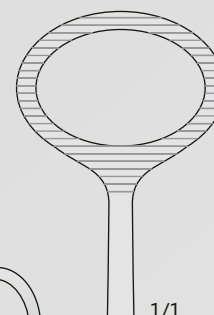

**1412-BA**  
170 mm

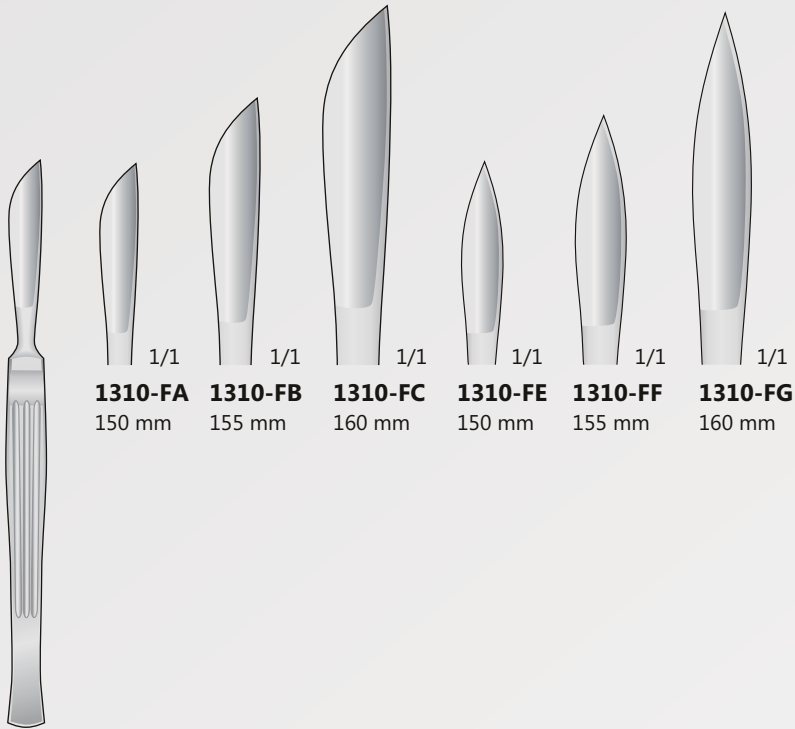

**1310-FA** 150 mm  
**1310-FB** 155 mm  
**1310-FC** 160 mm  
**1310-FE** 150 mm  
**1310-FF** 155 mm  
**1310-FG** 160 mm

**1310-FA/1310-FG**

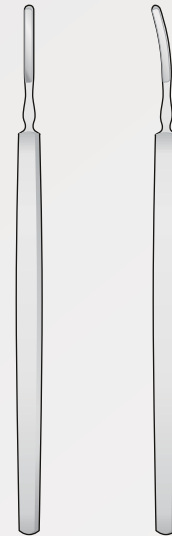

DESMARRES **1310-LF** 135 mm  
DESMARRES **1310-LG** 135 mm

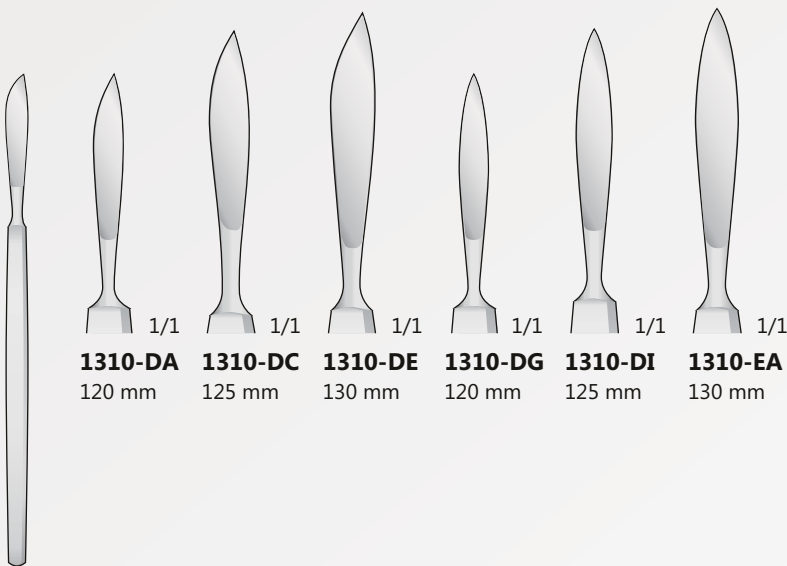

**1310-DA** 120 mm  
**1310-DC** 125 mm  
**1310-DE** 130 mm  
**1310-DG** 120 mm  
**1310-DI** 125 mm  
**1310-EA** 130 mm

**1310-DA/1310-EA**

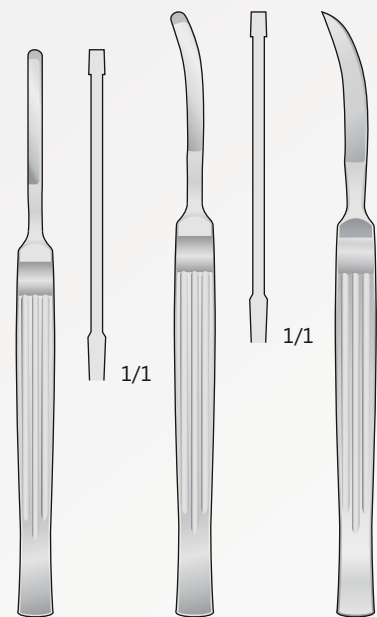

JOSEPH **1310-BAA** 150 mm  
CONVERSE **1310-BAB** 160 mm  
**1310-BAC** 160 mm

Skalpellgriffe  
 Scalpel handles  
 Manici per bisturi  
 Mangos de bisturias  
 Manches de bistouris

Scalpellklingen, steril  
 Scalpel blades, steril  
 Lame da bisturi sterili  
 Hojas de bisturias esteriles  
 Lames de bistouris steriles

Packungen à 100  
 Packages of 100 ea  
 Scatole da 100 pezzi  
 Cajas de 100 c/u  
 Boîtes de 100 pièces



Doppelschneidig  
 Double cutting  
 Doppio taglio  
 Doble corta  
 Deux tranchants

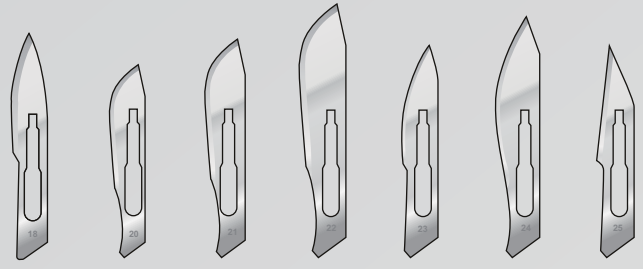
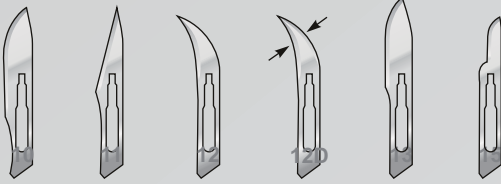

**1102-BA 1102-BB 1102-BC 1102-BC04 1102-BD 1102-BF**  
 Fig. 10 Fig. 11 Fig. 12 Fig. 12D Fig. 13 Fig. 15

**1102-BI 1102-CA 1102-CB 1102-CC 1102-CD 1102-CE 1102-CF**  
 Fig. 18 Fig. 20 Fig. 21 Fig. 22 Fig. 23 Fig. 24 Fig. 25

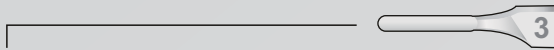

Fig. 4L

Fig. 3



Fig. 3M



Mit Mess  
 With scale  
 Con misurazione  
 Con escala  
 Avec échelle  
 Fig. 3M

Fig. 7



Fig. 5



Fig. 5a



Fig. 3L



Fig. 4



**1201-02D**  
 120 mm

**1201-02D12**  
 120 mm

**1201-02H**  
 160 mm

**1201-02B**  
 150 mm

**1201-02C**  
 150 mm

**1201-02D11**  
 190 mm

**1201-02E**  
 135 mm

**1201-02E11**  
 210 mm

Skalpelli, Klinge  
 Scalpel handles, Knives  
 Manici e bisturi  
 Mangos de bisturias, hojas  
 Manches de bistouris, lames

Für Mikro-Klingen  
 For Micro Blades  
 Per micro lame  
 Para micro Hojas  
 Pour Micro-Lame de bistouris

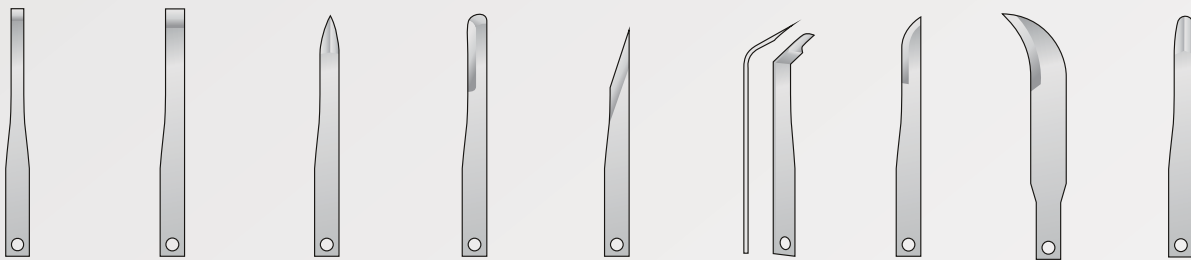

**1102-DGB** Conf. 10 pz.    **1102-DGC** Conf. 10 pz.    **1102-DGD** Conf. 1 pz.    **1102-DGE** Conf. 10 pz.    **1102-DGF** Conf. 10 pz.    **1102-DGG** Conf. 1 pz.    **1102-DGH** Conf. 10 pz.    **1102-DGI** Conf. 10 pz.    **1102-DGL** Conf. 1 pz.

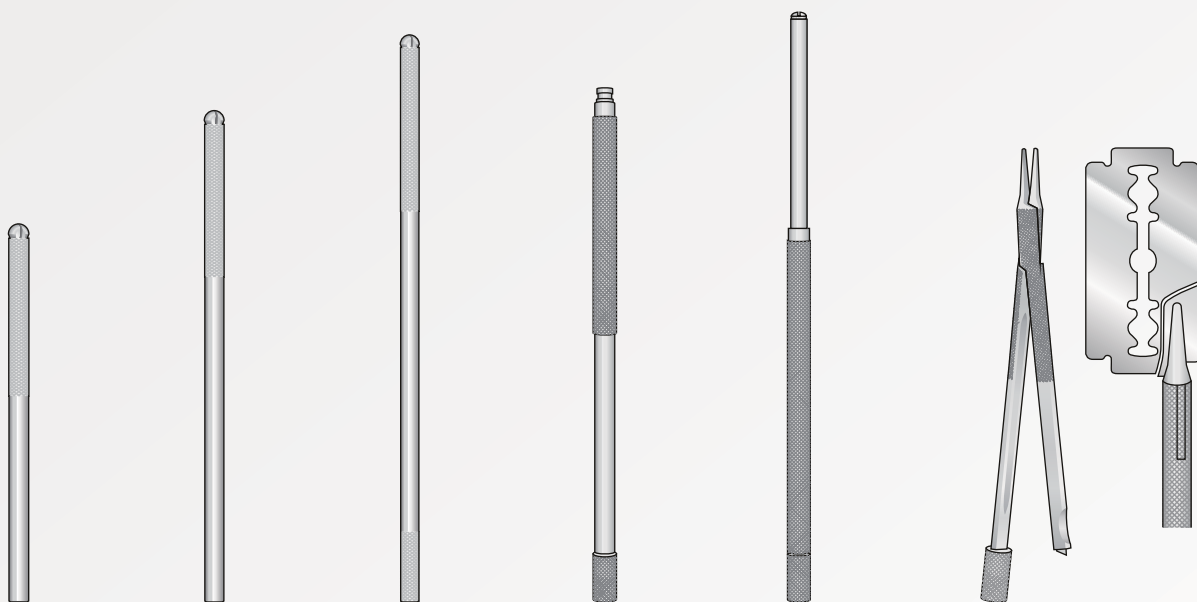

**1310-B** 100 mm    **1310-D** 130 mm    **1310-C** 150 mm    **0202-EG** 135 mm    **0202-EI** 155 mm    **1310-BC** 120 mm

Spiegeldurchmesser - Diameter of mirrors - Diametro dello specchio  
 Diámetro de los espejos - Diamètre des miroirs

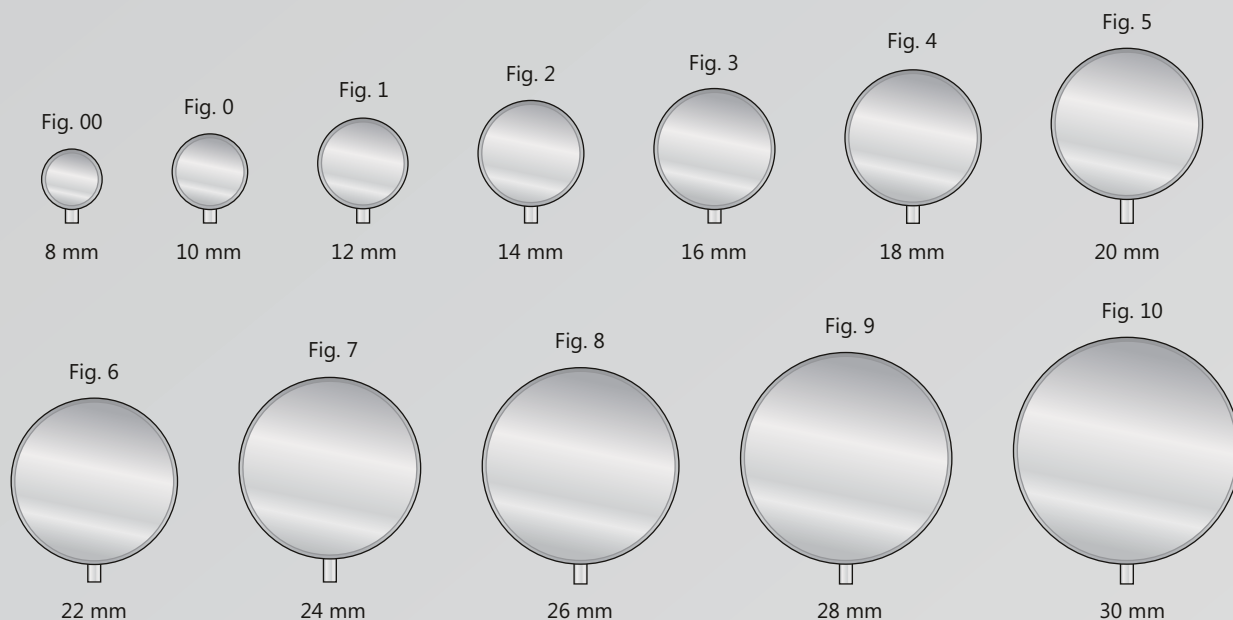

Inox

Kehlkopfspiegel mit Sechskantgriff  
 Laryngeal mirrors with hexagonal handle  
 Specchietto laringeo con manico esagonale  
 Espejos laringeos con manico exagonal  
 Miroirs laringiens avec manche hexagonal

	Fig.
<b>07-I</b>	00
<b>07-BA</b>	0
<b>07-BC</b>	1
<b>07-BE</b>	2
<b>07-BG</b>	3
<b>07-BI</b>	4
<b>07-CA</b>	5
<b>07-CC</b>	6
<b>07-CE</b>	7
<b>07-CG</b>	8
<b>07-CI</b>	9
<b>07-D0</b>	10

**07-I/07-D0**  
180 mm

Spiegelgriff  
 Mirrors handle  
 Manico per specchietti  
 Manico para espejos  
 Manche à miroir

Nikel-Chrom



**1201-G**  
120 mm

Kehlkopfspiegel  
 Laryngeal mirrors  
 Specchietto laringeo  
 Espejos laringeos  
 Miroirs laryngiens

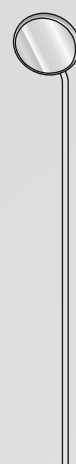
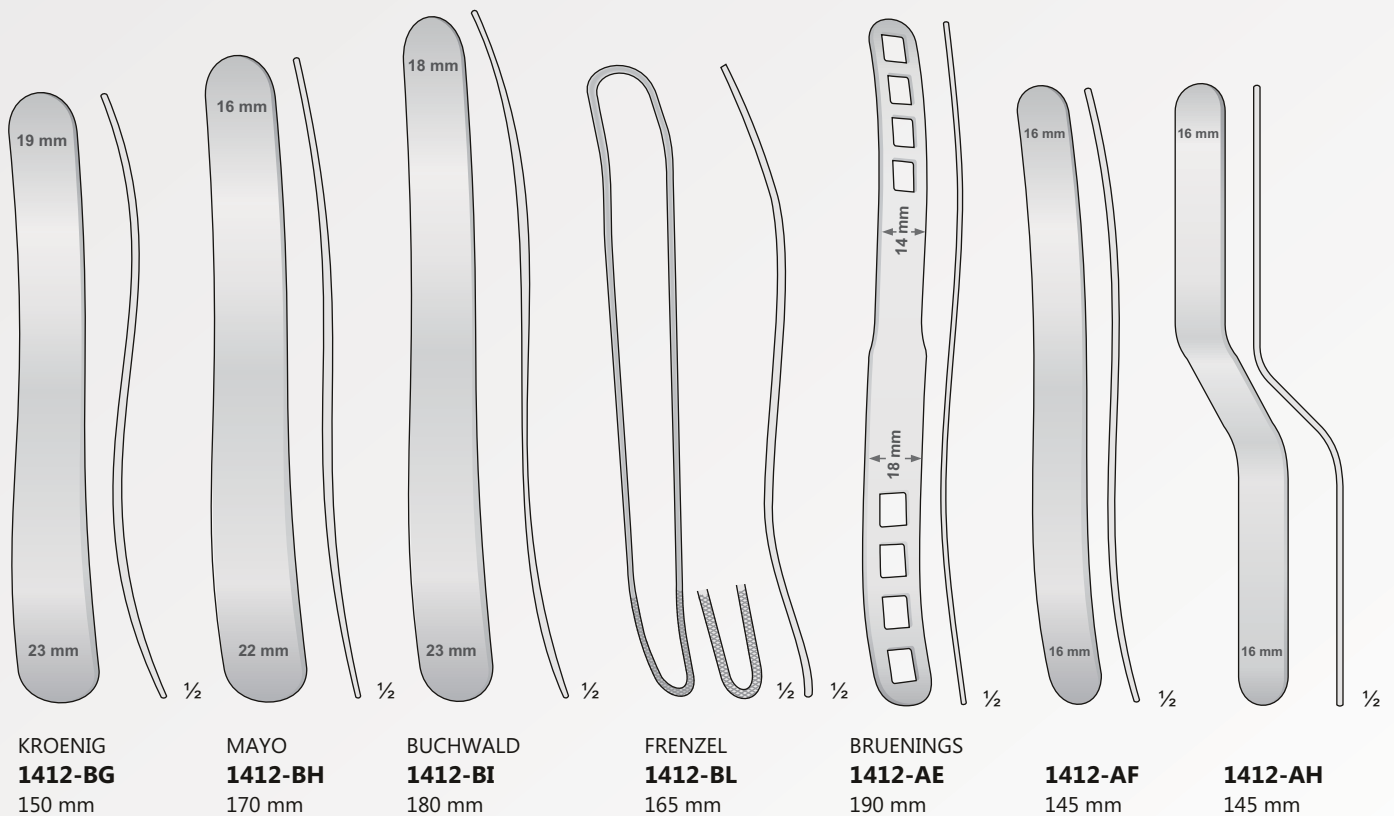

	Fig.
<b>15-AA</b>	00
<b>15-A</b>	0
<b>15-AB</b>	1
<b>15-AC</b>	2
<b>15-AD</b>	3
<b>15-AE</b>	4
<b>15-AF</b>	5
<b>15-AG</b>	6
<b>15-AG01</b>	7
<b>15-AG02</b>	8
<b>15-AG03</b>	9
<b>15-AG04</b>	10

**15-AA/15-A6D**  
120 mm





Bauch- und Darmspatel  
 Abdominal and Intestinal Spatulas  
 Spatole addominali e intestinali  
 Espátulas abdominales e intestinales  
 Spatules abdominaux et intestinaux

Biegsam - Malleable - Malleabile - Maleable - Malléable

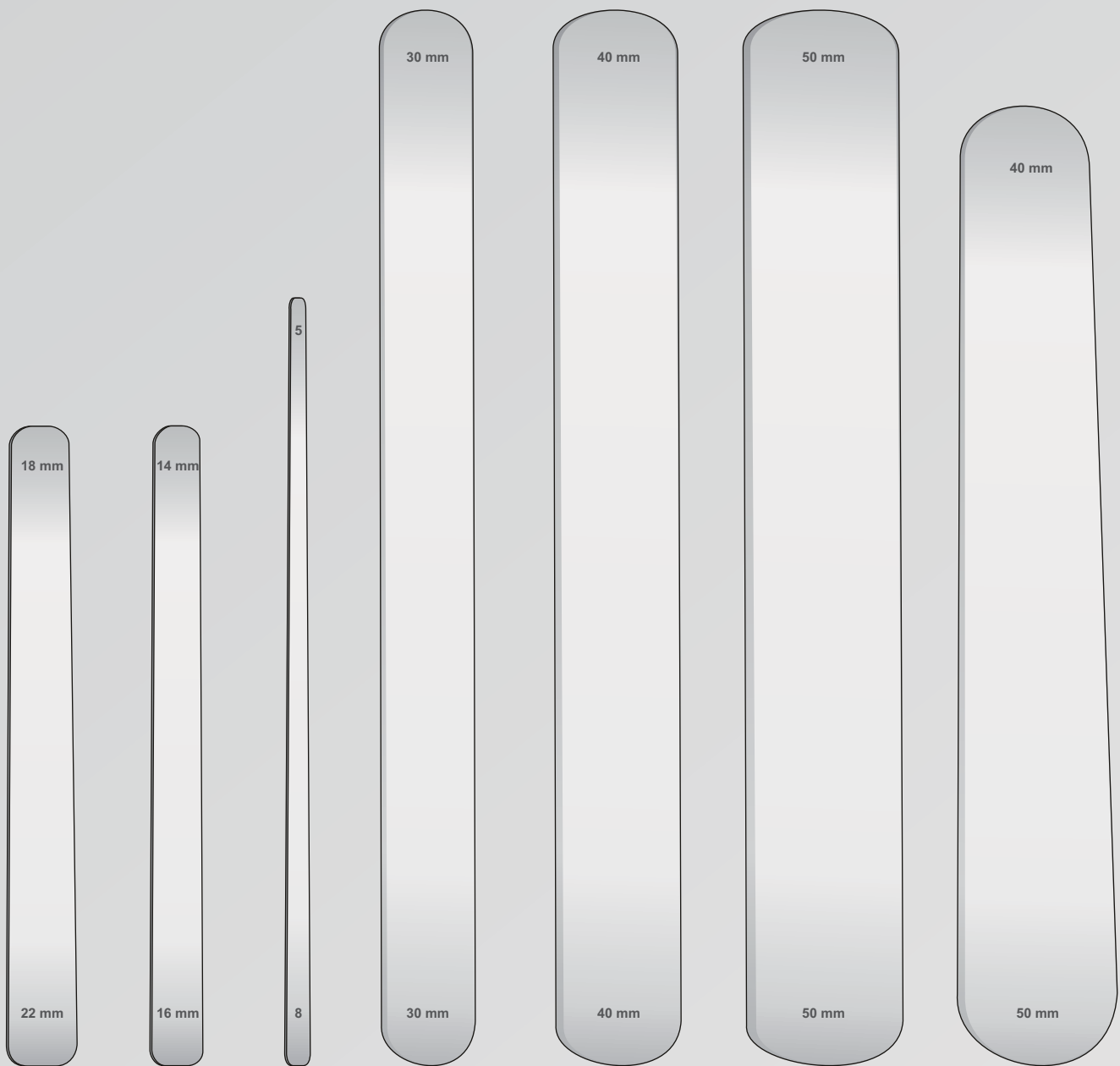

**1412-IA**  
200 mm

**1412-IB**  
200 mm

**1412-IC**  
240 mm

**1412-BAB**  
330 mm

**1412-BAC**  
330 mm

**1412-BAD**  
330 mm

HABERER  
**1412-BAE**  
300 mm

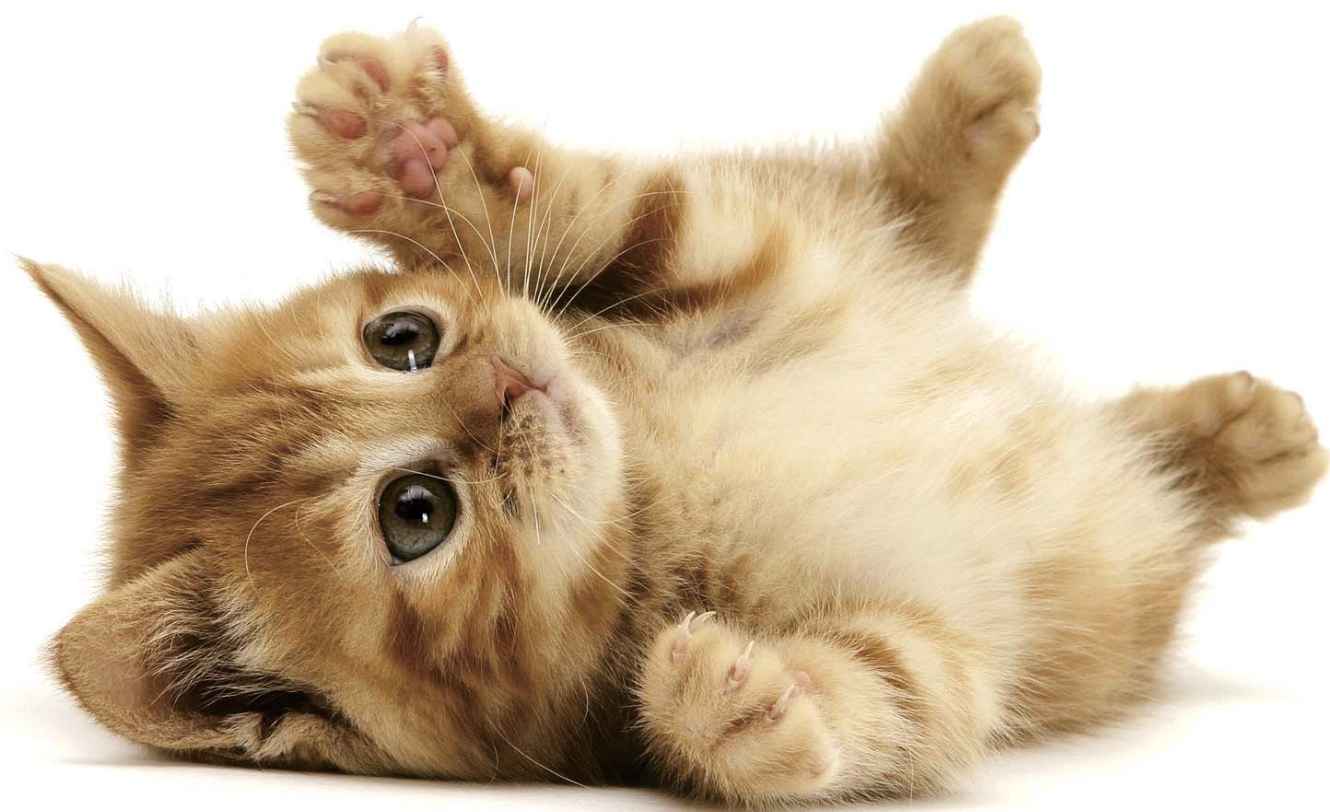

 ideal-tek

Scheren  
Scissors  
Forbici  
Tijeras  
Ciseaux



**SUPER  
 CUT**

Mit einer Schneide gezahnt  
 With one blade serrated  
 Con una lama dentellata  
 Con una hoja dentada  
 Avec une lame dentèle

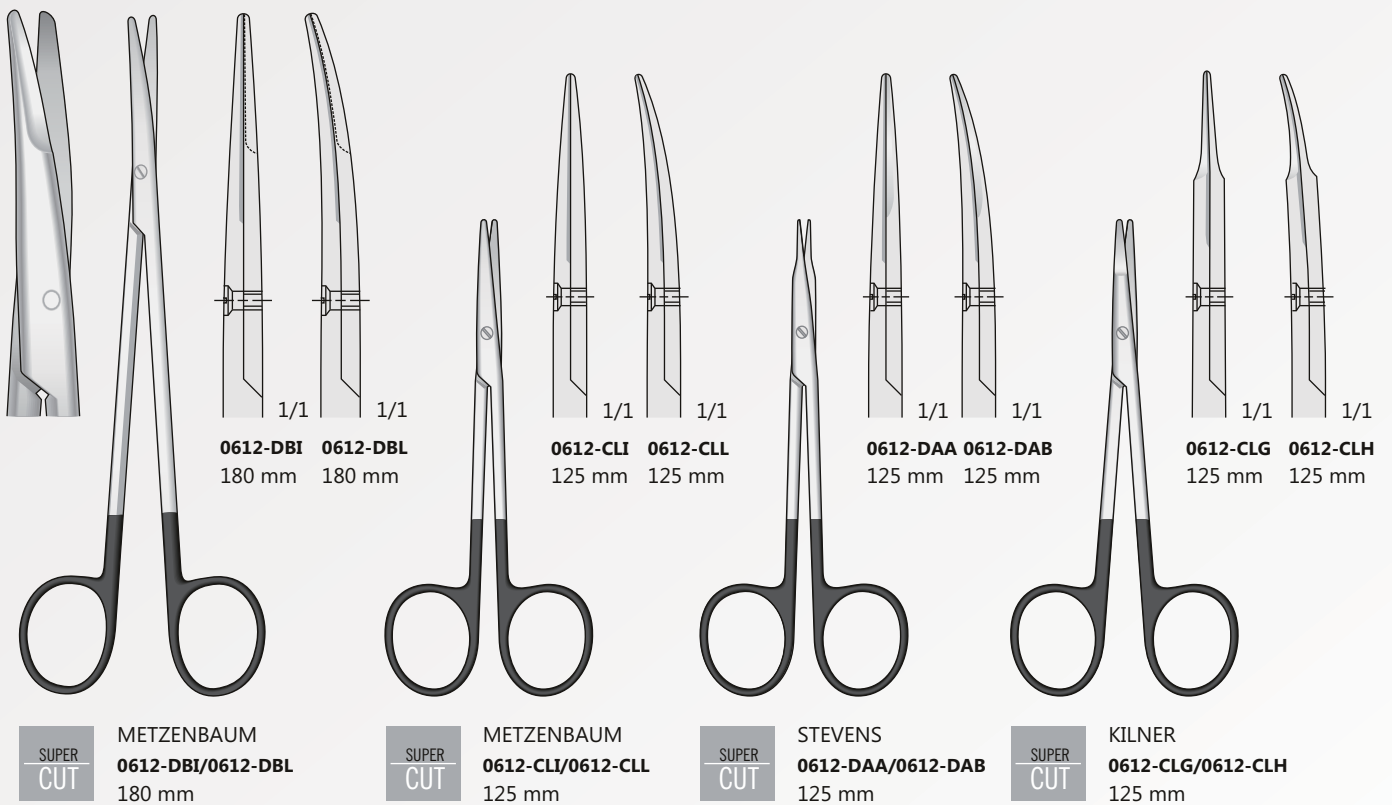

Chirurgische scheren  
 Operating scissors  
 Forbici chirurgiche  
 Tijeras para cirugía general  
 Ciseaux chirurgicaux

"Super-cut" scheren micro-schliff für tissue atrauma  
 "Super-cut" scissors for gripping tissue and cutting interproximally  
 Forbici "Super-cut" estremamente taglienti per tessuti con riduzione del trauma  
 Tijeras "super cortes" para cortar tissue-atrauma  
 Ciseaux "super cut" coupe les tissus en reduisant les risques de traumatisme

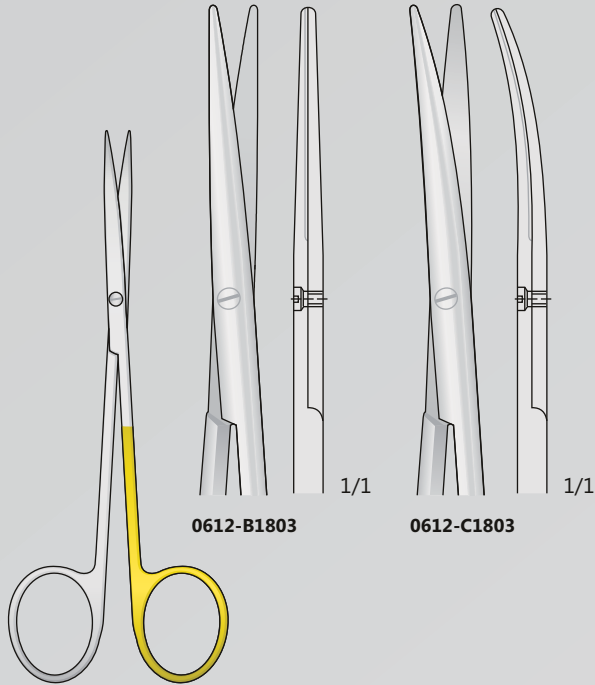

0612-B1803

0612-C1803

**SUPER CUT**  
 METZENBAUM  
**0612-B1803/0612-C1803**  
 145 mm

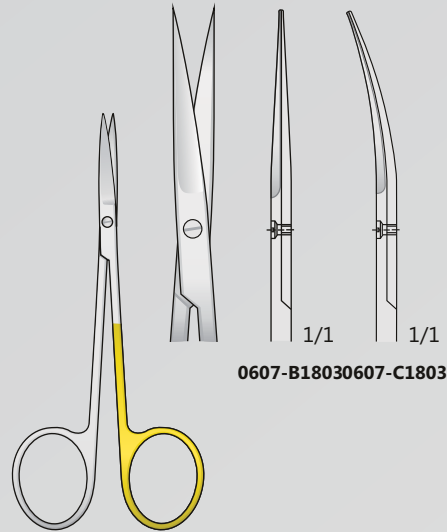

0607-B1803/0607-C1803

**SUPER CUT**  
 IRIS  
**0607-B1803/0607-C1803**  
 110 mm

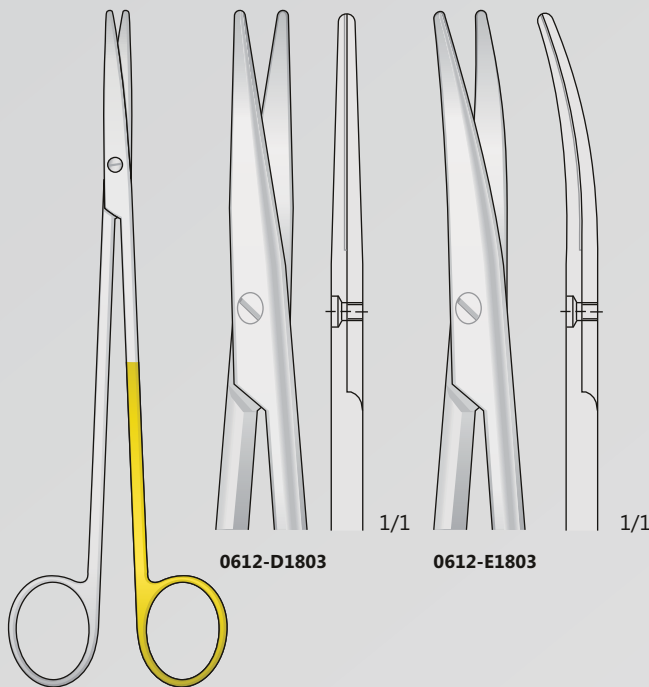

0612-D1803

0612-E1803

**SUPER CUT**  
 METZENBAUM  
**0612-D1803/0612-E1803**  
 185 mm

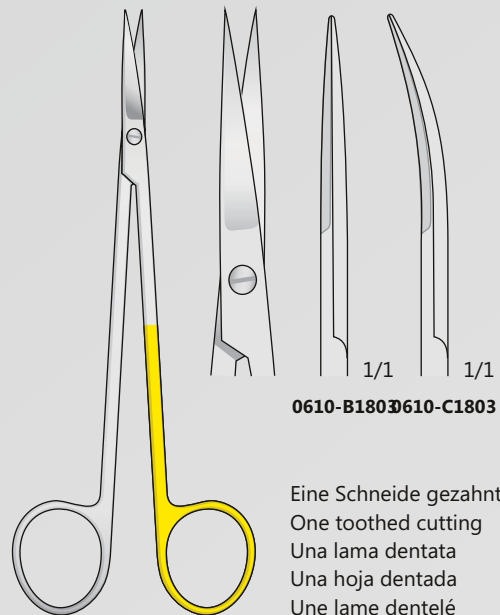

0610-B1803/0610-C1803

Eine Schneide gezahnt  
 One toothed cutting  
 Una lama dentata  
 Una hoja dentada  
 Une lame dentelé

**SUPER CUT**  
 KELLY  
**0610-B1803/0610-C1803**  
 160 mm

“Super-cut” scheren micro-schliff für tissue atrauma  
 “Super-cut” scissors for gripping tissue and cutting interproximally  
 Forbici “Super-cut” estremamente taglienti per tessuti con riduzione del trauma  
 Tijeras “super cortes” para cortar tissue-atrauma  
 Ciseaux “super cut” coupe les tissus en reduisant les risques de traumatisme

Chirurgische scheren  
 Operating scissors  
 Forbici chirurgiche  
 Tijeras para cirurgia general  
 Ciseaux chirurgicaux

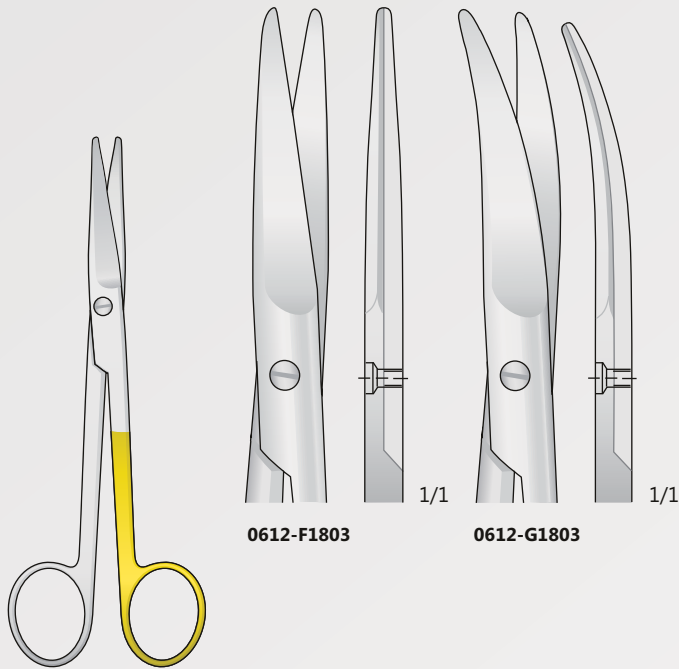

**SUPER CUT** MAYO  
**0612-F1803/0612-G1803**  
 140 mm

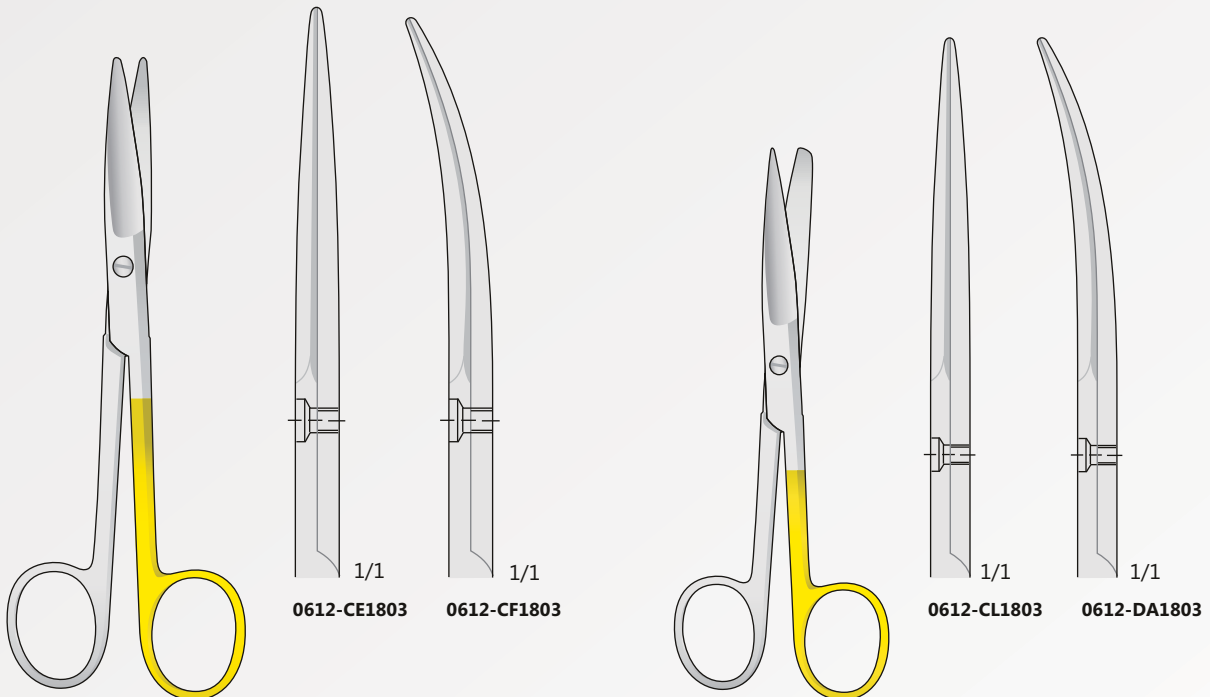

**SUPER CUT** MAYO  
**0612-CE1803/FM25SC**  
 170 mm

**SUPER CUT** **0612-CL1803/FM30SC**  
 145 mm

Chirurgische scheren  
 Operating scissors  
 Forbici chirurgiche  
 Tijeras para cirugía general  
 Ciseaux chirurgicaux

"Super-cut" scheren micro-schliff für tissue atrauma, mit einer Schneide gezahnt  
 "Super-cut" scissors for gripping tissue and cutting interproximally, with one blade serrated  
 Forbici "Super-cut" estremamente taglienti per tessuti con riduzione del trauma, con una lama dentellata  
 Tijeras "super cortes" para cortar tissue-atrauma, con una hoja dentada  
 Ciseaux "super cut" coupe les tissus en réduisant les risques de traumatisme, avec une lame dentèle

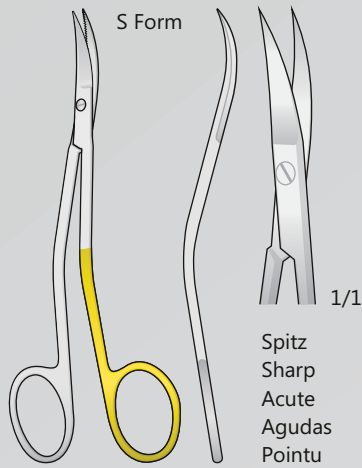

**SUPER CUT**  
 LA GRANGE  
**1107-B1803**  
 115 mm

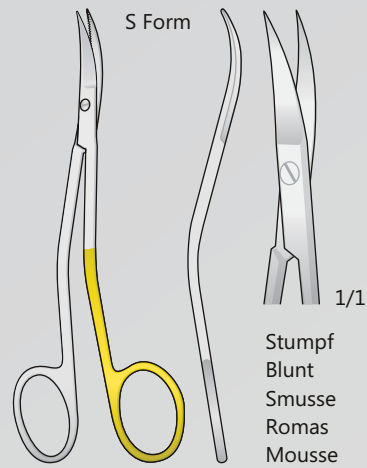

**SUPER CUT**  
 LA GRANGE  
**1107-C1803**  
 115 mm



**SUPER CUT**  
 GOLDMAN-FOX  
**070603-1803/070617-1803**  
 135 mm

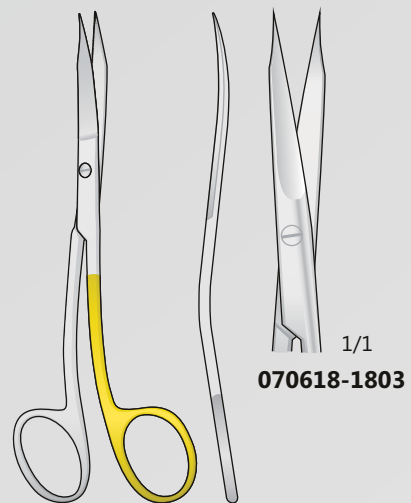

**SUPER CUT**  
 GOLDMAN-FOX  
**070618-1803**  
 130 mm



"Super-cut" scheren micro-schliff für tissue atrauma, mit einer Schneide gezahnt  
 "Super-cut" scissors for gripping tissue and cutting interproximally, with one blade serrated  
 Forbici "Super-cut" estremamente taglienti per tessuti con riduzione del trauma, con una lama dentellata  
 Tijeras "super cortes" para cortar tissue-atrauma, con una hoja dentada  
 Ciseaux "super cut" coupe les tissus en reduisant les risques de traumatisme, avec une lame dentèle

Chirurgische scheren  
 Operating scissors  
 Forbici chirurgiche  
 Tijeras para cirurgia general  
 Ciseaux chirurgicaux

## SUPER CUT

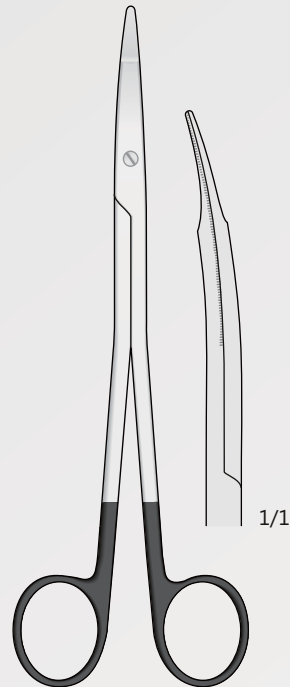

SUPER CUT  
**FREEMAN**  
**0612-DCI**  
 180 mm

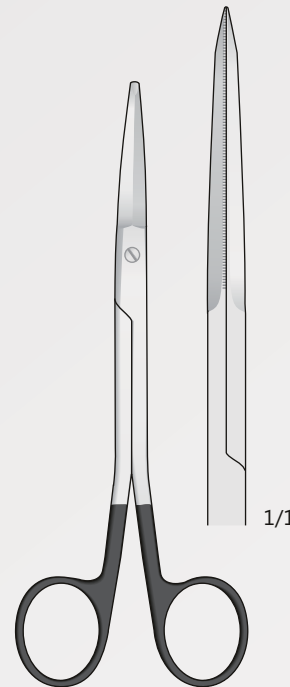

SUPER CUT  
**FACE-LIFT**  
**0612-DAI**  
 160 mm

Mit einer Schneide gezahnt  
 With one blade serrated  
 Con una lama dentellata  
 Con una hoja dentada  
 Avec une lame dentèle

## TUNGSTEN CARBIDE

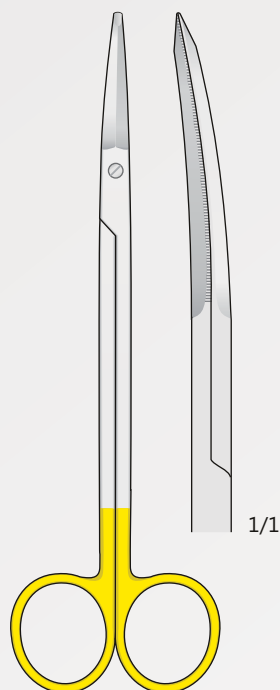

TUNGSTEN CARBIDE  
**FACE-LIFT**  
**0612-DED**  
 180 mm



TUNGSTEN CARBIDE SUPER CUT  
**KAYE FACE-LIFT**  
**0612-DAG**  
 150 mm

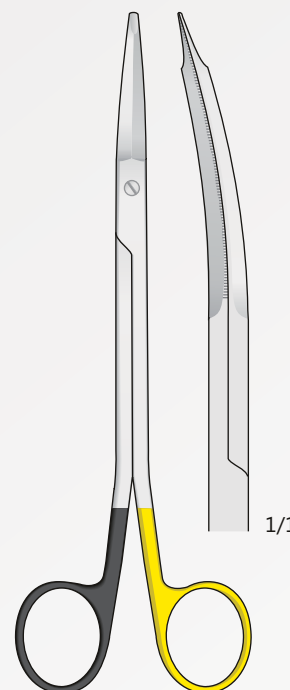

TUNGSTEN CARBIDE SUPER CUT  
**FREEMAN KAYE**  
**0612-DDH**  
 180 mm

Hartmetallschneiden  
 Tungsten-carbide edges  
 Lame al carburo di tungsteno  
 Filos de carburo tungsteno  
 Lames en carbure de tungstène

Chirurgische scheren  
 Operating scissors  
 Forbici chirurgiche  
 Tijeras para cirugía general  
 Ciseaux chirurgicaux

Hartmetallschneiden  
 Tungsten-carbide edges  
 Lama al carburo di tungsteno  
 Filos de carburo tungsteno  
 Lames en carbure de tungstène

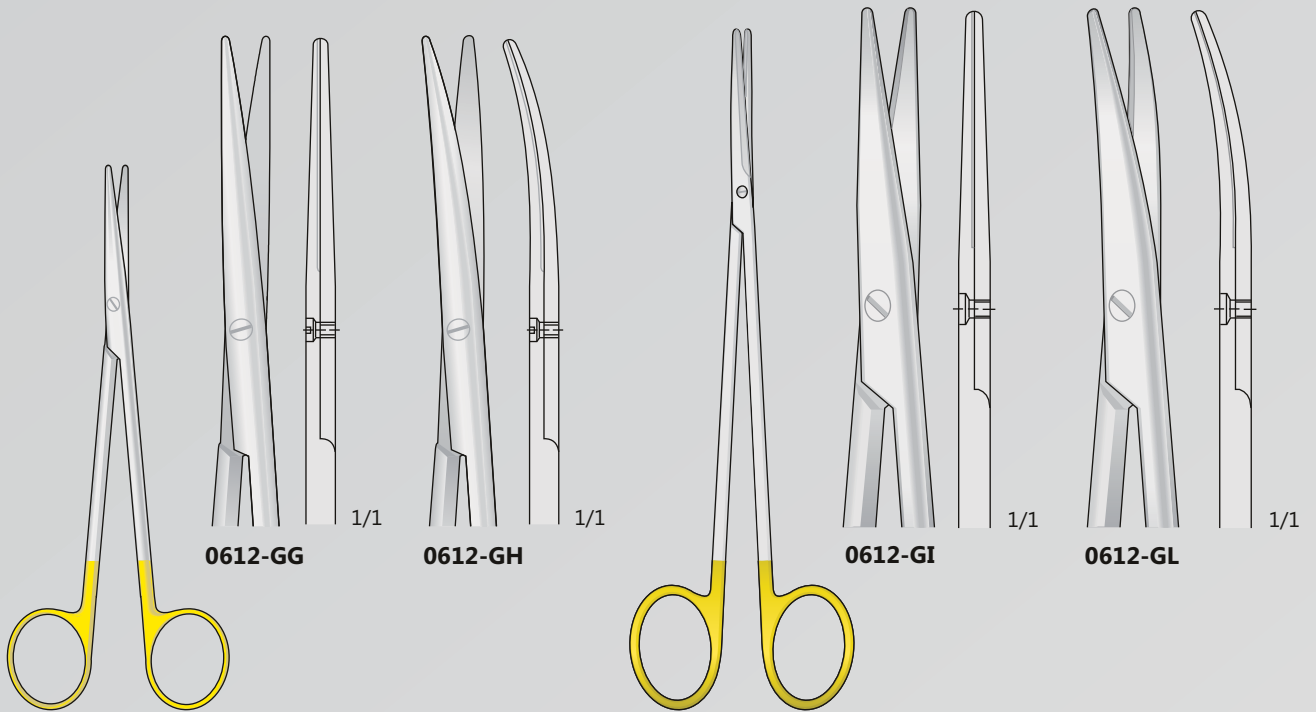

**TUNGSTEN CARBIDE** METZENBAUM  
**0612-GG/0612-GH**  
 145 mm

**TUNGSTEN CARBIDE** METZENBAUM  
**0612-GI/0612-GL**  
 185 mm

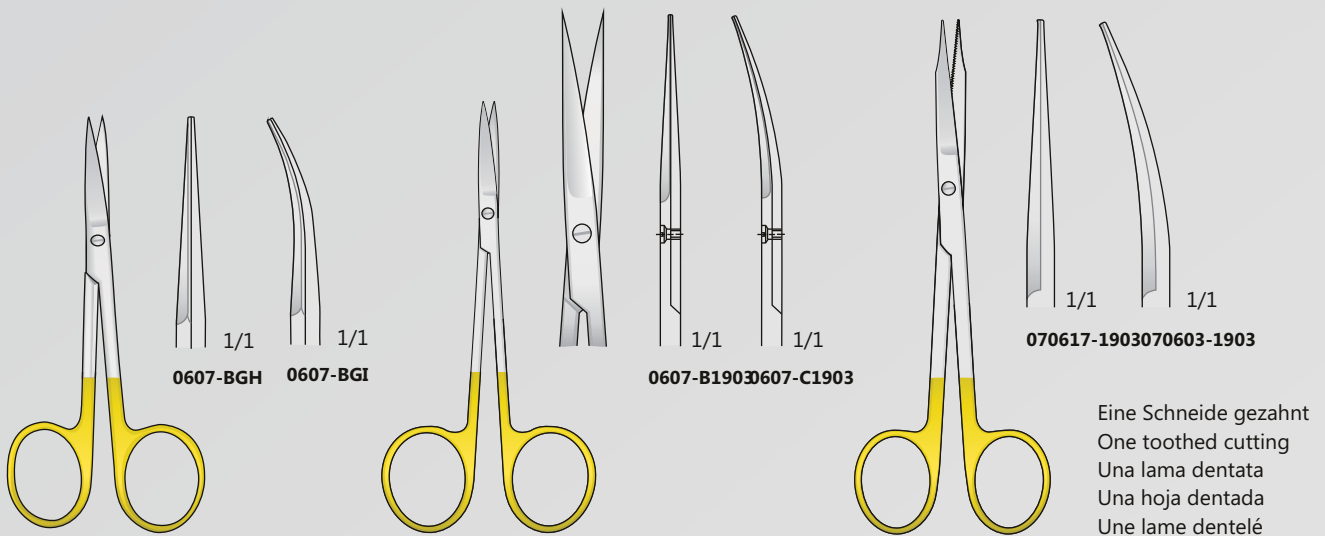

**TUNGSTEN CARBIDE** **0607-BGH/0607-BGI**  
 110 mm

**TUNGSTEN CARBIDE** IRIS  
**0607-B1903/0607-C1903**  
 115 mm

**TUNGSTEN CARBIDE** GOLDMAN-FOX  
**070617-1903/070603-1903**  
 135 mm

Eine Schneide gezahnt  
 One toothed cutting  
 Una lama dentata  
 Una hoja dentada  
 Une lame dentelé

Hartmetallschneiden  
 Tungsten-carbide edges  
 Lame al carburo di tungsteno  
 Filos de carburo tungsteno  
 Lames en carbure de tungstène

Chirurgische scheren  
 Operating scissors  
 Forbici chirurgiche  
 Tijeras para cirugía general  
 Ciseaux chirurgicaux

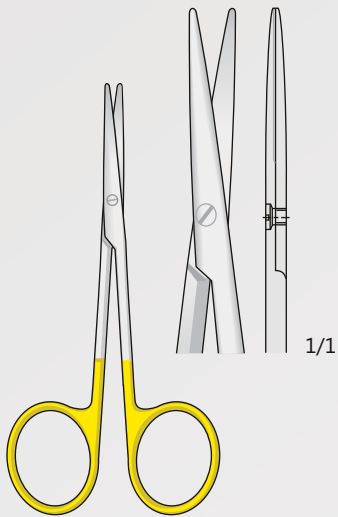

**TUNGSTEN CARBIDE**  
**0612-BBI**  
 115 mm

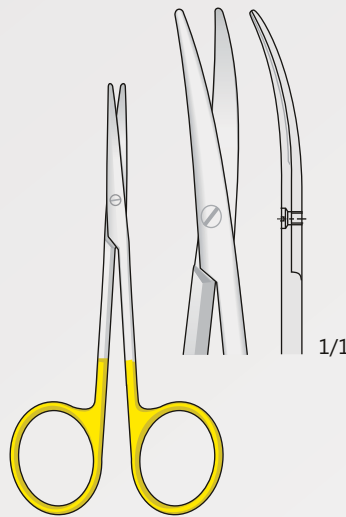

**TUNGSTEN CARBIDE**  
**0612-BBL**  
 115 mm

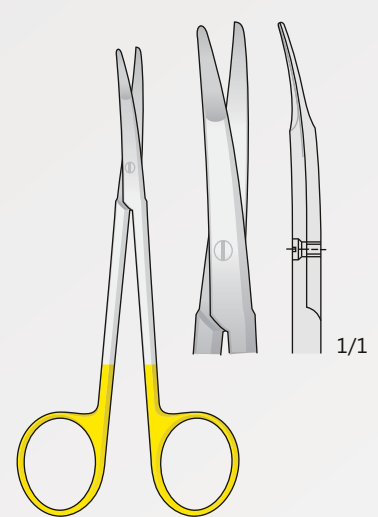

**TUNGSTEN CARBIDE**  
 KILNER (RAGNELL)  
**0612-DFA**  
 125 mm

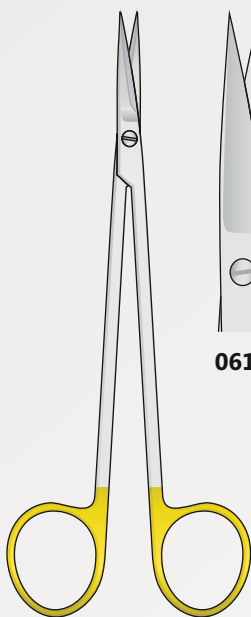

**TUNGSTEN CARBIDE**  
 KELLY  
**0610-B1903/0610-C1903**  
 160 mm

**0610-B1903**

**0610-C1903**

Eine Schneide gezahnt  
 One toothed cutting  
 Una lama dentata  
 Una hoja dentada  
 Une lame dentelé

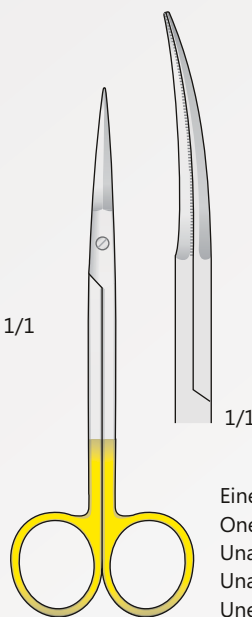

**TUNGSTEN CARBIDE**  
 PECK-JOSEPH  
**0607-LC**  
 140 mm

Eine Schneide gezahnt  
 One toothed cutting  
 Una lama dentata  
 Una hoja dentada  
 Une lame dentelé

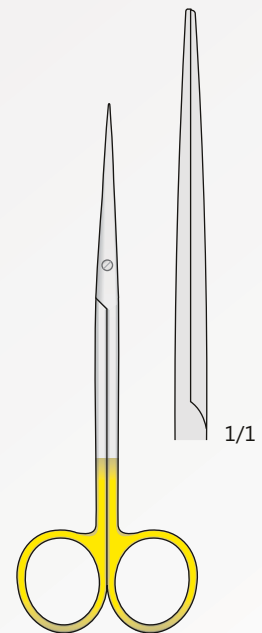

**TUNGSTEN CARBIDE**  
 METZENBAUM-FINO  
**0612-LG**  
 140 mm

Hartmetallschneiden  
 Tungsten-carbide edges  
 Lame al carburo di tungsteno  
 Filos de carburo tungsteno  
 Lames en carbure de tungstène

Chirurgische scheren  
 Operating scissors  
 Forbici chirurgiche  
 Tijeras para cirugía general  
 Ciseaux chirurgicaux

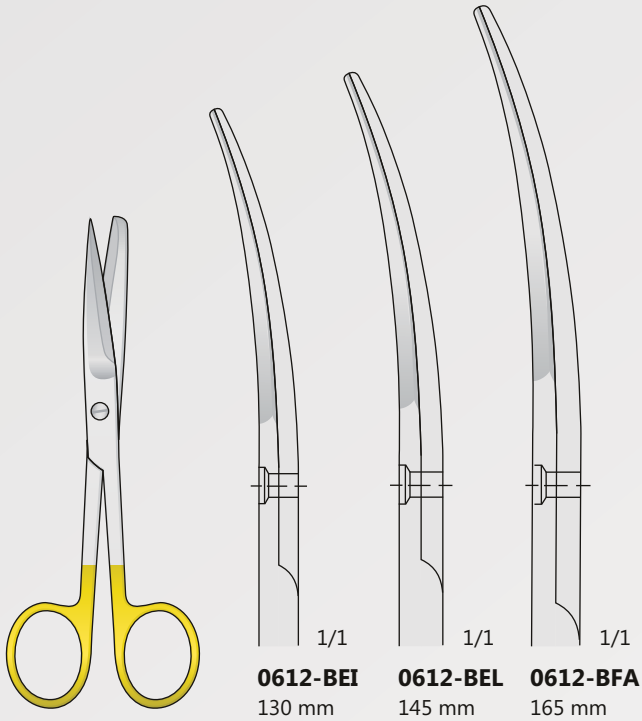

TUNGSTEN  
 CARBIDE

0612-BEI/0612-BFA

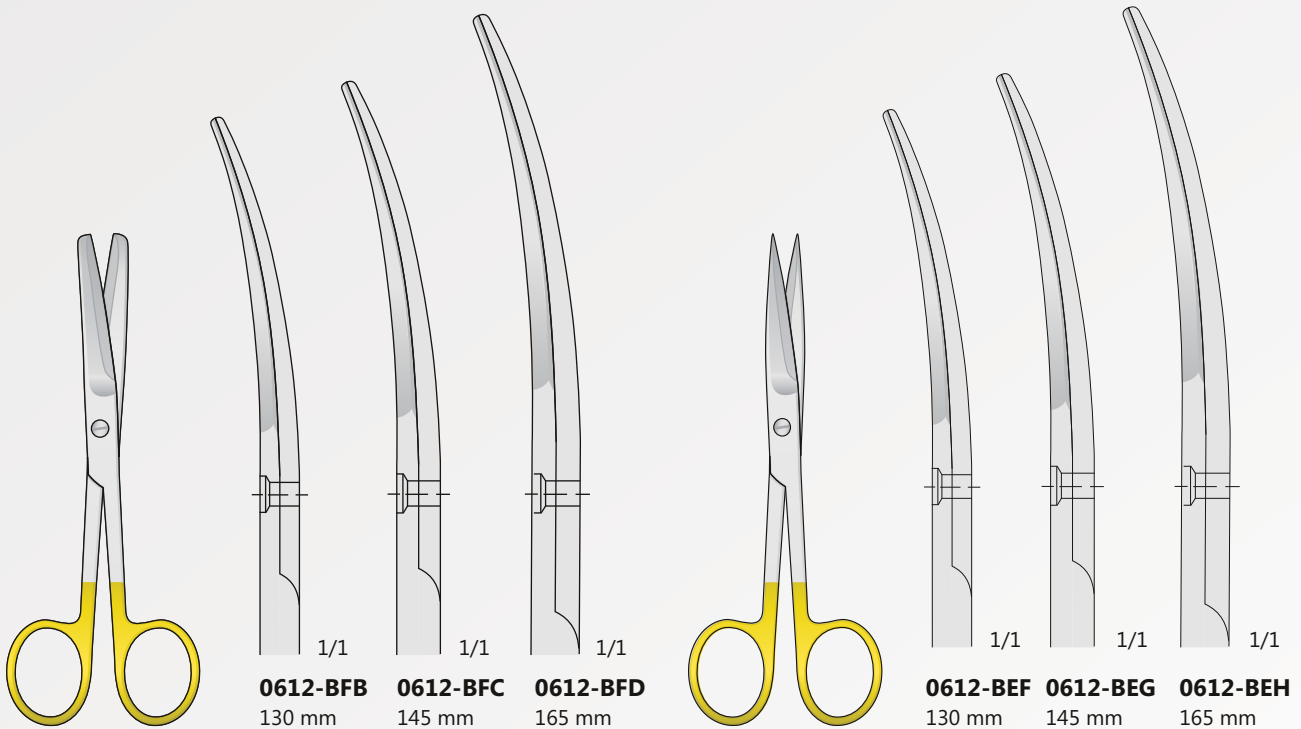

TUNGSTEN  
 CARBIDE

0612-BFB/0612-BFD

TUNGSTEN  
 CARBIDE

0612-BEF/0612-BEH

Chirurgische scheren  
 Operating scissors  
 Forbici chirurgiche  
 Tijeras para cirugía general  
 Ciseaux chirurgicaux

Hartmetallschneiden  
 Tungsten-carbide edges  
 Lame al carburo di tungsteno  
 Filos de carburo tungsteno  
 Lames en carbure de tungstène

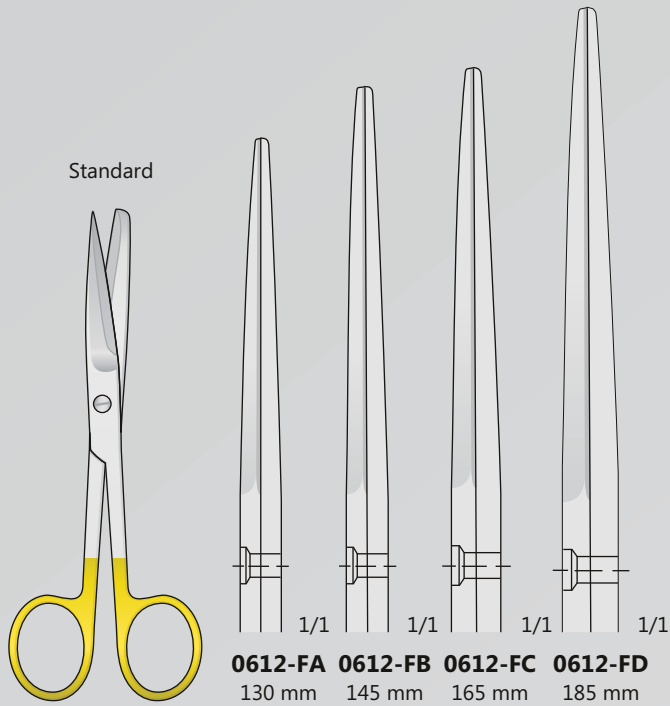

TUNGSTEN  
 CARBIDE

**0612-FA/0612-FD**

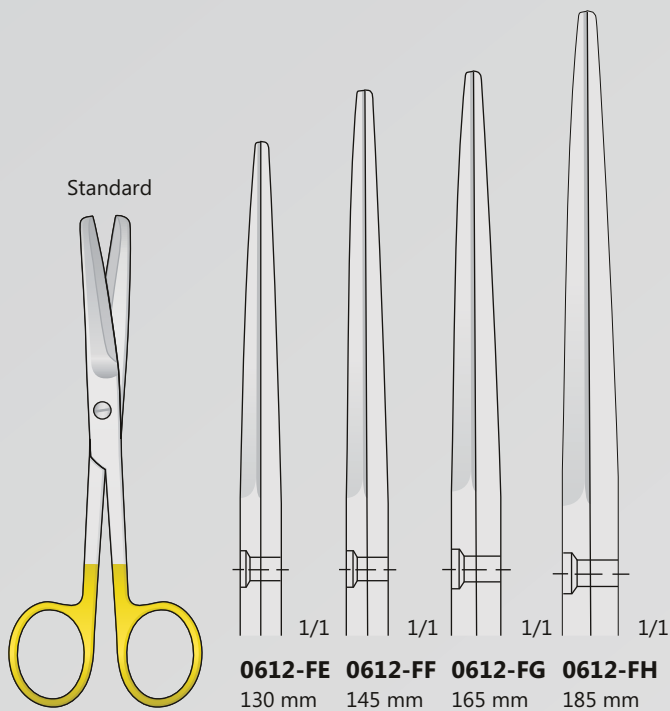

TUNGSTEN  
 CARBIDE

**0612-FE/0612-FH**

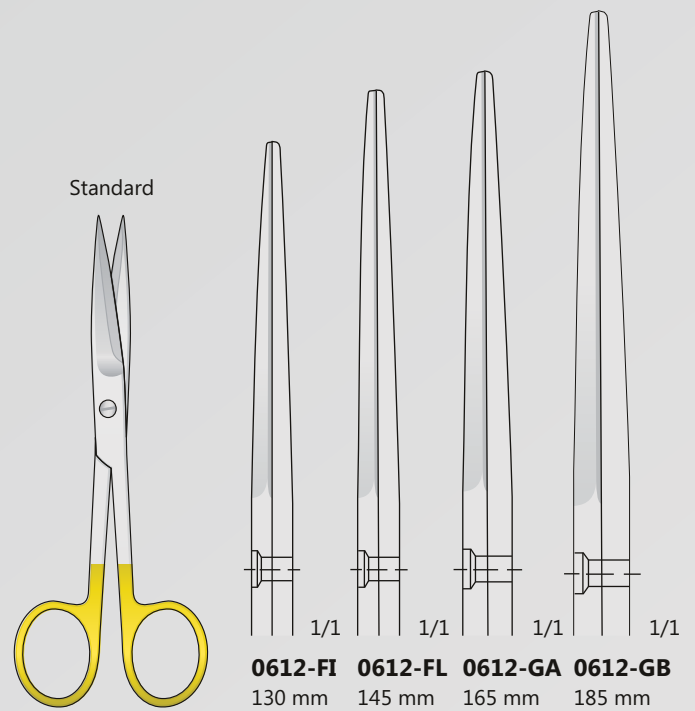

TUNGSTEN  
 CARBIDE

**0612-FI/0612-GB**

Chirurgische scheren  
 Operating scissors  
 Forbici chirurgiche  
 Tijeras para cirugía general  
 Ciseaux chirurgicaux

Hartmetallschneiden  
 Tungsten-carbide edges  
 Lame al carburo di tungsteno  
 Filos de carburo tungsteno  
 Lames en carbure de tungstène

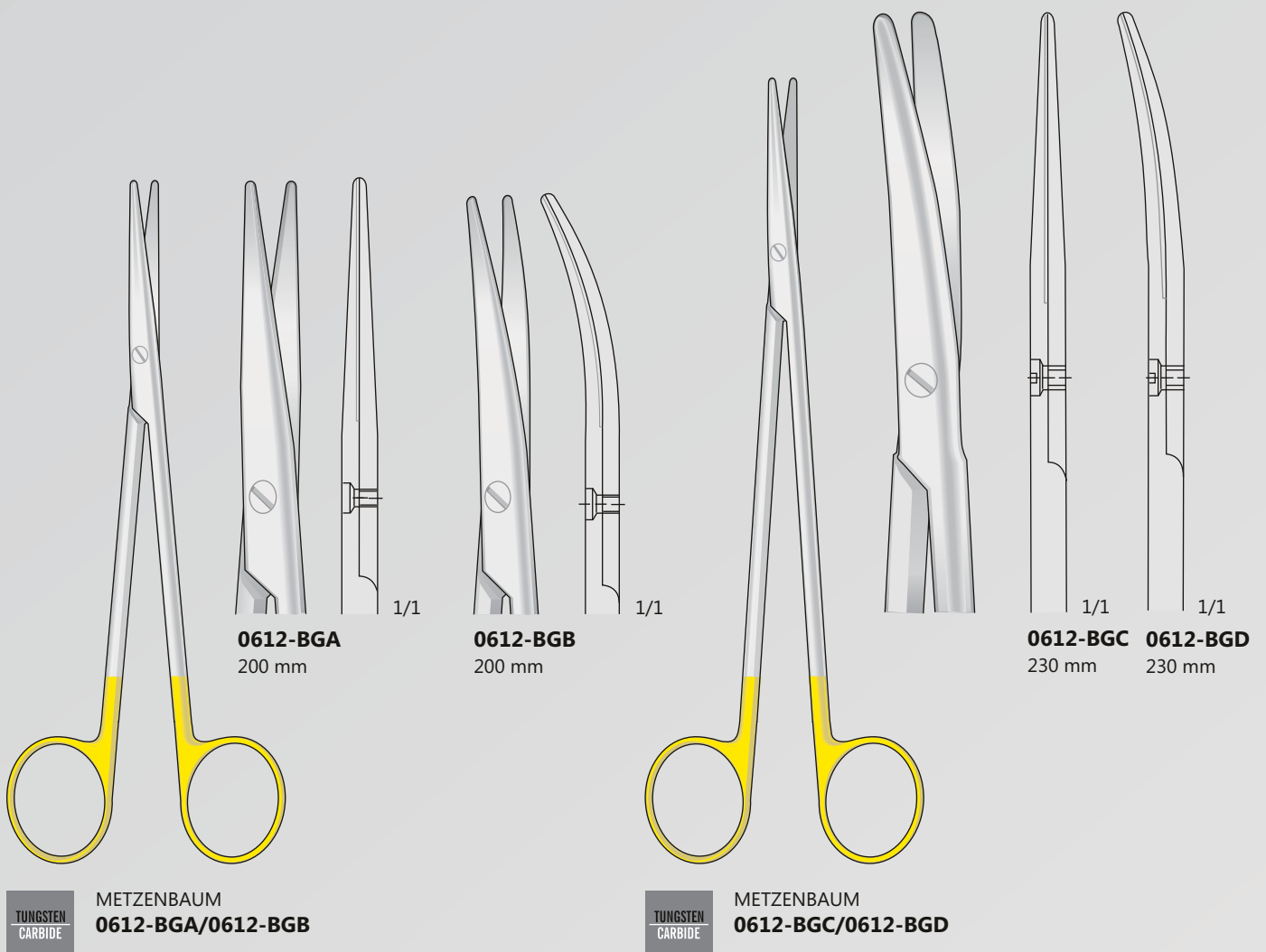

Hartmetallschneiden  
 Tungsten-carbide edges  
 Lame al carburo di tungsteno  
 Filos de carburo tungsteno  
 Lames en carbure de tungstène

Chirurgische scheren  
 Operating scissors  
 Forbici chirurgiche  
 Tijeras para cirugía general  
 Ciseaux chirurgicaux

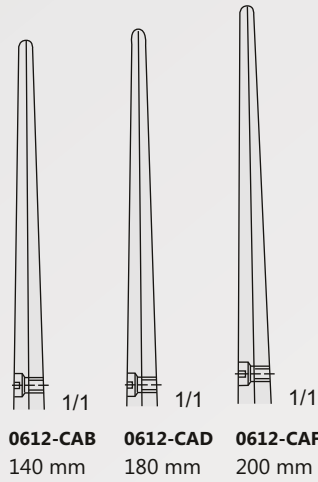

**TUNGSTEN CARBIDE**  
 METZENBAUM-FINO  
**0612-CAB/0612-CAG**

**TUNGSTEN CARBIDE**  
 METZENBAUM-FINO  
**0612-CAH/0612-CBC**

Chirurgische scheren  
 Operating scissors  
 Forbici chirurgiche  
 Tijeras para cirugía general  
 Ciseaux chirurgicaux

Hartmetallschneiden  
 Tungsten-carbide edges  
 Lame al carburo di tungsteno  
 Filos de carburo tungsteno  
 Lames en carbure de tungstène

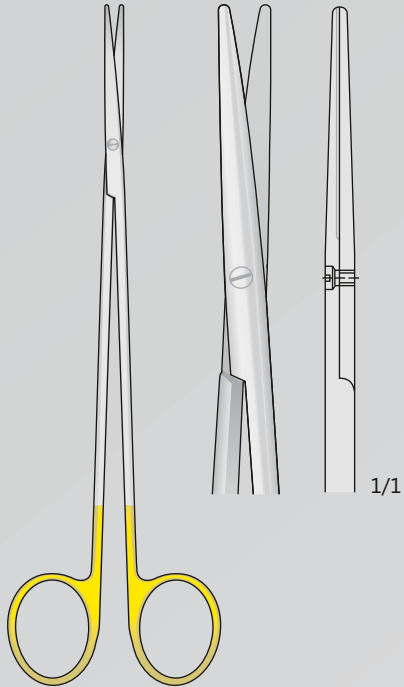

**TUNGSTEN CARBIDE**  
 TOENNIS-ADSON  
**0607-GD**  
 180 mm

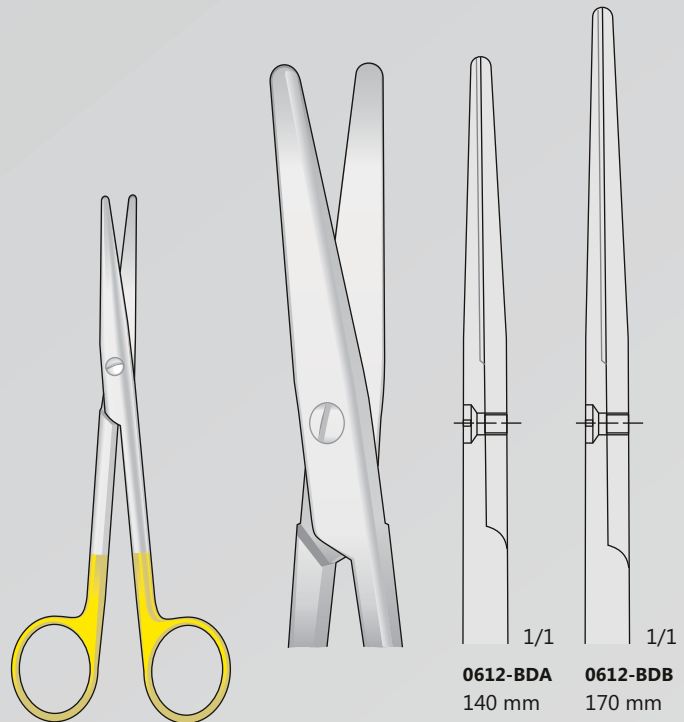

**TUNGSTEN CARBIDE**  
 MAYO-STILLE  
**0612-BDA/0612-BDB**

**0612-BDA** 140 mm  
**0612-BDB** 170 mm

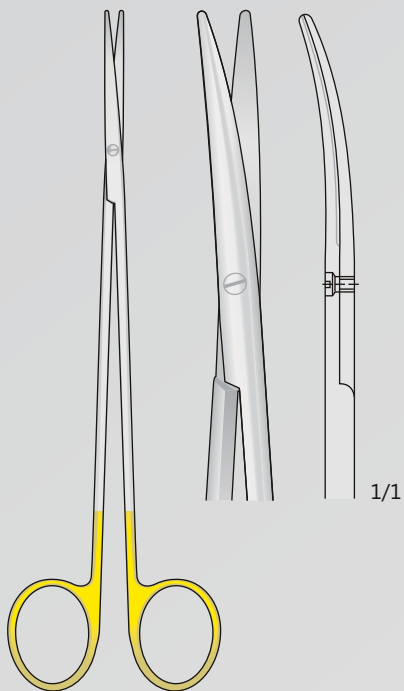

**TUNGSTEN CARBIDE**  
 TOENNIS-ADSON  
**0607-GE**  
 180 mm

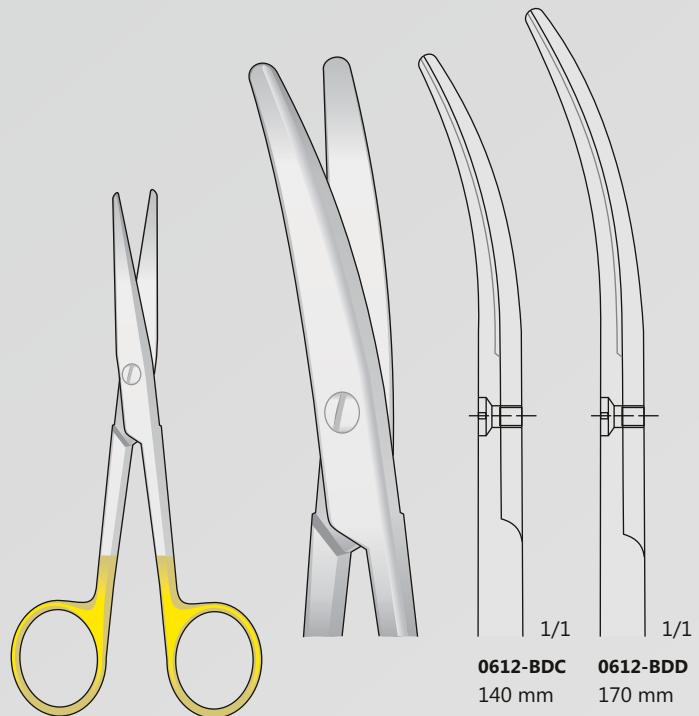

**TUNGSTEN CARBIDE**  
 MAYO-STILLE  
**0612-BDC/0612-BDD**

**0612-BDC** 140 mm  
**0612-BDD** 170 mm



Hartmetallschneiden  
 Tungsten-carbide edges  
 Lame al carburo di tungsteno  
 Filos de carburo tungsteno  
 Lames en carbure de tungstène

Chirurgische scheren  
 Operating scissors  
 Forbici chirurgiche  
 Tijeras para cirugía general  
 Ciseaux chirurgicaux



Chirurgische scheren  
 Operating scissors  
 Forbici chirurgiche  
 Tijeras para cirugía general  
 Ciseaux chirurgicaux

Hartmetallschneiden  
 Tungsten-carbide edges  
 Lame al carburo di tungsteno  
 Filos de carburo tungsteno  
 Lames en carbure de tungstène

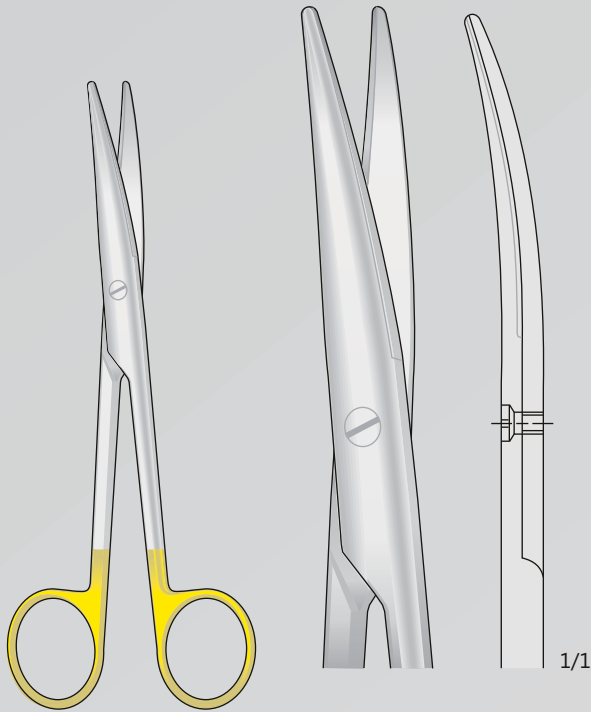

**TUNGSTEN CARBIDE** MAYO-LEXER  
**0612-BDL**  
 165 mm

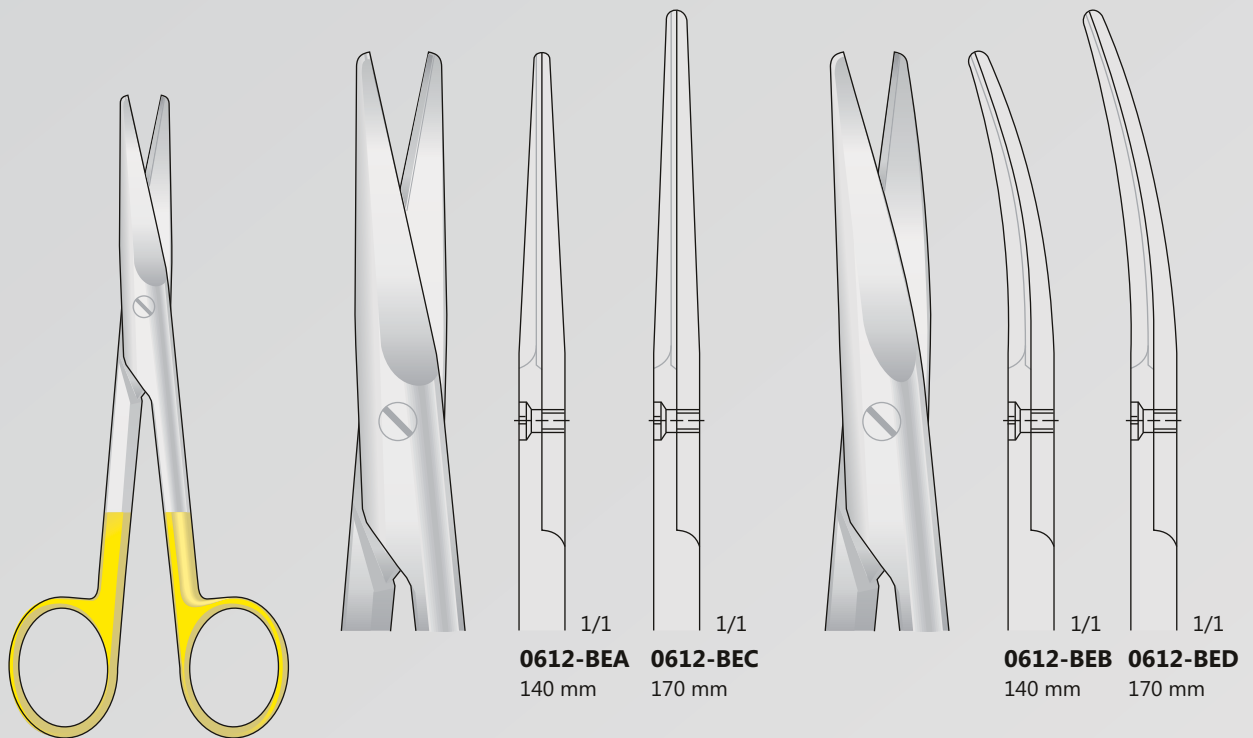

**TUNGSTEN CARBIDE** MAYO  
**0612-BEA/0612-BED**

**0612-BEA** 140 mm **0612-BEC** 170 mm

**0612-BEB** 140 mm **0612-BED** 170 mm

Hartmetallschneiden  
 Tungsten-carbide edges  
 Lame al carburo di tungsteno  
 Filos de carburo tungsteno  
 Lames en carbure de tungstène

Chirurgische scheren  
 Operating scissors  
 Forbici chirurgiche  
 Tijeras para cirugía general  
 Ciseaux chirurgicaux

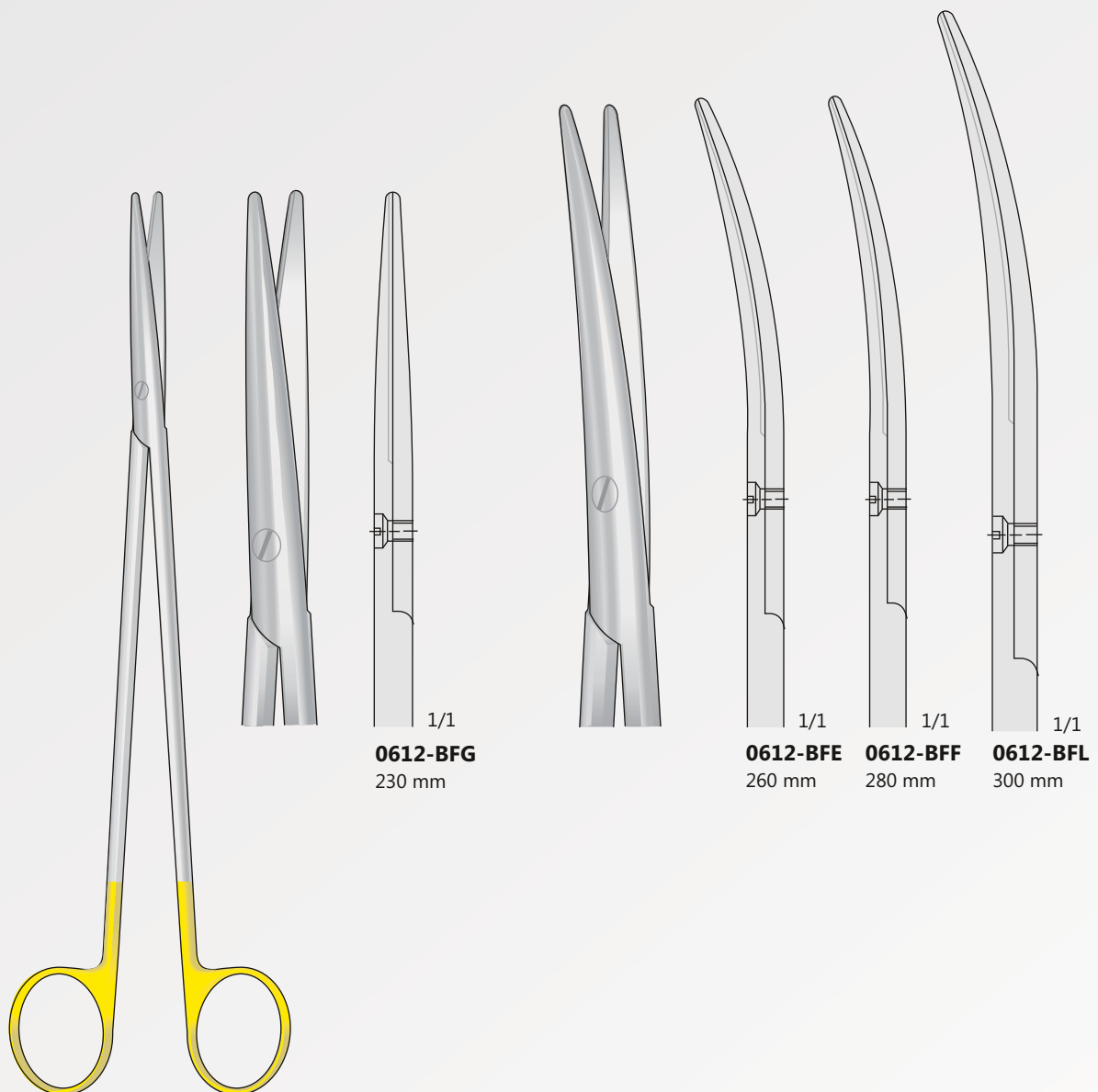

TUNGSTEN  
 CARBIDE

NELSON-METZENBAUM  
**0612-BFE/0612-BFL**

Chirurgische scheren  
 Operating scissors  
 Forbici chirurgiche  
 Tijeras para cirugía general  
 Ciseaux chirurgicaux

Hartmetallschneiden  
 Tungsten-carbide edges  
 Lame al carburo di tungsteno  
 Filos de carburo tungsteno  
 Lames en carbure de tungstène

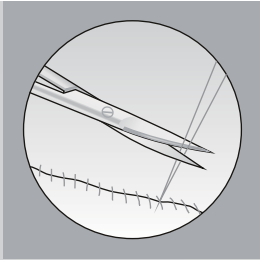

## Wellenschliff

Scheren mit wellenschliff auf einer Schnittfläche  
 Scissors cut one serrated cutting edge  
 Forbici con taglio ondulato su una lama  
 Tijeras con ondas afilados  
 Ciseaux avec affutage spécial ont une lame dentée

Links Scheren  
 Left Scissors  
 Forbici per mancini  
 Tijeras para zurdos  
 Gauche Ciseaux

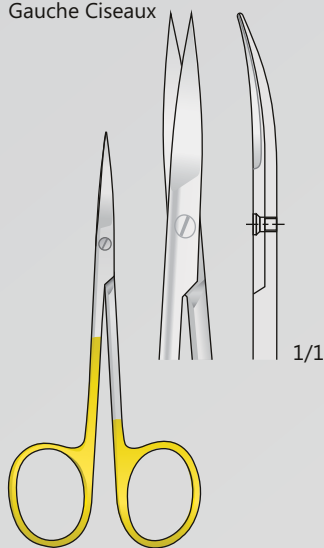

**TUNGSTEN CARBIDE**  
 IRIS  
**0612-BAA11**  
 110 mm

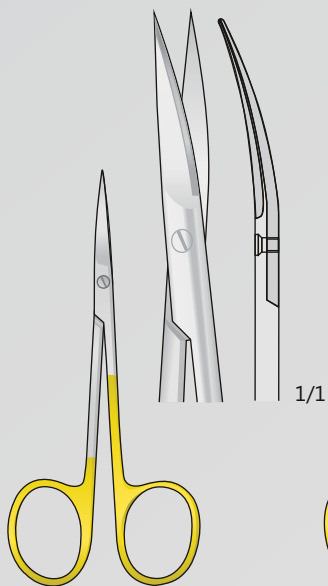

**TUNGSTEN CARBIDE**  
 IRIS  
**0612-BAA**  
 110 mm

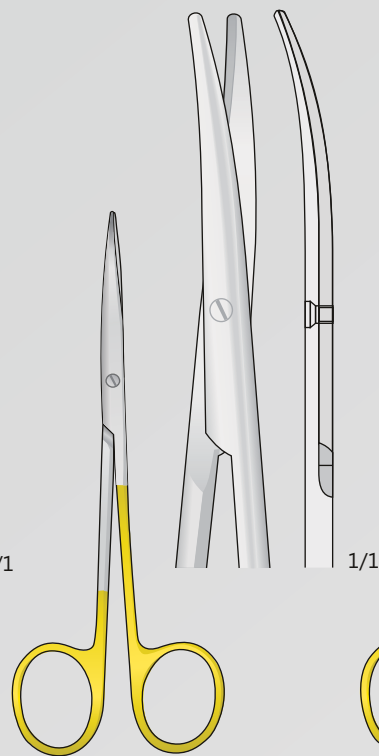

**TUNGSTEN CARBIDE**  
 METZENBAUM  
**0612-BAC**  
 145 mm

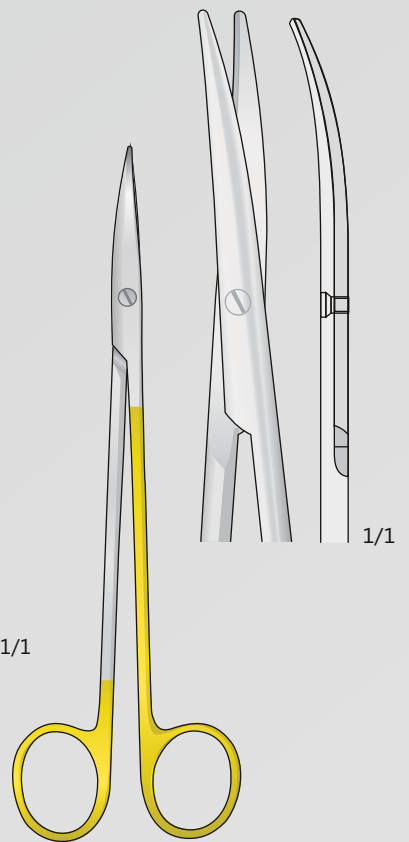

**TUNGSTEN CARBIDE**  
 METZENBAUM  
**0612-BAE**  
 185 mm

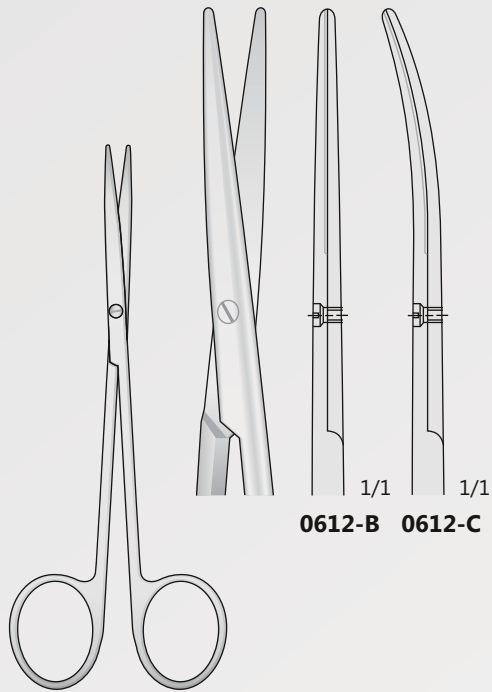

**0612-B 0612-C**

METZENBAUM  
**0612-B/0612-C**  
 145 mm

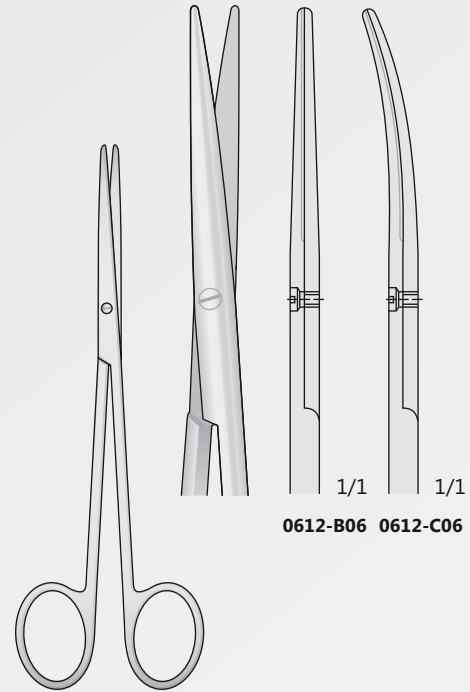

**0612-B06 0612-C06**

METZENBAUM-FINE  
**0612-B06/0612-C06**  
 145 mm

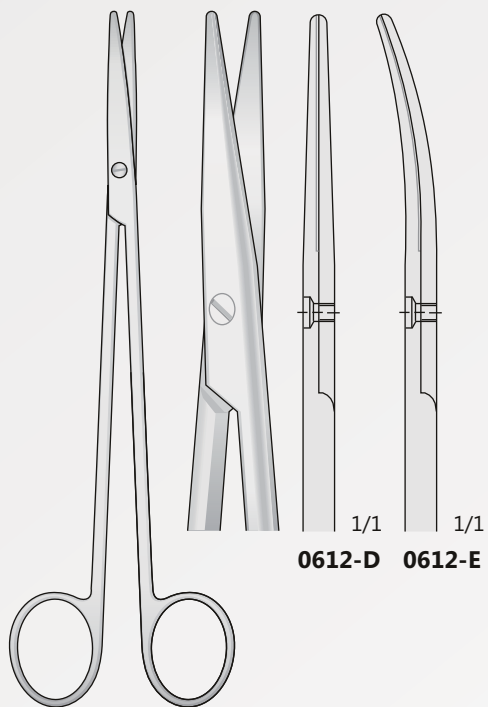

**0612-D 0612-E**

METZENBAUM  
**0612-D/0612-E**  
 185 mm

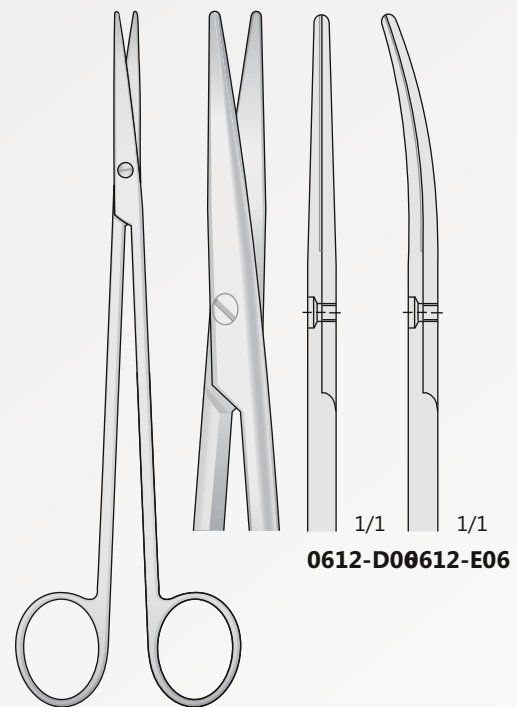

**0612-D06 0612-E06**

METZENBAUM-FINE  
**0612-D06/0612-E06**  
 185 mm

Chirurgische scheren  
 Operating scissors  
 Forbici chirurgiche  
 Tijeras para cirugía general  
 Ciseaux chirurgicaux

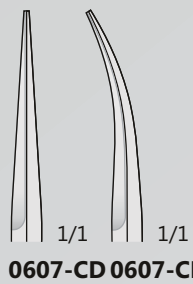
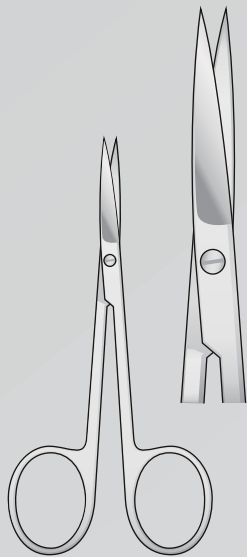

**0607-CD 0607-CE**

**0607-CD/0607-CE**  
110 mm

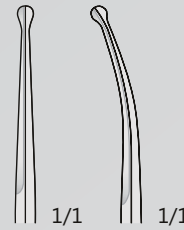
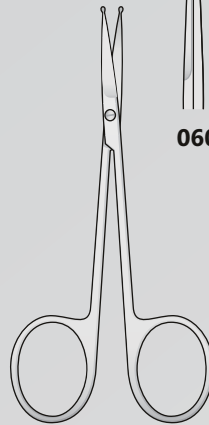

**0607-CF 0607-CG**

**0607-CF/0607-CG**  
110 mm

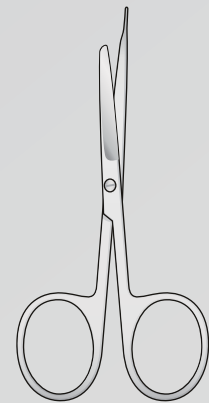

**0607-CH**  
100 mm

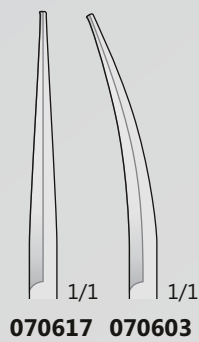
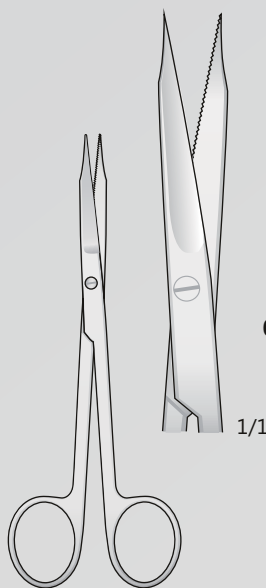

**070617 070603**

**GOLDMAN-FOX**  
**070617/070603**  
120 mm

Eine Schneide gezahnt  
 One toothed cutting  
 Una lama dentata  
 Una hoja dentada  
 Une lame dentelé

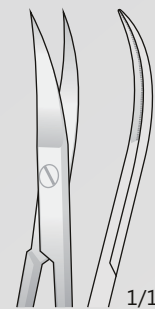
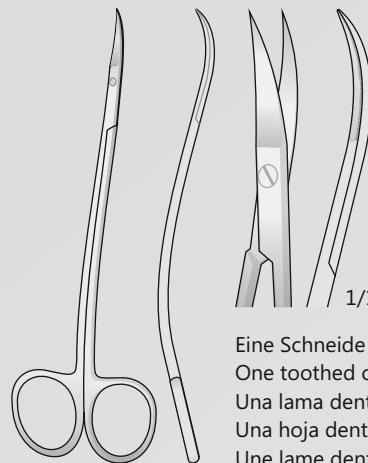

**LA GRANGE**  
**1107-B**  
115 mm

Eine Schneide gezahnt  
 One toothed cutting  
 Una lama dentata  
 Una hoja dentada  
 Une lame dentelé

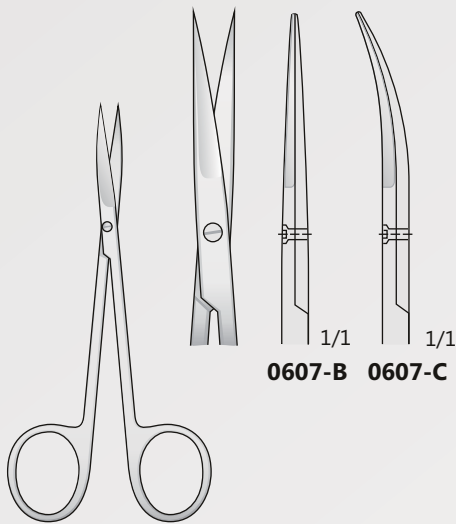

IRIS  
**0607-B/0607-C**  
110 mm



**0607-E/0607-F**  
105 mm

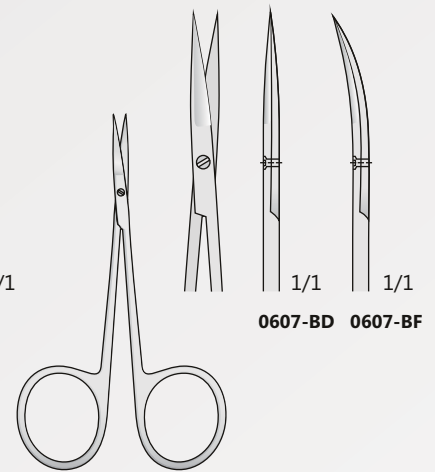

MICRO-IRIS  
**0607-BD/0607-BF**  
85 mm

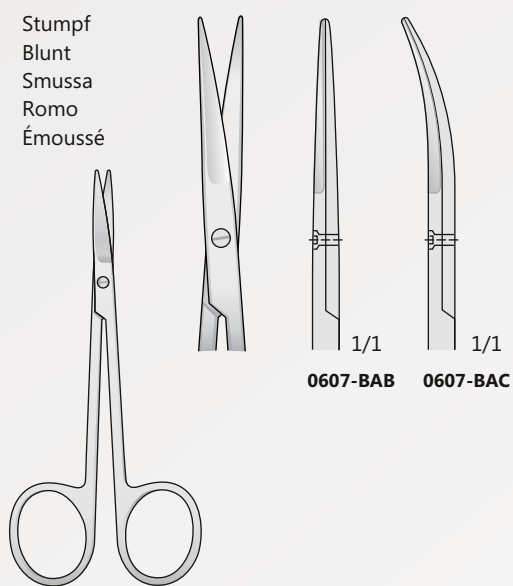

**0607-BAB/0607-BAC**  
110 mm

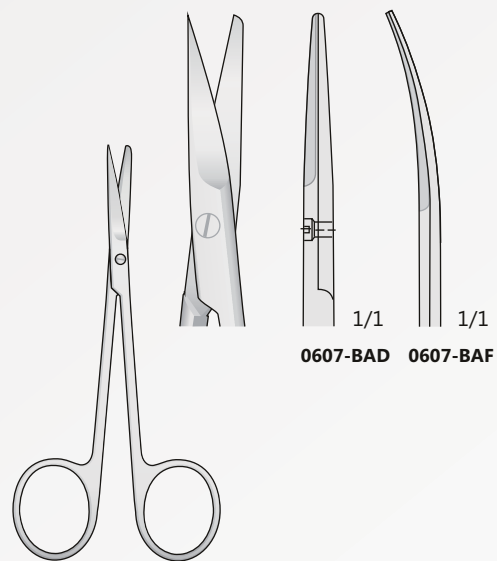

**0607-BAD/0607-BAF**  
110 mm

Feine Scheren  
 Delicate scissors  
 Forbici delicate  
 Tijeras finas  
 Ciseaux délicate

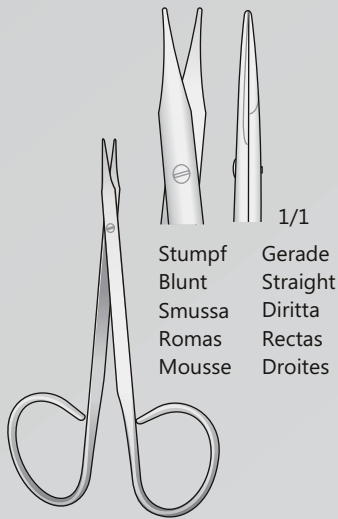

Stumpf  
Blunt  
Smussa  
Romas  
Mousse

Gerade  
Straight  
Diritta  
Rectas  
Droites

STEVENS  
**0607-CAL**  
 100 mm

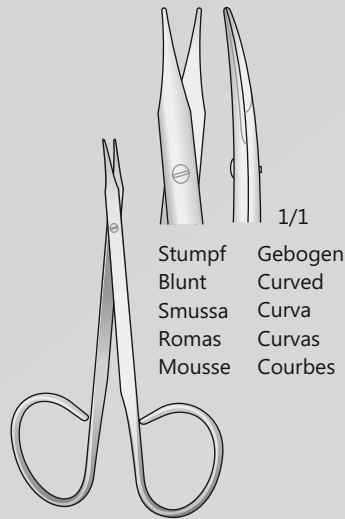

Stumpf  
Blunt  
Smussa  
Romas  
Mousse

Gebogen  
Curved  
Curva  
Curvas  
Courbes

STEVENS  
**0607-CBA**  
 100 mm

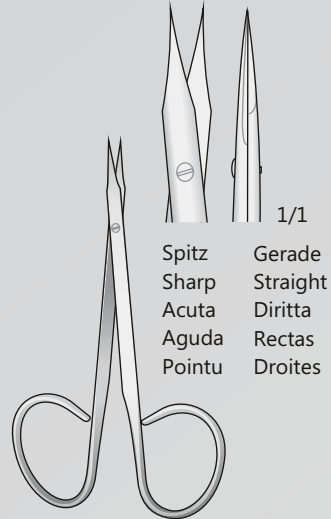

Spitz  
Sharp  
Acuta  
Aguda  
Pointu

Gerade  
Straight  
Diritta  
Rectas  
Droites

WALTON  
**0607-CBB**  
 100 mm

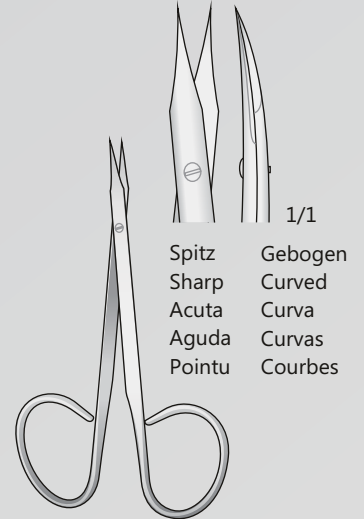

Spitz  
Sharp  
Acuta  
Aguda  
Pointu

Gebogen  
Curved  
Curva  
Curvas  
Courbes

WALTON  
**0607-CBC**  
 100 mm

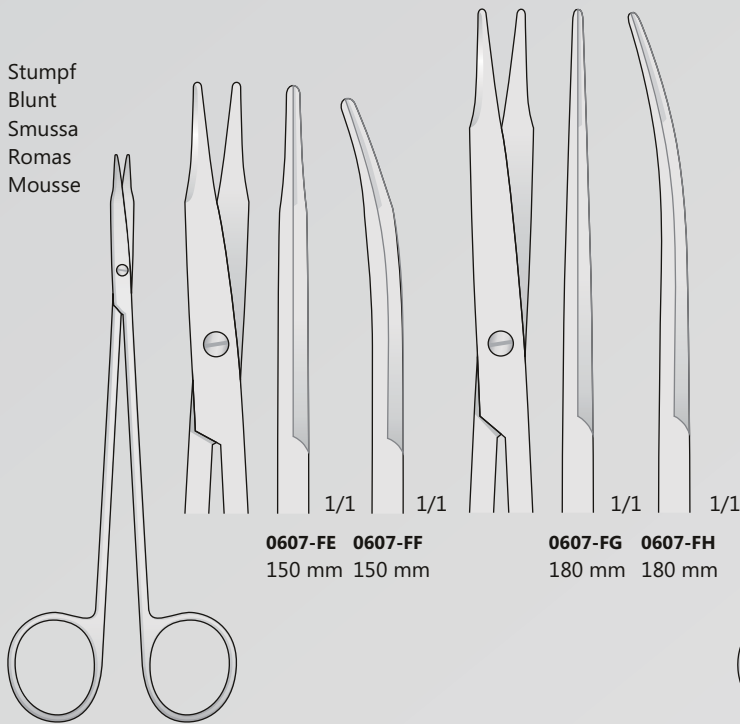

Stumpf  
Blunt  
Smussa  
Romas  
Mousse

**0607-FE 0607-FF**  
 150 mm 150 mm

**0607-FG 0607-FH**  
 180 mm 180 mm

REYNOLDS (JAMESON)  
**0607-FE/0607-FH**

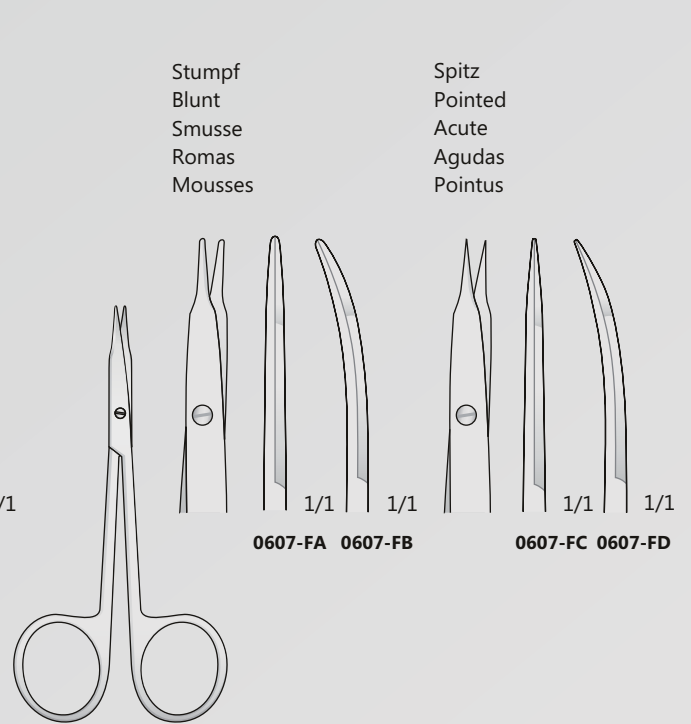

Stumpf  
Blunt  
Smusse  
Romas  
Mousses

Spitz  
Pointed  
Acute  
Agudas  
Pointus

**0607-FA 0607-FB**

**0607-FC 0607-FD**

STEVENS  
**0607-FA/0607-FD**  
 110 mm



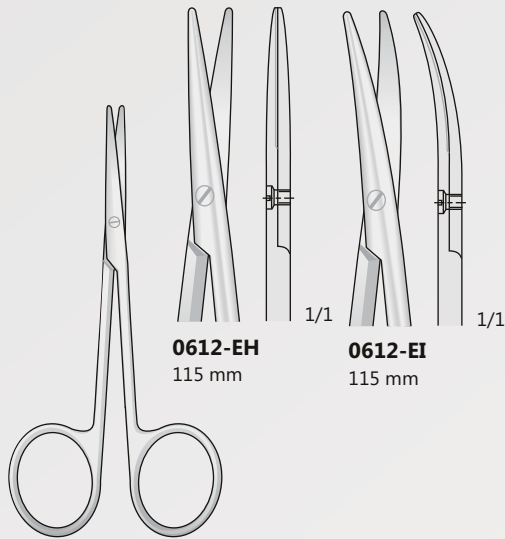

**0612-EH**  
115 mm

**0612-EI**  
115 mm

BABY - METZENBAUM  
**0612-EH/0612-EI**  
115 mm

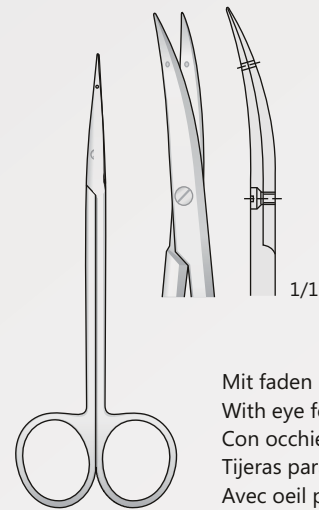

Mit faden bohrung  
With eye for suture  
Con occhiello per sutura  
Tijeras para ligaduras  
Avec oeil pour les sutures

LITTLER  
**0607-BAA**  
120 mm

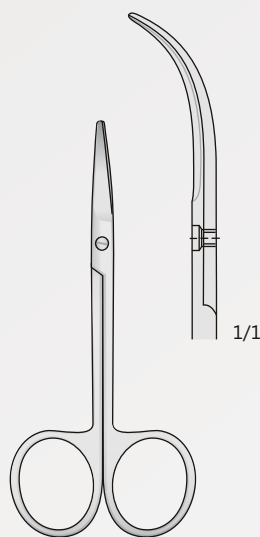

FOMON  
**0607-ED**  
110 mm

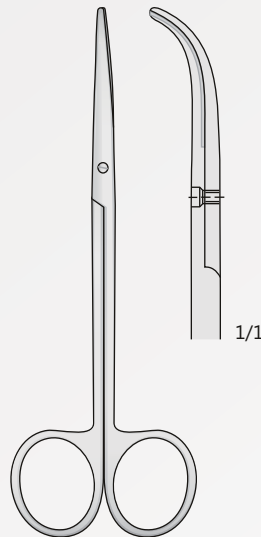

**0607-EE**  
140 mm

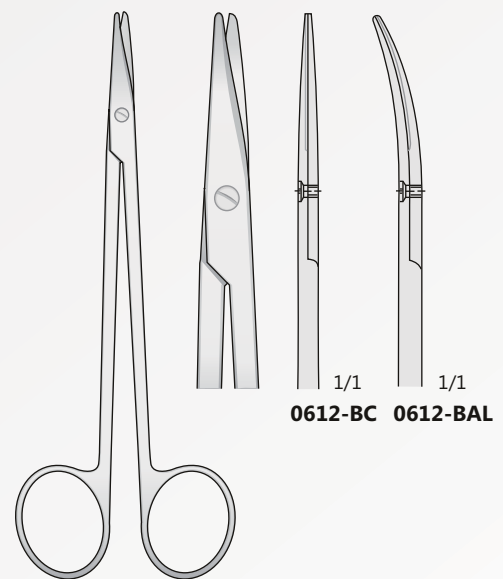

**0612-BC** **0612-BAL**

METZENBAUN  
**0612-BC/0612-BAL**  
150 mm

Chirurgische scheren  
 Operating scissors  
 Forbici chirurgiche  
 Tijeras para cirugía general  
 Ciseaux chirurgicaux

Inzisionscheren  
 Incision scissors  
 Forbici da incisione  
 Tijeras para incisión  
 Ciseaux à incision

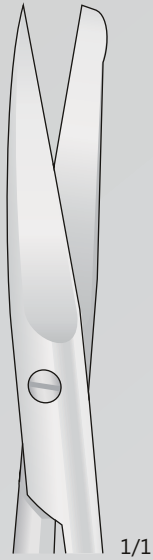
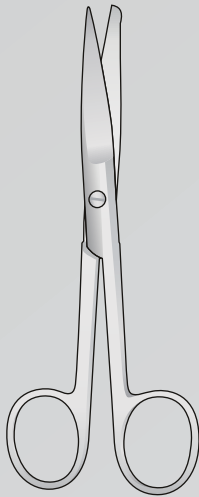

1/1



1/1

**0607-BG**  
130 mm



1/1

**0607-BH**  
145 mm



1/1

**0607-BI**  
185 mm

**0607-BG/0607-BI**

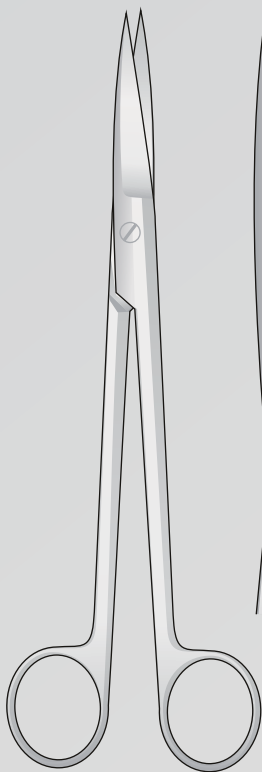

SIMS  
**0607-BDI**  
200 mm



1/1

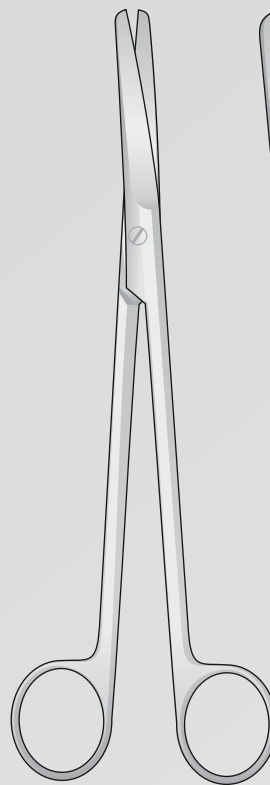

SIMS  
**0607-BDL**  
210 mm



1/1

Standard

Spitz  
 Sharp  
 Acuta  
 Agudo  
 Aigu

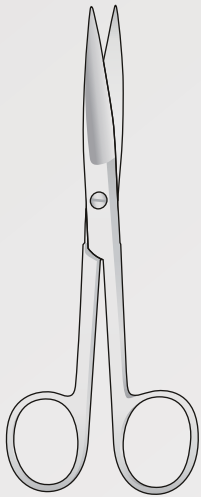

**0612-H/0612-H2**



1/1



1/1

**0612-EB**  
 130 mm



1/1

**0612-H**  
 145 mm



1/1

**0612-ED**  
 165 mm



1/1

**0612-EF**  
 185 mm



1/1

**0612-HC**  
 200 mm

Spitz  
 Sharp  
 Acuta  
 Agudo  
 Aigu

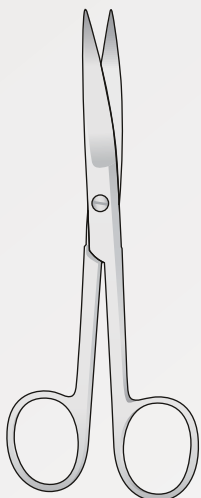

**0612-I/0612-HD**



1/1



1/1

**0612-EC**  
 130 mm

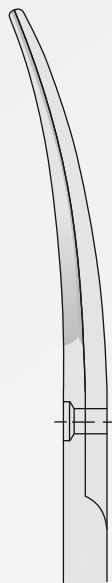

1/1

**0612-I**  
 145 mm



1/1

**0612-EE**  
 165 mm



1/1

**0612-EG**  
 185 mm



1/1

**0612-HD**  
 200 mm

**Standard**

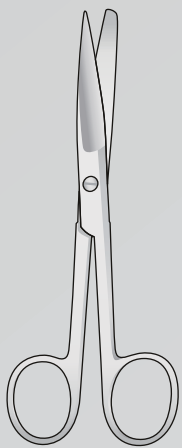

**0612-CH/0612-GC**



1/1



1/1

**0612-EL**  
115 mm



1/1

**0612-CH**  
130 mm



1/1

**0612-CL**  
145 mm



1/1

**0612-DB**  
165 mm



1/1

**0612-DD**  
185 mm

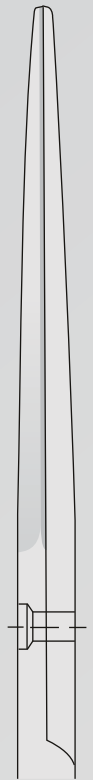

1/1

**0612-GC**  
200 mm

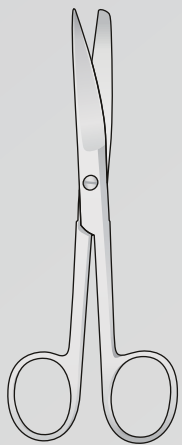

**0612-CI/0612-GD**

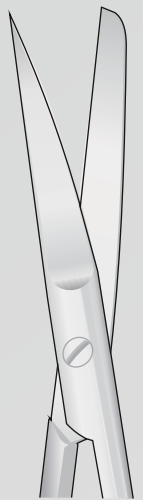

1/1



1/1

**0612-GD**  
115 mm



1/1

**0612-CI**  
130 mm



1/1

**0612-DA**  
145 mm



1/1

**0612-DC**  
165 mm

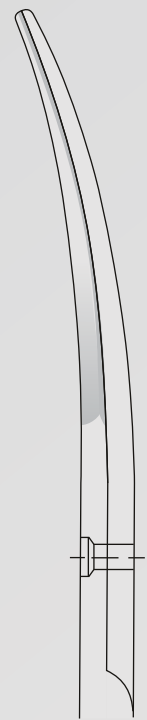

1/1

**0612-DE**  
185 mm

## Standard

Stumpf  
 Blunt  
 Smusse  
 Romas  
 Mousses

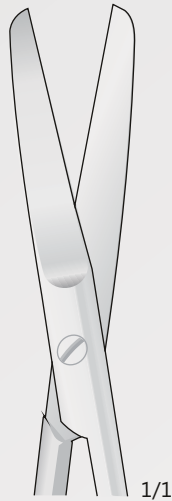
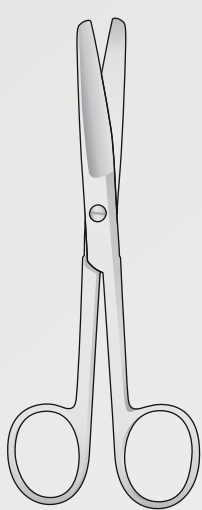

1/1



1/1

**0612-DF**  
 130 mm

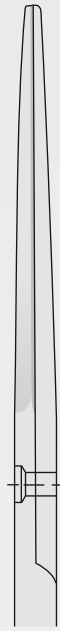

1/1

**0612-L**  
 145 mm

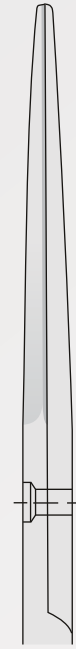

1/1

**0612-DH**  
 165 mm

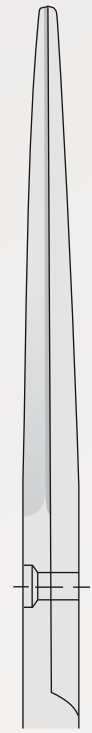

1/1

**0612-DL**  
 185 mm

Stumpf  
 Blunt  
 Smusse  
 Romas  
 Mousses

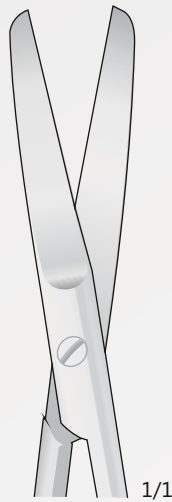
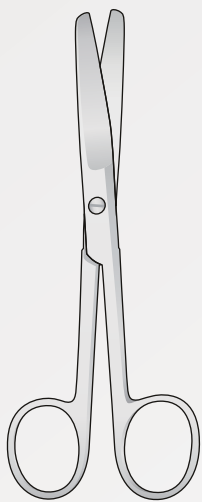

1/1



1/1

**0612-DG**  
 130 mm

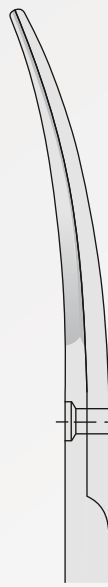

1/1

**0612-BA**  
 145 mm

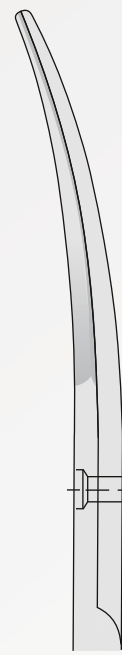

1/1

**0612-DI**  
 165 mm



1/1

**0612-EA**  
 185 mm

**0612-BA/0612-EA**

Chirurgische scheren  
 Operating scissors  
 Forbici chirurgiche  
 Tijeras para cirugía general  
 Ciseaux chirurgicaux

Stumpf  
 Blunt  
 Smussa  
 Romo  
 Moussés

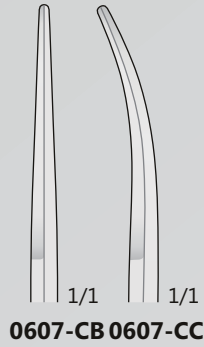
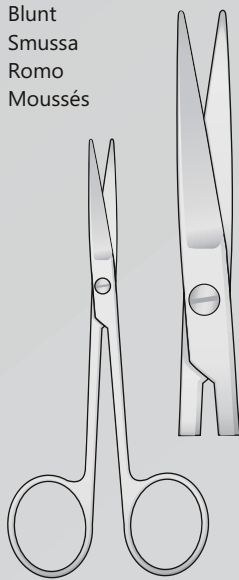

**0607-CB/0607-CC**  
 115 mm

Spitz  
 Sharp  
 Acuta  
 Agudo  
 Aigu

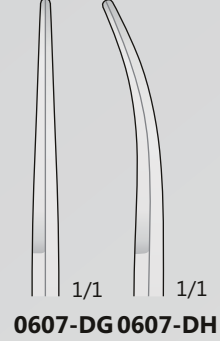
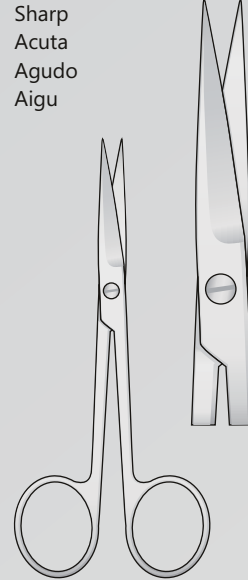

**0607-DG/0607-DH**  
 115 mm

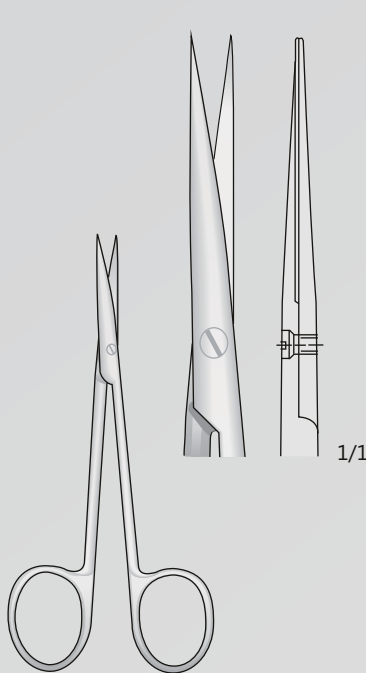

KILNER  
**0607-FI**  
 115 mm

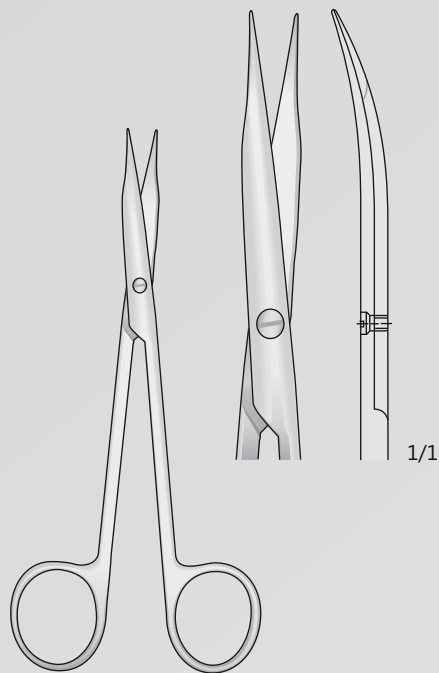

JAMESON  
**0607-BCE**  
 145 mm



IRIS  
**0607-BB11/0607-BC11**  
 110 mm

Schere für Linkshänder  
 Scissors for lefties  
 Forbici per mancini  
 Tijeras para zurdos  
 Ciseaux pour gauchers

Präparierscheren  
Dissecting Scissors  
Forbici per dissezione  
Tijeras para preparaciones  
Ciseaux à dissection

Chirurgische scheren  
Operating scissors  
Forbici chirurgiche  
Tijeras para cirugía general  
Ciseaux chirurgicaux

Spitz  
Sharp  
Acuta  
Agudo  
Aigu

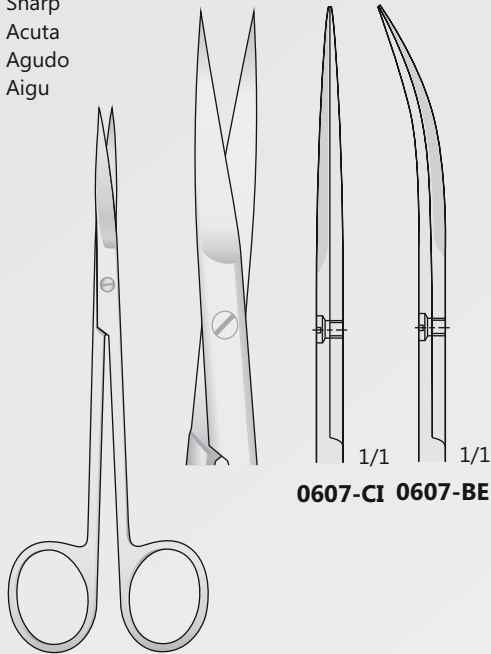

**0607-CI 0607-BE**

Spitz  
Sharp  
Acuta  
Agudo  
Aigu



**0612-BCG 0612-BCH**

METZENBAUM  
**0607-CI/0607-BE**  
145 mm

METZENBAUM  
**0612-BCG/0612-BCH**  
145 mm

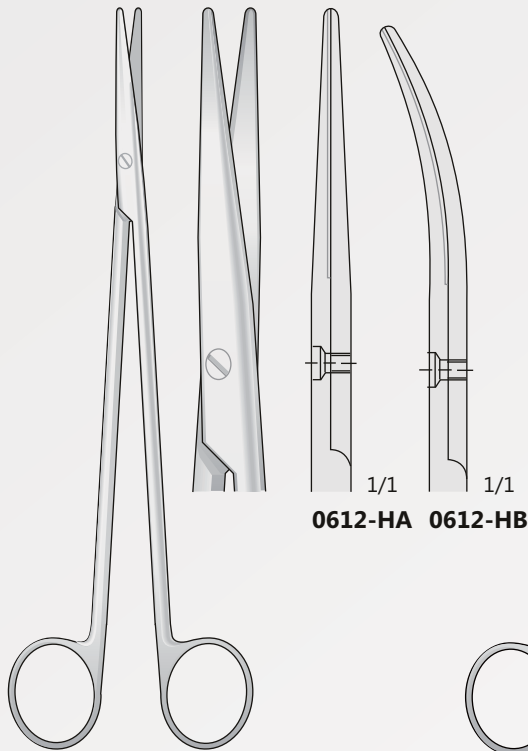

**0612-HA 0612-HB**

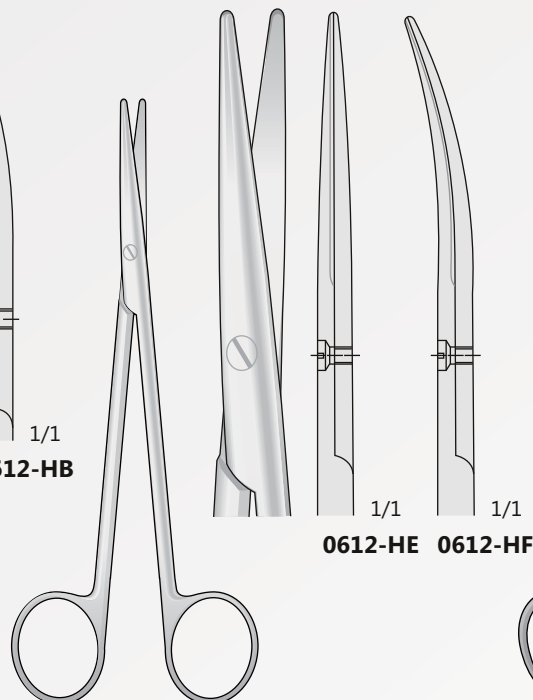

**0612-HE 0612-HF**

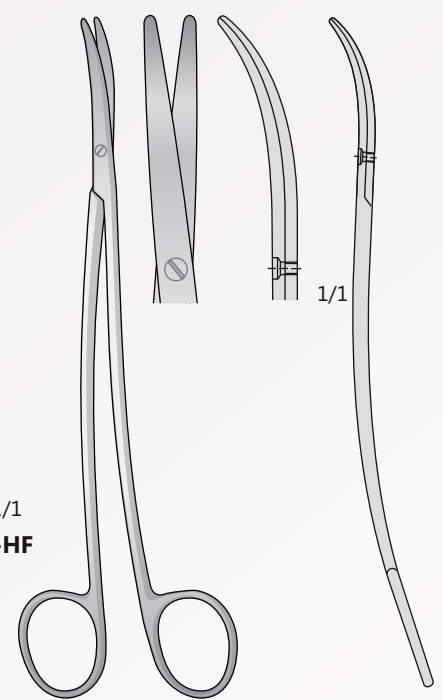

METZENBAUM-FINO  
**0612-BCA** - 180 mm  
**0612-BCB** - 200 mm  
**0612-BCC** - 230 mm

METZENBAUM  
**0612-HA/0612-HB**  
200 mm

METZENBAUM  
**0612-HE/0612-HF**  
160 mm

Chirurgische scheren  
 Operating scissors  
 Forbici chirurgiche  
 Tijeras para cirugía general  
 Ciseaux chirurgicaux

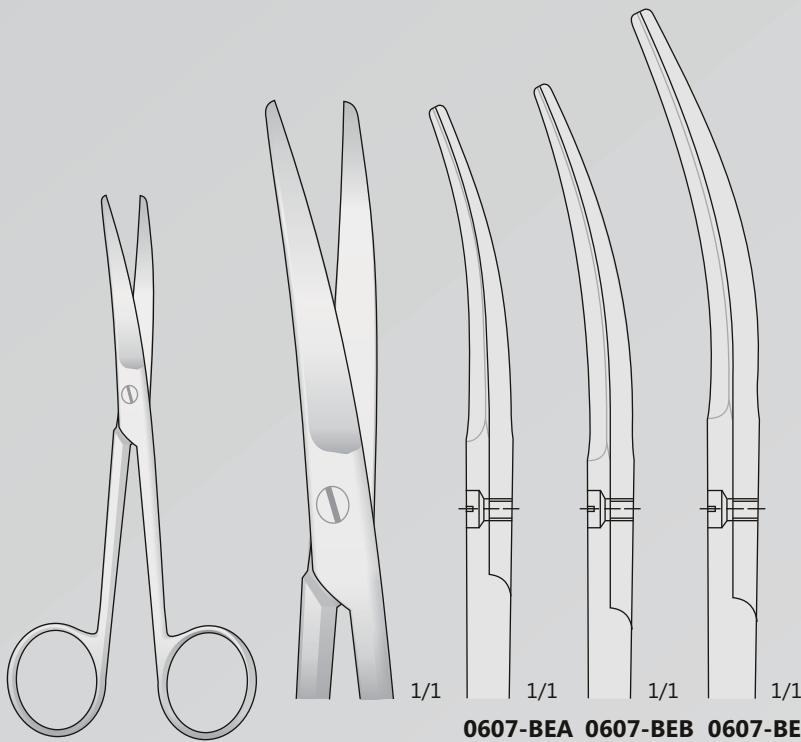

**0607-BEA** 145 mm  
**0607-BEB** 200 mm  
**0607-BEC** 230 mm

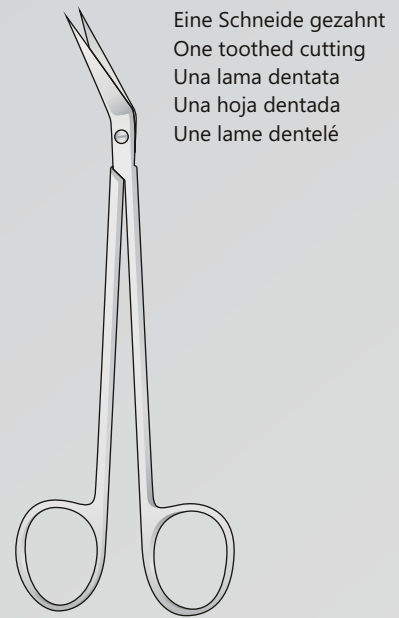

Eine Schneide gezahnt  
 One toothed cutting  
 Una lama dentata  
 Una hoja dentada  
 Une lame dentelé

**KELLY**  
**0610-BA**  
 160 mm

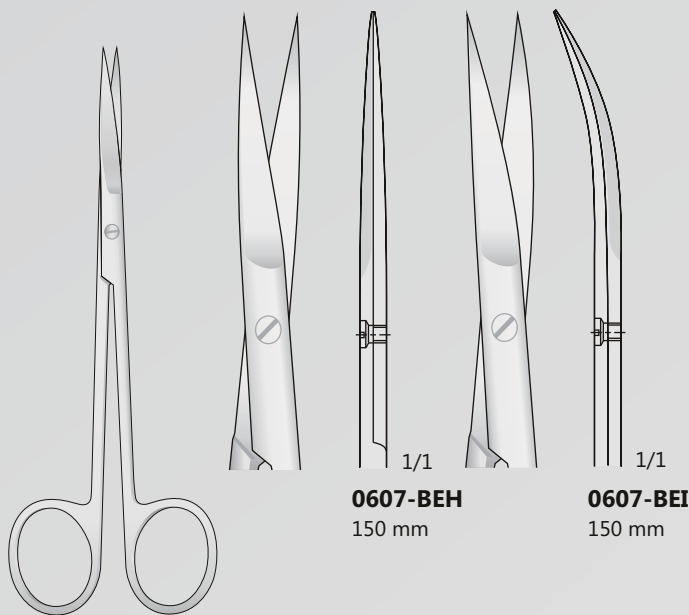

**0607-BEH**  
 150 mm

**0607-BEI**  
 150 mm

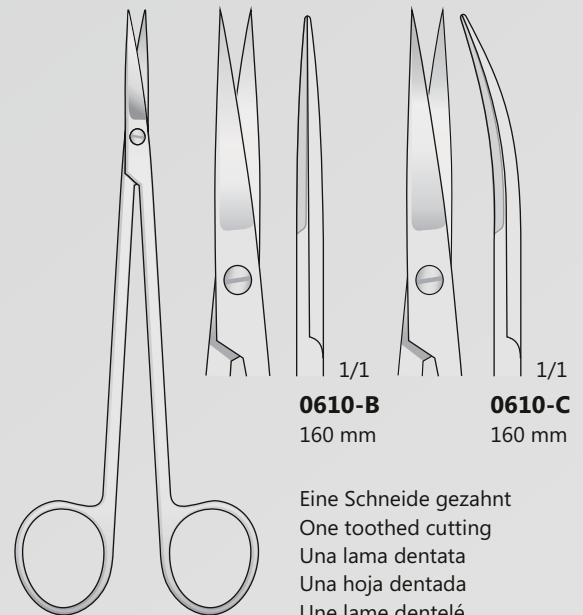

**0610-B**  
 160 mm

**0610-C**  
 160 mm

Eine Schneide gezahnt  
 One toothed cutting  
 Una lama dentata  
 Una hoja dentada  
 Une lame dentelé

**KELLY**  
**0610-B/0610-C**

**WERTHEIM**  
**0607-BEA/0607-BEC**

**JOSEPH**  
**0607-BEH/0607-BEI**  
 150 mm



Präparierscheren  
Dissecting Scissors  
Forbici per dissezione  
Tijeras para preparaciones  
Ciseaux à dissection

Chirurgische scheren  
Operating scissors  
Forbici chirurgiche  
Tijeras para cirugía general  
Ciseaux chirurgicaux

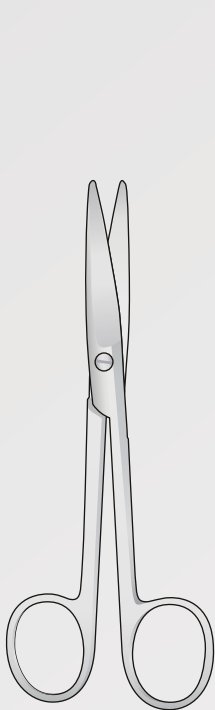

MAYO  
0612-F/0612-CF

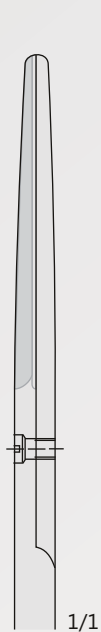

0612-F  
140 mm

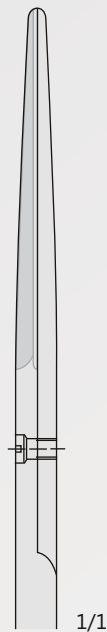

0612-CE  
170 mm

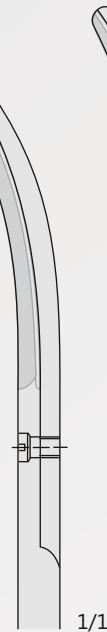

0612-G  
140 mm



0612-CF  
170 mm

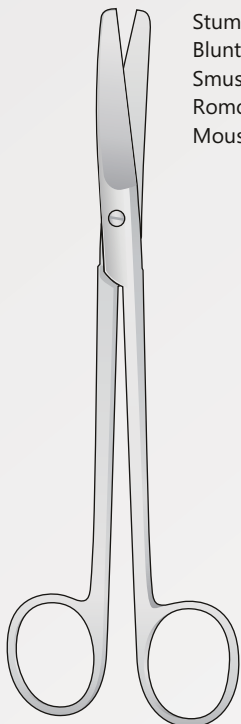

SIMS  
0612-CA/0612-CD

Stumpf  
Blunt  
Smussa  
Romo  
Moussés

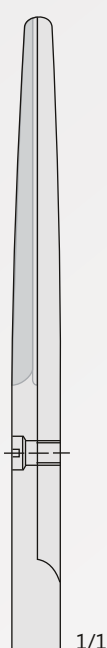
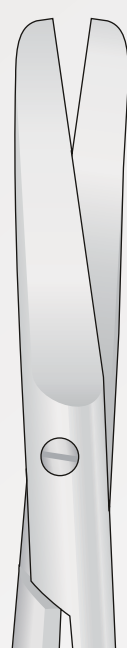

0612-CA  
200 mm

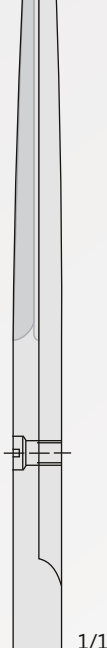

0612-CC  
230 mm

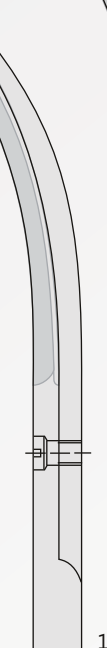

0612-CB  
200 mm



0612-CD  
230 mm

Chirurgische scheren  
 Operating scissors  
 Forbici chirurgiche  
 Tijeras para cirugía general  
 Ciseaux chirurgicaux

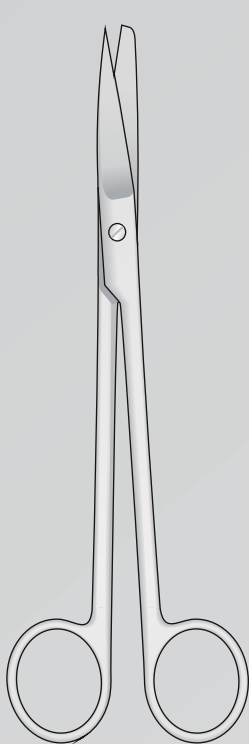

SIMS  
**0612-BE/0612-BH**



**0612-BE**  
 200 mm

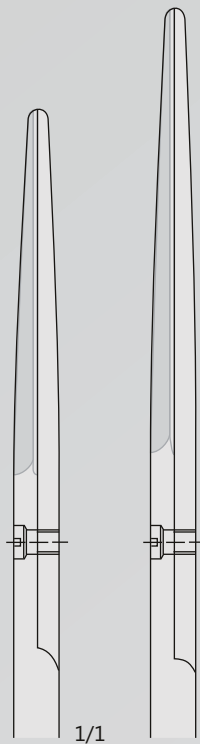

**0612-BG**  
 230 mm

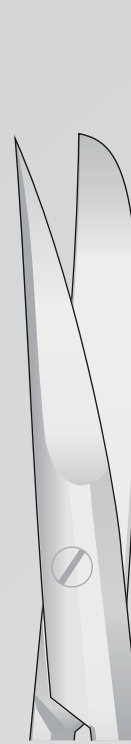

**0612-BF**  
 200 mm

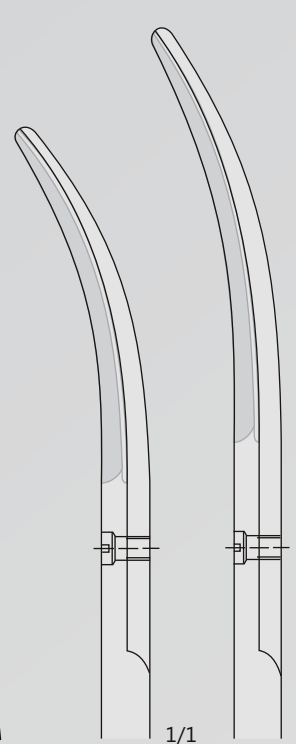

**0612-BH**  
 230 mm

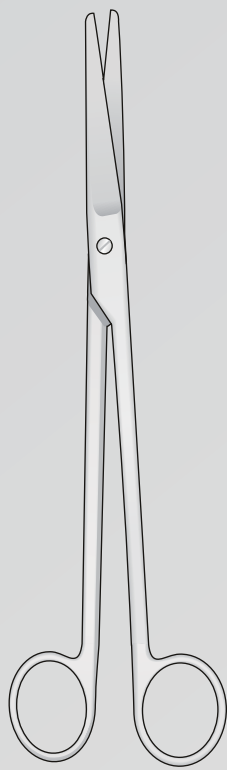

MAYO-HARRINGTON  
**0612-BI/0612-BL**  
 230 mm

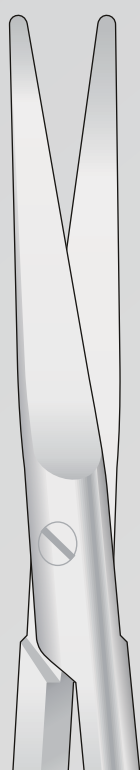

**0612-BI**  
 230 mm



**0612-BL**  
 230 mm

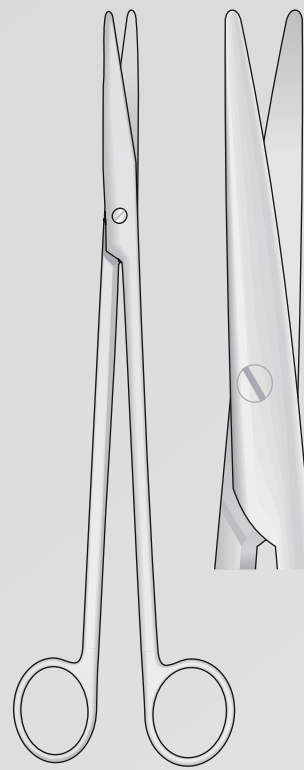

NELSON-METZENBAUM  
**0612-BB/0612-BD**  
 230 mm

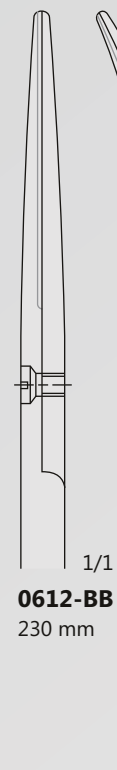

**0612-BB**  
 230 mm

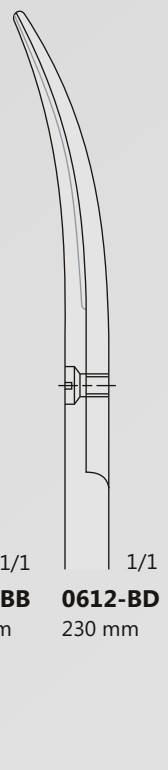

**0612-BD**  
 230 mm

Präparierscheren  
Dissecting Scissors  
Forbici per dissezione  
Tijeras para preparaciones  
Ciseaux à dissection

Chirurgische scheren  
Operating scissors  
Forbici chirurgiche  
Tijeras para cirugía general  
Ciseaux chirurgicaux

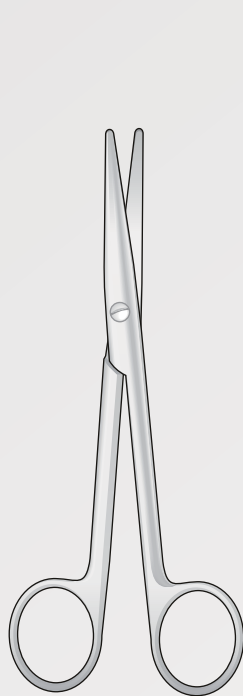

**0612-BBA**  
150 mm

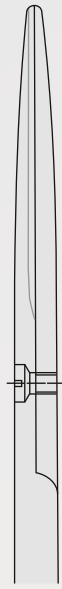

1/1



**0612-BBB**  
150 mm



1/1

STILLE  
**0612-BBA/0612-BBB**  
150 mm

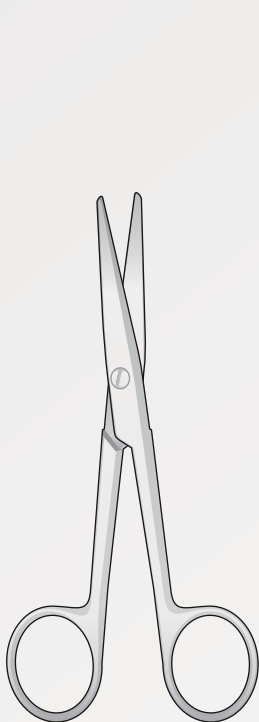

1/1

**0612-HG**  
140 mm



1/1

**0612-HH**  
170 mm

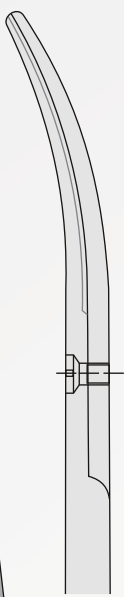
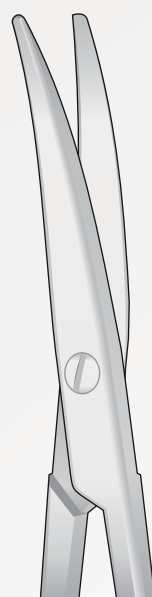

1/1

**0612-HI**  
140 mm

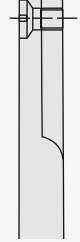
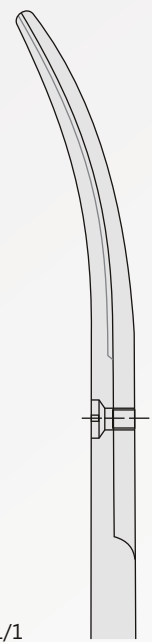

1/1

**0612-HL**  
170 mm

MAYO-STILLE  
**0612-HG/0612-HL**

Chirurgische scheren  
 Operating scissors  
 Forbici chirurgiche  
 Tijeras para cirugía general  
 Ciseaux chirurgicaux

Präparierschere  
 Dissecting Scissors  
 Forbici per dissezione  
 Tijeras para preparaciones  
 Ciseaux à dissection

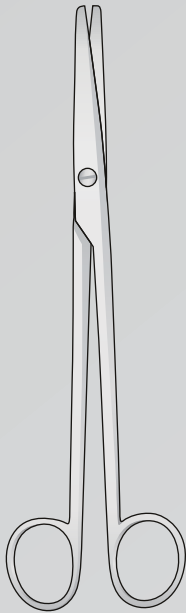

MAYO  
**0612-IA/0612-IC**

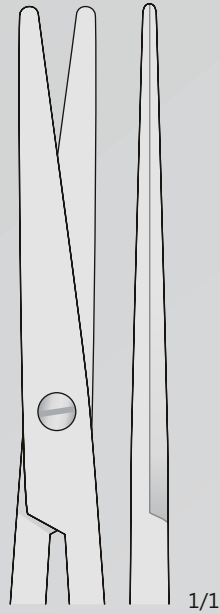

**0612-IA**  
 160 mm



**0612-IB**  
 190 mm

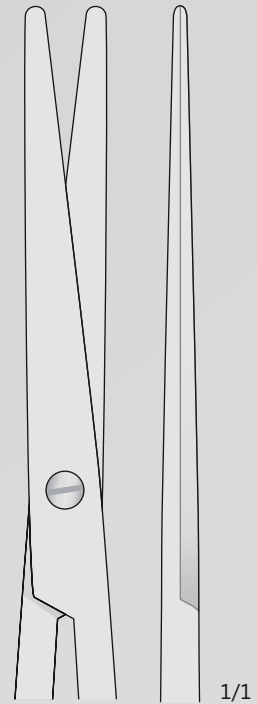

**0612-IC**  
 210 mm

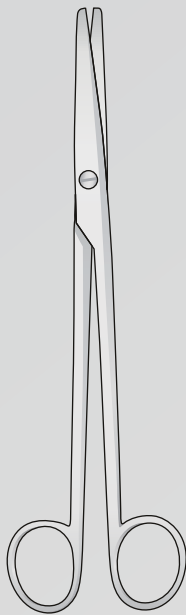

MAYO  
**0612-ID/0612-IF**

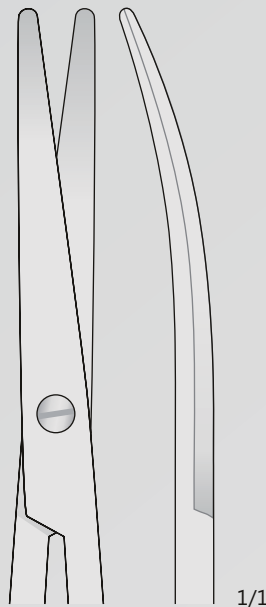

**0612-ID**  
 160 mm

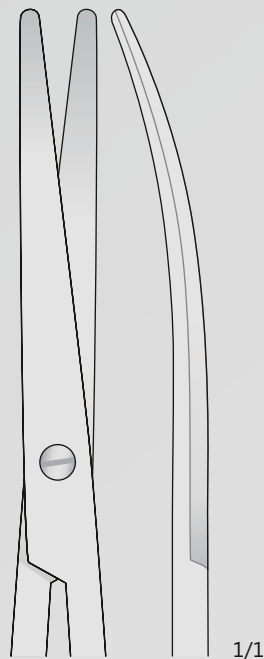

**0612-IE**  
 190 mm

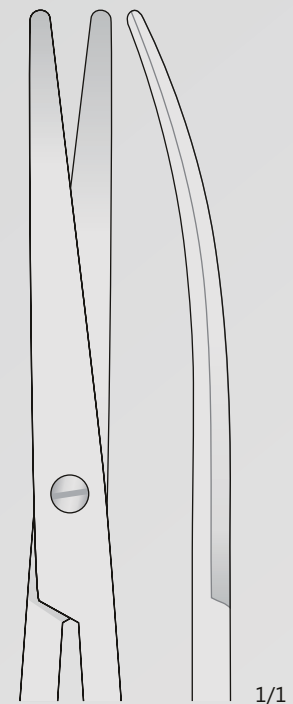

**0612-IF**  
 210 mm

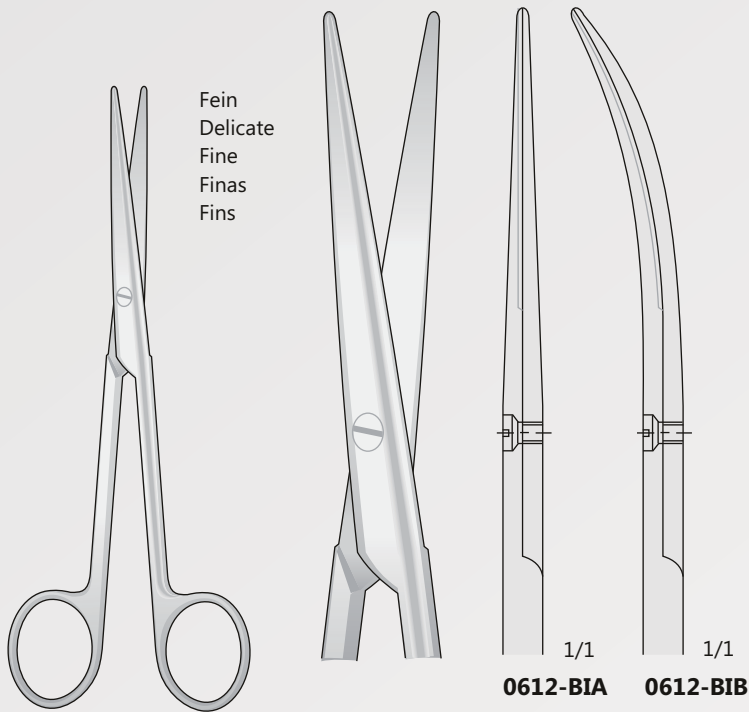

LEXER  
**0612-BIA/0612-BIB**  
 165 mm

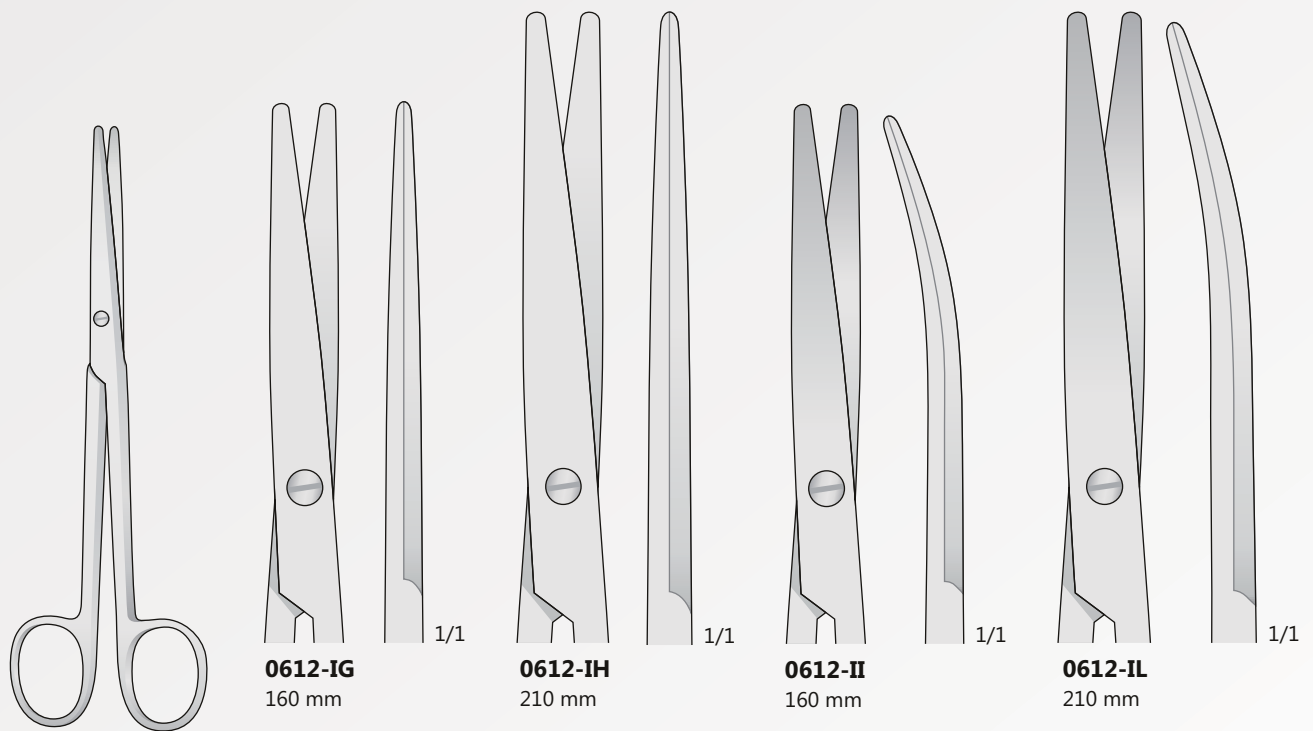

LEXER  
**0612-IG/0612-IL**

Gefäss Scheren  
 Vascular scissors  
 Forbici vascolari  
 Tijeras vasculares  
 Ciseaux vasculaires

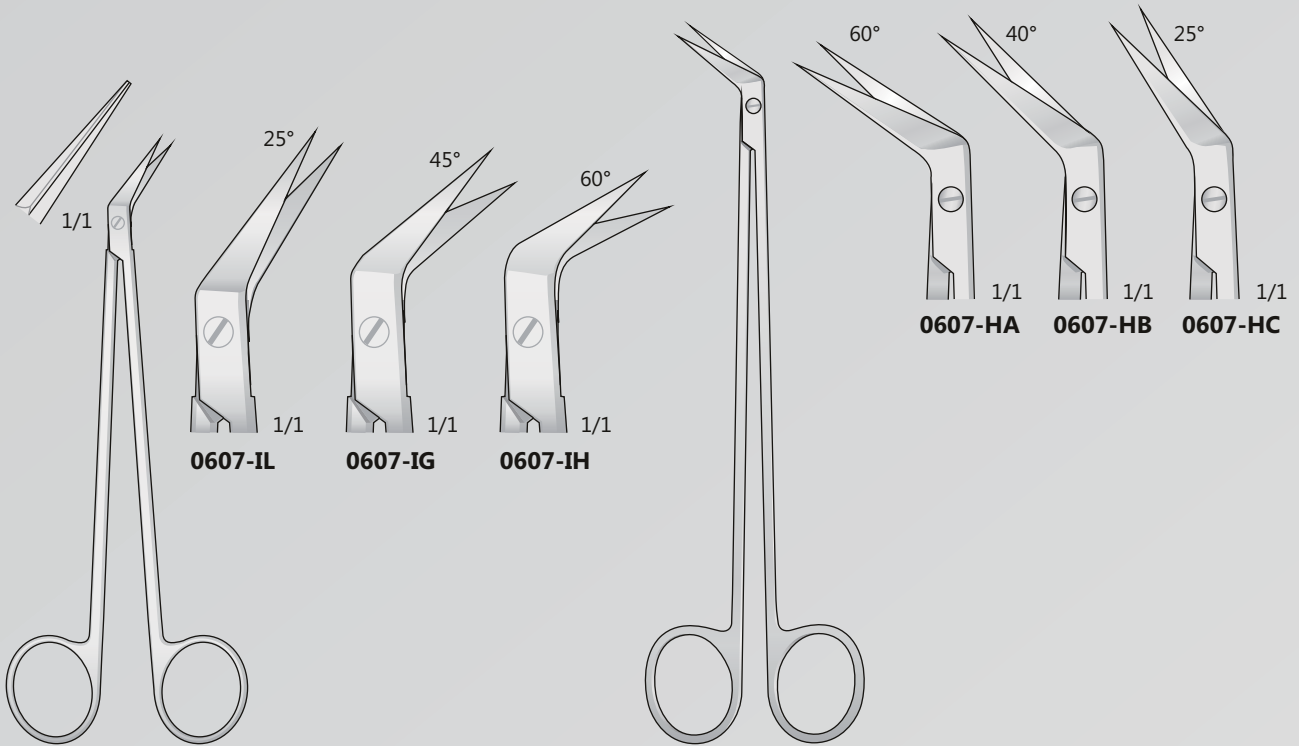

DE BAKEY (POTTS-SMITH)  
**0607-IG/0607-IL**  
 160 mm

POTTS-SMITH  
**0607-HA/0607-HC**  
 190 mm

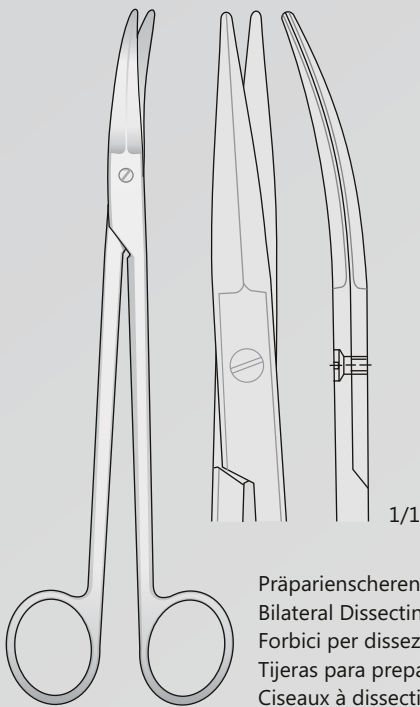

**0607-BA**  
 185 mm

Präparierscheren zu schneiden bilateralen  
 Bilateral Dissecting Scissors  
 Forbici per dissezione a taglio bilaterale  
 Tijeras para preparaciones cortado bilaterale  
 Ciseaux à dissection avec coupe bilatérale

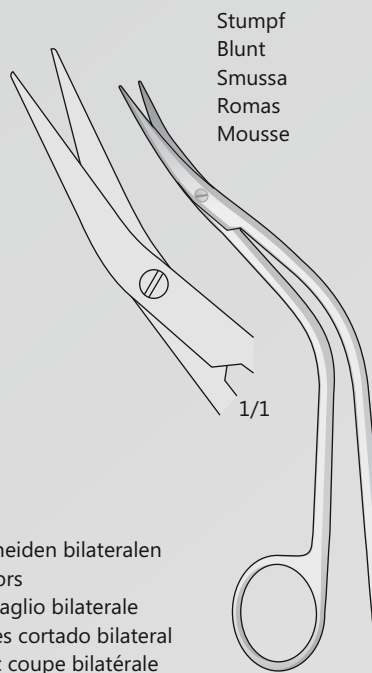

DE BAKEY  
**0607-HI**  
 155 mm

Stumpf  
 Blunt  
 Smussa  
 Romas  
 Mousse

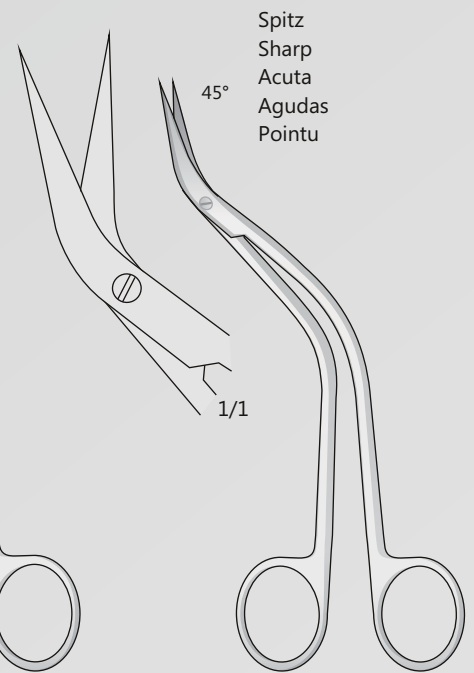

DE BAKEY  
**0607-HL**  
 155 mm

Spitz  
 Sharp  
 Acuta  
 Agudas  
 Pointu



Episotomie-Scheren  
 Episotomy scissors  
 Forbici per episiotomia  
 Tijeras para episiotomia  
 Ciseaux à épisotomie

**0607-LG**  
 200 mm

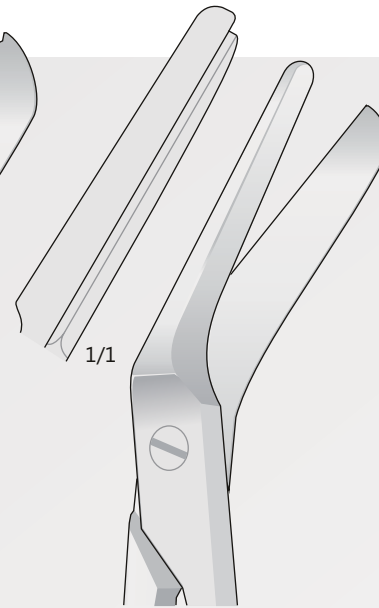

**0607-DE**  
 145 mm

BRAUN-STADLER  
**0607-DE/0607-LG**

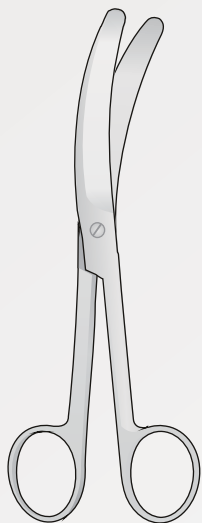

Nabelschnur Scheren  
 Umbilical cord scissors  
 Forbici per cordone ombelicale  
 Tijeras umbilicales  
 Ciseaux à cordon ombilical

**0607-DF/0607-LH**

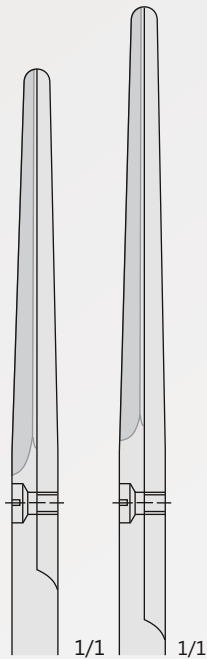

**0607-LH 0607-DF**  
 135 mm 160 mm



DUBOIS  
**0612-CG/0612-BHF**  
 270 mm

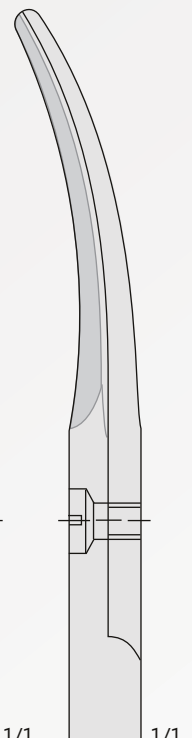

**0612-CG 0612-BHF**

Kephalotomie Scheren  
 Cephalotomy scissors  
 Forbici per cefalotomia  
 Tijeras para cefalotomia  
 Ciseaux à céphalotomie

Chirurgische scheren  
 Operating scissors  
 Forbici chirurgiche  
 Tijeras para cirugía general  
 Ciseaux chirurgicaux

Fein  
 Delicate  
 Fine  
 Finas  
 Fins

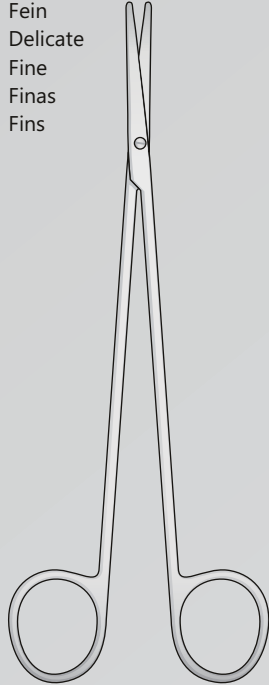

TOENNIS-ADSON  
**0607-GA/0607-GB**  
 180 mm

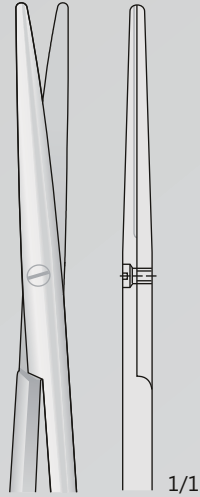

**0607-GA**  
 180 mm

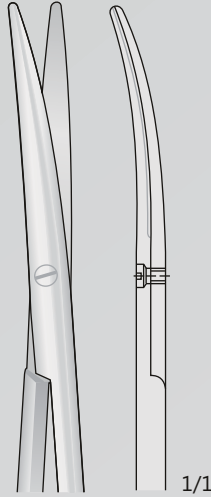

**0607-GB**  
 180 mm

Gezant  
 Serrated  
 Dentellate  
 Dentadas  
 Dentelé

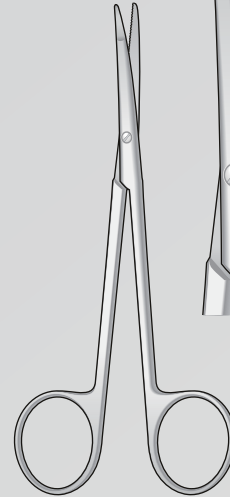

KILNER  
**0607-BCB**  
 130 mm

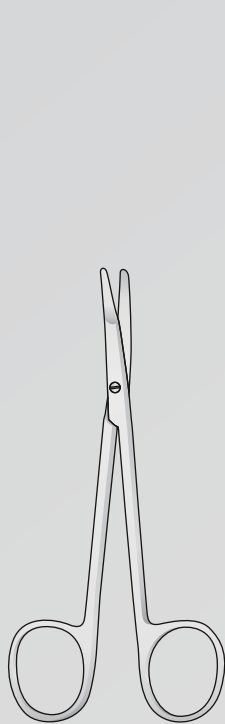
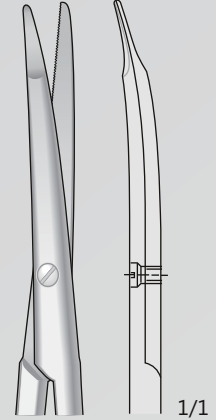

KILNER (RAGNELL)  
**0607-G03/0607-GH**

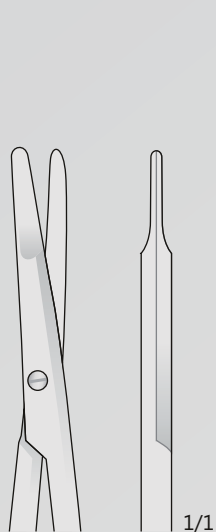

**0607-GG**  
 120 mm

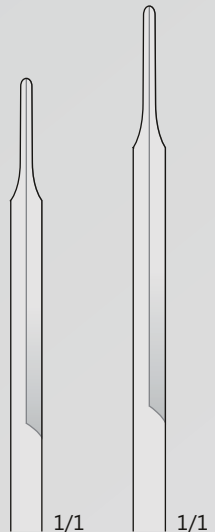

**0607-BL17**  
 135 mm

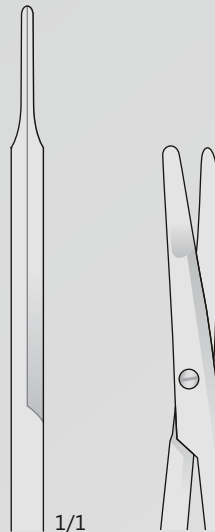

**0607-G17**  
 150 mm

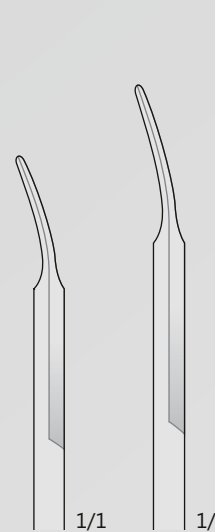

**0607-GH**  
 120 mm

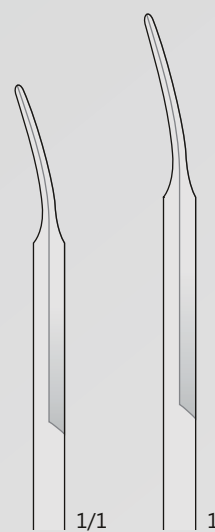

**0607-BL03**  
 135 mm

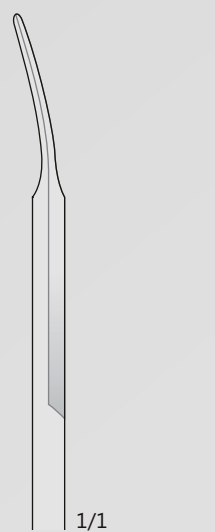

**0607-G03**  
 150 mm



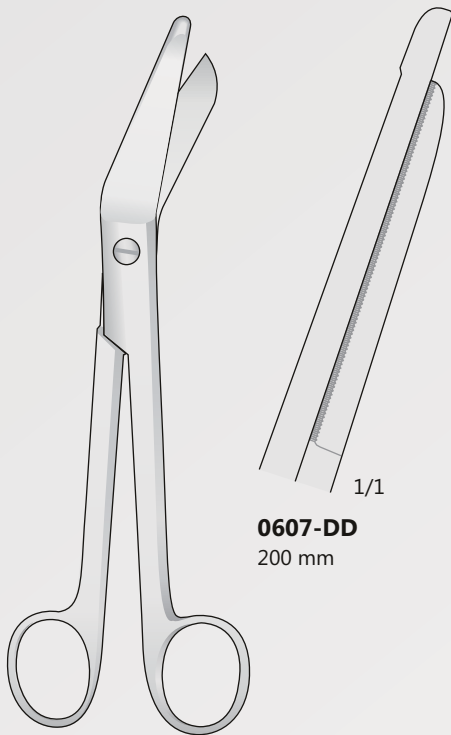

**0607-DD**  
 200 mm

ESMARCH  
**0607-DD**

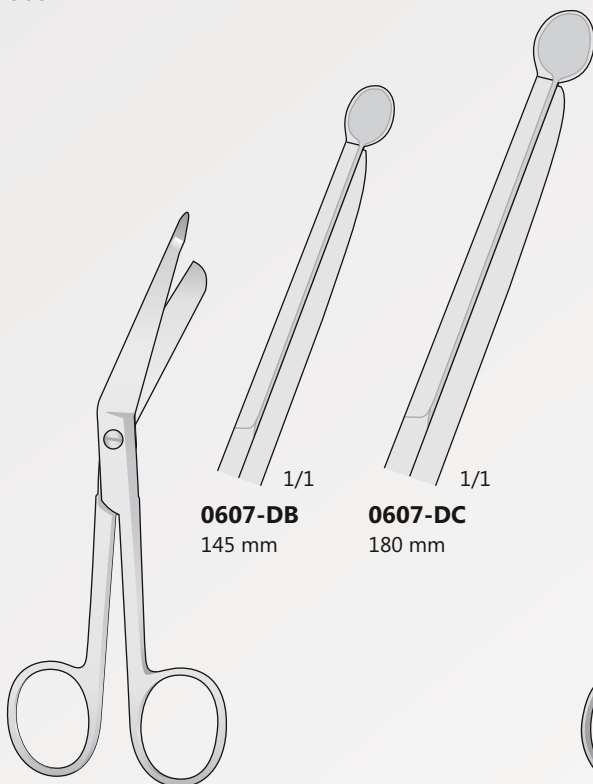

**0607-DB**  
 145 mm

**0607-DC**  
 180 mm

LISTER  
**0607-DB/0607-DC**

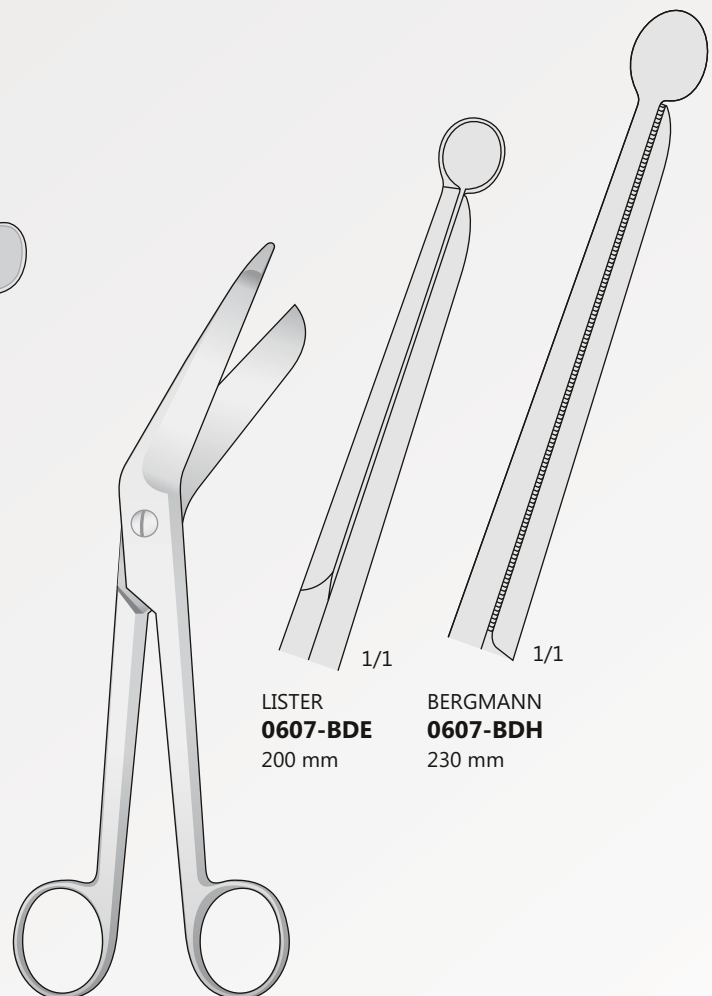

LISTER  
**0607-BDE**  
 200 mm

BERGMANN  
**0607-BDH**  
 230 mm

**0607-BDE/0607-BDH**

Ligatur Scheren  
 Ligature Scissors  
 Forbici per legature  
 Tijeras para ligaduras  
 Ciseaux à ligatures

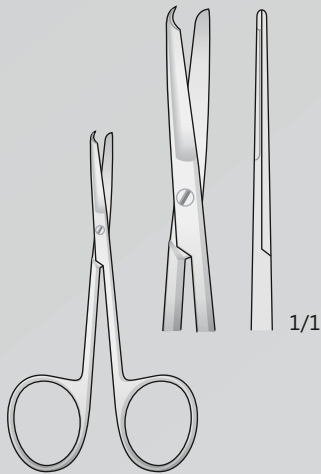

SPENCER  
**1803-L**  
 90 mm

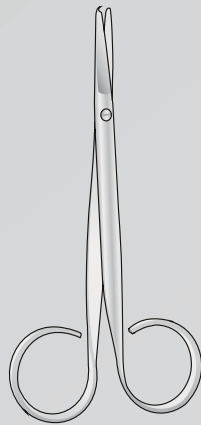

SPENCER  
**1803-B**  
 110 mm

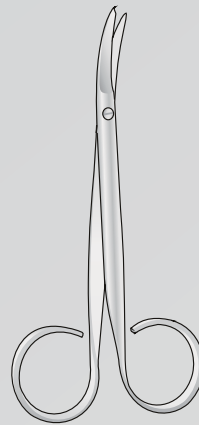

SPENCER  
**1803-F**  
 110 mm

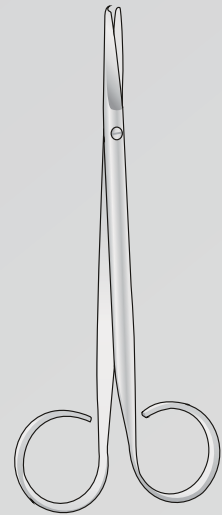

SPENCER  
**1803-C**  
 145 mm

Mit Drahtbindung  
 With wire retention  
 Con ritenzione del filo  
 Con la retención del alambre  
 Avec maintien du fil

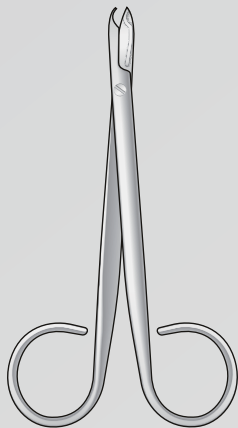

**1803-D**  
 110 mm

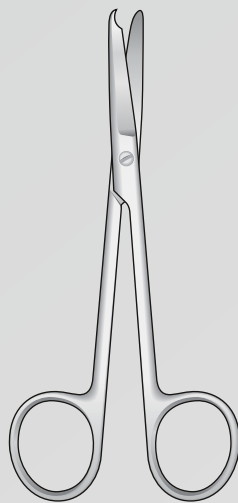

SPENCER  
**1803-BE**  
 120 mm

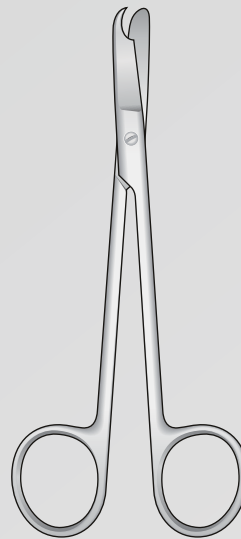

LITTAUER  
**1803-BF**  
 140 mm

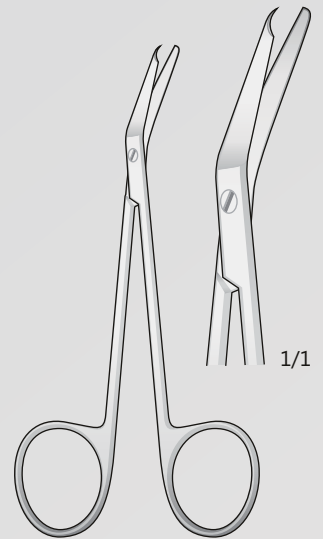

SPENCER  
**1803-BD**  
 130 mm

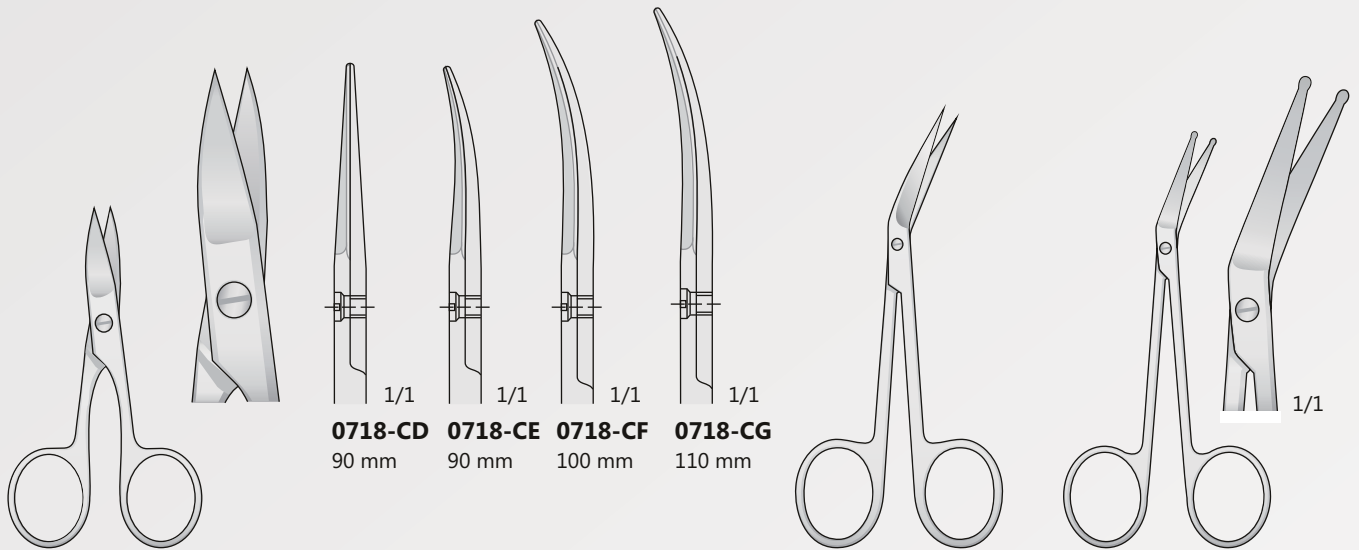

**0718-CD/0718-CG**

**1110-B**  
115 mm

LOCKLIN MOD.  
**1110-D**  
110 mm

Eine Schneide gezahnt  
One toothed cutting  
Una lama dentata  
Una hoja dentada  
Une lame dentelé

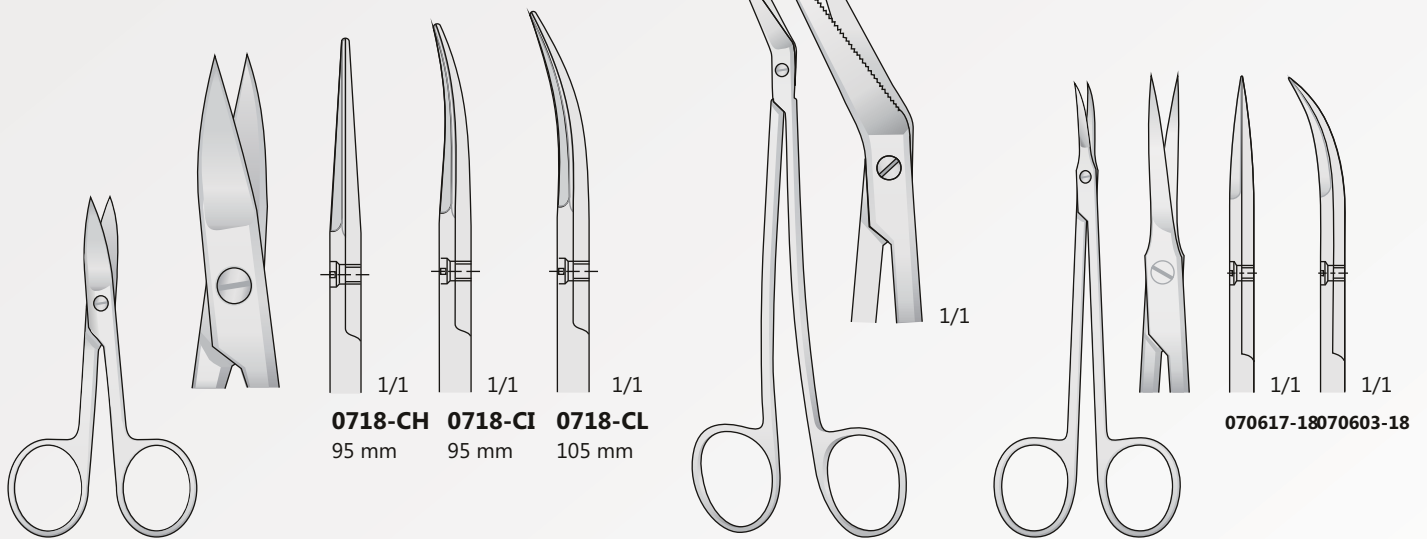

**0718-CH/0718-CL**

LOCKLIN  
**1110-C**  
160 mm

**070617-18/070603-18**  
120 mm

Klammeranlegepinzette  
 Clips applying and Removing Forceps  
 Pinze metti e toglì clips  
 Pinzas para ponery quitar agrafes  
 Pincès à poser et retirer les agrafes

1/1

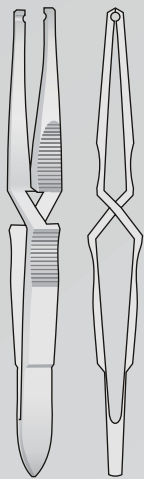

**HEGENBARTH**  
**0204-FC**  
 125 mm

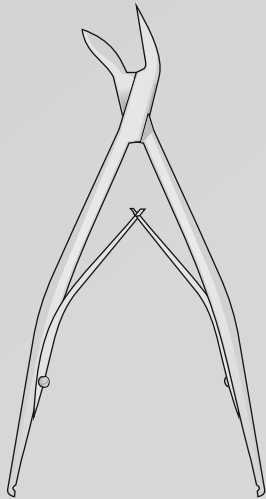

**MICHEL**  
**0206-GI**  
 130 mm

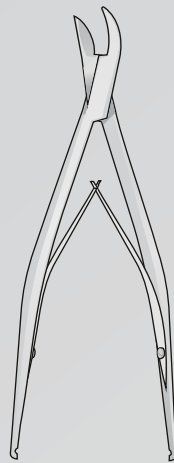

**MICHEL**  
**0206-GL**  
 120 mm

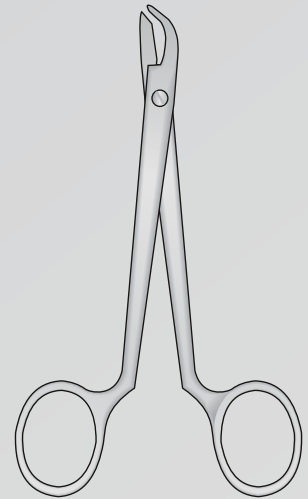

**COLLIN**  
**0206-GF**  
 135 mm

Nagelzangen  
 Nail cutters  
 Tronchesi per unghie  
 Pinzas para uña  
 Pince à ongles

Pinzette zum Entfernen von Drähten  
 Tweezers for removing wires  
 Pinza per rimozione punti metallici  
 Pinzas para la eliminación de cables  
 Pince à épiler pour enlever les fils

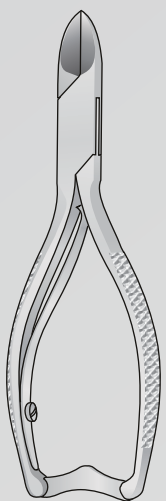

**0718-CA**  
 135 mm

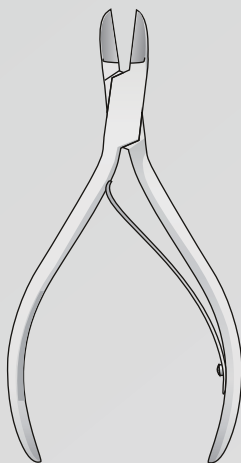

**0718-CB**  
 120 mm

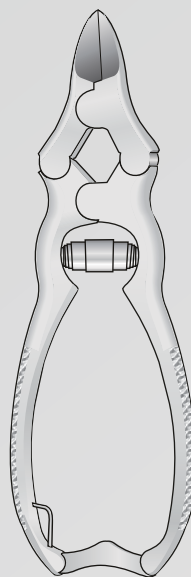

**0718-CC**  
 155 mm

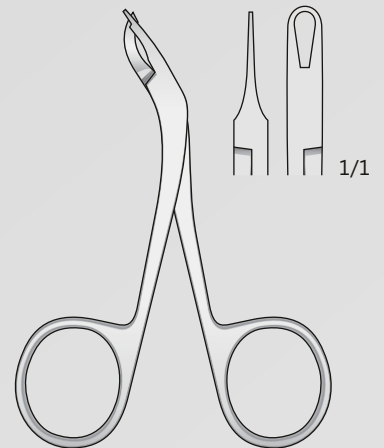

**0206-GE**  
 115 mm



 ideal-tek

Pinzetten  
Forceps  
Pinzette  
Pinzas  
Pincas



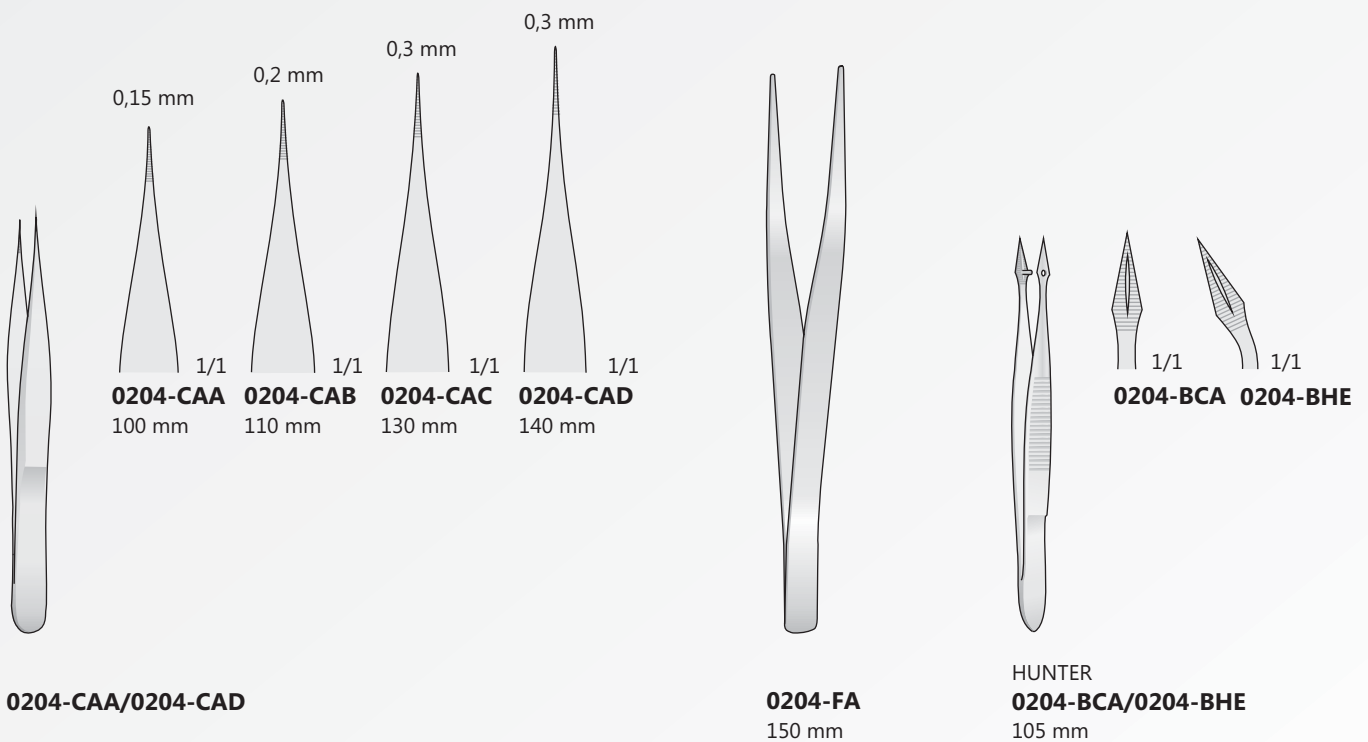
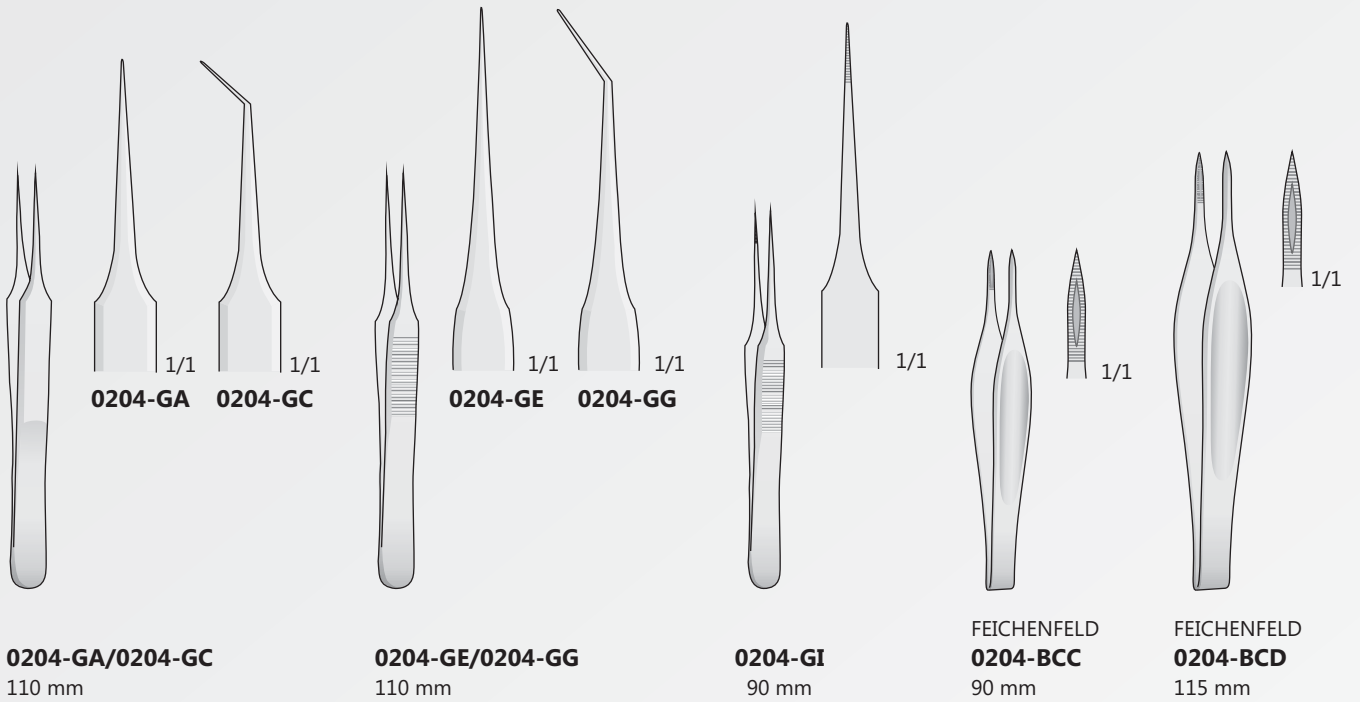

Chirurgische pinzetten  
 Tissue forceps  
 Pinzette chirurgiche  
 Pinzas quirùgicas  
 Pincas chirurgicales



**0204-DC 0204-DD**

**0204-DC/0204-DD**  
 100 mm

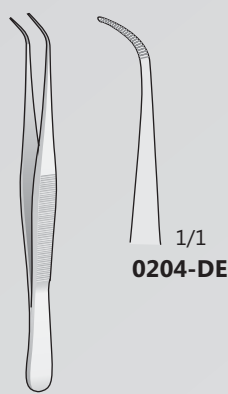

**0204-DE**

**0204-DE**  
 100 mm

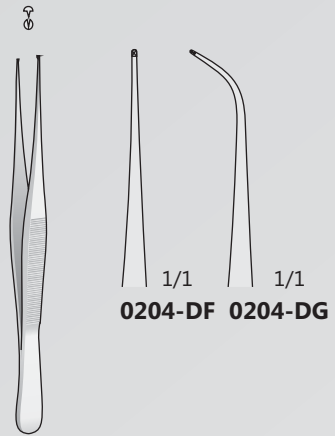

**0204-DF 0204-DG**

**0204-DF/0204-DG**  
 100 mm

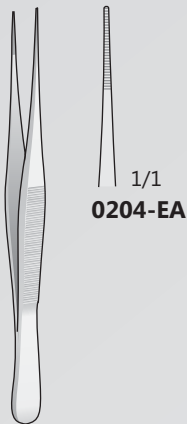

**0204-EA**

**0204-EA**  
 110 mm

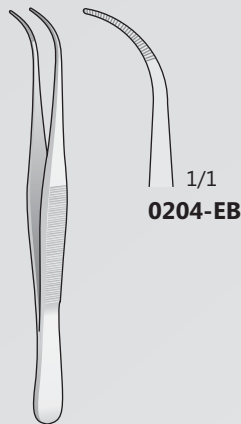

**0204-EB**

**0204-EB**  
 110 mm



**0204-EC 0204-ED**

**0204-EC/0204-ED**  
 110 mm



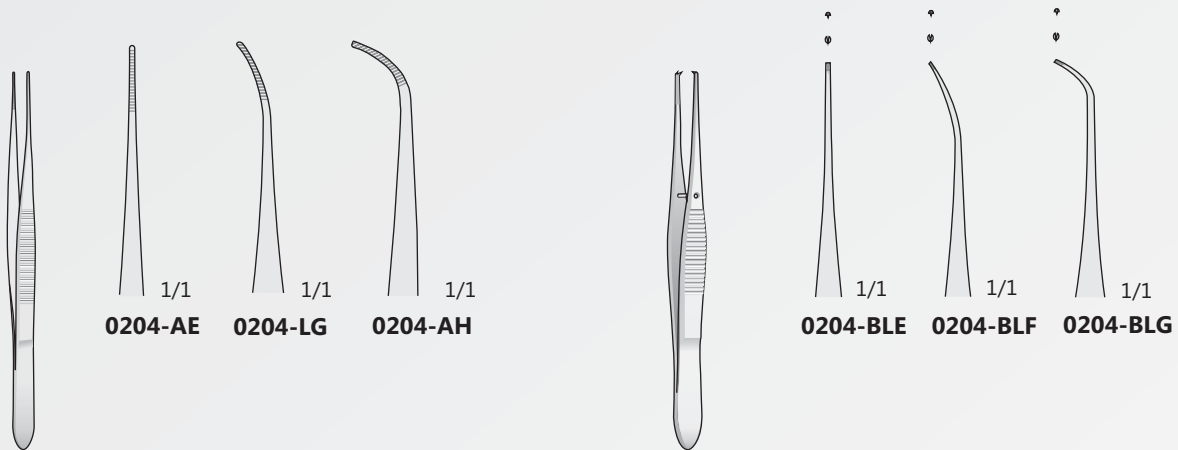

GRAEFE  
**0204-AE/0204-LG**  
100 mm

GRAEFE  
**0204-BLE/0204-BLG**  
100 mm

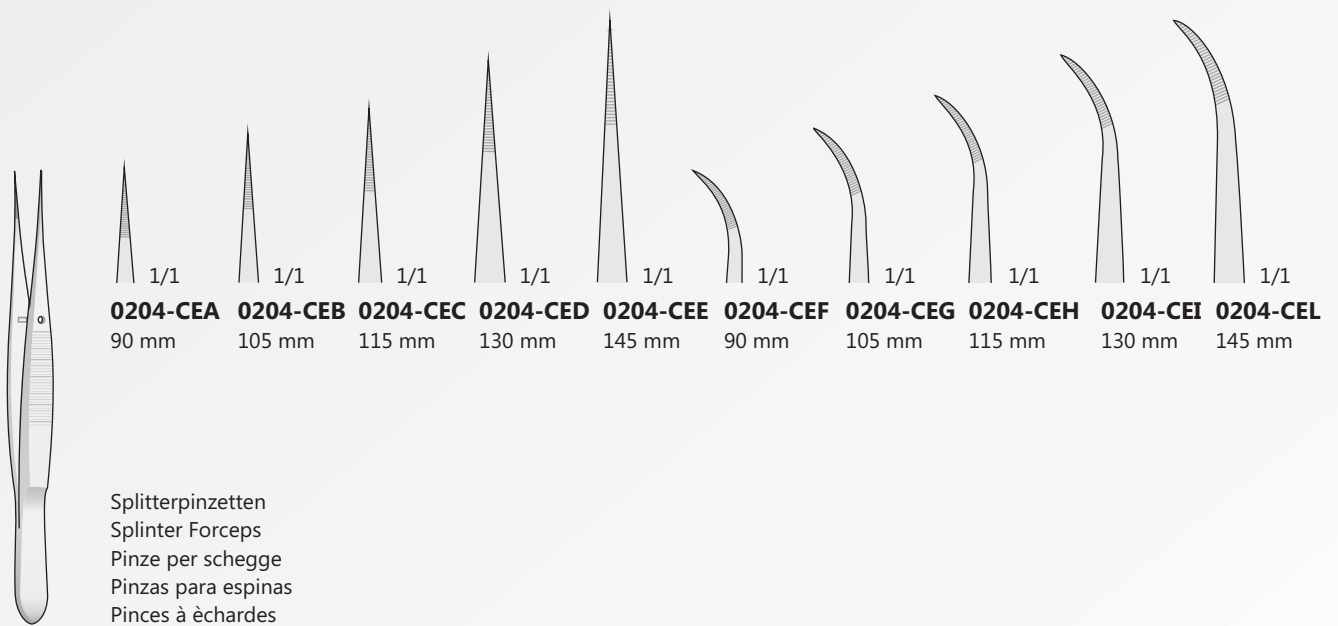

Splitterpinzetten  
Splinter Forceps  
Pinze per schegge  
Pinzas para espinas  
Pincas à échardes

**0204-CEA/0204-CEL**

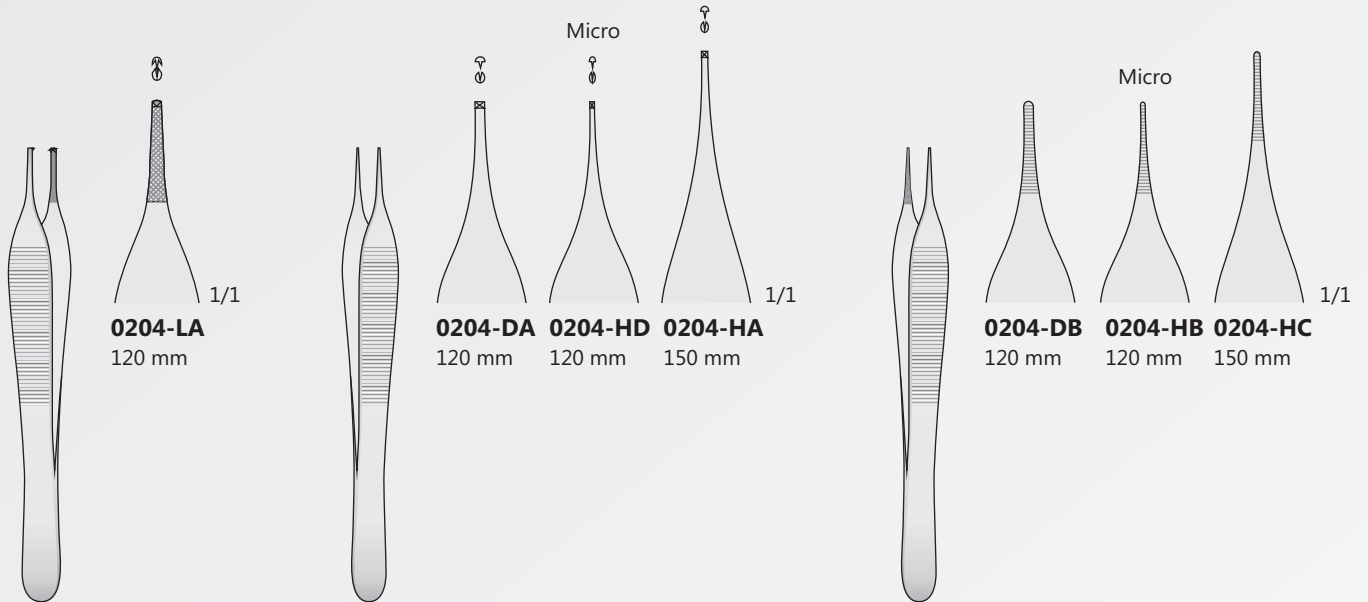

ADSON  
**0204-LA**  
120 mm

ADSON  
**0204-DA/0204-HD**

ADSON  
**0204-DB/0204-HC**

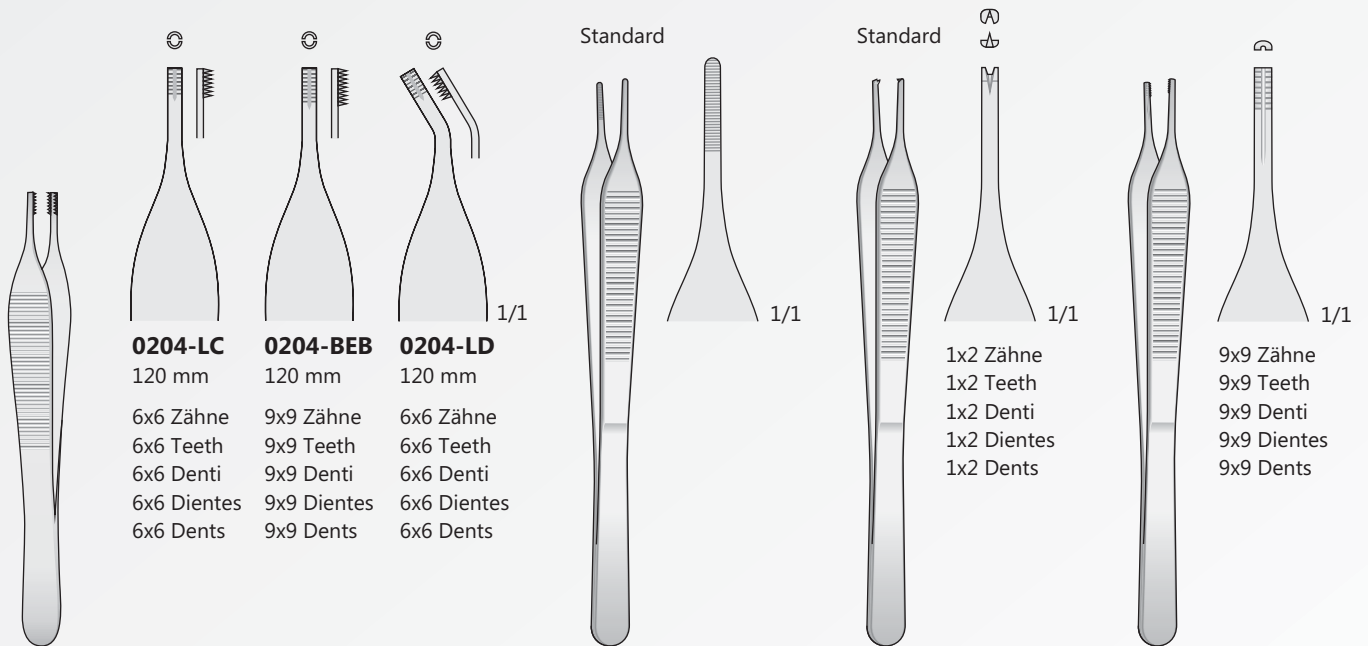

ADSON-BROWN  
**0204-LC/0204-BEB**  
120 mm

ADSON  
**0204-DIA**  
150 mm

ADSON  
**0204-DIB**  
150 mm

ADSON-BROWN  
**0204-DIC**  
150 mm

**0204-LC**  
120 mm  
6x6 Zähne  
6x6 Teeth  
6x6 Denti  
6x6 Dientes  
6x6 Dents

**0204-BEB**  
120 mm  
9x9 Zähne  
9x9 Teeth  
9x9 Denti  
9x9 Dientes  
9x9 Dents

**0204-LD**  
120 mm  
6x6 Zähne  
6x6 Teeth  
6x6 Denti  
6x6 Dientes  
6x6 Dents

**0204-DIB**  
1x2 Zähne  
1x2 Teeth  
1x2 Denti  
1x2 Dientes  
1x2 Dents

**0204-DIC**  
9x9 Zähne  
9x9 Teeth  
9x9 Denti  
9x9 Dientes  
9x9 Dents

Chirurgische pinzetten  
 Tissue forceps  
 Pinzette chirurgiche  
 Pinzas quirùgicas  
 Pincas quirurgicales

Fixier und fasspinzetten  
 Fixation and Grasping forceps  
 Pinze da fissazione oftalmica  
 Pinzas de fijaciòn y de aprehensiòn  
 Pince de fixation ophtalmique

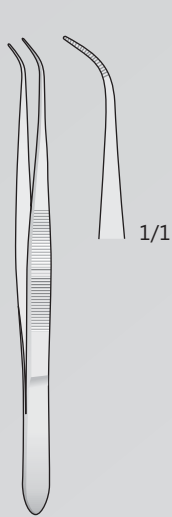

PERRY  
**0204-AF**  
 125 mm

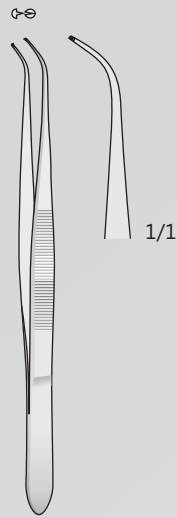

PERRY  
**0204-AG**  
 125 mm

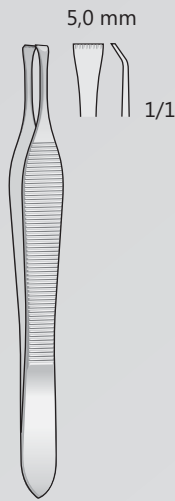

BEASLEY-BABCOCK  
**0204-FB**  
 120 mm

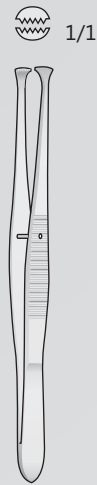

GRAEFE  
**0204-BDF**  
 110 mm

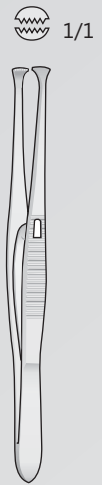

GRAEFE  
**0204-BDG**  
 110 mm

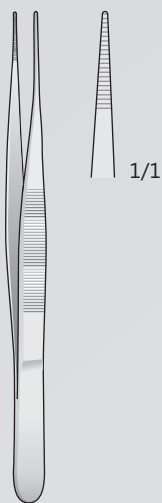

**0204-BEF**  
 130 mm

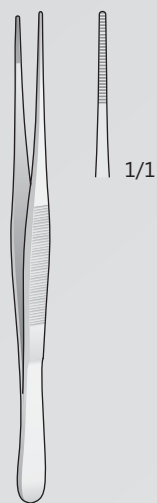

SEMKEN  
**0204-EE**  
 130 mm

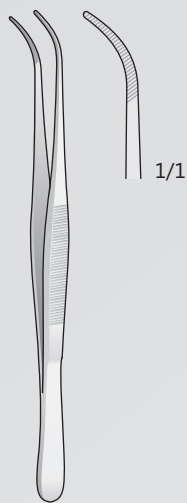

SEMKEN  
**0204-EF**  
 130 mm

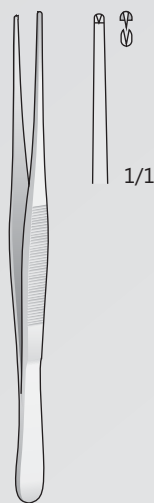

SEMKEN  
**0204-EG**  
 130 mm

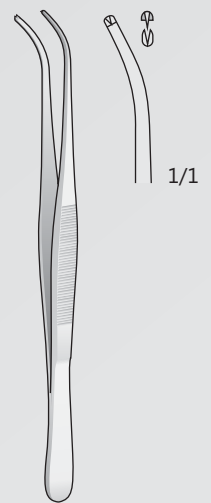

SEMKEN  
**0204-EH**  
 130 mm

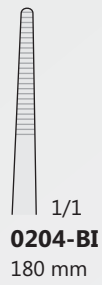
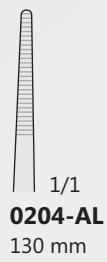

**0204-AL/0204-CA**

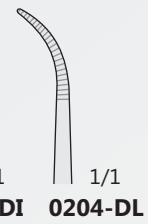

**0204-DI/0204-BDE**  
200 mm

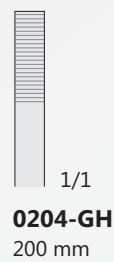
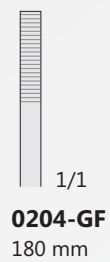
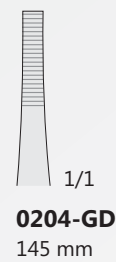
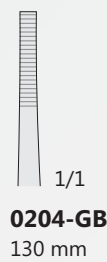

STILLE  
**0204-GB/0204-GH**

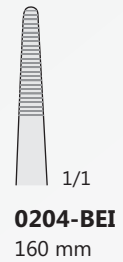
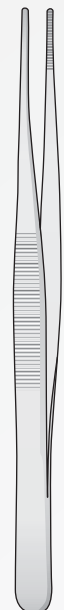

**0204-BG/0204-BEI**  
160 mm

Anatomische Pinzetten  
 Dressing forceps  
 Pinzette anatomiche  
 Pinzas de diseccion  
 Pincas anatomicas

Standard

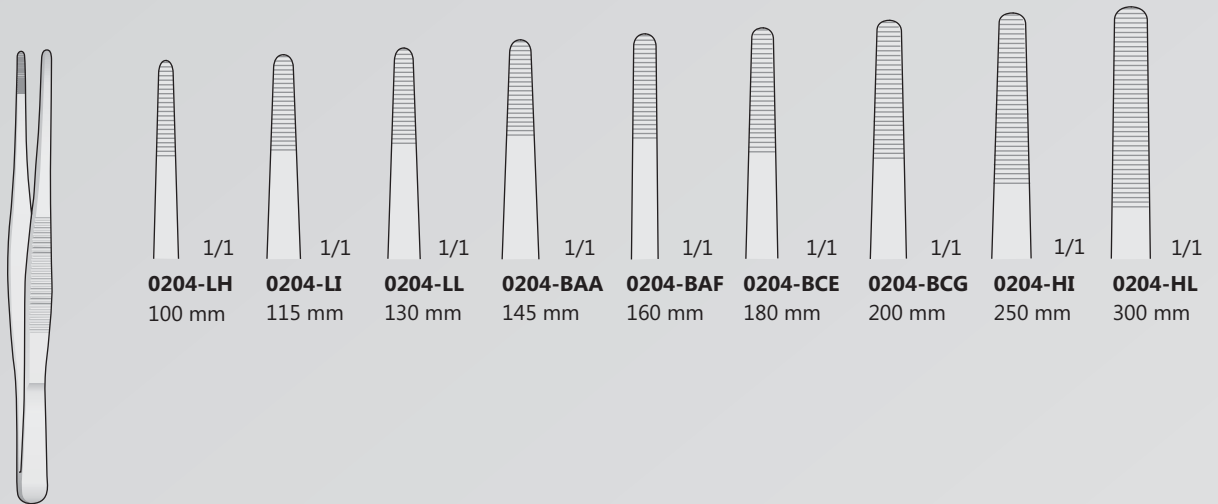

**0204-HI/0204-BCG**

Mod. Fine

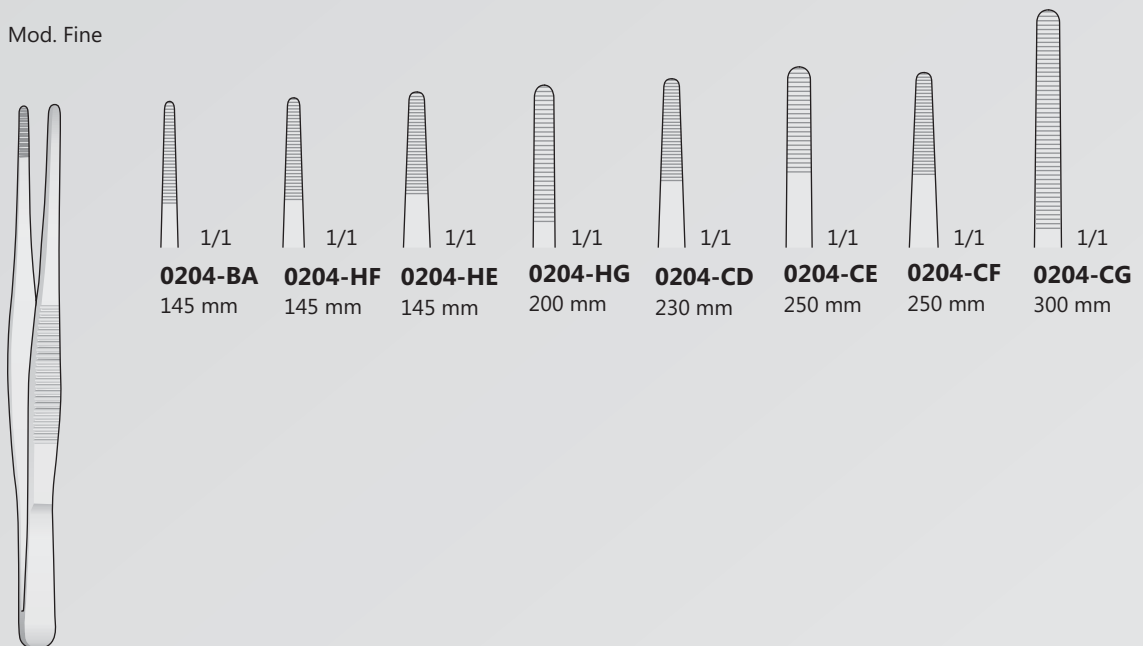

**0204-BA/0204-HG**

Chirurgische pinzetten  
 Tissue forceps  
 Pinzette chirurgische  
 Pinzas quirúrgicas  
 Pincas chirurgicales

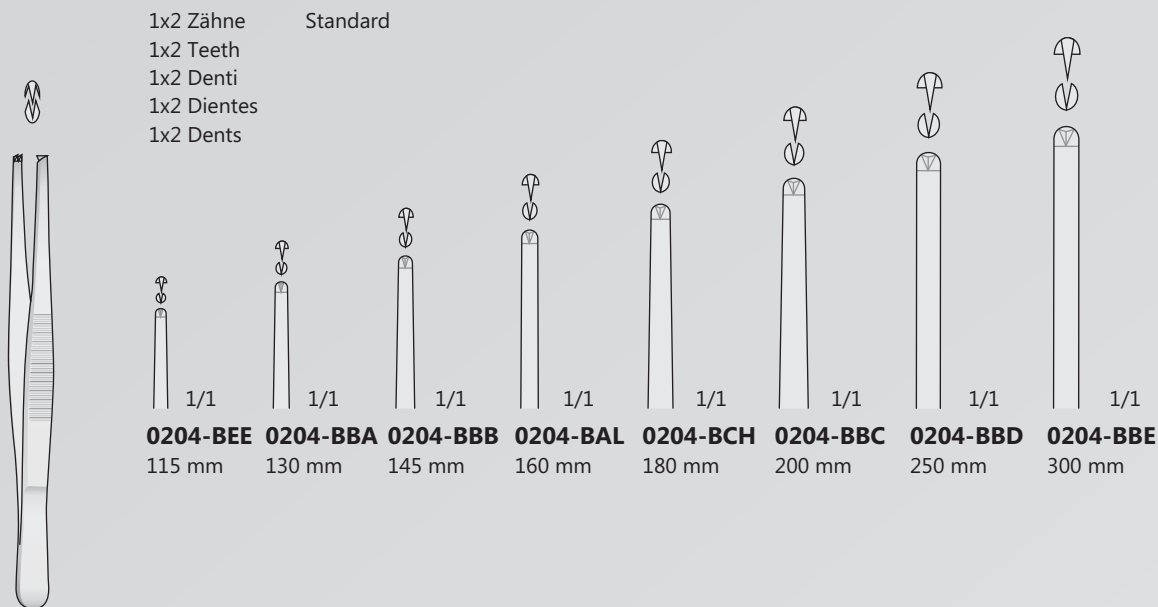

**0204-BAL/0204-BEE**

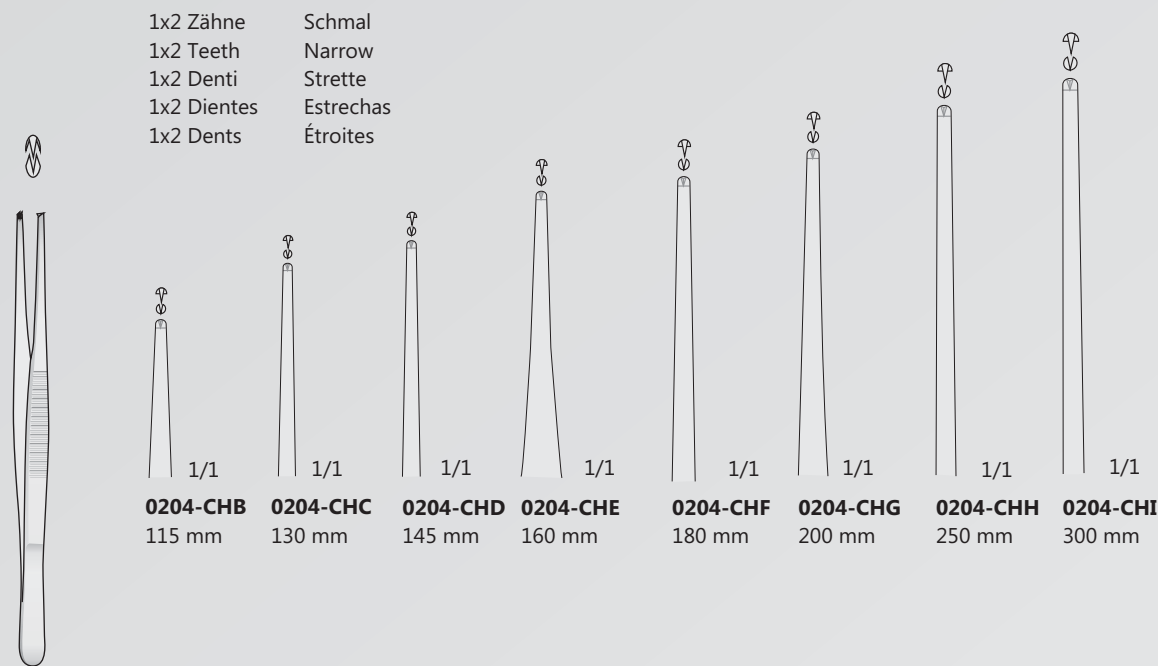

**0204-CHB/0204-CHI**

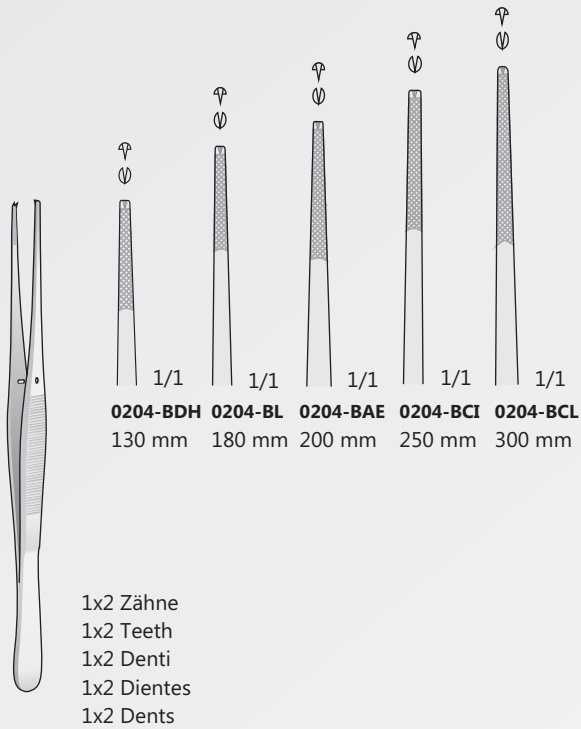

**0204-BL/0204-BDH**

<b>0204-BDH</b>	<b>0204-BL</b>	<b>0204-BAE</b>	<b>0204-BCI</b>	<b>0204-BCL</b>
130 mm	180 mm	200 mm	250 mm	300 mm

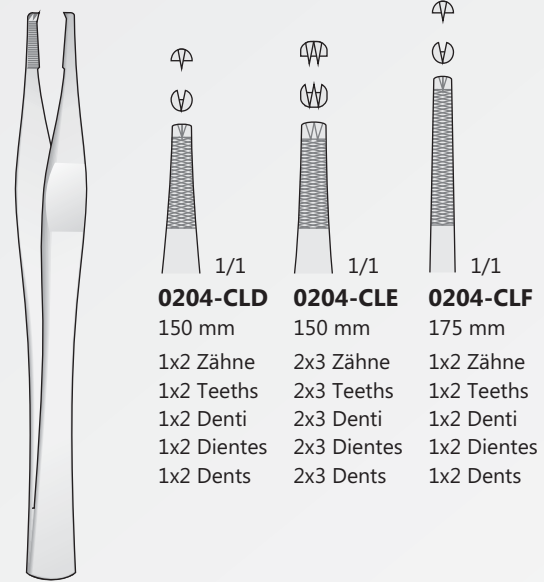

LANE  
**0204-CLD/0204-CLF**

<b>0204-CLD</b>	<b>0204-CLE</b>	<b>0204-CLF</b>
150 mm	150 mm	175 mm
1x2 Zähne	2x3 Zähne	1x2 Zähne
1x2 Teeths	2x3 Teeths	1x2 Teeths
1x2 Denti	2x3 Denti	1x2 Denti
1x2 Dientes	2x3 Dientes	1x2 Dientes
1x2 Dents	2x3 Dents	1x2 Dents

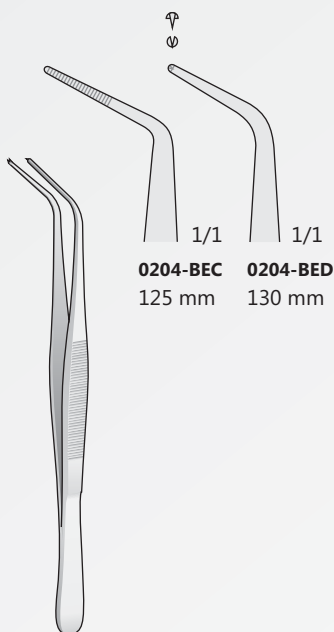

**0204-BEC/0204-BED**

<b>0204-BEC</b>	<b>0204-BED</b>
125 mm	130 mm

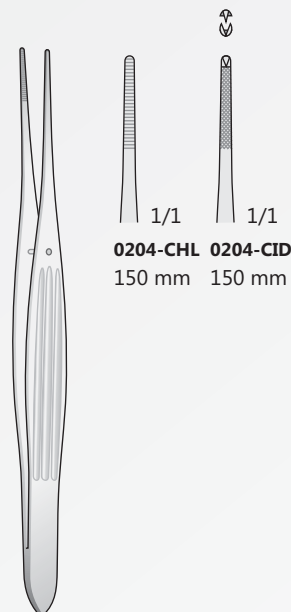

McINDOE  
**0204-CHL/0204-CID**  
150 mm

<b>0204-CHL</b>	<b>0204-CID</b>
150 mm	150 mm

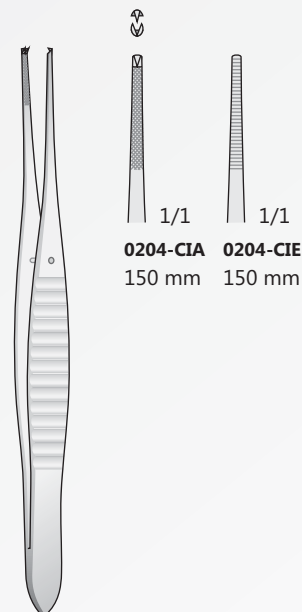

GILLIES  
**0204-CIA/0204-CIE**  
150 mm

<b>0204-CIA</b>	<b>0204-CIE</b>
150 mm	150 mm

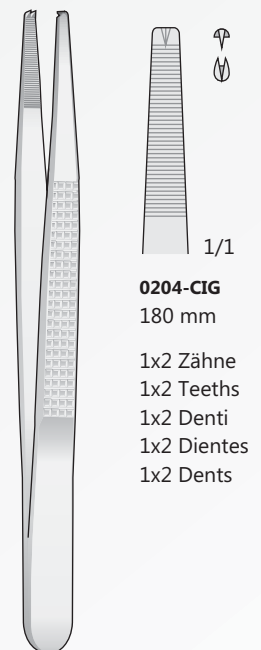

BONNEY  
**0204-CIG**  
180 mm

<b>0204-CIG</b>
180 mm

Chirurgische pinzetten  
 Tissue forceps  
 Pinzette chirurgische  
 Pinzas quirùrgicas  
 Pincas quirurgicales

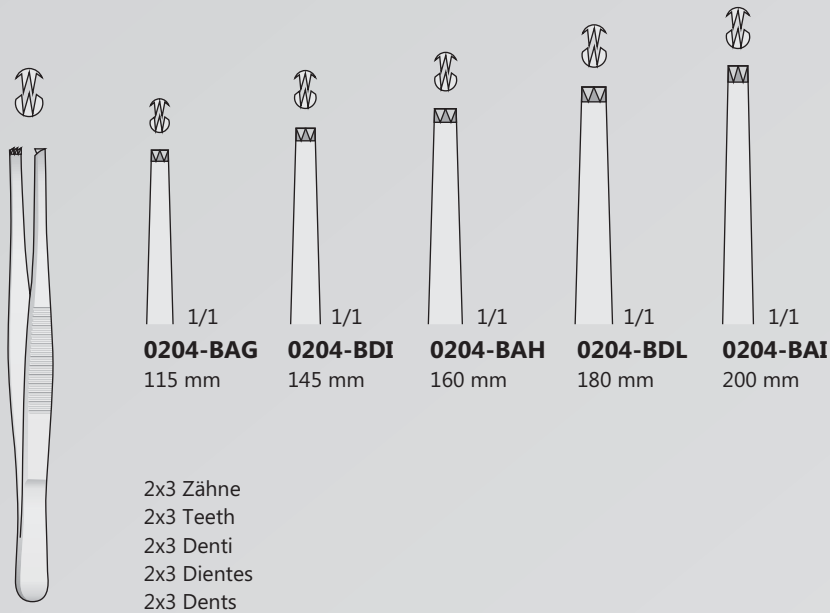

**0204-BAG/0204-BDL**

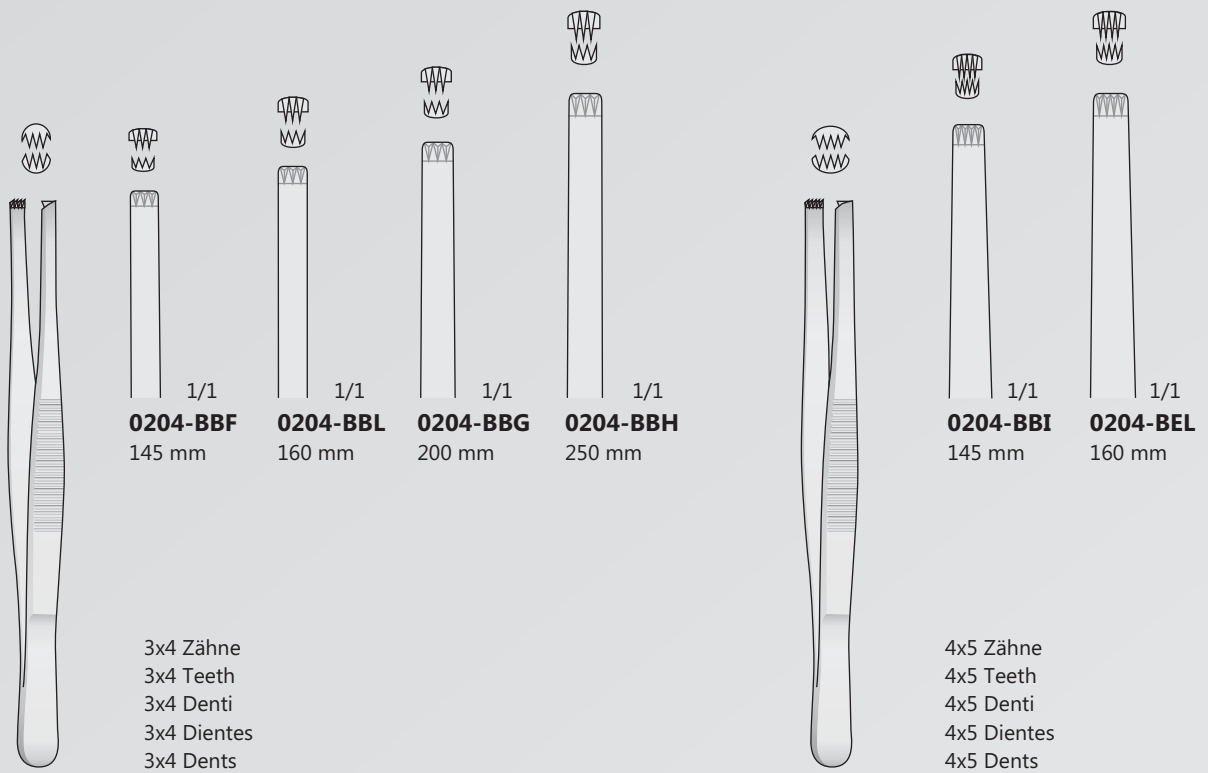

**0204-BBF/0204-BBL**

**0204-BBI/0204-BEL**



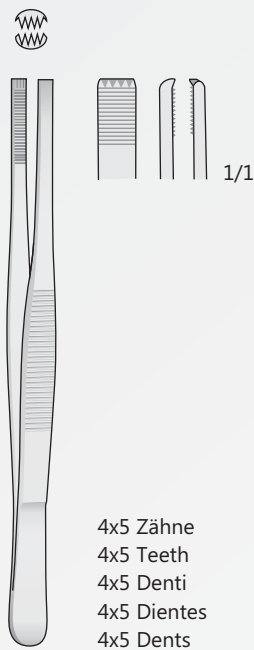

4x5 Zähne  
 4x5 Teeth  
 4x5 Denti  
 4x5 Dientes  
 4x5 Dents

ADLERKREUTZ  
**0204-CI** - 150 mm  
**0204-BFF** - 200 mm  
**0204-BFG** - 250 mm

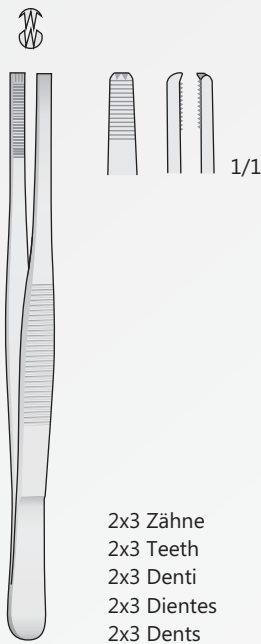

2x3 Zähne  
 2x3 Teeth  
 2x3 Denti  
 2x3 Dientes  
 2x3 Dents

ADLERKREUTZ  
**0204-BFD** - 150 mm  
**0204-BFE** - 200 mm

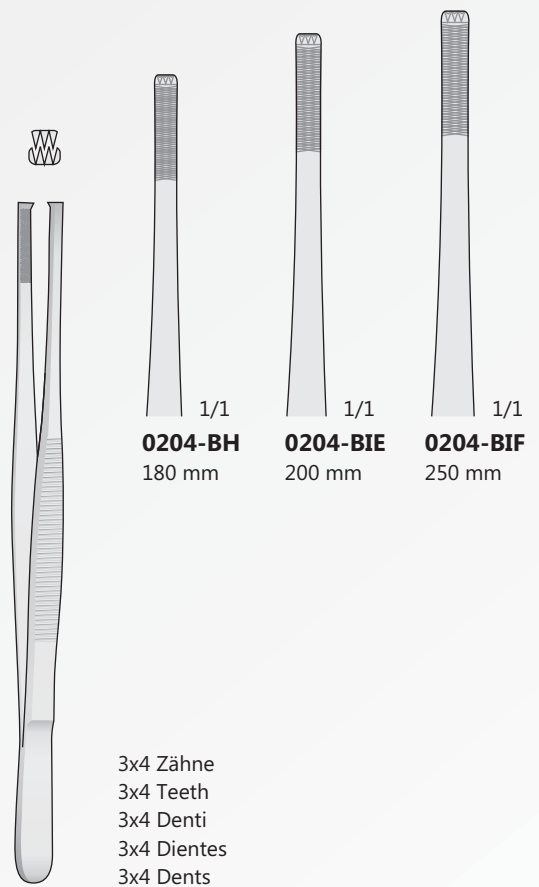

3x4 Zähne  
 3x4 Teeth  
 3x4 Denti  
 3x4 Dientes  
 3x4 Dents

STILLE-BARRAYA  
**0204-BH/0204-BIF**

**0204-BH** 180 mm  
**0204-BIE** 200 mm  
**0204-BIF** 250 mm

Anatomische Pinzetten  
 Dressing forceps  
 Pinzette anatomiche  
 Pinzas de diseccion  
 Pinces anatomiques

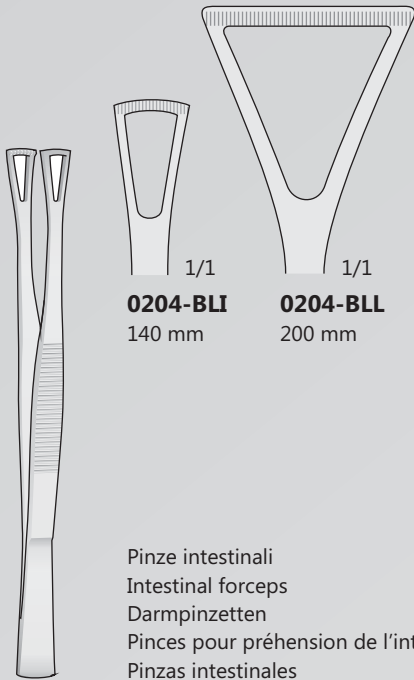

**0204-BLI** 140 mm  
**0204-BLL** 200 mm

Pinze intestinali  
 Intestinal forceps  
 Darmpinzetten  
 Pinces pour préhension de l'intestin  
 Pinzas intestinales

**DUVAL**  
**0204-BLI/0204-BLL**

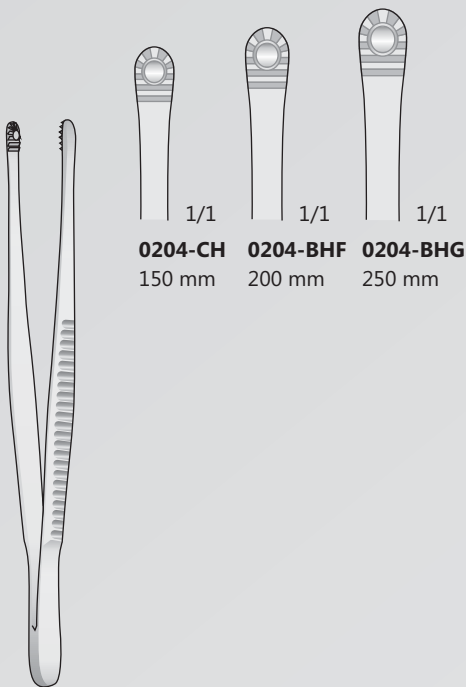

**0204-CH** 150 mm  
**0204-BHF** 200 mm  
**0204-BHG** 250 mm

**RUSSIAN**  
**0204-CH/0204-BHG**

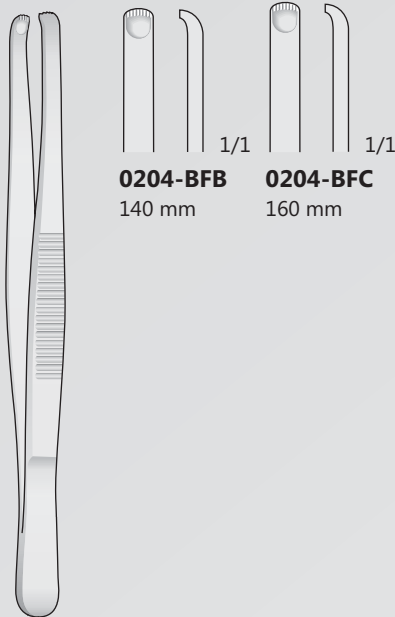

**0204-BFB** 140 mm  
**0204-BFC** 160 mm

**DURANTE**  
**0204-BFB/0204-BFC**

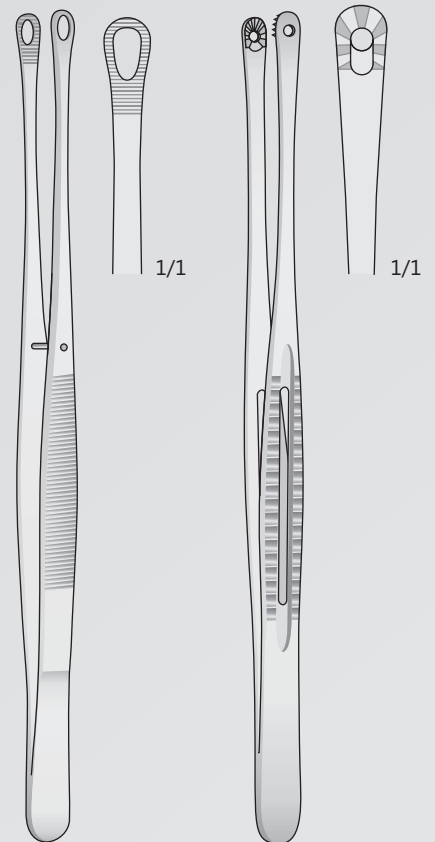

**SINGLEY-TUTTLE**  
**0204-CL**  
 230 mm

**MAYO-RUSSIAN**  
**0204-DH**  
 230 mm

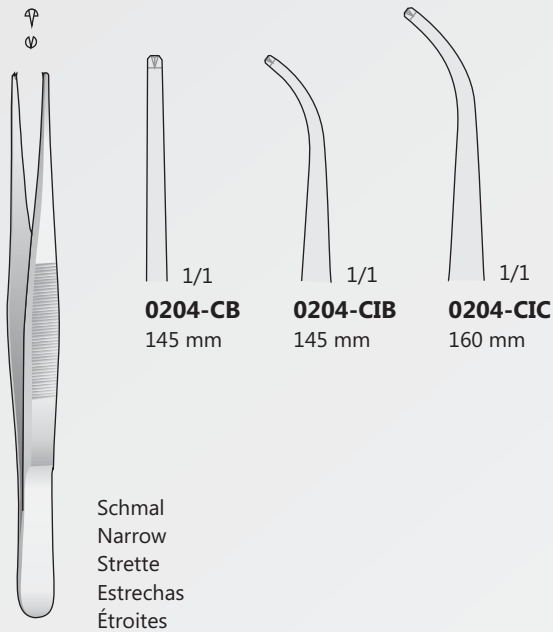

**0204-CB/0204-CIC**

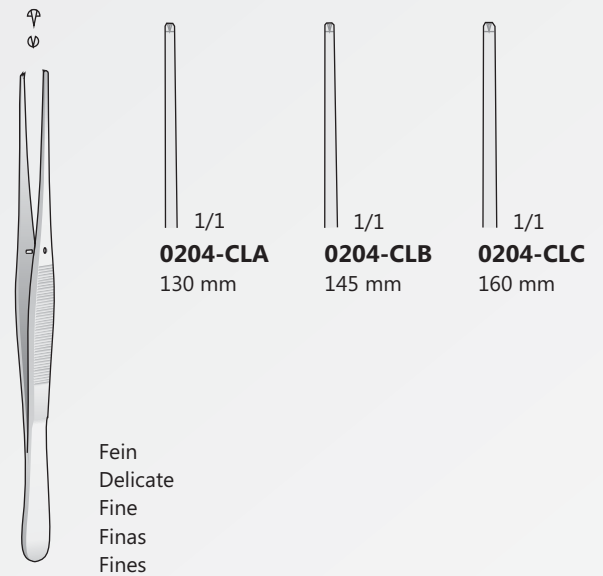

**0204-CLA/0204-CLC**

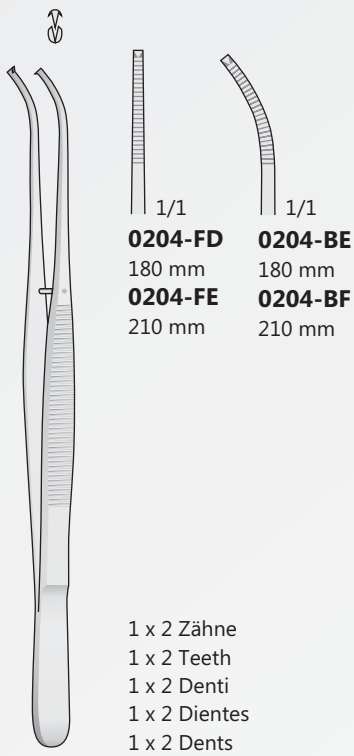

POTTS-SMITH  
**0204-BE/0204-FE**

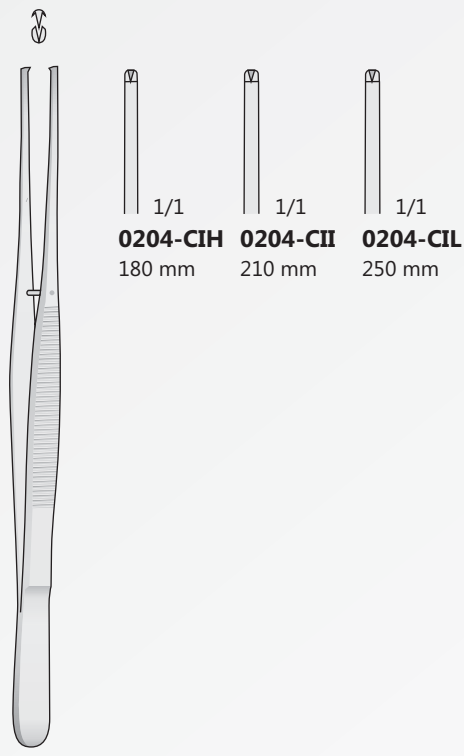

POTTS-SMITH  
**0204-CIH/0204-CIL**

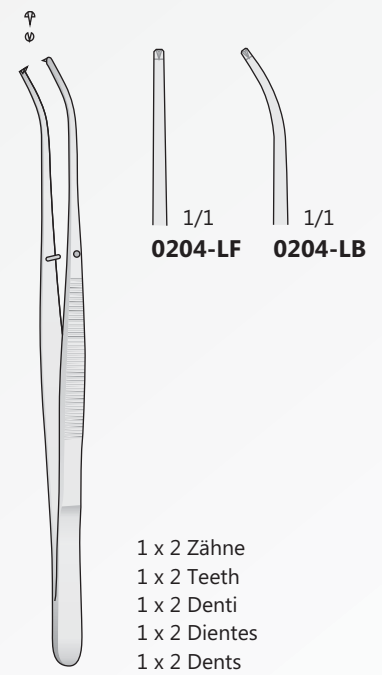

SEMKEN  
**0204-LB/0204-LF**  
150 mm

Atraumatische Pinzetten  
 Atraumatic Tissue forceps  
 Pinzette atraumatiche  
 Pinzas Atraumaticas  
 Pincas Atraumatiques

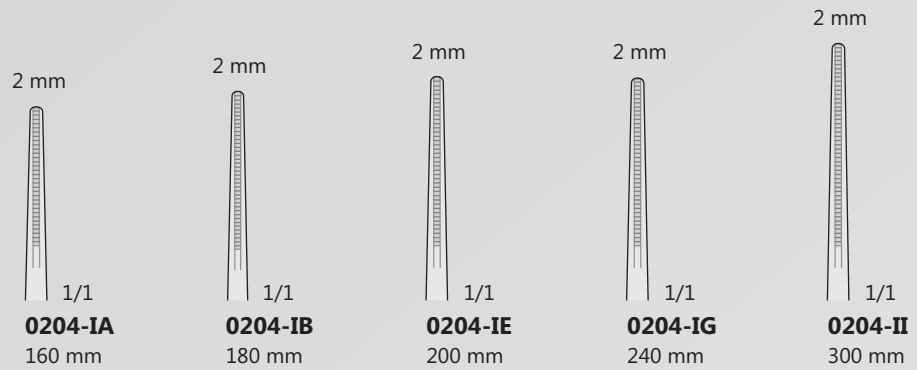
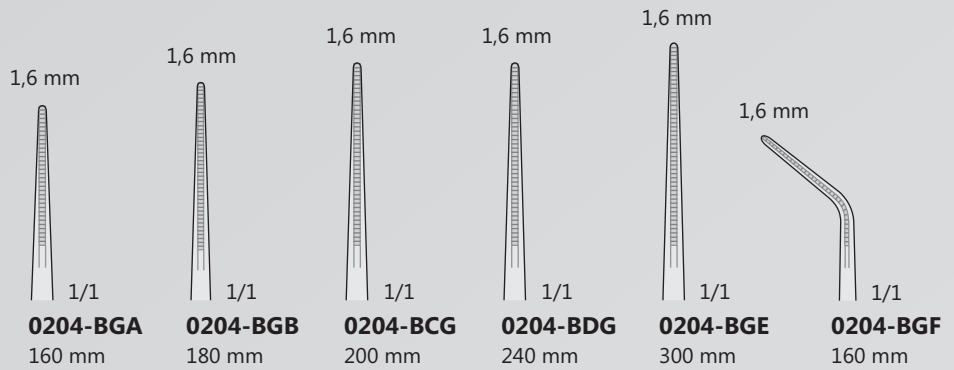

Atraumatische pinzetten  
 Non-traumatic vascular forceps  
 Pinzette atraumatiche  
 Pinzas atraumaticas  
 Pincas atraumatiques

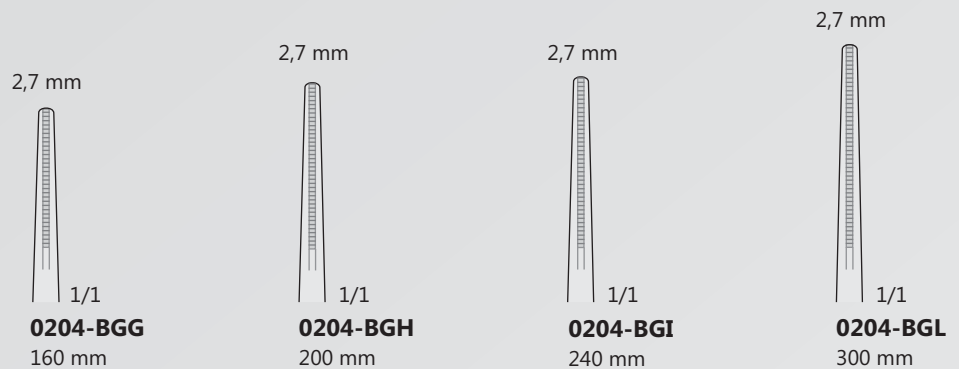
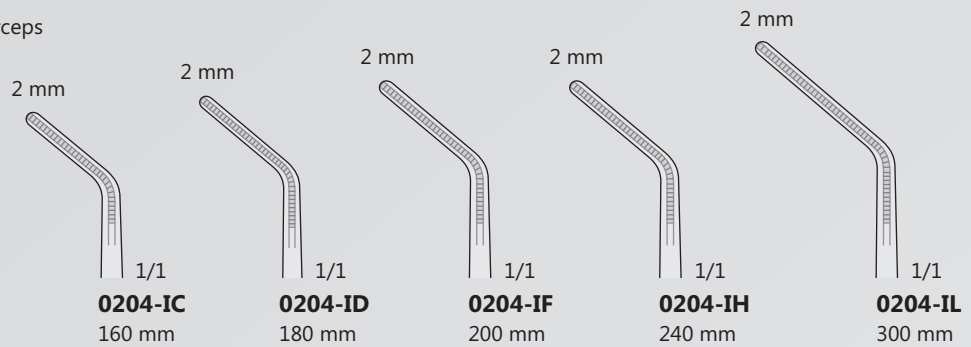

DE BAKEY  
**0204-IA/0204-BGL**

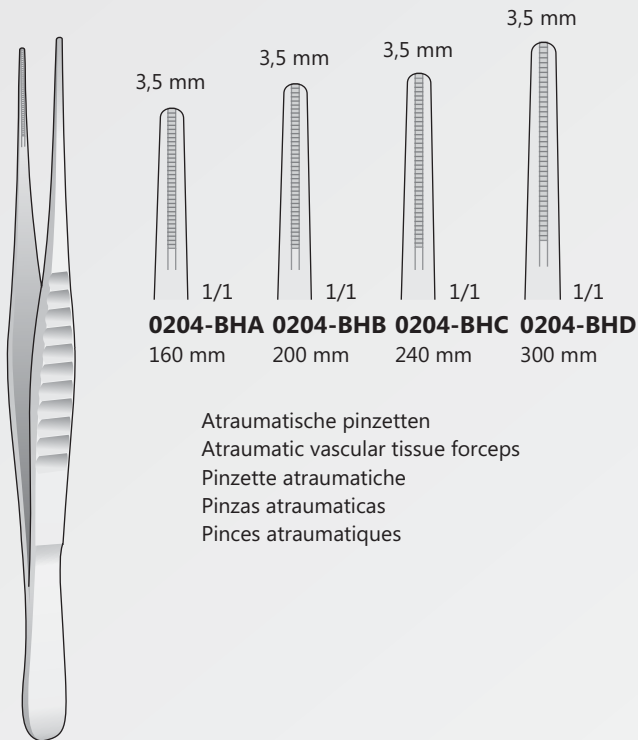

Atraumatische pinzetten  
Atraumatic vascular tissue forceps  
Pinzette atraumatiche  
Pinzas atraumaticas  
Pincas atraumatiques

DE BAKEY  
**0204-BHA/0204-BHD**

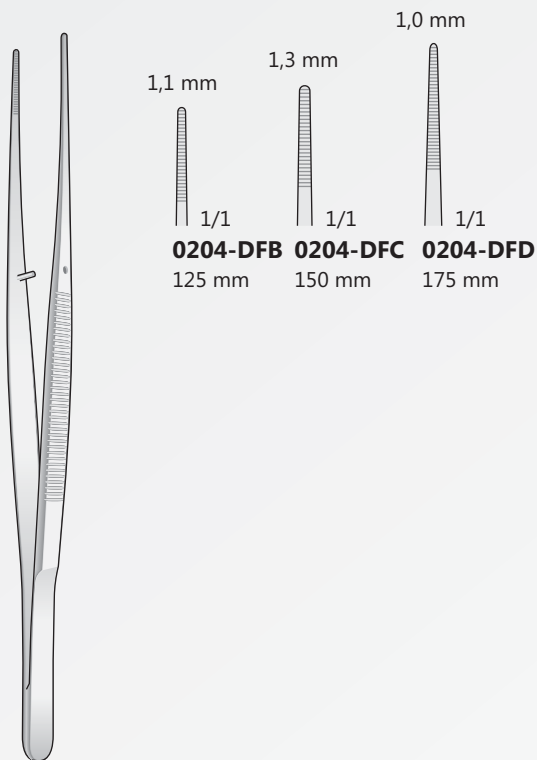

**0204-DFB/0204-DFD**

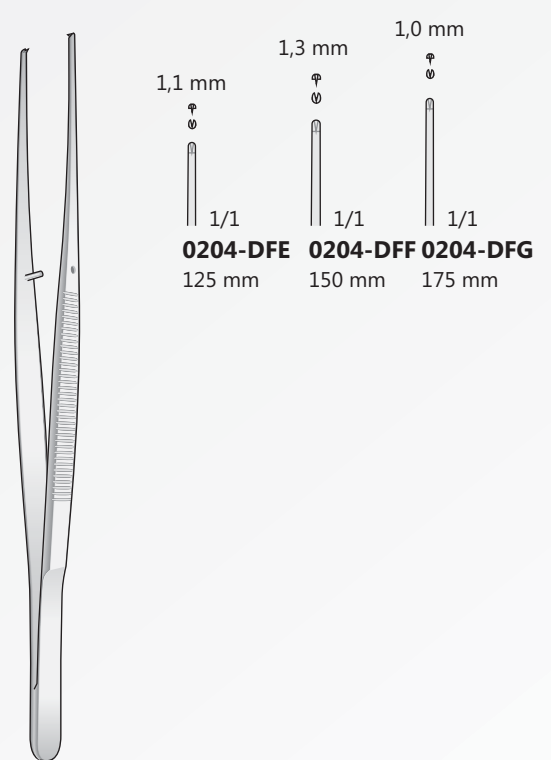

**0204-DFE/0204-DFF**

Chirurgische pinzetten  
 Tissue forceps  
 Pinzette chirurgische  
 Pinzas quirùrgicas  
 Pincas quirurgicales

 <b>TC</b> <b>0204-CDA</b> 120 mm 1/1	 <b>TC</b> <b>0204-CDB</b> 150 mm 1/1	 <b>TC</b> <b>0204-CFA</b> 120 mm 1/1	 <b>TC</b> <b>0204-CFB</b> 150 mm 1/1	 <b>Micro</b> <b>0204-DHE</b> 150 mm 1/1	 <b>Micro</b> <b>0204-DHF</b> 150 mm 1/1 1x2 Zähne 1x2 Tooth 1x2 Denti 1x2 Dientes 1x2 Dents	 <b>Micro</b> <b>0204-BHH</b> 150 mm 1/1	 <b>Micro</b> <b>0204-BHI</b> 150 mm 1/1
 <b>ADSON</b> <b>0204-CDA/0204-CDB</b>	 <b>ADSON</b> <b>0204-CFA/0204-CFB</b>	<b>MICRO-ADSON</b> <b>0204-DHE/0204-DHF</b> 150 mm	<b>ADSON</b> <b>0204-BHH/0204-BHI</b> 150 mm				

<p>Mit Fadenplatte          With tying platform          Con piano prendifilo          Con plataforma          Avec plateau</p> <b>ADSON</b> <b>0204-DHA</b> 120 mm	<p>Mit Fadenplatte          With tying platform          Con piano prendifilo          Con plataforma          Avec plateau</p> <b>ADSON</b> <b>0204-DHB</b> 120 mm	<p>Extra fein          Extra fine          Extra fine</p> <b>MICRO-ADSON</b> <b>0204-DHC</b> 120 mm	<p>Extra fein          Extra fine          Extra fine</p> <b>MICRO-ADSON</b> <b>0204-DHD</b> 120 mm	 <b>ADSON</b> <b>0204-DHH</b> 120 mm
1,0 mm 1/1	1,0 mm 1/1 1x2 Zähne 1x2 Tooth 1x2 Denti 1x2 Dientes 1x2 Dents	1,0 mm 1/1 Gebogen Curved Curva	1,0 mm 1/1 1x2 Zähne 1x2 Tooth 1x2 Denti 1x2 Dientes 1x2 Dents Gebogen Curved Curva	1/1 2x3 Zähne 2x3 Tooth 2x3 Denti 2x3 Dientes 2x3 Dents

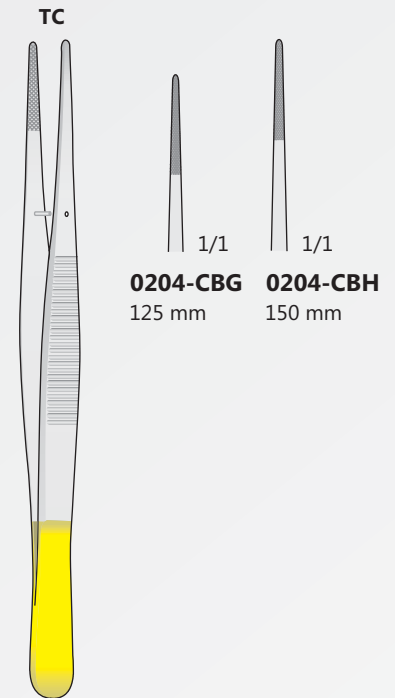
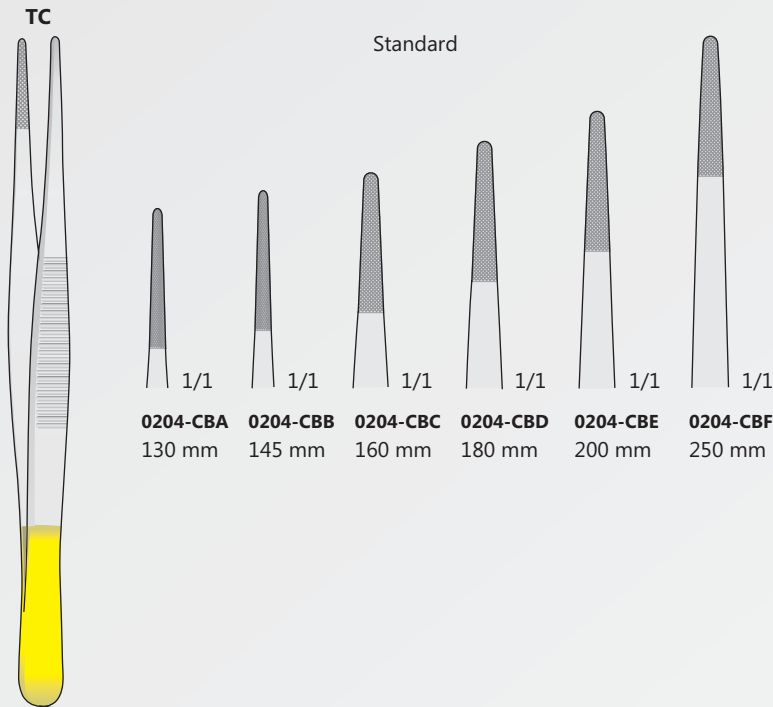

TUNGSTEN  
CARBIDE

0204-CBA/0204-CBF

TUNGSTEN  
CARBIDE

SEMKEN  
0204-CBG/0204-CBH

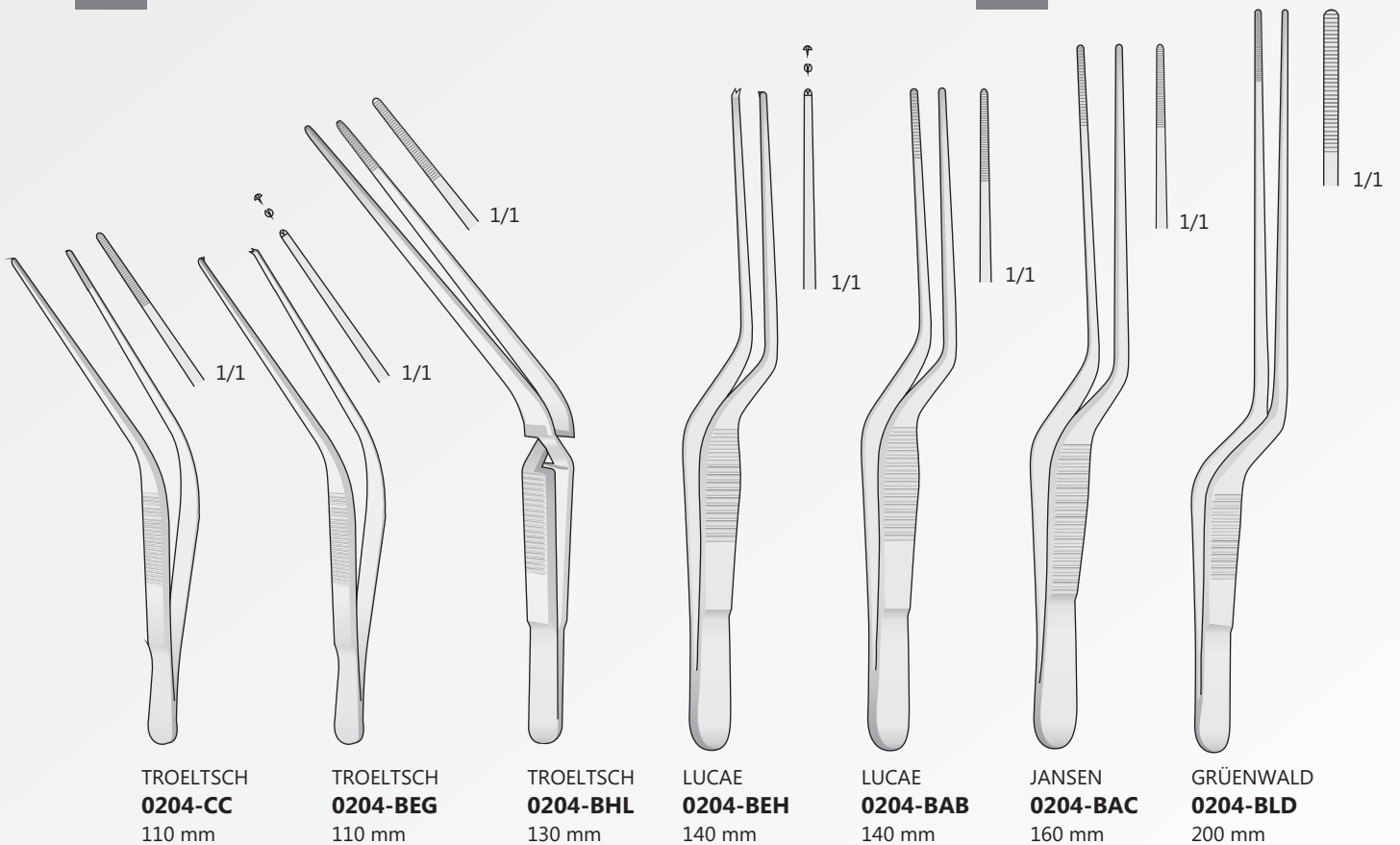

Bipolarpinzetten  
 Bipolar Forceps  
 Pinzette bipolari  
 Pinzas bipolares  
 Pince bipolaire



Kabel für bipolare pinzette EU  
 Cable for bipolar pinzette EU  
 Cavo per pinzette bipolari EU  
 Cable pour bipolar precelle UE  
 Cable para bipolar pinzette EU

**0806-BDA**  
 3,00 mt.

**0806-BFA**  
 5,00 mt.

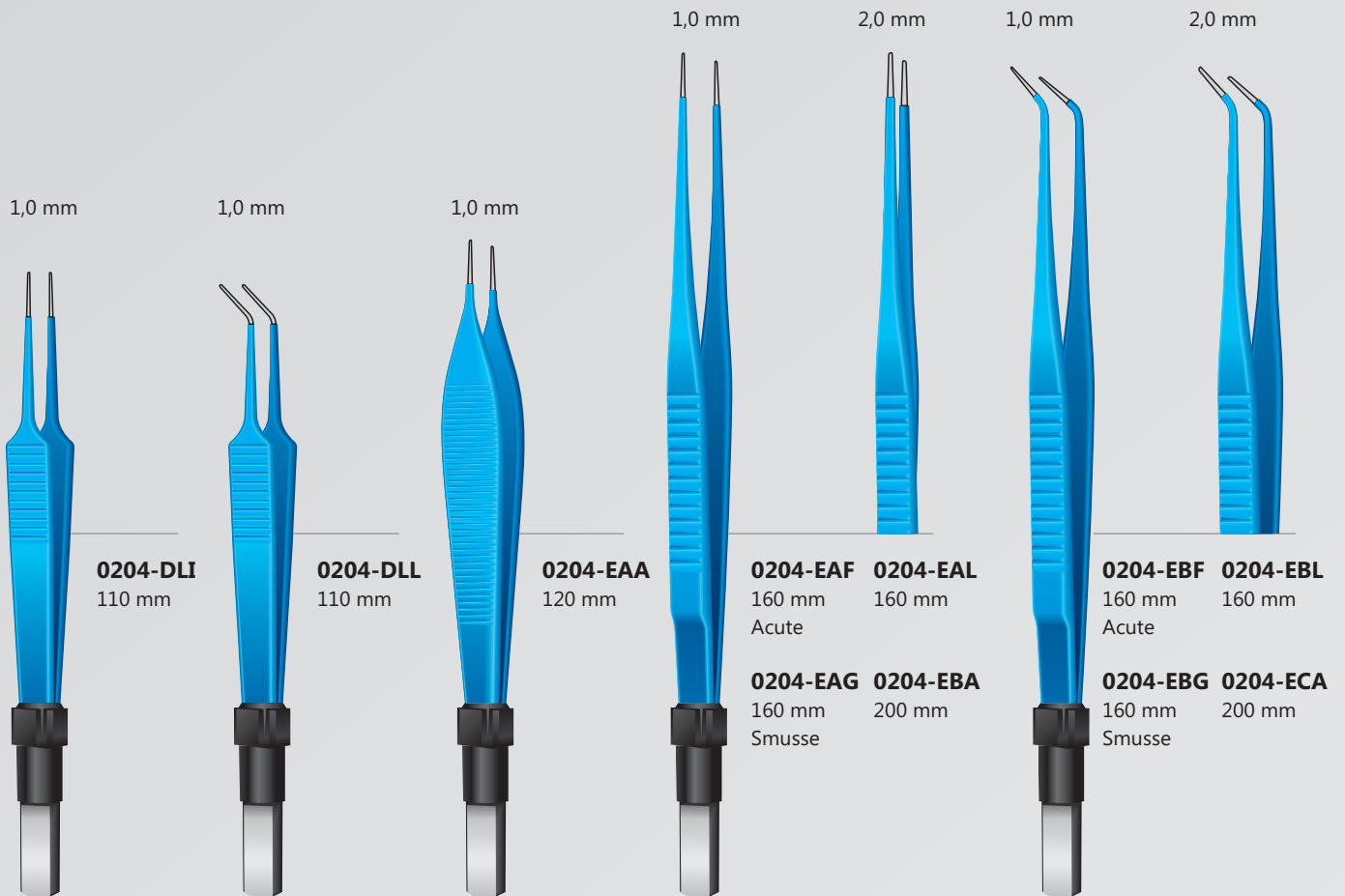





 ideal-tek

Tuchklemmen, Arterienklemmen und Bulldogklemmen  
Towel Forceps, Hemostatic Forceps and Bulldog Clamps  
Fissateli, Pinze emostatiche e Pinze Bulldog  
Pinzas para campos, Pinzas hemostáticas y Pinzas Bulldog  
Pinces à champs, Pinces hémostatiques et Pinces Bulldog



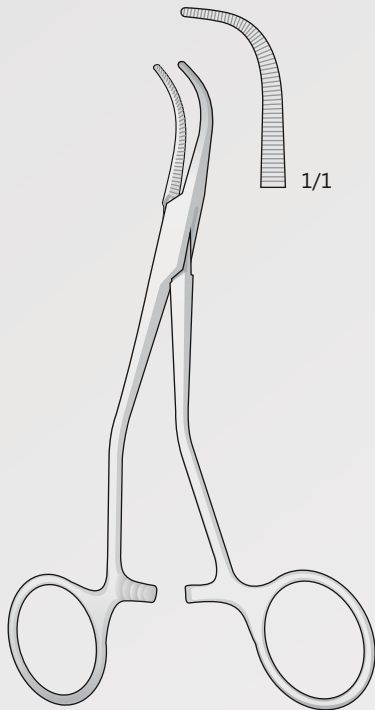

**15-BF**  
130 mm

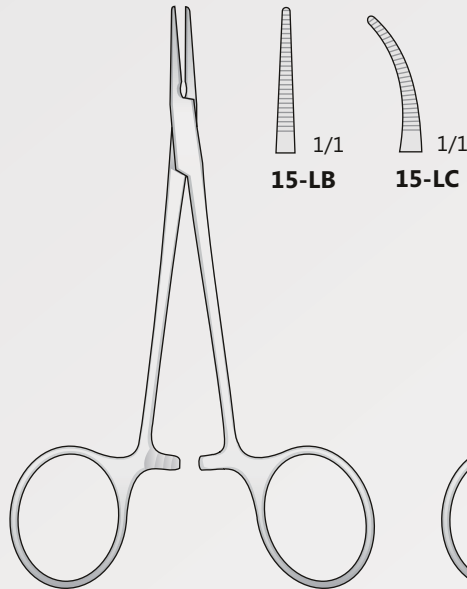

HALSTED  
**15-LB/15-LC**  
125 mm

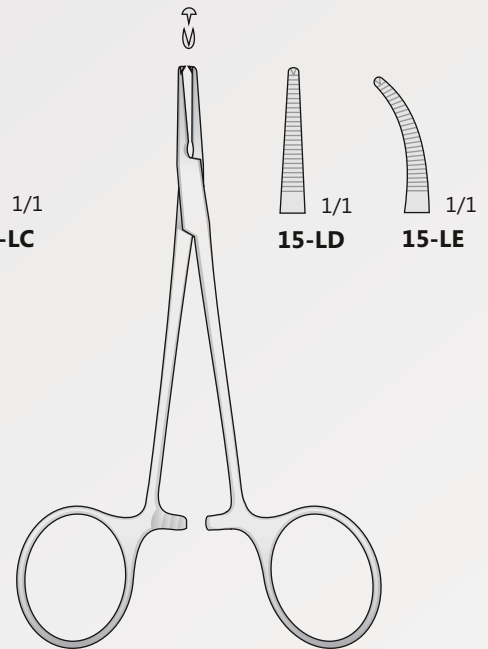

HALSTED  
**15-LD/15-LE**  
125 mm

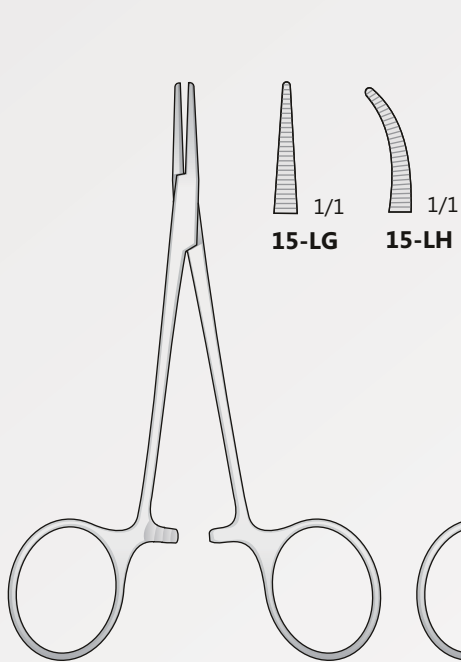

HALSTED-MOSQUITO  
**15-LG/15-LH**  
120 mm

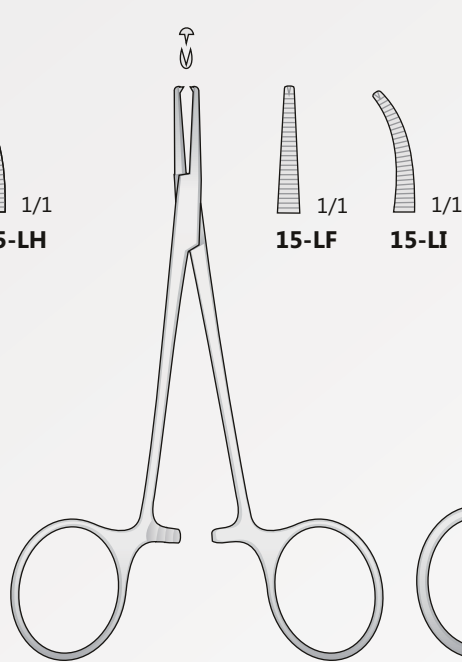

HALSTED-MOSQUITO  
**15-LF/15-LI**  
120 mm

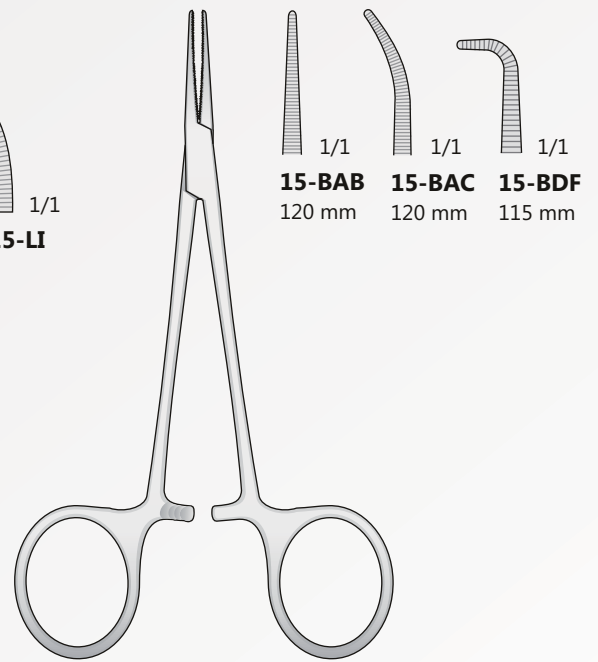

MICRO-HALSTED  
**15-BAB/15-BDF**

Arterienklemmen  
 Hemostatic forceps  
 Pinze emostatiche  
 Pinzas hemostáticas  
 Pincas hémostatiques

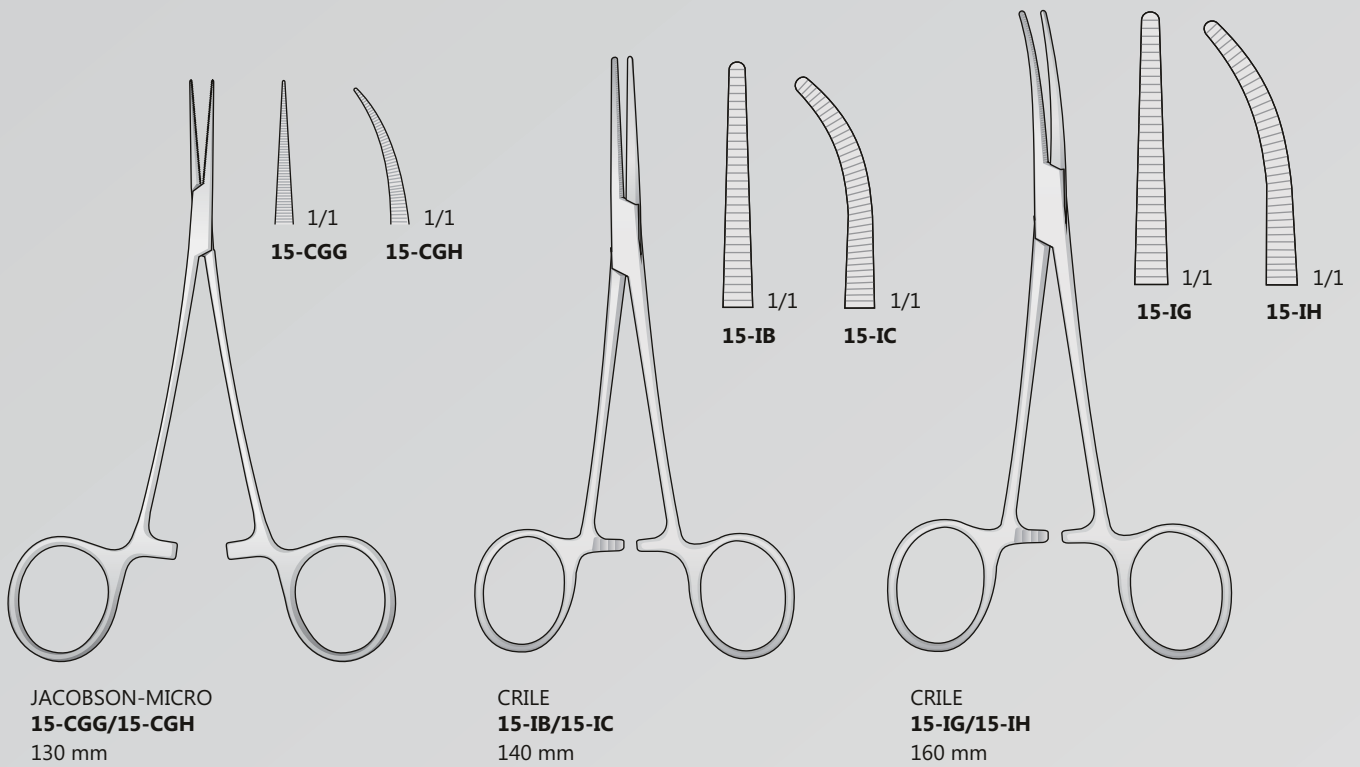

Curve sul lato  
 Curved to side  
 Seitwärts gebogen  
 Courbes latérales  
 Curvas laterales

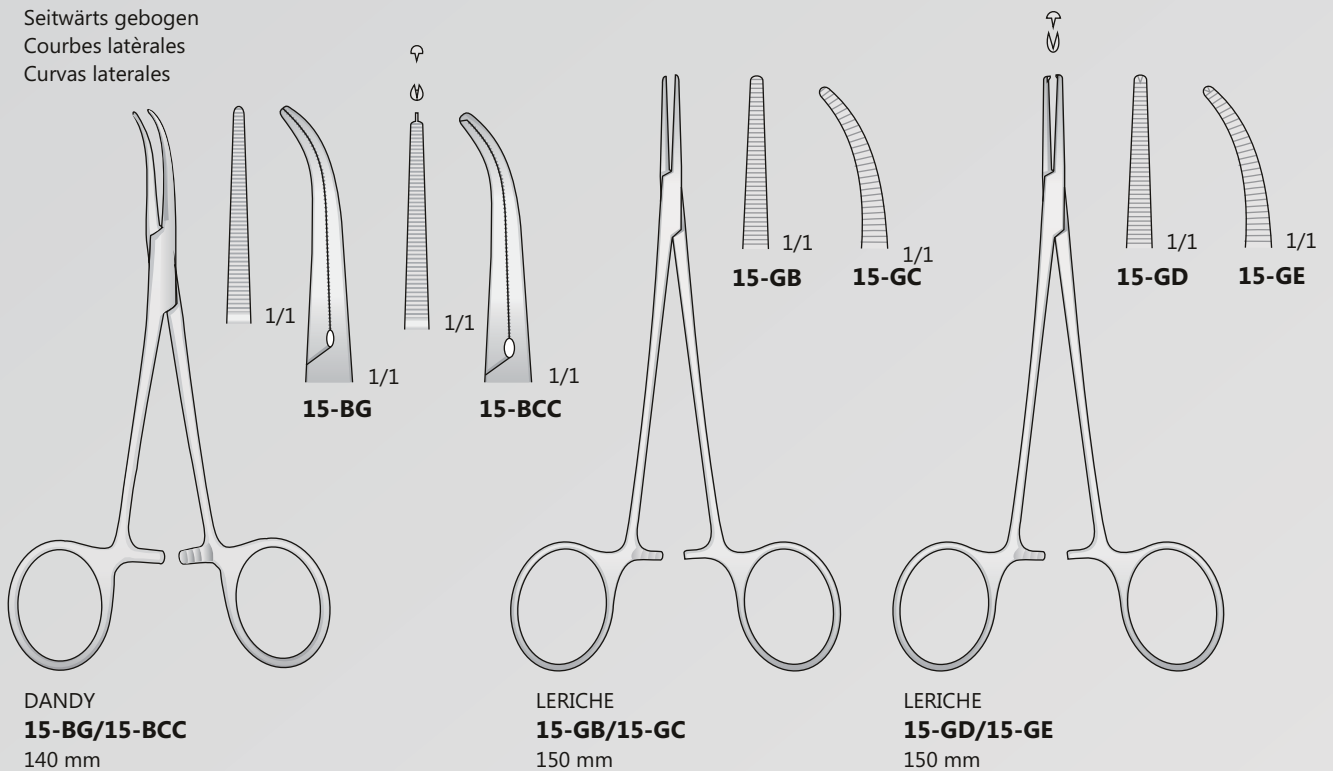

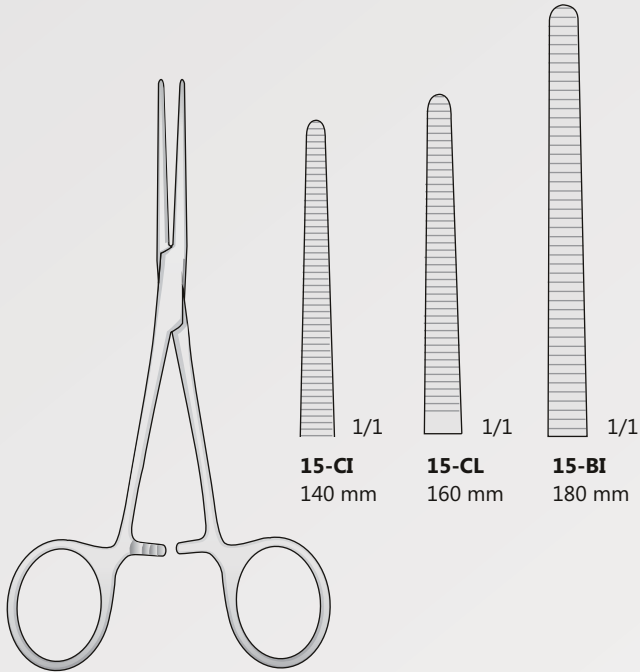

**15-CI**  
140 mm

**15-CL**  
160 mm

**15-BI**  
180 mm

ROCHESTER-PEAN  
**15-BI/15-CL**

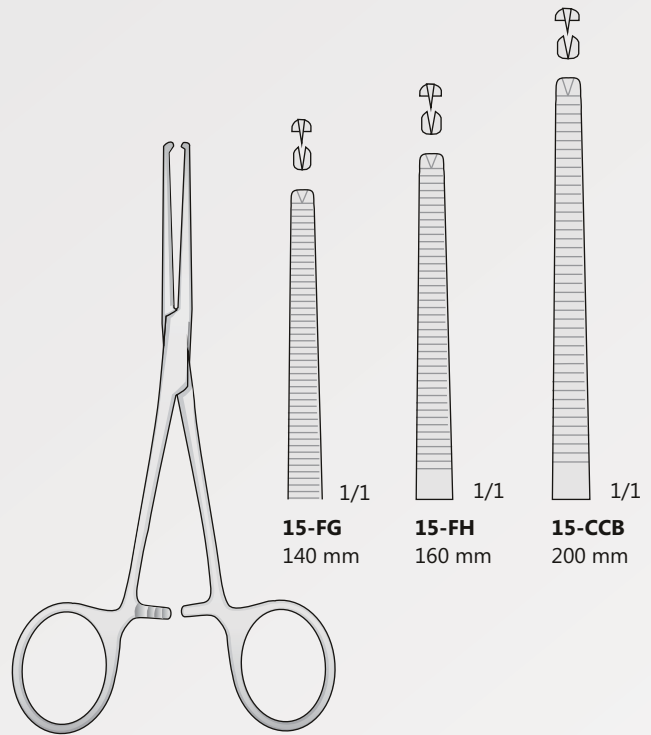

**15-FG**  
140 mm

**15-FH**  
160 mm

**15-CCB**  
200 mm

KOCHER-OCHSNER  
**15-FG/15-CCB**

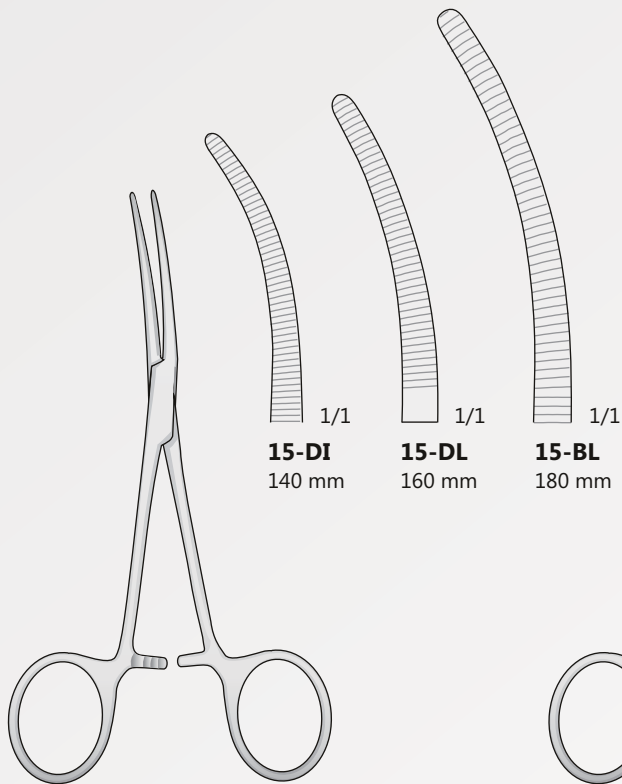

**15-DI**  
140 mm

**15-DL**  
160 mm

**15-BL**  
180 mm

ROCHESTER-PEAN  
**15-BL/15-DL**

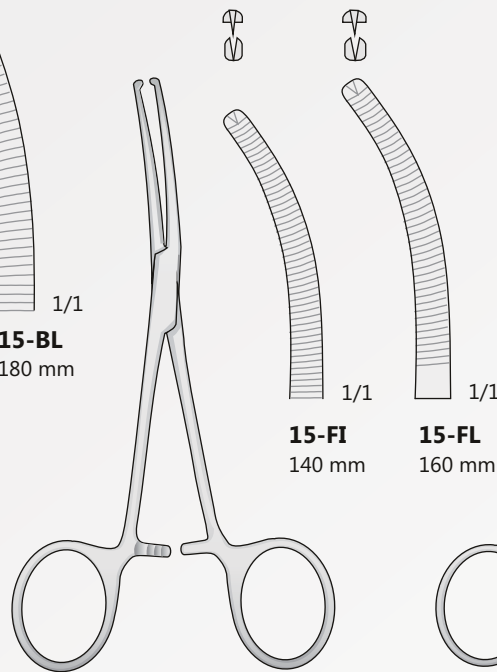

**15-FI**  
140 mm

**15-FL**  
160 mm

KOCHER-OCHSNER  
**15-FI/15-FL**

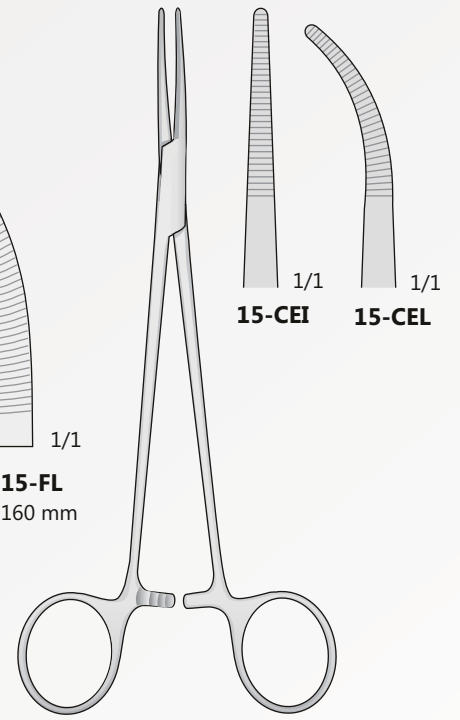

**15-CEI**

**15-CEL**

BIRKETT  
**15-CEI/15-CEL**  
 180 mm

Arterienklemmen  
 Hemostatic forceps  
 Pinze emostatiche  
 Pinzas hemostáticas  
 Pincas hémostatiques

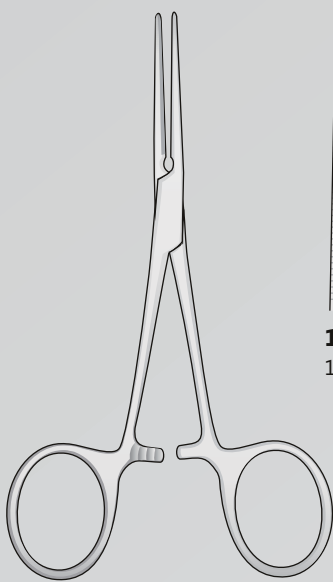

PEAN  
**15-CFA/15-CFF**

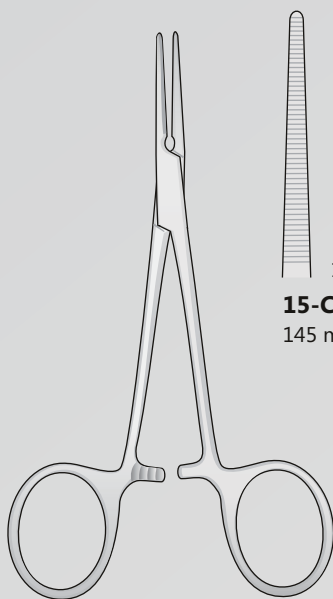
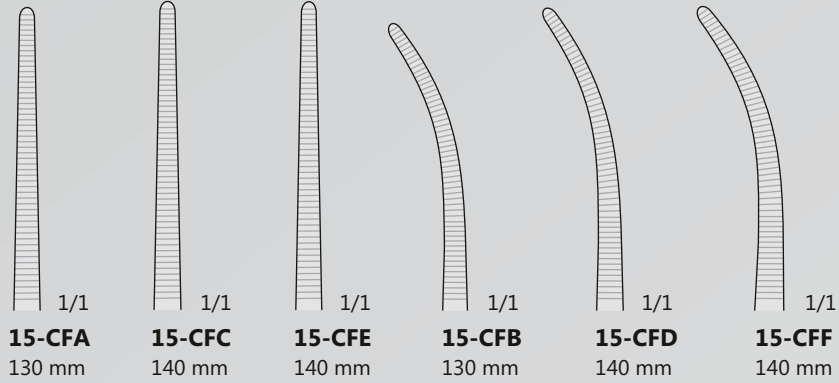

PEAN  
**15-CFG/15-CFL**

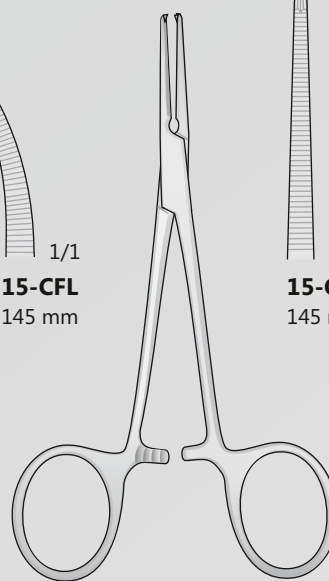
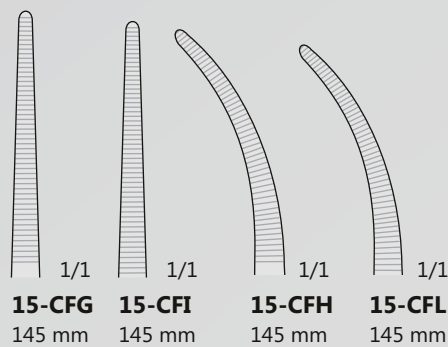

KOCHER  
**15-CGA/15-CGD**

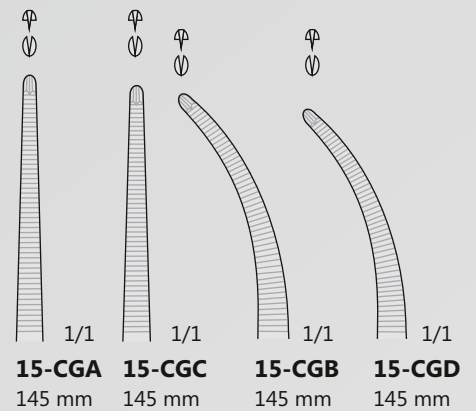

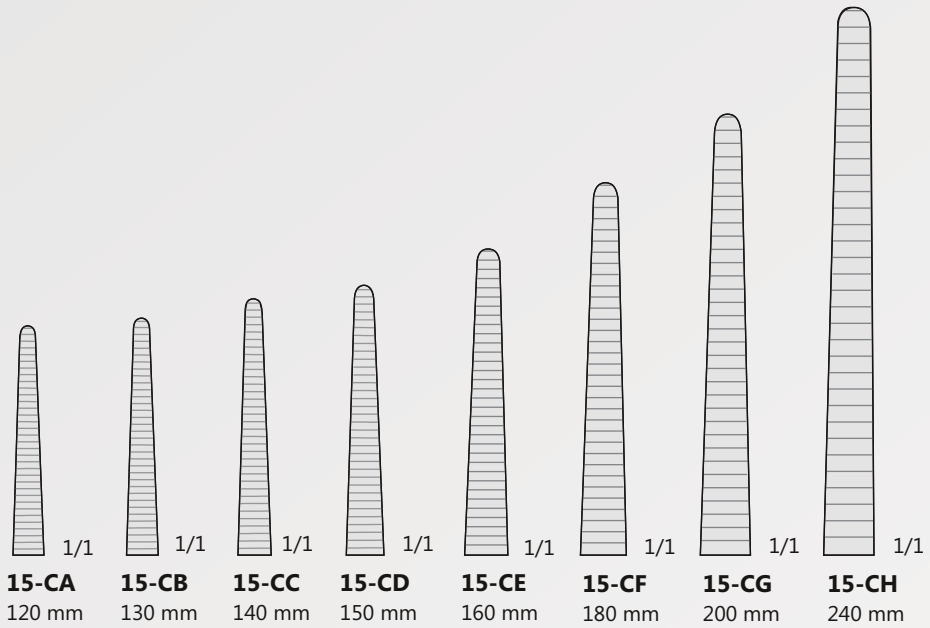
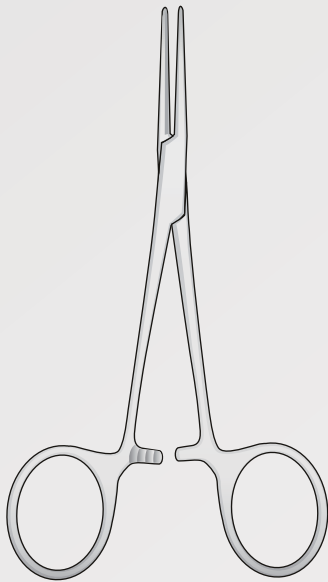

PEAN  
**15-CA/15-CH**

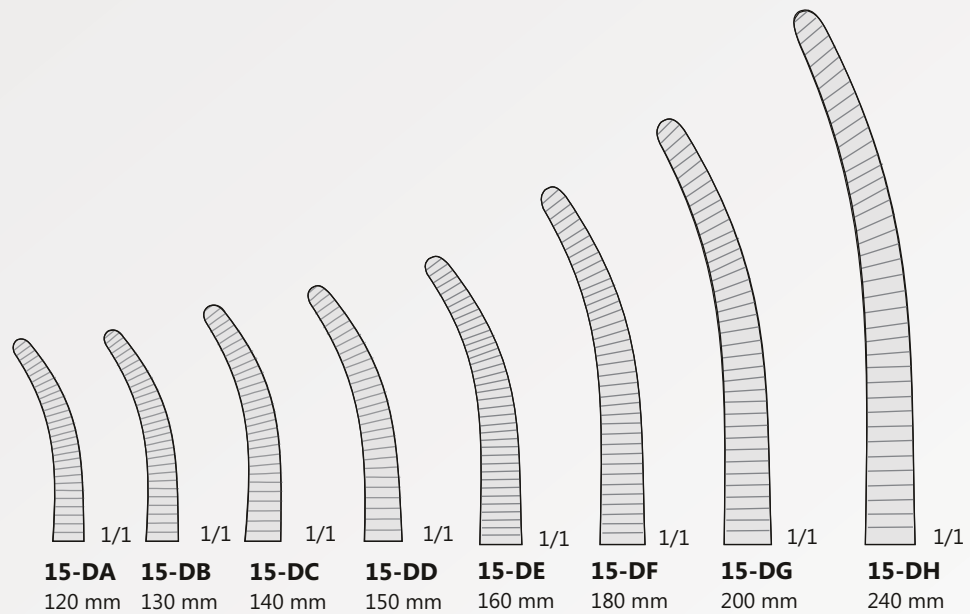
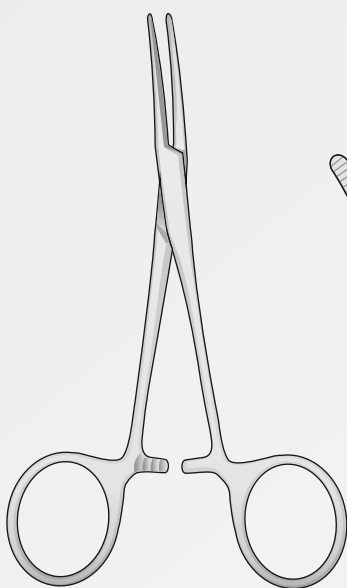

PEAN  
**15-DA/15-DH**

Arterienklemmen  
 Hemostatic forceps  
 Pinze emostatiche  
 Pinzas hemostáticas  
 Pincas hémostatiques

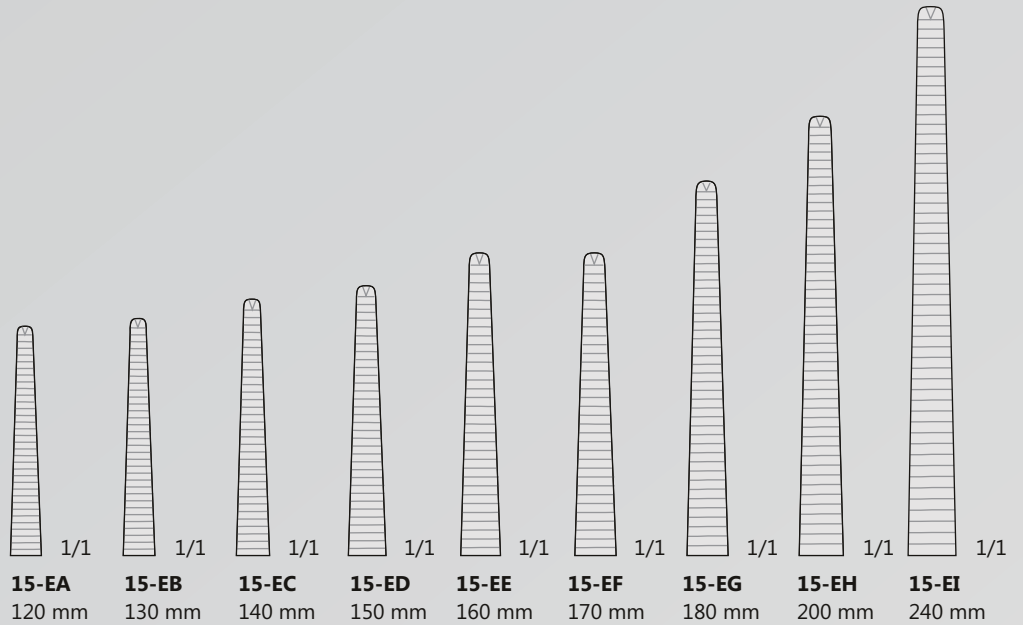
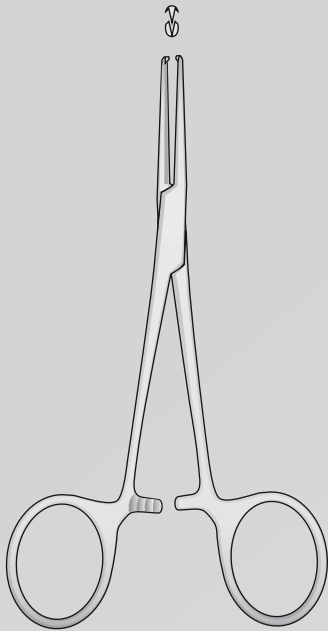

KOCHER  
**15-EA/15-EI**

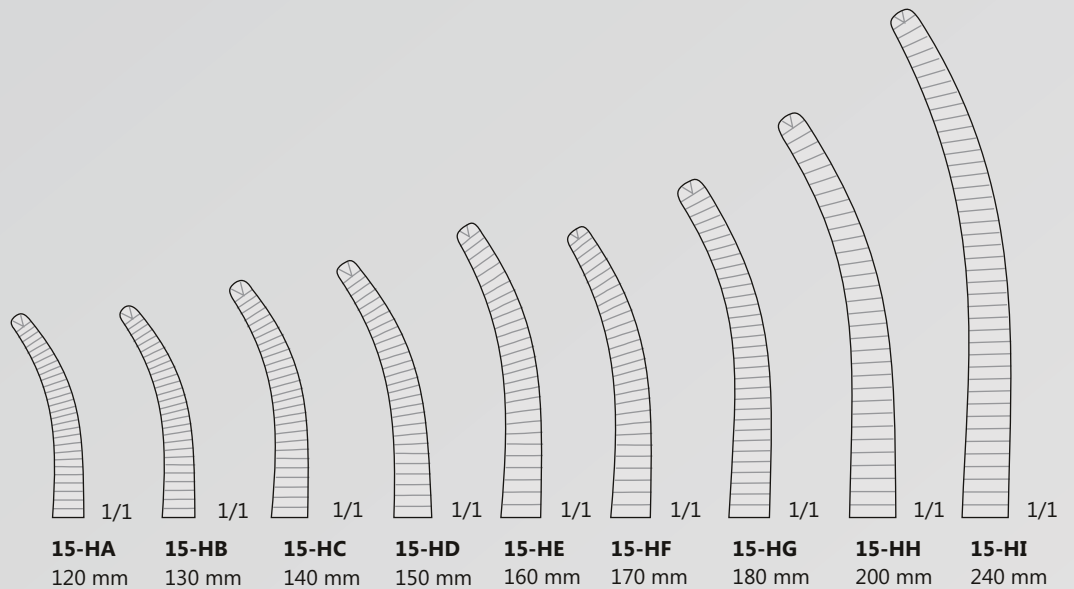
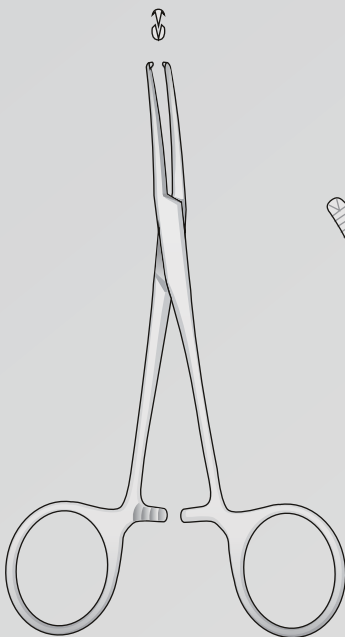

KOCHER  
**15-HA/15-HI**



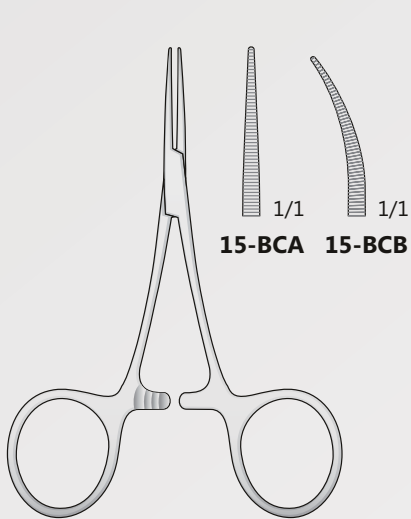

HARTMANN/BABY-MOSQUITO  
**15-BCA/15-BCB**  
 95 mm

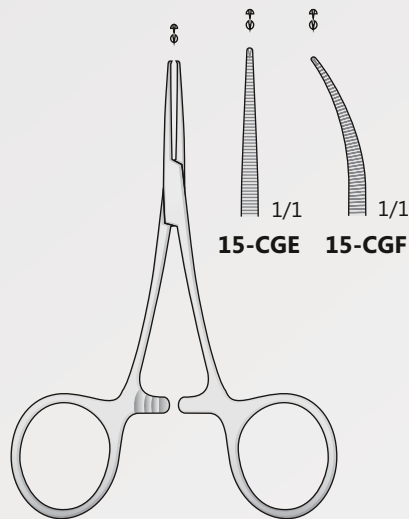

HARTMANN/BABY-MOSQUITO  
**15-CGE/15-CGF**  
 95 mm

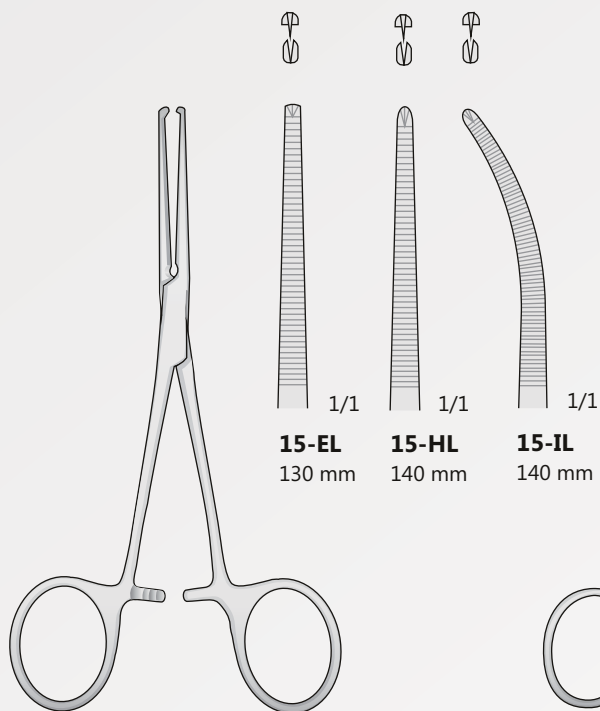

KOCHER  
**15-EL/15-IL**

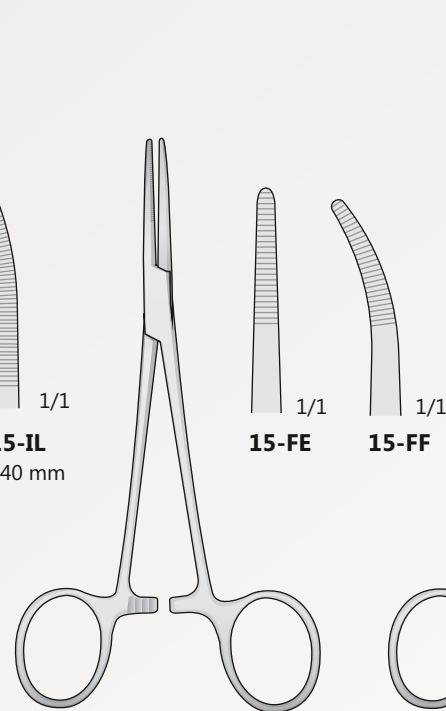

KELLY  
**15-FE/15-FF**  
 140 mm

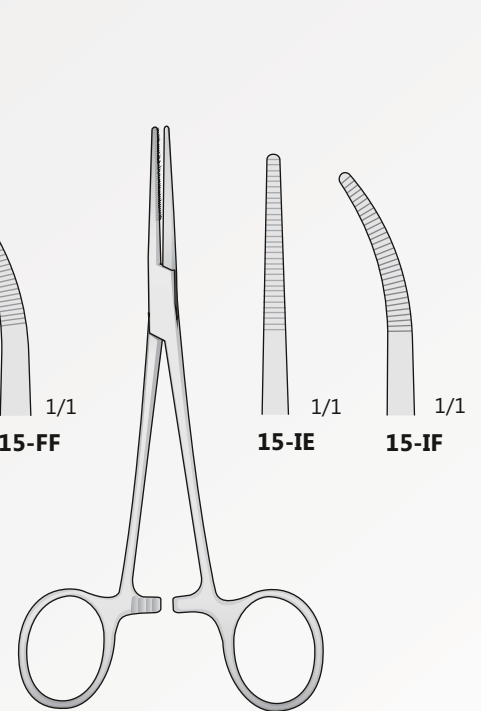

KELLY  
**15-IE/15-IF**  
 140 mm

Arterienklemmen  
 Hemostatic forceps  
 Pinze emostatiche  
 Pinzas hemostáticas  
 Pincés hémostatiques

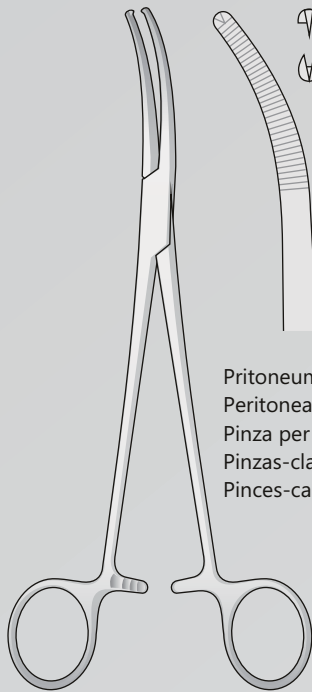

MIKULICZ  
**15-BAE**  
 190 mm

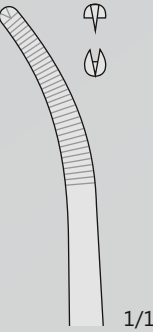

Pritoneum klemmen  
 Peritoneal clamps forceps  
 Pinza per peritoneo  
 Pinzas-clamps para peritoneo  
 Pincés-camps pour les péritoine

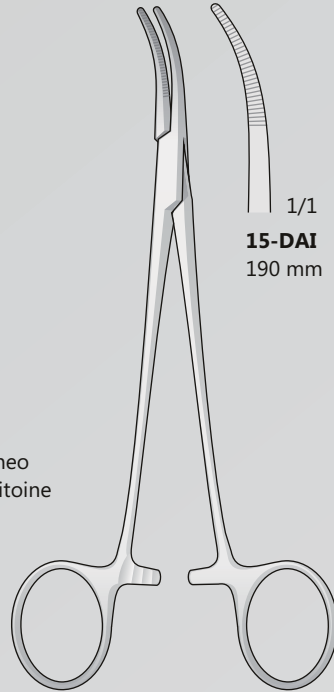

SCHNIDT  
**15-DAI**  
 190 mm

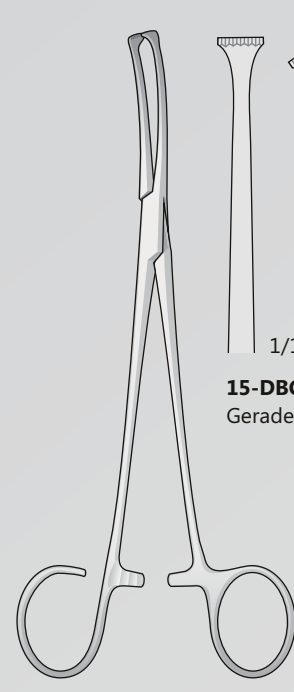
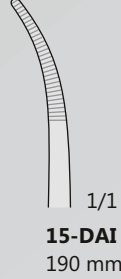

COLVER  
**15-DBC/15-DBD**  
 190 mm

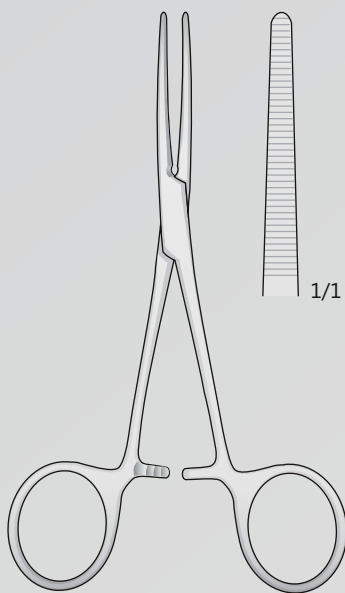
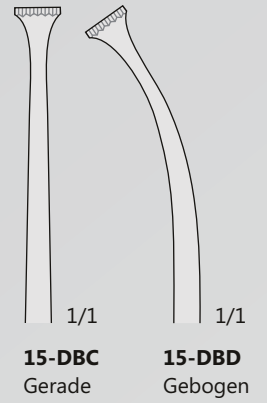

PEAN  
**15-BH**  
 140 mm

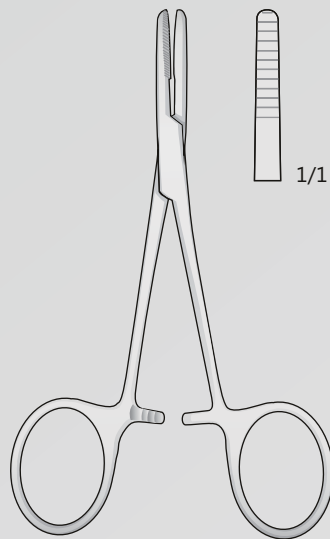

TERRIER  
**15-GA**  
 130 mm

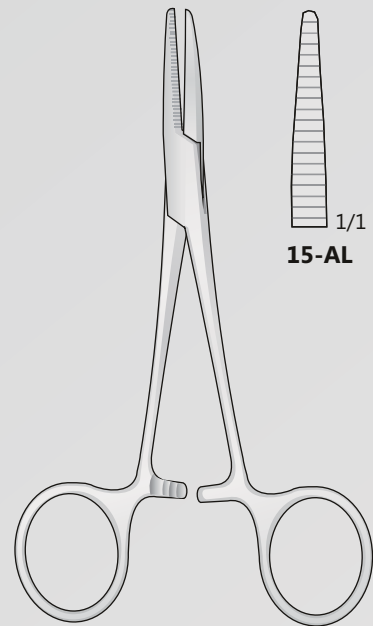

JONES  
**15-AL/15-AI**  
 150 mm

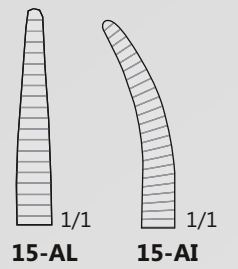

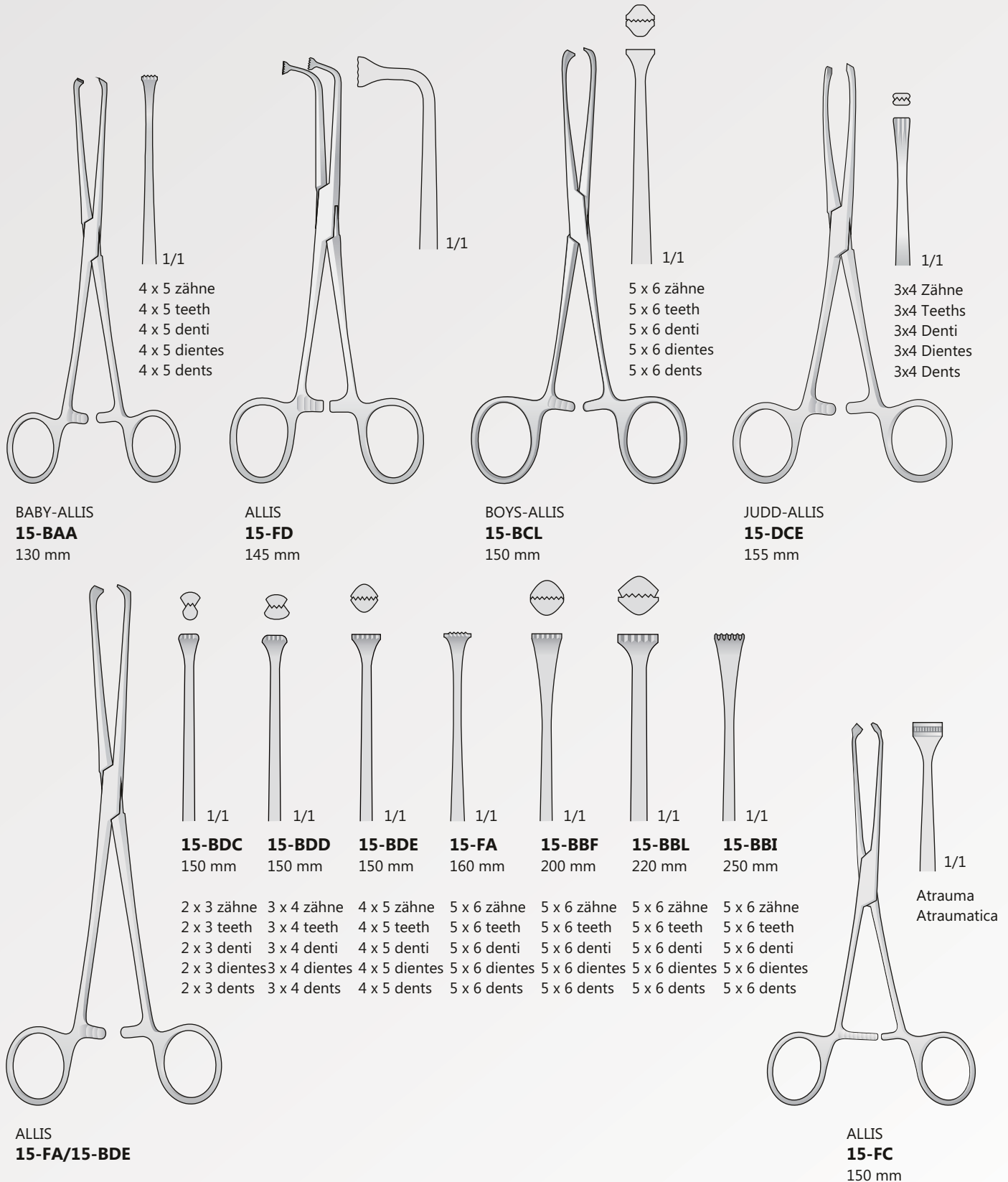

Arterienklemmen  
 Hemostatic forceps  
 Pinze emostatiche  
 Pinzas hemostáticas  
 Pincas hémostatiques

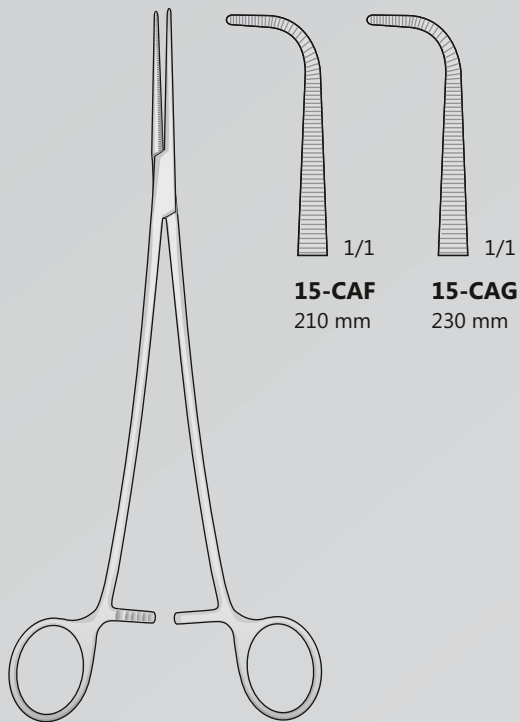

BENGOLEA  
**15-CAF/15-CAG**

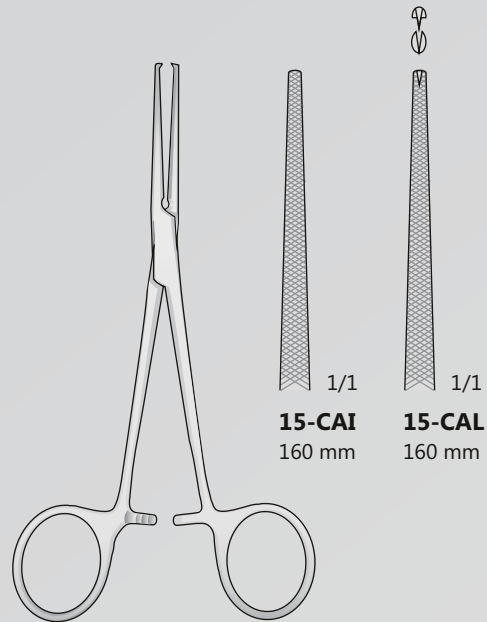

DIXON-LOVELACE  
**15-CAI/15-CAL**

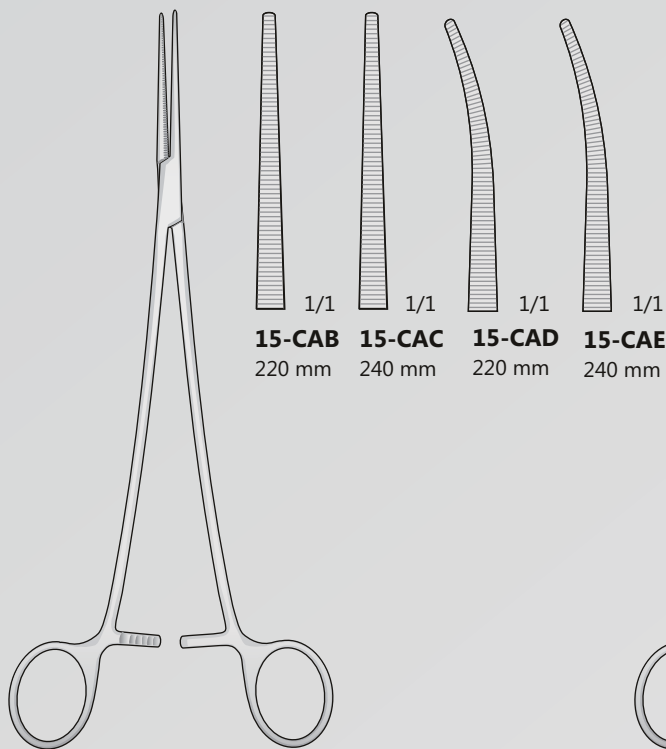

BENGOLEA  
**15-CAB/15-CAE**

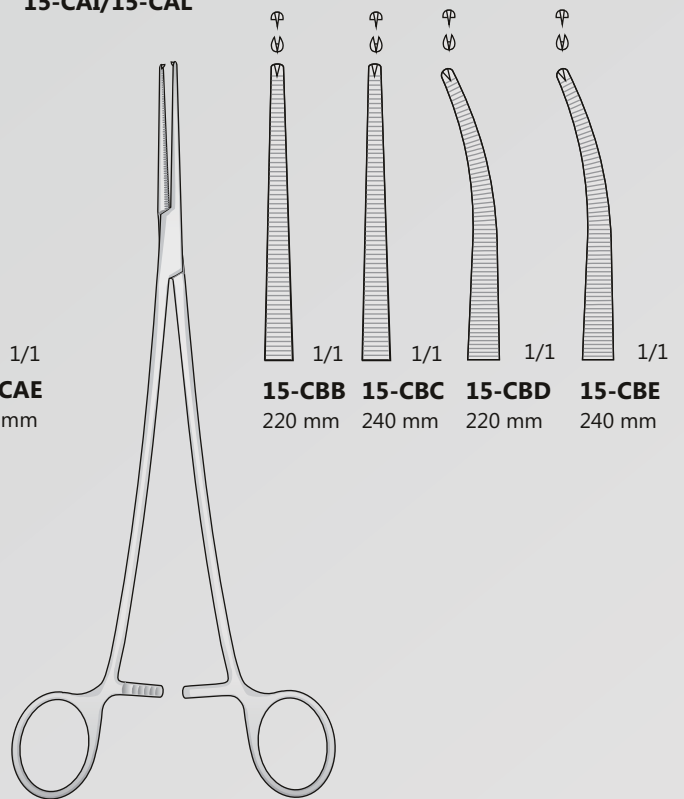

BENGOLEA  
**15-CBB/15-CBE**

Arterienklemmen Präparier und Ligaturklemmen  
 Artery forceps for preparation and ligature  
 Pinze emostatiche per preparazioni e legature  
 Pinzas hemostáticas Preparacion y para ligaduras  
 Pincas hemostàtiques à disséquer et à ligatures

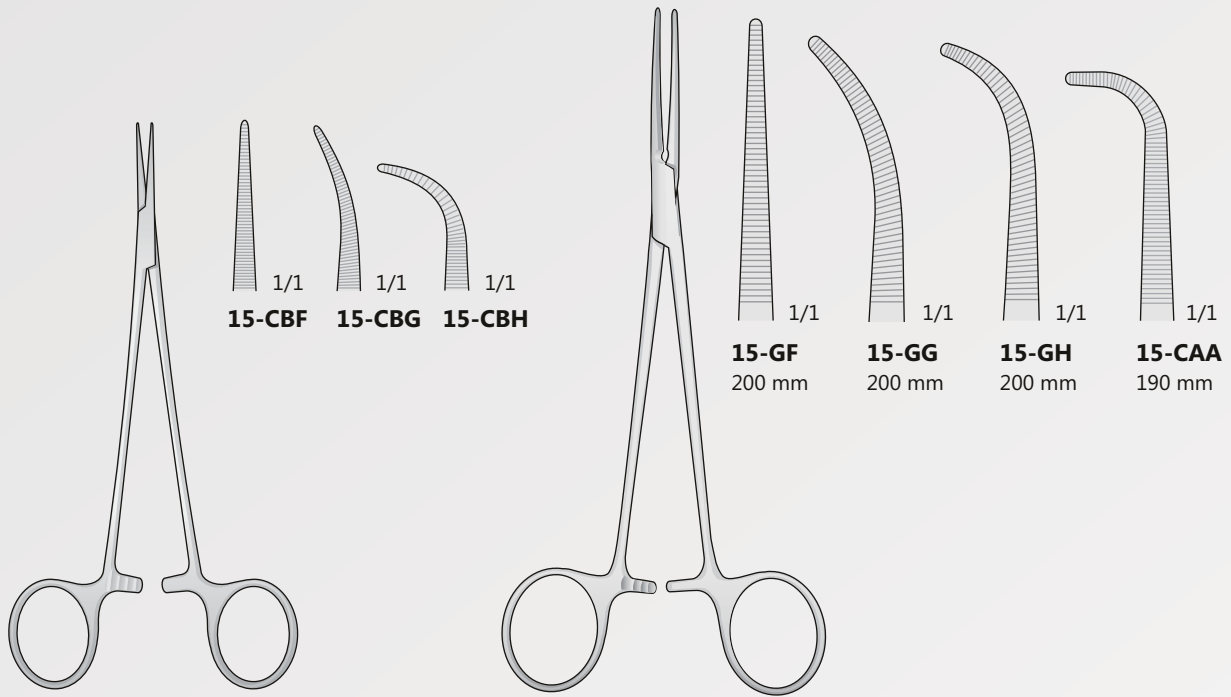

**15-CBF/15-CBH**  
160 mm

HEISS  
**15-GF/15-CAA**

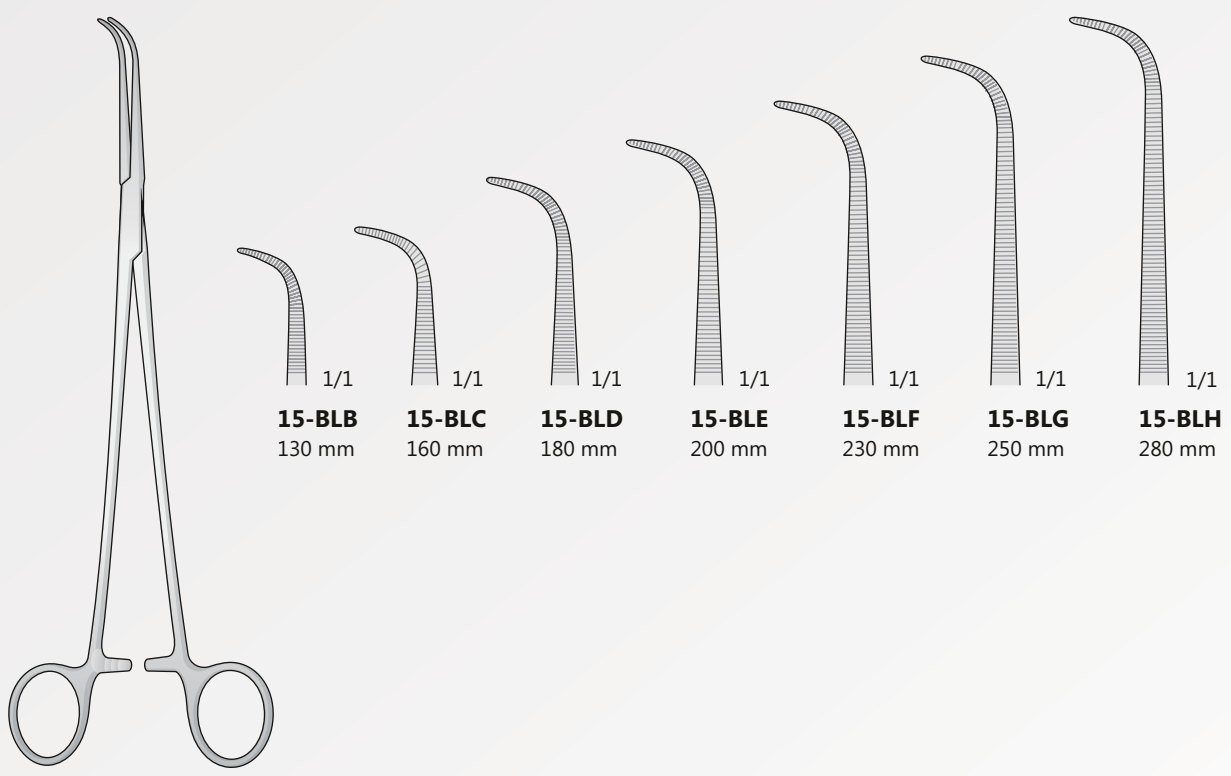

GEMINI  
**15-BLB/15-BLH**

Arterienklemmen Präparier und Ligaturklemmen  
 Artery forceps for preparation and ligature  
 Pinze emostatiche per preparazioni e legature  
 Pinzas hemostáticas Preparacion y para ligaduras  
 Pincas hemostàtiques à disséquer et à ligatures

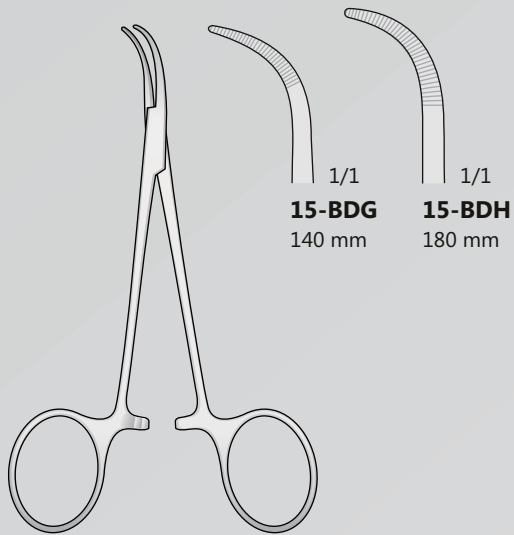

BABY-MIXTER  
**15-BDG/15-BDH**

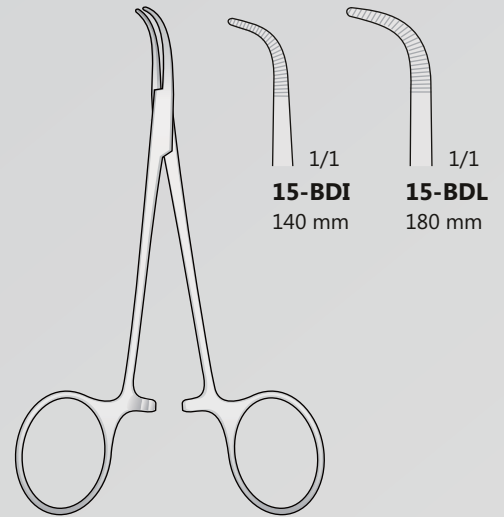

BABY-ADSON  
**15-BDI/15-BDL**

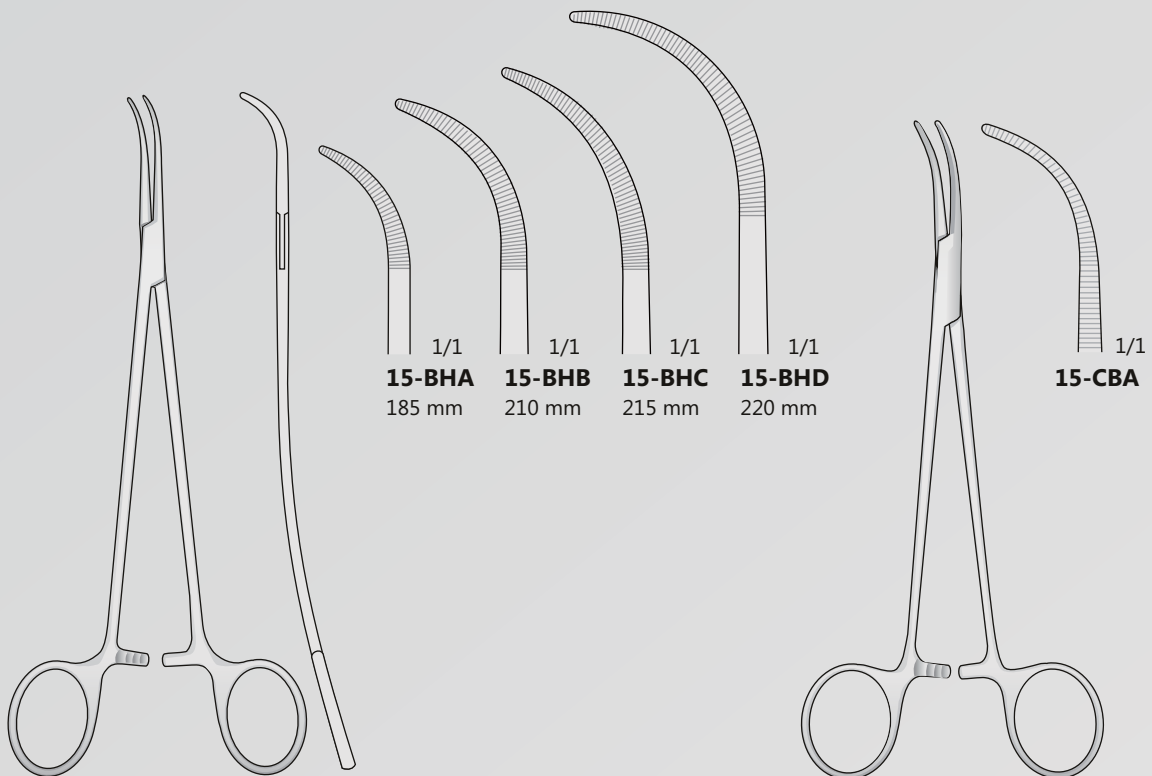

**15-BHA/15-BHD**

ROCHESTER-PEAN  
**15-CBA**  
 180 mm

Arterienklemmen Präparier und Ligaturklemmen  
 Artery forceps for preparation and ligature  
 Pinze emostatiche per preparazioni e legature  
 Pinzas hemostáticas Preparacion y para ligaduras  
 Pincas hemostàtiques à disséquer et à ligatures

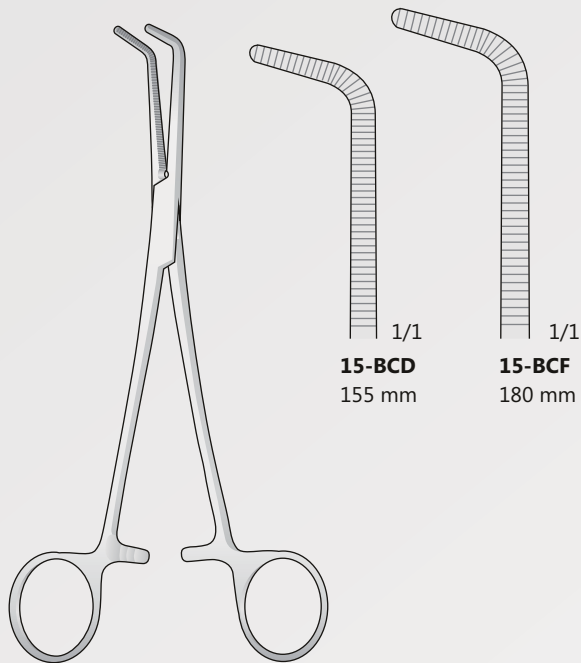

MIXTER  
**15-BCD/15-BCF**

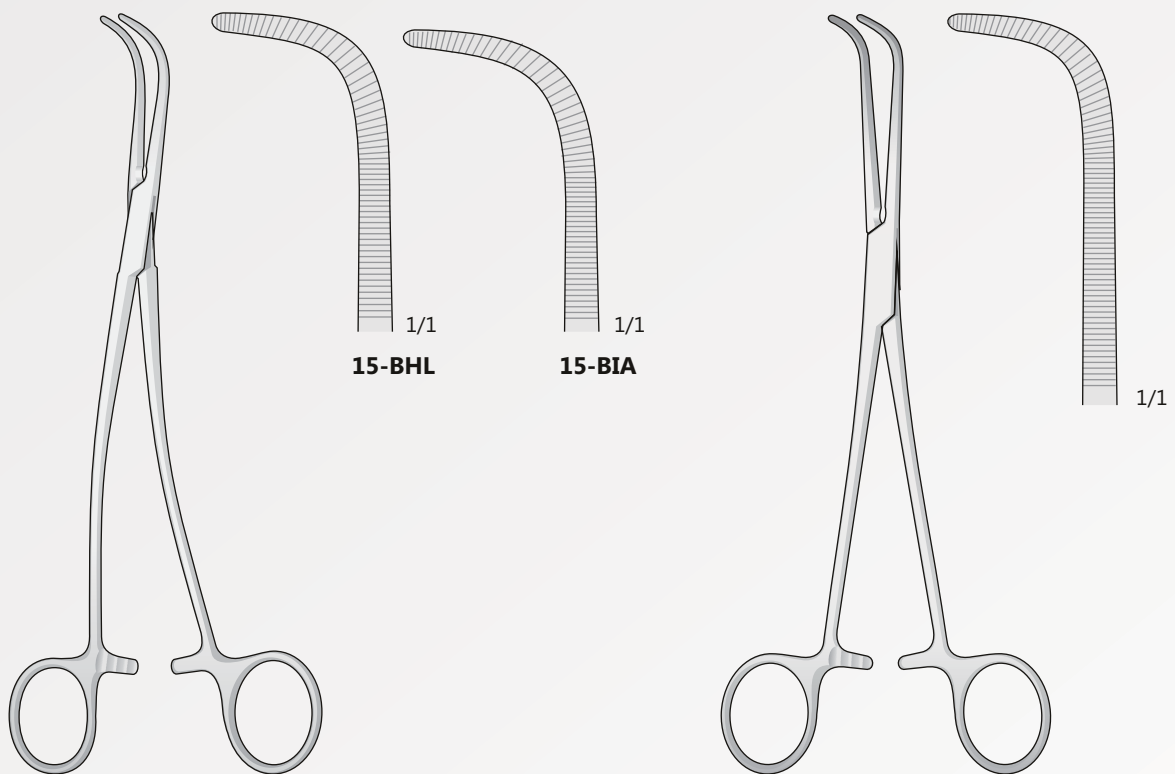

GRAY  
**15-BHL/15-BIA**  
 220 mm

WIKSTROEM  
**15-BIB**  
 205 mm

Arterienklemmen  
 Hemostatic forceps  
 Pinze emostatiche  
 Pinzas hemostáticas  
 Pincas hémostatiques

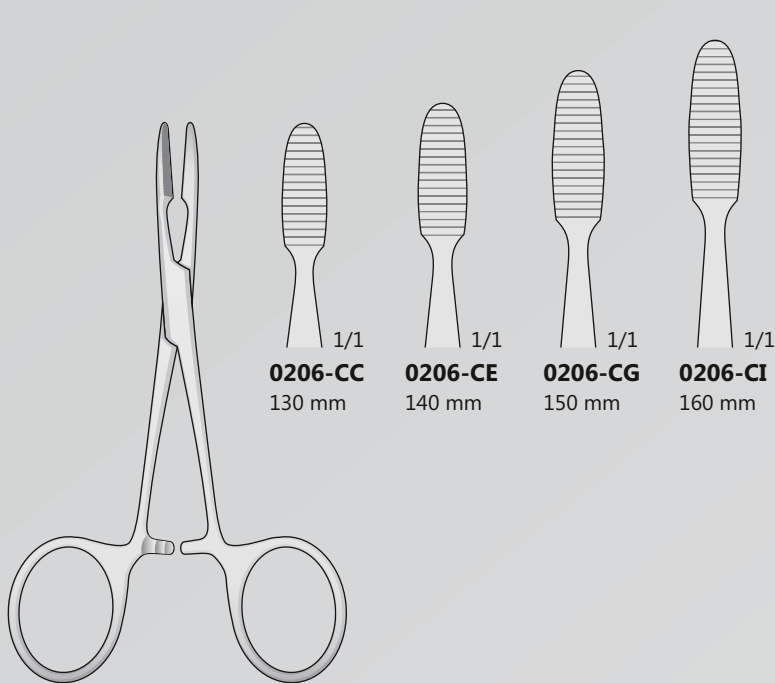

PEAN-MURPHY  
**0206-CC/0206-CI**

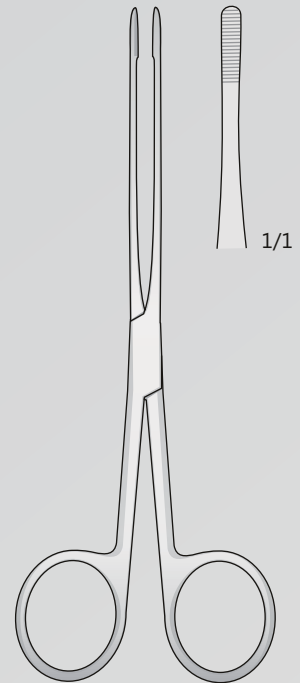

LISTER  
**0206-CA**  
 150 mm

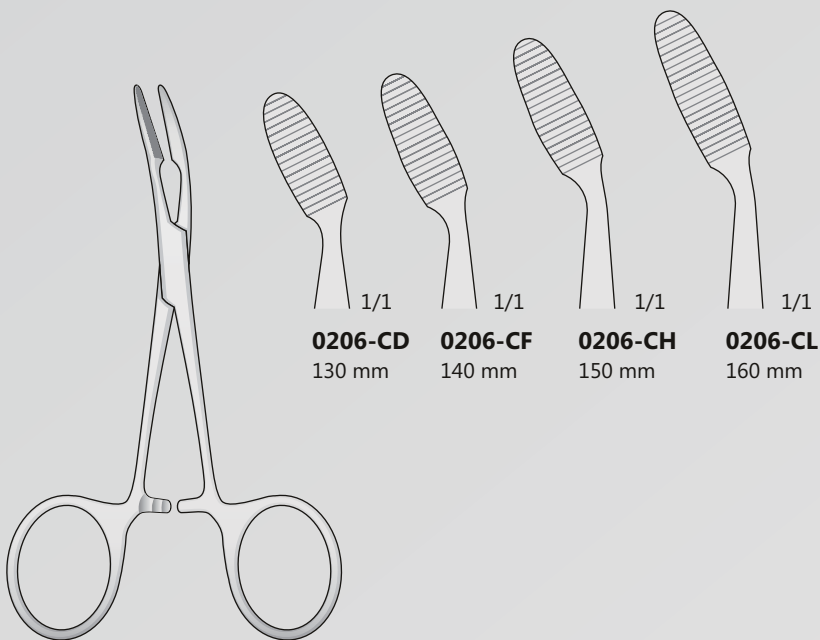

PEAN-MURPHY  
**0206-CD/0206-CL**

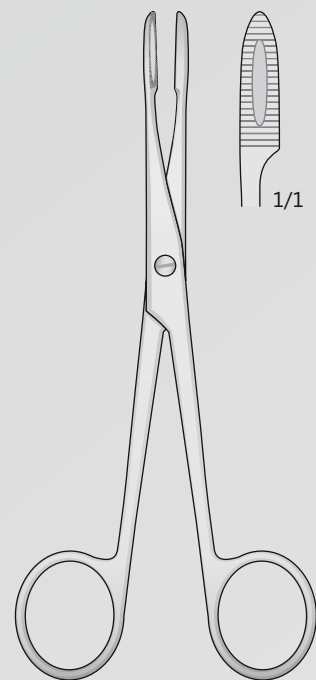

GROSS  
**0206-BA** - 130 mm  
**0206-BC** - 160 mm



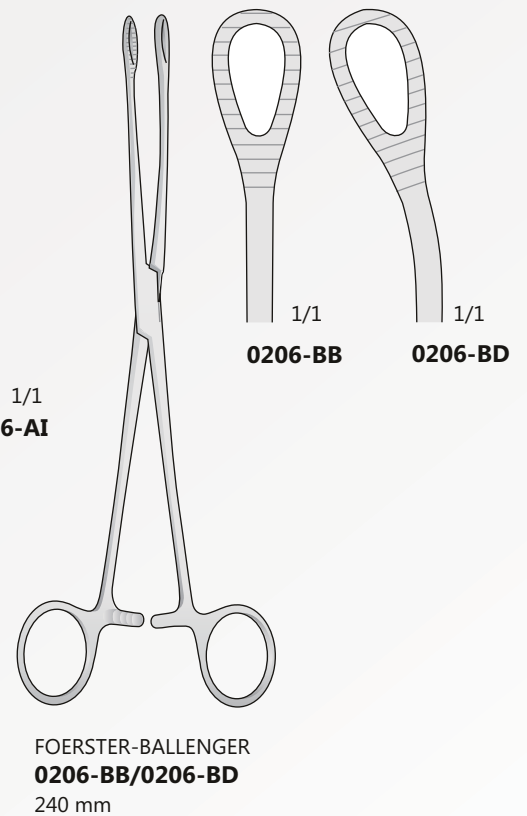
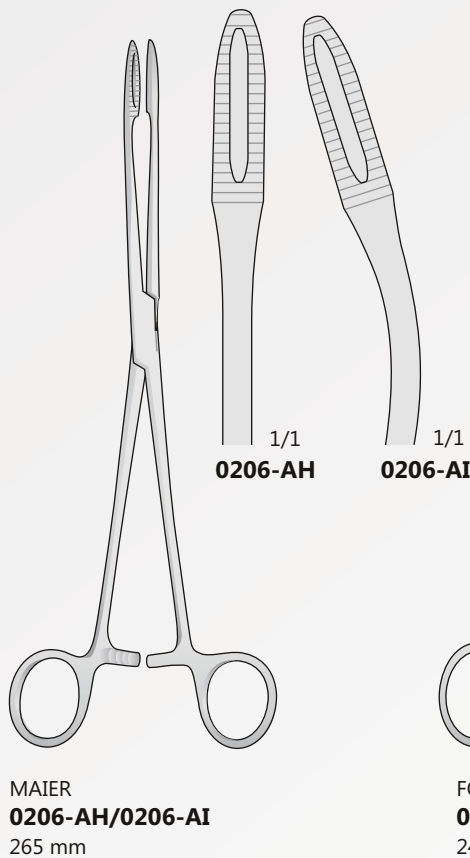
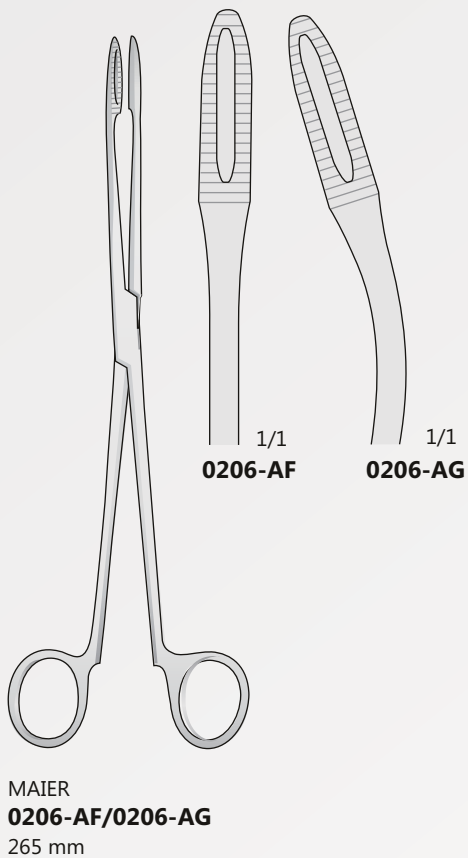
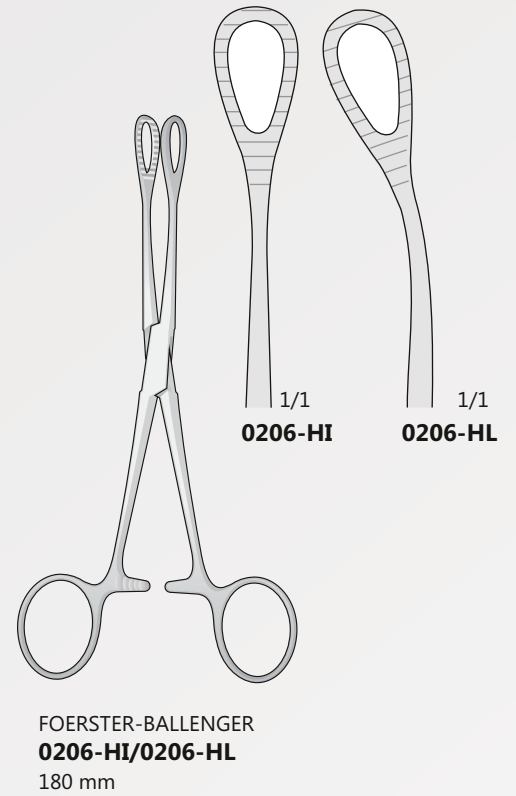
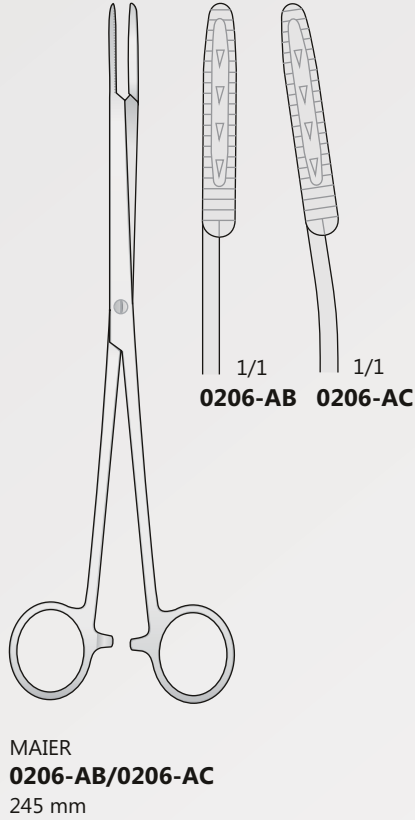
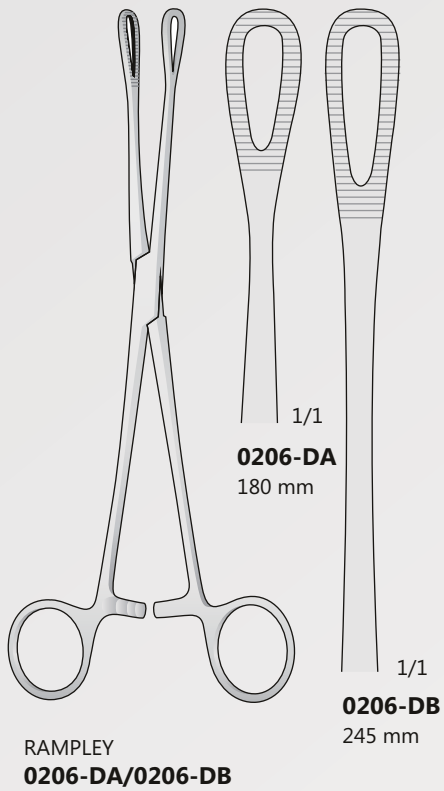

Tuchklemmen  
Towel clamps  
Fissateli  
Pinzas de campo  
Pincas pour fixer les compresses

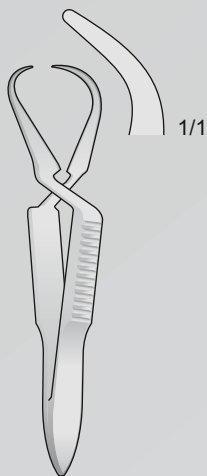

**0206-DH**  
55 mm

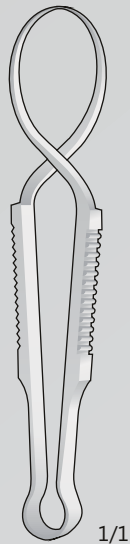

SCHAEDEL  
**0206-DI**  
85 mm

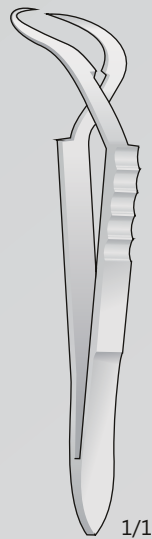

JONES  
**0206-EI**  
90 mm

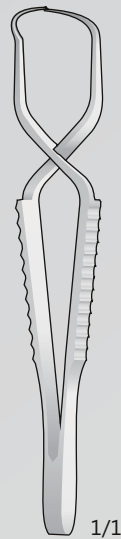

FAURE  
**0206-EA**  
85 mm

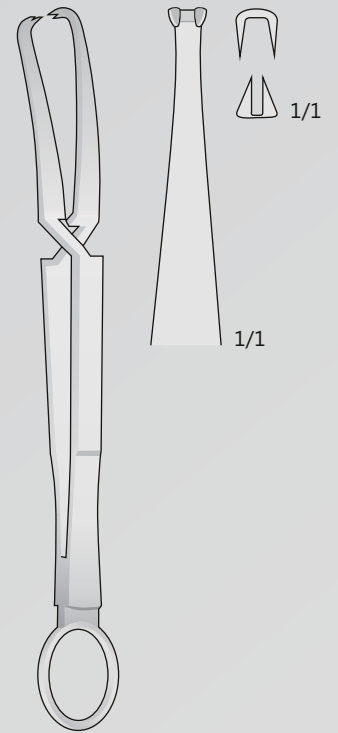

DOYEN  
**0206-DG**  
180 mm

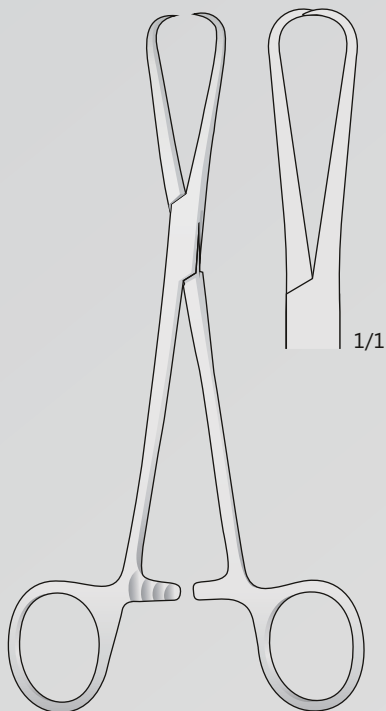

BERNHARD  
**0206-IC**  
165 mm

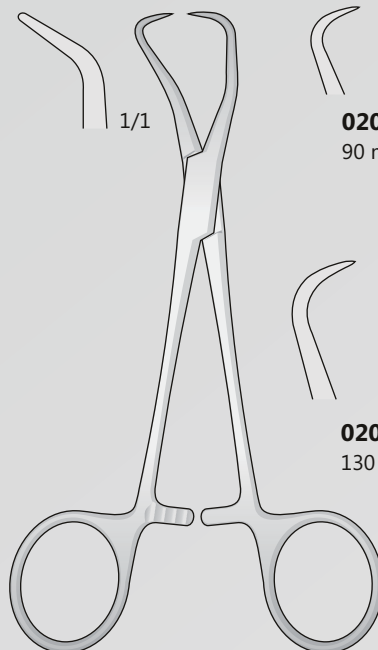

BACKHAUS  
**0206-EC/0206-EG**



**0206-EC**  
90 mm



**0206-EB**  
100 mm



**0206-EE**  
110 mm

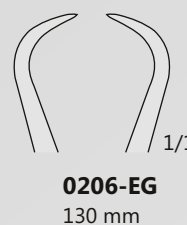

**0206-EG**  
130 mm

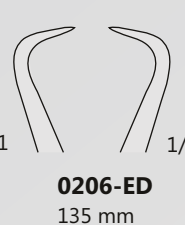

**0206-ED**  
135 mm



**0206-EF**  
140 mm

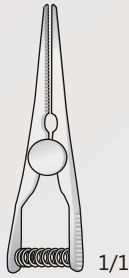

**0602-IE**  
35 mm

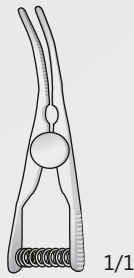

**0602-IF**  
35 mm

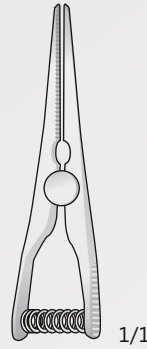

**0602-IG**  
45 mm

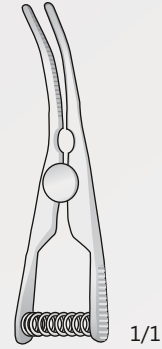

**0602-IH**  
45 mm

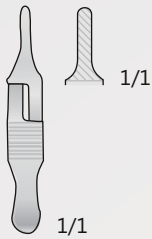

**0212-CH**  
30 mm

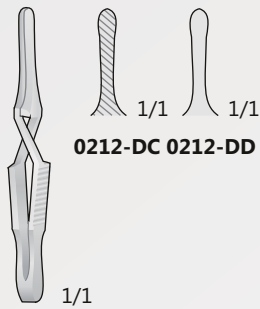

DIFFENBACH  
**0212-DC/0212-DD**  
40 mm

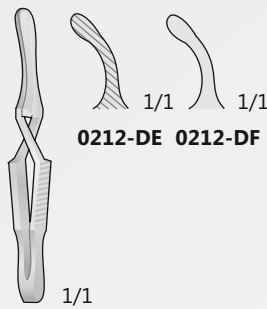

DIFFENBACH  
**0212-DE/0212-DF**  
40 mm

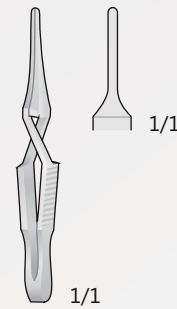

**0212-LD**  
40 mm

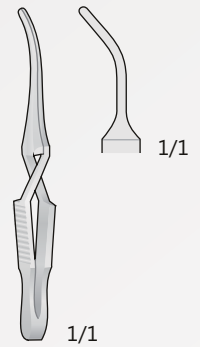

**0212-LF**  
45 mm

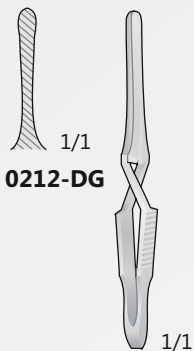

**0212-DG**  
**0212-DH**  
DIFFENBACH  
**0212-DG/0212-DH**  
45 mm

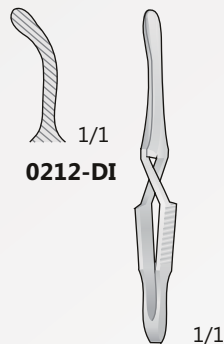
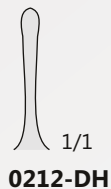

DIFFENBACH  
**0212-DI/0212-DL**  
45 mm

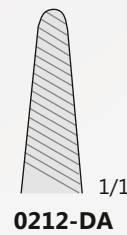

**0212-DA**

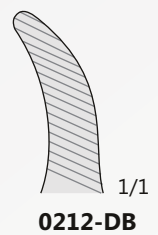

**0212-DB**

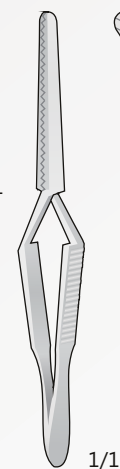

DIFFENBACH  
**0212-DA/0212-DB**  
60 mm





 ideal-tek

Atraumatische Gefäßklemmen  
Atraumatic Vessel Clamps  
Enterostati, Pinze atraumatiche  
Pinzas vasculares atraumáticas  
Pincas atraumatiques



Atraumatische Gefäßklemmen  
 Atraumatic vessel clamps  
 Pinze vascolari atraumatiche  
 Pinzas vasculares atraumáticas  
 Pincas hémostatiques atraumatiques

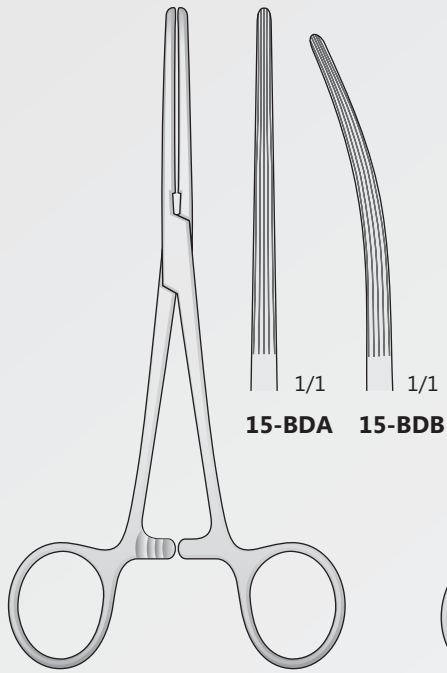

BAINBRIDGE  
**15-BDA/15-BDB**  
 150 mm

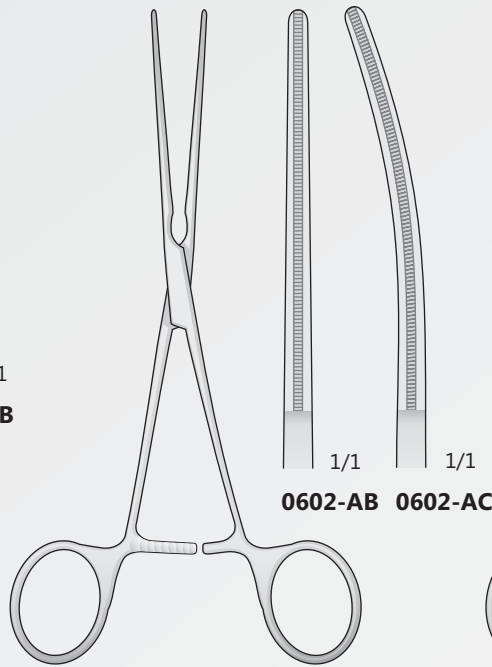

 De BAKEY - BAINBRIDGE  
**0602-AB/0602-AC**  
 180 mm

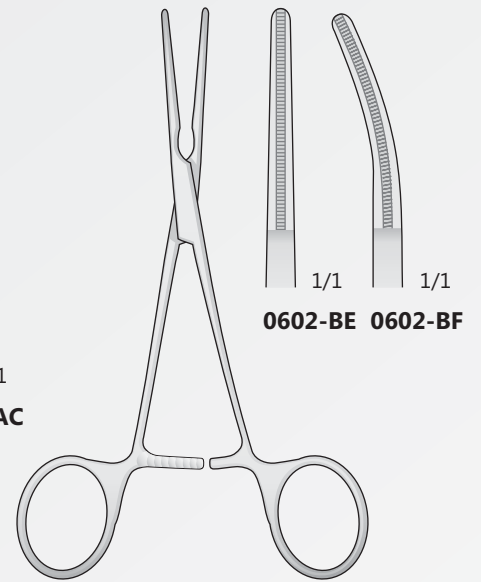

 De BAKEY - BAINBRIDGE  
**0602-BE/0602-BF**  
 155 mm

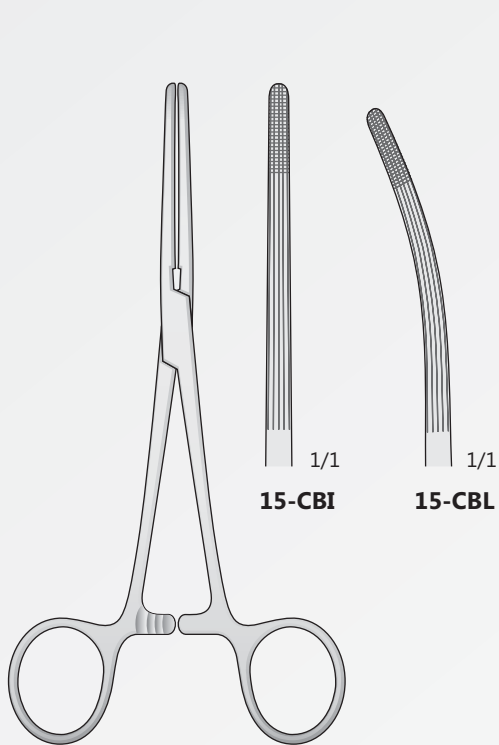

ROCHESTER-CARMALT  
**15-CBI/15-CBL**  
 160 mm

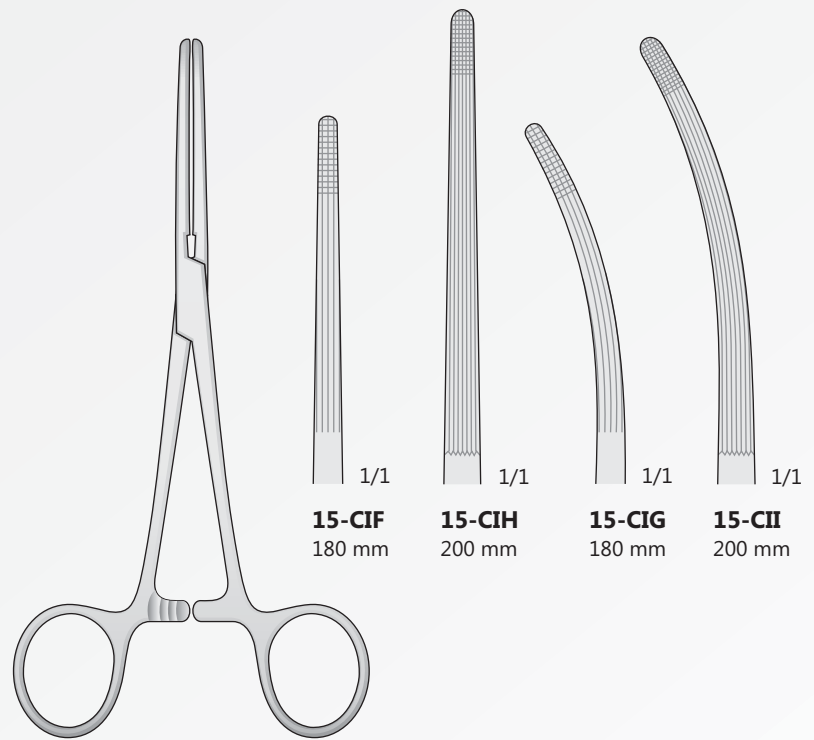

ROCHESTER-CARMALT  
**15-CIF/15-CII**

Darmklemmen Elastisch  
 Intestinal clamps soft elastic  
 Pinze intestinale elastiche  
 Pinzas intestinales  
 Pincas intestinales

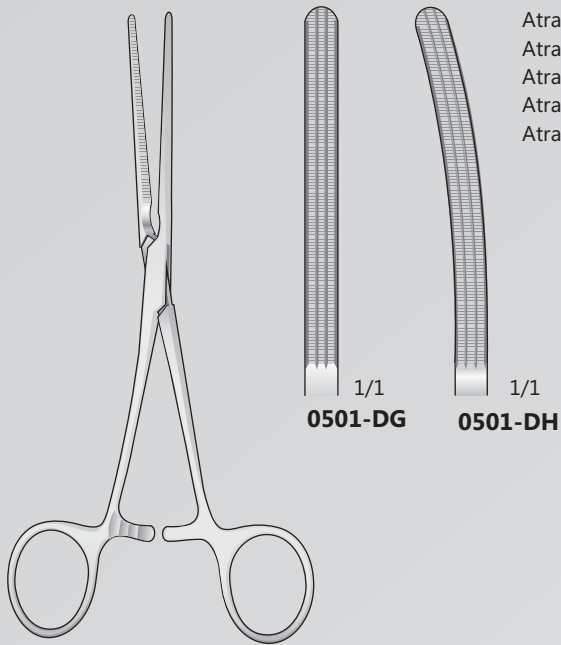

Atraumatische  
 Atraumatic  
 Atraumatische  
 Atraumàticas  
 Atraumatiques

DOYEN  
**0501-DG/0501-DH**  
 170 mm

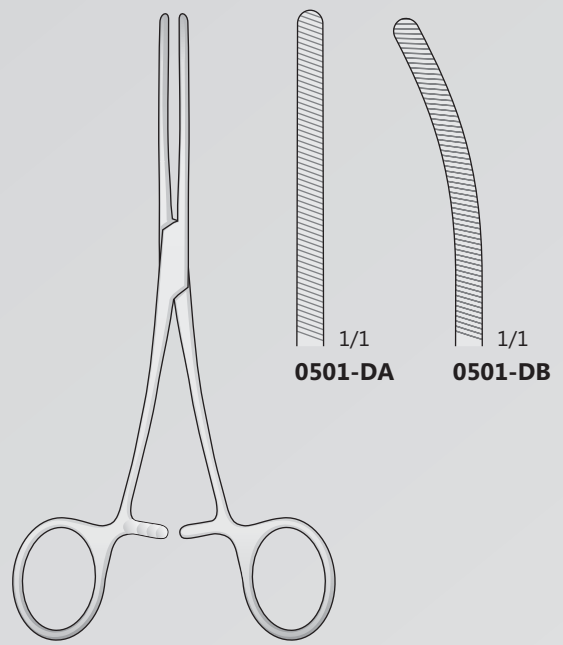

DOYEN  
**0501-DA/0501-DB**  
 170 mm

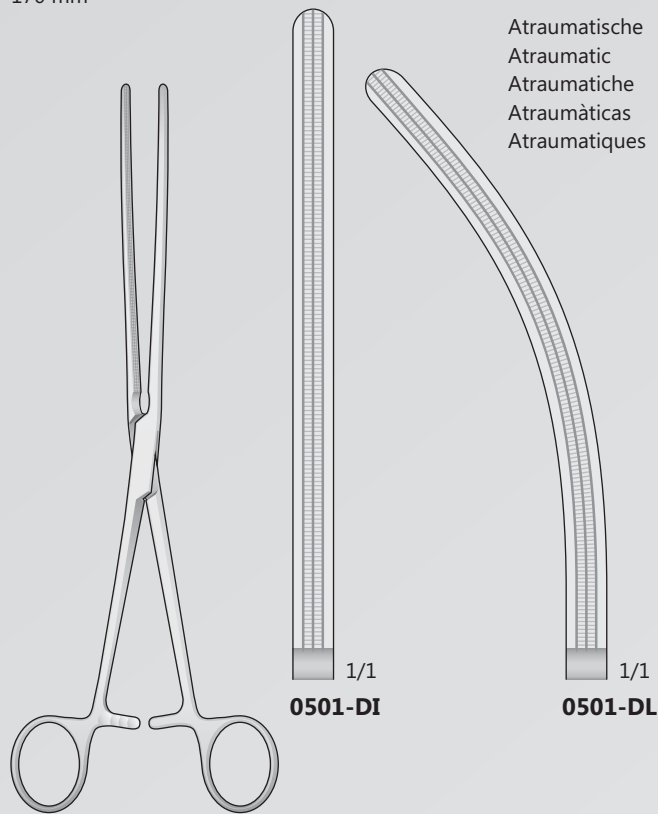

Atraumatische  
 Atraumatic  
 Atraumatische  
 Atraumàticas  
 Atraumatiques

DOYEN  
**0501-DI/0501-DL**  
 230 mm

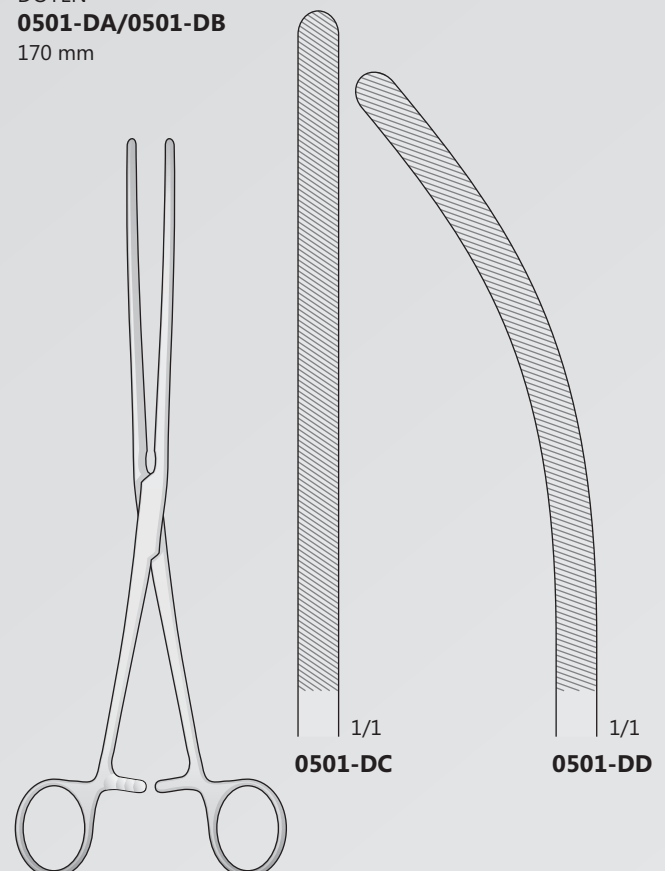

DOYEN  
**0501-DC/0501-DD**  
 230 mm



Darmklemmen Elastisch  
 Intestinal clamps soft elastic  
 Pinze intestinali elastiche  
 Pinzas intestinales  
 Pincas intestinales

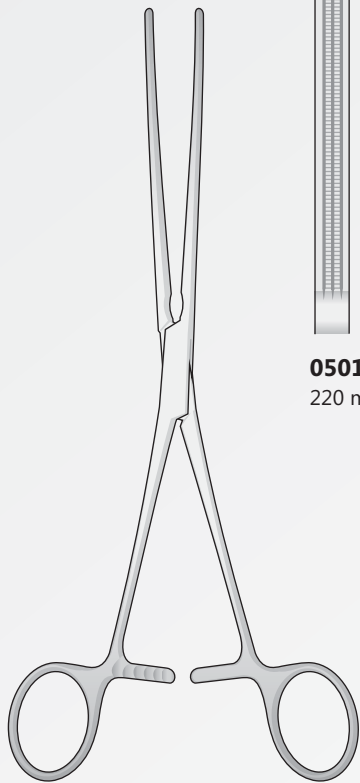
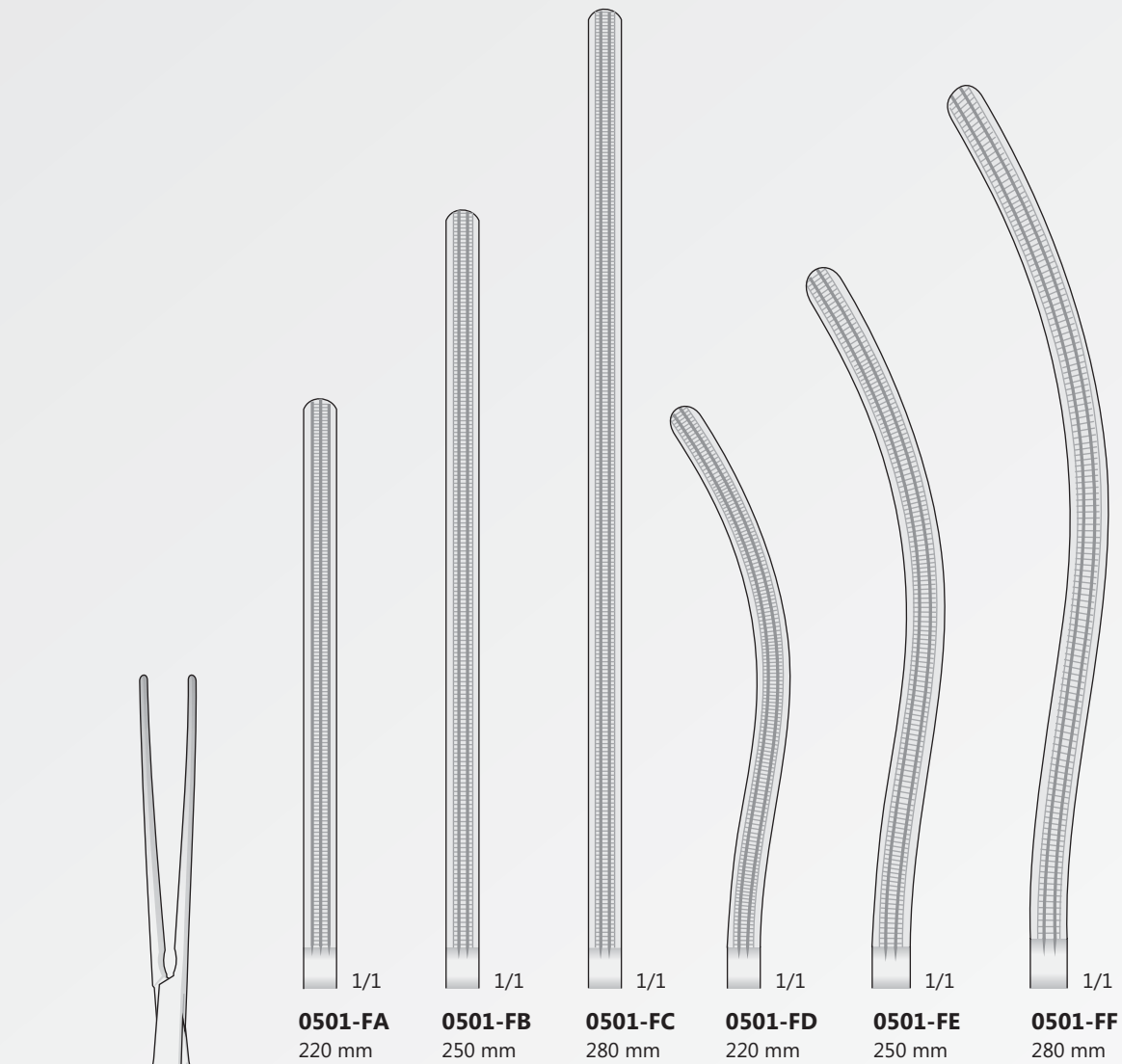

Atraumatische  
 Atraumatic  
 Atraumatiche  
 Atraumáticas  
 Atraumatiques



KOCHER  
**0501-FA/EA55**

Darmklemmen Elastisch  
Intestinal clamps soft elastic  
Pinze intestinali elastiche  
Pinzas intestinales  
Pincas intestinales

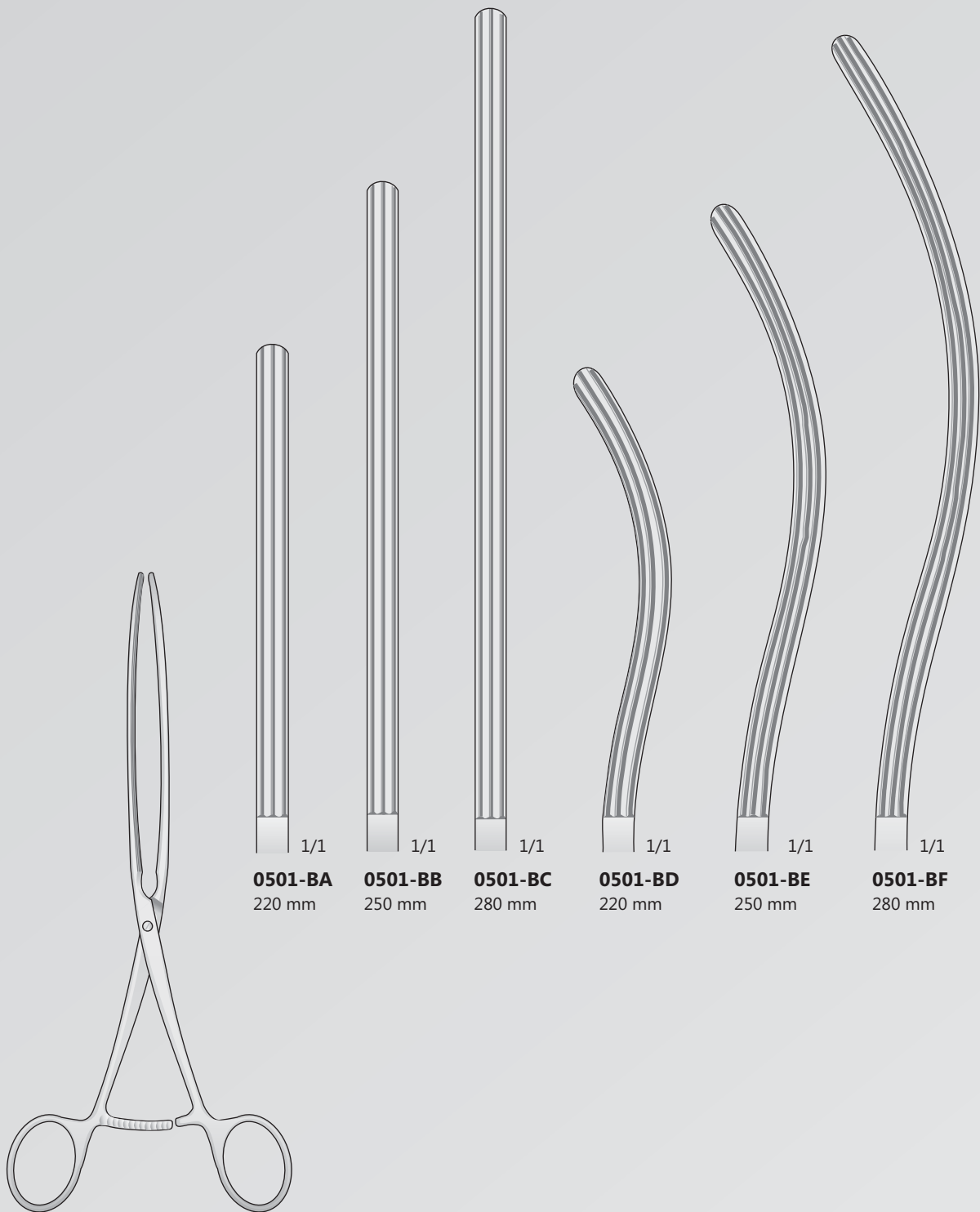

KOCHER  
0501-BA/0501-BF

Darmklemmen Elastisch  
 Intestinal clamps soft elastic  
 Pinze intestinali elastiche  
 Pinzas intestinales  
 Pincas intestinales

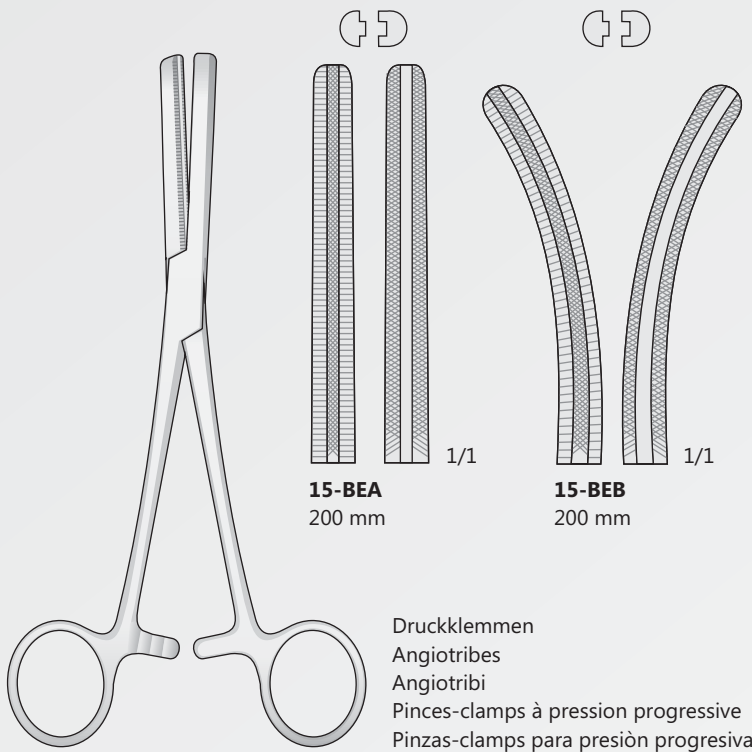

FERGUSSON  
**15-BEA/15-BEB**

Druckklemmen  
 Angiotribes  
 Angiotribi  
 Pincas-clamps à pression progressive  
 Pinzas-clamps para presión progresiva

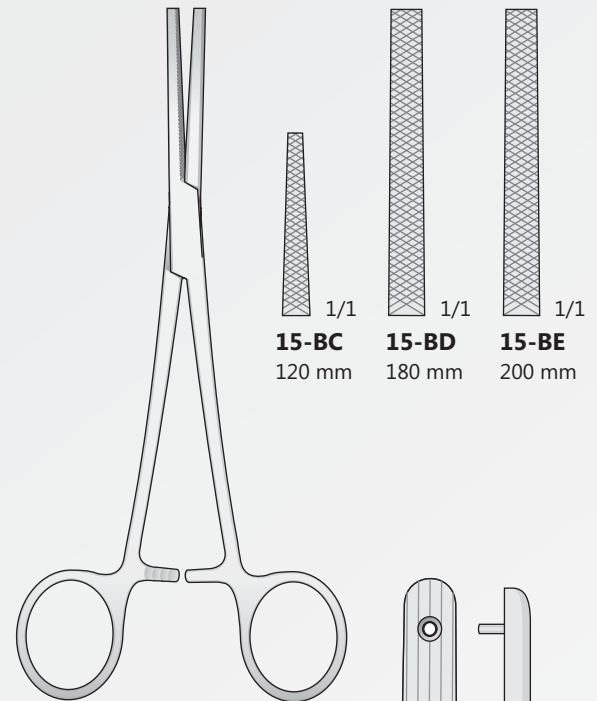

**15-BC/15-BE**

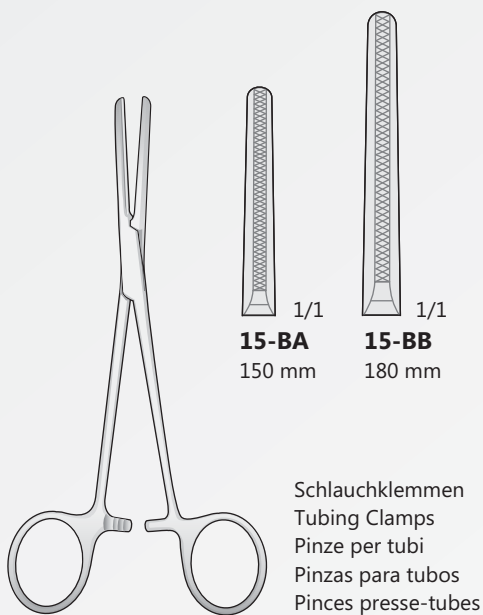

**15-BA/15-BB**

Schlauchklemmen  
 Tubing Clamps  
 Pinzas per tubi  
 Pincas para tubos  
 Pincas presse-tubes

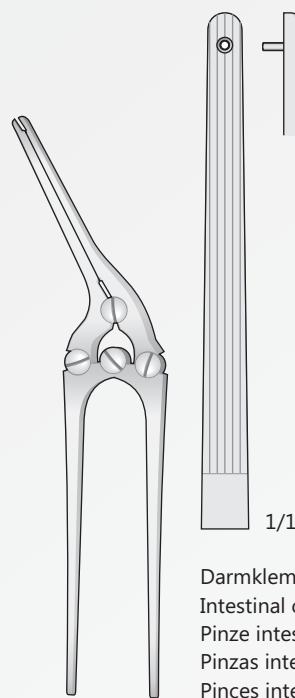

PAYR  
**0501-CA**  
 200 mm

Darmklemmen Elastisch  
 Intestinal clamps soft elastic  
 Pinze intestinali elastiche  
 Pinzas intestinales  
 Pincas intestinales

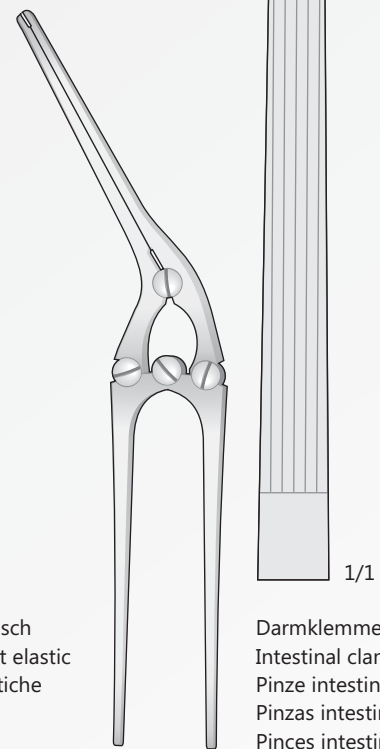

PAYR  
**0501-CB**  
 280 mm

Darmklemmen Elastisch  
 Intestinal clamps soft elastic  
 Pinze intestinali elastiche  
 Pinzas intestinales  
 Pincas intestinales

Atraumatische Gefäßklemmen  
 Atraumatic vessel clamps  
 Pinze atraumatiche  
 Pinzas vasculares atraumáticas  
 Pincas vasculaires atrauma

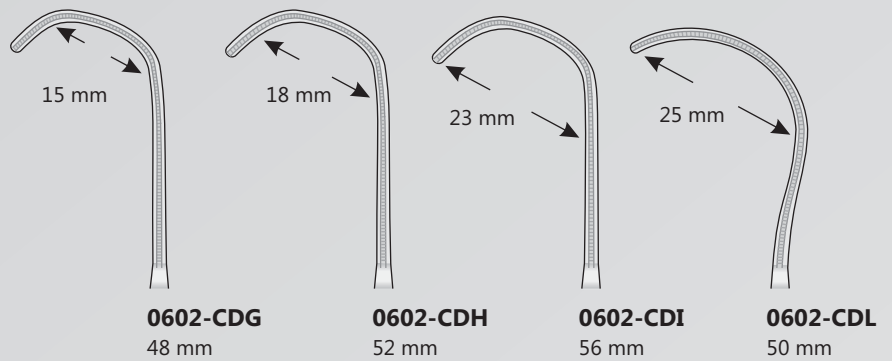
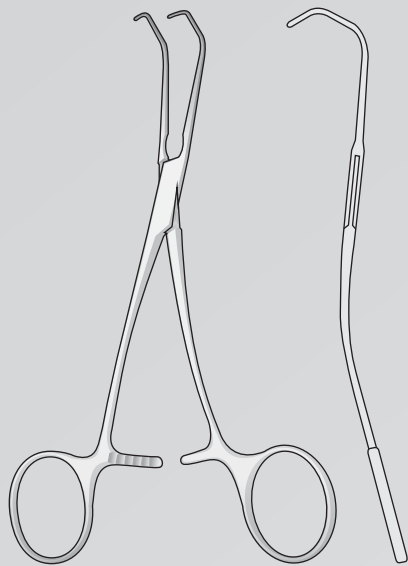

Atraumatische  
 Atraumatic  
 Atraumatiche  
 Atraumáticas  
 Atraumatiques



**CASTANEDA**  
**0602-CDG/0602-CDL**  
 155 mm

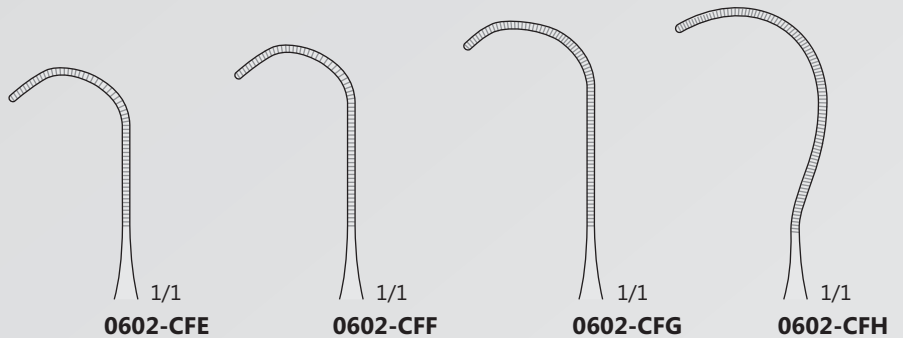
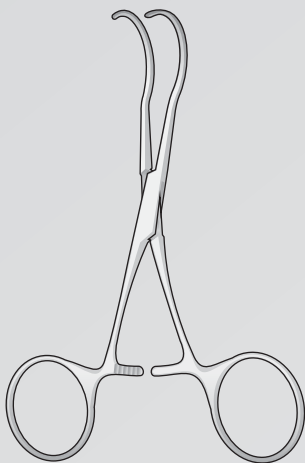
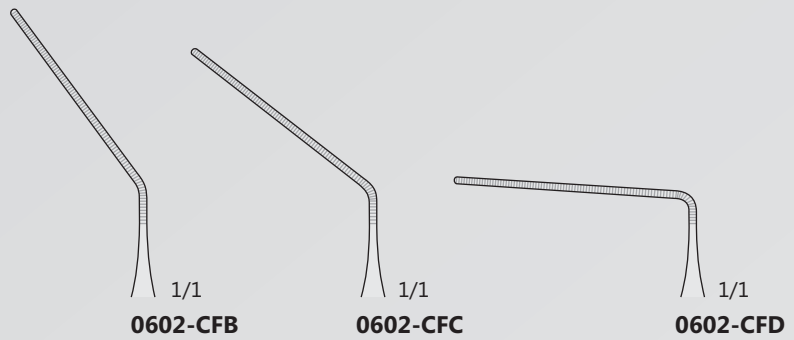

**CASTANEDA**  
**0602-CFB/FD-257**  
 120 mm



Atraumatische Gefäßklemmen  
 Atraumatic vessel clamps  
 Pinze vascolari atraumatiche  
 Pinzas vasculares atraumáticas  
 Pincas hémostatiques atraumatiques

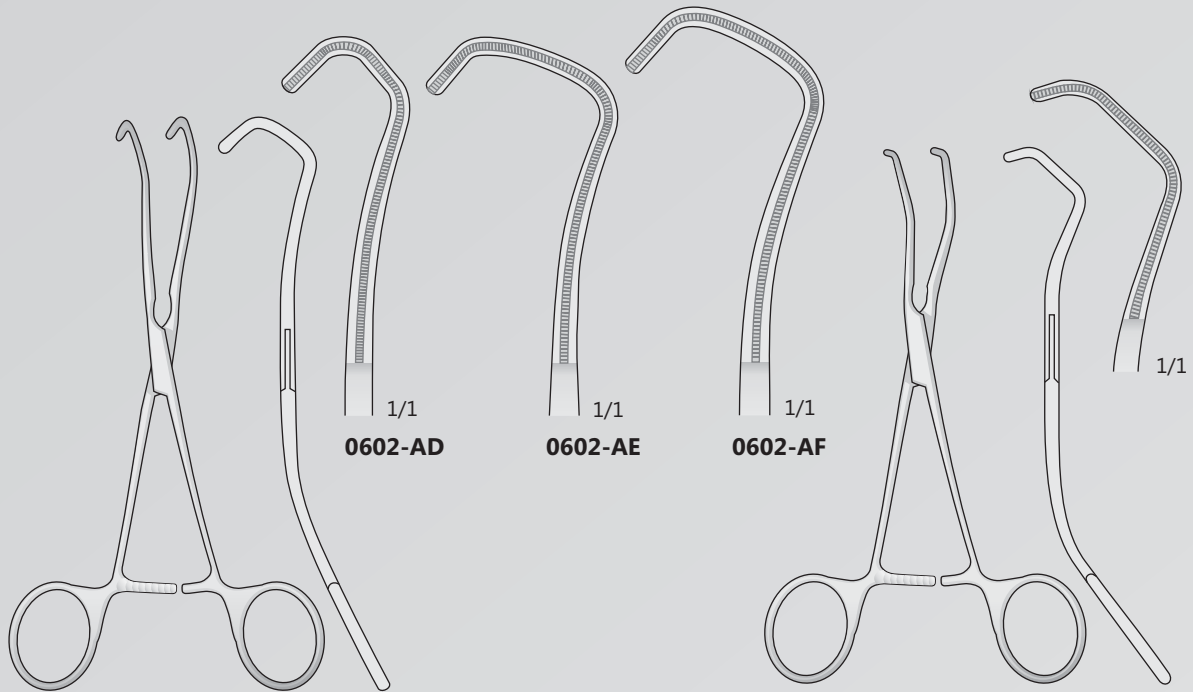

DERRA  
**0602-AD/0602-AE**  
 170 mm



COOLEY  
**0602-BG**  
 160 mm

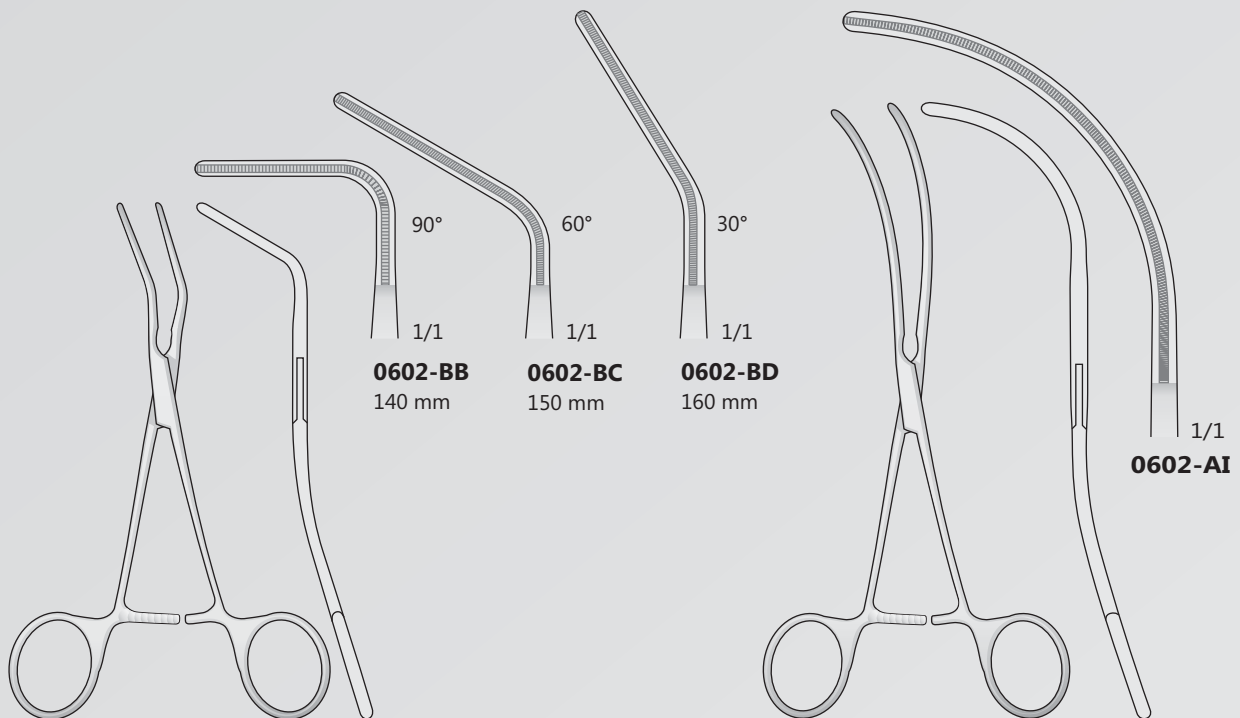

COOLEY  
**0602-BB/0602-BD**



DE BAKEY  
**0602-AI**  
 180 mm

Atraumatische Gefäßklemmen  
 Atraumatic vessel clamps  
 Pinze vascolari atraumatiche  
 Pinzas vasculares atraumáticas  
 Pincas hémostatiques atraumatiques

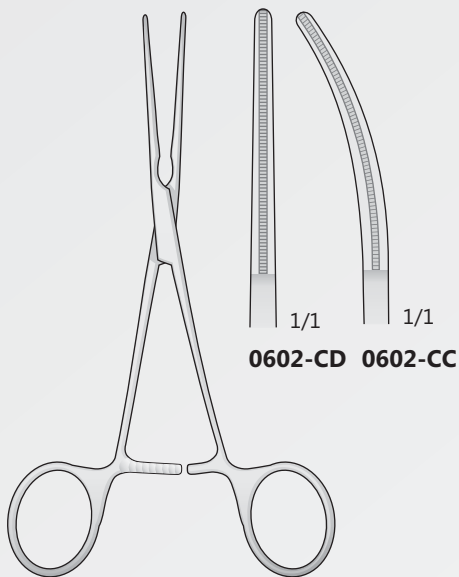

De BAKEY  
**0602-CC/0602-CD**  
 165 mm

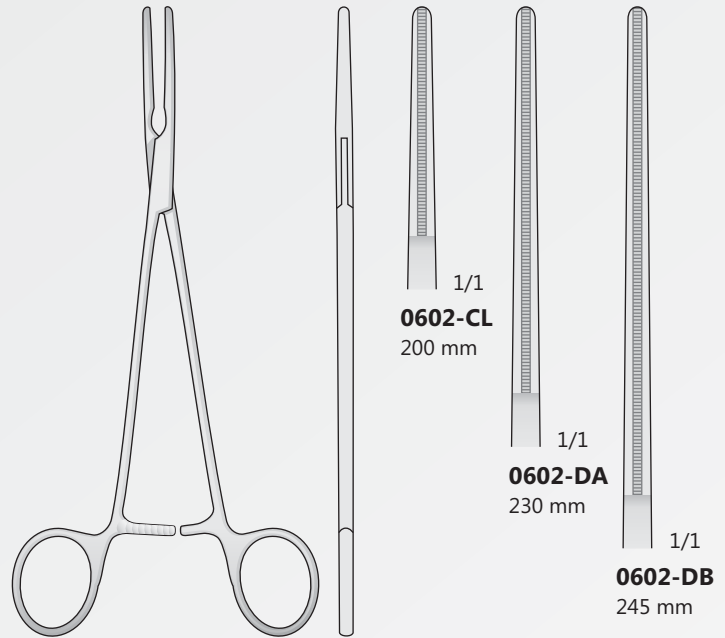

De BAKEY  
**0602-CL/0602-DB**

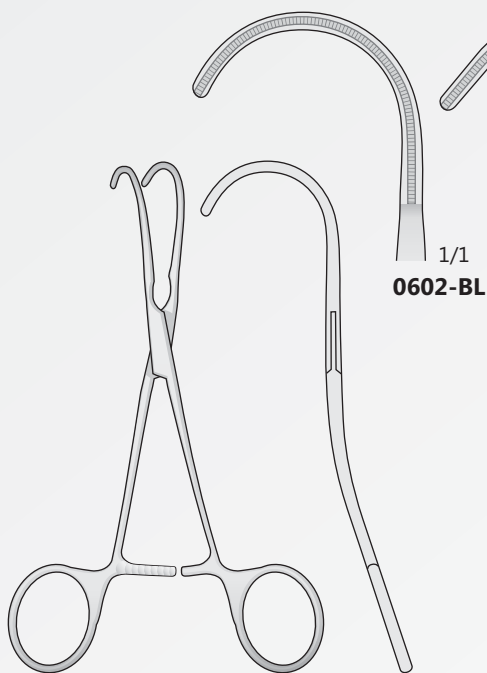

De BAKEY  
**0602-BL/0602-CA**  
 150 mm

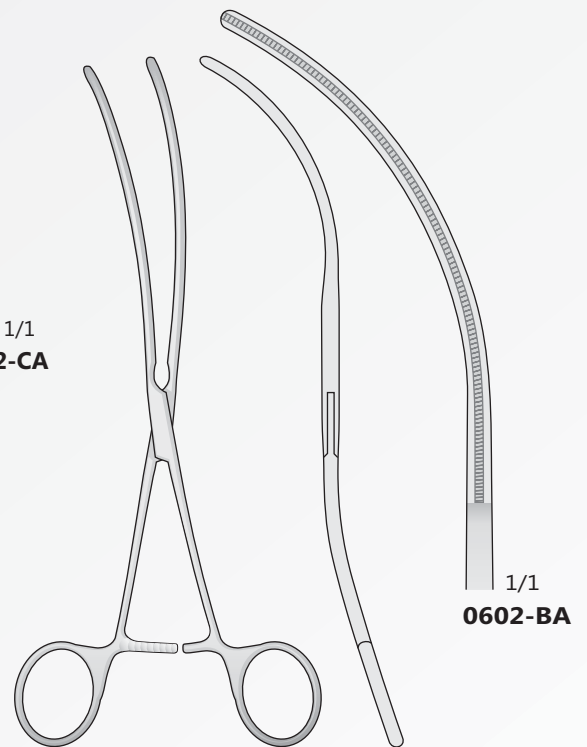

De BAKEY  
**0602-BA**  
 200 mm

Atraumatische Gefäßklemmen  
 Atraumatic vessel clamps  
 Pinze vascolari atraumatiche  
 Pinzas vasculares atraumáticas  
 Pincas hémostatiques atraumatiques

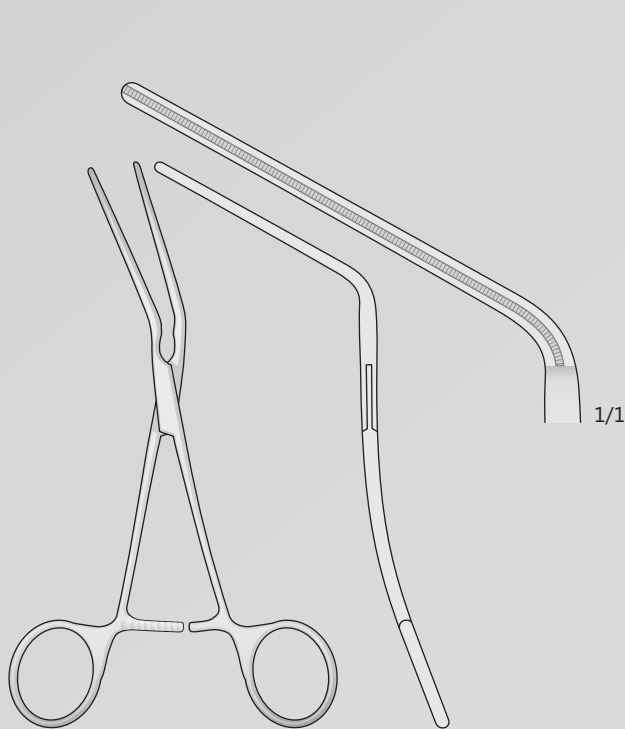

De BAKEY  
**0602-CB**  
 165 mm

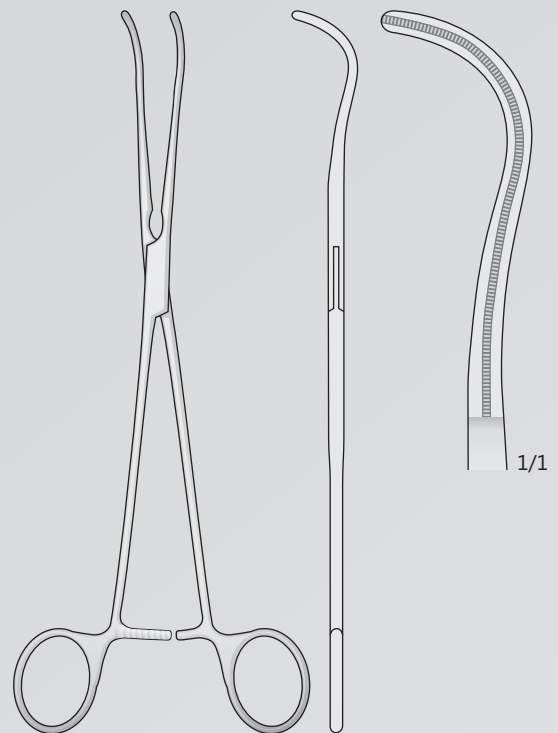

De BAKEY  
**0602-DH**  
 230 mm

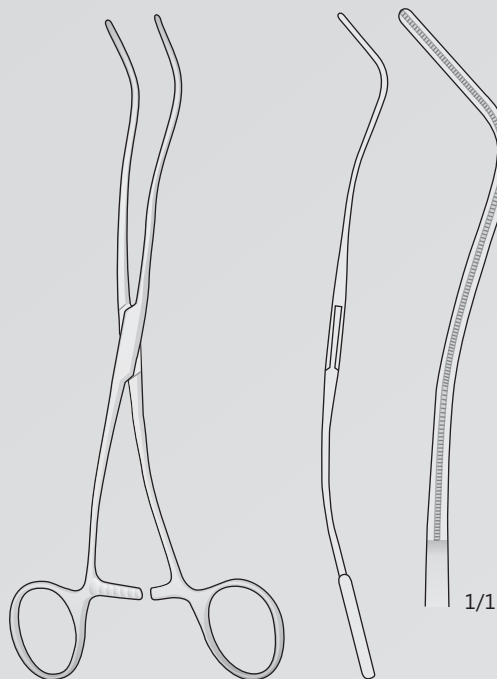

De BAKEY  
**0602-BH**  
 200 mm

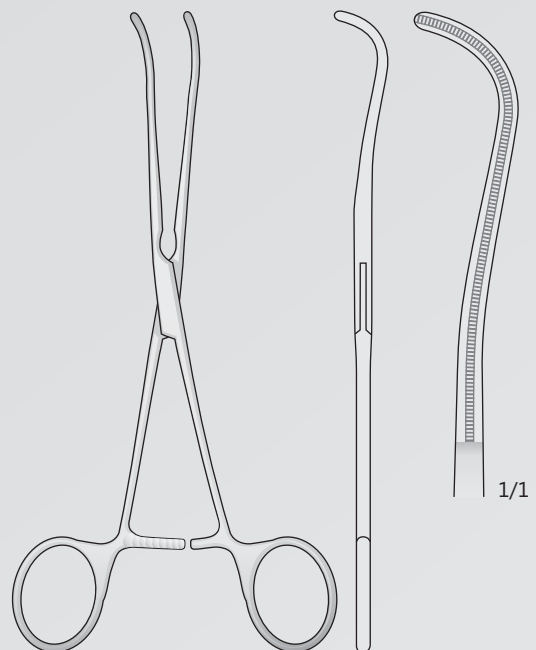

De BAKEY  
**0602-BI**  
 190 mm



Gewebe und organ Fasszangen  
 Gum and tissue forceps  
 Pinze per afferrare i tessuti  
 Pinzas para coger las encias  
 Pincas pour saisir les tissue

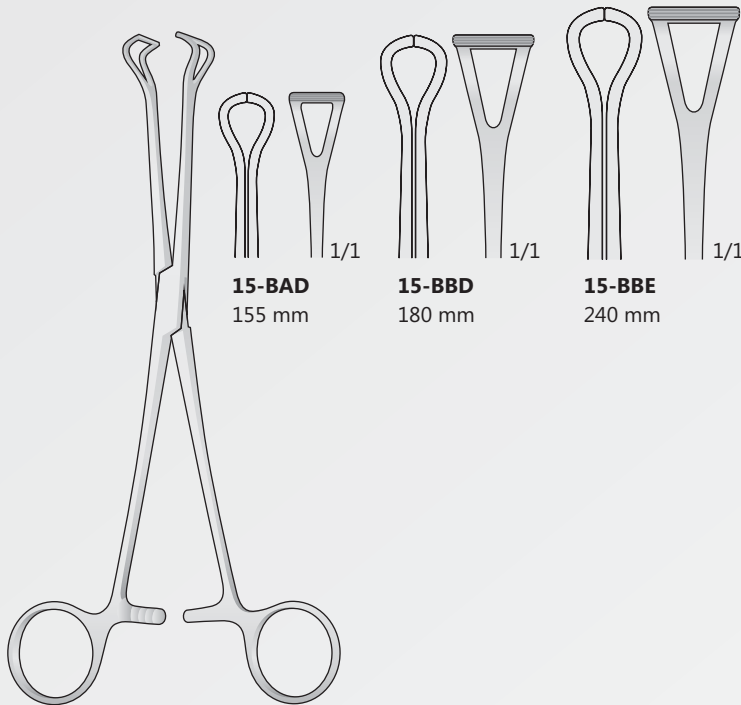

**15-BAD**  
155 mm

**15-BBD**  
180 mm

**15-BBE**  
240 mm

BABCOCK  
**15-BAD/15-BBE**

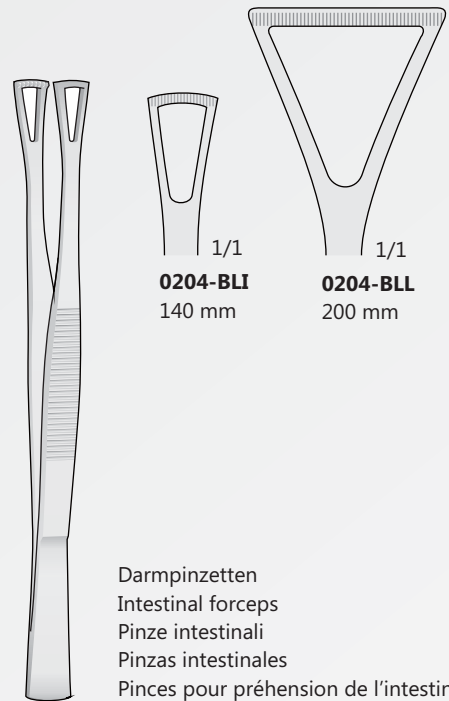

**0204-BLI**  
140 mm

**0204-BLL**  
200 mm

Darmpinzetten  
 Intestinal forceps  
 Pinze intestinali  
 Pinzas intestinales  
 Pincas pour préhension de l'intestin

DUVAL  
**0204-BLI/0204-BLL**

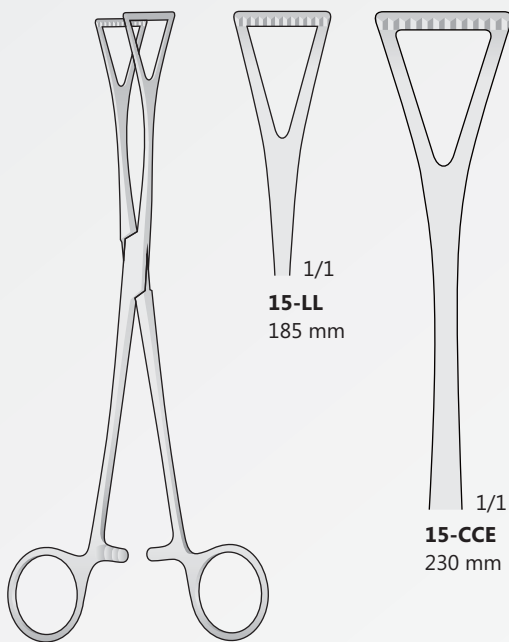

**15-LL**  
185 mm

**15-CCE**  
230 mm

DUVAL  
**15-LL/15-CCE**

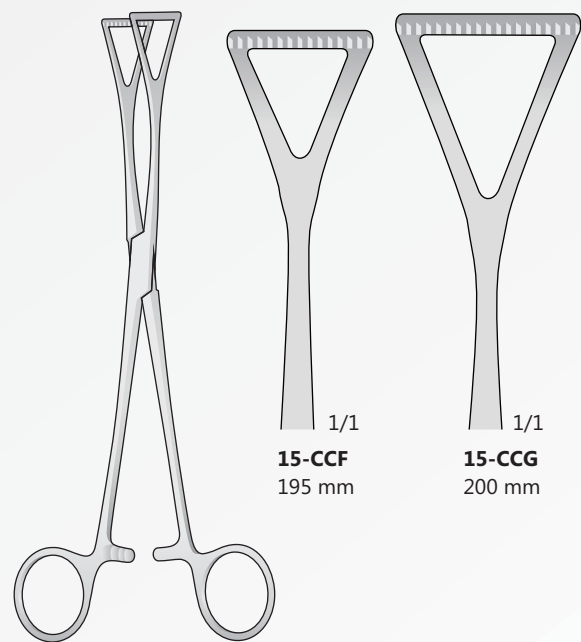

**15-CCF**  
195 mm

**15-CCG**  
200 mm

DUVAL-COLLIN  
**15-CCF/15-CCG**





 ideal-tek

Nahtinstrumente  
Suture Instruments  
Strumenti per sutura  
Instrumentos para sutura  
Instruments à suture



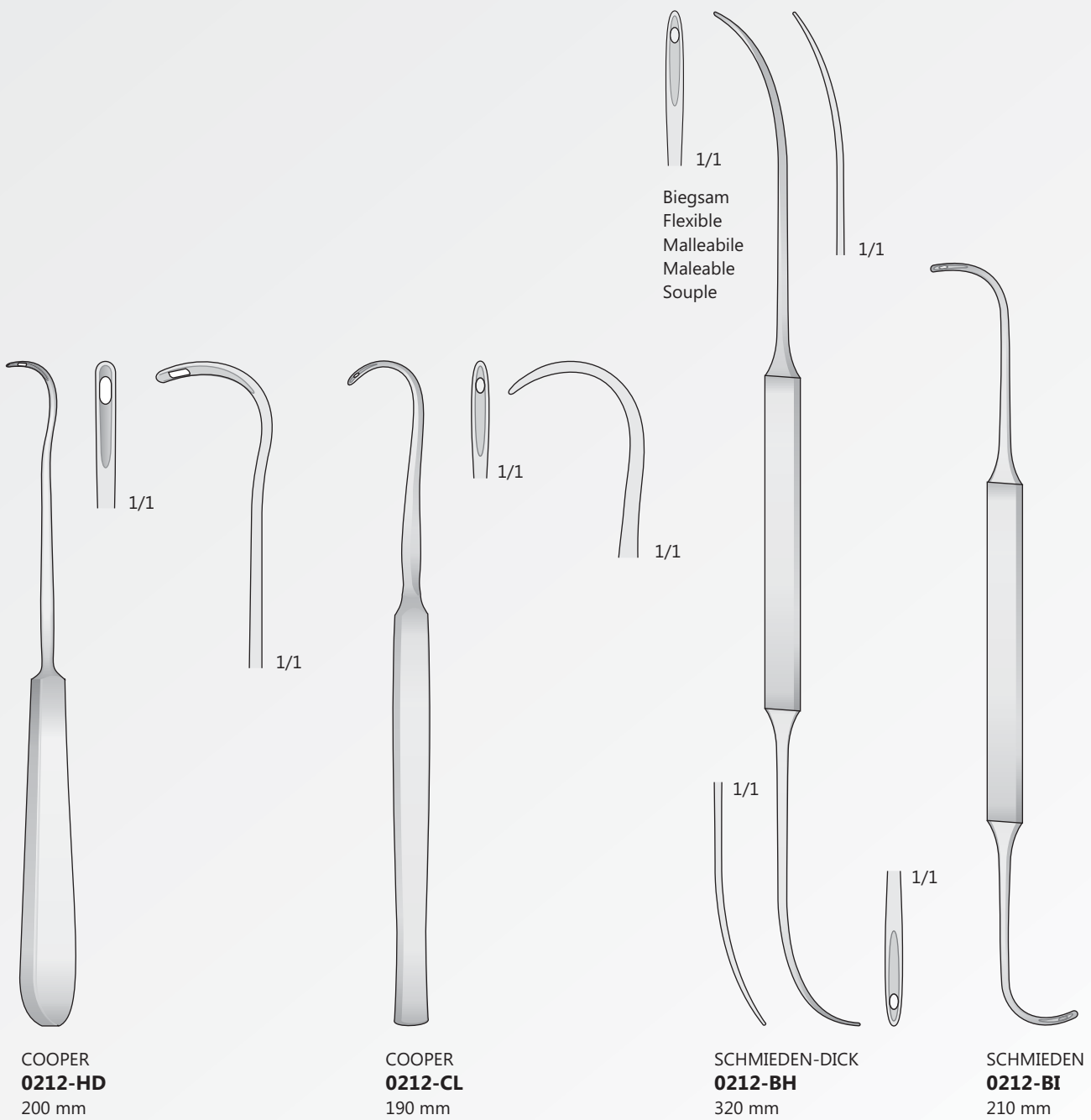

Unterbindungsnadeln  
 Ligature needles  
 Aghi per legature  
 Aguja para ligaduras  
 Aiguilles à ligatures

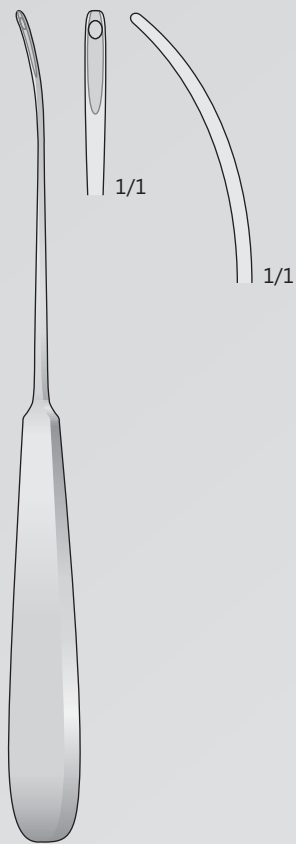

**0212-CI**  
200 mm

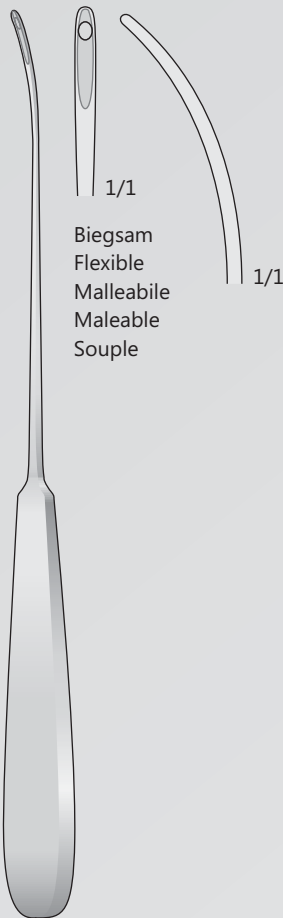

**0212-HE**  
230 mm

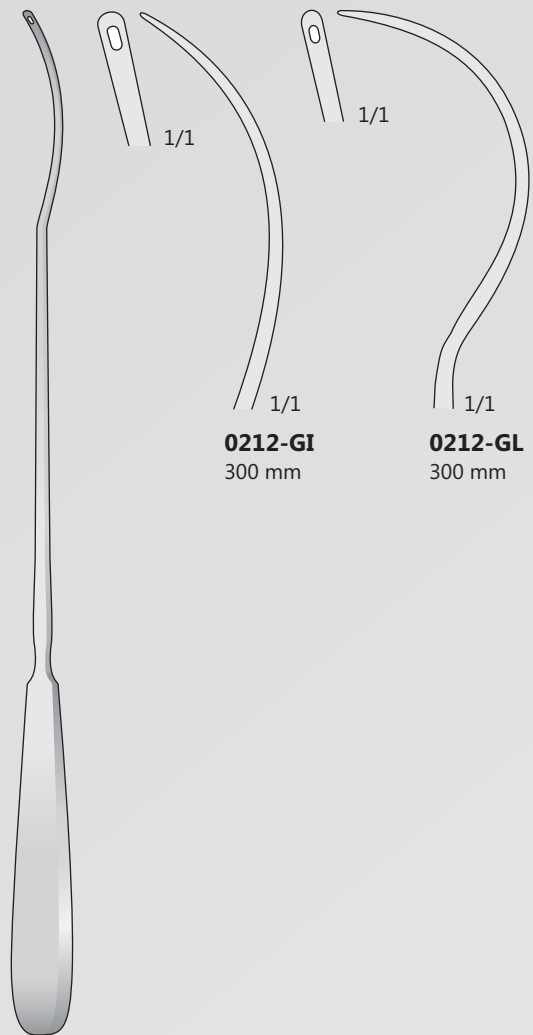

BRUNNER  
**0212-GI/0212-GL**  
 300 mm

**0212-GI**  
300 mm

**0212-GL**  
300 mm

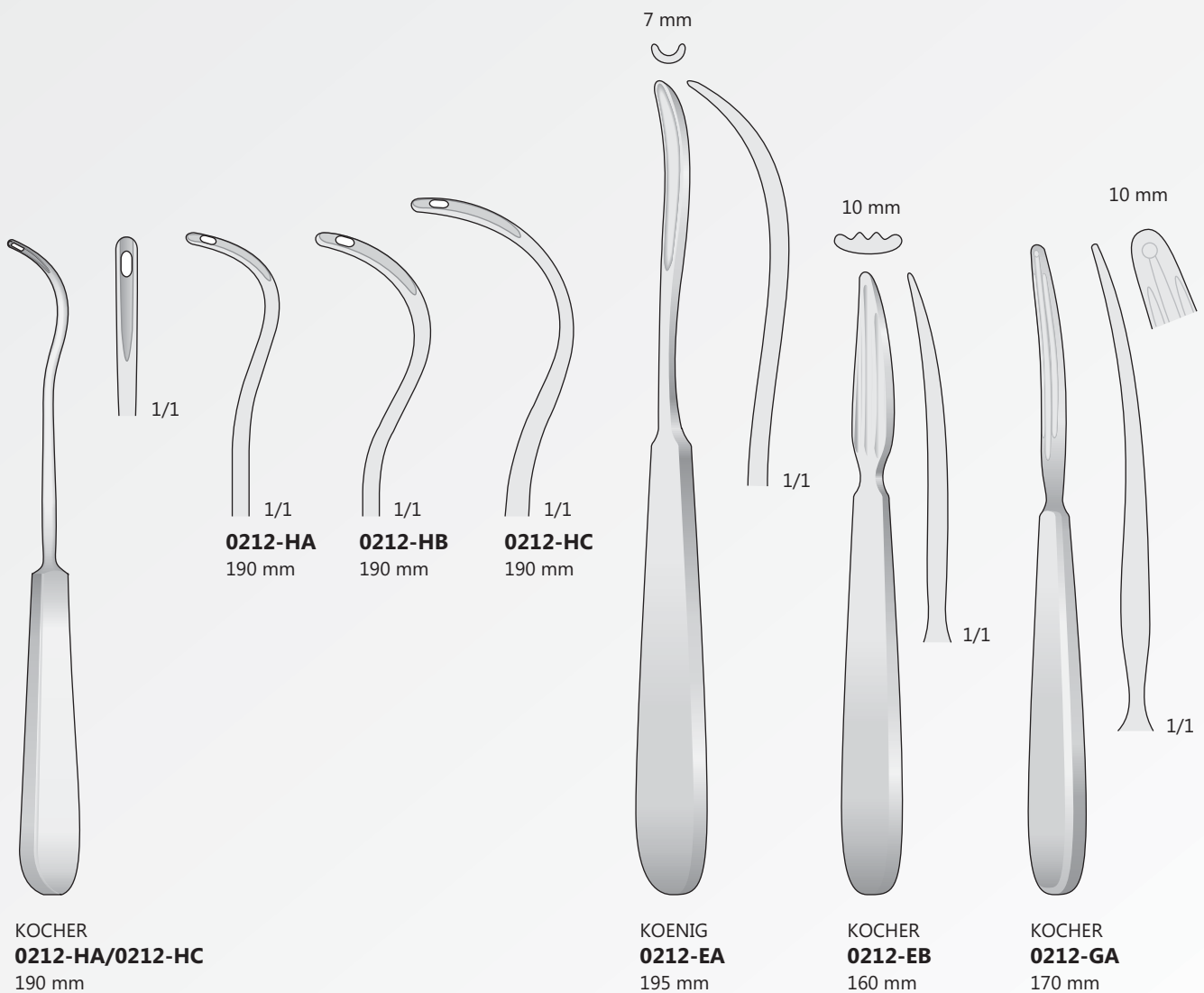

Unterbindungsadeln  
 Ligature needles  
 Aghi per legature  
 Agujas para ligaduras  
 Aiguilles à ligatures

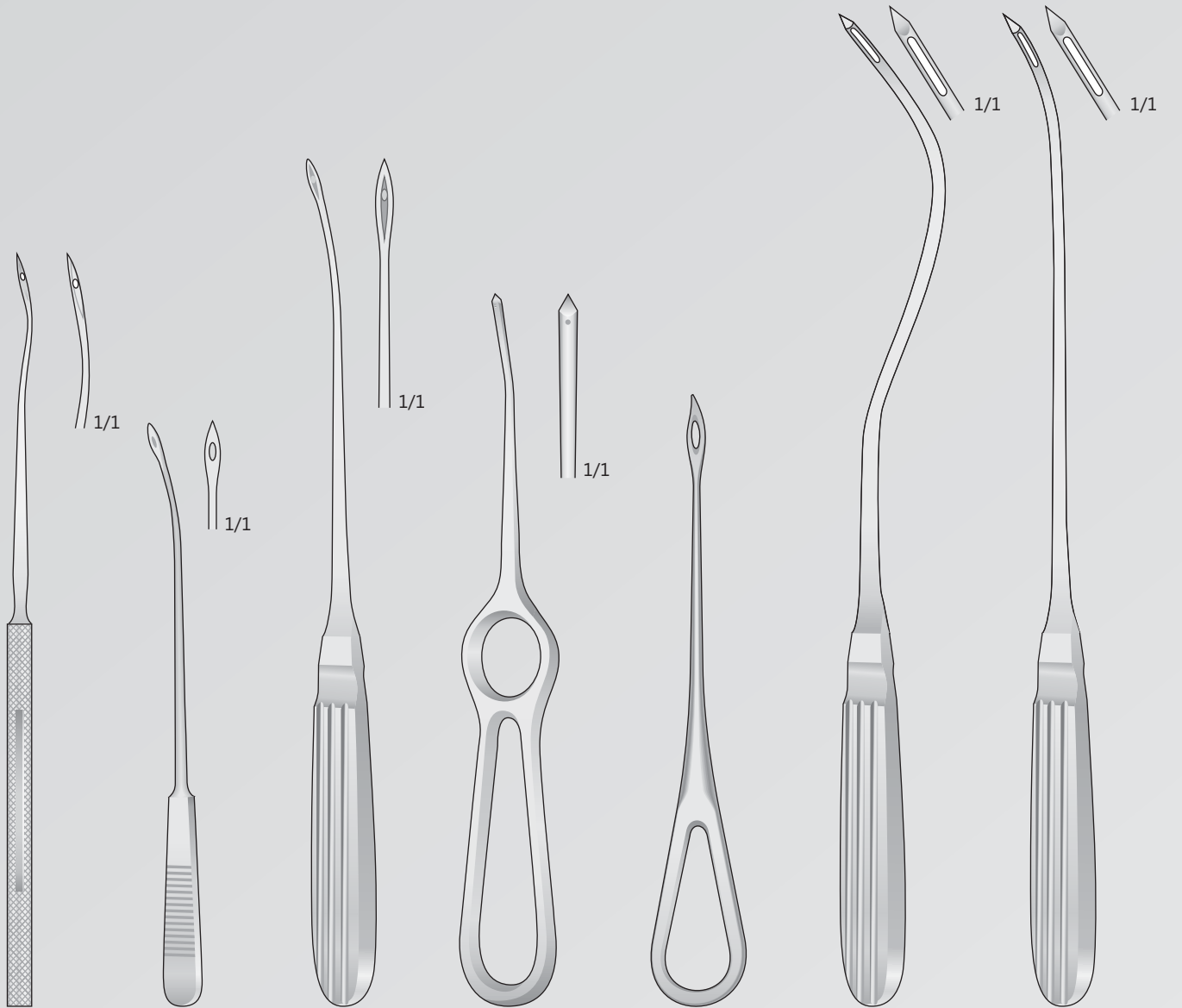

YANKAUER  
**0212-BFB**  
 170 mm

OBWEGESER  
**0414-DA**  
 140 mm

OBWEGESER  
**0414-DB**  
 230 mm

**0414-DC**  
 180 mm

GERLACH  
**0414-DD**  
 150 mm

SANDERS-BROWN  
**0414-EE**  
 290 mm

SANDERS-BROWN  
**0414-EL**  
 300 mm



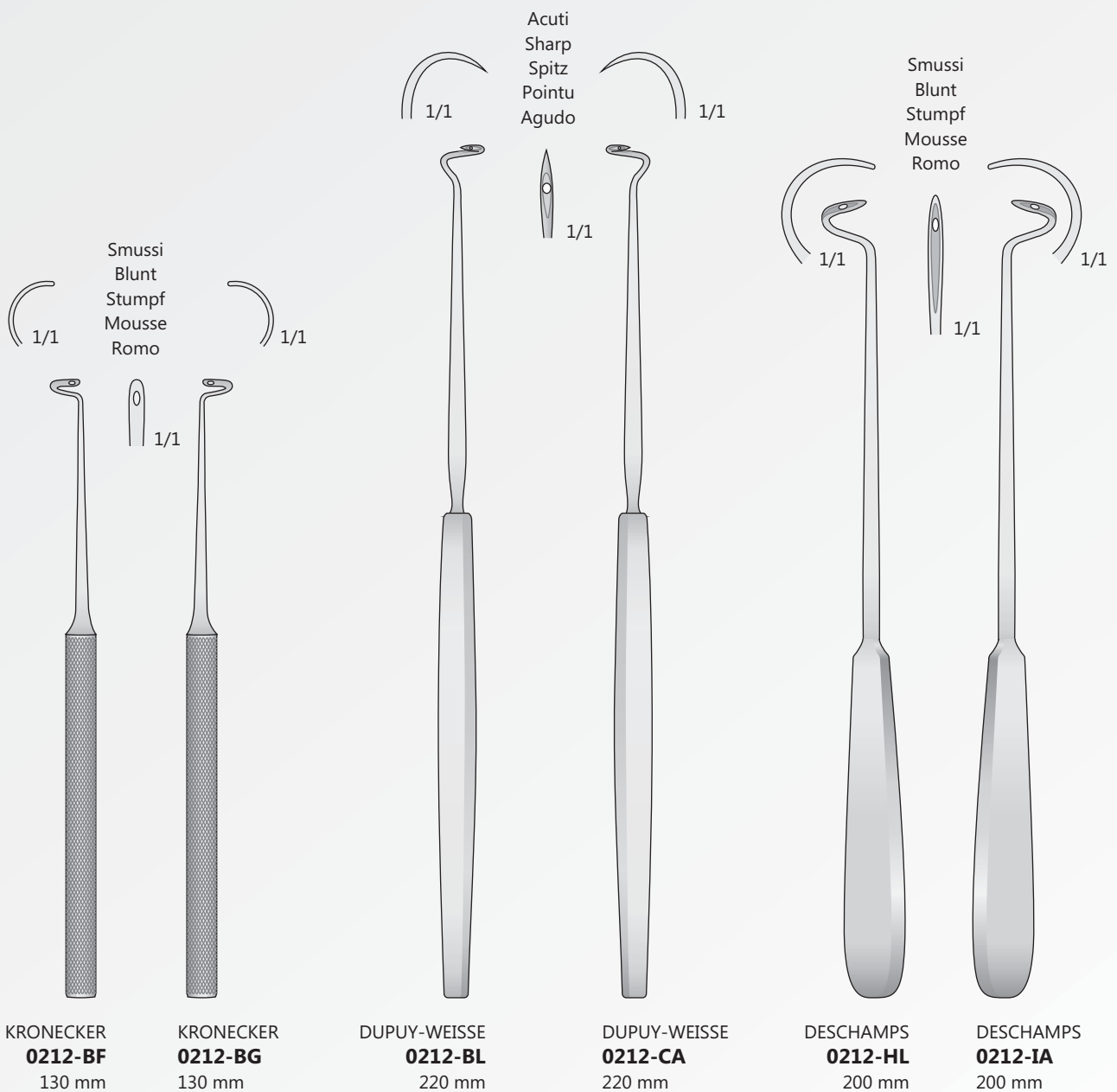

Unterbindungsnadeln  
 Ligature needles  
 Aghi per legature  
 Aguja para ligaduras  
 Aiguilles à ligatures

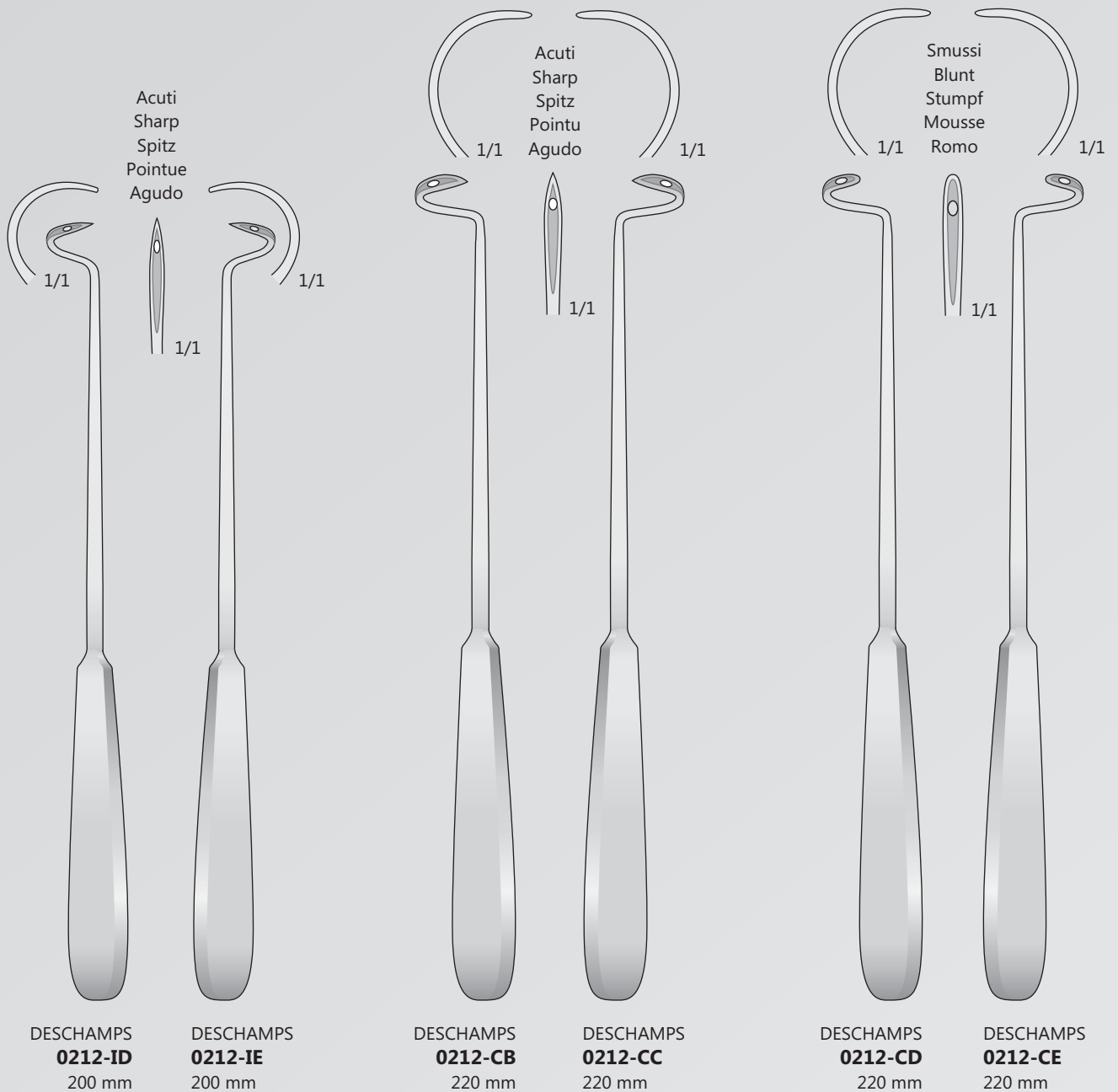

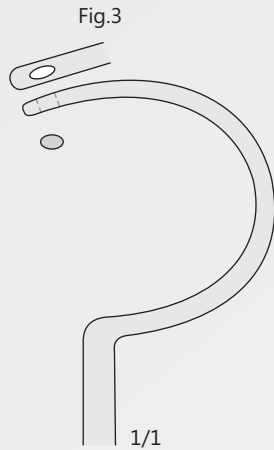

**0212-BC**  
275 mm

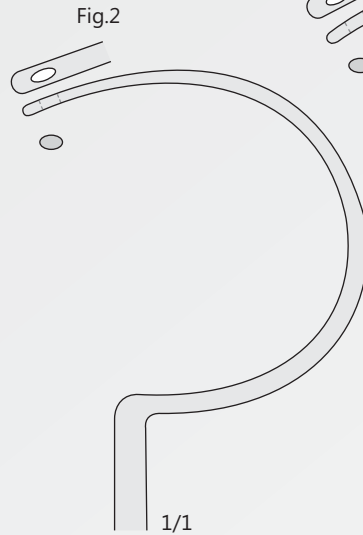

**0212-BD**  
285 mm

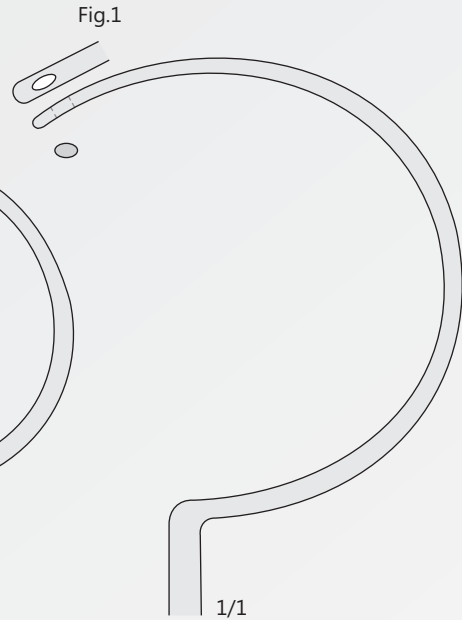

**0212-BE**  
295 mm

DEMEL  
**0212-BC/0212-BE**

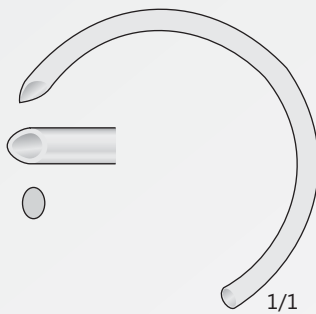
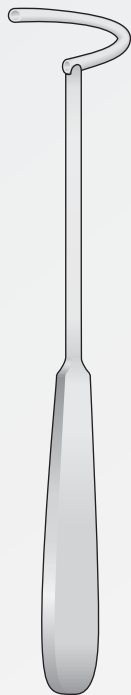

**0212-BA**  
225 mm

Hohl, Spitz  
Hollow, Sharp  
Cavo, Acuto  
Hueco, Agudo  
Creux, Pointu

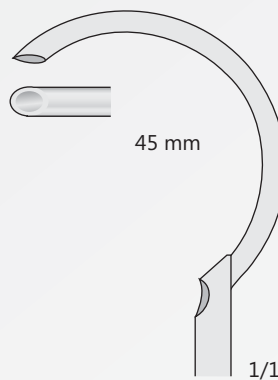

**0212-BB**  
240 mm

Hohl, Spitz  
Hollow, Sharp  
Cavo, Acuto  
Hueco, Agudo  
Creux, Pointu

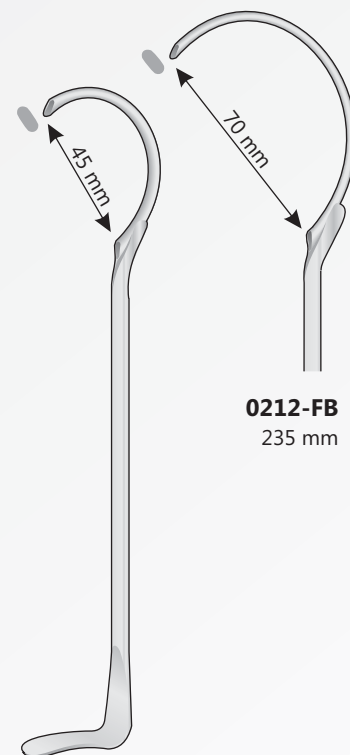

**0212-FB**  
235 mm

**0212-BA**  
225 mm

**0212-FA**  
185 mm

Nadelhalter	Nadelhalter mit Hartmetalleinlagen
Needle Holders	Needle Holders with tungsten-carbide inserts
Port'aghi	Portaghi con inserti al tungsteno
Portaagujas	Portaagujas con plaquitas de carburo de tungsteno
Porte aiguilles	Porte aiguilles avec plaquettes en carbure de tungstène

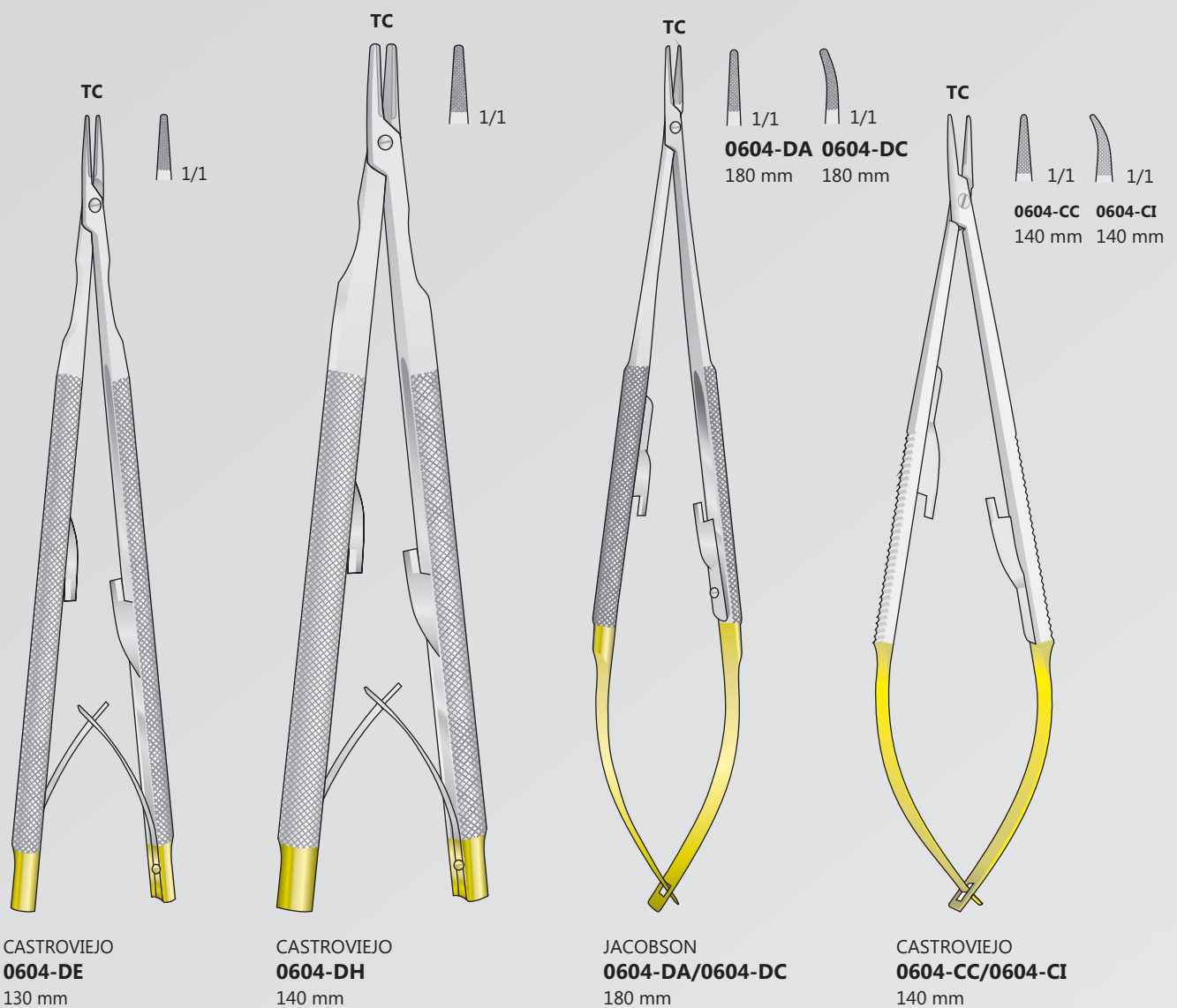

Nadelhalter mit Hartmetalleinlagen  
 Needle Holders with tungsten-carbide inserts  
 Portaghi con inserti al tungsteno  
 Portaagujas con plaquitas de carburo de tungsteno  
 Porte aiguilles avec plaquettes en carbure de tungstène

Nadelhalter  
 Needle Holders  
 Port'aghi  
 Portaagujas  
 Porte aiguilles

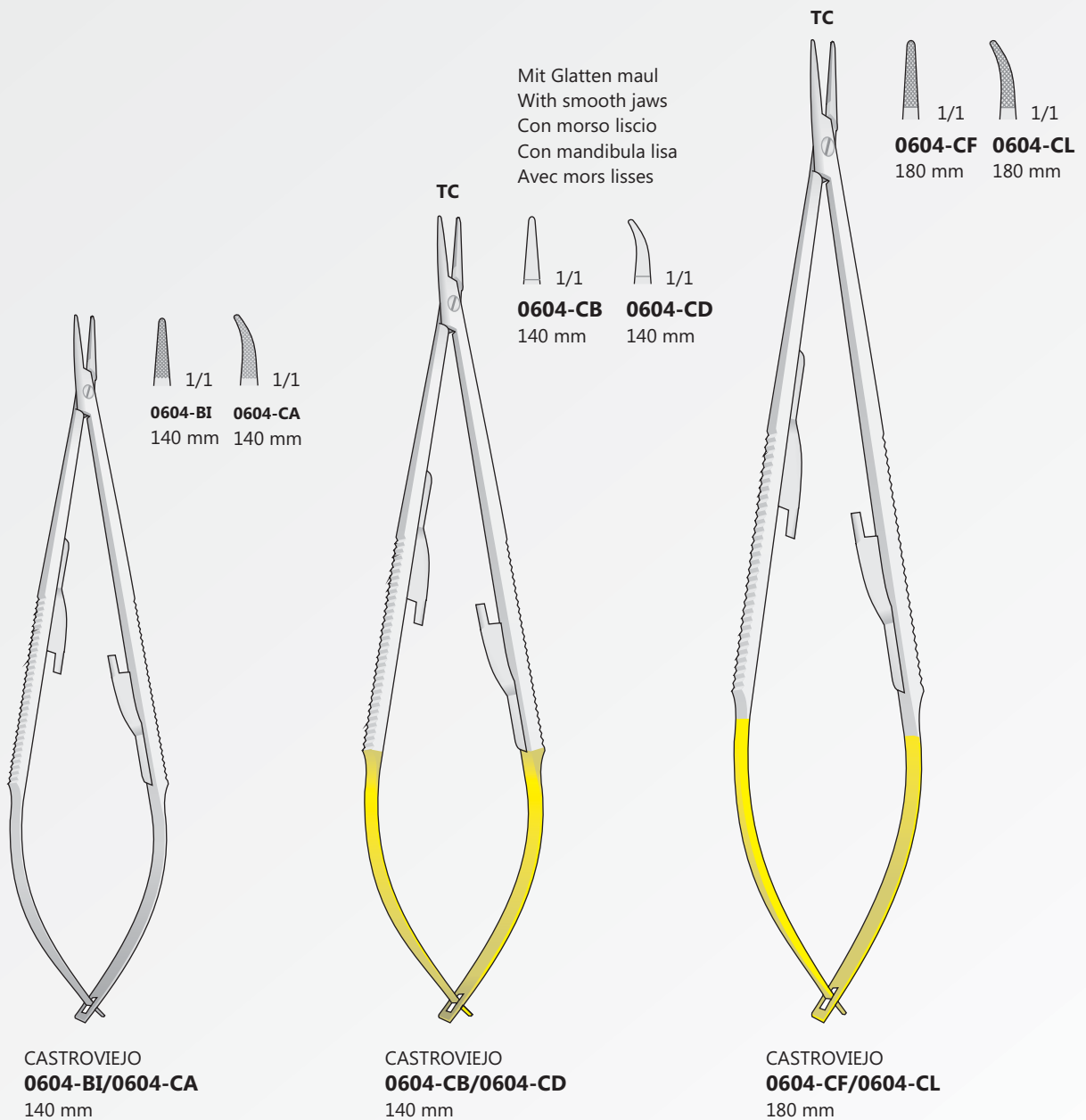

Nadelhalter      Nadelhalter mit Hartmetalleinlagen  
 Needle Holders      Needle Holders with tungsten-carbide inserts  
 Port'aghi      Portaghi con inserti al tungsteno  
 Portaaguja      Portaaguja con plaquitas de carburo de tungsteno  
 Porte aiguilles      Porte aiguilles avec plaquettes en carbure de tungstène

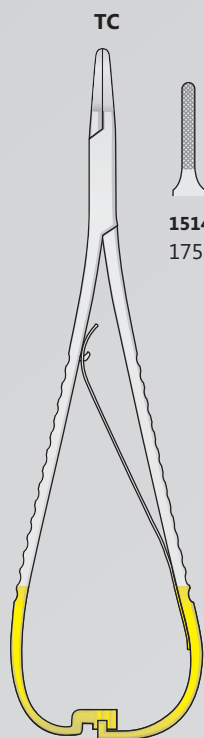

LICHTENBERG  
**1514-IG/1514-LG**

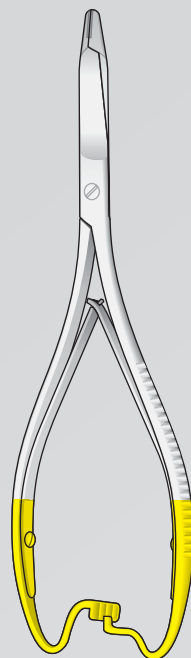
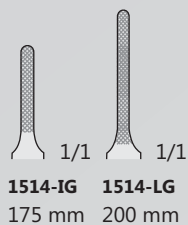

OLSEN-MATHIEU  
**1514-LF/1514-BAA**

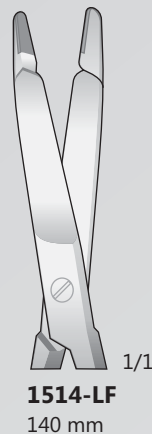

**1514-LF**  
 140 mm

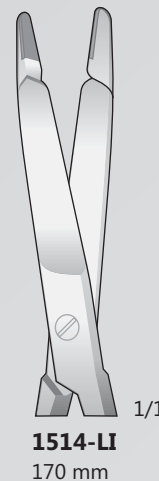

**1514-LI**  
 170 mm

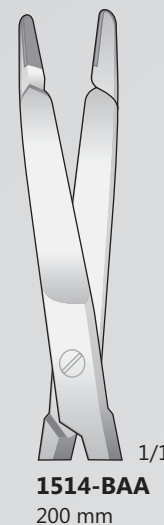

**1514-BAA**  
 200 mm

Mit Schere  
 With Scissors  
 Con Forbice  
 Con Tijeras  
 Avec Ciseaux

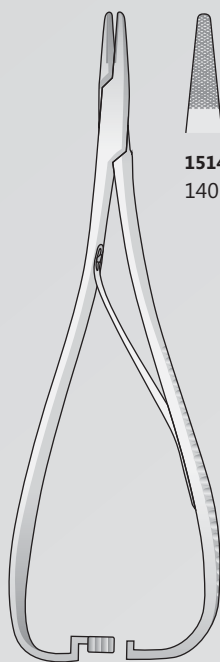

MATHIEU  
**1514-EG/1514-EI**

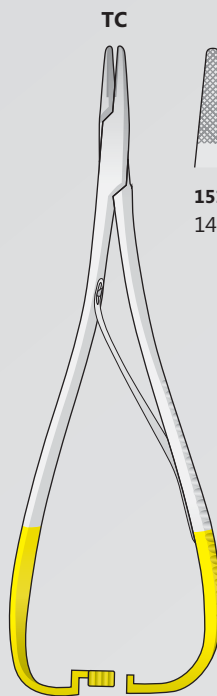
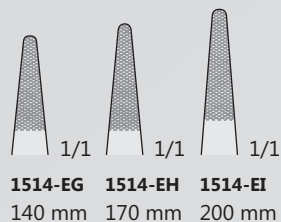

MATHIEU  
**1514-FA/1514-FC**

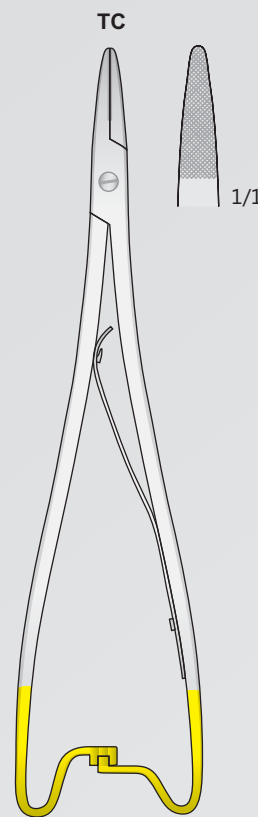
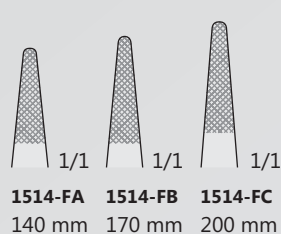

MATHIEU  
**1514-GG**  
 200 mm

Nadelhalter mit Hartmetalleinlagen  
 Needle Holders with tungsten-carbide inserts  
 Portaghi con inserti al tungsteno  
 Portaaguja con plaquitas de carburo de tungsteno  
 Porte aiguilles avec plaquettes en carbure de tungstène

Nadelhalter  
 Needle Holders  
 Port'aghi  
 Portaaguja  
 Porte aiguilles

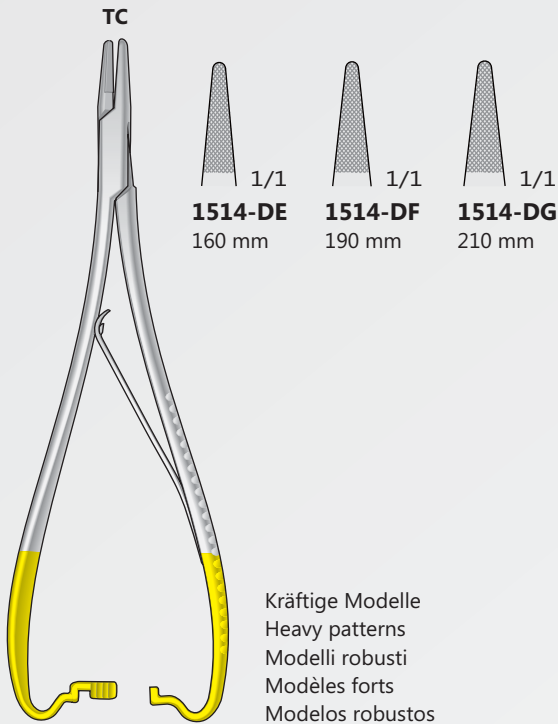

MATHIEU  
**1514-DE/1514-DG**

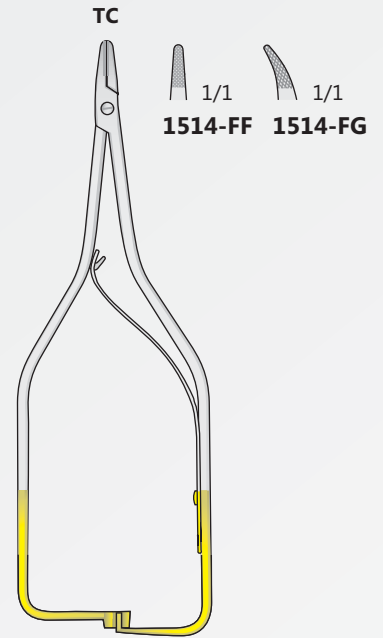

BOYNTON  
**1514-FF/1514-FG**  
 120 mm



MATHIEU  
**1514-IC/1514-LC**

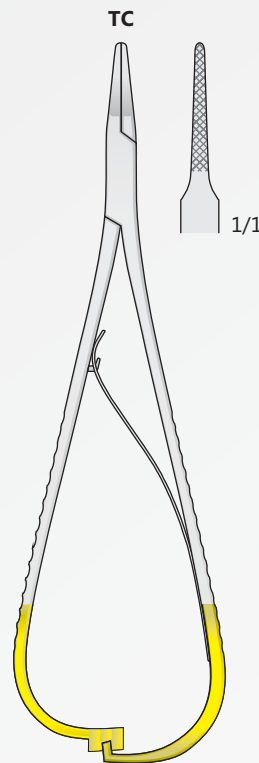

STILLE  
**1514-LD**  
 170 mm

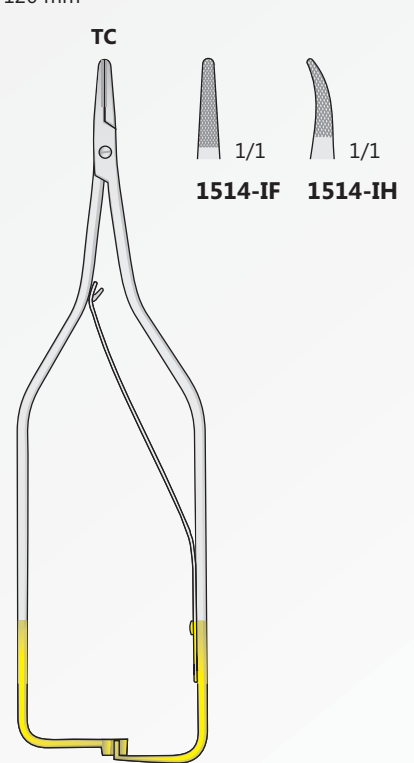

ARRUGA  
**1514-IF/1514-IH**  
 160 mm

Nadelhalter      Nadelhalter mit Hartmetalleinlagen  
 Needle Holders      Needle Holders with tungsten-carbide inserts  
 Port'aghi      Portaghi con inserti al tungsteno  
 Portaagujas      Portaagujas con plaquitas de carburo de tungsteno  
 Porte aiguilles      Porte aiguilles avec plaquettes en carbure de tungstène

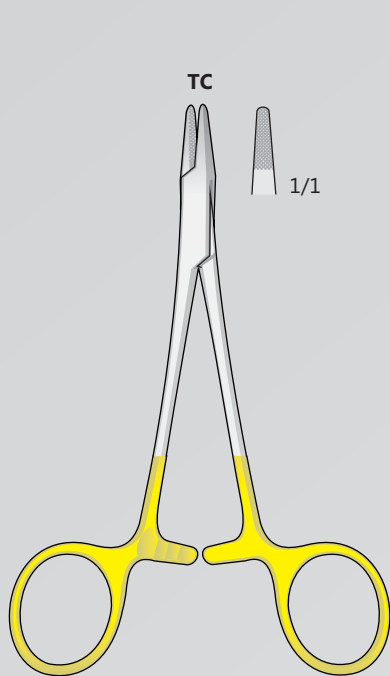

DERF  
**1508-GL**  
 115 mm

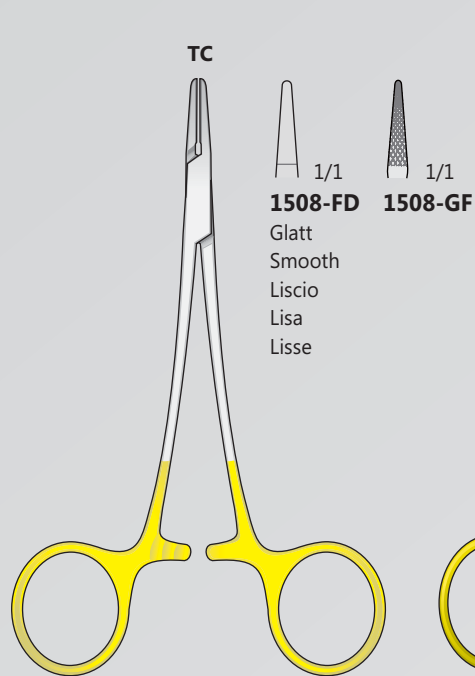

**1508-FD/1508-GF**  
 120 mm

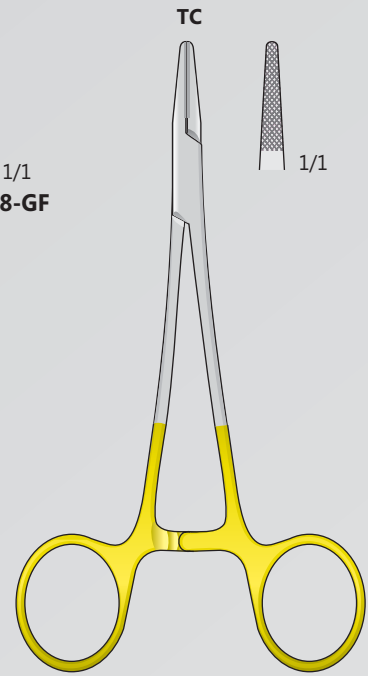

CONVERSE  
**1508-GI**  
 130 mm

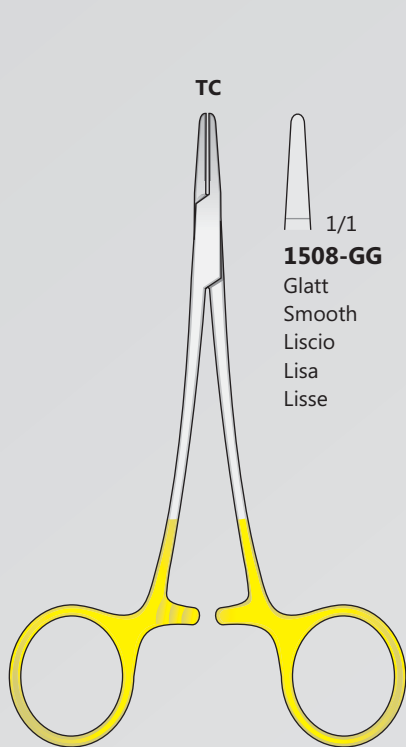

WEBSTER  
**1508-GG**  
 130 mm

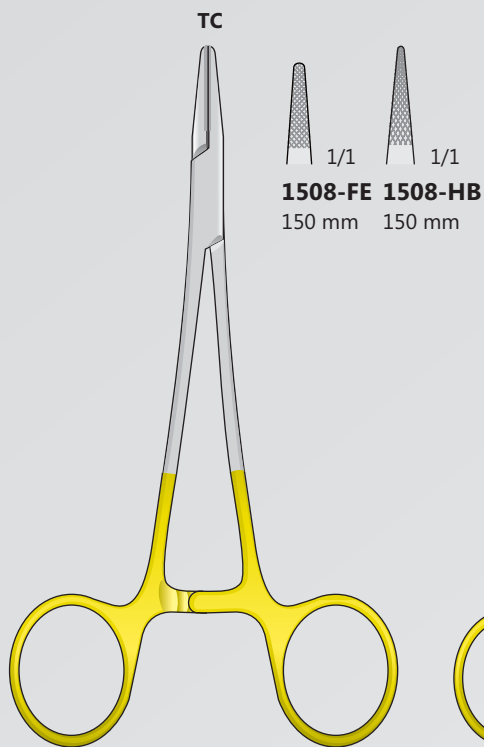

CRILE-WOOD  
**1508-FE/1508-HB**  
 150 mm

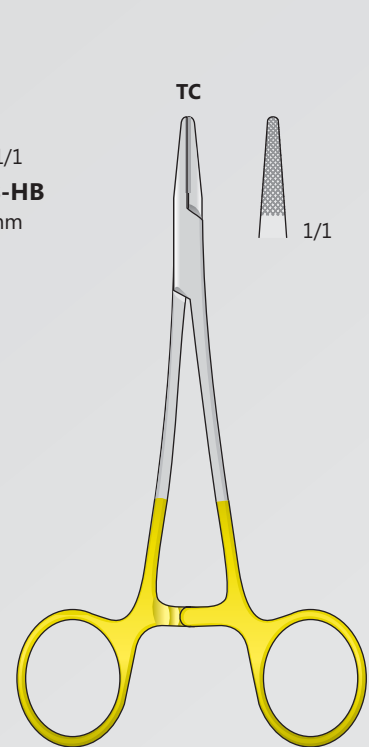

HALSEY  
**1508-HD**  
 130 mm



Nadelhalter mit Hartmetalleinlagen  
 Needle Holders with tungsten-carbide inserts  
 Portaghi con inserti al tungsteno  
 Portaaguja con plaquitas de carburo de tungsteno  
 Porte aiguilles avec plaquettes en carbure de tungstène

Nadelhalter  
 Needle Holders  
 Port'aghi  
 Portaaguja  
 Porte aiguilles

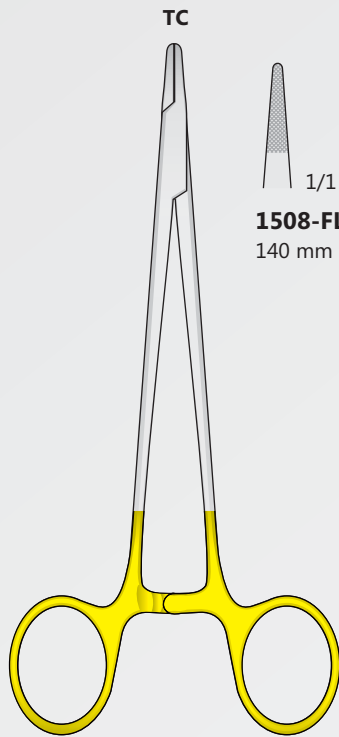

HEGAR  
**1508-FL/1508-HG**

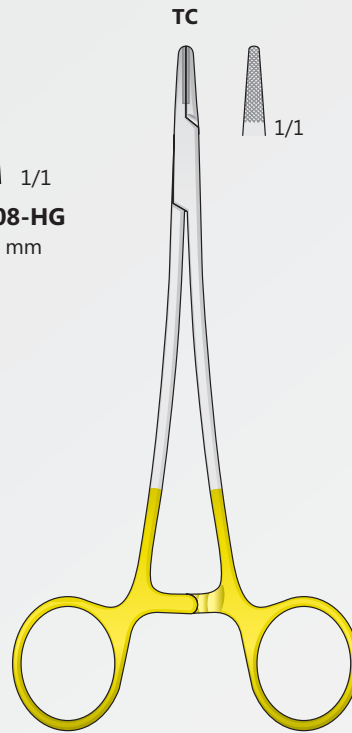
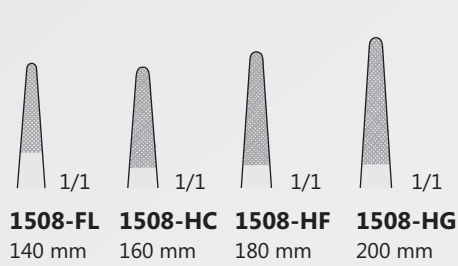

**1508-HL**  
 145 mm

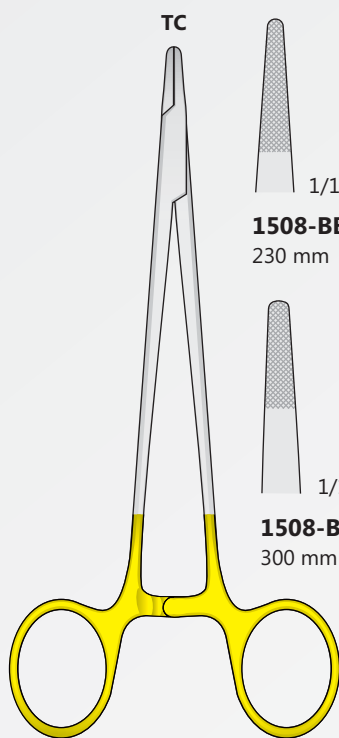

MAYO-HEGAR  
**1508-BBH/1508-BBL**

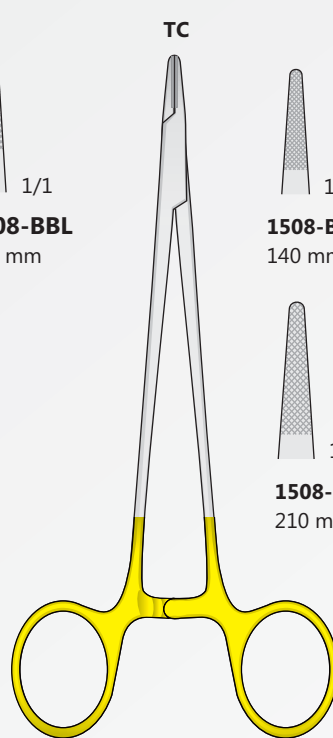
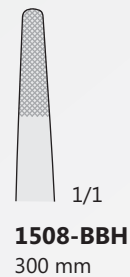
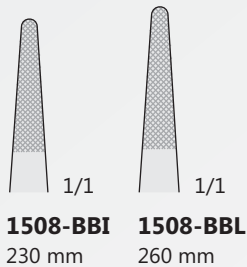

MAYO-HEGAR  
**1508-BCA/1508-BCF**

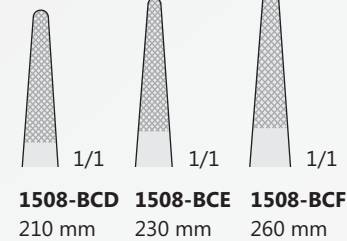
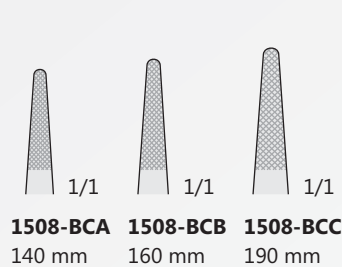

HEGAR  
**1508-BBF**  
 205 mm

Nadelhalter            Nadelhalter mit Hartmetalleinlagen  
 Needle Holders        Needle Holders with tungsten-carbide inserts  
 Port'aghi              Portaghi con inserti al tungsteno  
 Portaaguja            Portaaguja con plaquitas de carburo de tungsteno  
 Porte aiguilles        Porte aiguilles avec plaquettes en carbure de tungstène

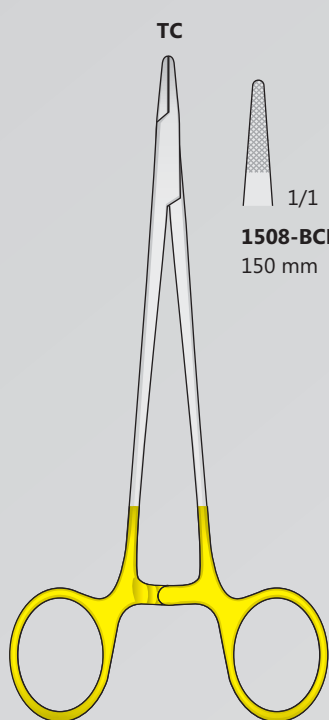

MAYO-HEGAR-FINO  
**1508-BCH/1508-BCL**

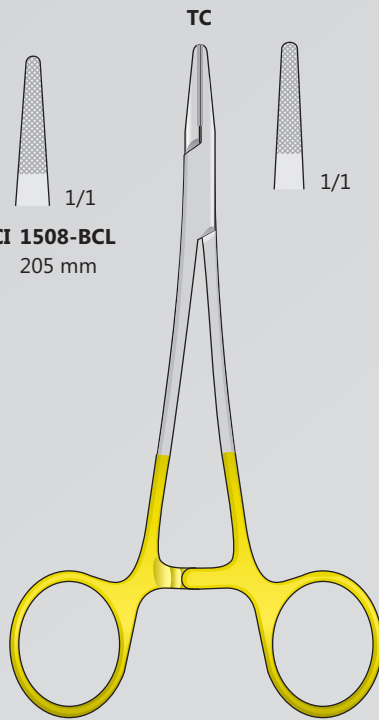

CRILE-WOOD  
**1508-HH**  
 180 mm

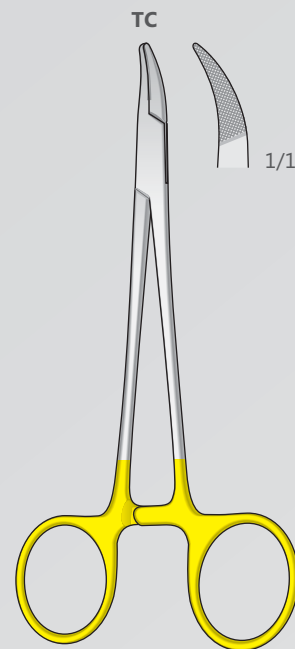

CRILE-WOOD  
**1508-LA**  
 150 mm

Nadelhalter, Draht-Zangen  
 Needle holder, wire forceps  
 Port'aghi, pinze per fili d'acciaio  
 Porta agujas, pinzas para hilos  
 Porte-aiguilles, pinces à saisir

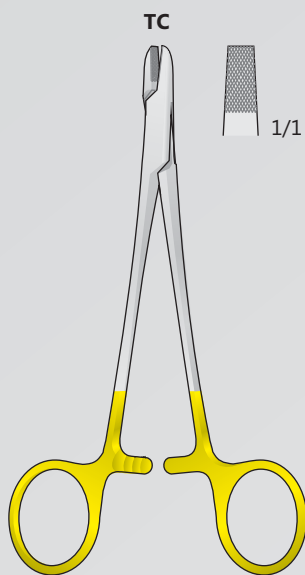

**1508-FI**  
 150 mm

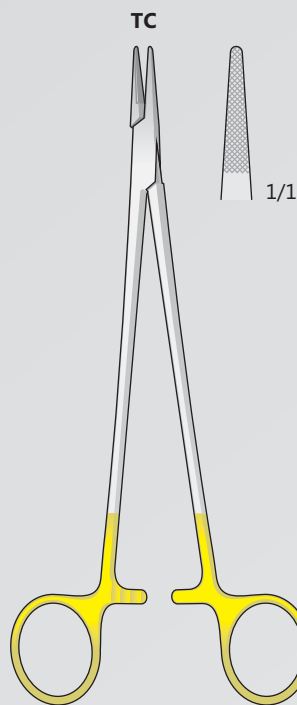

HEGAR-MAYO-SEELEY  
**1508-BDA**  
 200 mm

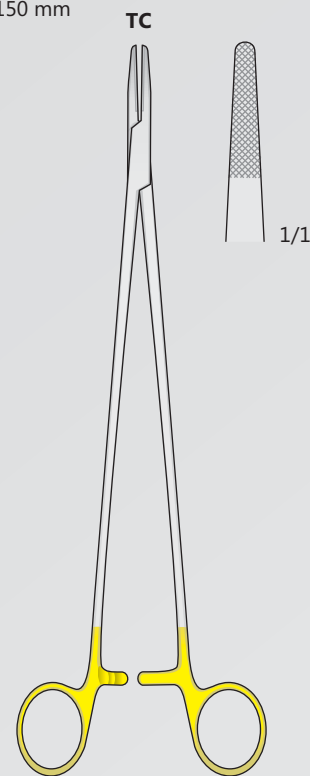

WANGENSTEEN  
**1508-BDB**  
 270 mm

Nadelhalter mit Hartmetalleinlagen  
 Needle Holders with tungsten-carbide inserts  
 Portaghi con inserti al tungsteno  
 Portaaguja con plaquitas de carburo de tungsteno  
 Porte aiguilles avec plaquettes en carbure de tungstène

Nadelhalter  
 Needle Holders  
 Port'aghi  
 Portaaguja  
 Porte aiguilles

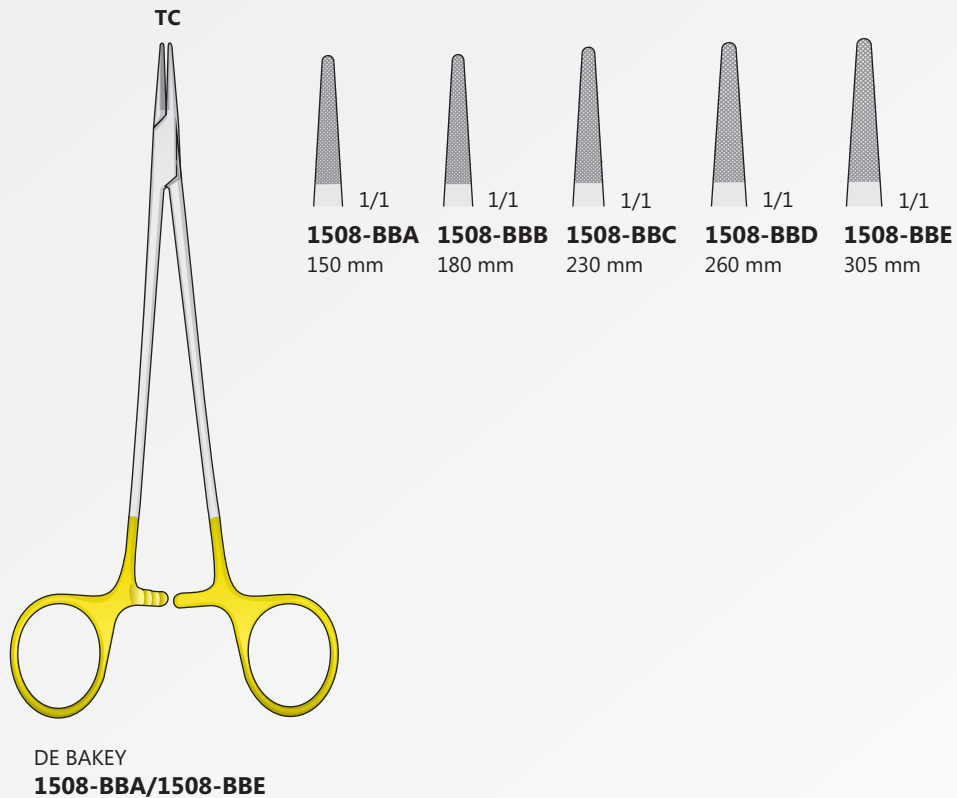
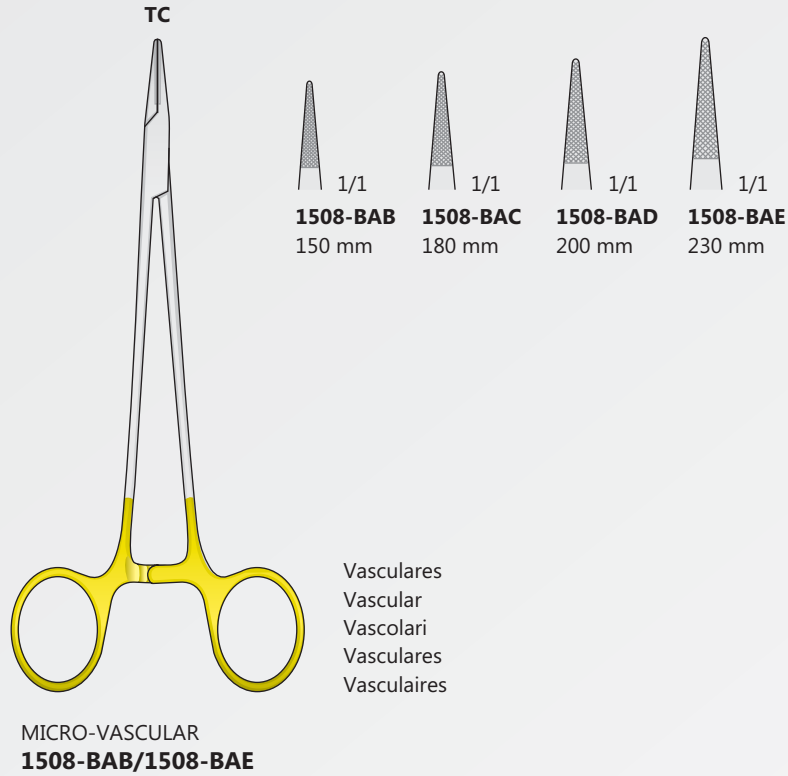

Nadelhalter mit Schere  
 Needle holders with scissors  
 Port'aghi con forbici  
 Portaagujas con tijeras  
 Porte aiguilles avec ciseaux

Nadelhalter mit Hartmetalleinlagen  
 Needle Holders with tungsten-carbide inserts  
 Portaghi con inserti al tungsteno  
 Portaagujas con plaquitas de carburo de tungsteno  
 Porte aiguilles avec plaquettes en carbure de tungstène

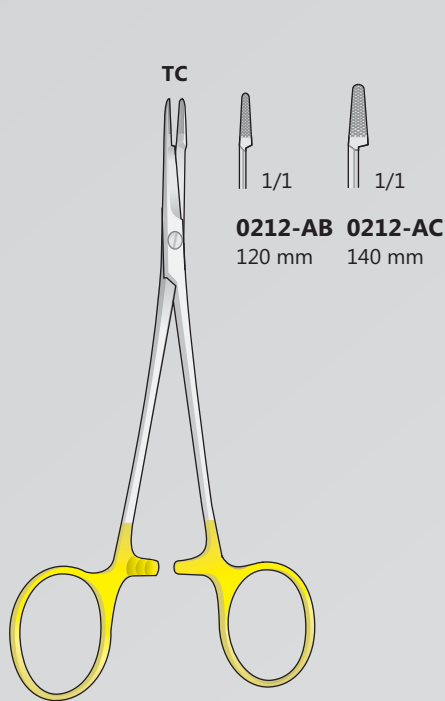

OLSEN-HEGAR  
**0212-AB/0212-AC**

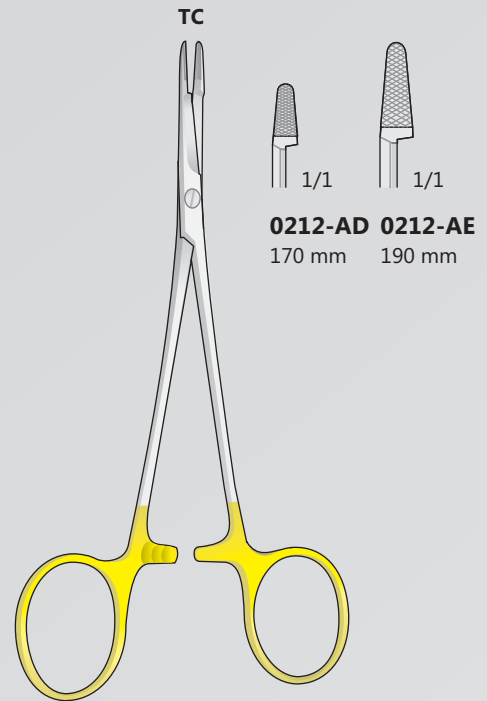

OLSEN-HEGAR  
**0212-AD/0212-AE**

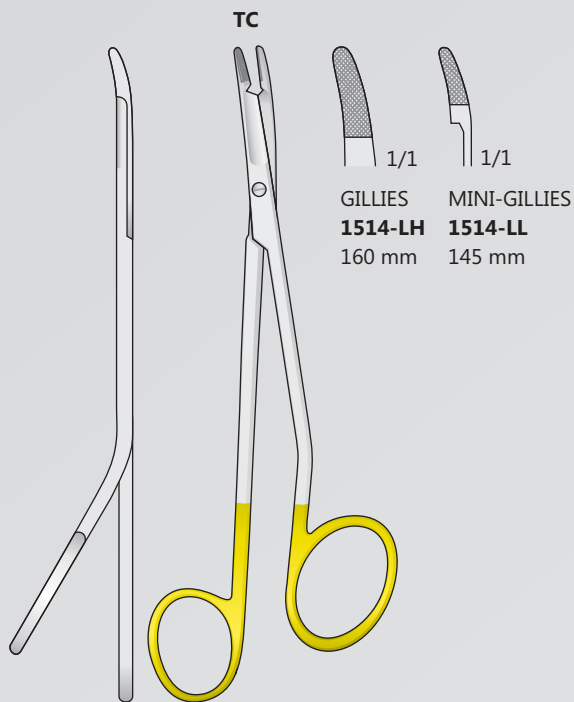

GILLIES  
**1514-LH/1514-LL**

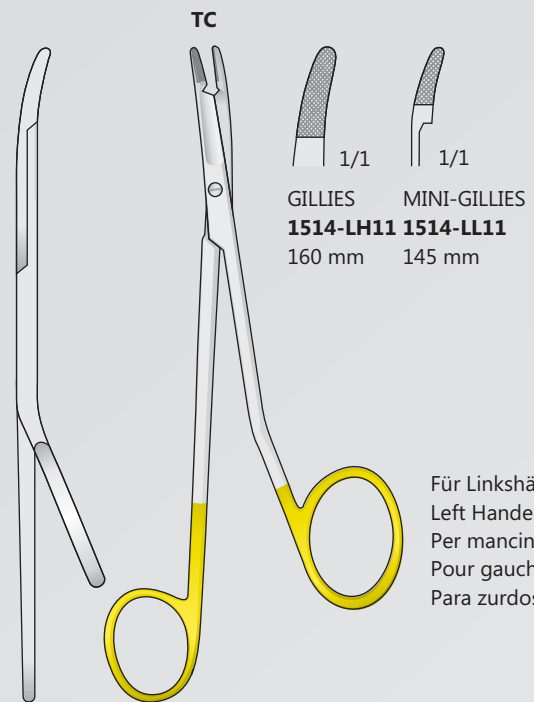

GILLIES  
**1514-LH11/1514-LL11**

Für Linkshänder  
 Left Handed  
 Per mancini  
 Pour gauche  
 Para zurdos

Nadelhalter mit Hartmetalleinlagen  
 Needle Holders with tungsten-carbide inserts  
 Portaghi con inserti al tungsteno  
 Portaaguja con plaquitas de carburo de tungsteno  
 Porte aiguilles avec plaquettes en carbure de tungstène

Nadelhalter  
 Needle Holders  
 Port'aghi  
 Portaaguja  
 Porte aiguilles

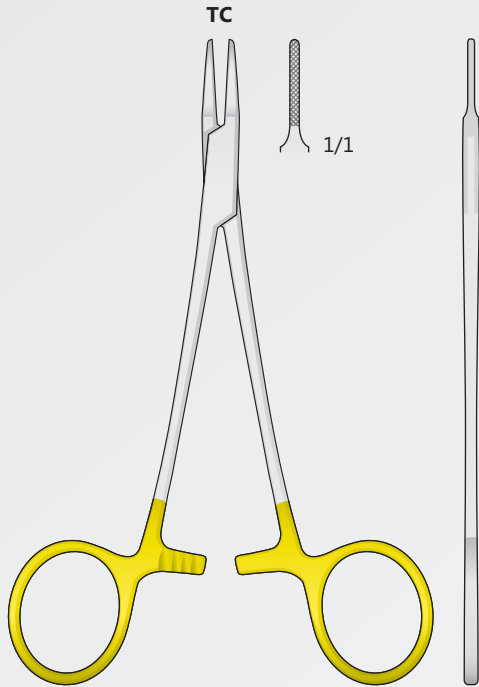

MICRO-RYDER  
**1508-ID**  
 140 mm

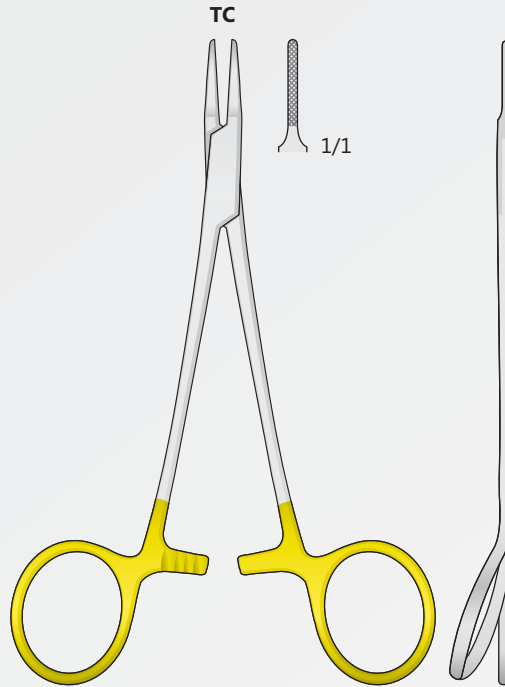

**1508-IE**  
 140 mm

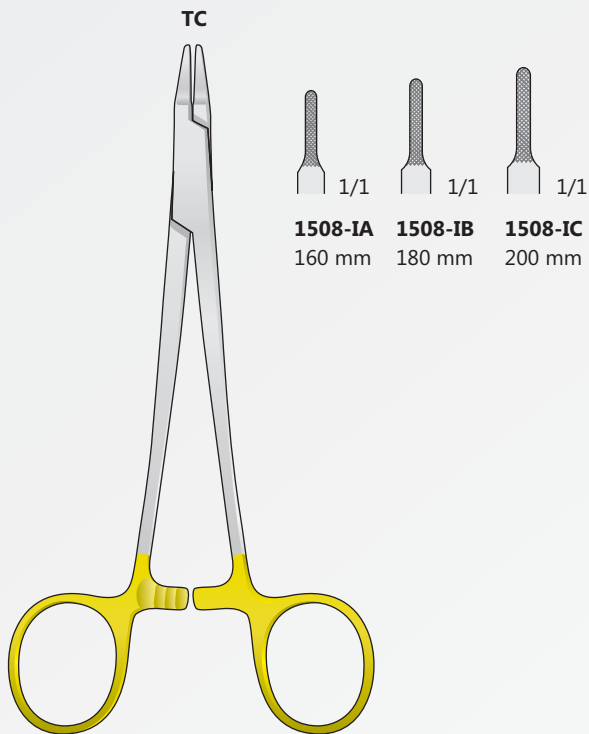

RYDER  
**1508-IA/1508-IC**

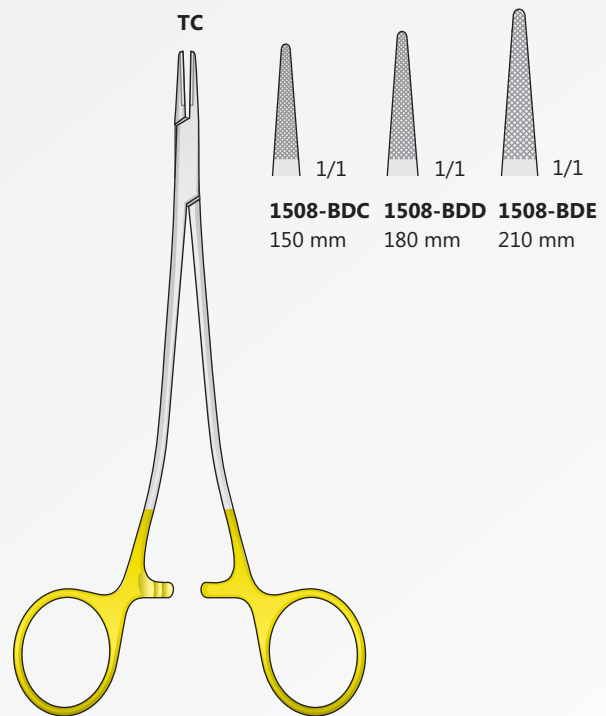

SAROT  
**1508-BDC/1508-BDE**

Nadelhalter  
Needle Holders  
Port'aghi  
Portaagujas  
Porte aiguilles

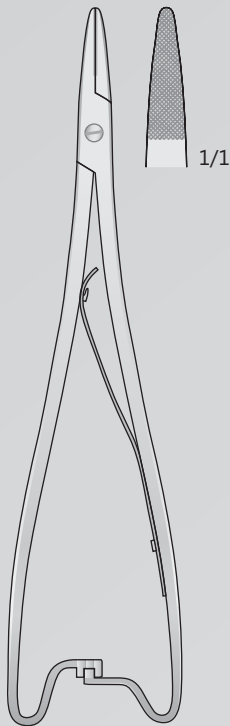

MATHIEU  
**1514-GH**  
200 mm

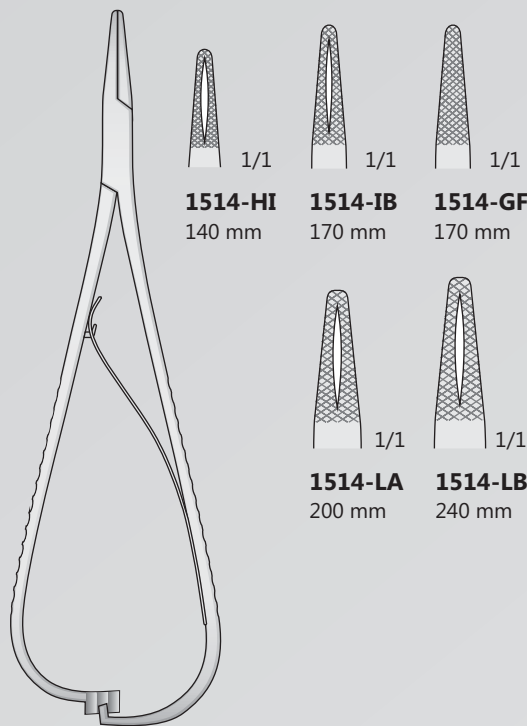

MATHIEU  
**1514-HI/1514-LB**

**1514-HI**  
140 mm

**1514-IB**  
170 mm

**1514-GF**  
170 mm

**1514-LA**  
200 mm

**1514-LB**  
240 mm

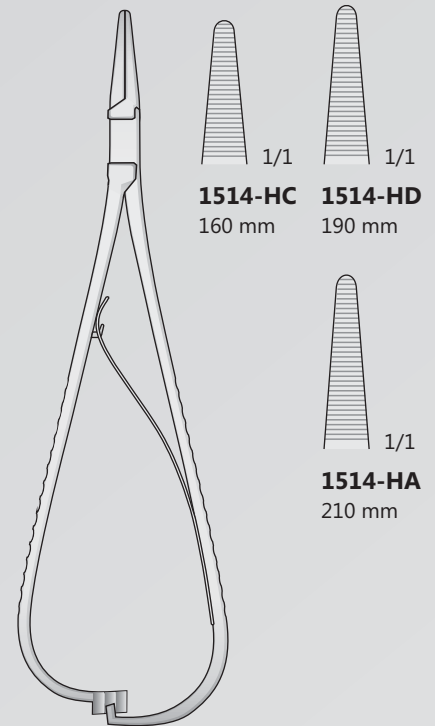

MATHIEU  
**1514-HA/1514-HD**

**1514-HC**  
160 mm

**1514-HD**  
190 mm

**1514-HA**  
210 mm

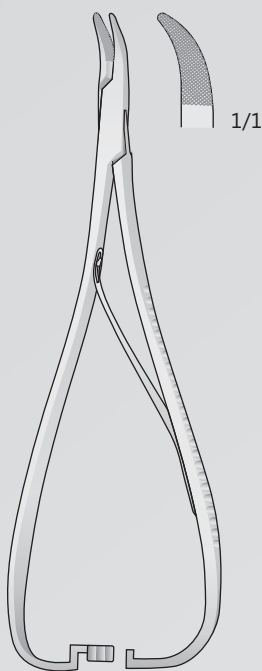

**1514-EA**  
140 mm

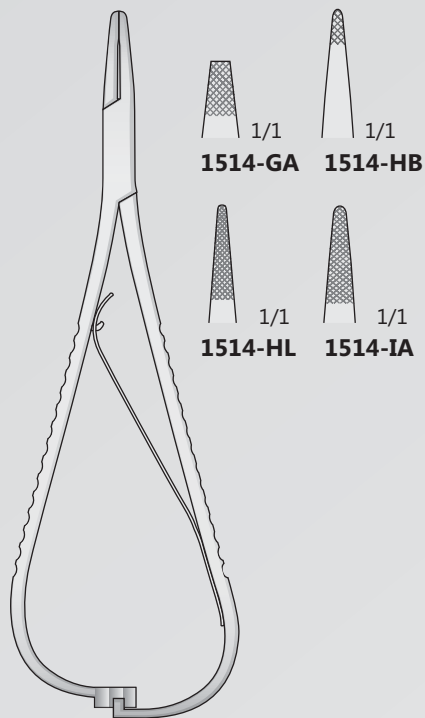

MATHIEU  
**1514-GA/1514-IA**  
140 mm

**1514-GA**  
1/1

**1514-HB**  
1/1

**1514-HL**  
1/1

**1514-IA**  
1/1

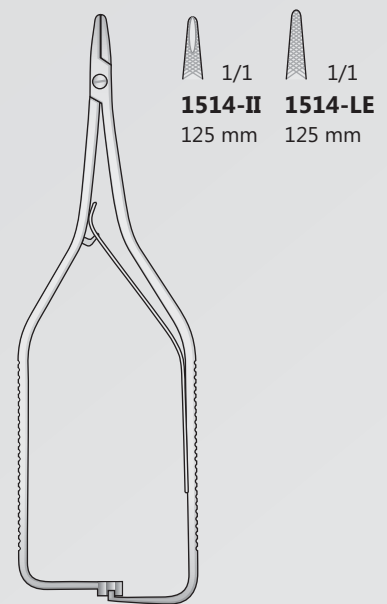

BOYNTON  
**1514-II/1514-LE**  
125 mm

**1514-II**  
125 mm

**1514-LE**  
125 mm

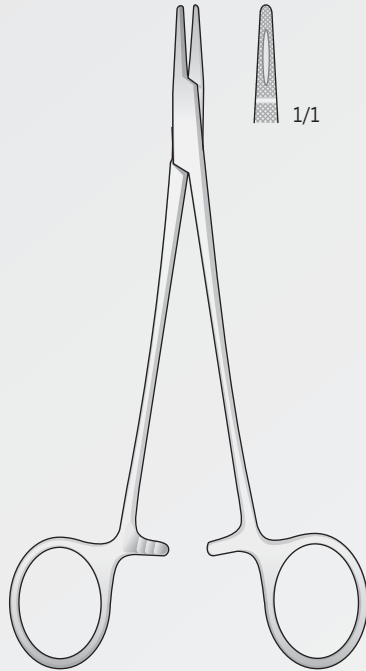

CRILE-WOOD  
**1508-GB**  
150 mm

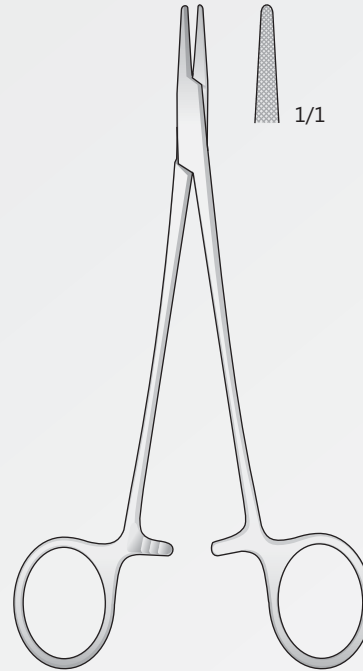

CRILE-MURRAY  
**1508-GC**  
150 mm

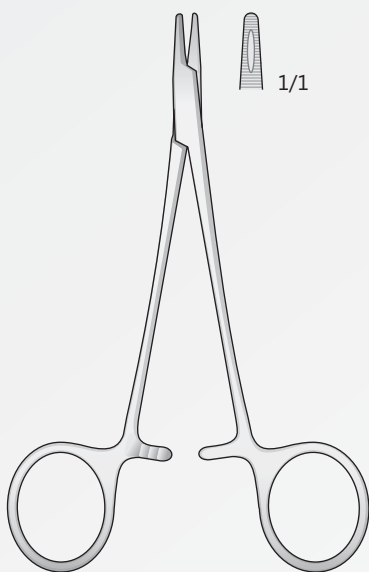

DERF  
**1508-DL**  
125 mm

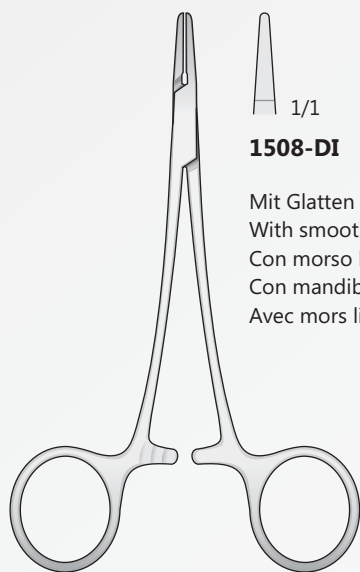

**1508-DI/1508-GE**  
120 mm

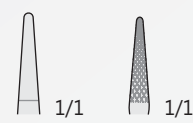

**1508-DI 1508-GE**

Mit Glatten mau  
With smooth jaws  
Con morso liscio  
Con mandibula lisa  
Avec mors lisses

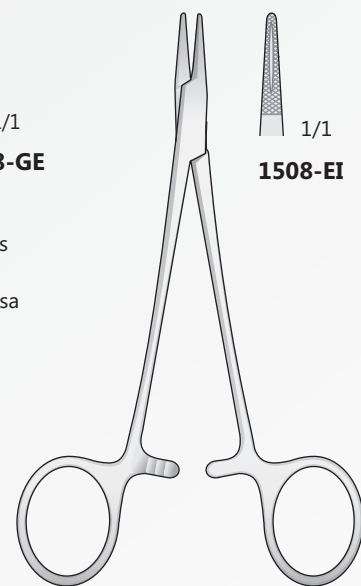

HALSEY  
**1508-EI/1508-GD**  
130 mm

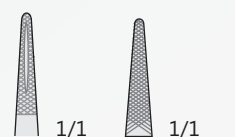

**1508-EI 1508-GD**

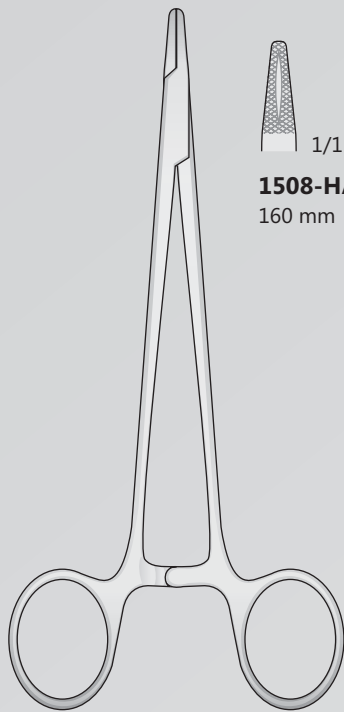

HEGAR  
**1508-HA/1508-HI**

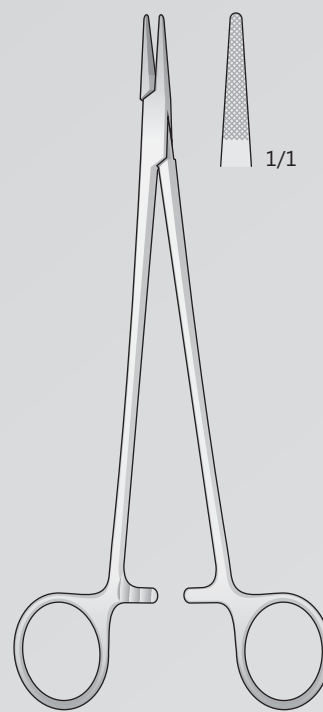
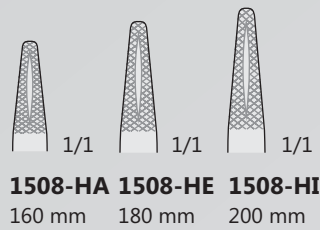

HEGAR-MAYO-SEELEY  
**1508-EG**  
200 mm

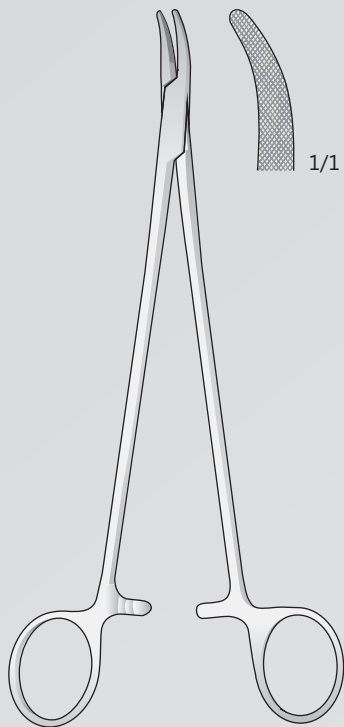
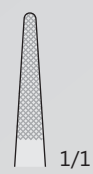

HEANEY (HEGAR)  
**1508-FC**  
200 mm

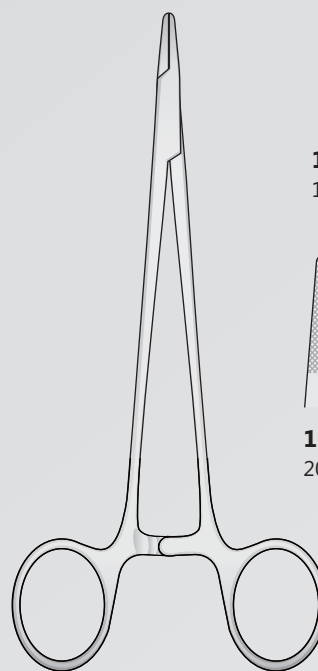
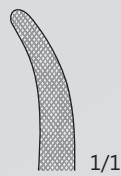

MAYO-HEGAR  
**1508-EA/1508-EF**

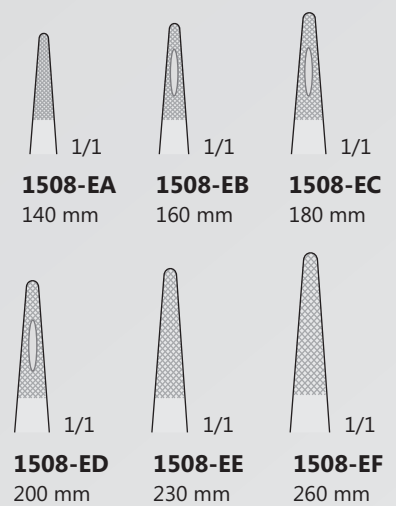

Schlankesmodell  
Delicate pattern  
Modello fine  
Modelo delegado  
Modèle fin



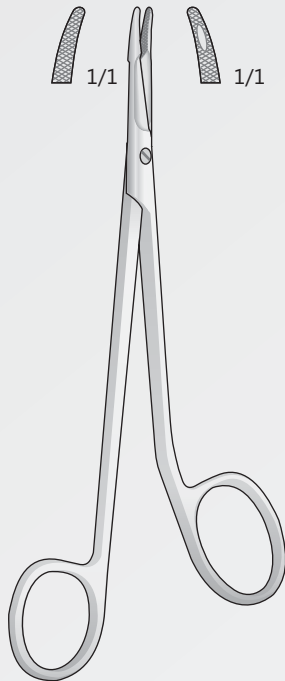

MINI-GILLIES  
**1514-FL**  
 145 mm

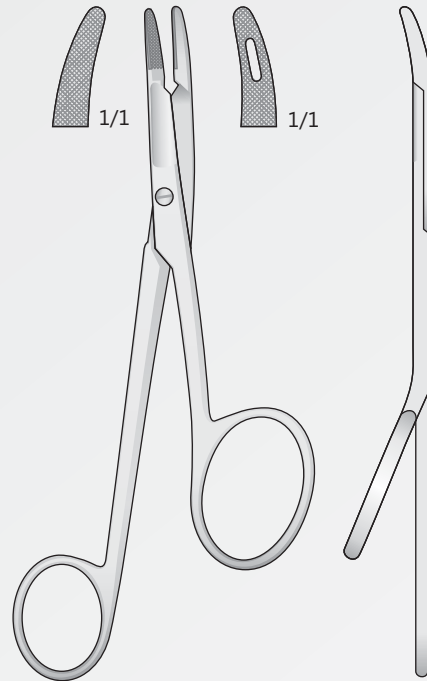

GILLIES  
**1514-IL**  
 160 mm



OLSEN-HEGAR  
**0212-GB/0212-GC**

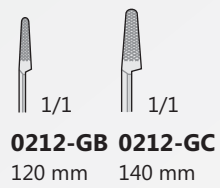

OLSEN-HEGAR  
**0212-GD/0212-GE**

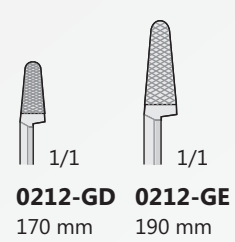





 ideal-tek

Wundhaken, Instrumente für Thorax  
Retractors, Instruments for Thoracic  
Divaricatori, Chirurgia Toracica  
Separadores, Cirugia Toràcica  
Ecarteurs, Chirurgie Thoracique



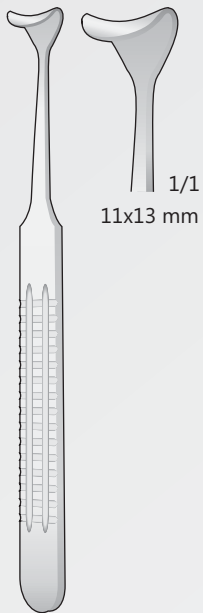

DESMARRES  
**0219-CI**  
160 mm



DESMARRES  
**0219-HA/0219-HH**  
140 mm

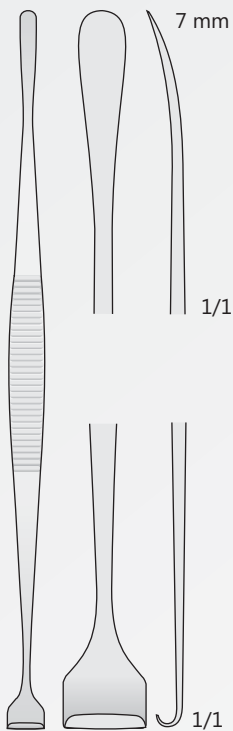
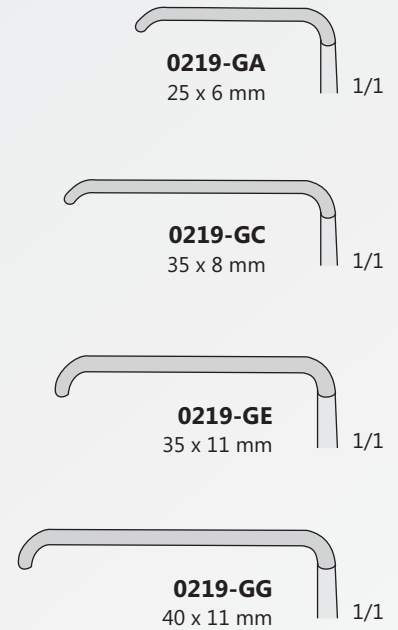
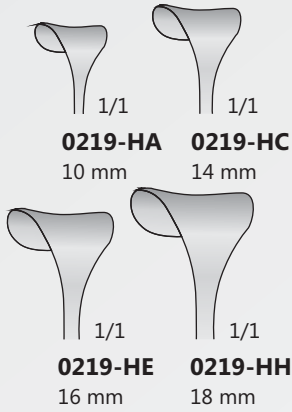

HURD  
**0219-B**  
220 mm

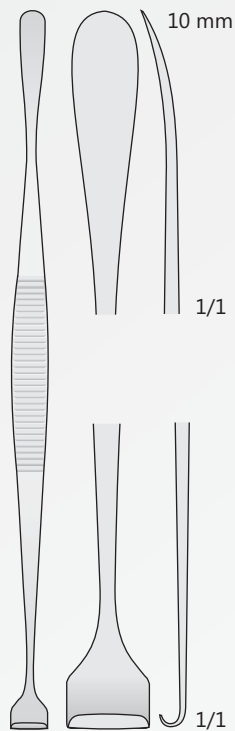

HURD  
**0219-C**  
220 mm



LANGENBECK  
**0219-DD/0219-ED**  
210 mm

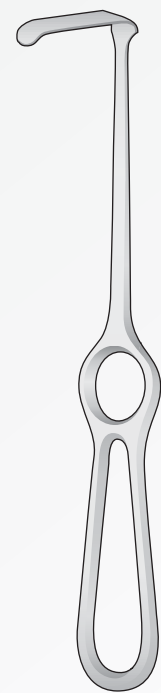

KOCHER-LANGENBECK  
**0219-GA/0219-GG**  
215 mm

Wundhaken  
Retractors  
Divaricatori  
Separadores  
Ecarteurs

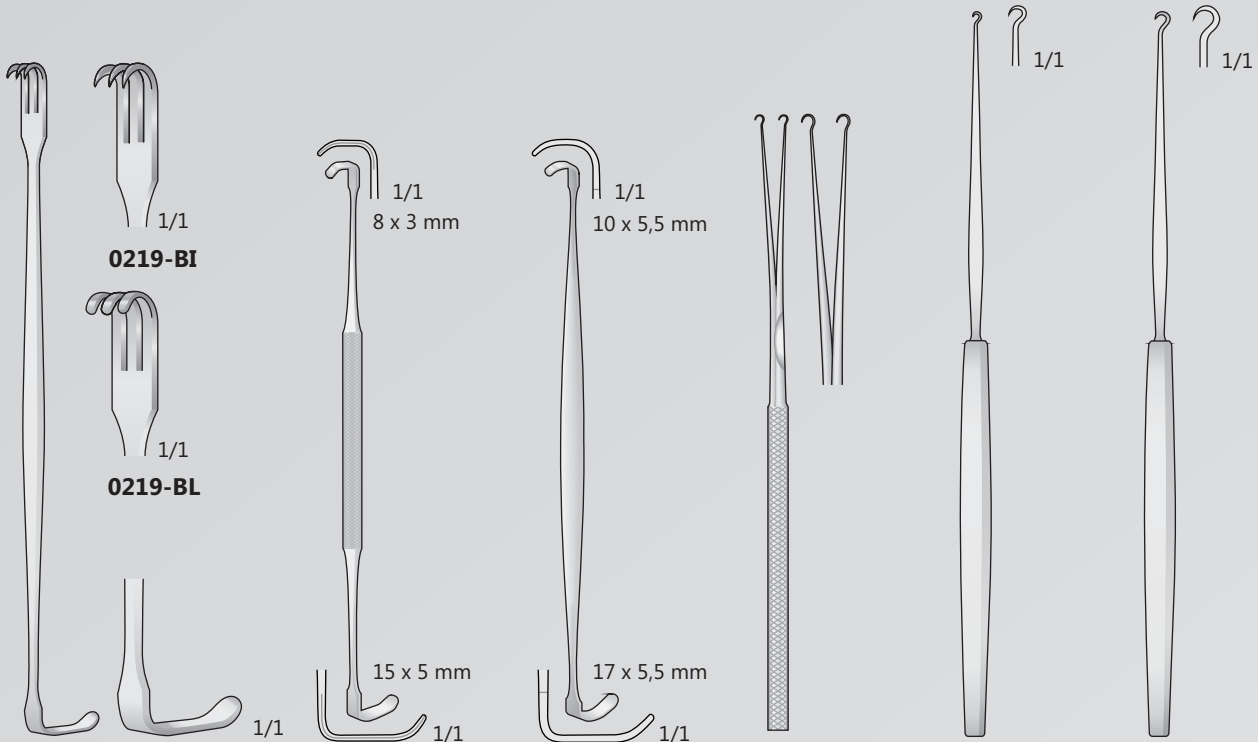

SENN-MILLER  
**0219-BI/0219-BL**  
160 mm

RAGNELL  
**0219-CH**  
140 mm

RAGNELL-DAVIS  
**0219-CG**  
140 mm

BARSKY  
**0219-DHA**  
150 mm

GILLIES  
**0219-BF**  
180 mm

GILLIES  
**0219-BG**  
180 mm

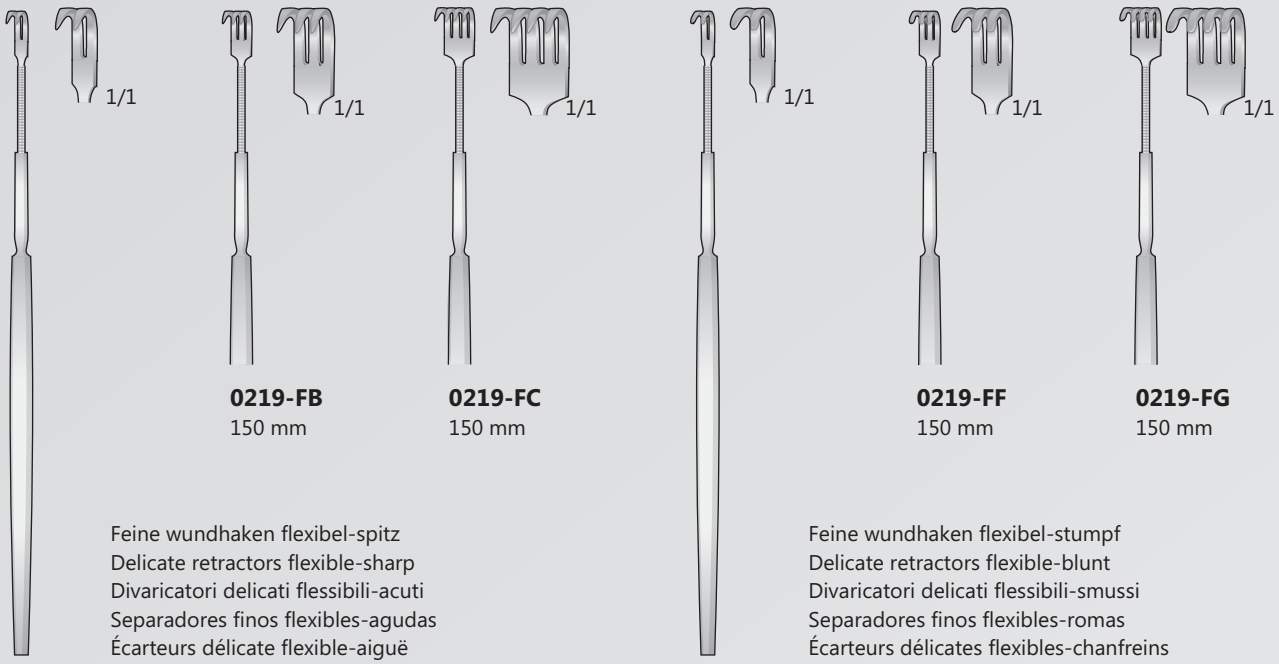

**0219-FA**  
150 mm

Feine wundhaken flexibel-spitz  
Delicate retractors flexible-sharp  
Divaricatori delicati flessibili-acuti  
Separadores finos flexibles-agudas  
Écarteurs délicates flexible-aiguë

**0219-FE**  
150 mm

Feine wundhaken flexibel-stumpf  
Delicate retractors flexible-blunt  
Divaricatori delicati flessibili-smussi  
Separadores finos flexibles-romas  
Écarteurs délicates flexibles-chanfreins

**0219-CID**

Set completo  
Set complete  
Komplettset  
Set complet  
Set completo

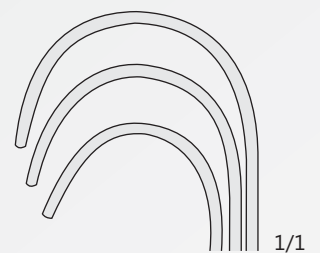

**0219-CIE** - 20x22 mm  
25x28 mm

**0219-CIF** - 23x26 mm  
29x38 mm

**0219-CIG** - 29x29 mm  
34x44 mm

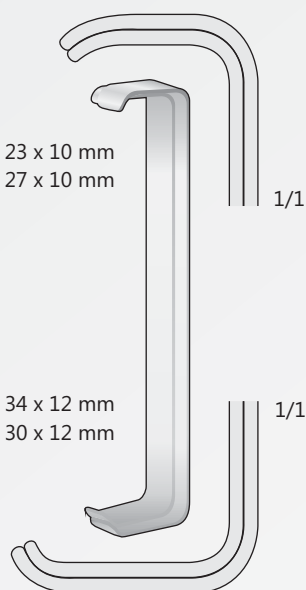

FARABEU  
**0219-CA**  
120 mm

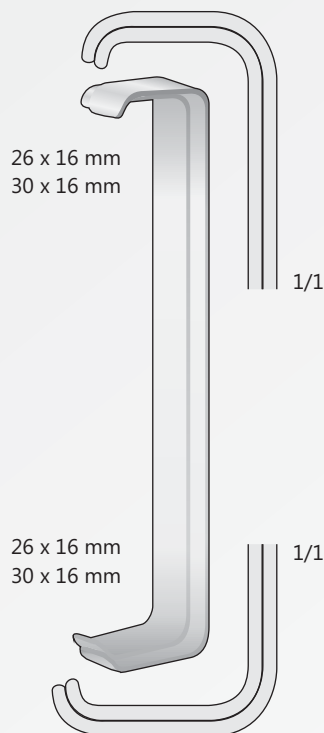

FARABEU  
**0219-CF**  
150 mm

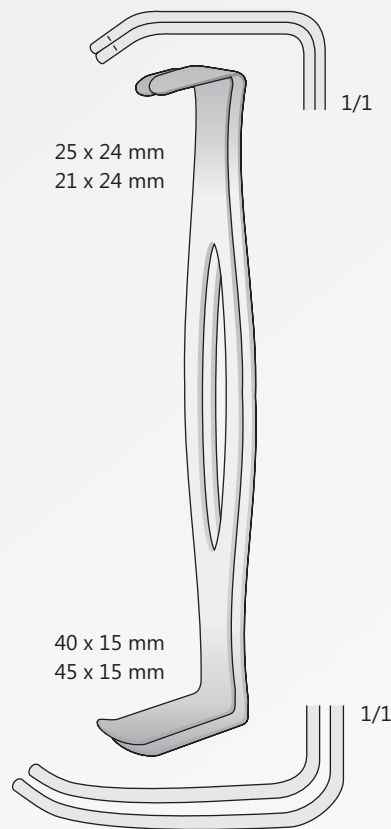

PARKER-LANGENBECK  
**0219-CLB**  
210 mm



ROUX  
**0219-CIE/0219-CIG**  
165 mm

Wundhaken  
 Retractors  
 Divaricatori  
 Separadores  
 Ecarteurs

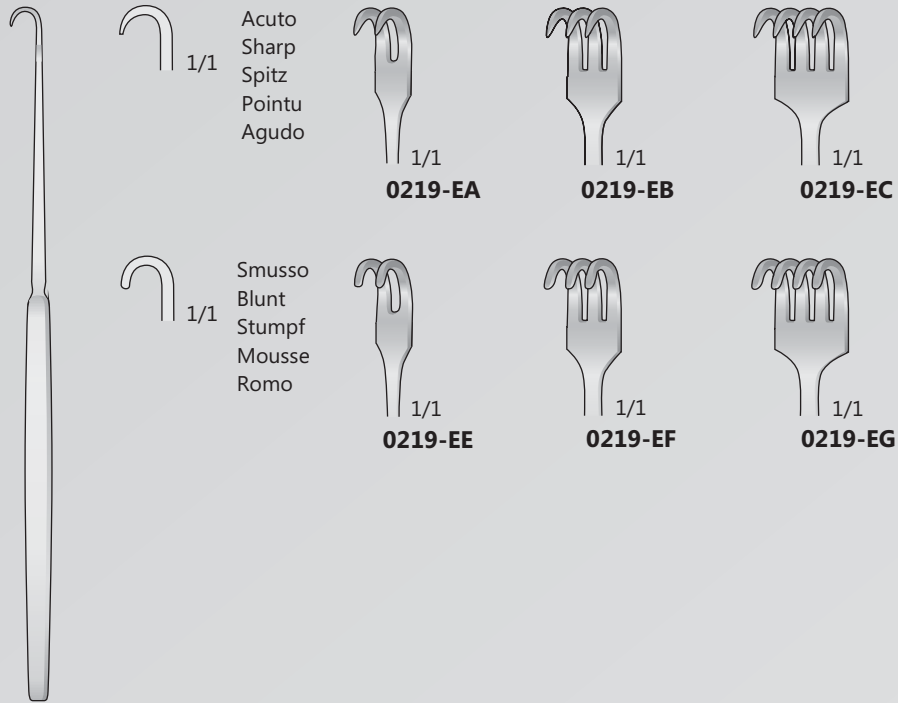

**0219-EA/0219-EG**  
 160 mm

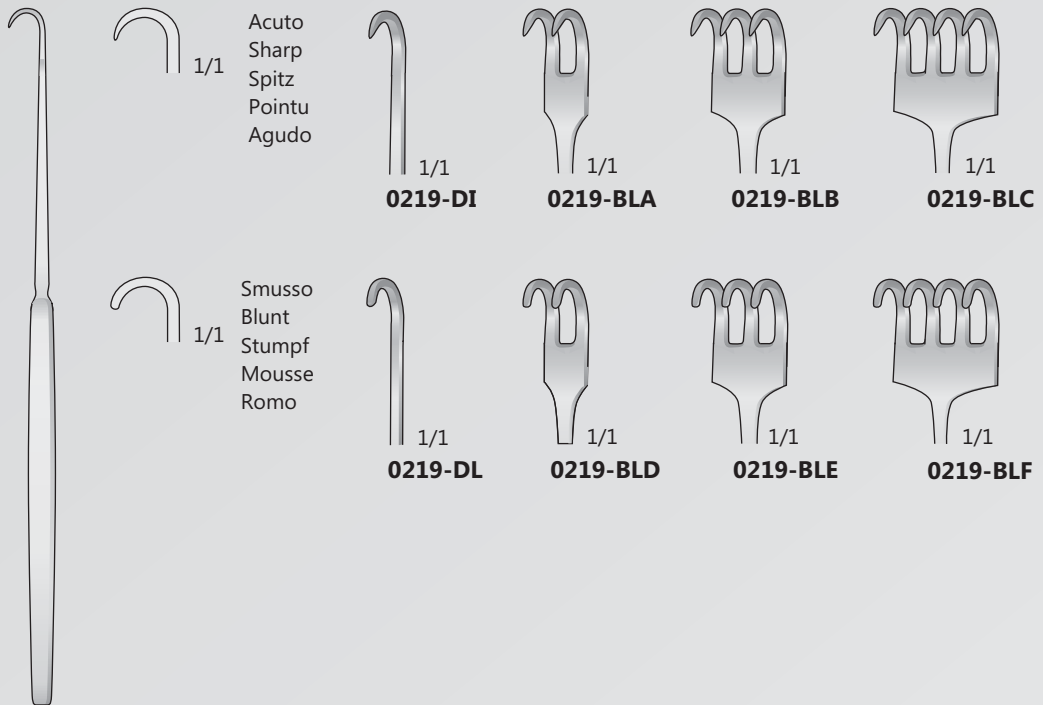

**0219-DI/0219-BLF**  
 160 mm



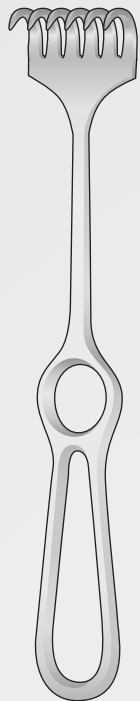

VOLKMANN  
**0219-BAB/0219-BAI**  
220 mm

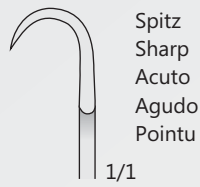

Spitz  
Sharp  
Acuto  
Agudo  
Pointu



**0219-BAB**  
9 x 8 mm



**0219-BAD**  
9 x 13 mm



**0219-BAF**  
9 x 19 mm

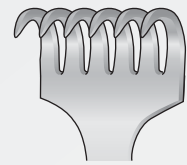

**0219-BAH**  
9 x 29 mm

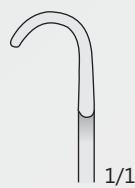

Stumpf  
Blunt  
Smusso  
Romo  
Mousse



**0219-BAC**  
9 x 8 mm



**0219-BAE**  
9 x 13 mm



**0219-BAG**  
9 x 19 mm

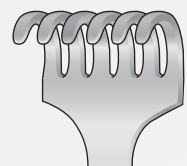

**0219-BAI**  
9 x 29 mm



KOCHER  
**0219-BEB/0219-BEI**  
220 mm



Spitz  
Sharp  
Acuto  
Agudo  
Pointu



**0219-BEB**  
16 x 9 mm



**0219-BED**  
16 x 14 mm



**0219-BEF**  
16 x 20 mm

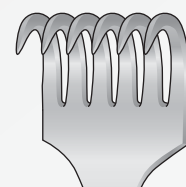

**0219-BEH**  
16 x 30 mm



Stumpf  
Blunt  
Smusso  
Romo  
Mousse



**0219-BEC**  
16 x 9 mm



**0219-BEE**  
16 x 14 mm



**0219-BEG**  
16 x 20 mm

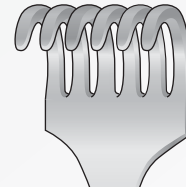

**0219-BEI**  
16 x 30 mm

GELPI Spreizer mit Schließung Zehen gekreuzt  
Retractor GELPI with closure toes crossed  
Retrattori GELPI con chiusura a punte incrociate  
Retractor GELPI con dedos cruzados de cierre  
Écarteur GELPI avec orteils de fermeture croisés

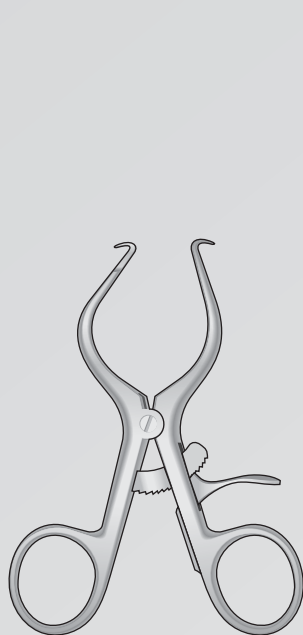
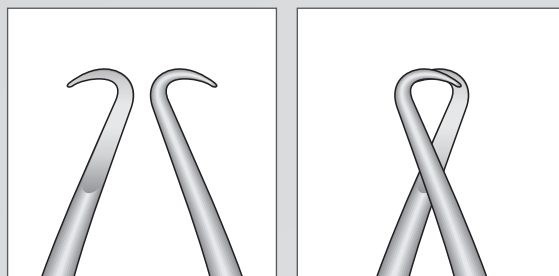

**0221-LBE**  
90 mm

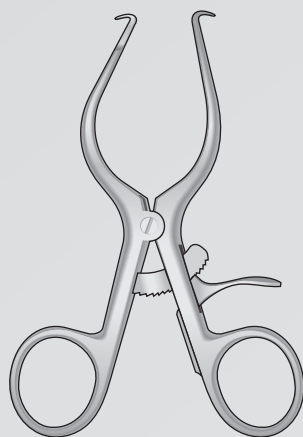

**0221-LBF**  
110 mm

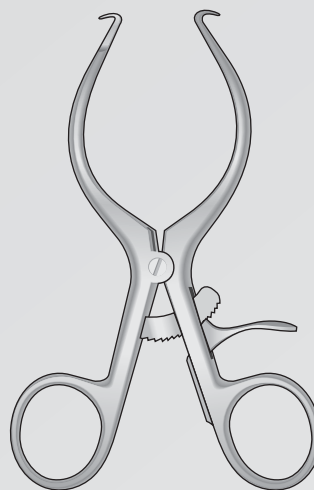

**0221-LBG**  
140 mm

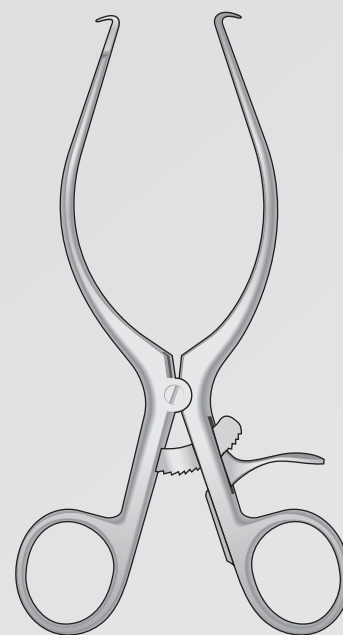

**0221-LBH**  
180 mm

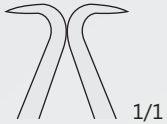

1/1

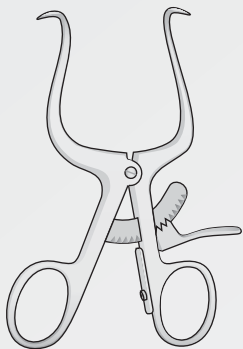

GELPI  
**0221-BE**  
90 mm

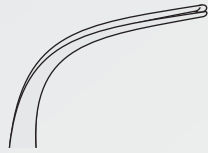

1/1

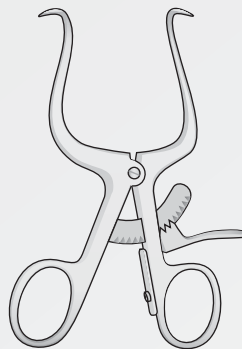

GELPI  
**0221-BE12**  
90 mm

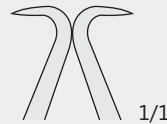

1/1

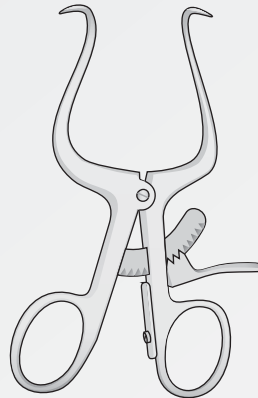

GELPI  
**0221-BF**  
110 mm

Femur-Wundspreizer  
Femur Retractor  
Divaricatore femorale  
Retractor femoral  
Ecarteur fémoral

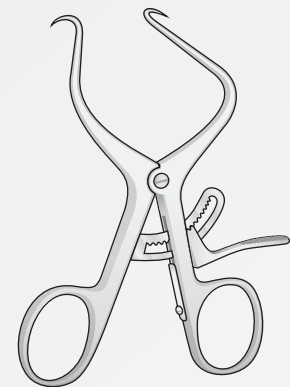
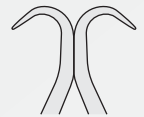

DE BAKEY  
**0221-DBF**  
100 mm

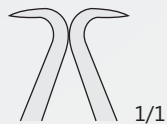

1/1

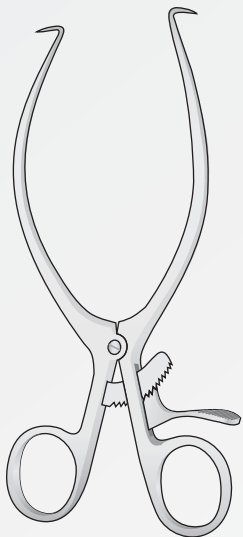

GELPI  
**0221-BG**  
140 mm

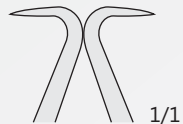

1/1

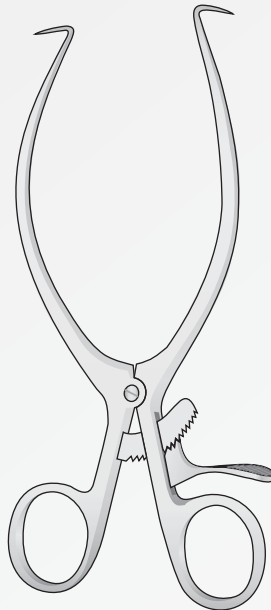

GELPI  
**0221-BH**  
180 mm

Femur-Wundspreizer  
Femur Retractor  
Divaricatore femorale  
Retractor femoral  
Ecarteur fémoral

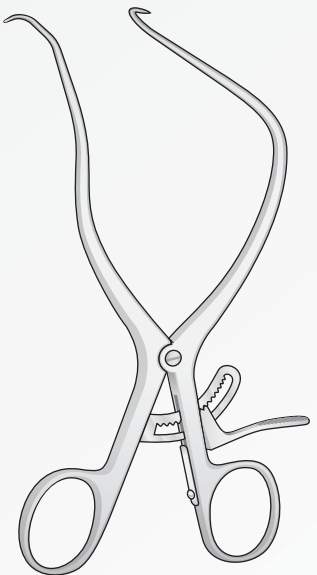
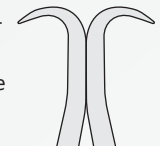

DE BAKEY  
**0221-DBG**  
170 mm

Wundspreizer  
Retractors  
Divaricatori  
Separadores  
Ecarteurs

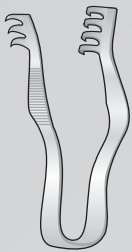

FINSEN  
**0221-DG/0221-DL**  
50 mm

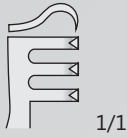

**0221-DG**

Spitz  
Sharp  
Acuto  
Agudas  
Pointù



**0221-DH**

Stumpf  
Blunt  
Smusso  
Romas  
Mousse



**0221-DI**

Spitz  
Sharp  
Acuto  
Agudas  
Pointù



**0221-DL**

Stumpf  
Blunt  
Smusso  
Romas  
Mousse

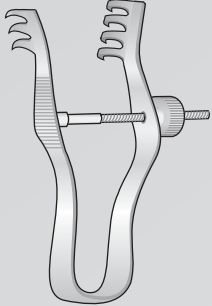

FINSEN  
**0221-EH/0221-EI**  
70 mm

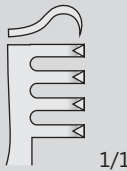

**0221-EH**

Spitz  
Sharp  
Acuto  
Agudas  
Pointù

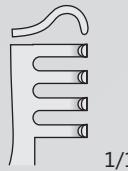

**0221-EI**

Stumpf  
Blunt  
Smusso  
Romas  
Mousse

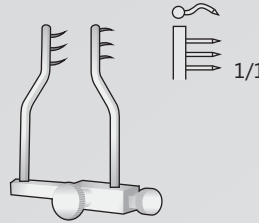

LOGAN  
**0221-EF**  
40 mm

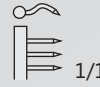

**0221-AI**  
100 mm

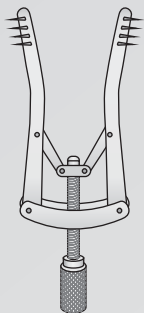

ALM  
**0221-BC/0221-EL**  
70 mm

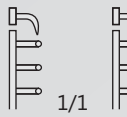

**0221-BC**

Spitz  
Sharp  
Acuto  
Agudas  
Pointù

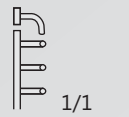

**0221-EL**

Stumpf  
Blunt  
Smusso  
Romas  
Mousse

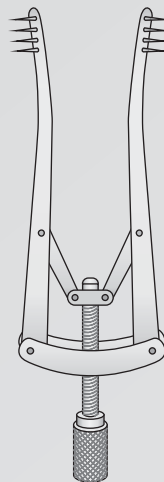

ALM  
**0221-BA/0221-FB**  
100 mm



**0221-BA**

Spitz  
Sharp  
Acuto  
Agudas  
Pointù



**0221-FB**

Stumpf  
Blunt  
Smusso  
Romas  
Mousse

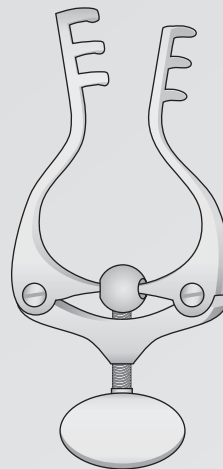

JANSEN  
**0221-FA/0221-FC**  
100 mm



**0221-FA**  
100 mm

Spitz  
Sharp  
Acuto  
Agudas  
Pointù

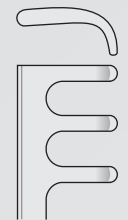

**0221-FC**  
100 mm

Stumpf  
Blunt  
Smusso  
Romas  
Mousse

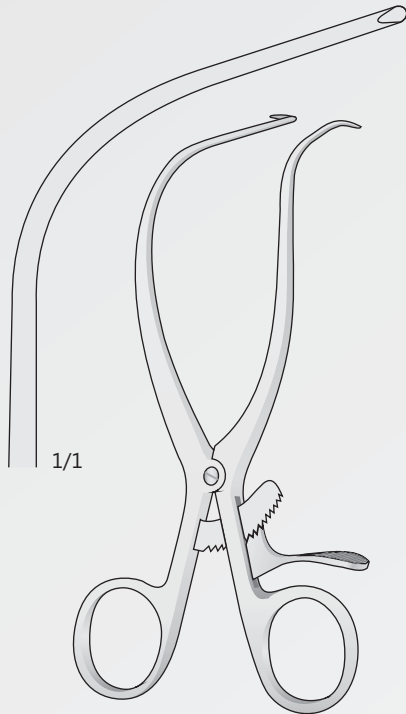

GELPI-SELETZ  
**0221-BB**  
165 mm

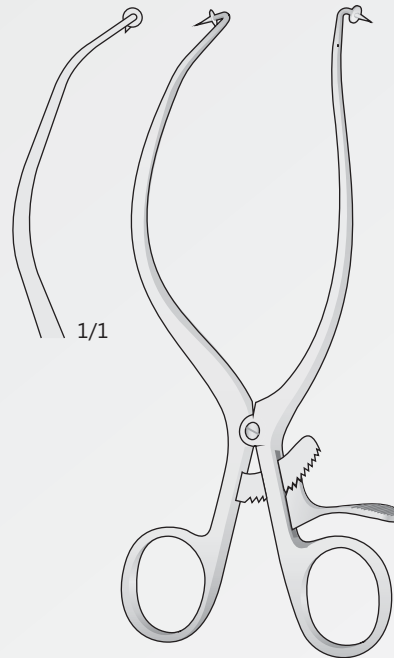

GELPI-LOKTITE  
**0221-BD**  
190 mm

Mit Kugel  
With stop  
Con stop  
Con alto  
Avec stop

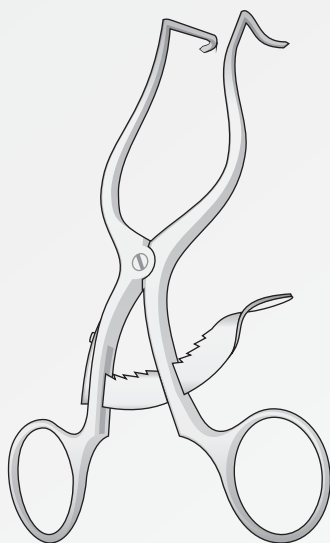

CLOWARD-CONTOUR  
**0221-BAI**  
140 mm

Spitz  
Scharp  
Acuto  
Agudo  
Pointu

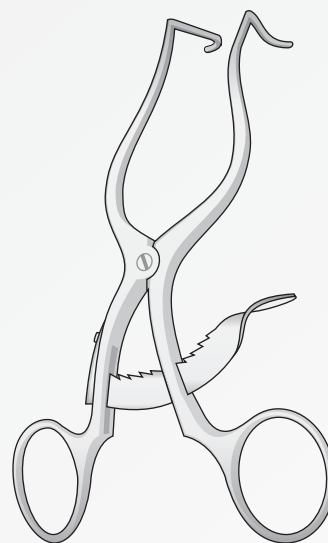

CLOWARD-CONTOUR  
**0221-BAL**  
140 mm

Stumpf  
Blunt  
Smusso  
Romas  
Mousse

Wundspreizer  
 Retractors  
 Divaricatori  
 Separadores  
 Ecarteurs

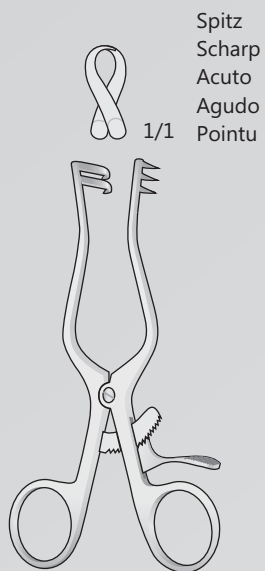

WEITLANER  
**0221-AH**  
 110 mm

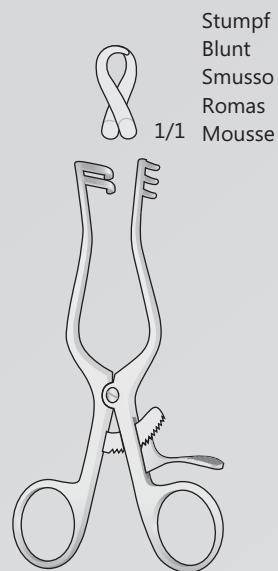

WEITLANER  
**0221-AL**  
 110 mm

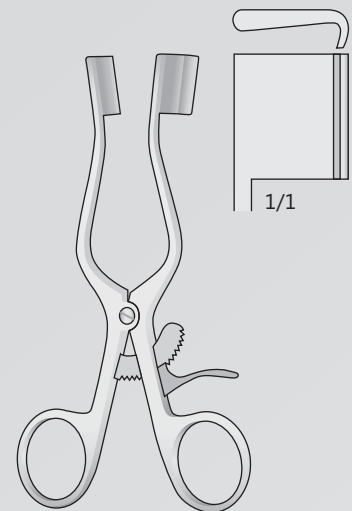

BABY-WEITLANER  
**0221-CG**  
 140 mm

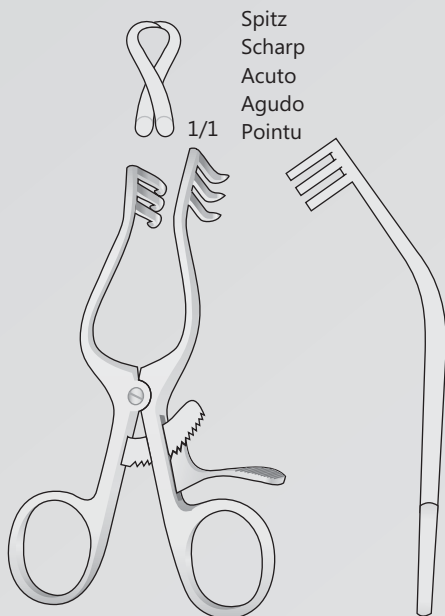

WULLSTEIN  
**0221-BBB**  
 105 mm

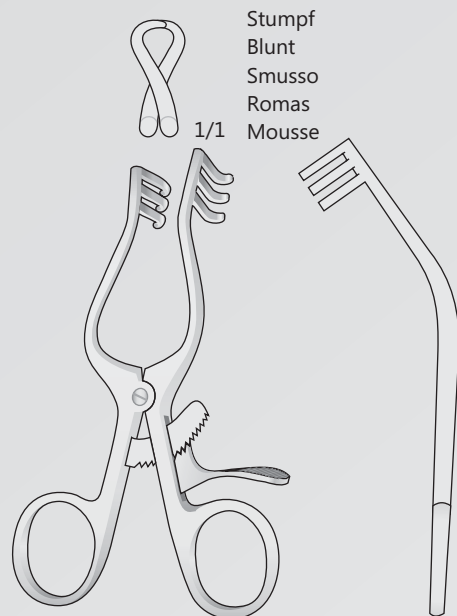

WULLSTEIN  
**0221-BBC**  
 105 mm

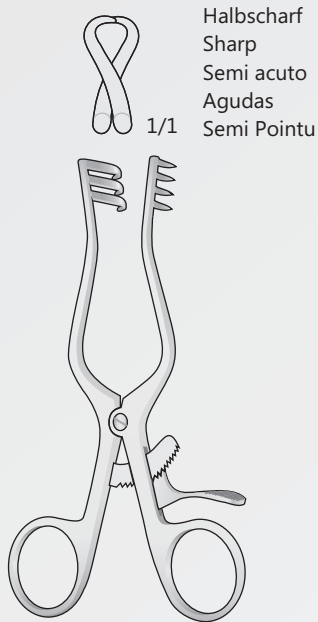

WEITLANER  
**0221-BI**  
135 mm

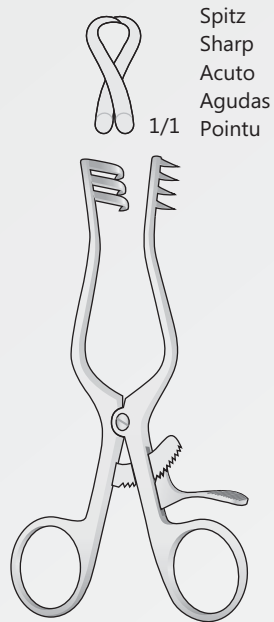

WEITLANER  
**0221-CA**  
135 mm

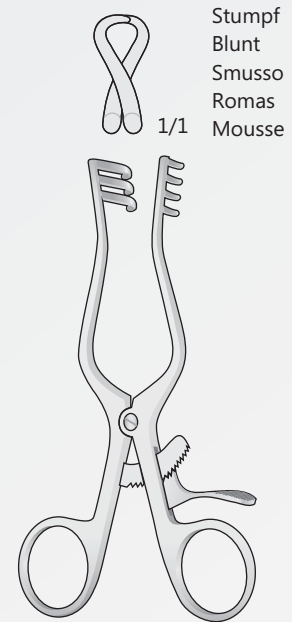

WEITLANER  
**0221-CC**  
135 mm

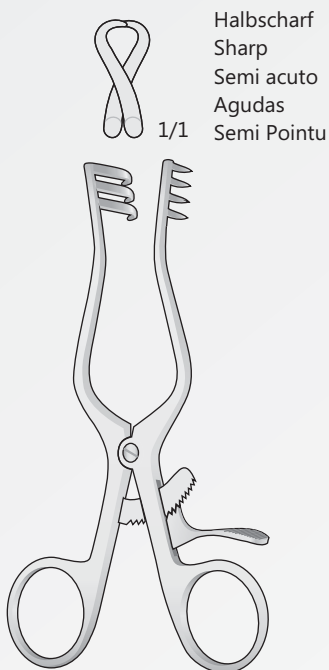

WEITLANER  
**0221-BL**  
165 mm

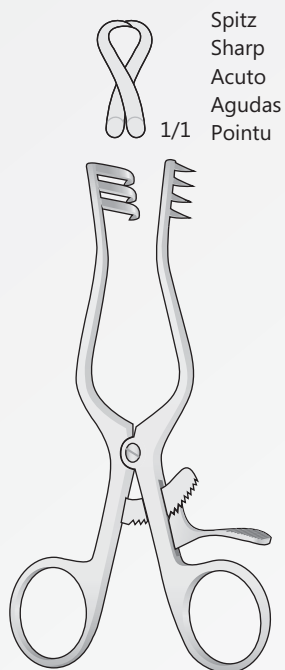

WEITLANER  
**0221-CB**  
165 mm

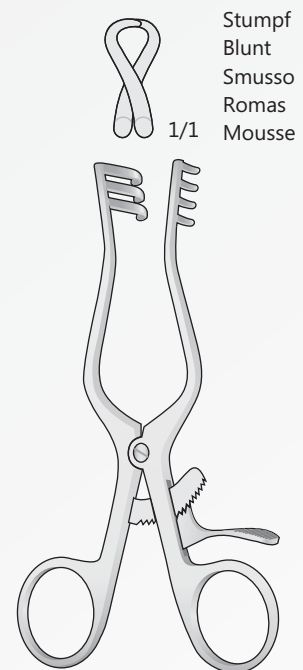

WEITLANER  
**0221-CD**  
165 mm

Wundspreizer  
 Retractors  
 Divaricatori  
 Separadores  
 Ecarteurs

Spitz  
 Sharp  
 Acuto  
 Agudas  
 Pointu

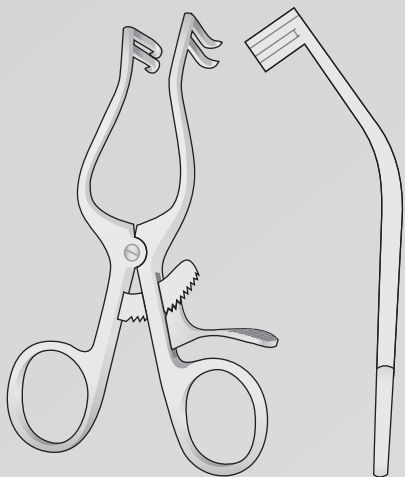

PLESTER  
**0221-LA**  
 110 mm

Stumpf  
 Blunt  
 Smusso  
 Romas  
 Mousse

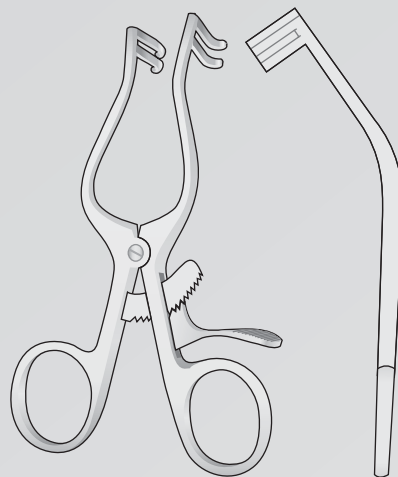

PLESTER  
**0221-LB**  
 110 mm

Spitz  
 Sharp  
 Acuto  
 Agudas  
 Pointu

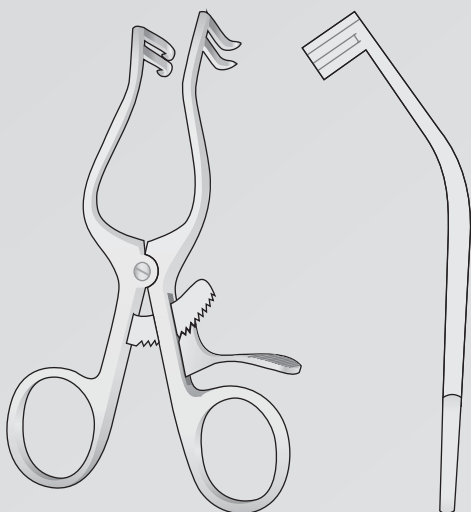

PLESTER  
**0221-LC**  
 135 mm

Stumpf  
 Blunt  
 Smusso  
 Romas  
 Mousse

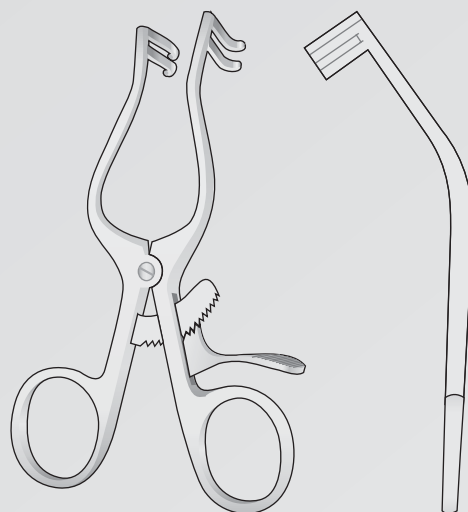

PLESTER  
**0221-LD**  
 135 mm



- 0221-HG** - 32 x 25 mm
- 0221-HH** - 60 x 25 mm
- 0221-HI** - 54 x 25 mm
- 0221-HL** - 60 x 20 mm

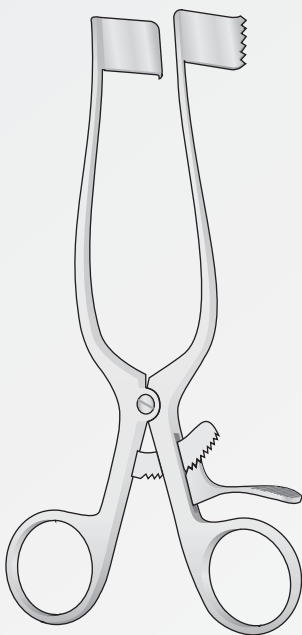

MEYERDING  
**0221-HG/0221-HL**  
180 mm

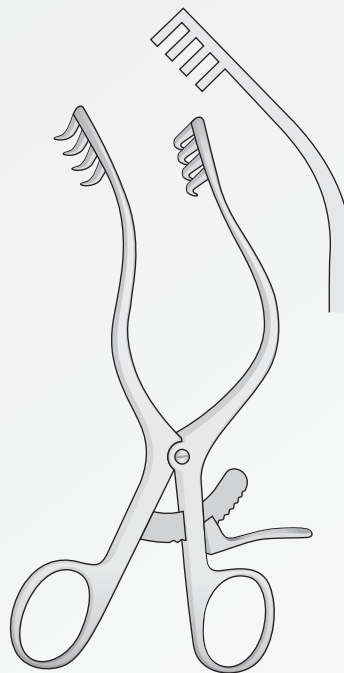

MOLLISON  
**0221-BBA**  
160 mm

Spitz  
Sharp  
Acuto  
Agudas  
Pointu

Stumpf  
Blunt  
Smusso  
Romos  
Mousse

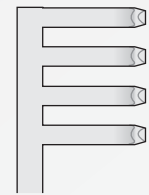
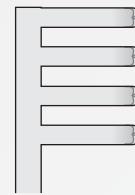
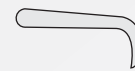

**0221-BBH**

**0221-BBI**



ANDERSON-ADSON  
**0221-BBH/0221-BBI**  
200 mm

Wundspreizer  
Retractors  
Divaricatori  
Separadores  
Ecarteurs

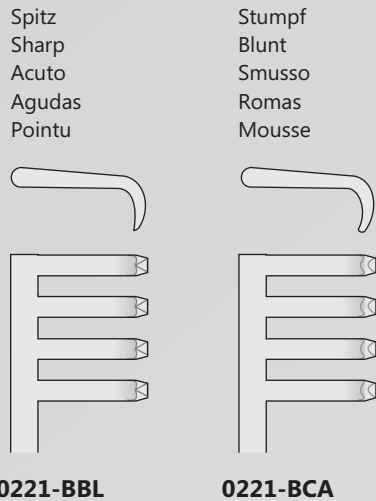

Spitz  
Sharp  
Acuto  
Agudas  
Pointu

Stumpf  
Blunt  
Smusso  
Romas  
Mousse

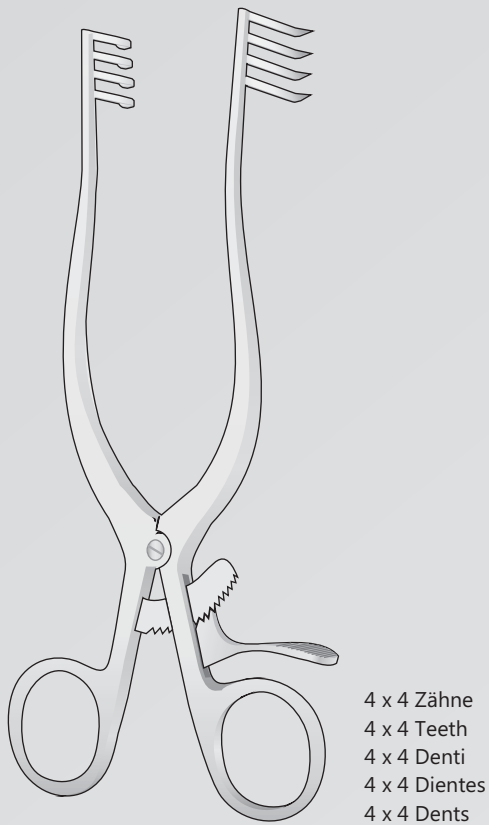
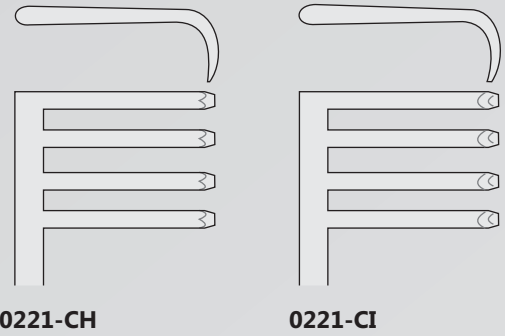

ADSON  
**0221-BBL/0221-BCA**  
200 mm



WEITLANER  
**0221-CH/0221-CI**  
250 mm

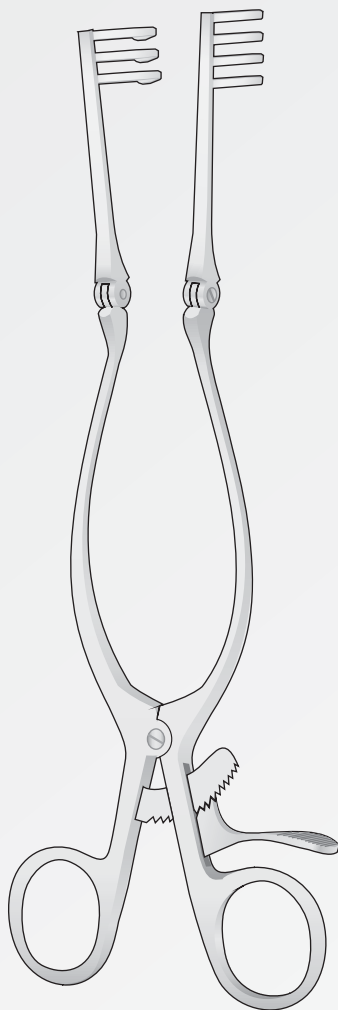

ADSON  
0221-GI/0221-HF

3 x 4 Zähne  
3 x 4 Teeth  
3 x 4 Denti  
3 x 4 Dientes  
3 x 4 Dents

Spitz  
Scharp  
Acuto  
Agudo  
Pointu

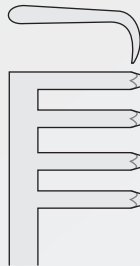

**0221-GI**  
140 mm

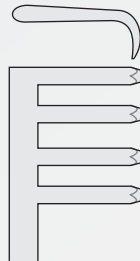

**0221-GL**  
165 mm

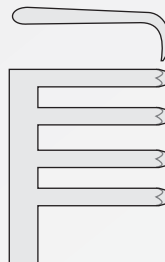

**0221-HC**  
200 mm

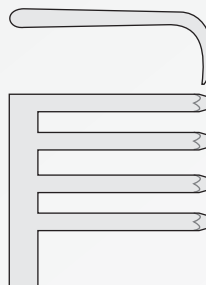

**0221-HE**  
250 mm

Stumpf  
Blunt  
Smusso  
Romas  
Mousse

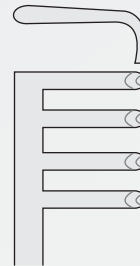

**0221-HA**  
140 mm

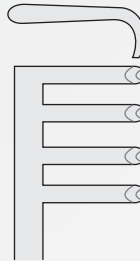

**0221-HB**  
165 mm

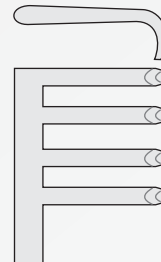

**0221-HD**  
200 mm

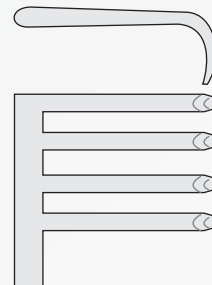

**0221-HF**  
250 mm

Wundspreizer  
 Retractors  
 Divaricatori  
 Separadores  
 Ecarteurs

Spreizer allein  
 Retractor without blades  
 Solo divaricatore senza valva  
 Separador sin valvas  
 Ecarteur sans valves

Spitz	Stumpf
Scharp	Blunt
Acuto	Smusso
Agudo	Romas
Pointu	Mousse

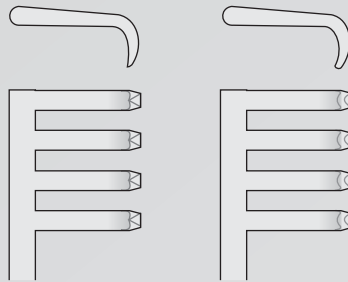

**0221-BDF**

**0221-BDG**

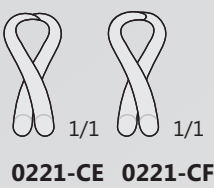
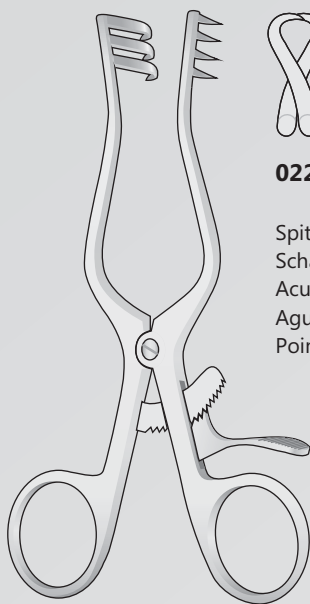

**0221-CE 0221-CF**

Spitz	Stumpf
Scharp	Blunt
Acuto	Smusso
Agudo	Romas
Pointu	Mousse

WEITLANER  
**0221-CE/0221-CF**  
 200 mm

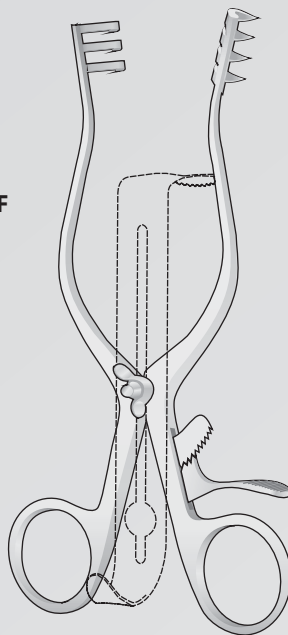

3 x 4 Zähne  
 3 x 4 Teeth  
 3 x 4 Denti  
 3 x 4 Dientes  
 3 x 4 Dents

HENLEY  
**0221-BDF/0221-BDG**  
 165 mm

Mittelblatt  
 Center blades  
 Valve centrali  
 Valvas centrales  
 Valves centrale

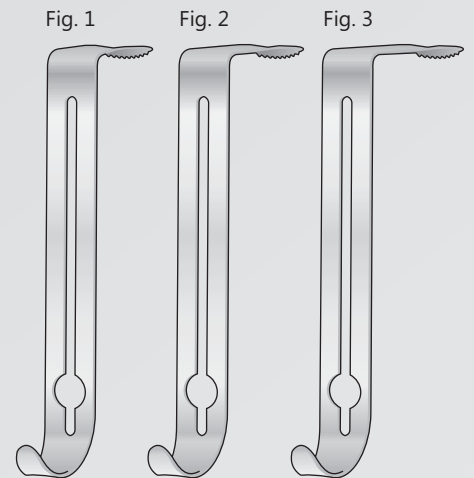

**0221-BDH 0221-BDI 0221-BDL**  
 16x19 mm 16x25 mm 16x32 mm

CLOWARD Modif.

**0221-DBL**

Sperrer, allein  
Retractor, only  
Divaricatore, solo  
Separador, suelto  
Ecarteur, seul

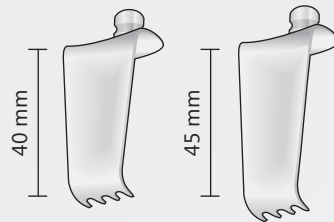

16 mm

16 mm

**0221-DCB**

**0221-DCC**

CLOWARD Modif.

**0221-DBH**

Sperrer, allein  
Retractor, only  
Divaricatore, solo  
Separador, suelto  
Ecarteur, seul

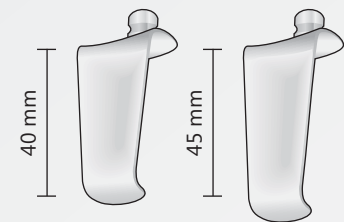

16 mm

16 mm

**0221-DCG**

**0221-DCH**

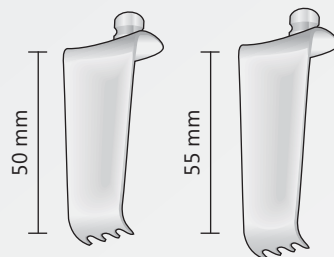

16 mm

16 mm

**0221-DCD**

**0221-DCE**

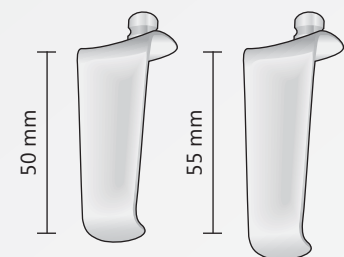

16 mm

16 mm

**0221-DCI**

**0221-DCL**

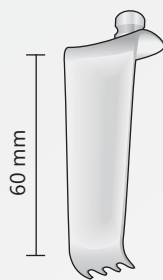

60 mm

16 mm

**0221-DCF**

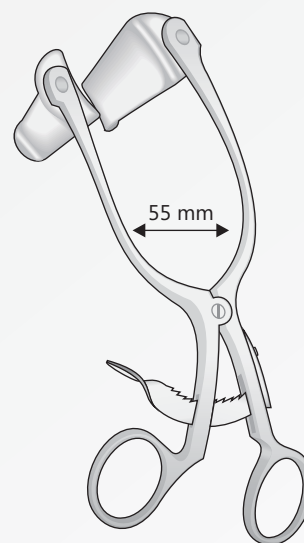

55 mm

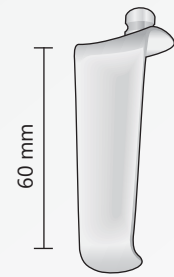

60 mm

16 mm

**0221-DDA**

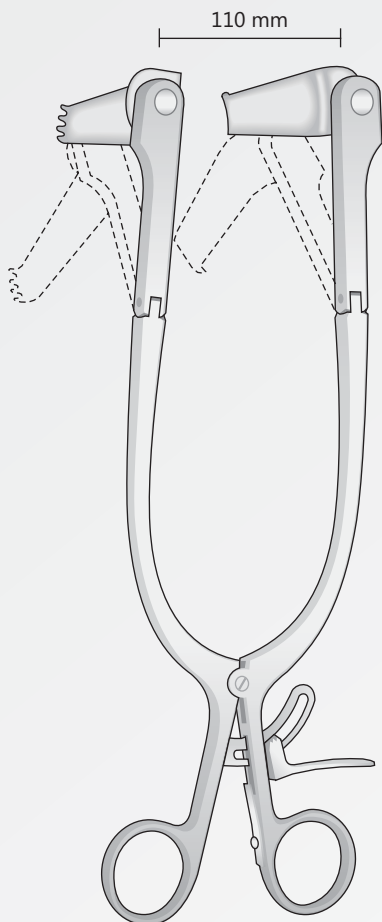

110 mm

Komplett mit 5 Valven  
Complete with 5 blades  
Completo di 5 valve  
Completo con 5 valvas  
Complet avec 5 valves

Komplett mit 5 Valven  
Complete with 5 blades  
Completo di 5 valve  
Completo con 5 valvas  
Complet avec 5 valves

CLOWARD modif.

**0221-DCA**

250 mm

CLOWARD

**0221-DBI**

160 mm

Rippensperrer  
 Rib Spreaders  
 Divaricatori costali  
 Separadores costales  
 Ecarteurs costaux

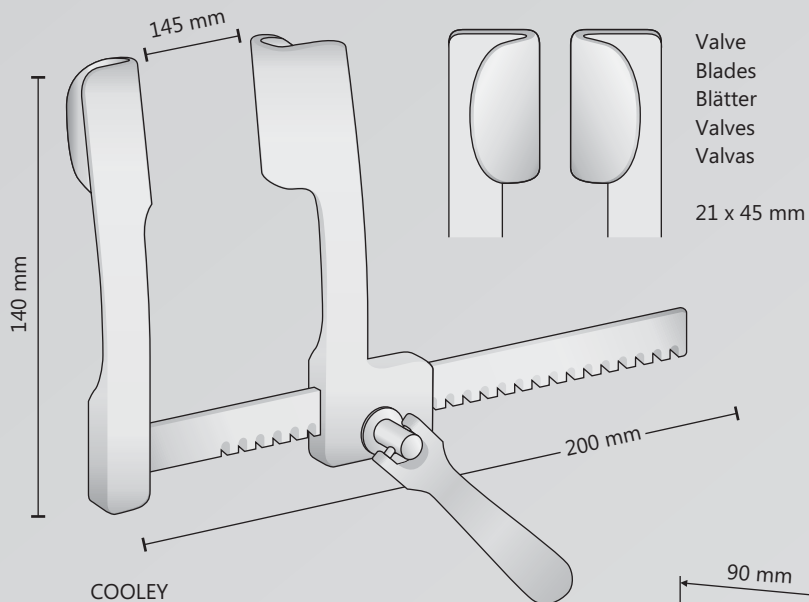

COOLEY  
**0221-FI**

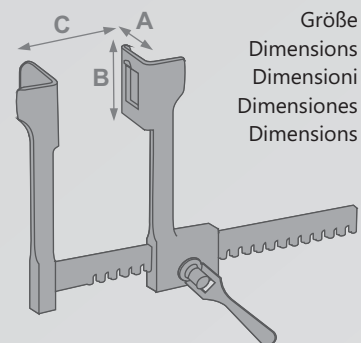

Größe  
 Dimensioni  
 Dimensioni  
 Dimensiones  
 Dimensions

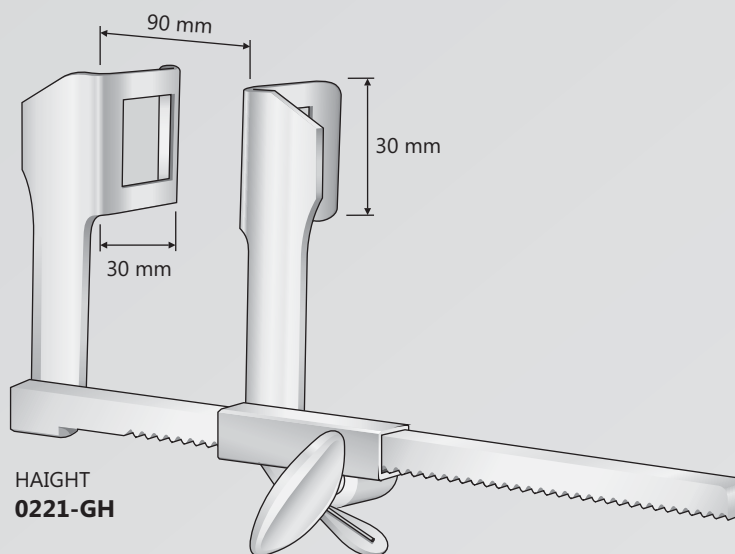

HAIGHT  
**0221-GH**

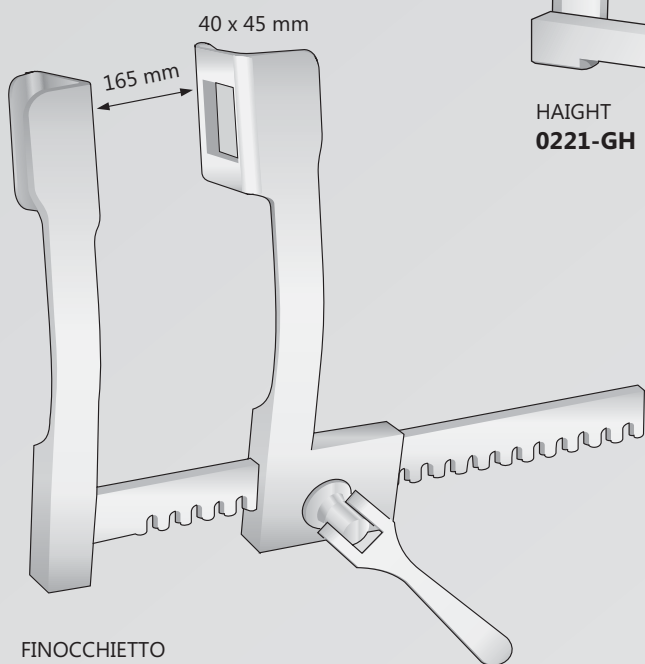

FINOCCHIETTO

- 0221-GC** A: 40 mm B: 45 mm C: 165 mm
- 0221-GE** A: 45 mm B: 65 mm C: 200 mm
- 0221-GG** A: 70 mm B: 65 mm C: 250 mm

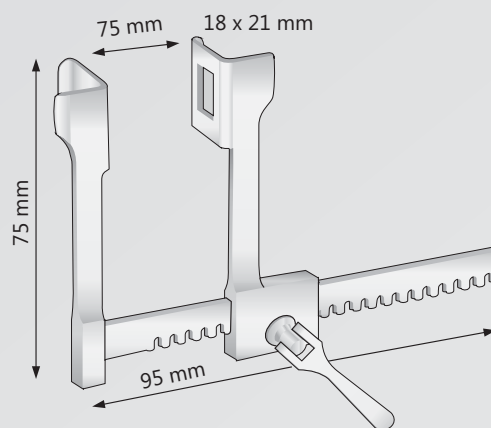

BABY FINOCCHIETTO

- 0221-GA** A: 18 mm B: 21 mm C: 75 mm

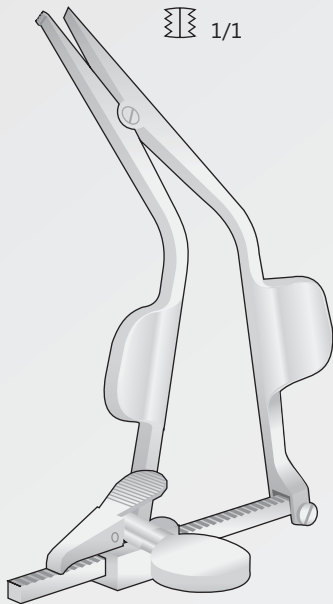

CLOWARD  
**0221-IG**  
 150 mm

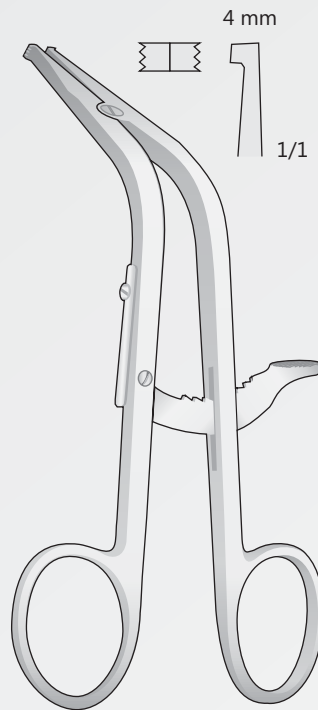

CLOWARD  
**0221-IE**  
 160 mm

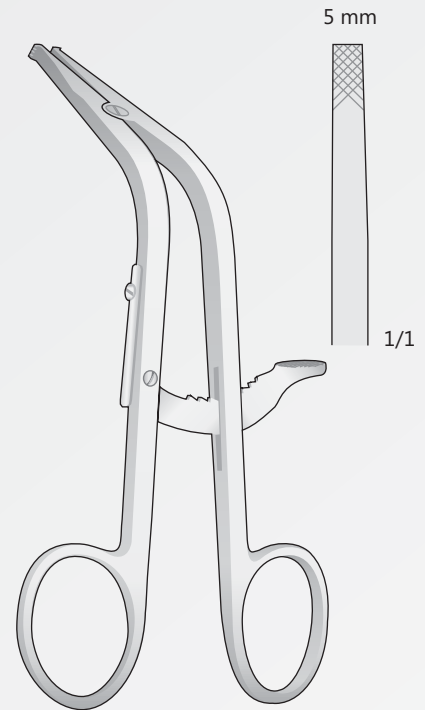

CLOWARD  
**0221-IF**  
 160 mm

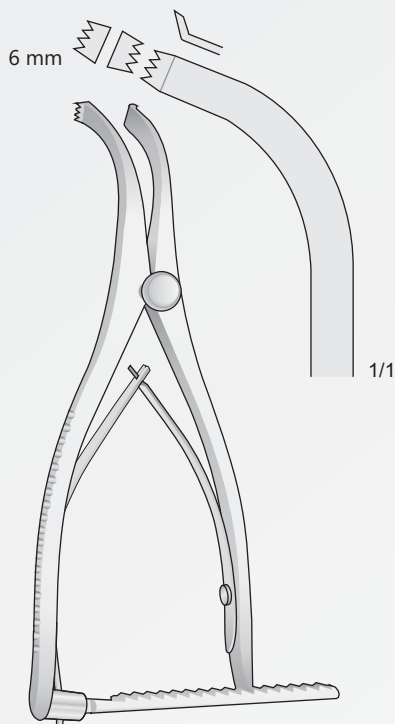

INGE  
**0221-IA**  
 160 mm

Rippenkontraktor  
 Rib Contractor  
 Approssimatore costale  
 Aproximador para costillas  
 Rapprocheur de côtes

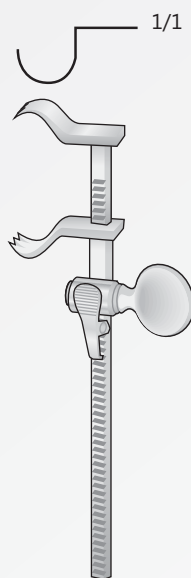

BAILEY-BABY  
**0602-CLG**  
 160 mm

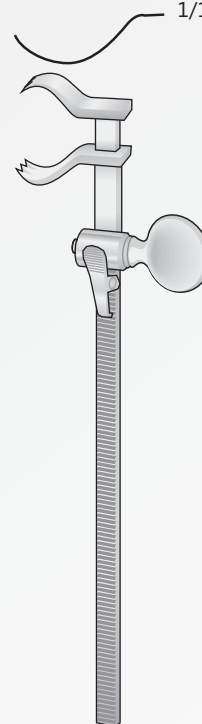

BAILEY  
**0602-CLH**  
 200 mm

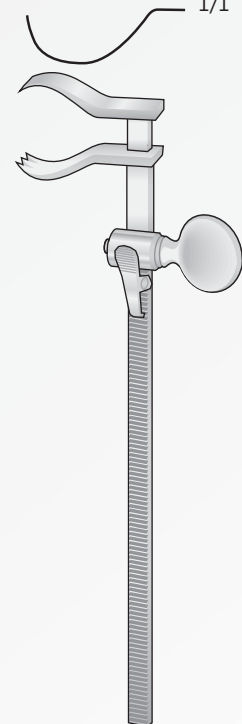

BAILEY  
**0602-CLI**  
 200 mm

Bauchdeckenhalter  
 Abdominal retractors  
 Divaricatori addominali  
 Separadores abdominales  
 Ecarteurs Abdominaux

**0221-BEB**

Komplett mit 1 Paar Valven  
 Complete with 1 pairs of blades  
 Completo con un paio di valve  
 Completos con 1 pares de valvas  
 Complete avec 1 paires de valves

**0221-BEG**

Komplett mit 2 paar valven  
 Complete with 2 pairs of blades  
 Completo con due paia di valve  
 Completos con 2 pares de valvas  
 Complete avec 2 paires de valves

**0221-BEF**

Komplett mit 1 Paar Valven  
 Complete with 1 pairs of blades  
 Completo con un paio di valve  
 Completos con 1 pares de valvas  
 Complete avec 1 paires de valves

**0221-BEI**

Sperrer allein  
 Retractor only  
 Divaricatore solo  
 Separador suelto  
 Ecarteur seul

**0221-DHC**

32x62 mm  
 Seitl.blätter - paar  
 Lateral blades - pairs  
 Valve laterali - paia  
 Valvas laterales - pares  
 Valves latérales - paires

**0221-BEC** 20x44 mm

**0221-BED** 30x44 mm

Seitl. Blätter - paar  
 Lateral blades - pairs  
 Valve laterali - paia  
 Valvas laterales - pares  
 Valves latérales - paires

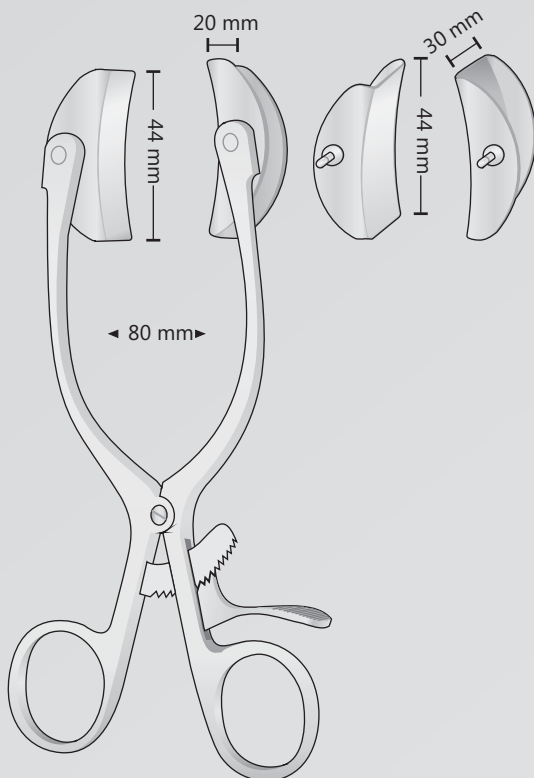

BABY-COLLIN  
**0221-BEB**  
 180 mm

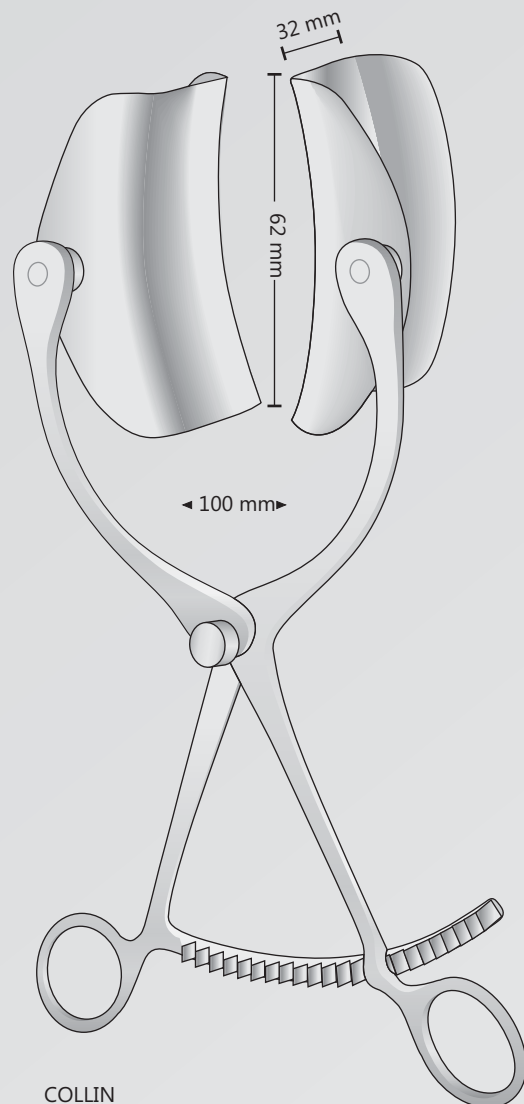

COLLIN  
**0221-BEF**  
 220 mm





MEYERDING  
**0219-LH/0219-LL**

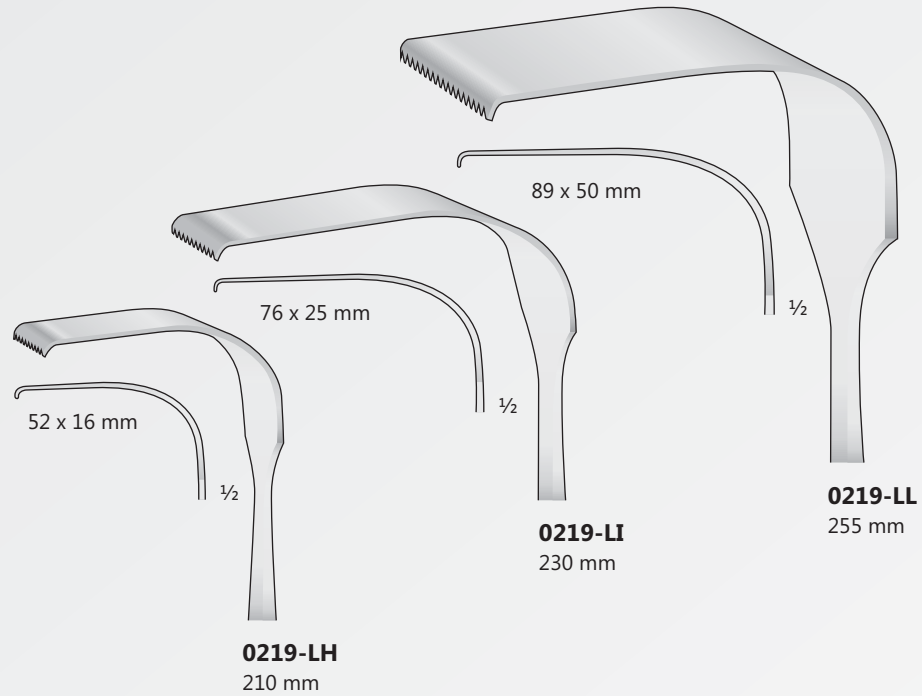

**0219-LH**  
210 mm

**0219-LI**  
230 mm

**0219-LL**  
255 mm

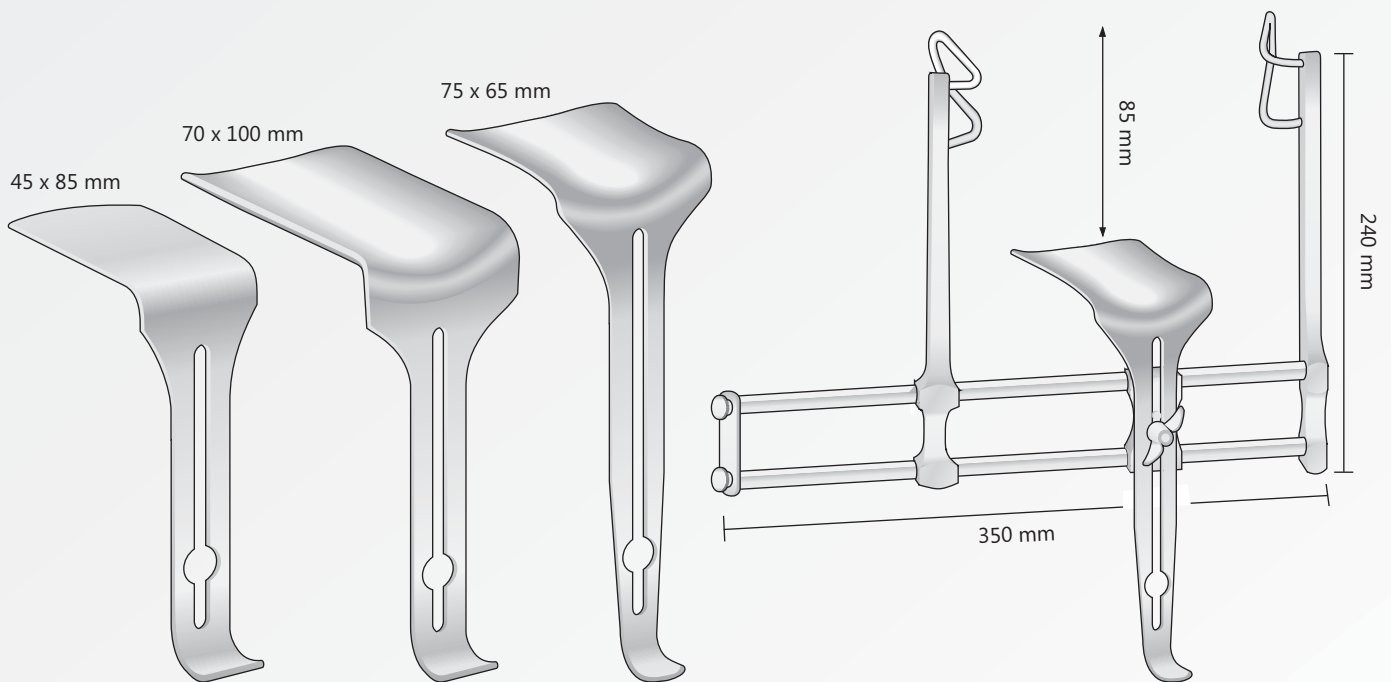

**0221-BFA**  
170 mm

**0221-BFC**  
200 mm

**0221-BFB**  
230 mm

BALFOUR MODIF.  
**0221-EG**

Bauchdeckenhalter  
 Abdominal retractors  
 Divaricatori addominali  
 Separadores abdominales  
 Ecarteurs Abdominaux

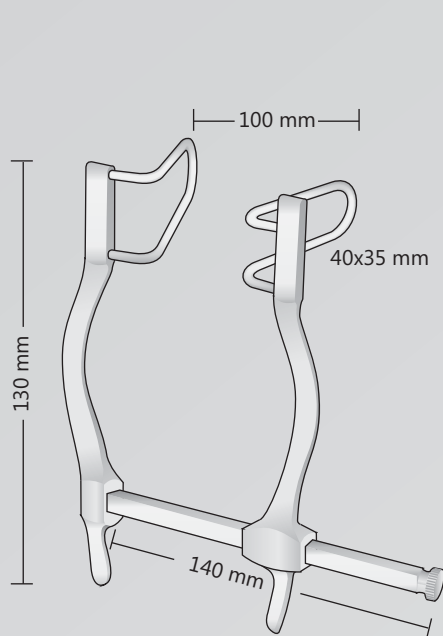

GOSSET  
**0221-DB**

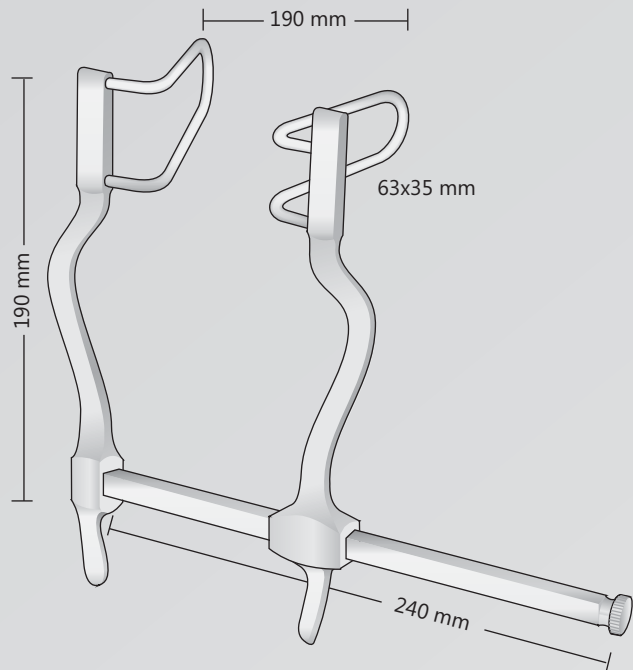

GOSSET  
**0221-DA**

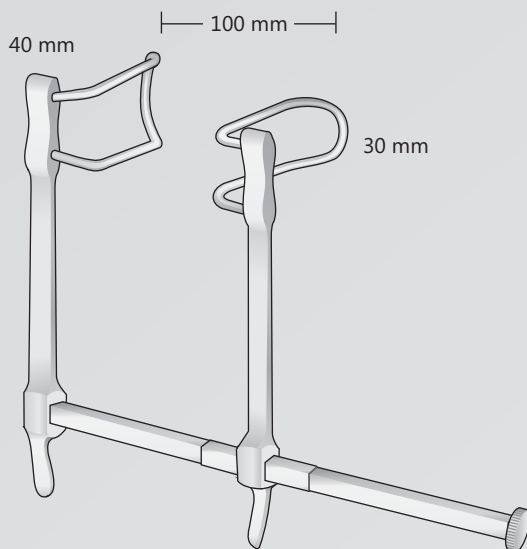

GOSSET  
**0221-DD**

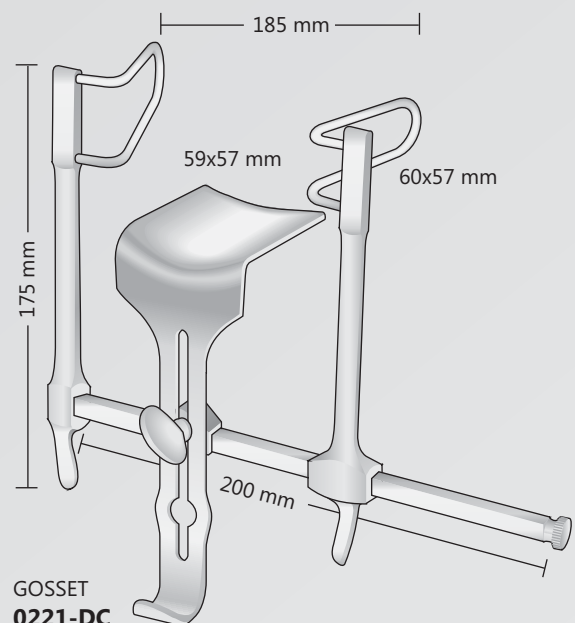

GOSSET  
**0221-DC**

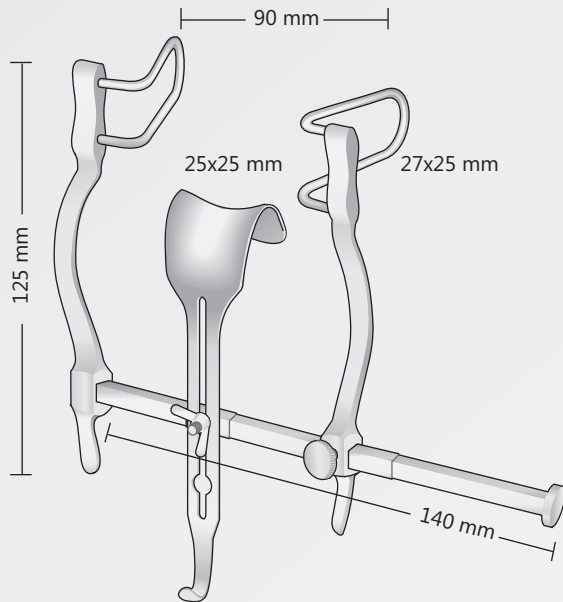

BALFOUR-BABY  
**0221-EB**

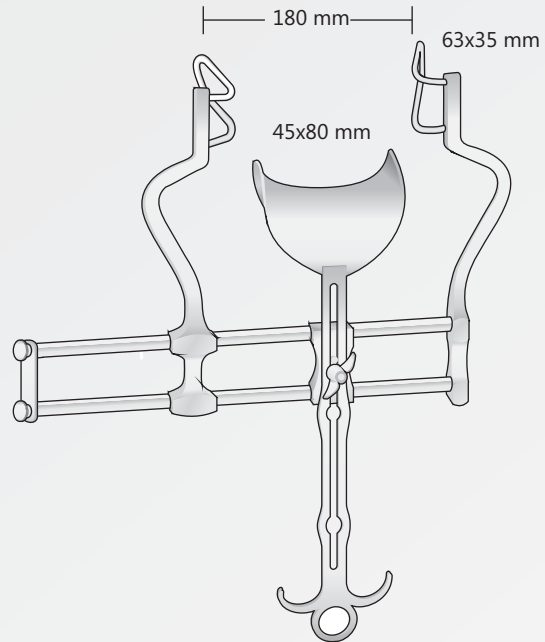

BALFOUR  
**0221-EA**

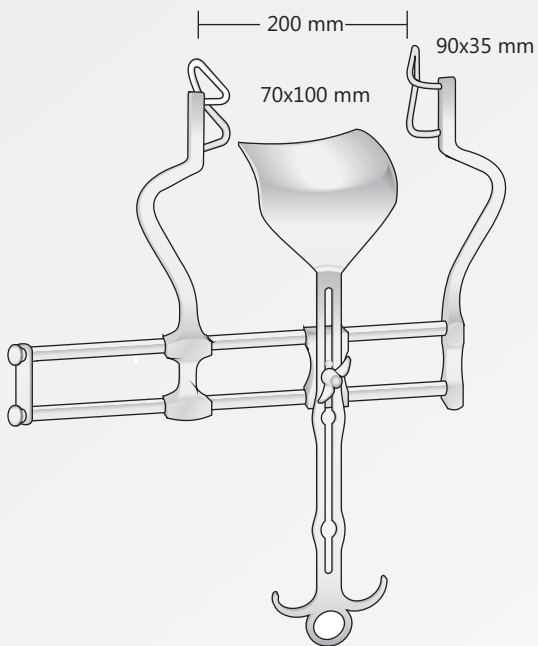

BALFOUR  
**0221-EC**

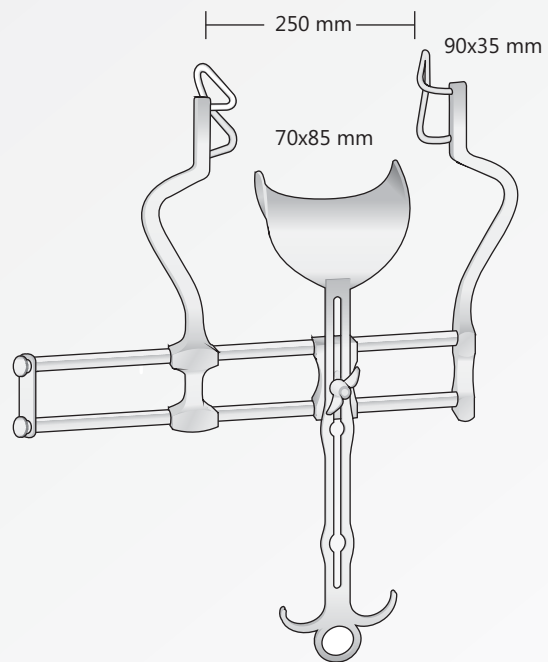

BALFOUR  
**0221-ED**

Schraubendreher  
Screw Driver  
Cacciavite  
Destornillador  
Tournevis



CASPAR  
**0606-CAG**  
200 mm

Spezialbohrer  
Special Drill  
Punta speciale  
Taladro especial  
Perceuse spéciale

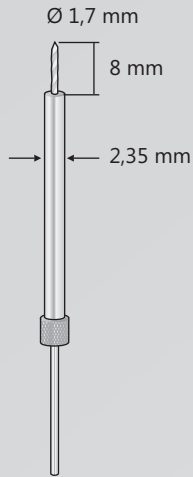

CASPAR  
**0606-CAD**  
145 mm

Distraktionsschrauben  
Distraction Screw  
Viti da distrazione  
Tornillos de distracción  
Vis de distraction

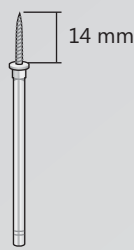

CASPAR  
**0606-CAE**  
70 mm



CASPAR  
**0606-CAF**  
70 mm

Bohrbüchse rechts, Allein  
Drilling Guide right, Only  
Guida punte destro, solo  
Drill Guide à droite, seule  
Guía de taladro derecho, sólo

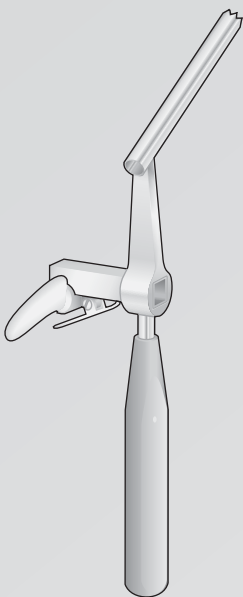

**0606-BLC**

Bohrbüchse Allein  
Drilling Guide only  
Guida punte solo  
Guía de taladro sólo  
Guide de perçage seulement

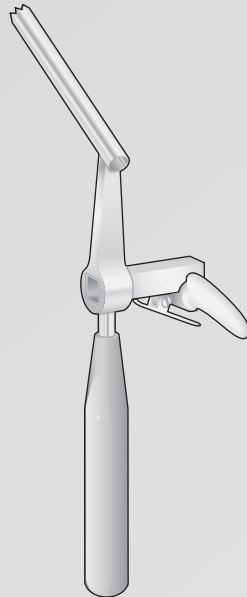

**0606-CAC**

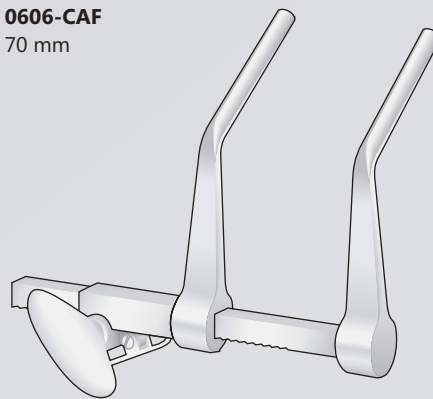

CASPAR  
**0606-BLB**  
Distraktor rechts, Allein  
Distractor right, Only  
Distrattore destro, solo  
Distractor derecho, sólo  
Distracteur droite seule

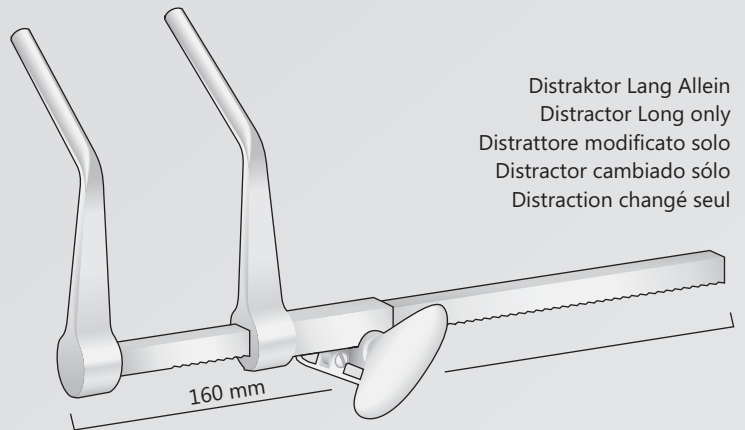

CASPAR  
**0606-CAB12**

Distraktor Lang Allein  
Distractor Long only  
Distrattore modificato solo  
Distractor cambiado sólo  
Distraction changé seul

CASPAR

**0606-BLA**

Distraktor komplett rechts  
Distractor complete right  
Distrattore completo destro

**0606-BLB** 1 Distraktor allein - 1 Distractor only

**0606-BLC** 1 Bohrbüchse - 1 Drilling Guide

**0606-CAD** 1 Spezialbohrer - 1 Special Drill

**0606-CAF** 2 Distraktionsschrauben - 2 Distraction Screws

**0606-CAG** 1 Schraubendreher - 1 Screw Driver

CASPAR

**0606-CAA12**

Distraktor Lang komplett  
Distractor Long complete  
Distrattore modificato completo

**0606-CAB12** 1 Distraktor Lang allein - 1 Distractor Long only

**0606-CAC** 1 Bohrbüchse - 1 Drilling Guide

**0606-CAD** 1 Spezialbohrer - 1 Special Drill

**0606-CAF** 2 Distraktionsschrauben - 2 Distraction Screws

**0606-CAG** 1 Schraubendreher - 1 Screw Driver

CASPAR

**0606-CAB**

Distraktor links, Allein  
Distractor left, Only  
Distrattore sinistro, solo  
Distractor izquierda, sólo  
Distracteur gauche, seule



 ideal-tek

**Elevatorii, Raspatorii und Scharfe Löffel**  
**Elevators, Periosteal Raspatories and Sharp curettes**  
**Curette, Cucchiari taglienti**  
**Elevadores, Legras y Cucharillas cortantes**  
**Elevateurs, Rugines, et Curettes tranchantes**



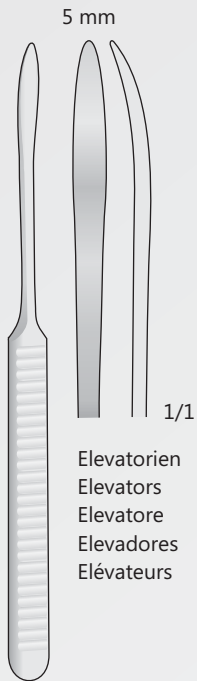

WILLIGER  
**2207-BA**  
 165 mm

Elevatorien  
 Elevators  
 Elevatore  
 Elevadores  
 Elévateurs

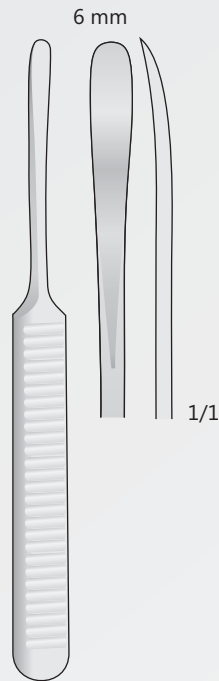

WILLIGER  
**2207-BC**  
 160 mm

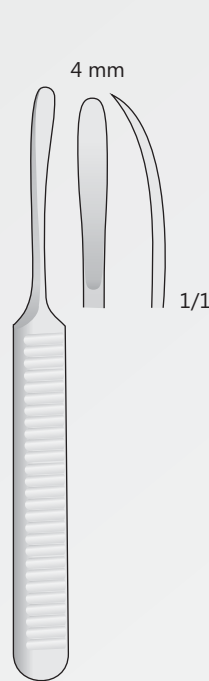

WILLIGER  
**2207-BE**  
 140 mm

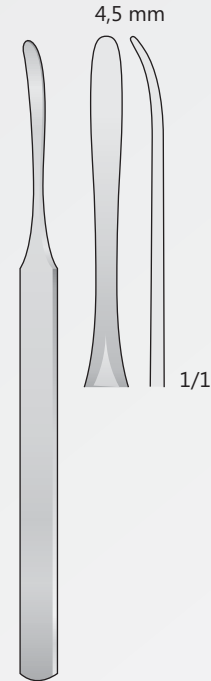

KÖNIG  
**1014-B**  
 155 mm

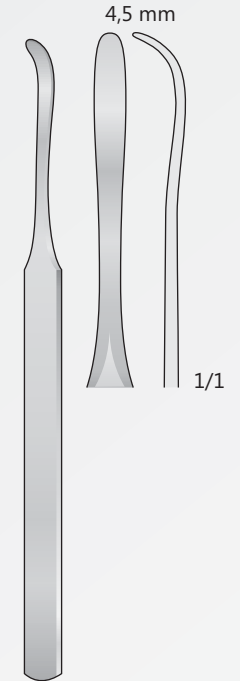

KÖNIG  
**1014-C**  
 155 mm

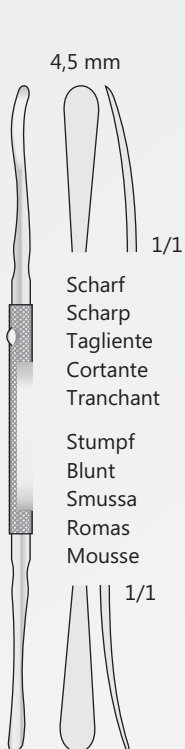

**0617050517**  
 180 mm

Scharf  
 Scharp  
 Tagliente  
 Cortante  
 Tranchant

Stumpf  
 Blunt  
 Smussa  
 Romas  
 Mousse

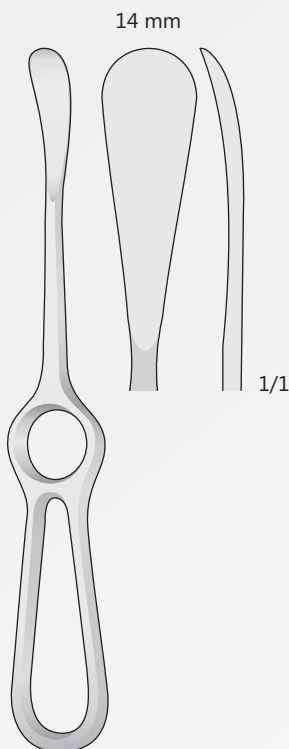

SEDILLOT  
**0219-DH**  
 210 mm

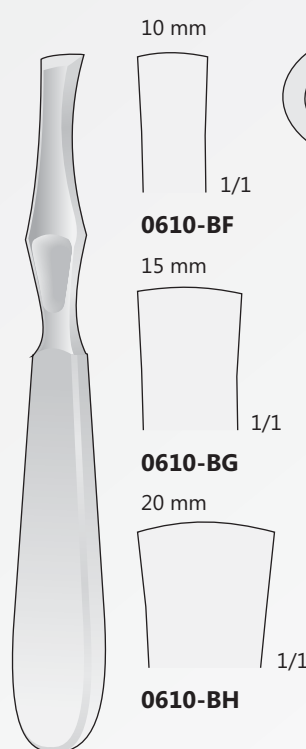

LAMBOTTE  
**0610-BF/0610-BH**  
 205 mm

**0610-BF**

15 mm

**0610-BG**

20 mm

**0610-BH**

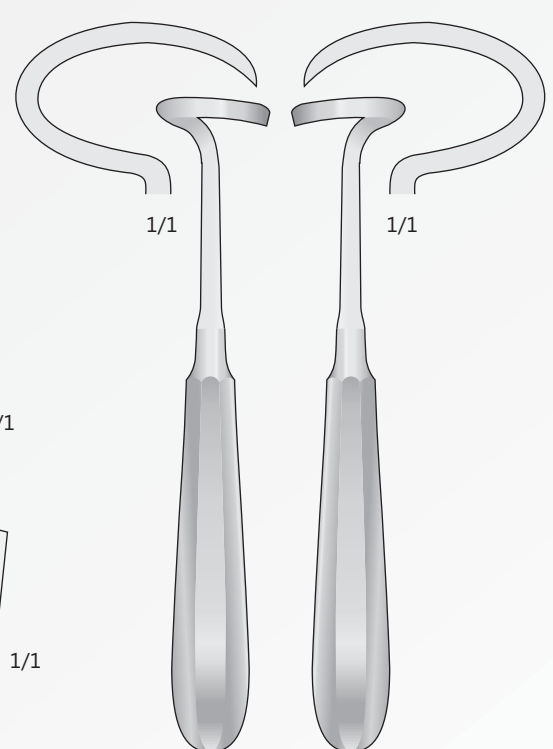

DOYEN  
**0610-BI**  
 180 mm

DOYEN  
**0610-BL**  
 180 mm

Raspatorien  
 Periosteal Raspatories  
 Periostotomi  
 Legras periostotomos  
 Rugines à periostomie

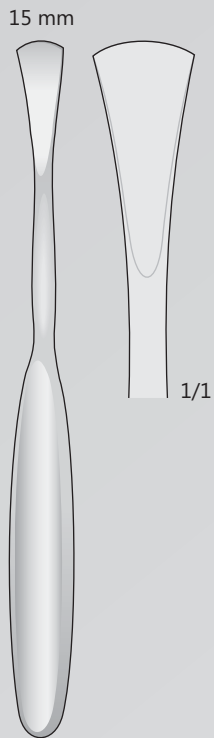

CUSHING  
**0610-CFC**  
 190 mm

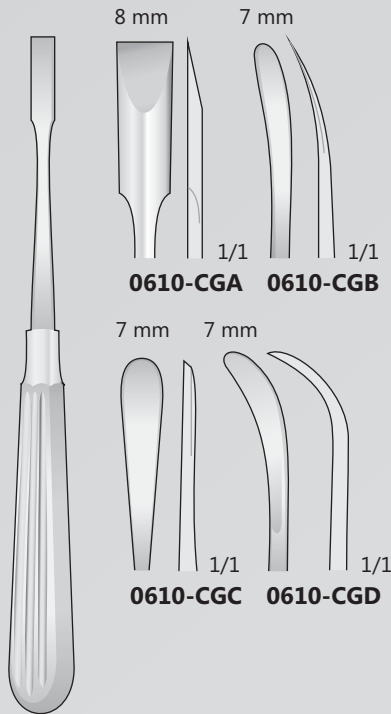

ADSON  
**0610-CGA/0610-CGD**  
 170 mm

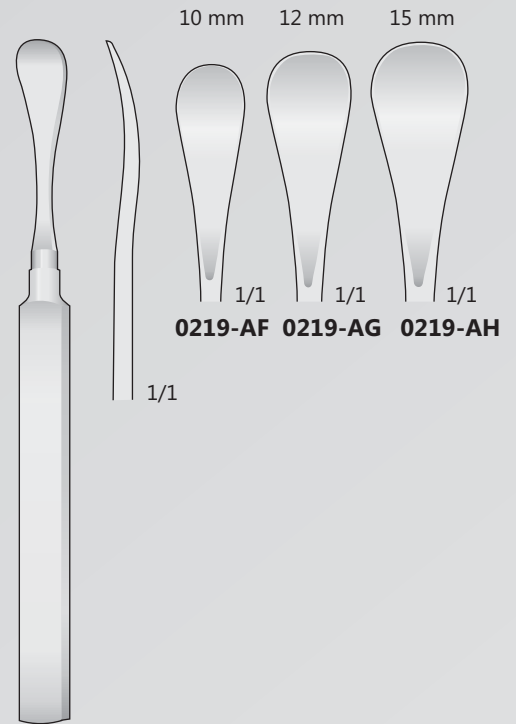

HENAHAN  
**0219-AF/0219-AH**  
 175 mm

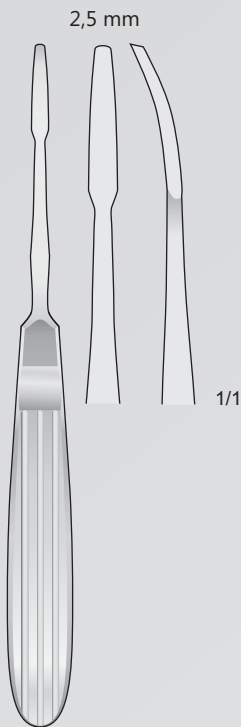

JOSEPH  
**0610-IA**  
 170 mm



JOSEPH  
**0610-IC**  
 180 mm

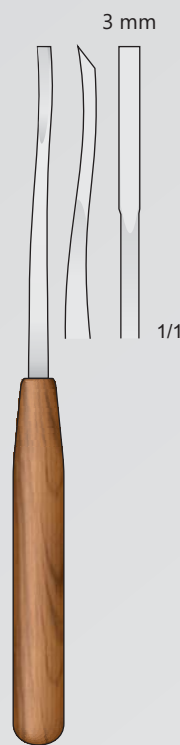

**0610-CDE**  
 180 mm

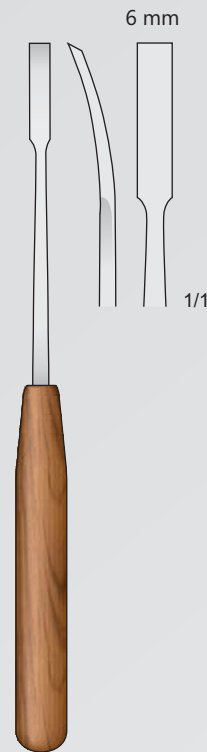

**0610-CDA**  
 190 mm

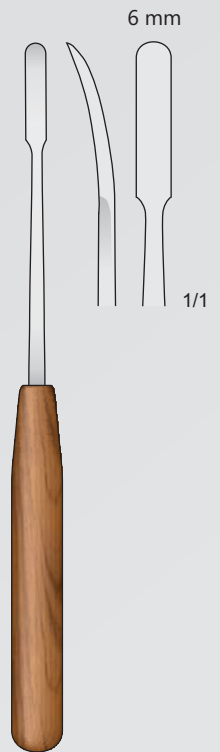

**0610-CDC**  
 190 mm



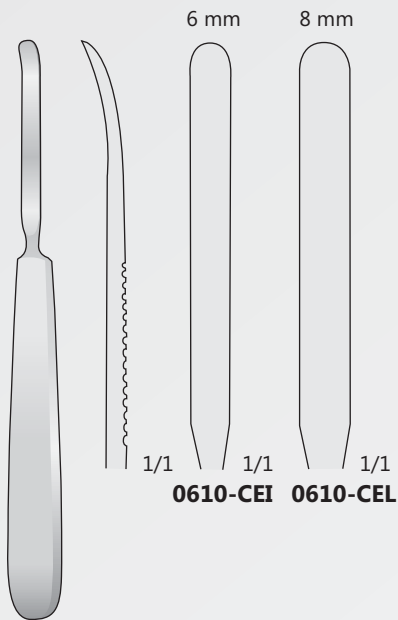

**0610-CEI/0610-CEL**  
 170 mm

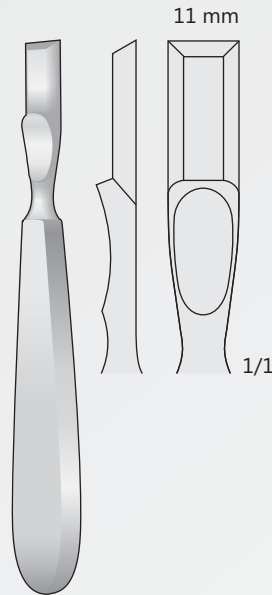

FARABEUF-COLLIN  
**0610-CEH**  
 160 mm

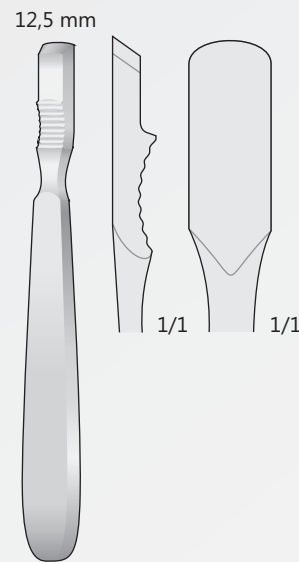

FARABEUF  
**0610-CFA**  
 150 mm

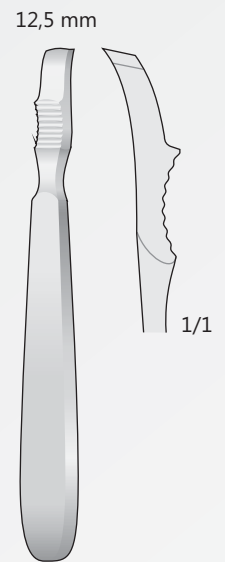

FARABEUF  
**0610-CFB**  
 150 mm

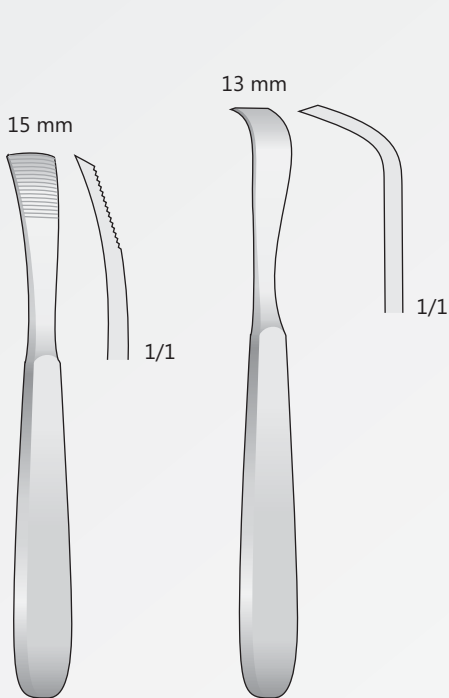

JANSEN  
**0610-CFF**  
 165 mm

SCHNEIDER  
**0610-CFI**  
 175 mm

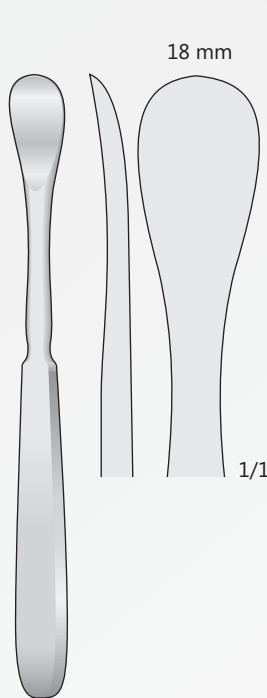

SEDILLOT  
**0610-CFE**  
 185 mm

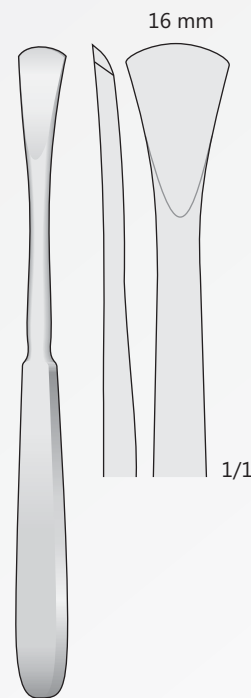

LANGENBECK  
**0610-CFG**  
 190 mm

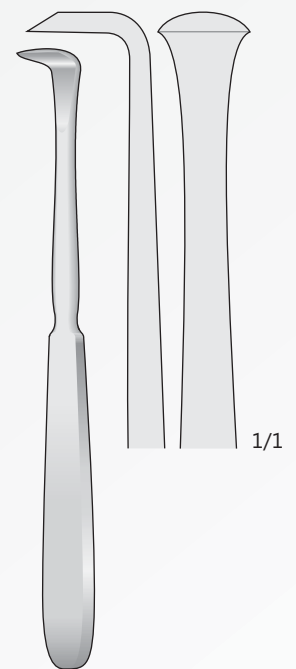

LANGENBECK  
**0610-CFH**  
 180 mm

Knochenhebel  
 Bone Levers  
 Leve per ossa  
 Elevadores para huesos  
 Leviers à os

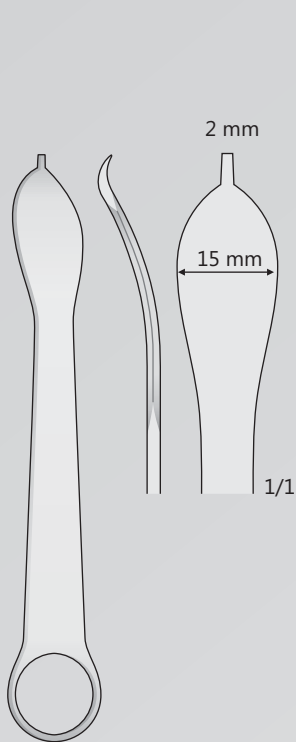

**0610-EF**  
120 mm

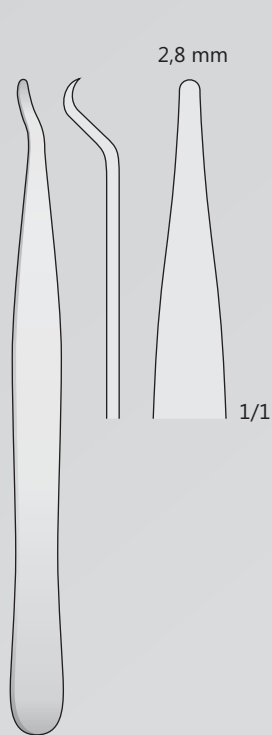

**0610-EG**  
140 mm

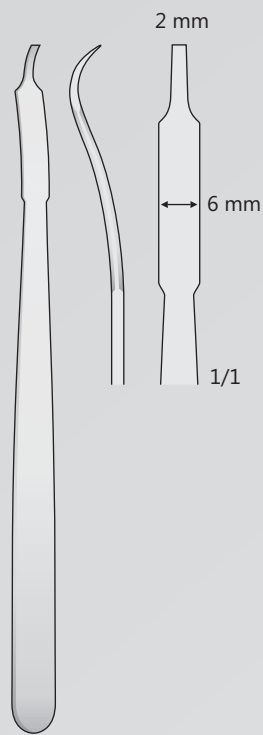

MINI-HOHMANN  
**0610-EI**  
160 mm

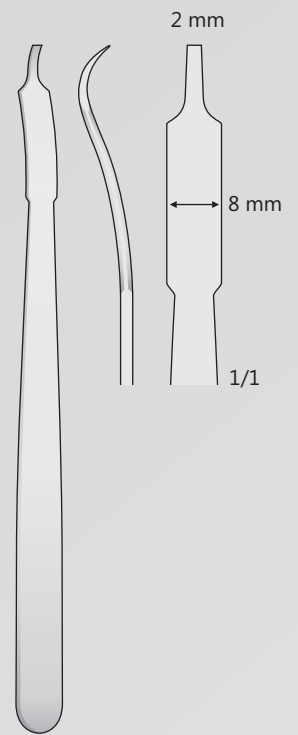

MINI-HOHMANN  
**0610-EL**  
160 mm

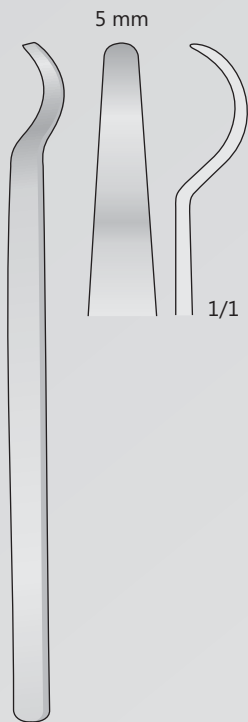

**0610-DA**  
150 mm

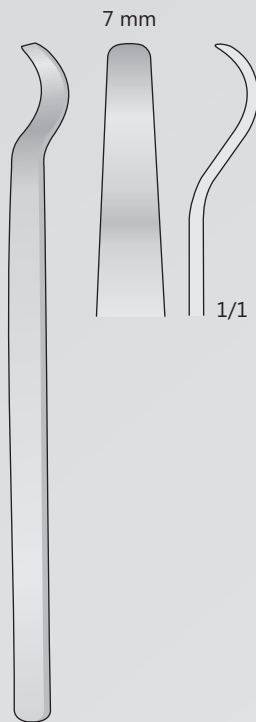

**0610-CI**  
150 mm

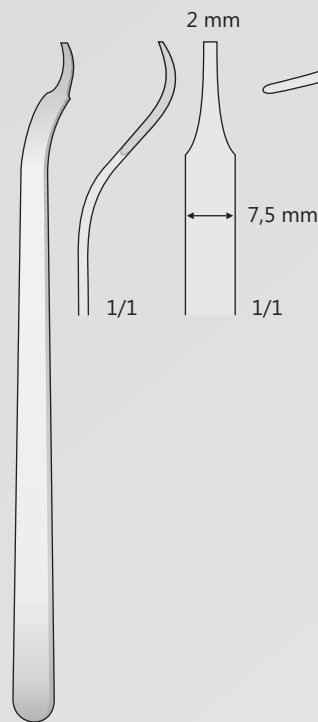

BUCK-GRAMCKO  
**0610-CA**  
150 mm

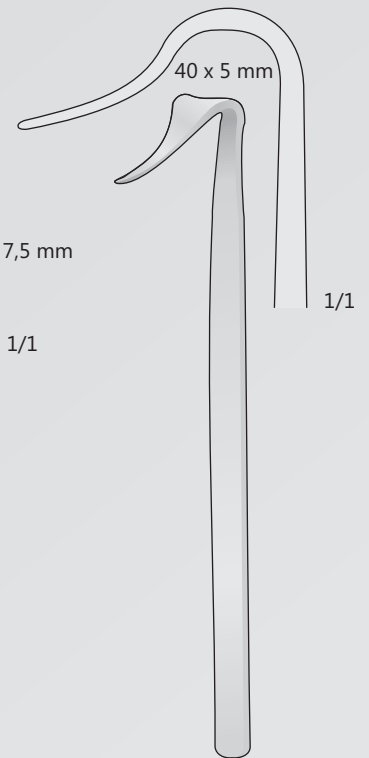

BLOUNT  
**0610-CH**  
175 mm

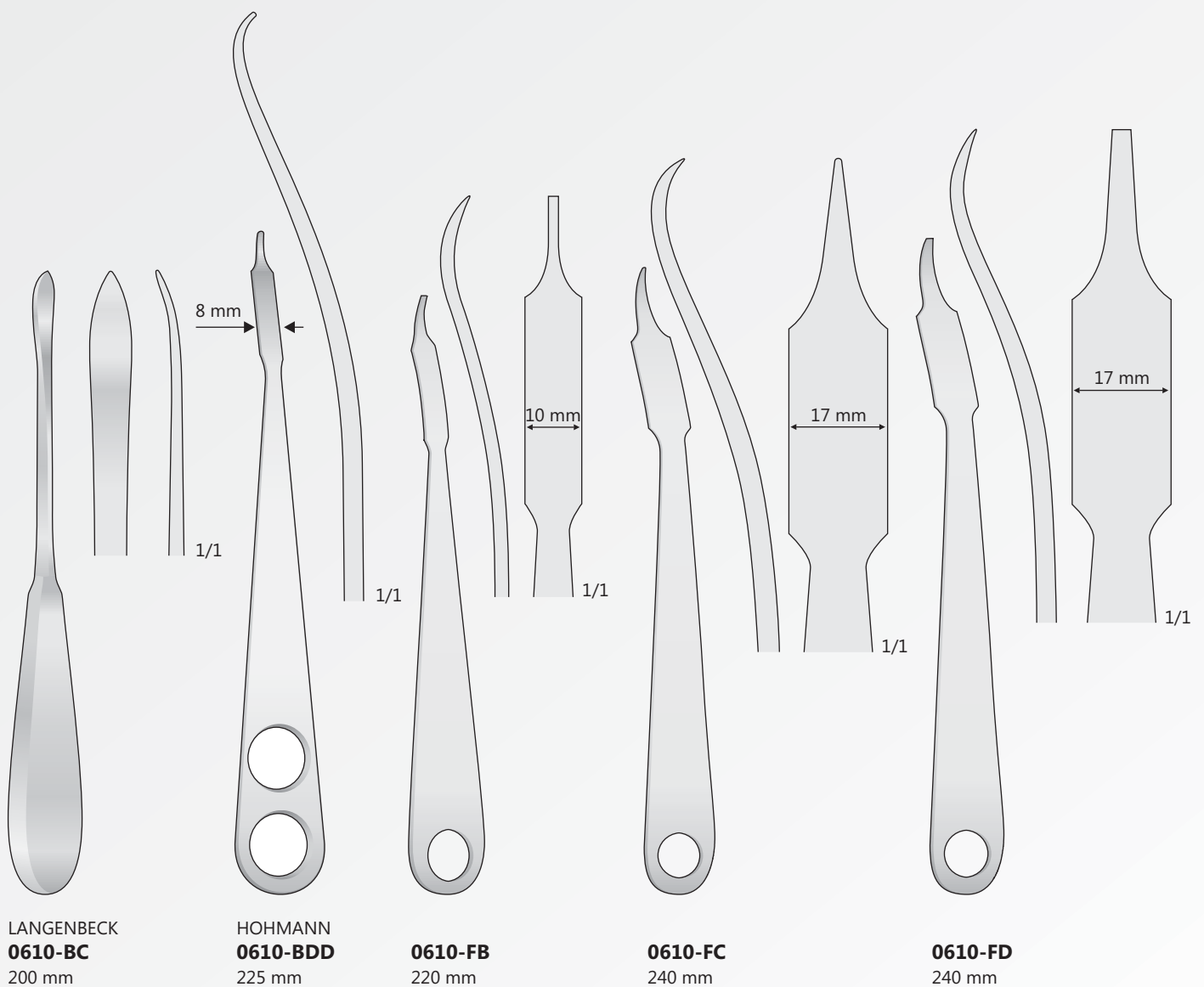

Knochenhebel  
Bone Levers  
Leve per ossa  
Elevadores para huesos  
Leviers à os

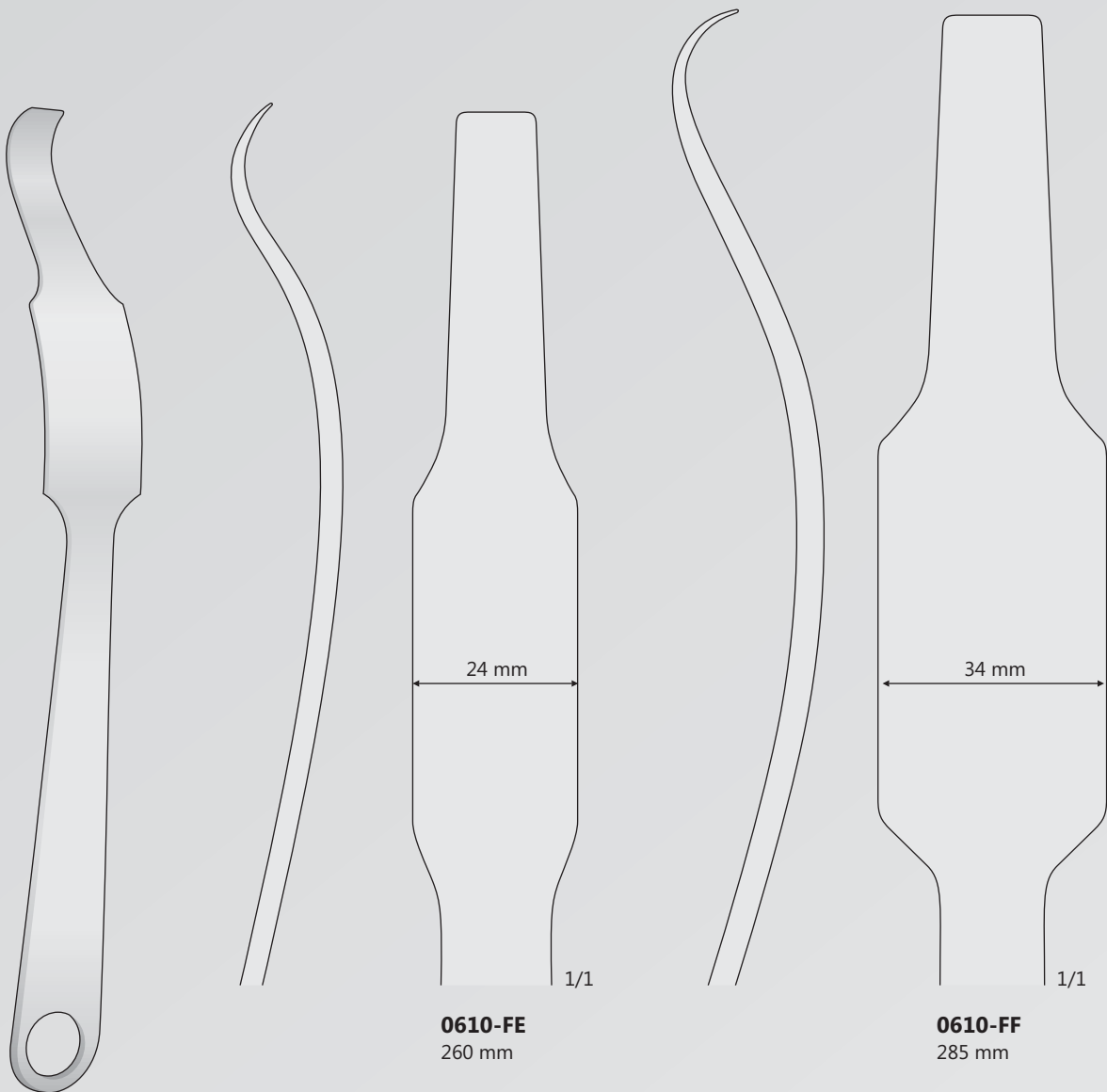

HOHMANN  
**0610-FE/0610-FF**

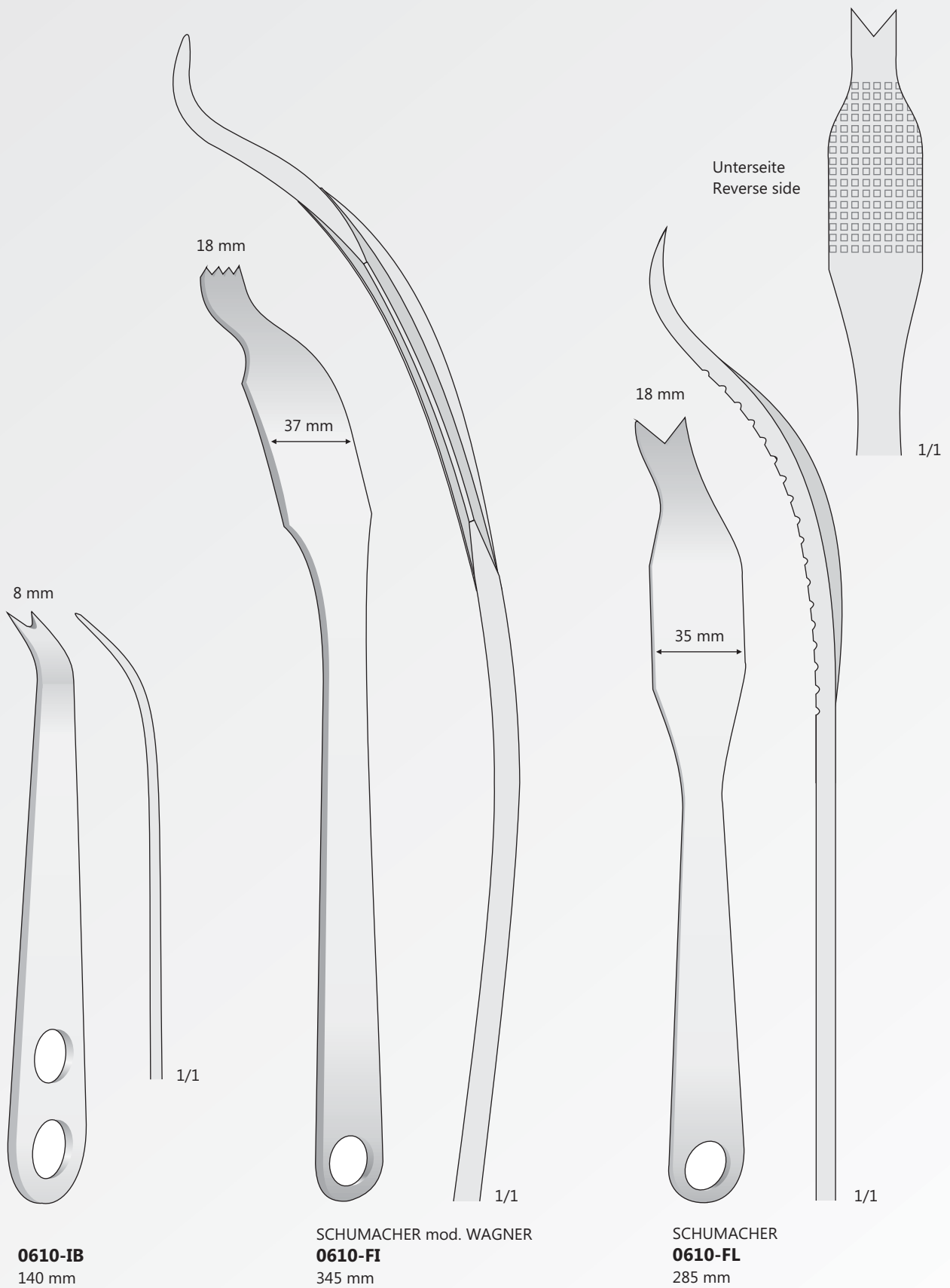

Knochenhebel  
 Bone Levers  
 Leve per ossa  
 Elevadores para huesos  
 Leviers à os

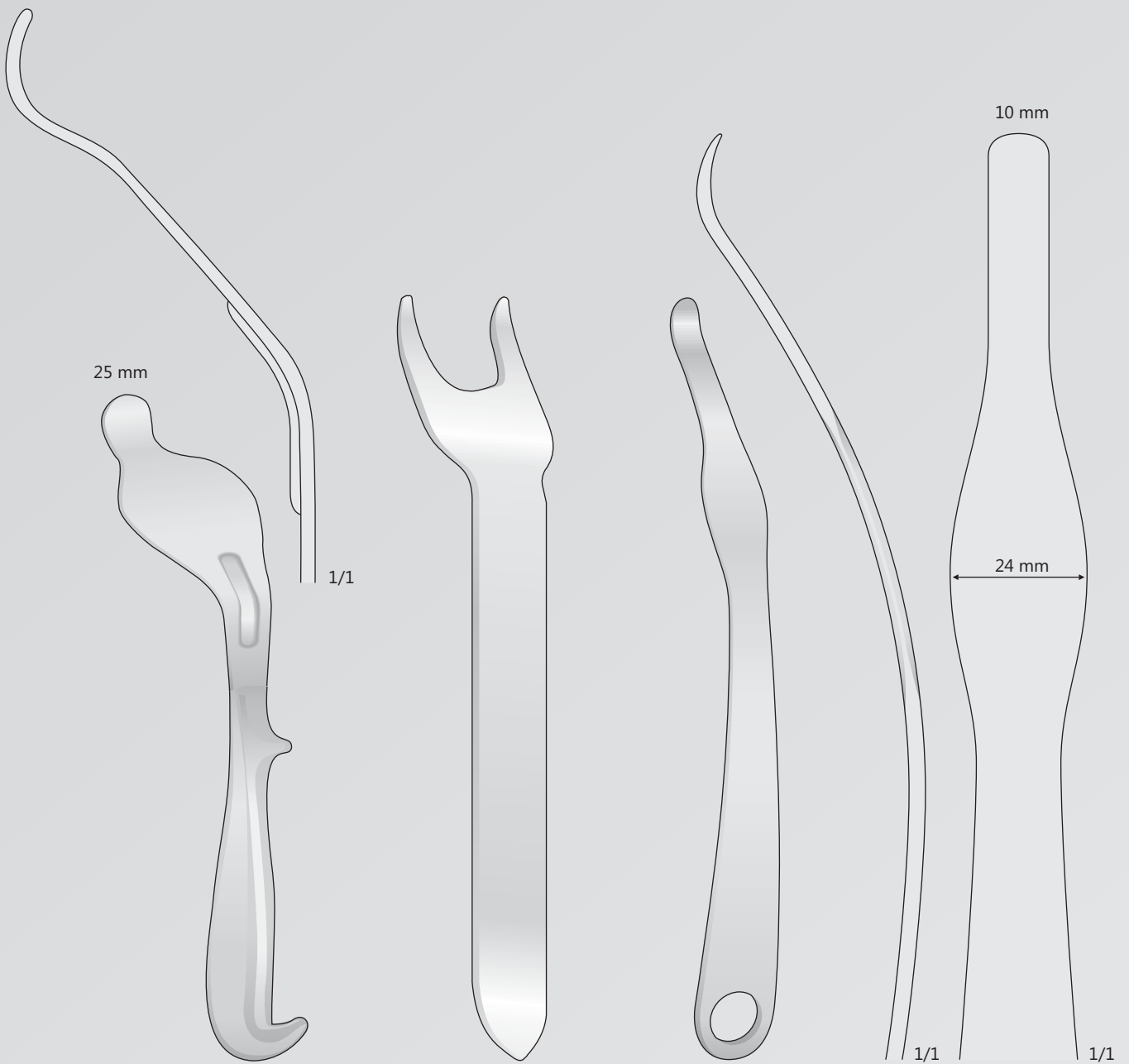

BENNETT  
**0610-BHG** 43 mm  
**0610-BHL** 60 mm  
 240 mm

BLOUNT  
**0610-LD**  
 260 mm

**0610-FG**  
 260 mm

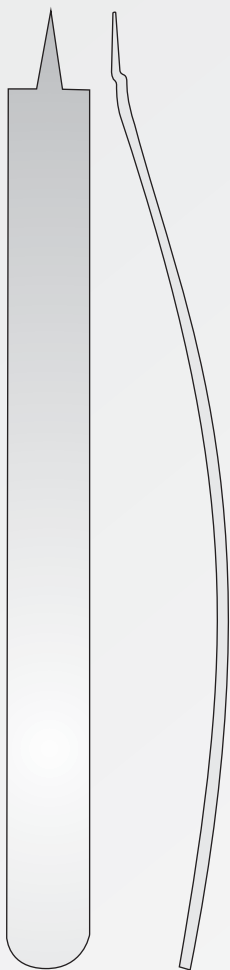

**0610-BGE**  
250 mm

Spinalhaken  
Spinal Retractors  
Divaricatore spinale  
Separadores espinales  
Ecarteurs spinaux

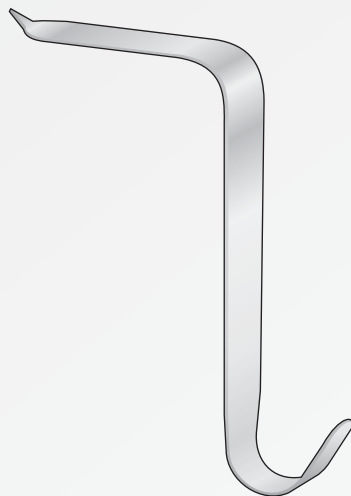

**0610-BGI** 75 x 30 mm  
**0610-BGL** 100 x 30 mm  
165 mm

TAYLOR

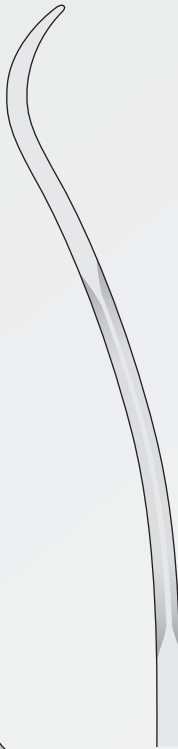

1/1

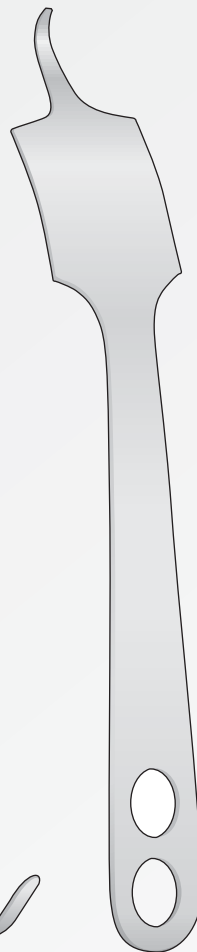

HOHMANN

**0610-EH/0610-FH**  
240 mm

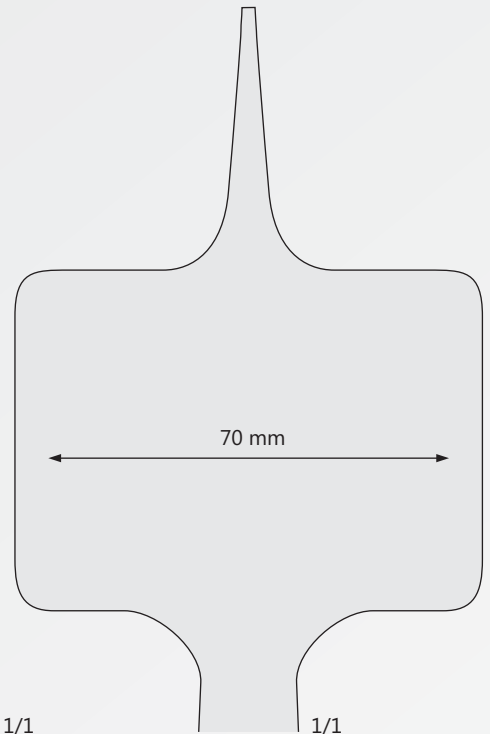

1/1

**0610-EH**  
240 mm

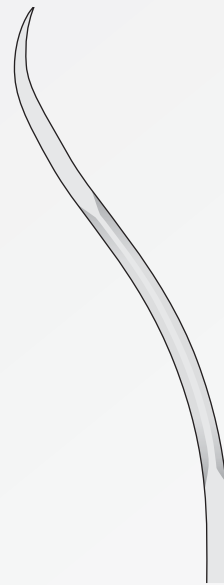

1/1

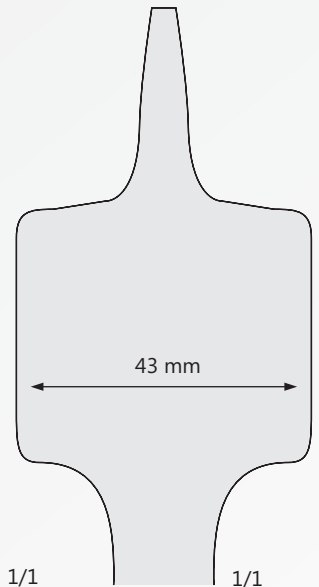

1/1

**0610-FH**  
240 mm

Scharfe Löffel  
 Sharp cures  
 Curette, Cucchiari taglienti  
 Cucharillas cortantes  
 Curettes tranchantes

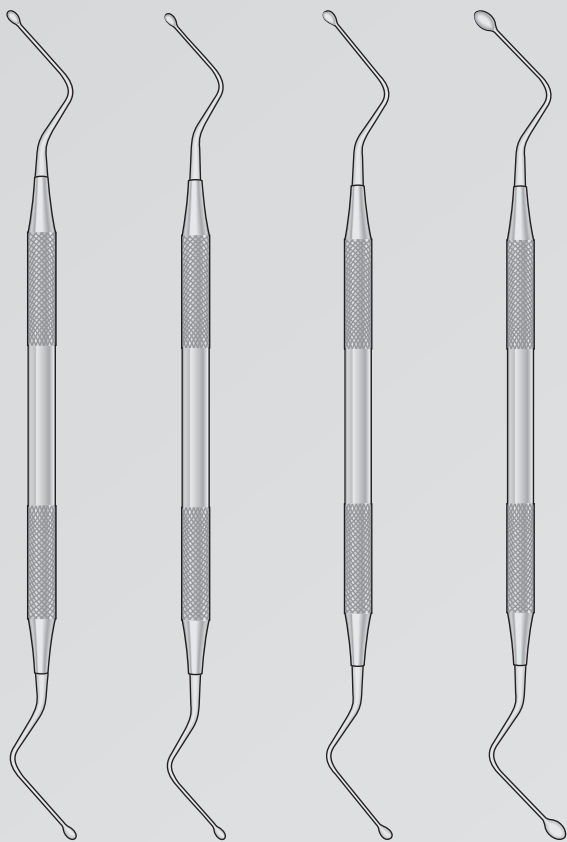

**HEMINGWAY 03-B** 175 mm  
**HEMINGWAY 03-C** 175 mm  
**HEMINGWAY 03-D** 175 mm  
**HEMINGWAY 03-E** 175 mm

Fig. 1

Fig. 2

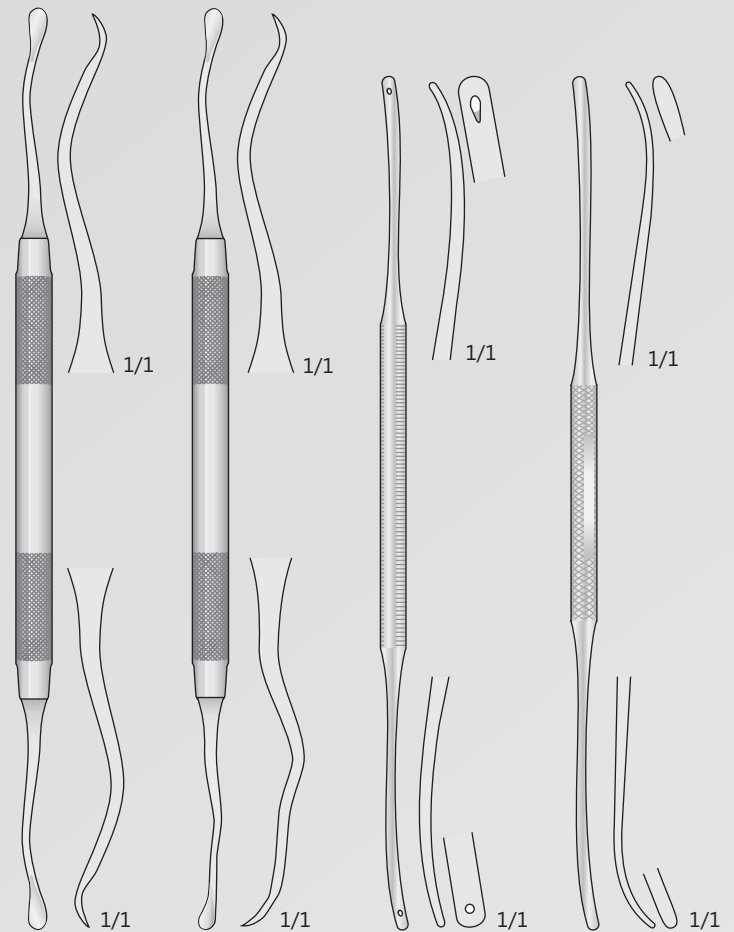

**1811-B** 200 mm  
**1811-C** 195 mm  
**1014-BG** 180 mm  
**OLIVECRONA 1014-EH** 180 mm



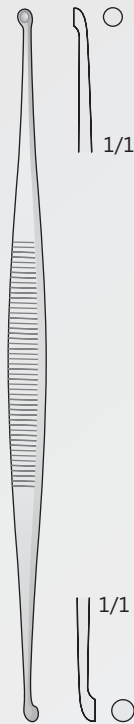

MARTINI  
**0610-HA**  
 140 mm

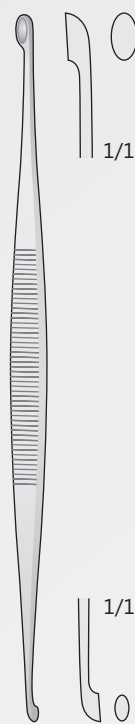

WILLIGER  
**0610-HB**  
 145 mm

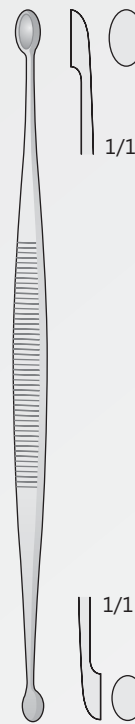

JACOBSON  
**0610-HF**  
 140 mm

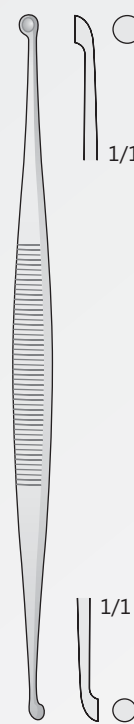

MARTINI  
**0610-HG**  
 140 mm

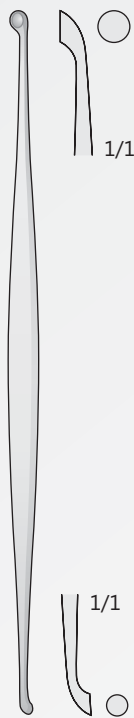

JANSEN  
**0610-HH**  
 160 mm



BARTH  
**0610-HI**  
 180 mm

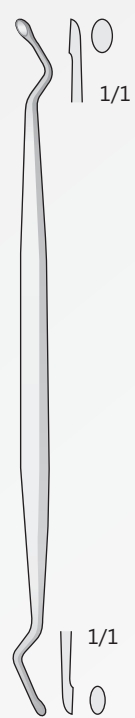

**0610-ID**  
 160 mm

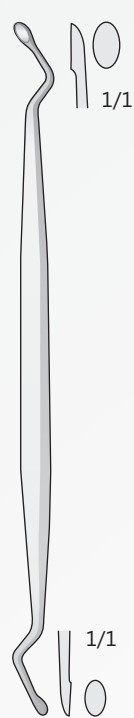

JANSEN  
**0610-IE**  
 160 mm

Scharfe Löffel  
 Sharp curettes  
 Curette, Cucchiari taglienti  
 Cucharillas cortantes  
 Curettes tranchantes

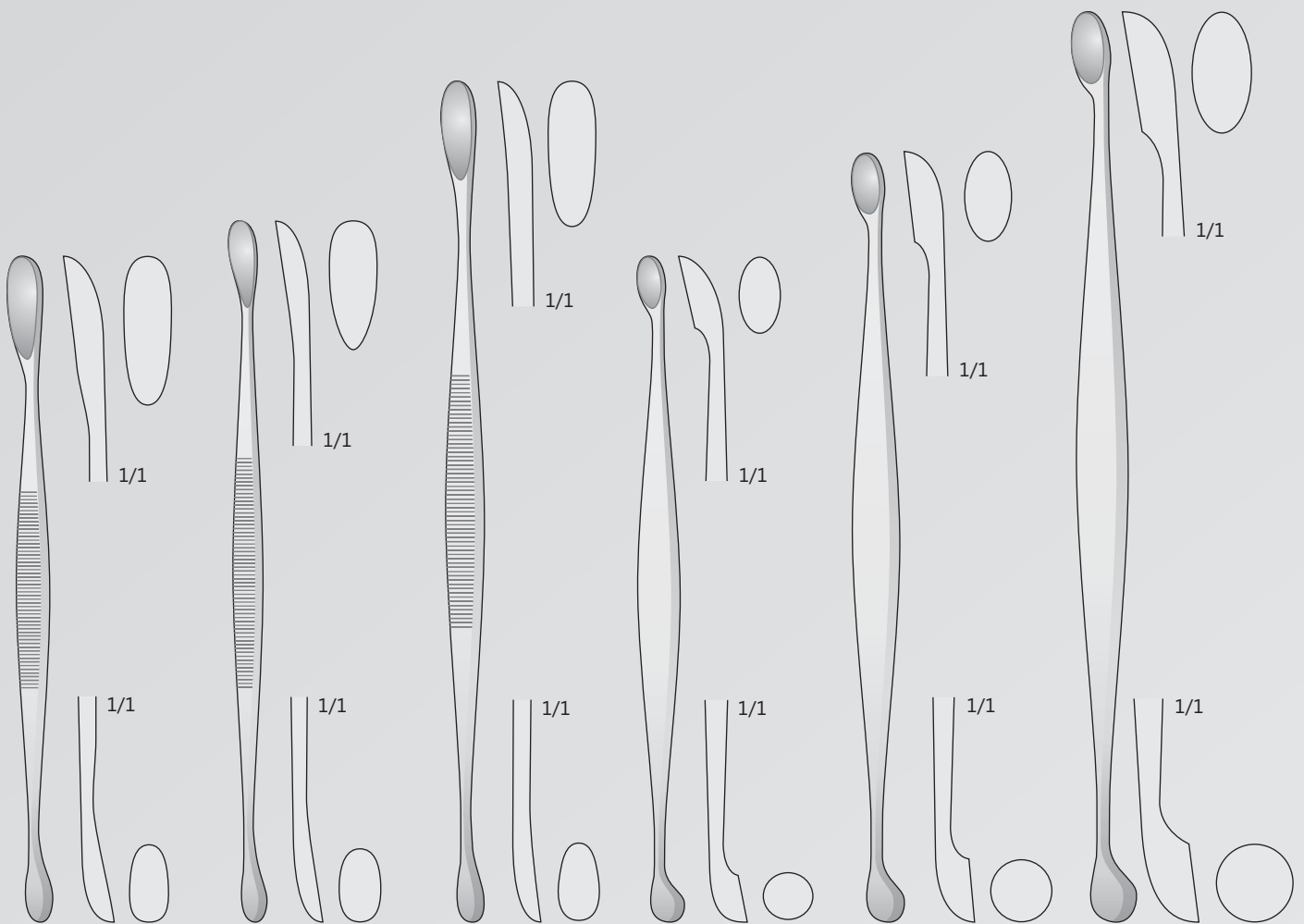

VOLKMANN  
**0610-HL**  
 130 mm

VOLKMANN  
**0610-HC**  
 145 mm

VOLKMANN  
**0610-HD**  
 170 mm

**0610-BHH**  
 130 mm

**0610-HE**  
 160 mm

**0610-BHI**  
 200 mm

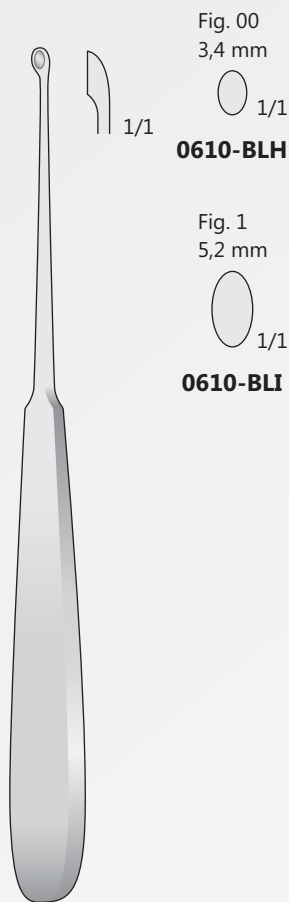

WILLIGER  
**0610-BLH/0610-BLI**  
 170 mm

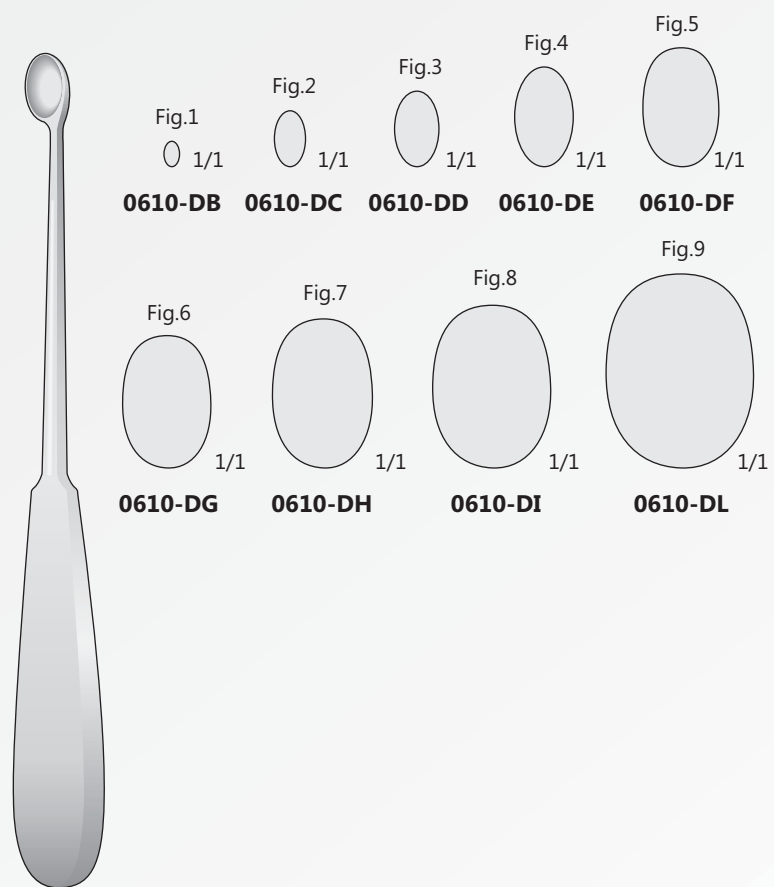

**0610-DB/0610-DL**  
 210 mm

Scharfe Löffel  
 Sharp currettes  
 Curette, Cucchiai taglienti  
 Cucharillas cortantes  
 Currettes tranchantes



- |                                  |                                  |                                  |                                  |
|----------------------------------|----------------------------------|----------------------------------|----------------------------------|
| Fig.1<br>○ 1/1<br><b>0610-AB</b> | Fig.2<br>○ 1/1<br><b>0610-AC</b> | Fig.3<br>○ 1/1<br><b>0610-AD</b> | Fig.4<br>○ 1/1<br><b>0610-AE</b> |
| Fig.5<br>○ 1/1<br><b>0610-AF</b> | Fig.6<br>○ 1/1<br><b>0610-AG</b> | Fig.7<br>○ 1/1<br><b>0610-AH</b> | Fig.8<br>○ 1/1<br><b>0610-AI</b> |

**0610-AB/0610-AI**  
 180 mm

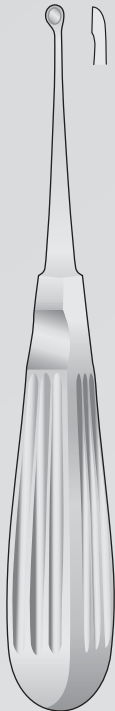

- |   |  |   |   |   |
|---|--|---|---|---|
| Fig.0000<br>2,8 mm<br>○ 1/1<br><b>0610-GA</b> | Fig.000<br>3,6 mm<br>○ 1/1<br><b>0610-GB</b> | Fig.00<br>4,4 mm<br>○ 1/1<br><b>0610-GC</b> | ,Fig.0<br>5,2 mm<br>○ 1/1<br><b>0610-GD</b> | Fig.1<br>6,8 mm<br>○ 1/1<br><b>0610-GE</b>  |
| Fig.2<br>8,5 mm<br>○ 1/1<br><b>0610-GF</b>    | Fig.3<br>10 mm<br>○ 1/1<br><b>0610-GG</b>    | Fig.4<br>11,5 mm<br>○ 1/1<br><b>0610-GH</b> | Fig.5<br>13 mm<br>○ 1/1<br><b>0610-GI</b>   | Fig.6<br>14,5 mm<br>○ 1/1<br><b>0610-GL</b> |

VOLKMANN  
**0610-GA/0610-GL**  
 170 mm

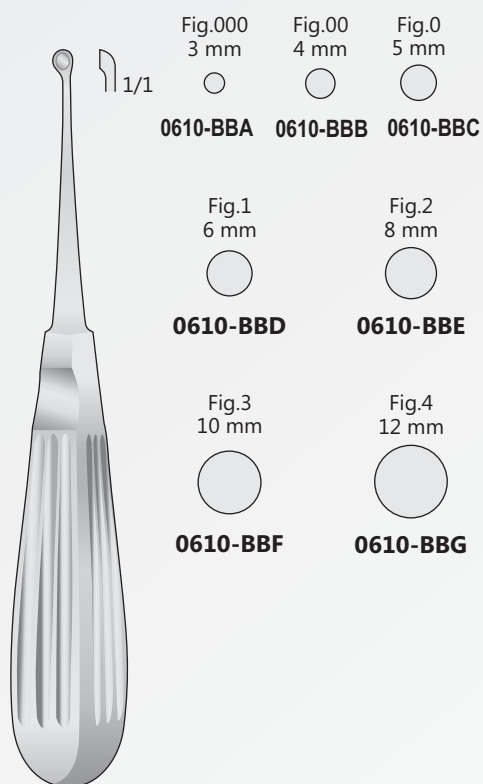

BRUNS  
**0610-BBA/0610-BBG**  
 165 mm

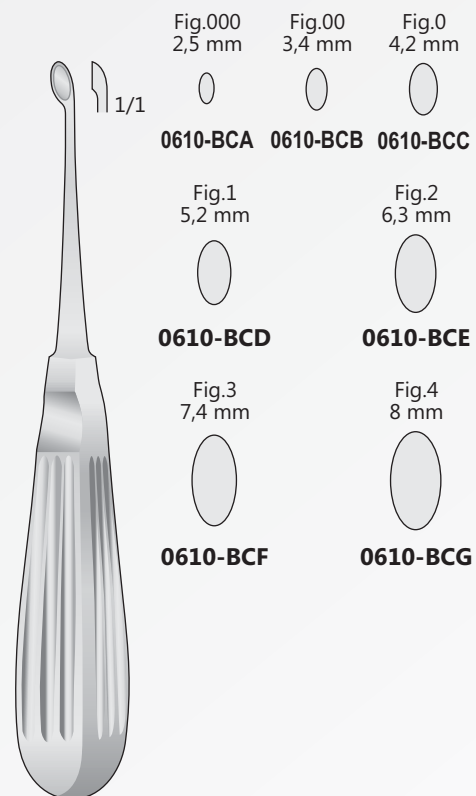

SCHEDE  
**0610-BCA/0610-BCG**  
 170 mm

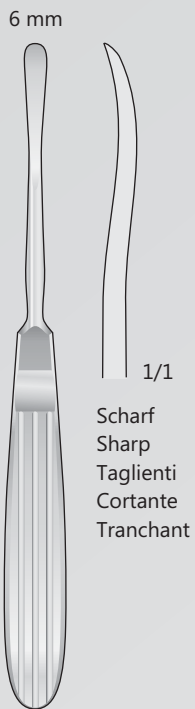

Scharf  
Sharp  
Taglienti  
Cortante  
Tranchant

OBWEGESER  
**0414-FL**  
175 mm

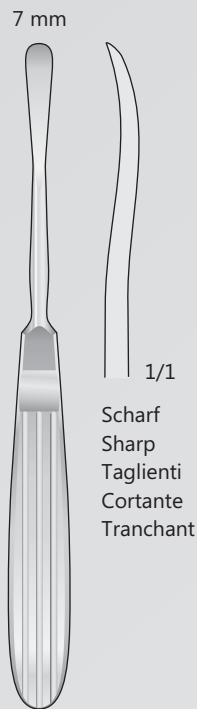

Scharf  
Sharp  
Taglienti  
Cortante  
Tranchant

OBWEGESER  
**0414-GD**  
175 mm

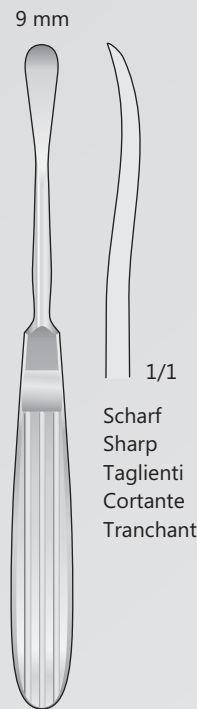

Scharf  
Sharp  
Taglienti  
Cortante  
Tranchant

OBWEGESER  
**0414-GH**  
175 mm

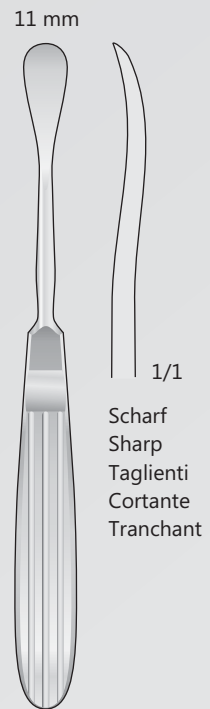

Scharf  
Sharp  
Taglienti  
Cortante  
Tranchant

OBWEGESER  
**0414-GF**  
175 mm



 ideal-tek

Hohlmeisselzangen, Laminektomie-Zangen  
Bone rongeurs, Laminectomy Rongeurs  
Pinze ossivore, Laminotomi  
Pinzas-Gubias, Pinzas cortantes para laminectomia  
Pincas-Gouges, Pincas emporte-pièces à laminectomie





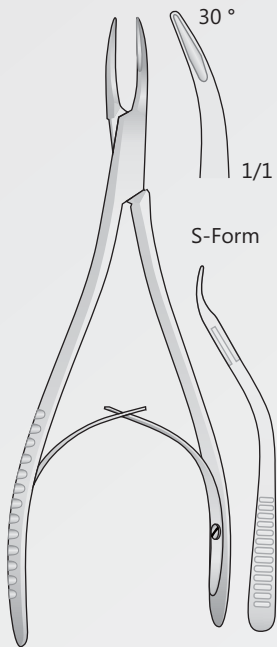

MINI-FRIEDMANN  
**0614-IF**  
 150 mm

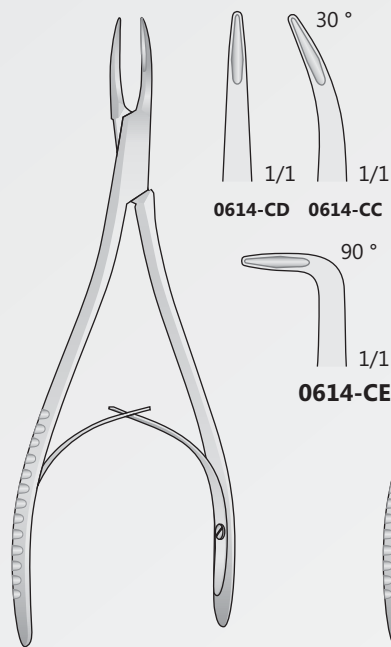

MINI-FRIEDMANN  
**0614-CC/0614-CE**  
 150 mm

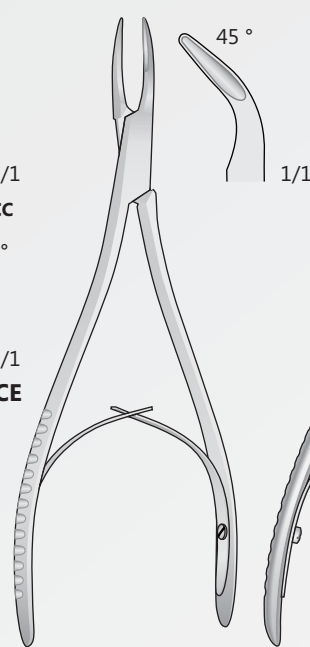

MINI-FRIEDMANN  
**0614-CCA**  
 150 mm

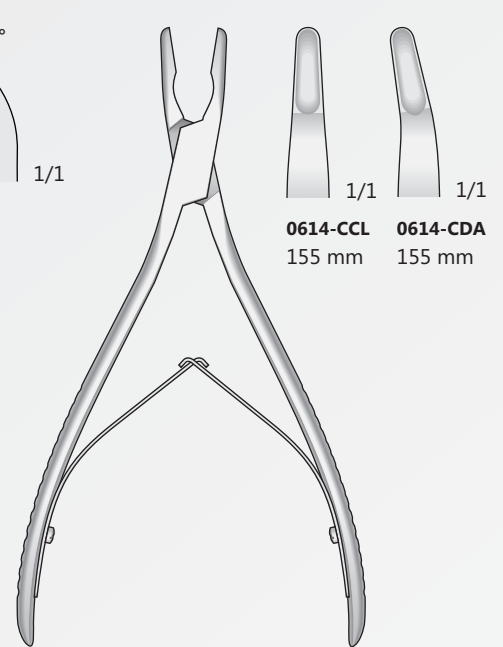

LEMPERT  
**0614-CCL/0614-CDA**  
 155 mm

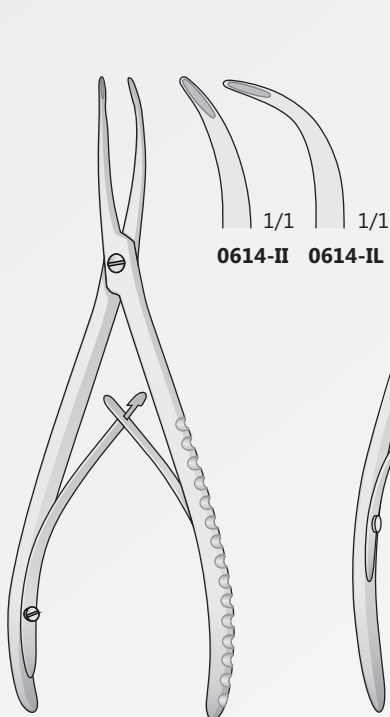

STELLBRINK  
**0614-II/0614-IL**  
 170 mm

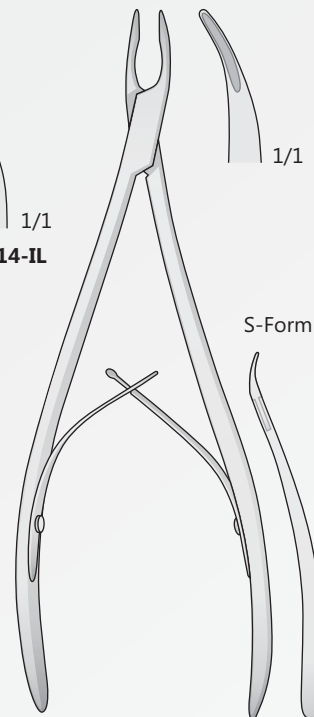

STELLBRINK  
**0614-IH**  
 190 mm

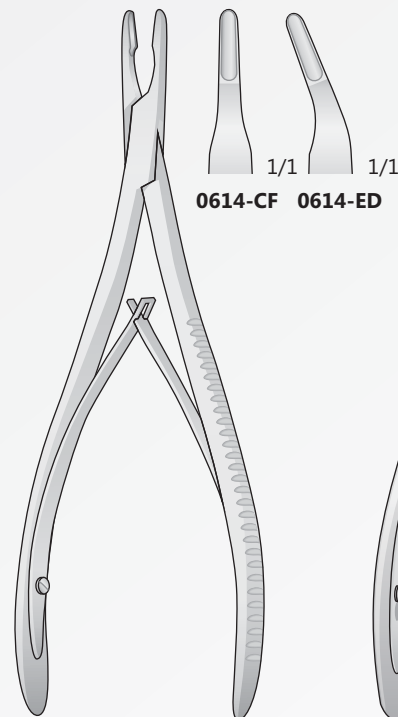

LEMPERT  
**0614-CF/0614-ED**  
 190 mm

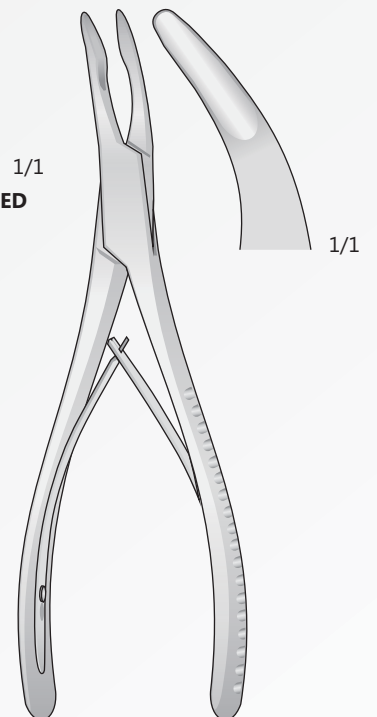

OLIVECRONA  
**0614-EF**  
 190 mm

Hohlmeißelzangen  
 Bone rongeurs  
 Pinze ossivore  
 Pinzas-gubias  
 Pincas-gouges

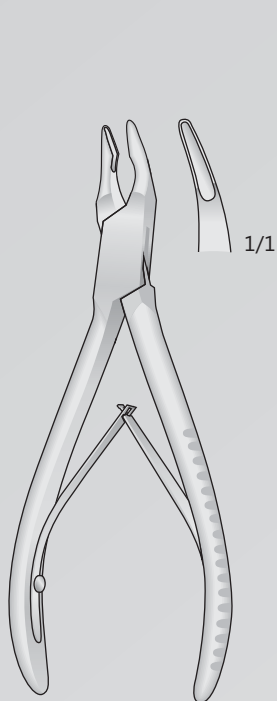

MINI FRIEDMANN  
**0614-BF**  
 120 mm

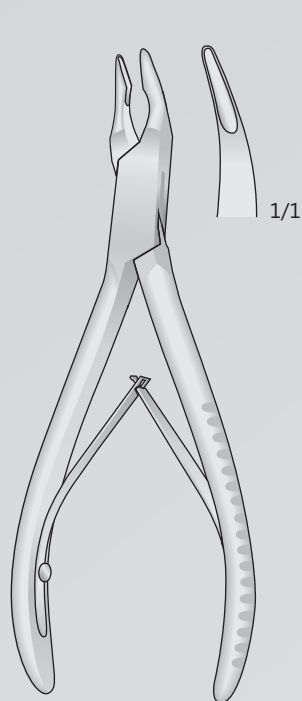

FRIEDMANN  
**0614-BH**  
 140 mm

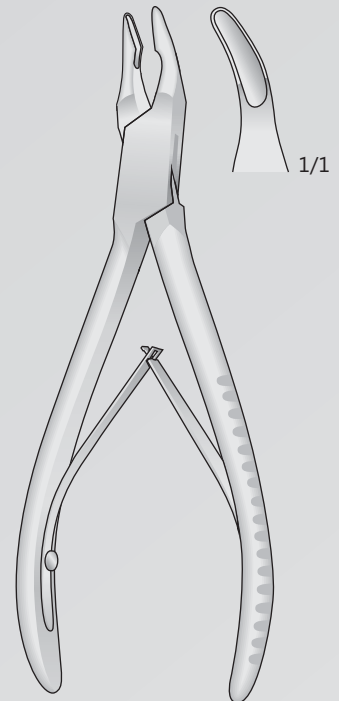

BLUMENTHAL  
**0614-BL**  
 155 mm

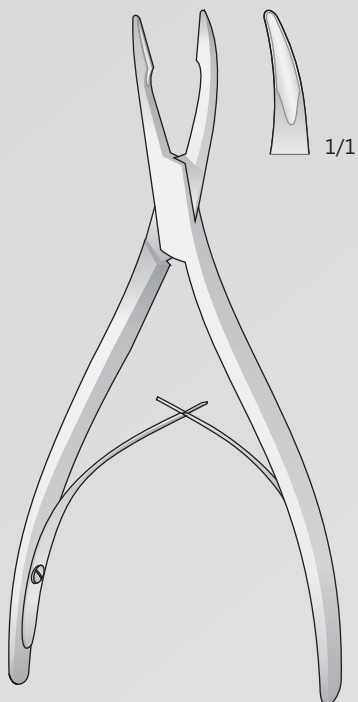

FRIEDMANN  
**0614-BG**  
 160 mm

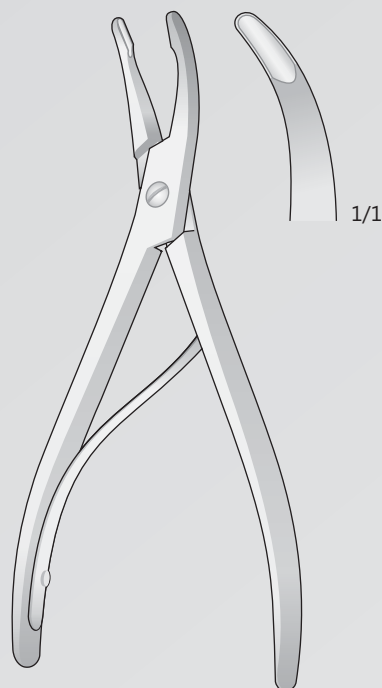

LUER  
**0614-BI**  
 155 mm

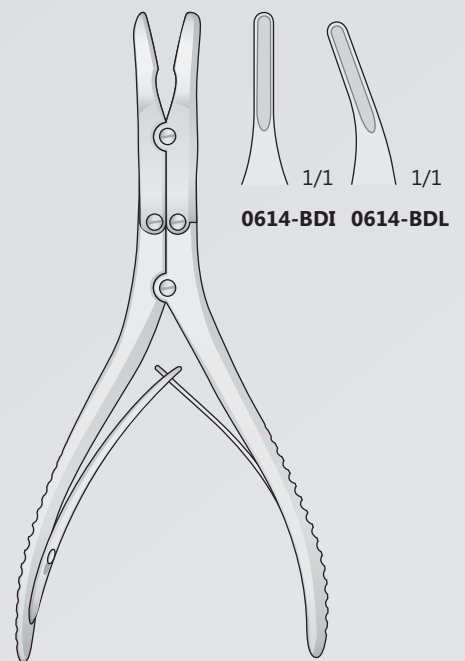

RUSKIN  
**0614-BDI/0614-BDL**  
 150 mm

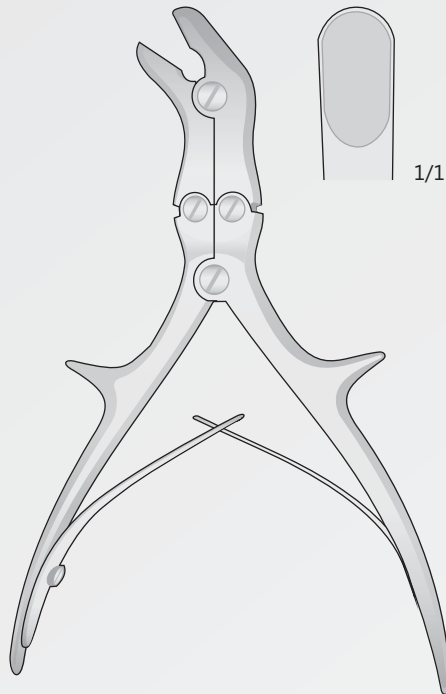

STILLE  
**0614-DG**  
 210 mm

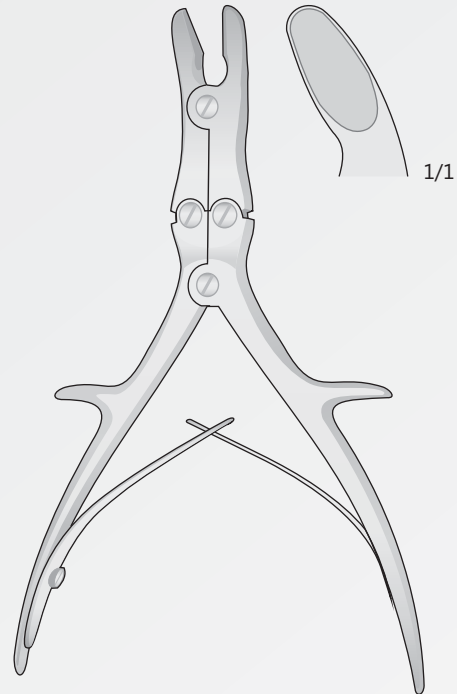

LUER-STILLE  
**0614-DI**  
 210 mm



CUSHING  
**0614-BB/0614-BC**  
 190 mm

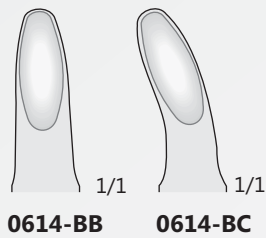

**0614-BB** 1/1 **0614-BC** 1/1

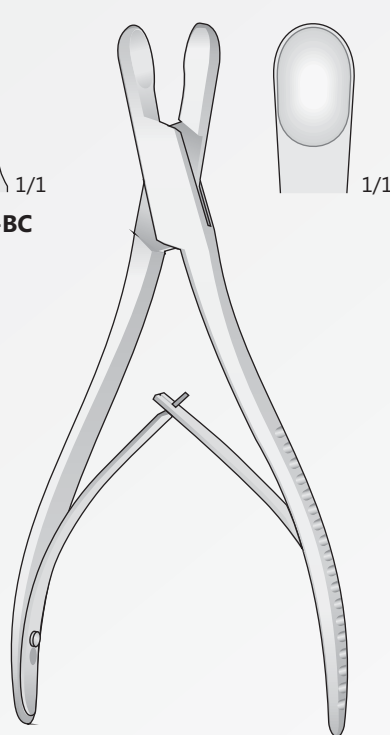

LUER-STILLE  
**0614-BD**  
 185 mm

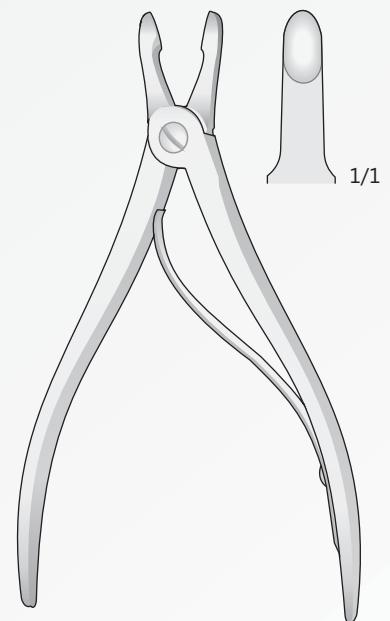

HARTMANN  
**0614-BE**  
 155 mm

Hohlmeißelzangen  
 Bone rongeurs  
 Pinze ossivore  
 Pinzas-gubias  
 Pincas-gouges

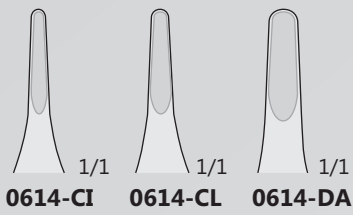
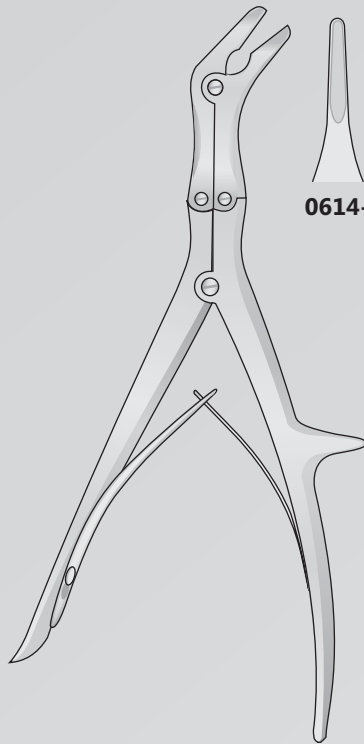

**0614-CI** **0614-CL** **0614-DA**

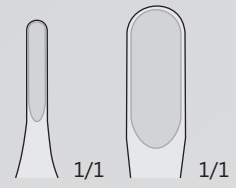
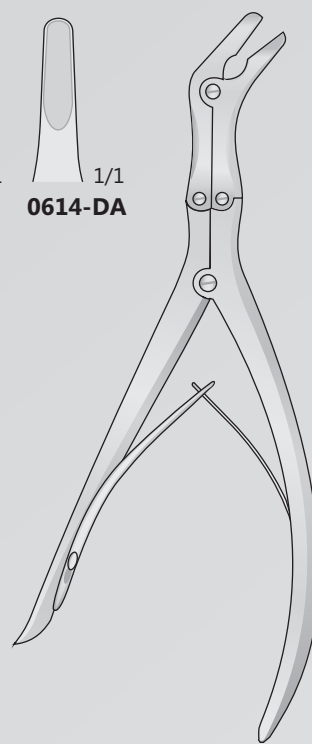

**0614-DB** **0614-DC**  
 240 mm 250 mm

ECHLIN  
**0614-CI/0614-DA**  
 230 mm

LEKSELL  
**0614-DB/0614-DC**

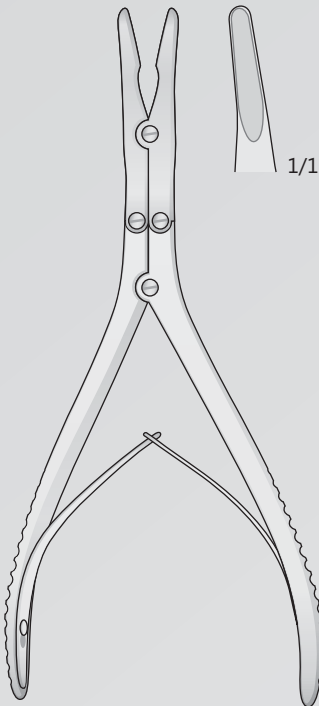

BEYER  
**0614-CA**  
 180 mm

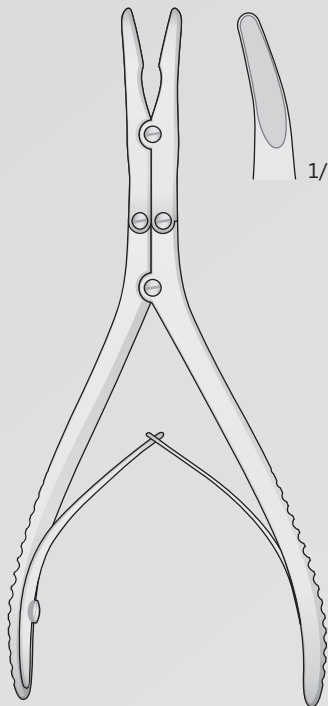

ZAUFGAL-JANSEN  
**0614-DE**  
 180 mm

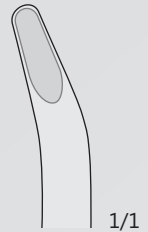
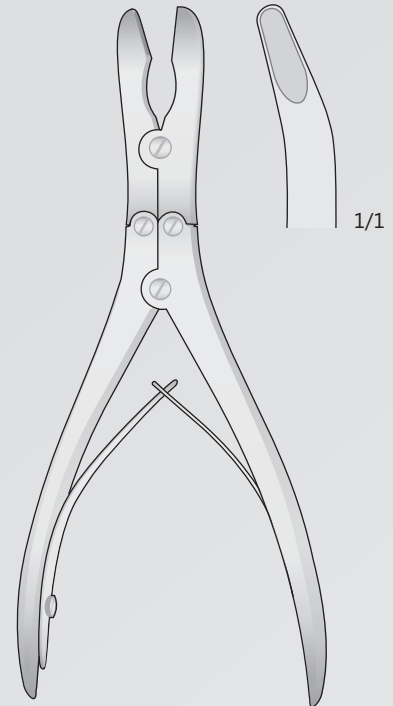

RUSKIN-STILLE  
**0614-DF**  
 180 mm

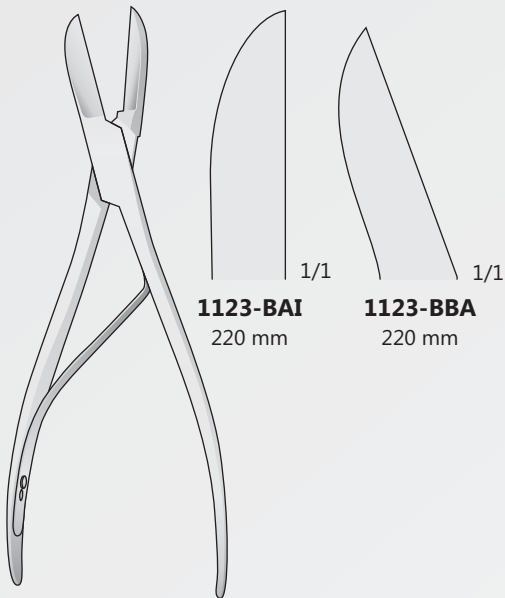

**1123-BAI**  
220 mm

**1123-BBA**  
220 mm

LISTON  
**1123-BAI/1123-BBA**  
220 mm

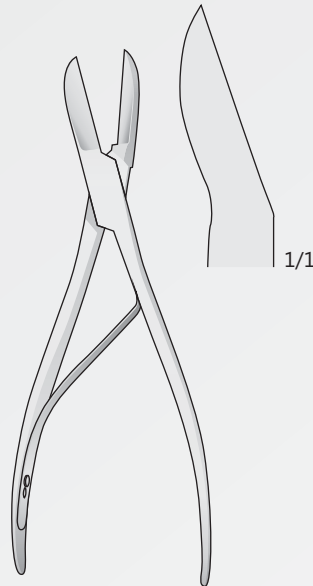

LISTON  
**1123-BAL**  
170 mm

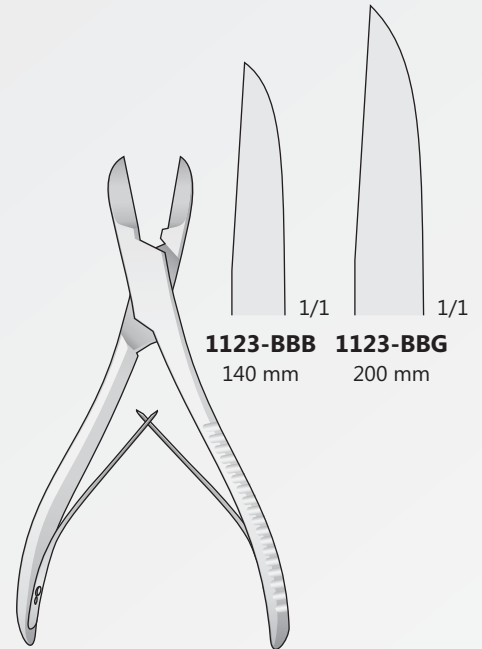

**1123-BBB**  
140 mm

**1123-BBG**  
200 mm

LISTON  
**1123-BBB/1123-BBG**  
140 mm

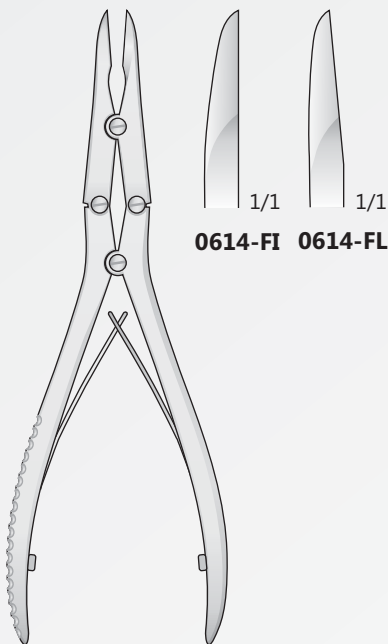

**0614-FI 0614-FL**

**0614-FI/0614-FL**  
180 mm

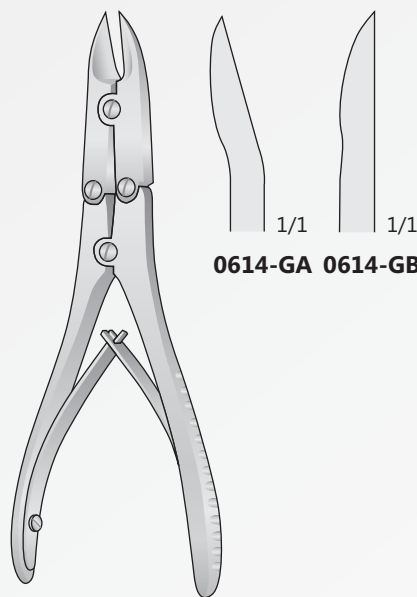

**0614-GA 0614-GB**

BÖHLER  
**0614-GA/0614-GB**  
150 mm

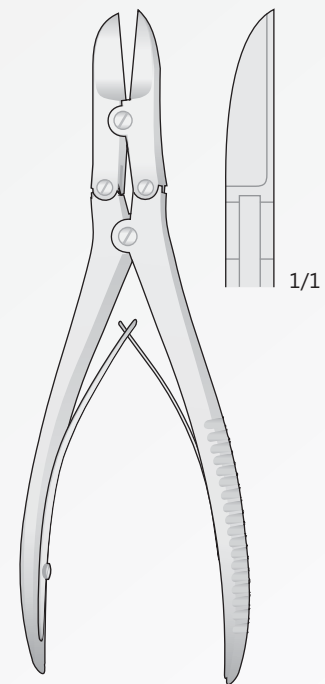

RUSKIN-LISTON  
**0614-BAI**  
190 mm

Knochensplitterzangen  
Bone cutting Forceps  
Cesoie per ossa  
Pinzas cortantes para huesos  
Pincas coupantes

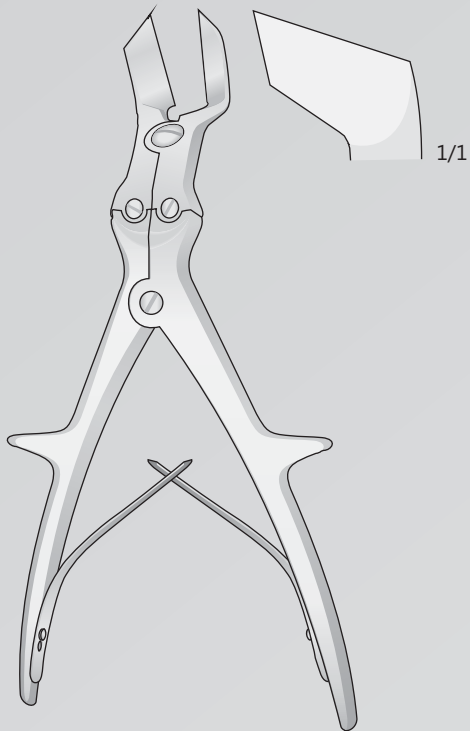

KEY-HORSLEY  
**0614-EA**  
235 mm

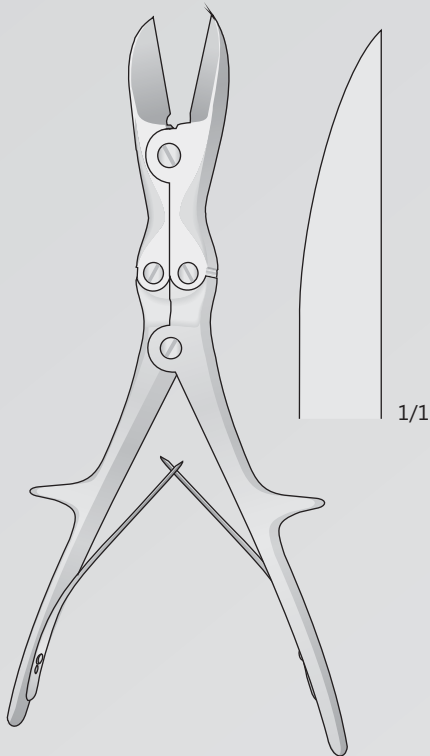

LISTON  
**0614-EB**  
270 mm

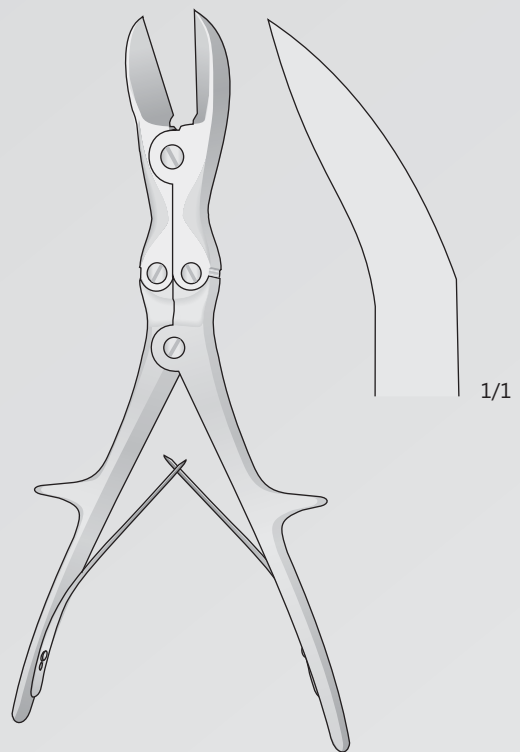

LISTON  
**0614-EC**  
270 mm

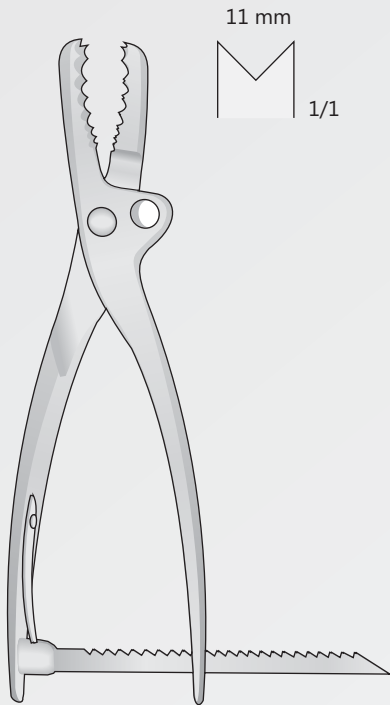

FARABEU-F-LAMBOTTE  
**0614-FC**  
 250 mm

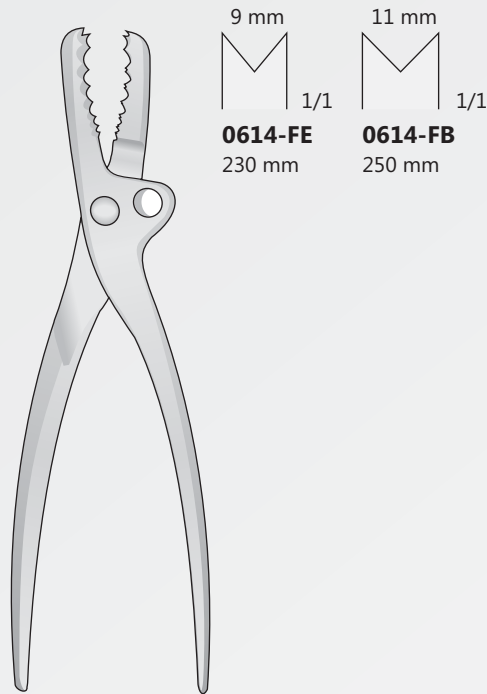

FARABEU  
**0614-FB/0614-FE**

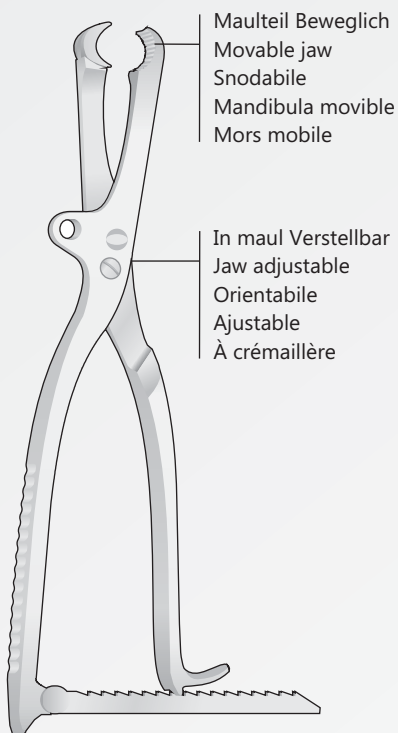

LAMBOTTE  
**0614-EE**  
 265 mm

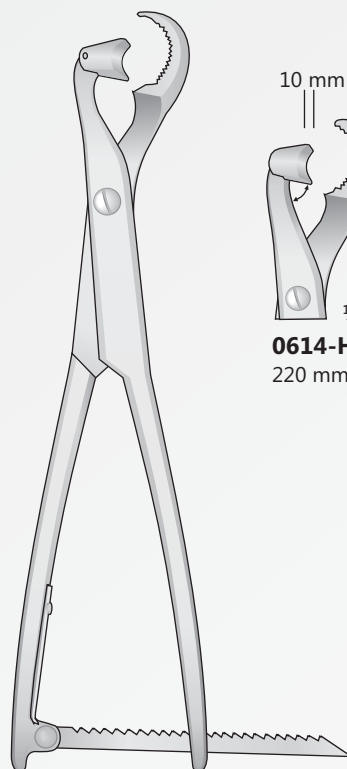

LAMBOTTE  
**0614-FA/0614-HG**

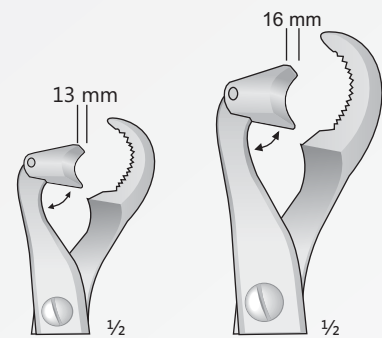

**0614-FD**  
 260 mm

**0614-FA**  
 330 mm

Knochenhaltezangen  
 Bone holding forceps  
 Pinze per fissazione ossea  
 Pinzas para huesos  
 Daviers porte-os

Selbstzentrierend mit Gewindesperre  
 Self-centering bone holding forceps with thread lock  
 Autocentrante con blocco  
 Autocentrante con cremallera de tuerca  
 À centrage automatique avec arrêt de filetage

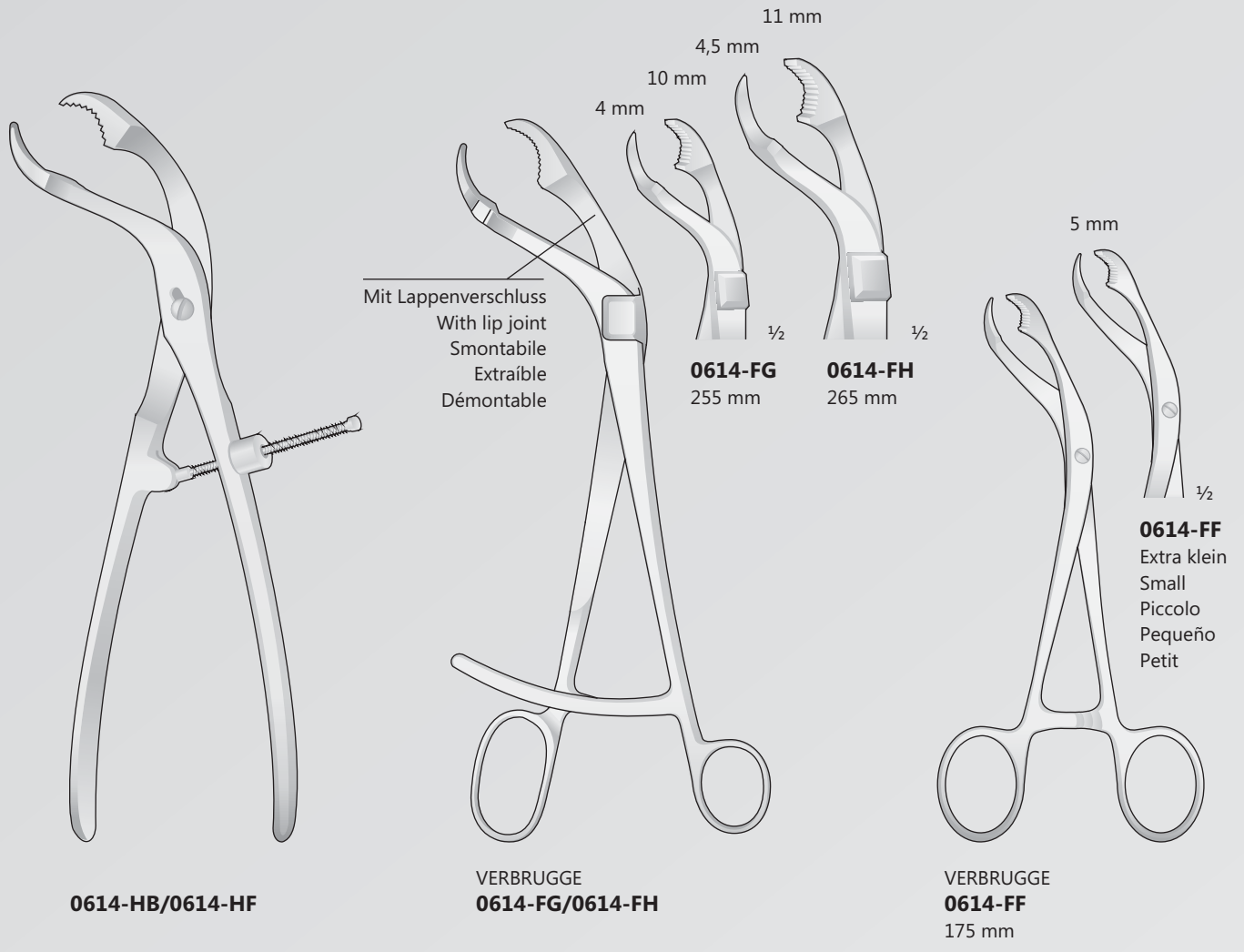
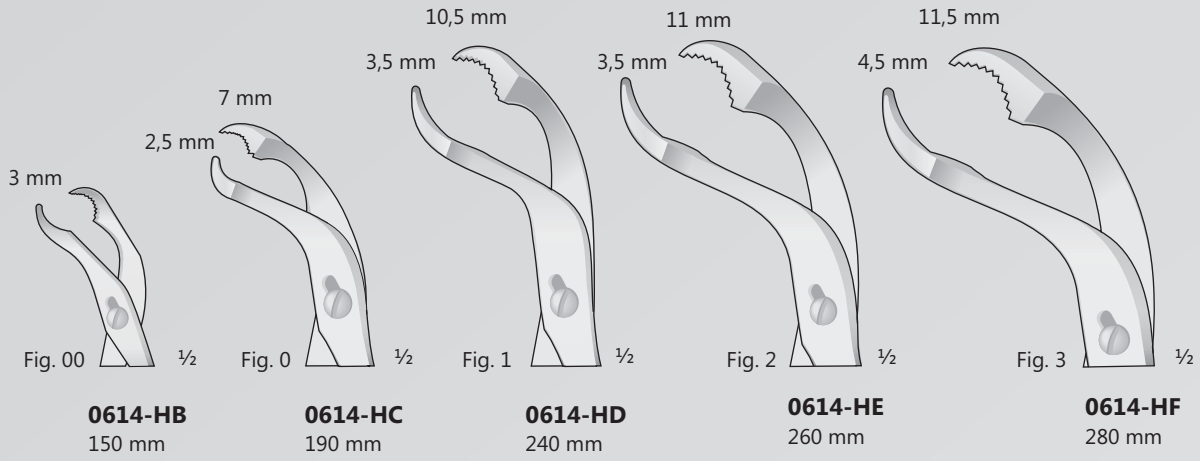



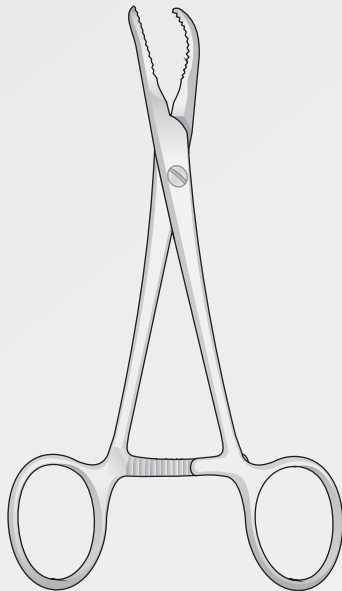

**0614-EH**  
140 mm

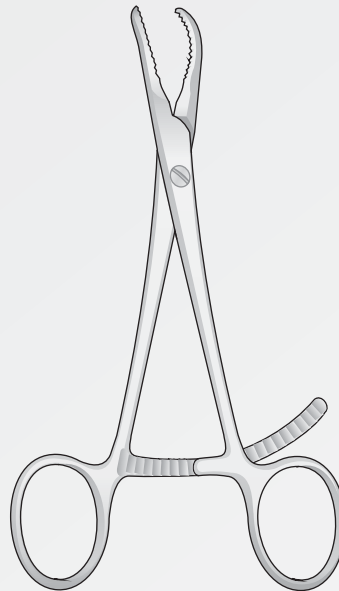

**0614-EH11**  
140 mm

Lange Rack  
 Long Rack  
 Cremagliera lunga  
 Rack largo  
 Cremalleure long

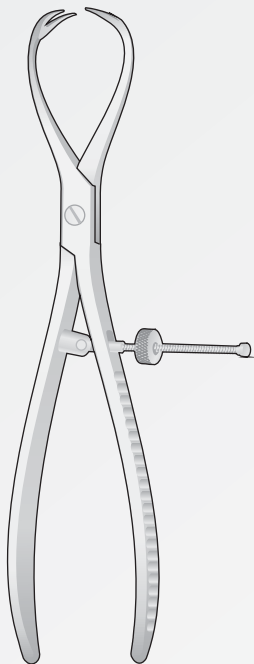
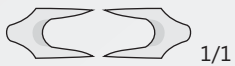

PATELLA  
**0614-EG**  
185 mm

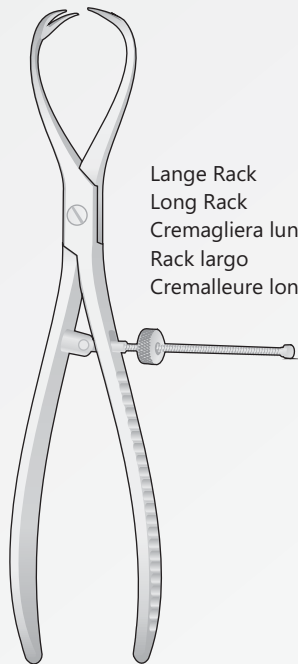
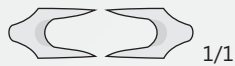

PATELLA  
**0614-EG11**  
185 mm

Lange Rack  
 Long Rack  
 Cremagliera lunga  
 Rack largo  
 Cremalleure long

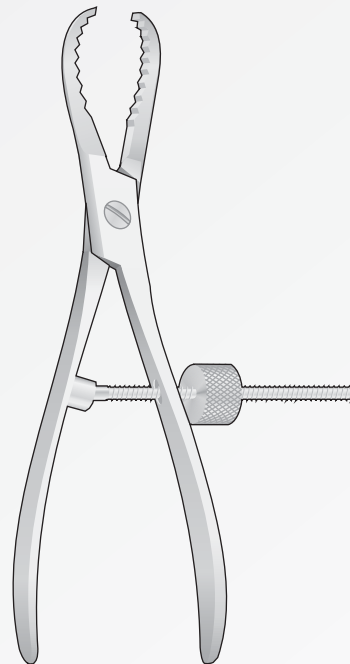

**0614-EI**  
170 mm

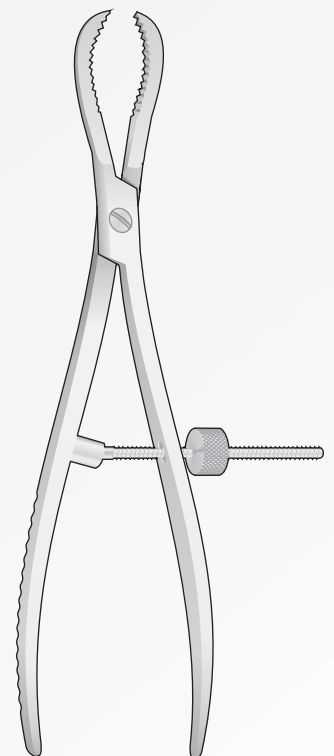

**0614-EL**  
235 mm

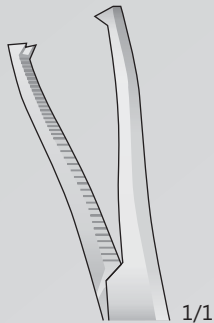
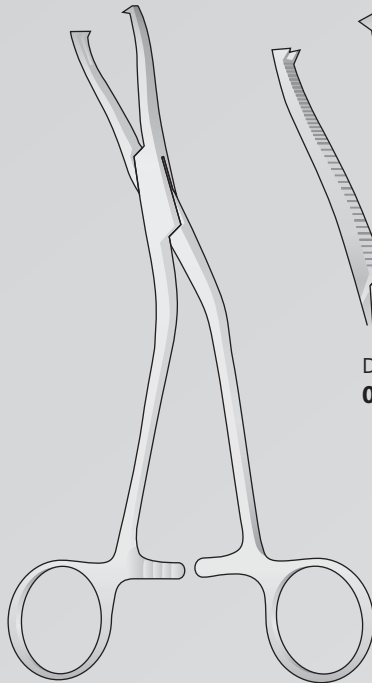

DINGMANN  
**0614-BDA**

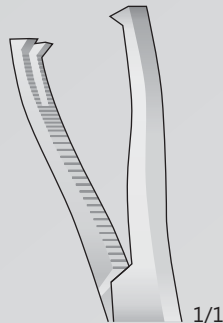

DINGMANN MODIF.  
**0614-BDB**

Meniskus und Knorpelfasszangen  
 Meniscus and cartilage clamp  
 Pinze per menisco e cartilagine  
 Alicates para menisco y cartilago  
 Pincès à saisir ménisque et cartilages

DINGMANN  
**0614-BDA/0614-BDB**  
 190 mm

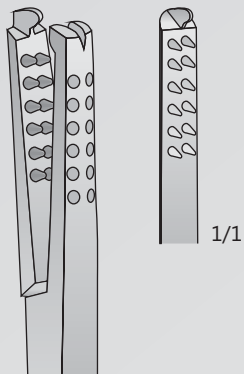
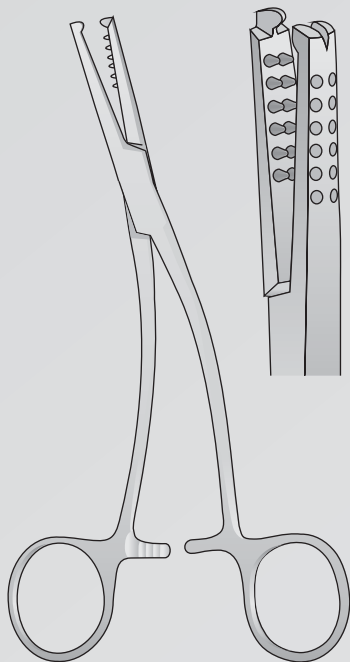

**0614-BDE**  
 185 mm

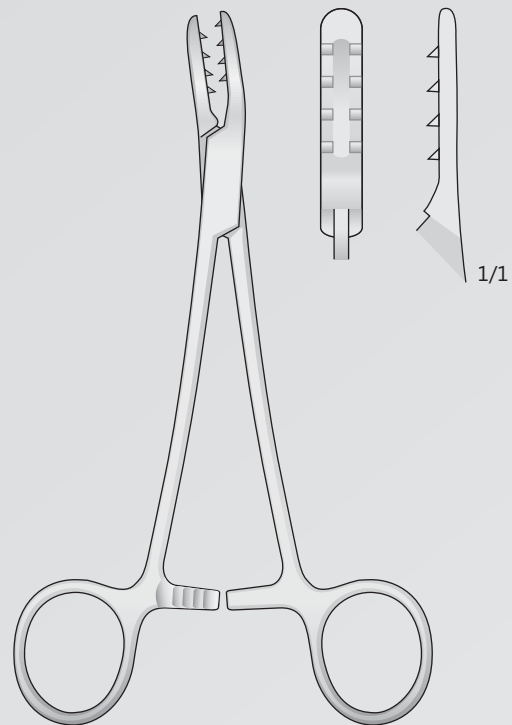

MARTIN  
**0614-BDD**  
 200 mm

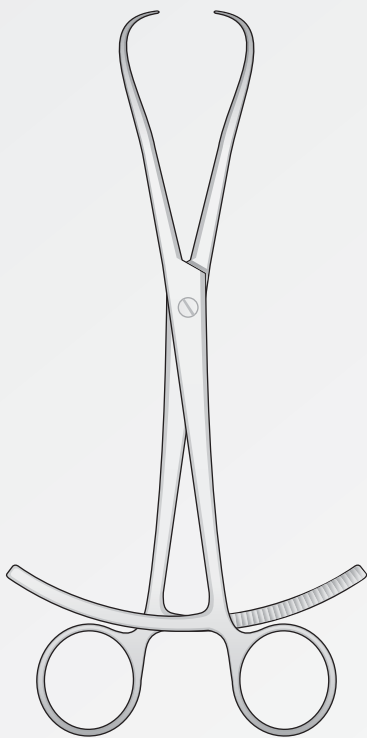

**0614-GI**  
 200 mm

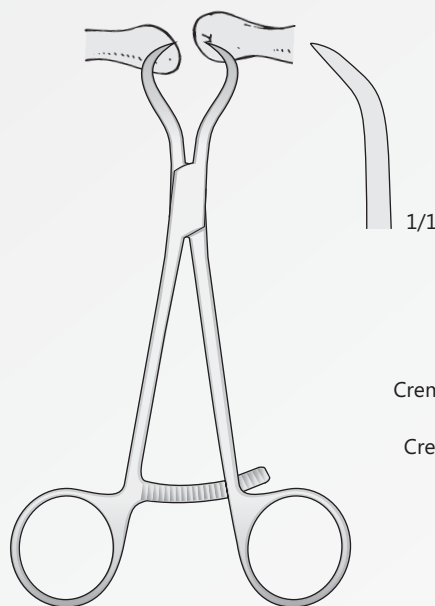

**0614-GG**  
 135 mm

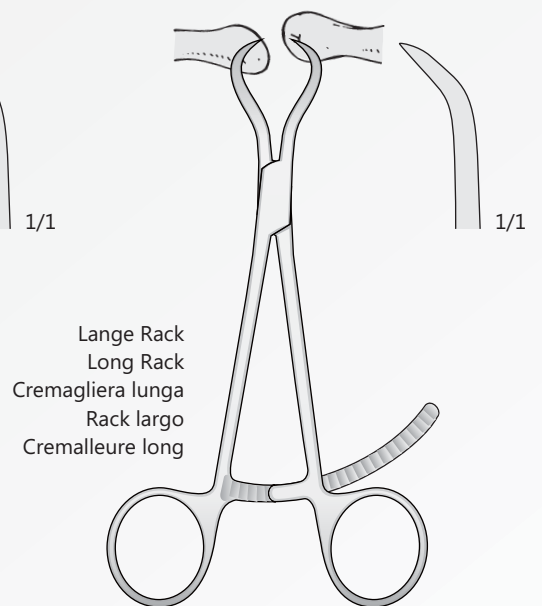

Lange Rack  
 Long Rack  
 Cremagliera lunga  
 Rack largo  
 Cremalleure long  
**0614-GG11**  
 135 mm

Knochenchirurgie      Repositionszangen  
 Bone surgery          Reposition forceps  
 Chirurgia ossea        Pinze riposizionatrici di osso  
 Cirurgia òsea          Pinzas para la reducci3n de huesos  
 Chirurgie osseuse      Pincès de l'os

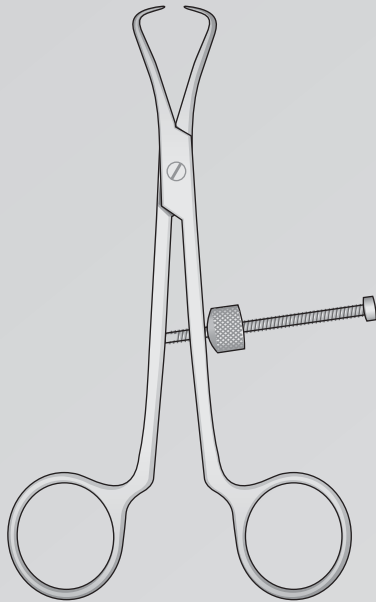

**0614-HL**  
140 mm

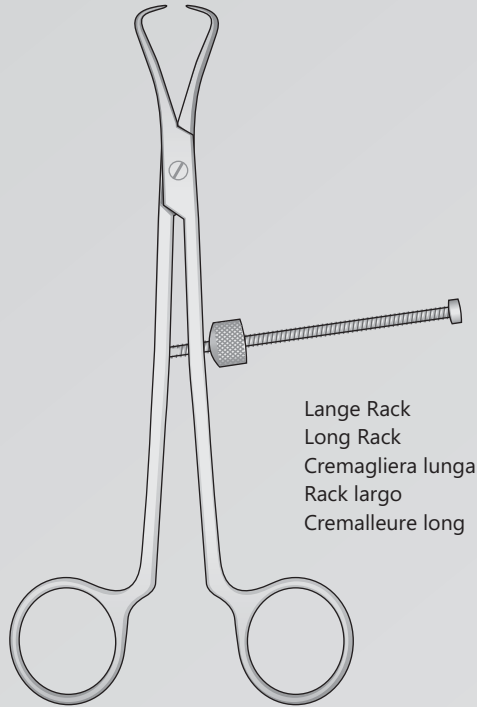

**0614-HL11**  
160 mm

Lange Rack  
 Long Rack  
 Cremagliera lunga  
 Rack largo  
 Cremalleure long

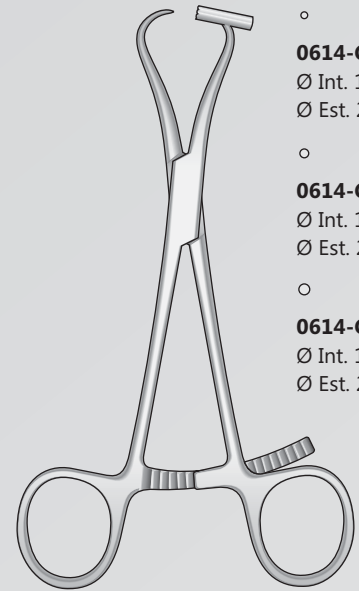

**0614-CEA/0614-CEC**  
140 mm

- **0614-CEA**  
Ø Int. 1,0 mm  
Ø Est. 2,0 mm
- **0614-CEB**  
Ø Int. 1,3 mm  
Ø Est. 2,3 mm
- **0614-CEC**  
Ø Int. 1,6 mm  
Ø Est. 2,6 mm

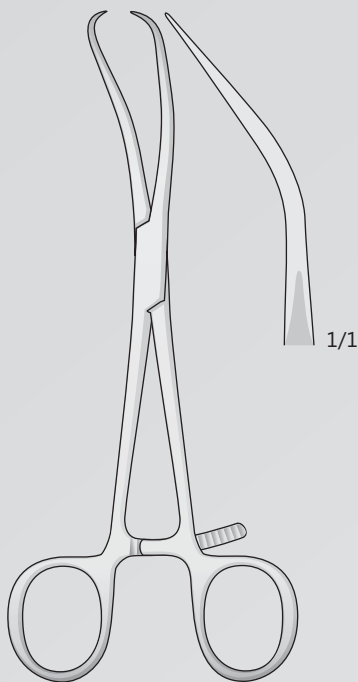

REILL  
**0614-GE**  
170 mm

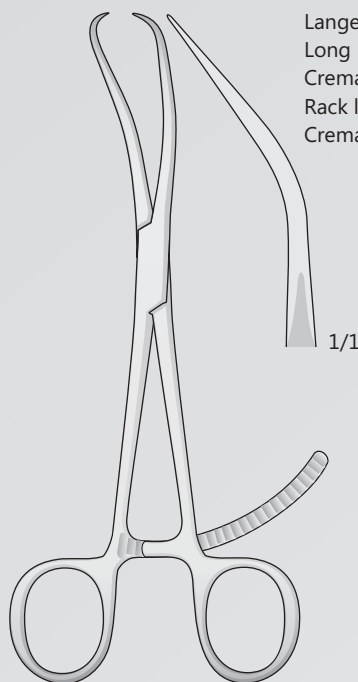

REILL  
**0614-GE11**  
170 mm

Lange Rack  
 Long Rack  
 Cremagliera lunga  
 Rack largo  
 Cremalleure long

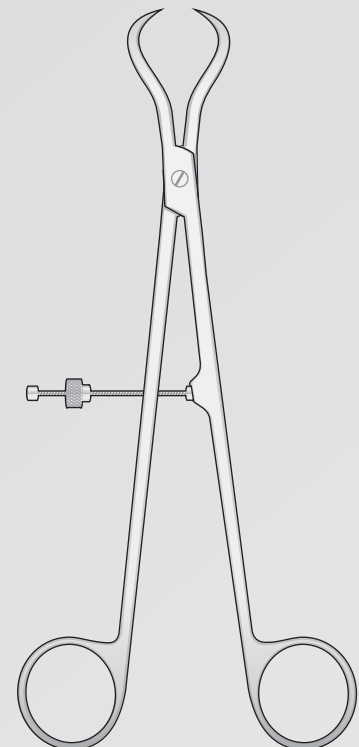

**0614-IB**  
210 mm

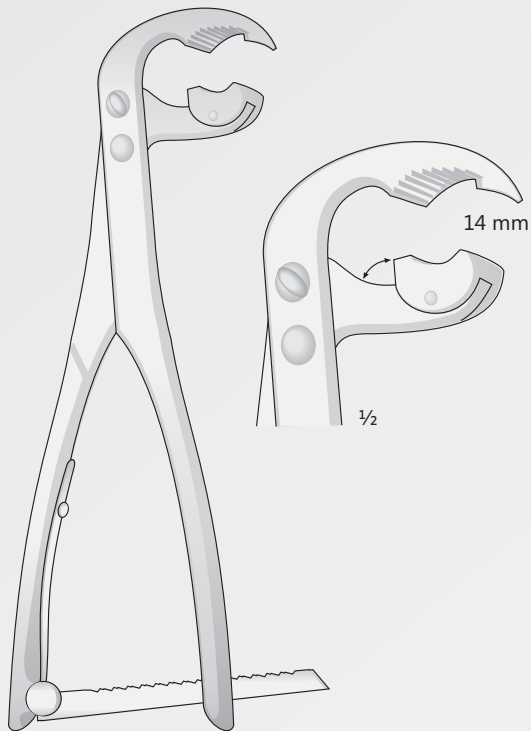

**0614-HI**  
 215 mm

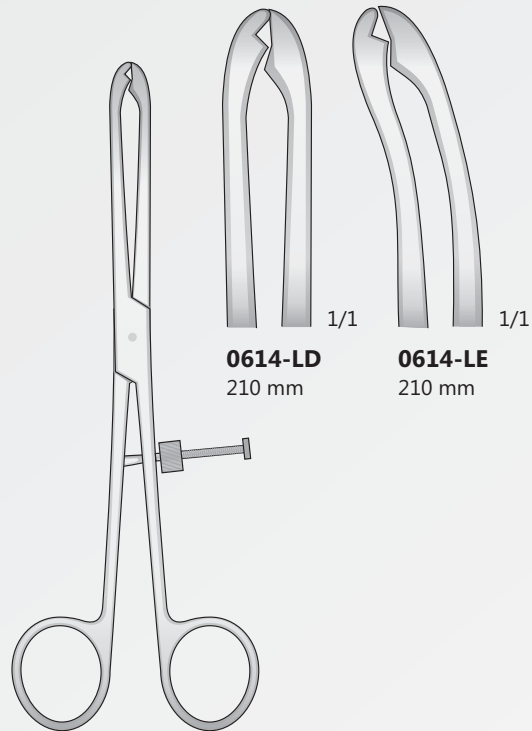

FIBULA  
**0614-LD/0614-LE**  
 210 mm



LEWIN  
**0614-GL**  
 180 mm

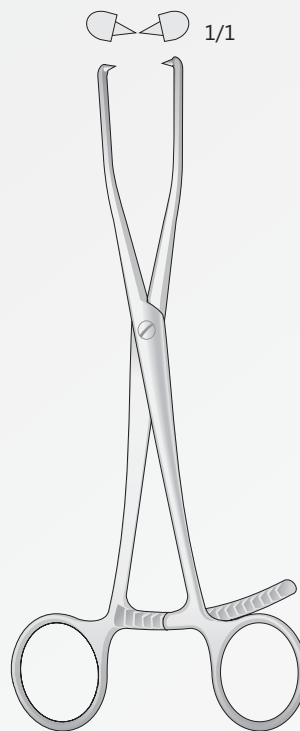

**0614-GH**  
 210 mm

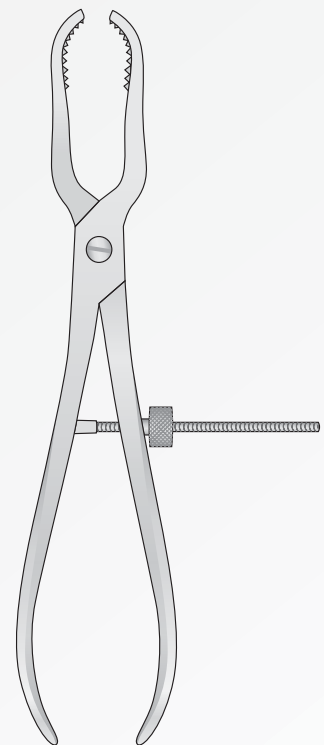

**0614-GF**  
 230 mm

Knochenhaltezaugen  
 Bone holding forceps  
 Pinze per fissazione ossea  
 Pinzas para huesos  
 Daviers porte-os

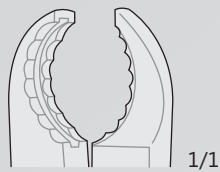

**0614-CAG**  
220 mm

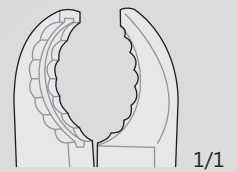

**0614-GC**  
230 mm

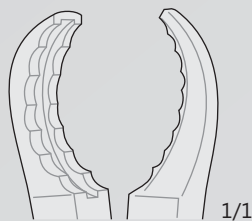

**0614-CAH**  
240 mm

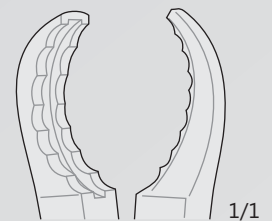

**0614-IC**  
250 mm

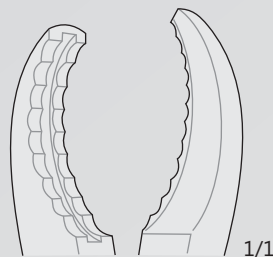

**0614-HA**  
270 mm

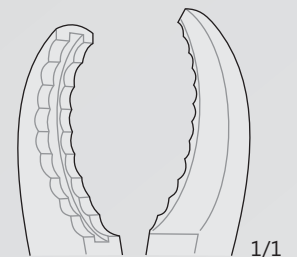

**0614-BAF**  
280 mm

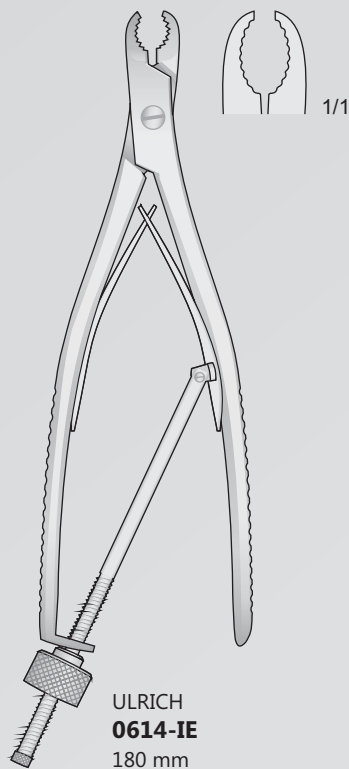

ULRICH  
**0614-IE**  
180 mm

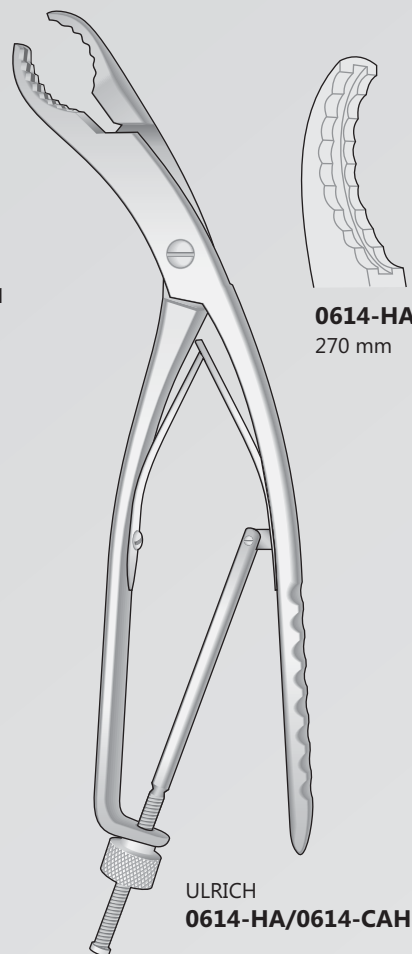

ULRICH  
**0614-HA/0614-CAH**

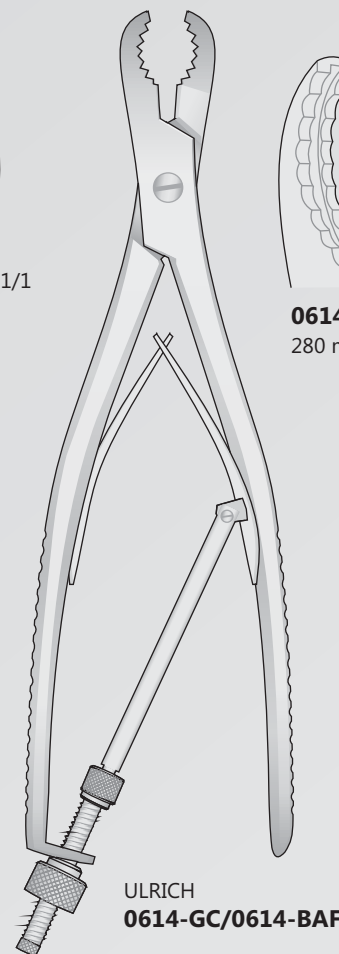

ULRICH  
**0614-GC/0614-BAF**

Knochenhaltezangen  
 Bone holding forceps  
 Pinze per fissazione ossea  
 Pinzas para huesos  
 Daviers porte-os

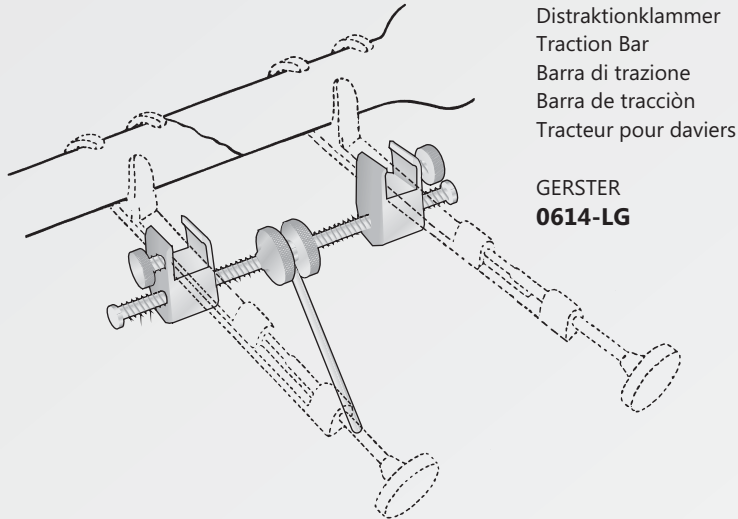

Distractionklammer  
 Traction Bar  
 Barra di trazione  
 Barra de tracciòn  
 Tracteur pour daviers

GERSTER  
**0614-LG**

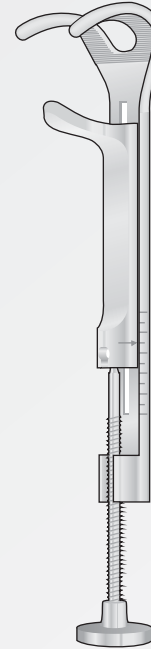

GERSTER-LOWMAN  
**0614-LA** 120 mm  
**0614-LB** 185 mm  
**0614-LC** 200 mm

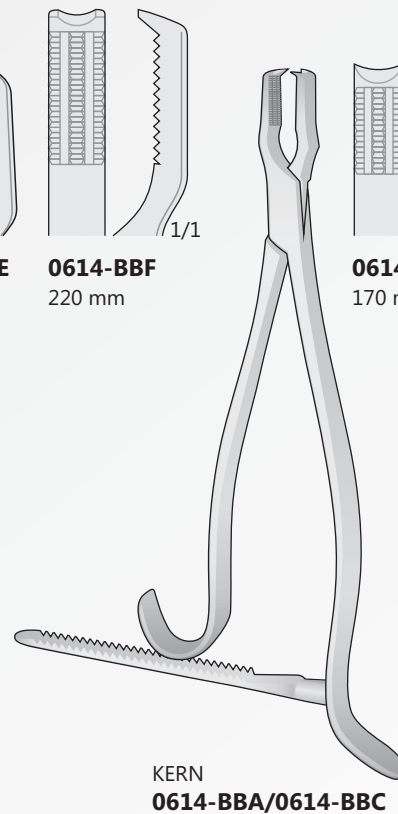
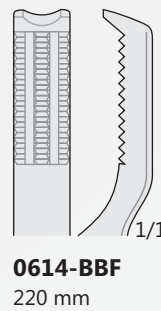
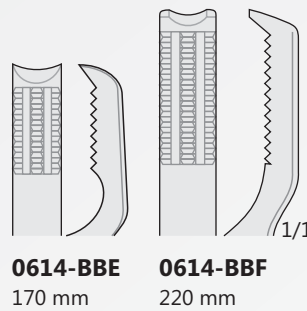
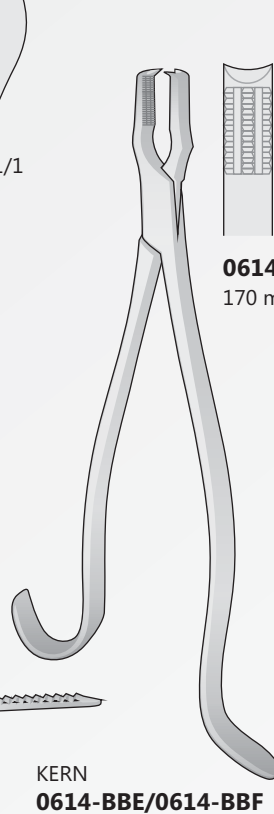
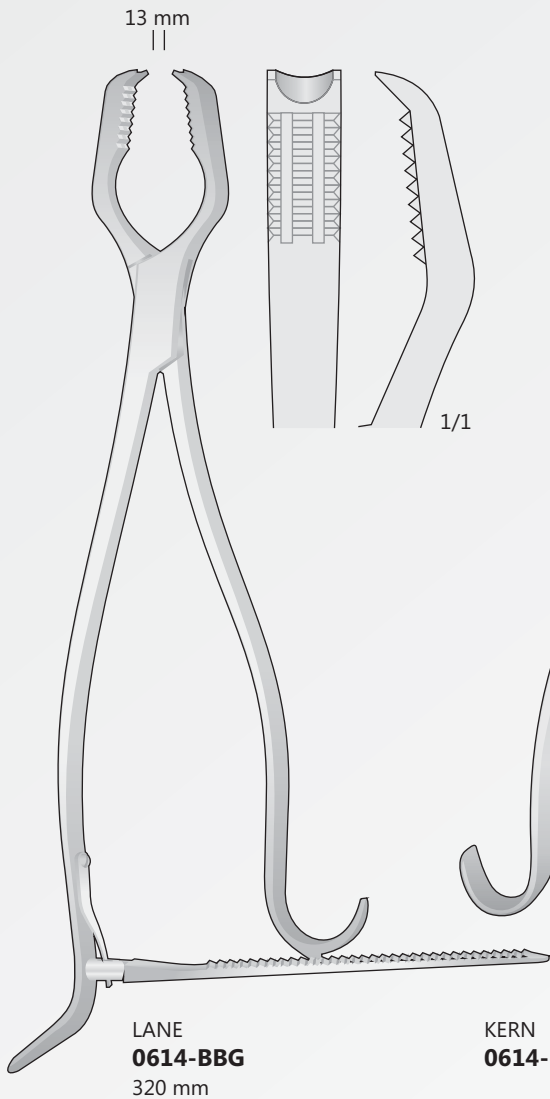

Laminektomie  
Laminectomy  
Laminectomia  
Laminectomia  
Laminectomie

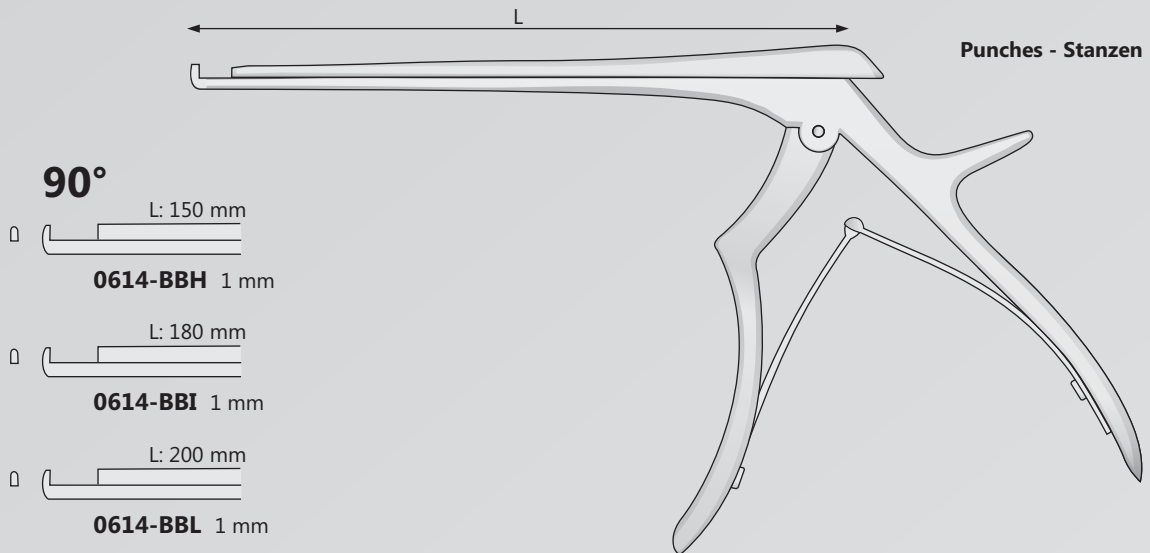

FERRIS-SMITH-KERRISON  
**0614-BBH/0614-BBL**

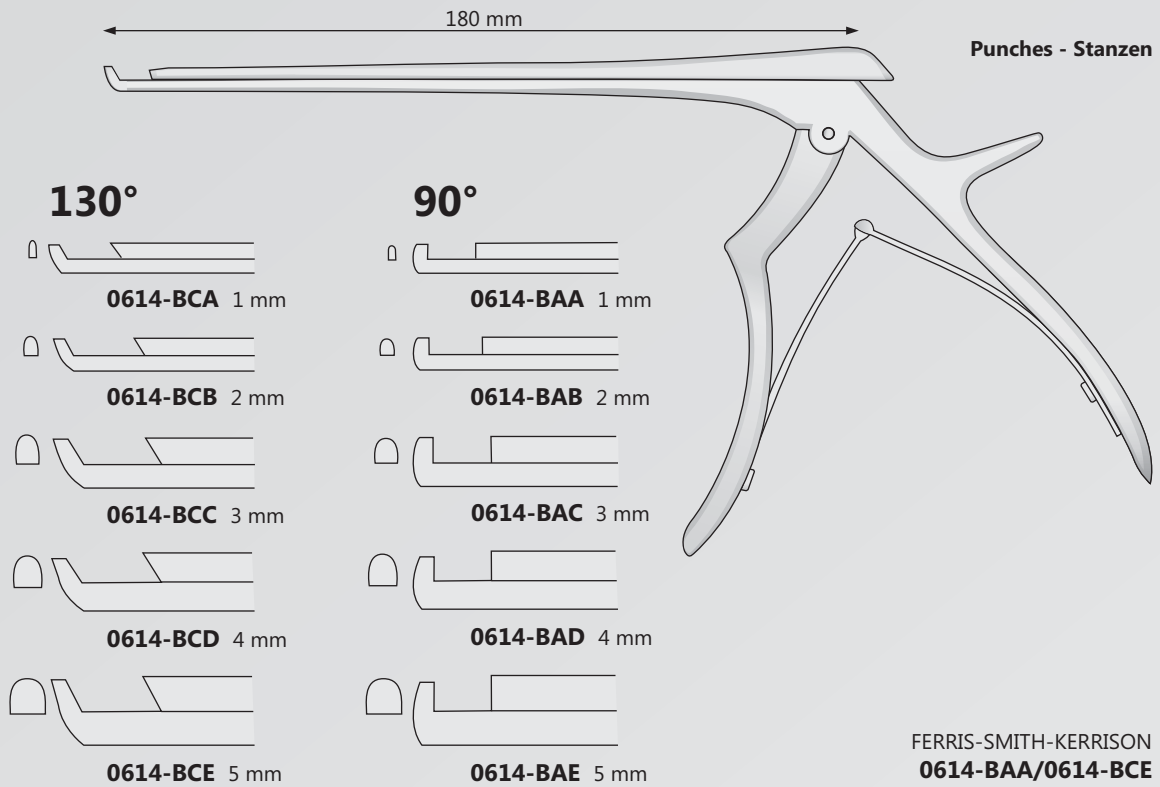

FERRIS-SMITH-KERRISON  
**0614-BAA/0614-BCE**



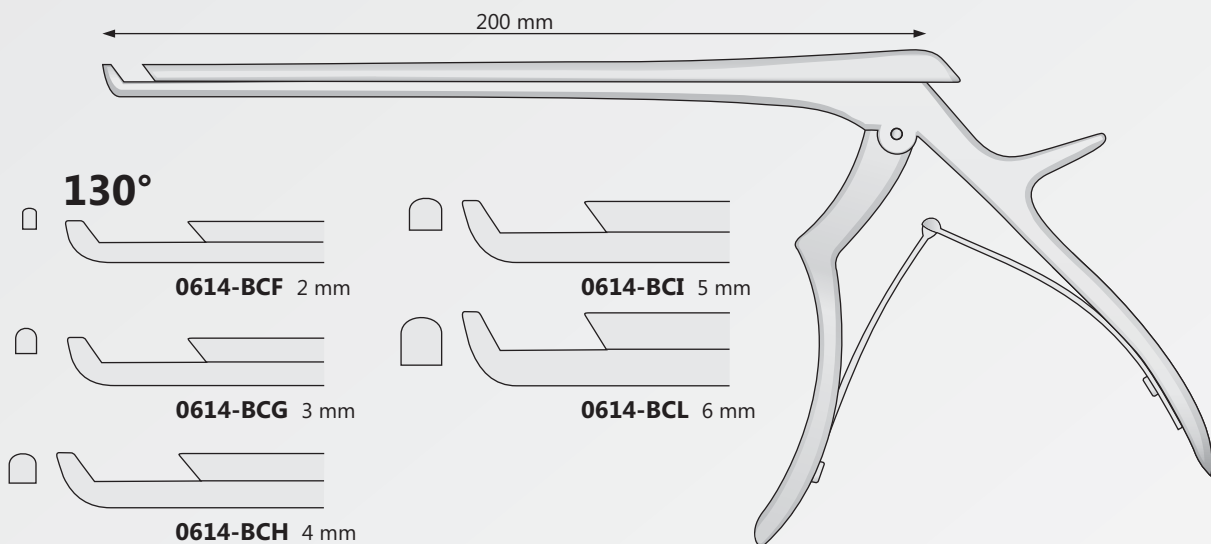

FERRIS-SMITH-KERRISON  
**0614-BCF/0614-BCL**

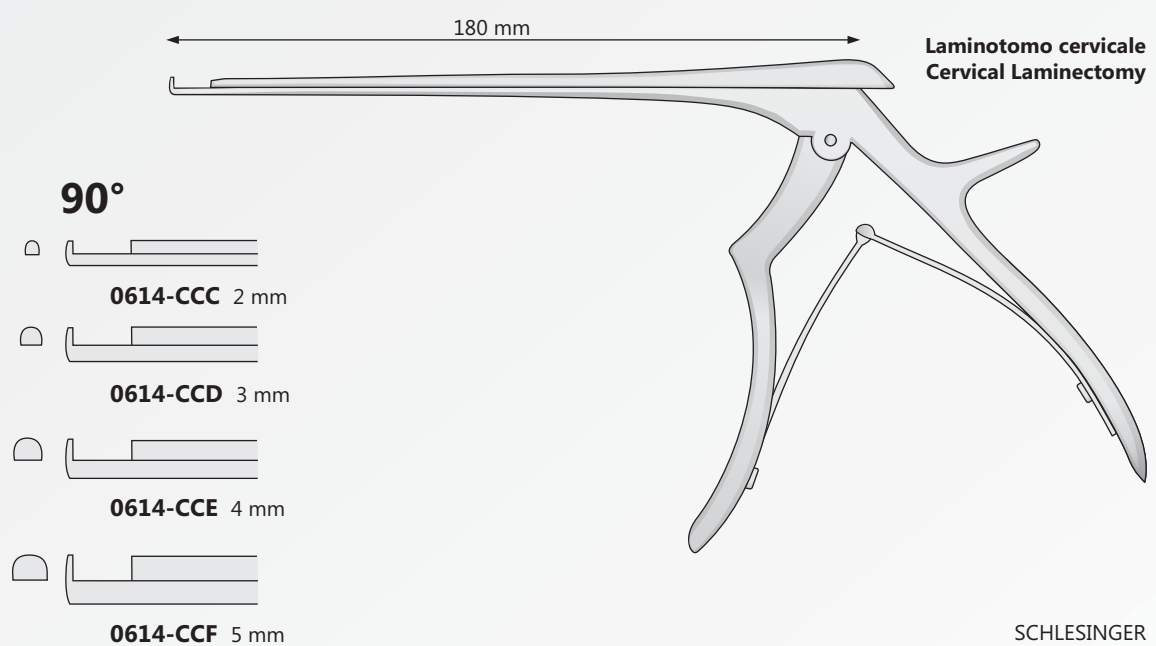

SCHLESINGER  
**0614-CCC/0614-CCF**

Laminektomie  
Laminectomy  
Laminectomia  
Laminectomia  
Laminectomie

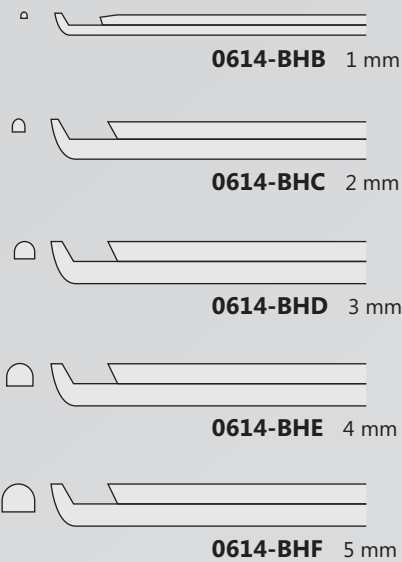
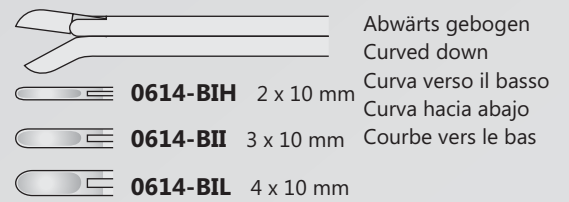
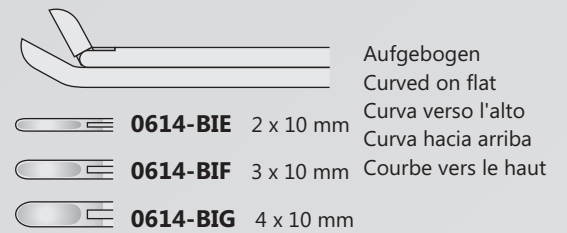
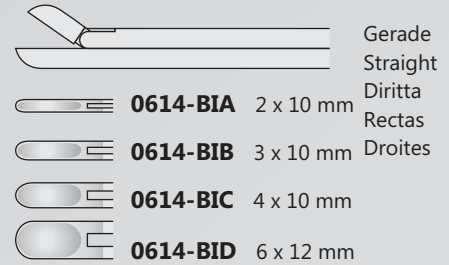

180 mm

180 mm

130°

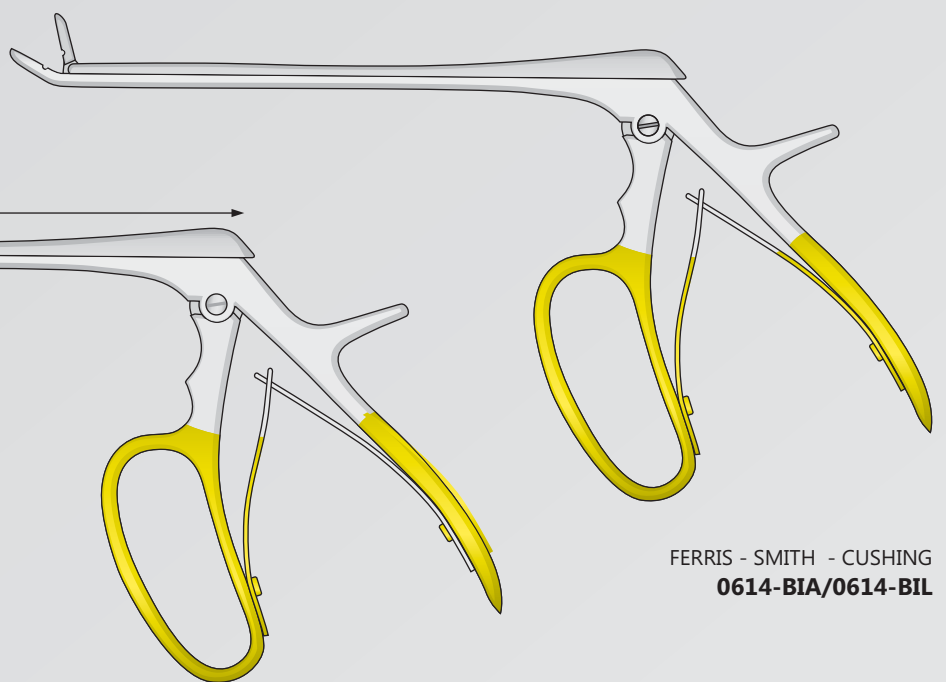

FERRIS - SMITH - CUSHING  
**0614-BIA/0614-BIL**

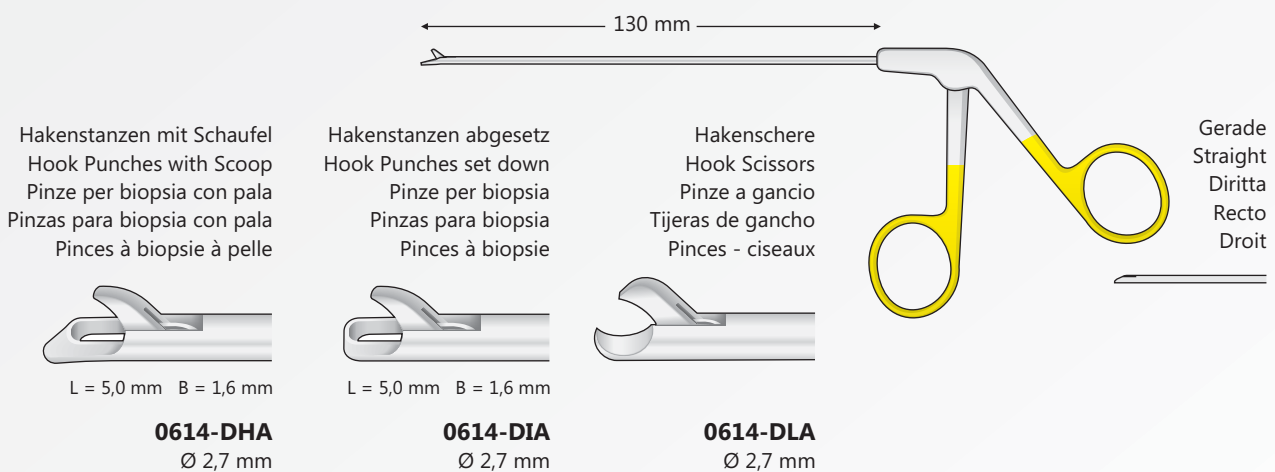
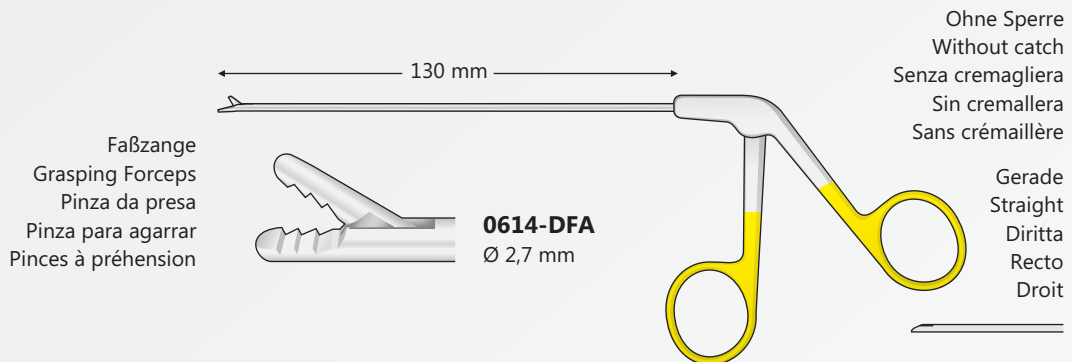
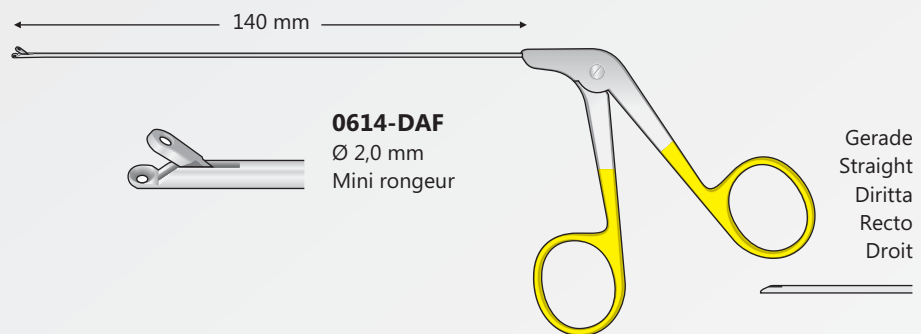
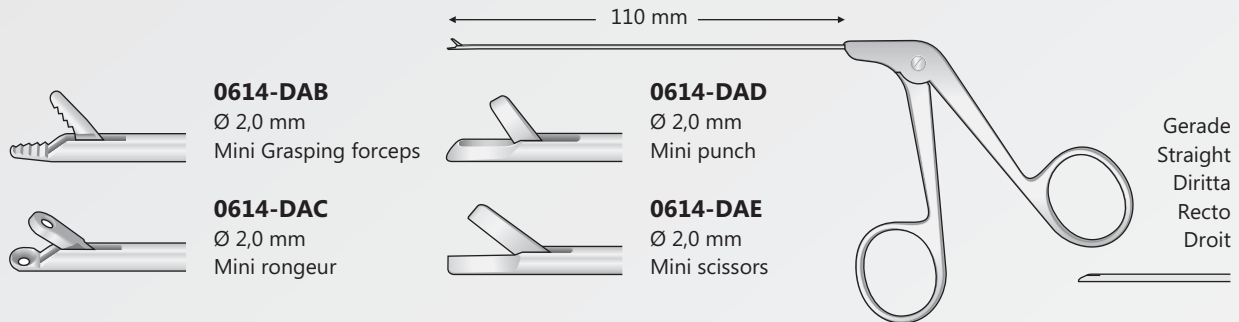

FERRIS - SMITH - KERRISON  
**0614-BHB/0614-BHF**

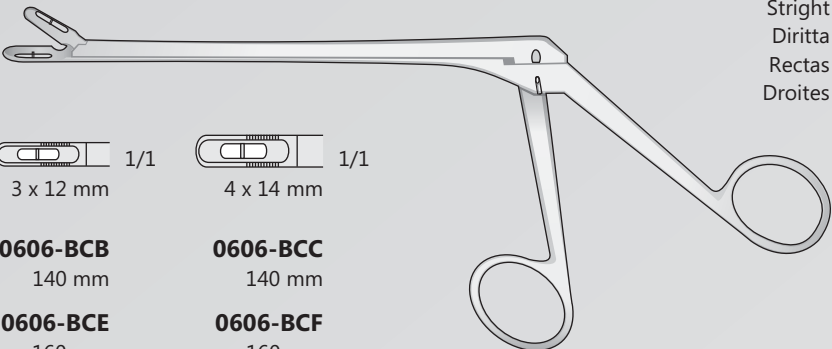

Laminectomy Rongeur  
 Laminectomy rongeurs  
 Pinze per biopsia  
 Pinzas cortantes para laminectomia  
 Pincas a laminectomia



Gerade  
 Stright  
 Diritta  
 Rectas  
 Droites



 1/1 2 x 12 mm	 1/1 3 x 12 mm	 1/1 4 x 14 mm
<b>0606-BCA</b> 140 mm	<b>0606-BCB</b> 140 mm	<b>0606-BCC</b> 140 mm
<b>0606-BCD</b> 160 mm	<b>0606-BCE</b> 160 mm	<b>0606-BCF</b> 160 mm
<b>0606-BCI</b> 185 mm	<b>0606-BCL</b> 185 mm	<b>0606-BDA</b> 185 mm

CASPAR  
**0606-BCA/0606-BDA**

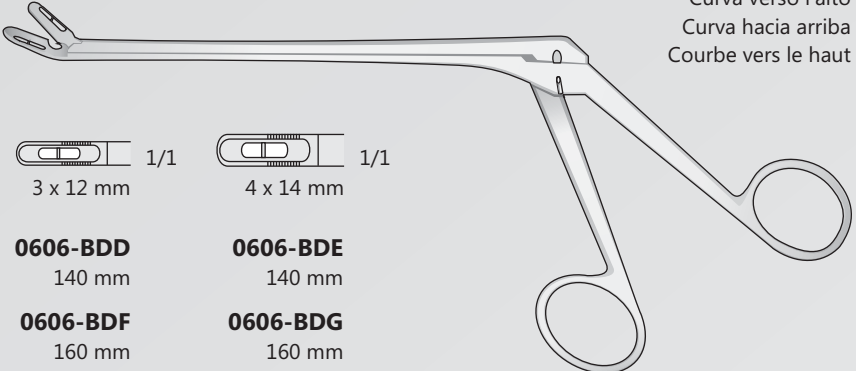
**150°**



Aufgebogen  
 Curved on flat  
 Curva verso l'alto  
 Curva hacia arriba  
 Courbe vers le haut

 1/1 3 x 12 mm	 1/1 4 x 14 mm
<b>0606-BDD</b> 140 mm	<b>0606-BDE</b> 140 mm
<b>0606-BDF</b> 160 mm	<b>0606-BDG</b> 160 mm
<b>0606-BDI</b> 185 mm	<b>0606-BDL</b> 185 mm

CASPAR  
**0606-BDD/0606-BDL**

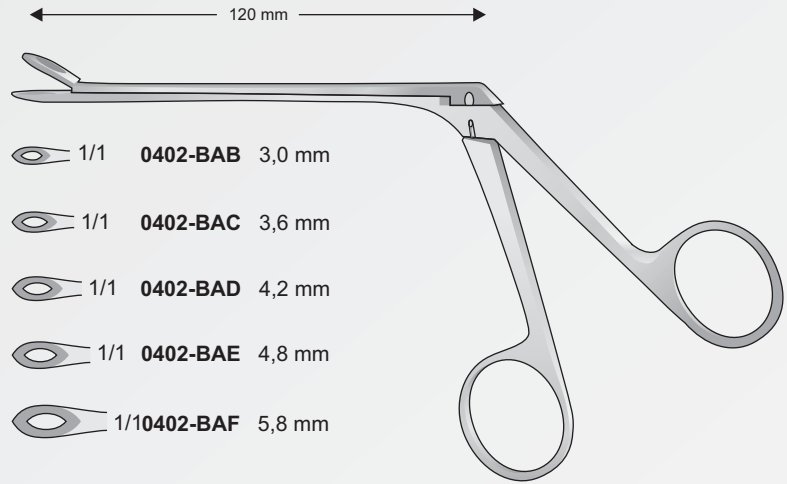

Laminectomy Rongeur  
 Laminectomy rongeurs  
 Pinze per biopsia  
 Pinzas cortantes para laminectomia  
 Pincas a laminectomia

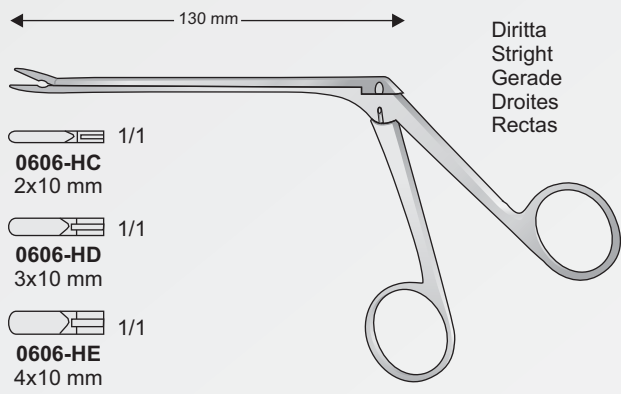

-  1/1 **0402-BAB** 3,0 mm
-  1/1 **0402-BAC** 3,6 mm
-  1/1 **0402-BAD** 4,2 mm
-  1/1 **0402-BAE** 4,8 mm
-  1/1 **10402-BAF** 5,8 mm

WEIL-BLAKESLEY  
**0402-BAB/0402-BAF**  
 190 mm



-  1/1 **0606-HC** 2x10 mm
-  1/1 **0606-HD** 3x10 mm
-  1/1 **0606-HE** 4x10 mm

Diritta  
 Stright  
 Gerade  
 Droites  
 Rectas

LOVE-GRUENWALD  
**0606-HC/0606-HE**

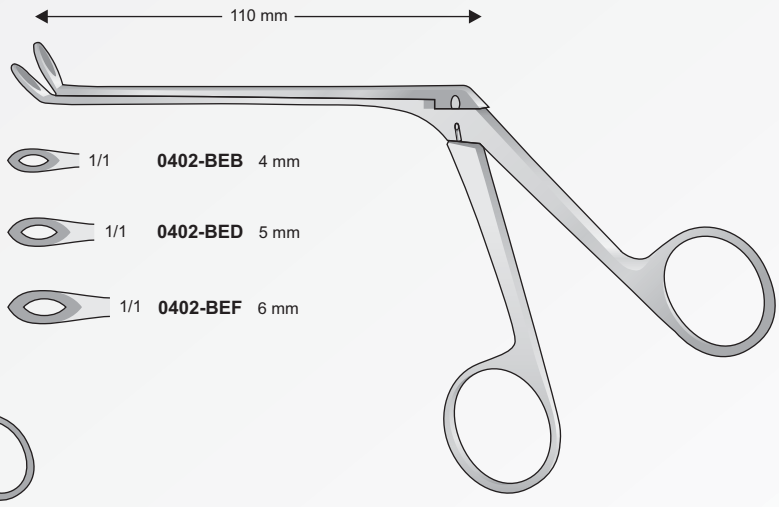

-  1/1 **0402-BEB** 4 mm
-  1/1 **0402-BED** 5 mm
-  1/1 **0402-BEF** 6 mm

WEIL-BLAKESLEY  
**0402-BEB/0402-BEF**  
 190 mm

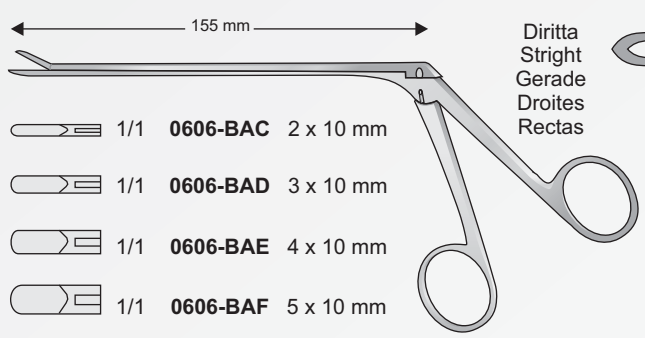

-  1/1 **0606-BAC** 2 x 10 mm
-  1/1 **0606-BAD** 3 x 10 mm
-  1/1 **0606-BAE** 4 x 10 mm
-  1/1 **0606-BAF** 5 x 10 mm

Diritta  
 Stright  
 Gerade  
 Droites  
 Rectas

CASPAR  
**0606-BAC/0606-BAF**

Handle only  
 Griff allein  
 125 mm

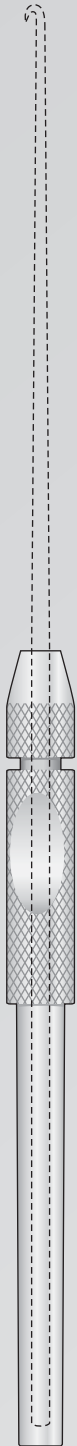

**0118-BA**  
 125 mm

Spoon Ø 3 mm  
 30° curved  
 Löffel Ø 3 mm  
 30° gebogen



**0118-BG**  
 225 mm

Probe graduated  
 2,5 mm  
 Sonde graduiret  
 2,5 mm



**0118-BL**  
 220 mm

Probe graduated  
 3,5 mm  
 Sonde graduiret  
 3,5 mm



**0118-CA**  
 220 mm

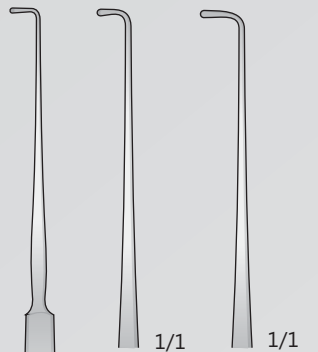

**0219-CLG 0219-CLH**

CUSHING  
**0219-CLG/0219-CLH**  
 190 mm

Meniscotome  
 Meniskotome



**0118-DB**  
 220 mm

Hook-Probe  
 Hakensonde  
 4 mm



**0118-DF**  
 220 mm

Spoon ø 3 mm  
 30° curved  
 Löffel ø 3 mm  
 30° gebogen



**0118-DG**  
 220 mm



COLLIN  
**1123-BBC**  
 195 mm



**0614-IA**  
 170 mm

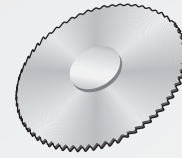

**0614-IA17**  
 Ersatzsägeblatt  
 Spare saw blade  
 Lama di ricambio per sega  
 Hoja de requesto  
 Lame de scie de rechange

Fingerringsägen  
 Forceps for opening rings  
 Pinza taglia anelli  
 Sierra para anillos  
 Scies pour bagues

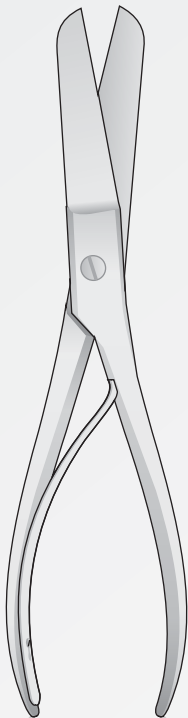

**0607-EA**  
 230 mm

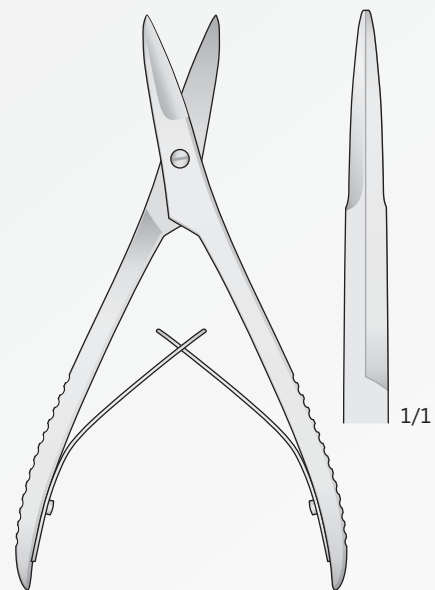
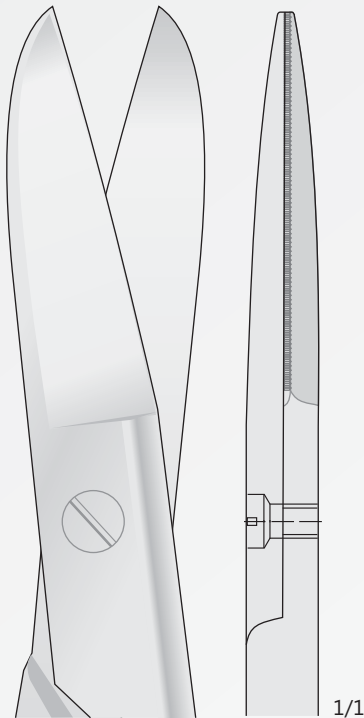

**0614-GD**  
 160 mm

Gipsspreizer Gipsabreisszangen  
 Plaster spreader Plaster cast breakers  
 Strumenti per gesso  
 Pinza para arrancar vendajes  
 Pinces pour appareils plâtrés

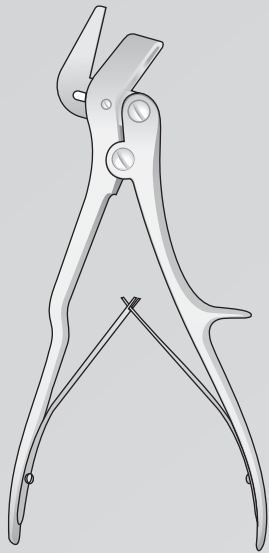

STILLE  
**1123-BCA**  
 230 mm

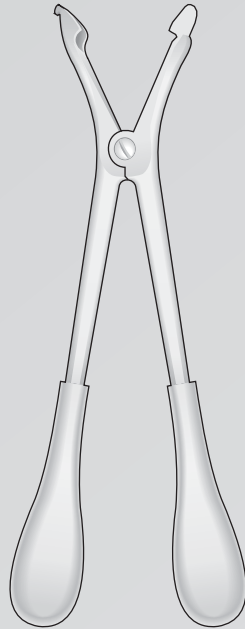

HAGLUND  
**1123-BCB**  
 280 mm

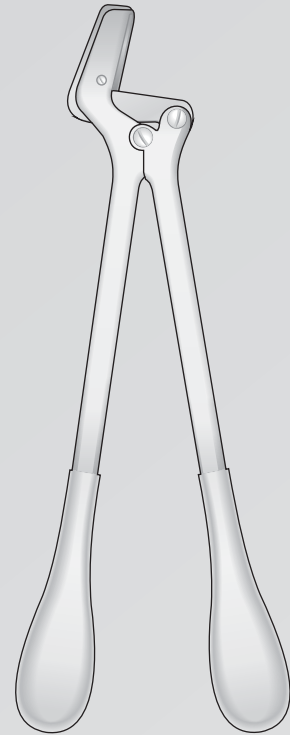

STILLE  
**1123-BCC**  
 370 mm

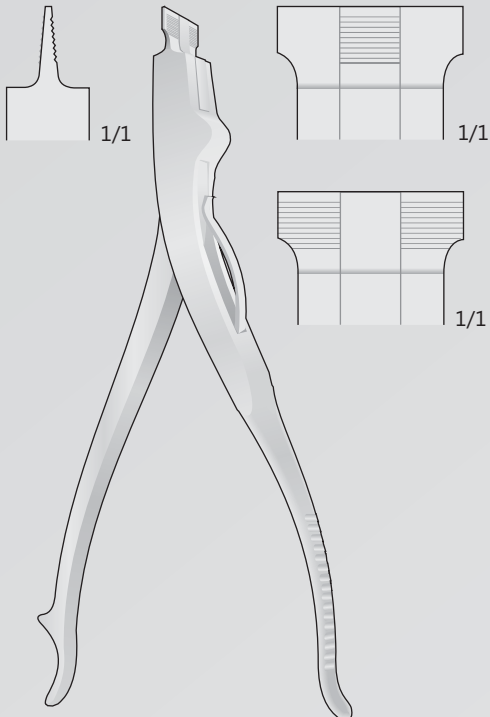

**1123-BBF**  
 220 mm

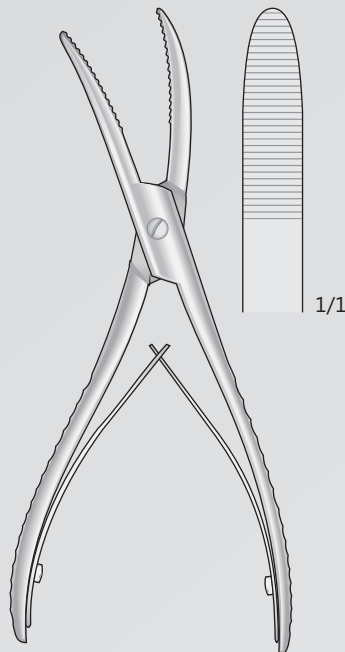

WOLFF  
**1123-BBD**  
 180 mm

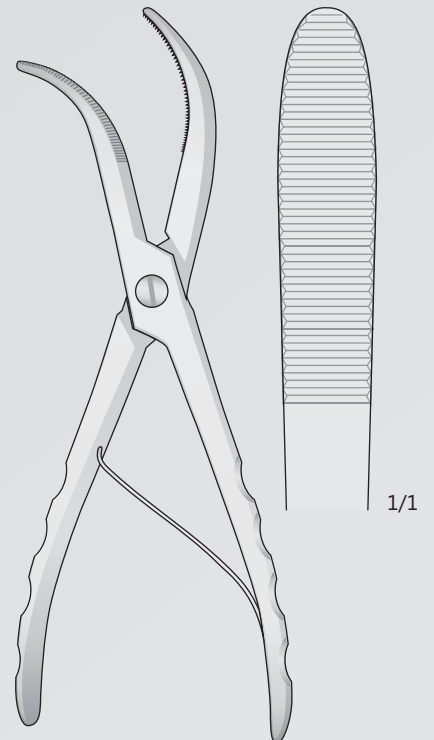

WOLFF  
**1123-BBE**  
 250 mm





 ideal-tek

Trokare  
Trocars  
Trequarti  
Tròcares  
Trocarts



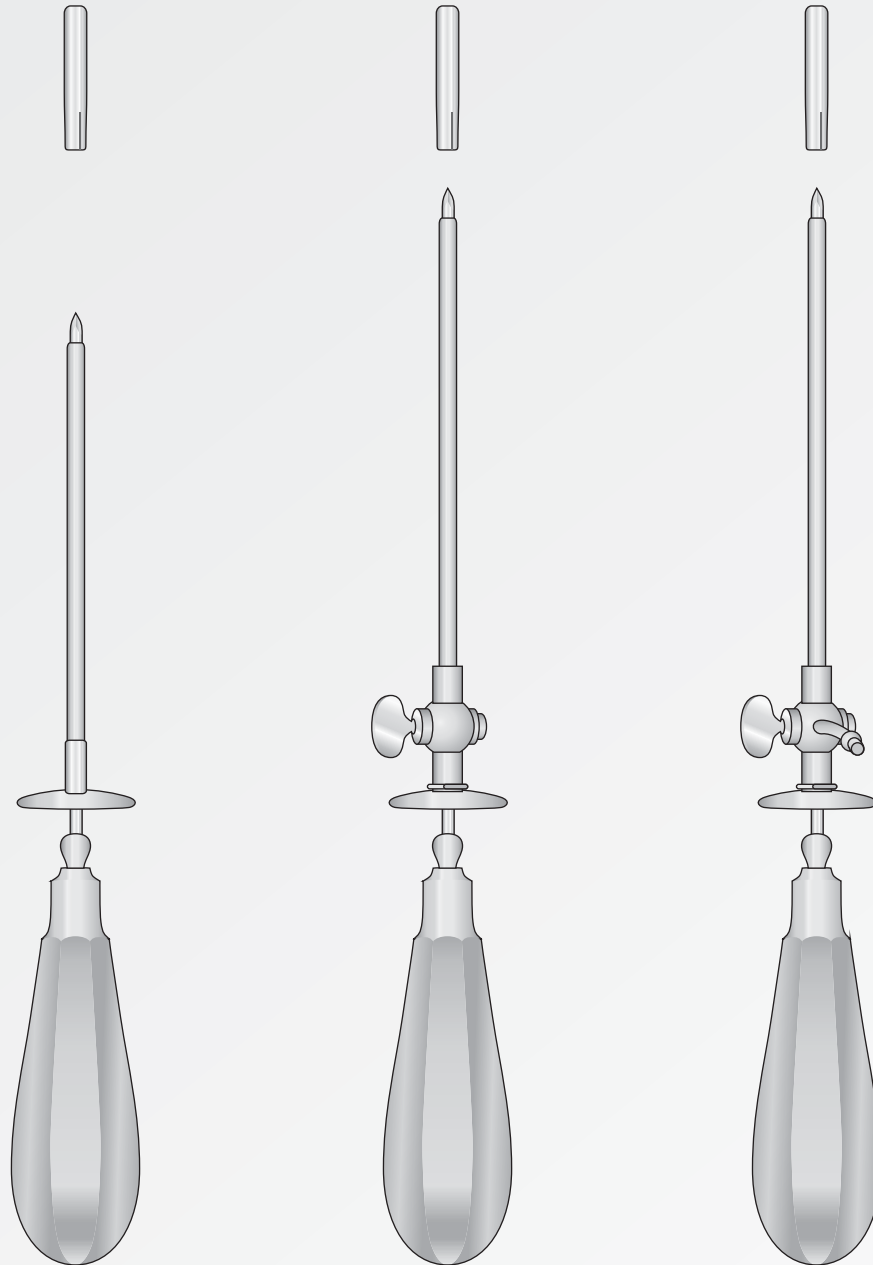

Ø mm	Ø mm
Esterno	Interno
Outside	Inside
Außen	Innen
Extérieur	Intérieur
Exterior	Interior

STANDARD

STANDARD

STANDARD

3,0	2,0	<b>1917-EA</b>	<b>1917-CA</b>	<b>1917-FB</b>
3,5	2,5	<b>1917-EE</b>	<b>1917-CB</b>	<b>1917-FC</b>
4,0	3,0	<b>1917-EB</b>	<b>1917-CC</b>	<b>1917-FD</b>
4,5	3,5	<b>1917-EF</b>	<b>1917-CD</b>	<b>1917-FE</b>
5,0	4,0	<b>1917-EC</b>	<b>1917-CE</b>	<b>1917-FF</b>
5,5	4,5	<b>1917-EG</b>	<b>1917-CF</b>	<b>1917-FG</b>
6,0	5,0	<b>1917-ED</b>	<b>1917-CG</b>	<b>1917-FH</b>
		110 mm	120 mm	120 mm

Krause Komplettsset  
Krause set complete  
Set completo Krause  
Set completo Krause  
Set complet Krause

Ø 5,5 mm

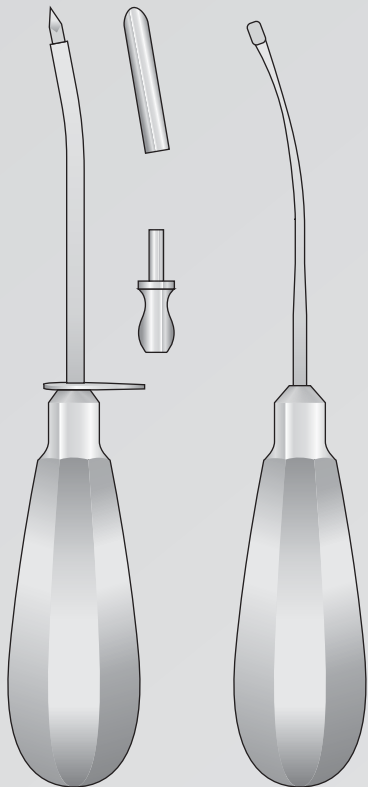

KRAUSE  
**1917-DF**  
160 mm

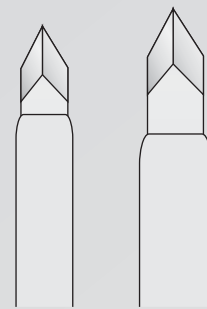

Fig. 1

Fig. 2

Für die gallenblase  
For gall bladder  
Per vescica biliare  
Para vesicula biliar  
Pour la vésicule biliaire

Ø mm	Ø mm
Außen	Innen
Outside	Inside
Esterno	Interno
Exterior	Interior
Extérieur	Intérieur

		NELSON	
7,5	6,0	Fig. 1	<b>1917-GB</b>
9,5	8,0	Fig. 2	<b>1917-GC</b>
			210 mm

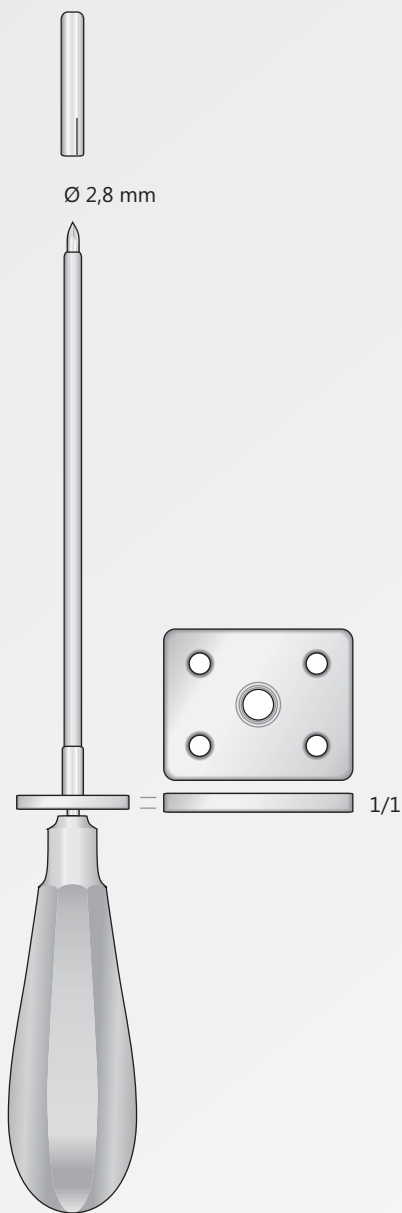

**1917-GA**  
250 mm

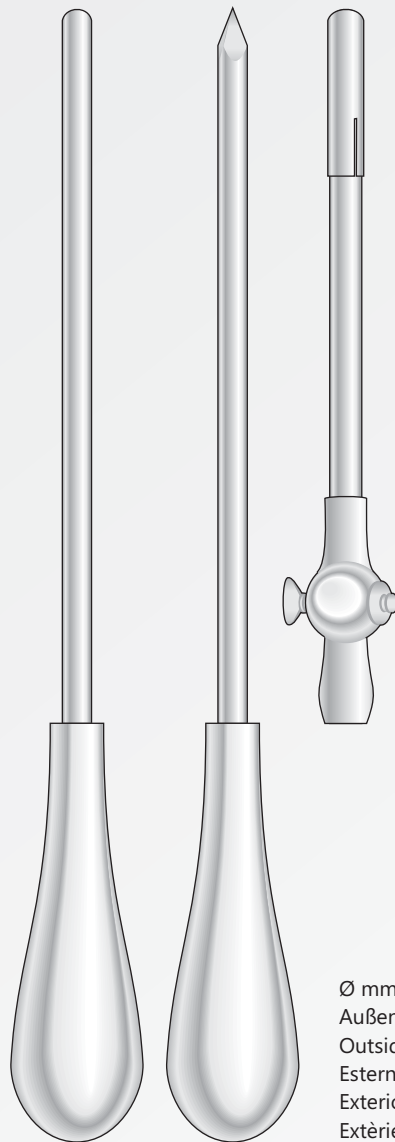

Ø mm	Ø mm
Außen	Innen
Outside	Inside
Esterno	Interno
Exterior	Interior
Extérieur	Intérieur

BUELAU	
8	6,5
10	8,5
<b>1917-GI</b>	
<b>1917-GL</b>	
240 mm	

Sternal-Punktionskanülen  
Sternal puncture needle  
Ago per la puntura dello sterno  
Agujas para punción esternal  
Aiguilles pour la ponction sternale

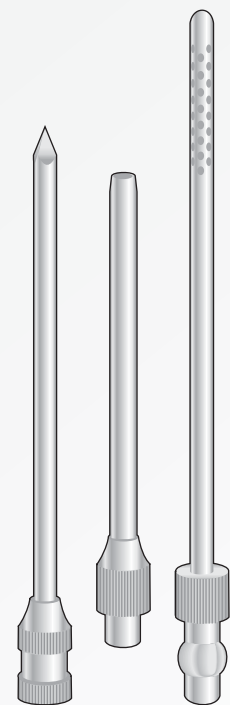

**DUKE**  
**0706-BAG**  
110 mm - 5,5 mm

Trokare  
Trocars  
Trequarti  
Tròcares  
Trocarts

Mit Holzgriff  
With wooden handle  
Manico in legno  
Con mango de leña  
Avec poignée en bois





Ø 4,5 mm

Ø 3 mm

Ø 1,75 mm

Satz zu 3 Stück  
 Set of 3 pieces  
 Trequarti con 3 punte  
 Juego de 3 piezas  
 Jeu de 3 pièces

**1917-EL**  
 130 mm

- MENGHINI
- 1411-BFA** 1,00 x 35 mm
  - 1411-BFB** 1,00 x 70 mm
  - 1411-BFC** 1,20 x 70 mm
  - 1411-BFD** 1,20 x 100 mm
  - 1411-BFE** 1,40 x 70 mm
  - 1411-BFF** 1,40 x 100 mm
  - 1411-BFG** 1,60 x 70 mm
  - 1411-BFH** 1,80 x 100 mm

- MENGHINI
- 1411-BFI** 1,40 x 168 mm
  - 1411-BFL** 1,80 x 168 mm

- QUINCKE
- 1411-EE** - 0,70 x 80 mm
  - 1411-EF** - 0,70 x 90 mm
  - 1411-EG** - 1,00 x 80 mm
  - 1411-EH** - 1,00 x 90 mm
  - 1411-EI** - 1,20 x 90 mm
  - 1411-EL** - 1,20 x 100 mm

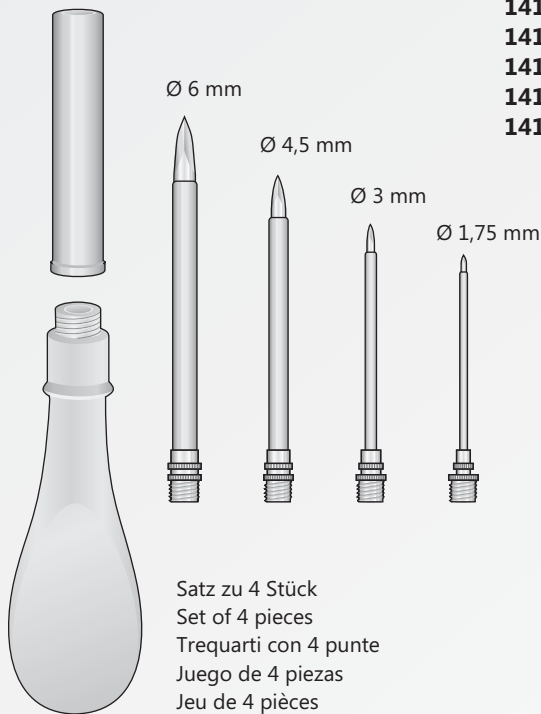

Ø 6 mm

Ø 4,5 mm

Ø 3 mm

Ø 1,75 mm

Satz zu 4 Stück  
 Set of 4 pieces  
 Trequarti con 4 punte  
 Juego de 4 piezas  
 Jeu de 4 pièces

**1917-FA**  
 130 mm

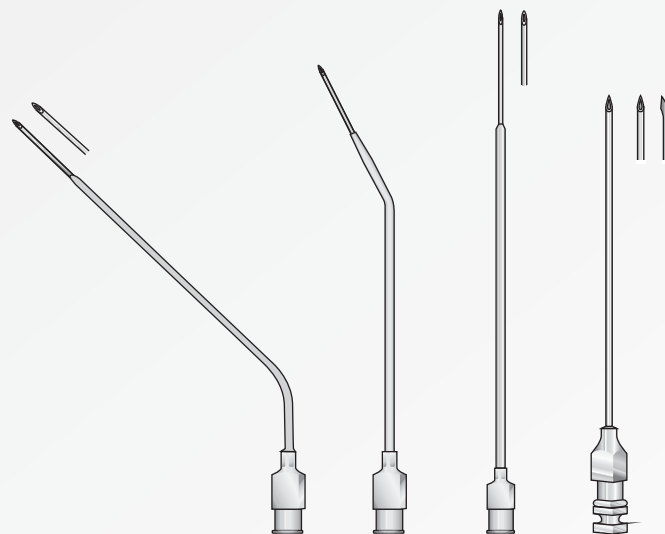

- SEPTUN-NADEL
- 1411-AE** 110 mm
  - 1411-AF** 110 mm
  - 1411-AB** 120 mm

- TUOHY
- 1411-EB** - 1,30 x 80 mm
  - 1411-EC** - 1,50 x 80 mm
  - 1411-ED** - 1,65 x 80 mm

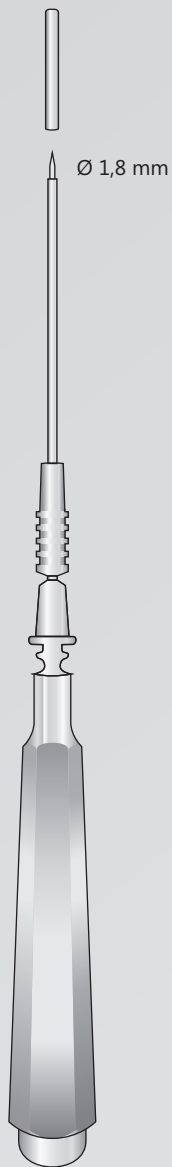

LICHTWITZ  
**1917-DA**  
 190 mm

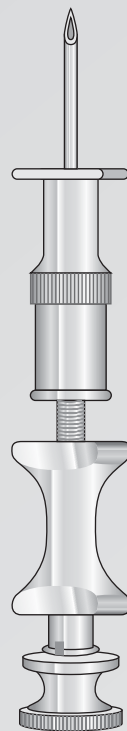

KLIMA-ROSEGGER  
**1411-EA**  
 1,80 x 35 mm



VERESS  
**0706-IL/0706-LA**

LUER LOCK

**0706-IL** 120 mm  
**0706-LA** 150 mm



Knochenbiopsie instrumente  
 Bone Biopsy instruments  
 Strumento per prelievo osseo  
 Trepanador manual parà biopsia òsea  
 Biopsie osseuse



**0610-LA**

Interno	Esterno
Inside	Outside
Innen	Außen
Intérieur	Extérieur
Interior	Exterior
Ø 3,9 mm	Ø 5 mm



**0610-LB**

Interno	Esterno
Inside	Outside
Innen	Außen
Intérieur	Extérieur
Interior	Exterior
Ø 6,4 mm	Ø 8 mm



**0610-LC**

Innen	Außen
Inside	Outside
Interno	Esterno
Interior	Exterior
Intérieur	Extérieur
Ø 3 mm	Ø 4 mm

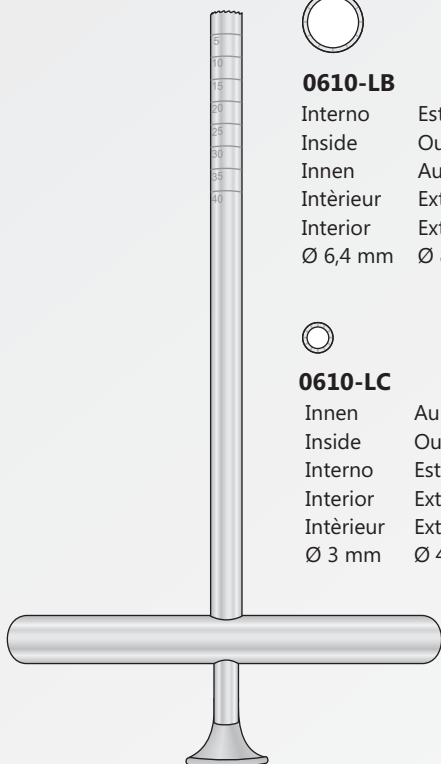

**0610-LA/0610-LC**  
170 mm

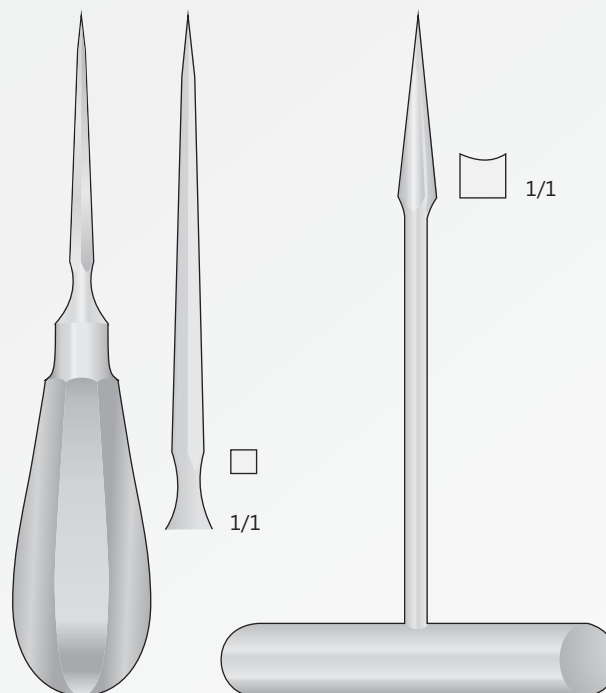

**1917-HH**  
140 mm

**1917-HG**  
140 mm

Punche da biopsia  
 Dermal punches  
 Haut-Trephinen  
 Tréphinés cutanées  
 Trépanos cutâneos

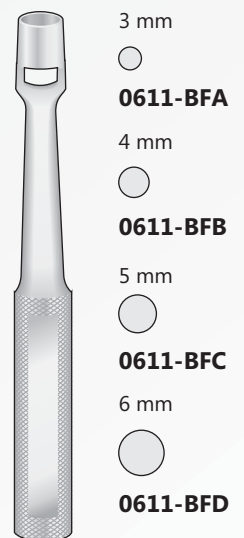

KEYES  
**0611-BFA/0611-BFD**  
100 mm

**0610-BAA**

Komplettset mit 4 Teilen  
 Set complete with 4 pieces  
 Set completo di 4 pezzi  
 Set completo con 4 piezas  
 Set complet avec 4 pièces

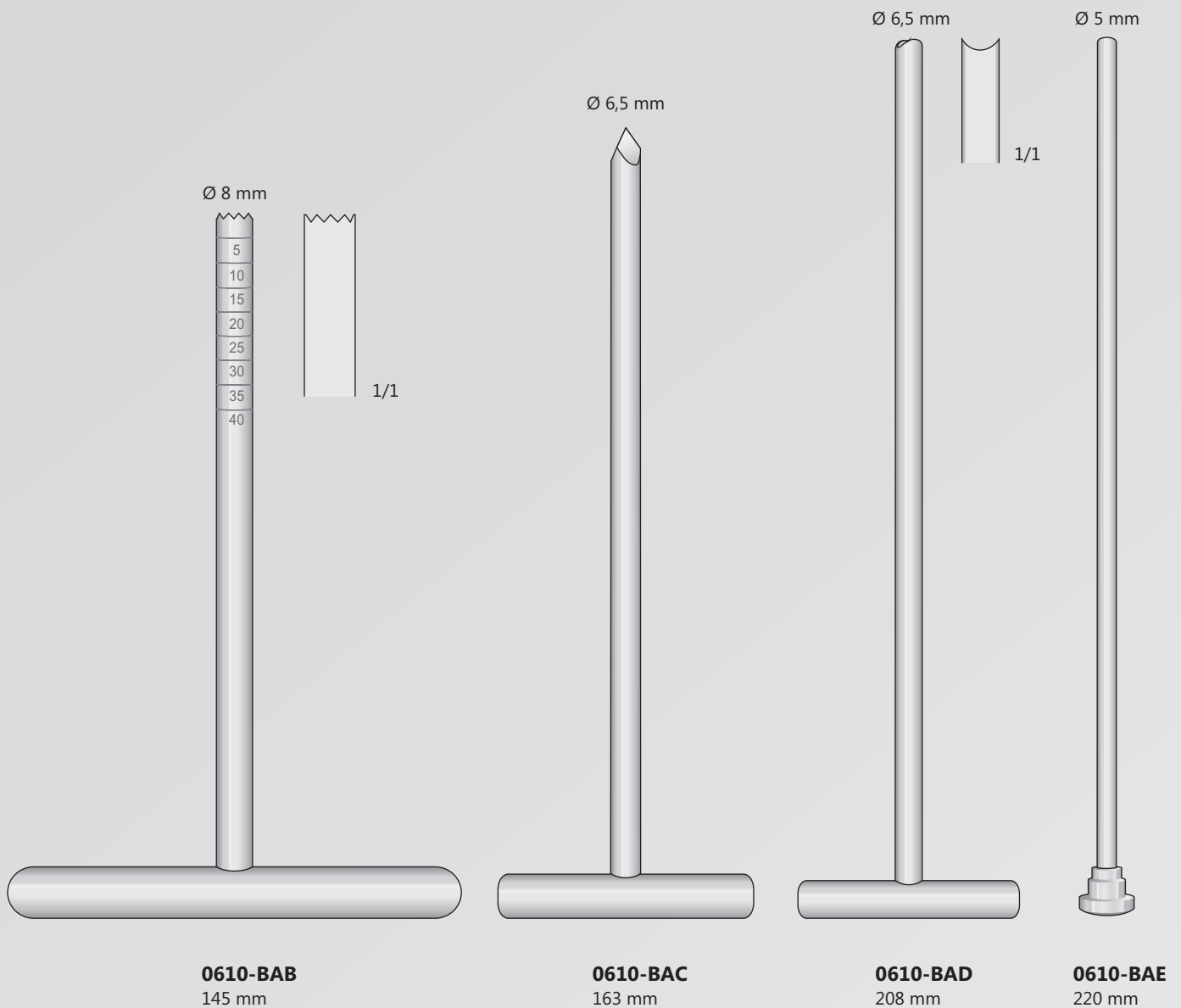

**0610-BAF**

Komplettsset mit 4 Teilen  
 Set complete with 4 pieces  
 Set completo di 4 pezzi  
 Set completo con 4 piezas  
 Set complet avec 4 pièces

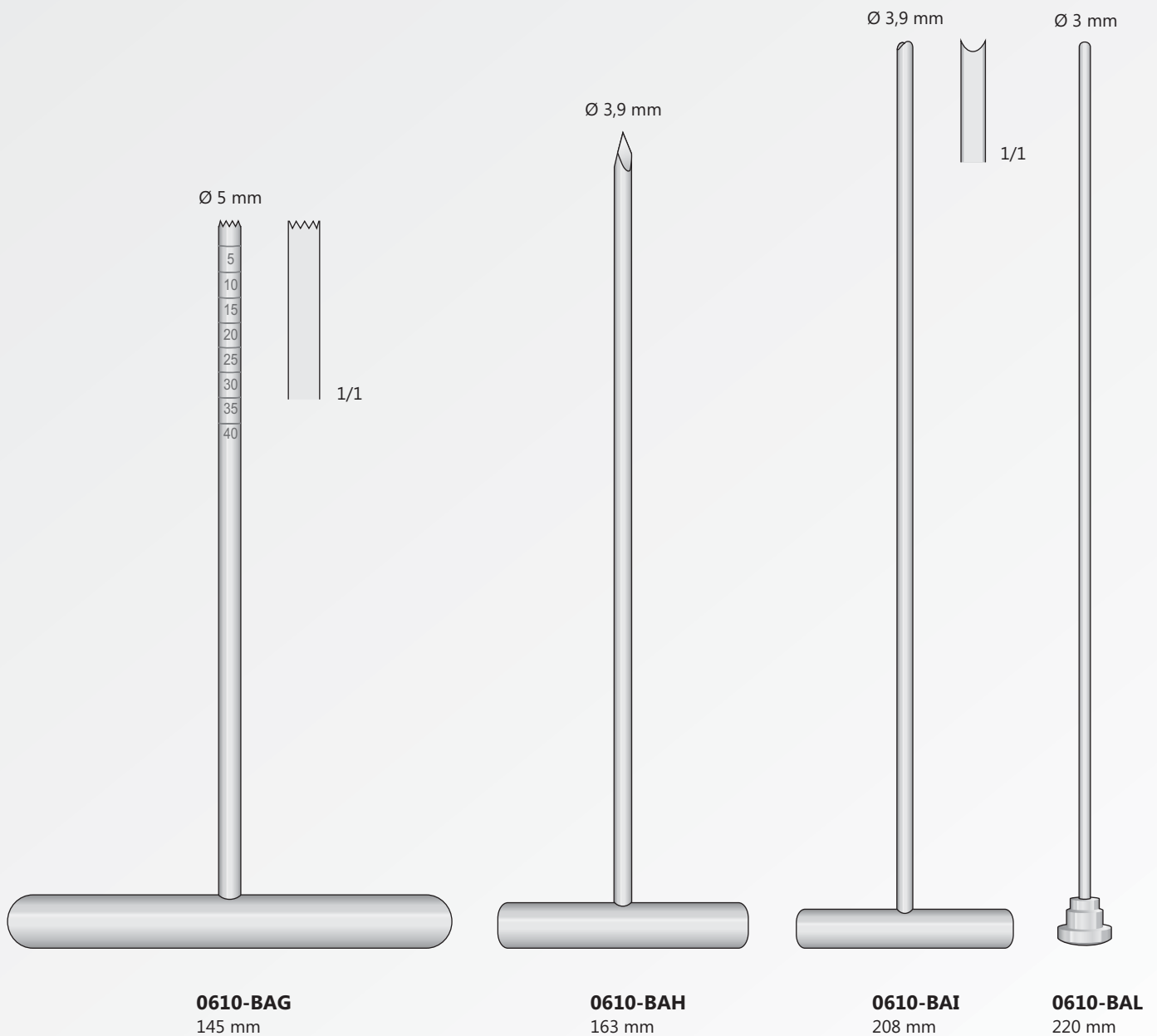





 ideal-tek

Hämmer, Flachmeissel, Knochenfeilen-Raspeln  
Mallets, Chisels, Bone Files-Rasps  
Martelli, Scalpelli, Lime e Raspe  
Martillos, Cinceles Limas para huesos  
Maillets, Ciseaux-Burins, Limes-Râpes



1 Seite flach  
1 Side flat  
1 Lato piatto  
1 Parte plana  
1 Face plate

1 Seite convex  
1 Side convex  
1 Lato convesso  
1 Parte convexa  
1 Face convexe

Ø 30 mm - 240 g



COTTLE  
**0611-BAE**  
185 mm

Ø 30 mm - 300 g



BERGMANN  
**0611-BAF**  
235 mm

Ø 40 mm - 550 g



OMBREDANNE  
**0611-BAI**  
240 mm

Ø 30 mm - 450 g

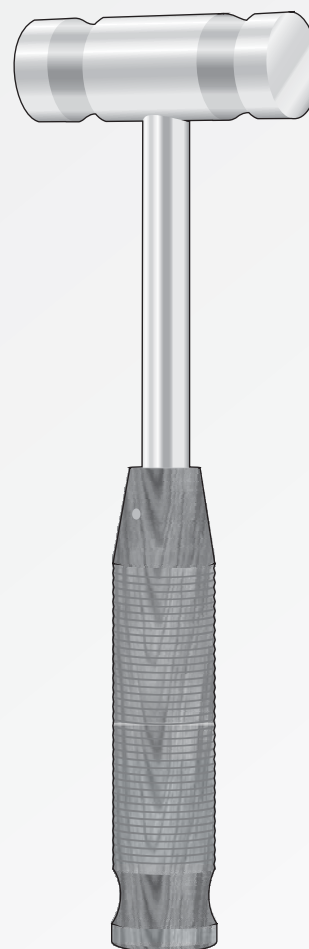

**0611-AG**  
260 mm

Ø 40 mm - 900 g

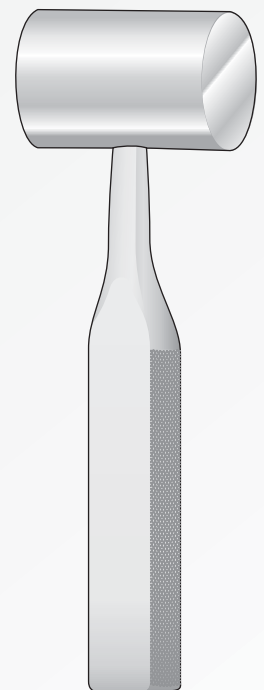

**0611-BBC**  
190 mm

Ø 20 mm - 140 g



**0611-AB**  
165 mm

Ø 25 mm - 300 g

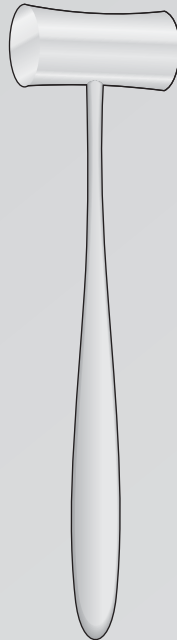

LUCAE  
**0611-BA12**  
190 mm

Ø 27 mm - 135 g

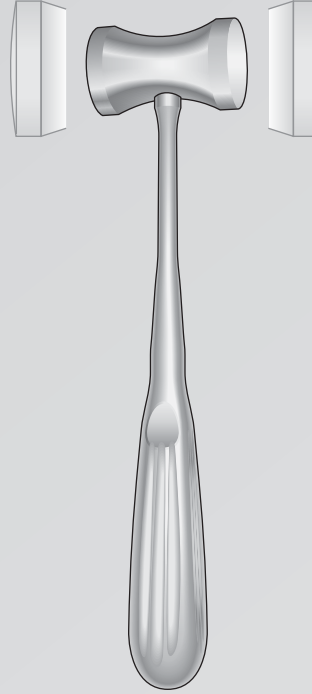

HAJEK  
**0611-BCI**  
200 mm

Ø 25 mm - 200 g

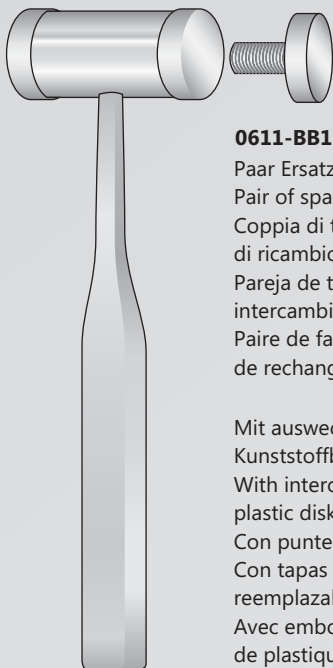

MEAD  
**0611-BB**  
200 mm

**0611-BB17**

Paar Ersatzbacken  
Pair of spare faces  
Coppia di teste  
di ricambio  
Pareja de tapas  
intercambiables  
Paire de faces  
de rechange

Mit auswechselbaren  
Kunststoffbacken  
With interchangeable  
plastic disks  
Con punte e ricambi in teflon  
Con tapas de plástico  
reemplazables  
Avec embouts  
de plastique rechangeables

Ø 26 mm - 320 g



MEAD  
**0611-BC**  
190 mm



**0611-BC17**

Paar Ersatzbacken  
Pair of spare faces  
Coppia di teste  
di ricambio  
Pareja de tapas  
intercambiables  
Paire de faces  
de rechange

Mit auswechselbaren  
Kunststoffbacken  
With interchangeable  
plastic disks  
Con punte e ricambi in teflon  
Con tapas de plástico  
reemplazables  
Avec embouts  
de plastique rechangeables





-  **0606-BEH**  
Ø3 mm
-  **0606-BEI**  
Ø5 mm
-  **0606-BEL**  
Ø8 mm



-  **0611-CFD**  
Ø12 mm
-  **0611-CFE**  
Ø14 mm
-  **0611-CFF**  
Ø16 mm

CASPAR

**0606-BEH/0606-BEL**  
200 mm

**0611-CFD/0611-CFF**  
200 mm



 Ø 3 mm



 Ø 5 mm



 Ø 7 mm



 Ø 2 mm



 Ø 4 mm



 Ø 3 mm



 Ø 5 mm



**0611-CFG**  
3x8 mm



**0611-CFH**  
4x10 mm



**0611-CFI**  
5x15 mm



**0611-CFL**  
6x20 mm

**0611-CA**  
155 mm

**0611-CB**  
155 mm

**0611-CC**  
155 mm

**0611-DA**  
155 mm

**0611-DB**  
155 mm

**0611-DD**  
155 mm

**0611-DF**  
155 mm

SYPERT

**0611-CFG/0611-CFL**  
290 mm

Osteotome  
 Osteotomes  
 Osteotomi  
 Osteòtomos  
 Ostèotomes

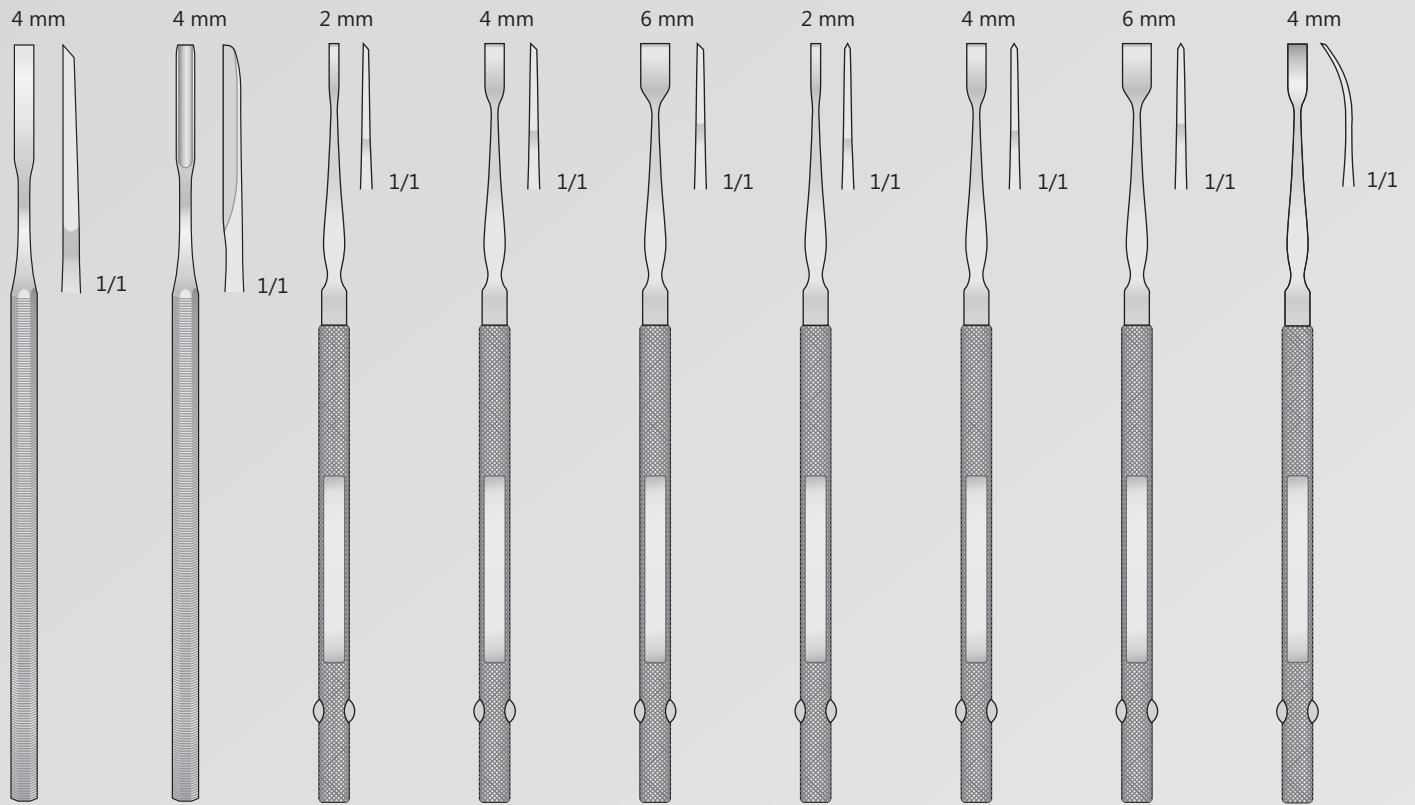

**BUCKLEY**  
**1907-EA**  
 160 mm

**BUCKLEY**  
**1907-EB**  
 160 mm

**1907-BA**  
 160 mm

**1907-BB**  
 160 mm

**1907-BC**  
 160 mm

**1907-CA**  
 160 mm

**1907-CB**  
 160 mm

**1907-CC**  
 160 mm

**FREER**  
**1907-CD**  
 160 mm

Osteotome - Hohlmeissel  
 Osteotomes - Gouges  
 Osteotomi - Scalpelli  
 Osteótomos - Cinceles  
 Ostéotomes - Scalpel

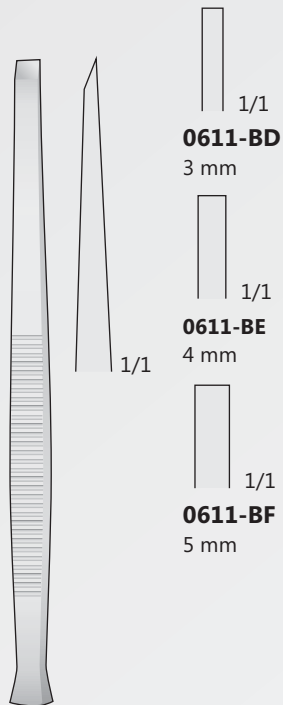

PARTSCH  
**0611-BD/0611-BF**  
 140 mm

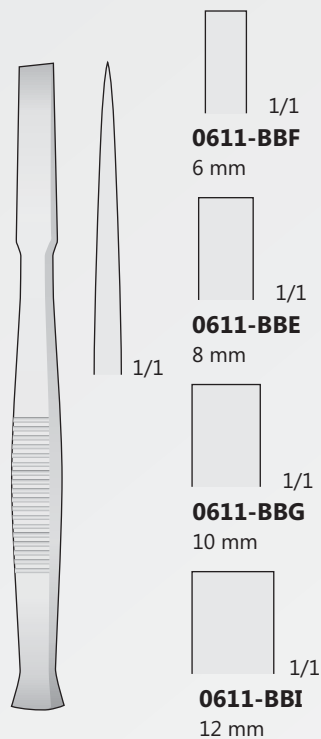

**0611-BBE/FL-118**  
 140 mm

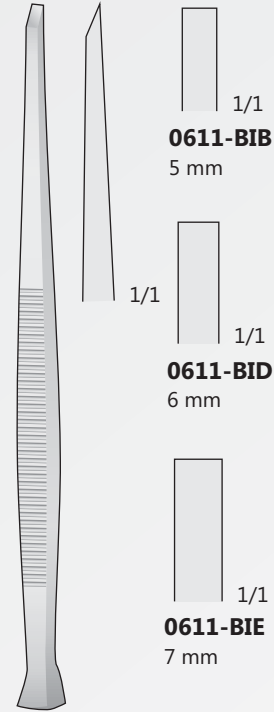

PARTSCH  
**0611-BIB/0611-BIE**  
 170 mm

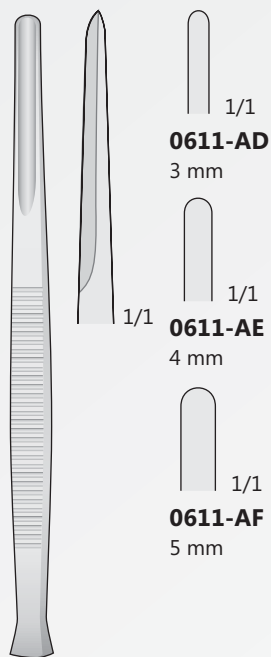

PARTSCH  
**0611-AD/0611-AF**  
 140 mm

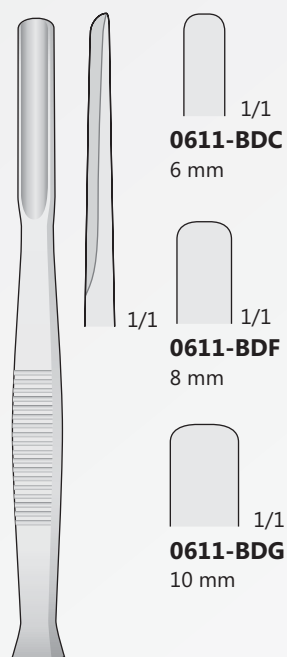

**0611-BDC/0611-BDG**  
 140 mm

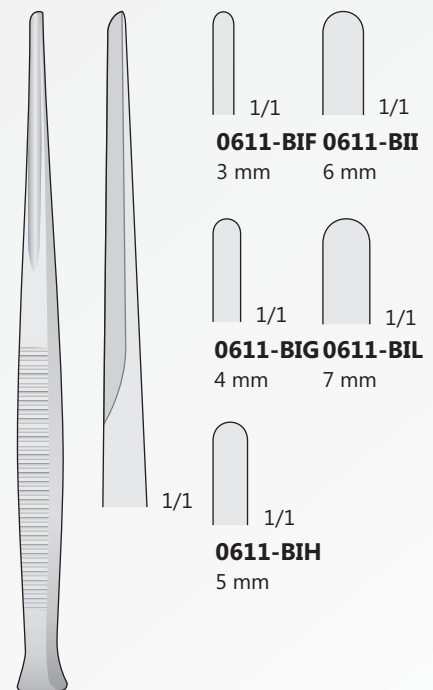

PARTSCH  
**0611-BIF/0611-BIL**  
 170 mm

Osteotome  
 Osteotomes  
 Osteotomi  
 Osteòtomos  
 Ostèotomes

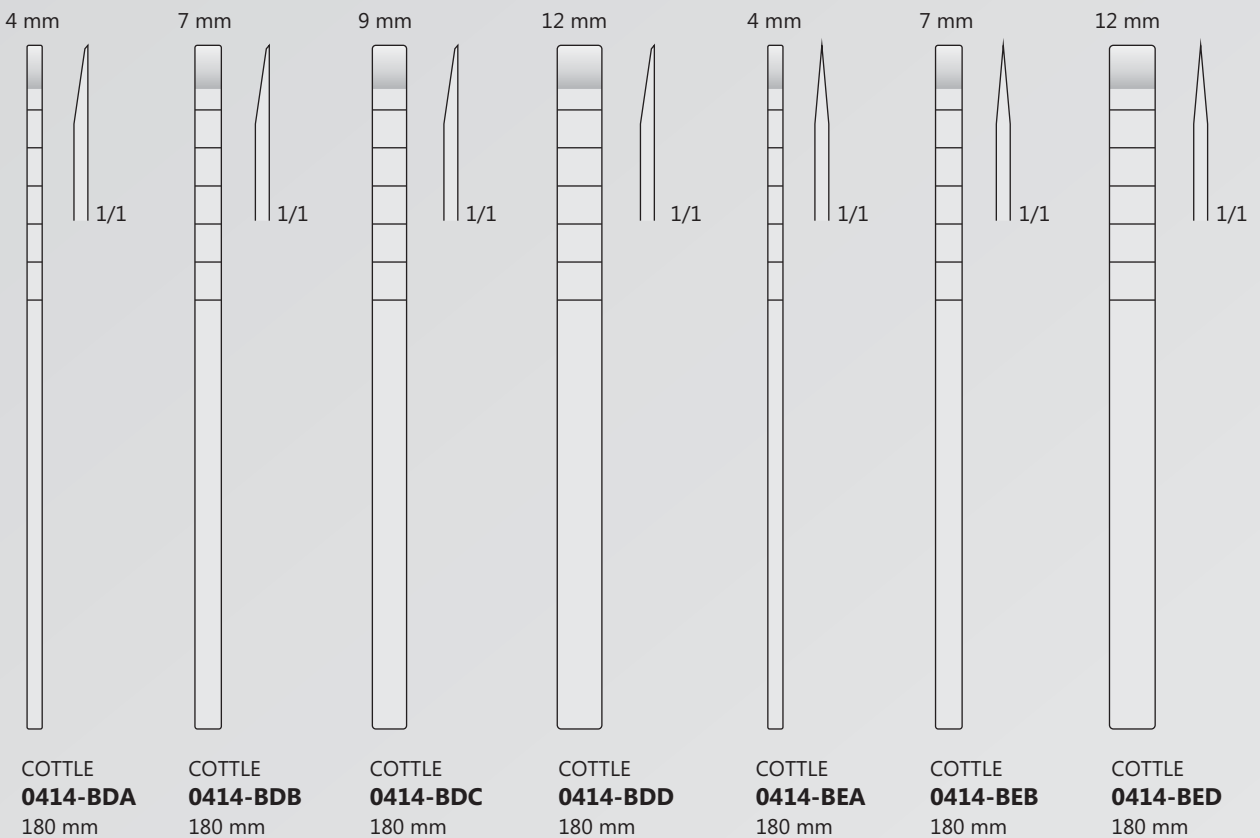
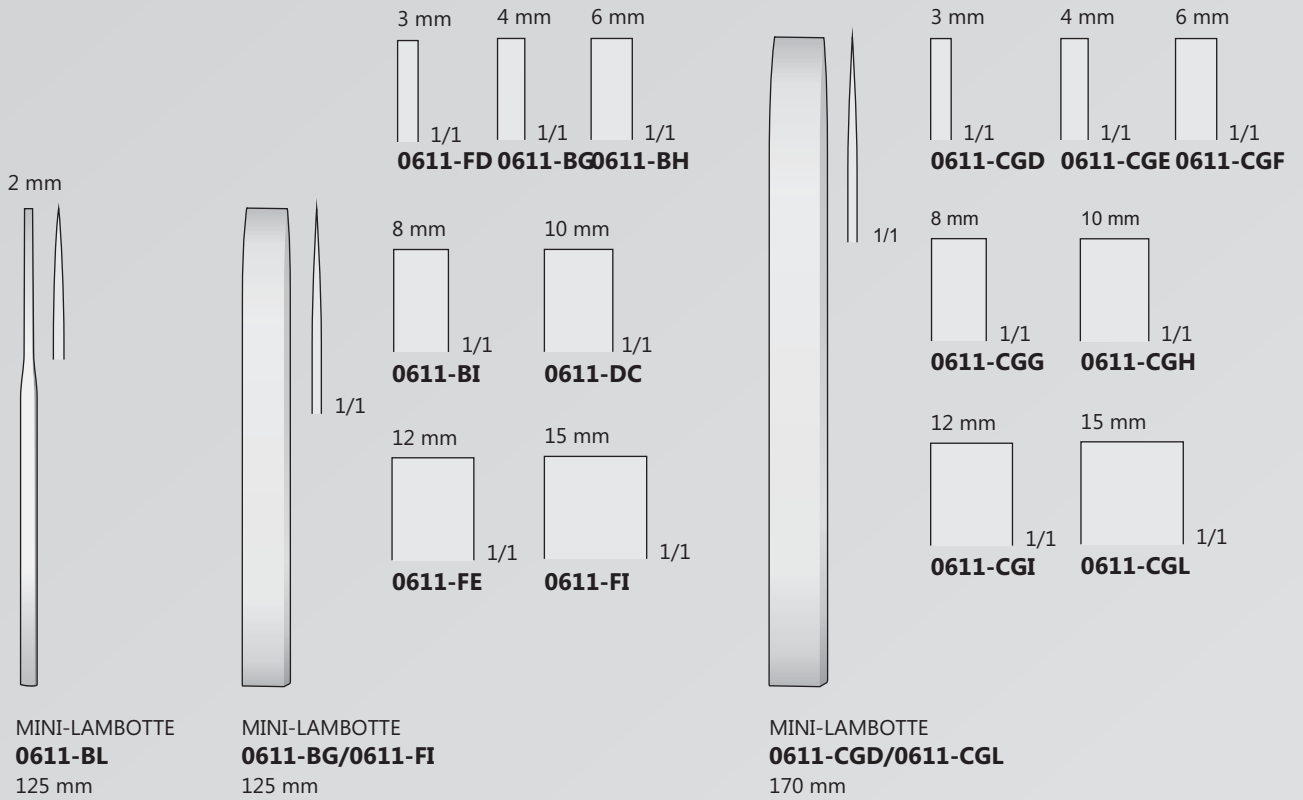



EPKER  
**0414-BIA/0414-BIC**  
180 mm

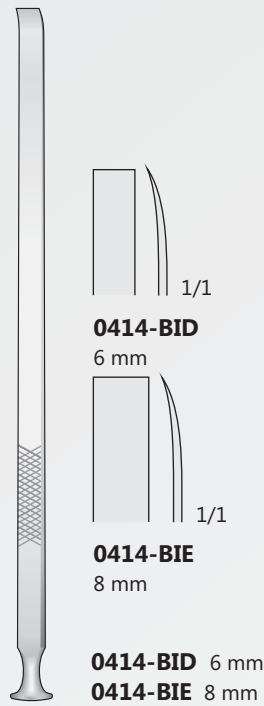

EPKER  
**0414-BID/0414-BIE**  
180 mm

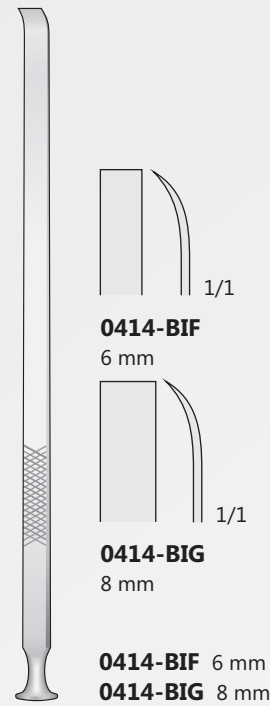

EPKER  
**0414-BIF/0414-BIG**  
180 mm

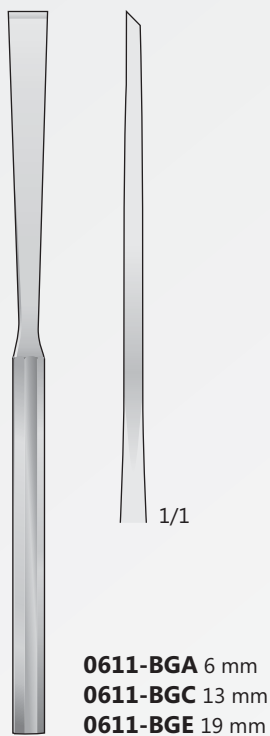

HIBBS  
**0611-BGA/0611-BGE**  
230 mm

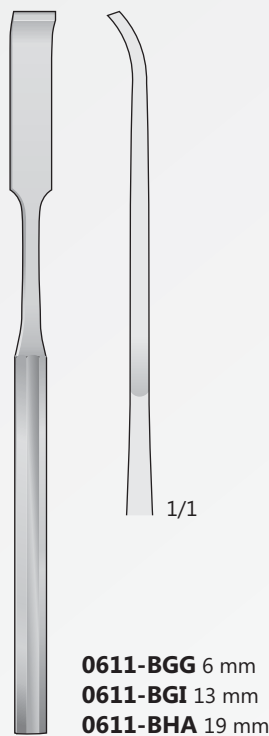

HIBBS  
**0611-BGG/0611-BHA**  
230 mm

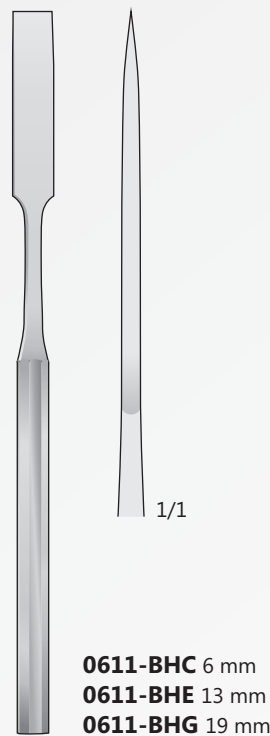

HIBBS  
**0611-BHC/0611-BHG**  
230 mm

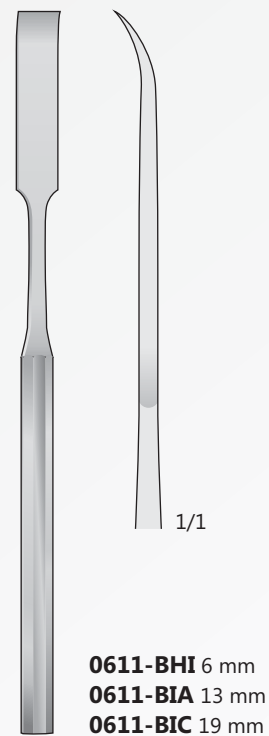

HIBBS  
**0611-BHI/0611-BIC**  
230 mm

Osteotome - Hohlmeissel  
 Osteotomes - Gouges  
 Osteotomi - Scalpelli  
 Osteótomos - Cinceles  
 Ostéotomes - Scalpel

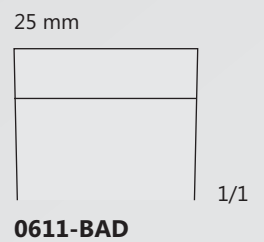
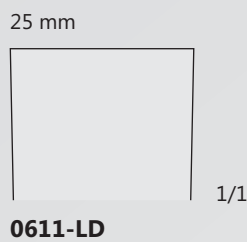
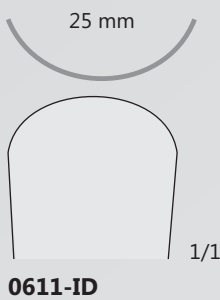
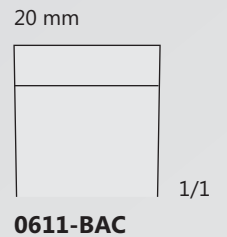
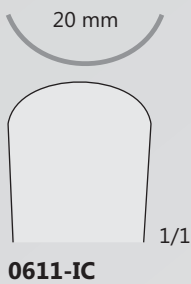
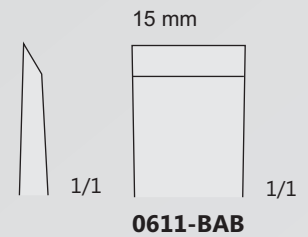
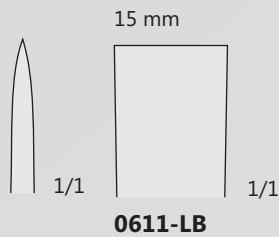
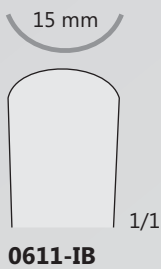
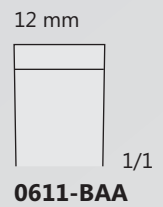
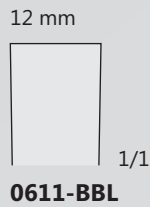
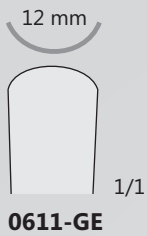
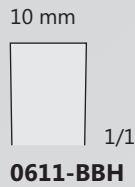

STILLE  
**0611-GD/0611-ID**  
 200 mm

STILLE  
**0611-LB/0611-BBL**  
 200 mm

STILLE  
**0611-BAA/0611-BBA**  
 200 mm

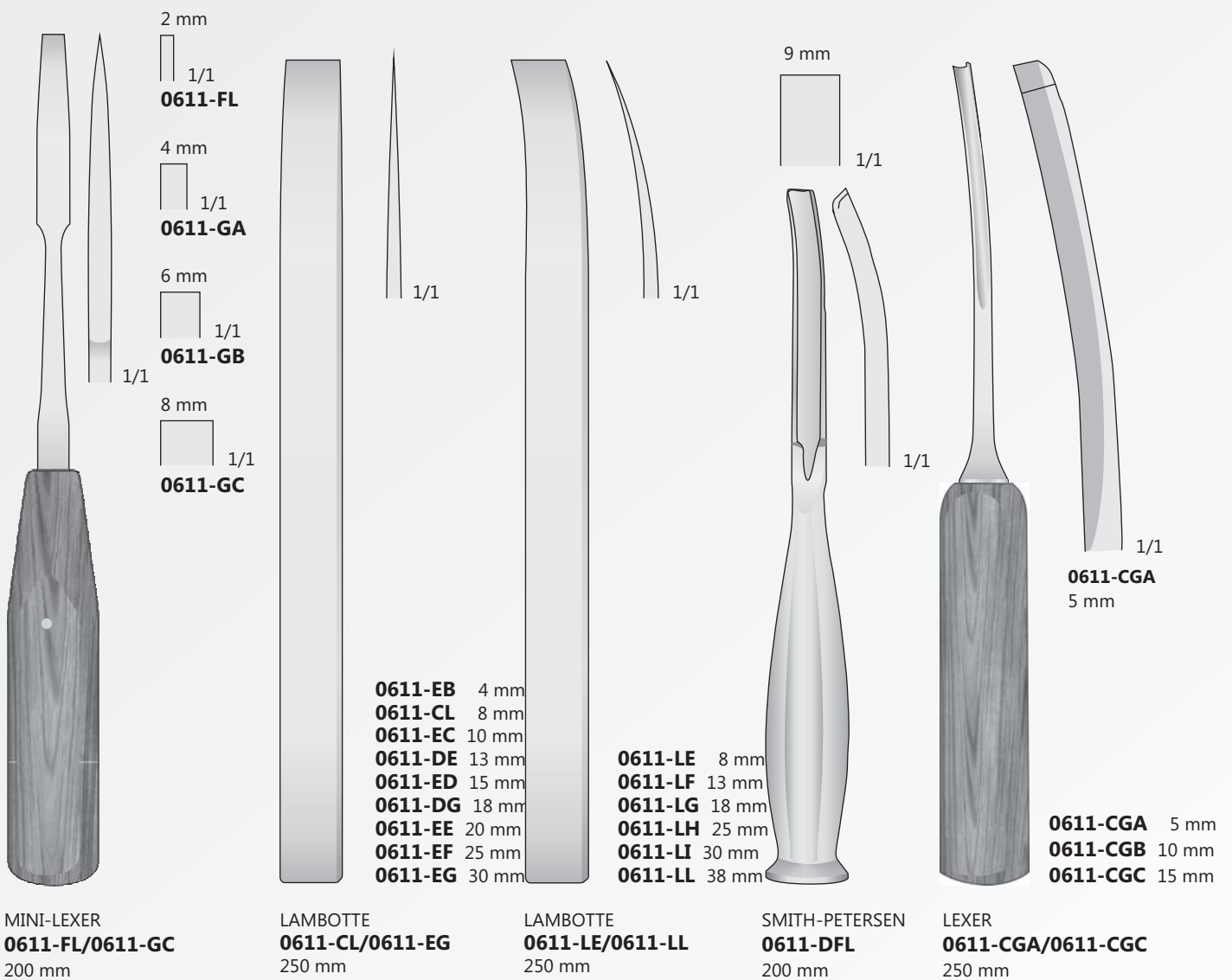

Osteotome  
 Osteotomes  
 Osteotomi  
 Osteòtomos  
 Ostèotomes

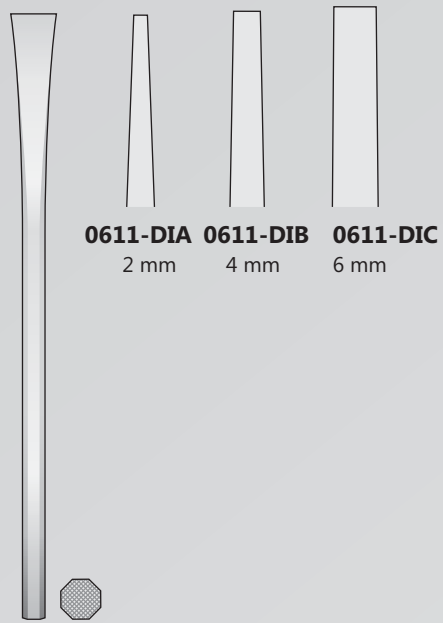

SHEEHAN  
**0611-DIA/0611-DIC**  
 160 mm

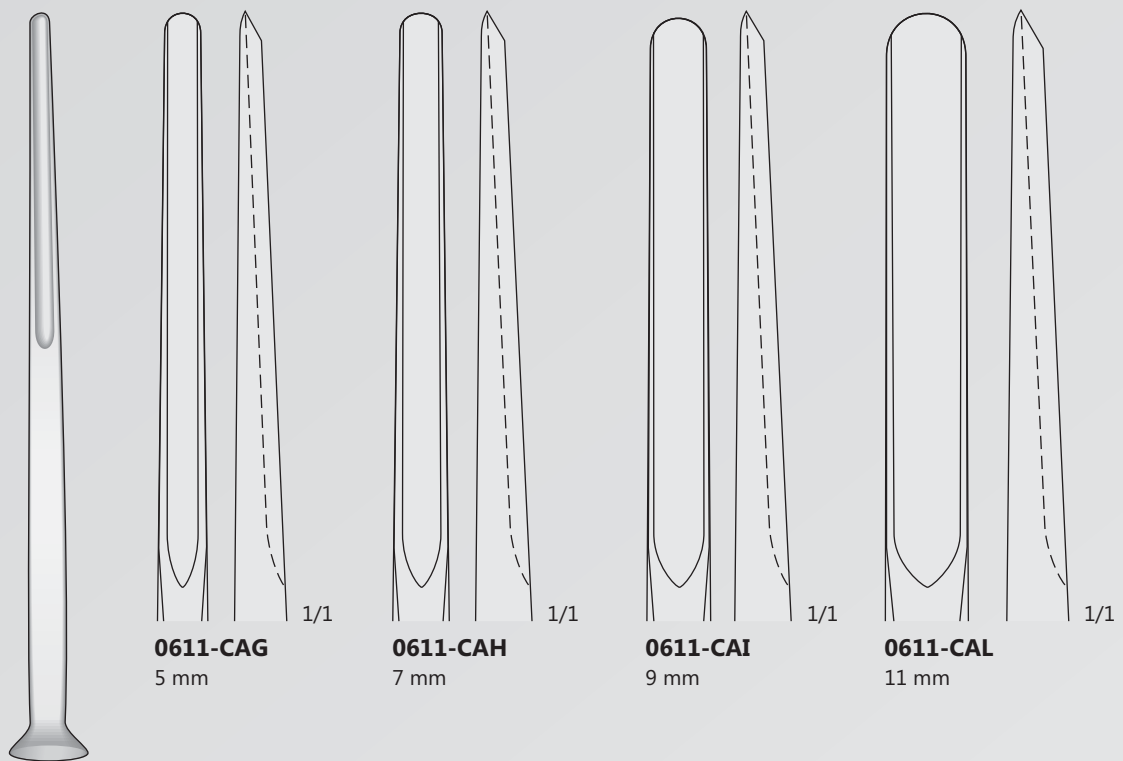

ALEXANDER  
**0611-CAG/0611-CAL**  
 170 mm



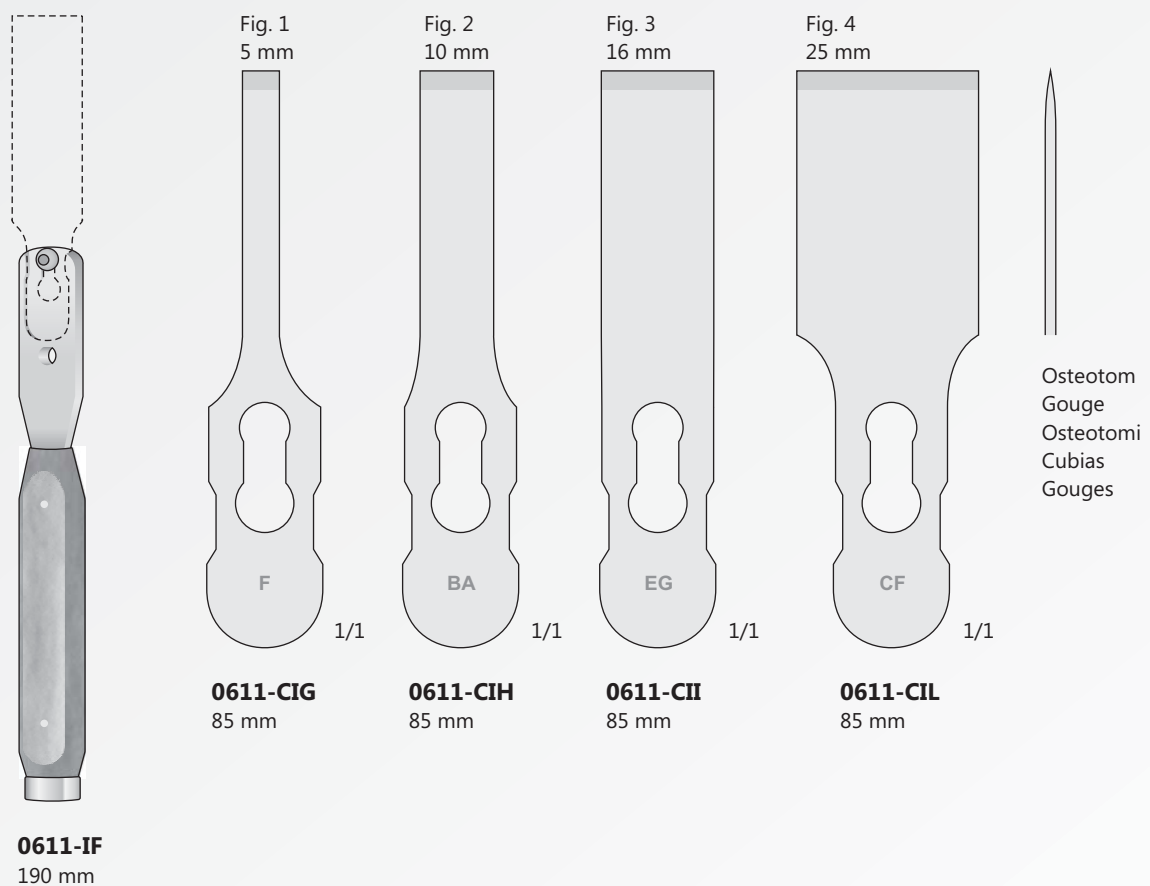
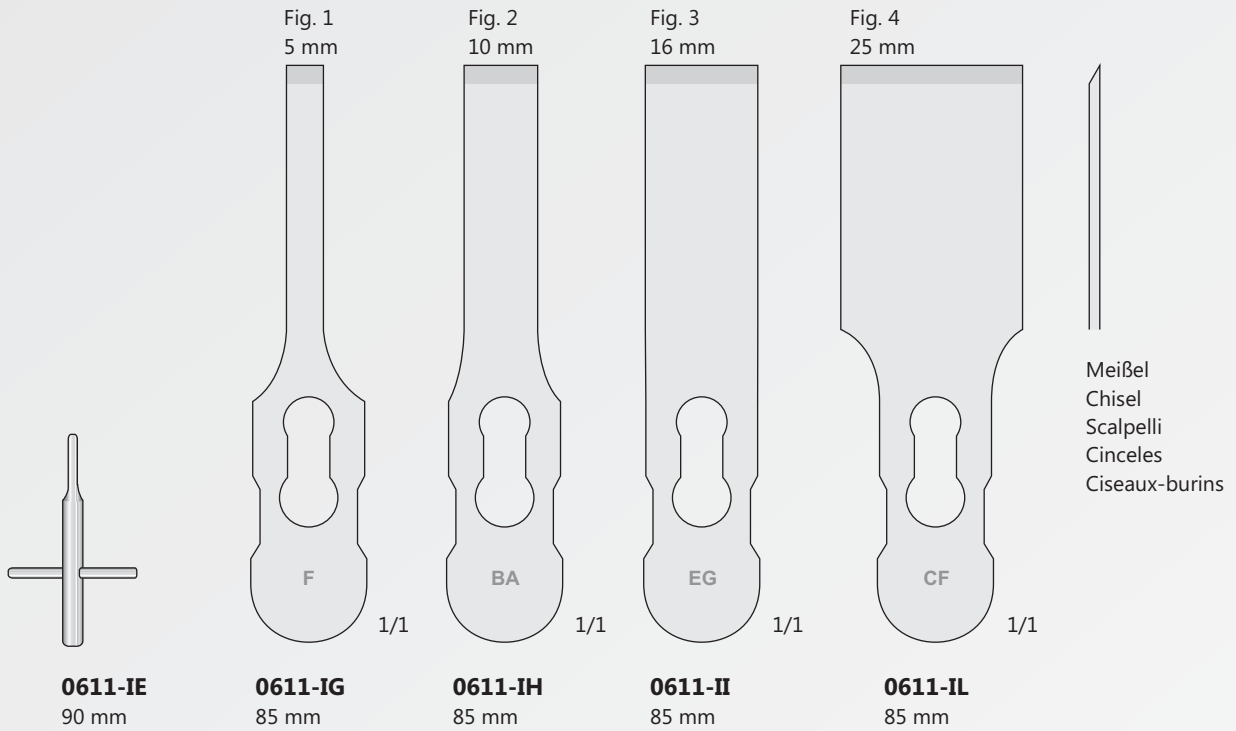

Raspeln  
 Rasps  
 Raspe  
 Escofinas  
 Râpes



**0610-IL**  
 170 mm

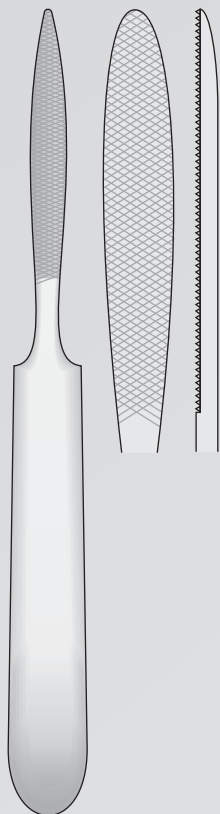

JOSEPH  
**0610-BLD**  
 160 mm

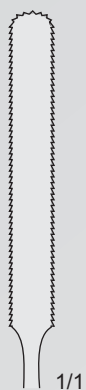

1/1



GALLAHER  
**0610-BLE/0610-BLG**  
 160 mm



1/1

**0610-BLE**  
 160 mm



1/1

**0610-BLF**  
 160 mm



1/1



1/1

**0610-BLG**  
 160 mm



1/1

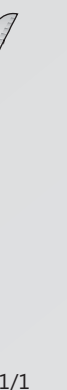

1/1



1/1

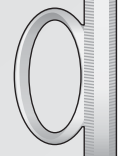

GOOD  
**0610-BLL**  
 160 mm



1/1



1/1

Fig. 67

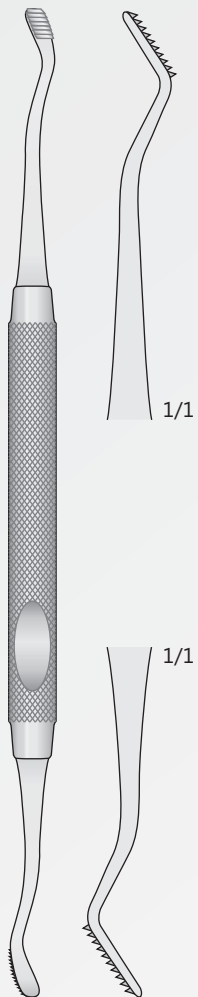

HOWARD  
**0414-B**  
180 mm

Fig. 45

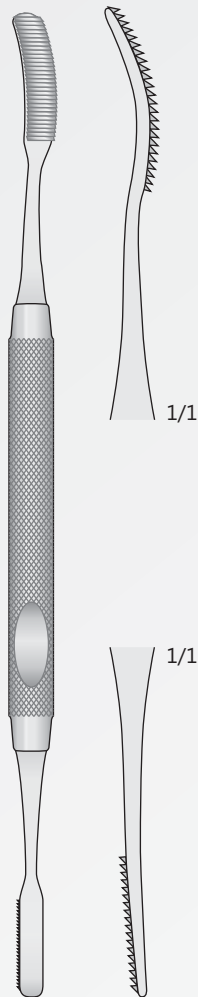

MILLER  
**0414-C**  
185 mm

Fig. 52

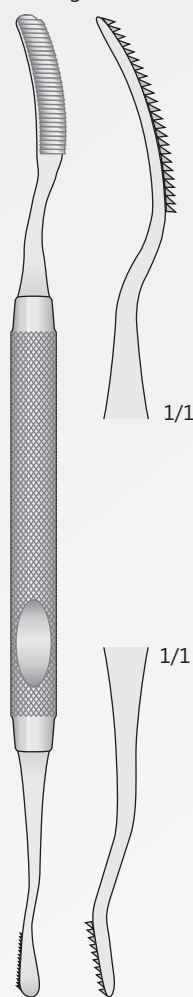

MILLER  
**0414-D**  
180 mm



**0414-CGH**  
190 mm

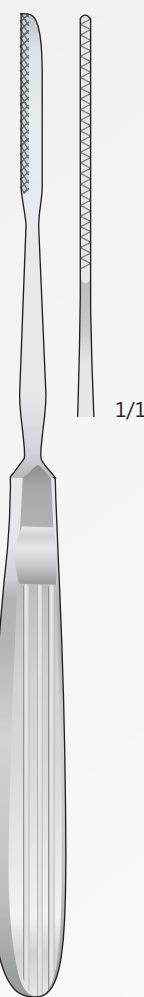

JOSEPH  
**0414-BAL**  
190 mm

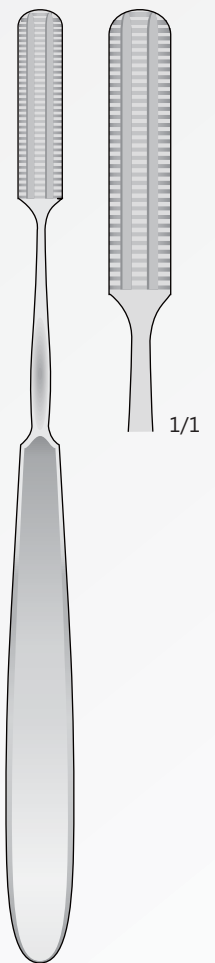

MALTZ  
**0414-BHL**  
180 mm

Raspeln  
 Rasps  
 Raspe  
 Escofinas  
 Râpes

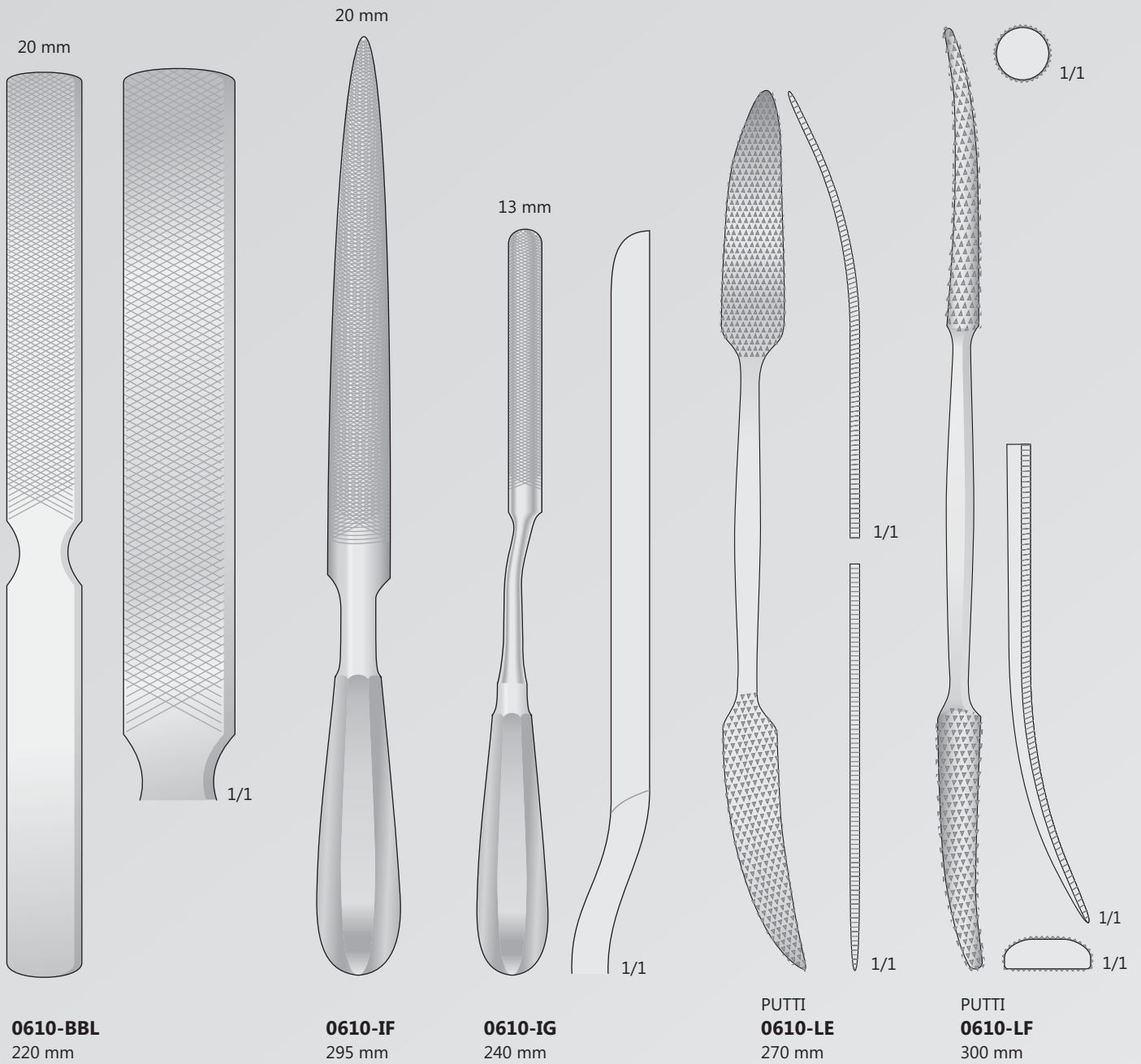

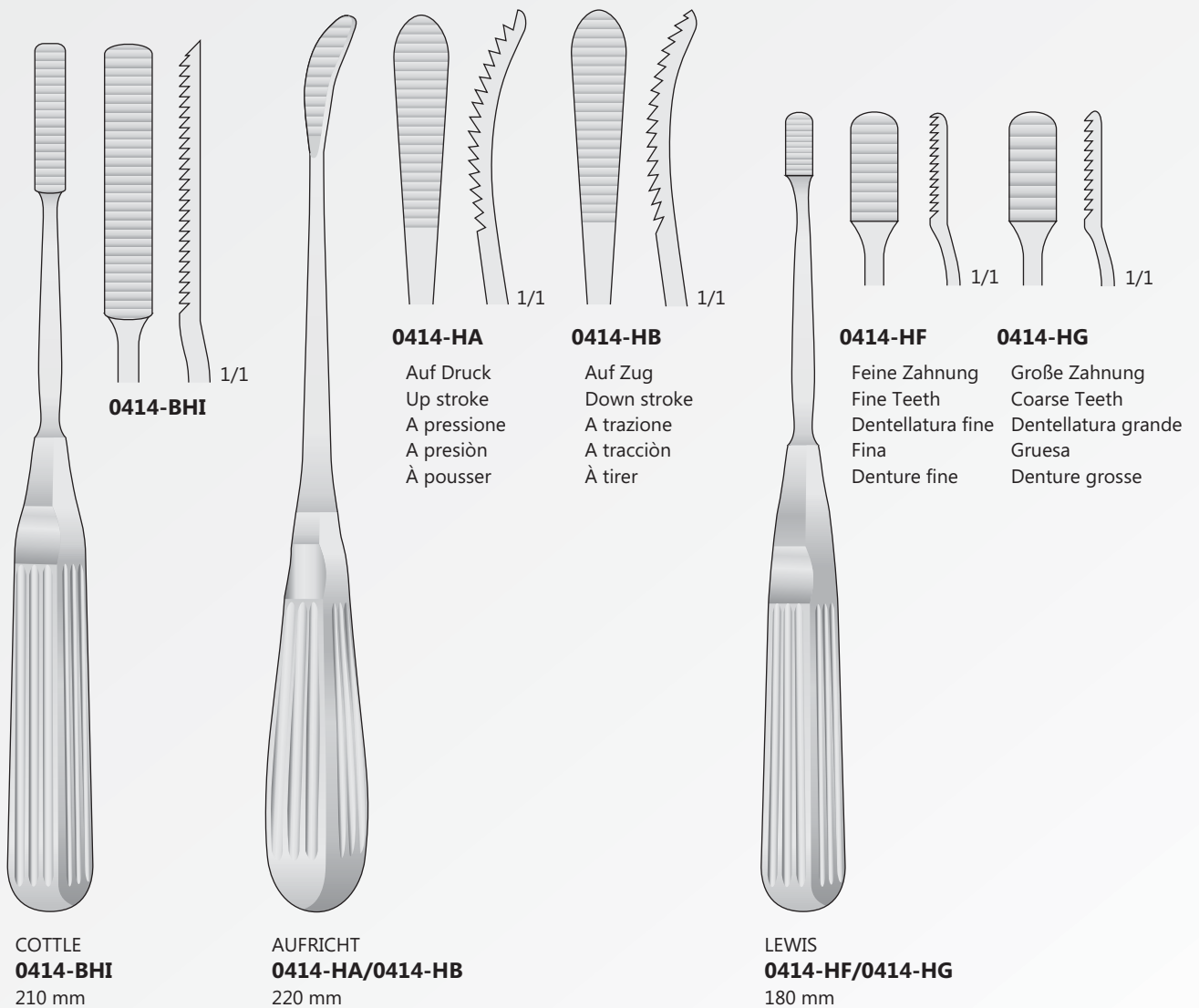

Raspeln  
 Rasps  
 Raspe  
 Escofinas  
 Râpes

8 mm



8 mm

**0610-LG**  
 210 mm

2 mm



5 mm

**0610-LH**  
 210 mm



1/1



1/1

8 mm

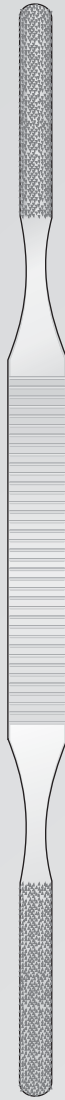

8 mm

**0610-LI**  
 210 mm

8 mm

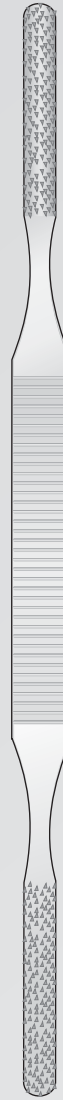

8 mm

**0610-LL**  
 210 mm

Feilen  
File  
Lima  
Lima  
Lime



FOMON 7,5 mm  
**0414-BGI**  
210 mm

Raspel  
Rasp  
Raspa  
Raspador  
Râpe

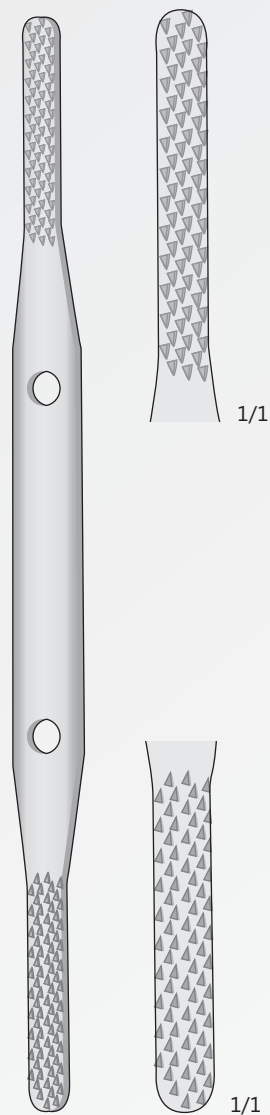

FOMON 7,5 mm  
**0414-BGL**  
210 mm

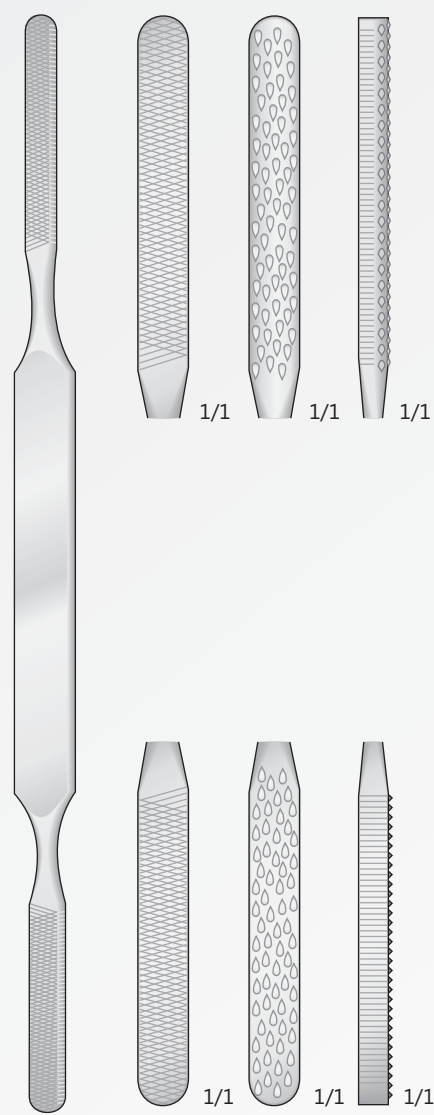

FOMON  
**0610-BHF**  
210 mm



CONVERSE  
**0610-BHE**  
180 mm



Handgriffe für Drahtsägen  
 Hook Handles for wire saws  
 Manico ad uncino per sega  
 Mango con gancho para sierras de hilo  
 Poignées pour scies

- 1 Paar
- 1 Pair
- 1 Paio
- 1 Par
- 1 Paire

GIGLI  
**0610-BB**

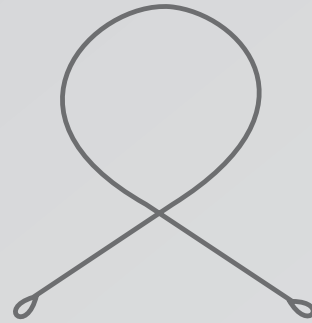

Drahtsägen  
 Wire Saws  
 Fili per sega  
 Sierras de hilo  
 Fils-Scies

Rostfrei  
 Stainless Steel  
 Acciaio  
 Acero  
 Inox

5/1

OLIVECRONA-GIGLI  
**0610-BD** 300 mm  
**0610-BE** 500 mm

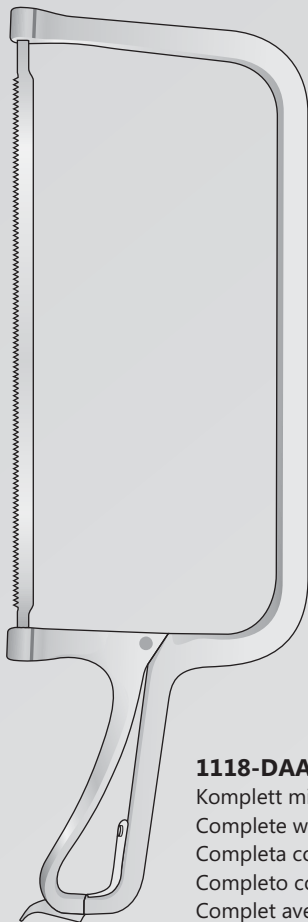

**1118-DAA**  
 Komplet mit 3 Sägen  
 Complete with 3 saws  
 Completa con 3 seghe  
 Completo con 3 sierras  
 Complet avec 3 scies

COLLIN  
**1118-DAA**  
 390 mm

Fig.1



Fig.2



Fig.3



**1118-DAB** 280 mm  
**1118-DAC** 280 mm  
**1118-DAD** 280 mm



1/1

LINDEMANN  
**0610-CED**  
 200 mm



LANGENBECK  
**0610-CEE**  
 235 mm



**1118-CDD**

Komplett mit - Complete with  
Completo con - Completos con  
Completés avec:

- 1 **1118-CDG**
- 1 **1118-CCL**
- 1 **1118-CEB**

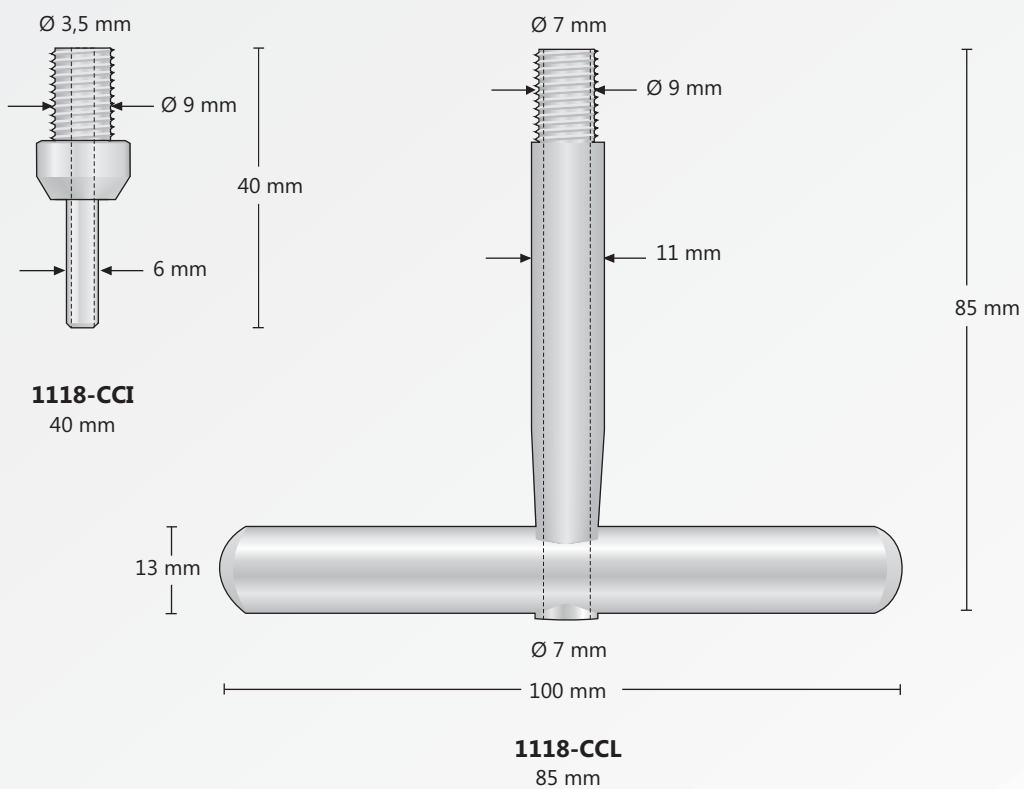
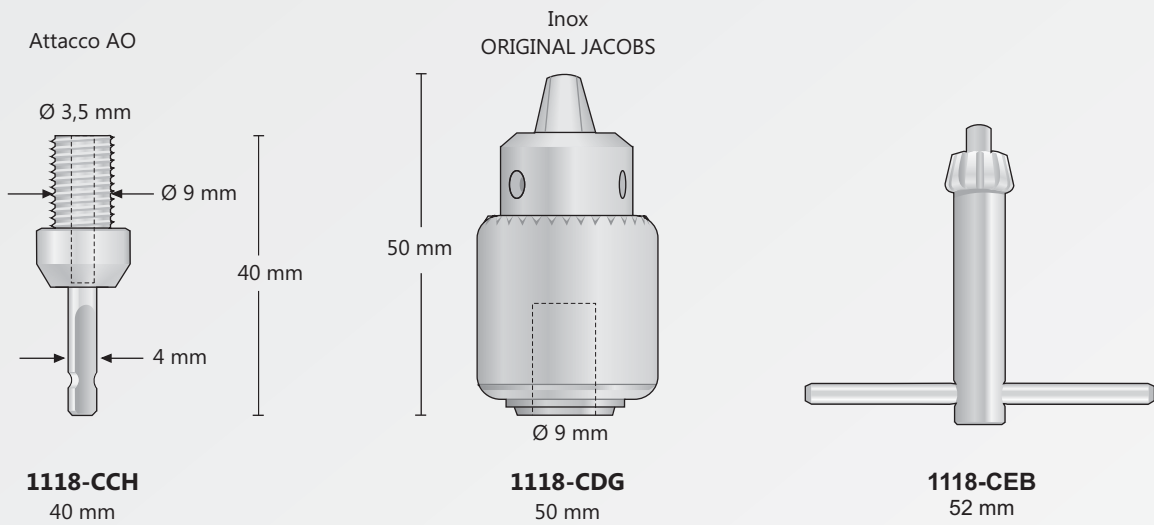

Handbohrfutter  
 Drilling Chucks  
 Perforatori a mano con mandrino  
 Perforadores para huesos  
 Perforateurs à os

Handbohrapparate  
 Hand Bone Drills  
 Trapani a mano per ossa  
 Perforadores de mano  
 Perforateurs à main

**1118-CDL**

Komplett mit - Complete with  
 Completo con - Completos con  
 Completes avec:

- 1 **1118-CDG**
- 1 **1118-CDH**
- 1 **1118-CDI**
- 1 **1118-CEB**

Inox  
 ORIGINAL JACOBS

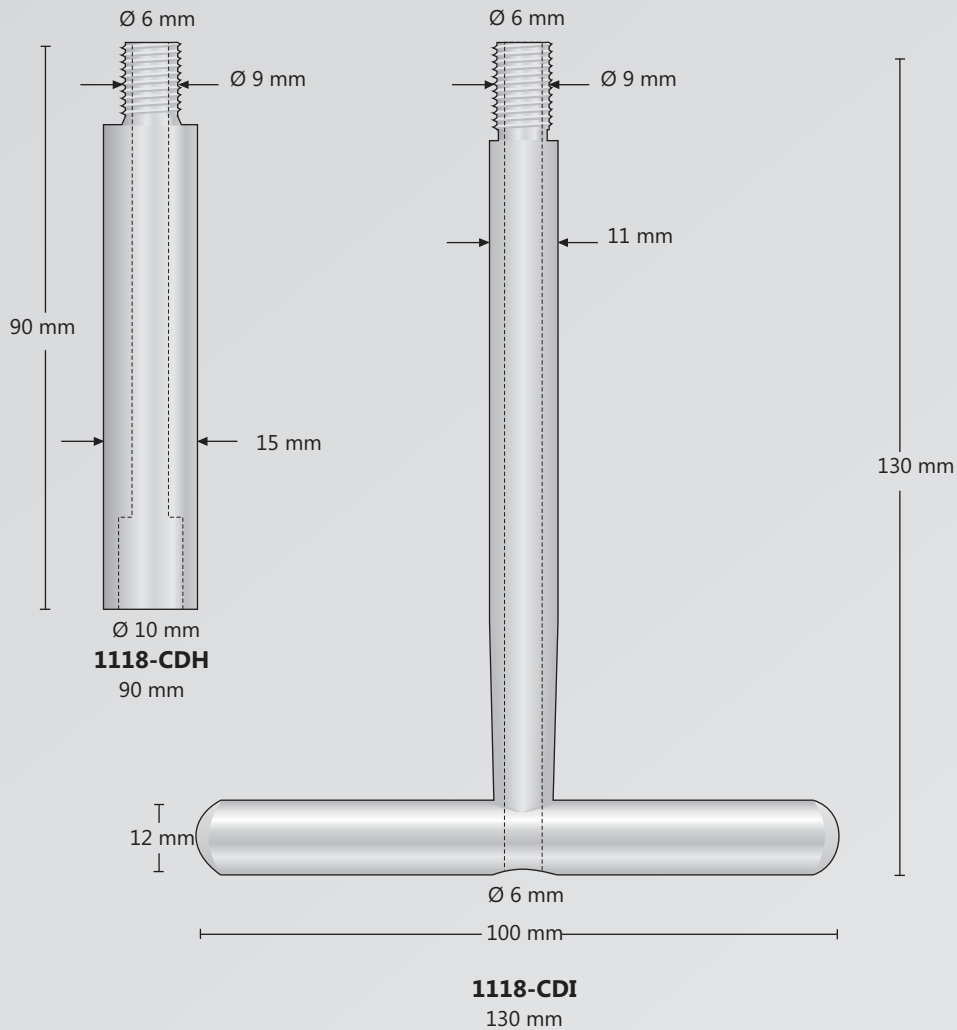
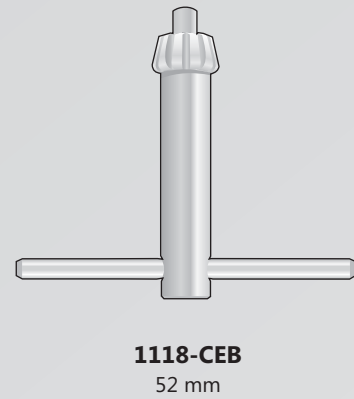
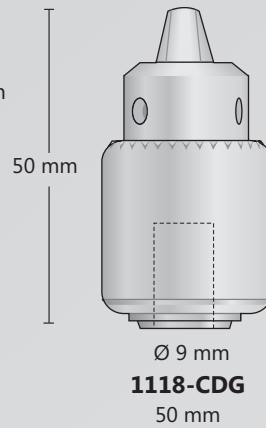

Handbohrapparate  
Hand Bone Drills  
Trapani a mano per ossa  
Perforadores de mano  
Perforateurs à main

Handbohrfutter  
Drilling Chucks  
Perforatori a mano con mandrino  
Perforadores para huesos  
Perforateurs à os

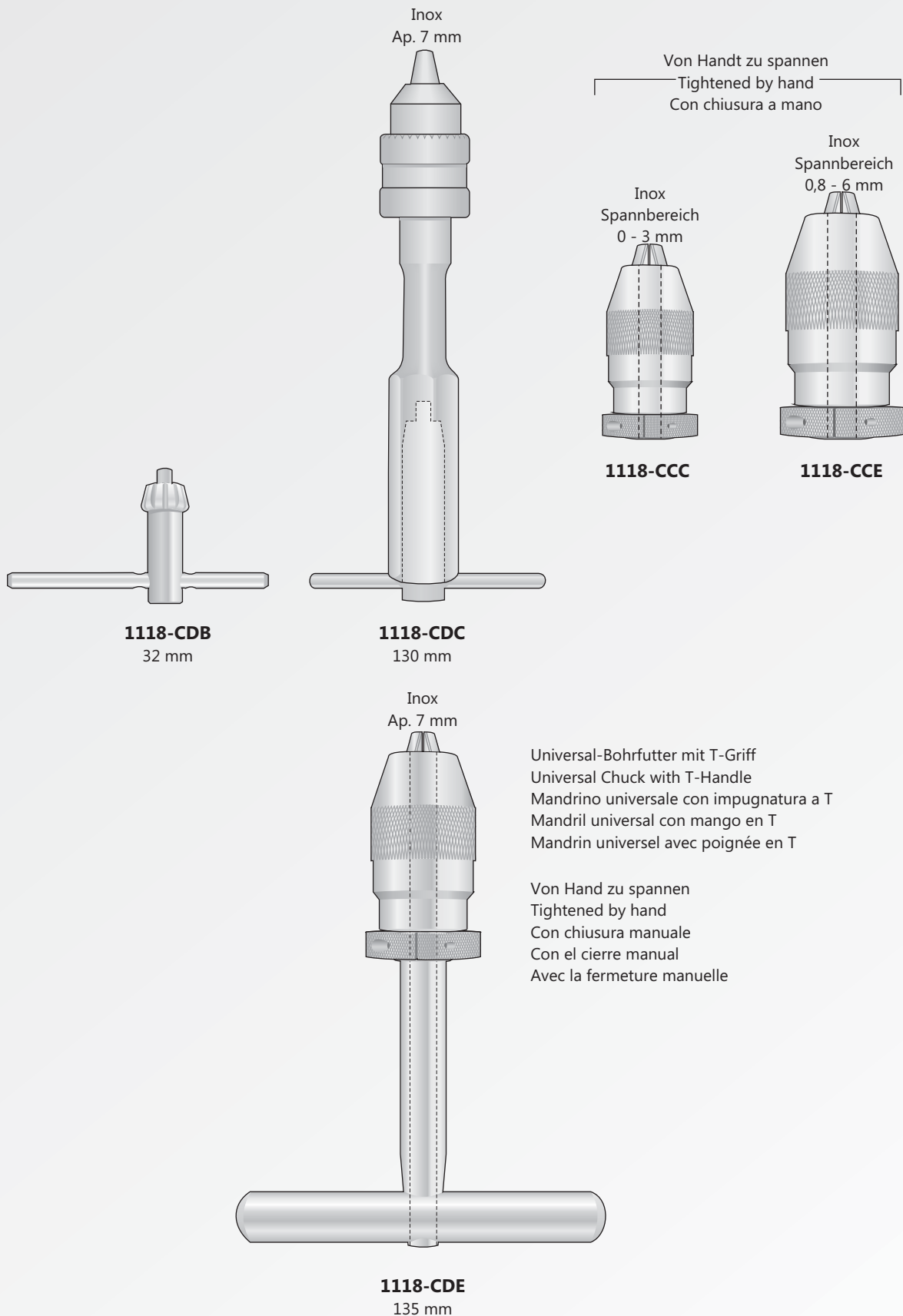

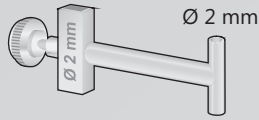

**1118-LG**

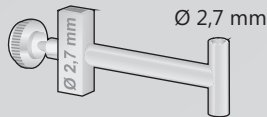

**1118-LH**

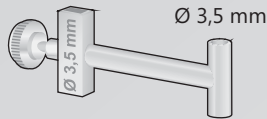

**1118-LI**



Steckbohrbüchsen  
 Insert-drill  
 Centrapunte  
 Manicotto dentato

Cod. Art.	Ø Außen Ø Outside Ø Esterno Ø Exterior Ø Extérieur	Ø Für Bohrer Ø For drills Ø Per punte Ø Para agujas Ø Pour Mèches
<b>1118-BBD</b>	4,5 mm	3,2 mm
<b>1118-BBE</b>	3,5 mm	2 mm
<b>1118-BBF</b>	3,5 mm	2,7 mm

**1118-LF**  
 Complete with 3 guide  
 Completo di 3 guide  
**1118-LE+1118-LG+1118-LH+1118-LI**

**1118-LE**  
 Drill guide only  
 Centratore solo

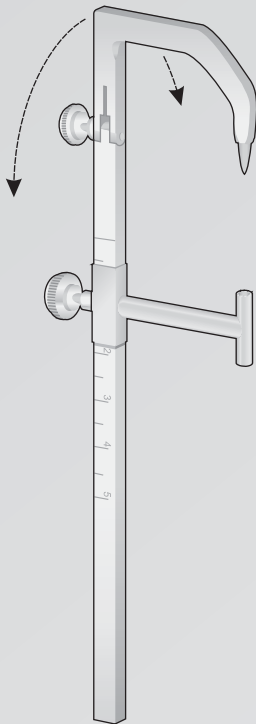

**1118-LF**  
 145 mm

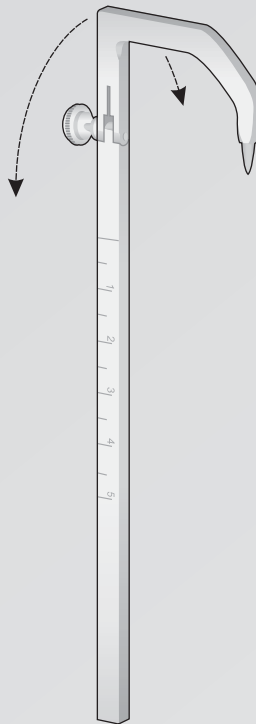

**1118-LE**  
 145 mm

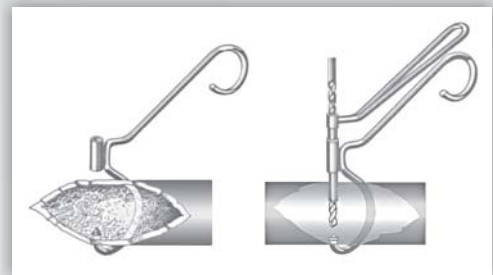

Innen Ø 6,5 mm  
 Inside Ø 6,5 mm  
 Interno Ø 6,5 mm  
 Interior Ø 6,5 mm  
 Intérieur Ø 6,5 mm

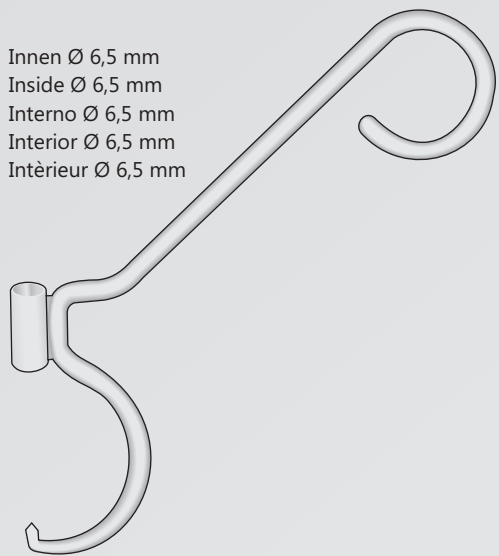

**1118-BBC**

Bohrbüchsen zu Knochenplatten - Drill guides - Centrori guida punte - Guide méche

**Color codification**

green = centric  
 gold = eccentric

Drill  
 Ø 1,5 mm  
 Cortical screws  
 Ø 2,0 mm

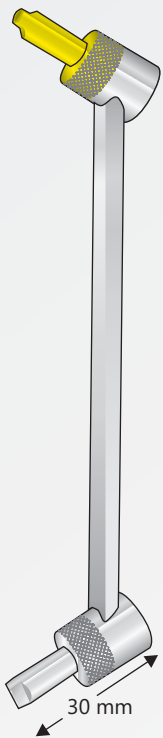

**1118-LB18**  
 140 mm

Drill  
 Ø 2,0 mm  
 Cortical screws  
 Ø 2,7 mm

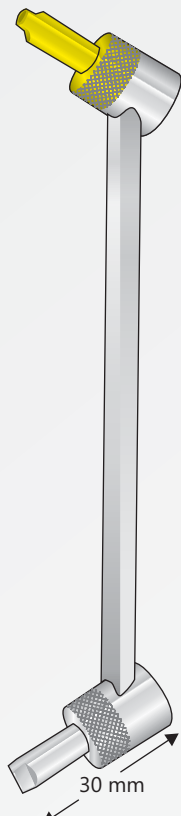

**1118-LB**  
 140 mm

Drill  
 Ø 2,5 mm  
 Cortical screws  
 Ø 3,5 mm

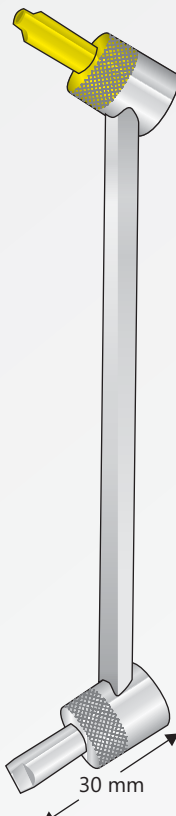

**1118-LA**  
 140 mm

Drill  
 Ø 3,2 mm  
 Cortical screws  
 Ø 4,5 mm

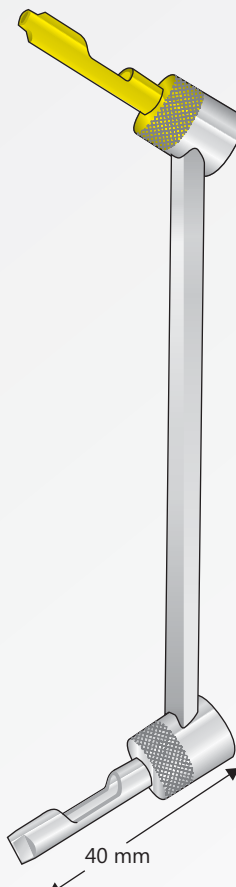

**1118-LC**  
 165 mm

Drill  
 Ø 3,2 mm  
 Cortical screws  
 Ø 4,5 mm

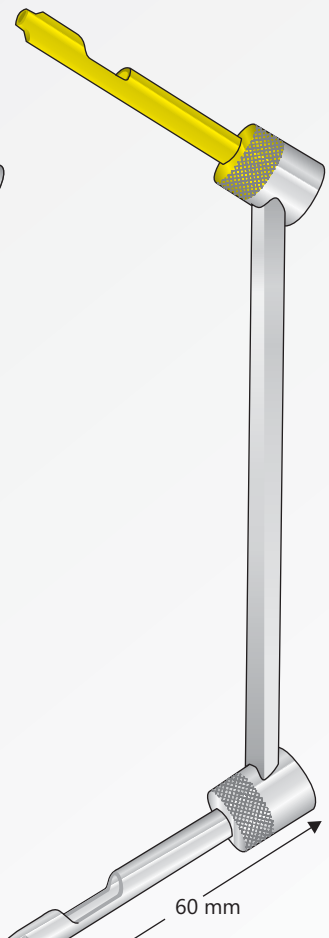

**1118-LD**  
 170 mm

Bohrbüchsen zu Knochenplatten - Drill guides - Centrori guida punte - Guide méche

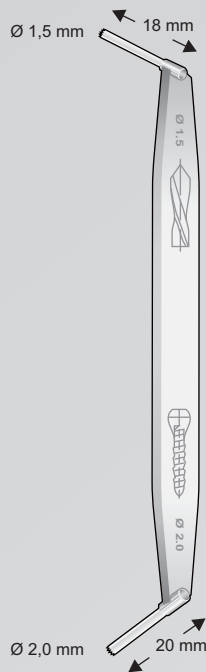

**1118-HD**  
120 mm

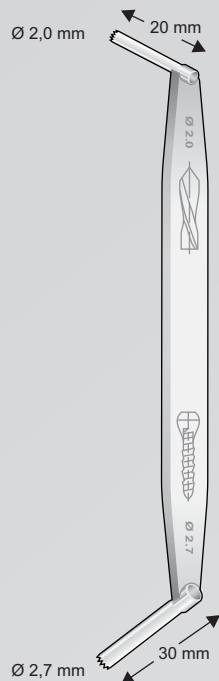

**1118-HE**  
120 mm



**1118-HF**  
120 mm

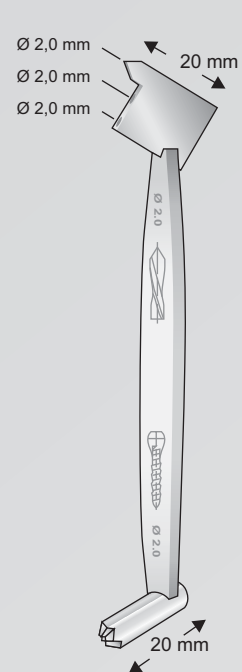

**1118-IA**  
110 mm

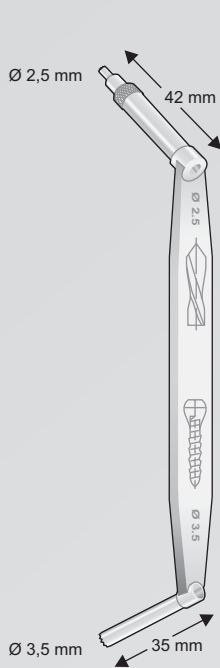

**1118-IB**

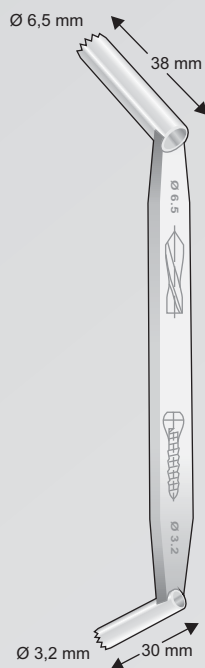

**1118-IC**

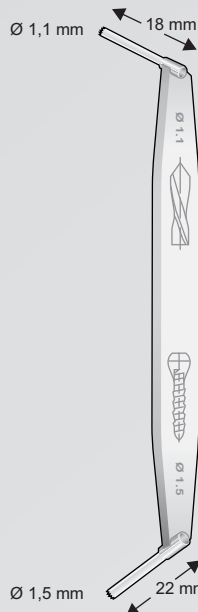

**1118-ID**  
105 mm

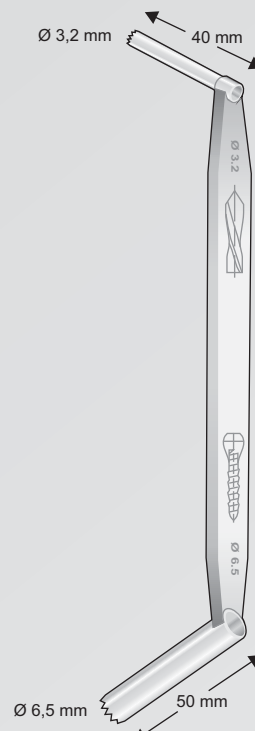

**1118-IE**  
160 mm

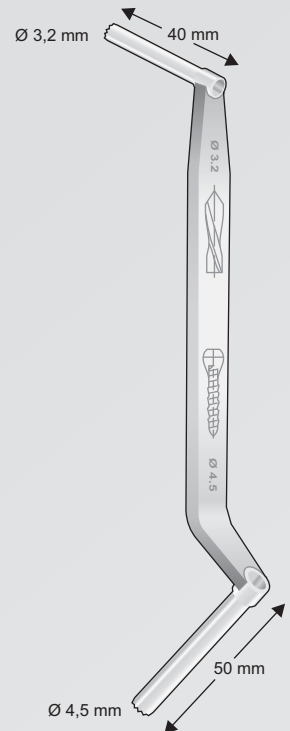

**1118-IF**

Bohrbüchsen zu Knochenplatten - Drill guides - Centratori guida punte - Guide méche

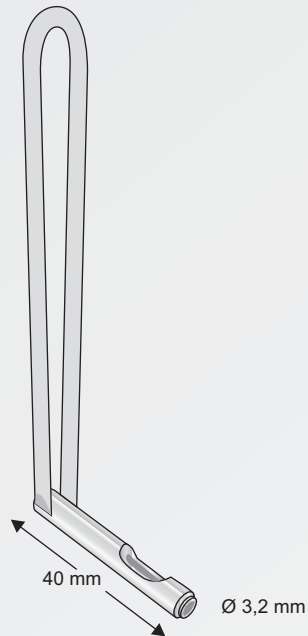

**1118-BBH**  
125 mm

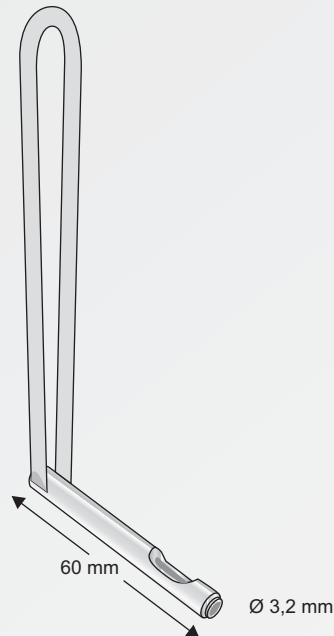

**1118-BCE**  
125 mm

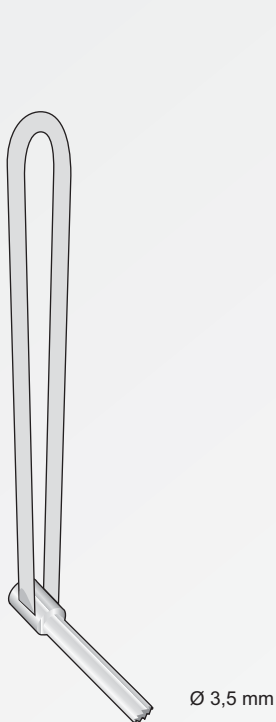

**1118-BBG**  
125 mm

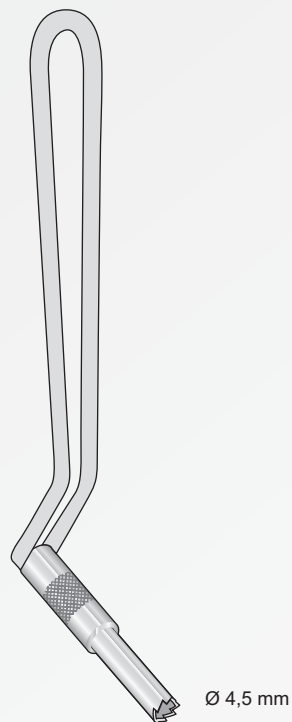

**1118-BBL**  
150 mm

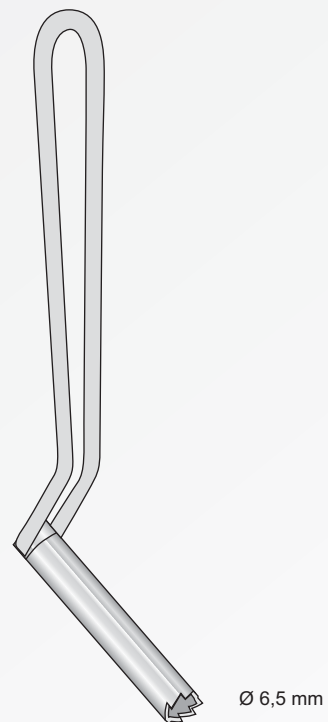

**1118-BCB**  
150 mm

Handgriffe mit schnellspann futter  
 Handles with quick-action chuck  
 Manico con mandrino rapido  
 Poignées avec mandrins rapides

AO-Schaft



Dental-Schaft



4kant-Schaft



Ø 4 mm

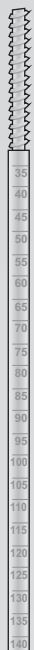

**1118-BCA**  
260 mm



MANICO FERROZELL  
**1118-CEC**  
125 mm



**1118-CEE**  
110 mm

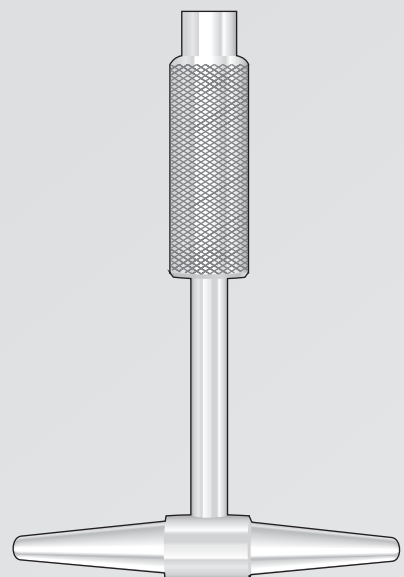

**1118-CEA**  
80 mm



Biege Instrument  
 für Bohrdrähte  
 Wire Bending  
 Instrument

Ø 2,0 mm



Ø 3,2 mm

**1118-LL**  
 150 mm

Ø 1,2 mm



Ø 2,5 mm

**1118-BAA**  
 120 mm

Fino a Ø 3 mm  
 Bis Ø 3 mm  
 Up to Ø 3 mm



WAGNER  
**1118-BAG**  
 300 mm

Extraktionshaken  
 Extraction hooks  
 Gancio d'estrazione  
 Ganchos extractores  
 Crochets d'extraction

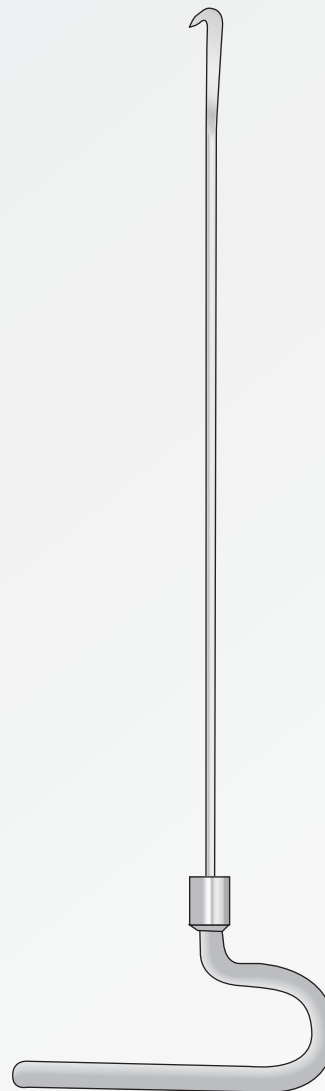

**1009-DAG** - 290 mm  
**1009-DAH** - 370 mm  
**1009-DAI** - 420 mm

0,5 mm



**1118-AL**  
 150 mm

0,5 mm



**1118-AG**  
 300 mm

Messgerät zur Bestimmung die Schraubenlänge  
 Screw depth gauges, to select proper length of screw  
 Misuratore per determinare la lunghezza delle viti  
 Metro de longitud de los tornillos  
 Instruments de mesure pour determiner la longueur de vis

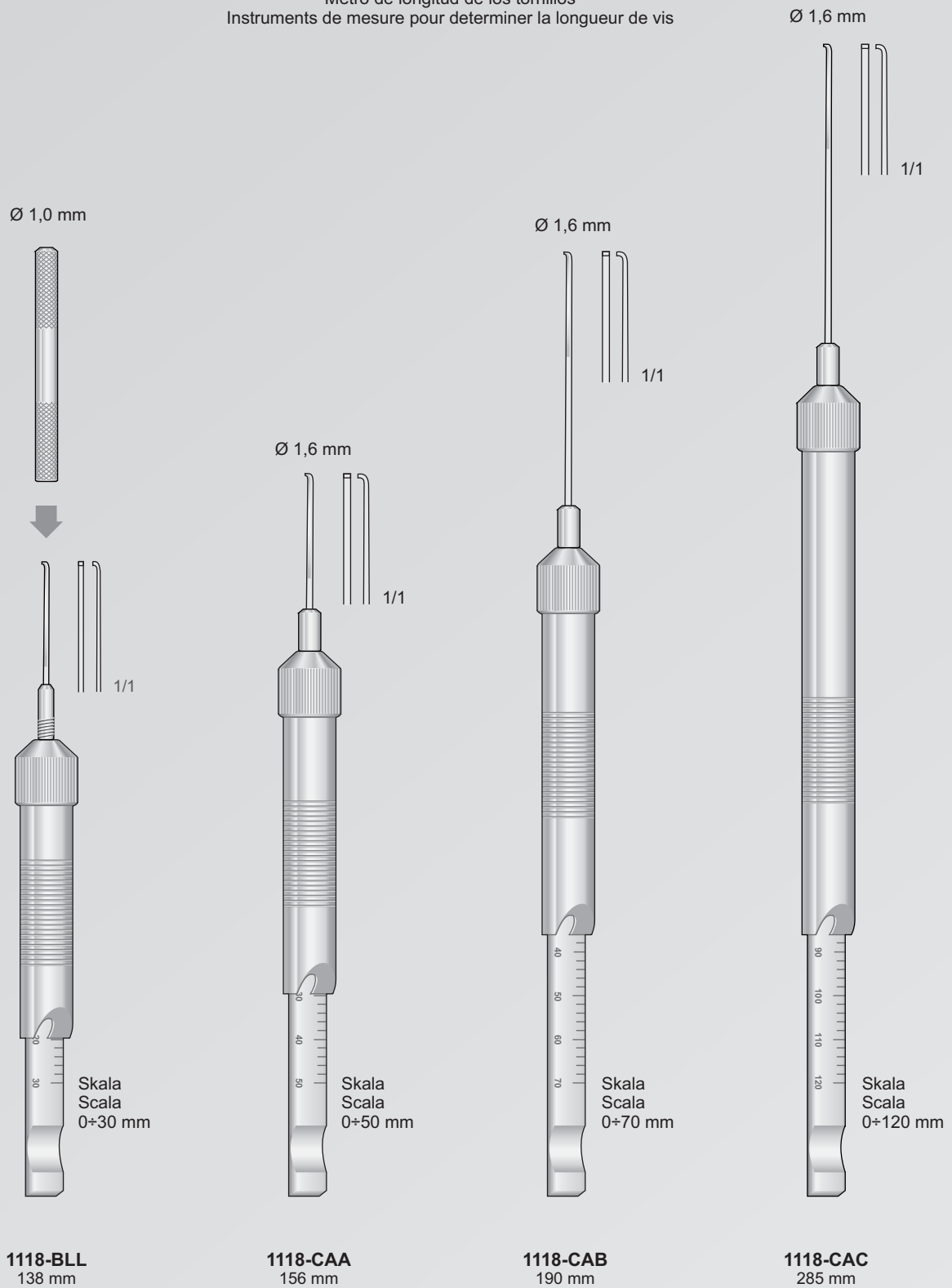

Schraubenzieher mit Ferrozellgriff  
Screws driver with Ferrozell handle  
Giraviti con manico di Ferrozell  
estornilladores con mango de Ferrozell  
DJeux de tournevis avec poignée en Ferrozell

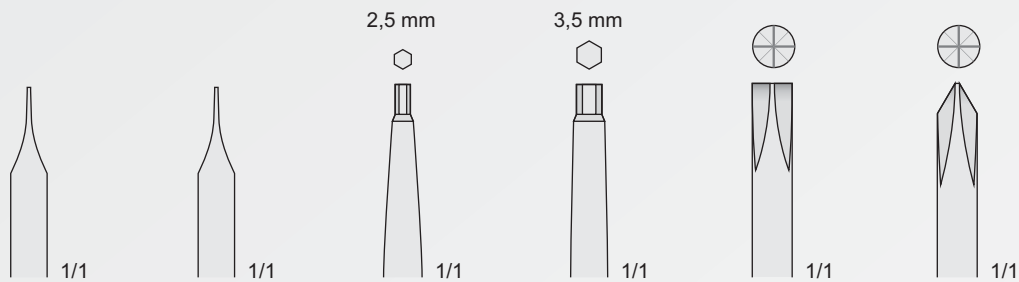

**1118-DBA**  
170 mm

LANE  
**1118-DBB**  
250 mm

**1118-DBC**  
250 mm

**1118-DBD**  
250 mm

**1118-DBE**  
250 mm

PHILIPS  
**1118-DBF**  
250 mm



**1118-DCB**  
140 mm



**1118-DCC**  
140 mm



**1118-DCD**  
140 mm



**1118-DCE**  
140 mm

2,5 mm



**1118-DCF**  
140 mm

3,5 mm



**1118-DCG**  
140 mm

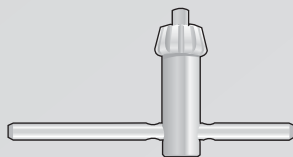

**1118-CDB**  
32 mm



**1118-DCA**  
145 mm

Max. Ø 6,3 mm

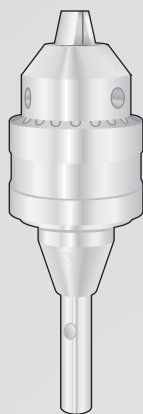

**UNIVERSAL**  
**1118-CDF**  
75 mm

**1118-DDA**

Schraubenzieher, Set mit Etui - Komplett  
 Box with screws driver - Complete  
 Scatola con set giraviti - Completo  
 Set destornilladores - Completos  
 Jeu de tournevis, en boîte - Complete

Etui allein  
 Box only  
 Solo scatola  
 Seul boîte

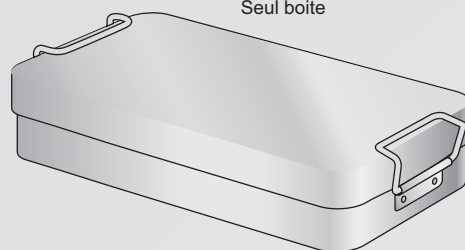

**1118-DCL**  
200x100x40 mm

Schraubenzieher mit Ferrozellgriff  
 Screws driver with Ferrozell handle  
 Giraviti con manico di Ferrozell  
 estornilladores con mango de Ferrozell  
 D'Jeu de tournevis avec poignée en Ferrozell

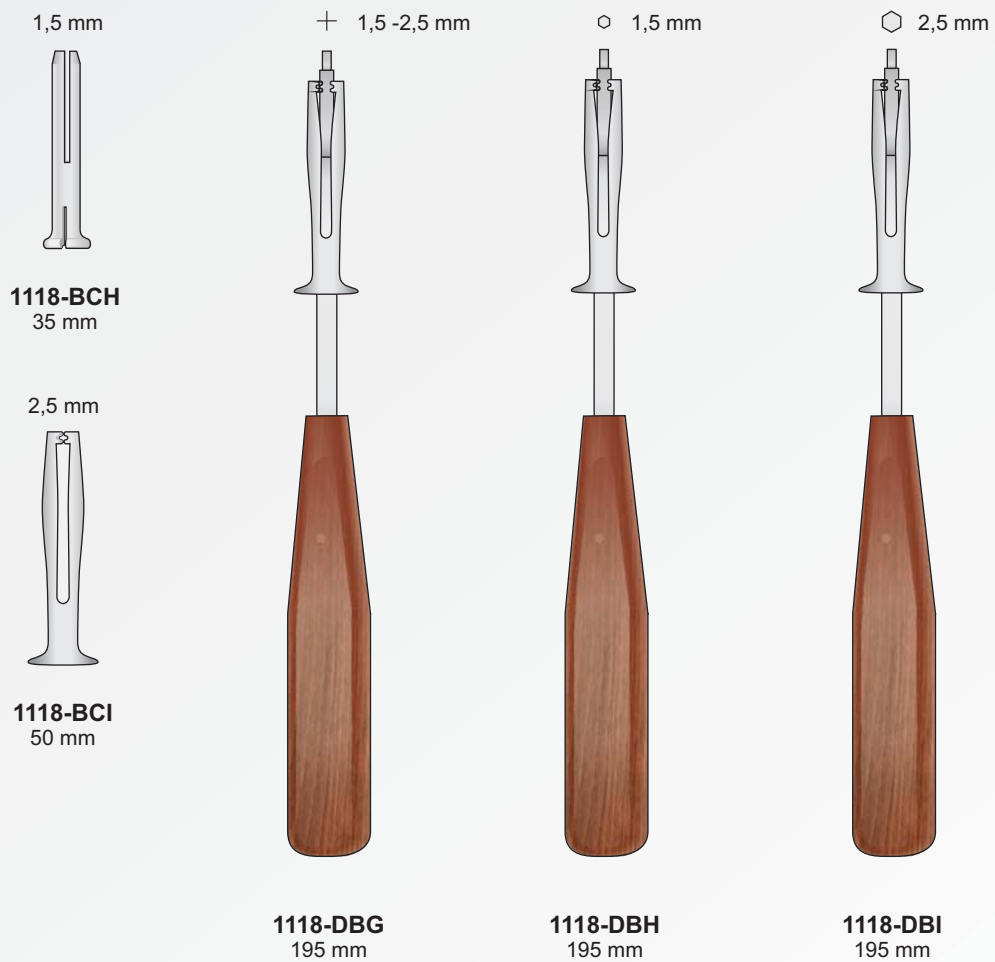

Nadelhalter  
 Needle holders  
 Port'aghi per fili metallici  
 Portaagujas para hilos  
 Porte aiguilles pour fil métallique

Drahtspannzangen mit Hartmetalleinlagen  
 Wire twisting Forceps with Tungsten Carbide inserts  
 Pinze per filo con morsi in Carburo di Tungsteno  
 Pinzas cierra-hilos con bocas de Carburo Tungsteno  
 Pincas serre-fils avec mors en Tungstène

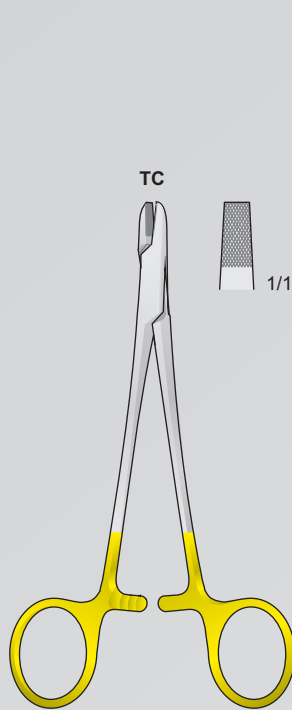

**1508-FI**  
150 mm

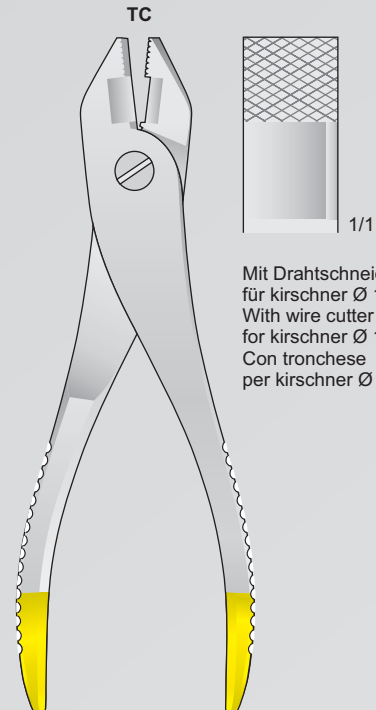

**1123-BCF**  
220 mm

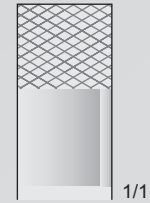

Mit Drahtschneider  
 für kirschner Ø 1,5 mm  
 With wire cutter  
 for kirschner Ø 1,5 mm  
 Con tronchese  
 per kirschner Ø 1,5 mm

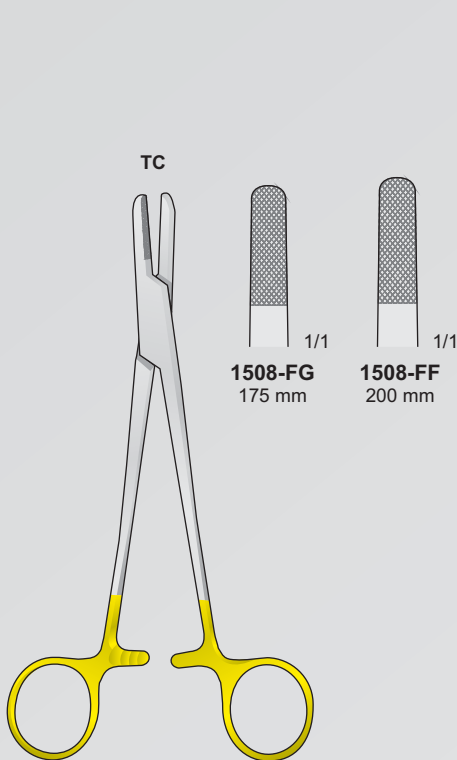

**1508-FF/1508-FG**

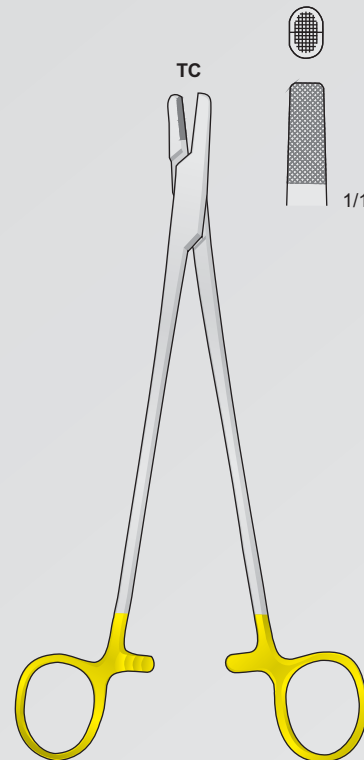

**BAUMGARTNER**  
**1508-FH**  
200 mm



Extraktionszangen für bohrdrähte  
 Extraction pliers for boring wires  
 Pinze per estrazione fili metallici  
 Pinzas para extracción de hilo metálico  
 Pinces pour l'extraction des broches

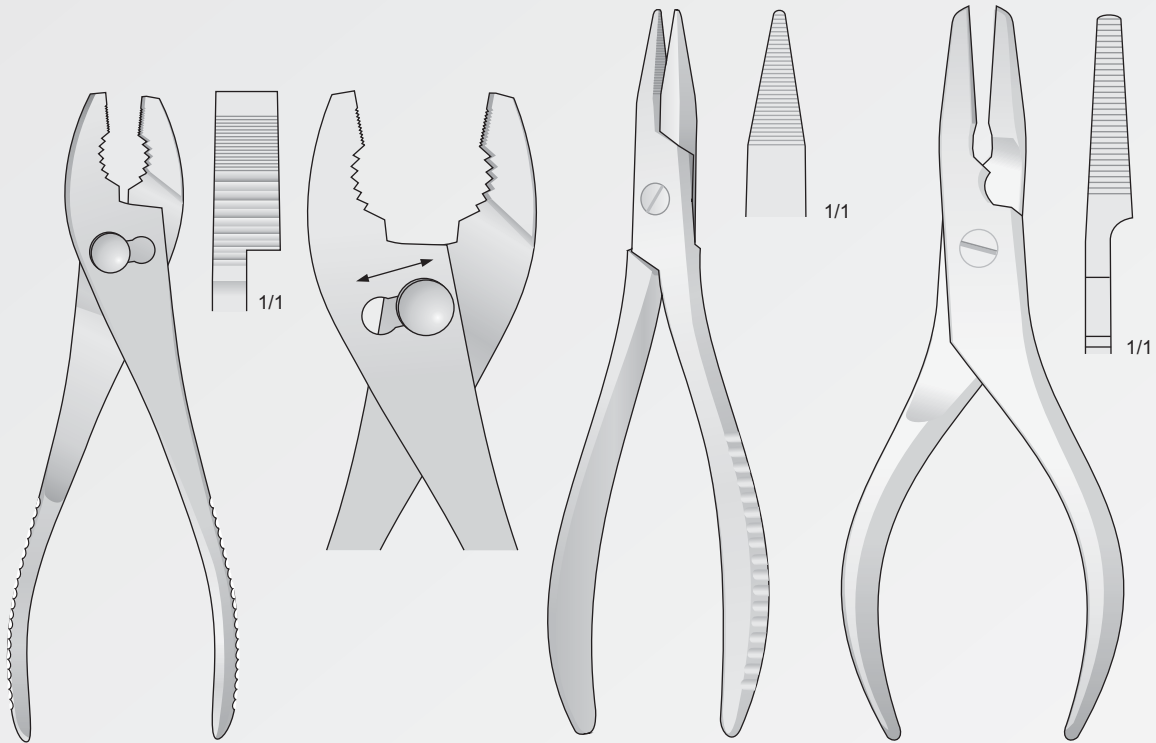

**2108-EA**  
200 mm

**2108-CD**  
190 mm

**1123-BDE**  
160 mm

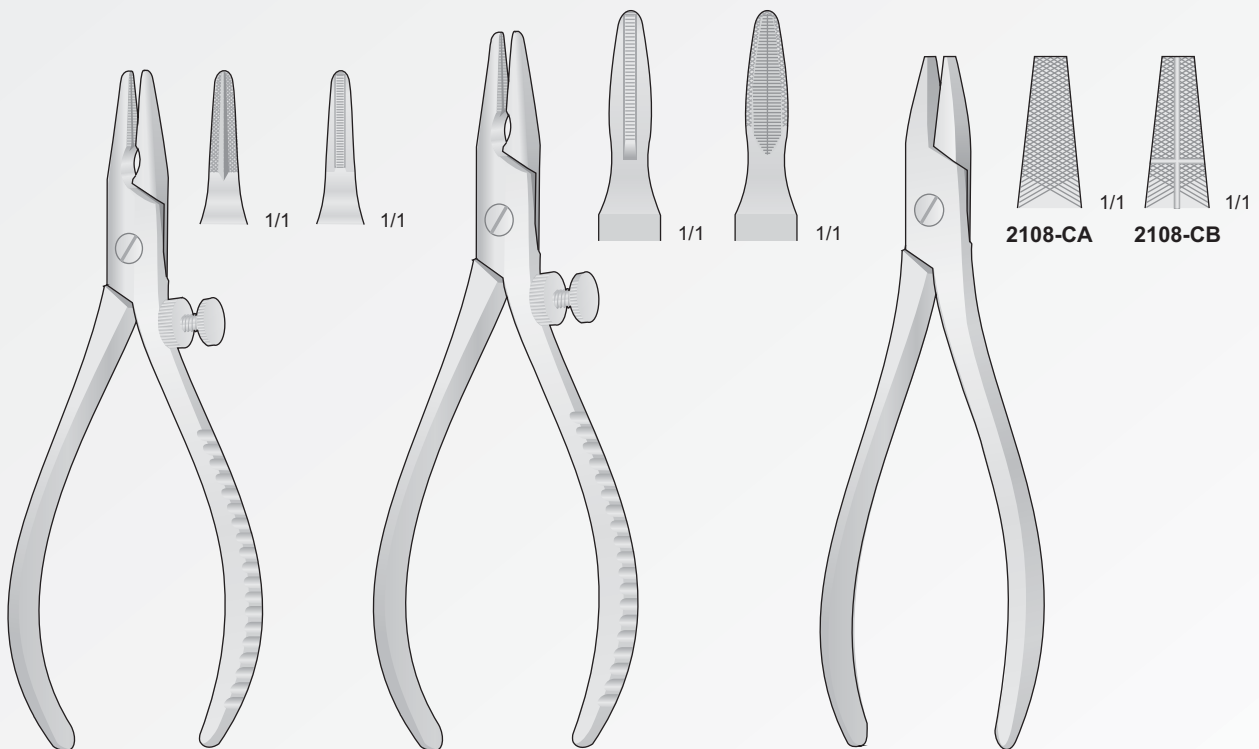

**1123-BDA**  
140 mm

**1123-BDB**  
180 mm

**2108-CA/2108-CB**  
175 mm

Drahtschneidezangen  
 Wire cutting pliers  
 Tronchesi per fili metallici  
 Alicates para cortar alambre  
 Pincas à couper le fil

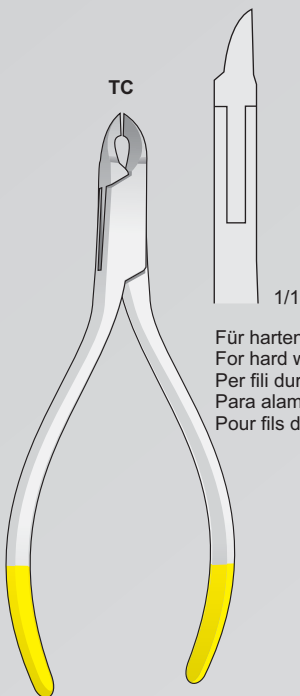

Für harten Draht bis  $\varnothing$  0,4 mm  
 For hard wire with  $\varnothing$  0,4 mm  
 Per fili duri di  $\varnothing$  0,4 mm  
 Para alambres duros de  $\varnothing$  0,4 mm  
 Pour fils durs avec  $\varnothing$  0,4 mm

ANGLE  
**1123-LF1903**  
 130 mm

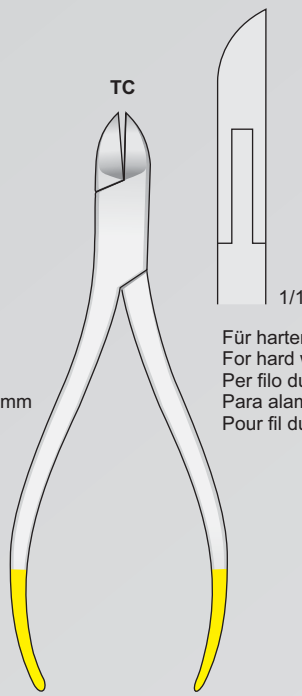

Für harten Draht bis  $\varnothing$  1 mm  
 For hard wire with  $\varnothing$  1 mm  
 Per filo duro  $\varnothing$  1 mm  
 Para alambres duro  $\varnothing$  1 mm  
 Pour fil dur avec  $\varnothing$  1 mm

**1123-LL**  
 130 mm

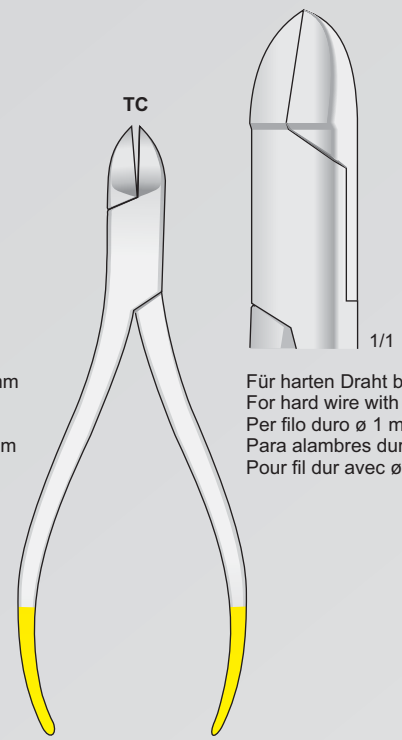

Für harten Draht bis  $\varnothing$  1 mm  
 For hard wire with  $\varnothing$  1 mm  
 Per filo duro  $\varnothing$  1 mm  
 Para alambres duro  $\varnothing$  1 mm  
 Pour fil dur avec  $\varnothing$  1 mm

**1123-LG1903**  
 150 mm

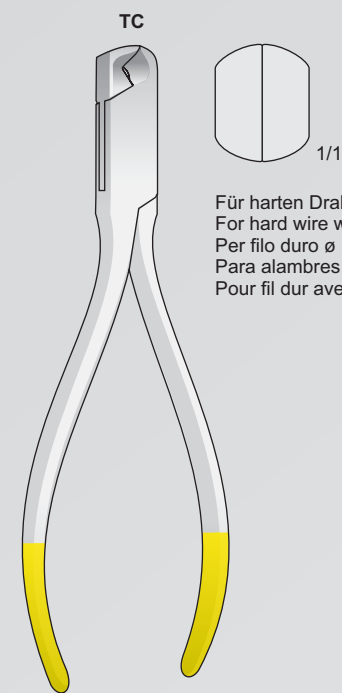

Für harten Draht bis  $\varnothing$  1 mm  
 For hard wire with  $\varnothing$  1 mm  
 Per filo duro  $\varnothing$  1 mm  
 Para alambres duro  $\varnothing$  1 mm  
 Pour fil dur avec  $\varnothing$  1 mm

**1123-LC1903**  
 145 mm



Für harten Draht bis  $\varnothing$  1,7 mm  
 For hard wire with  $\varnothing$  1,7 mm  
 Per filo duro  $\varnothing$  1,7 mm  
 Para alambres duro  $\varnothing$  1,7 mm  
 Pour fil dur avec  $\varnothing$  1,7 mm

**1123-IC**  
 185 mm

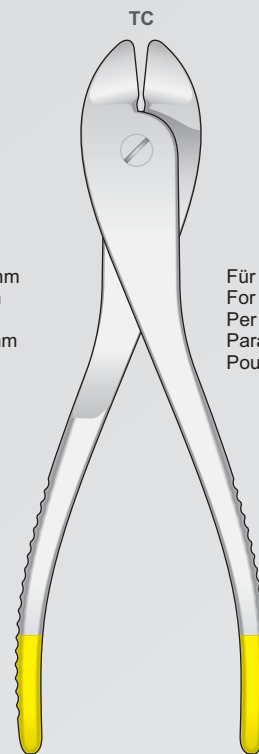

Für harten Draht bis  $\varnothing$  1,7 mm  
 For hard wire with  $\varnothing$  1,7 mm  
 Per filo duro  $\varnothing$  1,7 mm  
 Para alambres duro  $\varnothing$  1,7 mm  
 Pour fil dur avec  $\varnothing$  1,7 mm

**1123-BAB**  
 185 mm



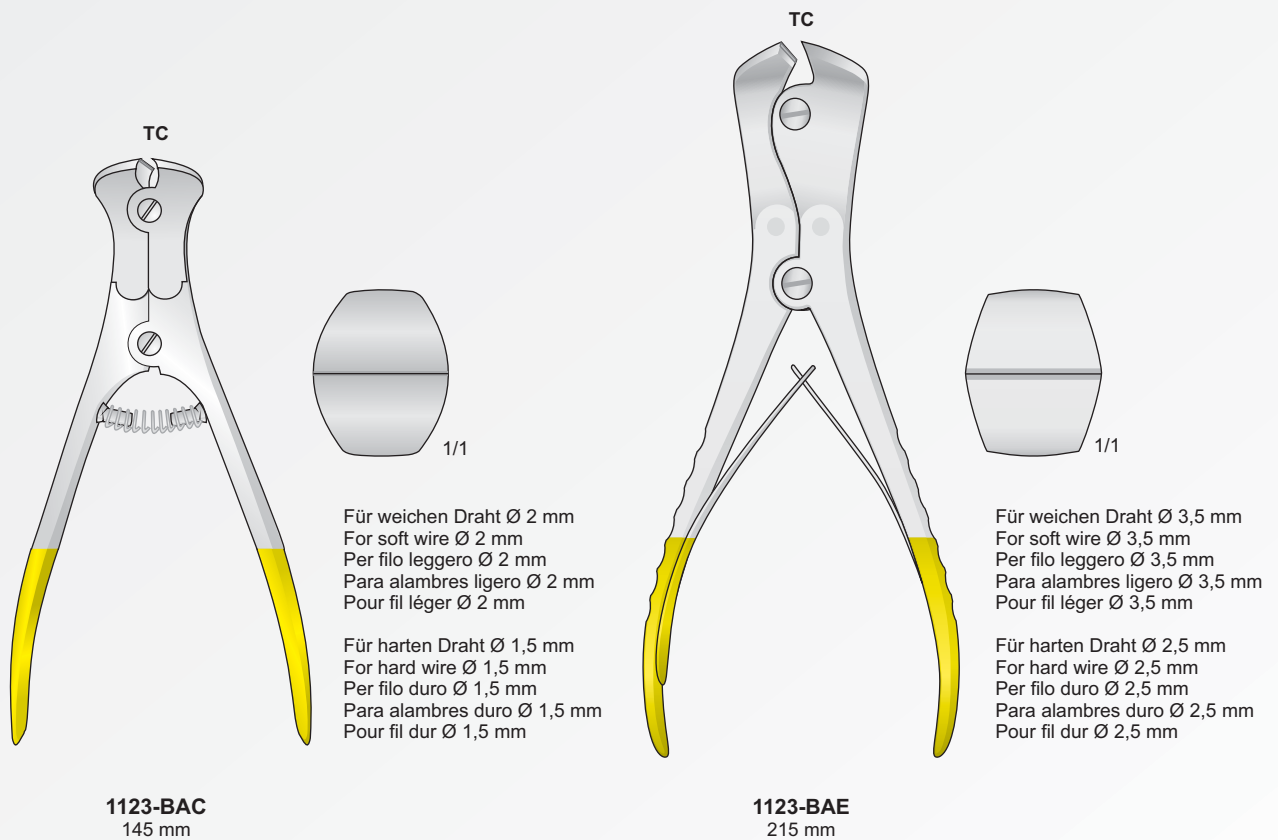

Drahtschneidezangen  
Wire cutting pliers  
Tronchesi per fili metallici  
Alicates para cortar alambre  
Pinces à couper le fil

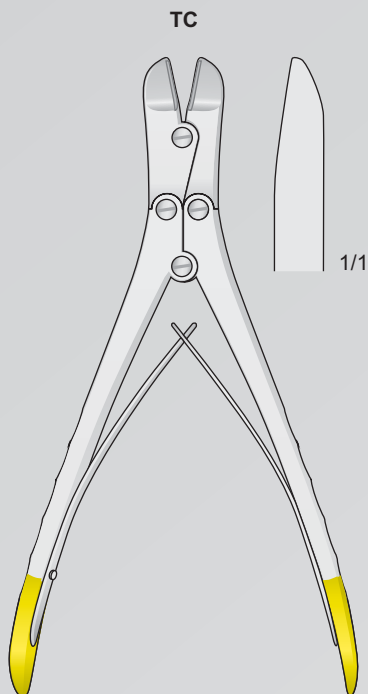

Für weichen Draht Ø 2 mm  
For soft wire Ø 2 mm  
Per filo leggero Ø 2 mm  
Para alambres ligero Ø 2 mm  
Pour fil léger Ø 2 mm

Für harten Draht Ø 1,6 mm  
For hard wire Ø 1,6 mm  
Per filo duro Ø 1,6 mm  
Para alambres duro Ø 1,6 mm  
Pour fil dur Ø 1,6 mm

**1123-BAD**  
170 mm

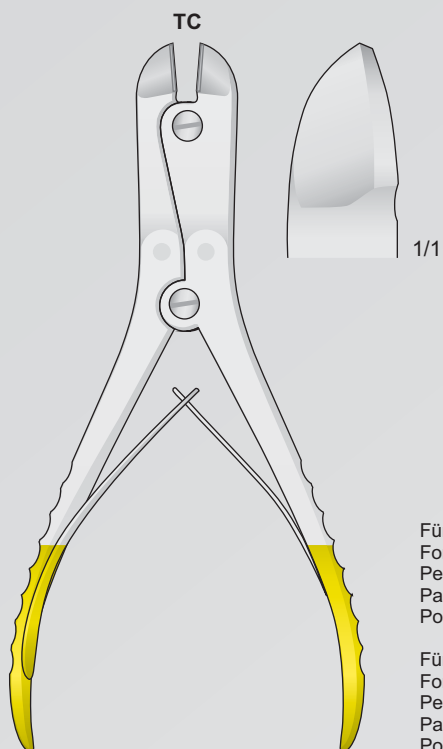

Für weichen Draht Ø 3 mm  
For soft wire Ø 3 mm  
Per filo leggero Ø 3 mm  
Para alambres ligero Ø 3 mm  
Pour fil léger Ø 3 mm

Für harten Draht Ø 2,2 mm  
For hard wire Ø 2,2 mm  
Per filo duro Ø 2,2 mm  
Para alambres duro Ø 2,2 mm  
Pour fil dur Ø 2,2 mm

**1123-BAG**  
230 mm

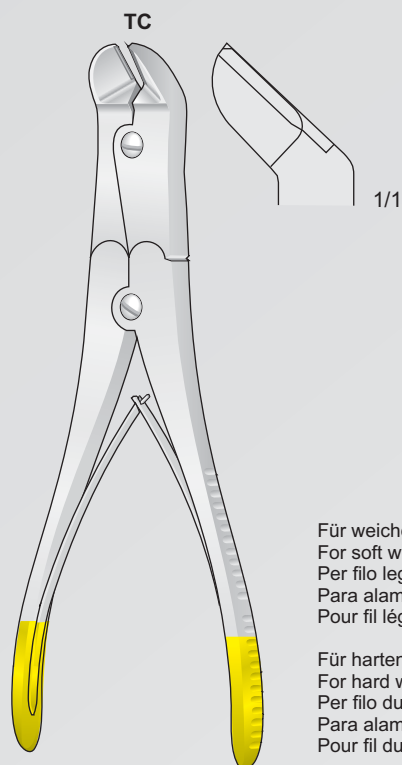

Für weichen Draht Ø 2,5 mm  
For soft wire Ø 2,5 mm  
Per filo leggero Ø 2,5 mm  
Para alambres ligero Ø 2,5 mm  
Pour fil léger Ø 2,5 mm

Für harten Draht Ø 2 mm  
For hard wire Ø 2 mm  
Per filo duro Ø 2 mm  
Para alambres duro Ø 2 mm  
Pour fil dur Ø 2 mm

**1123-BAF**  
230 mm

Für weichen Draht Ø 7 mm  
For soft wire Ø 7 mm  
Per filo leggero Ø 7 mm  
Para alambres ligero Ø 7 mm  
Pour fil léger Ø 7 mm

Für harten Draht Ø 6 mm  
For hard wire Ø 6 mm  
Per filo duro Ø 6 mm  
Para alambres duro Ø 6 mm  
Pour fil dur Ø 6 mm

Für weichen Draht Ø 7 mm  
For soft wire Ø 7 mm  
Per filo leggero Ø 7 mm  
Para alambres ligero Ø 7 mm  
Pour fil léger Ø 7 mm

Für harten Draht Ø 6 mm  
For hard wire Ø 6 mm  
Per filo duro Ø 6 mm  
Para alambres duro Ø 6 mm  
Pour fil dur Ø 6 mm

Für weichen Draht Ø 5 mm  
For soft wire Ø 5 mm  
Per filo leggero Ø 5 mm  
Para alambres ligero Ø 5 mm  
Pour fil léger Ø 5 mm

Für harten Draht Ø 4,5 mm  
For hard wire Ø 4,5 mm  
Per filo duro Ø 4,5 mm  
Para alambres duro Ø 4,5 mm  
Pour fil dur Ø 4,5 mm

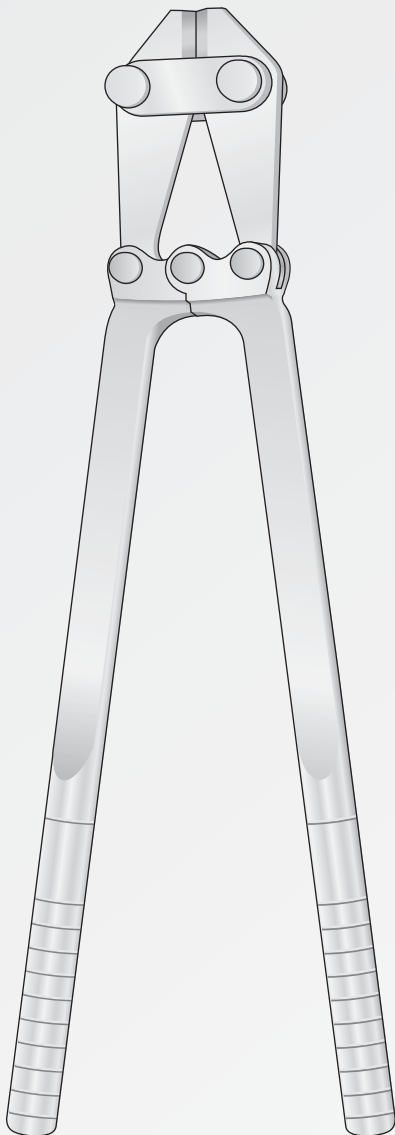

**2106-LI**  
480 mm

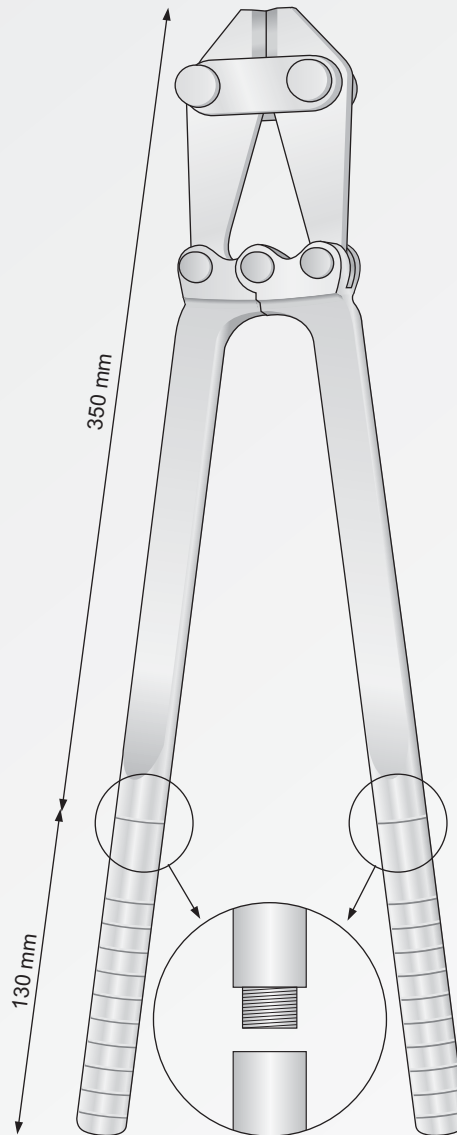

**2106-LI12**  
480 mm

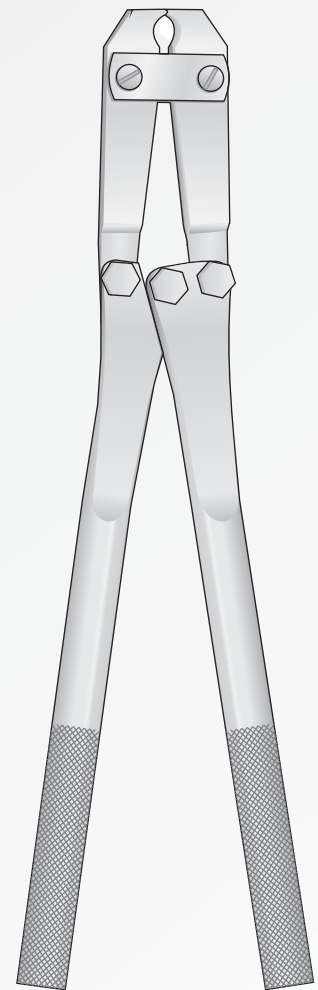

**1123-BAH**  
375 mm

Extraktionszangen für bohrdrähte  
 Extraction pliers for boring wires  
 Pinze per estrazione fili metallici  
 Pinzas para extracción de hilo metálico  
 Pincas pour l'extraction des broches

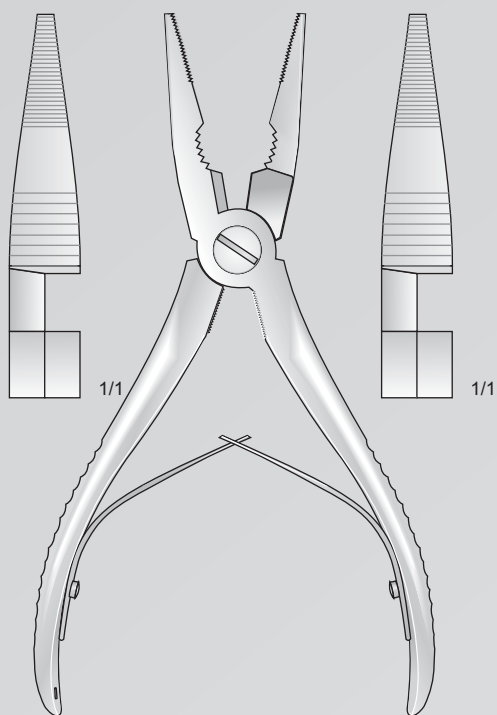

**1123-BDF**  
175 mm

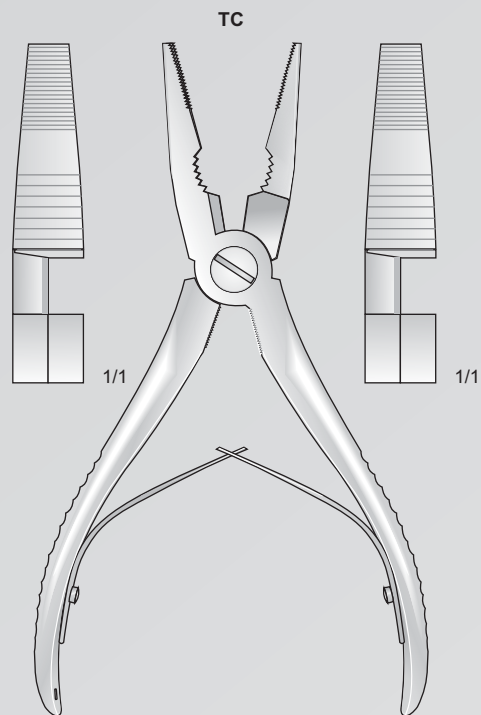

**1123-BDG**  
165 mm

Parallel-Flachzange - Flat-nosed pliers, parallel  
 Pinza a branche parallele - Alicates planos - Pincas plates

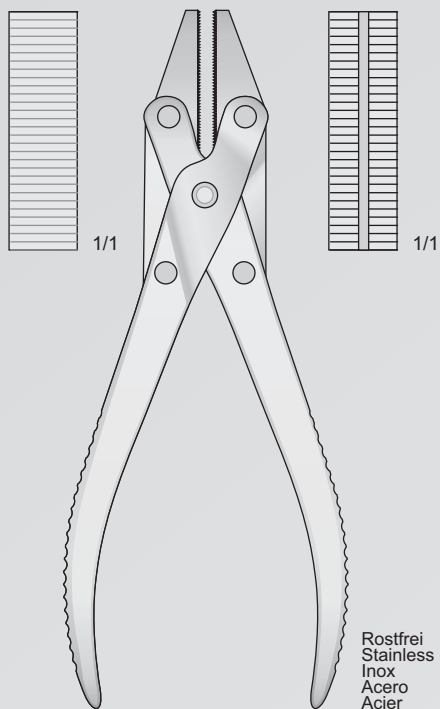

**2108-CF**  
185 mm

Parallel-Flachzange mit Seitenschneider  
 Flat-nose pliers parallel with lateral wire cutter  
 Pinza a branche parallele con tronchese

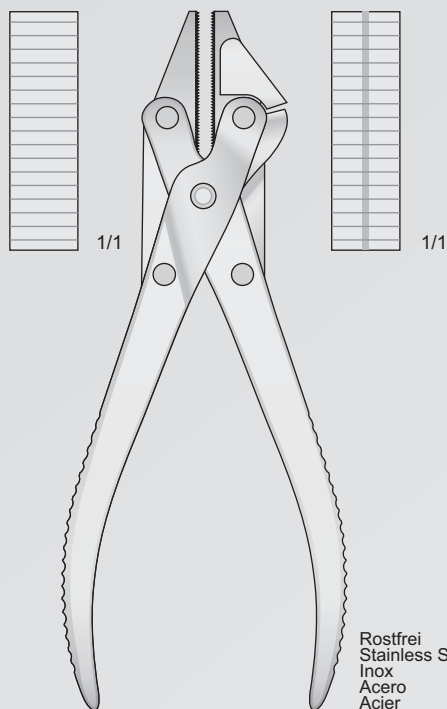

**1123-IA**  
185 mm

Rostfrei  
 Stainless Steel  
 Inox  
 Acero  
 Acier

Rostfrei  
 Stainless Steel  
 Inox  
 Acero  
 Acier

Extraktionszangen für bohrdrähte  
 Extraction pliers for boring wires  
 Pinze per estrazione fili metallici  
 Pinzas para extracción de hilo metálico  
 Pinces pour l'extraction des broches

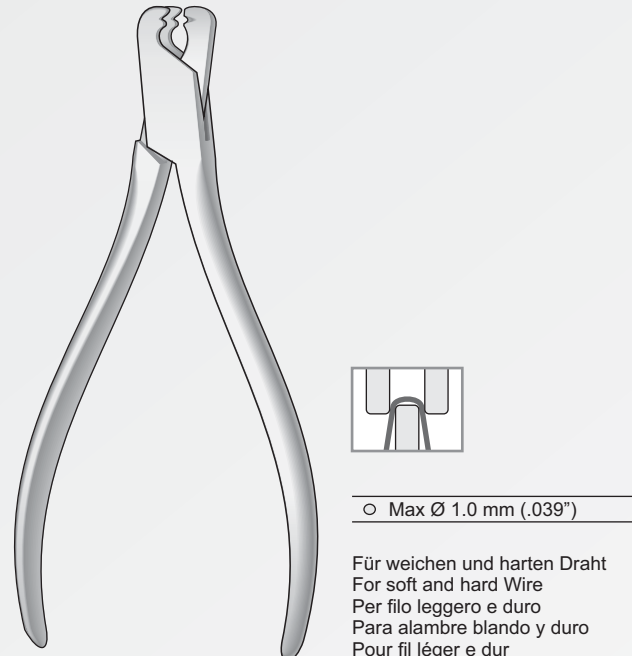
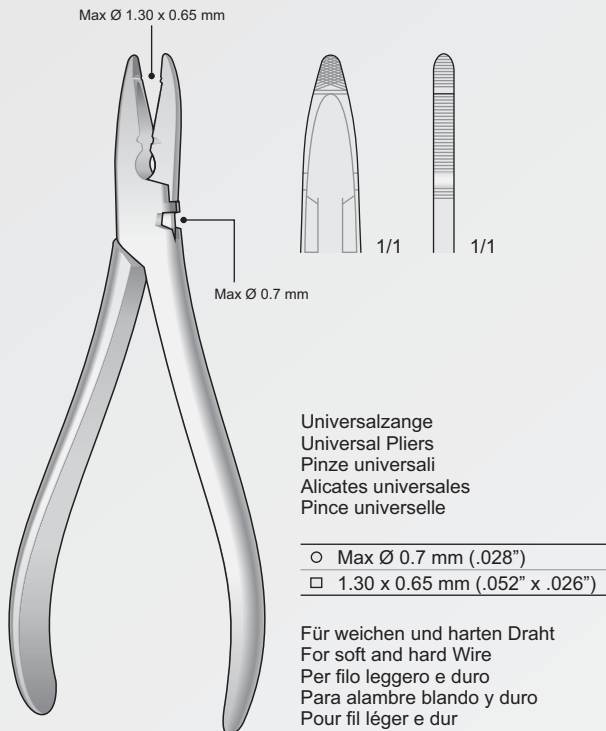

**WALDSACHS**  
**0415-IE**  
 150 mm

**ADERER**  
**0415-EB**  
 145 mm

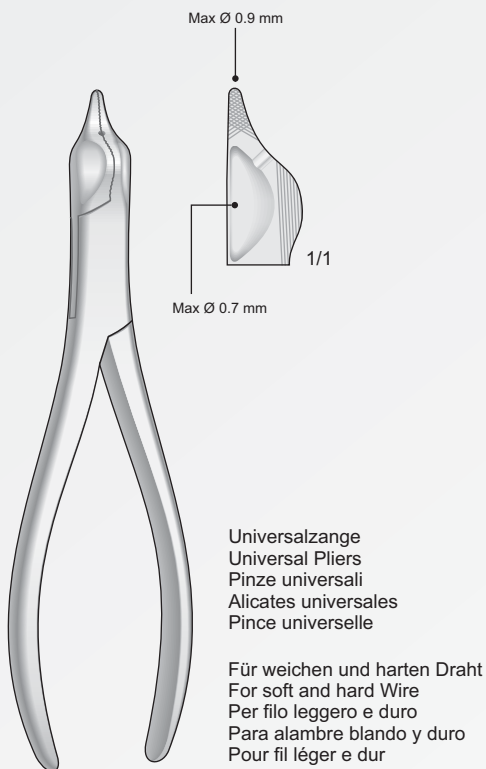

**0415-HB**  
 150 mm

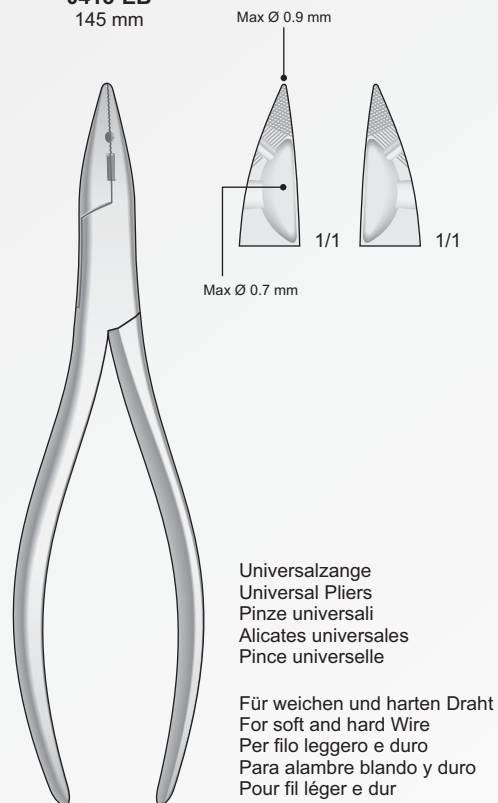

**0415-HF**  
 160 mm

Draht und Blechscheren  
 Wire and plate cutting scissors  
 Forbici per fili metallici  
 Tijeras para cortar alambre  
 Ciseaux coupe-fils métalliques

Draht-und Blechscherer gezahnt  
 Wire cutting scissor serrated  
 Forbice universale dentellata  
 Tijeras para cortar hilo de acero dentadas  
 Ciseaux à couper les fils métalliques

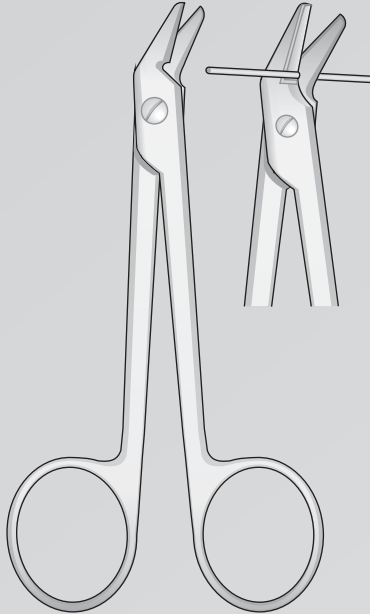

**0415-LA**  
120 mm

Smusse  
 Blunt  
 Stumpf  
 Mousses  
 Romas

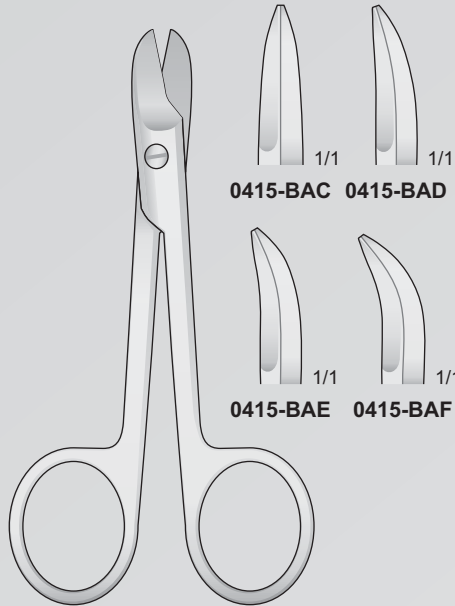

BEEBE  
**0415-BAC/0415-BAF**  
110 mm

Acute  
 Sharp  
 Spitz  
 Pointus  
 Agudas

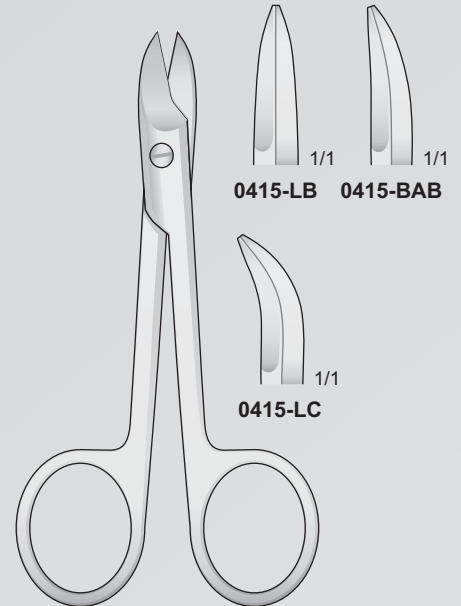

BEEBE  
**0415-LB/0415-BAB**  
110 mm

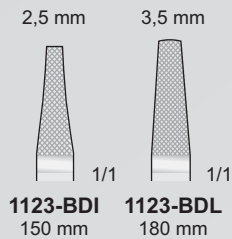

**1123-BDI** 150 mm  
**1123-BDL** 180 mm

Flachzange, Extraktionszange  
 für Bohrdrähte  
 Flat pliers, Extraction  
 pliers for wires  
 Pinze per estrazione fili  
 Alicates para extracción,  
 Alicates para sacar alambre  
 Pince plate, Pincers pour  
 extraction des broches

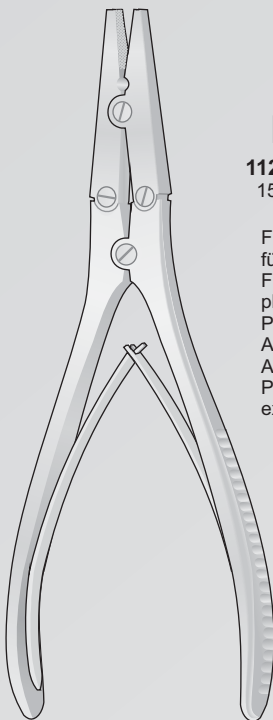

**1123-BDI/1123-BDL**

Wire Cutter  
 TC

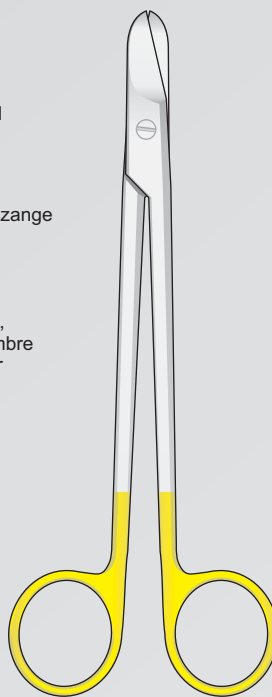

SMITH  
**0607-BGA**  
160 mm

Wire Cutter  
 TC

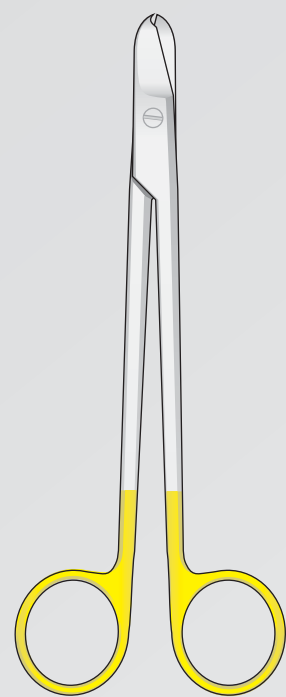

SMITH  
**0607-BGB**  
160 mm

Zangen für schränkhebel platten  
 Forceps for plattes  
 Pinze per placche  
 Pinzas para placas  
 Pincas à courber pour plaques

Plattebiegezeuge - Plate Bending pliers  
 Pinze piegaplacche - Pinzas para torcer placas  
 Pincas à plier plaques



**1118-EAF**  
200 mm

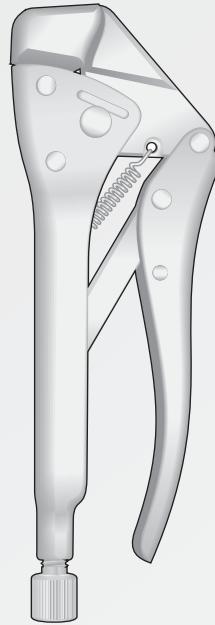

**1118-EAG**  
240 mm

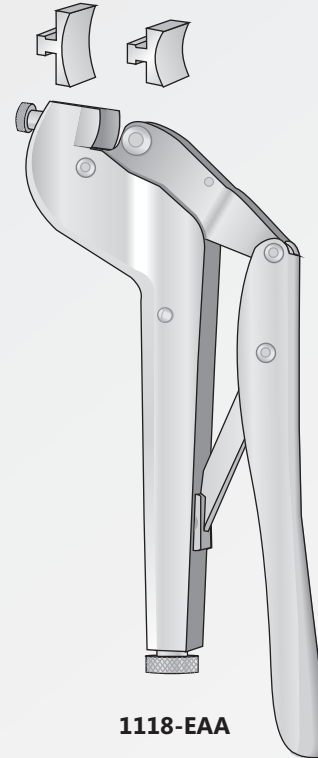

**1118-EAA**

Komplett aus rostfreiem Stahl gefertigte und gehärtete Backen sorgen für einen guten Halt.  
 Spannen und lösen erfolgt mit einer Hand

Locking Pliers - Pinza bloccante - Pinzas de fijar - Pincas à caler



**1118-EAH**  
180 mm



**1118-EAI**  
200 mm



**1118-EAL**  
240 mm

Biege und schränkhebel  
 Forceps for plattes  
 Pinze e chiavi per placche  
 Pinzas para placas  
 Pincas à courber pour plaques

Biegepresse - Bending press - Pressa piegaplacche - Presse pour plier

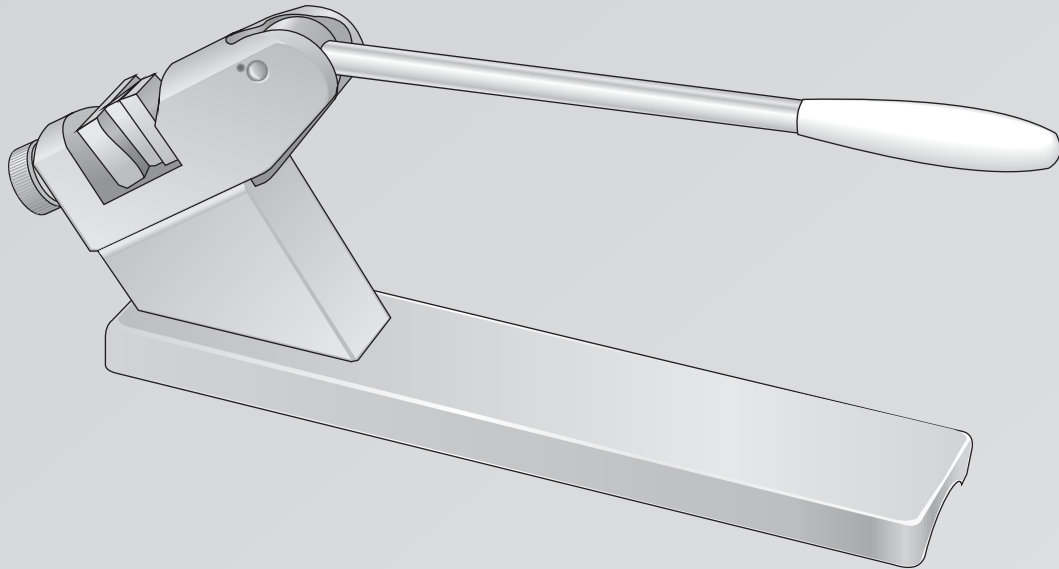

**1118-EBA**

For standard plates  
 Für Standard-Platten

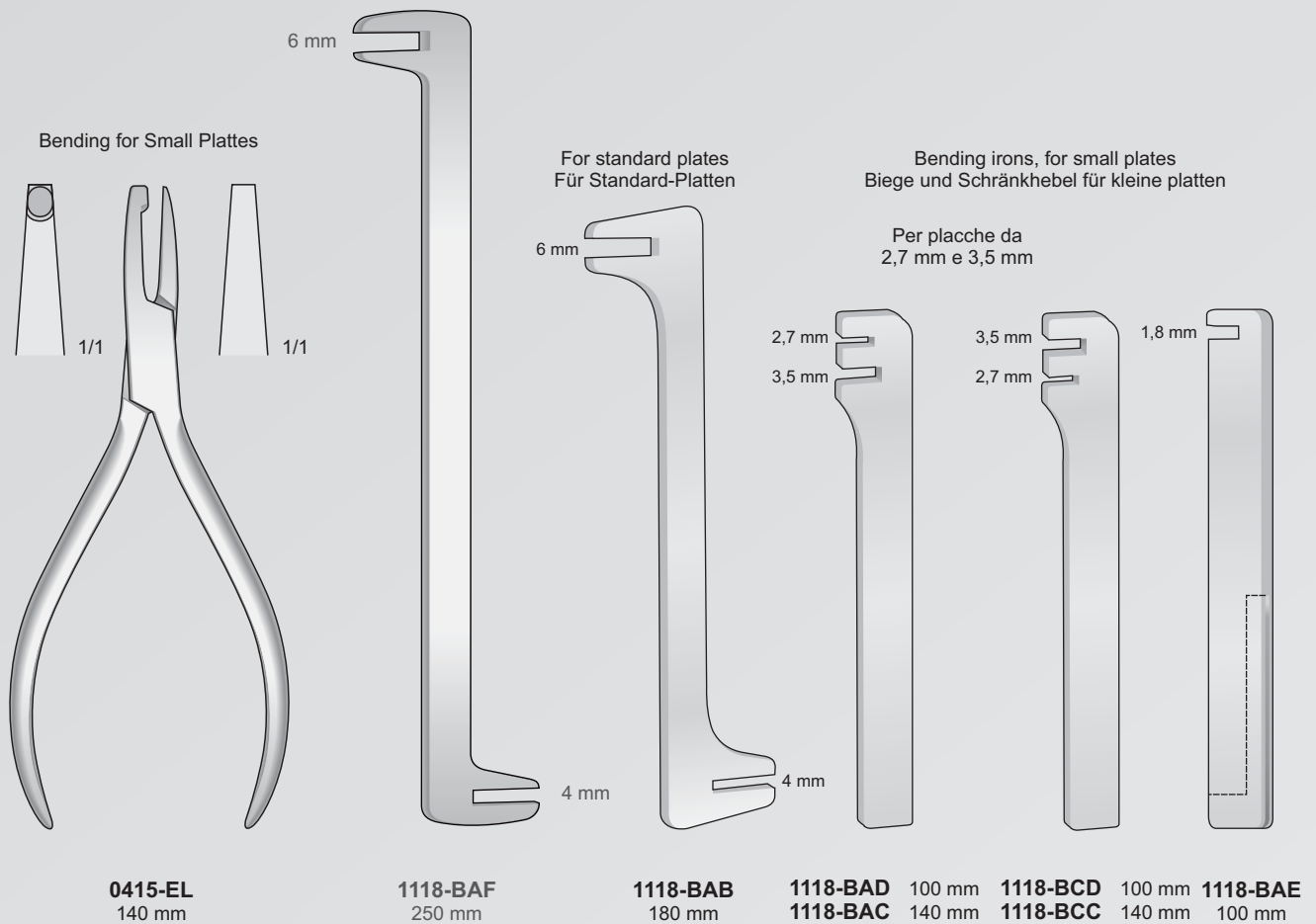



Zangen für schränkhebel platten  
 Forceps for plattes  
 Pinze per placche  
 Pinzas para placas  
 Pincas à courber pour plaques

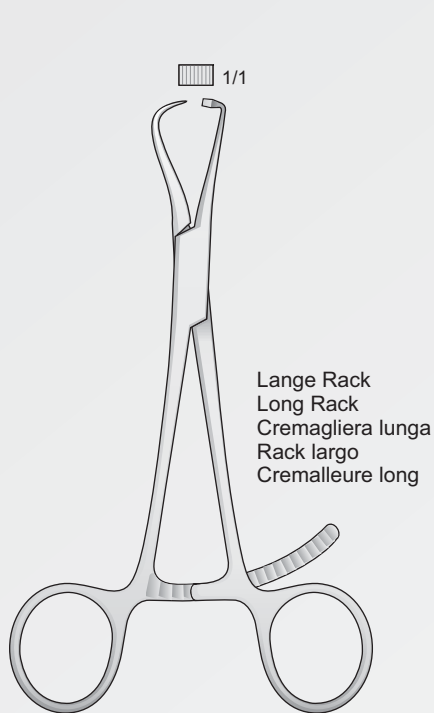

Lange Rack  
 Long Rack  
 Cremagliera lunga  
 Rack largo  
 Cremalleure long

**1118-HG11**  
 120 mm

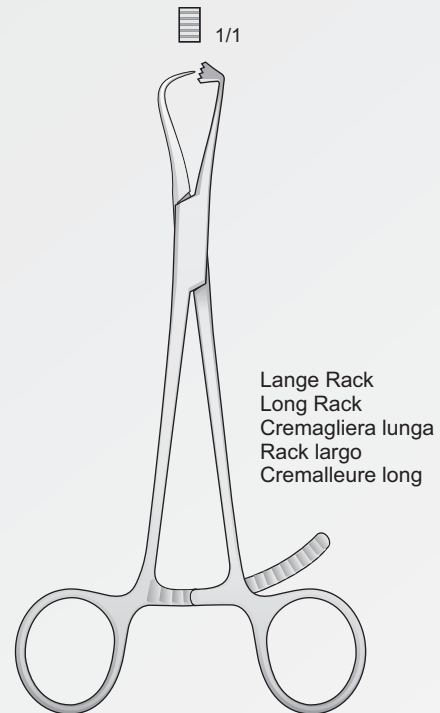

Lange Rack  
 Long Rack  
 Cremagliera lunga  
 Rack largo  
 Cremalleure long

**1118-HI11**  
 125 mm

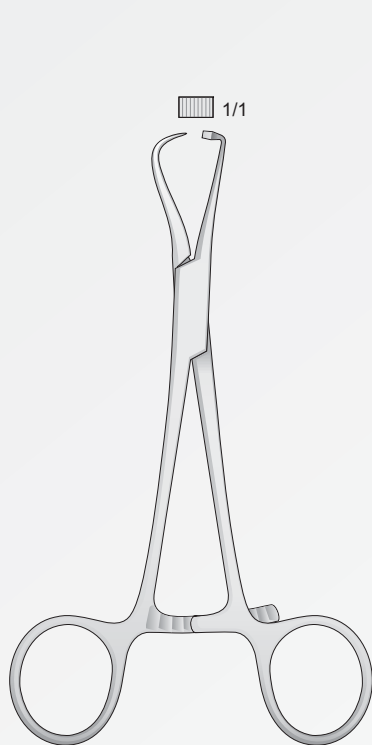

**1118-HG**  
 120 mm

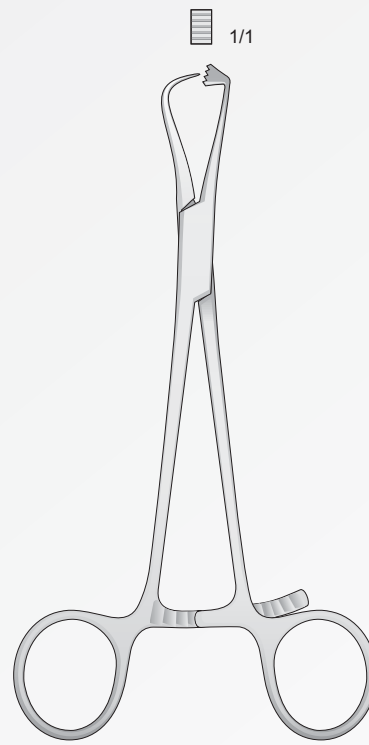

**1118-HI**  
 125 mm



**KIRSCHNER**

Trokarspitze  
Trocar point  
Punta trequarti  
Punta de tròcar  
Pointe de Trocart



**KIRSCHNER**

Trokarspitze  
Trocar point  
Punta trequarti  
Punta de tròcar  
Pointe de Trocart



**KIRSCHNER**

Lanzenspitze  
Lance point  
Punte lanceolate  
Punta lanceolar  
Pointe lancette



Trokarspitze  
Trocar point  
Punta trequarti  
Punta de tròcar  
Pointe de Trocart

310 mm



Rundes ende  
Round shaft  
Punta rotonda  
Punta redonda  
Pointe ronde

310 mm



Lanzenspitze  
Lance point  
Punte lanceolate  
Punta lanceolar  
Pointe lancette

310 mm

Ø/Diam.	Pack. 10 pcs
0,8 mm	<b>1009-LL</b>
1,0 mm	<b>1009-BAA</b>
1,2 mm	<b>1009-BAC</b>
1,4 mm	<b>1009-BBE</b>
1,5 mm	<b>1009-BBF</b>
1,6 mm	<b>1009-BBG</b>
1,7 mm	<b>1009-BBH</b>
1,8 mm	<b>1009-BBI</b>
2,0 mm	<b>1009-BCA</b>
2,2 mm	<b>1009-BCC</b>
2,5 mm	<b>1009-BCF</b>
3,0 mm	<b>1009-BDA</b>

Ø/Diam.	Pack. 10 pcs
0,8 mm	<b>1009-AA</b>
1,0 mm	<b>1009-AB</b>
1,2 mm	<b>1009-AC</b>
1,4 mm	<b>1009-BE</b>
1,5 mm	<b>1009-BF</b>
1,6 mm	<b>1009-BG</b>
1,7 mm	<b>1009-BH</b>
1,8 mm	<b>1009-BI</b>
2,0 mm	<b>1009-CA</b>
2,2 mm	<b>1009-CC</b>
2,5 mm	<b>1009-CF</b>
3,0 mm	<b>1009-DA</b>

Ø/Diam.	Pack. 10 pcs
0,8 mm	<b>1009-EA</b>
1,0 mm	<b>1009-EB</b>
1,2 mm	<b>1009-EC</b>
1,5 mm	<b>1009-ED</b>
1,6 mm	<b>1009-EE</b>
1,8 mm	<b>1009-EF</b>
2,0 mm	<b>1009-EG</b>
2,2 mm	<b>1009-EH</b>
2,5 mm	<b>1009-EI</b>
3,0 mm	<b>1009-EL</b>



**KIRSCHNER**

Trokarspitze  
Trocar point  
Punta trequarti  
Punta de trócar  
Pointe de Trocart



**KIRSCHNER**

Trokarspitze  
Trocar point  
Punta trequarti  
Punta de trócar  
Pointe de Trocart

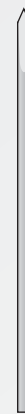

**KIRSCHNER**

Lanzenspitze  
Lance point  
Punte lanceolate  
Punta lanceolar  
Pointe lancette



Rundes ende  
Round shaft  
Punta rotonda  
Punta redonda  
Pointe ronde

150 mm



Trokarspitze  
Trocar point  
Punta trequarti  
Punta de trócar  
Pointe de Trocart

150 mm



Lanzenspitze  
Lance point  
Punte lanceolate  
Punta lanceolar  
Pointe lancette

150 mm

Ø/Diam.	Pack. 10 pcs
0,8 mm	<b>1009-GL</b>
1,0 mm	<b>1009-HA</b>
1,2 mm	<b>1009-HC</b>
1,4 mm	<b>1009-HE</b>
1,5 mm	<b>1009-HF</b>
1,6 mm	<b>1009-HG</b>
1,7 mm	<b>1009-HH</b>
1,8 mm	<b>1009-HI</b>
2,0 mm	<b>1009-IA</b>
2,2 mm	<b>1009-IC</b>
2,5 mm	<b>1009-IF</b>
3,0 mm	<b>1009-LA</b>

Ø/Diam.	Pack. 10 pcs
0,8 mm	<b>1009-GA</b>
1,0 mm	<b>1009-GB</b>
1,2 mm	<b>1009-GC</b>
1,4 mm	<b>1009-GD</b>
1,6 mm	<b>1009-GE</b>
1,8 mm	<b>1009-GF</b>
2,0 mm	<b>1009-GG</b>
2,2 mm	<b>1009-GH</b>
2,5 mm	<b>1009-GI</b>
3,0 mm	<b>1009-HB</b>

Ø/Diam.	Pack. 10 pcs
0,8 mm	<b>1009-CL</b>
1,0 mm	<b>1009-DB</b>
1,2 mm	<b>1009-DC</b>
1,5 mm	<b>1009-DD</b>
1,6 mm	<b>1009-DE</b>
1,8 mm	<b>1009-DF</b>
2,0 mm	<b>1009-DG</b>
2,2 mm	<b>1009-DH</b>
2,5 mm	<b>1009-DI</b>
3,0 mm	<b>1009-DL</b>

Kirschner Bohrdrähte  
 Kirschner Wires Drills  
 Chiodi di Kirschner  
 Agujas de Kirschner  
 Broches de Kirschner

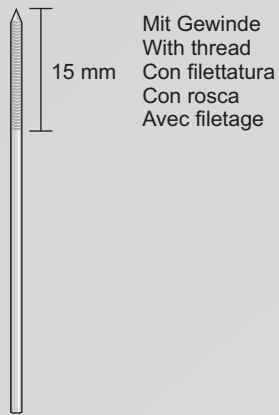

Mit Gewinde  
 With thread  
 Con filettatura  
 Con rosca  
 Avec filetage



Runde  
 Round  
 Rotonda  
 Redonda  
 Ronde

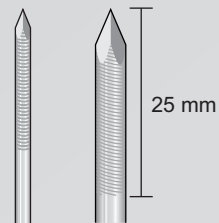

Mit Trokarspitze  
 With trocar point  
 Con punte lanceolate  
 A' pointe trocar  
 Puntas de trocar



Mit rundem Ende  
 With round shaft  
 Con punta rotonda  
 A' extrémité ronde  
 Con vástago redondo



KIRSCHNER			
Code	Ø mm	Lenght	Wire Len.
<b>1009-CCA</b>	1,5	150	5
<b>1009-CCB</b>	1,6	150	15
<b>1009-CCC</b>	2	150	15
<b>1009-CCD</b>	2	200	15

KIRSCHNER			
Code	Ø mm	Lenght	Wire Len.
<b>1009-CCE</b>	2,5	200	25
<b>1009-CCF</b>	2,5	230	25
<b>1009-CCG</b>	2,5	300	25
<b>1009-CCH</b>	3,0	300	25
<b>1009-CCI</b>	3,5	300	25
<b>1009-CCL</b>	4,0	260	25
<b>1009-CDD</b>	4,5	300	25

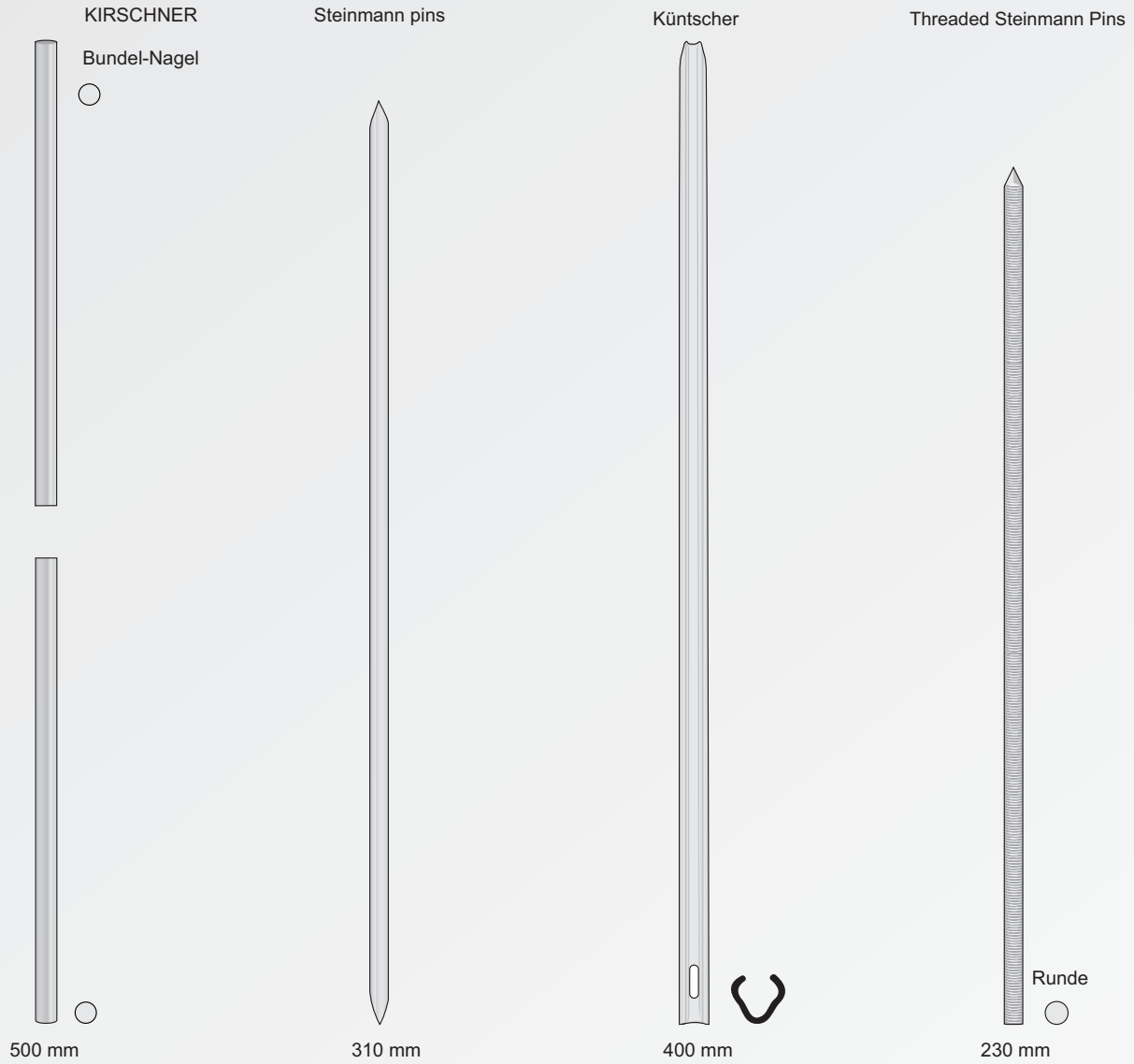

Ø/Diam.	Pack. 10 pcs
2,0 mm	<b>1009-FA</b>
2,5 mm	<b>1009-FB</b>
3,0 mm	<b>1009-FC</b>
3,5 mm	<b>1009-FD</b>
4,0 mm	<b>1009-FE</b>
4,5 mm	<b>1009-FF</b>
5,0 mm	<b>1009-FG</b>
5,5 mm	<b>1009-FH</b>
6,0 mm	<b>1009-FI</b>

Ø/Diam.	Pack. 1 pc
3,5 mm	<b>1009-CIA</b>
4,0 mm	<b>1009-CIC</b>
4,5 mm	<b>1009-CIE</b>
5,0 mm	<b>1009-CIG</b>
6,0 mm	<b>1009-CII</b>
6,5 mm	<b>1009-CLA</b>

Ø/Diam.	Pack. 1 pc
6,0 mm	<b>1009-CFC</b>
7,0 mm	<b>1009-CFE</b>
8,0 mm	<b>1009-CFG</b>
9,0 mm	<b>1009-CFI</b>
10 mm	<b>1009-CGA</b>
11 mm	<b>1009-CGC</b>
12 mm	<b>1009-CGE</b>

Ø/Diam.	Pack. 1 pc
2,0 mm	<b>1009-BGA</b>
2,5 mm	<b>1009-BGB</b>

Bohrdrähte und Knochennägel mit Gewinde  
 Threaded Wires and pins  
 Chiodi filettati Schanz  
 Agujas y clavos con rosca  
 Broches et clous avec filetage

Negative

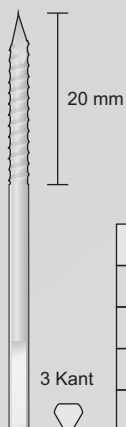

SCHANZ			
Code	Ø mm	Lenght	Wire Len.
1009-CDA	3	60	20
1009-CDB	3	80	20
1009-CDC	4	60	25

Negative



SCHANZ			
Code	Ø mm	Lenght	Wire Len.
1009-CLD	2	150	50
1009-CLE	3	150	50
1009-CLF	3,5	150	50
1009-CLG	4	150	50
1009-CLH	4,5	150	50
1009-CLI	5	150	50

Negative



SCHANZ			
Code	Ø mm	Lenght	Wire Len.
1009-CDI	2	150	50
1009-CEA	3	150	50
1009-CEC	3,5	150	50
1009-CEE	4	150	50
1009-CEG	4,5	150	50
1009-CEI	5	150	50

Positive

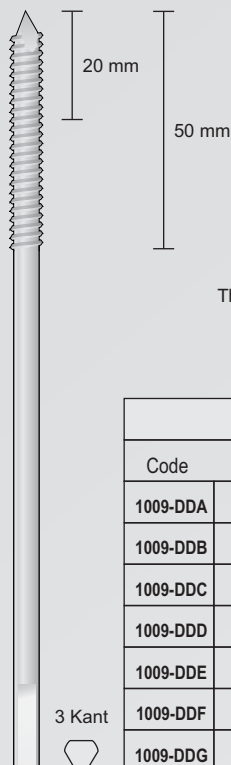

Thread - Ø is 0,5 mm more than pin - Ø

SCHANZ			
Code	Ø mm	Lenght	Wire Len.
1009-DDA	2	150	20
1009-DEB	3	150	20
1009-DDC	3,5	150	50
1009-DDD	4	150	25
1009-DDE	4	150	50
1009-DDF	4,5	150	50
1009-DDG	5	150	50

Cerclage Instrumente  
 Cerclage instruments  
 Strumenti per cerchiaggio  
 Instrumentos para cerclaje  
 Instruments pour cerclage

Bohrdrähte und Knochennägel mit Gewinde  
 Threaded Wires and pins  
 Chiodi filettati Schanz  
 Agujas y clavos con rosca  
 Broches et clous avec filetage

**Positive**

Thread - Ø is 0,5 mm  
 more than pin - Ø

Steinmann Pins with Central Threa  
 with Trocar Point

Sterilisation-Bohrdrahtspender  
 Sterilization Wire Drill dispenser  
 Contenitore per sterilizzazione chiodi  
 Esterilización - Dispensador de Agujas  
 Stérilisation - Distributeur de broches

Ø 10 mm

Draht weich  
 Wire soft  
 Filo malleabile  
 per compattare l'osso  
 Hilos de cerclaje  
 Fil à os

Ø/Diam.	Code
0,2 mm	<b>1009-CAC</b>
0,3 mm	<b>1009-CAD</b>
0,4 mm	<b>1009-CAE</b>
0,5 mm	<b>1009-CAF</b>
0,6 mm	<b>1009-CAG</b>
0,7 mm	<b>1009-CAH</b>
0,8 mm	<b>1009-CAI</b>
0,9 mm	<b>1009-CAL</b>
1,0 mm	<b>1009-CBA</b>
1,2 mm	<b>1009-CBB</b>
1,5 mm	<b>1009-CBC</b>
1,8 mm	<b>1009-CBD</b>
2,0 mm	<b>1009-CBE</b>

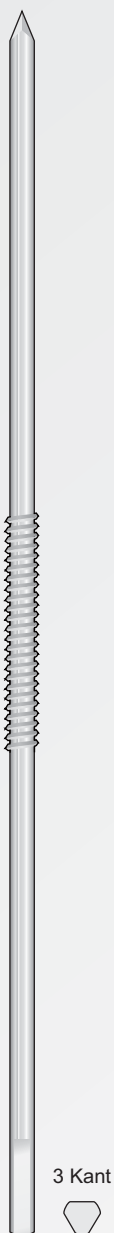

STEINMANN PINS		
Code	Ø mm	Lenght
1009-BHF	3	150
1009-BHG	3	180
1009-BHH	3	200
1009-BHI	3	230
1009-BHL	3,5	150
1009-BIA	3,5	180
1009-BIB	3,5	200
1009-BIC	3,5	230
1009-BID	4	150
1009-BIE	4	180
1009-BIF	4	200
1009-BIG	4	230
1009-BIH	4	250
1009-BII	4,5	150
1009-BIL	4,5	180
1009-BLA	4,5	200
1009-BLB	4,5	230
1009-BLC	4,5	250
1009-BLD	4,5	300
1009-BLE	5	150
1009-BLF	5	180
1009-BLG	5	200
1009-BLH	5	230
1009-BLI	5	250
1009-BLL	5	300

3 Kant

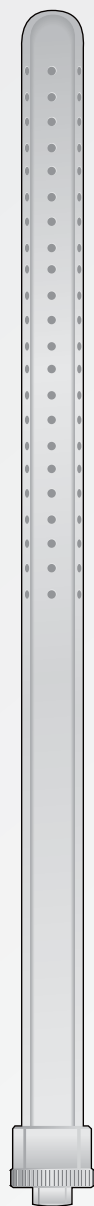

**1009-DAA**  
 320 mm  
**1009-DAB**  
 190 mm

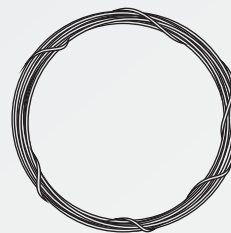

10 mt.

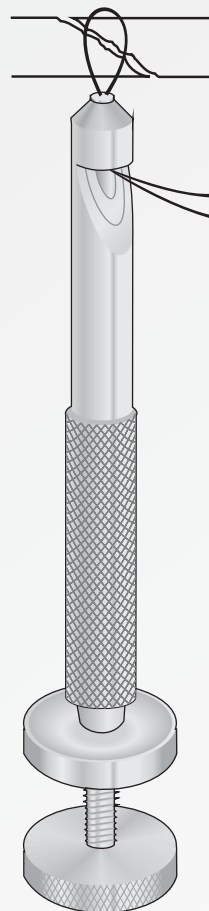

LOUTE  
**1009-DCC**  
 220 mm

Drahtspanninstrument  
 Bone Wire tighteners  
 Strumenti tendifilo  
 Tensor cierra hilos  
 Tendeur serre fils

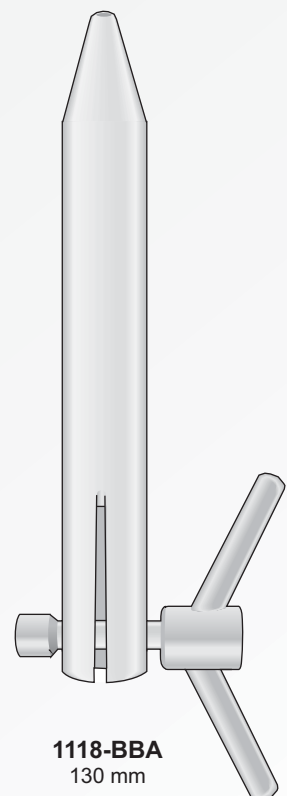

**1118-BBA**  
 130 mm

Punte elicoidali con innesto rapido

Mit AO schaft  
 Drill bits  
 Attacco AO

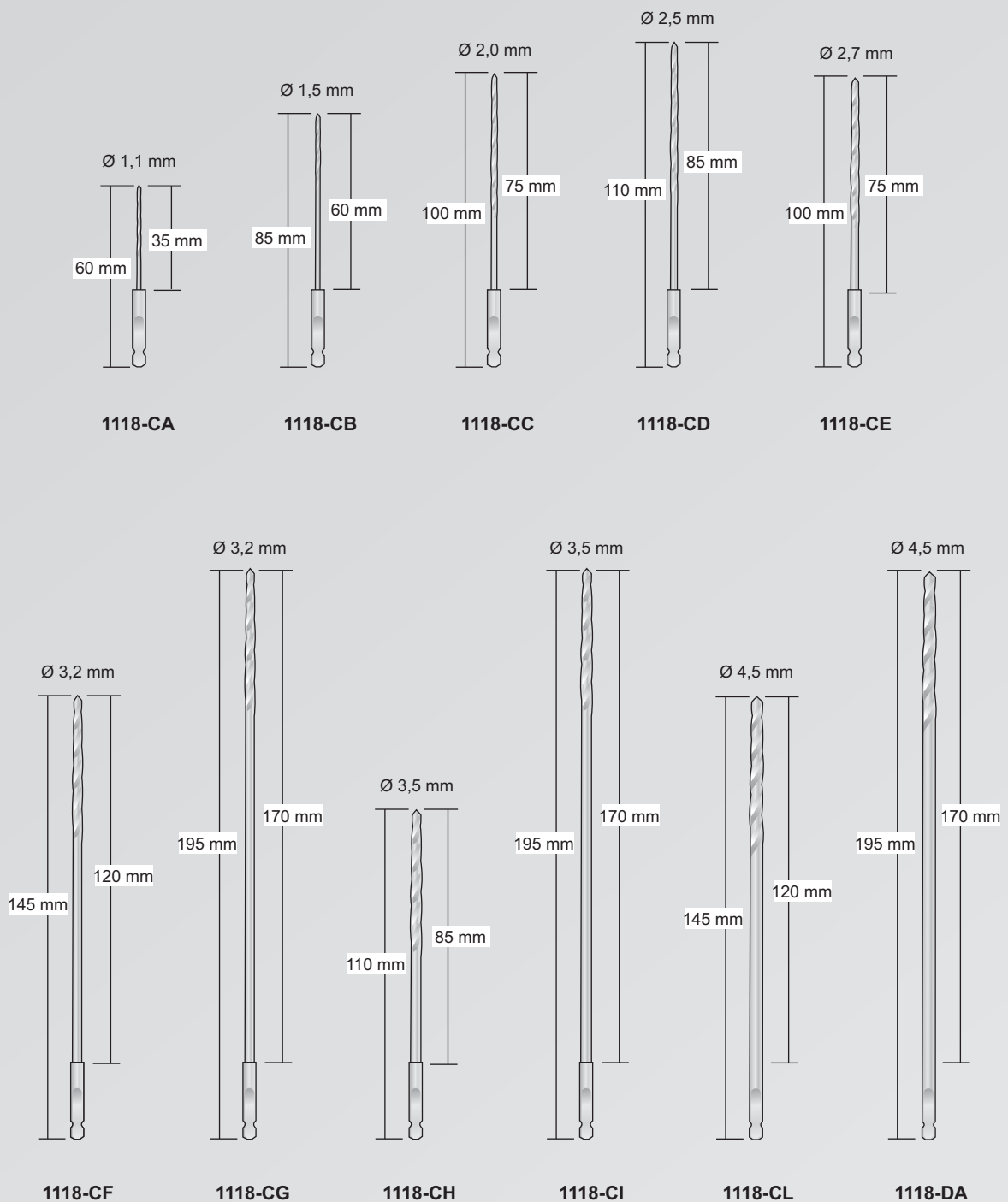



Punte elicoidali

Mit rundschaft  
Drill bits  
Con attacco rotondo

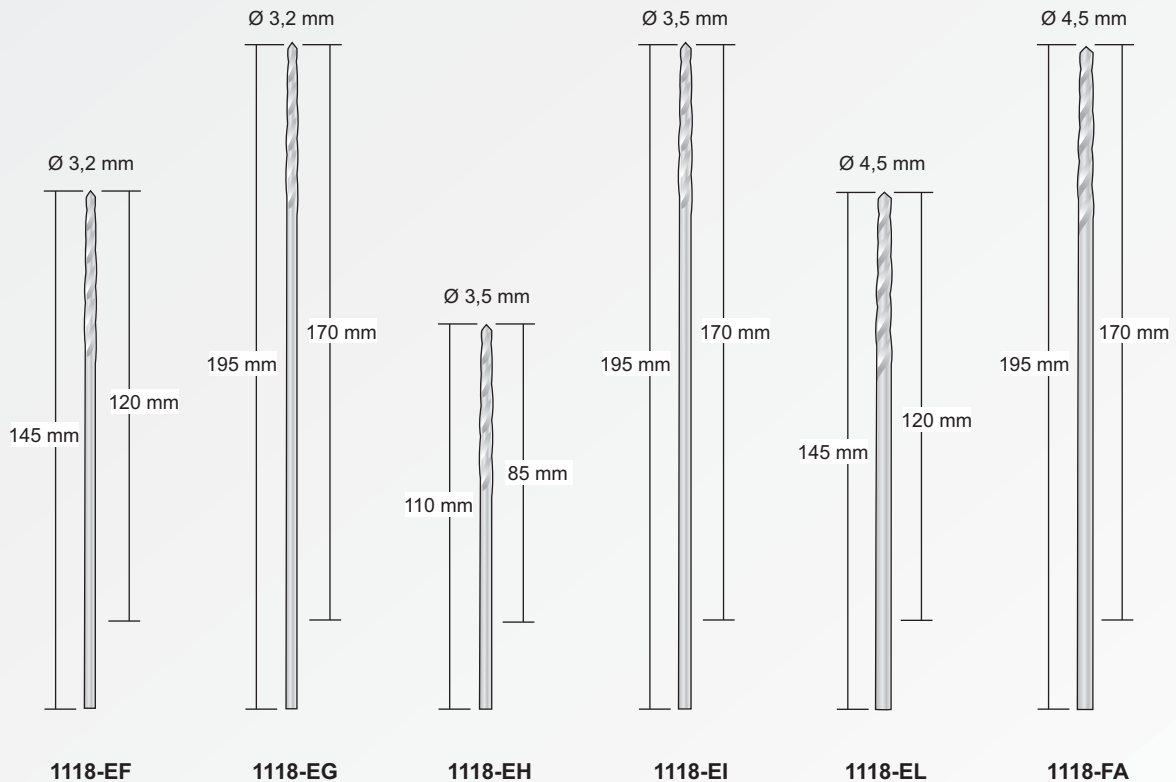
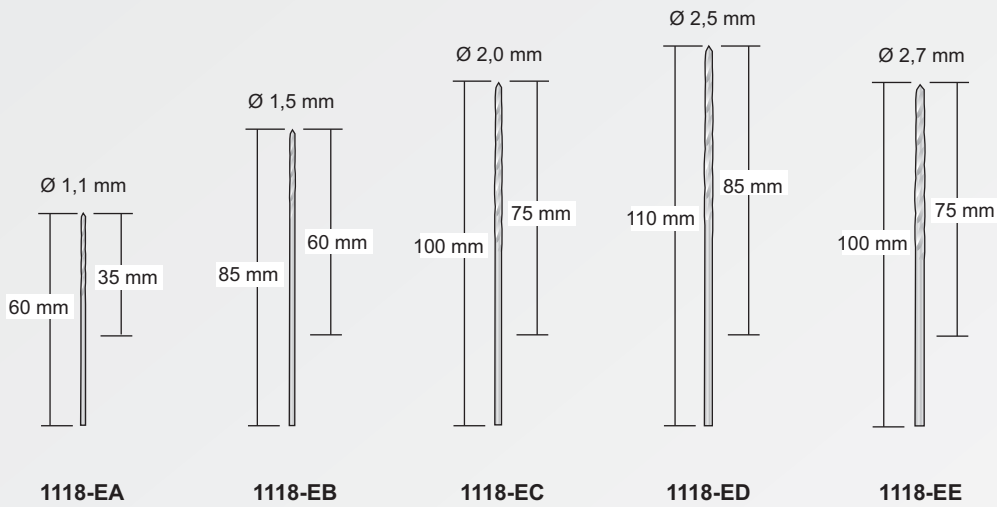

Mit rundschaft  
 Drill bits  
 Con attacco rotondo

Punte elicoidali

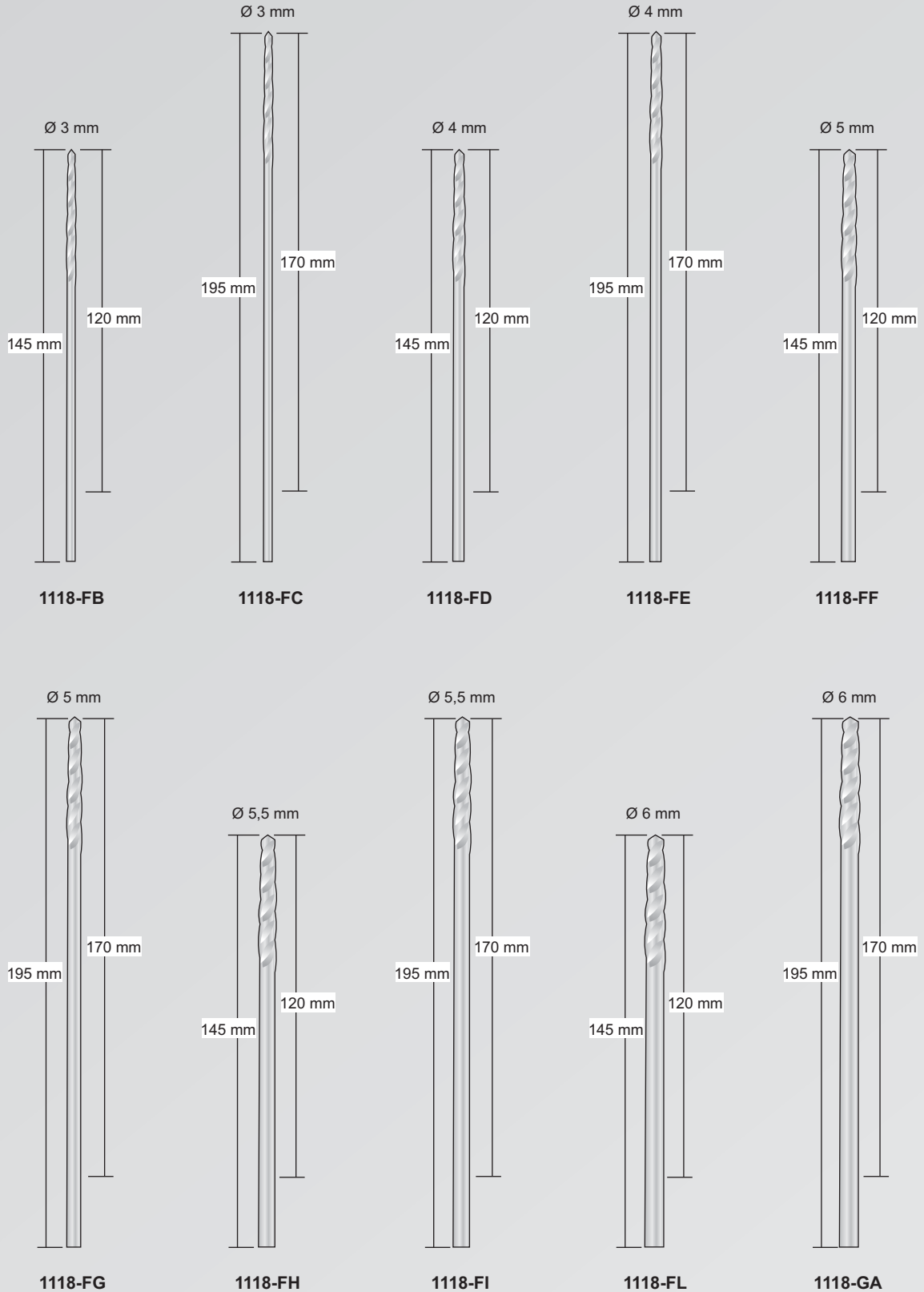

Dental schaft  
Attacco Dentale

Ø 1,5 mm



**1118-DC**  
50 mm

Ø 2,0 mm



**1118-DD**  
55 mm

Meßlehre für Kirschnerdrähte  
Measuring Gauge for nails  
Misuratore per chiodi Kirschner



**1009-BA**

Mit AO schaft  
Attacco AO

Ø 1,5 mm



**1118-BA**  
65 mm

Ø 2 mm



**1118-BB**  
70 mm

Ø 2,7 mm



**1118-BC**  
100 mm

Passo della vite  
a 1,25 mm

Ø 3,5 mm



**1118-BD**  
110 mm

Passo della vite  
a 1,75 mm

Ø 3,5 mm

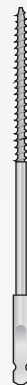

**1118-BE**  
110 mm

Ø 4,5 mm



**1118-BF**  
130 mm

Ø 4,5 mm



**1118-BG**  
130 mm

Ø 6,5 mm



**1118-BH**  
170 mm

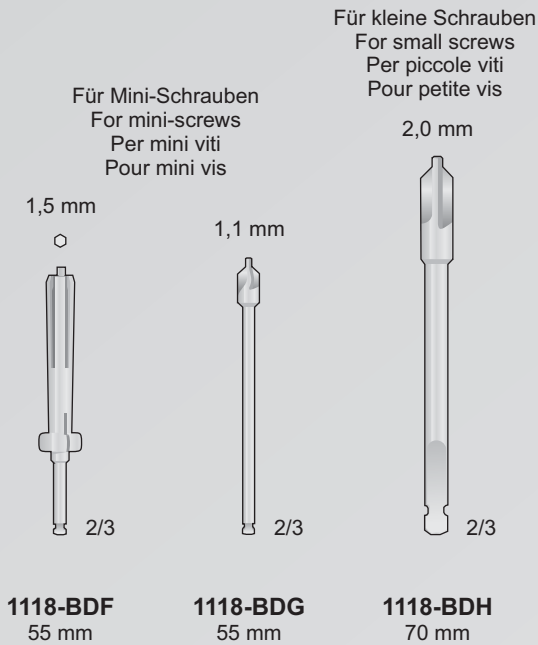

Für Malleolarschrauben  
 For malleolar screws  
 Per viti malleolari  
 Pour vis à malléole

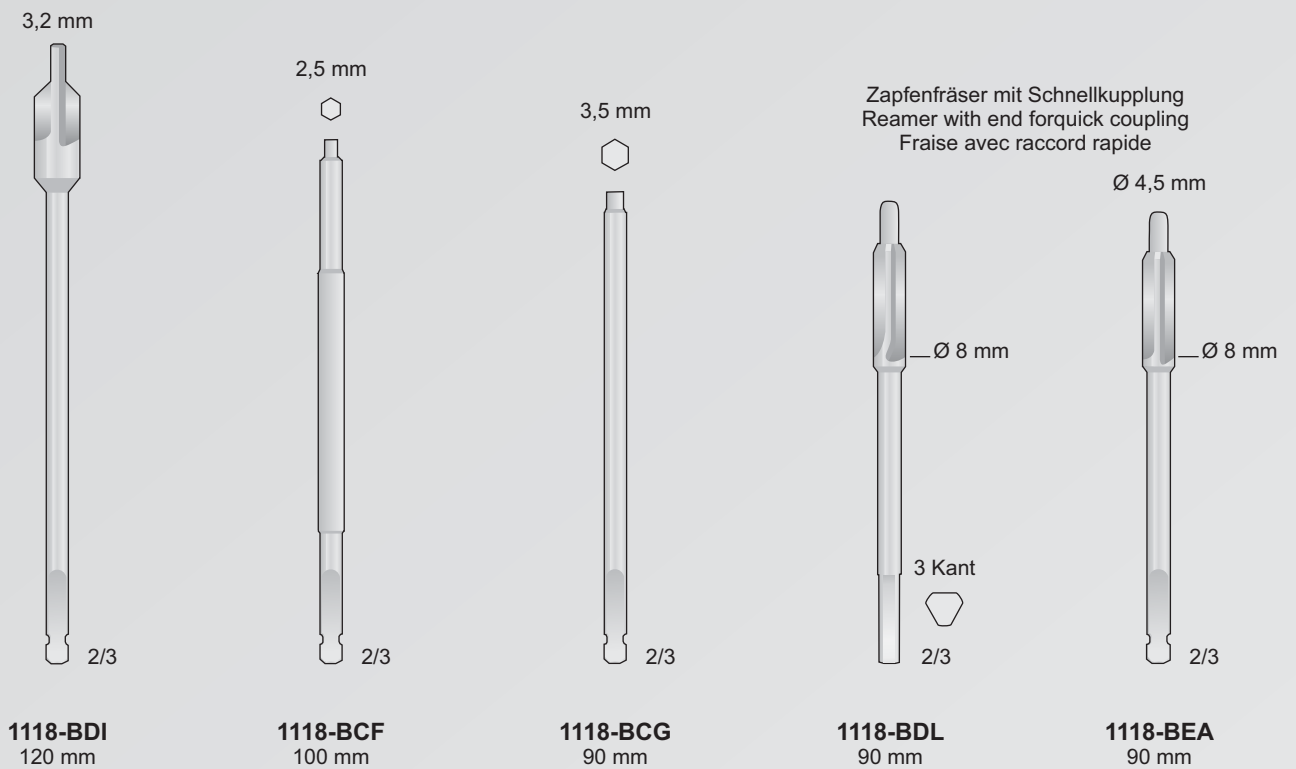



 ideal-tek

Otologie  
Otology  
Otologia  
Otologia  
Otologie



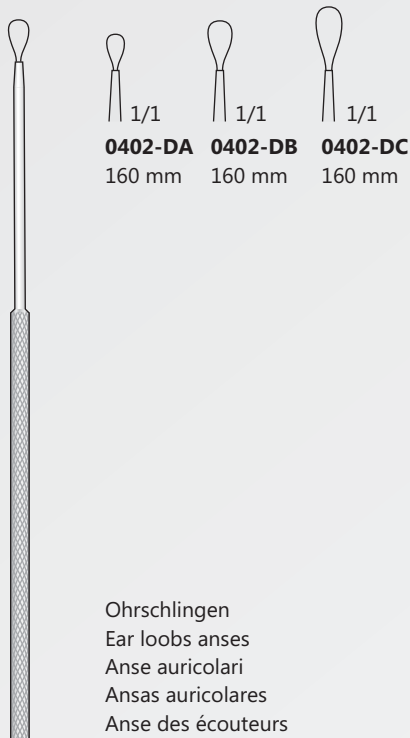

BILLEAU  
**0402-DA/0402-DC**  
 160 mm



SHAPLEIGH  
**0402-DG/0402-DL**  
 130 mm

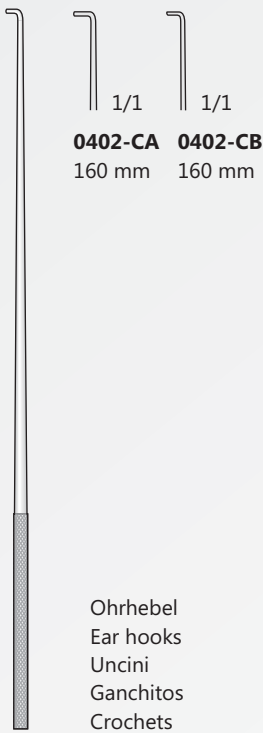

DAY  
**DB-20/DB-21**  
 160 mm

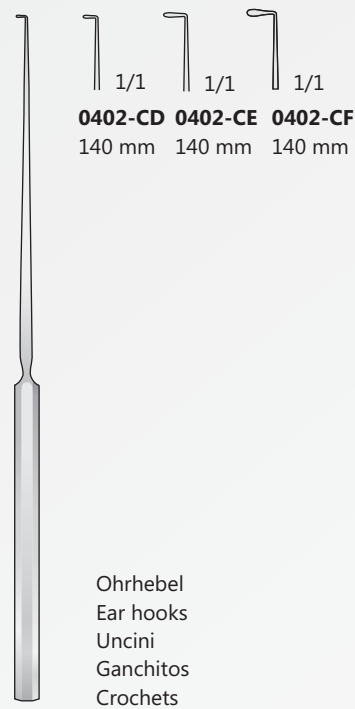

LUCAE  
**DB-23/DB-25**  
 140 mm

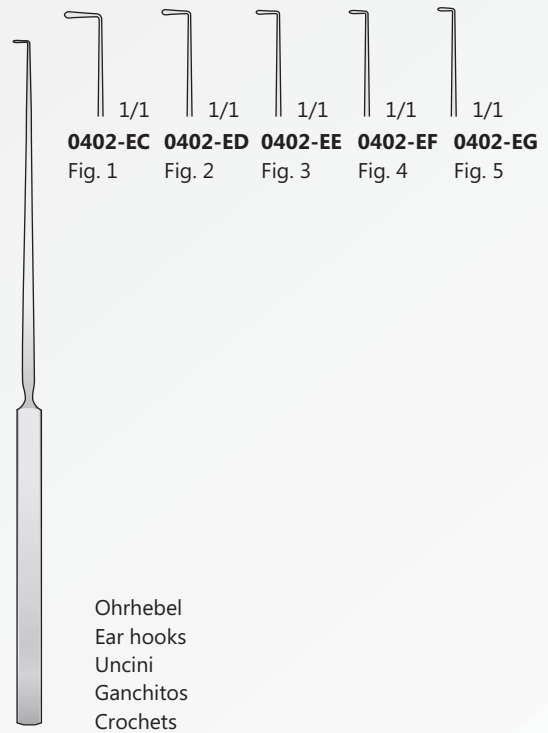

WAGENER  
**DB-42/DB-46**  
 140 mm

Palpatorischen    Mikro-Küretten  
 Palpatory        Micro Curettes  
 Palpatori         Micro Cucchai  
 Palpación        Micro Cucharillas  
 Palpatoire        Micro Curettes



GRAEFE  
**1310-CEF**  
 130 mm



**01-B**  
 125 mm



**HBD-BAB**



**HBD-BAC**



**HBH-BAA**

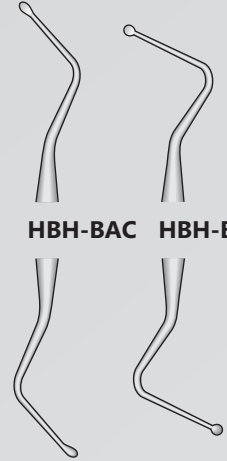

**HBH-BAC    HBH-BBC**

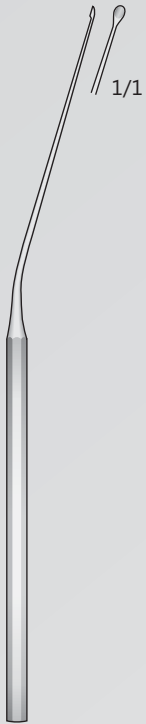

SHEA  
**0617-BFI**  
 160 mm



SHEA  
**0617-BFL**  
 160 mm

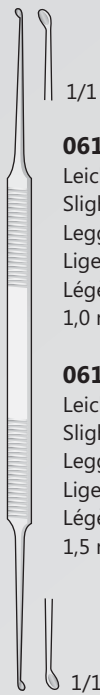

HOUSE  
**0617-BGA/0617-BGB**  
 150 mm

**0617-BGA**  
 Leicht gebogen  
 Slightly curved  
 Leggermente curvo  
 Ligeramente curvado  
 Légèrement incurvée  
 1,0 mm/1,2 mm

**0617-BGB**  
 Leicht gebogen  
 Slightly curved  
 Leggermente curvo  
 Ligeramente curvado  
 Légèrement incurvée  
 1,5 mm/1,8 mm

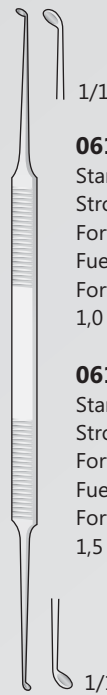

HOUSE  
**0617-BGC/0617-BGD**  
 150 mm

**0617-BGC**  
 Stark gebogen  
 Strong curved  
 Fortemente curva  
 Fuerte curvada  
 Fort incurvée  
 1,0 mm/1,2 mm

**0617-BGD**  
 Stark gebogen  
 Strong curved  
 Fortemente curva  
 Fuerte curvada  
 Fort incurvée  
 1,5 mm/1,8 mm

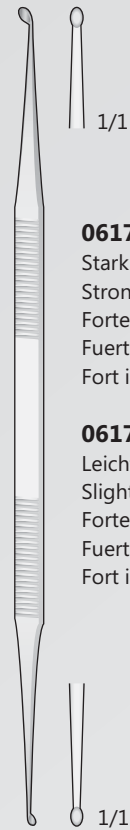

HOUSE  
**0617-BGE/0617-BGF**  
 180 mm

**0617-BGE**  
 Stark gebogen  
 Strong curved  
 Fortemente curva  
 Fuerte curvada  
 Fort incurvée

**0617-BGF**  
 Leicht gebogen  
 Slightly curved  
 Fortemente curva  
 Fuerte curvada  
 Fort incurvée



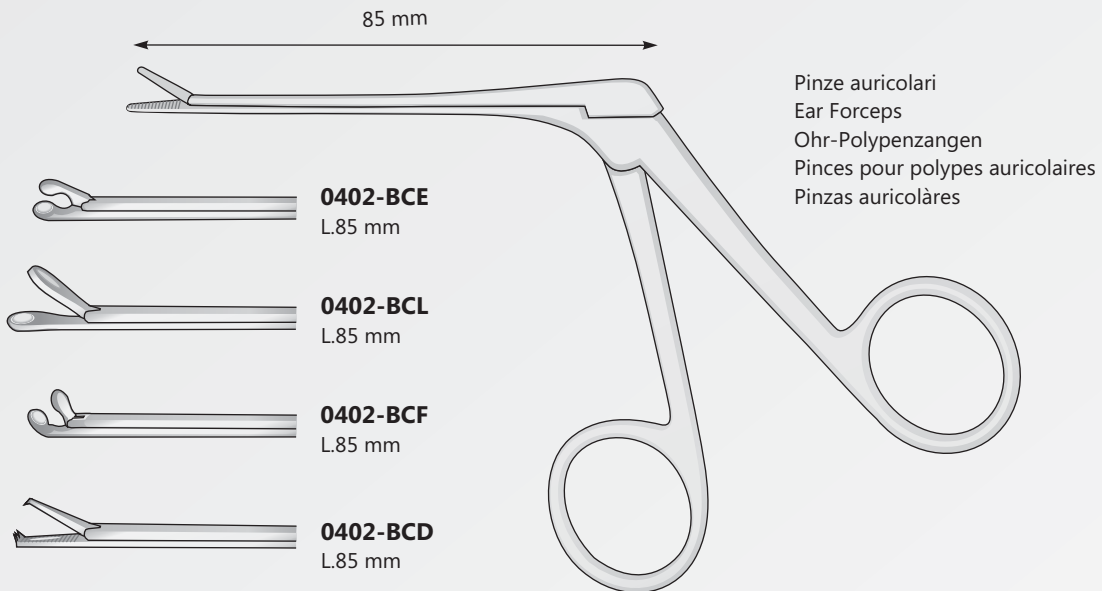

**0402-BCD/0402-BCL**  
 L. 85 mm

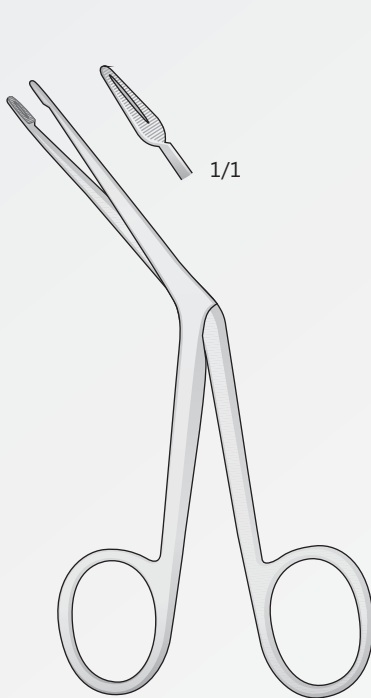

LITTAUER  
**0402-BBB**  
 120 mm

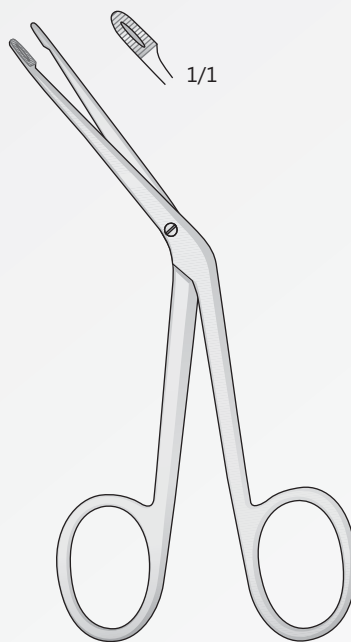

HARTMANN  
**0402-BBD**  
 120 mm

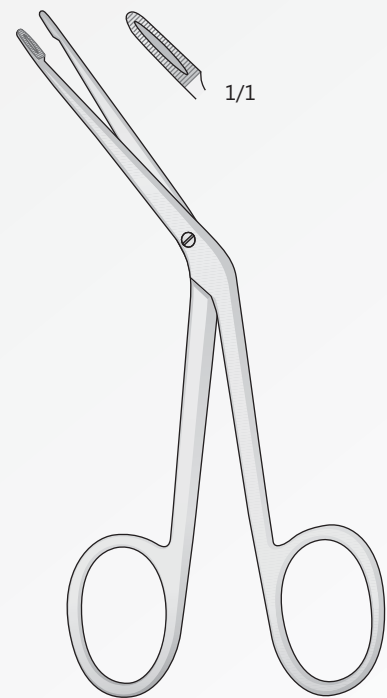

HARTMANN  
**0402-BBE**  
 140 mm

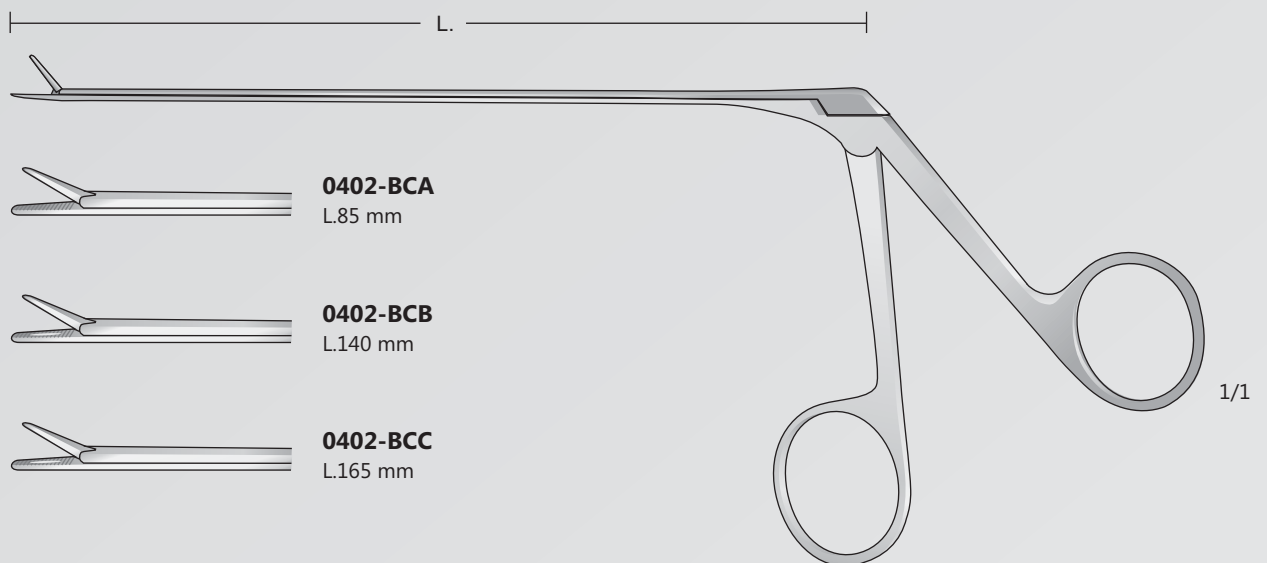
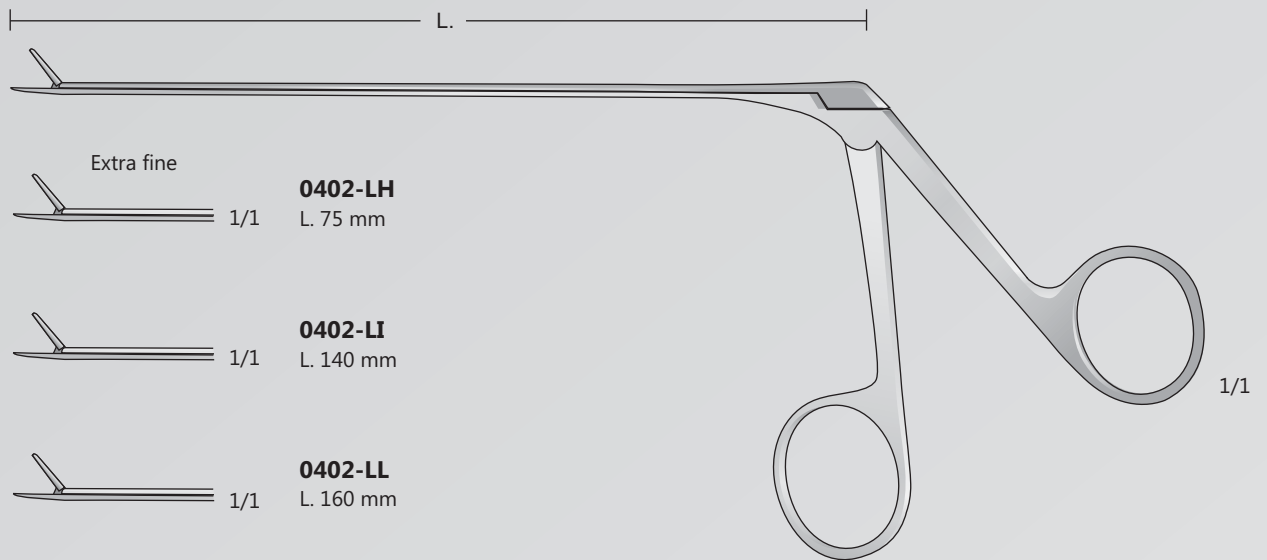

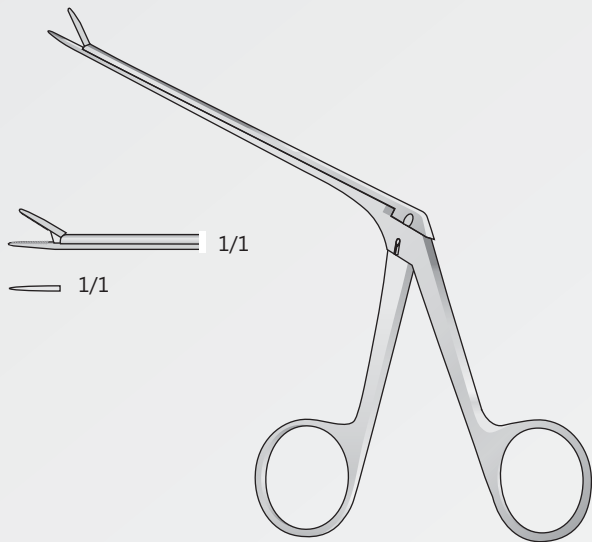

**0402-BAA**  
 80 mm

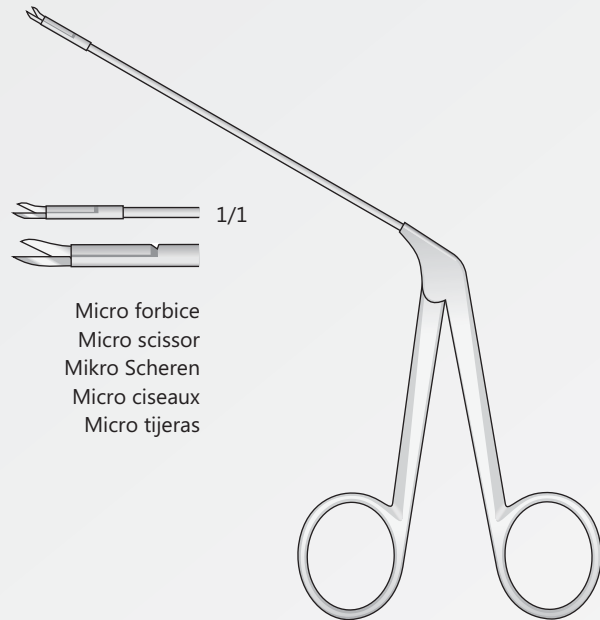

BELLUCCI  
**0402-BAG**  
 80 mm

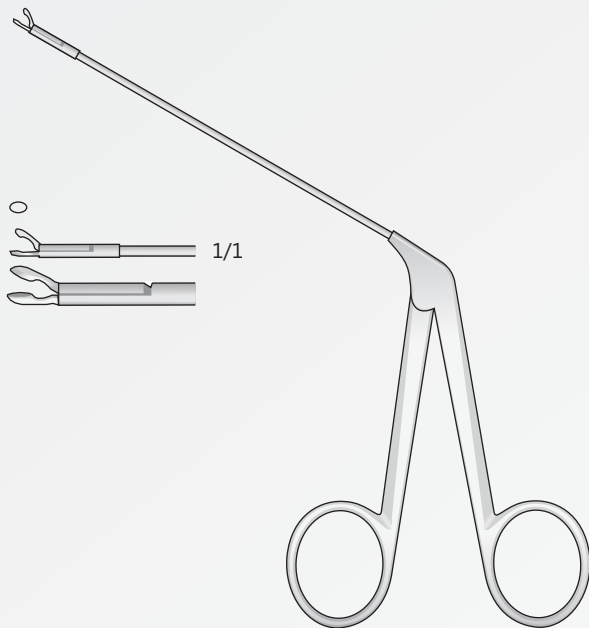

WULLSTEIN  
**0402-BAH**  
 80 mm

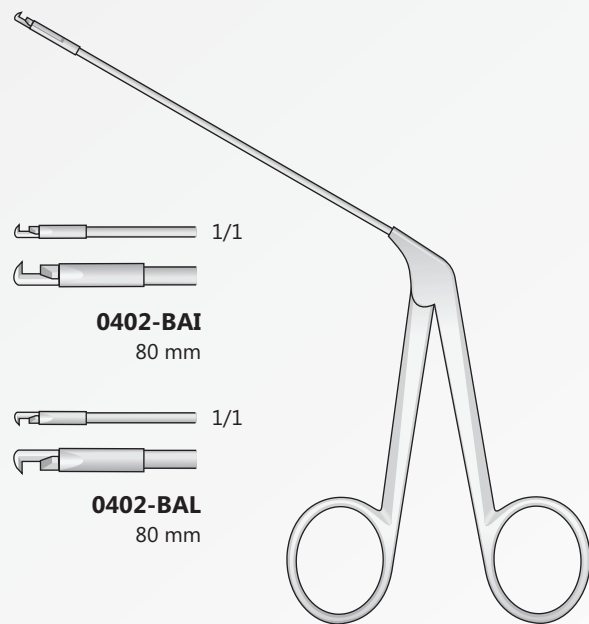

DIETER  
**0402-BAI/0402-BAL**  
 80 mm

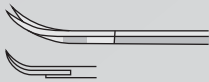

FAHLBUSCH  
**0606-EAB**  
165 mm

Mikro-Scheren, sehr feines Modell, aufgebogen  
Micro Scissors, extra delicate pattern, curved on flat  
Micro forbici, extra delicate, curve verso l'alto  
Micro Tijeras, muy delicados, curvada hacia arriba  
Micro-ciseaux, très délicates, incurvée vers le haut

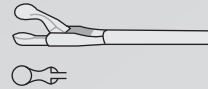

NICOLA  
**0606-EAC**  
165 mm

Scharfe Zange mit Löffelförmigem Maul  
Forceps, scoop-shaped  
Pinze taglienti a cucchiaio  
Alicates afilados en forma de cucharillo  
Pincés tranchantes à cuillère

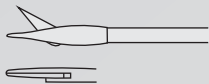

NICOLA  
**0606-EAD**  
165 mm

Mikro-Schere, gerade  
Micro Scissors, straight  
Micro forbici, diritte  
Micro Tijeras, recta  
Micro Ciseaux, droite

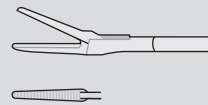

YASARGIL-NICOLA  
**0606-EAE**  
165 mm

Faßzange mit feinem Maul  
Forceps with delicate jaws  
Pinze con morsi delicati  
Alicates con agarre suave  
Pince avec poignée légère

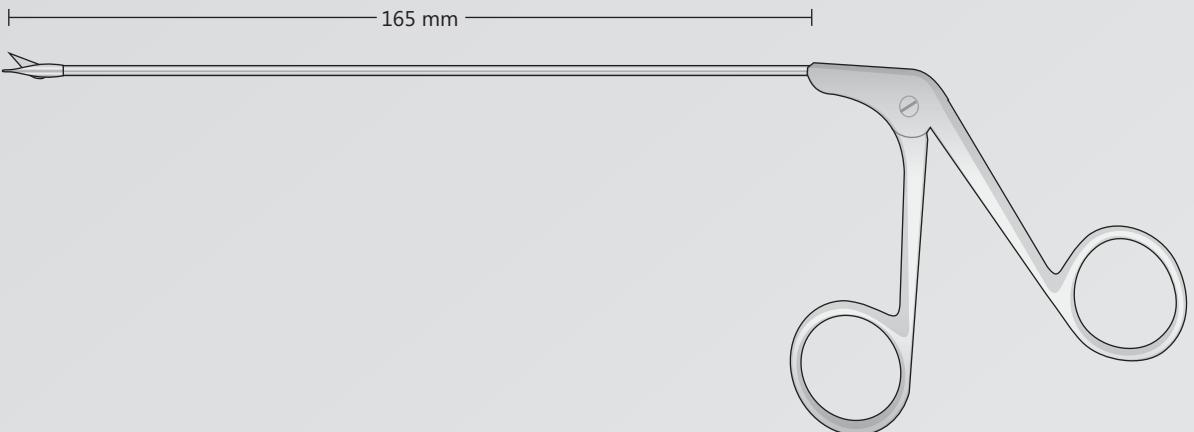

NICOLA  
**0606-EAD**  
165 mm

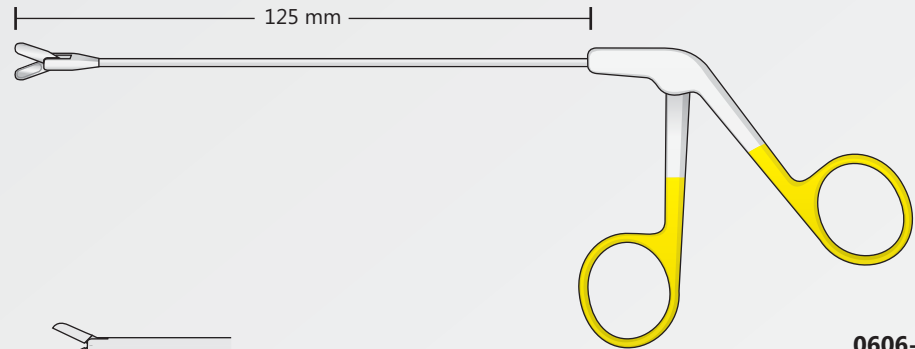

**0606-BD**

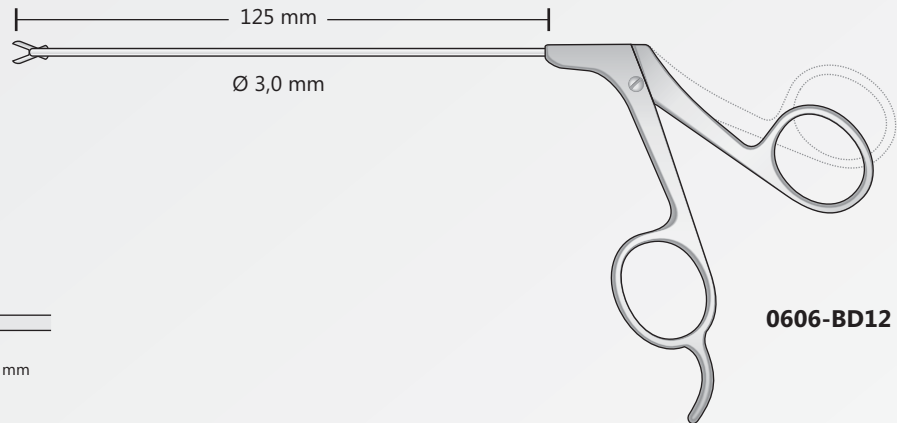
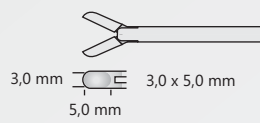

**0606-BD12**

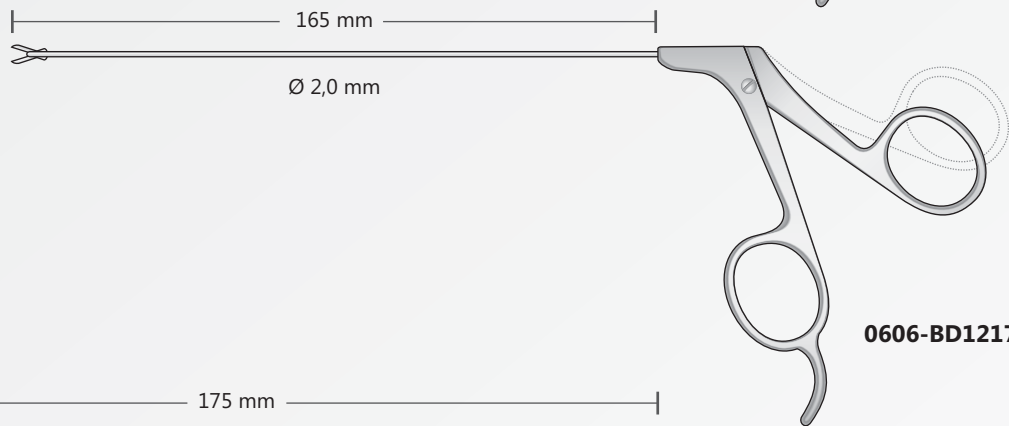
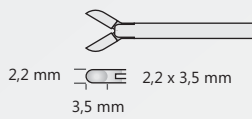

**0606-BD1217**

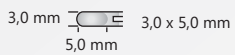
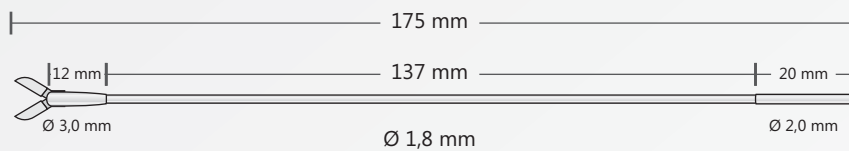

**0606-BD121719**





 ideal-tek

Ophtalmologie  
Opthalmology  
Oftalmologia  
Ophtalmologia  
Ophtlamologie





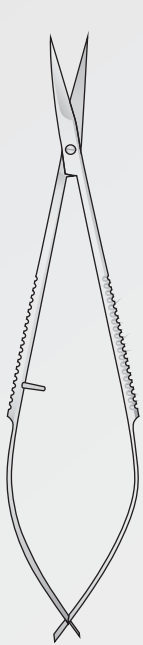

1/1  
**0604-BA**  
Spitz  
Sharp  
Acuta  
Agudas  
Pointu

NOYES  
**0604-BA**  
120 mm

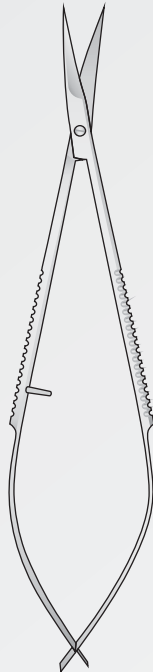

1/1  
**0604-BC**  
Spitz  
Sharp  
Acuta  
Agudas  
Pointu

NOYES  
**0604-BC**  
120 mm

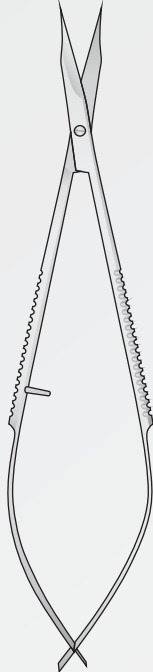

1/1  
**0604-BD**  
Spitz  
Sharp  
Acuta  
Agudas  
Pointu

WESTCOTT  
**0604-BD**  
120 mm

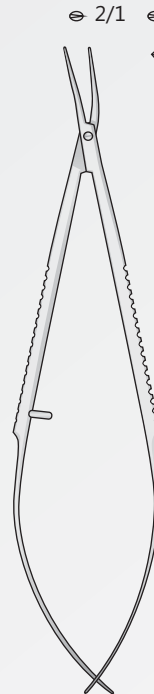

2/1 2/1 2/1  
1/1 1/1  
**0604-BCE 0604-BCF**

**0604-BCE/0604-BCF**  
110 mm

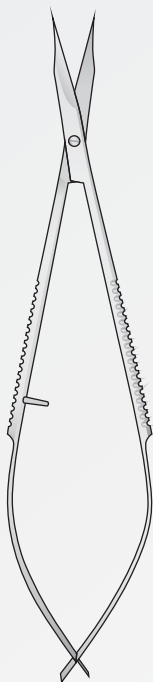

1/1  
**0604-BF**  
Spitz  
Sharp  
Acuta  
Agudas  
Pointu

WESTCOTT  
**0604-BF**  
120 mm

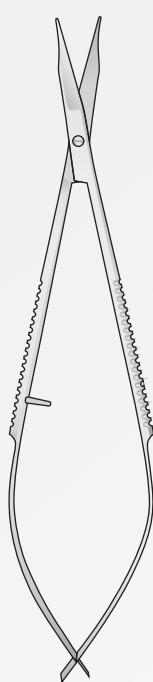

1/1  
**0604-GE**  
Stumpf  
Blunt  
Smussa  
Romas  
Mousse

WESTCOTT  
**0604-GE**  
120 mm

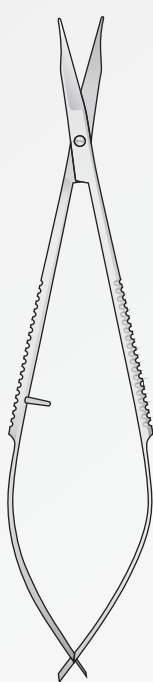

1/1  
**0604-GF**  
Stumpf  
Blunt  
Smussa  
Romas  
Mousse

WESTCOTT  
**0604-GF**  
120 mm

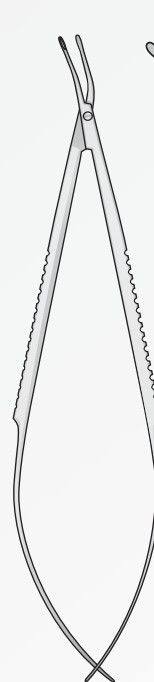

1/1 1/1  
**0604-BCG 0604-BCH**

**0604-BCG/0604-BCH**  
110 mm

Micro Scheren  
 Micro scissors  
 Micro forbici  
 Micro tijeras  
 Micro ciseaux

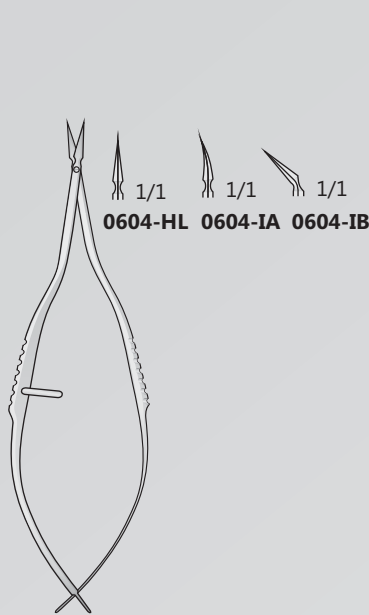

VANNAS  
**0604-HL/0604-IB**  
 85 mm

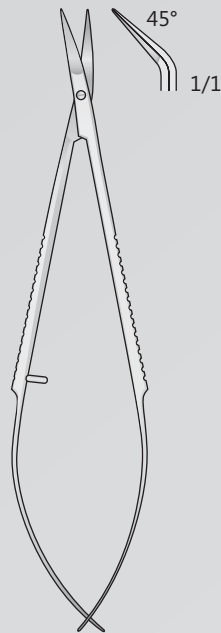

**0604-BB**  
 110 mm



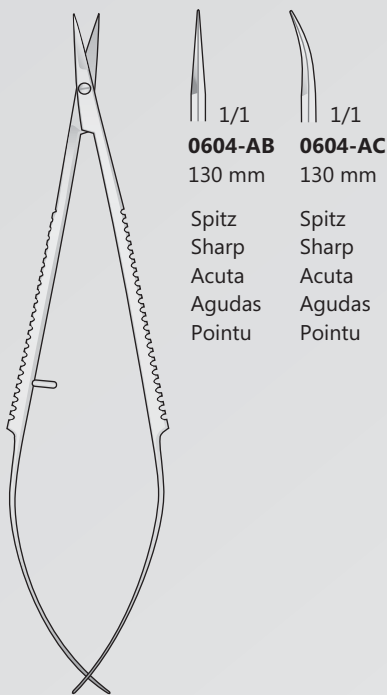

**0604-AE/0604-AF**  
 110 mm



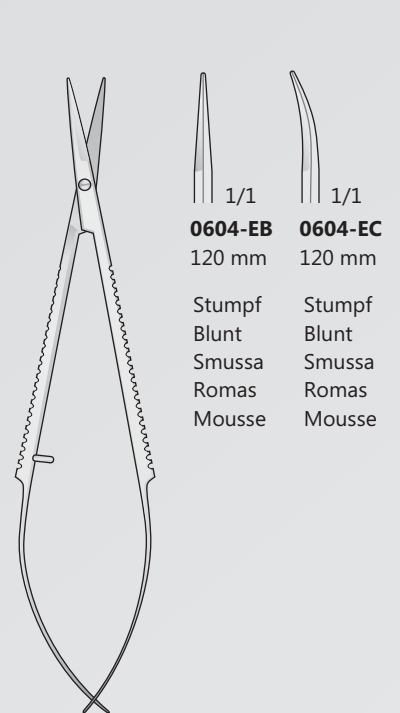



**0604-AB/0604-AC**  
 130 mm



**0604-EB/0604-EC**  
 120 mm

 1/1	 1/1
<b>0604-AE</b>	<b>0604-AF</b>
110 mm	110 mm
Spitz	Spitz
Sharp	Sharp
Acuta	Acuta
Agudas	Agudas
Pointu	Pointu

 1/1	 1/1
<b>0604-AB</b>	<b>0604-AC</b>
130 mm	130 mm
Spitz	Spitz
Sharp	Sharp
Acuta	Acuta
Agudas	Agudas
Pointu	Pointu

 1/1	 1/1
<b>0604-EB</b>	<b>0604-EC</b>
120 mm	120 mm
Stumpf	Stumpf
Blunt	Blunt
Smussa	Smussa
Romas	Romas
Mousse	Mousse

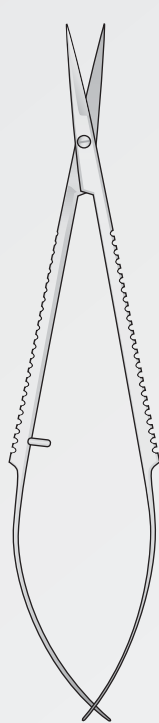

1/1



1/1

**0604-AH 0604-AL**  
135 mm 135 mm

Spitz  
Sharp  
Acuta  
Agudas  
Pointu

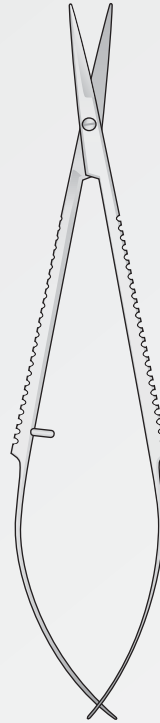

1/1



1/1

**0604-ED 0604-EE**  
135 mm 135 mm

Stumpf  
Blunt  
Smussa  
Romas  
Mousse

**0604-AH/0604-AL**  
135 mm

**0604-ED/0604-EE**  
135 mm

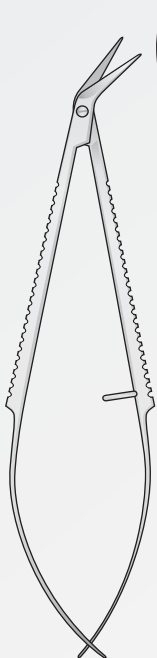

1/1

Hornhaut Schere  
Corneal Scissors  
Forbici corneali  
Tijeras de córnea  
Corneal Ciseaux

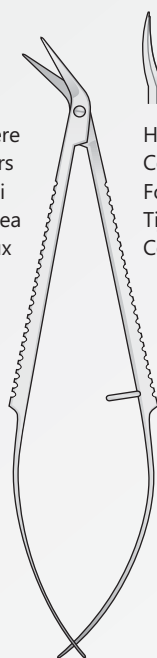

1/1

Hornhaut Schere  
Corneal Scissors  
Forbici corneali  
Tijeras de córnea  
Corneal Ciseaux

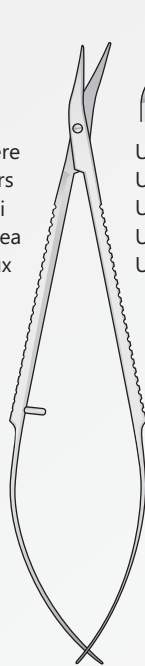

1/1

Universal  
Universal  
Universale  
Universal  
Universel

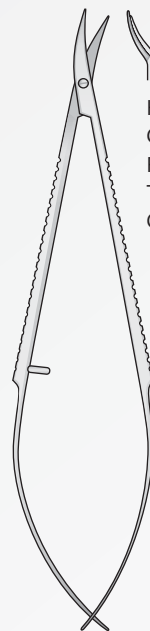

1/1

Hornhaut Schere  
Corneal Scissors  
Forbici corneali  
Tijeras de córnea  
Corneal Ciseaux

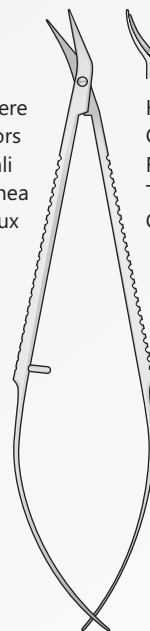

1/1

Hornhaut Schere  
Corneal Scissors  
Forbici corneali  
Tijeras de córnea  
Corneal Ciseaux

CASTROVIEJO  
**0604-GG**  
110 mm

CASTROVIEJO  
**0604-GH**  
110 mm

CASTROVIEJO  
**0604-GI**  
110 mm

TROUTMAN  
**0604-GL**  
110 mm

TROUTMAN  
**0604-HA**  
110 mm

Präparierscheren  
 Dissecting Scissors  
 Forbici per dissezione  
 Tijeras para preparaciones  
 Ciseaux à dissection

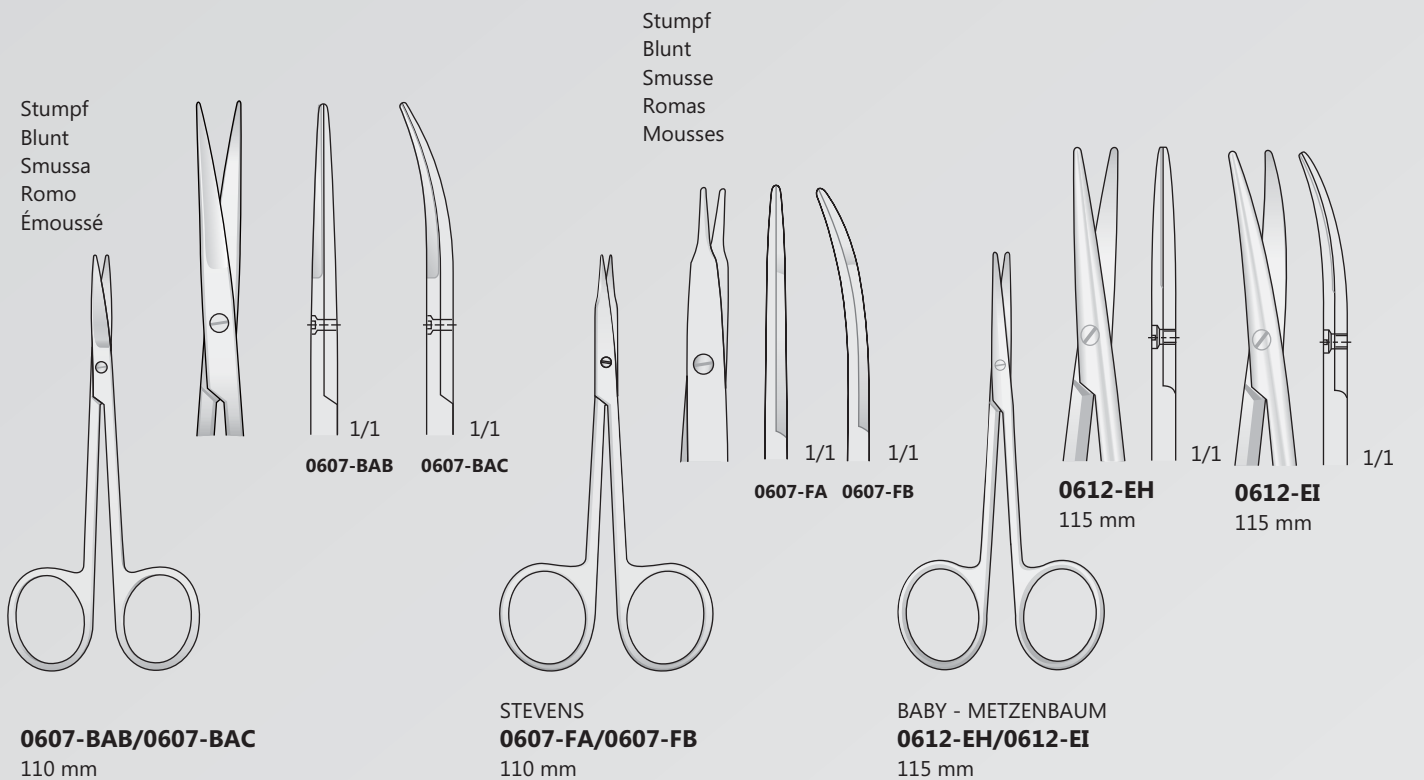
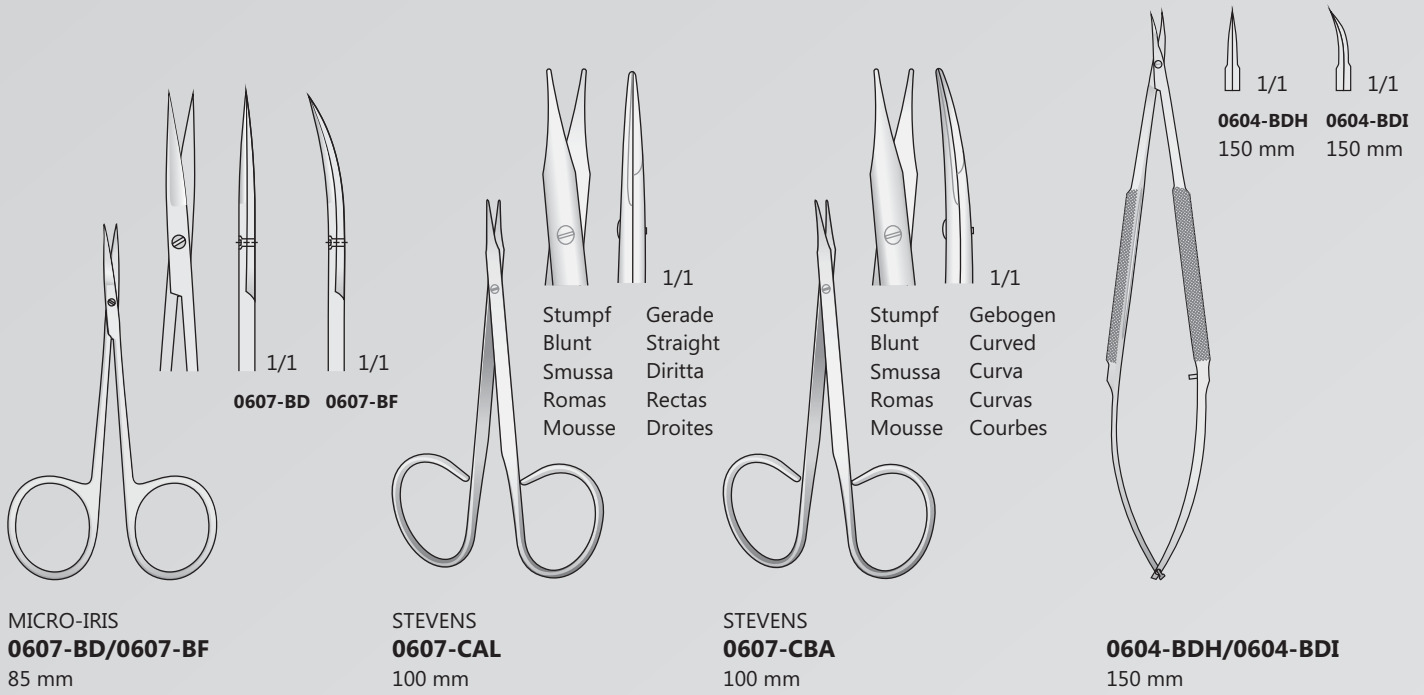

Glattes Maul  
Smooth jaws  
Morso liscio  
Bocas lisas  
Mors lisses

Micro Nadelhalter  
Micro Needle Holders  
Micro port'aghi  
Micro portaagujas  
Micro porte aiguilles

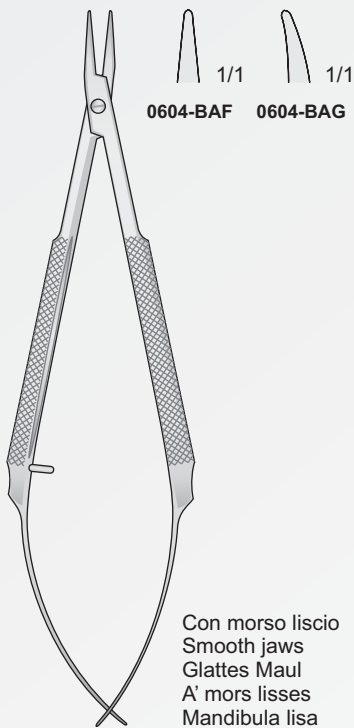

0604-BAF 0604-BAG

Con morso liscio  
Smooth jaws  
Glattes Maul  
A' mors lisses  
Mandibula lisa

0604-BAF/0604-BAG  
110 mm

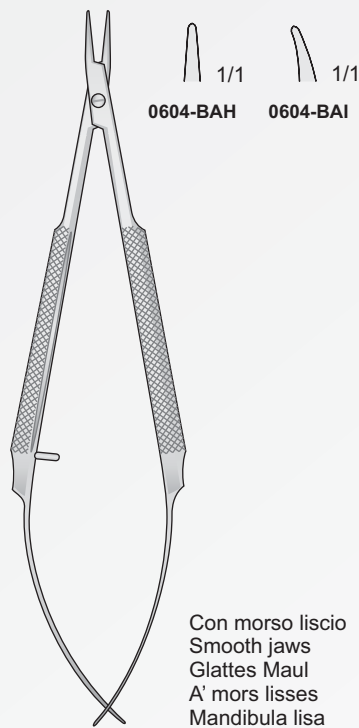

0604-BAH 0604-BAI

Con morso liscio  
Smooth jaws  
Glattes Maul  
A' mors lisses  
Mandibula lisa

0604-BAH/0604-BAI  
110 mm

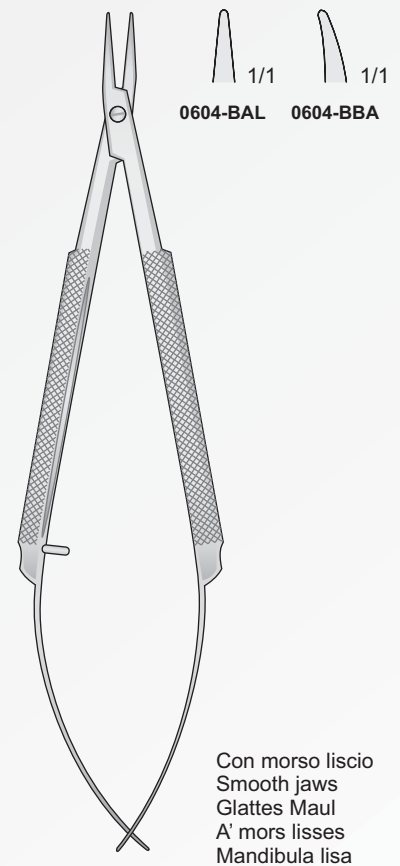

0604-BAL 0604-BBA

Con morso liscio  
Smooth jaws  
Glattes Maul  
A' mors lisses  
Mandibula lisa

0604-BAL/0604-BBA  
125 mm

Micro Nadelhalter  
 Micro Needle Holders  
 Micro port'aghi  
 Micro portaagujas  
 Micro porte aiguilles

Glattes Maul  
 Smooth jaws  
 Morso liscio  
 Bocas lisas  
 Mors lisses

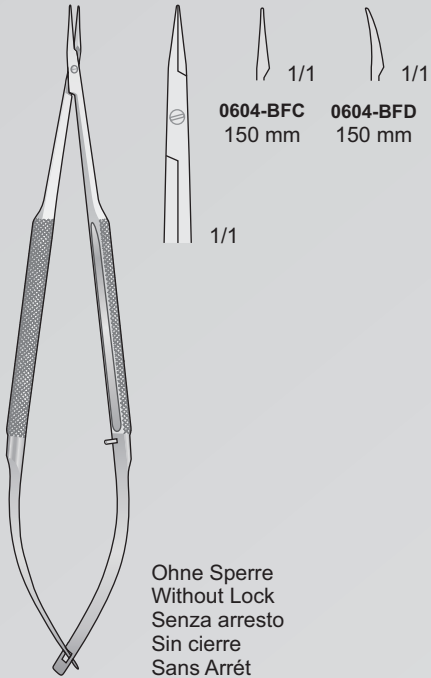

**BARRAQUER**  
**0604-BFC/0604-BFD**  
 150 mm

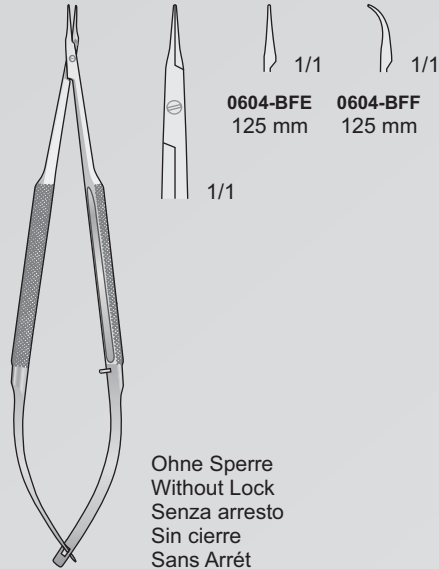

**BARRAQUER**  
**0604-BFE/0604-BFF**  
 125 mm

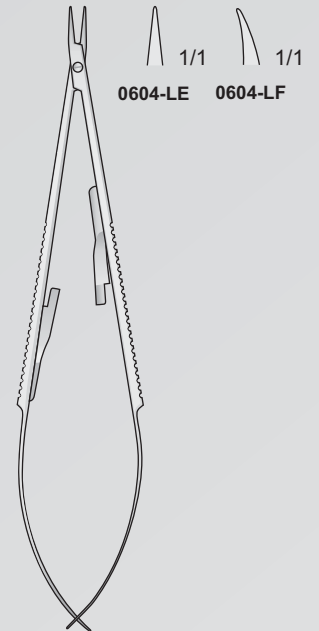

**0604-LE/0604-LF**  
 135 mm

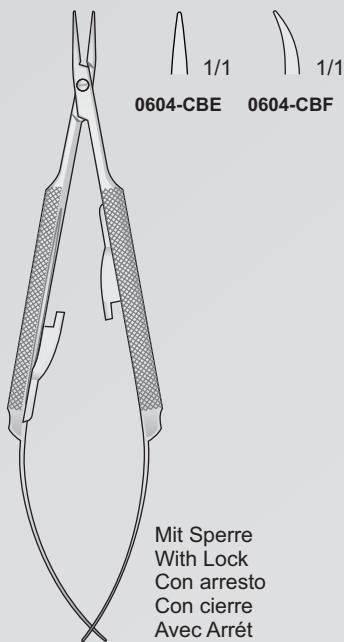

**BARRAQUER**  
**0604-CBE/0604-CBF**  
 125 mm

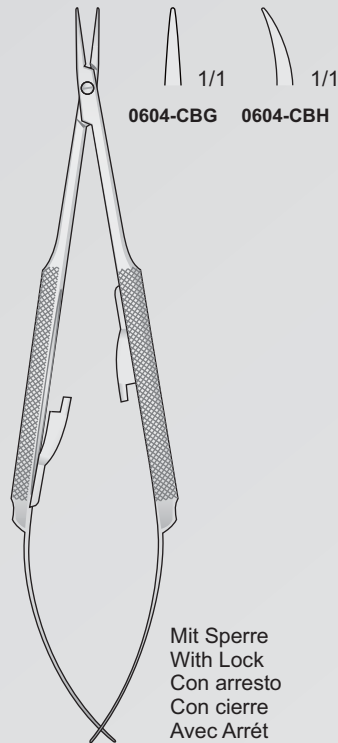

**BARRAQUER**  
**0604-CBG/0604-CBH**  
 150 mm

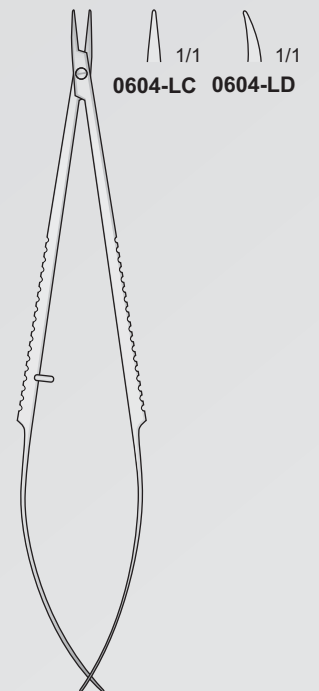

**0604-LC/0604-LD**  
 135 mm

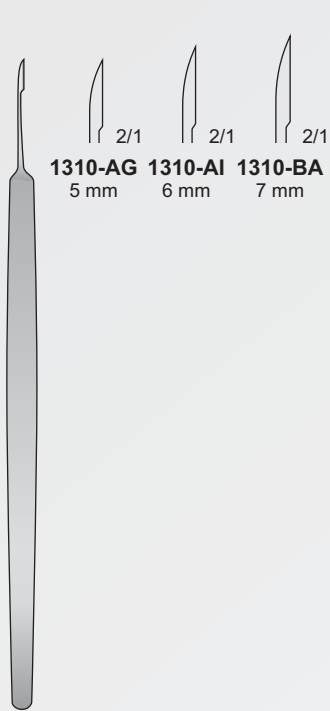

ZIEGLER  
**1310-AG/1310-BA**  
 115 mm

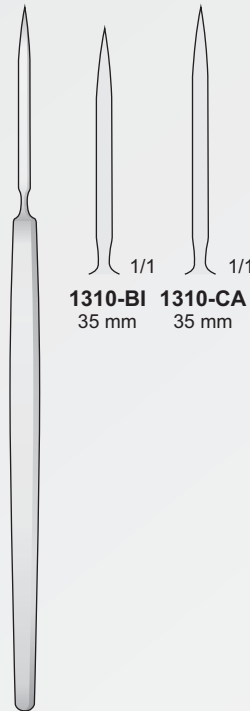

GRAEFE  
**1310-BI/1310-CA**  
 140 mm

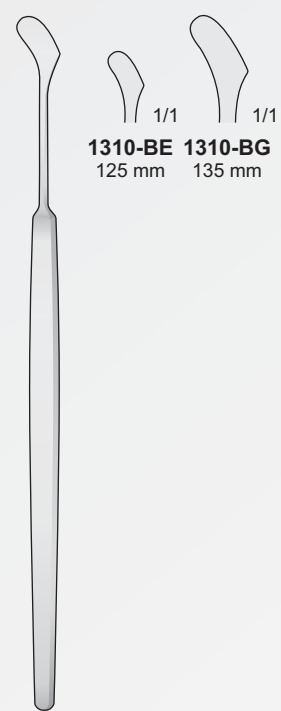

GRAEFE  
**1310-BE/1310-BG**

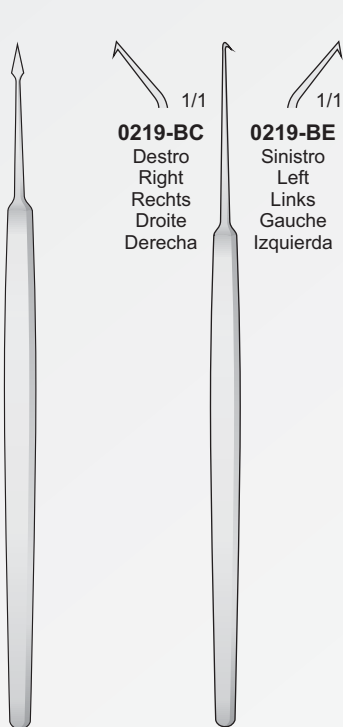

**1310-EL**  
 125 mm

GRAEFE  
**0219-BA**  
 130 mm

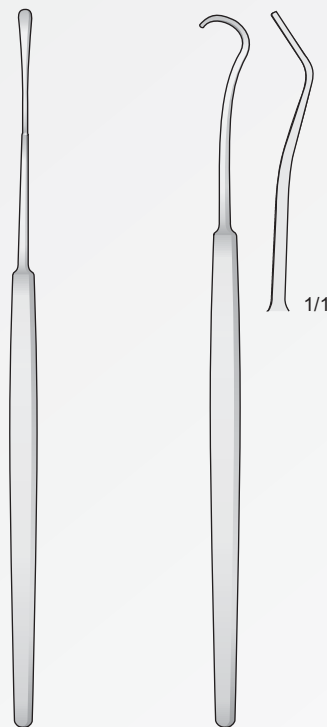

KIMURA  
**1310-EI**  
 150 mm

ARRUGA  
**1310-FL**  
 140 mm

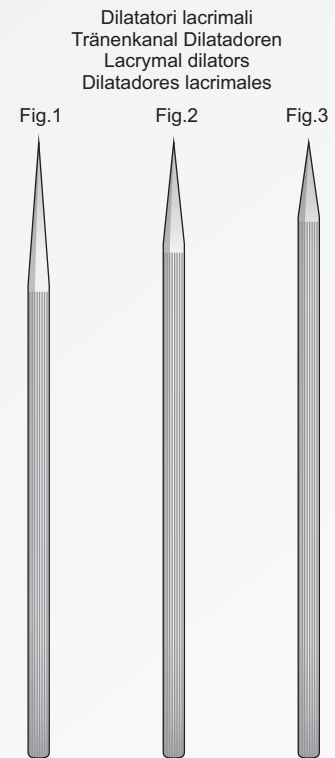

WILDER  
**1310-LH**  
 100 mm

WILDER  
**1310-LI**  
 100 mm

WILDER  
**1310-LL**  
 100 mm

Dilatatori lacimali  
 Tränenkanal Dilatatoren  
 Lacrymal dilators  
 Dilatadores lacrimales

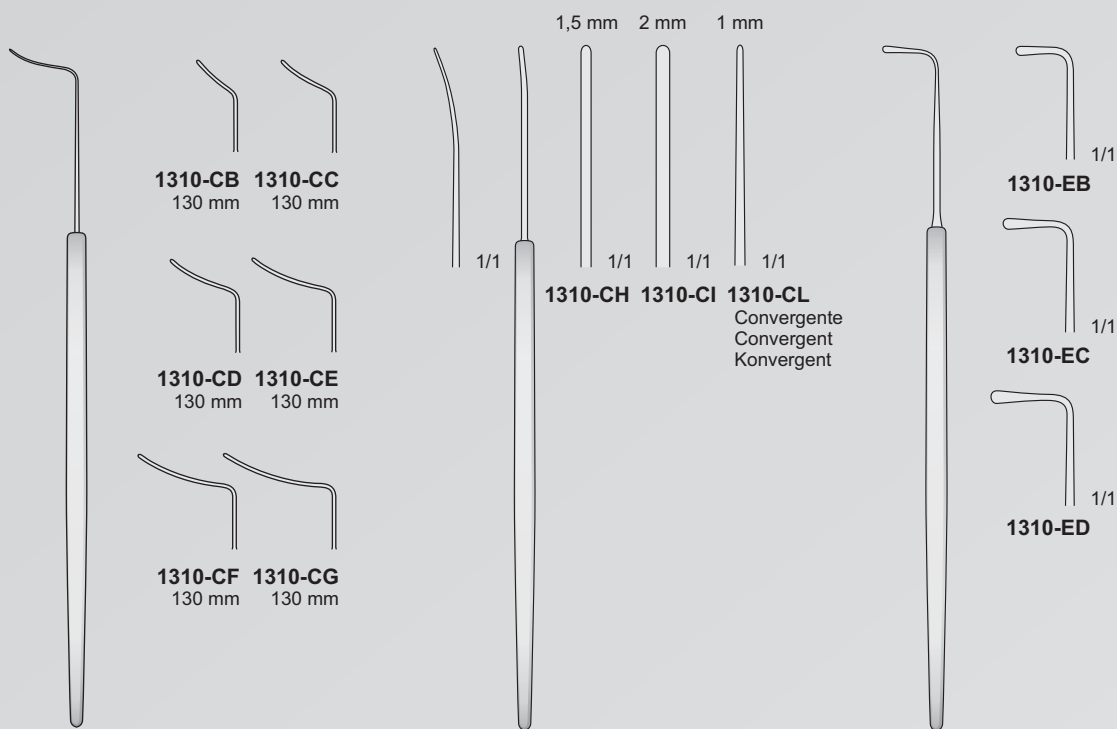

CASTROVIEJO  
 1310-CB/1310-CG

WECKER  
 1310-CH/1310-CL  
 130 mm

GRAEFE  
 1310-EB/1310-ED  
 130 mm

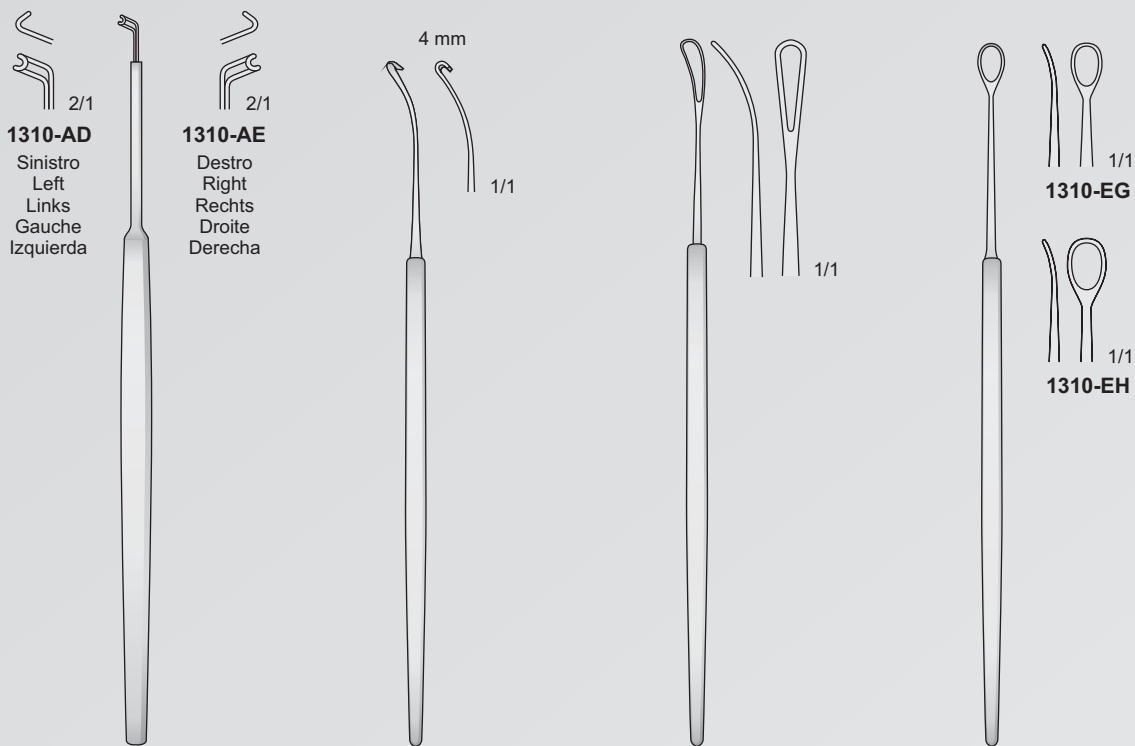

1310-AD/1310-AE  
 140 mm

1310-EE  
 130 mm

SNELLEN  
 1310-EF  
 135 mm

WEBER  
 1310-EG/1310-EH  
 135 mm



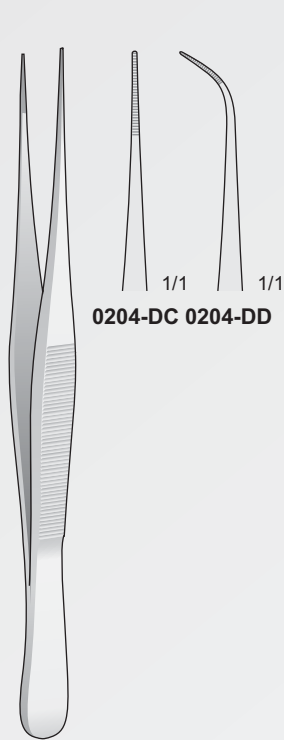

0204-DC 0204-DD

0204-DC/0204-DD  
100 mm

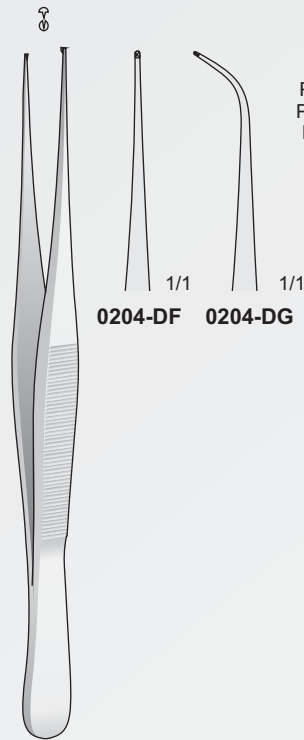

0204-DF 0204-DG

0204-DF/0204-DG  
100 mm

Lidplatte  
 Lid Plate  
 Placca per palpebre  
 Placa para párpados  
 Plaque à paupières



JAEGER  
1412-AL  
110 mm

Okkluder Aluminium  
 Occluder Aluminium  
 Oclusore in Alluminio  
 Ocluser de aluminio  
 Obturateur aluminium

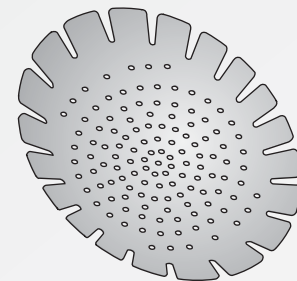

1411-CA  
75 mm

Chalazionpinzetten  
 Chalazion Forceps  
 Pinzette da calazio  
 Pinzas para chalazion  
 Pincès à chalazion

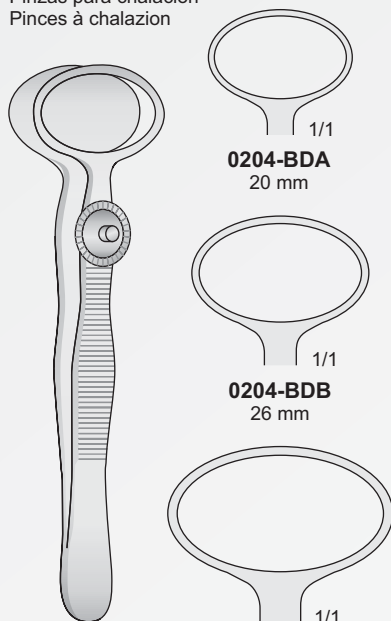

0204-BDA  
20 mm

0204-BDB  
26 mm

0204-BDC  
31 mm

DESMARRES  
0204-BDA/0204-BDC  
90 mm



0204-FG/0204-FL  
100 mm

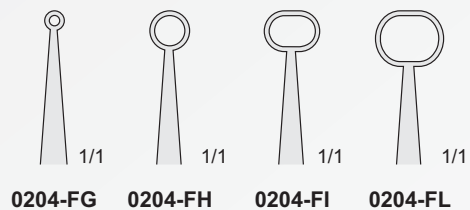

0204-FG 0204-FH 0204-FI 0204-FL

Pinzetten dritte Augenlid  
 Tweezers third eyelid  
 Pinza terza palpebra  
 Pinzas párpado tercero  
 Brucelles troisième paupière

Pinze da Fissazione-oftalmica - Fixier und fasspinzetten  
 Fixation and Grasping forceps - Pinzas de fijación y de aprehensión

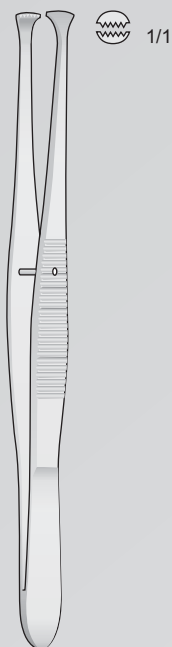

GRAEFE  
**0204-BDF**  
 110 mm

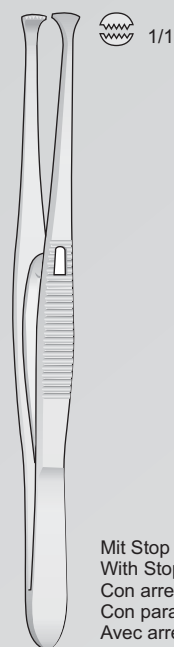

GRAEFE  
**0204-BDG**  
 110 mm

Mit Stop  
 With Stop  
 Con arresto  
 Con parada  
 Avec arret

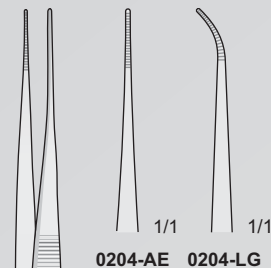

GRAEFE  
**0204-AE/0204-LG**  
 100 mm

Tissue Forceps  
 1x2 Teeth

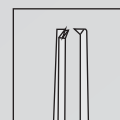

BISHOP-HARMON  
**1206-BHH** 1,2 mm  
 85 mm

Dressing Forceps  
 criss-cross serrated tips

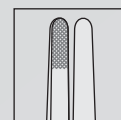

BISHOP-HARMON  
**1206-CEL** 1,2 mm  
 85 mm

Micro Pinzette - Micro Forceps - Mikro Pinzetten - Micro pinces - Pinzas finas

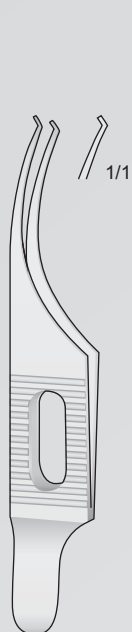

COLIBRI  
**1310-GA**  
 80 mm

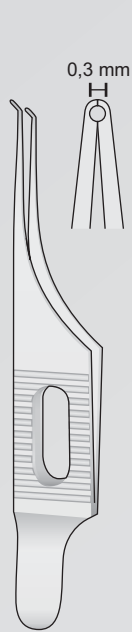

PIERSE  
**1310-GC**  
 80 mm

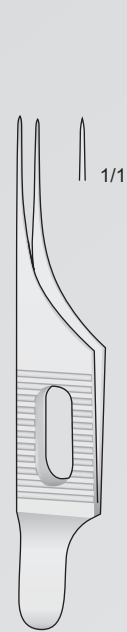

COLIBRI  
**1310-GE**  
 80 mm

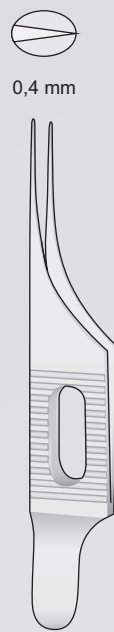

COLIBRI  
**1310-GG**  
 75 mm

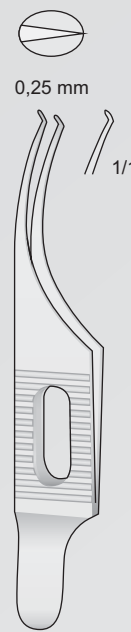

COLIBRI  
**1310-GL**  
 80 mm

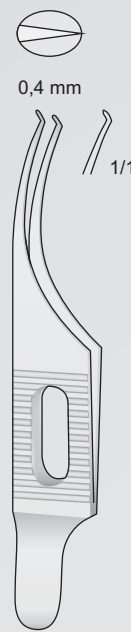

COLIBRI  
**1310-HA**  
 80 mm

Corneal Fixation Forceps  
 1x1 Pierce teeth of 0.1 mm

Mit Fadenplatte  
 With tying platform  
 Con piano prendifilo  
 Con plataforma  
 Avec plateau pour monofil

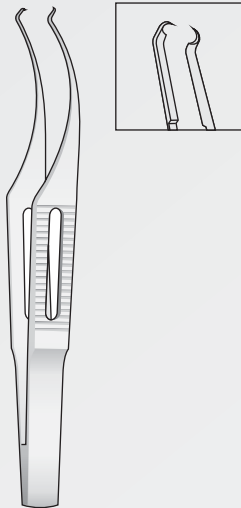

COLIBRI  
**1206-BHC**  
 83 mm

Corneal Suturing Forceps  
 1x2 Teeth of 0.12 mm, 45°

Mit Fadenplatte  
 With tying platform  
 Con piano prendifilo  
 Con plataforma  
 Avec plateau pour monofil

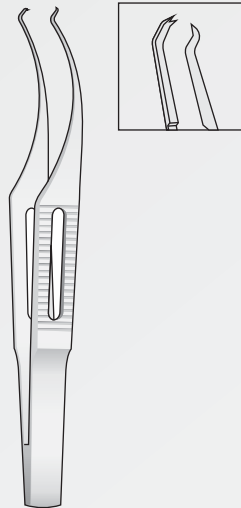

COLIBRI  
**1206-BHD**  
 83 mm

Corneal Utility Forceps  
 1x2 teeth set at 90°, smooth

Ohne Fadenplatte  
 Jaws without platform  
 Senza piano prendifilo  
 Sin plataforma  
 Sans plateaux

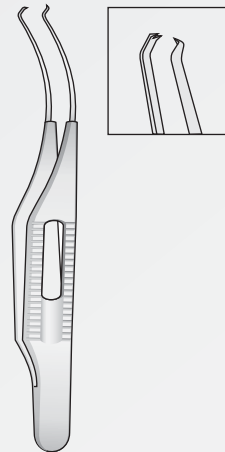

BARRAQUER  
**1310-EAB**  
 75 mm

Corneal Suturing Forceps  
 1x2 teeth set at 90°, smooth

Mit Fadenplatte  
 With tying platform  
 Con piano prendifilo  
 Con plataforma  
 Avec plateau pour monofil

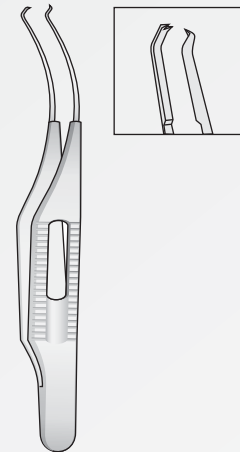

BARRAQUER  
**1310-EAD**  
 75 mm

Pinzetta serrafili con solo  
 piano prendifilo fine  
 Tying Forceps  
 delicate 5 mm long platform  
 for 7-0 to 9-0 sutures

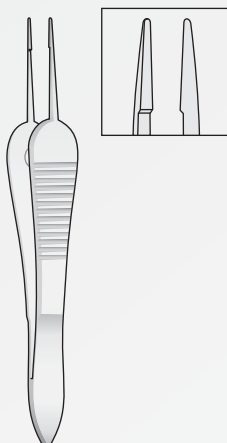

St.MARTIN  
**1206-CAA**  
 85 mm

Tying & Utility Forceps  
 standard 7 mm long platform  
 for sutures below 7-0

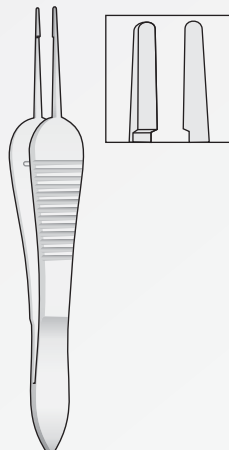

PAUFIQUE  
**1206-CAB**  
 88 mm

Suturing Forceps  
 1x2 teeth of 0,3 mm set at 45°  
 with delicate platform

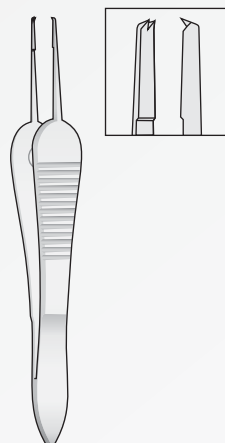

St.MARTIN  
**1206-CAF**  
 85 mm

Allzweck Pinzette  
 mit Fadenplatte  
 Universal Suturing Forceps  
 1x2 teeth of 0,7 mm set at 45°  
 with heavy platform

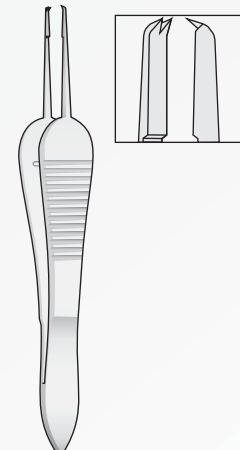

PAUFIQUE  
**1206-CAG**  
 88 mm

Cilien Pinzetten  
 Cilia Forceps  
 Pinzette depilatorie  
 Pinzas depilatoria  
 Pincas à cils

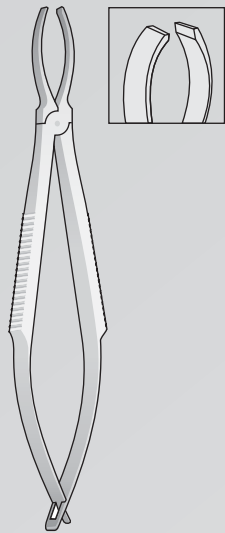

**GRADLE**  
**0604-BDB**  
 95 mm

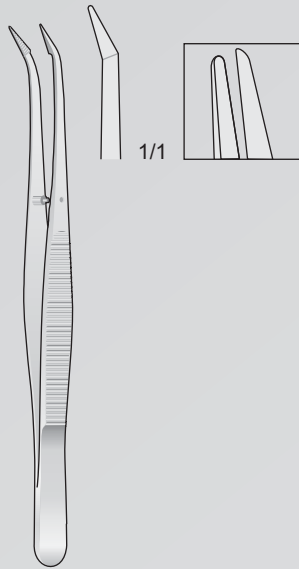

**BARRAQUER**  
**0518-GF**  
 105 mm

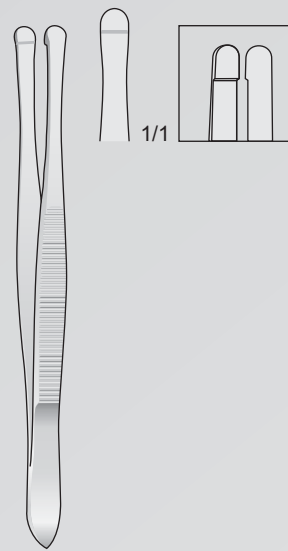

**BEER**  
**0518-EI**  
 90 mm

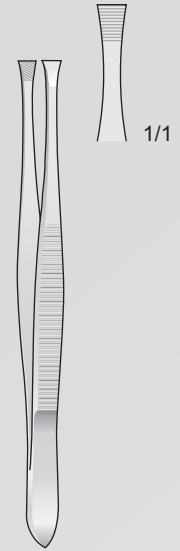

**LITTAUER**  
**0518-GE**  
 85 mm

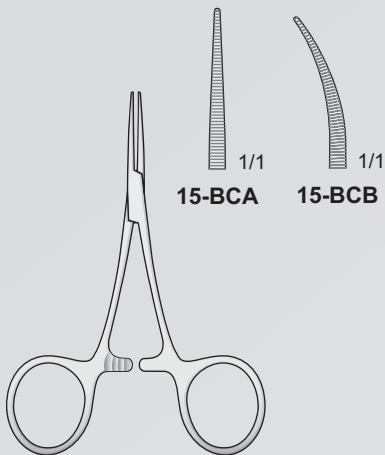

**HARTMANN-BABY-MOSQUITO**  
**15-BCA/15-BCB**  
 95 mm

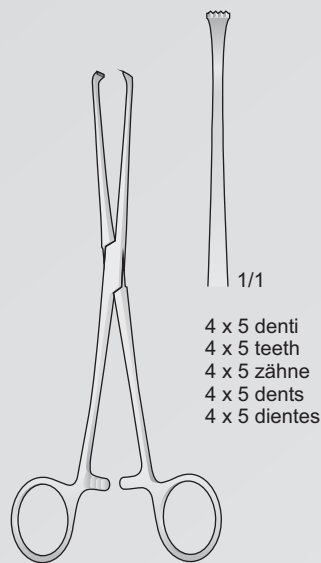

**BABY-ALLIS**  
**15-BAA**  
 130 mm

4 x 5 denti  
 4 x 5 teeth  
 4 x 5 zähne  
 4 x 5 dents  
 4 x 5 dientes



**0202-EG**  
 135 mm



**1102-DGB**  
 Conf. 10 pz.



**1102-DGE**  
 Conf. 10 pz.



**1102-DGF**  
 Conf. 10 pz.



**1102-DGH**  
 Conf. 10 pz.

Strumenti per aspirazione e lavaggio  
Aspirating and Irrigating instruments  
Saug- und Spülinstrumente  
Instruments à aspiration et à irrigation  
Instrumentos de aspiración y de lavado

Lagerungsgestell für 15 Stück Nadeln  
Rack for 15 needles  
Piastra per 15 aghi oftalmici  
150 x 100 x 2 mm

Comparative lachrymal probes scale

Fig.	0000	000	00	0	1	2
Ø in mm.	0.5	0.6	0.7	0.8	0.9	1.1

Fig.	3	4	5	6	7	8
Ø in mm.	1.3	1.4	1.5	1.6	1.8	1.9



**BOWMAN**  
**1506-DA** 00/0    **1506-DE** 5 /G  
**1506-DB** 1 /2    **1506-DF** 7 /I  
**1506-DD** 3 /4    **1506-DG** 6 /H

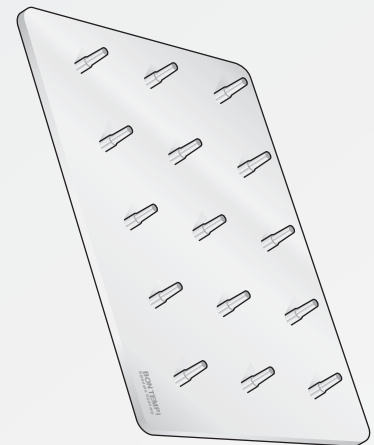
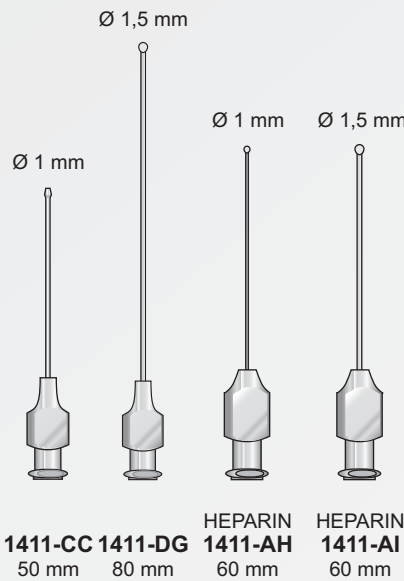

**0218-CA**  
150 x 100 x 2 mm

Spülkanülen  
Irrigating cannulas  
Cannule di irrigazione  
Cánulas de irrigación  
Canules d'irrigation

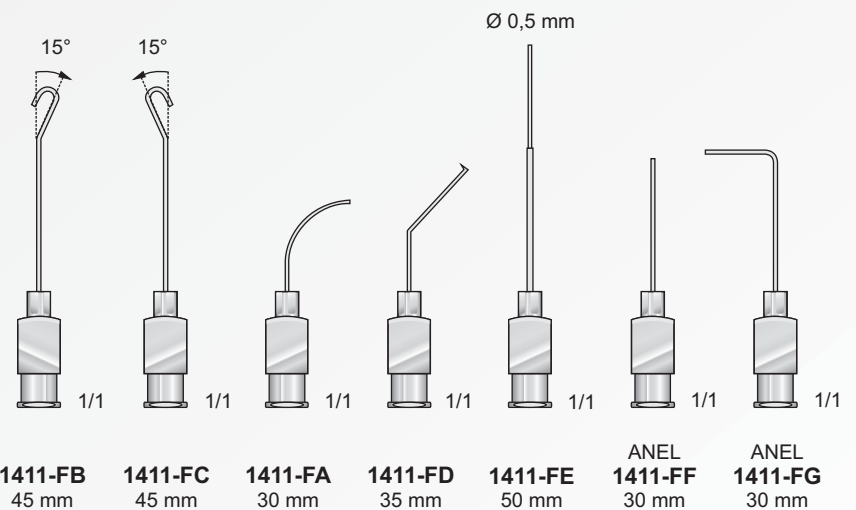

Meßbereich: 0 - 15 mm  
 Measuring range: 0 - 15 mm  
 Campo di misura: 0 - 15 mm  
 Alcance de medición: 0 - 15 mm  
 Etendue de mesure: 0 - 15 mm

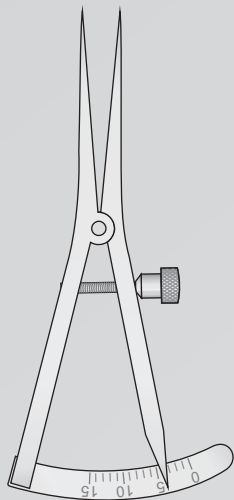

**CASTROVIEJO  
 1417-BF  
 90 mm**

Meßbereich: 0 - 20 mm  
 Measuring range: 0 - 20 mm  
 Campo di misura: 0 - 20 mm  
 Alcance de medición: 0 - 20 mm  
 Etendue de mesure: 0 - 20 mm

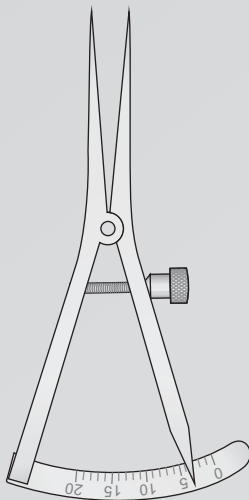

**CASTROVIEJO  
 1417-BH  
 90 mm**

Meßbereich: 0 - 20 mm  
 Measuring range: 0 - 20 mm  
 Campo di misura: 0 - 20 mm  
 Alcance de medición: 0 - 20 mm  
 Etendue de mesure: 0 - 20 mm

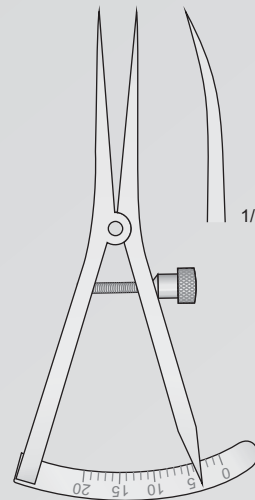

**CASTROVIEJO  
 1417-BL  
 90 mm**

Meßbereich: 0 - 40 mm  
 Measuring range: 0 - 40 mm  
 Campo di misura: 0 - 40 mm  
 Alcance de medición: 0 - 40 mm  
 Etendue de mesure: 0 - 40 mm

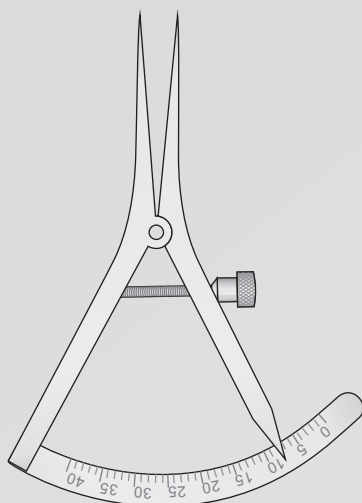

**CASTROVIEJO  
 1417-BB  
 90 mm**

Meßbereich: 0 - 40 mm  
 Measuring range: 0 - 40 mm  
 Campo di misura: 0 - 40 mm  
 Alcance de medición: 0 - 40 mm  
 Etendue de mesure: 0 - 40 mm

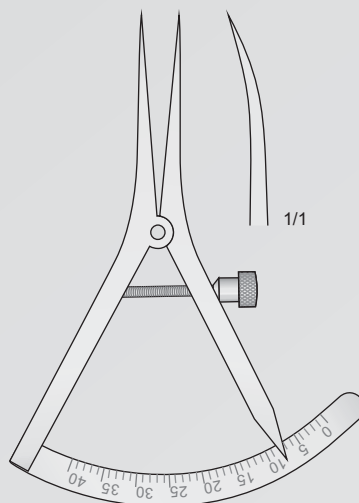

**CASTROVIEJO  
 1417-BD  
 90 mm**

0,5 mm

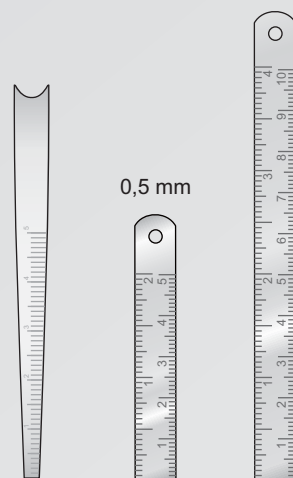

**1118-AE  
 80 mm**

**1118-AH  
 50 mm**

**1118-AI  
 100 mm**

Lidsperrer, Wundsperrer  
 Eye Speculums, Retractors  
 Blefarostati, Divaricatori  
 Blefarostatos, Separador  
 Blépharostats, Ecarteurs

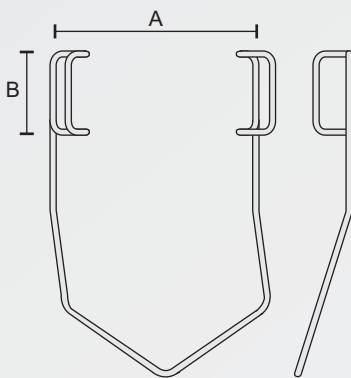

A B  
**1310-HL** 27 mm 11 mm  
 BARRAQUER

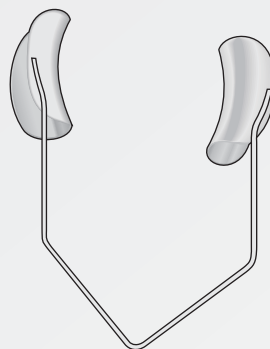

BARRAQUER  
**1310-ID**

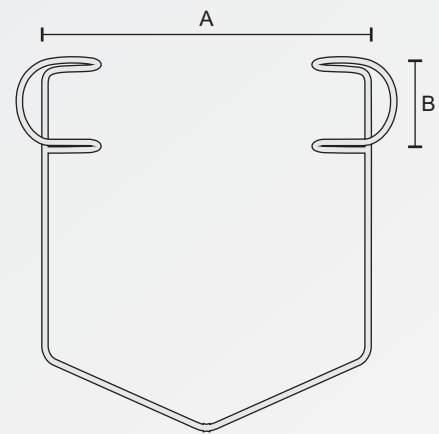

A B  
**1310-IA** 27 mm 5 mm  
**1310-IC** 34 mm 9 mm  
**1310-IE** 42 mm 12 mm  
**1310-IG** 42 mm 14 mm  
 BARRAQUER

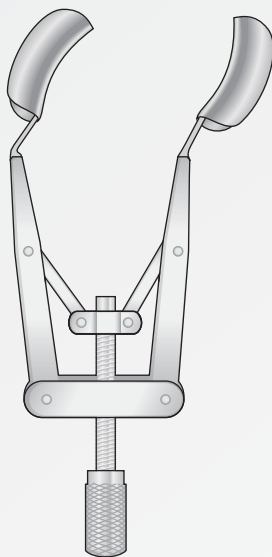

KERSHNER  
**1310-ECA**

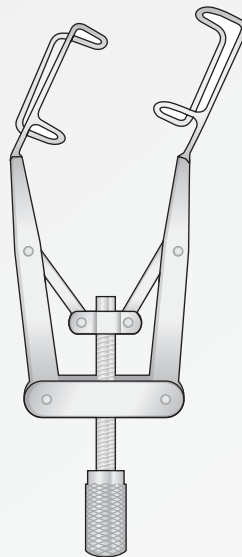

KERSHNER  
**1310-ECB**

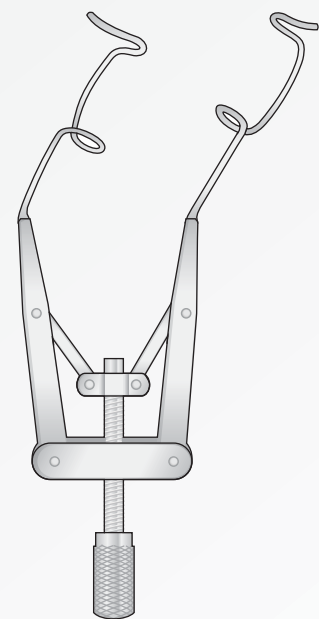

LIEBERMANN-TENNANT  
**1310-ECC**

Lidsperrer  
 Eye Speculums  
 Blefarostati  
 Blefarostatos  
 Blépharostats

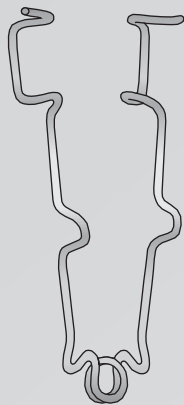

**BOWMANN**  
**1310-BAG**  
 70 mm

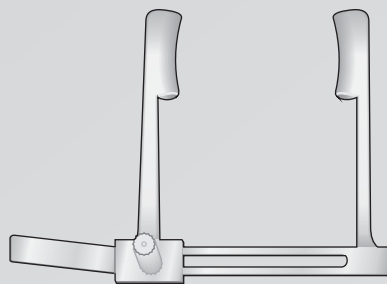

**PROST**  
**1310-LC**

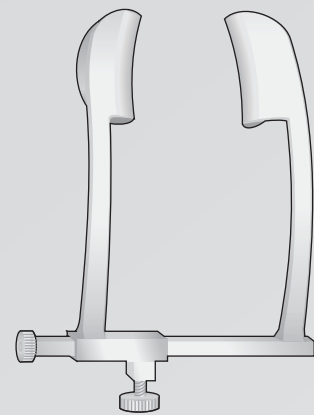

**COOK**  
**1310-BDB**

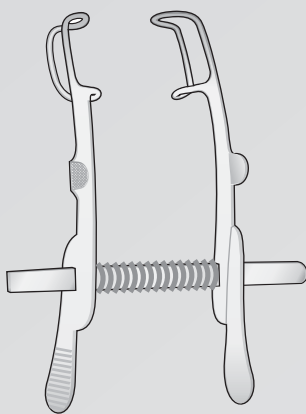

**MELLINGER**  
**0221-AC**  
 70 mm

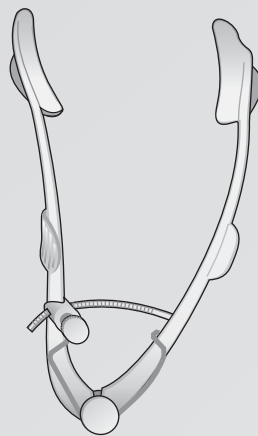

**LISTER-BURCH**  
**0221-AE**  
 80 mm

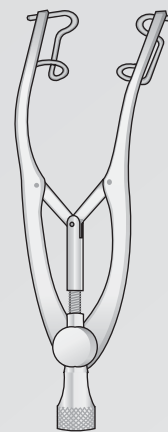

**CASTROVIEJO**  
**0221-AF**  
 80 mm

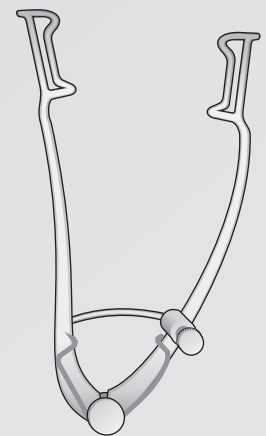

**WILLIAMS**  
**0221-AG**  
 80 mm



Set für Augenheilkunde  
 Set for Ophthalmology  
 Set per Oftalmologia  
 Set para Oftalmología  
 Fixée pour Ophtalmologie

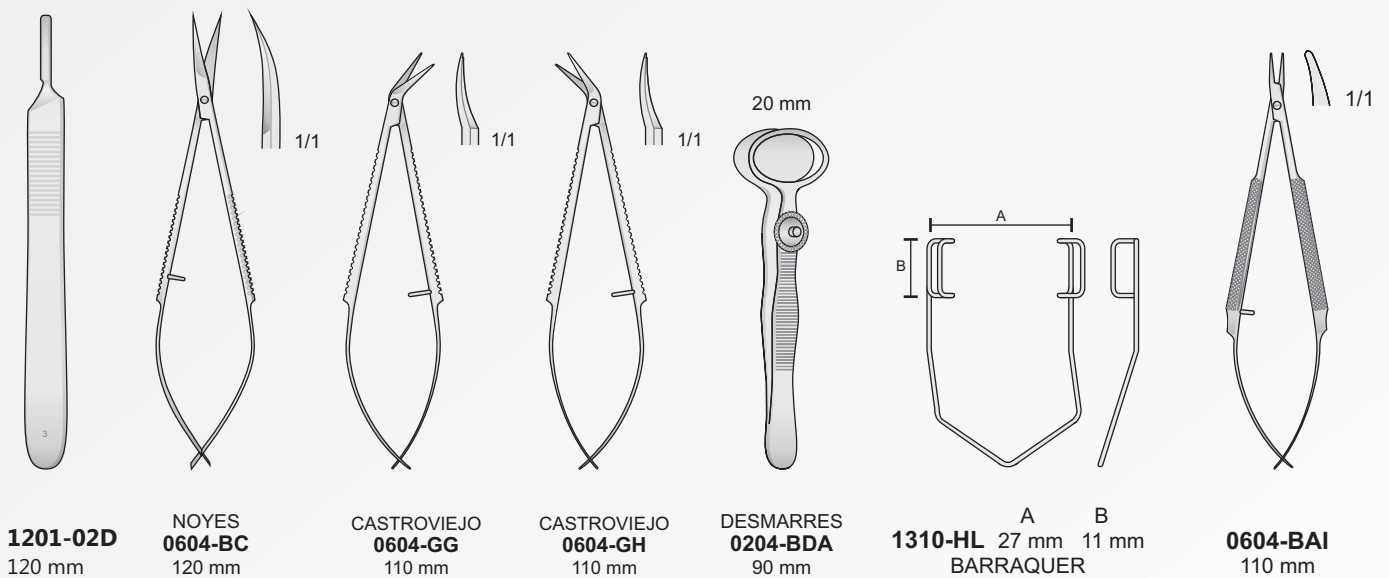
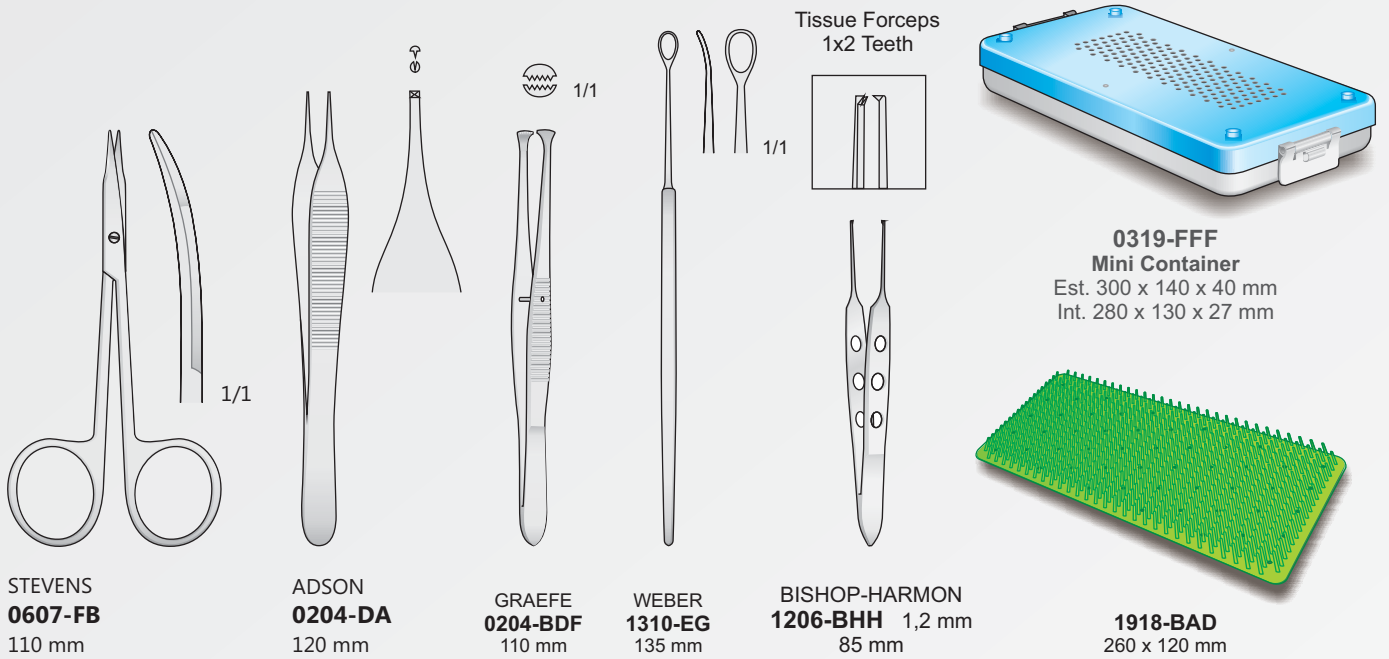





 ideal-tek

Sonden, Entdeckern, Watterträger und Absaugkanülen  
Probes, Directors, Cotton Applicators, Suctions tubes  
Sonde, Specilli, Porta cotone e Cannule per aspirazione  
Sondas, Estiletos, Portaalgodòn, Cànulas aspiradoras  
Sondes, Stylets, Porte coton, Canules aspiratrices



Ø 1 mm    Ø 1,5 mm    Ø 2 mm    Ø 2 mm    Ø 1,5 mm    Ø 1,0 mm



Tränenkanal-Sonden  
Lachrymal Probes  
Sonde per canale lacrimale  
Estiletos para canal lacrimal  
Stylets pour canal lacrimal

Silber  
Silver  
Argento  
Plata  
Argent

**1506-CA** 145 mm    **1506-DC** 130 mm    **1506-CH** 145 mm    **1506-DG** 130 mm    **1506-H** 145 mm  
**1506-CB** 160 mm    **1506-CC** 145 mm    **1506-CD** 160 mm    **1506-BF** 145 mm  
**1506-CF** 160 mm    **1506-CI** 200 mm    **1506-CL** 160 mm  
**1506-CG** 200 mm    **1506-EE** 250 mm    **1506-DI** 200 mm

STACKE  
**1506-BE**  
110 mm

BOWMAN  
**1506-DA** 00/0    **1506-DE** 5/G  
**1506-DB** 1/C    **1506-DF** 7/I  
**1506-DD** 3/E    **1506-DG** 6/H

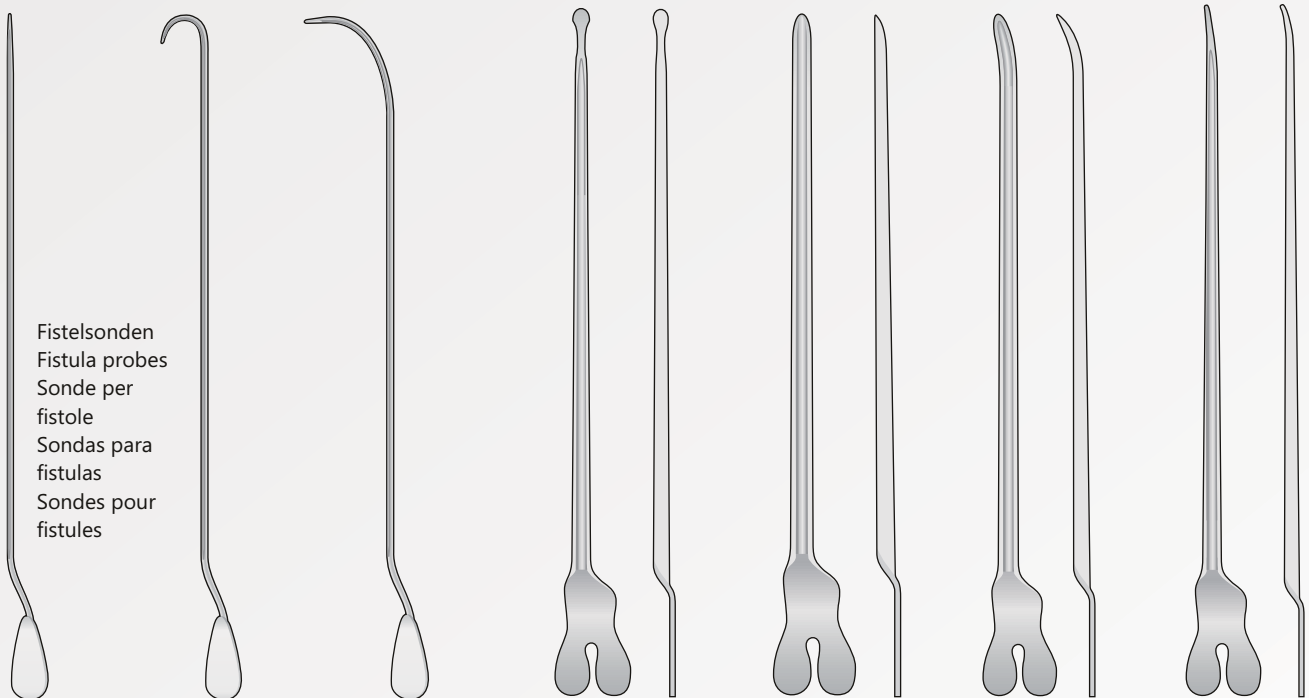

Fistelsonden  
Fistula probes  
Sonde per fistole  
Sondas para fistulas  
Sondes pour fistules

LOCHART  
**1506-IA**  
170 mm

LOCHART  
**1506-IC**  
170 mm

LOCHART  
**1506-ID**  
170 mm

Hohlsonde  
**1506-FE** 145 mm    **1506-FD** 130 mm  
**1506-FF** 160 mm    **1506-FH** 145 mm  
**1506-BL** 180 mm    **1506-FI** 160 mm  
**1506-FG** 200 mm    **1506-FL** 180 mm

DOYEN  
**1506-CE**  
145 mm

NELATON  
**1506-BH**  
160 mm

Watterträger  
Cotton applicators  
Porta cotone  
Portaalgodòn  
Porte cotons

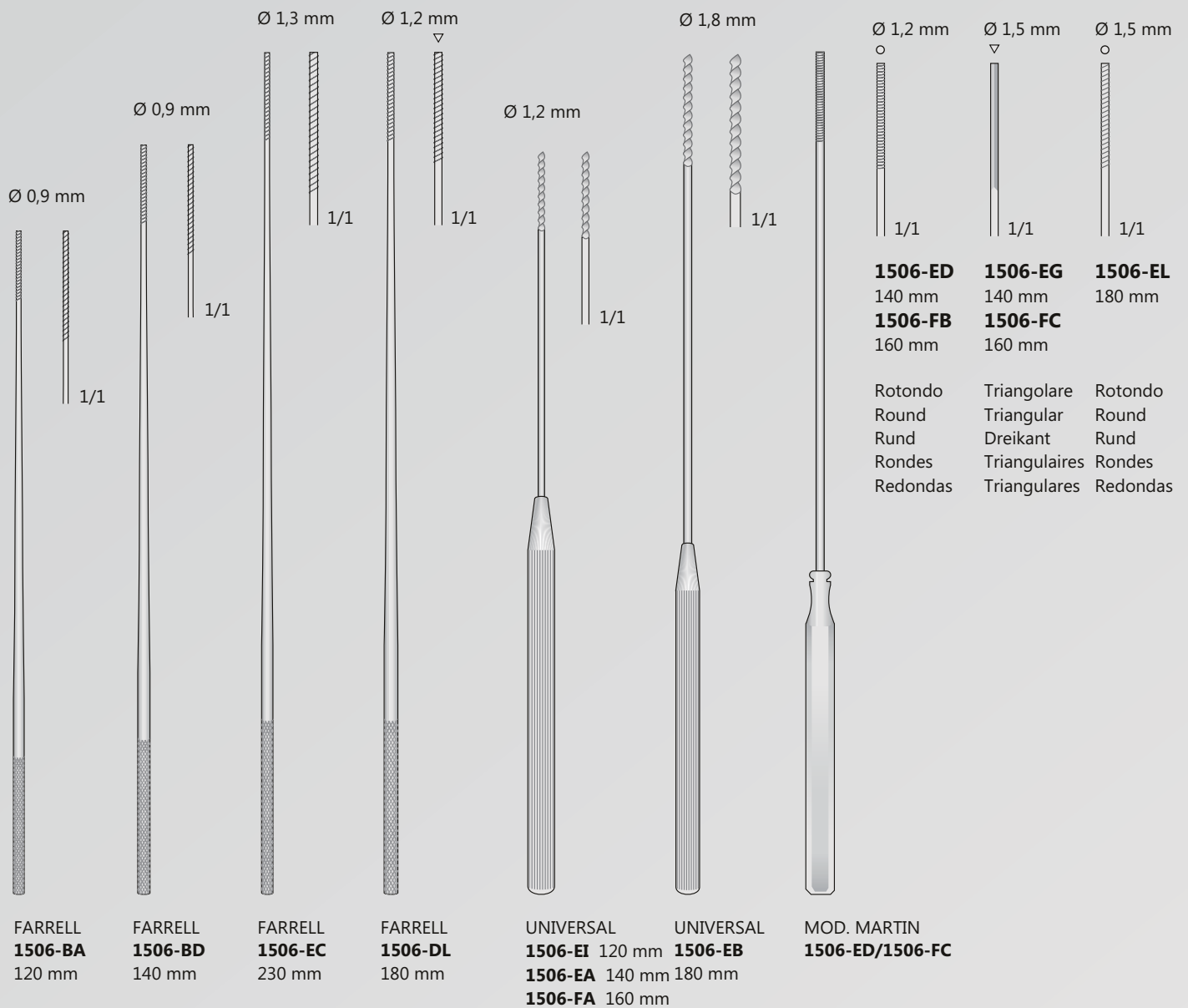

Spülkanülen  
Irrigation Cannulae  
Cannule per irrigazione  
Cànulas para irrigaciòn  
Canules d'irrigation

Absaugkanülen  
Suctions tubes  
Cannule per aspirazione  
Cànulas aspiradoras  
Canules aspiratrices

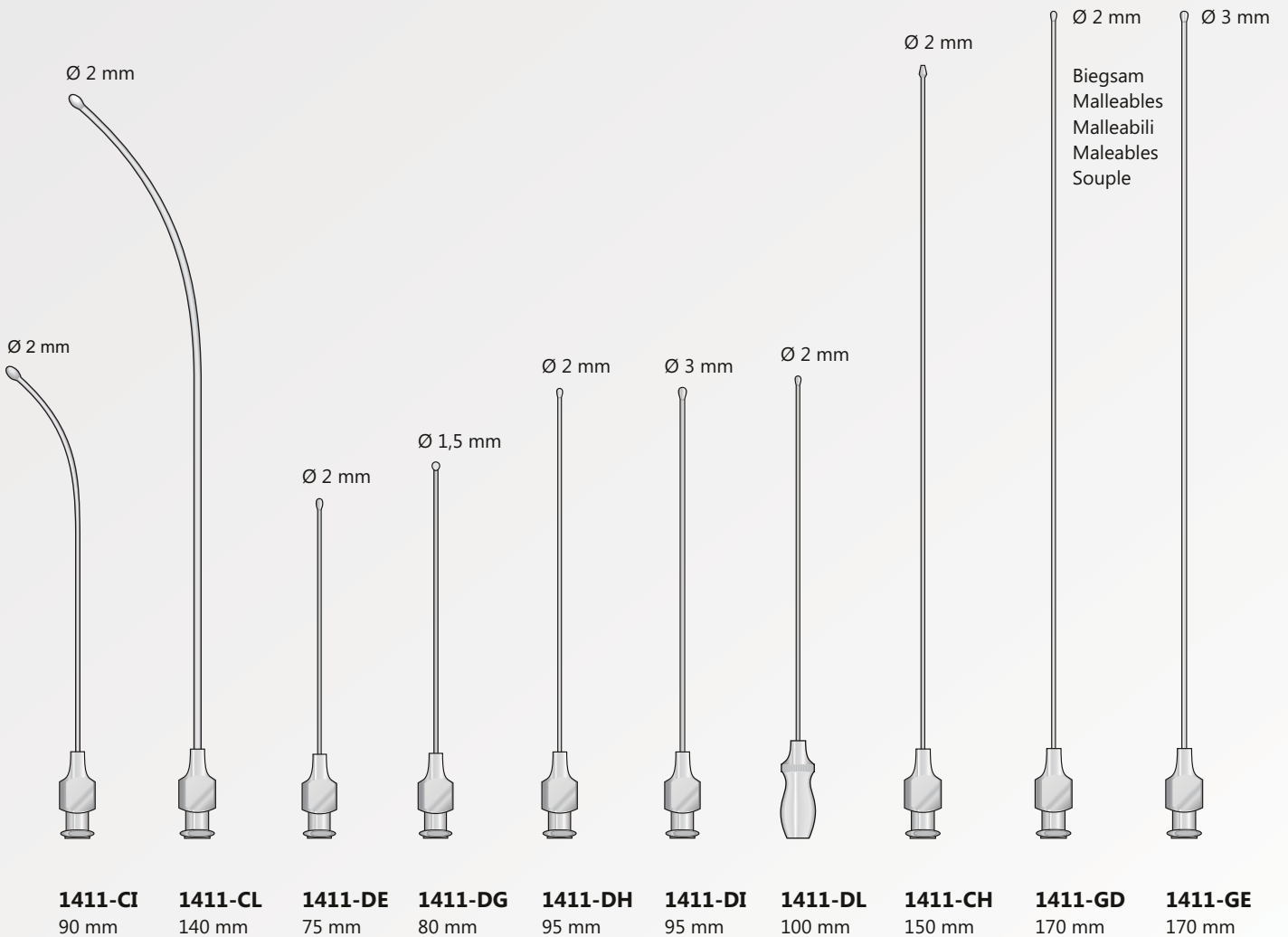
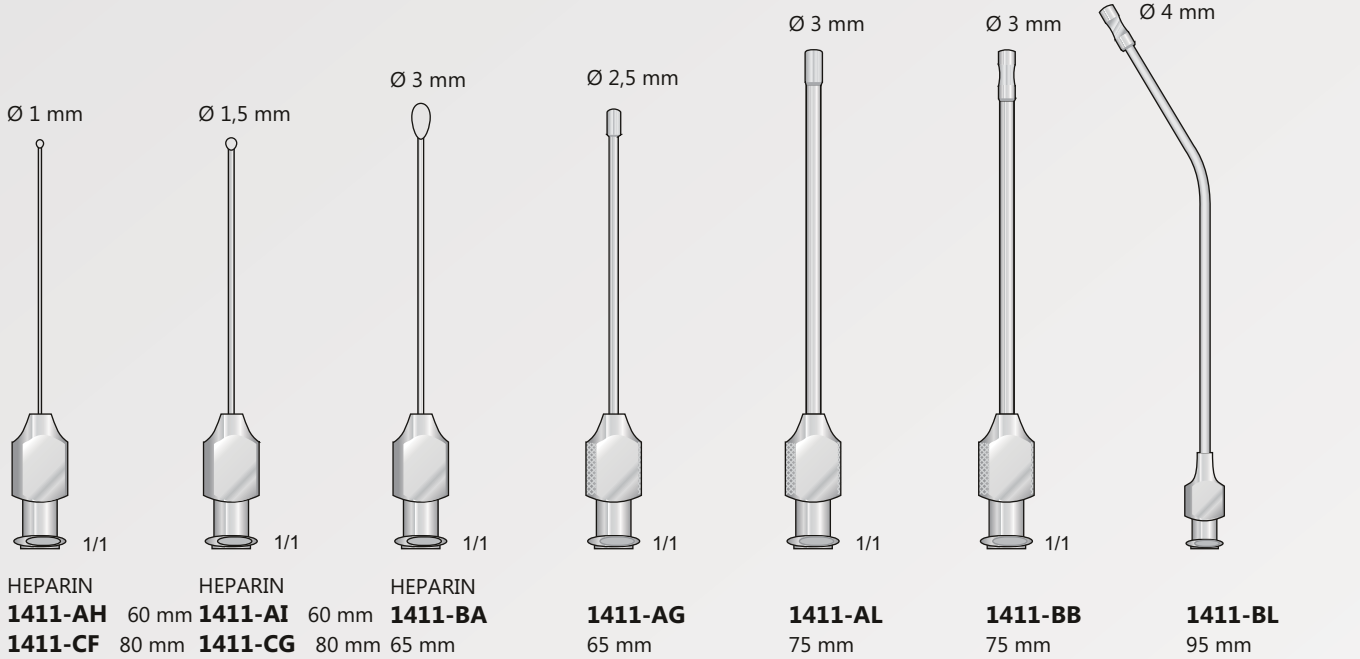

Absaugkanülen

Suctions tubes

Cannule per aspirazione

Cànulas aspiradoras

Canules aspiratrices

Spülkanülen

Irrigation Cannulae

Cannule per irrigazione

Cànulas para irrigación

Canules d'irrigation

WULLSTEIN Spül- und Saughandgriff mit Luer-Konus, passend für WULLSTEIN Spül- oder Saugrohre  
 WULLSTEIN Irrigating suction handle, with Luer cone, for WULLSTEIN irrigating or Suction tubes  
 WULLSTEIN manico per aspirazione e lavaggio, con cono Luer, per cannule per aspirazione e lavaggio di WULLSTEIN  
 WULLSTEIN mango irrigador y ispirador, con cono Luer, apropiado para los tubos de lavado y de aspiración según WULLSTEIN  
 WULLSTEIN manche aspirateur et irrigateur, à cône Luer, s'adaptant aux tubes aspirateurs/irrigateurs de WULLSTEIN



WULLSTEIN  
**0706-GE**  
120 mm



**0706-GG**  
110 mm



**0706-GC**  
65 mm

Mit LUER-LOCK-Ansatz  
 With LUER-LOCK attachment  
 Con cono LUER-LOCK  
 Con cono LUER-LOCK  
 Avec cône LUER-LOCK



ROSEN  
**1411-BG** Ø 0,70 mm  
**1411-BH** Ø 0,90 mm  
**1411-BI** Ø 1,25 mm  
95 mm



ROSEN  
**1411-BD** Ø 0,70 mm  
**1411-BE** Ø 0,90 mm  
**1411-BF** Ø 1,25 mm  
95 mm

Saug- und Spülinstrumente  
 Aspirating and Irrigating instruments  
 Strumenti per aspirazione e lavaggio  
 Instrumentos de aspiración y de lavado  
 Instruments à aspiration et à irrigation

Ø 1 mm

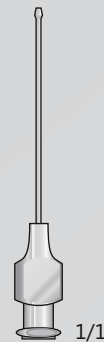

**1411-CC**  
50 mm

Ø 2 mm

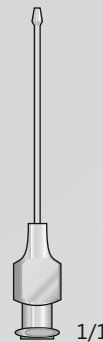

**1411-CD**  
50 mm

Ø 3 mm

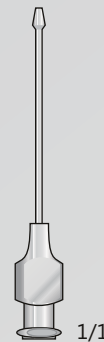

**1411-CE**  
50 mm

Gefäß-spülkanülen, biegsam  
 Vessel irrigating cannulas, malleable  
 Cannule per irrigazione dei vasi, malleabili  
 Cànulas de irrigacion para vasos, maleables  
 Canules d'irrigation pour vaisseaux, malléables

Ø 3 mm



SCHMID  
**1411-DA**  
150 mm

Ø 4 mm



SCHMID  
**1411-DB**  
150 mm

Ø 5 mm



SCHMID  
**1411-DC**  
150 mm

Ø 6 mm



SCHMID  
**1411-DD**  
150 mm



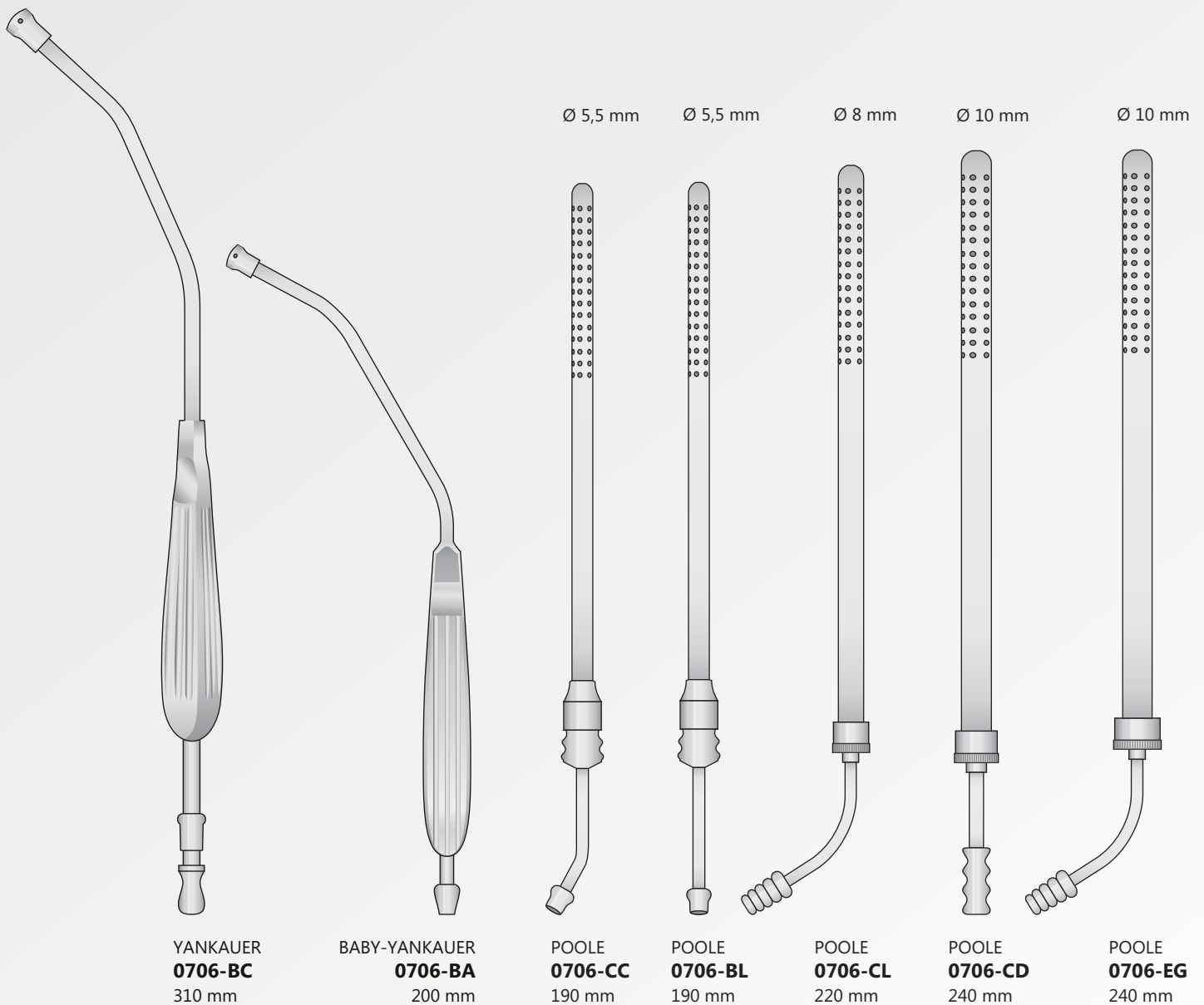

Absaugkanülen  
 Suctions tubes  
 Cannule per aspirazione  
 Cánulas aspiradoras  
 Canules aspiratrices

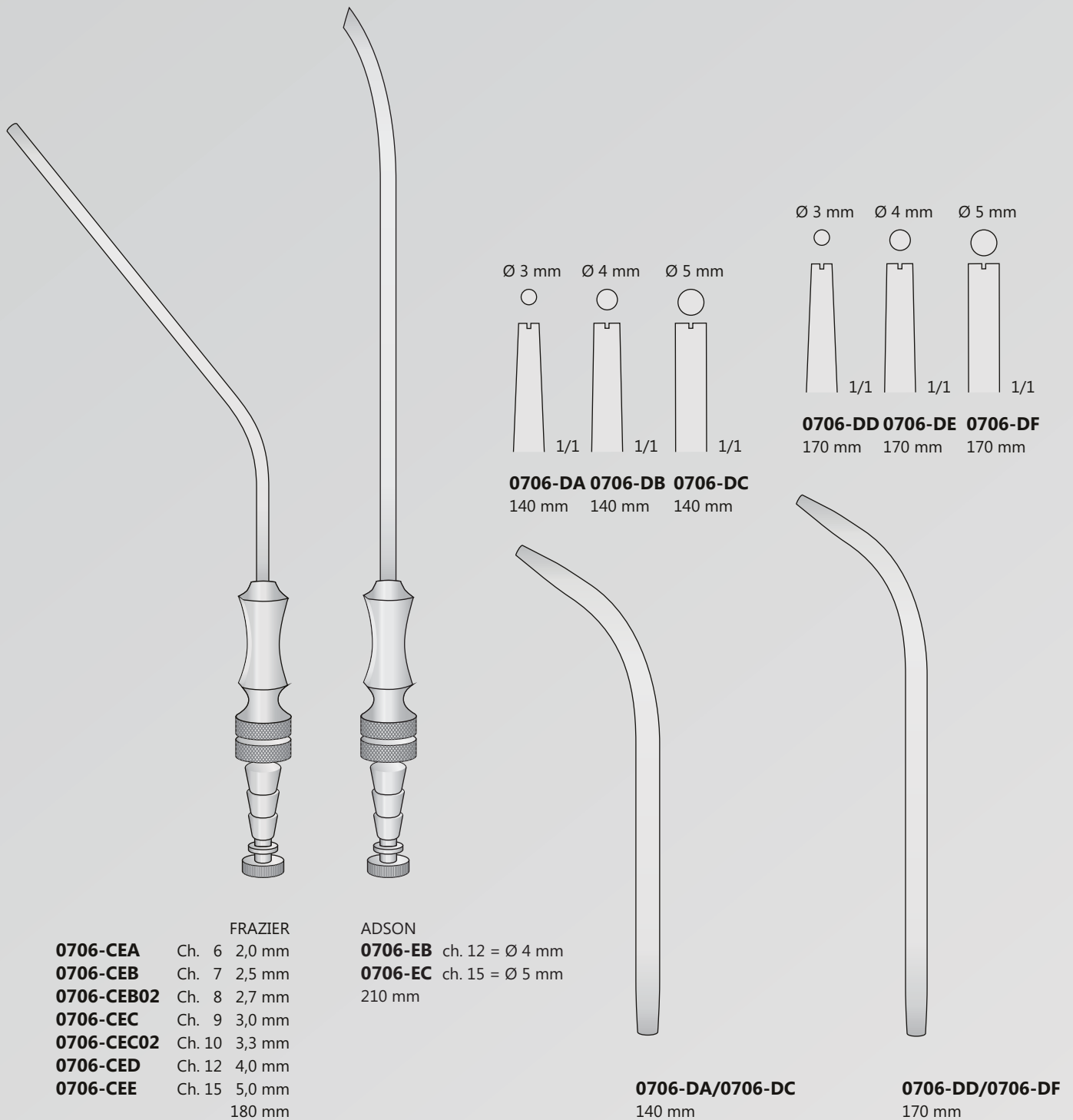

Tubo per aspirazione  
Suction tube  
Saugrohr  
Tube d'aspiration

Tubo per irrigazione  
Irrigation tube  
Spülrohr  
Tube d'irrigation

Char. 3	= 1 mm
Char 5	= 1,7 mm
Char 7	= 2,5 mm
Char 10	= 3,3 mm
Char 12	= 4 mm
Char 14	= 4,6 mm

Char. 2	= 0,6 mm
Char 4	= 1,21 mm
Char 5	= 1,7 mm
Char 7	= 2,5 mm
Char 8	= 2,4 mm
Char 12	= 4 mm

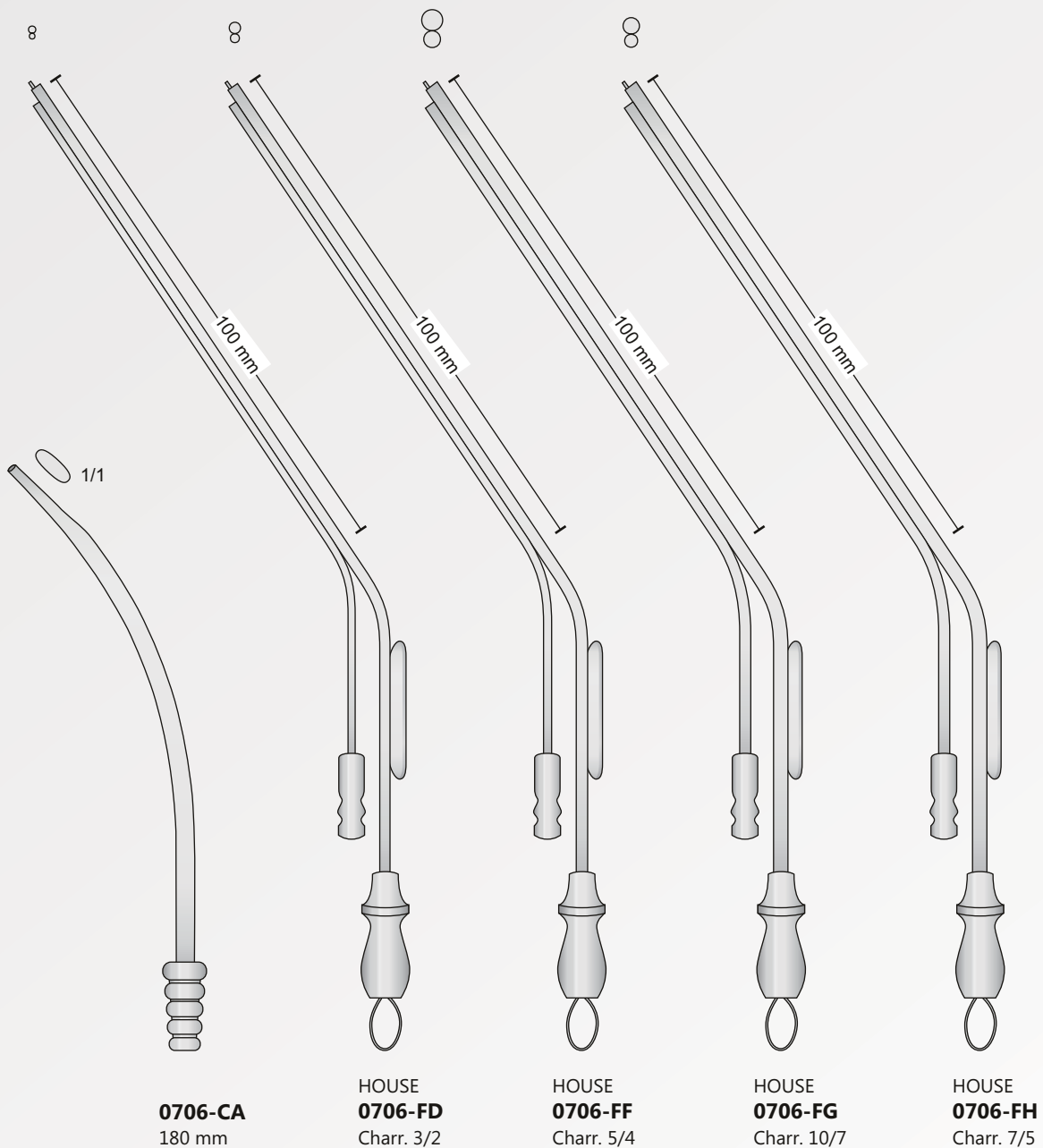





 ideal-tek

Urologie, Gynäkologie  
Urology, Gynecology  
Urologia e Ginecologia  
Urologia, Ginecologia  
Urologie, Gynécologie



Rektal und Vaginal-Spekula für Kleintiere  
 Specula for small animals for Vaginal and Rectal Examination  
 Specoli vaginali e rettali per piccoli animali  
 Rectal y vaginal espéculos para animales pequeños  
 Rectale et vaginale Spéculums pour petits animaux

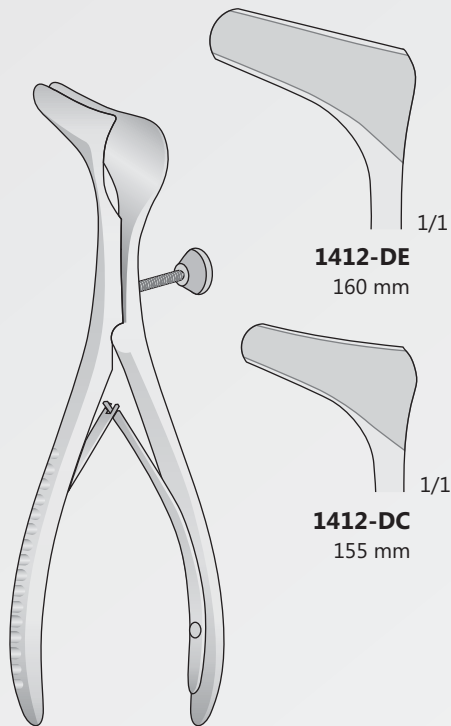

HARTMANN  
**1412-DC/1412-DE**

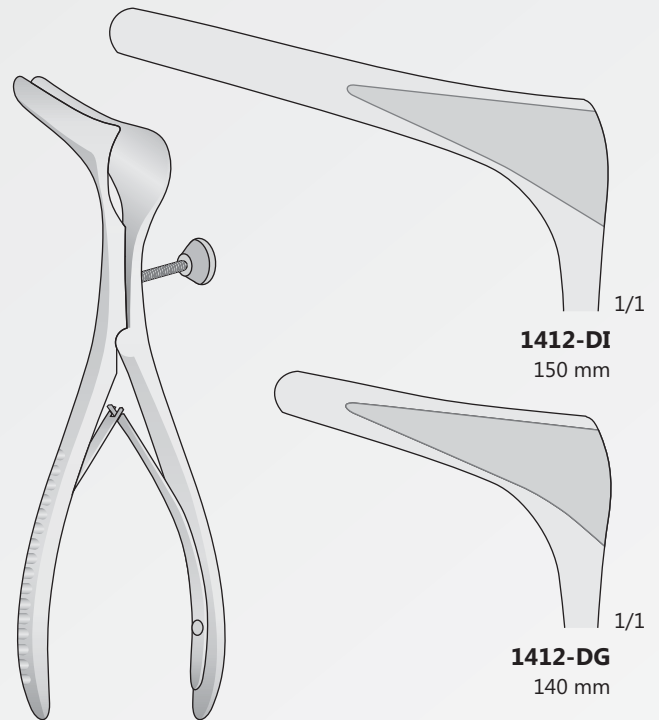

KILLIAN  
**1412-DG/1412-DI**

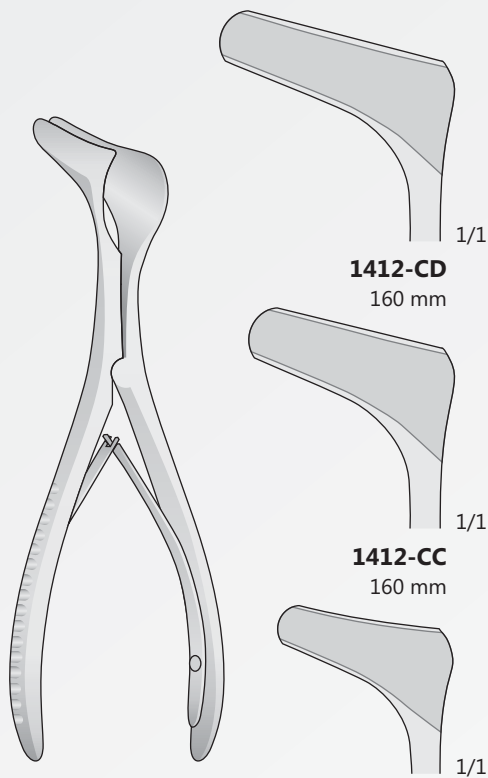

HARTMANN  
**1412-CA/1412-CD**

**1412-CA**  
 155 mm

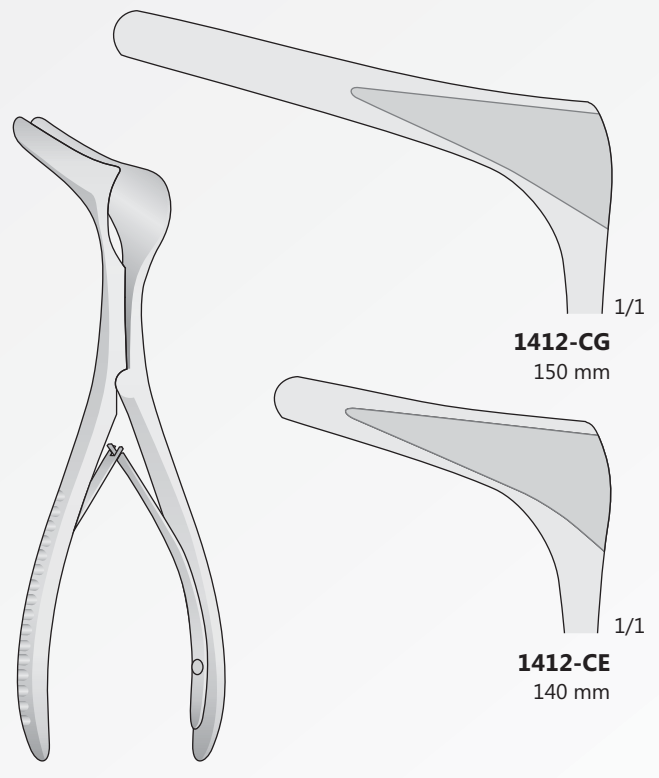

KILLIAN  
**1412-CE/1412-CG**

**1412-CE**  
 140 mm

Rektal und Vaginal-Spekula für Kleintiere  
 Specula for small animals for Vaginal and Rectal Examination  
 Specoli vaginali e rettali per piccoli animali  
 Rectal y vaginal espéculos para animales pequeños  
 Rectale et vaginale Spéculums pour petits animaux

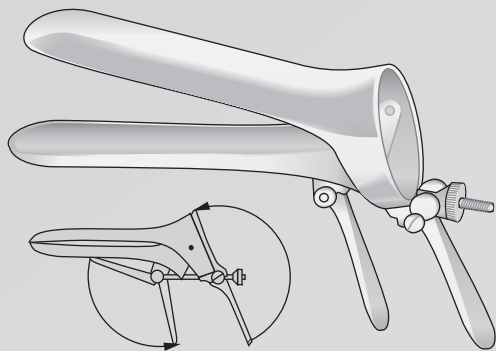

CUSCO  
**0517-EL** Fig.0 77x17 mm

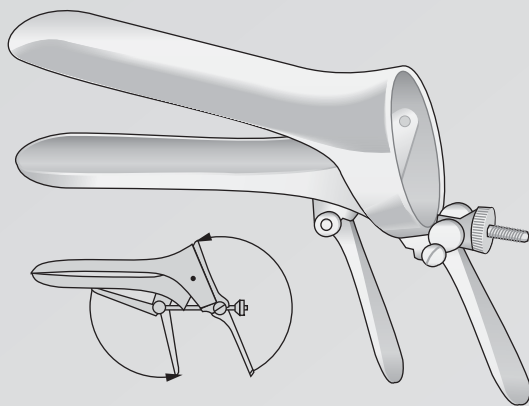

CUSCO  
 SCHWEIZER MODELL  
**0517-GB** Fig.1 90x23 mm  
**0517-GC** Fig.2 100x24 mm  
**0517-GD** Fig.3 105x27 mm

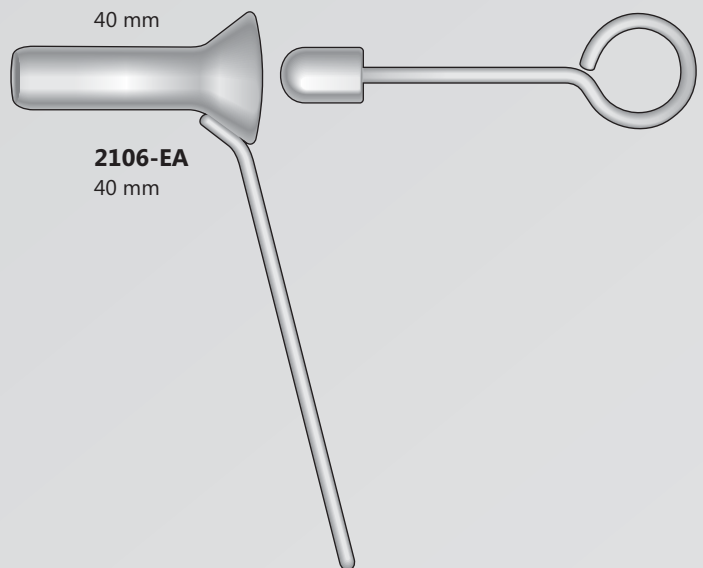

40 mm  
**2106-EA**  
 40 mm

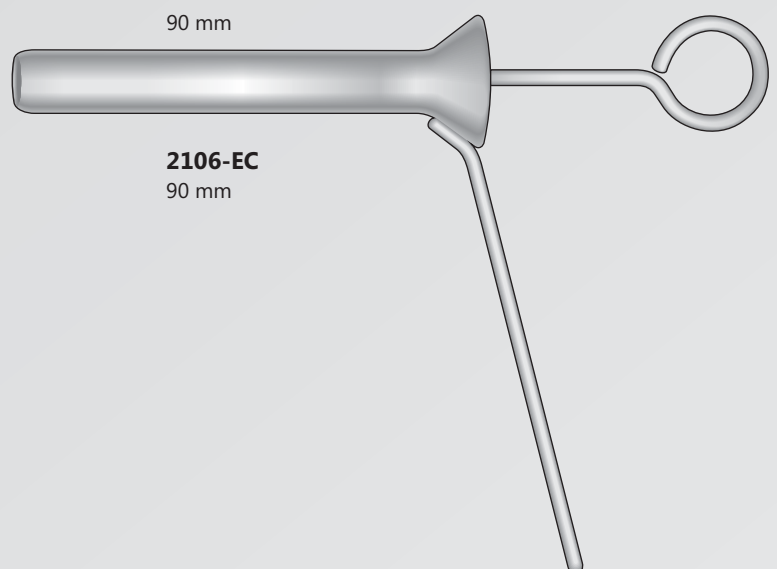

90 mm  
**2106-EC**  
 90 mm



<b>0501-GA</b>	8	Charrière Ø 2,7 mm
<b>0501-GC</b>	10	Charrière Ø 3,3 mm
<b>0501-GD</b>	12	Charrière Ø 4,0 mm
<b>0501-GE</b>	14	Charrière Ø 4,7 mm
<b>0501-GF</b>	16	Charrière Ø 5,3 mm
<b>0501-GG</b>	18	Charrière Ø 6,0 mm
<b>0501-GH</b>	20	Charrière Ø 6,7 mm



<b>0501-HA</b>	6	Charrière Ø 2,0 mm
<b>0501-HC</b>	8	Charrière Ø 2,7 mm
<b>0501-HE</b>	10	Charrière Ø 3,3 mm
<b>0501-HG</b>	12	Charrière Ø 4,0 mm
<b>0501-HH</b>	14	Charrière Ø 4,7 mm
<b>0501-HI</b>	16	Charrière Ø 5,3 mm
<b>0501-HL</b>	18	Charrière Ø 6,0 mm



Ø 2,0 mm  
 Ø 3,0 mm



Ø 2,0 mm  
 Ø 3,0 mm



Ø 4,0 mm



Ø 5,0 mm

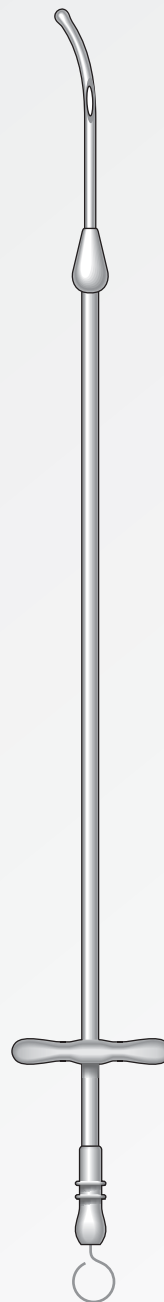

Ø 5,0 mm



Ø 11,0 mm

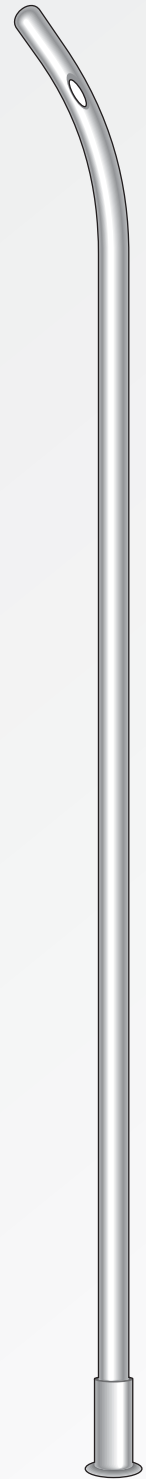

**0501-GA/0501-GH**  
 290 mm

**0501-HA/0501-HL**  
 160 mm

MUNGILATTE  
**2106-BDC** Ø 2 mm  
**2106-BDD** Ø 3 mm  
 100 mm

FÜRSTENBERG  
**2106-BBH** Ø 2 mm  
**2106-BCD** Ø 3 mm  
 100 mm

**2106-BBC**  
 440 mm

**2106-BBD**  
 440 mm

**2106-BBE**  
 420 mm

**2106-BBA**  
 550 mm

Strickanalschere  
Teat Sittng Scissors  
Forbice a doppio taglio  
Tijera de doble filo  
Ciseaux à double tranchant

Sterilisierhaken für Katzen  
Spayhook for Cats  
Uncini per sterilizzazione gatte  
Ganchos esterilizantes para gatos  
Crochets de stérilisation pour chats

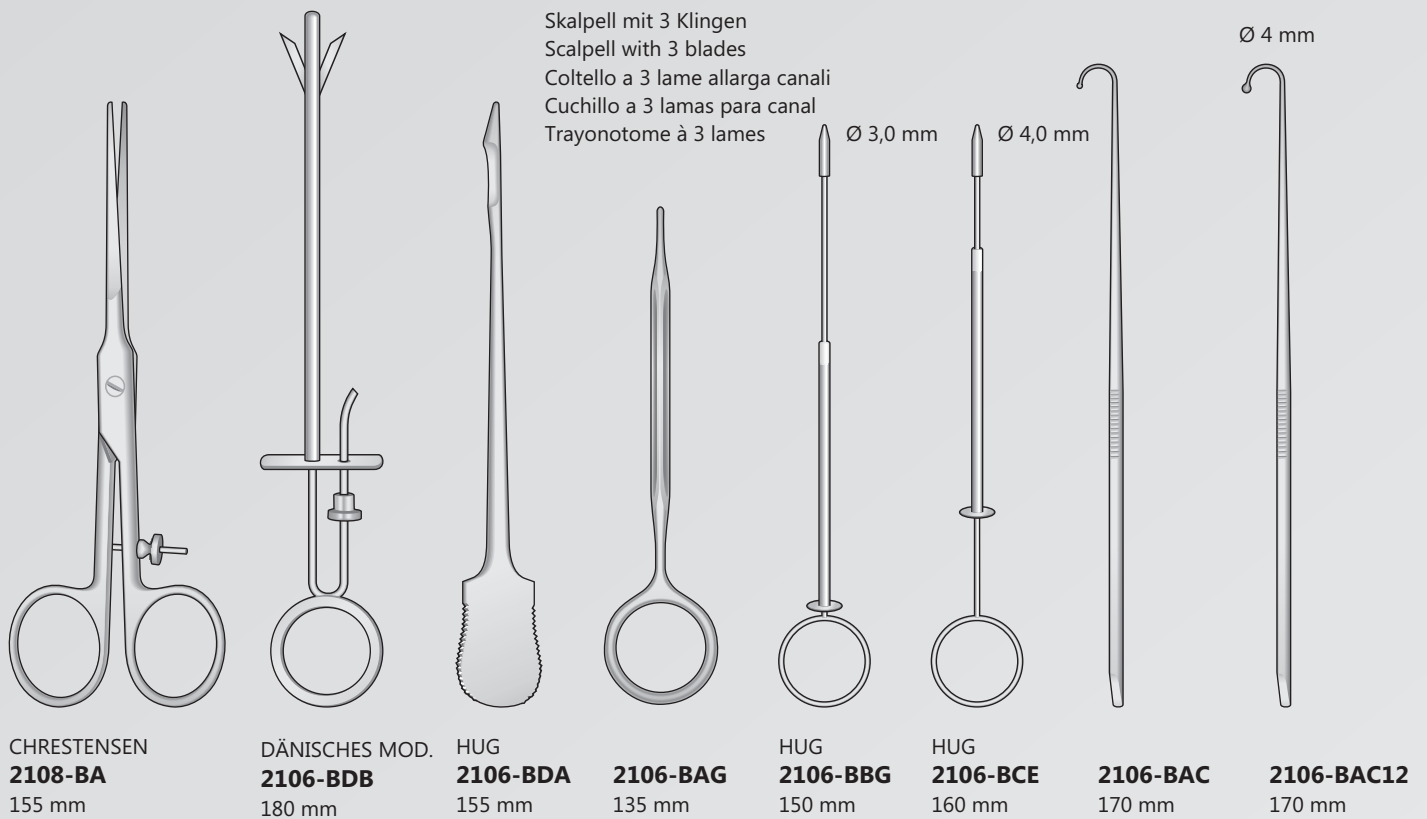



 ideal-tek

Erhaltung für Instrumente, Steril-Container  
Maintening of instruments, Sterilizing Containers  
Mantenimento strumentario, Bacinelle e Box per Sterilizzazione  
Mantenimiento del instrumental, Contenedores para esterilización  
Nettoyage de l'instruments, Containers pour stérilizer



Kanülenreinigungs-bürsten  
 Cleaning brush for tubes  
 Scovolini per pulizia cannule  
 Cepillo para limpiar cánulas  
 Brosse de nettoyage pour canules

Special Gummi für Metal  
 Special Rubber for Metal  
 Gomme speciali per metalli  
 Caucho especial para metales  
 Caoutchouc spécial pour métal

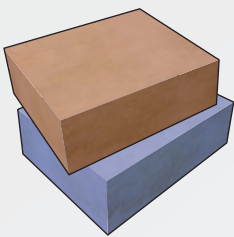

<b>0402-AH</b>	<b>0402-AI</b>
50 x 40 x 20 mm	50 x 40 x 20 mm
Fein - Fine	Größ - Large
Grana Fine	Grana grossa
Finas - Fin	Grande - Large

Sterilisier bar	Handwaschbürste
Autoclavable	Nail brushes
Autoclavabile	Spazzola per unghie
Esterilizable	Cepillos de uñas
Stérilisable	Brosse à ongles

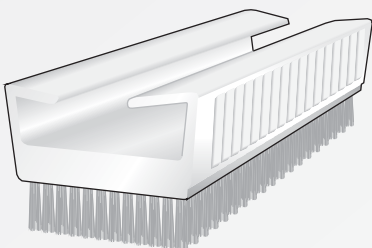

**0706-CAA**  
 4 x 11 cm

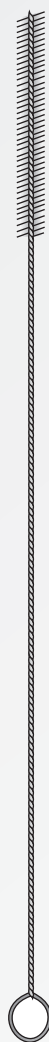

**0706-EA**  
 235 mm



**0706-BII**  
 220 mm

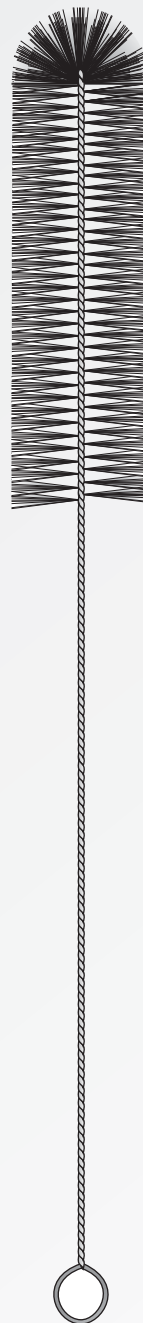

**0706-BIH**  
 300 mm

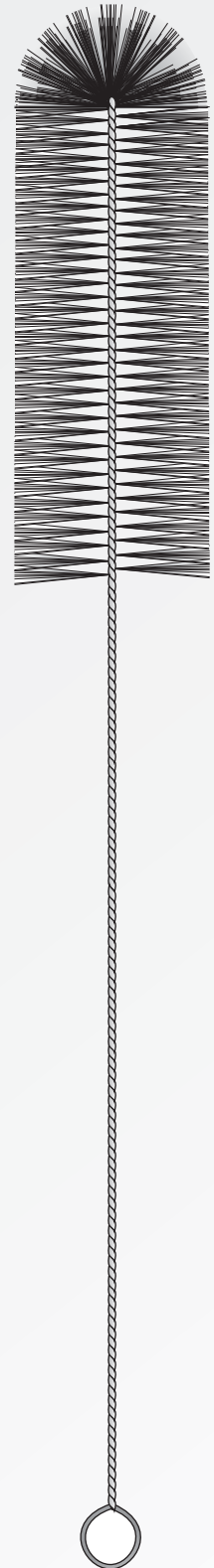

**0706-BIL**  
 360 mm

Erhaltung für instrumente  
 Maintaining of instruments  
 Mantenimento dello strumentario  
 Mantenimiento del instrumental  
 Nettoyage d'instruments

Wasserlösliche Schmiermittel  
 von chirurgische Instrumenten  
 Lubrificant Oil for surgical instruments  
 Olio lubrificante per strumenti chirurgici  
 Lubrificante para instrumentos  
 Entretien pour instruments

**0402-141117**  
 50 cc



**RODHOIL**

Schmiermittel mit hoher Dichte. Es sichert den perfekten Gebrauch und die Leichtgängigkeit aller chirurgischen Instrumente. Man gibt es auf die Verbindungen und Gelenke in alle beweglichen Teile, die Reibungen unterworfen sind.

**RODHOIL**

Lubrificant to high density. It assures the perfect utility and fluency of all the surgical instruments. For apply in to loosens, join and in all the parts in subject movement subject to attrition.

**RODHOIL**

Lubrificante ad alta densità. Assicura la perfetta funzionalità e scorrevolezza di tutti gli strumenti chirurgici. Da applicare negli snodi, giunture e in tutte le parti in movimento soggette ad attrito.

Das wasserlösliche Schmiermittel verlängert die Lebensdauer von chirurgische Instrumenten  
 Soluble lubricant extends useful life of surgical instruments  
 Lubrificante anticorrosivo e detergente per strumenti chirurgici  
 Lubrificante soluble en agua, so uso prolonga la duraciòn de los instrumentos quirùrgicos  
 Lubrifiant soluble dans l'eau prolonge la vie des instruments chirurgicaux

**0402-FA12**  
 500 cc

**0402-B11**  
 1000 cc



**CLEANLACT**

Reinigungskonzentrat für chirurgische Instrumente. Es wirkt antibakteriell, nicht-ätzend und schmierig. Es garantiert die perfekte Erhaltung aller Instrumente aus Stahl, entfernt eventuelle Flecken, Ränder, und Bräunungen von Sterilisationen, Desinfektionen und Reinigungen mit hartem Wasser. Es sollte regelmäßig verwendet werden.

**CLEANLACT**

Product concentrated for surgical instruments. It explains an action anti-corrosive, antibacterium and lubricant. It guarantees the perfect maintenance of all the instruments in steel eliminating eventual stains and burnishes to sterilization, disinfection and to washings with hard waters. It used periodically.

**CLEANLACT**

Prodotto concentrato per strumenti chirurgici. Esplica un azione anticorrosiva batteriostatica e lubrificante. Garantisce il perfetto mantenimento di tutti gli strumenti in acciaio eliminando eventuali macchie, aloni e bruniture dovute a sterilizzazioni, disinfezioni e a lavaggi con acque dure. Va usato periodicamente.

*Original Arkansas*

Arkansas Schleifsteine  
Arkansas Sharpening Stone  
Pietre di Arkansas per affilatura strumenti  
Materiales de Arkansas para afilar  
Pierres d'affutage de Arkansas

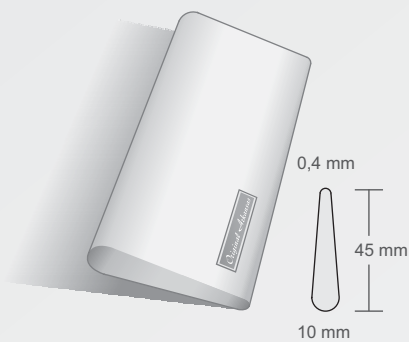

**0402-G01**  
ARKANSAS n°6A  
100 mm



**0402-D**  
INDIA n°6  
100 mm



**0402-CLL**  
ARKANSAS  
conica n° 299  
90 mm



**0402-E**  
ARKANSAS n°4  
100 mm

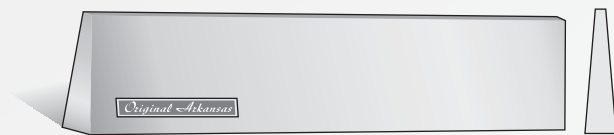

**0402-CC01**  
ARKANSAS



**0402-LG**  
ARKANSAS n°8  
100 x 50 x 13 mm



**0402-1411**  
30 cc

Schleifstein-Öl  
Oil for grinding stones  
Olio per affilatura strumenti  
Huile d'affutage

Sterilisierzangen zum Fassen und Halten Steriler Instrumente  
 Sterilizing forceps for picking up and holding of sterile instruments  
 Pinze per prelevare strumenti sterilizzati  
 Pinzas para esterilización  
 Pinces pour instruments stérilisés



**0718-AC**  
145 mm

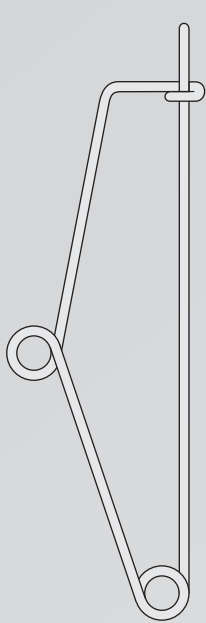

MAYO  
**0718-AB**  
140 mm

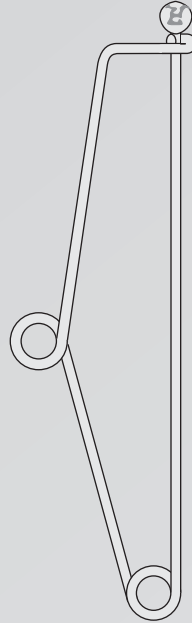

MAYO  
**0718-AH**  
140 mm

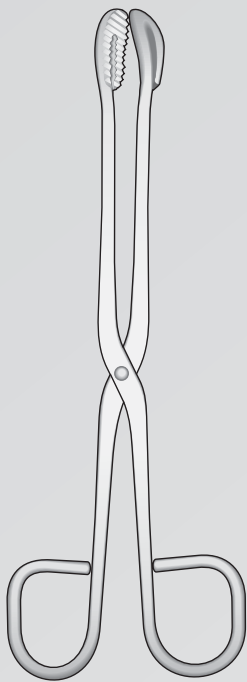

**0718-BD** 200 mm  
**0718-BE** 300 mm

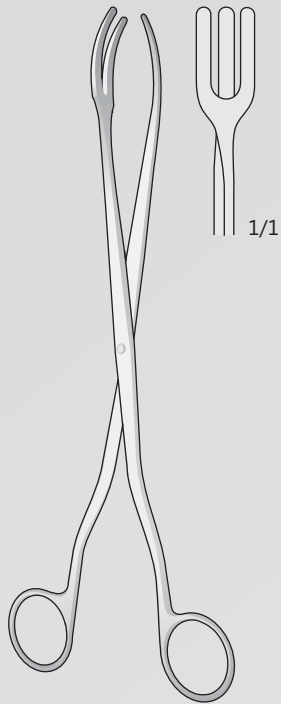

**0718-BA**  
200 mm

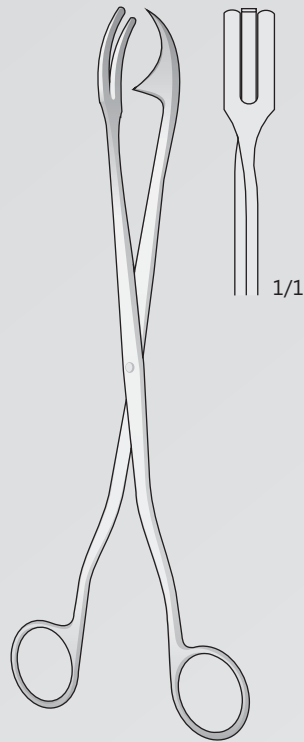

ROGGE  
**0718-AG**  
230 mm

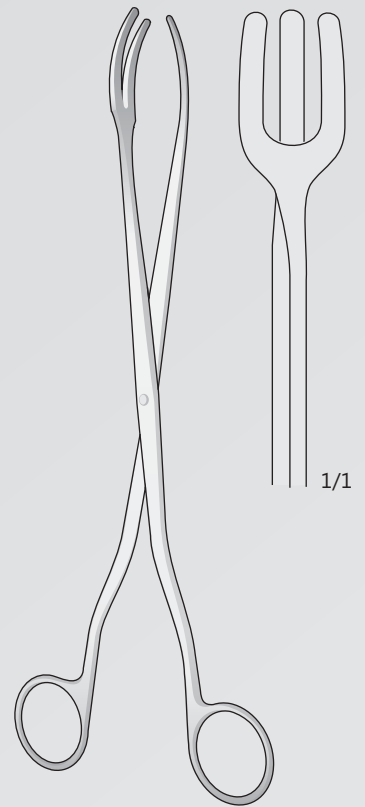

**0718-BB**  
300 mm



Matte en silicone  
 Silikon matte  
 Tappeti in aghi di silicone  
 Tapete en agujas de silicona  
 Tapis en Silicone

Sterilisierbar  
 Autoclavable  
 Autoclavabili

**1918-BAC**  
 135 x 180 mm

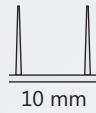

**1918-BAB**  
 135 x 180 mm

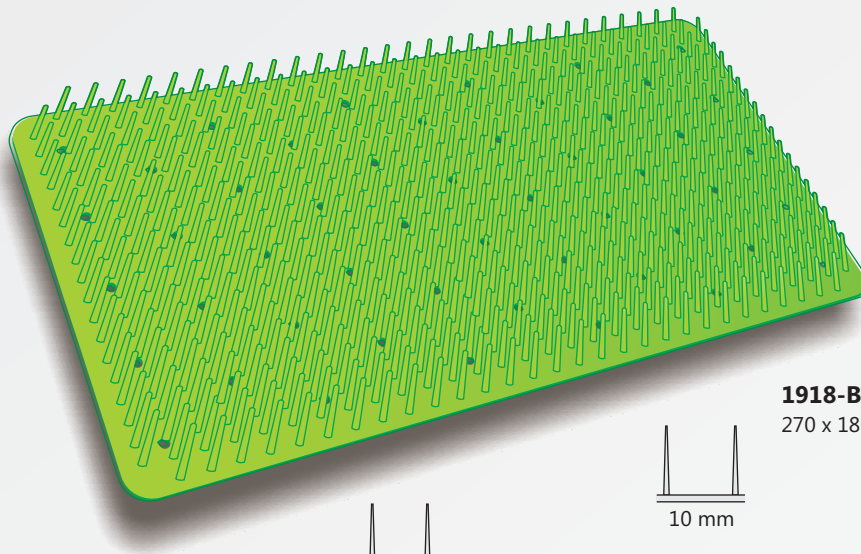

**1918-BAE**  
 270 x 180 mm

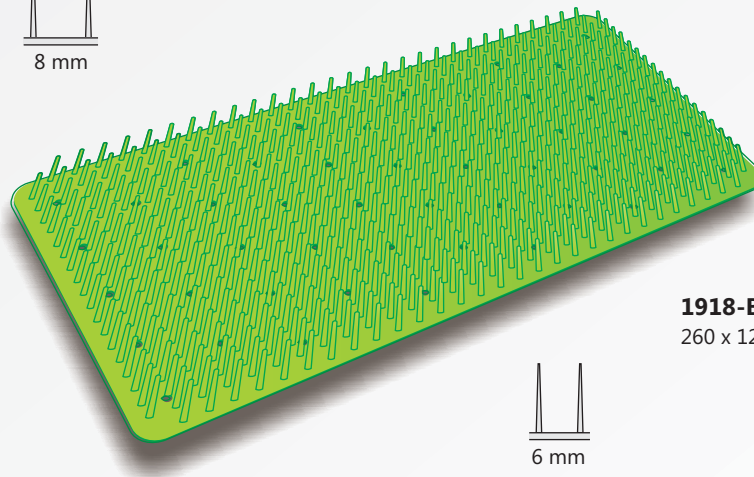
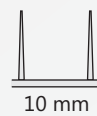

**1918-BAD**  
 260 x 120 mm



Steril Container  
 Sterilizing containers  
 Contenitori per sterilizzare  
 Contenedores para esterilización  
 Containers pour stérilizer

Bacinella a 7 scomparti

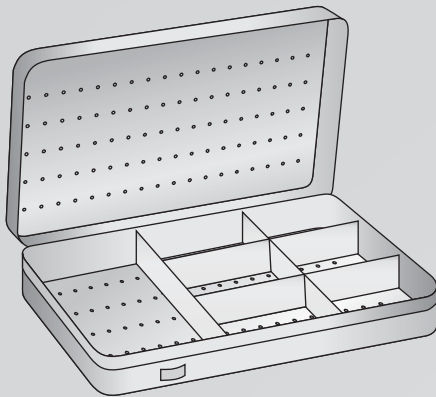

**0218-CH**  
 150 x 90 x 20 mm

Rostfrei  
 Stainless steel  
 Acciaio Inossidabile  
 Acero inoxidable  
 Acier inoxydable

Bacinella a 3 scomparti

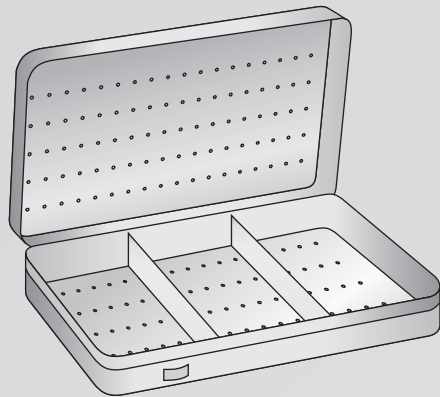

**0218-CD**  
 150 x 90 x 20 mm

Instrumentenkästen  
 Instrument boxes  
 Scatole per sterilizzazione a secco  
 Cajas para instrumentos  
 Boites pour instruments

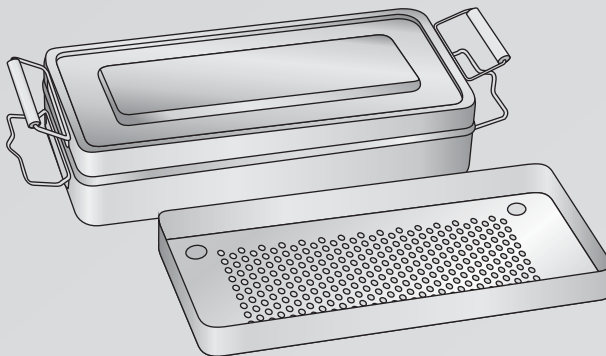

**0318-GB** 150 x 90 x 40 mm  
**0318-GH** 320 x 150 x 60 mm

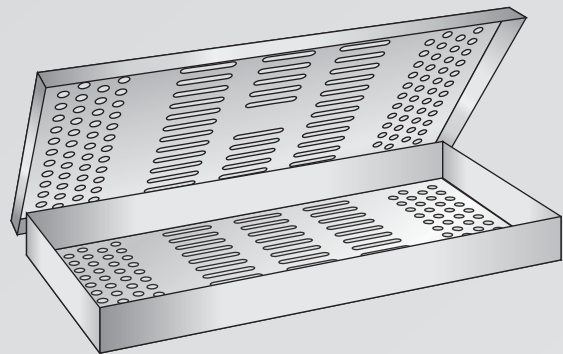

**0218-EB**  
 275 x 130 x 25 mm

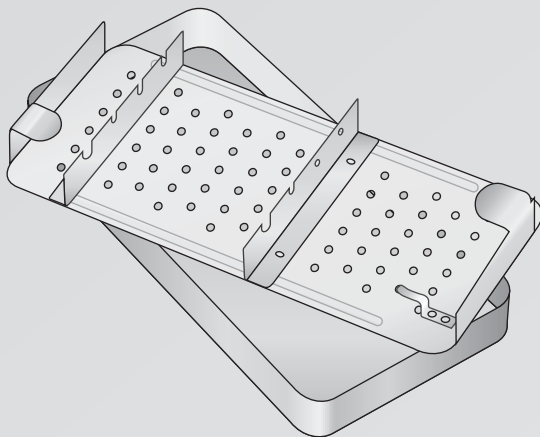

**0218-DA**  
 180 x 90 x 35 mm 2 ripiani

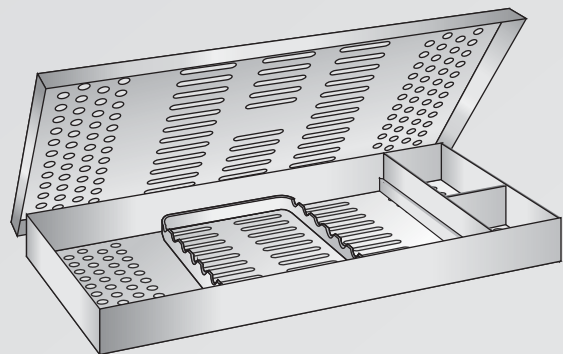

**0218-EA** 275 x 130 x 25 mm Con griglia e scomparti  
**0218-EC** 285 x 190 x 25 mm Con griglia e scomparti

Bacinelle reniformi  
Kidney bowls  
Nierenschalen  
Bassins réniformes  
Riñoneras



**0217-CA** 200 mm  
**0217-CF** 250 mm  
**0217-CI** 280 mm

Vassoio porta-strumenti  
Trays  
Schalen  
Bassins  
Bandejas



**2118-CA** 210 x 110 x 25 mm  
**2118-CG** 250 x 180 x 30 mm  
**2118-DA** 300 x 220 x 30 mm

Sterilbehälter für Nadeln  
Box for needles  
Sterilizzazione aghi da sutura  
Estuche para agujas  
Boite pour aiguilles de suture

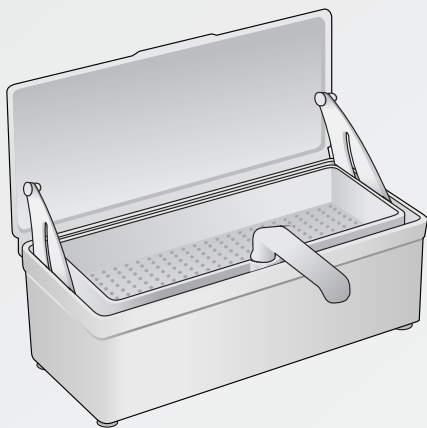

STERILTRAY  
**0218-BAA**  
25,5 X 10,5 X 8,5

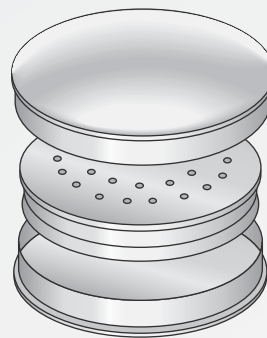

**0218-B**  
Ø 78 mm h 15 mm

Runder Sterilbehälter mit Ausguss  
Lotion bowls capsules  
Capsule inox con fondo piano e becco  
Capsule en acier inox  
Capsule inoxydable fond et bec

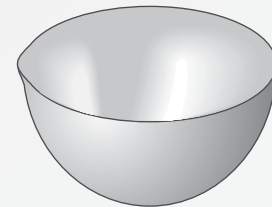

**0318-AB** Ø 40 mm 15 cc  
**0318-AC** Ø 60 mm 75 cc  
**0318-AD** Ø 80 mm 225 cc  
**0318-AE** Ø 100 mm 325 cc  
**0318-AF** Ø 120 mm 500 cc  
**0318-AG** Ø 150 mm 600 cc

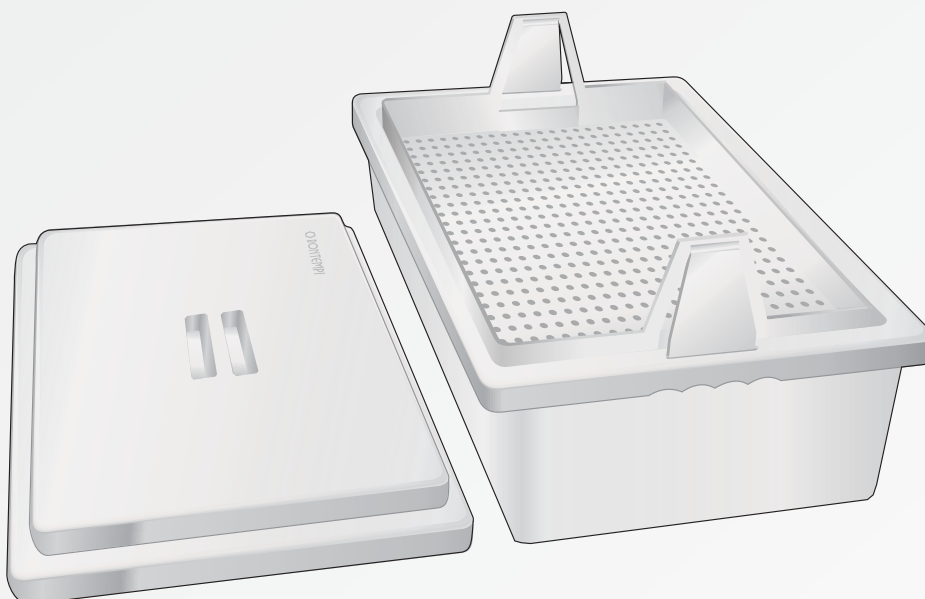

Plastica  
Autoclavabile

**0218-BAF**  
350 x 240 x 120 mm

Steril Container  
 Sterilizing containers  
 Contenitori per sterilizzare  
 Contenedores para esterilización  
 Containers pour stérilizer



#### Kleinsetcontainer / Mini Container

Außen / outside / esterno  
 exterior / extérieur  
 300 x 140 x 40 mm

0319-FFF  
 0319-FFG  
 0319-FFH  
 0319-FFI  
 0319-FFL

Innen / inside / interno  
 interior / intérieur  
 280 x 130 x 27 mm

#### Kleinsetcontainer / Mini Container

Außen / outside / esterno  
 exterior / extérieur  
 300 x 140 x 70 mm

0319-FGA  
 0319-FGB  
 0319-FGC  
 0319-FGD  
 0319-FGE

Innen / inside / interno  
 interior / intérieur  
 280 x 130 x 55 mm

#### Kleinsetcontainer / Mini Container

Außen / outside / esterno  
 exterior / extérieur  
 300 x 140 x 100 mm

0319-FGF  
 0319-FGG  
 0319-FGH  
 0319-FGI  
 0319-FGL

Innen / inside / interno  
 interior / intérieur  
 280 x 130 x 84 mm

#### 1918-BAD

260 x 120 mm - 6 mm

Silikon Noppenmatten  
 Silicon Mats  
 Tappeti in aghi di silicone  
 Tapete en agujas de silicona  
 Tapis de silicone

Sterilisierbar  
 Autoclavable  
 Autoclavabili  
 Esterilizable  
 Stérilisable

#### 0319-GGA

94 x 215 mm - Box 1 pc.

Teflon Filter für 1200 Zyklen  
 Teflon Filter for 1200 cycles  
 Filtro in teflon per 1200 cicli  
 Filtro de teflón para 1200 ciclos  
 Filtre de téflon pour 1200 cycles

#### 0319-GHA

Box 100 pc.

Kunststoff-Dichtungen  
 Plastic seals  
 Sigilli di plastica  
 Sellos de plástico  
 Scellés en plastique

#### 0319-GHC

Box 100 pc.

Label Einweg  
 Disposable-Label  
 Etichetta monouso  
 Etiqueta desechables  
 Étiquettes jetables

#### 0319-HAC

65 x 65 mm

Baumwolle Handtuch Verpackung  
 Cotton Towel Packaging  
 Telo in cotone per confezionamento  
 Embalaje de toallas de algodón  
 Emballage de serviettes de coton

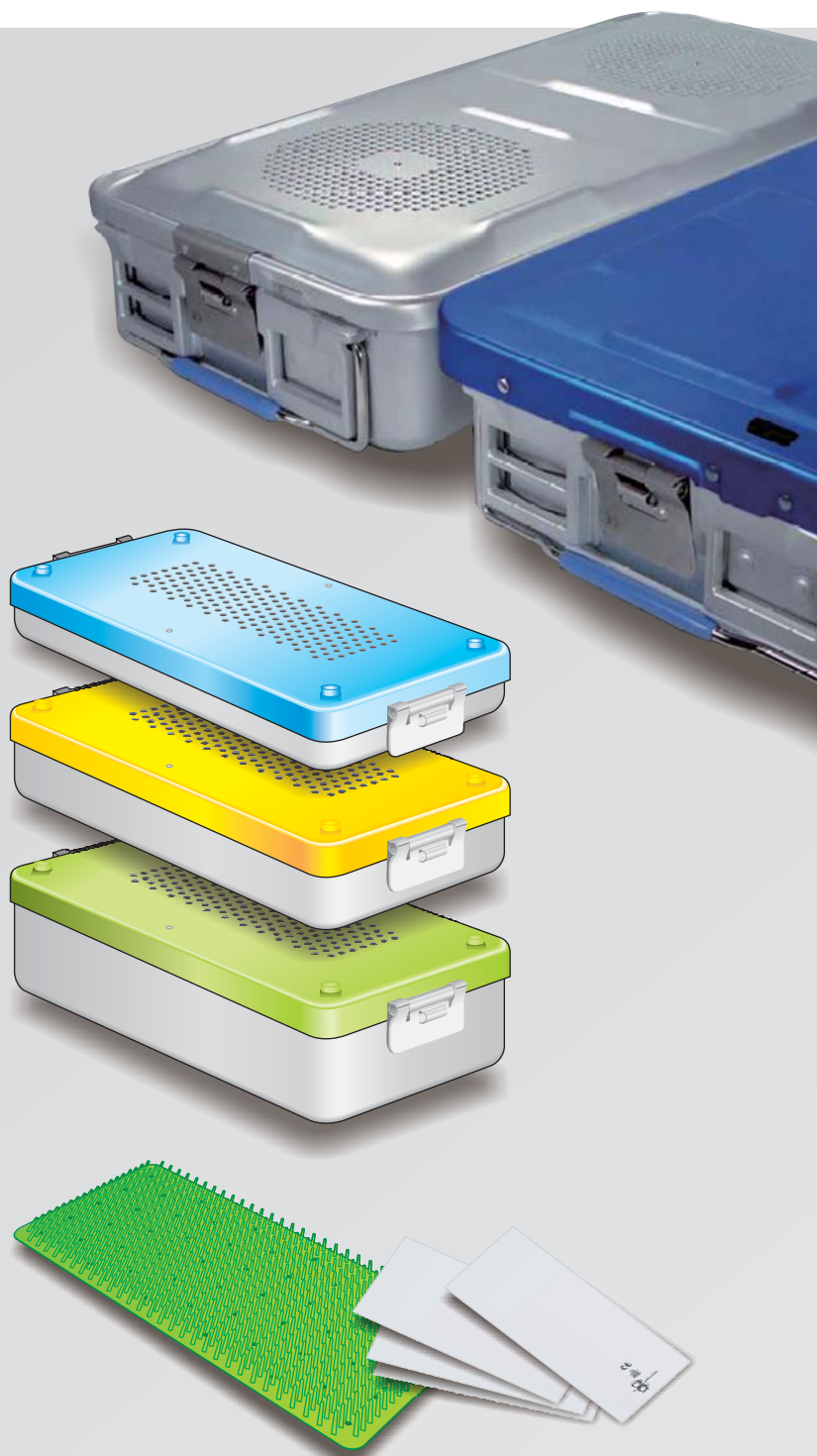



 ideal-tek

Tier Zahnmedizin  
Animal Dentistry  
Odontoiatria animale  
Odontologia animal  
Animaux dentisterie



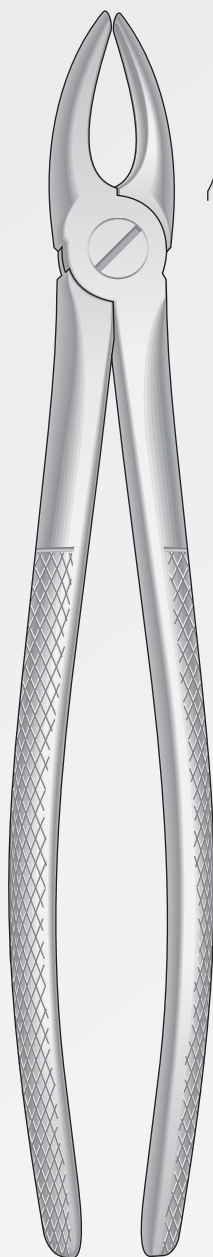

**B**  
 Fig. 1

Obere Schneide- und Eckzähne  
 Upper Incisors and cuspids  
 Incisivi e canini superiori  
 Incisivos y caninos superiores  
 Incisives et canines supérieures

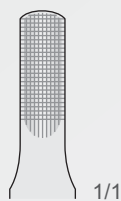

1/1

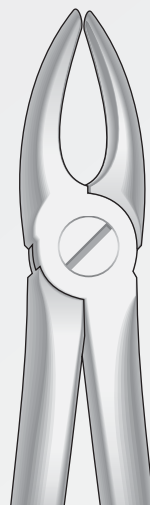

**C**  
 Fig. 2

Obere Schneide- und Eckzähne  
 Upper Incisors and cuspids  
 Incisivi e canini superiori  
 Incisivos y caninos superiores  
 Incisives et canines supérieures

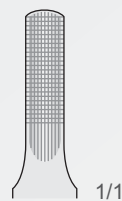

1/1

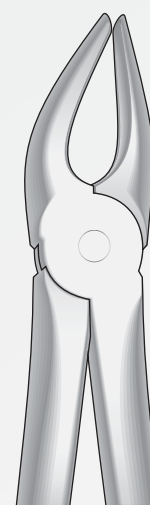

**H**  
 Fig. 7

Obere Prämolaren  
 Upper premolars  
 Premolari superiori  
 Premolares superiores  
 Prémolaires supérieures

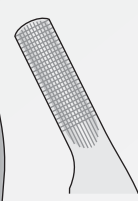

1/1



Zahnzangen Englische Form  
 Extracting Forceps English Pattern  
 Pinze per estrazione Forma Inglese  
 Pinzas da extracciòn Forma Inglesa  
 Daviers Forme Anglaise

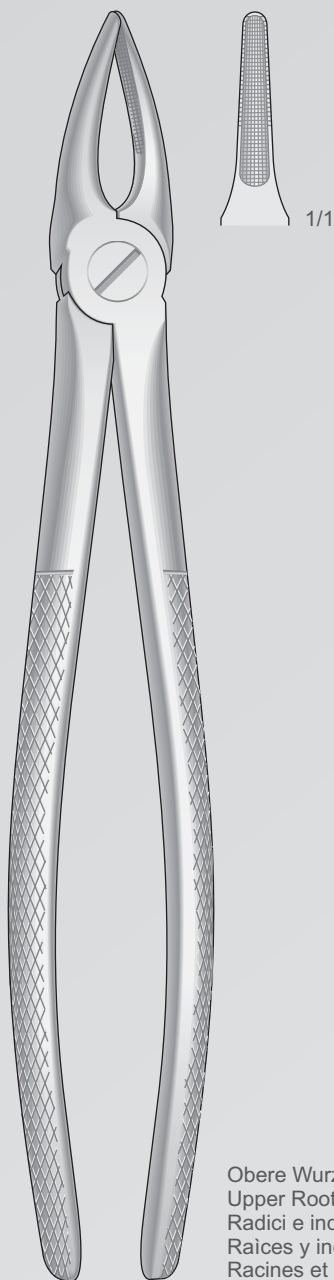

**CL**  
 Fig. 29

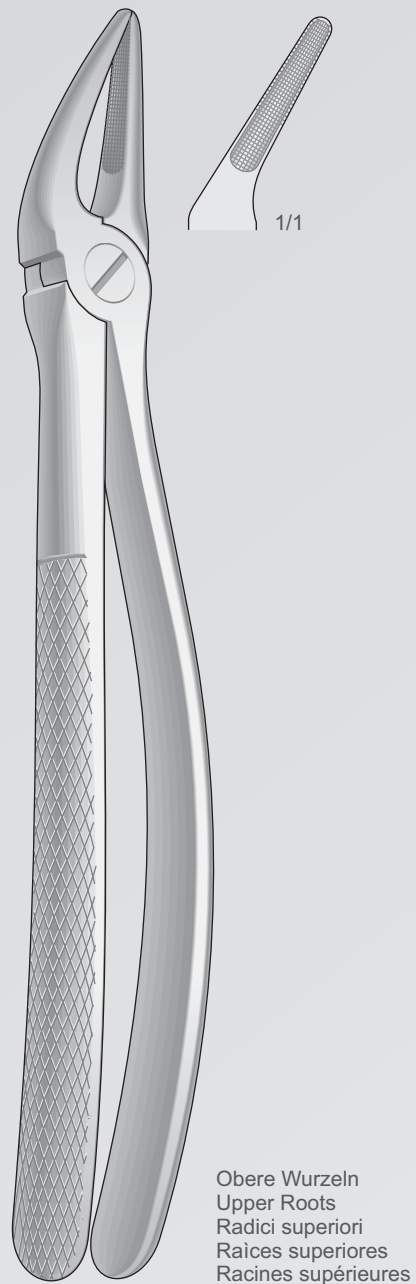

**DA**  
 Fig. 30



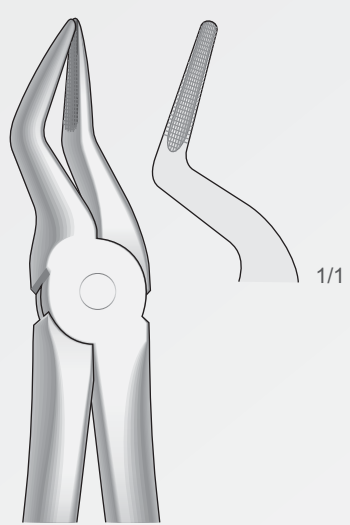
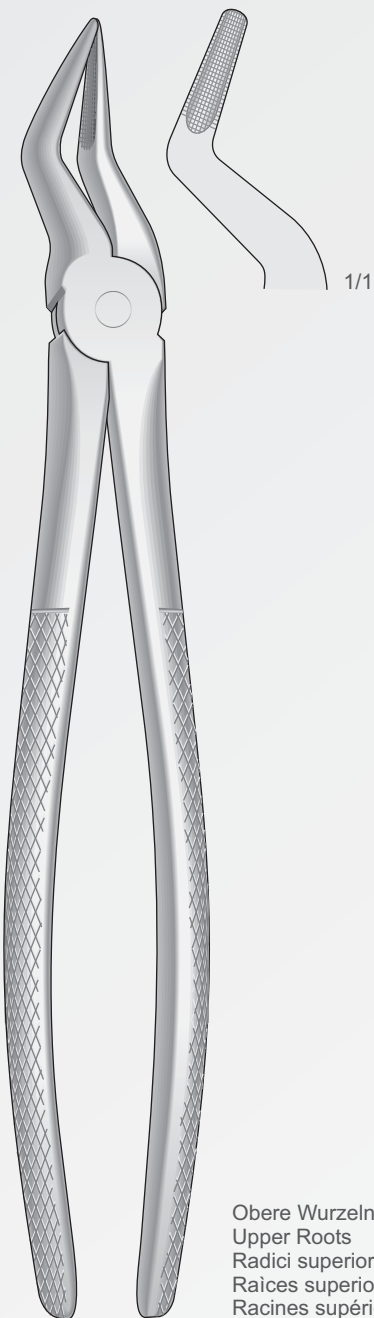

**FB01**  
 Fig. 51A

Obere Wurzeln  
 Upper Roots  
 Radici superiori  
 Raíces superiores  
 Racines supérieures

Obere Wurzeln  
 Upper Roots  
 Radici superiori  
 Raíces superiores  
 Racines supérieures

**FB**  
 Fig. 51

Molaren  
 Podo Lower Molars  
 Molari  
 Molares  
 Molaires

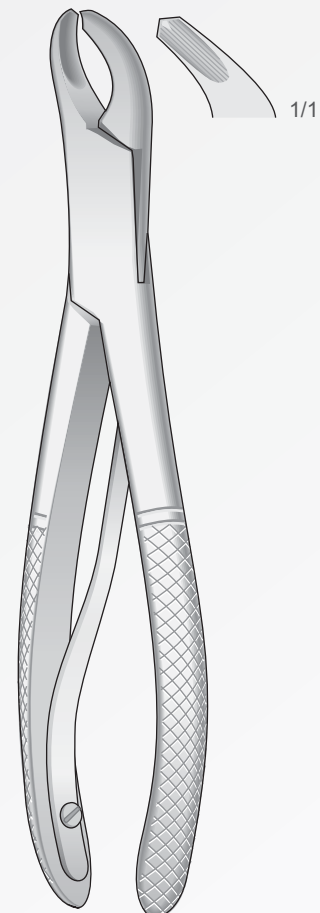

**150502-BH18**  
 Fig. 17SK

Zahnzangen Englische Form  
 Extracting Forceps English Pattern  
 Pinze per estrazione Forma Inglese  
 Pinzas da extracciòn Forma Inglesa  
 Daviers Forme Anglaise

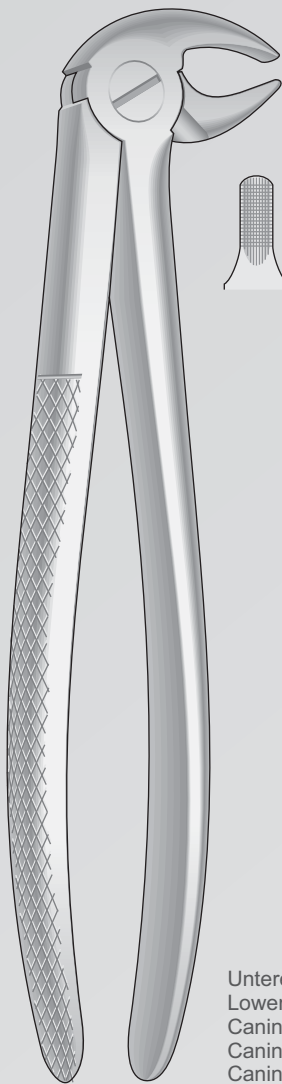

**BD**  
 Fig. 13

Untere Eckzähne und Prämolaren  
 Lower cuspids and premolars  
 Canini e premolari inferiori  
 Caninos y premolares inferiores  
 Canines et prémolaires inférieures

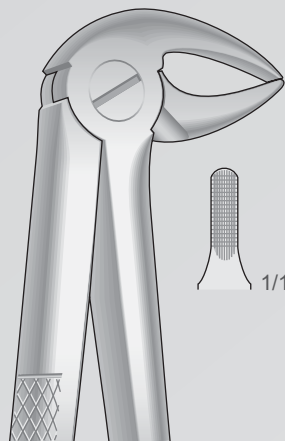

**DD**  
 Fig. 33

Untere Prämolaren,  
 Schneidezähne und Wurzeln  
 Lower incisors,  
 premolars and roots  
 Incisivi, premolari  
 e radici inferiori  
 Incisivos, premolares  
 y raíces inferiores  
 Incisives, prémolaires  
 et racines inférieures

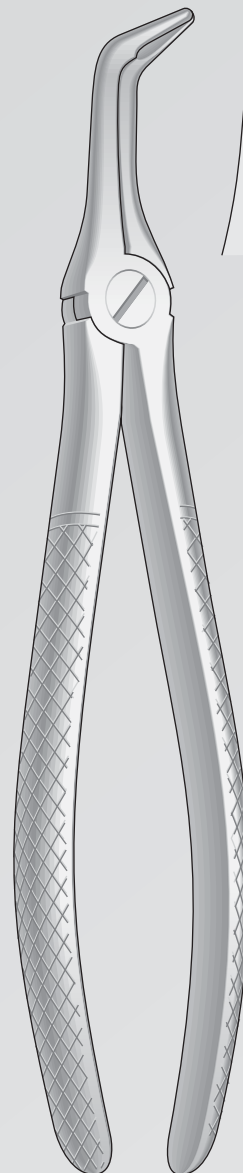

**EF**  
 Fig. 45

Untere Wurzeln  
 Lower roots  
 Radici inferiori  
 Raíces inferiores  
 Racines inférieures

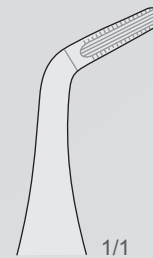

**EG**  
 Fig. 46

Untere Wurzeln  
 Lower roots  
 Radici inferiori  
 Raíces inferiores  
 Racines inférieures

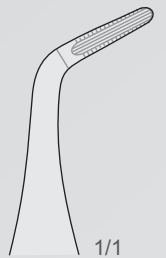

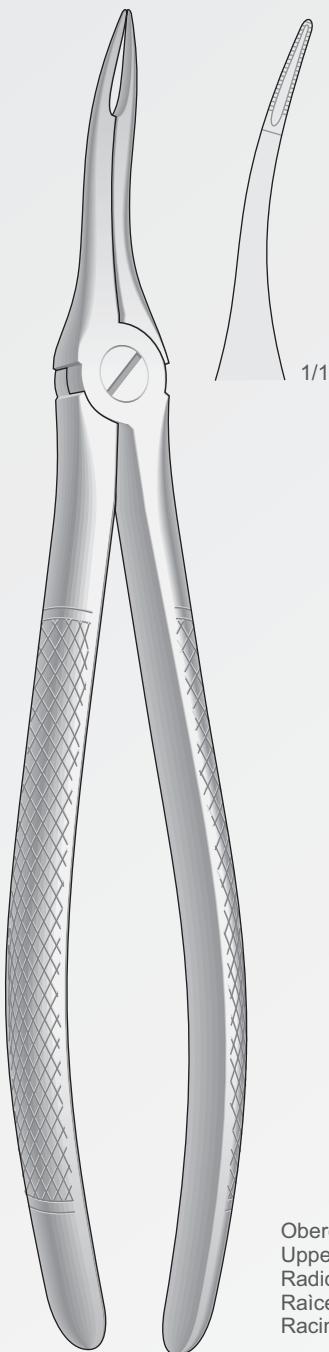

**EL**  
 Fig. 49

Obere Wurzeln sehr feine  
 Upper very fine roots  
 Radici superiori molto sottili  
 Raices superiores muy finas  
 Racines supérieures très fines

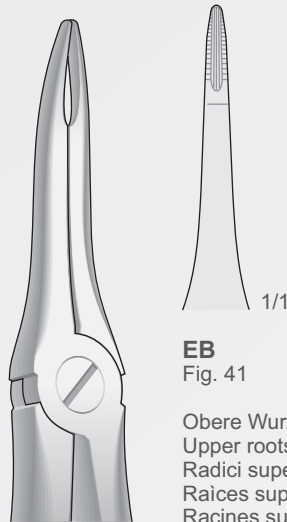

**EB**  
 Fig. 41

Obere Wurzeln  
 Upper roots  
 Radici superiori  
 Raices superiores  
 Racines supérieures

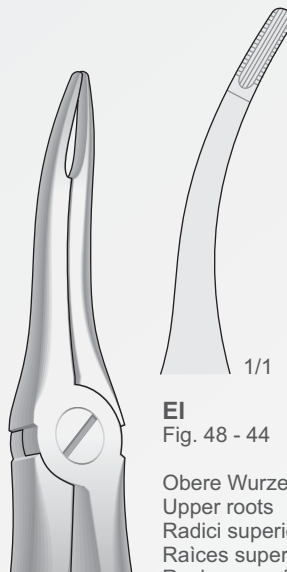

**EI**  
 Fig. 48 - 44

Obere Wurzeln  
 Upper roots  
 Radici superiori  
 Raices superiores  
 Racines supérieures

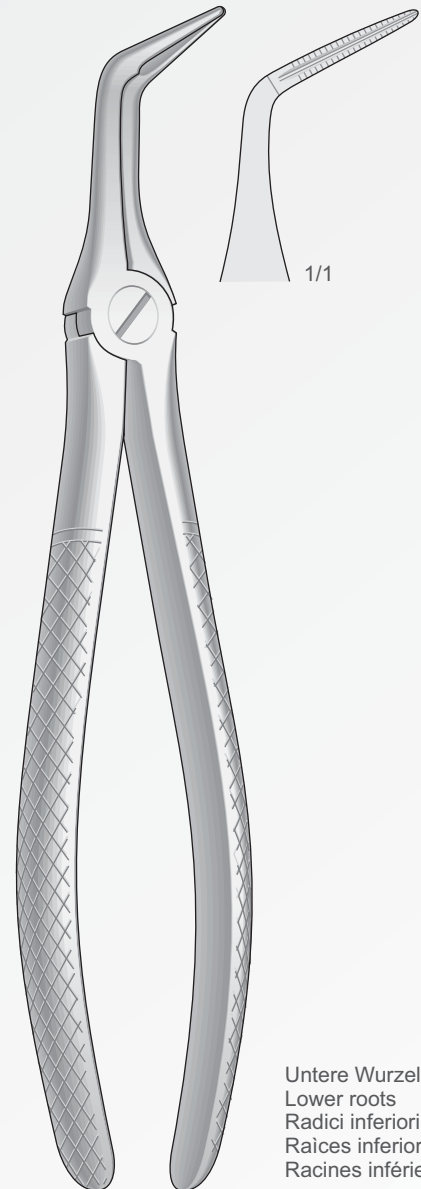

**EG11**  
 Fig. 46L

Untere Wurzeln  
 Lower roots  
 Radici inferiori  
 Raices inferiores  
 Racines inférieures

Zahnzangen Englische Form  
 Extracting Forceps English Pattern  
 Pinze per estrazione Forma Inglese  
 Pinzas da extracciòn Forma Inglesa  
 Daviers Forme Anglaise

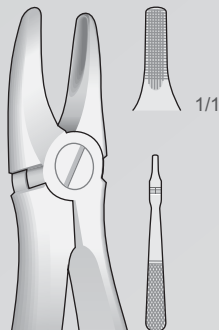

**150502-B**  
 Fig. 137

Obere Schneidezähne  
 Upper Incisors  
 Incisivi superiori  
 Incisivos superiores  
 Incisives supérieures

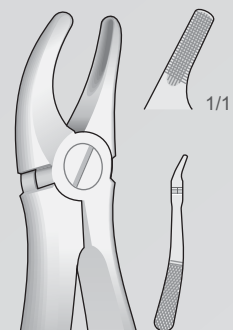

**150502-C**  
 Fig. 139

Obere Prämolaren  
 Upper Premolars  
 Premolari superiori  
 Premolares superiores  
 Prémolaires supérieures

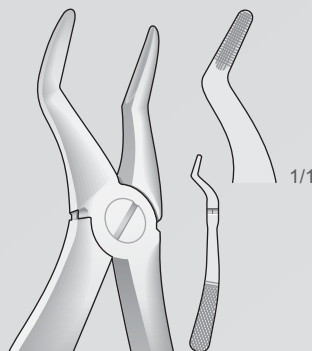

**150502-E**  
 Fig. 51S

Obere Wurzeln  
 Upper roots  
 Radici superiori  
 Raíces superiores  
 Racines supérieures

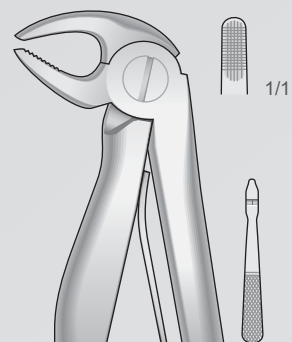

**150502-F**  
 Fig. 5

Untere Schneidezähne  
 Lower incisors  
 Incisivi inferiori  
 Incisivos inferiores  
 Incisives inférieures

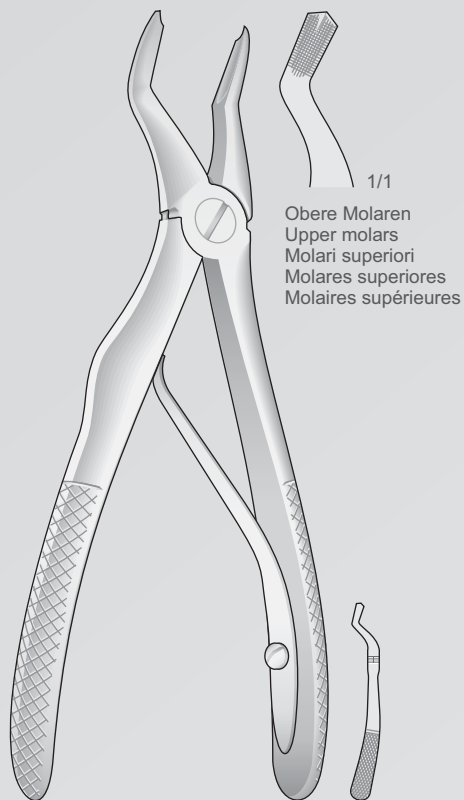

**150502-D**

Obere Molaren  
 Upper molars  
 Molari superiori  
 Molares superiores  
 Molaires supérieures

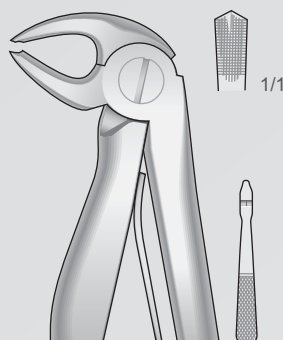

**150502-G**  
 Fig. 6

Untere Molaren  
 Lower Molars  
 Molari inferiori  
 Molares inferiores  
 Molaires inférieures

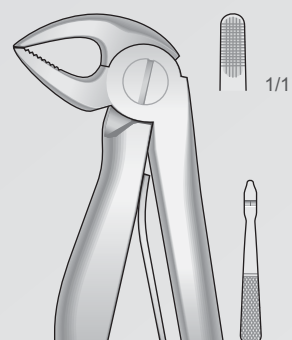

**150502-H**  
 Fig. 7

Untere Wurzeln  
 Lower roots  
 Radici inferiori  
 Raíces inferiores  
 Racines inférieures

Fragmente- und Wurzelstiftezaugen  
 Pliers fragments and root canal pins  
 Pinze per frammenti e perni canalari  
 Alicates para fragmentos y los pins del conducto radicular  
 Pinces pour Fragments et épingles de canal

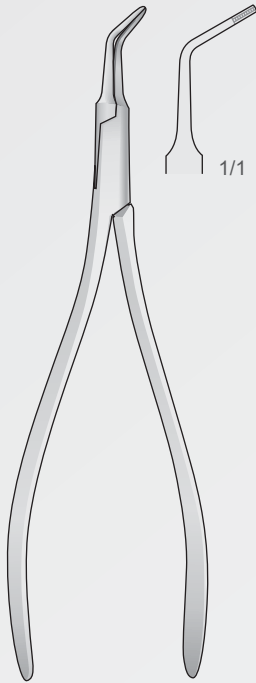

**0401-AB**  
130 mm

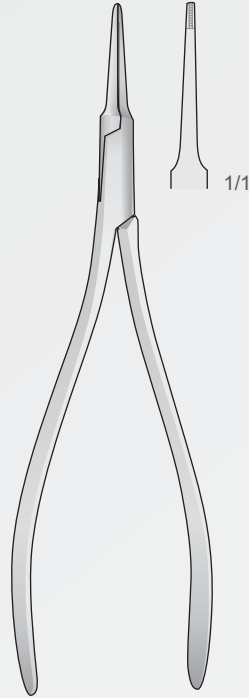

**0401-AC**  
130 mm

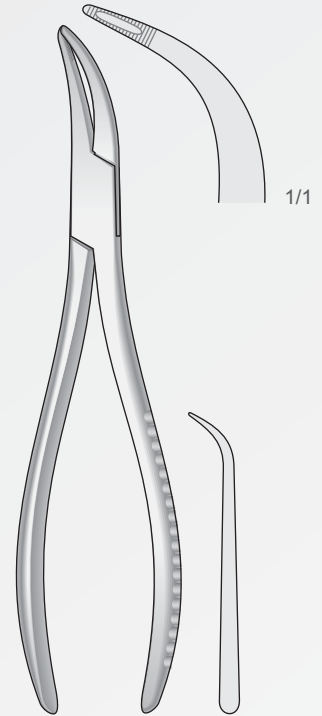

**WITZEL**  
**0410-CI**  
165 mm

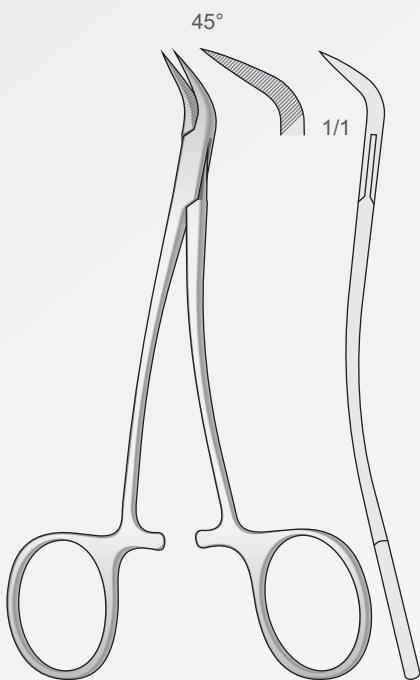

**PEET**  
**0417-EA**  
120 mm

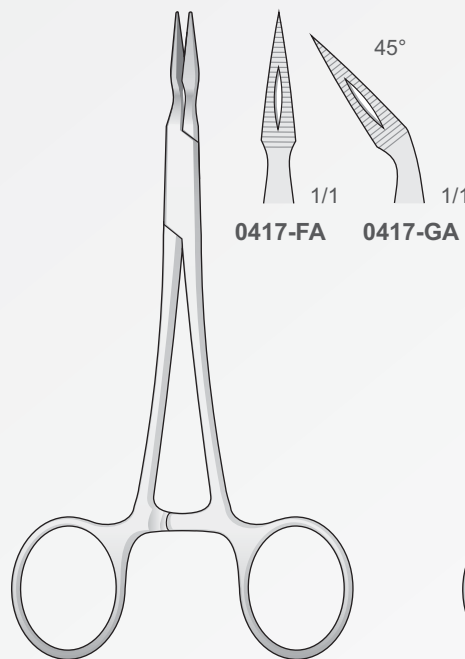

**STIEGLITZ**  
**0417-FA/0417-GA**  
140 mm

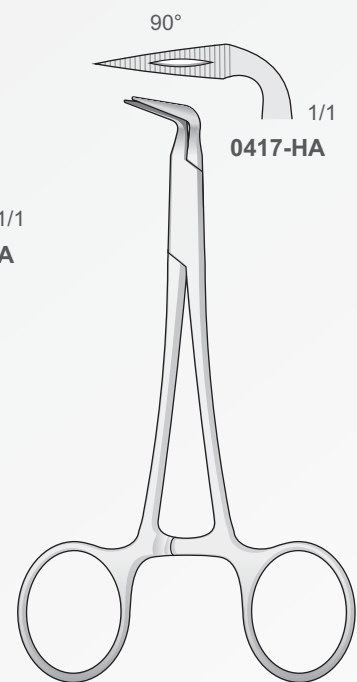

**STIEGLITZ**  
**0417-HA**  
120 mm

Wurzelheber  
Root Elevators  
Leve per radici  
Elevadores para raices  
Elevateurs à racines

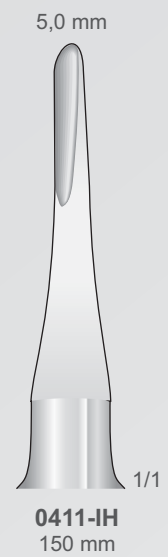
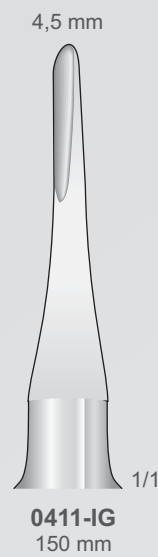
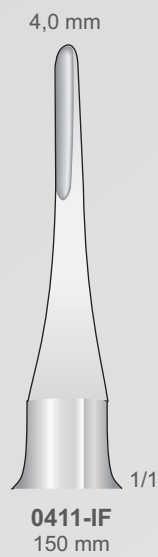
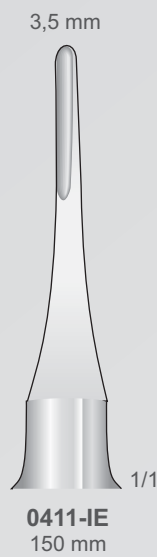
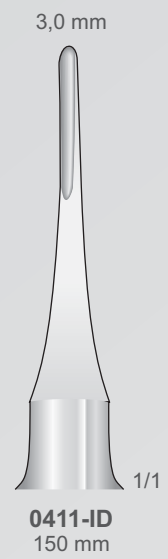
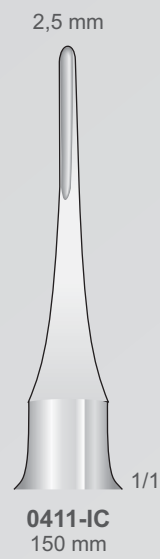
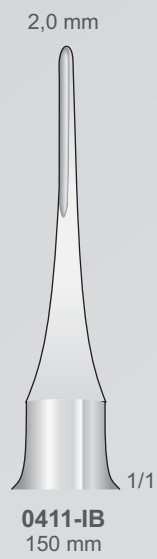

**0411-IB/0411-IH**  
150 mm

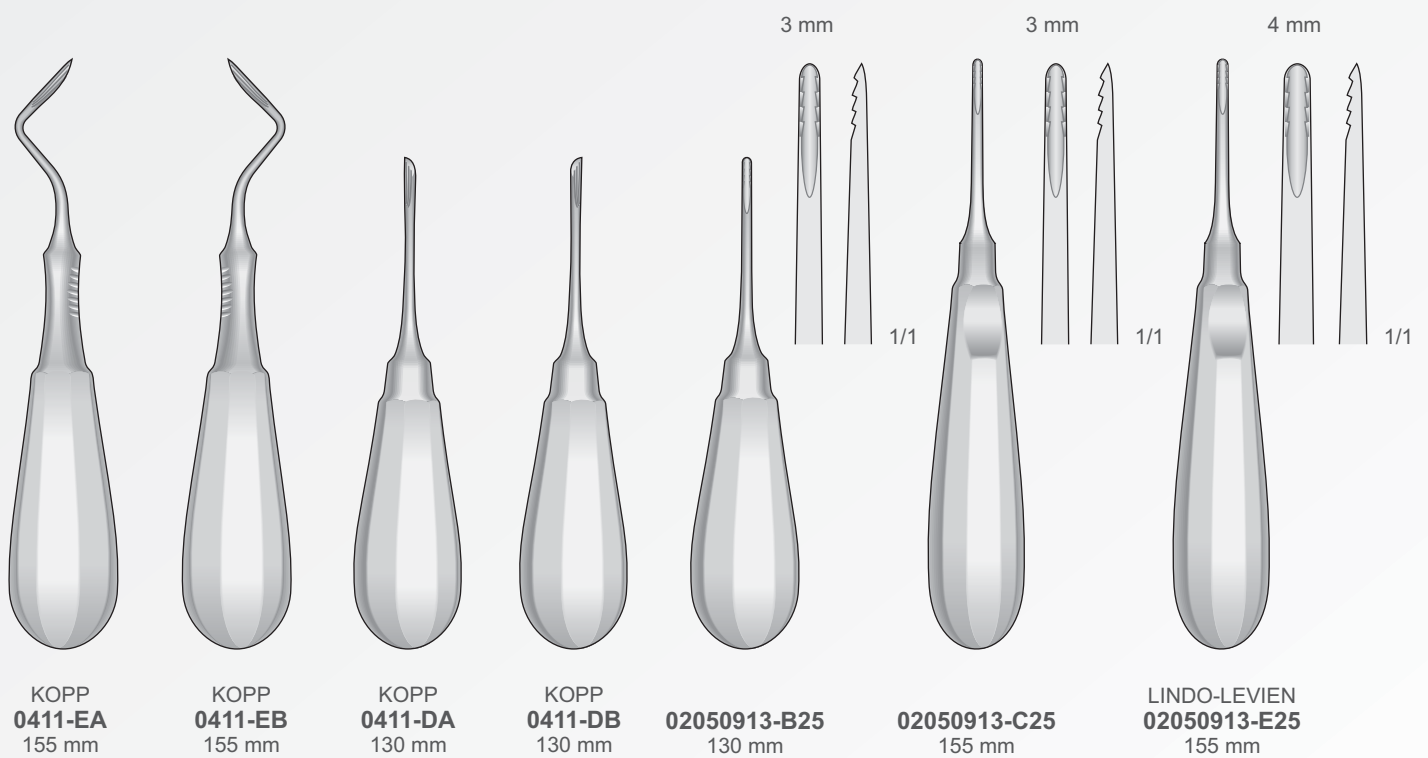

Wurzelheber  
 Root Elevators  
 Leve per radici  
 Elevadores para raices  
 Elevateurs à racines

Wurzelheber  
 Root Elevators  
 Leve per radici  
 Elevadores para raices  
 Elévateurs de racines

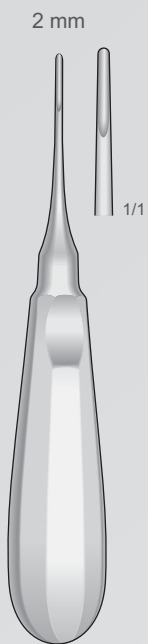

**02050913-C**  
155 mm

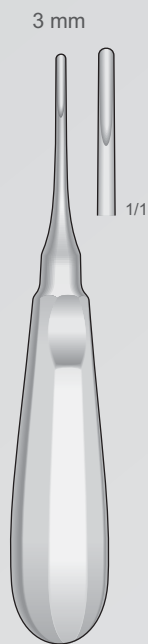

**02050913-D**  
155 mm

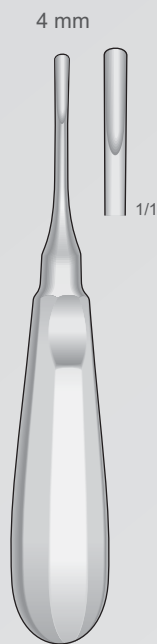

**02050913-E**  
155 mm



WARWICK-JAMES  
**0411-CA**  
160 mm



WARWICK-JAMES  
**0411-CB**  
155 mm



WARWICK-JAMES  
**0411-CC**  
155 mm

Obere  
Upper  
Superiori  
Superiores  
Supérieures

Untere  
Lower  
Inferiori  
Inferiores  
Inférieures

Untere  
Lower  
Inferiori  
Inferiores  
Inférieures



Gezahnt  
 Serrated  
 Dentellate  
 Dentadas  
 Dentelé

Eine seite gezahnt  
 One side serrated  
 Un lato dentellato  
 Dentadura más lado  
 Dentelure sur un côté



Fig. 77L Fig. 77R

Fig. 100L

Fig. 100R

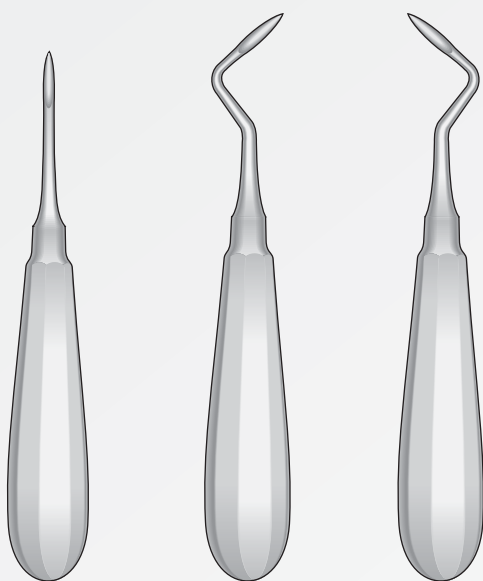

0611140817-B  
140 mm

0611140817-C  
150 mm

0611140817-D  
150 mm

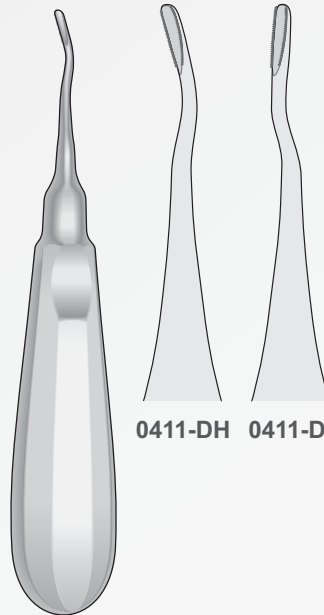

APEXO  
 0411-DH/0411-DI  
 160 mm

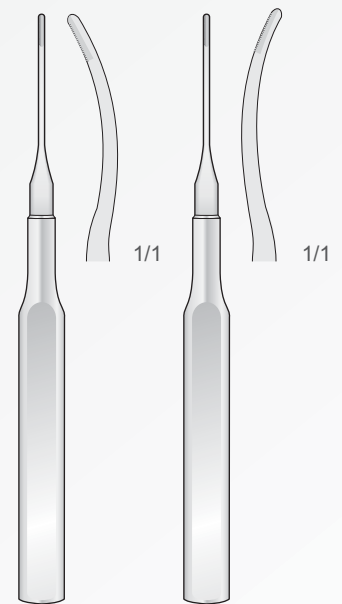

0411-HI  
155 mm

0411-HL  
155 mm

Wurzelheber  
 Root Elevators  
 Leve per radici  
 Elevadores para raices  
 Elevateurs à racines

Luxatoren  
 Luxators  
 Lussatori  
 Luxadores  
 Luxateurs

Wurzelspitzenheber  
 Root fragment Elevators  
 Leve per frammenti di radice  
 Elevadores para fragmentos de raices  
 Elévateurs de fragments de racines

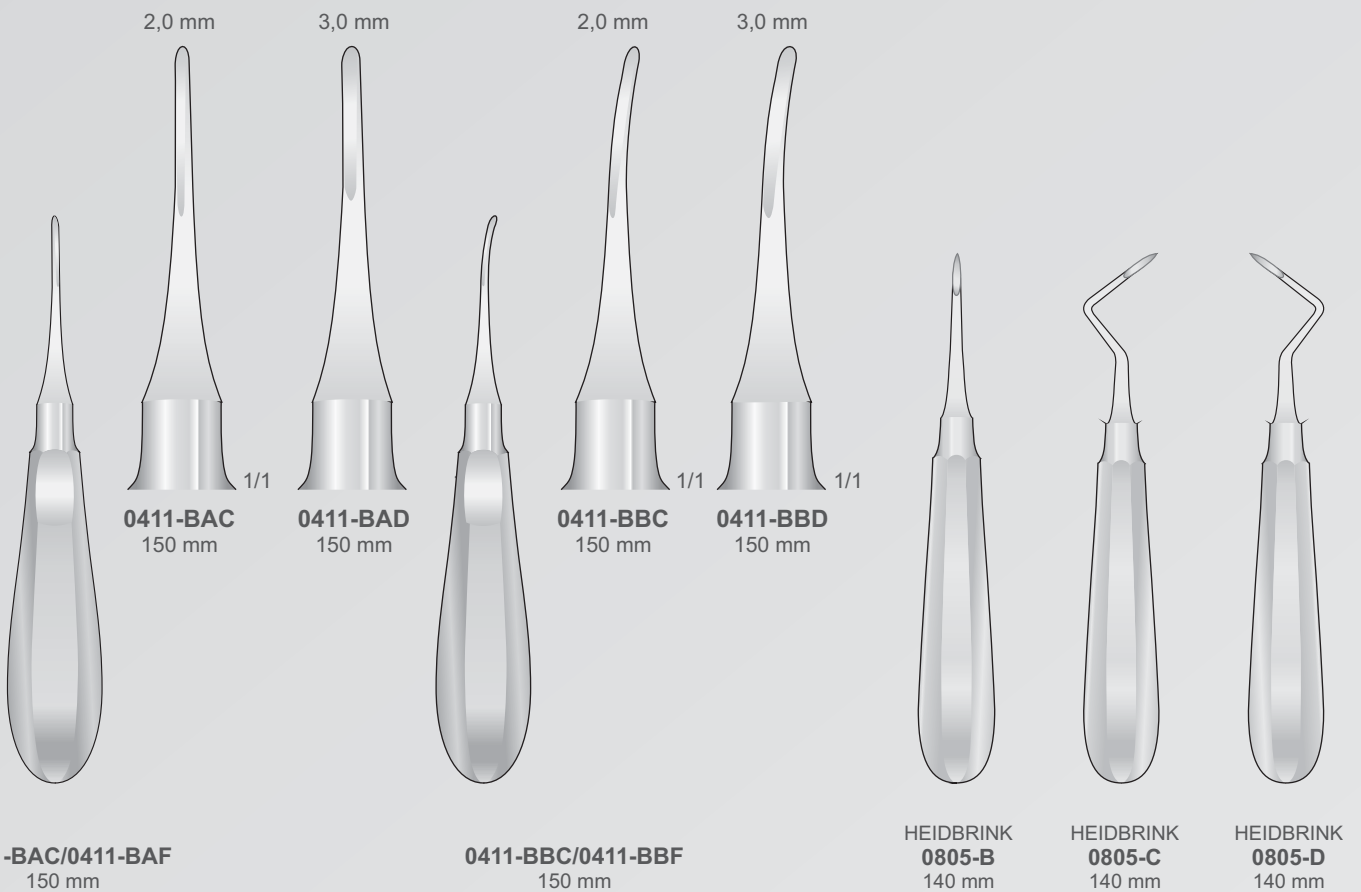

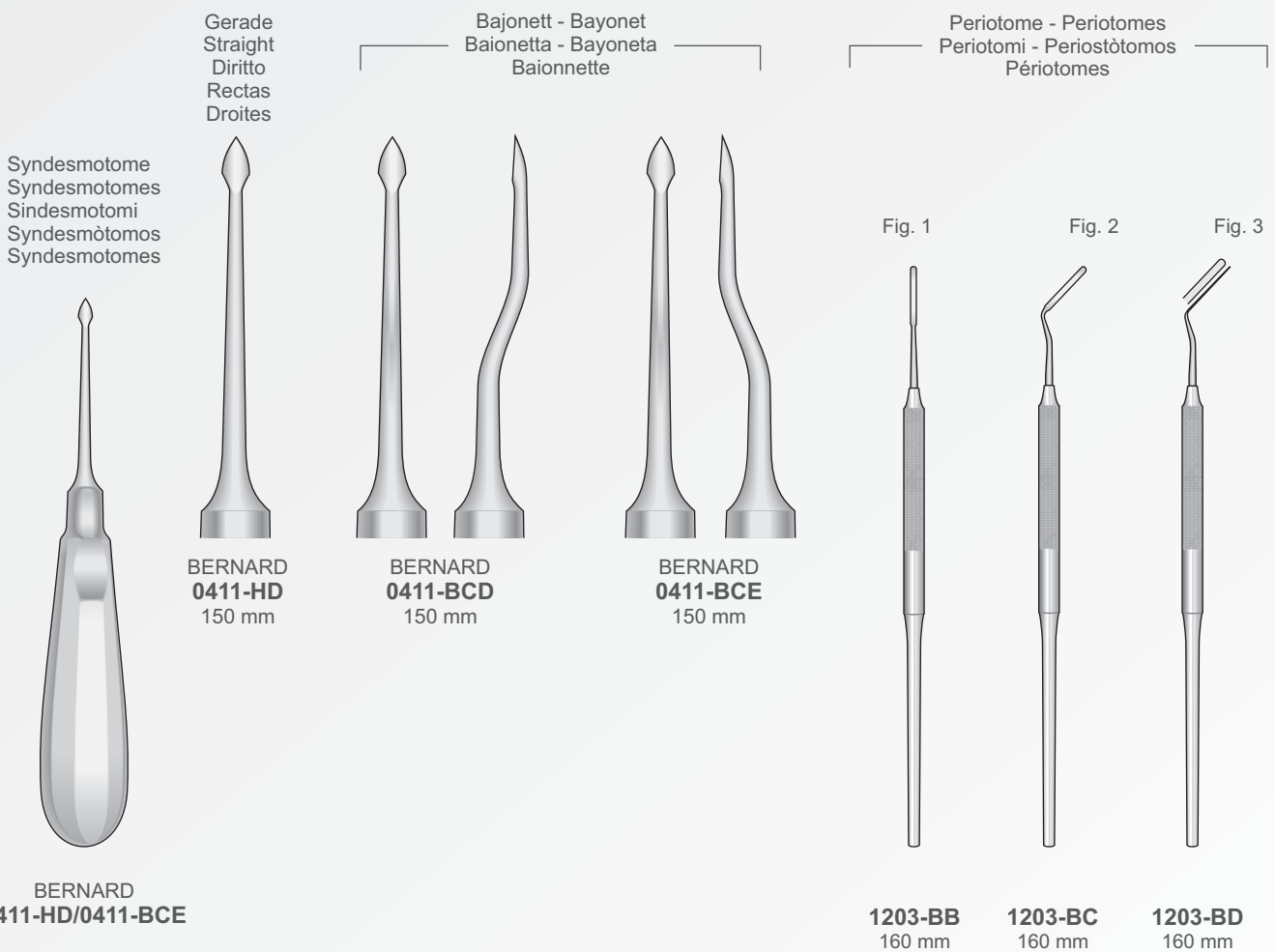

Mundsperrer  
 Mouth Gags  
 Apri bocca  
 Abre bocas  
 écarteur buccal

Erweitert Wange  
 Widens Cheek  
 Allargagancia  
 Amplia la mejilla  
 Élargit la joue



**2106-BCB18**  
40 mm

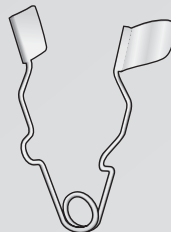

**2106-BCB**  
60 mm

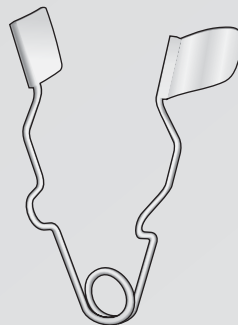

**2106-BCC**  
85 mm

Apribocca

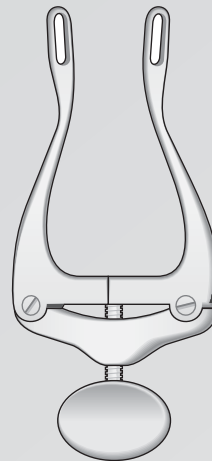

SCHMIDTKE  
**2106-BCA**  
120 mm

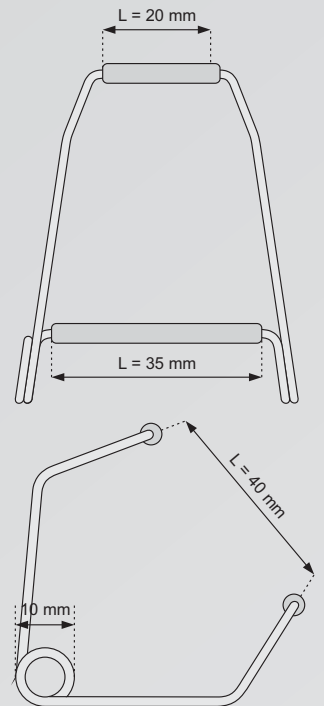

**2108-EG** 40 mm  
**2108-FC** 60 mm  
**2108-FD** 105 mm  
**2108-FE** 150 mm  
**2108-FF** 175 mm

Hunde - Dogs  
 Cani - Perros  
 Chiens

Katzen - Cats  
 Gatti - Gatos  
 Chats

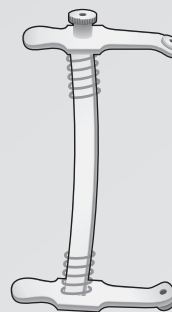

**2108-EI** 60 mm  
**2108-EL** 80 mm

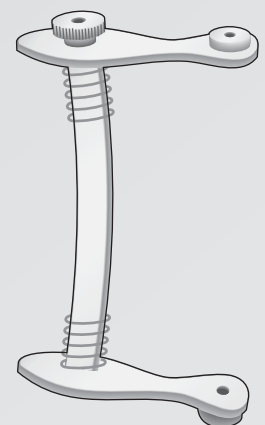

**2108-FA** 110 mm  
**2108-FB** 160 mm



**2108-BG**  
175 mm

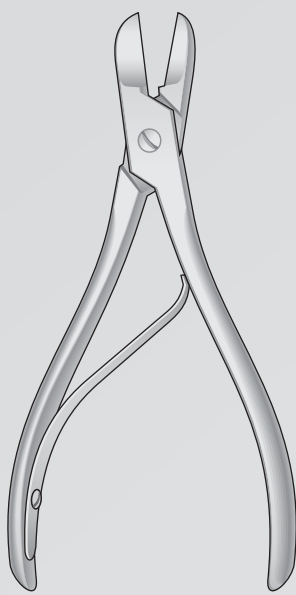

**1123-HA**  
155 mm

2,2 mm



FAHRENKRUG  
**0411-AF**  
 190 mm

3,0 mm



FAHRENKRUG  
**0411-AG**  
 190 mm

Strumento per denti  
 dei conigli

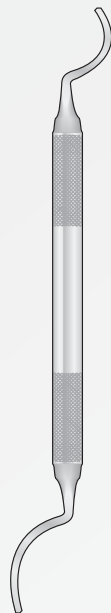

**2106-BCG**  
 160 mm



**2106-BCH**  
 185 mm

Zange zum Abkneifen Ferkeelzähnen  
 Forceps for small animals teeth  
 Pinza per denti di piccoli animali  
 Pinza para dientes de pequeños animales



**1123-LI**  
 175 mm

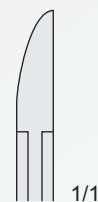

1/1



Mit Hartmetalleinsätzen  
 With Hard Metal Inserts  
 Con punte in metallo duro  
 Con puntas de metal duro  
 Avec mors en métal dur

Long Handle  
 Con manici lunghi

Retractor reflectantes  
 Retrattore riflettente

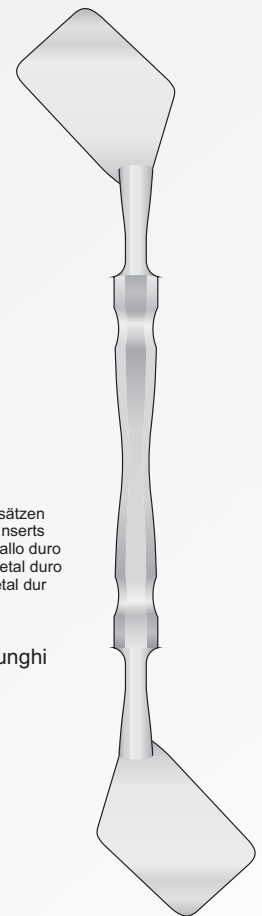

FAHRENKRUG  
**0411-FG**  
 240 mm

Syndesmotome und Küretten  
 Syndesmotome and Curettes  
 Sindesmotomo e Curette  
 Syndesmotomo y Curetas  
 Syndesmotome et Curetts

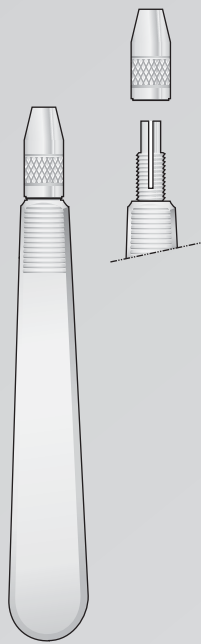

**1804-12**

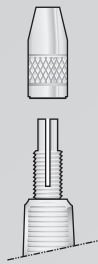

Cervical Blades  
 Lame cervicali  
 Hojas cervical  
 Lames pour  
 syndesmotome

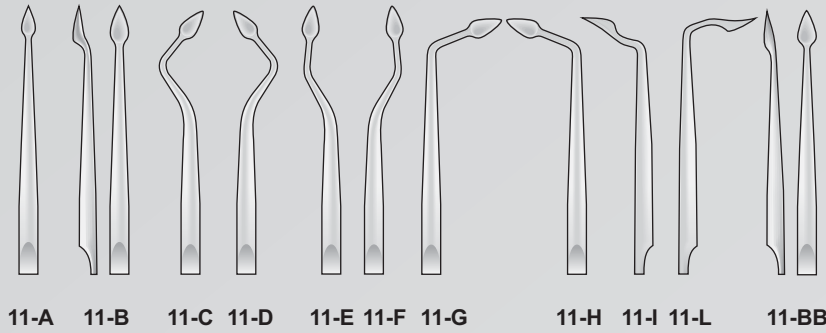

**11-A 11-B 11-C 11-D 11-E 11-F 11-G 11-H 11-I 11-L 11-BB**

Apical Blades  
 Lame apicali  
 Hojas apical

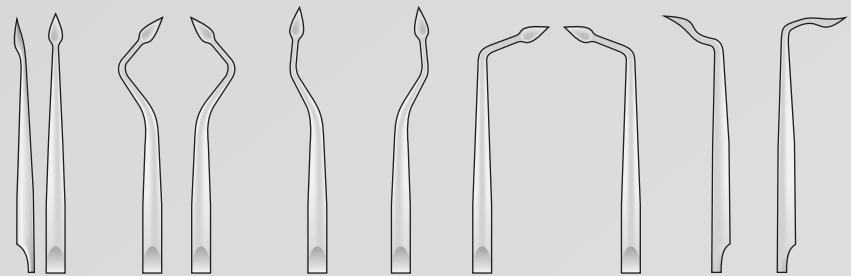

**11-CB 11-CD1-CD 11-CE 11-CF 11-CG 11-CH 11-CI 11-CL**

Scalers

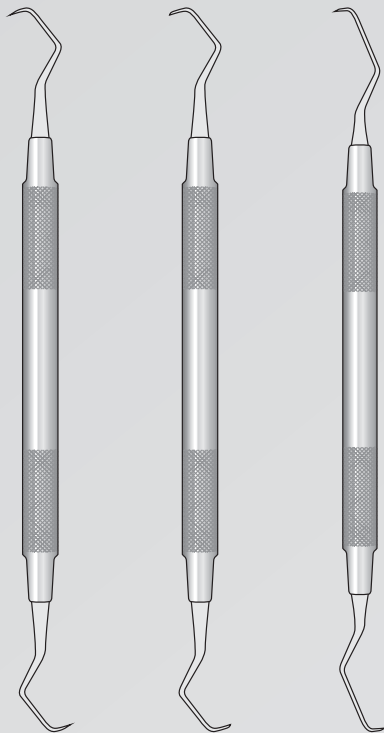

**HBI-12CD 165 mm**  
**HBI-12CD01 165 mm**  
**HBI-12CD02 170 mm**

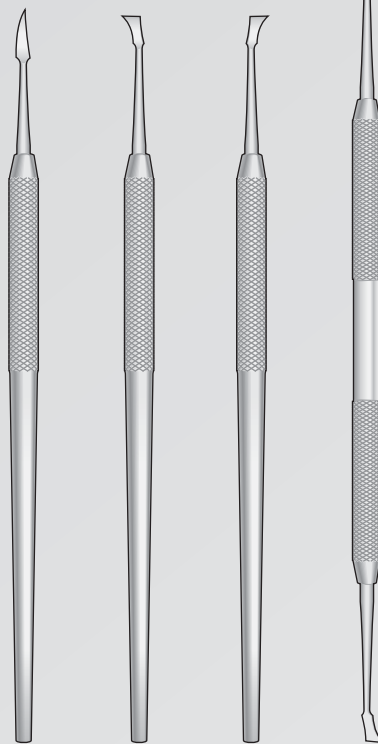

**0119-B 0119-C17 0119-C11 0119-G**

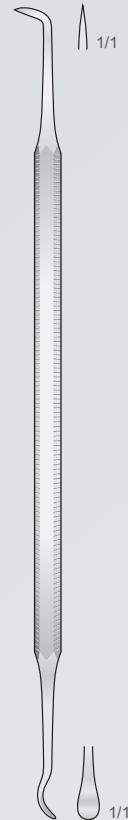

**MITCHEL 0119-BC 170 mm**

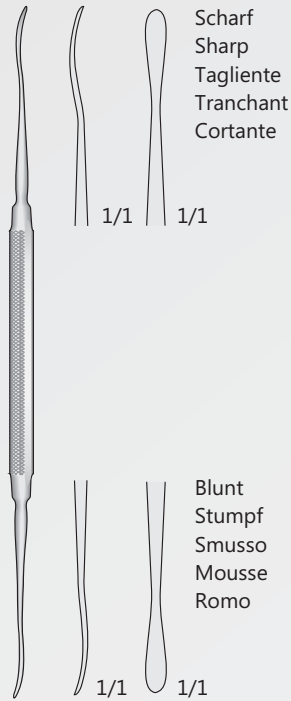

FREER  
**0617-BG**  
185 mm

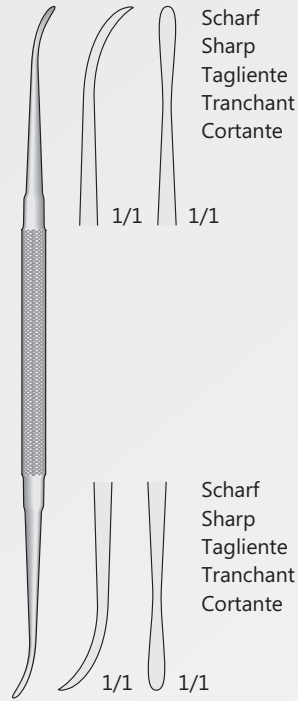

FREER-YASARGIL  
**0617-BH**  
185 mm

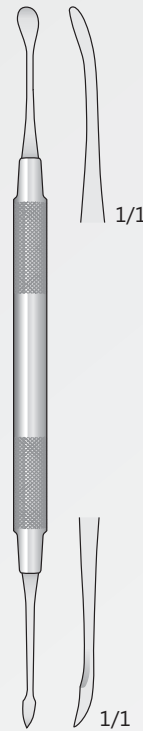

MOLT  
**1214-I**  
185 mm

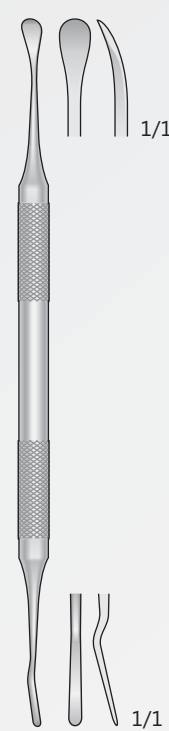

**1105-AI**  
175 mm

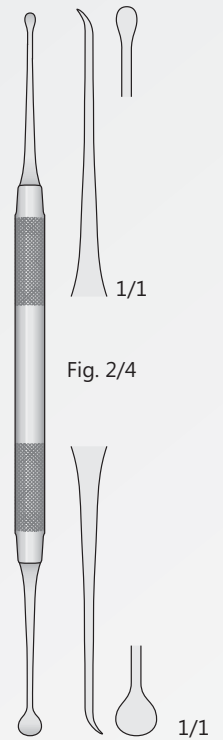

MOLT  
**1214-BA**  
180 mm

Bevel IN  
Fig.1



OCHSENBEIN-1  
**141802-B**  
165 mm

Bevel OUT  
Fig.2



OCHSENBEIN-2  
**141802-C**  
165 mm

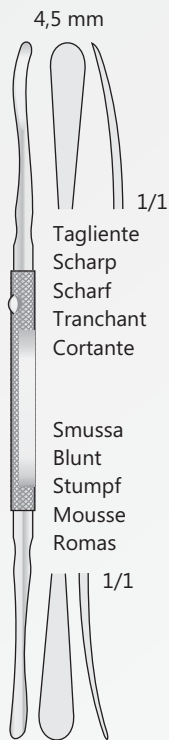

**0617050517**  
180 mm

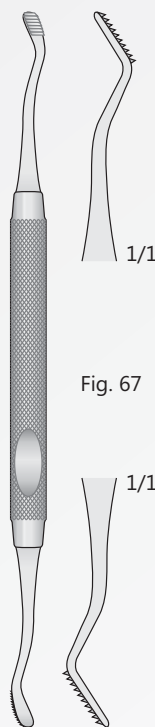

HOWARD  
**0414-B**  
180 mm

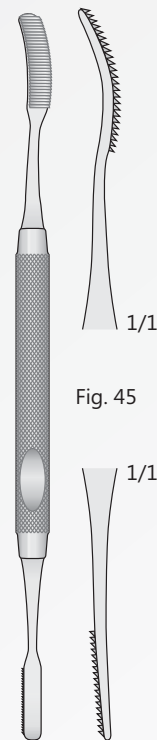

MILLER  
**0414-C**  
185 mm

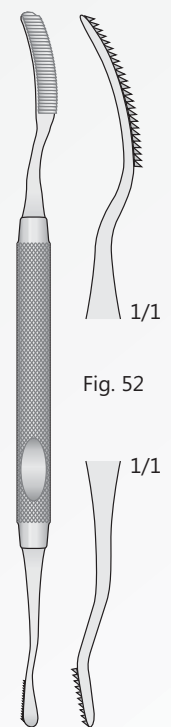

MILLER  
**0414-D**  
180 mm

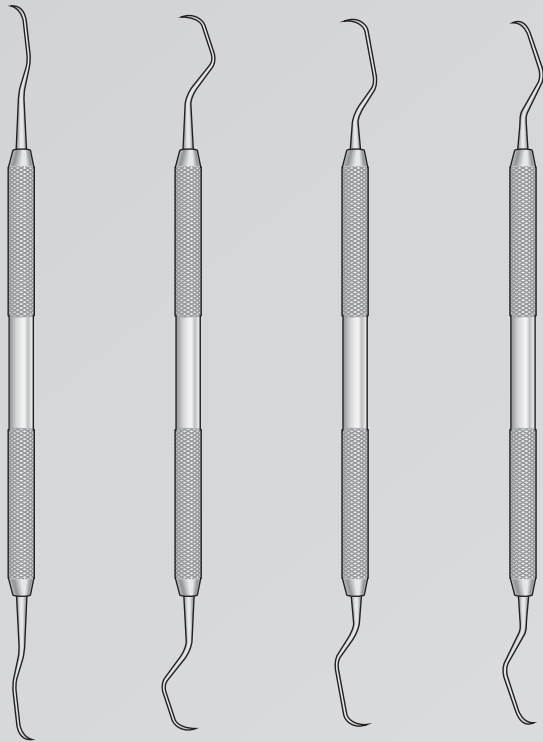

GRACEY  
**0320-B/C**

GRACEY  
**0320-D/E**

GRACEY  
**0320-F/G**

GRACEY  
**0320-H/I**

Leere Griff Ø 8,0 mm  
 Empty handle Ø 8.0 mm  
 Manico Vuoto Ø 8,0 mm  
 Mango vacío Ø 8,0 mm  
 Poignée vide Ø 8,0 mm

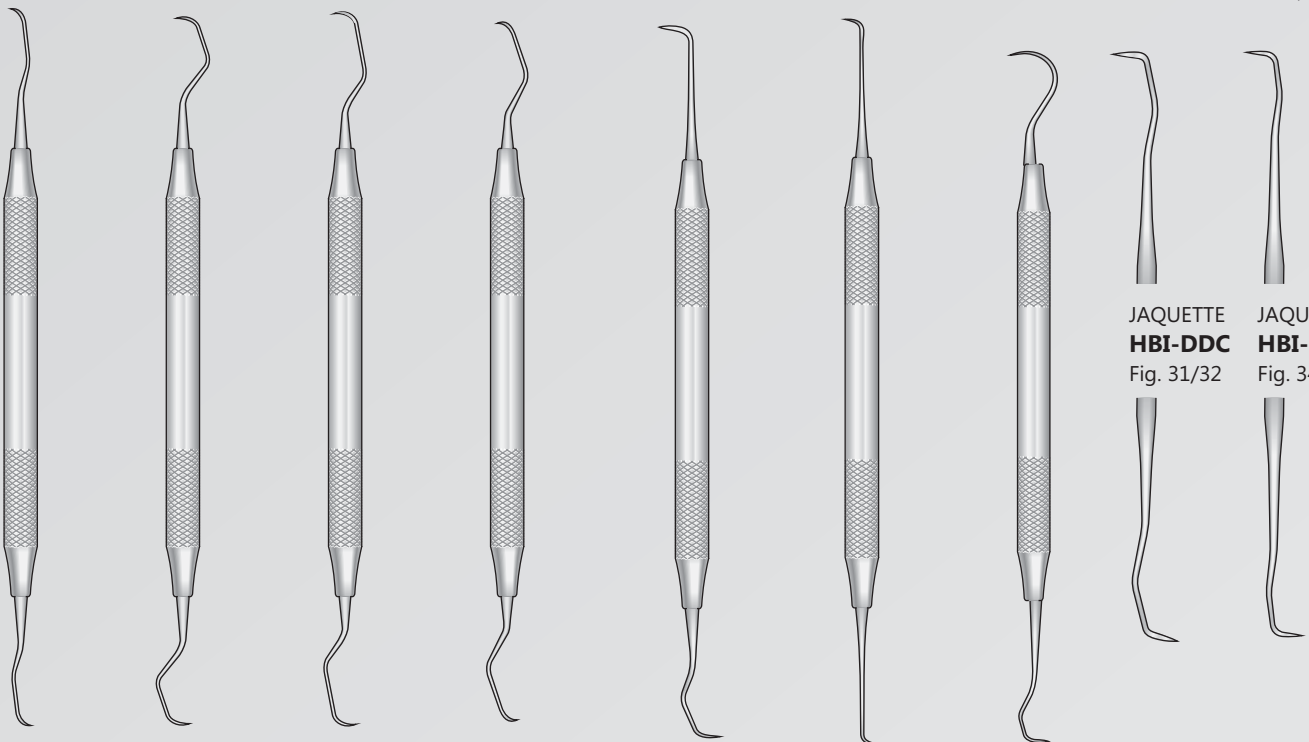

GRACEY  
**HBI-B/C**

GRACEY  
**HBI-D/E**

GRACEY  
**HBI-F/G**

GRACEY  
**HBI-H/I**

GOLDMAN-FOX  
**HBI-CHB**  
 Fig. 1

GOLDMAN-FOX  
**HBI-CHH**  
 Fig. 21

TOWNER-JAQUETTE  
**HBL-BBB**  
 Fig. U15/33

JAQUETTE  
**HBI-DDC**  
 Fig. 31/32

JAQUETTE  
**HBI-DDF**  
 Fig. 34/35



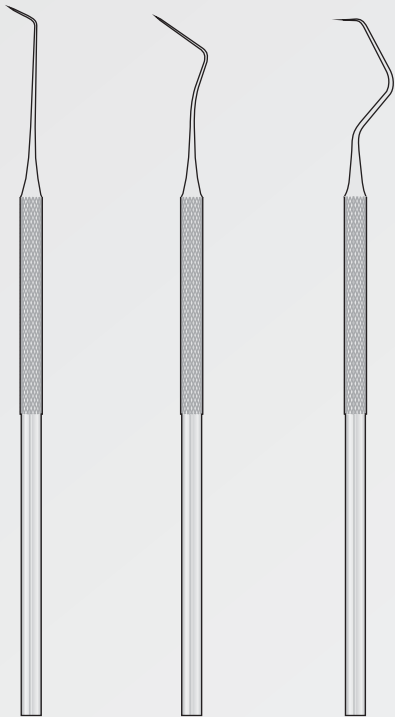

**1814-D**  
Fig. 6

**1814-E**  
Fig. 9

**1814-BA**  
Fig. 17A

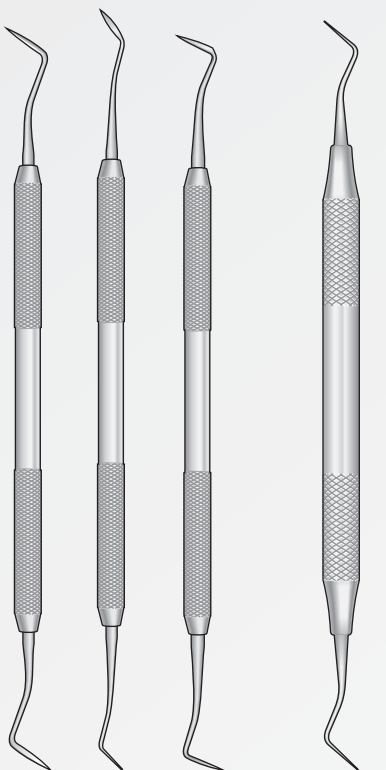

**17-B**

**17-C**

**17-D**

**HOLLENBACK**  
**HBF-BAB**

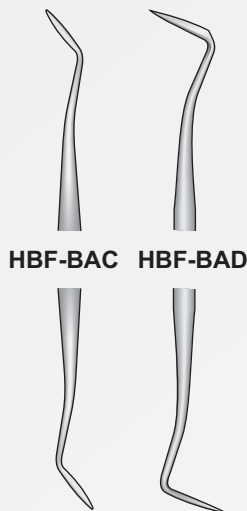

**HBF-BAC** **HBF-BAD**



**WILLIAMS**  
**1812-B**



**MERRIT B**  
**1812-D**



**GOLDMAN-FOX**  
**1812-E**

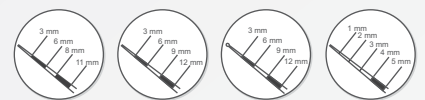

Flach  
Flat  
Piatta



**CP-11**  
**1812-BB**  
160 mm



**CP-12**  
**1812-BC**  
160 mm



**CP-12S**  
**1812-BD**  
160 mm

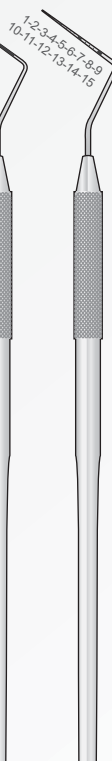

**CP-15UNC**  
**1812-BF**  
160 mm

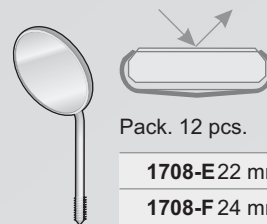

Pack. 12 pcs.

**1708-E** 22 mm

**1708-F** 24 mm

Rhodiumspiegel  
Rhodium Mirror  
Specchietto rodiato  
Espejo de rodio  
Miroir au rhodium



Massiv  
Solid  
Pieno  
Sólido  
Massif

Rostfrei  
Stainless  
Inox  
Inoxidable  
Inoxydable

**1201-B**  
120 mm



Massiv  
Solid  
Pieno  
Sólido  
Massif

Rostfrei  
Stainless  
Inox  
Inoxidable  
Inoxydable

**1201-C**  
125 mm



Hohl  
Hollow  
Vuoto  
Hueco  
Creux

Rostfrei  
Stainless  
Inox  
Inoxidable  
Inoxydable

**1201-D**  
125 mm



Pack. 12 pcs.

**15-D** 18 mm

**15-E** 22 mm

**15-F** 24 mm

Plan  
Plane  
Piano  
Planos  
Plans



Pack. 12 pcs.

**07-D** 18 mm

**07-E** 22 mm

**07-F** 24 mm

Hohl-Vergrößernd  
Concave with enlarging effect  
Concavo con ingrandimento  
Còncavo con efecto de aumento  
Creux avec effect agrandissant



 ideal-tek

Chirurgische Instrumente für große Tiere  
Surgical Instruments for big animals  
Strumenti chirurgici per grandi animali  
Instrumentos Quirúrgicos para animales grandes  
Instruments chirurgicaux pour les grands animaux



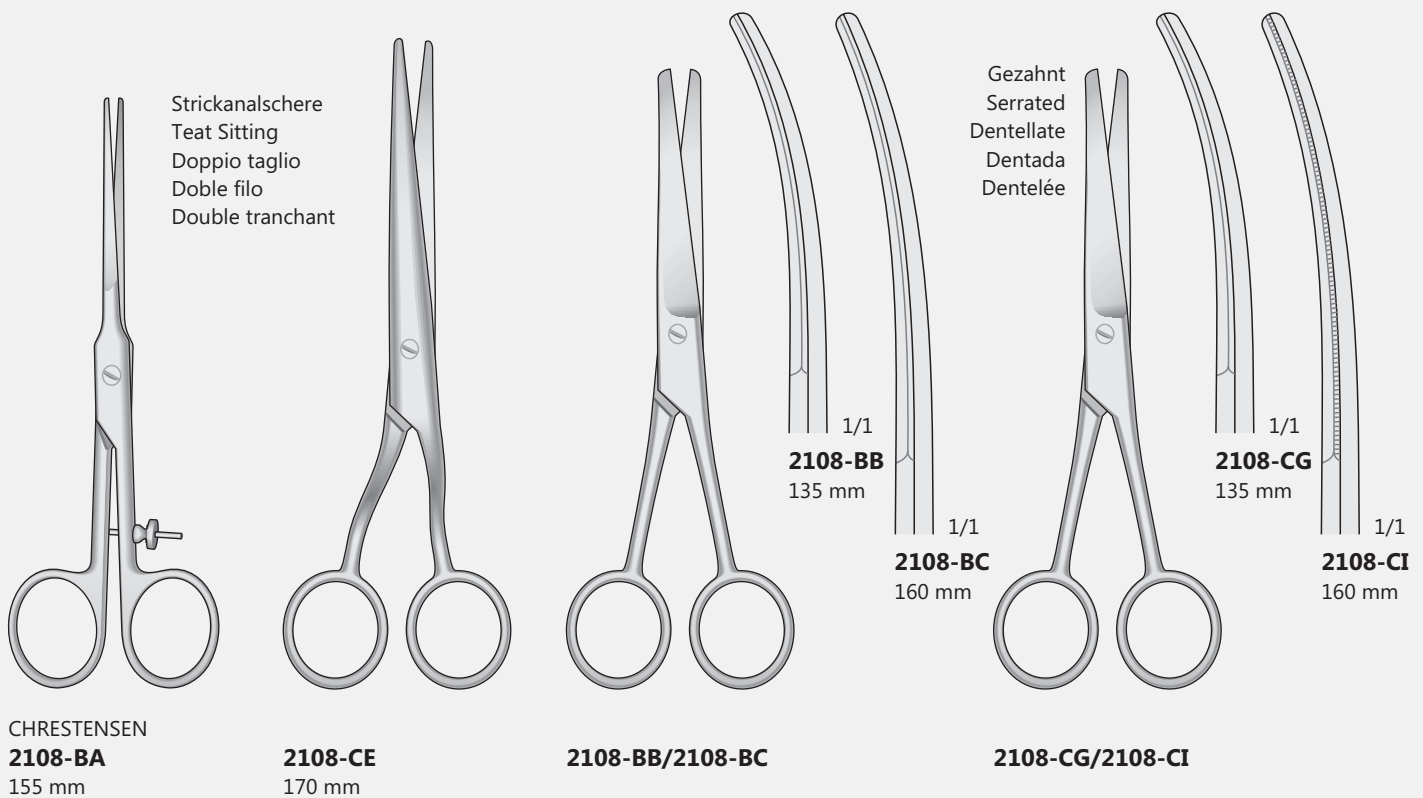
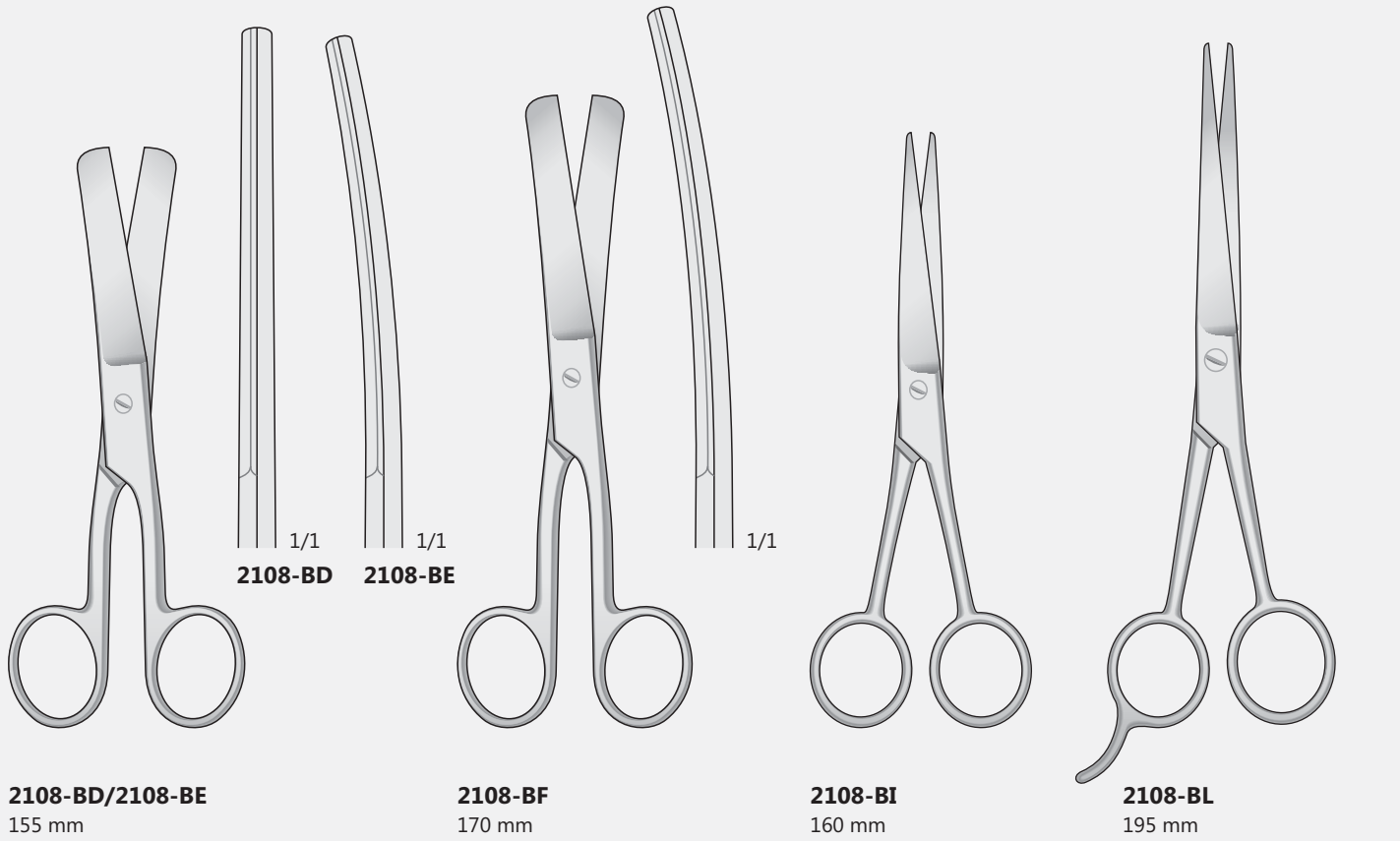

Bull Holders

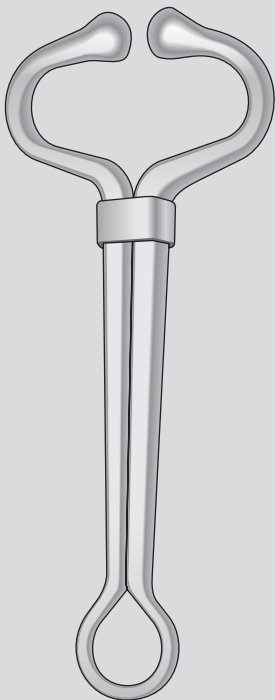

HARMS  
**2106-DI**  
 200 mm

Bull Holders

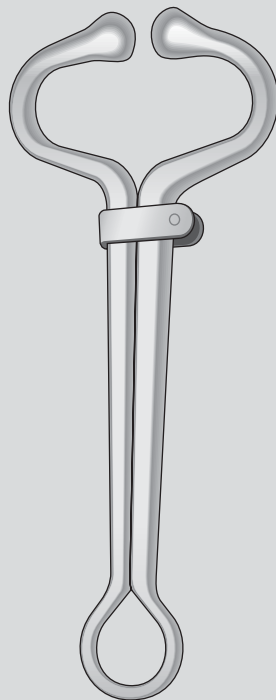

HARMS  
**2106-DL**  
 200 mm

Pig Ring Applicator  
 Applicatore di anelli per suini

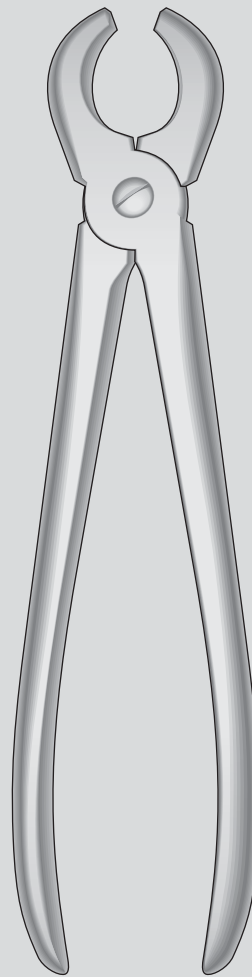

**2106-CF**  
 265 mm

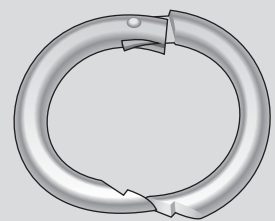

Schweinerüsselringe  
 Pig Ring  
 Anello per suini  
 Narigon  
 Anneau pour les porcs

Innendurchmesser  
 Inside Diameter  
 Diametro interno  
 Diámetro interno  
 Diamètre interne  
**28,0 mm**

**2106-CG**

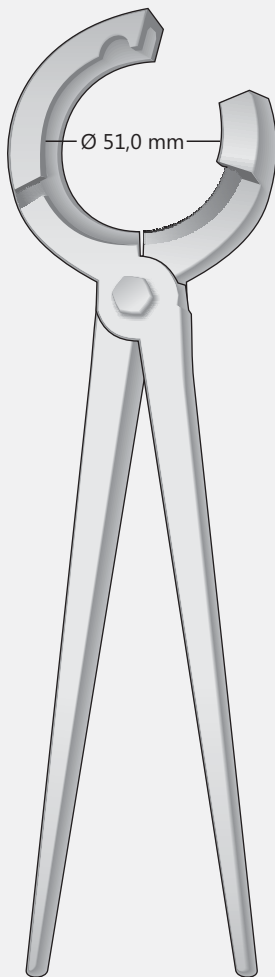

**2106-DC**  
 320 mm

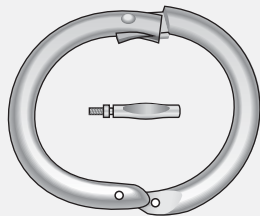

**2106-DH**  
 Innendurchmesser  
 Inside Diameter  
 Diametro interno  
 Diámetro interno  
 Diamètre interne  
**51,0 mm**

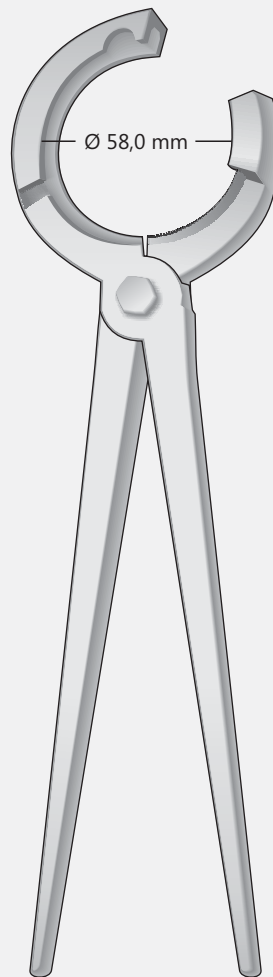

**2106-FA**  
 320 mm

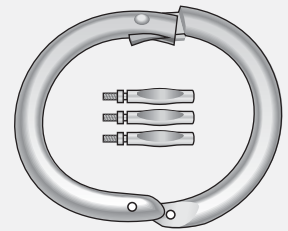

**2106-CI**  
 Innendurchmesser  
 Inside Diameter  
 Diametro interno  
 Diámetro interno  
 Diamètre interne  
**58,0 mm**

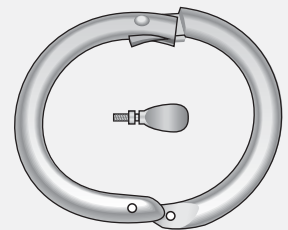

**2106-CL**  
 Innendurchmesser  
 Inside Diameter  
 Diametro interno  
 Diámetro interno  
 Diamètre interne  
**58,0 mm**

Instrumente für große Tiere  
 Instruments for big animals  
 Strumenti per grandi animali  
 Instrumentos para animales grandes  
 Instruments pour les grands animaux

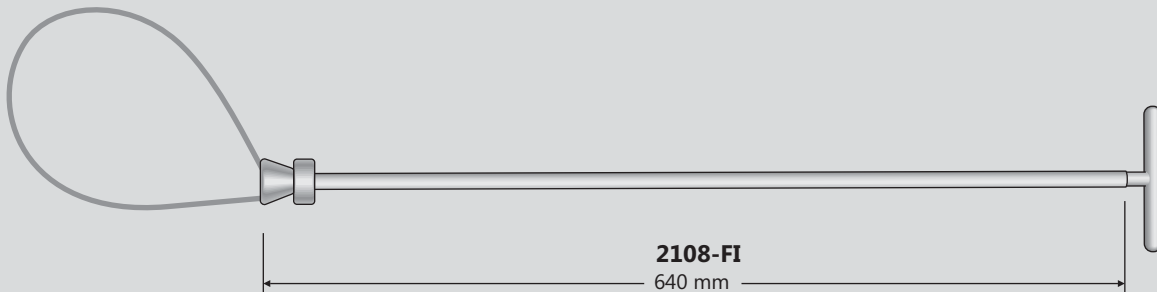

**2108-FI**  
640 mm

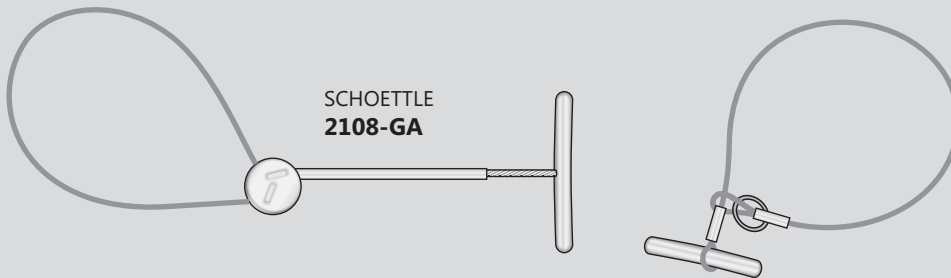

SCHOETTLE  
**2108-GA**

Schlingendrahtbremse für Schweine  
 Wire noose pig holder  
 Laccio per suini  
 Freno nasal para credos  
 Piège pour les porcs

**2108-FL**  
580 mm

Augenkanüle für Pferde  
 Eye Cannula for Horses  
 Cannula lacrimale per cavalli  
 Cánula lagrimal para caballos  
 Canule lacrymale pour les chevaux



TRANA  
**0706-LF**  
160 mm

Malgatter Rostfrei  
 Mouth gags for big animal  
 Apribocca per grandi animali  
 Abrebocas para gran animales  
 Ouvre bouche pour grand animaux

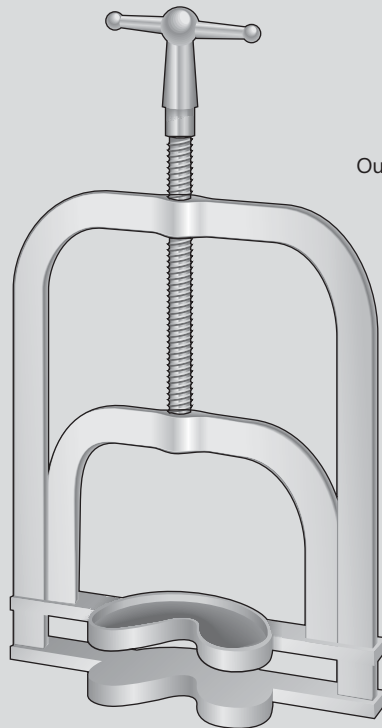

GUNTHER  
**2108-FG**

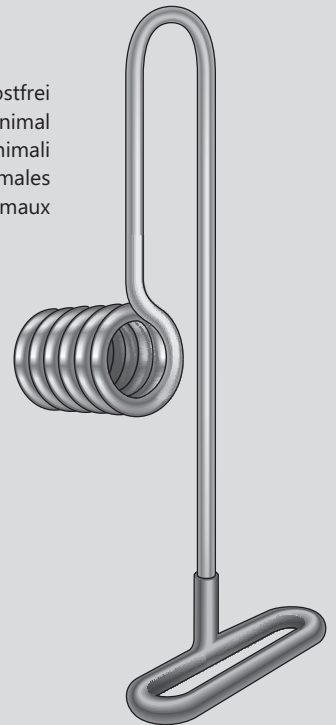

SCHOUPE  
**2108-HE**  
260 mm



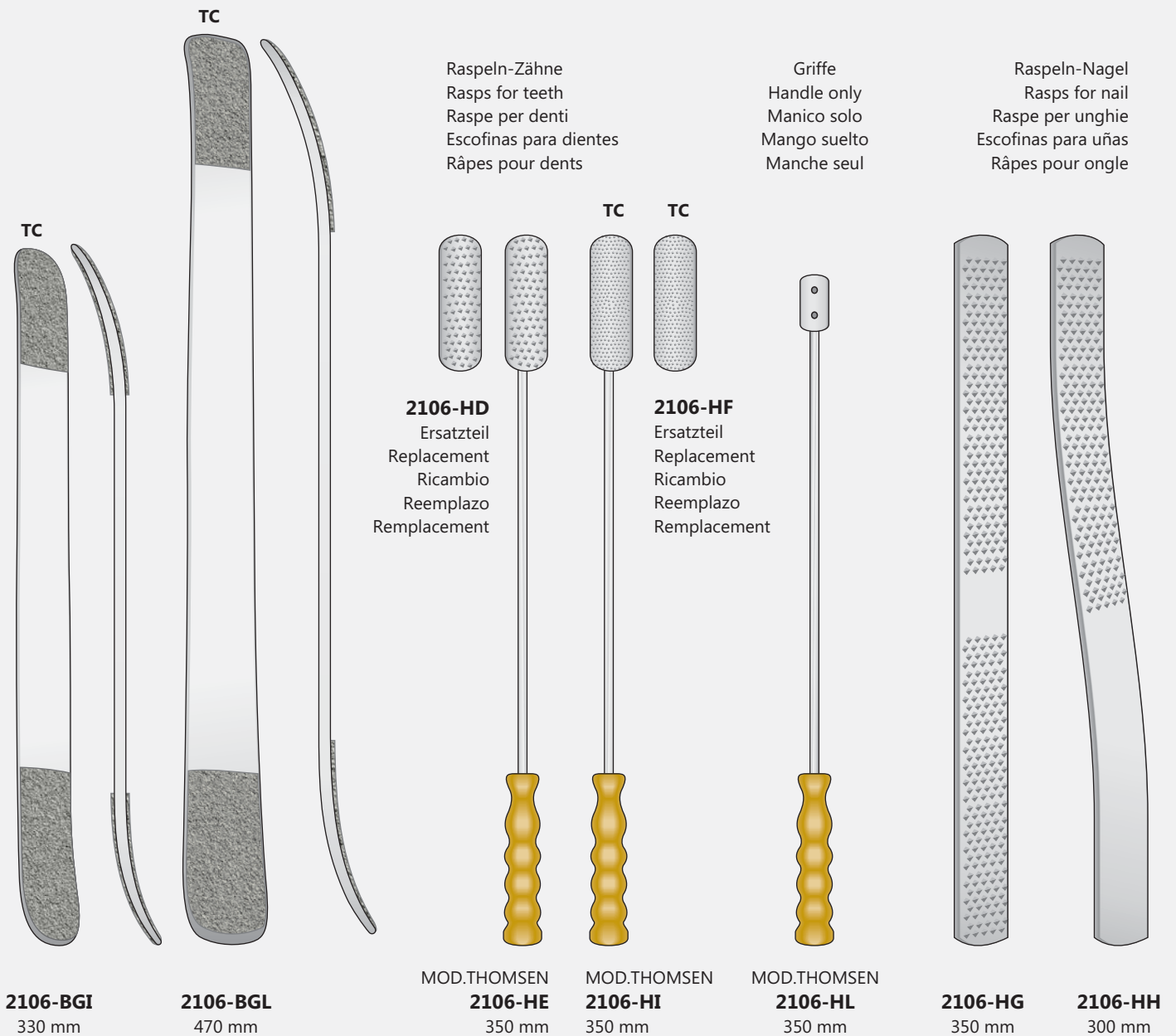

Raspen-Zähne  
Rasps for teeth  
Raspe per denti  
Escofinas para dientes  
Râpes pour dents

Griffe  
Handle only  
Manico solo  
Mango suelto  
Manche seul

Raspen-Nagel  
Rasps for nail  
Raspe per unghie  
Escofinas para uñas  
Râpes pour ongle

**2106-HD**  
Ersatzteil  
Replacement  
Ricambio  
Reemplazo  
Remplacement

**2106-HF**  
Ersatzteil  
Replacement  
Ricambio  
Reemplazo  
Remplacement

MOD.THOMSEN  
**2106-HE**  
350 mm

MOD.THOMSEN  
**2106-HI**  
350 mm

MOD.THOMSEN  
**2106-HL**  
350 mm

**2106-HG**  
350 mm

**2106-HH**  
300 mm

Kastrierzangen  
 Castration forceps  
 Strumenti per castrazione  
 Pinzas para castración  
 Instruments pour la castration

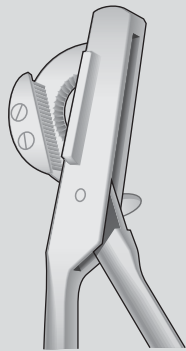

**2106-IL**  
 310 mm  
 With clampings  
 parts

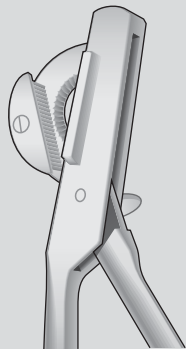
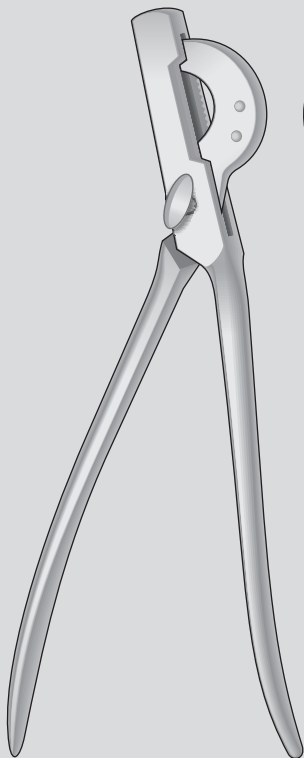

**2106-LA**  
 310 mm  
 With movable  
 clampings parts

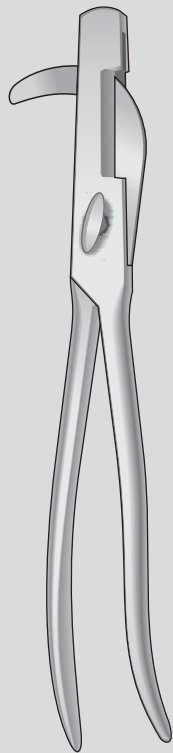

HAUSSMAN  
**2106-IA/2106-ID**

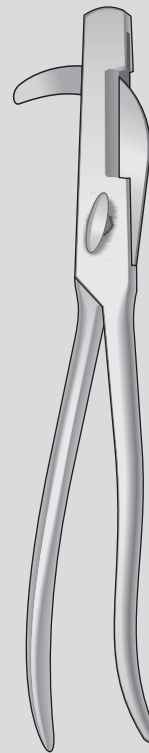

HAUSSMAN  
**2106-IE/2106-IG**



SAND  
**2106-II**  
 310 mm

Griff Gebogen  
 Curved Handles  
 Manico curvo  
 Mango curvo  
 Manche  
 recourbé

**2106-IA**  
 195 mm  
**2106-IB**  
 230 mm  
**2106-IC**  
 270 mm  
**2106-ID**  
 330 mm

**2106-IE**  
 185 mm  
**2106-IF**  
 265 mm  
**2106-IG**  
 310 mm

**2106-IL/2106-LA**

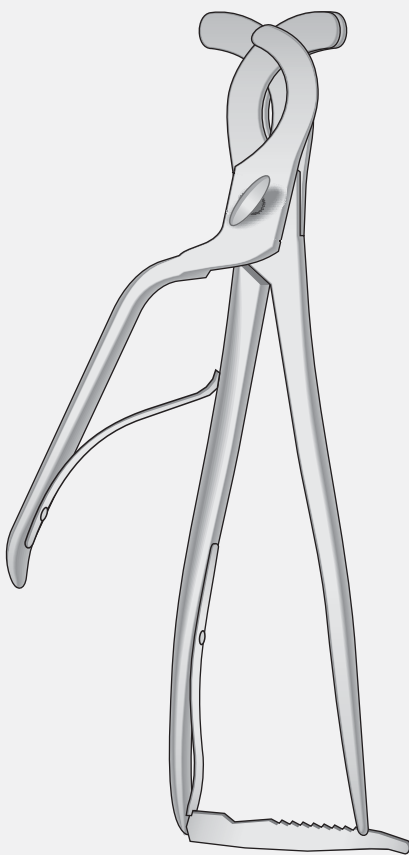

REIMERS  
**2106-DAC**  
310 mm



BERTSCHY  
**2106-DAA**  
360 mm

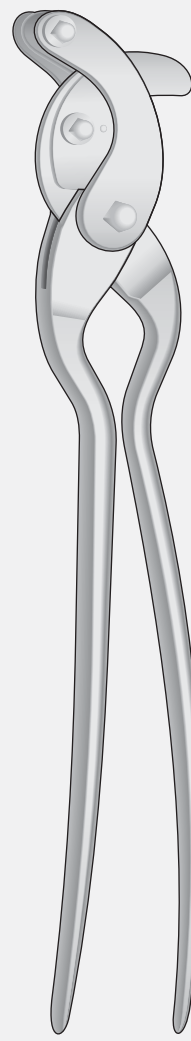

BERTSCHY MOD.  
**2106-DAB**  
350 mm

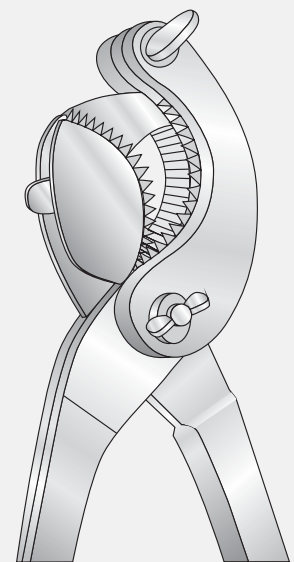

Kastrierzangen  
 Castration forceps  
 Strumenti per castrazione  
 Pinzas para castración  
 Instruments pour la castration

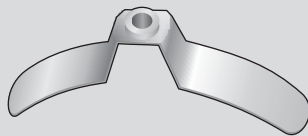

**2106-FF**

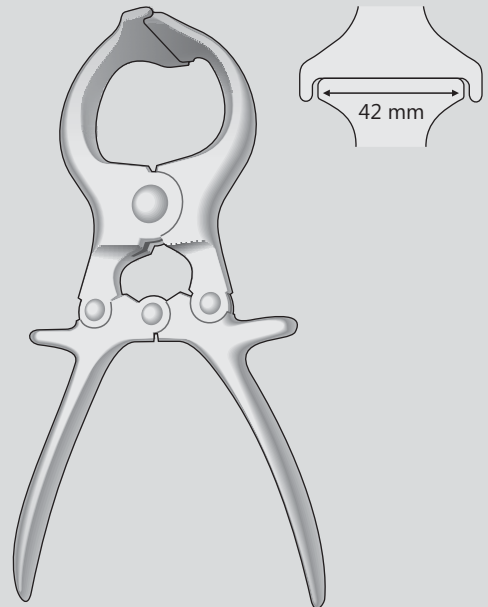

**2106-FG**  
230 mm

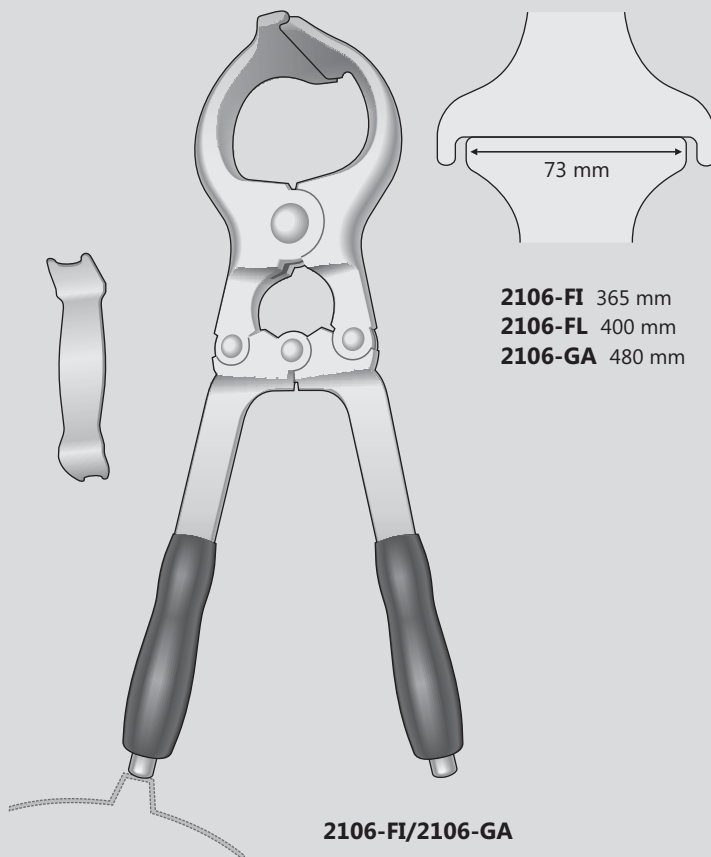

**2106-FI** 365 mm  
**2106-FL** 400 mm  
**2106-GA** 480 mm

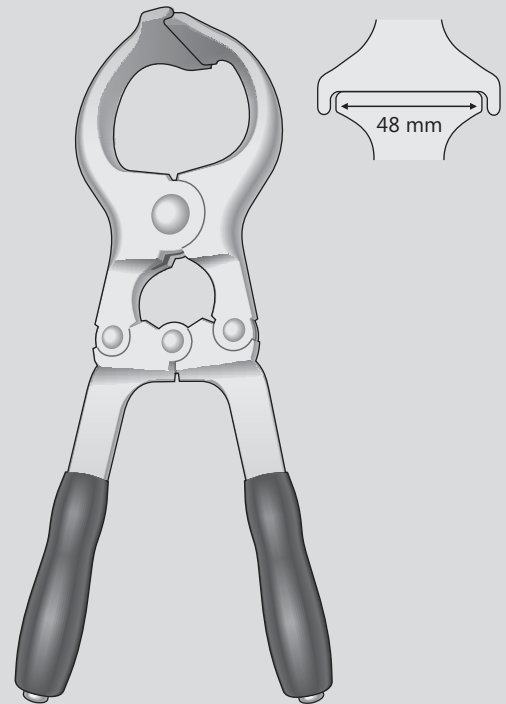

**2106-FH**  
300 mm

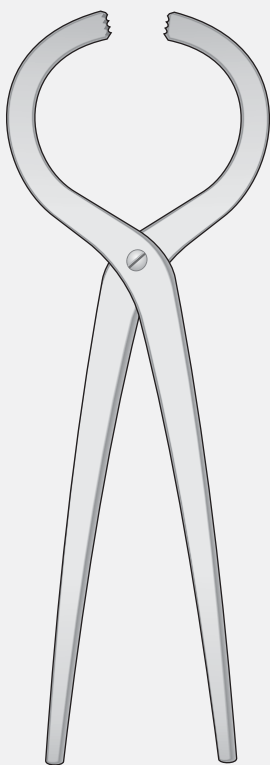

**2106-BG**  
300 mm

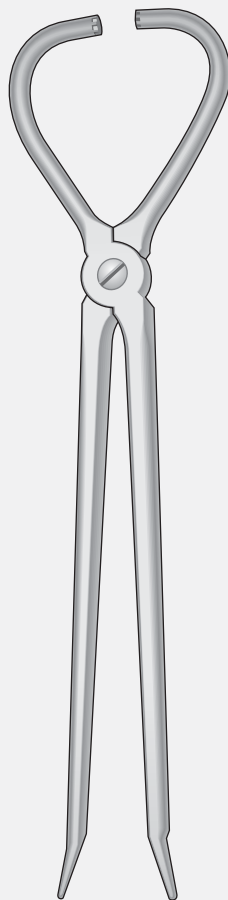

**2106-BH**  
380 mm

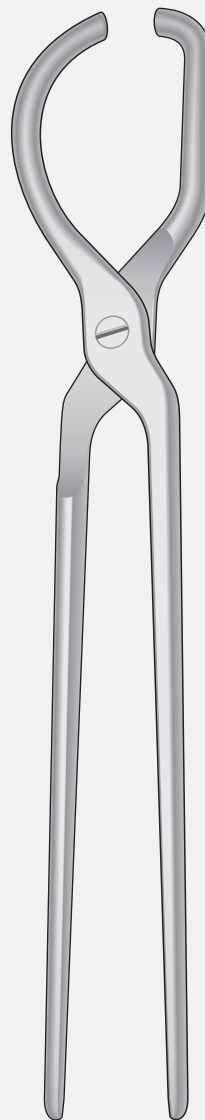

**2106-BF**  
405 mm

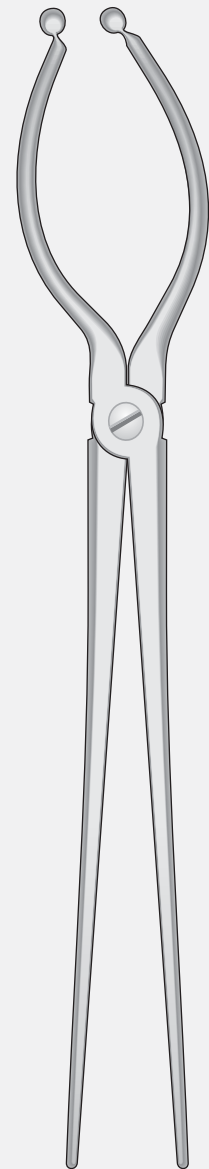

MICHALIK  
**2106-CH**  
425 mm

Hufmesser mit Holzgriff  
 Hoof knives with wooden handle  
 Coltelli per zoccoli con manico in legno  
 Cuchillos para casco con mango de madera  
 Couteaux sabot avec manche en bois



**2106-CAB**  
 Rechts  
 Right  
 Destra  
 Derecha  
 Droit



**2106-CAC**  
 Rechts  
 Right  
 Destra  
 Derecha  
 Droit



**2106-CAD**  
 Links  
 Left  
 Sinistra  
 Izquierda  
 Gauche

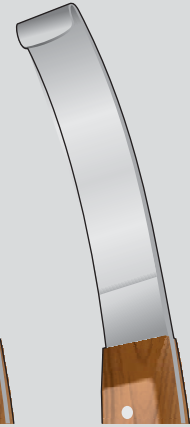

**2106-CAE**  
 Links  
 Left  
 Sinistra  
 Izquierda  
 Gauche



Holzgriff  
 Wooden Handle  
 Manico in legno  
 Mango de madera  
 Manche en bois

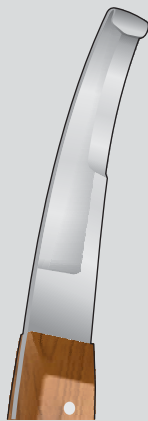

**2106-CAH**  
 Doppelschneidig  
 Double Cutting  
 Doppio taglio  
 Filo doble  
 Double Coupe

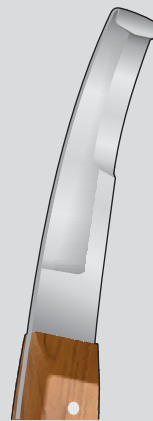

**2106-CAI**  
 Doppelschneidig  
 Double Cutting  
 Doppio taglio  
 Filo doble  
 Double Coupe

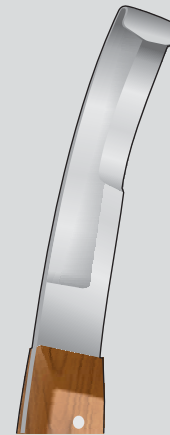

**2106-CAL**  
 Doppelschneidig  
 Double Cutting  
 Doppio taglio  
 Filo doble  
 Double Coupe

200 mm



WEINGART  
**2106-LF**  
 280 mm

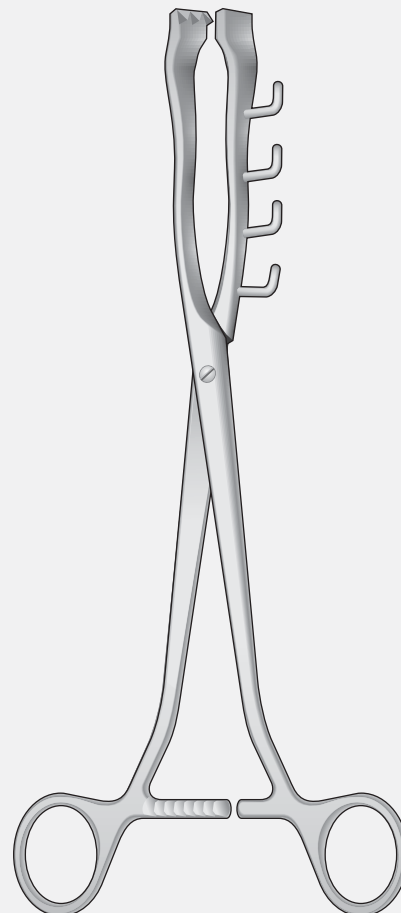

WEINGART  
**2106-LH**  
 240 mm



WEINGART  
**2106-LL**  
 80 mm

**2106-BAA**  
 Komplet-Set  
 Complete Set  
 Set completo  
 Serie completa  
 Set complet

**2106-LF** - 1 pcs.  
**2106-LH** - 1 pcs.  
**2106-LL** - 8 pcs.

Hakenzangen  
 Uterine Forceps  
 Pinze uterine  
 Pinzas para útero  
 Pincas utérine

Nickelplated

Vulselum Forceps  
 Pinza uterina

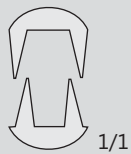

Paar Ersatzgummi  
 Pair of Rubber Pads  
 Coppia di gommini di ricambio

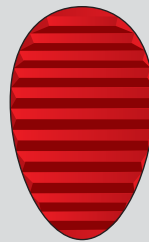

**2106-BEB**  
 Ricambio

Forceps for Rumenotomy  
 Pinza per Ruminotomia

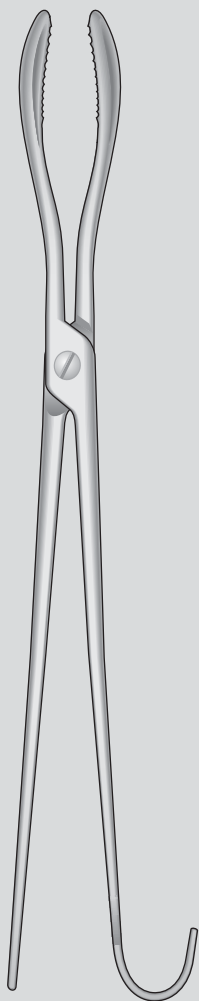

WITT-GERTH  
**2106-LC**  
 450 mm

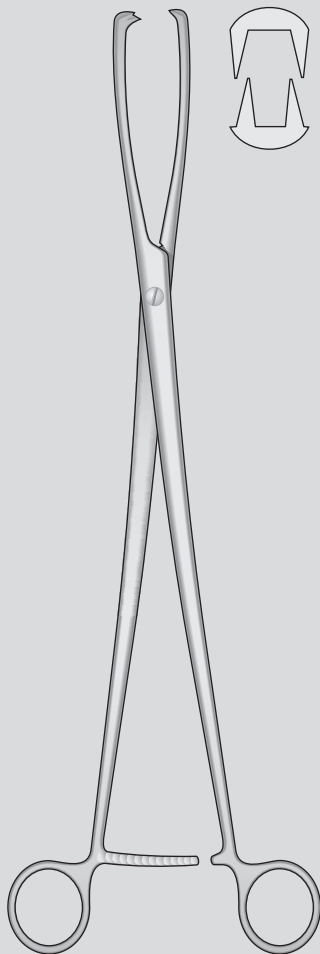

ALBRECHTSEN  
**2106-LE**  
 430 mm

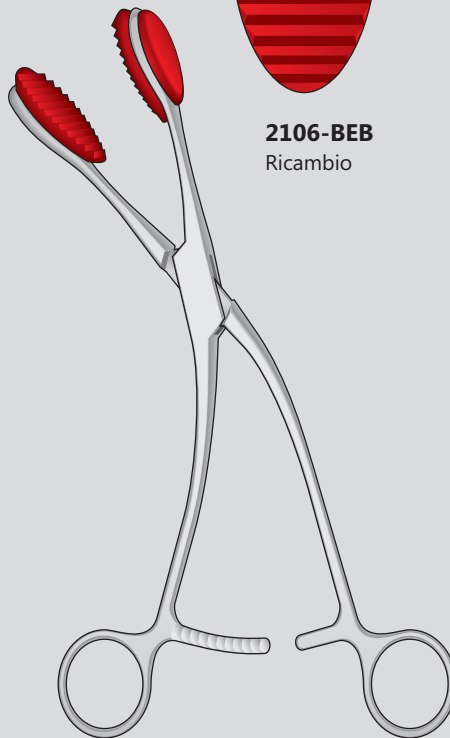

YOUNG  
**2106-BEA**  
 280 mm

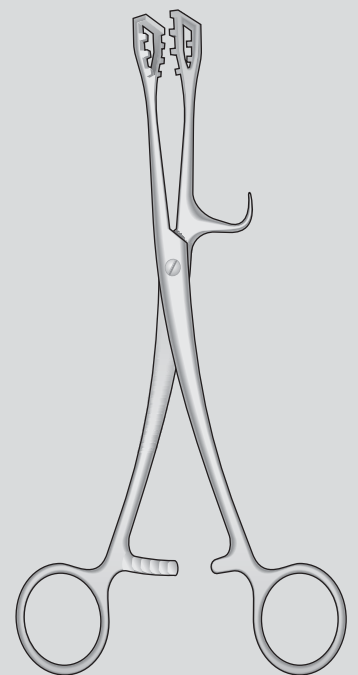

BLERNDINGER  
**2106-LG**  
 195 mm



Nadel zum Einziehen  
 von Schneidenschlingen  
 Needles for inserting  
 vulva sutures  
 Ago passante per  
 suturare la vulva  
 Aguja para suturar la vulva  
 Aiguille pour suturer la vulve

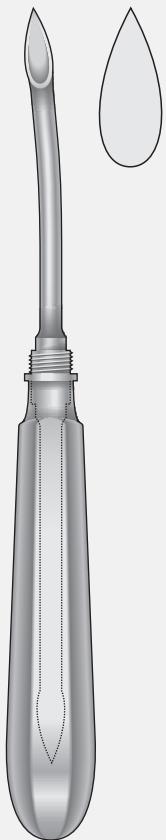

**2106-BFA**  
200 mm



**2106-BBF**  
800 mm



**2106-BBL**  
440 mm



**2106-BBI**  
440 mm



**2106-BFB**  
100 mm

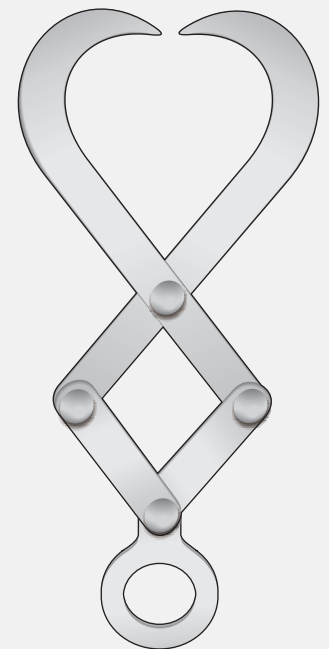

KREY SCHÖTTLER  
**2106-HA**  
210 mm

Geburtshaken  
 Obstetric Hook  
 Gancio aiuto parto  
 Gancho para obstetricia  
 Crochette de parturition

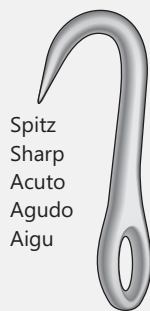

Spitz  
 Sharp  
 Acuto  
 Agudo  
 Aigu

HARMS  
**2106-HB**  
80 mm

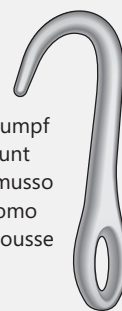

Stumpf  
 Blunt  
 Smusso  
 Romo  
 Mousse

HARMS  
**2106-HC**  
80 mm



GUNTHER  
**2106-BAI**  
65 mm



LINDE  
**2106-BAH**  
115 mm

Haken mit 4 Verbindungen für Rückzug Totgeburt  
 Hook with 4 joints for withdrawal stillbirth  
 Gancio a 4 snodi per prelevamento feto morto  
 Crochet avec 4 joints pour retrait de mortinatalité  
 Gancho con 4 articulaciones para retirada muerte fetal

Scheidenspekula  
 Vaginal Speculum  
 Speculum vaginali  
 Espéculos vaginales  
 Spéculum vaginaux

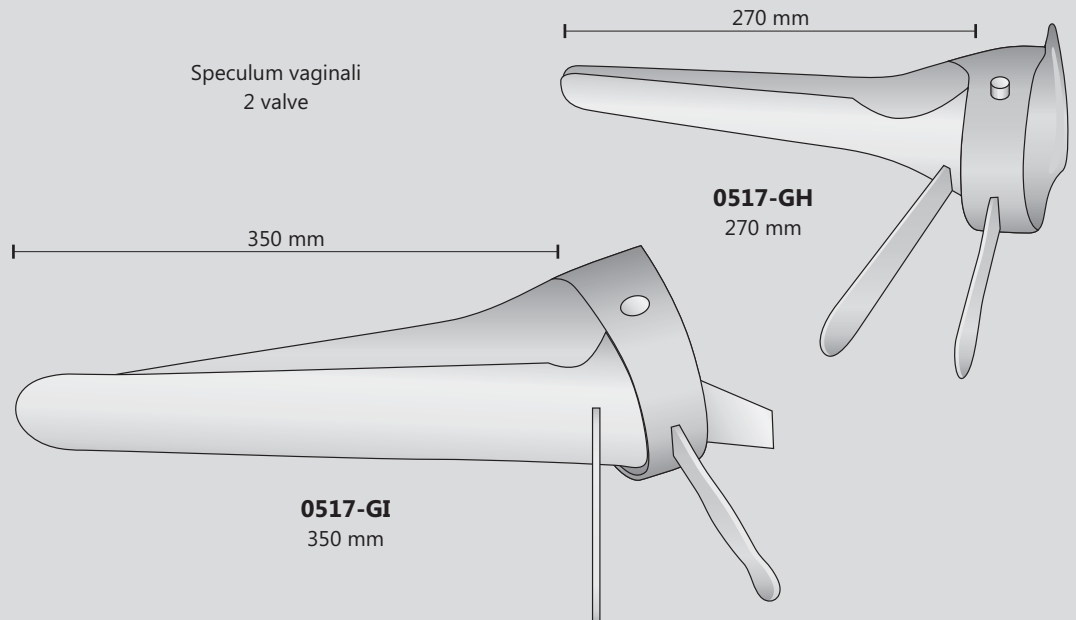

Speculum vaginale 3 valve per grandi animali  
**Inox**

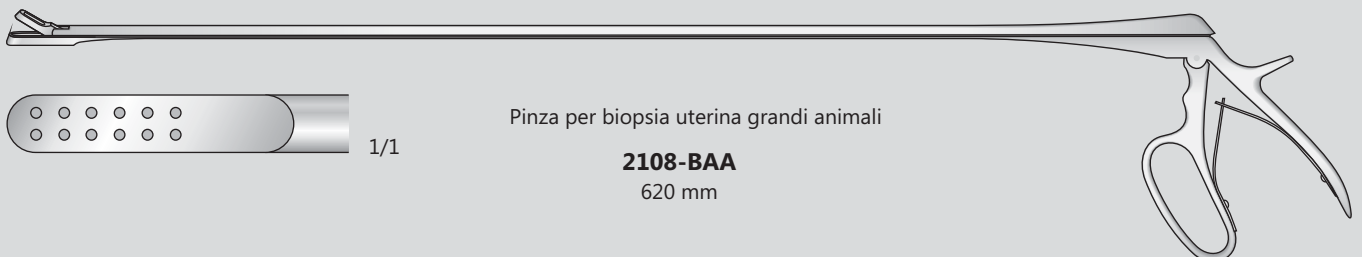
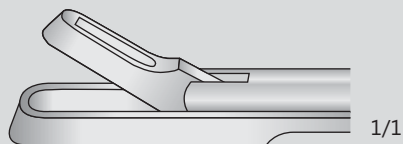
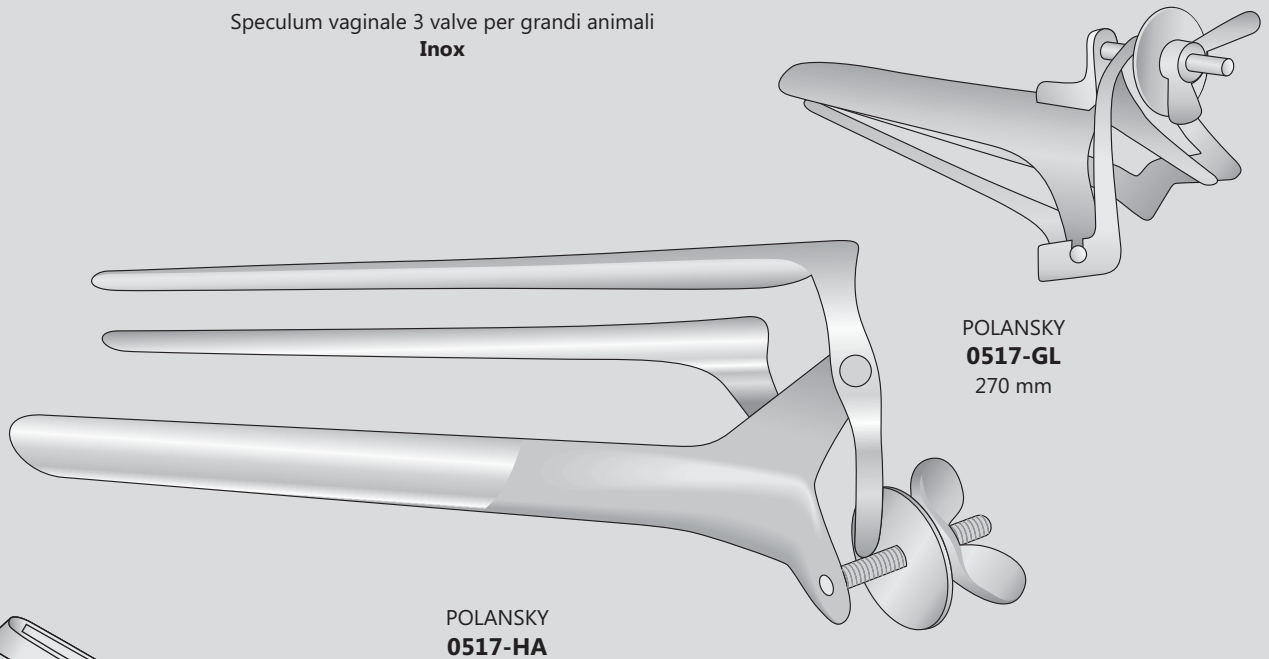

Schlingenführer Embryotomy  
 Wire and Rope carriers Obstetric instruments  
 Strumenti per ostetricia  
 Instrumentos para obstetricia  
 Instruments pour l'obstétrique

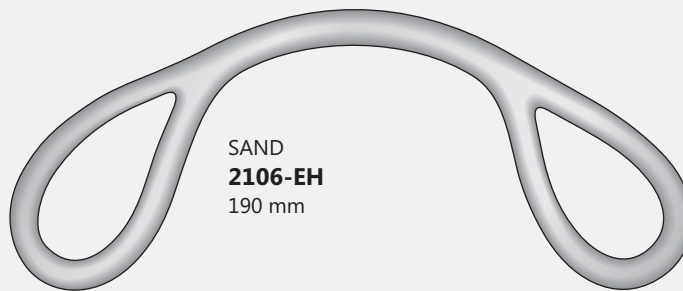

SAND  
**2106-EH**  
 190 mm

Leichtes Modell  
 Light model  
 Modello leggero



SAND  
**2106-EI**  
 190 mm

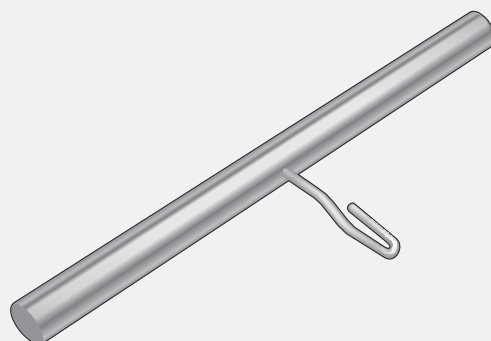

**2106-GL**  
 250 mm

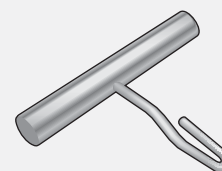

**2106-GI**  
 100 mm

Mit einer Klinge gezahnt  
With one blade serrated  
Con una lama dentellata  
Con una hoja dentada  
Avec une lame dentelée

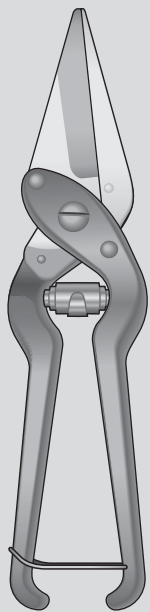

**2108-DA**  
240 mm

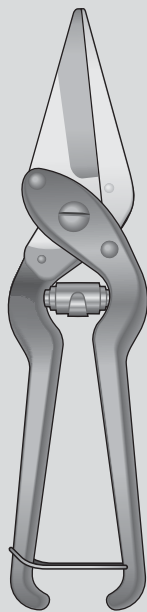

**2108-DB**  
240 mm

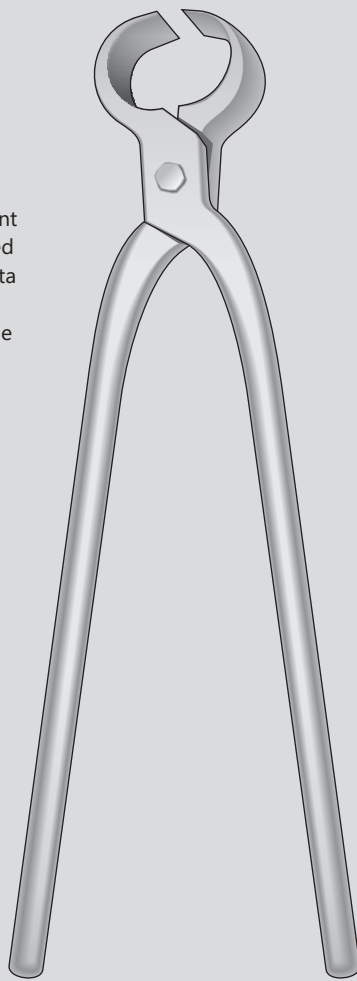

FRANK  
**2108-DC**  
400 mm

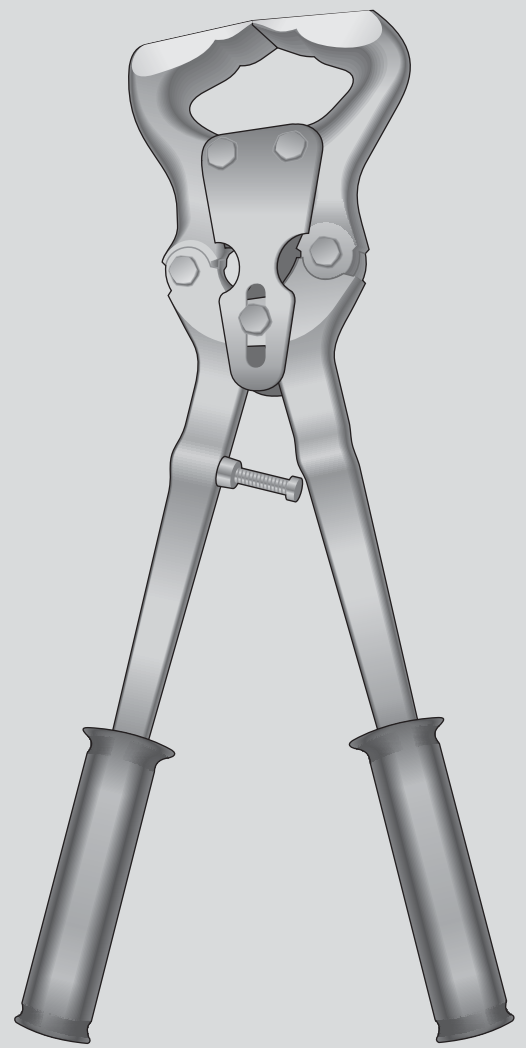

**2106-FC**  
420 mm

Guaranteed exact dosage  
Movement of the lever means a volume of 0,1 ml  
È garantito l'esatto dosaggio  
Movimento del punto intermedio a volume di 0,1 ml

**TBC**

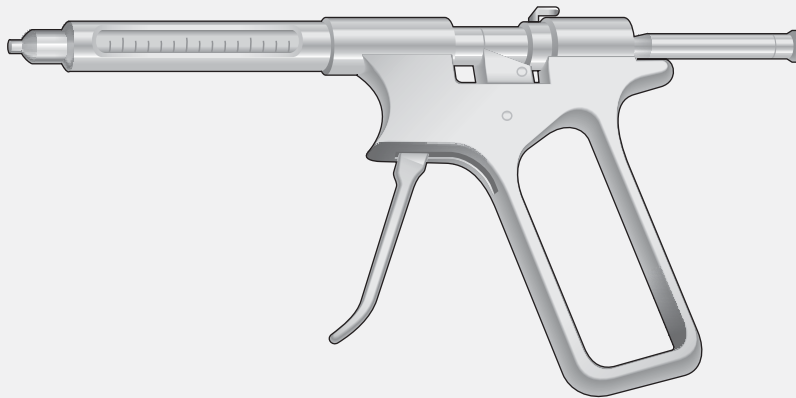

JECT TBC  
**1821-CB**

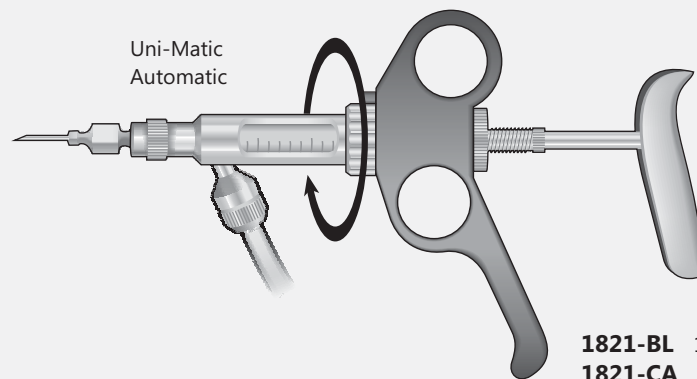

Uni-Matic  
Automatic

**1821-BL** 1 ml  
**1821-CA** 2 ml

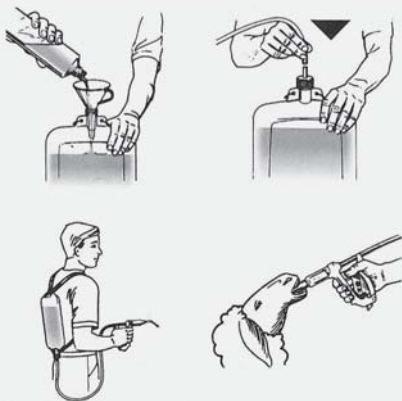

Drench-Matic 20

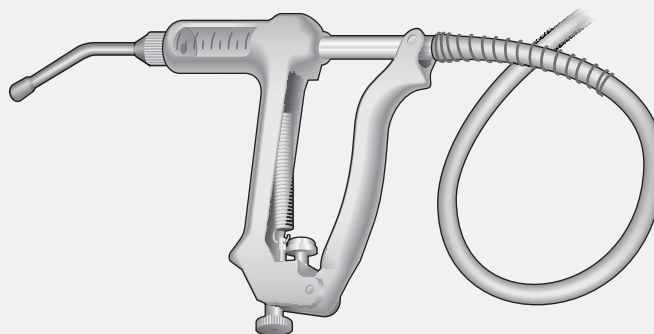

**1821-BI** Completo di sacca di plastica 2,5 lt.  
**1821-BI18** Accessorio sacca di plastica 2,5 lt.

Dosierspritzen  
 Dosing Syringe  
 Siringhe per dosaggi  
 Jeringas dosificadoras  
 Seringues pour des doses

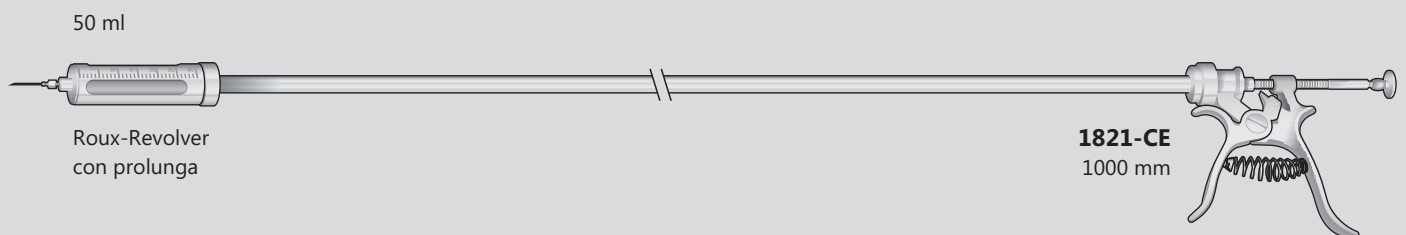

**1821-BC/17B**

Ersatzteil-Set, Dichtung und Pumpe  
 Replacement set, seal and pump  
 Set di ricambio, due guarnizioni e pistone  
 Repuesto set 2 adorno y piston  
 Rechange set 2 garnitures et piston

**1821-BD/17B**

Ersatzzylinder aus Glas für SV-13, 50 ml  
 Replacement glass cylinder for SV-13, 50 ml  
 Ricambio cilindro in vetro per SV-13, 50ml  
 Repuesto vidrio para SV-13, 50 ml  
 Rechange en verre pour SV-13, 50 ml

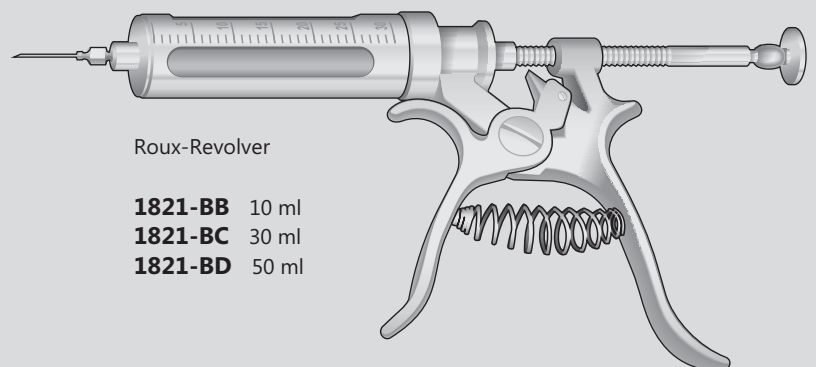

Vet-Matic M/91

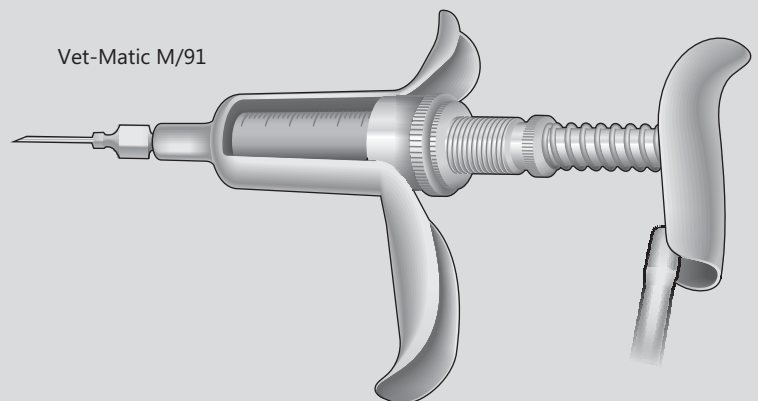

**1821-BF** 5 ml  
**1821-BG** 10 ml

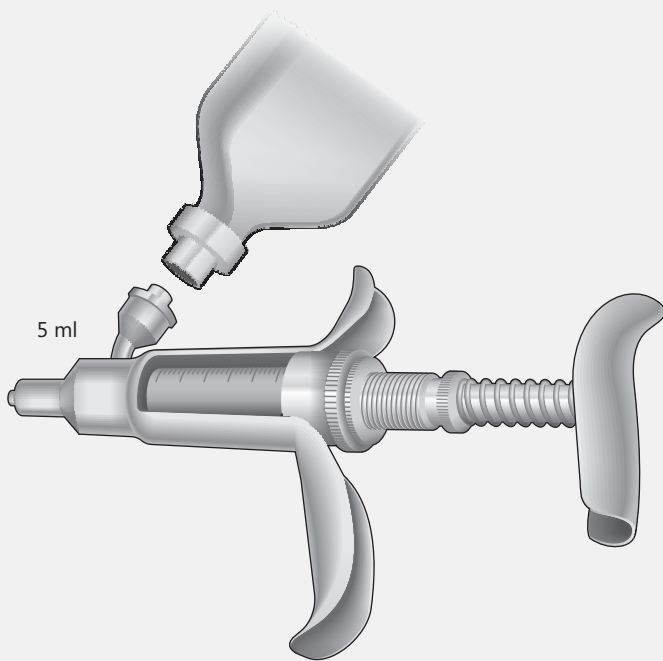

5 ml

**1821-BH**

**Premium**

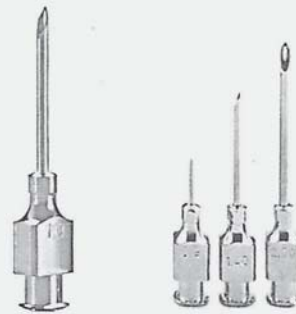

Luer Lock

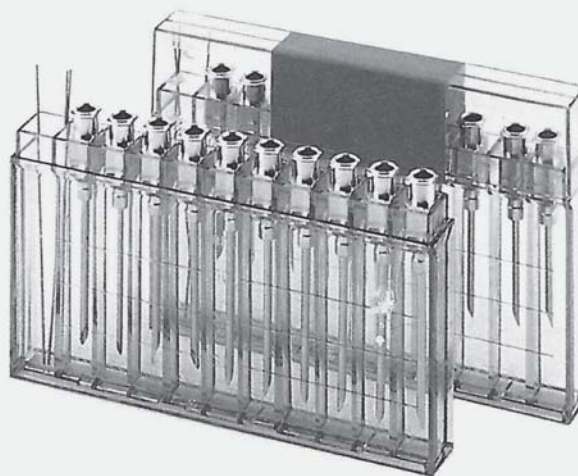

Packung mit 10 Stück  
Pack of 10 pieces  
Confezione 10 pezzi  
Paquete de 10 piezas  
Pack de 10 pièces

Nadel	Maß
Needle	Measure
Ago	Misura
Aguja	Medida
Aiguille	Mesure

- 1111-AB** 0,80x10
- 1111-AC** 0,80x25
- 1111-AD** 0,90x10
- 1111-AE** 0,90x15
- 1111-AF** 0,90x20
- 1111-AG** 0,90x25
- 1111-AH** 0,90x35
- 1111-AI** 100x10
- 1111-AL** 100x15
- 1111-BA** 100x20
- 1111-BB** 120x15
- 1111-BC** 120x20
- 1111-BD** 120x25
- 1111-BE** 140x15
- 1111-BF** 140x20
- 1111-BG** 140x25
- 1111-BH** 140x35
- 1111-BI** 160x15
- 1111-BL** 160x20
- 1111-CA** 160x25
- 1111-CB** 160x35
- 1111-CC** 180x15
- 1111-CD** 180x20
- 1111-CE** 180x25
- 1111-CF** 180x35
- 1111-CG** 200x20
- 1111-CH** 200x25
- 1111-CI** 200x35
- 1111-CL** 140x30
- 1111-DA** 160x30
- 1111-DB** 180x30
- 1111-DC** 200x15
- 1111-DD** 200x30

Punch per orecchio

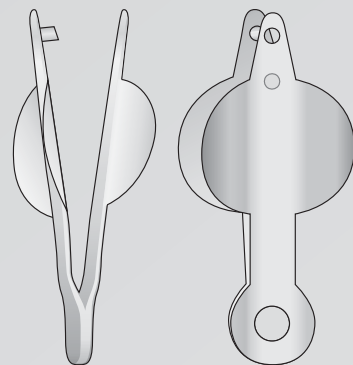

**0204-BFA**  
50 mm

Lama ricambio

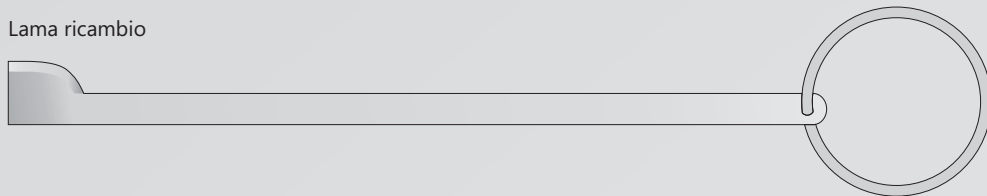

**2106-BIB**  
150 mm

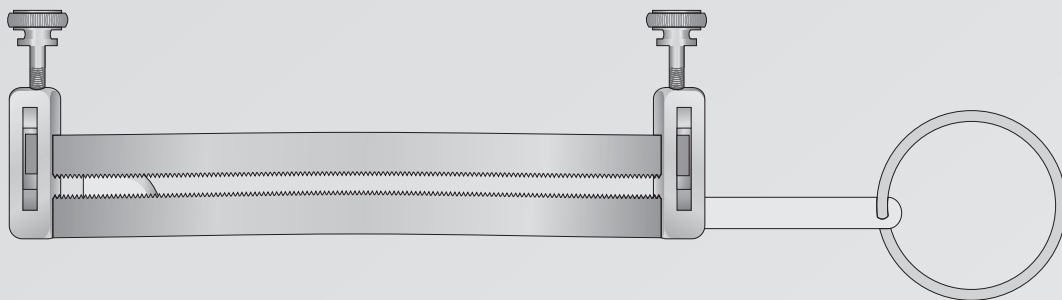

**2106-BIA**  
130 mm





 ideal-tek

Nummernverzeichnis  
Alphanumerical Index  
Indice alfanumerico  
Indice alfanumerico  
Index alphanumérique



<b>B</b>	333	<b>0101-FAA</b>	6	<b>0204-CB</b>	73	<b>0204-LC</b>	65
<b>C</b>	333	<b>0101-FAB</b>	6	<b>0204-CC</b>	77	<b>0204-LD</b>	65
<b>H</b>	333	<b>0101-FAC</b>	6	<b>0204-CD</b>	66	<b>0204-LF</b>	73
<b>BD</b>	336	<b>0101-FAD</b>	6	<b>0204-CE</b>	66	<b>0204-LG</b>	63, 296
<b>CL</b>	334	<b>0101-FAE</b>	6	<b>0204-CF</b>	66	<b>0204-LH</b>	66
<b>DA</b>	334	<b>0101-02BAA</b>	3, 4, 5	<b>0204-CG</b>	66	<b>0204-LI</b>	66
<b>DD</b>	336	<b>0101-02BAB</b>	3, 4, 5	<b>0204-CH</b>	72	<b>0204-LL</b>	66
<b>EB</b>	336	<b>0101-18BAD</b>	3	<b>0204-CI</b>	71	<b>0204-BAA</b>	66
<b>EF</b>	336	<b>0101-18BAE</b>	3	<b>0204-CL</b>	72	<b>0204-BAB</b>	77
<b>EG</b>	336	<b>0101-18BAF</b>	3	<b>0204-DA</b>	65	<b>0204-BAC</b>	77
<b>Eg11</b>	337	<b>0101-18CAD</b>	4	<b>0204-DB</b>	65	<b>0204-BAE</b>	69
<b>EI</b>	337	<b>0101-18CAE</b>	4	<b>0204-DC</b>	62, 295	<b>0204-BAF</b>	66
<b>EL</b>	337	<b>0101-18CAF</b>	4	<b>0204-DD</b>	62, 295	<b>0204-BAG</b>	70
<b>FB</b>	335	<b>0101-18CFD</b>	7	<b>0204-DE</b>	62	<b>0204-BAH</b>	70
<b>Fb01</b>	335	<b>0101-18CFE</b>	7	<b>0204-DF</b>	62, 295	<b>0204-BAI</b>	70
		<b>0101-18CFF</b>	7	<b>0204-DG</b>	62, 295	<b>0204-BAL</b>	68
<b>HBD-BAB</b>	278	<b>0101-18EAD</b>	5	<b>0204-DH</b>	72	<b>0204-BBA</b>	68
<b>HBD-BAC</b>	278	<b>0101-18EAE</b>	5	<b>0204-DI</b>	67	<b>0204-BBB</b>	68
		<b>0101-18FAD</b>	6	<b>0204-DL</b>	67	<b>0204-BBC</b>	68
<b>HBF-BAB</b>	351	<b>0101-18FAE</b>	6	<b>0204-EA</b>	62	<b>0204-BBD</b>	68
<b>HBF-BAC</b>	351	<b>0101-18FAF</b>	6	<b>0204-EB</b>	62	<b>0204-BBE</b>	68
<b>HBF-BAD</b>	351			<b>0204-EC</b>	62	<b>0204-BBF</b>	70
		<b>0102-BA</b>	9	<b>0204-ED</b>	62	<b>0204-BBG</b>	70
<b>HBH-BAA</b>	278	<b>0102-BE</b>	9	<b>0204-EE</b>	64	<b>0204-BBH</b>	70
<b>HBH-BAC</b>	278	<b>0102-BG</b>	9	<b>0204-EF</b>	64	<b>0204-BBI</b>	70
<b>HBH-BBC</b>	278	<b>0102-BI</b>	9	<b>0204-EG</b>	64	<b>0204-BBL</b>	70
		<b>0102-DC17</b>	8	<b>0204-EH</b>	64	<b>0204-BCA</b>	61
<b>HBI-B/C</b>	350	<b>0102-EB</b>	8	<b>0204-FA</b>	61	<b>0204-BCC</b>	61
<b>HBI-D/E</b>	350	<b>0102-EB17</b>	8	<b>0204-FB</b>	64	<b>0204-BCD</b>	61
<b>HBI-F/G</b>	350	<b>0102-EG</b>	8	<b>0204-FC</b>	58	<b>0204-BCE</b>	66
<b>HBI-H/I</b>	350	<b>0102-EE17</b>	8	<b>0204-FD</b>	73	<b>0204-BCG</b>	66
<b>HBI-CHB</b>	350	<b>0102-EG17</b>	8	<b>0204-FE</b>	73	<b>0204-BCH</b>	68
<b>HBI-CHH</b>	350	<b>0102-EI</b>	8	<b>0204-FG</b>	295	<b>0204-BCI</b>	69
<b>HBI-DDC</b>	350	<b>0102-EL</b>	8	<b>0204-FH</b>	295	<b>0204-BCL</b>	69
<b>HBI-DDF</b>	350	<b>0102-FA</b>	9	<b>0204-FI</b>	295	<b>0204-BDA</b>	295
<b>HBI-12CD</b>	348			<b>0204-FL</b>	295	<b>0204-BDB</b>	295
<b>HBI-12CD01</b>	348	<b>0118-BA</b>	204	<b>0204-GA</b>	61	<b>0204-BDC</b>	295
<b>HBI-12CD02</b>	348	<b>0118-BG</b>	204	<b>0204-GB</b>	67	<b>0204-BDF</b>	64, 296
		<b>0118-BL</b>	204	<b>0204-GC</b>	61	<b>0204-BDG</b>	64, 296
<b>HBL-BBB</b>	350	<b>0118-CA</b>	204	<b>0204-GD</b>	67	<b>0204-BDH</b>	69
		<b>0118-DB</b>	204	<b>0204-GE</b>	61	<b>0204-BDI</b>	70
<b>01-B</b>	278	<b>0118-DF</b>	204	<b>0204-GF</b>	67	<b>0204-BDL</b>	70
		<b>0118-DG</b>	204	<b>0204-GG</b>	61	<b>0204-BEB</b>	65
<b>0101-HA</b>	3, 4, 5			<b>0204-GH</b>	67	<b>0204-BEC</b>	69
<b>0101-IA</b>	3, 4, 5	<b>0119-B</b>	348	<b>0204-GI</b>	61	<b>0204-BED</b>	69
<b>0101-LA08</b>	6, 7	<b>0119-C11</b>	348	<b>0204-HA</b>	65	<b>0204-BEE</b>	68
<b>0101-BAA</b>	3	<b>0119-C17</b>	348	<b>0204-HB</b>	65	<b>0204-BEF</b>	64
<b>0101-BAB</b>	3	<b>0119-G</b>	348	<b>0204-HC</b>	65	<b>0204-BEG</b>	77
<b>0101-BAC</b>	3	<b>0119-BC</b>	348	<b>0204-HD</b>	65	<b>0204-BEH</b>	77
<b>0101-BAD</b>	3			<b>0204-HE</b>	66	<b>0204-BEI</b>	67
<b>0101-BAE</b>	3	<b>0202-EG</b>	13, 298	<b>0204-HF</b>	66	<b>0204-BEL</b>	70
<b>0101-BDA</b>	6, 7	<b>0202-EI</b>	13	<b>0204-HG</b>	66	<b>0204-BFA</b>	374
<b>0101-CAA</b>	4			<b>0204-HI</b>	66	<b>0204-BFB</b>	72
<b>0101-CAB</b>	4	<b>0204-AE</b>	63, 296	<b>0204-HL</b>	66	<b>0204-BFC</b>	72
<b>0101-CAC</b>	4	<b>0204-AF</b>	64	<b>0204-IA</b>	74	<b>0204-BFD</b>	71
<b>0101-CAD</b>	4	<b>0204-AG</b>	64	<b>0204-IB</b>	74	<b>0204-BFE</b>	71
<b>0101-CAE</b>	4	<b>0204-AH</b>	63	<b>0204-IC</b>	74	<b>0204-BFF</b>	71
<b>0101-CFA</b>	7	<b>0204-AL</b>	67	<b>0204-ID</b>	74	<b>0204-BFG</b>	71
<b>0101-CFB</b>	7	<b>0204-BA</b>	66	<b>0204-IE</b>	74	<b>0204-BGA</b>	74
<b>0101-CFC</b>	7	<b>0204-BE</b>	73	<b>0204-IF</b>	74	<b>0204-BGB</b>	74
<b>0101-CFD</b>	7	<b>0204-BF</b>	73	<b>0204-IG</b>	74	<b>0204-BGC</b>	74
<b>0101-CFE</b>	7	<b>0204-BG</b>	67	<b>0204-IH</b>	74	<b>0204-BGD</b>	74
<b>0101-EAB</b>	5	<b>0204-BH</b>	71	<b>0204-II</b>	74	<b>0204-BGE</b>	74
<b>0101-EAC</b>	5	<b>0204-BI</b>	67	<b>0204-IL</b>	74	<b>0204-BGF</b>	74
<b>0101-EAD</b>	5	<b>0204-BL</b>	69	<b>0204-LA</b>	65	<b>0204-BGG</b>	74
<b>0101-EAE</b>	5	<b>0204-CA</b>	67	<b>0204-LB</b>	73	<b>0204-BGH</b>	74

0204-BGI	74	0204-CLC	73	0206-ED	96	0212-LF	97
0204-BGL	74	0204-CLD	69	0206-EE	96	0212-BFB	118
0204-BHA	75	0204-CLE	69	0206-EF	96		
0204-BHB	75	0204-CLF	69	0206-EG	96	0217-CA	329
0204-BHC	75	0204-DFB	75	0206-EI	96	0217-CF	329
0204-BHD	75	0204-DFC	75	0206-GE	58	0217-CI	329
0204-BHE	61	0204-DFD	75	0206-GF	58		
0204-BHF	72	0204-DFE	75	0206-GI	58	0218-B	329
0204-BHG	72	0204-DFG	75	0206-GL	58	0218-CA	299
0204-BHH	76	0204-DFH	75	0206-HI	95	0218-CD	328
0204-BHI	76	0204-DHA	76	0206-HL	95	0218-CH	328
0204-BHL	77	0204-DHB	76	0206-IC	96	0218-DA	328
0204-BIE	71	0204-DHC	76			0218-EA	328
0204-BIF	71	0204-DHD	76	0212-AB	130	0218-EB	328
0204-BLD	77	0204-DHE	76	0212-AC	130	0218-EC	328
0204-BLE	63	0204-DHF	76	0212-AD	130	0218-BAA	329
0204-BLF	63	0204-DHH	76	0212-AE	130	0218-BAF	329
0204-BLG	63	0204-DIA	65	0212-BA	121		
0204-BLI	72	0204-DIB	65	0212-BB	121	0219-AF	166
0204-BLL	72	0204-DIC	65	0212-BC	121	0219-AG	166
0204-CAA	61	0204-DLI	78	0212-BD	121	0219-AH	166
0204-CAB	61	0204-DLL	78	0212-BE	121	0219-B	139
0204-CAC	61	0204-EAA	78	0212-BF	119	0219-C	139
0204-CAD	61	0204-EAF	78	0212-BG	119	0219-BA	293
0204-CBA	77	0204-EAG	78	0212-BH	115	0219-BC	293
0204-CBB	77	0204-EAL	78	0212-BI	115	0219-BE	293
0204-CBC	77	0204-EBA	78	0212-BL	119	0219-BF	140
0204-CBD	77	0204-EBF	78	0212-CA	119	0219-BG	140
0204-CBE	77	0204-EBG	78	0212-CB	120	0219-BI	140
0204-CBF	77	0204-EBL	78	0212-CC	120	0219-BL	140
0204-CBG	75	0204-ECA	78	0212-CD	120	0219-CA	141
0204-CBH	75			0212-CE	120	0219-CF	141
0204-CDA	76	02050913-B25	341	0212-CH	97	0219-CG	140
0204-CDB	76	02050913-C	342	0212-CI	116	0219-CH	140
0204-CEA	63	02050913-C25	341	0212-CL	115	0219-CI	139
0204-CEB	63	02050913-D	342	0212-DA	97	0219-DD	139
0204-CEC	63	02050913-E	342	0212-DB	97	0219-DE	139
0204-CED	63	02050913-E25	341	0212-DC	97	0219-DF	139
0204-CEE	63			0212-DD	97	0219-DG	139
0204-CEF	63	0206-AB	95	0212-DE	97	0219-DH	165
0204-CEG	63	0206-AC	95	0212-DF	97	0219-DI	142
0204-CEH	63	0206-AF	95	0212-DG	97	0219-DL	142
0204-CEI	63	0206-AG	95	0212-DH	97	0219-EA	142
0204-CEL	63	0206-AH	95	0212-DI	97	0219-EB	142
0204-CFA	76	0206-AI	95	0212-DL	97	0219-EC	142
0204-CFB	76	0206-BA	94	0212-EA	117	0219-ED	139
0204-CHB	68	0206-BB	95	0212-EB	117	0219-EE	142
0204-CHC	68	0206-BC	94	0212-FA	121	0219-EF	142
0204-CHD	68	0206-BD	95	0212-FB	121	0219-EG	142
0204-CHE	68	0206-CA	94	0212-GA	117	0219-FA	140
0204-CHF	68	0206-CC	94	0212-GB	135	0219-FB	140
0204-CHG	68	0206-CD	94	0212-GC	135	0219-FC	140
0204-CHH	68	0206-CE	94	0212-GD	135	0219-FE	140
0204-CHI	68	0206-CF	94	0212-GE	135	0219-FF	140
0204-CHL	69	0206-CG	94	0212-GI	116	0219-FG	140
0204-CIA	69	0206-CH	94	0212-GL	116	0219-GA	139
0204-CIB	73	0206-CI	94	0212-HA	117	0219-GC	139
0204-CIC	73	0206-CL	94	0212-HB	117	0219-GE	139
0204-CID	69	0206-DA	95	0212-HC	117	0219-GG	139
0204-CIE	69	0206-DB	95	0212-HD	115	0219-HA	139
0204-CIG	69	0206-DG	96	0212-HE	116	0219-HC	139
0204-CIH	73	0206-DH	96	0212-HL	119	0219-HE	139
0204-CII	73	0206-DI	96	0212-IA	119	0219-HH	139
0204-CIL	73	0206-EA	96	0212-ID	120	0219-LH	159
0204-CLA	73	0206-EB	96	0212-IE	120	0219-LI	159
0204-CLB	73	0206-EC	96	0212-LD	97	0219-LL	159

0219-BAB	143	0221-EC	161	0221-DCF	155	0402-DA	277
0219-BAC	143	0221-ED	161	0221-DCG	155	0402-DB	277
0219-BAD	143	0221-EF	146	0221-DCH	155	0402-DC	277
0219-BAE	143	0221-EG	159	0221-DCI	155	0402-DG	277
0219-BAF	143	0221-EH	146	0221-DCL	155	0402-DH	277
0219-BAG	143	0221-EI	146	0221-DDA	155	0402-DI	277
0219-BAH	143	0221-FC	146	0221-DHC	158	0402-DL	277
0219-BAI	143	0221-FI	156	0221-LBE	144	0402-EC	277
0219-BEB	143	0221-GA	156	0221-LBF	144	0402-ED	277
0219-BEC	143	0221-GC	156	0221-LBG	144	0402-EE	277
0219-BED	143	0221-GE	156	0221-LBH	144	0402-EF	277
0219-BEE	143	0221-GG	156			0402-EG	277
0219-BEF	143	0221-GH	156	03-B	174	0402-FA12	324
0219-BEG	143	0221-GI	153	03-C	174	0402-LG	325
0219-BEH	143	0221-GL	153	03-D	174	0402-LH	280
0219-BEI	143	0221-HA	153	03-E	174	0402-LI	280
0219-BLA	142	0221-HB	153			0402-LL	280
0219-BLB	142	0221-HC	153	0318-AB	329	0402-BAA	281
0219-BLC	142	0221-HD	153	0318-AC	329	0402-BAB	203
0219-BLD	142	0221-HE	153	0318-AD	329	0402-BAC	203
0219-BLE	142	0221-HF	153	0318-AE	329	0402-BAD	203
0219-BLF	142	0221-HG	151	0318-AF	329	0402-BAE	203
0219-CIE	141	0221-HH	151	0318-AG	329	0402-BAF	203
0219-CIG	141	0221-HI	151	0318-GB	328	0402-BAG	281
0219-CLB	141	0221-HL	151	0318-GH	328	0402-BAH	281
0219-CLG	204	0221-IA	157			0402-BAI	281
0219-CLH	204	0221-IE	157	0319-FFF	330	0402-BAL	281
0219-DHA	140	0221-IF	157	0319-FFG	330	0402-BBB	279
		0221-IG	157	0319-FFH	330	0402-BBD	279
0221-AC	302	0221-LA	150	0319-FFI	330	0402-BBE	279
0221-AE	302	0221-LB	150	0319-FFL	330	0402-BCA	280
0221-AF	302	0221-LC	150	0319-FGA	330	0402-BCB	280
0221-AG	302	0221-LD	150	0319-FGB	330	0402-BCC	280
0221-AH	148	0221-BAI	147	0319-FGC	330	0402-BCD	279
0221-AI	146	0221-BAL	147	0319-FGD	330	0402-BCE	279
0221-AL	148	0221-BBA	151	0319-FGE	330	0402-BCF	279
0221-BA	146	0221-BBB	148	0319-FGF	330	0402-BCL	279
0221-BB	147	0221-BBC	148	0319-FGG	330	0402-BEB	203
0221-BC	146	0221-BBH	151	0319-FGH	330	0402-BED	203
0221-BD	147	0221-BBI	151	0319-FGI	330	0402-BEF	203
0221-BE	145	0221-BBL	152	0319-FGL	330	0402-CLL	325
0221-BE12	145	0221-BCA	152	0319-GGA	330		
0221-BF	145	0221-BDF	154	0319-GHA	330	0402-1411	325
0221-BG	145	0221-BDG	154	0319-GHC	330	0402-141117	324
0221-BH	145	0221-BDH	154	0319-HAC	330		
0221-BI	149	0221-BDI	154			0410-CI	339
0221-BL	149	0221-BDL	154	0320-B/C	350		
0221-CA	149	0221-BEB	158	0320-D/E	350	0411-AF	347
0221-CB	149	0221-BEC	158	0320-F/G	350	0411-AG	347
0221-CC	149	0221-BED	158	0320-H/I	350	0411-CA	342
0221-CD	149	0221-BEF	158			0411-CB	342
0221-CE	154	0221-BEG	158	0401-AB	339	0411-CC	342
0221-CF	154	0221-BEI	158	0401-AC	339	0411-DA	341
0221-CG	148	0221-BFA	159			0411-DB	341
0221-CH	152	0221-BFB	159	0402-AH	323	0411-DH	343
0221-CI	152	0221-BFC	159	0402-AI	323	0411-DI	343
0221-DA	160	0221-DBF	145	0402-B11	324	0411-EA	341
0221-DB	160	0221-DBG	145	0402-D	325	0411-EB	341
0221-DC	160	0221-DBH	155	0402-E	325	0411-FG	347
0221-DD	160	0221-DBI	155	0402-G01	325	0411-HD	345
0221-DG	146	0221-DBL	155	0402-CA	277	0411-HI	343
0221-DH	146	0221-DCA	155	0402-CB	277	0411-HL	343
0221-DI	146	0221-DCB	155	0402-CC01	325	0411-IB	340
0221-DL	146	0221-DCC	155	0402-CD	277	0411-IC	340
0221-EA	161	0221-DCD	155	0402-CE	277	0411-ID	340
0221-EB	161	0221-DCE	155	0402-CF	277	0411-IE	340

0411-IF	340				
0411-IG	340				
0411-IH	340				
0411-BAC	344				
0411-BAD	344				
0411-BBC	344				
0411-BBD	344				
0411-BCD	345				
0411-BCE	345				
0414-B	233, 349				
0414-C	233, 349				
0414-D	233, 349				
0414-DA	118				
0414-DB	118				
0414-DC	118				
0414-DD	118				
0414-EE	118				
0414-EL	118				
0414-FL	180				
0414-GD	180				
0414-GF	180				
0414-GH	180				
0414-HA	235				
0414-HB	235				
0414-HF	235				
0414-HG	235				
0414-BAL	233				
0414-BDA	226				
0414-BDB	226				
0414-BDC	226				
0414-BDD	226				
0414-BEA	226				
0414-BEB	226				
0414-BED	226				
0414-BGI	237				
0414-BGL	237				
0414-BHI	235				
0414-BHL	233				
0414-BIA	227				
0414-BIB	227				
0414-BIC	227				
0414-BID	227				
0414-BIE	227				
0414-BIF	227				
0414-BIG	227				
0414-CGH	233				
0415-EB	259				
0415-EL	262				
0415-HB	259				
0415-HF	259				
0415-IE	259				
0415-LA	260				
0415-LB	260				
0415-LC	260				
0415-BAB	260				
0415-BAC	260				
0415-BAD	260				
0415-BAE	260				
0415-BAF	260				
0417-EA	339				
0417-FA	339				
0417-GA	339				
0417-HA	339				
0501-BA	104				
0501-BB	104				
0501-BC	104				
0501-BD	104				
0501-BE	104				
0501-BF	104				
0501-CA	105				
0501-CB	105				
0501-DA	102				
0501-DB	102				
0501-DC	102				
0501-DD	102				
0501-DG	102				
0501-DH	102				
0501-DI	102				
0501-DL	102				
0501-FA	103				
0501-FB	103				
0501-FC	103				
0501-FD	103				
0501-FE	103				
0501-FF	103				
0501-GA	319				
0501-GC	319				
0501-GD	319				
0501-GE	319				
0501-GF	319				
0501-GG	319				
0501-GH	319				
0501-HA	319				
0501-HC	319				
0501-HE	319				
0501-HG	319				
0501-HH	319				
0501-HI	319				
0501-HL	319				
0517-EL	318				
0517-GB	318				
0517-GC	318				
0517-GD	318				
0517-GH	368				
0517-GI	368				
0517-GL	368				
0517-HA	368				
0518-EI	298				
0518-GE	298				
0518-GF	298				
0602-AB	101				
0602-AC	101				
0602-AD	108				
0602-AE	108				
0602-AF	108				
0602-AI	108				
0602-AI	108				
0602-BA	109				
0602-BB	108				
0602-BC	108				
0602-BD	108				
0602-BE	101				
0602-BF	101				
0602-BG	108				
0602-BH	110				
0602-BI	110				
0602-BL	109				
0602-CA	109				
0602-CB	110				
0602-CC	109				
0602-CD	109				
0602-CL	109				
0602-DA	109				
0602-DB	109				
0602-DH	109				
0602-EG	107				
0602-FA	107				
0602-FB	107				
0602-IE	97				
0602-IF	97				
0602-IG	97				
0602-IH	97				
0602-II	107				
0602-IL	107				
0602-CDG	106				
0602-CDH	106				
0602-CDI	106				
0602-CDL	106				
0602-CFB	106				
0602-CFC	106				
0602-CFD	106				
0602-CFE	106				
0602-CFF	106				
0602-CFG	106				
0602-CFH	106				
0602-CLG	157				
0602-CLH	157				
0602-CLI	157				
0604-AB	288				
0604-AC	288				
0604-AE	288				
0604-AF	288				
0604-AH	289				
0604-AL	289				
0604-BA	287				
0604-BB	289				
0604-BC	287				
0604-BD	287				
0604-BF	287				
0604-BI	123				
0604-CA	123				
0604-CB	123				
0604-CC	122				
0604-CD	123				
0604-CF	123				
0604-CI	122				
0604-CL	123				
0604-DA	122				
0604-DC	122				
0604-DE	122				
0604-DH	122				
0604-EB	288				
0604-EC	288				
0604-ED	288				
0604-EE	288				
0604-GE	287				
0604-GF	287				
0604-GG	289				
0604-GH	289				
0604-GI	289				
0604-GL	289				
0604-HA	289				
0604-HL	289				
0604-IA	289				
0604-IB	289				
0604-LC	292				
0604-LD	292				
0604-LE	292				
0604-LF	292				
0604-BAF	291				
0604-BAG	291				
0604-BAH	291				
0604-BAI	291				
0604-BAL	291				
0604-BBA	291				
0604-BCE	287				
0604-BCF	287				
0604-BCG	287				
0604-BCH	287				
0604-BDB	298				
0604-BDH	290				
0604-BDI	290				
0604-BFC	292				
0604-BFD	292				
0604-BFE	292				
0604-BFF	292				
0604-CBE	292				
0604-CBF	292				
0604-CBG	292				
0604-CBH	292				
0606-BD	283				
0606-BD12	283				
0606-BD1217	283				
0606-BD121719	283				
0606-HC	203				
0606-HD	203				
0606-HE	203				
0606-BAC	203				
0606-BAD	203				
0606-BAE	203				
0606-BAF	203				
0606-BCA	202				
0606-BCB	202				
0606-BCC	202				
0606-BCD	202				
0606-BCE	202				
0606-BCF	202				
0606-BCI	202				
0606-BCL	202				
0606-BDA	202				
0606-BDD	202				
0606-BDE	202				
0606-BDF	202				
0606-BDG	202				
0606-BDI	202				
0606-BDL	202				
0606-BEH	223				
0606-BEI	223				
0606-BEL	223				
0606-BLA	162				
0606-BLB	162				
0606-BLC	162				
0606-CAA12	162				
0606-CAB	162				
0606-CAB12	162				

0606-CAC	162	0607-HB	52	0610-DF	177	0610-BAL	217
0606-CAD	162	0607-HC	52	0610-DG	177	0610-BBA	179
0606-CAE	162	0607-HI	52	0610-DH	177	0610-BBB	179
0606-CAF	162	0607-HL	52	0610-DI	177	0610-BBC	179
0606-CAG	162	0607-IG	52	0610-DL	177	0610-BBD	179
0606-CAH	162	0607-IH	52	0610-EF	168	0610-BBE	179
0606-EAB	282	0607-IL	52	0610-EG	168	0610-BBF	179
0606-EAC	282	0607-LC	25	0610-EH	173	0610-BBG	179
0606-EAD	282	0607-LG	53	0610-EI	168	0610-BBL	234
0606-EAE	282	0607-LH	53	0610-EL	168	0610-BCA	179
		0607-BAA	39	0610-FB	169	0610-BCB	179
0607-B	37	0607-BAB	37, 290	0610-FC	169	0610-BCC	179
0607-B1803	20	0607-BAC	37, 290	0610-FD	169	0610-BCD	179
0607-B1903	24	0607-BAD	37	0610-FE	170	0610-BCE	179
0607-C	37	0607-BAF	37	0610-FF	170	0610-BCF	179
0607-C1803	20	0607-BCB	54	0610-FG	172	0610-BCG	179
0607-C1903	24	0607-BCE	44	0610-FH	173	0610-BDD	169
0607-E	37	0607-BDE	55	0610-FI	171	0610-BGE	173
0607-F	37	0607-BDH	55	0610-FL	171	0610-BGI	173
0607-G03	54	0607-BDI	40	0610-GA	178	0610-BGL	173
0607-G17	54	0607-BDL	40	0610-GB	178	0610-BHE	237
0607-BA	52	0607-BEA	46	0610-GC	178	0610-BHF	237
0607-BB11	44	0607-BEB	46	0610-GD	178	0610-BHG	172
0607-BC11	44	0607-BEC	46	0610-GE	178	0610-BHH	176
0607-BD	37, 290	0607-BEH	46	0610-GF	178	0610-BHI	176
0607-BE	45	0607-BEI	46	0610-GG	178	0610-BHL	172
0607-BF	37, 290	0607-BGA	260	0610-GH	178	0610-BLD	232
0607-BG	40	0607-BGB	260	0610-GI	178	0610-BLE	232
0607-BH	40	0607-BGH	24	0610-GL	178	0610-BLF	232
0607-BI	40	0607-BGI	24	0610-HA	175	0610-BLG	232
0607-BL03	54	0607-CAL	38, 290	0610-HB	175	0610-BLH	177
0607-BL17	54	0607-CBA	38, 290	0610-HC	176	0610-BLI	177
0607-CB	44	0607-CBB	38	0610-HD	176	0610-BLL	232
0607-CC	44	0607-CBC	38	0610-HE	176	0610-CDA	166
0607-CD	36			0610-HF	175	0610-CDC	166
0607-CE	36	0610-AB	178	0610-HG	175	0610-CDE	166
0607-CF	36	0610-AC	178	0610-HH	175	0610-CED	238
0607-CG	36	0610-AD	178	0610-HI	175	0610-CEE	238
0607-CH	36	0610-AE	178	0610-HL	176	0610-CEH	167
0607-CI	45	0610-AF	178	0610-IA	166	0610-CEI	167
0607-DB	55	0610-AG	178	0610-IB	171	0610-CEL	167
0607-DC	55	0610-AH	178	0610-IC	166	0610-CFA	167
0607-DD	55	0610-AI	178	0610-ID	175	0610-CFB	167
0607-DE	53	0610-B	46	0610-IE	175	0610-CFC	166
0607-DF	53	0610-B1803	20	0610-IF	234	0610-CFE	167
0607-DG	44	0610-B1903	25	0610-IG	234	0610-CFF	167
0607-DH	44	0610-C	46	0610-IL	232	0610-CFG	167
0607-EA	205	0610-C1803	20	0610-LA	215	0610-CFH	167
0607-ED	39	0610-C1903	25	0610-LB	215	0610-CFI	167
0607-EE	39	0610-BB	238	0610-LC	215	0610-CGA	166
0607-FA	38, 290	0610-BC	169	0610-LD	172	0610-CGB	166
0607-FB	38, 290	0610-BD	238	0610-LE	234	0610-CGC	166
0607-FC	38	0610-BE	238	0610-LF	234	0610-CGD	166
0607-FD	38	0610-BF	165	0610-LG	236		
0607-FE	38	0610-BG	165	0610-LH	236	0611-AB	222
0607-FF	38	0610-BH	165	0610-LI	236	0611-AD	225
0607-FG	38	0610-BI	165	0610-LL	236	0611-AE	225
0607-FH	38	0610-BL	165	0610-BAA	216	0611-AF	225
0607-FI	44	0610-CA	168	0610-BAB	216	0611-AG	221
0607-GA	54	0610-CH	168	0610-BAC	216	0611-BA12	222
0607-GB	54	0610-CI	168	0610-BAD	216	0611-BB	222
0607-GD	30	0610-DA	168	0610-BAE	216	0611-BB17	222
0607-GE	30	0610-DB	177	0610-BAF	217	0611-BC	222
0607-GG	54	0610-DC	177	0610-BAG	217	0611-BC17	222
0607-GH	54	0610-DD	177	0610-BAH	217	0611-BD	225
0607-HA	52	0610-DE	177	0610-BAI	217	0611-BE	225

0611-BF	225	0611-BDF	225	0612-D	35	0612-FL	26
0611-BG	226	0611-BDG	225	0612-D06	35	0612-GA	26
0611-BH	226	0611-BFA	215	0612-D1803	20	0612-GB	26
0611-BI	226	0611-BFB	215	0612-E	35	0612-GC	42
0611-BL	226	0611-BFC	215	0612-E06	35	0612-GD	42
0611-CA	223	0611-BFD	215	0612-E1803	20	0612-GG	24
0611-CB	223	0611-BGA	227	0612-F	47	0612-GH	24
0611-CC	223	0611-BGC	227	0612-F1803	21	0612-GI	24
0611-CL	229	0611-BGE	227	0612-G	47	0612-GL	24
0611-DA	223	0611-BGG	227	0612-G1803	21	0612-HA	45
0611-DB	223	0611-BGI	227	0612-H	41	0612-HB	45
0611-DC	226	0611-BHA	227	0612-I	41	0612-HC	41
0611-DD	223	0611-BHC	227	0612-L	43	0612-HD	41
0611-DE	229	0611-BHE	227	0612-BA	43	0612-HE	45
0611-DF	223	0611-BHG	227	0612-BB	48	0612-HF	45
0611-DG	229	0611-BHI	227	0612-BC	39	0612-HG	49
0611-EB	229	0611-BIA	227	0612-BD	48	0612-HH	49
0611-EC	229	0611-BIB	225	0612-BE	48	0612-HI	49
0611-ED	229	0611-BIC	227	0612-BF	48	0612-HL	49
0611-EE	229	0611-BID	225	0612-BG	48	0612-IA	50
0611-EF	229	0611-BIE	225	0612-BH	48	0612-IB	50
0611-EG	229	0611-BIF	225	0612-BI	48	0612-IC	50
0611-FD	226	0611-BIG	225	0612-BL	48	0612-ID	50
0611-FE	226	0611-BIH	225	0612-CA	47	0612-IE	50
0611-FI	226	0611-BII	225	0612-CB	47	0612-IF	50
0611-FL	229	0611-BIL	225	0612-CC	47	0612-IG	51
0611-GA	229	0611-CAG	230	0612-CD	47	0612-IH	51
0611-GB	229	0611-CAH	230	0612-CE	47	0612-II	51
0611-GC	229	0611-CAI	230	0612-CE1803	21	0612-IL	51
0611-GD	228	0611-CAL	230	0612-CF	47	0612-LG	25
0611-GE	228	0611-CFD	223	0612-CF1803	21	0612-BAA	34
0611-IB	228	0611-CFE	223	0612-CG	53	0612-BAA11	34
0611-IC	228	0611-CFF	223	0612-CH	42	0612-BAC	34
0611-ID	228	0611-CFG	223	0612-CI	42	0612-BAE	34
0611-IE	231	0611-CFH	223	0612-CL	42	0612-BAL	39
0611-IF	231	0611-CFI	223	0612-CL1803	21	0612-BBA	49
0611-IG	231	0611-CFL	223	0612-DA	42	0612-BBB	49
0611-IH	231	0611-CGA	229	0612-DA1803	21	0612-BBI	25
0611-II	231	0611-CGB	229	0612-DB	42	0612-BBL	25
0611-IL	231	0611-CGC	229	0612-DC	42	0612-BCA	45
0611-LB	228	0611-CGD	226	0612-DD	42	0612-BCB	45
0611-LC	228	0611-CGE	226	0612-DE	42	0612-BCC	45
0611-LD	228	0611-CGF	226	0612-DF	43	0612-BCG	45
0611-LE	229	0611-CGG	226	0612-DG	43	0612-BCH	45
0611-LF	229	0611-CGH	226	0612-DH	43	0612-BDA	30
0611-LG	229	0611-CGI	226	0612-DI	43	0612-BDB	30
0611-LH	229	0611-CGL	226	0612-DL	43	0612-BDC	30
0611-LI	229	0611-CIG	231	0612-EA	43	0612-BDD	30
0611-LL	229	0611-CIH	231	0612-EB	41	0612-BDE	31
0611-BAA	228	0611-CII	231	0612-EC	41	0612-BDF	31
0611-BAB	228	0611-CIL	231	0612-ED	41	0612-BDG	31
0611-BAC	228	0611-DFL	229	0612-EE	41	0612-BDH	31
0611-BAD	228	0611-DIA	230	0612-EF	41	0612-BDL	32
0611-BAE	221	0611-DIB	230	0612-EG	41	0612-BEA	32
0611-BAF	221	0611-DIC	230	0612-EH	39, 290	0612-BEB	32
0611-BAI	221			0612-EI	39, 290	0612-BEC	32
0611-BBA	228	0611140817-B	343	0612-EL	42	0612-BED	32
0611-BBC	221	0611140817-C	343	0612-FA	26	0612-BEF	27
0611-BBE	225	0611140817-D	343	0612-FB	26	0612-BEG	27
0611-BBF	225			0612-FC	26	0612-BEH	27
0611-BBG	225	0612-B	35	0612-FD	26	0612-BEI	27
0611-BBH	228	0612-B06	35	0612-FE	26	0612-BEL	27
0611-BBI	225	0612-B1803	20	0612-FF	26	0612-BFA	27
0611-BBL	228	0612-C	35	0612-FG	26	0612-BFB	27
0611-BCI	222	0612-C06	35	0612-FH	26	0612-BFC	27
0611-BDC	225	0612-C1803	20	0612-FI	26	0612-BFD	27



0612-BFE	33	0614-EF	183	0614-BBH	198	0617050517	165, 349
0612-BFF	33	0614-EG	191	0614-BBI	198	07-D	352
0612-BFG	33	0614-EG11	191	0614-BBL	198	07-E	352
0612-BFL	33	0614-EH	191	0614-BCA	198	07-F	352
0612-BGA	28	0614-EH11	191	0614-BCB	198	07-I	14
0612-BGB	28	0614-EI	191	0614-BCC	198	07-BA	14
0612-BGC	28	0614-EL	191	0614-BCD	198	07-BC	14
0612-BGD	28	0614-FA	189	0614-BCE	198	07-BE	14
0612-BHF	53	0614-FB	189	0614-BCF	199	07-BG	14
0612-BIA	51	0614-FC	189	0614-BCG	199	07-BI	14
0612-BIB	51	0614-FD	189	0614-BCH	199	07-CA	14
0612-CAB	29	0614-FE	189	0614-BCI	199	07-CC	14
0612-CAC	29	0614-FF	190	0614-BCL	199	07-CE	14
0612-CAD	29	0614-FG	190	0614-BDA	192	07-CG	14
0612-CAE	29	0614-FH	190	0614-BDB	192	07-CI	14
0612-CAF	29	0614-FI	187	0614-BDD	192	07-DA	14
0612-CAG	29	0614-FL	187	0614-BDE	192	0706-BA	311
0612-CAH	29	0614-GA	187	0614-BDI	184	0706-BC	311
0612-CAI	29	0614-GB	187	0614-BDL	184	0706-BL	311
0612-CAL	29	0614-GC	196	0614-BHB	200	0706-CA	313
0612-CBA	29	0614-GD	205	0614-BHC	200	0706-CC	311
0612-CBB	29	0614-GE	194	0614-BHD	200	0706-CD	311
0612-CBC	29	0614-GE11	194	0614-BHE	200	0706-CL	311
0612-CLG	19	0614-GF	195	0614-BHF	200	0706-DA	312
0612-CLH	19	0614-GG	193	0614-BIA	200	0706-DB	312
0612-CLI	19	0614-GG11	193	0614-BIB	200	0706-DC	312
0612-CLL	19	0614-GH	195	0614-BIC	200	0706-DD	312
0612-DAA	19	0614-GI	193	0614-BID	200	0706-DE	312
0612-DAB	19	0614-GL	195	0614-BIE	200	0706-DF	312
0612-DAG	23	0614-HA	196	0614-BIF	200	0706-EA	323
0612-DAI	23	0614-HB	190	0614-BIG	200	0706-EB	312
0612-DBI	19	0614-HC	190	0614-BIH	200	0706-EC	312
0612-DBL	19	0614-HD	190	0614-BII	200	0706-EG	311
0612-DCI	23	0614-HE	190	0614-BIL	200	0706-FD	313
0612-DDH	23	0614-HF	190	0614-CAG	196	0706-FF	313
0612-DED	23	0614-HG	189	0614-CAH	196	0706-FH	313
0612-DFA	25	0614-HI	195	0614-CCA	183	0706-GC	310
		0614-HL	194	0614-CCC	199	0706-GE	310
0614-BB	185	0614-HL11	194	0614-CCD	199	0706-GG	310
0614-BC	185	0614-IA	205	0614-CCE	199	0706-IL	214
0614-BD	185	0614-IA17	205	0614-CCF	199	0706-LA	214
0614-BE	185	0614-IB	194	0614-CCL	183	0706-LF	358
0614-BF	184	0614-IC	196	0614-CDA	183	0706-BAG	211
0614-BG	184	0614-IE	196	0614-CEA	194	0706-BIH	323
0614-BH	184	0614-IF	183	0614-CEB	194	0706-BII	323
0614-BI	184	0614-IH	183	0614-CEC	194	0706-BIL	323
0614-BL	184	0614-II	183	0614-DAB	201	0706-CAA	323
0614-CA	186	0614-IL	183	0614-DAC	201	0706-CEA	312
0614-CC	183	0614-LA	197	0614-DAD	201	0706-CEB	312
0614-CD	183	0614-LB	197	0614-DAE	201	0706-CEC	312
0614-CE	183	0614-LC	197	0614-DAF	201	0706-CEC02	312
0614-CF	183	0614-LD	195	0614-DFA	201	0706-CED	312
0614-CI	186	0614-LE	195	0614-DHA	201	0706-CEE	312
0614-CL	186	0614-LG	197	0614-DIA	201	070603	36
0614-DA	186	0614-BAA	198	0614-DLA	201	070603-18	57
0614-DB	186	0614-BAB	198			070603-1803	22
0614-DC	186	0614-BAC	198	0617-BG	349	070603-1903	24
0614-DE	186	0614-BAD	198	0617-BH	349	070617	36
0614-DF	186	0614-BAE	198	0617-BFI	278	070617-18	57
0614-DG	185	0614-BAF	196	0617-BFL	278	070617-1803	22
0614-DI	185	0614-BAI	187	0617-BGA	278	070617-1903	24
0614-EA	188	0614-BBA	197	0617-BGB	278		
0614-EB	188	0614-BBC	197	0617-BGC	278		
0614-EC	188	0614-BBE	197	0617-BGD	278		
0614-ED	183	0614-BBF	197	0617-BGE	278		
0614-EE	189	0614-BBG	197	0617-BGF	278		

<b>070618-1803</b>	22	<b>1009-FE</b>	267	<b>1009-CAC</b>	269	<b>1014-B</b>	165
<b>0718-AB</b>	326	<b>1009-FF</b>	267	<b>1009-CAD</b>	269	<b>1014-C</b>	165
<b>0718-AC</b>	326	<b>1009-FG</b>	267	<b>1009-CAE</b>	269	<b>1014-BG</b>	162
<b>0718-AG</b>	326	<b>1009-FH</b>	267	<b>1009-CAF</b>	269	<b>1014-EH</b>	162
<b>0718-AH</b>	326	<b>1009-FI</b>	267	<b>1009-CAG</b>	269	<b>11-A</b>	348
<b>0718-BA</b>	326	<b>1009-GA</b>	265	<b>1009-CAH</b>	269	<b>11-B</b>	348
<b>0718-BB</b>	326	<b>1009-GB</b>	265	<b>1009-CAI</b>	269	<b>11-C</b>	348
<b>0718-BD</b>	326	<b>1009-GC</b>	265	<b>1009-CAL</b>	269	<b>11-D</b>	348
<b>0718-BE</b>	326	<b>1009-GD</b>	265	<b>1009-CBA</b>	269	<b>11-E</b>	348
<b>0718-CA</b>	58	<b>1009-GE</b>	265	<b>1009-CBB</b>	269	<b>11-F</b>	348
<b>0718-CB</b>	58	<b>1009-GF</b>	265	<b>1009-CBC</b>	269	<b>11-G</b>	348
<b>0718-CC</b>	58	<b>1009-GG</b>	265	<b>1009-CBD</b>	269	<b>11-H</b>	348
<b>0718-CD</b>	57	<b>1009-GH</b>	265	<b>1009-CBE</b>	269	<b>11-I</b>	348
<b>0718-CE</b>	57	<b>1009-GI</b>	265	<b>1009-CCA</b>	266	<b>11-J</b>	348
<b>0718-CF</b>	57	<b>1009-GL</b>	265	<b>1009-CCB</b>	266	<b>11-L</b>	348
<b>0718-CG</b>	57	<b>1009-HA</b>	265	<b>1009-CCC</b>	266	<b>11-BB</b>	348
<b>0718-CH</b>	57	<b>1009-HB</b>	265	<b>1009-CCD</b>	266	<b>11-CB</b>	348
<b>0718-CI</b>	57	<b>1009-HC</b>	265	<b>1009-CCE</b>	266	<b>11-CC</b>	348
<b>0718-CL</b>	57	<b>1009-HE</b>	265	<b>1009-CCF</b>	266	<b>11-CD</b>	348
<b>0805-B</b>	344	<b>1009-HF</b>	265	<b>1009-CCG</b>	266	<b>11-CE</b>	348
<b>0805-C</b>	344	<b>1009-HG</b>	265	<b>1009-CCH</b>	266	<b>11-CF</b>	348
<b>0805-D</b>	344	<b>1009-HH</b>	265	<b>1009-CCI</b>	266	<b>11-CG</b>	348
<b>0806-BDA</b>	78	<b>1009-HI</b>	265	<b>1009-CCL</b>	266	<b>11-CH</b>	348
<b>0806-BFA</b>	78	<b>1009-IA</b>	265	<b>1009-CDA</b>	268	<b>11-CI</b>	348
<b>1009-AA</b>	264	<b>1009-IC</b>	265	<b>1009-CDB</b>	268	<b>11-CL</b>	348
<b>1009-AB</b>	264	<b>1009-IF</b>	265	<b>1009-CDC</b>	268	<b>1102-BA</b>	12
<b>1009-AC</b>	264	<b>1009-LA</b>	265	<b>1009-CDD</b>	266	<b>1102-BB</b>	12
<b>1009-BA</b>	273	<b>1009-LL</b>	264	<b>1009-CDI</b>	268	<b>1102-BC</b>	12
<b>1009-BE</b>	264	<b>1009-BAA</b>	264	<b>1009-CEA</b>	268	<b>1102-BC04</b>	12
<b>1009-BF</b>	264	<b>1009-BAC</b>	264	<b>1009-CEC</b>	268	<b>1102-BD</b>	12
<b>1009-BG</b>	264	<b>1009-BBE</b>	264	<b>1009-CEE</b>	268	<b>1102-BF</b>	12
<b>1009-BH</b>	264	<b>1009-BBF</b>	264	<b>1009-CEG</b>	268	<b>1102-BI</b>	12
<b>1009-BI</b>	264	<b>1009-BBG</b>	264	<b>1009-CEI</b>	268	<b>1102-CA</b>	12
<b>1009-CA</b>	264	<b>1009-BBH</b>	264	<b>1009-CFC</b>	267	<b>1102-CB</b>	12
<b>1009-CC</b>	264	<b>1009-BBI</b>	264	<b>1009-CFE</b>	267	<b>1102-CB</b>	12
<b>1009-CF</b>	264	<b>1009-BCA</b>	264	<b>1009-CFG</b>	267	<b>1102-CC</b>	12
<b>1009-CL</b>	265	<b>1009-BCC</b>	264	<b>1009-CFI</b>	267	<b>1102-CD</b>	12
<b>1009-DA</b>	264	<b>1009-BCF</b>	264	<b>1009-CGA</b>	267	<b>1102-CE</b>	12
<b>1009-DB</b>	265	<b>1009-BDA</b>	264	<b>1009-CGC</b>	267	<b>1102-CF</b>	12
<b>1009-DC</b>	265	<b>1009-BGA</b>	267	<b>1009-CGE</b>	267	<b>1102-DGB</b>	13, 298
<b>1009-DD</b>	265	<b>1009-BGB</b>	267	<b>1009-CIA</b>	267	<b>1102-DGC</b>	13
<b>1009-DE</b>	265	<b>1009-BHF</b>	269	<b>1009-CIC</b>	267	<b>1102-DGD</b>	13
<b>1009-DF</b>	265	<b>1009-BHG</b>	269	<b>1009-CIE</b>	267	<b>1102-DGE</b>	13, 298
<b>1009-DG</b>	265	<b>1009-BHH</b>	269	<b>1009-CIG</b>	267	<b>1102-DGF</b>	13, 298
<b>1009-DH</b>	265	<b>1009-BHI</b>	269	<b>1009-CII</b>	267	<b>1102-DGG</b>	13
<b>1009-DI</b>	265	<b>1009-BHL</b>	269	<b>1009-CLA</b>	267	<b>1102-DGH</b>	13, 298
<b>1009-DL</b>	265	<b>1009-BIA</b>	269	<b>1009-CLD</b>	268	<b>1102-DGI</b>	13
<b>1009-EA</b>	264	<b>1009-BIB</b>	269	<b>1009-CLE</b>	268	<b>1102-DGL</b>	13
<b>1009-EB</b>	264	<b>1009-BIC</b>	269	<b>1009-CLF</b>	268	<b>1105-AI</b>	349
<b>1009-EC</b>	264	<b>1009-BID</b>	269	<b>1009-CLG</b>	268	<b>1107-B</b>	36
<b>1009-ED</b>	264	<b>1009-BIE</b>	269	<b>1009-CLH</b>	268	<b>1107-B1803</b>	22
<b>1009-EE</b>	264	<b>1009-BIF</b>	269	<b>1009-CLI</b>	268	<b>1107-C1803</b>	22
<b>1009-EF</b>	264	<b>1009-BIG</b>	269	<b>1009-CLI</b>	268	<b>1110-B</b>	57
<b>1009-EG</b>	264	<b>1009-BIH</b>	269	<b>1009-DAA</b>	269	<b>1110-C</b>	57
<b>1009-EH</b>	264	<b>1009-BII</b>	269	<b>1009-DAB</b>	269	<b>1110-D</b>	57
<b>1009-EI</b>	264	<b>1009-BIL</b>	269	<b>1009-DAG</b>	247	<b>1111-AB</b>	373
<b>1009-EL</b>	264	<b>1009-BLA</b>	269	<b>1009-DAH</b>	247	<b>1111-AC</b>	373
<b>1009-EF</b>	264	<b>1009-BLB</b>	269	<b>1009-DAI</b>	247	<b>1111-AD</b>	373
<b>1009-EG</b>	264	<b>1009-BLC</b>	269	<b>1009-DCC</b>	269	<b>1111-AE</b>	373
<b>1009-EH</b>	264	<b>1009-BLD</b>	269	<b>1009-DDA</b>	268	<b>1111-AF</b>	373
<b>1009-EI</b>	264	<b>1009-BLE</b>	269	<b>1009-ddb</b>	268	<b>1111-AG</b>	373
<b>1009-EL</b>	264	<b>1009-BLF</b>	269	<b>1009-DDC</b>	268	<b>1111-AH</b>	373
<b>1009-FA</b>	267	<b>1009-BLG</b>	269	<b>1009-DDD</b>	268		
<b>1009-FB</b>	267	<b>1009-BLH</b>	269	<b>1009-DDE</b>	268		
<b>1009-FC</b>	267	<b>1009-BLI</b>	269	<b>1009-DDF</b>	268		
<b>1009-FD</b>	267	<b>1009-BLL</b>	269	<b>1009-DDG</b>	268		

1111-AI	373	1118-FD	272	1118-CCC	241	1123-BBB	187
1111-AL	373	1118-FE	272	1118-CCE	241	1123-BBC	205
1111-BA	373	1118-FF	272	1118-CCH	239	1123-BBD	206
1111-BB	373	1118-FG	272	1118-CCI	239	1123-BBE	206
1111-BC	373	1118-FH	272	1118-CCL	239	1123-BBF	206
1111-BD	373	1118-FI	272	1118-CDB	241	1123-BBG	187
1111-BE	373	1118-FL	272	1118-CDC	241	1123-BCA	206
1111-BF	373	1118-GA	272	1118-CDD	239	1123-BCB	206
1111-BG	373	1118-HD	244	1118-CDE	241	1123-BCC	206
1111-BH	373	1118-HE	244	1118-CDF	250	1123-BCF	252
1111-BI	373	1118-HF	244	1118-CDG	239, 240	1123-BDA	253
1111-BL	373	1118-HG	263	1118-CDH	240	1123-BDB	253
1111-CA	373	1118-HG11	263	1118-CDI	240	1123-BDE	253
1111-CB	373	1118-HI	263	1118-CDL	240	1123-BDF	258
1111-CC	373	1118-HI11	263	1118-CEA	246	1123-BDG	258
1111-CD	373	1118-IA	244	1118-CEB	239, 240	1123-BDI	260
1111-CE	373	1118-IB	244	1118-CEC	246	1123-BDL	260
1111-CF	373	1118-IC	244	1118-CEE	246		
1111-CG	373	1118-ID	244	1118-DAA	238	1201-B	352
1111-CH	373	1118-IE	244	1118-DAB	238	1201-C	352
1111-CI	373	1118-IF	244	1118-DAC	238	1201-D	352
1111-CL	373	1118-LA	243	1118-DAD	238	1201-G	14
1111-DA	373	1118-LB	243	1118-DBA	249	1201-02B	12
1111-DB	373	1118-LB18	243	1118-DBB	249	1201-02C	12
1111-DC	373	1118-LC	243	1118-DBC	249	1201-02D	12
1111-DD	373	1118-LD	243	1118-DBD	249	1201-02D11	12
		1118-LE	242	1118-DBE	249	1201-02D12	12
1118-AE	300	1118-LF	242	1118-DBF	249	1201-02E	12
1118-AG	247	1118-LG	242	1118-DBG	251	1201-02E11	12
1118-AH	300	1118-LH	242	1118-DBH	251	1201-02H	12
1118-AI	300	1118-LI	242	1118-DBI	251		
1118-AL	247	1118-LL	247	1118-DCA	250	1203-BB	345
1118-BA	273	1118-BAA	247	1118-DCB	250	1203-BC	345
1118-BB	273	1118-BAB	262	1118-DCC	250	1203-BD	345
1118-BC	273	1118-BAC	262	1118-DCD	250		
1118-BD	273	1118-BAD	262	1118-DCE	250	1206-BHC	297
1118-BE	273	1118-BAE	262	1118-DCF	250	1206-BHD	297
1118-BF	273	1118-BAF	262	1118-DCG	250	1206-BHH	296
1118-BG	273	1118-BAG	247	1118-DCL	250	1206-CAA	297
1118-BH	273	1118-BBA	269	1118-DDA	250	1206-CAB	297
1118-CA	270	1118-BBC	242	1118-EAA	261	1206-CAF	297
1118-CB	270	1118-BBD	242	1118-EAF	261	1206-CAG	297
1118-CC	270	1118-BBE	242	1118-EAG	261	1206-CEL	296
1118-CD	270	1118-BBF	242	1118-EAH	261		
1118-CE	270	1118-BBG	245	1118-EAI	261	1214-BA	349
1118-CF	270	1118-BBH	245	1118-EAL	261	1214-I	349
1118-CG	270	1118-BBL	245	1118-EBA	262		
1118-CH	270	1118-BCA	246			1310-AD	294
1118-CI	270	1118-BCB	245	1123-HA	346	1310-AE	294
1118-CL	270	1118-BCC	262	1123-IA	258	1310-AG	293
1118-DA	270	1118-BCD	262	1123-IC	254	1310-AI	293
1118-DC	273	1118-BCE	245	1123-LC1903	254	1310-B	13
1118-DD	273	1118-BCF	274	1123-LF1903	254	1310-C	13
1118-EA	271	1118-BCG	274	1123-LG1903	254	1310-D	13
1118-EB	271	1118-BCH	251	1123-LI	347	1310-BA	293
1118-EC	271	1118-BCI	251	1123-LL	254	1310-BC	13
1118-ED	271	1118-BDF	274	1123-BAB	254	1310-BE	293
1118-EE	271	1118-BDG	274	1123-BAC	255	1310-BG	293
1118-EF	271	1118-BDH	274	1123-BAD	256	1310-BI	293
1118-EG	271	1118-BDI	274	1123-BAE	255	1310-CA	293
1118-EH	271	1118-BDL	274	1123-BAF	256	1310-CB	294
1118-EI	271	1118-BEA	274	1123-BAG	256	1310-CC	294
1118-EL	271	1118-BLL	248	1123-BAH	257	1310-CD	294
1118-FA	271	1118-CAA	248	1123-BAI	187	1310-CE	294
1118-FB	272	1118-CAB	248	1123-BAL	187	1310-CF	294
1118-FC	272	1118-CAC	248	1123-BBA	187	1310-CG	294

1310-CH	294	1411-BE	310	1412-BH	15	15-CF	85
1310-CI	294	1411-BF	310	1412-BI	15	15-CG	85
1310-CL	294	1411-BG	310	1412-BL	15	15-CH	85
1310-DA	11	1411-BH	310	1412-CA	317	15-CI	83
1310-DC	11	1411-BI	310	1412-CC	317	15-CL	83
1310-DE	11	1411-BL	309	1412-CD	317	15-DA	85
1310-DG	11	1411-CA	295	1412-CE	317	15-DB	85
1310-DI	11	1411-CC	299, 310	1412-CG	317	15-DC	85
1310-EA	11	1411-CD	310	1412-DA	10	15-DD	85
1310-EB	294	1411-CE	310	1412-DC	317	15-DE	85
1310-EC	294	1411-CF	309	1412-DE	317	15-DF	85
1310-ED	294	1411-CG	309	1412-DG	317	15-DG	85
1310-EE	294	1411-CH	309	1412-DI	317	15-DH	85
1310-EF	294	1411-CI	309	1412-EE	10	15-DI	83
1310-EG	294	1411-CL	309	1412-EF	10	15-DL	83
1310-EH	294	1411-DA	310	1412-EG	10	15-EA	86
1310-EI	293	1411-DB	310	1412-EH	10	15-EB	86
1310-EL	293	1411-DC	310	1412-IA	16	15-EC	86
1310-FA	11	1411-DD	310	1412-IB	16	15-ED	86
1310-FB	11	1411-DE	309	1412-IC	16	15-EE	86
1310-FC	11	1411-DG	299, 309	1412-BAB	16	15-EF	86
1310-FD	11	1411-DH	309	1412-BAC	16	15-EG	86
1310-FE	11	1411-DI	309	1412-BAD	16	15-EH	86
1310-FF	11	1411-DL	309	1412-BAE	16	15-EI	86
1310-FG	11	1411-EA	214			15-EL	87
1310-FL	293	1411-EB	213	1417-BB	300	15-FA	89
1310-GA	296	1411-EC	213	1417-BD	300	15-FC	89
1310-GC	296	1411-ED	213	1417-BF	300	15-FD	89
1310-GE	296	1411-EE	213	1417-BH	300	15-FE	87
1310-GG	296	1411-EF	213	1417-BL	300	15-FF	87
1310-GL	296	1411-EG	213			15-FG	83
1310-HA	296	1411-EH	213	141802-B	349	15-FH	83
1310-HL	301	1411-EI	213	141802-C	349	15-FI	83
1310-IA	301	1411-EL	213			15-FL	83
1310-IC	301	1411-FA	299	15-AA	14	15-GA	88
1310-ID	301	1411-FB	299	15-A	14	15-GB	82
1310-IE	301	1411-FC	299	15-AB	14	15-GC	82
1310-IG	301	1411-FD	299	15-AC	14	15-GD	82
1310-LC	302	1411-FE	299	15-AD	14	15-GE	82
1310-LF	11	1411-FF	299	15-AE	14	15-GF	91
1310-LG	11	1411-FG	299	15-AF	14	15-GG	91
1310-LH	293	1411-FH	299	15-AG	14	15-GH	91
1310-LI	293	1411-FI	299	15-AG01	14	15-HA	86
1310-LL	293	1411-GD	309	15-AG02	14	15-HB	86
1310-BAA	11	1411-GE	309	15-AG03	14	15-HC	86
1310-BAB	11	1411-BFA	213	15-AG04	14	15-HD	86
1310-BAC	11	1411-BFB	213	15-AI	88	15-HE	86
1310-BAG	302	1411-BFC	213	15-AL	88	15-HF	86
1310-BDB	302	1411-BFD	213	15-D	352	15-HG	86
1310-CEF	278	1411-BFE	213	15-E	352	15-HH	86
1310-EAB	297	1411-BFF	213	15-F	352	15-HI	86
1310-EAD	297	1411-BFG	213	15-BA	105	15-HL	87
1310-ECA	301	1411-BFH	213	15-BB	105	15-IB	82
1310-ECB	301	1411-BFI	213	15-BC	105	15-IC	82
1310-ECC	301	1411-BFL	213	15-BD	105	15-IE	87
				15-BE	105	15-IF	87
1411-AB	213	1412-AE	15	15-BF	81	15-IG	82
1411-AE	213	1412-AF	15	15-BG	82	15-IH	82
1411-AF	213	1412-AH	15	15-BH	88	15-IL	87
1411-AG	309	1412-AL	295	15-BI	83	15-LB	81
1411-AH	299, 309	1412-BA	10	15-BL	83	15-LC	81
1411-AI	299, 309	1412-BC	10	15-CA	85	15-LD	81
1411-AL	309	1412-BD	10	15-CB	85	15-LE	81
1411-BA	309	1412-BE	10	15-CC	85	15-LF	81
1411-BB	309	1412-BF	10	15-CD	85	15-LG	81
1411-BD	310	1412-BG	15	15-CE	85	15-LH	81

15-LI	81	15-CCE	111	1506-DI	307	1508-BAC	129
15-LL	111	15-CCF	111	1506-DL	308	1508-BAD	129
15-BAA	89, 298	15-CCG	111	1506-EA	308	1508-BAE	129
15-BAB	81	15-CEI	83	1506-EB	308	1508-BBA	129
15-BAC	81	15-CEL	83	1506-EC	308	1508-BBB	129
15-BAD	111	15-CFA	84	1506-ED	308	1508-BBC	129
15-BAE	88	15-CFB	84	1506-EE	307	1508-BBD	129
15-BBD	111	15-CFC	84	1506-EG	308	1508-BBE	129
15-BBE	111	15-CFD	84	1506-EI	308	1508-BBF	127
15-BBF	89	15-CFE	84	1506-EL	308	1508-BBH	127
15-BBI	89	15-CFF	84	1506-FA	308	1508-BBI	127
15-BBL	89	15-CFG	84	1506-FB	308	1508-BBL	127
15-BCA	87, 298	15-CFH	84	1506-FC	308	1508-BCA	127
15-BCB	87, 298	15-CFI	84	1506-FD	307	1508-BCB	127
15-BCC	82	15-CFL	84	1506-FE	307	1508-BCC	127
15-BCD	93	15-CGA	84	1506-FF	307	1508-BCD	127
15-BCF	93	15-CGB	84	1506-FG	307	1508-BCE	127
15-BCL	89	15-CGC	84	1506-FH	307	1508-BCF	127
15-BDA	101	15-CGD	84	1506-FI	307	1508-BCH	128
15-BDB	101	15-CGE	87	1506-FL	307	1508-BCI	128
15-BDC	89	15-CGF	87	1506-IA	307	1508-BCL	128
15-BDD	89	15-CGG	82	1506-IC	307	1508-BDA	128
15-BDE	89	15-CGH	82	1506-ID	307	1508-BDB	128
15-BDF	81	15-CIF	101			1508-BDC	131
15-BDG	92	15-CIG	101	1508-DI	133	1508-BDD	131
15-BDH	92	15-CIH	101	1508-DL	133	1508-BDE	131
15-BDI	92	15-CII	101	1508-EA	134		
15-BDL	92	15-DAI	88	1508-EB	134	1514-DE	125
15-BEA	105	15-DBC	88	1508-EC	134	1514-DF	125
15-BEB	105	15-DBD	88	1508-ED	134	1514-DG	125
15-BHA	92	15-DCE	89	1508-EE	134	1514-EA	132
15-BHB	92			1508-EF	134	1514-EG	124
15-BHC	92	150502-B	338	1508-EG	134	1514-EH	124
15-BHD	92	150502-C	338	1508-EI	133	1514-EI	124
15-BHL	93	150502-D	338	1508-FC	134	1514-FA	124
15-BIA	93	150502-E	338	1508-FD	126	1514-FB	124
15-BIB	93	150502-F	338	1508-FE	126	1514-FC	124
15-BLB	91	150502-G	338	1508-FF	252	1514-FF	125
15-BLC	91	150502-H	338	1508-FG	252	1514-FG	125
15-BLD	91	150502-BH18	335	1508-FH	252	1514-FL	135
15-BLE	91			1508-FI	128, 252	1514-GA	132
15-BLF	91	1506-H	307	1508-FL	127	1514-GF	132
15-BLG	91	1506-BA	308	1508-GB	133	1514-GG	124
15-BLH	91	1506-BD	308	1508-GC	133	1514-GH	132
15-BLI	111	1506-BE	307	1508-GD	133	1514-HA	132
15-BLL	111	1506-BF	307	1508-GE	133	1514-HB	132
15-CAA	91	1506-BH	307	1508-GF	126	1514-HC	132
15-CAB	90	1506-BL	307	1508-GG	126	1514-HD	132
15-CAC	90	1506-CA	307	1508-GI	126	1514-HI	132
15-CAD	90	1506-CB	307	1508-GL	126	1514-HL	132
15-CAE	90	1506-CC	307	1508-HA	134	1514-IA	132
15-CAF	90	1506-CD	307	1508-HB	126	1514-IB	132
15-CAG	90	1506-CE	307	1508-HC	127	1514-IC	125
15-CAI	90	1506-CF	307	1508-HD	126	1514-ID	125
15-CAL	90	1506-CG	307	1508-HE	134	1514-IE	125
15-CBA	92	1506-CH	307	1508-HF	127	1514-IF	125
15-CBB	90	1506-CI	307	1508-HG	127	1514-IG	124
15-CBC	90	1506-CL	307	1508-HH	128	1514-IH	125
15-CBD	90	1506-DA	307	1508-HI	134	1514-II	132
15-CBE	90	1506-DB	307	1508-IA	131	1514-IL	135
15-CBF	91	1506-DC	307	1508-IB	131	1514-LA	132
15-CBG	91	1506-DD	307	1508-IC	131	1514-LB	132
15-CBH	91	1506-DE	307	1508-ID	131	1514-LC	125
15-CBI	101	1506-DF	307	1508-IE	131	1514-LD	125
15-CBL	101	1506-DG	307	1508-LA	128	1514-LE	132
15-CCB	83	1506-DH	307	1508-BAB	129	1514-LF	124

<b>1514-LG</b>	124				
<b>1514-LH</b>	130				
<b>1514-LH11</b>	130				
<b>1514-LI</b>	124				
<b>1514-LL</b>	130				
<b>1514-LL11</b>	130				
<b>1514-BAA</b>	124				
<b>17-B</b>	351				
<b>17-C</b>	351				
<b>17-D</b>	351				
<b>1708-E</b>	352				
<b>1708-F</b>	352				
<b>1803-B</b>	56				
<b>1803-C</b>	56				
<b>1803-D</b>	56				
<b>1803-F</b>	56				
<b>1803-L</b>	56				
<b>1803-BD</b>	56				
<b>1803-BE</b>	56				
<b>1803-BF</b>	56				
<b>1804-12</b>	348				
<b>1811-B</b>	174				
<b>1811-C</b>	174				
<b>1812-B</b>	351				
<b>1812-D</b>	351				
<b>1812-E</b>	351				
<b>1812-BB</b>	351				
<b>1812-BC</b>	351				
<b>1812-BD</b>	351				
<b>1812-BF</b>	351				
<b>1814-D</b>	351				
<b>1814-E</b>	351				
<b>1814-BA</b>	351				
<b>1821-BB</b>	372				
<b>1821-BC</b>	372				
<b>1821-BC/17B</b>	372				
<b>1821-BD</b>	372				
<b>1821-BD/17B</b>	372				
<b>1821-BE</b>	372				
<b>1821-BF</b>	372				
<b>1821-BG</b>	372				
<b>1821-BH</b>	373				
<b>1821-BI</b>	371				
<b>1821-BI18</b>	371				
<b>1821-BL</b>	371				
<b>1821-CA</b>	371				
<b>1821-CB</b>	371				
<b>1821-CE</b>	371				
<b>1907-BA</b>	224				
<b>1907-BB</b>	224				
<b>1907-BC</b>	224				
<b>1907-CA</b>	224				
<b>1907-CB</b>	224				
<b>1907-CC</b>	224				
<b>1907-CD</b>	224				
<b>1907-EA</b>	224				
<b>1907-EB</b>	224				
<b>1917-BE</b>	212				
<b>1917-BG</b>	212				
<b>1917-BI</b>	212				
<b>1917-CA</b>	209				
<b>1917-CB</b>	209				
<b>1917-CC</b>	209				
<b>1917-CD</b>	209				
<b>1917-CE</b>	209				
<b>1917-CF</b>	209				
<b>1917-CG</b>	209				
<b>1917-DA</b>	214				
<b>1917-DF</b>	210				
<b>1917-EA</b>	209				
<b>1917-EB</b>	209				
<b>1917-EC</b>	209				
<b>1917-ED</b>	209				
<b>1917-EE</b>	209				
<b>1917-EF</b>	209				
<b>1917-EG</b>	209				
<b>1917-EL</b>	213				
<b>1917-FA</b>	213				
<b>1917-FB</b>	209				
<b>1917-FC</b>	209				
<b>1917-FD</b>	209				
<b>1917-FE</b>	209				
<b>1917-FF</b>	209				
<b>1917-FG</b>	209				
<b>1917-FH</b>	209				
<b>1917-GA</b>	211				
<b>1917-GB</b>	210				
<b>1917-GC</b>	210				
<b>1917-GI</b>	211				
<b>1917-GL</b>	211				
<b>1917-HG</b>	215				
<b>1917-HH</b>	215				
<b>1918-BAB</b>	327				
<b>1918-BAC</b>	327				
<b>1918-BAD</b>	327				
<b>1918-BAE</b>	327				
<b>2106-BF</b>	363				
<b>2106-BG</b>	363				
<b>2106-BH</b>	363				
<b>2106-CF</b>	356				
<b>2106-CG</b>	356				
<b>2106-CH</b>	363				
<b>2106-CI</b>	357				
<b>2106-CL</b>	357				
<b>2106-DC</b>	357				
<b>2106-DH</b>	357				
<b>2106-DI</b>	356				
<b>2106-DL</b>	356				
<b>2106-EA</b>	318				
<b>2106-EC</b>	318				
<b>2106-EH</b>	369				
<b>2106-EI</b>	369				
<b>2106-FC</b>	370				
<b>2106-FA</b>	357				
<b>2106-FF</b>	362				
<b>2106-FG</b>	362				
<b>2106-FH</b>	362				
<b>2106-FI</b>	362				
<b>2106-FL</b>	362				
<b>2106-GA</b>	362				
<b>2106-GI</b>	369				
<b>2106-GL</b>	369				
<b>2106-HA</b>	367				
<b>2106-HB</b>	367				
<b>2106-HC</b>	367				
<b>2106-HD</b>	359				
<b>2106-HE</b>	359				
<b>2106-HF</b>	359				
<b>2106-HG</b>	359				
<b>2106-HH</b>	359				
<b>2106-HI</b>	359				
<b>2106-HL</b>	359				
<b>2106-IA</b>	360				
<b>2106-IB</b>	360				
<b>2106-IC</b>	360				
<b>2106-ID</b>	360				
<b>2106-IE</b>	360				
<b>2106-IF</b>	360				
<b>2106-IG</b>	360				
<b>2106-II</b>	360				
<b>2106-IL</b>	320				
<b>2106-LA</b>	320				
<b>2106-LC</b>	366				
<b>2106-LE</b>	366				
<b>2106-LF</b>	365				
<b>2106-LG</b>	366				
<b>2106-LH</b>	365				
<b>2106-LI</b>	257				
<b>2106-LI12</b>	257				
<b>2106-LL</b>	365				
<b>2106-BAA</b>	365				
<b>2106-BAC</b>	320				
<b>2106-BAC12</b>	320				
<b>2106-BAG</b>	320				
<b>2106-BAH</b>	367				
<b>2106-BAI</b>	367				
<b>2106-BBA</b>	319				
<b>2106-BBC</b>	319				
<b>2106-BBD</b>	319				
<b>2106-BBE</b>	319				
<b>2106-BBF</b>	367				
<b>2106-BBG</b>	320				
<b>2106-BBH</b>	319				
<b>2106-BBI</b>	367				
<b>2106-BBL</b>	367				
<b>2106-BCA</b>	346				
<b>2106-BCB</b>	346				
<b>2106-BCB18</b>	346				
<b>2106-BCC</b>	346				
<b>2106-BCD</b>	319				
<b>2106-BCE</b>	320				
<b>2106-BCG</b>	347				
<b>2106-BCH</b>	347				
<b>2106-BDA</b>	320				
<b>2106-BDB</b>	320				
<b>2106-BDC</b>	319				
<b>2106-BDD</b>	319				
<b>2106-BEA</b>	366				
<b>2106-BEB</b>	366				
<b>2106-BFA</b>	367				
<b>2106-BFB</b>	367				
<b>2106-BGI</b>	359				
<b>2106-BGL</b>	359				
<b>2106-BIA</b>	374				
<b>2106-BIB</b>	374				
<b>2106-CAB</b>	364				
<b>2106-CAC</b>	364				
<b>2106-CAD</b>	364				
<b>2106-CAE</b>	364				
<b>2106-CAH</b>	364				
<b>2106-CAI</b>	364				
<b>2106-CAL</b>	364				
<b>2106-DAA</b>	361				
<b>2106-DAB</b>	361				
<b>2106-DAC</b>	361				
<b>2108-BA</b>	320, 355				
<b>2108-BB</b>	355				
<b>2108-BC</b>	355				
<b>2108-BD</b>	355				
<b>2108-BE</b>	355				
<b>2108-BF</b>	355				
<b>2108-BG</b>	346				
<b>2108-BI</b>	355				
<b>2108-BL</b>	355				
<b>2108-CA</b>	253				
<b>2108-CB</b>	253				
<b>2108-CD</b>	253				
<b>2108-CE</b>	355				
<b>2108-CF</b>	258				
<b>2108-CG</b>	355				
<b>2108-CI</b>	355				
<b>2108-DA</b>	370				
<b>2108-DB</b>	370				
<b>2108-DC</b>	370				
<b>2108-EA</b>	253				
<b>2108-EG</b>	346				
<b>2108-EI</b>	346				
<b>2108-EL</b>	346				
<b>2108-FA</b>	346				
<b>2108-FB</b>	346				
<b>2108-FC</b>	346				
<b>2108-FD</b>	346				
<b>2108-FE</b>	346				
<b>2108-FF</b>	346				
<b>2108-FG</b>	358				
<b>2108-FI</b>	358				
<b>2108-FL</b>	358				
<b>2108-GA</b>	358				
<b>2108-HE</b>	358				
<b>2108-BAA</b>	368				
<b>2118-CA</b>	329				
<b>2118-CG</b>	329				
<b>2118-DA</b>	329				
<b>2207-BA</b>	165				
<b>2207-BC</b>	165				
<b>2207-BE</b>	165				





ideal-tek  
manufacturer & supplier of precision instruments 

**Ideal-tek SA**  
via Motta 4  
6828 Balerna  
Switzerland

Phone: +41 91 683 32 29  
Fax: +41 91 683 03 71  
E-mail: [info@ideal-tek.com](mailto:info@ideal-tek.com)